

MELSOFT

Engineering Software

# GX Works3 Operating Manual

---

-SW1DND-GXW3-E

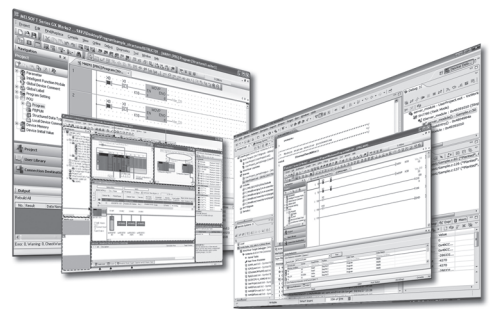



# SAFETY PRECAUTIONS

---

(Read these precautions before using this product.)

Before using this product, please read this manual carefully and pay full attention to safety to handle the product correctly. If products are used in a different way from that specified by manufacturers, the protection function of the products may not work properly.

The precautions given in this manual are concerned with this product only. For the safety precautions for the programmable controller system, refer to the user's manual for the module used and MELSEC iQ-R Module Configuration Manual.

In this manual, the safety precautions are classified into two levels: "⚠️ WARNING" and "⚠️ CAUTION".



## WARNING

Indicates that incorrect handling may cause hazardous conditions, resulting in death or severe injury.

---



## CAUTION

Indicates that incorrect handling may cause hazardous conditions, resulting in minor or moderate injury or property damage.

---

Under some circumstances, failure to observe the precautions given under "⚠️ CAUTION" may lead to serious consequences.

Observe the precautions of both levels because they are important for personal and system safety.

Make sure that the end users read this manual and then keep the manual in a safe place for future reference.

## [Design Precautions]

---



## WARNING

- When data change, program change, or status control are performed from a personal computer to a running CPU module, create an interlock circuit outside the programmable controller to ensure that the whole system always operates safely.

Furthermore, for the online operations performed from a personal computer to a programmable controller CPU, the corrective actions against a communication error due to such as a cable connection fault should be predetermined as a system.

- For the considerations specific to an safety CPU, refer to the following:

📖 MELSEC iQ-R CPU Module User's Manual (Startup)

📖 MELSEC iQ-R CPU Module User's Manual (Application)

---

## [Security Precautions]

---



## WARNING

- To maintain the security (confidentiality, integrity, and availability) of the programmable controller and the system against unauthorized access, denial-of-service (DoS) attacks, computer viruses, and other cyberattacks from external devices via the network, take appropriate measures such as firewalls, virtual private networks (VPNs), and antivirus solutions.
-

## [Startup and Maintenance Precautions]



---

### **CAUTION**

---

- The online operations performed from a personal computer to a running CPU module (program change while a CPU module is in RUN, operating status changes such as RUN-STOP switching, and remote control operation) must be executed after the manual has been carefully read and the safety has been ensured.
- When changing a program while a CPU module is in RUN (online program change), it may cause a program corruption in some operating conditions. Fully understand the precautions before use.
- The positioning test functions such as OPR, JOG, inching, or testing positioning data for positioning module must be executed with the CPU module set to STOP after the manual has been carefully read and the safety has been ensured.

Specially when executing the function on the network system, ensure the safety thoroughly since the machinery whose operation cannot be checked by an operator may be activated. The operation failure may cause the injury or machine damage.

- For the considerations specific to an safety CPU, refer to the following:
    -  MELSEC iQ-R CPU Module User's Manual (Startup)
    -  MELSEC iQ-R CPU Module User's Manual (Application)
-

# CONDITIONS OF USE FOR THE PRODUCT

---

- (1) MELSEC programmable controller ("the PRODUCT") shall be used in conditions;
- i) where any problem, fault or failure occurring in the PRODUCT, if any, shall not lead to any major or serious accident; and
  - ii) where the backup and fail-safe function are systematically or automatically provided outside of the PRODUCT for the case of any problem, fault or failure occurring in the PRODUCT.
- (2) The PRODUCT has been designed and manufactured for the purpose of being used in general industries. MITSUBISHI ELECTRIC SHALL HAVE NO RESPONSIBILITY OR LIABILITY (INCLUDING, BUT NOT LIMITED TO ANY AND ALL RESPONSIBILITY OR LIABILITY BASED ON CONTRACT, WARRANTY, TORT, PRODUCT LIABILITY) FOR ANY INJURY OR DEATH TO PERSONS OR LOSS OR DAMAGE TO PROPERTY CAUSED BY the PRODUCT THAT ARE OPERATED OR USED IN APPLICATION NOT INTENDED OR EXCLUDED BY INSTRUCTIONS, PRECAUTIONS, OR WARNING CONTAINED IN MITSUBISHI ELECTRIC USER'S, INSTRUCTION AND/OR SAFETY MANUALS, TECHNICAL BULLETINS AND GUIDELINES FOR the PRODUCT.
- ("Prohibited Application")
- Prohibited Applications include, but not limited to, the use of the PRODUCT in;
- Nuclear Power Plants and any other power plants operated by Power companies, and/or any other cases in which the public could be affected if any problem or fault occurs in the PRODUCT.
  - Railway companies or Public service purposes, and/or any other cases in which establishment of a special quality assurance system is required by the Purchaser or End User.
  - Aircraft or Aerospace, Medical applications, Train equipment, transport equipment such as Elevator and Escalator, Incineration and Fuel devices, Vehicles, Manned transportation, Equipment for Recreation and Amusement, and Safety devices, handling of Nuclear or Hazardous Materials or Chemicals, Mining and Drilling, and/or other applications where there is a significant risk of injury to the public or property.
- Notwithstanding the above restrictions, Mitsubishi Electric may in its sole discretion, authorize use of the PRODUCT in one or more of the Prohibited Applications, provided that the usage of the PRODUCT is limited only for the specific applications agreed to by Mitsubishi Electric and provided further that no special quality assurance or fail-safe, redundant or other safety features which exceed the general specifications of the PRODUCTS are required. For details, please contact the Mitsubishi Electric representative in your region.
- (3) Mitsubishi Electric shall have no responsibility or liability for any problems involving programmable controller trouble and system trouble caused by DoS attacks, unauthorized access, computer viruses, and other cyberattacks.

# INTRODUCTION

---

Thank you for purchasing the engineering software, MELSOFT series.

This manual describes the programming and functions required when using GX Works3.

Before using this product, please read this manual carefully, and develop familiarity with the functions and performance of GX Works3 to handle the product correctly.

Note that the menu names and operating procedures may differ depending on an operating system in use and its version.

When reading this manual, replace the names and procedures with the applicable ones as necessary.

# CONTENTS

SAFETY PRECAUTIONS	1
CONDITIONS OF USE FOR THE PRODUCT	3
INTRODUCTION	4
RELEVANT MANUALS	15
TERMS	15
GENERIC TERMS AND ABBREVIATIONS	17

## PART 1 FUNDAMENTALS OF GX Works3

### CHAPTER 1 BEFORE USING THIS PRODUCT 20

1.1 Main Functions of GX Works3	20
1.2 RnPCPU	23
Process Control System	23
Redundant system	29
1.3 RnSFCPU	30
Safety system	30
1.4 RnPSFCPU	32
Process control system	32
Safety system	32
Redundant system	32
1.5 Remote Head Module	33
1.6 NCCPU	33
1.7 Procedure from Project Creation to CPU Module Operation	34
1.8 Learning Operation Methods of GX Works3	42
Displaying Help	42
Connecting to MITSUBISHI ELECTRIC FA Global Website	43
Checking the version of GX Works3	43
1.9 Connection Configurations between a Personal Computer and a CPU Module	44

### CHAPTER 2 SCREEN CONFIGURATION AND BASIC OPERATIONS 47

2.1 Start and End	47
2.2 Display Language Switching	50
2.3 Screen Configuration	51
Main frame	51
Navigation window	54
Connection destination window	57
Element selection window	57
2.4 Menu List	61
2.5 Quick Search	78
2.6 Checking and Changing Shortcut Keys	80
2.7 Checking and Changing Colors and Fonts	81
2.8 Displaying and Reading Comments	82
2.9 Option Settings for Each Function	84
2.10 Printing Data	92

## PART 2 SYSTEM DESIGN AND SETTINGS

## CHAPTER 3 PROJECT MANAGEMENT

98

<b>3.1</b>	<b>Project File and Data Configuration</b> .....	<b>98</b>
	File format .....	98
	Safety project backup .....	99
	Data configuration .....	100
<b>3.2</b>	<b>Creating a Project File</b> .....	<b>103</b>
	Creating a project .....	103
	Opening a project .....	105
	Opening another format project .....	106
	Opening a GX Works2 format project .....	107
	Opening a PX Developer format project .....	110
	Opening a GX IEC Developer format project .....	115
	Opening a GX Developer format project .....	124
	Saving a project .....	126
	Deleting a project .....	127
<b>3.3</b>	<b>Creating Data</b> .....	<b>128</b>
	Creating data .....	129
	Editing data .....	130
	Importing data .....	132
	Associating data with a help file .....	133
	Properties .....	135
<b>3.4</b>	<b>Searching the Navigation Window</b> .....	<b>138</b>
<b>3.5</b>	<b>Changing the Module Type and Operation Mode of Projects</b> .....	<b>139</b>
<b>3.6</b>	<b>Verifying Projects</b> .....	<b>143</b>
	Verification .....	143
	Checking a verification result .....	145
<b>3.7</b>	<b>Project Revision History</b> .....	<b>160</b>
	Registering a revision .....	160
	Revision list screen .....	162
<b>3.8</b>	<b>Project Version Management</b> .....	<b>164</b>
	Registering/acquiring/editing/deleting a project .....	168
	Update Revision screen .....	170
	Troubleshooting .....	183
<b>3.9</b>	<b>Managing Profiles</b> .....	<b>186</b>

## CHAPTER 4 CREATING MODULE CONFIGURATION DIAGRAM AND SETTING PARAMETERS

187

<b>4.1</b>	<b>Creating a Module Configuration Diagram</b> .....	<b>188</b>
	Editor configuration when creating a module configuration diagram .....	188
	Placing objects .....	190
	Checking the module information .....	192
	Setting parameters on the module configuration diagram .....	193
	Multiple CPU configuration .....	195
	Redundant system configurations .....	197
	Inputting the start XY in a batch .....	198
	Inputting default points in a batch .....	198
	XY assignment display .....	198
	Checking the power supply capacity and I/O points .....	198
	Checking a system configuration .....	198
	Operation for Write to PLC/Read from PLC .....	198



<b>4.2</b>	<b>Setting Parameters</b> .....	<b>199</b>
	Common operations for parameter settings .....	201
	Setting system parameters .....	202
	Setting parameters of control CPU .....	204
	Setting parameters of modules .....	205
	Parameter interaction with MELSOFT Navigator .....	217
<b>4.3</b>	<b>Other Settings of Intelligent Function Modules</b> .....	<b>218</b>
	Setting with a module tool/drive tool .....	218
	Simple motion module setting function .....	219
	Motion control setting function .....	219
<b>4.4</b>	<b>Predefined Protocol Support Function</b> .....	<b>220</b>
	Start and End .....	220
<b>4.5</b>	<b>Circuit Trace Function</b> .....	<b>221</b>
<b>4.6</b>	<b>Change Module</b> .....	<b>222</b>

## **CHAPTER 5 REGISTERING LABELS** **225**

---

<b>5.1</b>	<b>About Labels</b> .....	<b>225</b>
<b>5.2</b>	<b>Registering Labels</b> .....	<b>227</b>
	Configuration of a label editor .....	227
	Entering information .....	230
	Checking assigned devices .....	241
	Creating a defined structure .....	242
	Setting a label comment .....	243
	Exporting/importing a label .....	245
	Registering an undefined label .....	247
<b>5.3</b>	<b>Registering Module Labels</b> .....	<b>248</b>
<b>5.4</b>	<b>Registering Tag FBs</b> .....	<b>249</b>
	Configuration of the tag FB setting editor .....	249
	Entering information .....	251
	Data to be added with tag FB registration .....	252
<b>5.5</b>	<b>Registering System Labels</b> .....	<b>254</b>
	About system labels .....	254
	Registering labels in system label database .....	255
	Importing system labels in system label database to GX Works3 .....	255
	Releasing system labels .....	255
	Verifying system label information .....	256
	Importing the changes of system label database .....	256

## **PART 3 PROGRAMMING**

---

### **CHAPTER 6 CREATING PROGRAMS** **258**

---

<b>6.1</b>	<b>Programming Function</b> .....	<b>258</b>
	Creation procedure .....	259
<b>6.2</b>	<b>Program Execution Order and Execution Type Settings</b> .....	<b>260</b>
	Program execution order setting .....	260
	Program execution type change .....	261
	Execution control of an FBD/LD program for process control .....	262
<b>6.3</b>	<b>Creating a Ladder Program</b> .....	<b>264</b>
	Configuration of a ladder editor .....	264
	Entering ladders .....	269

	Entering comments/statements/notes . . . . .	284
	Inserting/deleting NOP instruction . . . . .	289
	Changing TC setting values . . . . .	289
	Copying and pasting a ladder . . . . .	290
	Returning ladder diagrams to the condition before editing . . . . .	292
	Changing ladder blocks temporarily . . . . .	293
	Searching for/replacing data in a program . . . . .	295
	Displaying instruction help . . . . .	296
	Copying an image to the clipboard . . . . .	296
	Importing/exporting ladder programs . . . . .	297
<b>6.4</b>	<b>Creating an ST Program . . . . .</b>	<b>309</b>
	Configuration of an ST editor . . . . .	309
	Entering programs . . . . .	312
	Searching for/replacing data in a program . . . . .	317
	Displaying instruction help . . . . .	318
<b>6.5</b>	<b>Creating an FBD/LD Program . . . . .</b>	<b>319</b>
	Configuration of an FBD/LD editor . . . . .	319
	Entering programs . . . . .	325
	Linking a comment . . . . .	338
	Displaying FBD network blocks in a list . . . . .	340
	Searching for/replacing data in a program . . . . .	341
	Displaying Help . . . . .	341
<b>6.6</b>	<b>Creating an SFC Program . . . . .</b>	<b>342</b>
	Configuration of an SFC diagram editor . . . . .	343
	Creating SFC diagrams . . . . .	350
	Creating/displaying Zooms (action/transition) . . . . .	369
	Displaying an SFC block list . . . . .	372
	Searching for/replacing data in a program . . . . .	374
	Displaying Help . . . . .	374
<b>6.7</b>	<b>Setting Initial Values of FB Properties . . . . .</b>	<b>375</b>
	Display/setting an FB property . . . . .	375
	Displaying the FB property page . . . . .	377
	Creating a setting file . . . . .	381
	FB property management (offline) . . . . .	397
<b>6.8</b>	<b>Registering Device Comments . . . . .</b>	<b>400</b>
	Device comments . . . . .	400
	Configuration of a device comment editor . . . . .	402
	Creating device comments . . . . .	404
	Deleting unused device comments . . . . .	406
	Clearing all device comments . . . . .	406
	Importing/exporting device comments . . . . .	407
	Searching for device comments . . . . .	408
	Reading sample comments . . . . .	409
<b>6.9</b>	<b>Checking/Editing the Relation between Programs . . . . .</b>	<b>410</b>
	Display mode . . . . .	411
	Edit mode . . . . .	414
<b>6.10</b>	<b>Checking a Program . . . . .</b>	<b>416</b>
	Syntax check . . . . .	416
	Program check . . . . .	417
<b>6.11</b>	<b>Converting Programs . . . . .</b>	<b>420</b>
	Converting any or all programs . . . . .	420

Performing the online program change simultaneously at conversion .....	430
Checking for errors and warnings .....	431
<b>6.12 Calculating Memory Size .....</b>	<b>432</b>
<b>CHAPTER 7 SETTING DEVICE MEMORY .....</b>	<b>434</b>
<b>7.1 Device Memory .....</b>	<b>434</b>
<b>7.2 Configuration of a Device Memory Editor .....</b>	<b>435</b>
Setting the display format .....	435
<b>7.3 Setting Device Memory .....</b>	<b>436</b>
Setting a value for each point .....	436
Setting values in batch .....	437
Setting character strings .....	438
Clearing whole memory of device memory .....	438
Linkage with initial device values .....	439
<b>7.4 Writing/Reading Data to/from CPU Module .....</b>	<b>439</b>
<b>7.5 Exporting Device Memory Data .....</b>	<b>440</b>
<b>CHAPTER 8 INITIAL DEVICE VALUE SETTING .....</b>	<b>441</b>
<b>8.1 Initial Device Values .....</b>	<b>441</b>
<b>8.2 Configuration of an Initial Device Value Editor .....</b>	<b>442</b>
<b>8.3 Initial Device Value Settings .....</b>	<b>443</b>
<b>CHAPTER 9 SEARCHING FOR DATA .....</b>	<b>445</b>
<b>9.1 Searching for/Replacing Devices and Labels .....</b>	<b>448</b>
<b>9.2 Searching for/Replacing Instructions .....</b>	<b>450</b>
<b>9.3 Searching for/Replacing Character Strings .....</b>	<b>451</b>
<b>9.4 Changing Contacts between Open Contact and Close Contact .....</b>	<b>453</b>
<b>9.5 Batch Replacing of Devices and Labels .....</b>	<b>454</b>
<b>9.6 Displaying Device and Label Reference Information .....</b>	<b>456</b>
Displaying cross reference information .....	457
Displaying a list of unused labels .....	463
<b>9.7 Displaying Device Usage .....</b>	<b>465</b>
<b>9.8 Displaying a Range Affected by/Affecting a Device/Label .....</b>	<b>467</b>
Target range of data flow analysis .....	467
Displaying a data flow diagram .....	467
Monitoring devices/labels .....	475
<b>9.9 Registering a Bookmark .....</b>	<b>479</b>
<b>CHAPTER 10 SEGMENTING PROGRAMS .....</b>	<b>482</b>
<b>10.1 Creating a Function Block .....</b>	<b>484</b>
Function block .....	484
Creating a new function block .....	485
Creating a function block from an existing ladder block .....	489
Creating a user-defined tag FB .....	497
Using a module FB .....	500
<b>10.2 Creating a Function .....</b>	<b>504</b>
Functions .....	504
Creating a function .....	504
<b>10.3 Enhancing Use of User Library .....</b>	<b>506</b>
User library .....	506

Creating a library . . . . .	507
Enhanced use of libraries . . . . .	510
<b>10.4 Enhanced Use of Application Library/MELSOFT Library . . . . .</b>	<b>515</b>

## **PART 4 DEBUGGING AND OPERATION**

---

### **CHAPTER 11 PROGRAM SIMULATION 518**

---

<b>11.1 Simulation Function . . . . .</b>	<b>518</b>
Safety and handling consideration . . . . .	521
<b>11.2 Simulation . . . . .</b>	<b>522</b>
Simulation of a CPU module . . . . .	522
<b>11.3 System Simulation . . . . .</b>	<b>524</b>
Multiple CPU system . . . . .	529
Programmable controller CPU and motion CPU . . . . .	532
Simple motion module/motion module . . . . .	536
Network modules . . . . .	538
SD memory card . . . . .	542
Saving a simulation environment file . . . . .	545
Opening a simulation environment file . . . . .	546
Ending a system simulation . . . . .	546
<b>11.4 Simulation of External Device Operations . . . . .</b>	<b>547</b>
I/O System Setting function . . . . .	547
Execution procedure of I/O System Setting function . . . . .	547
Executing I/O System Setting function . . . . .	548
Available devices/labels . . . . .	555

### **CHAPTER 12 SETTING ROUTE TO CPU MODULE 557**

---

<b>12.1 Specification of Connection Destination . . . . .</b>	<b>557</b>
<b>12.2 Direct Connection . . . . .</b>	<b>559</b>
USB connection . . . . .	559
Ethernet connection . . . . .	559
Serial connection . . . . .	563
<b>12.3 Accessing via Network (Single Network) . . . . .</b>	<b>564</b>
<b>12.4 Accessing via Network (Co-existence Network) . . . . .</b>	<b>566</b>
<b>12.5 Accessing via Serial Communication Module . . . . .</b>	<b>567</b>
Connection on a 1:1 basis . . . . .	567
Connection on a 1:n basis . . . . .	568
<b>12.6 Accessing via GOT (GOT Transparent Function) . . . . .</b>	<b>569</b>
Access via a GOT . . . . .	569
Accessing via a GOT and a module . . . . .	569
<b>12.7 Accessing via QCPU (Q mode) . . . . .</b>	<b>570</b>
<b>12.8 Accessing via QJ71E71-100 . . . . .</b>	<b>571</b>
<b>12.9 Connection to the Multiple CPU System . . . . .</b>	<b>572</b>
<b>12.10 Connection to the Redundant System . . . . .</b>	<b>574</b>
<b>12.11 Considerations of Communication with a CPU module . . . . .</b>	<b>576</b>

### **CHAPTER 13 WRITING/READING DATA TO CPU MODULE 577**

---

<b>13.1 Writing/Reading Programmable Controller Data . . . . .</b>	<b>577</b>
Configuration of the online data operation screen . . . . .	577
Writing data to a programmable controller . . . . .	580

Reading data from a programmable controller . . . . .	589
Deleting data in a CPU module . . . . .	593
Considerations for Online data operation . . . . .	593
<b>13.2 Verifying Programmable Controller Data . . . . .</b>	<b>595</b>
<b>13.3 Writing Programs While a CPU Module is in the RUN State . . . . .</b>	<b>597</b>
Considerations . . . . .	598
Writing data after changing programs partially while a CPU module is running (Online program change) . . . . .	600
Writing data for each file while a CPU module is running (file batch online change) . . . . .	605
<b>13.4 Reading/Writing/Deleting User Data . . . . .</b>	<b>607</b>
<b>13.5 Deleting All Files (Initialization) . . . . .</b>	<b>608</b>
<b>13.6 Reading/Writing the Label Memory . . . . .</b>	<b>608</b>
<b>13.7 Writing/Reading Data to/from Memory Card . . . . .</b>	<b>609</b>
Configuration of the memory card operation screen . . . . .	609
Writing to/Reading from a memory card . . . . .	610

## **CHAPTER 14 CHECKING OPERATION OF PROGRAMS . . . . . 611**

<b>14.1 Monitor Status . . . . .</b>	<b>613</b>
<b>14.2 Checking Execution Programs on a Program Editor . . . . .</b>	<b>616</b>
Ladder . . . . .	620
ST . . . . .	622
FBD/LD . . . . .	623
SFC . . . . .	626
<b>14.3 Checking Device/Buffer Memory in a Batch . . . . .</b>	<b>633</b>
<b>14.4 Checking Current Values by Registering Devices/Labels . . . . .</b>	<b>637</b>
<b>14.5 Turning Input/Output Devices ON/OFF Forcibly . . . . .</b>	<b>644</b>
<b>14.6 Changing Device/Label Value by Setting Conditions . . . . .</b>	<b>646</b>
Registration of a device test with execution conditions . . . . .	646
Displaying a registered device test with execution conditions . . . . .	648
<b>14.7 Pausing/Restarting the Operation of Function Blocks . . . . .</b>	<b>650</b>
Pause . . . . .	651
Restart . . . . .	652
List display . . . . .	652
<b>14.8 Measuring the Scan Time of a Program . . . . .</b>	<b>653</b>
<b>14.9 Checking the Processing Time of a Program . . . . .</b>	<b>655</b>
<b>14.10 Checking Execution Counts of Interrupt Programs . . . . .</b>	<b>657</b>
<b>14.11 Checking Current Values in an Intelligent Function Module . . . . .</b>	<b>658</b>
<b>14.12 Checking Current Logging Data . . . . .</b>	<b>661</b>
Procedure for using the realtime monitor . . . . .	661
<b>14.13 Checking Tag Data . . . . .</b>	<b>662</b>
Checking tag data on the gauge window (faceplate) . . . . .	662
PX Developer Monitor Tool interaction . . . . .	665
<b>14.14 Setting Current Values of FB Properties as their Initial Values . . . . .</b>	<b>666</b>
FB Property Management (Online) screen . . . . .	666

## **PART 5 MAINTENANCE AND INSPECTION**

### **CHAPTER 15 PROTECTING DATA . . . . . 670**

<b>15.1 Preventing Illegal Access to Programs (Block Password) . . . . .</b>	<b>671</b>
Block password function . . . . .	671
Procedure for using the block password function . . . . .	671

Setting block password . . . . .	671
<b>15.2 Preventing Illegal Access to Programs (Security Key) . . . . .</b>	<b>673</b>
Security key authentication function for a project . . . . .	673
Procedure for using the security key authentication function for a project . . . . .	674
Creating/deleting a security key . . . . .	675
Copying a security key . . . . .	677
Registering a security key in a program file. . . . .	678
<b>15.3 Preventing Illegal Program Execution (Security Key) . . . . .</b>	<b>680</b>
Security key authentication function for a CPU module . . . . .	680
Procedure for using the security key authentication function for a CPU module. . . . .	680
Writing/deleting security key to/from CPU module . . . . .	681
<b>15.4 Preventing Illegal Access to Project (User Authentication) . . . . .</b>	<b>683</b>
User authentication function for a project . . . . .	683
Procedure for using the user authentication function for a project . . . . .	684
Logging on to a project . . . . .	684
Changing a password of the logon user . . . . .	684
User management. . . . .	685
<b>15.5 Preventing Illegal Access to CPU Module (User Authentication) . . . . .</b>	<b>686</b>
User authentication function for a CPU module . . . . .	686
Procedure for using the user authentication function for a CPU module. . . . .	689
Writing user information to a CPU module . . . . .	689
Reading user information from a CPU module . . . . .	689
Logging on to CPU module . . . . .	690
Changing a password . . . . .	691
Authentication destination setting in the online function . . . . .	691
Logging off from a CPU module . . . . .	691
Copying user information to the other system. . . . .	691
<b>15.6 Preventing Illegal Data Reading/Writing (File Password) . . . . .</b>	<b>692</b>
File password function. . . . .	692
Procedure for using the file password function . . . . .	694
Setting a file password . . . . .	695
<b>15.7 Preventing Illegal Access to/Falsification of Data (Security Version) . . . . .</b>	<b>697</b>
Security version. . . . .	697
Procedure for using a security version . . . . .	698
<b>15.8 Restricting Access from Other Than Specific Communication Route (Remote Password) . . . . .</b>	<b>699</b>
Remote password function . . . . .	699
Procedure for using the remote password function. . . . .	699
Setting remote password. . . . .	700
<b>CHAPTER 16 MODULE DIAGNOSTICS . . . . .</b>	<b>701</b>
<hr/>	
<b>16.1 Module Status Check of a System . . . . .</b>	<b>702</b>
<b>16.2 Sensor/Device Status Check . . . . .</b>	<b>705</b>
<b>16.3 Recording Status Check . . . . .</b>	<b>707</b>
<b>16.4 Module Diagnostics . . . . .</b>	<b>708</b>
Error information . . . . .	709
Module information list. . . . .	713
<b>16.5 Network Diagnostics . . . . .</b>	<b>714</b>
Ethernet diagnostics . . . . .	714
CC-Link IE Controller Network diagnostics . . . . .	715
CC-Link IE TSN/CC-Link IE Field Network diagnostics. . . . .	717

CC-Link IE Field Network Basic diagnostics . . . . .	719
MELSECNET diagnostics . . . . .	720
CC-Link diagnostics . . . . .	721
Simple CPU communication diagnostics . . . . .	722
<b>16.6 Error History/Operation History Check . . . . .</b>	<b>723</b>

**CHAPTER 17 COLLECTING/REPRODUCING DATA 725**

<b>17.1 Memory Dump Function . . . . .</b>	<b>726</b>
Procedure for using the memory dump function . . . . .	726
Setting the internal buffer capacity for the memory dump function . . . . .	726
Writing memory dump settings . . . . .	727
Reading memory dump results . . . . .	728
Displaying memory dump results . . . . .	729
Deleting memory dump results . . . . .	729
<b>17.2 Data Logging Function . . . . .</b>	<b>730</b>
Procedure for using the data logging function . . . . .	730
Setting internal buffer capacity for the data logging function . . . . .	731
<b>17.3 Recording Function . . . . .</b>	<b>732</b>
Procedure for using the recording function . . . . .	732
Settings of the recording function . . . . .	732
Reading/deleting a recording file . . . . .	734
<b>17.4 Checking Collected Data on Program Editor . . . . .</b>	<b>736</b>
Checking memory dump results . . . . .	736
Checking logging data . . . . .	738
Checking a recording file . . . . .	740
Operating the seek bar . . . . .	743
Adding a log marker . . . . .	747
Checking an event history (offline monitor) . . . . .	749
Checking a device/label value . . . . .	751
Displaying waveform data . . . . .	754
Displaying the GOT offline monitor . . . . .	755
Playing a video . . . . .	756

**CHAPTER 18 CHECKING/CHANGING MODULE OPERATION 757**

<b>18.1 Clock Setting in a CPU Module . . . . .</b>	<b>758</b>
<b>18.2 Remote Operation . . . . .</b>	<b>759</b>
<b>18.3 Redundant Programmable Controller Operations . . . . .</b>	<b>761</b>
System switching . . . . .	761
Operation mode change . . . . .	761
Memory copy from the control system to the standby system . . . . .	762
Control system forced start while waiting for the other system started . . . . .	762
Redundant function module communication test . . . . .	762
System A/B setting . . . . .	763
<b>18.4 Safety Programmable Controller Operations . . . . .</b>	<b>764</b>
Safety operation mode switching . . . . .	764
Identification check for safety data . . . . .	767
Safety backup/restoration function . . . . .	767
Safety module operation . . . . .	768
<b>18.5 Checking Memory Usage . . . . .</b>	<b>769</b>
<b>18.6 Initializing/Clearing a Memory . . . . .</b>	<b>771</b>

18.7	Reading/Writing the Label Memory	773
18.8	Firmware Update	776

## **APPENDIX** **777**

---

<b>Appendix 1</b>	<b>Additions and Changes from Previous Version</b>	<b>777</b>
	Functions, operability, and performance	777
	Modules	864
<b>Appendix 2</b>	<b>Using a Project in a Different Version</b>	<b>868</b>
<b>Appendix 3</b>	<b>Using a Previous Version of Function</b>	<b>882</b>
	Checking logging data in version 1.063R or earlier	882
<b>Appendix 4</b>	<b>Unusable Character Strings (Reserved Words)</b>	<b>885</b>
<b>Appendix 5</b>	<b>Applicable Devices in GX Works3</b>	<b>889</b>
	RCPUs	889
	LHCPUs	892
	FX5CPUs	894
	Remote head modules	896
<b>Appendix 6</b>	<b>Label Memory Types</b>	<b>898</b>
<b>Appendix 7</b>	<b>Replacement of Another Format Project</b>	<b>900</b>
	Replacement of a GX Works2 format project	900
	Replacement of a PX Developer format project	918
	Replacement of a GX Developer format project	924
<b>Appendix 8</b>	<b>Considerations for Changing from FX5CPUs to RCPUs</b>	<b>929</b>
<b>Appendix 9</b>	<b>Using the Simulation Function</b>	<b>933</b>
	Supported modules	933
	Supported CPU module functions	942
	Supported devices	951
	Supported instructions	952
	Supported parameters	956
	Process response operation	963
	Module buffer memory	965
	Link devices of network module	967
	Network	968
	Considerations	974
<b>Appendix 10</b>	<b>Using Sample Programs</b>	<b>982</b>
<b>Appendix 11</b>	<b>USB Driver Installation Procedure</b>	<b>984</b>
<b>Appendix 12</b>	<b>Troubleshooting</b>	<b>986</b>
<b>Appendix 13</b>	<b>Differences from Existing MELSOFT Applications</b>	<b>988</b>
	Differences of functions	988
	Differences of option settings	1018

## **INDEX** **1034**

---

REVISIONS	1036
INFORMATION AND SERVICES	1040
TRADEMARKS	1040
COPYRIGHTS	1040



# RELEVANT MANUALS

Manual name [manual number]	Description	Available form
GX Works3 Operating Manual [SH-081215ENG] (this manual)	System configurations, parameter settings, and operation methods for the online function in GX Works3	e-Manual PDF

## Point

e-Manual refers to the Mitsubishi Electric FA electronic book manuals that can be browsed using a dedicated tool.

e-Manual has the following features:

- Required information can be cross-searched in multiple manuals.
- Other manuals can be accessed from the links in the manual.
- Hardware specifications of each part can be found from the product figures.
- Pages that users often browse can be bookmarked.
- Sample programs can be copied to an engineering tool.

# TERMS

Unless otherwise specified, this manual uses the following terms.

Term	Description
Buffer memory	Memory in an intelligent function module to store data such as setting values and monitor values. For CPU modules, it refers to memory to store data such as setting values and monitor values of the Ethernet function, or data used for data communication of the multiple CPU system function.
Control CPU	A CPU module that controls connected I/O modules and intelligent function modules. In a multiple CPU system, a control CPU can be set for each module.
Cyclic transmission	A function by which data are periodically exchanged among stations on the same network using link devices.
Ethernet port direct connection	A direct connection between a programmable controller and personal computer without using a hub.
Execution program	A converted program that can be executed in a CPU module.
FB instance	A label created based on the definition of a function block.
Intelligent function module	A module that has functions other than an input or output, such as an A/D converter module and D/A converter module.
iQSS	iQ Sensor Solution. Cooperation of sensors, programmable controllers, HMI (Human Machine Interface), and engineering tool to facilitate the start-up or maintenance of sensors.
MELSOFT Library	A generic term for components (FB library, sample programs, drawing data) which provide easy operation of programmable controller related modules, GOTs, and other devices that are connected to the modules and GOTs. To obtain components of MELSOFT Library, please contact your local Mitsubishi Electric sales office or representative.
Multiple CPU system	A system where two to four CPU modules separately control I/O modules and intelligent function modules.
Single CPU system	A system where a single CPU module controls I/O modules and intelligent function modules.
Transient transmission	A function of communication with another station, which is used when requested by a dedicated instruction or a programming tool.

For the terms of data, refer to the following:

 Page 100 Data configuration

## For a process control system

Term	Description
Assignment information data	Assignment information on the tag data assigned to a file register. Device information of a CPU module is stored.
Faceplate	Gauge window on which an indicator such as a controller is displayed in image format. Monitoring the tag data and changing the current value can be performed.
FB property	A label of 'VAR_PUBLIC' class or 'VAR_PUBLIC_RETAIN' class in a local label defined in an FB. For a tag FB, the member of tag data is included in the member of tag FB. Operation of a function block can be changed by setting the initial value of an FB property, or changing the current value of an FB property while running a program.
FBD/LD program for process control	An FBD/LD program with the extended function for the process control.
Process control extension	Extending the functions of GX Works3 for the instrumentation engineering.

Term	Description
Process control function block	In the engineering tool project of the Process CPU and the SIL2 Process CPU, the function block supplied by the manufacturer that can be used in the FBD/LD program with the process control extension enabled. The process control instruction corresponding to the Process CPU and the SIL2 Process CPU is executed in the function block.
Tag access FB	A usable process control function block in a user-defined tag FB. The processing is executed by accessing tag data of a user-defined tag FB.
Tag data	Data in which a process condition and process status in a tag FB are defined as a structure.
Tag FB	A function block to work as a device such as a controller and indicator for process control. The processing is executed by accessing tag data defined as a global label.
Tag type	Classification of process control functions such as a controller and indicator. The tag type defines the types of a data tag structure and faceplate.
User-defined tag FB	A function block to customize the process control processing of a manufacturer-defined tag FB. Tag data in a user-created FB program can be referred by combining a function, a function block, and a process control function block.

## For a redundant system

Term	Description
Connective system	Refers to the system of a CPU module specified in the "Specify Connection Destination" screen.
Other system	Refers to the system connected to the connective system with a tracking cable.

For definitions of other terms for a redundant system, refer to the following:

 MELSEC iQ-R CPU Module User's Manual (Application)

## For a system using an RnPSFCPU and a safety system

For definitions of terms for an RnPSFCPU and an RnSFCPU, refer to the following:

 MELSEC iQ-R CPU Module User's Manual (Application)

 MELSEC iQ-R Safety Application Guide

# GENERIC TERMS AND ABBREVIATIONS

Unless otherwise specified, this manual uses the following generic terms and abbreviations.

Generic term/abbreviation	Description
Built-in Ethernet CPU	A CPU module with an Ethernet port
FX5CPU	FX5SCPU, FX5UJCPU, FX5UCPU, FX5UCCPU
FX5SCPU	FX5S-30MR/ES, FX5S-30MT/ES, FX5S-30MT/ESS, FX5S-40MR/ES, FX5S-40MT/ES, FX5S-40MT/ESS, FX5S-60MR/ES, FX5S-60MT/ES, FX5S-60MT/ESS, FX5S-80MR/ES, FX5S-80MT/ES, FX5S-80MT/ESS
FX5UCCPU	FX5UC-32MR/DS-TS, FX5UC-32MT/D, FX5UC-32MT/DS-TS, FX5UC-32MT/DSS, FX5UC-32MT/DSS-TS, FX5UC-64MT/D, FX5UC-64MT/DSS, FX5UC-96MT/D, FX5UC-96MT/DSS
FX5UCPU	FX5U-32MR/DS, FX5U-32MR/ES, FX5U-32MT/DS, FX5U-32MT/DSS, FX5U-32MT/ES, FX5U-32MT/ESS, FX5U-64MR/DS, FX5U-64MR/ES, FX5U-64MT/DS, FX5U-64MT/DSS, FX5U-64MT/ES, FX5U-64MT/ESS, FX5U-80MR/DS, FX5U-80MR/ES, FX5U-80MT/DS, FX5U-80MT/DSS, FX5U-80MT/ES, FX5U-80MT/ESS
FX5UJCPU	FX5UJ-24MR/ES, FX5UJ-24MT/ES, FX5UJ-24MT/ESS, FX5UJ-40MR/ES, FX5UJ-40MT/ES, FX5UJ-40MT/ESS, FX5UJ-60MR/ES, FX5UJ-60MT/ES, FX5UJ-60MT/ESS, FX5UJ-24MR/DS, FX5UJ-24MT/DS, FX5UJ-24MT/DSS, FX5UJ-40MR/DS, FX5UJ-40MT/DS, FX5UJ-40MT/DSS, FX5UJ-60MR/DS, FX5UJ-60MT/DS, FX5UJ-60MT/DSS
FX5-SSC-G(S)	FX5-40SSC-G(S), FX5-80SSC-G(S) (S) refers to the simple motion mode.
LCPU	L02S, L02S-P, L02, L02-P, L06, L06-P, L26, L26-P, L26-BT, L26-PBT
LHCPU	L04HCPU, L08HCPU, L16HCPU, L32HCPU
LD78G(S)	LD78G4(S), LD78G16(S) (S) refers to the simple motion mode.
QSCPU	QS001CPU
RCPU	RnCPU, RnENCPU, RnPCPU, RnPSFCPU, RnSF CPU
RD78G(S)	RD78G4(S), RD78G8(S), RD78G16(S) (S) refers to the simple motion mode.
RnCPU	R00CPU, R01CPU, R02CPU, R04CPU, R08CPU, R16CPU, R32CPU, R120CPU
RnENCPU	R04ENCPU, R08ENCPU, R16ENCPU, R32ENCPU, R120ENCPU
RnPCPU	R08PCPU, R16PCPU, R32PCPU, R120PCPU
RnPSFCPU	R08PSFCPU, R16PSFCPU, R32PSFCPU, R120PSFCPU
RnSF CPU	R08SF CPU, R16SF CPU, R32SF CPU, R120SF CPU
Windows® 10 or later	Windows 10, Windows 11
Personal computer	A personal computers on which Windows operates
Process CPU	Q02PHCPU, Q06PHCPU, Q12PHCPU, Q25PHCPU
Universal model QCPU	Q00UJCPU, Q00UCPU, Q01UCPU, Q02UCPU, Q03UDCPU, Q03UDECPU, Q04UDHCPU, Q04UDEHCPU, Q06UDHCPU, Q06UDEHCPU, Q10UDHCPU, Q10UDEHCPU, Q13UDHCPU, Q13UDEHCPU, Q20UDHCPU, Q20UDEHCPU, Q26UDHCPU, Q26UDEHCPU, Q50UDEHCPU, Q100UDEHCPU
Universal model process CPU	Q04UDPVCPU, Q06UDPVCPU, Q13UDPVCPU, Q26UDPVCPU
High-speed universal model QCPU	Q03UDVCPU, Q04UDVCPU, Q06UDVCPU, Q13UDVCPU, Q26UDVCPU
Remote head module	An RJ72GF15-T2 CC-Link IE Field Network remote head module
Redundant CPU	Q12PRHCPU, Q25PRHCPU

# MEMO

---

# PART 1

# FUNDAMENTALS OF GX Works3

This part explains the screen configuration and basic operations of GX Works3.

1 BEFORE USING THIS PRODUCT

---

2 SCREEN CONFIGURATION AND BASIC OPERATIONS

---

# 1 BEFORE USING THIS PRODUCT

GX Works3 is an engineering tool for configuring settings, programming, debugging, and performing the maintenance for programmable controllers such as MELSEC iQ-R series/MELSEC iQ-L series/MELSEC iQ-F series.

By comparing with conventional GX Works2, the functions are enhanced and their operability have been improved.

## 1.1 Main Functions of GX Works3

GX Works3 manages programs and parameters in each project for each CPU module.

GX Works3 functions are shown below.

### Program creation function

Programs can be created in a programming language appropriate for the processing contents.

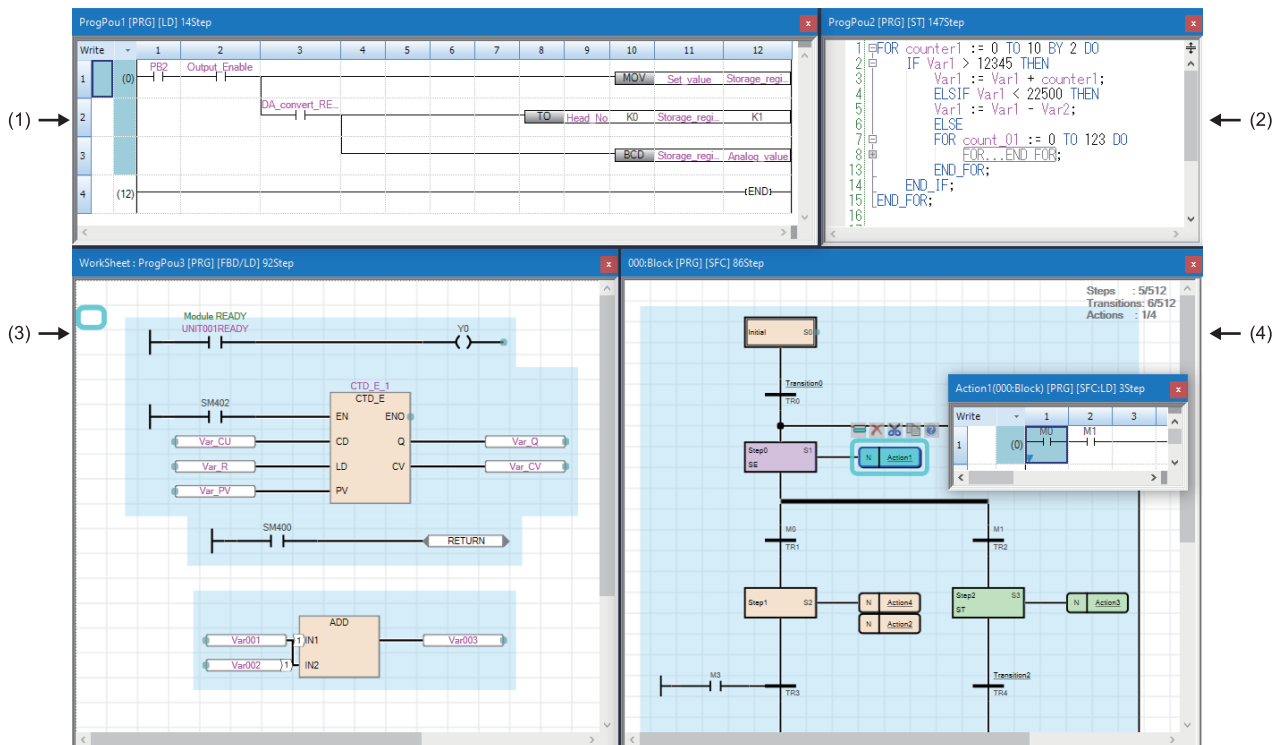

(1): Ladder program

(2): ST program

(3): FBD/LD program

(4): SFC program

## Parameter setting function

Parameters of CPU modules, I/O modules, and intelligent function modules can be set.

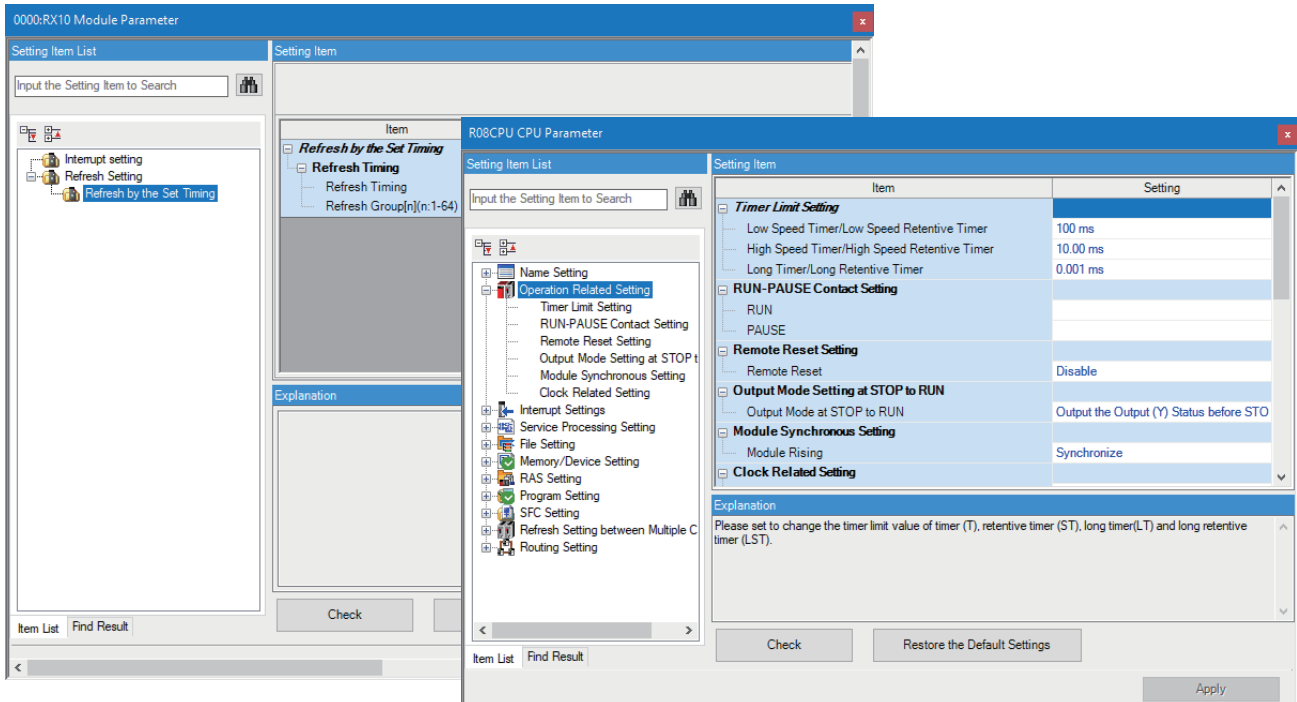

## Write to/Read from PLC function

Created sequence programs can be written to or read from a CPU module with the 'Write to PLC' function or the 'Read from PLC' function.

In addition, by using the online change function, sequence programs can be modified even when a CPU module is running.

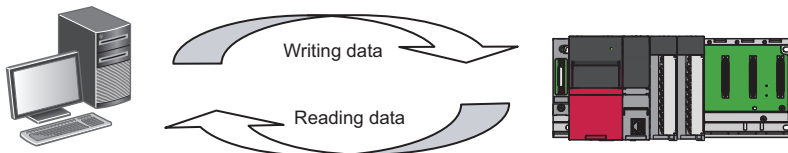

## Monitor/debug function

Data such as device values can be monitored while sequence programs that were written to a CPU module are executed.

Even when a CPU module is not connected, programs can be debugged by using a virtual programmable controller (simulation function).

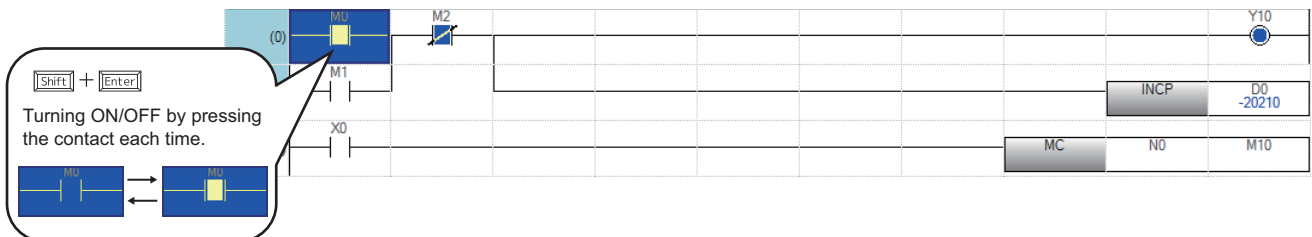

## Diagnostics function

The current error status and error history of a CPU module or network can be diagnosed. The recovery time will be shortened by this function.

Detailed information on a module, such as an intelligent function module, can be acquired by using the system monitor function. The recovery time will be much shortened by this function when an error occurs.

### ■CPU module diagnostics (module diagnostics screen)

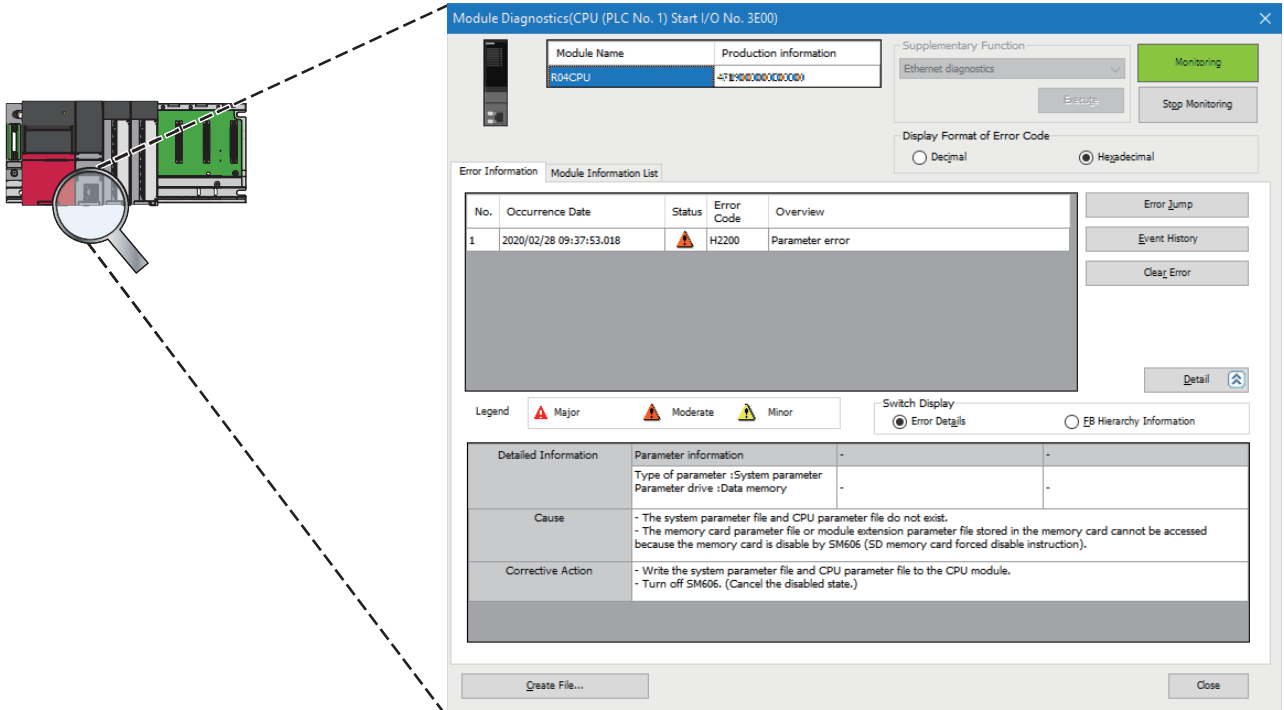

The screenshot shows the 'Module Diagnostics(CPU (PLC No. 1) Start I/O No. 3E00)' window. On the left, a physical CPU module is shown with a magnifying glass highlighting the diagnostic area. The software interface includes the following elements:

- Module Information:** Module Name: R04CPU, Production information: 4TE#000000CB000
- Supplementary Function:** Ethernet diagnostics (Monitoring button)
- Display Format of Error Code:** Hexadecimal (selected)
- Error Information Table:**

No.	Occurrence Date	Status	Error Code	Overview
1	2020/02/28 09:37:53.018	Major	H2200	Parameter error
- Legend:** Major (Red triangle), Moderate (Yellow triangle), Minor (Green triangle)
- Switch Display:** Error Details (selected), EB Hierarchy Information
- Detailed Information:**

Parameter information	Type of parameter :System parameter Parameter drive :Data memory	-	-
Cause	- The system parameter file and CPU parameter file do not exist. - The memory card parameter file or module extension parameter file stored in the memory card cannot be accessed because the memory card is disable by SM606 (SD memory card forced disable instruction).		
Corrective Action	- Write the system parameter file and CPU parameter file to the CPU module. - Turn off SM606. (Cancel the disabled state.)		
- Buttons:** Error\_Jump, Event\_History, Clear\_Error, Detail, Create File..., Close



# 1.2 RnPCPU

GX Works3 supports both MELSEC iQ-R series RnPCPUs constructing a process control system and a redundant system and process control programs.

In RnPCPUs, two operation modes are available: process mode and redundant mode. The type of project which can be created differs depending on the selected mode.

Mode	Description	Reference
Process	To create a project for process control programs.	This section
Redundant	To create a project for process control programs and the functions for a redundant system.	This section Page 29 Redundant system

## Process Control System

Refer to the following manual as well as the contents of this manual.

 MELSEC iQ-R Programming Manual (Process Control Function Blocks/Instructions)

### List of functions supporting a process control system

GX Works3 includes functions to create process control programs, adjust and maintain a process control system (process control functions). By programming a sequence control and a process control with a single engineering tool, those controls can seamlessly be combined into one.

Function	Description	Reference
Tag FB setting	To register tag FB instances and tag data used in an FBD/LD program for process control in a batch.	Page 249 Registering Tag FBs
User-defined tag FB	To create a function block to refer tag data. It can be created by combining a function, function block, and process control function block.	Page 497 Creating a user-defined tag FB
FB property	To display and change the initial values of labels of 'VAR_PUBLIC' class and 'VAR_PUBLIC_RETAIN' class in an FB and a tag FB.	Page 375 Setting Initial Values of FB Properties
FB property page	To check and change the initial values of FB properties in the dedicated screen. In addition, settings for a function generator can be checked with a graph.	Page 377 Displaying the FB property page
FB property management (offline)	To export the initial values of FB properties saved in a project to a CSV file. In addition, the initial values of FB properties can be imported from the CSV file into the project.	Page 397 FB property management (offline)
Pause FB/restart FB	To pause and restart the execution of a process control function block in a running program. The operation of a program can be checked by pausing the operation of the preceding process control function block and changing the current value of the output variable of the paused process control function block.	Page 650 Pausing/Restarting the Operation of Function Blocks
Faceplate	To display tag data contents in an image of a device such as a controller. The values of each tag data can be changed. To use this function, the latest PX Developer is required to be installed in a personal computer.	Page 662 Checking tag data on the gauge window (faceplate)
FB property management (online)	To save the current value of an FB property that was read from a programmable controller as the initial value of the property.	Page 666 FB Property Management (Online) screen
PX Developer Monitor Tool interaction	To manage, monitor, and control the operations of FBD/LD programs for process control, which were created in GX Works3, in PX Developer Monitor Tool. Moreover, a GOT screen project can be created using the GOT screen generator of PX Developer Monitor Tool.	Page 665 PX Developer Monitor Tool interaction

## Settings for using process control functions

The following are required to be set for using process control functions. For other settings, set them in the same manner as a normal project.

### ■Enabling of the process control extension

Set the following to enable the process control extension for a program file.

- Open the "Properties" screen of a program file for which the process control extension is to be enabled in the navigation window, then select "Yes" for "Use the process control extension."

(It can be set by dragging and dropping a process control function block and tag FB from the element selection window.)

The process control extension can be enabled only for program files of the scan execution type and the fixed cycle execution type.

For the scan execution type, only one program file with the process control extension enabled can be created.

To divide a program with the process control extension enabled into multiple programs, create multiple program blocks in the program file or multiple worksheets in the program block.

### ■Option setting of the process control extension (required)

Check and set the following options.

Option item	Setting content	Reason for the setting
[Tool] ⇒ [Options] ⇒ "Convert" ⇒ "Process Control Extension Setting"	Check and set each item to fit a project to be created. (☞ Page 90 Process control extension setting)	To use a process control function in a project to be used.
[Tool] ⇒ [Options] ⇒ "Convert" ⇒ "Basic Setting" ⇒ "Conversion Operation" ⇒ "Enable Rebuild All (Retain)"	Select "No."	By 'Rebuild All (Retain)' and 'Convert,' only labels added after data was written to a programmable controller cannot be initialized when rewriting the data next time.*1
[Tool] ⇒ [Options] ⇒ "Convert" ⇒ "Basic Setting" ⇒ "Conversion Operation" ⇒ "Enable Conversion"		
[Tool] ⇒ [Options] ⇒ "Convert" ⇒ "Basic Setting" ⇒ "Operational Setting" ⇒ "Reassign Labels in Executing Rebuild All"	Select "Yes."	

\*1 To initialize added/changed labels only, perform the online program change.

### ■CPU parameter setting

Set the following items of "CPU Parameter."

Parameter item	Setting content	Reason for the setting
"File Setting" ⇒ "File Register Setting" ⇒ "Use Or Not Setting"	Select "Use Common File Register in All Programs."	Tag FBs use file registers.
"Memory/Device Setting" ⇒ "Device/Label Memory Area Setting" ⇒ "Device/Label Memory Area Detailed Setting" ⇒ "Device Setting"	Set 'ZR(R)' in the [Latch (2)] tab in the "Latch Range Setting" screen.*1,*2	File registers used in tag FBs need to be latched.
"File Setting" ⇒ "Label Initial Value Reflection Setting" ⇒ "Label Initial Value Reflection Setting at STOP to RUN"	Select "Disable."	To apply initial label values only once to the current values at the timing when the status of a CPU module switches from STOP to RUN after writing the data.
"Memory/Device Setting" ⇒ "Index Register Setting" ⇒ "Points Setting" ⇒ "Total Points" ⇒ "Index Register (Z)"	Set seven points or higher.	'Z0' to 'Z6' are used for system data (system header and system footer) to extend a process control.
"Redundant System Settings" ⇒ "Tracking Setting" ⇒ "Tracking Device/Label Setting"*3	Select "Detailed setting."*4	To transfer (track) file registers used for tag FBs and system data (system header and system footer).
"Redundant System Settings" ⇒ "Tracking Setting" ⇒ "Tracking Device/Label Setting" ⇒ "Device/Label Detailed Setting"*3	For the "Global Device Setting" column except for tracking block No.64, specify devices or file registers that are not used in an FBD/LD program for process control.*5	If "Detailed setting" is specified for "Tracking Device/Label Setting," devices or labels to be transferred (tracked) need to be set manually.

- \*1 The "Latch Range Setting" screen appears by selecting in "Device Setting" ⇒ [...] button of "Detailed Setting" ⇒ [...] button on the "Latch (2)" column
- \*2 Can also be set by clicking the [Yes] button in the screen that appears when setting "Use Common File Register in All Programs" for the following parameter item:  
"File Setting" ⇒ "File Register Setting" ⇒ "Use Or Not Setting"
- \*3 Required only when a CPU module operation mode is "Redundant."
- \*4 "Detailed setting" is automatically set for this item if a program with the process control extension enabled is converted.
- \*5 Ranges of devices and devices set for the following parameter item can be applied to the global device settings in a batch by clicking the [Device Setting Reflection] button in the "Global Device Setting" screen.  
"Memory/Device Setting" ⇒ "Device/Label Memory Area Setting" ⇒ "Device/Label Memory Area Detailed Setting" ⇒ "Device Setting"

## ■ Execution interval setting

Set the execution interval for a program with the process control extension enabled to fit the processing.

Execution type	Setting content
Scan	Set the execution interval and phase in the "Program File Setting" screen or the "Properties" screen of a program block. (Page 263 Execution interval and phase)
Fixed scan	Set the fixed cycle interval in the program setting of CPU parameters.

## ■ Process control extension toolbar

The following toolbar appears in a project for which the process control functions are usable.



## ■ Multiple comment display setting

Descriptions of the labels in a tag FB and in the structure members of tag data are displayed by setting "English" for "Target" in the "Multiple Comments Display Setting" screen.\*1

\*1 Appears by selecting the following menu:

[View] ⇒ [Multiple Comments] ⇒ [Display Setting]

The following table shows the display examples.

Function	Display location	Display example
FBD/LD editor	Option in the edit box	
	Label comment	
	Tool hint	
FB property	Explanation column in the "FB Property" window	
FB property management	Explanation column in the "FB Property Management (Offline)" screen	
	Explanation column in the "FB Property Management (Online)" screen	

## Precautions

Note the following when the process control extension is enabled for a program file.

Target project/ program	Item	Consideration
Program with the process control extension enabled (including a function and a function block used in the program)	Timer device	Time cannot be counted properly if timers, retentive timers, or timer function blocks (TIMER_Q_M) are used. To measure time, use long timers, long retentive timers, pulse timers (TP(E)), on delay timers (TON(E)), and off delay timers (TOF(E)).
	Counter device and counter function block	The rises of the count input signals of counters, long counters, or counter function blocks cannot be detected when they are turned ON or OFF in intervals shorter than the execution intervals. Therefore, the values of those devices may be different from expected ones. Turn the count input signal ON or OFF at an interval longer than the execution interval.
	Special relay	The values of special relays may be different from expected ones. The values will be ones acquired in the target program.
Project including a program with the process control extension enabled	QDRSET(P) instruction	Do not use the QDRSET(P) instruction. If the file name of a file register is changed with the QDRSET(P) instruction, the program will not run properly.
	Label class	To hold the values of labels in process control programs when a programmable controller is turned OFF or reset, specify 'VAR_RETAIN,' 'VAR_OUTPUT_RETAIN,' or 'VAR_PUBLIC_RETAIN' as a class for each label.
	Writing of global label setting (file register) to a programmable controller	When writing global labels to a programmable controller, follow the procedure below. ① Write CPU parameters to a programmable controller. ② Reset or cycle the power of the programmable controller. ③ Write the global label setting (file register) <sup>*1</sup> .
	System resource (file register: ZR or R)	File registers in the range set in the option <sup>*2</sup> are used for the system area and a tag data assignment. Therefore, do not use the file registers in programs. However, they can be used for tag data items which are made public. Refer to 'Tag Data List' in the following manual to use file registers.  MELSEC iQ-R Programming Manual (Process Control Function Blocks/Instructions)
	System resource (index register: Z)	Index registers in the range displayed in the option <sup>*3</sup> , Z0 to Z6, are used for the internal processing. Therefore, do not use the index registers Z0 to Z6 in programs with the process control extension enabled and within its programs of the functions/functions.
	Periodic execution type program Interrupt program	Due to the following cause, a periodic execution type program <sup>*4</sup> and interrupt program <sup>*4</sup> may not be executed at the specified timing. <sup>*5</sup> • Cause: During the execution of a process control function block, executing a periodic execution type program and interrupt program is prohibited by the DI instruction. (It is released by the EI instrument after the execution of the process control function block is completed.) This may affect high-speed pulse measurement with a CPU module and the result may be inaccurate. In that case, use a counter function of a high-speed counter module or a pulse input module. When using these modules, refer to the manual of the module and create a program.
Program with the process control extension disabled	Function block	Do not use the following function blocks. The program will not run properly. • Process control function block • User-defined tag FB • Function block using a process control function block or user-defined tag FB

\*1 When writing the global label setting to a programmable controller, data of file registers in the range set in the following option is automatically written.

[Tool] ⇒ [Options] ⇒ "Convert" ⇒ "Process Control Extension Setting" ⇒ "System Resource" ⇒ "File Register: ZR"

\*2 [Tool] ⇒ [Options] ⇒ "Convert" ⇒ "Process Control Extension Setting" ⇒ "System Resource" ⇒ "File Register: ZR"

\*3 [Tool] ⇒ [Options] ⇒ "Convert" ⇒ "Process Control Extension Setting" ⇒ "System resource" ⇒ "Index Register: Z"

\*4 For details on a periodic execution type program and interrupt program, refer to the following:

 MELSEC iQ-R CPU Module User's Manual (Application)

\*5 The execution time and the number of execution times of a running program can be checked in the "Program List Monitor" screen.  
( Page 655 Checking the Processing Time of a Program)

## Differences in terms between GX Works3 and PX Developer

There are differences in terms related to the process control functions between PX Developer and GX Works3 that are engineering tools used to create process control programs. The following table shows the terms in PX Developer and GX Works3 to compare each other.

Terms for PX Developer	Terms for GX Works3
Reading the current value of an FB property	FB property management (online)
FB property management	FB property management (online)
Global variable	Global label
Cold-start compile	Rebuild all (reassignment)
Compile (online change)	Online program change
Tag FB variable	Tag FB instance and tag data
Device variable	Device
Program execution setting	Execution type of a program file
Project parameter	[Tool] ⇒ [Options] ⇒ "Convert" ⇒ "Process Control Extension Setting"
Process function, process FB	Process control function block
Hot-start compile	Rebuild all (retain), convert
User-defined FB	Function block
Module FB	Module label and module FB
Local variable	Local Label
General function, general FB	Standard function, standard function block
Public variable	VAR_PUBLIC, VAR_PUBLIC_RETAIN
Output variable	VAR_OUTPUT, VAR_OUTPUT_RETAIN
Constant	VAR_CONSTANT
Internal variable	VAR, VAR_RETAIN
I/O simulation setting	[Tool] ⇒ [I/O System Setting] or [Start I/O System Setting] in GX Simulator3 screen
Input variable	VAR_INPUT
Entry variable monitor	Watch

## Redundant system

A project used for a CPU module in a redundant system configuration can be created by selecting "Redundant" for the operation mode when creating a new project.

In addition, both the control system and the standby system are managed in one project used for CPU modules in a redundant system configuration.

### List of functions supporting a redundant system

GX Works3 includes functions to operate CPU modules in a redundant system configuration.

Function name	Description	Reference
Operation mode change	To change the operation modes (backup mode or separate mode).	Page 761 Operation mode change
System A/B setting	To set system A or system B.	Page 763 System A/B setting
System switching	To switch the control system to the standby system.	Page 761 System switching
Memory copy	To transfer the memory contents of the control system to the standby system.	Page 762 Memory copy from the control system to the standby system
Control system forced start while waiting for the other system started	To start a CPU module as the control system while waiting for another system to start.	Page 762 Control system forced start while waiting for the other system started
Redundant function module communication test	To test the communication of a redundant function module (R6RFM only).	Page 762 Redundant function module communication test

### Operation modes of RnPCPUs (redundant mode)

There are two operation modes in an RnPCPU (redundant mode): backup mode and separate mode.

The following table shows the operations of each mode in GX Works3.

Operation mode	Description
Backup mode	An online operation is performed in both systems. When writing data, same data is written to both systems.
Separate mode	An online operation is performed only in the connective system.

# 1.3 RnSF CPU

GX Works3 supports MELSEC iQ-R series RnSF CPUs constructing a safety system.

## Safety system

In this manual, projects for an RnPSF CPU and an RnSF CPU are defined as 'safety projects,' and other projects are defined as 'standard projects.'

There are two types of data in a safety project: safety data and standard data.

Both a safety program and a standard program can be created in a safety project.

Name		Description
Data	Safety data	Safety program, safety FB/FUN, safety global label, and parameter for RnPSF CPUs and RnSF CPUs
	Standard data	Standard program, standard FB/FUN, standard global label, standard/safety shared label, and parameter for CPU modules other than RnPSF CPUs and RnSF CPUs
Program, FB/FUN	Safety program, safety FB/FUN	Program for a safety control
	Standard program, standard FB/FUN	Program for a general control
Label	Safety global label	Global label that can be used only in safety programs
	Standard global label	Global label that can be used only in standard programs
	Standard/safety shared label	Global label that can be used in both safety programs and standard programs. When using a standard/safety shared label in a safety program, create the program so that a safety condition can be checked.

## Usable devices, labels, and FBs/FUNs

Usable devices, labels, and FBs/FUNs are different between a safety project and a standard project.

### ■ Usable devices/labels

Project	Safety device	Safety global label	Standard/safety shared label	Standard device	Standard global label
Safety program	○	○	○	×	×
Standard program	×	×	○	○	○

For details on the usable devices in each project, refer to the following:

 Page 889 Applicable Devices in GX Works3

### ■ Usable FBs/FUNs

Project	Safety FB	Safety FUN	Standard FB	Standard FUN
Safety program	○	○	×	×
Standard program	×	×	○	○

## List of functions supporting a safety system

GX Works3 includes functions to create a safety project.

Function name	Description	Reference
Safety operation mode switching	To switch the safety operation modes of CPU modules.	Page 764 Safety operation mode switching
User authentication	To perform a user authentication before opening a project in order to prevent illegal access from users with no authority.	Page 683 Preventing Illegal Access to Project (User Authentication)
	To perform a user authentication before accessing a CPU module or SD memory card inserted in a CPU module in order to prevent illegal access from users with no authority.	
Identification check for safety data	To check if data in a CPU module is the one written by the user.	Page 767 Identification check for safety data



## Safety operation modes

There are two safety operation modes: safety mode and test mode.

The following table shows the operations of each mode in GX Works3.

Operation mode	Description
Safety mode	A mode used when running a system. This mode prohibits operations which change the control of a CPU module such as data writing to a CPU module, current value change, CPU memory operation, and settings for a security key and a file password.
Test mode	A mode used when starting a system or performing maintenance. All functions can be used. (The available functions differ depending on the access level of user who is logging on to the personal computer.)

## Safety data identification display

In safety data, an icon and the background color are emphasized.

■Icon

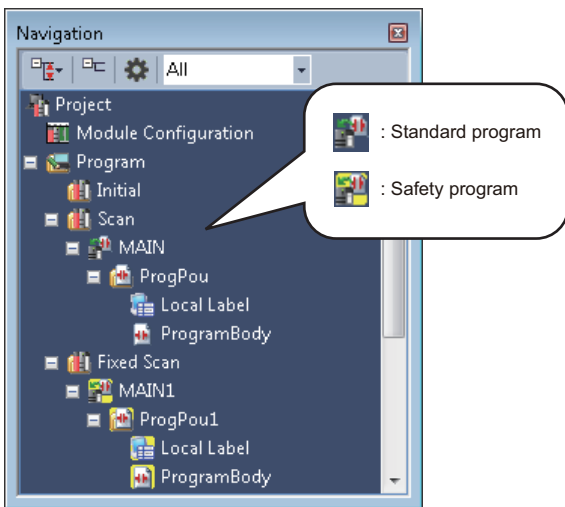

■Grid background color

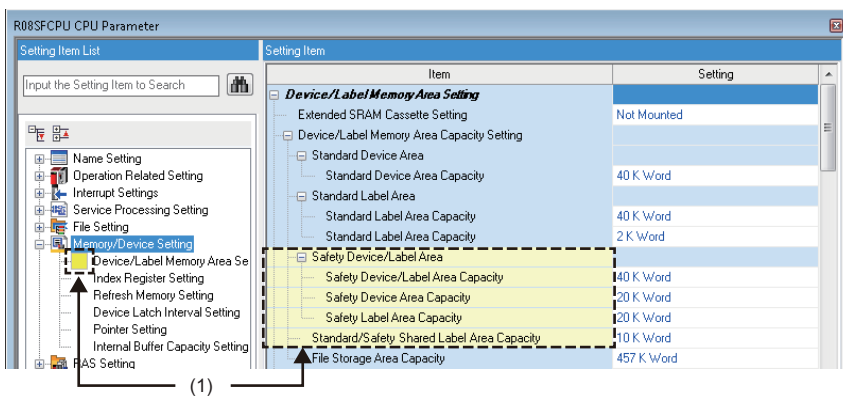

(1): Setting and items for safety

### Point

The data category (standard/safety) can be checked in the "Properties" screen of each data. (Page 135 Properties)

# 1.4 RnPSFCPU

GX Works3 supports MELSEC iQ-R series RnPSFCPUs constructing a process control system, a safety system, and a redundant system.

For details on an RnPSFCPU system, refer to the following:

📖 MELSEC iQ-R CPU Module User's Manual (Application)

## Process control system

Two types of programs, safety program and standard program, can be created in a project for an RnPSFCPU.

Process control programs can only be created in a standard program.

For a process control system, refer to the following:

📖 Page 23 Process Control System

## Safety system

For a safety system, refer to the following:

📖 Page 30 Safety system

### List of functions supporting a safety system using an RnPSFCPU

For the functions common to a safety system using an RnPSFCPU, refer to the following:

📖 Page 30 List of functions supporting a safety system

The following functions can be used only in a system using an RnPSFCPU.

Function name	Description	Reference
User authentication	To log off from a CPU module that the user authentication is performed.	Page 691 Logging off from a CPU module
	To copy user information to the other system to match it between both systems.	Page 691 Copying user information to the other system
Safety module operation	To set whether or not to enable the safety communication function for modules used in a system using an RnPSFCPU.	Page 768 Safety module operation

## Redundant system

Only the redundant mode can be selected for the operation mode of an RnPSFCPU.

For a redundant system, refer to the following:

📖 Page 29 Redundant system

### Operation modes of RnPSFCPUs

Only the backup mode can be selected for the operation mode of an RnPSFCPU.

An online operation is performed in both systems in the backup mode.

## 1.5 Remote Head Module

GX Works3 supports MELSEC iQ-R series remote head modules.

And, a remote head module supports a redundant system configuration.

When creating a new project, a module type needs to be selected according to the system configuration to be created.

Project	System configuration
RJ72GF15-T2	Configuration other than that for a redundant system
RJ72GF15-T2(SR)	Redundant system configuration (single line)
RJ72GF15-T2(LR)	Redundant system configuration (redundant line)

For details on a redundant system configuration, refer to the following:

📖 MELSEC iQ-R CC-Link IE Field Network Remote Head Module User's Manual (Application)

Any programs cannot be created for a project of a remote head module.

Therefore, a program needs to be created for a project of a CPU module on the master station.

### List of functions supporting remote head modules in a redundant system configuration

GX Works3 includes functions to operate remote head modules in a redundant system configuration.

Function name	Description	Reference
System switching	To switch the control system of a remote head module to the standby system.	Page 761 System switching

## 1.6 NCCPU

GX Works3 supports MELSEC iQ-R series NCCPUs.

In a project for an NCCPU, ladder programs including devices can be applied. Data of labels and parameters can be edited but they are not written.

For details on NCCPUs, refer to the manual of NCCPUs.

# 1.7 Procedure from Project Creation to CPU Module Operation

The operating procedure from program creation to a CPU module operation in GX Works3 is shown below.

For the operation methods of a CPU module, refer to the following:

📖 MELSEC iQ-R CPU Module User's Manual (Application)

📖 MELSEC iQ-F FX5 User's Manual (Application)

📖 MELSEC iQ-R CC-Link IE Field Network Remote Head Module User's Manual (Application)

## Standard project

Target module type: RnCPUs, RnENCPU, RnP CPUs (with the process control extension disabled)

Start



1. Create a project.
Start GX Works3.
Create a new project.

📖 Page 47 Start

📖 Page 103 Creating a project



2. Set the parameters.
------------------------

📖 Page 199 Setting Parameters



3. Create a program.
Create a Program Organization Unit (POU).
Set an execution order and an execution type.
Set the global labels/local labels.
Edit the program of each POU.
Perform conversion.

📖 Page 129 Creating data

📖 Page 260 Program Execution Order and Execution Type Settings

📖 Page 227 Registering Labels

📖 Page 264 Creating a Ladder Program, Page 309 Creating an ST Program,

Page 319 Creating an FBD/LD Program, Page 342 Creating an SFC Program,

Page 484 Creating a Function Block, Page 504 Creating a Function

📖 Page 420 Converting Programs



4. Perform debugging with the simulator.
--

📖 Page 518 PROGRAM SIMULATION



5. Connect a personal computer to a CPU module, and set the connection destination.
---

📖 Page 557 SETTING ROUTE TO CPU MODULE



6. Write parameters/programs to the CPU module.

☞ Page 580 Writing data to a programmable controller



7. Check the operation.

Monitor the execution status and device contents of the program to check the operation.

Check the error occurrence in the CPU module.

☞ Page 616 Checking Execution Programs on a Program Editor

☞ Page 708 Module Diagnostics



8. Operate the system.

## Process control project

Target module type: RnPCPUs (with the process control extension enabled)

For the creation method of programs, refer to the following manual as well as the contents of this manual.

 MELSEC iQ-R Programming Manual (Process Control Function Blocks/Instructions)

Start



### 1. Create a project.

Start GX Works3.

Create a new project.

 Page 47 Start

 Page 103 Creating a project



### 2. Set the parameters.

 Page 199 Setting Parameters



### 3. Set the settings for using process control functions.

Enable the process control extension of a program file.

Set the option setting of the process control extension.

Set the option setting of the conversion operation.

Set the CPU parameters.

 Page 24 Settings for using process control functions



### 4. Create a program.

Register a tag FB.

Create an FBD/LD program for process control.

Set the initial value of an FB property.

Create a program for sequence control.

Perform conversion.

 Page 249 Registering Tag FBs

 Page 129 Creating data

 Page 375 Display/setting an FB property, Page 397 FB property management (offline)

 Page 319 Creating an FBD/LD Program, Page 484 Creating a Function Block, Page 337 Utilizing a tag FB, Page 497 Creating a user-defined tag FB, Page 504 Creating a Function

 Page 420 Converting Programs



### 5. Connect a personal computer to a CPU module, and set the connection destination.

 Page 557 SETTING ROUTE TO CPU MODULE



### 6. Write parameters/programs to the CPU module.

 Page 580 Writing data to a programmable controller

**7. Check the operation.**

Monitor the execution status and device contents of the program to check the operation.

Check the error occurrence in the CPU module.

Check the control status of a tag FB on a faceplate.

Change the current value of an FB property on the watch window.

Set the current value of an FB property as the initial value of the FB property.

 Page 616 Checking Execution Programs on a Program Editor, Page 650 Pausing/Restarting the Operation of Function Blocks

 Page 708 Module Diagnostics

 Page 637 Checking Current Values by Registering Devices/Labels

 Page 662 Checking Tag Data

 Page 666 FB Property Management (Online) screen

**8. Operate the system.**

## Safety project

Target module type: RnSFCPU, RnPSFCPU (with the process control extension disabled)

Start



1. Create a project.
Start GX Works3.
Create a new project.
Register user information.
Save the project.

Page 47 Start

Page 103 Creating a project

Page 685 User management

Page 126 Saving a project



2. Set the parameters.
Setting the safety device/label area is required.

Page 199 Setting Parameters



3. Create a program.
Create a Program Organization Unit (POU).
Set an execution order and an execution type.
Set the global labels/local labels.
Edit the program of each POU.
Perform conversion.

Page 129 Creating data

Page 260 Program Execution Order and Execution Type Settings

Page 227 Registering Labels

Page 264 Creating a Ladder Program, Page 484 Creating a Function Block, Page 504 Creating a Function

Page 420 Converting Programs



4. Connect a personal computer to a CPU module, and set the connection destination.
---

Page 557 SETTING ROUTE TO CPU MODULE



5. Write parameters/programs to the CPU module.
---

Page 580 Writing data to a programmable controller



6. Check the operation. (Test mode)
Monitor the execution status and device contents of the program to check the operation.
Check the error occurrence in the CPU module.





7. Switch the safety operation modes.
Check whether the written project is correct.
Switch it the safety mode.



8. Operate the system.
------------------------

## Safety project for which the process control extension is set to be used

Target module type: RnPSFCPU (with the process control extension enabled)

For the creation method of programs, refer to the following manual as well as the contents of this manual.

MELSEC iQ-R Programming Manual (Process Control Function Blocks/Instructions)



1. Create a project.
Start GX Works3.
Create a new project.
Register user information.
Save the project.



2. Set the parameters.
Setting the safety device/label area is required.



3. Set the settings for using process control functions.
Enable the process control extension of a program file.
Set the option setting of the process control extension.
Set the option setting of the conversion operation.
Set the CPU parameters.



4. Create a program.

Register a tag FB.

Create an FBD/LD program for process control.

Set the initial value of an FB property.

Create a program for sequence control.

Perform conversion.

☞ Page 249 Registering Tag FBs

☞ Page 129 Creating data

☞ Page 375 Display/setting an FB property, Page 397 FB property management (offline)

☞ Page 319 Creating an FBD/LD Program, Page 484 Creating a Function Block, Page 337 Utilizing a tag FB, Page 497 Creating a user-defined tag FB, Page 504 Creating a Function

☞ Page 420 Converting Programs



5. Connect a personal computer to a CPU module, and set the connection destination.

☞ Page 557 SETTING ROUTE TO CPU MODULE



6. Write parameters/programs to the CPU module.

☞ Page 580 Writing data to a programmable controller



7. Check the operation. (Test mode)

Monitor the execution status and device contents of the program to check the operation.

Check the error occurrence in the CPU module.

Check the control status of a tag FB on a faceplate.

Change the current value of an FB property on the watch window.

Set the current value of an FB property as the initial value of the FB property.

☞ Page 616 Checking Execution Programs on a Program Editor, Page 650 Pausing/Restarting the Operation of Function Blocks

☞ Page 708 Module Diagnostics

☞ Page 637 Checking Current Values by Registering Devices/Labels

☞ Page 662 Checking Tag Data

☞ Page 666 FB Property Management (Online) screen



8. Switch the safety operation modes.

Check whether the written project is correct.

Switch it the safety mode.

☞ Page 767 Identification check for safety data

☞ Page 764 Safety operation mode switching



9. Operate the system.

## Remote head module project

Start



1. Create a project.
Start GX Works3.
Create a new project.

- ☞ Page 47 Start
- ☞ Page 103 Creating a project



2. Set the parameters.

- ☞ Page 199 Setting Parameters



3. Set the labels.
Set the global labels.

- ☞ Page 227 Registering Labels



4. Connect a personal computer to a Remote head module, and set the connection destination.

- ☞ Page 557 SETTING ROUTE TO CPU MODULE



5. Write parameters/labels to the Remote head module.

- ☞ Page 580 Writing data to a programmable controller



6. Check the operation.
Monitor the execution status and device contents of the sequence program to check the operation.

- ☞ Page 708 Module Diagnostics



7. Operate the system.

# 1.8 Learning Operation Methods of GX Works3

This section explains the operation methods of GX Works3.

## Displaying Help



Use Help to learn about operations and functions, and check error codes of a CPU module.

### Operating procedure

Select [Help] ⇒ [GX Works3 Help] (🔍).

e-Manual Viewer starts and the manual appears.

### Find Help

Enter a search term in  on the toolbar and press the  key to start searching it in e-Manual Viewer. The search is executed in the manuals registered in e-Manual Viewer.

### Help of an element

The manual section that is related to an element can be displayed from each screen.

The following table shows the operation in each screen and the elements that can display the manual.

Screen	Operation	Target element
Navigation window	Select an element, and press the  key.	Instruction
Element selection window		Function* <sup>1</sup>
		Function block* <sup>1</sup>
		Module FB
		User library* <sup>1</sup>
		library POU* <sup>1</sup>
Program editor	Ladder editor	Instruction
		Function* <sup>1</sup>
	ST editor	Function block* <sup>1</sup>
		Module FB
	FBD/LD editor	Special relay
		Special register
	SFC diagram editor	User library* <sup>1</sup>
		Library POU* <sup>1</sup>
Enter ladder screen	Click the [Manual] button.	Instruction
Input argument screen		

\*1 If the element is associated with a help file, the help file opens. (It is not displayed if the operation is performed in an SFC diagram editor.)

For the method for associating data with a help file, refer to the following:

 Page 133 Associating data with a help file

### Help of a function

The manual section that is related to the following function can be displayed while using the function.

#### ■Faceplate

Press  on a faceplate.

## Connecting to MITSUBISHI ELECTRIC FA Global Website

---

Open the MITSUBISHI ELECTRIC FA Global Website in a web browser.  
Make sure your personal computer connect to the Internet in advance.

1

### Operating procedure

Select [Help] ⇒ [Connection to MITSUBISHI ELECTRIC FA Global Website].

## Checking the version of GX Works3

---

Display information such as the software version of GX Works3.

### Operating procedure

Select [Help] ⇒ [Version Information].

# 1.9 Connection Configurations between a Personal Computer and a CPU Module

The following section shows the configurations when connecting a personal computer and a CPU module or remote head module.

## Connection through USB ports

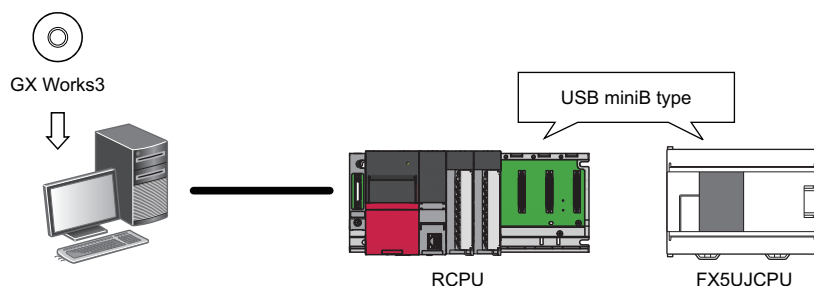

The USB cables, of which the operations are ensured by Mitsubishi Electric Corporation, are shown below. When using a USB cable for the first time, install the USB driver.

For details, refer to the following:

☞ Page 984 USB Driver Installation Procedure

Product name	Model name	Manufacturer
USB cable (USB A type — USB miniB type)	KU-AMB530	SANWA SUPPLY INC.
	KU-AMB550	
	MR-J3USBCBL3M	Mitsubishi Electric Corporation
	GT09-C30USB-5P	Mitsubishi Electric System & Service Co., Ltd.
USB adapter (USB B type — USB miniB type)	AD-USBBFTM5M	ELECOM CO., LTD.

For the considerations when accessing a CPU module, refer to the following:

☞ Page 576 Communication with the CPU module using a USB cable

FX5UCPUs and FX5UCCPUs do not support this connection.

### ■ Configuration of USB connection

Only one CPU module can be connected to a personal computer at the same time.

Connection with a CPU module in the following configurations is not applied.

- Connection to multiple CPU modules from a personal computer with multiple USB ports

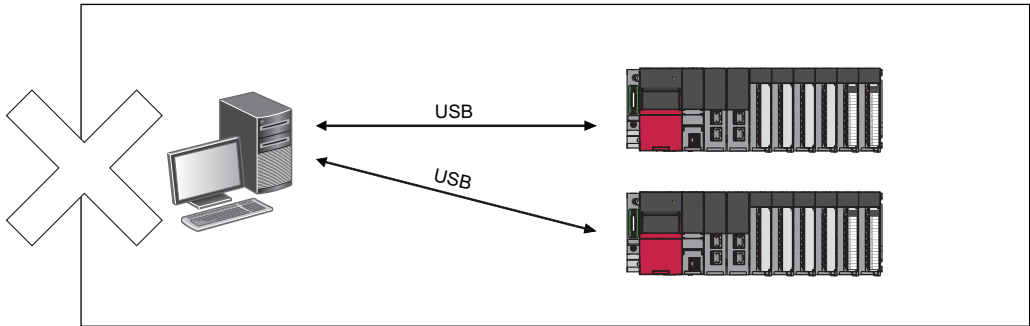

- Connection to multiple CPU modules via a USB hub

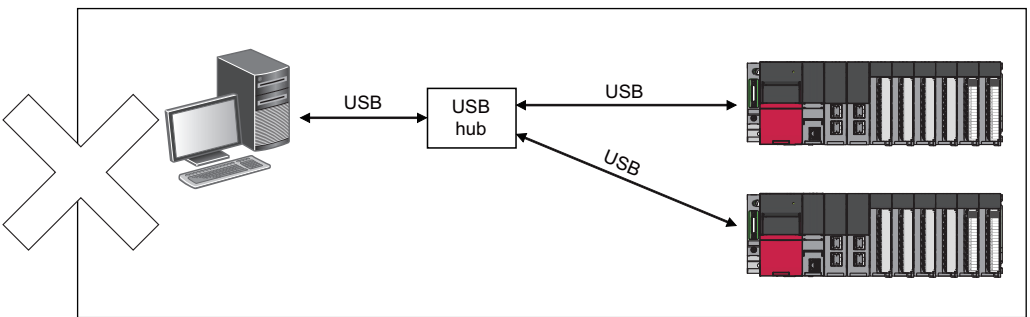

## Connection through I/F boards

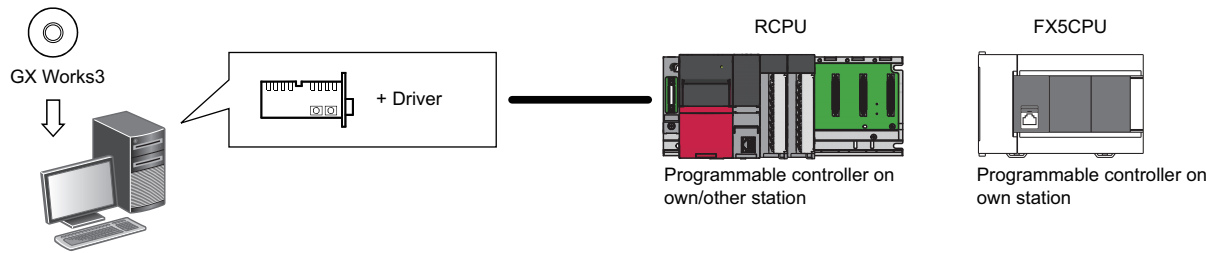

The following I/F boards are supported.

- Ethernet board: An Ethernet board that is built-in to a personal computer or commercially available
- CC-Link IE Controller Network interface board<sup>\*1</sup>, CC-Link IE Field Network interface board<sup>\*1</sup>, CC-Link Ver.2 board<sup>\*1</sup>, CC-Link IE TSN interface board<sup>\*1</sup>: Refer to the manuals of each I/F board for details.

\*1 LHCPUs and FX5CPUs do not support it.

## Connection through serial ports

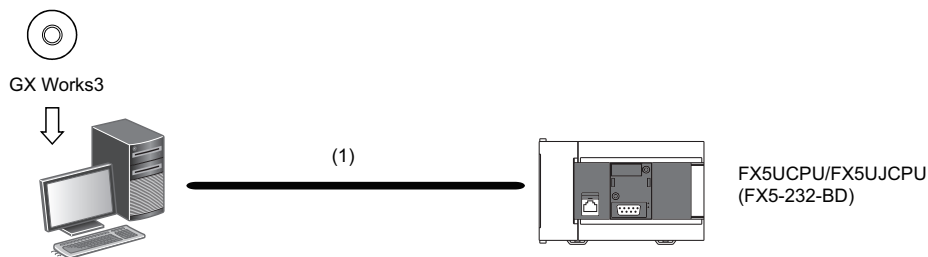
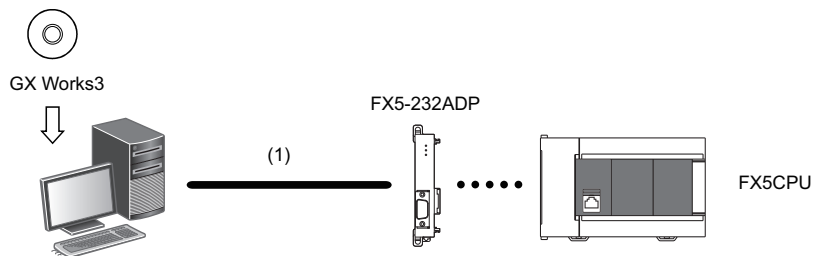

Product name	Model name	Manufacturer
(1) RS-232 cable	FX-232CAB-1	Mitsubishi Electric Corporation

RCPU and remote head modules do not support this connection.



# 2 SCREEN CONFIGURATION AND BASIC OPERATIONS

This chapter explains the screen configuration and basic operations of GX Works3.

2

## 2.1 Start and End

This section explains the methods for starting and ending GX Works3.

### Start

#### Operating procedure

Start GX Works3 from "MELSOFT" in Windows Start.

## ■ Starting GX Works3 by specifying the display position and window size

The display position and window size of GX Works3 at startup can be specified by specifying the following options in a command line.

In addition, offline monitoring can be started after starting GX Works3.

- To start in full screen  
-WINDOWSIZE
  - To start by specifying the display position (left<sup>\*1</sup>, top<sup>\*2</sup>) and window size (width, height)  
-WINDOWSIZE=left,top,width,height
  - To display the screen for selecting a recording file to be used for offline monitoring after startup  
-OFFLINEMONITOR
  - To start offline monitoring of a recording file specified in the file path after startup  
-OFFLINEMONITOR=path
- \*1 For 'left,' enter an integer value by taking the upper left of the main display as the coordinates (0,0) and the rightward direction as positive.  
When specifying '0,' the window frame is displayed transparently by Windows settings; therefore, a gap appears for a few pixels on the left side of the main display.  
(This can be avoided by turning high contrast mode ON in Windows settings.)
- \*2 For 'top,' enter an integer value by taking the upper left of the main display as the coordinates (0,0) and the downward direction as positive.

### Ex.

When starting GX Works3 from the command prompt, specify an option after 'gxw3' as follows.

In addition, specify the installation folder of GX Works3 for the current directory.

- To start in full screen  
gxw3 "-WINDOWSIZE"
- To start at the specified display position and in the specified window size, and open a GX Works3 project (D:\Files\Project1.gx3)  
gxw3 "-WINDOWSIZE=10,20,800,600" "D:\Files\Project1.gx3"
- To display the screen for selecting a recording file to be used for offline monitoring after startup  
gxw3 "-OFFLINEMONITOR"
- To start offline monitoring of a recording file (D:\Files\record.melrc) after startup  
gxw3 "-OFFLINEMONITOR=D:\Files\record.melrc"
- To start in full screen and start offline monitoring of a recording file (D:\Files\record.melrc)  
gxw3 "-WINDOWSIZE" "-OFFLINEMONITOR=D:\Files\record.melrc"

### Ex.

When starting GX Works3 from a shortcut, specify an option in "Target" in the shortcut properties as follows.

- To start in full screen  
"C:\Program Files (x86)\MELSOFT\GPPW3\GXW3.exe" "-WINDOWSIZE"
- To start at the specified display position and in the specified window size, and open a GX Works3 project (D:\Files\Project1.gx3)  
"C:\Program Files (x86)\MELSOFT\GPPW3\GXW3.exe" "-WINDOWSIZE=100,50,1200,900" "D:\Files\Project1.gx3"
- To display the screen for selecting a recording file to be used for offline monitoring after startup  
"C:\Program Files (x86)\MELSOFT\GPPW3\GXW3.exe" "-OFFLINEMONITOR"
- To start offline monitoring of a recording file (D:\Files\record.melrc) after startup  
"C:\Program Files (x86)\MELSOFT\GPPW3\GXW3.exe" "-OFFLINEMONITOR=D:\Files\record.melrc"
- To start in full screen and start offline monitoring of a recording file (D:\Files\record.melrc)  
"C:\Program Files (x86)\MELSOFT\GPPW3\GXW3.exe" "-WINDOWSIZE" "-OFFLINEMONITOR=D:\Files\record.melrc"

## End

### Operating procedure

Select [Project] ⇒ [Exit].



GX Works3 can also be started or ended in MELSOFT Navigator.

## 2.2 Display Language Switching

GX Works3 supports multiple languages, and therefore the display language such as one on the menu can be switched on a personal computer.

### Window

Select [View] ⇒ [Switch Display Language].

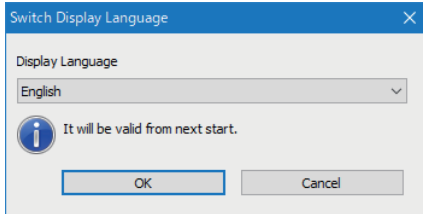

### Precautions

- If the display language differs from the one for the operating system, texts may not displayed properly in the screen. (Displayed texts may get cut.)
- When switching the display language in Windows 10 or later, supplemental fonts of the target language are required. The fonts can be added by the following operation:  
Select [Apps] ⇒ [Apps & features] ⇒ [Optional features] ⇒ [Add a feature] in Windows settings.
- A character entered arbitrarily is not switched even if the display language is switched.

## 2.3 Screen Configuration

This section explains the screen configuration when starting GX Works3.

### Main frame

The main frame configuration is shown below.

The following screen includes a work window and docked windows displayed.

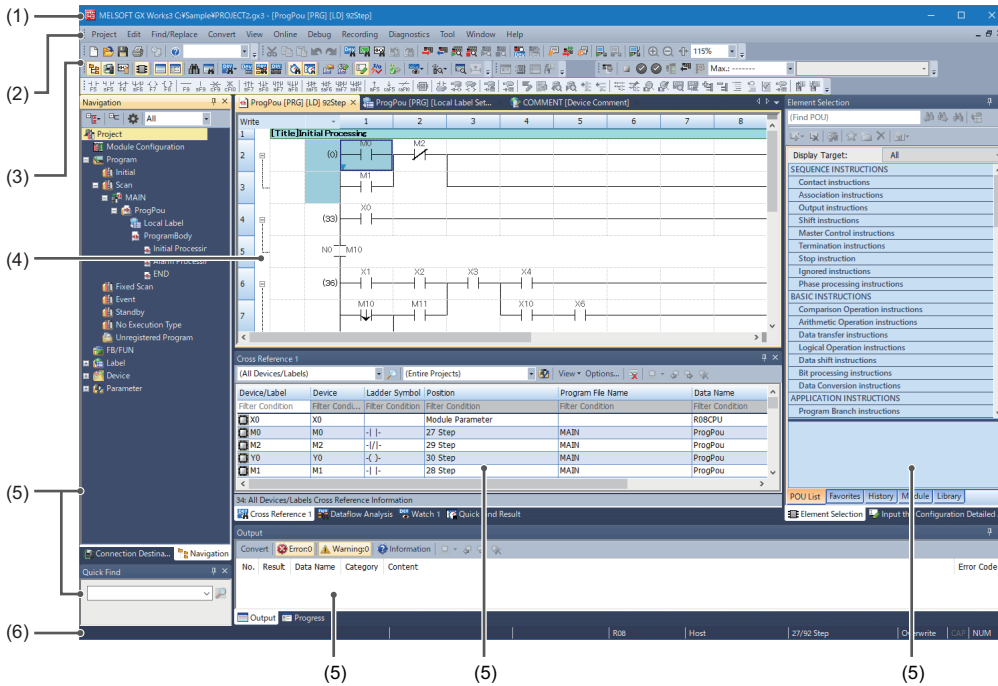

#### Displayed items

Name	Description
(1) Title bar	A project name, etc. are displayed.
(2) Menu bar	Menu options for performing each function are displayed.
(3) Toolbar	Tool buttons for performing various functions are displayed.
(4) Work window	A main screen used for operations such as programming, parameter setting, and monitoring
(5) Docked window	A sub screen to support operations performed in a work window
(6) Status bar	Information on the project being edited is displayed.

### Window operation

#### ■ Displaying docked windows

[View] ⇒ [Docking Window] ⇒ [(target item)]



When the docked window is not displayed by selecting it from the menu, select [Window] ⇒ [Return Window Layout to Initial Status].

#### ■ Switching docked windows and a work window

Various windows or files can be switched by pressing the [Ctrl] + [Tab] keys.

Select a particular window or file by pressing the [Ctrl] + [←] / [→] / [↑] / [↓] keys.

## ■ Arranging work windows

The list of open windows appears.

A specified window can be opened and arranged.

When multiple windows are open, they can efficiently be displayed by arranging them.

### Window

Select [Window] ⇒ [Window].

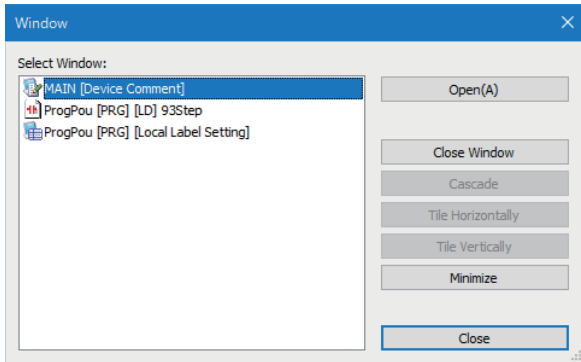

## ■ Docking/floating dockable windows

- Docked display: Drag the title bar of a floating dockable window and drop it to the displayed icon (guidance) to dock the main frame.

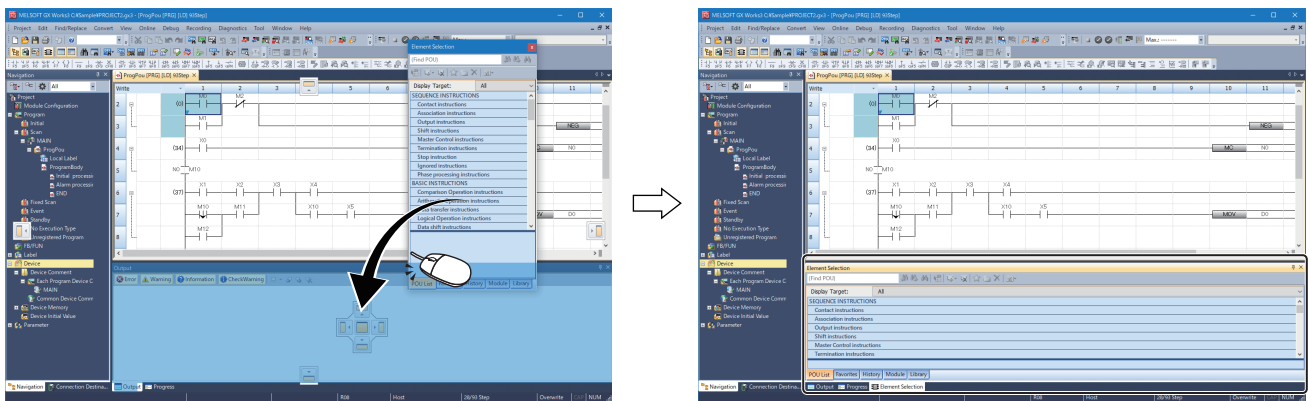

- Floating display: Drag the title bar of a docked window and drop it to the arbitrary position to float from the main frame.

## ■ Docking/floating work windows

- Docked display: Select the floating work window and select [Window] ⇒ [Docking].
- Floating display: Select the docked work window and select [Window] ⇒ [Floating].



Docked windows can be switched between the docked display and the floating display by double-clicking the title bar.

## ■ Combining work windows in one window

When dragging a floating work window close to another one, the guidance appears.

By dropping the work window onto the guidance, it is combined to the other window.

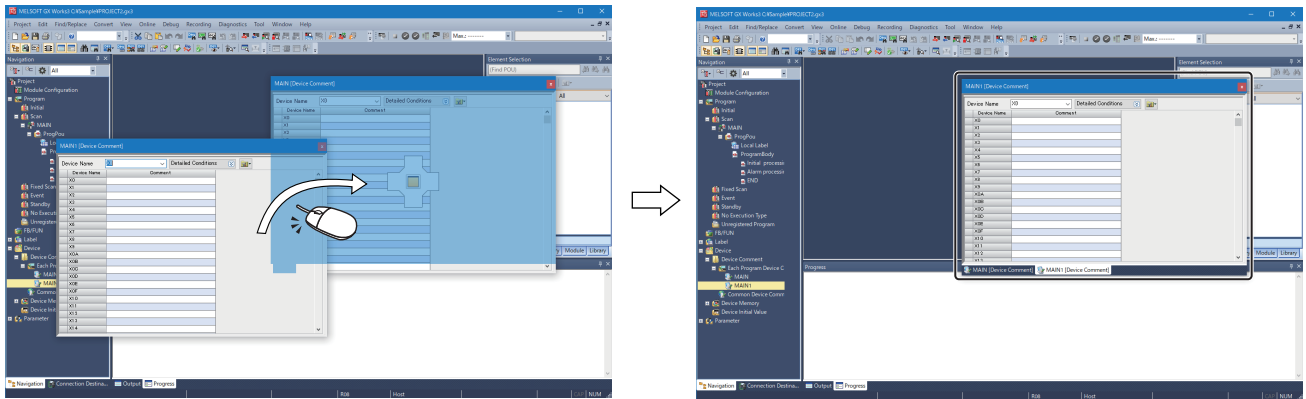

2

## Customizing/resetting toolbars

Set the types of tool buttons to be displayed on each toolbar.

The selected tool buttons on the list are displayed on the toolbar.

### Operating procedure

#### ■ Customizing toolbar

1. Click  on the toolbar, and select [Show/Hide Buttons] ⇒ [(toolbar name)].
2. Select the tool button to be displayed from the list.

#### ■ Resetting toolbar

Click  on the toolbar, and select [Show/Hide Buttons] ⇒ [Reset].

# Navigation window

The navigation window displays project data in a tree format.

Operations such as creating new data and displaying editing screens can be performed on the tree.

For details, refer to the following:

☞ Page 128 Creating Data

For the configuration of the data displayed in the navigation window, refer to the following:

☞ Page 100 Data configuration

## Window

Select [View] ⇒ [Docking Window] ⇒ [Navigation] (  ).

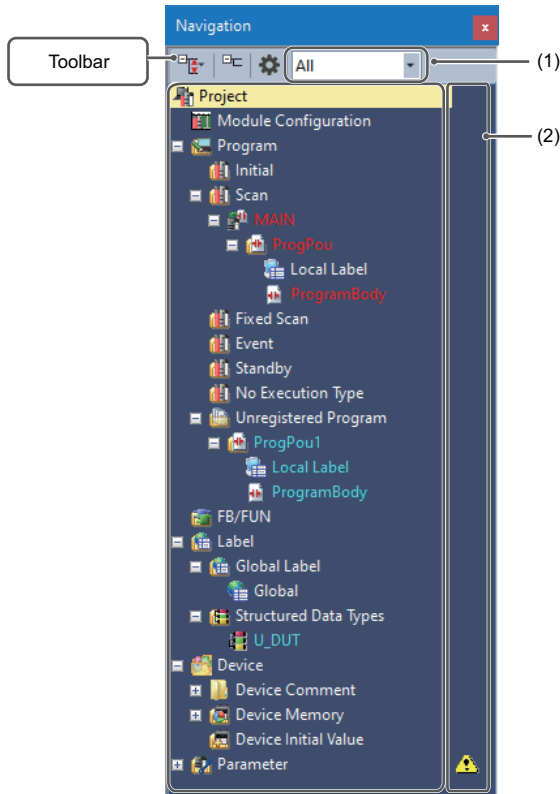

POUs, global labels, and structures are displayed in the following color.

Color	Data
White	Converted data
Red	Unconverted data Unused data before conversion
Light blue	Unconverted data <sup>*1</sup>

\*1 Data that failed in conversion is displayed as unused data before conversion.

## Displayed items

Name	Description	Reference
(1) Filter	Data displayed in a tree format can be filtered. <ul style="list-style-type: none"> <li>• ALL: All items are displayed.</li> <li>• Parameter: Module Configuration and Parameter are displayed.</li> <li>• Program: Program, FB/FUN, Label, and Device are displayed.</li> </ul>	—
(2) Status icons	To display icons indicating the status of a project.	Page 56 Status icons



The font color and the background color can be changed.

 Page 81 Checking and Changing Colors and Fonts

## Sorting data

Sort data displayed in the tree format.

### Operating procedure

Select and right-click any of the following items, then select [Sort] ⇒ [(sort type)] from the shortcut menu.

- Execution Type
- Program File
- Program Block
- Folder
- FB/FUN
- FB File
- Function Block
- FUN File
- Function
- Global Label
- Structure
- Each Program Device Comment
- Device Memory
- Device Initial Value
- Module Information

- Data can be sorted by dragging and dropping the data or selecting [Order] ⇒ [Move Up]/[Move Down] from the shortcut menu.
- Program files, program blocks, and worksheets can be sorted in a batch by selecting and right-clicking "Project," then selecting [Sort All] ⇒ [Name]/[Last Change]/[Execution Order] from the shortcut menu.

## Creating folders

A folder for grouping and managing the created data can be created.

### Operating procedure



1. Select a program file and select [Project] ⇒ [Data Operation] ⇒ [New Folder].
2. Change a folder name.
3. Select a program to be stored and drag and drop it onto the created folder.

## Simple display

An unused folder can be hidden by clicking  on the toolbar.

## Status icons

The following table shows icons indicating the status of a project.

Icon	Status	Display timing	Item	Description
	Parameter mismatched	Offline	Module folder	This icon is displayed when a mismatch was detected between the system parameters and the property of a module.
	Unconfirmed required settings		Module parameter	This icon is displayed when the [Apply] button has never been clicked in the module parameter (network) setting screen that includes a required setting.

## Connection destination window

The connection destination window displays the connection destination for a programmable controller in a list format.

### Window

Select [View] ⇒ [Docking Window] ⇒ [Connection Destination] ( ).

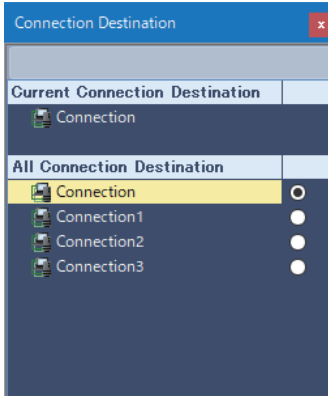

For setting methods of a connection destination, refer to the following:

☞ Page 557 SETTING ROUTE TO CPU MODULE

## Element selection window

The element selection window displays elements used for creating programs, such as instructions, standard functions, and function blocks, in a list format.

### Window

Select [View] ⇒ [Docking Window] ⇒ [Element Selection] ( ).

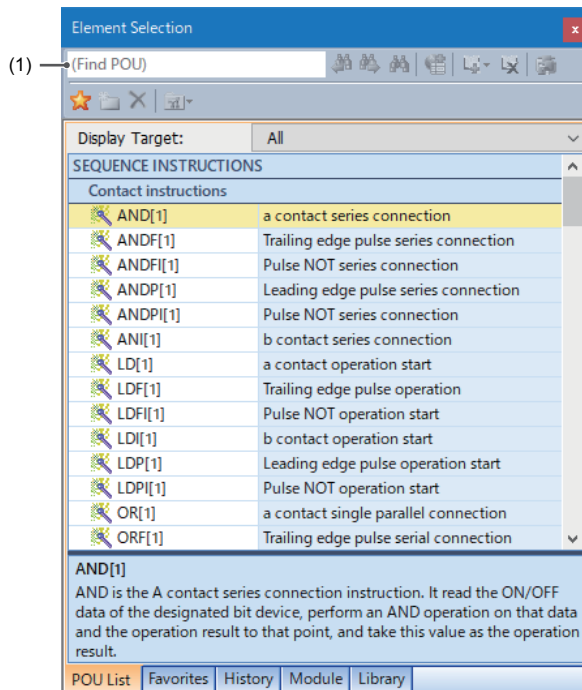

(1): Toolbar

- By selecting a category from the pull-down list of "Display Target," only the elements in the category can be displayed.



### Restriction

For Windows 11, when a personal computer returns from the sleep mode, the color of a part of the element selection window may change.

## Searching for elements

Elements that include an entered keyword in their names or descriptions can be searched for.

### Operating procedure

1. Enter a character string in the text box of the toolbar.
2. Click  (Previous)/ (Next).

The focus will move to an matching element.

### Point

By clicking  (Find All) after entering a character string in the [POU List] tab, only the matching elements can be displayed.

## Pasting elements

### ■Pasting elements in a program

When a program editor is active, elements which can be pasted are displayed in the element selection window. Elements can be pasted by dragging and dropping them from the list onto a program.

### Point

For ST editor, the selected element is pasted at the cursor position by pressing the  key.

### ■Pasting objects on the module configuration diagram

When a module configuration diagram is active, elements which can be pasted are displayed in the element selection window. Elements can be pasted by dragging and dropping them from the list onto the module configuration diagram.

## Favorites

Frequently used modules and elements/SFC elements (devices, labels, instructions, FB instances, functions) can be added in the [Favorites] tab for each category.

A new folder, which is for classification of elements, can be created by clicking  on the toolbar. The created folder can be moved by dragging and dropping and the folder name can also be changed.

When a module configuration diagram is active, only modules are displayed.

When a program editor is active, elements which can be used in the editor are displayed.

### Operating procedure

### ■Adding elements from the element list

Modules, instructions, functions, and function blocks can be added to the [Favorites] tab.

1. Select an element to add from the list in the element selection window, and click  on the toolbar.
2. Select a registration destination in the "Add to Favorites" screen, and click the [OK] button.

### ■Adding from the navigation window

Functions and function blocks can be added to the [Favorites] tab.

1. Select an element to add in the navigation window, and drag and drop it onto the element selection window.
2. Select a registration destination in the "Add to Favorites" screen, and click the [OK] button.

### ■Adding from a ladder editor

Devices, labels, instructions, and FB instances can be added to the [Favorites] tab.

1. Select the cell of an element to add, and drag the border of the cell and drop it onto the element selection window.
2. Select a registration destination in the "Add to Favorites" screen, and click the [OK] button.

### ■Adding from an ST editor

Devices, labels, and FB instances can be added to the [Favorites] tab.

1. Select the token of a part to add, and drag and drop it onto the element selection window.
2. Select a registration destination in the "Add to Favorites" screen, and click the [OK] button.

### ■Adding from an FBD/LD editor

Devices, labels, and FB instances can be added to the [Favorites] tab.

1. Select an element to add, and drag and drop it onto the element selection window with the  key held down.
2. Select a registration destination in the "Add to Favorites" screen, and click the [OK] button.

### ■Adding from an SFC diagram editor

Devices and labels can be added to the [Favorites] tab.

1. Select an SFC element to add, and drag and drop it onto the element selection window.
2. Select a registration destination in the "Add to Favorites" screen, and click the [OK] button.

### ■Adding from a label editor

Labels can be added to the [Favorites] tab.

1. Select the line header of a label to add, and drag and drop it onto the element selection window.
2. Select a registration destination in the "Add to Favorites" screen, and click the [OK] button.

### ■Adding from the "Label Comment" window

Labels can be added to the [Favorites] tab.

1. Select the name of a label to add, and drag and drop it onto the element selection window.
2. Select a registration destination in the "Add to Favorites" screen, and click the [OK] button.

### ■Adding templates classified by purpose

In GX Works3, templates classified by purpose are prepared for adding elements depending on the purpose to the [Favorites] tab at once.

By deleting unnecessary elements after templates are added, the elements can be placed efficiently.

1. Select the [Favorites] tab in the element selection window.
2. Select  on the toolbar in the element selection window ⇒ [Import to Favorites] ⇒ [Category by Target Template].

### ■Adding module templates

In GX Works3, module templates are prepared for adding frequently-used modules to the [Favorites] tab at once.

Module templates can be imported when a module configuration diagram is active.

1. Select the [Favorites] tab in the element selection window.
2. Select  on the toolbar in the element selection window ⇒ [Import to Favorites] ⇒ [Module Template].

#### Point

By importing an exported file (\*.xml), elements registered in the [Favorites] tab can be used on other personal computers.

Select  on the toolbar ⇒ [Export Favorites]/[Import to Favorites]

## History

By selecting the [History] tab, elements used previously are displayed in the order by date.

The order can be changed to the descending order of used count from the pull-down list.

## Module

Module labels and module FBs, which are registered in a project, are displayed by selecting the [Module] tab.

For details on the registration methods, refer to the following:

 Page 248 Registering Module Labels, Page 500 Importing module FBs in a project

## Library

POUs, which are registered in a library file, are displayed by selecting the [Library] tab.

For details on the registration methods, refer to the following:

 Page 511 Registering user libraries in the library list

## 2.4 Menu List

### Basic menus

[Project]	
⇒ [New]	Page 103 Creating a project
⇒ [Open]	Page 105 Opening a project
⇒ [Close]	—
⇒ [Save]	Page 127 Overwriting projects
⇒ [Save As]	Page 126 Saving projects under the specified name
⇒ [Delete]	Page 127 Deleting a project
⇒ [Project Verify]	Page 143 Verifying Projects
⇒ [Project Revision] ⇒ [Register Revision]	Page 160 Registering a revision
⇒ [Project Revision] ⇒ [Revision List]	Page 162 Revision list screen
⇒ [Change Module Type/Operation Mode]	Page 139 Changing the Module Type and Operation Mode of Projects
⇒ [Data Operation] ⇒ [New Data]	Page 129 Creating data
⇒ [Data Operation] ⇒ [Add New Worksheet]	Page 132 Adding worksheets
⇒ [Data Operation] ⇒ [New Folder]	Page 56 Creating folders
⇒ [Data Operation] ⇒ [Rename]	Page 130 Changing a data name
⇒ [Data Operation] ⇒ [Delete Data]	Page 132 Deleting data
⇒ [Data Operation] ⇒ [Copy Data]	Page 130 Copying and pasting data
⇒ [Data Operation] ⇒ [Paste Data]	
⇒ [Data Operation] ⇒ [Add New Module]	Page 205 Setting parameters of modules Page 219 Simple motion module setting function Page 219 Motion control setting function
⇒ [Data Operation] ⇒ [Properties]	Page 135 Properties
⇒ [Data Operation] ⇒ [Help]	Page 133 Associating data with a help file
⇒ [Intelligent Function Module] ⇒ [Module Parameter List]	Page 214 Checking/changing the number of intelligent function module parameters
⇒ [Open Other Format File] ⇒ [GX IEC Developer Format] ⇒ [Open ASC Format File]	Page 115 Opening a GX IEC Developer format project
⇒ [Open Other Format File] ⇒ [GX IEC Developer Format] ⇒ [Open SUL Format User Library]	Page 509 Creating a GX Works3 format library from a GX IEC Developer format library
⇒ [Open Other Format File] ⇒ [GX Works2 Format] ⇒ [Open Project]	Page 107 Opening a GX Works2 format project
⇒ [Open Other Format File] ⇒ [GX Works2 Format] ⇒ [Open User Library]	Page 508 Creating a GX Works3 format library from a GX Works2 format library
⇒ [Open Other Format File] ⇒ [GX Works3 Format] ⇒ [Open User Library]	Page 510 Editing libraries
⇒ [Open Other Format File] ⇒ [PX Developer Format] ⇒ [Open Project]	Page 110 Opening a PX Developer format project
⇒ [Open Other Format File] ⇒ [GX Developer Format] ⇒ [Open QSCPU Series Project]	Page 124 Opening a GX Developer format project
⇒ [Import File] ⇒ [Simulink PLC Coder XML Format]	Page 132 Importing data
⇒ [Library Operation] ⇒ [Export Library]	Page 507 Creating a library file
⇒ [Library Operation] ⇒ [Register to Library List] ⇒ [User Library]	Page 511 Registering user libraries in the library list
⇒ [Library Operation] ⇒ [Register to Library List] ⇒ [Library]	Page 515 Registering libraries of which file extensions are 'mslm'
⇒ [Library Operation] ⇒ [Delete from Library List]	Page 511 Deleting libraries/updating display information
⇒ [Library Operation] ⇒ [Update the Display Information of Library]	
⇒ [Library Operation] ⇒ [Show Program/FB/FUN File]	Page 511 Displaying program files/FB files/FUN files
⇒ [Library Operation] ⇒ [Update Library POU]	Page 514 Updating library POUs
⇒ [Library Operation] ⇒ [Help]	Page 511 Displaying Help
⇒ [Security] ⇒ [User Management]	Page 685 User management
⇒ [Security] ⇒ [Change User Password]	Page 684 Changing a password of the logon user
⇒ [Security] ⇒ [Security Key Setting]	Page 678 Registering a security key in a program file Page 681 Writing/deleting security key to/from CPU module
⇒ [Security] ⇒ [Security Key Management]	Page 675 Creating/deleting a security key

<b>[Project]</b>	
⇒ [Security] ⇒ [Block Password Setting]	Page 671 Setting block password
⇒ [Security] ⇒ [File Password Setting]	Page 695 Setting a file password
⇒ [Printer Setup]	Page 92 Printing Data
⇒ [Page Setup]	
⇒ [Print Preview]	
⇒ [Print]	
⇒ [Recent Projects] ⇒ [(project path used recently 1 to 10)]	
⇒ [Start GX Works2]	—
⇒ [Exit]	Page 49 End
<b>[Edit]</b>	
⇒ [Undo]	—
⇒ [Redo]	
⇒ [Cut]	
⇒ [Copy]	
⇒ [Paste]	
<b>[Find/Replace]</b>	
⇒ [Cross Reference]	Page 457 Displaying cross reference information
⇒ [Device List]	Page 465 Displaying Device Usage
⇒ [Dataflow Analysis]	Page 467 Displaying a Range Affected by/Affecting a Device/Label
⇒ [Unused Label List]	Page 463 Displaying a list of unused labels
⇒ [Bookmark]	Page 479 Registering a Bookmark
⇒ [Find Device/Label]	Page 448 Searching for/Replacing Devices and Labels
⇒ [Find Instruction]	Page 450 Searching for/Replacing Instructions
⇒ [Find Contact or Coil]	Page 451 Searching for/Replacing Character Strings
⇒ [Find String]	
⇒ [Replace Device/Label]	Page 448 Searching for/Replacing Devices and Labels
⇒ [Replace Instruction]	Page 450 Searching for/Replacing Instructions
⇒ [Replace Character String]	Page 451 Searching for/Replacing Character Strings
⇒ [Change Open/Close Contact]	Page 453 Changing Contacts between Open Contact and Close Contact
⇒ [Device Batch Replace]	Page 454 Batch Replacing of Devices and Labels
⇒ [Register to Device Batch Replace]	—
⇒ [Quick Find]	Page 138 Searching the Navigation Window
⇒ [Previous]	—
⇒ [Next]	—
<b>[Convert]</b>	
⇒ [Convert]	Page 420 Converting any or all programs
⇒ [Online Program Change]	Page 600 Writing data after changing programs partially while a CPU module is running (Online program change)
⇒ [Rebuild All]	Page 420 Converting any or all programs
⇒ [Check Syntax] ⇒ [Current POU]	Page 416 Syntax check
⇒ [Check Syntax] ⇒ [ALL POUs]	
⇒ [Program File Setting]	Page 260 Program execution order setting
⇒ [Worksheet Execution Order Setting]	Page 261 Worksheet execution order setting
⇒ [Setting]	—



<b>[View]</b>	
⇒ [Toolbar] ⇒ [Standard]	Page 51 Main frame
⇒ [Toolbar] ⇒ [Program Common]	
⇒ [Toolbar] ⇒ [Docking Window]	
⇒ [Toolbar] ⇒ [Monitor Status]	
⇒ [Toolbar] ⇒ [Process Control Extension]	
⇒ [Statusbar]	
⇒ [Color and Font]	Page 81 Checking and Changing Colors and Fonts
⇒ [Docking Window] ⇒ [Navigation]	Page 54 Navigation window
⇒ [Docking Window] ⇒ [Connection Destination]	Page 57 Connection destination window
⇒ [Docking Window] ⇒ [Bookmark]	Page 479 Registering a Bookmark
⇒ [Docking Window] ⇒ [Element Selection]	Page 57 Element selection window
⇒ [Docking Window] ⇒ [Output]	Page 51 Main frame
⇒ [Docking Window] ⇒ [Progress]	
⇒ [Docking Window] ⇒ [Find/Replace]	—
⇒ [Docking Window] ⇒ [Find Results]	
⇒ [Docking Window] ⇒ [(Cross Reference 1 to 2)]	Page 457 Displaying cross reference information
⇒ [Docking Window] ⇒ [Device List]	Page 465 Displaying Device Usage
⇒ [Docking Window] ⇒ [Dataflow Analysis]	Page 467 Displaying a Range Affected by/Affecting a Device/Label
⇒ [Docking Window] ⇒ [Device Assignment Confirmation]	Page 211 Checking refresh devices assigned to a module
⇒ [Docking Window] ⇒ [Quick Find]	Page 78 Quick Search
⇒ [Docking Window] ⇒ [Quick Find Result]	
⇒ [Docking Window] ⇒ [Guidance Flow]	Page 200 Guidance flow function
⇒ [Docking Window] ⇒ [FB Property]	Page 375 Display/setting an FB property
⇒ [Docking Window] ⇒ [Label Comment]	Page 243 Setting a label comment
⇒ [Docking Window] ⇒ [Input the Configuration Detailed Information]	—
⇒ [Docking Window] ⇒ [Result of Power Supply Capacity and I/O Points Check]	
⇒ [Docking Window] ⇒ [Module Start I/O No. Related Area]	
⇒ [Docking Window] ⇒ [(Watch 1 to 4)]	Page 637 Checking Current Values by Registering Devices/Labels
⇒ [Docking Window] ⇒ [Intelligent Function Module Monitor] ⇒ [(Intelligent Function Module Monitor 1 to 10)]	Page 658 Checking Current Values in an Intelligent Function Module
⇒ [Docking Window] ⇒ [Event History (Offline Monitor)]	Page 736 Checking Collected Data on Program Editor
⇒ [Docking Window] ⇒ [Seek Bar (Offline Monitor)]	
⇒ [Docking Window] ⇒ [Find Changed Point(Offline Monitor)]	Page 751 Checking a device/label value
⇒ [Docking Window] ⇒ [Changed Point List(Offline Monitor)]	
⇒ [Zoom] ⇒ [Set Zoom Factor]	—
⇒ [Zoom] ⇒ [Zoom In]	
⇒ [Zoom] ⇒ [Zoom Out]	
⇒ [Zoom] ⇒ [Fit the editor width to the window width]	
⇒ [Switch Display Language]	Page 50 Display Language Switching
⇒ [Multiple Comments] ⇒ [Display Setting]	Page 82 Displaying and Reading Comments
⇒ [Multiple Comments] ⇒ [Read Comment]	
<b>[Online]</b>	
⇒ [Current Connection Destination]	Page 557 Specification of Connection Destination
⇒ [Read from PLC]	Page 577 Writing/Reading Programmable Controller Data
⇒ [Write to PLC]	
⇒ [Verify with PLC]	Page 595 Verifying Programmable Controller Data
⇒ [Remote Operation]	Page 759 Remote Operation
⇒ [Safety PLC Operation] ⇒ [Check Safety Data Identity]	Page 767 Identification check for safety data
⇒ [Safety PLC Operation] ⇒ [Switch Safety Operation Mode]	Page 764 Safety operation mode switching
⇒ [Safety PLC Operation] ⇒ [Safety Module Operation]	Page 768 Safety module operation

[Online]	
⇒ [Safety PLC Operation] ⇒ [Automatic Restore Setting] ⇒ [Enable]	Page 767 Automatic restoration setting
⇒ [Safety PLC Operation] ⇒ [Automatic Restore Setting] ⇒ [Disable]	
⇒ [Redundant PLC Operation] ⇒ [Redundant Operation]	Page 761 Redundant Programmable Controller Operations
⇒ [Redundant PLC Operation] ⇒ [System A/B Setting]	Page 763 System A/B setting
⇒ [CPU Memory Operation]	Page 769 Checking Memory Usage
⇒ [Delete PLC Data]	Page 577 Configuration of the online data operation screen
⇒ [User Data] ⇒ [Read]	Page 607 Reading/Writing/Deleting User Data
⇒ [User Data] ⇒ [Write]	
⇒ [User Data] ⇒ [Delete]	
⇒ [Set Clock]	Page 758 Clock Setting in a CPU Module
⇒ [Monitor] ⇒ [Monitor Mode]	Page 268 Switching the ladder edit mode (read/write/monitor read/monitor write)
⇒ [Monitor] ⇒ [Monitor (Write Mode)]	
⇒ [Monitor] ⇒ [Start Monitoring (All Windows)]	Page 613 Starting/stopping monitoring
⇒ [Monitor] ⇒ [Stop Monitoring (All Windows)]	
⇒ [Monitor] ⇒ [Start Monitoring]	
⇒ [Monitor] ⇒ [Stop Monitoring]	
⇒ [Monitor] ⇒ [Change Value Format (Decimal)]	Page 613 Changing display format of word devices
⇒ [Monitor] ⇒ [Change Value Format (Hexadecimal)]	
⇒ [Monitor] ⇒ [Device/Buffer Memory Batch Monitor]	Page 633 Checking Device/Buffer Memory in a Batch
⇒ [Monitor] ⇒ [Program List Monitor]	Page 655 Checking the Processing Time of a Program
⇒ [Monitor] ⇒ [Interrupt Program List Monitor]	Page 657 Checking Execution Counts of Interrupt Programs
⇒ [Monitor] ⇒ [SFC All Blocks Batch Monitoring]	Page 632 Monitoring all SFC blocks in batch/active steps
⇒ [Monitor] ⇒ [SFC Auto-scroll]	Page 629 Monitoring with the SFC auto-scroll
⇒ [Monitor] ⇒ [SFC Activated Step Monitor]	Page 630 Monitoring SFC steps which were activated
⇒ [Monitor] ⇒ [Switch ST Monitor Display (All)]	Page 622 ST
⇒ [Monitor] ⇒ [Switch ST Monitor Display (Bit Type Only)]	
⇒ [FB Property Management (Online)]	Page 666 FB Property Management (Online) screen
⇒ [Watch] ⇒ [Start Watching]	Page 637 Checking Current Values by Registering Devices/Labels
⇒ [Watch] ⇒ [Stop Watching]	
⇒ [Watch] ⇒ [Register to Watch Window] ⇒ [(Watch Window 1 to 4)]	
⇒ [Watch] ⇒ [Batch Register to Watch Window] ⇒ [(Watch Window 1 to 4 (Batch Register))]	
⇒ [User Authentication] ⇒ [Log on to PLC]	Page 690 Logging on to CPU module
⇒ [User Authentication] ⇒ [Log off from PLC]	Page 691 Logging off
⇒ [User Authentication] ⇒ [Log off All Users from PLC]	Page 691 Logging off all users
⇒ [User Authentication] ⇒ [Authentication Destination] ⇒ [Both Systems]	Page 691 Authentication destination setting in the online function
⇒ [User Authentication] ⇒ [Authentication Destination] ⇒ [Connective System]	
⇒ [User Authentication] ⇒ [Change the Password of PLC]	Page 691 Changing a password
⇒ [User Authentication] ⇒ [Read User Information from PLC]	Page 689 Reading user information from a CPU module
⇒ [User Authentication] ⇒ [Write User Information to PLC]	Page 689 Writing user information to a CPU module
⇒ [User Authentication] ⇒ [Copy User Information to Other System PLC]	Page 691 Copying user information to the other system
⇒ [User Authentication] ⇒ [Initialize all PLC Data]	Page 690 When a user name and a password used in the user authentication function are lost
[Debug]	
⇒ [Simulation] ⇒ [Start Simulation]	Page 522 Simulation
⇒ [Simulation] ⇒ [Stop Simulation]	
⇒ [Simulation] ⇒ [System Simulation] ⇒ [Start System Simulation]	Page 524 System Simulation
⇒ [Simulation] ⇒ [System Simulation] ⇒ [Connect Simulation]	
⇒ [Simulation] ⇒ [System Simulation] ⇒ [Disconnect Simulation]	Page 546 Ending a system simulation
⇒ [Modify Value]	Page 612 Changing current values
⇒ [Change History of Current Value]	

<b>[Debug]</b>	
⇒ [Register/Cancel Forced Input/Output]	Page 644 Turning Input/Output Devices ON/OFF Forcibly
⇒ [Device Test with Execution Condition] ⇒ [Register]	Page 646 Changing Device/Label Value by Setting Conditions
⇒ [Device Test with Execution Condition] ⇒ [Check/Disable Register]	
⇒ [Device Test with Execution Condition] ⇒ [Batch Disable]	
⇒ [Scan Time Measurement]	Page 653 Measuring the Scan Time of a Program
⇒ [Memory Dump] ⇒ [Setting]	Page 726 Memory Dump Function
⇒ [Memory Dump] ⇒ [Read Results]	
⇒ [Memory Dump] ⇒ [Display Result]	
⇒ [Process Control Extension] ⇒ [Pause FB]	
⇒ [Process Control Extension] ⇒ [Restart FB]	Page 650 Pausing/Restarting the Operation of Function Blocks
⇒ [Process Control Extension] ⇒ [Paused FB List]	
<b>[Recording]</b>	
⇒ [Recording Setting] ⇒ [New]	Page 732 Recording Function
⇒ [Recording Setting] ⇒ [Edit]	
⇒ [Read Recording File]	
⇒ [Start Offline Monitor] ⇒ [Recording File]	Page 736 Checking Collected Data on Program Editor
⇒ [Start Offline Monitor] ⇒ [Logging File]	
⇒ [Start Offline Monitor] ⇒ [Memory Dump]	
⇒ [Stop Offline Monitor]	
⇒ [GOT Offline Monitor] ⇒ [Start]	
⇒ [GOT Offline Monitor] ⇒ [End]	
⇒ [GOT Offline Monitor] ⇒ [End]	
<b>[Diagnostics]</b>	
⇒ [System Monitor]	Page 702 Module Status Check of a System
⇒ [Sensor/Device Monitor]	Page 705 Sensor/Device Status Check
⇒ [Recording Monitor]	Page 707 Recording Status Check
⇒ [Module Diagnostics (CPU Diagnostics)]	Page 708 Module Diagnostics
⇒ [Ethernet Diagnostics]	Page 714 Ethernet diagnostics
⇒ [CC-Link IE Control Diagnostics (Optical Cable)]	Page 715 CC-Link IE Controller Network diagnostics
⇒ [CC-Link IE Control Diagnostics (Twisted Pair Cable)]	
⇒ [CC-Link IE TSN/CC-Link IE Field Diagnostics]	Page 717 CC-Link IE TSN/CC-Link IE Field Network diagnostics
⇒ [CC-Link IEF Basic Diagnostics]	Page 719 CC-Link IE Field Network Basic diagnostics
⇒ [MELSECNET Diagnostics]	Page 720 MELSECNET diagnostics
⇒ [CC-Link Diagnostics]	Page 721 CC-Link diagnostics
⇒ [Simple CPU Communication Diagnostics]	Page 722 Simple CPU communication diagnostics
<b>[Tool]</b>	
⇒ [Memory Card] ⇒ [Read from Memory Card]	Page 610 Writing to/Reading from a memory card
⇒ [Memory Card] ⇒ [Write to Memory Card]	
⇒ [Check Program]	Page 417 Program check
⇒ [Check Parameter]	Page 201 Checking parameters
⇒ [Check the Assigned Device of Global Label]	Page 241 Checking assigned devices
⇒ [Confirm Memory Size (Offline)]	Page 432 Calculating Memory Size
⇒ [Logging Configuration Tool]	Page 730 Data Logging Function
⇒ [Realtime Monitor Function]	Page 661 Checking Current Logging Data
⇒ [GX VideoViewer]	Page 756 Playing a video
⇒ [Module Tool List]	Page 218 Displaying the module tool list
⇒ [Drive Tool List]	Page 218 Displaying the drive tool list
⇒ [Predefined Protocol Support Function]	Page 220 Predefined Protocol Support Function
⇒ [Circuit Trace]	Page 221 Circuit Trace Function
⇒ [Update Firmware]	Page 776 Firmware Update
⇒ [Program Configuration Diagram]	Page 410 Checking/Editing the Relation between Programs

<b>[Tool]</b>	
⇒ [Profile Management] ⇒ [Register]	Page 186 Registration
⇒ [Profile Management] ⇒ [Delete]	Page 186 Deletion
⇒ [Register Simple Device Communication Library]	Page 217 Registering a simple device communication library
⇒ [Configuration Management] ⇒ [Acquire Project]	Page 169 Acquiring a project
⇒ [Configuration Management] ⇒ [Register Project]	Page 168 Registering a project
⇒ [Configuration Management] ⇒ [Update Revision]	Page 170 Update Revision screen
⇒ [Register Sample Library]	Page 515 Registering libraries of which file extensions are 'gx3s'
⇒ [FB Property Management (Offline)]	Page 397 FB property management (offline)
⇒ [Shortcut Key]	Page 80 Checking and Changing Shortcut Keys
⇒ [Options]	Page 84 Option Settings for Each Function
<b>[Window]</b>	
⇒ [Cascade]	—
⇒ [Tile Vertically]	—
⇒ [Tile Horizontally]	
⇒ [Arrange Icons]	
⇒ [Close All Windows]	
⇒ [Return Window Layout to Initial Status]	Page 51 Displaying docked windows
⇒ [Split]	Page 309 Configuration of an ST editor Page 267 Splitting a ladder editor Page 402 Configuration of a device comment editor Page 435 Configuration of a Device Memory Editor
⇒ [Restore Split]	—
⇒ [Split Window Operation] ⇒ [Focus on Next Window]	—
⇒ [Split Window Operation] ⇒ [Focus on Previous Window]	
⇒ [Split Window Operation] ⇒ [Synchronous Scrolling in Side by Side]	Page 267 Splitting a ladder editor
⇒ [Floating]	Page 52 Docking/floating work windows
⇒ [Docking]	—
⇒ [(Window information being displayed)]	—
⇒ [Window]	Page 52 Arranging work windows
<b>[Help]</b>	
⇒ [GX Works3 Help]	Page 42 Displaying Help
⇒ [Connection to MITSUBISHI ELECTRIC FA Global Website]	Page 43 Connecting to MITSUBISHI ELECTRIC FA Global Website
⇒ [Version Information]	Page 43 Checking the version of GX Works3

## Available menus when editing a module configuration diagram

[Edit]	
⇒ [Delete]	—
⇒ [Select All]	
⇒ [Bring to Front]	
⇒ [Send to Back]	
⇒ [Module Status Setting (Empty)]	Page 191 Module status setting (empty)
⇒ [Display Module Information]	Page 192 Displaying model names on module objects
⇒ [XY Assignment Display]	Page 198 XY assignment display
⇒ [Check] ⇒ [Power Supply Capacity and I/O Points]	Page 198 Checking the power supply capacity and I/O points
⇒ [Check] ⇒ [System Configuration]	Page 198 Checking a system configuration
⇒ [Parameter] ⇒ [Fix]	Page 193 Setting parameters on the module configuration diagram
⇒ [Parameter] ⇒ [Input Detailed Configuration Information Window]	Page 193 Setting parameters on the module configuration diagram
⇒ [Start XY Batch Input]	Page 198 Inputting the start XY in a batch
⇒ [Default Points Batch Input]	Page 198 Inputting default points in a batch
[View]	
⇒ [Toolbar] ⇒ [Module Configuration Diagram]	—
[Online]	
⇒ [Read Module Configuration from PLC]	Page 191 Reading the module configuration from an actual system

## Available menus when displaying a program configuration diagram

[Edit]	
⇒ [Delete]	Page 414 Edit mode
⇒ [Layout] ⇒ [Insert Row]	
⇒ [Layout] ⇒ [Delete Row]	
⇒ [Layout] ⇒ [Insert Column]	
⇒ [Layout] ⇒ [Delete Column]	
⇒ [Element] ⇒ [Program Block]	
⇒ [Element] ⇒ [Function Block]	
⇒ [Expand/Collapse All] ⇒ [Expand All Blocks]	Page 411 Expanding/collapsing a block
⇒ [Expand/Collapse All] ⇒ [Collapse All Blocks]	
⇒ [Mode] ⇒ [Display Mode]	—
⇒ [Mode] ⇒ [Edit Mode]	
⇒ [Update Configuration Diagram]	Page 411 Updating a program configuration diagram
⇒ [Filter]	Page 411 Filtering a block
[View]	
⇒ [Display Title]	Page 413 Data name and comment
⇒ [Display Comment]	
⇒ [Open Label Setting of Selected Element] ⇒ [Open in Front]	Page 411 Displaying a label editor
⇒ [Open Label Setting of Selected Element] ⇒ [Tile Horizontally]	

## Available menus when displaying a parameter editor

[Edit]	
⇒ [Set Maximum Value]	The menus to be displayed differ depending on the module.
⇒ [Set Minimum Value]	
⇒ [Copy Positioning Data]	
⇒ [Paste Positioning Data]	
⇒ [Channel Copy]	
⇒ [Copy Axis]	
⇒ [Refresh Batch Setting] ⇒ [Enable All]	
⇒ [Refresh Batch Setting] ⇒ [Disable All]	
⇒ [Refresh Batch Setting] ⇒ [Back to User Default]	
⇒ [Automatic Device Assignment]	
⇒ [Setting Method] ⇒ [Start/End]	
⇒ [Setting Method] ⇒ [Points/Start]	
⇒ [Link Side Device Batch Setting]	
⇒ [Auto-refresh Batch Setting]	
⇒ [Points Batch Setting]	
⇒ [Device Assignment Method] ⇒ [Start/End]	
⇒ [Device Assignment Method] ⇒ [Points/Start]	
⇒ [Word Device Setting Value Input Format] ⇒ [Decimal]	
⇒ [Word Device Setting Value Input Format] ⇒ [Hexadecimal]	
⇒ [IP Address Input Format] ⇒ [Decimal]	
⇒ [IP Address Input Format] ⇒ [Hexadecimal]	

## Available menus when editing a ladder program

[Edit]	
⇒ [Image Clip]	Page 296 Copying an image to the clipboard
⇒ [Continuous Paste]	Page 291 Pasting device numbers or label names consecutively
⇒ [Insert and Paste]	Page 290 Pasting
⇒ [Delete]	—
⇒ [Switch Overwrite/Insert mode]	
⇒ [Revert to Start Editing Circuit]	Page 292 Returning ladder diagrams to the condition before editing
⇒ [Insert Row]	—
⇒ [Delete Row]	
⇒ [Insert Column]	
⇒ [Delete Column]	
⇒ [NOP Batch Insert]	Page 289 Inserting/deleting NOP instruction
⇒ [NOP Batch Delete]	
⇒ [Change TC Setting Value]	Page 289 Changing TC setting values
⇒ [Ladder Edit Mode] ⇒ [Read Mode]	Page 268 Switching the ladder edit mode (read/write/monitor read/monitor write)
⇒ [Ladder Edit Mode] ⇒ [Write Mode]	
⇒ [Ladder Edit Mode] ⇒ [Read Mode (All Windows)]	
⇒ [Ladder Edit Mode] ⇒ [Write Mode (All Windows)]	
⇒ [Ladder Edit Mode] ⇒ [Read Mode (All Ladder Programs Elements)]	
⇒ [Ladder Edit Mode] ⇒ [Write Mode (All Ladder Programs Elements)]	
⇒ [Edit Mode] ⇒ [Use Assigned Device for Label Input]	

[Edit]	
⇒ [Ladder Symbol] ⇒ [Open Contact]	Page 269 Inserting from the menu or on the toolbar
⇒ [Ladder Symbol] ⇒ [Close Contact]	
⇒ [Ladder Symbol] ⇒ [Open Branch]	
⇒ [Ladder Symbol] ⇒ [Close Branch]	
⇒ [Ladder Symbol] ⇒ [Coil]	
⇒ [Ladder Symbol] ⇒ [Application Instruction]	
⇒ [Ladder Symbol] ⇒ [Vertical Line]	
⇒ [Ladder Symbol] ⇒ [Horizontal Line]	
⇒ [Ladder Symbol] ⇒ [Delete Vertical Line]	
⇒ [Ladder Symbol] ⇒ [Delete Horizontal Line]	
⇒ [Ladder Symbol] ⇒ [Pulse Contact Symbol] ⇒ [Rising Pulse]	
⇒ [Ladder Symbol] ⇒ [Pulse Contact Symbol] ⇒ [Falling Pulse]	
⇒ [Ladder Symbol] ⇒ [Pulse Contact Symbol] ⇒ [Rising Pulse Branch]	
⇒ [Ladder Symbol] ⇒ [Pulse Contact Symbol] ⇒ [Falling Pulse Branch]	
⇒ [Ladder Symbol] ⇒ [Pulse Contact Symbol] ⇒ [Rising Pulse Close]	
⇒ [Ladder Symbol] ⇒ [Pulse Contact Symbol] ⇒ [Falling Pulse Close]	
⇒ [Ladder Symbol] ⇒ [Pulse Contact Symbol] ⇒ [Rising Pulse Close Branch]	
⇒ [Ladder Symbol] ⇒ [Pulse Contact Symbol] ⇒ [Falling Pulse Close Branch]	
⇒ [Ladder Symbol] ⇒ [Invert Operation Results]	—
⇒ [Ladder Symbol] ⇒ [Operation Result Rising Pulse]	
⇒ [Ladder Symbol] ⇒ [Operation Result Falling Pulse]	
⇒ [Inline Structured Text] ⇒ [Insert Inline Structured Text Box]	Page 281 Inserting an inline structured text box
⇒ [Inline Structured Text] ⇒ [Display Template]	Page 315 Displaying syntax templates
⇒ [Inline Structured Text] ⇒ [Mark Template (Left)]	
⇒ [Inline Structured Text] ⇒ [Mark Template (Right)]	
⇒ [Inline Structured Text] ⇒ [Register Label]	Page 315 Registering an undefined label
⇒ [Inline Structured Text] ⇒ [Comment Out of Selected Range]	Page 314 Batch comment out/uncomment of a program
⇒ [Inline Structured Text] ⇒ [Disable Comment Out of Selected Range]	
⇒ [Create FB]	Page 489 Creating a function block from an existing ladder block
⇒ [Edit FB Instance]	Page 273 Changing an FB instance name
⇒ [Change FB/FUN Data]	Page 274 Replacing an FB instance Page 280 Replacing functions
⇒ [Update FB/FUN]	Page 276 Function block whose definition is unclear Page 280 Function whose definition is unclear
⇒ [I/O Argument] ⇒ [Increment Argument]	Page 279 Adding/deleting arguments
⇒ [I/O Argument] ⇒ [Delete Argument]	
⇒ [Documentation] ⇒ [Edit Device/Label Comment]	Page 284 Entering/editing comments
⇒ [Documentation] ⇒ [Edit Statement]	Page 285 Entering/editing statements
⇒ [Documentation] ⇒ [Edit Note]	Page 288 Entering/editing notes
⇒ [Documentation] ⇒ [Delete Device/Label Comment]	—
⇒ [Documentation] ⇒ [Statement/Note Batch Edit]	Page 285 Entering/editing statements Page 288 Entering/editing notes
⇒ [Documentation] ⇒ [Show/Hide of Navigation Window]	Page 287 Line statement to be displayed in the navigation window
⇒ [Easy Edit] ⇒ [Connect Horizontal Line to Right-Side Ladder Symbol]	—
⇒ [Easy Edit] ⇒ [Connect Horizontal Line to Left-Side Ladder Symbol]	
⇒ [Easy Edit] ⇒ [Enter/Delete Horizontal Line to Rightward]	
⇒ [Easy Edit] ⇒ [Enter/Delete Horizontal Line to Leftward]	
⇒ [Easy Edit] ⇒ [Enter/Delete Vertical Line to Downward]	
⇒ [Easy Edit] ⇒ [Enter/Delete Vertical Line to Upward]	
⇒ [Easy Edit] ⇒ [Switch Ladder Symbol Invert]	Page 270 Switching methods for contacts/instructions
⇒ [Easy Edit] ⇒ [Switch Pulse/Switch SET and RST Instruction]	

<b>[Edit]</b>	
⇒ [Easy Edit] ⇒ [Switch Statement/Note Type]	—
⇒ [Easy Edit] ⇒ [Instruction Partial Edit]	—
⇒ [Temporarily Change Ladders] ⇒ [Temporarily Change Ladders]	Page 293 Temporary changing
⇒ [Temporarily Change Ladders] ⇒ [Restore the Changes]	Page 294 Applying/restoring the changes
⇒ [Temporarily Change Ladders] ⇒ [Apply the Changes]	—
⇒ [Temporarily Change Ladders] ⇒ [Temporarily Changed Ladder List]	Page 294 Displaying ladder blocks changed temporarily in a list
⇒ [Import File]	Page 297 Importing/exporting ladder programs
⇒ [Export to File]	Page 297 Importing/exporting ladder programs
<b>[Find/Replace]</b>	
⇒ [Line Statement List]	Page 286 Displaying a list
⇒ [Jump]	Page 296 Jump
⇒ [Jump to Next Ladder Block Start]	—
⇒ [Jump to Previous Ladder Block Start]	—
⇒ [Inline Structured Text] ⇒ [Incremental Search] ⇒ [Search Down]	Page 317 Incremental search
⇒ [Inline Structured Text] ⇒ [Incremental Search] ⇒ [Search Up]	—
<b>[View]</b>	
⇒ [Toolbar] ⇒ [Ladder]	—
⇒ [Comment Display]	Page 284 Entering/editing comments
⇒ [Statement Display]	Page 285 Entering/editing statements
⇒ [Note Display]	Page 288 Entering/editing notes
⇒ [Comment/Statement/Note Batch Display]	Page 284 Entering/editing comments Page 285 Entering/editing statements Page 288 Entering/editing notes
⇒ [Display Lines of Monitored Current Value]	—
⇒ [Grid Display]	—
⇒ [Display Format for Device Comment]	—
⇒ [Change Display Format of Device/Label Name] ⇒ [1 Cell Display]	Page 264 Configuration of a ladder editor
⇒ [Change Display Format of Device/Label Name] ⇒ [Wrapping Ladder Display]	—
⇒ [Outline] ⇒ [Expand/Collapse of Outlines]	—
⇒ [Outline] ⇒ [Expand/Collapse of All Outlines]	—
⇒ [Outline] ⇒ [Show/Hide of Outlines]	Page 264 Configuration of a ladder editor
⇒ [Display Device]	—
⇒ [Text Size] ⇒ [Bigger]	—
⇒ [Text Size] ⇒ [Smaller]	—
⇒ [Text Size] ⇒ [Autofit]	Page 264 Configuration of a ladder editor
⇒ [Height Setting of Inline Structured Text]	Page 282 Changing the number of rows to display
⇒ [Open Label Setting of Selected Element] ⇒ [Open in Front]	—
⇒ [Open Label Setting of Selected Element] ⇒ [Tile Horizontally]	—
⇒ [Open Program Body of Selected Element] ⇒ [Open in Front]	—
⇒ [Open Program Body of Selected Element] ⇒ [Tile Horizontally]	—
⇒ [Open Label Setting] ⇒ [Open in Front]	—
⇒ [Open Label Setting] ⇒ [Tile Horizontally]	—
⇒ [Open Device Comment Setting] ⇒ [Open in Front]	Page 403 Displaying a device comment editor from a program editor
⇒ [Open Device Comment Setting] ⇒ [Tile Horizontally]	—
⇒ [Open Zoom Source Block]	Page 369 Creating/displaying Zooms (action/transition)
⇒ [Instruction Help]	Page 296 Displaying instruction help



## Available menus when editing an ST program

[Edit]	
⇒ [Delete]	—
⇒ [Switch Insert/Overwrite mode]	Page 309 Configuration of an ST editor
⇒ [Move Selected Lines Up]	—
⇒ [Move Selected Lines Down]	—
⇒ [Comment Out of the Selected Range]	Page 314 Batch comment out/uncomment of a program
⇒ [Disable Comment Out of Selected Range]	—
⇒ [Register Label]	Page 315 Registering an undefined label
⇒ [Display Template]	Page 315 Displaying syntax templates
⇒ [Mark Template (Left)]	—
⇒ [Mark Template (Right)]	—
[Find/Replace]	
⇒ [Jump]	Page 317 Jump
⇒ [Incremental Search] ⇒ [Search Down]	Page 317 Incremental search
⇒ [Incremental Search] ⇒ [Search Up]	—
[View]	
⇒ [Toolbar] ⇒ [ST]	—
⇒ [Open Label Setting of Selected Element] ⇒ [Open in Front]	—
⇒ [Open Label Setting of Selected Element] ⇒ [Tile Horizontally]	—
⇒ [Open Program of Selected Element] ⇒ [Open in Front]	—
⇒ [Open Program of Selected Element] ⇒ [Tile Horizontally]	—
⇒ [Open Label Setting] ⇒ [Open in Front]	—
⇒ [Open Label Setting] ⇒ [Tile Horizontally]	—
⇒ [Open Device Comment Setting] ⇒ [Open in Front]	Page 403 Displaying a device comment editor from a program editor
⇒ [Open Device Comment Setting] ⇒ [Tile Horizontally]	—
⇒ [Open Zoom Source Block]	Page 369 Creating/displaying Zooms (action/transition)
⇒ [Switch Between Worksheets] ⇒ [Switch to Previous Worksheet]	—
⇒ [Switch Between Worksheets] ⇒ [Switch to Next Worksheet]	—
⇒ [Outline] ⇒ [Expand/Collapse of Outlines]	—
⇒ [Outline] ⇒ [Expand/Collapse of All Outlines]	—
⇒ [Outline] ⇒ [Show/Hide of Outlines]	Page 309 Configuration of an ST editor

## Available menus when editing an FBD/LD program

[Edit]	
⇒ [Delete]	—
⇒ [Select FBD Network Block]	Page 327 Common operations of elements
⇒ [Layout] ⇒ [Insert Row]	Page 335 Inserting a row
⇒ [Layout] ⇒ [Delete Row]	Page 335 Deleting a row
⇒ [Layout] ⇒ [Insert Column(in FBD Network Block)]	Page 335 Inserting/deleting a column
⇒ [Layout] ⇒ [Delete Column(in FBD Network Block)]	—
⇒ [Layout] ⇒ [Insert Multiple Rows]	Page 335 Inserting multiple rows
⇒ [Layout] ⇒ [Delete Multiple Rows]	Page 335 Deleting multiple rows
⇒ [Layout] ⇒ [Layout Correction in FBD Network Block]	Page 335 Correcting layout in an FBD network block
⇒ [Layout] ⇒ [Batch Correction of Layout in FBD Network Block]	Page 335 Correcting layout in an FBD network block in a batch
⇒ [Layout] ⇒ [Delete the Blank Row Between FBD Network Blocks]	Page 335 Deleting a blank row between FBD network blocks
⇒ [Layout] ⇒ [Batch Alignment of All FBD Network Blocks to the Left]	Page 335 Aligning FBD network blocks to the left side in a batch

<b>[Edit]</b>	
⇒ [Add Element (Ladder Symbol)] ⇒ [Open Contact]	Page 325 Inserting from the menu or on the toolbar
⇒ [Add Element (Ladder Symbol)] ⇒ [Close Contact]	
⇒ [Add Element (Ladder Symbol)] ⇒ [Open Branch]	
⇒ [Add Element (Ladder Symbol)] ⇒ [Close Branch]	
⇒ [Add Element (Ladder Symbol)] ⇒ [Coil]	
⇒ [Add Element (Ladder Symbol)] ⇒ [Left Power Rail]	
⇒ [Add Element (Ladder Symbol)] ⇒ [Pulse Contact Symbol] ⇒ [Rising Pulse]	
⇒ [Add Element (Ladder Symbol)] ⇒ [Pulse Contact Symbol] ⇒ [Falling Pulse]	
⇒ [Add Element (Ladder Symbol)] ⇒ [Pulse Contact Symbol] ⇒ [Rising Pulse Branch]	
⇒ [Add Element (Ladder Symbol)] ⇒ [Pulse Contact Symbol] ⇒ [Falling Pulse Branch]	
⇒ [Add Element (Ladder Symbol)] ⇒ [Pulse Contact Symbol] ⇒ [Rising Pulse Close]	
⇒ [Add Element (Ladder Symbol)] ⇒ [Pulse Contact Symbol] ⇒ [Falling Pulse Close]	
⇒ [Add Element (Ladder Symbol)] ⇒ [Pulse Contact Symbol] ⇒ [Rising Pulse Close Branch]	
⇒ [Add Element (Ladder Symbol)] ⇒ [Pulse Contact Symbol] ⇒ [Falling Pulse Close Branch]	
⇒ [Add Element (Ladder Symbol)] ⇒ [Open Contact and Coil]	
⇒ [Add Element (Ladder Symbol)] ⇒ [Variable]	
⇒ [Add Element (Ladder Symbol)] ⇒ [Connector]	
⇒ [Add Element (Ladder Symbol)] ⇒ [Jump]	
⇒ [Add Element (Ladder Symbol)] ⇒ [Jump Label]	
⇒ [Add Element (Ladder Symbol)] ⇒ [Return]	
⇒ [Add Element (Ladder Symbol)] ⇒ [Inline Structured Text]	
⇒ [Add Element (Ladder Symbol)] ⇒ [Comment]	
⇒ [Change Name]	—
⇒ [Toggle FB/FUN Height] ⇒ [Adapt Width]	Page 334 Changing the height of an element
⇒ [Toggle FB/FUN Height] ⇒ [Keep Width]	
⇒ [Change FB/FUN Data]	Page 330 Replacing function elements/function block elements
⇒ [Update FB/FUN]	Page 332 FB/FUN whose definition is unclear
⇒ [Edit Mode] ⇒ [Element Auto-connect]	Page 327 Common operations of elements
⇒ [Edit Mode] ⇒ [Use Assigned Device for Label Input]	Page 325 Entering programs
⇒ [I/O Argument] ⇒ [Increment Argument]	Page 330 Adding/deleting arguments
⇒ [I/O Argument] ⇒ [Delete Argument]	
⇒ [I/O Argument] ⇒ [Mark as Hidden]	Page 331 Hiding arguments
⇒ [I/O Argument] ⇒ [Unmark as Hidden]	
⇒ [I/O Argument] ⇒ [Hide Argument]	
⇒ [I/O Argument] ⇒ [Show Argument]	
⇒ [Easy Edit] ⇒ [Invert Contact (Open/Close)]	Page 326 Switching methods for contacts/instructions
⇒ [Easy Edit] ⇒ [Switch Pulse]	
⇒ [Easy Edit] ⇒ [Switch SET and RST]	
⇒ [Easy Edit] ⇒ [Link Comment]	Page 338 Linking a comment element with a single element
⇒ [Easy Edit] ⇒ [Unlink Comment]	Page 338 Releasing links
⇒ [Easy Edit] ⇒ [Comment Batch Link]	Page 339 Linking comment elements and elements in a batch
⇒ [Order Comment] ⇒ [Bring to Front]	
⇒ [Order Comment] ⇒ [Bring Forward]	
⇒ [Order Comment] ⇒ [Send Backward]	
⇒ [Order Comment] ⇒ [Send to Back]	
⇒ [Process Control Extension] ⇒ [Add Structured Data Type Label for Tag Data Reference]	Page 497 Creating a user-defined tag FB
<b>[Find/Replace]</b>	
⇒ [FBD Network Block List]	Page 340 Displaying FBD network blocks in a list
<b>[View]</b>	
⇒ [Toolbar] ⇒ [FBD/LD]	—

[View]		
⇒ [Comment Display] ⇒ [Device/Label Comment]	Page 319 Configuration of an FBD/LD editor	
⇒ [Comment Display] ⇒ [Switch FB/FUN Argument]		
⇒ [Device Display]		
⇒ [FBD Network Block No. Display]		
⇒ [Display Execution Order]		
⇒ [Grid Display]		
⇒ [Display Page Break]		
⇒ [Open Label Setting of Selected Element] ⇒ [Open in Front]		—
⇒ [Open Label Setting of Selected Element] ⇒ [Tile Horizontally]		
⇒ [Open Program Body of Selected Element] ⇒ [Open in Front]		
⇒ [Open Program Body of Selected Element] ⇒ [Tile Horizontally]		
⇒ [Open Label Setting] ⇒ [Open in Front]		
⇒ [Open Label Setting] ⇒ [Tile Horizontally]		
⇒ [Open Device Comment Setting] ⇒ [Open in Front]		Page 403 Displaying a device comment editor from a program editor
⇒ [Open Device Comment Setting] ⇒ [Tile Horizontally]		
⇒ [Open Zoom Source Block]	Page 369 Creating/displaying Zooms (action/transition)	
⇒ [Switch Between Worksheets] ⇒ [Switch to Previous Worksheet]	—	
⇒ [Switch Between Worksheets] ⇒ [Switch to Next Worksheet]		
[Online]		
⇒ [Monitor] ⇒ [Faceplate]	Page 662 Checking tag data on the gauge window (faceplate)	

## Available menus when editing an SFC program (SFC diagram)

[Edit]		
⇒ [Delete]	—	
⇒ [Select SFC Network Block]	Page 358 Common operations of SFC elements	
⇒ [Change TC Setting Value]	Page 289 Changing TC setting values	
⇒ [Modify] ⇒ [Name]	Page 351 Changing a step name/step No./step attribute/step attribute target Page 353 Changing a transition name/Transition No.	
⇒ [Modify] ⇒ [Direct Expression for Transition]	Page 353 Creating a transition	
⇒ [Modify] ⇒ [Qualifier]	—	
⇒ [Modify] ⇒ [End Step/Jump]	Page 346 SFC element	
⇒ [Modify] ⇒ [Step Attribute]	Page 351 Changing a step name/step No./step attribute/step attribute target	
⇒ [Modify] ⇒ [No Step Attribute]		
⇒ [Modify] ⇒ [SC: Coil HOLD Step]		
⇒ [Modify] ⇒ [SE: Operation HOLD Step (without Transition Check)]		
⇒ [Modify] ⇒ [ST: Operation HOLD Step (with Transition Check)]		
⇒ [Modify] ⇒ [R: Reset Step]		
⇒ [Modify] ⇒ [BC: Block Start Step (with END Check)]		
⇒ [Modify] ⇒ [BS: Block Start Step (without END Check)]		
⇒ [Modify] ⇒ [Step Attribute Target]		
⇒ [Modify] ⇒ [Device]		
⇒ [Modify] ⇒ [Switch between Jump Symbol and Connection Line]		Page 355 Switching a jump/connection line
⇒ [Modify] ⇒ [Toggle Transition Size]		Page 354 Entering comments of Transition No.
⇒ [Insert] ⇒ [Step]		Page 351 Inserting a normal step
⇒ [Insert] ⇒ [Transition]		Page 353 Inserting a transition
⇒ [Insert] ⇒ [Action]	Page 354 Inserting an action	
⇒ [Insert] ⇒ [Jump]	Page 355 Inserting a jump	
⇒ [Insert] ⇒ [Selection Branch]	Page 357 Inserting a branch below a step/transition	
⇒ [Insert] ⇒ [Simultaneous Branch]		

<b>[Edit]</b>	
⇒ [Insert] ⇒ [Selection Branch Leg]	Page 357 Adding a selection branch on the right side of a transition/selection condition
⇒ [Insert] ⇒ [Simultaneous Branch Leg]	Page 357 Adding a simultaneous branch on the right side of a step/simultaneous branch
⇒ [Insert FBD/LD Element] ⇒ [Left Power Rail]	—
⇒ [Insert FBD/LD Element] ⇒ [Open Contact]	
⇒ [Insert FBD/LD Element] ⇒ [Close Contact]	
⇒ [Insert FBD/LD Element] ⇒ [Open Branch]	
⇒ [Insert FBD/LD Element] ⇒ [Close Branch]	
⇒ [Insert FBD/LD Element] ⇒ [Pulse Contact Symbol] ⇒ [Rising Pulse]	
⇒ [Insert FBD/LD Element] ⇒ [Pulse Contact Symbol] ⇒ [Falling Pulse]	
⇒ [Insert FBD/LD Element] ⇒ [Pulse Contact Symbol] ⇒ [Rising Pulse Branch]	
⇒ [Insert FBD/LD Element] ⇒ [Pulse Contact Symbol] ⇒ [Falling Pulse Branch]	
⇒ [Insert FBD/LD Element] ⇒ [Pulse Contact Symbol] ⇒ [Rising Pulse Close]	
⇒ [Insert FBD/LD Element] ⇒ [Pulse Contact Symbol] ⇒ [Falling Pulse Close]	
⇒ [Insert FBD/LD Element] ⇒ [Pulse Contact Symbol] ⇒ [Rising Pulse Close Branch]	
⇒ [Insert FBD/LD Element] ⇒ [Pulse Contact Symbol] ⇒ [Falling Pulse Close Branch]	
⇒ [Insert FBD/LD Element] ⇒ [Variable]	
⇒ [Insert FBD/LD Element] ⇒ [Connector]	
⇒ [Insert FBD/LD Element] ⇒ [Comment]	
⇒ [Edit Mode] ⇒ [Element Auto-connect]	
⇒ [I/O Argument] ⇒ [Increment Argument]	Page 330 Adding/deleting arguments
⇒ [I/O Argument] ⇒ [Delete Argument]	
⇒ [Easy Edit] ⇒ [Invert Contact (Open/Close)]	Page 326 Switching methods for contacts/instructions
⇒ [Easy Edit] ⇒ [Switch Pulse]	
⇒ [Easy Edit] ⇒ [Link Comment]	Page 338 Linking a comment element with a single element Page 368 Linking a comment
⇒ [Easy Edit] ⇒ [Unlink Comment]	Page 338 Releasing links
⇒ [Easy Edit] ⇒ [Comment Batch Link]	Page 339 Linking comment elements and elements in a batch
⇒ [Order Comment] ⇒ [Bring to Front]	Page 334 Order of comment elements
⇒ [Order Comment] ⇒ [Bring Forward]	
⇒ [Order Comment] ⇒ [Send Backward]	
⇒ [Order Comment] ⇒ [Send to Back]	
⇒ [Edit Step/Transition]	Page 368 Editing Step No./Transition No.
⇒ [Change Type of Transition]	Page 348 Changing the display format (type) of a transition
⇒ [Properties]	—
<b>[Convert]</b>	
⇒ [Convert Block]	Page 368 Converting a block
<b>[View]</b>	
⇒ [Toolbar] ⇒ [SFC]	—
⇒ [Comment Display]	Page 343 Configuration of an SFC diagram editor
⇒ [Device Display]	
⇒ [Display Step/Transition]	
⇒ [Switch Ladder Display] ⇒ [Detailed Expression]	
⇒ [Switch Ladder Display] ⇒ [MELSAP-L (Instruction Format)]	
⇒ [Grid Display]	
⇒ [Hide Actions]	
⇒ [Open SFC Block List]	Page 372 Displaying an SFC block list
⇒ [Open Zoom List]	Page 371 Displaying a Zoom list

<b>[View]</b>	
⇒ [Open Label Setting of Selected Element] ⇒ [Open in Front]	—
⇒ [Open Label Setting of Selected Element] ⇒ [Tile Horizontally]	
⇒ [Open Program Body of Selected Element] ⇒ [Open in Front]	
⇒ [Open Program Body of Selected Element] ⇒ [Tile Horizontally]	
⇒ [Open Label Setting] ⇒ [Open in Front]	
⇒ [Open Label Setting] ⇒ [Tile Horizontally]	
⇒ [Open Device Comment Setting] ⇒ [Open in Front]	Page 403 Displaying a device comment editor from a program editor
⇒ [Open Device Comment Setting] ⇒ [Tile Horizontally]	
⇒ [Open Zoom/Start Destination Block]	Page 343 Configuration of an SFC diagram editor
⇒ [Open Start Source Block]	Page 352 Creating a step that makes another block activated

<b>[Debug]</b>	
⇒ [Control SFC Steps] ⇒ [Activate the Selected Steps]	Page 631 Changing the active status
⇒ [Control SFC Steps] ⇒ [Deactivate the Selected Steps]	
⇒ [Control SFC Steps] ⇒ [Activate the Selected Steps Only]	

## Available menus when editing an SFC program (block list)

<b>[Edit]</b>	
⇒ [Delete]	—
<b>[Find/Replace]</b>	
⇒ [Jump]	Page 373 Jump
⇒ [Block Information Find Device]	Page 373 Searching for block information
<b>[View]</b>	
⇒ [SFC Block List Comment]	Page 372 Displaying an SFC block list
⇒ [Display Device]	
⇒ [Open SFC Body]	Page 372 Displaying SFC diagrams
⇒ [Open Label Setting]	Page 373 Displaying local label editor

## Available menus when displaying a label editor

[Edit]	
⇒ [Delete]	—
⇒ [Select All]	
⇒ [New Declaration (Before)]	Page 229 Editing a row
⇒ [New Declaration (After)]	
⇒ [Delete Row]	
⇒ [Import File]	Page 245 Exporting/importing a label
⇒ [Export to File]	
⇒ [System Label] ⇒ [Reservation to Register System Label]	Page 255 Registering labels in system label database
⇒ [System Label] ⇒ [Reservation to Release System Label]	Page 255 Releasing system labels
⇒ [System Label] ⇒ [Import System Label]	Page 255 Importing system labels in system label database to GX Works3
⇒ [System Label] ⇒ [Reflect to System Label Database]	Page 255 Registering labels in system label database
⇒ [System Label] ⇒ [Check the changes of the System Label Database]	Page 256 Importing the changes of system label database
⇒ [System Label] ⇒ [Execute Verification Synchronous with System Label]	Page 256 Verifying system label information
⇒ [Copy Device Comment]	Page 239 Copying a device comment
⇒ [Delete Blank Rows]	Page 229 Deleting a blank row
⇒ [Duplicate Structured Data Type Label]	Page 234 Duplicating a structure type global label
[View]	
⇒ [Toolbar] ⇒ [Label]	—
⇒ [Show/Hide of Label Item]	
⇒ [Display Program Editor]	
⇒ [Open Label Comment setting]	Page 227 Configuration of a label editor

## Available menus when displaying a device memory editor

[Edit]	
⇒ [Delete]	—
⇒ [Enter Character String]	Page 438 Setting character strings
⇒ [Clear All (All Devices)]	Page 438 Clearing whole memory of device memory
⇒ [Clear All (Displayed Devices)]	
⇒ [FILL]	Page 437 Setting values in batch
⇒ [Register/Import Device Initial Value]	Page 439 Linkage with initial device values
⇒ [Export to File]	Page 440 Exporting Device Memory Data
[View]	
⇒ [Toolbar] ⇒ [Device Memory]	—
⇒ [Display Format Detailed Setting]	
[Online]	
⇒ [Device Memory] ⇒ [Read Selected Range]	Page 439 Writing/Reading Data to/from CPU Module
⇒ [Device Memory] ⇒ [Write Selected Range]	

## Available menus when editing a device comment

[Edit]	
⇒ [Delete]	—
⇒ [Select All]	
⇒ [Detect the Mismatched Comment]	Page 404 Detecting devices with empty cell
⇒ [Read from Sample Comment]	Page 409 Reading sample comments
⇒ [Delete Unused Device Comment]	Page 406 Deleting unused device comments
⇒ [Clear All (All Devices)]	Page 406 Clearing all device comments
⇒ [Clear All (Displayed Devices)]	
⇒ [Import File]	Page 407 Importing/exporting device comments
⇒ [Export to File]	
⇒ [Hide All Bit Specification Information]	—
⇒ [Show All Bit Specification Information]	
⇒ [Hide All Linefeed Comments]	
⇒ [Show All Linefeed Comments]	
⇒ [Cut the Range Including Hidden Bit Specification Information]	Page 404 Creating device comments
⇒ [Copy the Range Including Hidden Bit Specification Information]	
⇒ [Paste the Range Including Hidden Bit Specification Information]	

## Available menus when displaying the verify result window

[Edit]	
⇒ [Export to File]	Page 145 Checking a verification result
[Find/Replace]	
⇒ [Next Mismatch]	Page 145 Checking a verification result
⇒ [Previous Mismatch]	
[View]	
⇒ [Toolbar] ⇒ [Verify Result]	—
⇒ [Return to Result List]	
⇒ [Close Detailed Result]	
⇒ [Close All Detailed Result]	
⇒ [Show only Mismatches]	Page 145 Checking a verification result

## Available menus when displaying the device/buffer memory batch monitor window

[View]	
⇒ [Toolbar] ⇒ [Device/Buffer Memory Batch Monitor]	—
⇒ [Display Format Detailed Setting]	

## Available menus when displaying the tag FB setting editor

[Edit]	
⇒ [Delete]	—
⇒ [Select All]	
⇒ [New Declaration (Before)]	
⇒ [Delete Row]	
⇒ [Export Assignment Information Database File]	
⇒ [FB Property Page]	Page 377 Displaying the FB property page

## 2.5 Quick Search

The quick search is a function to search for a specified keyword in GX Works3, and to display or execute a result.

### Window

Select [Find/Replace] ⇒ [Quick Find] (🔍).

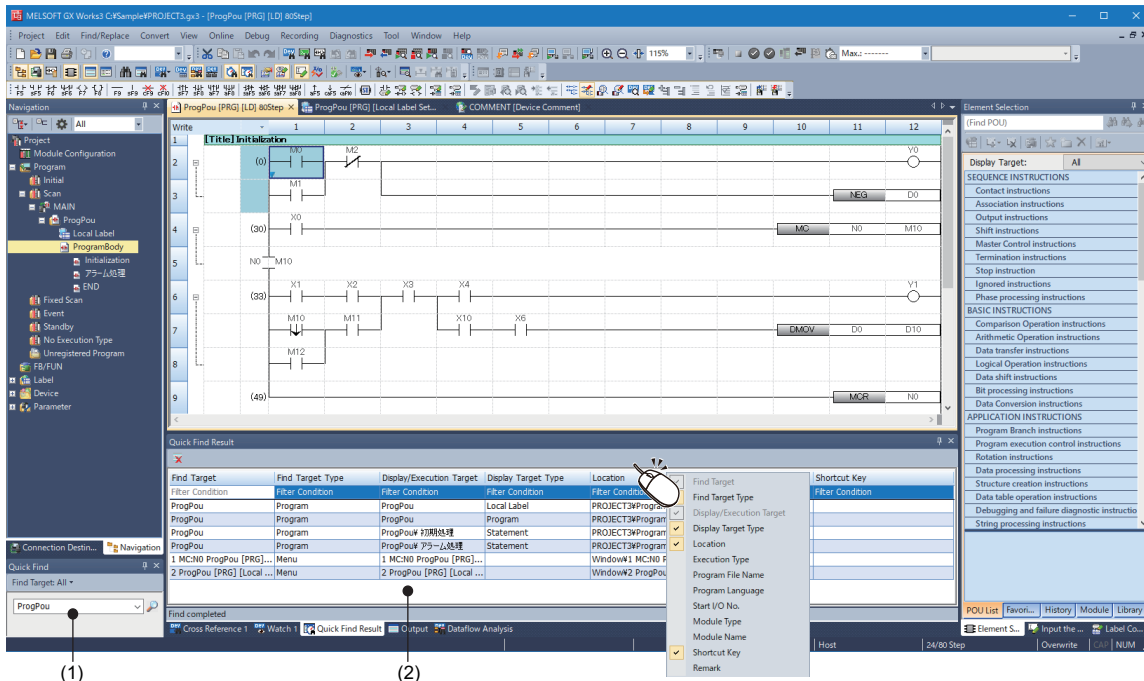

- (1) Quick find window
- (2) Quick find result window

### Operating procedure

1. Enter a search keyword in the input field of the "Quick Find" window (1).
2. Click 🔍.
3. Double-click a search result displayed in the "Quick Find Result" window (2).

The selected data is displayed, or the selected menu is executed.

### Point

- By selecting a search target category from the pull-down list of the "Quick Find" window (1), the only selected category can be targeted for searching.
- By pressing the **[Shift]** + **[Enter]** keys or double-clicking a search result with the **[Shift]** key held down in the "Quick Find Result" window (2), jumping to the data or executing the menu is possible while the cursor remains in the "Quick Find Result" window (2).



## Search targets

The following table shows the targets of quick search.

Target	Description
Navigation window	Data in the navigation window can be searched for.
Menu	<p>Menus can be searched for.</p> <p>Search results may differ depending on the editor that is active in searching.</p> <p>In addition, when searching with a function name of an existing MELSOFT application, the similar function of GX Works3 can be displayed.</p> <p>If an existing MELSOFT application has a function similar to the displayed function, the application name is displayed in the "Remark" column. To display the "Remark" column, right-click on the column header and select [Remark] from the shortcut menu.</p> <p>The applicable existing MELSOFT applications are as follows:</p> <ul style="list-style-type: none"> <li>• GX Developer</li> <li>• GX Works2</li> </ul>

## Filtering display

The displayed search results can be filtered.

### Operating procedure

Enter or select a filtering condition in the "Quick Find Result" window (2), and press the  key.

#### ■Filtering condition

The previously entered keywords or search results can be selected from the pull-down list.

#### ■Deleting a filtering condition

Filtering of a column can be cleared by deleting the keyword entered as a filtering condition for the column.

#### ■Keywords for a filtering condition

A wild card '\*' can be set as a filtering condition.

## Sorting display

The columns can be sorted in ascending/descending order by clicking the column header.

## 2.6 Checking and Changing Shortcut Keys

Shortcut keys of each function can be checked and changed in the "Shortcut Key" screen.

Up to three shortcut keys can be assigned to one command.

Settings on changed shortcut keys are saved in a personal computer for each user who logs on to Windows.

### Window

Select [Tool] ⇒ [Shortcut Key].

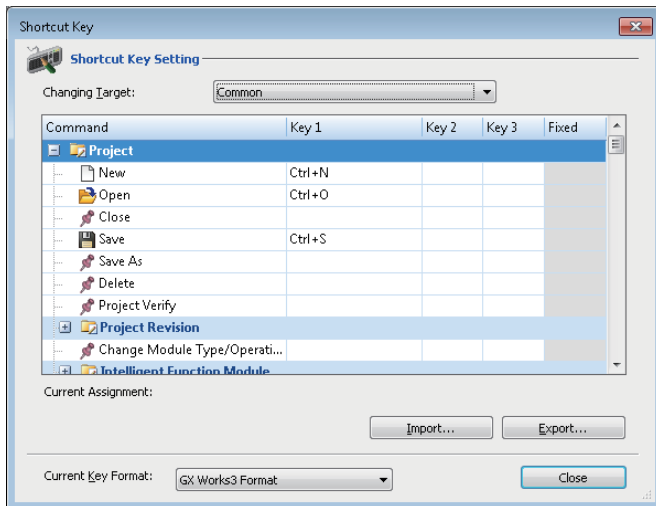

### Operating procedure

1. Double-click a command cell to change the shortcut key.
2. Press a key to assign on the keyboard.

### ■ Changing the default setting

The shortcut key assignment set to the default can be changed by selecting a format from the pull-down list for "Current Key Format."

The available formats are as follows:

- GX Works3 format: Select this to reset the shortcut key assignment to the original one. Keys same as GX Works2 are included.
- GPPA format: Select this to change the shortcut key assignment for all commands to one same as GPPA in a batch.
- GPPW format: Select this to change the shortcut key assignment for all commands to one same as GX Developer in a batch.
- MEDOC format: Select this to change the shortcut key assignment for all commands to one same as MELSEC MEDOC in a batch.

### Point

By importing an exported file (\*.gks), the setting can be utilized on other personal computers. Setting files exported in GX Works2 can also be imported.

## 2.7 Checking and Changing Colors and Fonts

Colors and fonts used in each editor can be checked and changed in the "Color and Font" screen. The changed color and font settings are saved in a personal computer for each user who logs on to Windows.

2

### Window

Select [View] ⇒ [Color and Font].

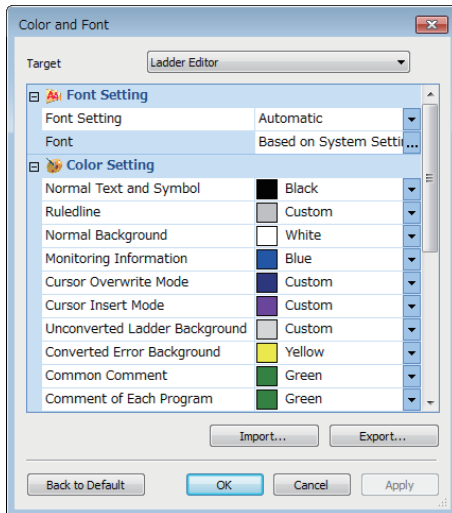

### Operating procedure

1. Select an editor from the pull-down list for "Target."
2. Select "User Setting" from the pull-down list for "Font Setting."
3. Set each item in the "Font" screen, and click the [OK] button.
4. Select a color to change in "Color Setting," and click the [Apply] button.
5. Click the [OK] button.

### Point

By importing an exported file (\*.gcs), the setting can be utilized on other personal computers. Setting files exported in GX Works2 can also be imported. However, color names may differ.

### Precautions

Some fonts may be displayed as garbled characters. If this happens, change the setting to another font.

## 2.8 Displaying and Reading Comments

Comments to be used in a project and ones to be displayed in each screen can be set in the "Multiple Comments Display Setting" screen.

Comments of elements such as common instructions or module FBs can be read in the "Read Comment" screen.

### Display setting for multiple comments

In the "Multiple Comments Display Setting" screen, whether or not to use multiple comments for each element in a project can be set.

A comment to be used in a project and one to be displayed in each screen can be set as well.

### Window

Select [View] ⇒ [Multiple Comments] ⇒ [Display Setting].

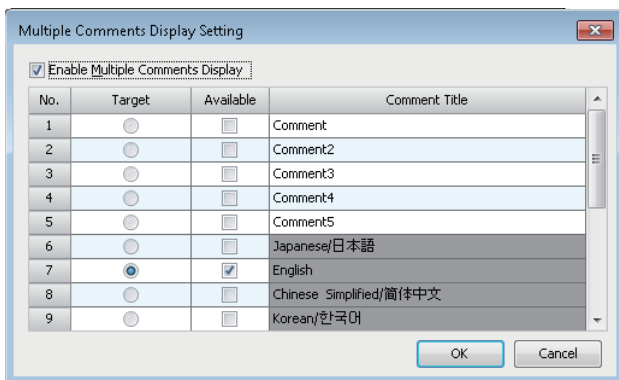

### Operating procedure

1. Select the checkbox of "Enable Multiple Comments Display."
2. Select the checkbox of "Available," and enter a comment title.
3. Select a comment to display in a program editor or each monitor screen in the "Target" column, and click the [OK] button.

### Point

- Up to five comment titles (comment No.1 to 5) can be set.
- Comment No.6 to 12 are used for entering comments in each language.

### Precautions

Do not use comment No.13 to 16 (Reserved 1 to 4).

## Reading comments

Comments of elements such as a common instruction and module FB can be read.

### Window

Select [View] ⇒ [Multiple Comments] ⇒ [Read Comment].

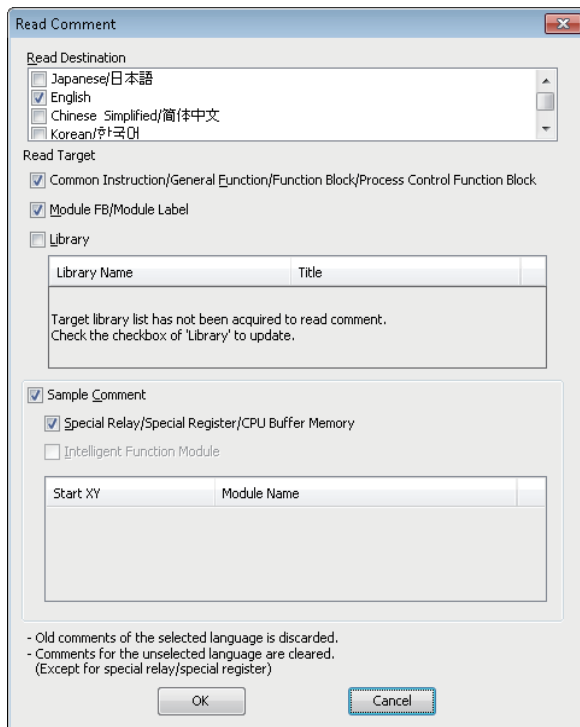

2

### Operating procedure

1. Select the checkbox of a language to display in "Read Destination."
2. Select the checkboxes of elements to read their comments in "Read Target," then click the [OK] button. The comment for each element is applied to the device comment editor of "Common Device Comment."

#### Point

For the elements which have been used in a project, comments in another language can be added. To switch the display language of the comments, use the "Multiple Comments Display Setting" screen.  
☞ Page 82 Display setting for multiple comments

### Precautions

- For the considerations for reading sample comments, refer to the following:  
☞ Page 409 Reading sample comments
- When reading label comments of process control function blocks, module FBs, module labels, and libraries, only Japanese and English comments can be read. Even if the checkboxes of other languages are selected, the comments in those languages are not read.

## 2.9 Option Settings for Each Function

Some functions and editors include the option settings. By changing the option settings, the screen display format can be changed and the detailed operation settings for each function can be set.

The changed option settings are saved in a project. However, they are saved in a personal computer for each user who logs on to Windows if set as default values.

### Window

Select [Tool] ⇒ [Options].

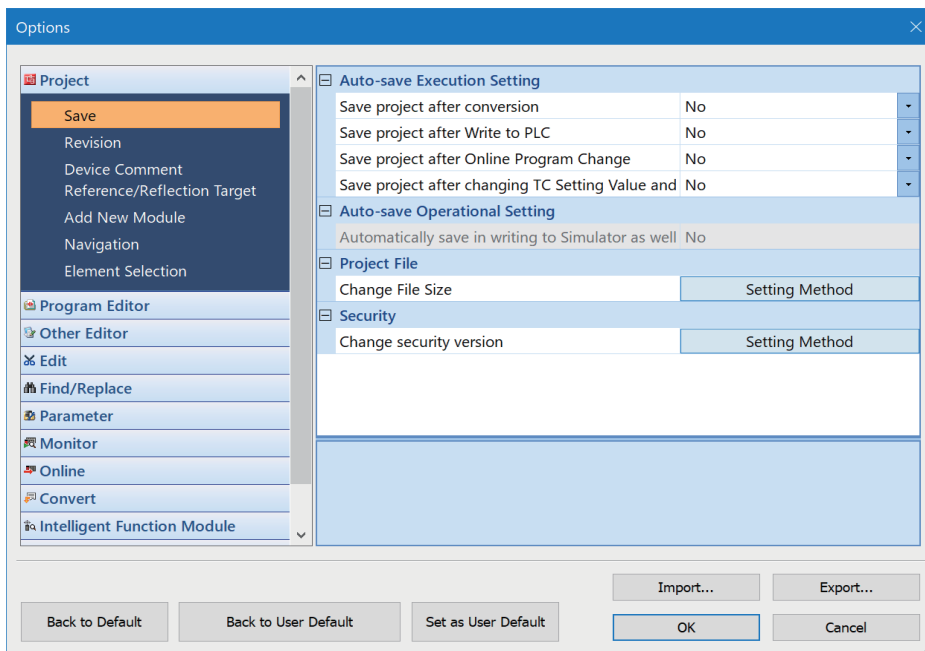

### Operating procedure

Set each item and click the [OK] button.

#### Point

By importing an exported file (\*.gos), the settings can be utilized on other personal computers.

However, note that settings of the following option items are not exported:

- "Project" ⇒ "Device Comment Reference/Reflection Target"
- "Monitor" ⇒ "Common Item" ⇒ "Timing to Execute Monitor Function and Modify Value Function" ⇒ "After the execution of specified program"

### Precautions

#### ■ Converting programs

After changing the following option setting, converting all programs is required.

- [Tool] ⇒ [Options] ⇒ "Other Editor" ⇒ "Label Editor Common" ⇒ "Data Type Setting"
- [Tool] ⇒ [Options] ⇒ "Convert" ⇒ "Basic Setting" ⇒ "Operational Setting"

As a precautionary measure, perform the following operation before switching the CPU module to RUN.

1. Reset the CPU module.
2. Clear values of devices/labels to '0' (Including latch).
3. Clear values of file registers to '0.'

## Optimization of the number of steps

By setting the following options, the number of program steps can be reduced.

### ■RCPU

- [Tool] ⇒ [Options] ⇒ "Convert" ⇒ "Basic Setting" ⇒ "Operational Setting" ⇒ "Optimization of Number of Steps" ⇒ "Optimize the Number of Steps."
- [Tool] ⇒ [Options] ⇒ "Convert" ⇒ "Basic Setting" ⇒ "Operational Setting" ⇒ "Optimization of Number of Steps" ⇒ "Optimize Level"

### ■FX5CPU

- [Tool] ⇒ [Options] ⇒ "Convert" ⇒ "Basic Setting" ⇒ "Operational Setting" ⇒ "Optimization of Number of Steps" ⇒ "Optimize the Number of Steps."
- [Tool] ⇒ [Options] ⇒ "Convert" ⇒ "Basic Setting" ⇒ "Operational Setting" ⇒ "Optimization of Number of Steps" ⇒ "Collectively Allocate Temporary Area to Optimize the Number of Steps"
- [Tool] ⇒ [Options] ⇒ "Convert" ⇒ "Basic Setting" ⇒ "Operational Setting" ⇒ "Optimization of Number of Steps" ⇒ "Optimize Level"

## Precautions

- Depending on each option setting and the version of GX Works3, the number of steps of a program, module FB, and library (with the "mslm" extension) may differ from the value mentioned in each manual.

### ■Optimize level

The following shows the difference in processing between the optimize levels.

- Level 1: By optimizing the redundant processing in a program at conversion, the number of steps in the program is reduced.
- Level 2: In addition to the processing in the level 1, the number of steps may be further reduced if any of the following conditions is satisfied in each program.

Condition	Program
A standard function is being used.	Ladder program ST program SFC program FBD/LD program
An input/output label (VAR_IN_OUT) is being used in a macro type function block.	ST program FBD/LD program
Binary operation is being used.	ST program
Unary operation is being used.	
ELSE is being used in a select statement (IF statement or CASE statement).	
A contact element is connected to a left power rail element.	FBD/LD program
Any of the following instructions or functions is being used. <ul style="list-style-type: none"> <li>• Rising instruction (PLS)</li> <li>• Falling instruction (PLF)</li> <li>• Boolean function</li> <li>• Comparison function</li> </ul>	FBD/LD program
Ladders containing a variable element which substitutes its value into the next variable element are consecutively placed.	
ENO of a function is connected to EN of another function.	
ENO of a function is not connected to another element.	

## ■Project for which "Yes" is selected for "Optimize the Number of Steps."



A conversion error may occur in a project that satisfies the following two conditions. In that case, a subroutine program or interrupt program must be changed to a program using an FB or inline structured text box.

- "Yes" is selected for "Optimize the Number of Steps." in [Tool] ⇒ [Options] ⇒ "Convert" ⇒ "Basic Setting" ⇒ "Operational Setting" ⇒ "Optimization of Number of Steps"\*1.

- Any of the data in the following table is used in a subroutine program or an interrupt program.

\*1 For a project for an FX5CPU, "Yes" needs to be selected in the following option as well.

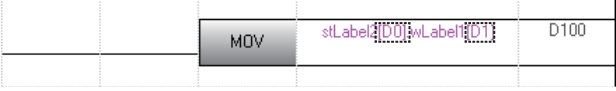
[Tool] ⇒ [Options] ⇒ "Convert" ⇒ "Basic Setting" ⇒ "Operational Setting" ⇒ "Optimization of Number of Steps" ⇒ "Collectively Allocate Temporary Area to Optimize the Number of Steps"

No.	Data
1	<p>A label for which two or more devices or labels are used as the index of an array set for the data type (Example) Data type: structure array</p>  <p>(Example) Data type: two-dimensional array</p> 
2	A subroutine type function block in which EN/ENO is used
3	<p>Standard function DINT_TO_BCD(_E), BCD_TO_DINT(_E), MUL(_E), DIV(_E), MOD(_E), XOR(_E), MAX(_E), MIN(_E), MUX(_E), LT(_E), LE(_E), EQ(_E), GE(_E), GT(_E), MID(_E), CONCAT(_E), INSERT(_E), MUL_TIME(_E), DIV_TIME(_E)</p>

Modify a subroutine program or an interrupt program by any of the following methods.

- (1) Change a program to a function block.

### Subroutine program

- Change the subroutine program (1) to the function block (2), and change the program to call the created function block (2).

(Example) Program before modification

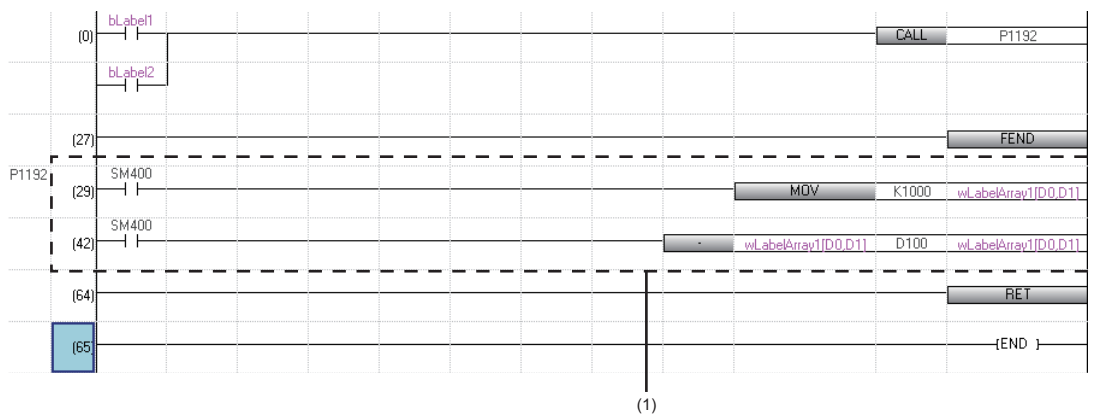

(Example) Program after modification

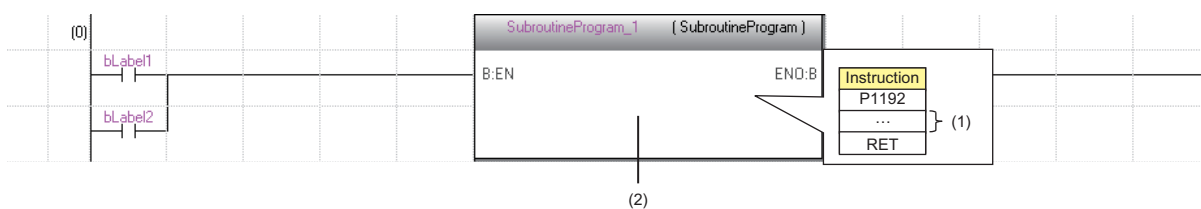



## Interrupt program

- Change the interrupt program (1) to the function block (2).

(Example) Program before modification

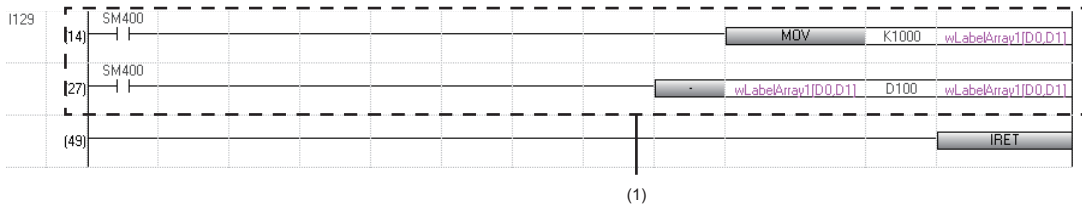

(Example) Program after modification

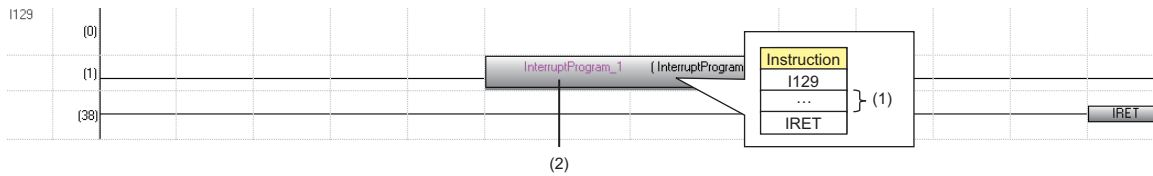

(2) Change a program to an inline structured text box.

### Subroutine program

- Create the subroutine program (1) to the inline structured text box (2), and change the program to call the created inline structured text box (2).

(Example) Program before modification

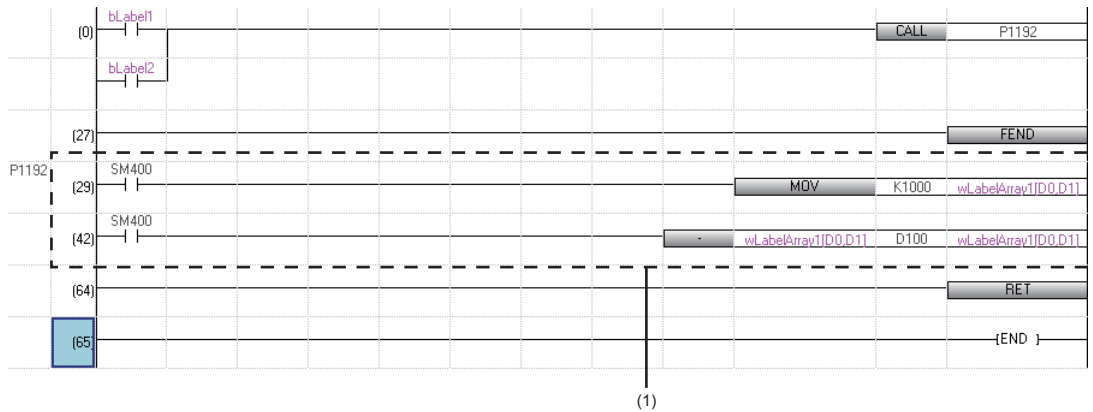

(Example) Program after modification

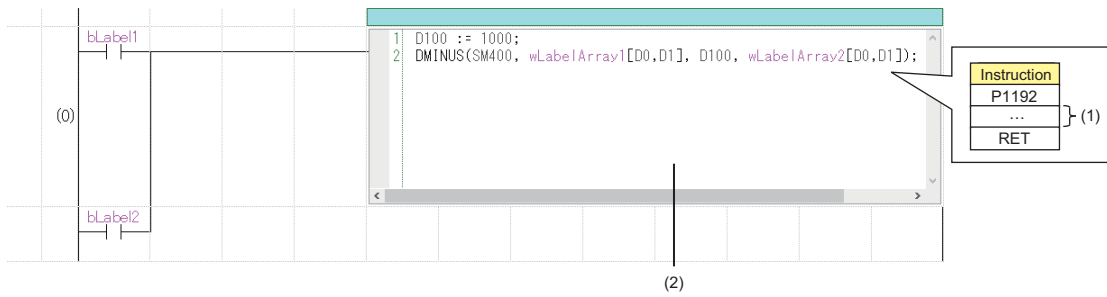

### Interrupt program

- Change the interrupt program (1) to the inline structured text box (2).

(Example) Program before modification

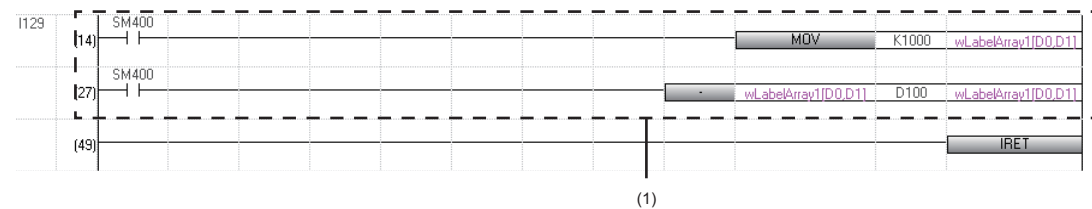

(Example) Program after modification

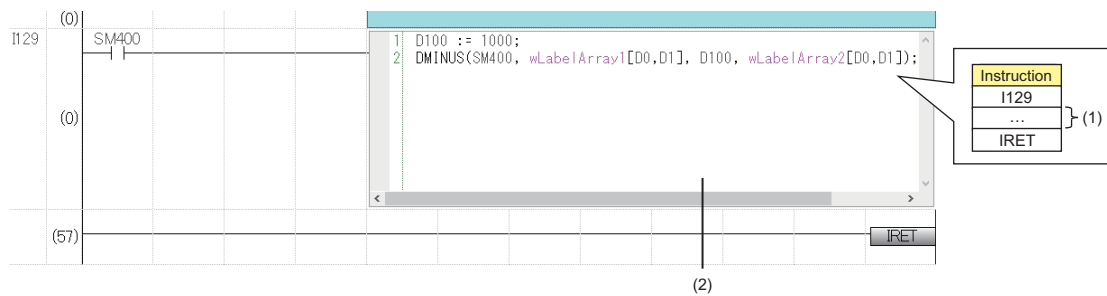

### ■An error 'Temporary area exceeded' occurs in an FX5CPU

A temporary area is used for passing and receiving the arguments of function blocks and functions, and calculating operations.

The memory capacity for a temporary area that can be allocated for each program block in a program file is limited. If a program file including a program block exceeding the capacity is written to a CPU module, an error 'Temporary area exceeded' will occur.

In that case, reduce the usage of the temporary area for one program block by any of the following actions.

- Set "No" for "Collectively Allocate Temporary Area to Optimize the Number of Steps" in [Tool] ⇒ [Options] ⇒ "Convert" ⇒ "Basic Setting" ⇒ "Operational Setting" ⇒ "Optimization of Number of Steps."
- Divide one program block into some program blocks.

The capacity of a temporary area can be extended from 700 words to 32767 words by setting the following CPU parameter to "128000 Steps":

- "Program Setting" ⇒ "Program Capacity Setting"

For details, refer to the following:

 MELSEC iQ-F FX5 User's Manual (Application)

## Process control extension setting

### ! CAUTION

■ To set the event notification, confirm the setting contents carefully.

If there is no module set in "Event Notification" or the setting contents is incorrect, the following phenomena may result when an event occurs.

- The CPU module stopped due to the error.
- The network module communication error occurs.
- No event notification is received.

When adjusting the system, after confirming that nothing affects of the actual system, it is recommended to check that the above phenomena do not result when an event occurs by an operation such as switching the control modes of a faceplate (example: MANUAL → AUTO, AUTO → MANUAL).

### Window

Select [Tool] ⇒ [Options] ⇒ "Convert" ⇒ "Process Control Extension Setting."

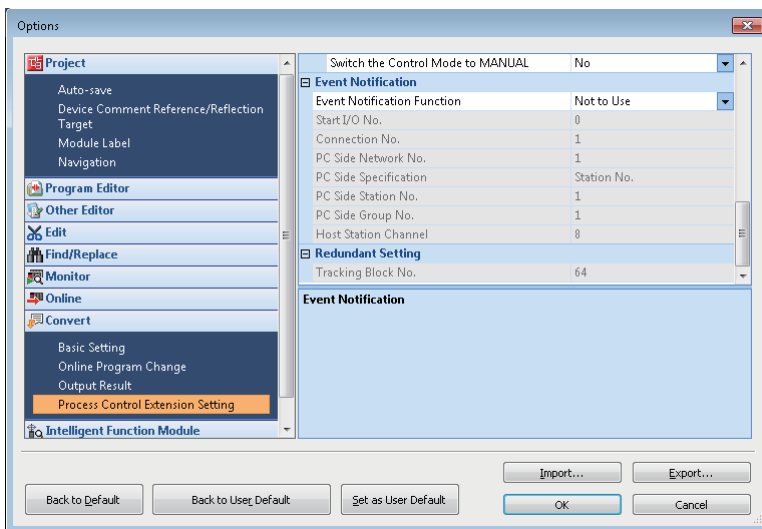

### ■ Event notification

The following table shows the options of "Event Notification Function."

Options	Description
Not to Use	No event is notified to PX Developer Monitor Tool even though an event occurs (including an alarm) in a CPU module.
Built-in Ethernet Port CPU	Events (including an alarm) occurred in a CPU module are notified to PX Developer Monitor Tool via an Ethernet port.
Ethernet	Events (including an alarm) occurred in a CPU module are notified to PX Developer Monitor Tool via Ethernet.
Q Compatible Ethernet	Specify the connection number of port 1 for "Connection No.". When using an Ethernet module (Port 1 network type: Q-compatible Ethernet), select "Q Compatible Ethernet." For details on Q-compatible Ethernet, refer to the following: <a href="#">MELSEC iQ-R Ethernet/CC-Link IE User's Manual (Startup)</a>
CC-Link IE Controller Network	Events (including an alarm) occurred in a CPU module are notified to PX Developer Monitor Tool via CC-Link IE Controller Network.

## Precautions

### ■For CC-Link IE Controller Network

Do not use the following channel numbers for the link dedicated instructions in a ladder program.

- Channel number used by the own station: Channel number set in "Event Notification"
- Channel number of a target station used for storing data: 1 (number for PX Developer Monitor Tool)

For details on channel numbers, refer to the manual of a network module used.

### ■For an Ethernet module/built-in Ethernet CPU

Broadcast in UDP/IP is used for sending data.

The UDP connection device number (broadcast) that was added in the following parameter is required to be set for "Connection No." in "Event Notification."

- Ethernet module: "Module Information" ⇒ "(module name)" ⇒ "(module parameter)" ⇒ "Basic Settings" ⇒ "External Device Configuration"
- Built-in Ethernet CPU: "(CPU model name of the project)" ⇒ "Module Parameter" ⇒ "Basic Settings" ⇒ "External Device Configuration"

The same number needs to be set for "Port No." of "Sensor/Device" and "Event Notification UDP Port No.(HEX)" in PX Developer Monitor Tool.

For details, refer to the following:

 PX Developer Version 1 Operating Manual (Monitor Tool)

## 2.10 Printing Data

This section explains the printing method of data created in GX Works3.

### Window

Select [Project] ⇒ [Print] (🖨️).

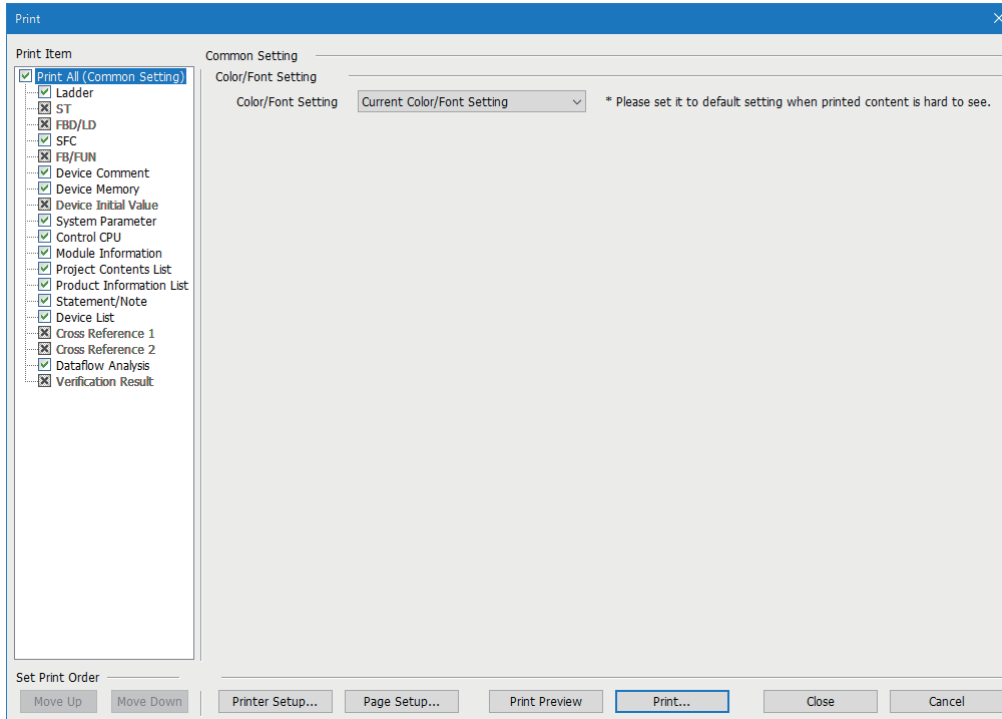

When no data to be printed exists, × is shown on the checkbox of print items.

### Operating procedure

1. Select data to print and set each setting.
2. Change the printer by clicking the [Printer Setup] button and set the page setting by clicking the [Page Setup] button.
3. Click the [Print] button.

### Point

If the print result is hard to see, it will be more visible by changing its colors and fonts to the defaults when printing. (Example: When the background color of an editor is set to black, the background color in print result can be changed to white.)

By setting the following option, the color and font for the printing can be changed.

- "Print All (Common Setting)" ⇒ "Common Setting" ⇒ "Color/Font Setting" in the "Print" screen

## Print image preview

The print image of each data can be checked.

### Window

Select [Project] ⇒ [Print Preview].

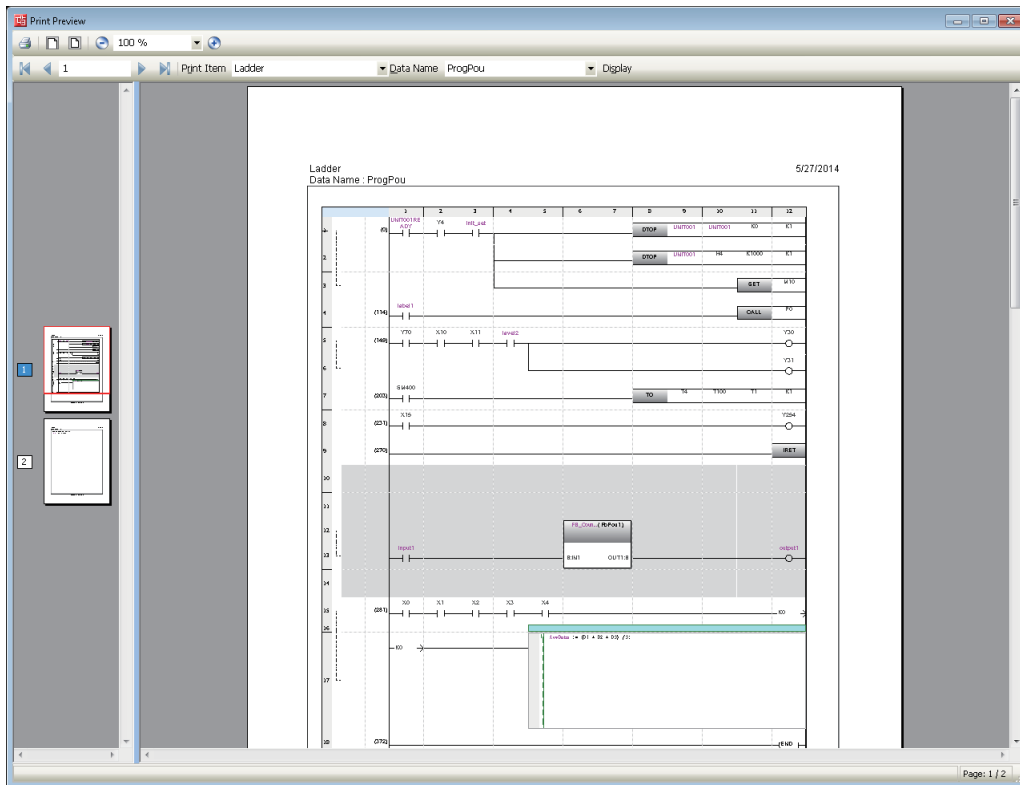

### Operating procedure

1. Select [Project] ⇒ [Print Preview].
2. Click the [Print Preview] button in the "Print" screen.
3. To change data to preview, select "Print Item" and "Data Name," and click the [Display] button.

## Considerations

### ■ Displaying print previews and printing data

While the following functions are being performed, neither displaying print preview nor printing data can be performed.

- Monitor
- Simulation
- Offline monitor

### ■ Printing a large amount of data

Large amount of data may not be printed at all or printed half way due to the limitations of printer driver or Windows print spooler. In this case, print the data by any of the following methods.

- Split the data by setting a print range.
- Select "Print directly to the printer" in the [Advanced] tab of the property screen (select [View devices and printers] in the control panel of Windows).
- Set "Output by Item" for the print job output in the "Printer Setup" screen.

## ■Outputting the print contents on a file

- When print contents are output to a file, the "Save As" screen may appear in the background of other screens.  
Press the **Alt** + **Tab** keys or **Alt** + **Esc** keys to bring the screen in the foreground.
- GX Works3 will not respond if it is operated while the "Save As" screen is being displayed.  
When the message appears, select "Wait for the program to respond." Selecting "Close the program" results in loss of unsaved data.

## ■Printing ladder programs

For "Start Row" and "--End Row" of "Specify Print Range," specify the rows that is shown when a whole program is displayed in a ladder editor.

Depending on the following setting and menu selection, the number of rows in print result may differ from that of the range specified.

- Print screen setting: "Ladder" ⇒ "Setting by Item (Ladder)" ⇒ "Additional Information" ⇒ "Statement/Note" in the "Print" screen
  - View menu: [View] ⇒ [Statement Display] and [Note Display]
- : Selected, —: Unselected

Print screen setting	View menu		Print result
	Statement	Note	
○	○	○	Matched
	○	—	
	—	○	
	—	—	
—	○	○	Mismatched
	○	—	
	—	○	
	—	—	
			Matched

The display magnification of a print result is 100%.

If the display magnification<sup>\*1</sup> of a ladder editor is set to a value other than 100%, some texts may get cut in a print result. In this case, set the display magnification<sup>\*1</sup> of a ladder editor to 100%, and adjust the column width as necessary.

- \*1 Can be set in the following menu:  
[View] ⇒ [Zoom] ⇒ [Set Zoom Factor]

### Point

When the character size is adjusted according to the display magnification of the editor by using the following menu, the characters are printed in that size.

- [View] ⇒ [Text Size] ⇒ [Autofit]



## ■ Printing FBD/LD programs

In an FBD/LD editor, elements can be placed anywhere. Therefore, the elements may be printed across multiple pages as shown below.

Check where the page breaks are by any of the following methods before printing.

- Select [View] ⇒ [Display Page Break].
- Click the [Print Preview] button in the "Print" screen.

The paper setting different from one in the page setting can be set in "FBD/LD" in the "Print" screen.

### Ex.

When the elements are printed across multiple pages, dashed lines (1) are displayed on the verges of the pages.

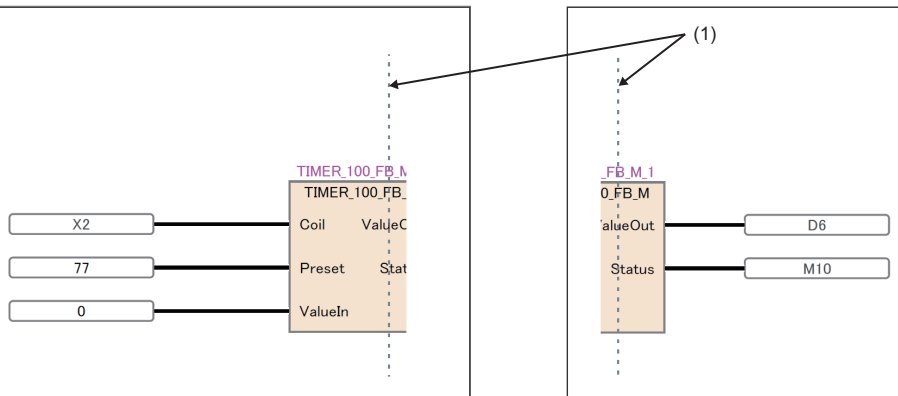

When setting "Zoom" in "Setting by Item (FBD/LD)" of the "Print" screen, note the following:

- If an FBD/LD program is too big, the program may be printed across multiple pages even when the checkbox of "Fit to One Page" is selected.
- The page break in an FBD/LD editor is always displayed on the basis of a magnification of 100% regardless of the selection status of "Fit to One Page" and the value in "Zoom."

Therefore, the page break for printing may differ from the one displayed in the editor.

## ■ Printing inline structured text programs used in FBD/LD programs

An inline structured text program used in an FBD/LD program can be printed by selecting the checkbox of the following item:

- "Print" screen ⇒ "Setting by Item (FBD/LD)" ⇒ "Additional Information" ⇒ "Inline Structured Text"

Line numbers can be printed by selecting the checkbox of the following item:

- "Print" screen ⇒ "Setting by Item (ST)" ⇒ "Print Conditions" ⇒ "Print Row No."

However, the print range cannot be changed. The whole range of an inline structured text program is printed.

## ■Printing SFC programs

- When printing statements and notes, ones in a Zoom are not printed.
- In an SFC diagram editor, SFC elements may be printed across multiple pages as shown below. Check the layout in the print preview before printing.

**Ex.**

When the elements are printed across multiple pages, dashed lines (1) are displayed on the verges of the pages.

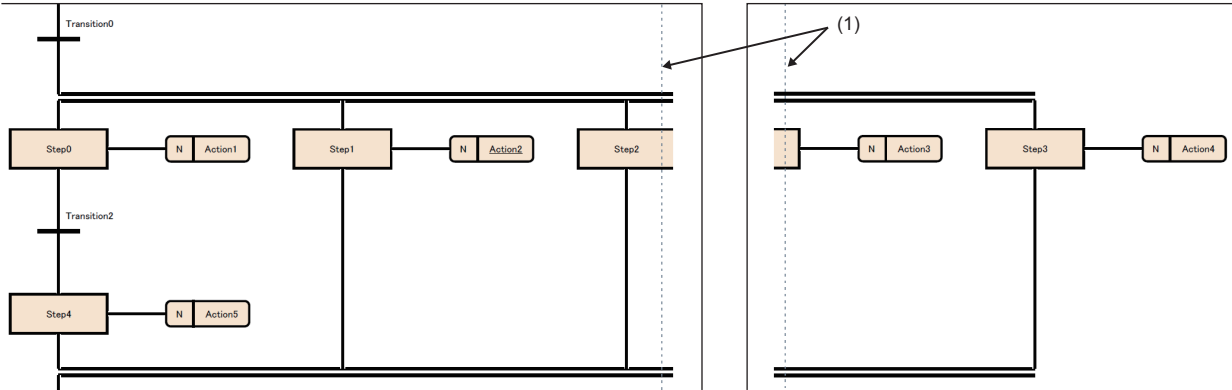

When setting "SFC Diagram Detailed Settings" in "Setting by Item (SFC)" of the "Print" screen, note the following:

- "SFC Diagram Detailed Settings" can be set only when the checkbox of "SFC Diagram" in "Program Block Print Item" is selected.
- If an SFC program is too big, the program may be printed across multiple pages even when the checkbox of "Fit to One Page" is selected.
- Actions on an SFC diagram are not printed if the checkboxes of the following two items are selected; however, Zooms (actions/transitions) are printed.
  - "Program Block Print Item" — "Action/Transition"
  - "SFC Diagram Detailed Settings" — "Do not Print Actions"

## ■Printing a product information list

The information in a specified CSV file is printed out within the range of 500 rows × 20 columns.

## ■Printing a data flow diagram

- In a data flow diagram, blocks may be printed across multiple pages as shown below. Check the layout in the print preview before printing.

**Ex.**

When the blocks are printed across multiple pages, dashed lines (1) are displayed on the verges of the pages.

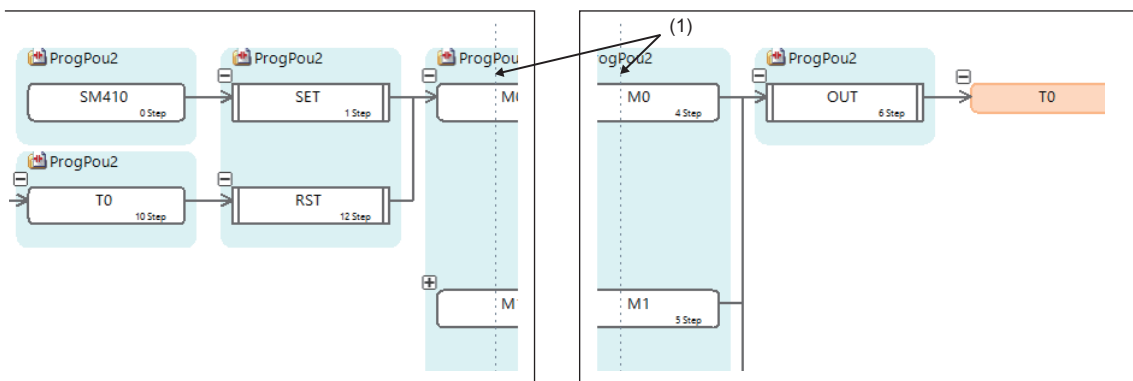

- If a data flow diagram is too big, the diagram may be printed across multiple pages even when the checkbox of "Fit to One Page" is selected.

# PART 2

# SYSTEM DESIGN AND SETTINGS

This part explains the system design such as project management and parameter/label settings.

3 PROJECT MANAGEMENT

---

4 CREATING MODULE CONFIGURATION DIAGRAM AND SETTING PARAMETERS

---

5 REGISTERING LABELS

---

# 3 PROJECT MANAGEMENT

This chapter explains basic operations and management of a project.

## 3.1 Project File and Data Configuration

Projects created in GX Works3 are saved as a workspace format or single file format.

Data created in a project is displayed in the navigation window.

### File format

#### Workspace format

A workspace manages multiple projects at once.

When constructing a system composed with multiple CPU modules, a project file needs to be created for each CPU module.

Multiple project files in a same system can be managed by saving them as a workspace format.

<System configuration example>

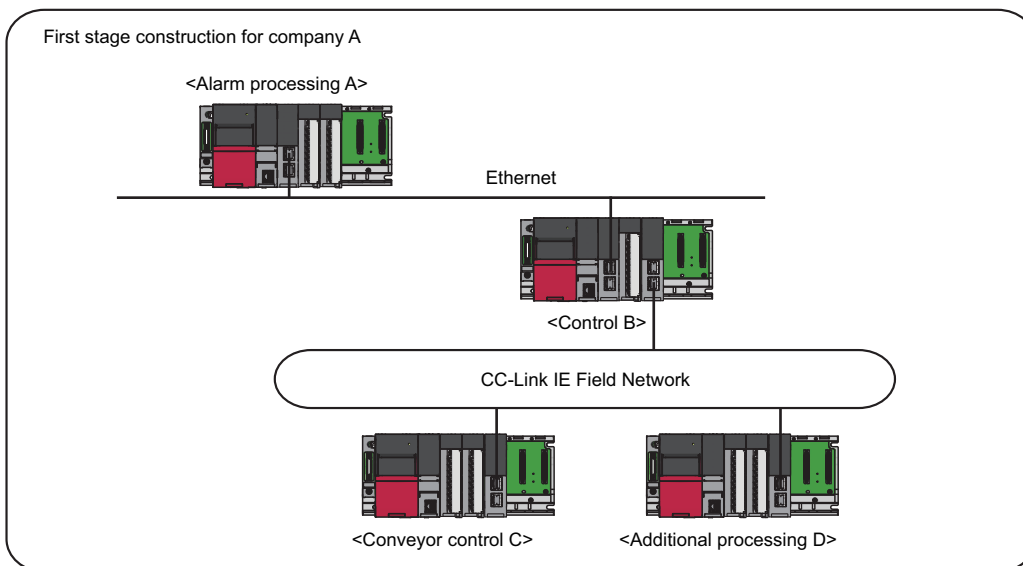

Batch-manage projects in the workspace format

<GX Works3 project management>

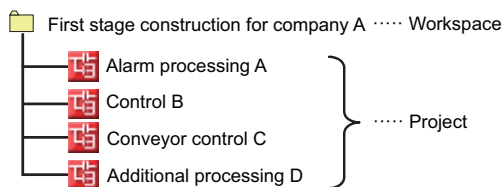

## Workspace/project configuration

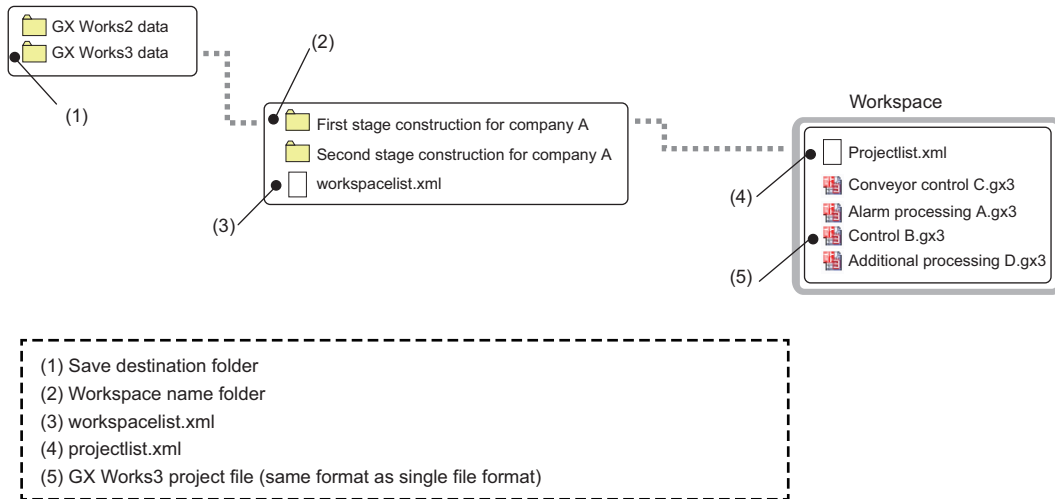

- (1) Save destination folder
- (2) Workspace name folder
- (3) workspacelist.xml
- (4) projectlist.xml
- (5) GX Works3 project file (same format as single file format)

### ● Editing a configuration or name

Do not change or delete a workspace configuration or project name by using an application such as Windows Explorer. A project that does not contain actual data may remain in the project list displayed in the "Open Project" screen. (Select [Project] ⇒ [Delete] to delete the project.)

### ● Copying a project

To copy a project by using an application such as Windows Explorer, perform any of the operations listed below. By doing so, a project can be copied without collapsing the configuration of the workspace/project.

- Copy an entire save destination folder ((1) in the above figure).
- Copy a workspace name folder and "workspacelist.xml" ((2) and (3) in the above figure).
- Copy a GX Works3 project with the same name.

## Single file format

A single file format does not need a workspace.

Projects can be managed regardless of the folder configuration and the file configuration by saving projects as a single file format.

Thereby, operations such as changing a project name, copying and pasting a project, and sending and receiving data can easily be performed using an application such as Windows Explorer.

## Safety project backup

A system administrator needs to back up a safety project and save the data securely to restore it anytime.

To back up a project, be sure to use the menu [Project] ⇒ [Save As] in GX Works3.

# Data configuration

## Data displayed in the navigation window

The following shows the data displayed in the navigation window in a tree. (Default data names are used.)

### Module configuration data



Creation method:  Page 188 Creating a Module Configuration Diagram

Image	Item	Description
 Module Configuration	Module configuration diagram	Data that displays a target system of a project graphically.

### Program data

Creation method:  Page 128 Creating Data

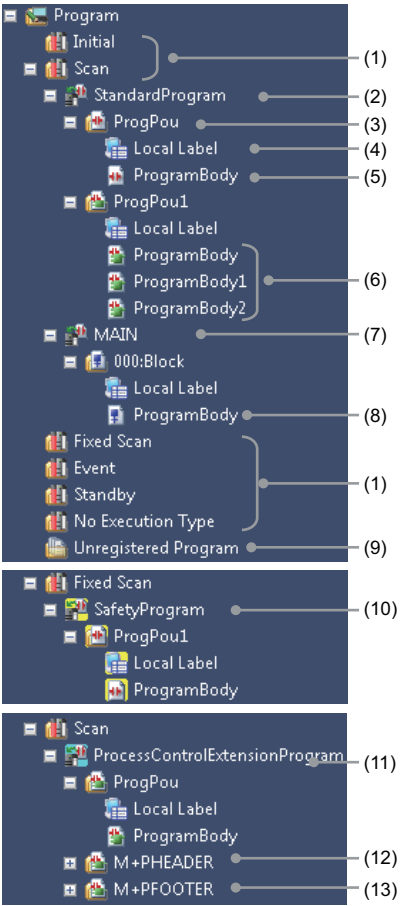



Image	Item	Description
	(1) Execution type	A setting for a situation when a program runs. To execute a program in a CPU module, the program need to be assigned to any of the execution types.  Page 261 Setting method
	(2) Program file	A file that manages programs. It should be created for each execution process. Created files are written to a CPU module individually.
	(3) Program block (POU)	Data that composes programs. The execution order can be set (  Page 260 Program execution order setting).
	(4) Local label	Label data that can be used only in a defined program block
	(5) Program body	Program data that is created in Ladder Diagram language
	(6) Worksheet (Program body)	Program data that is created in Structured Text or Function Block Diagram/Ladder Diagram language. By using Structured Text or Function Block Diagram/Ladder Diagram language, multiple worksheets (program bodies) can be created in a program block. The execution order can be set (  Page 261 Worksheet execution order setting).
	(7) Block	Data that composes SFC blocks
	(8) Program body	SFC diagram data that is created by using Sequential Function Chart language
	(9) Unregistered program	A folder that temporarily stores program files with no execution type determined. Stored program files will not be executed if they are written to a programmable controller.
	(10) Program file (For safety)	A file that manages safety programs
	(11) Program file (For process control)	A program file with the process control extension enabled
	(12) System header	A program block required to execute a process control program of the scan execution type. No editing is allowed.  Page 425 System header and system footer
	(13) System footer	

Image	Item	Description
	(14) FB file	A file that manages function blocks. FB files are written to a CPU module individually. ☞ Page 484 Creating a Function Block
	(15) Function block (POU)	Data that composes the programs of function blocks
	(16) Local label	Label data that can be used only in defined function blocks
	(17) Program body	Function block data that is created in Ladder Diagram language. This data is referred to as an 'FB program' in this manual.
	(18) Worksheet (Program body)	Function block data that is created in Structured Text or Function Block Diagram/Ladder Diagram language. Multiple worksheets can be created in a function block. In addition, the execution order can be set (☞ Page 261 Worksheet execution order setting). This data is referred to as an 'FB program' in this manual.
	(19) FB file (For safety)	A file that manages a function block of a safety program
	(20) FUN file	A file that manages functions. The function files are written to a CPU module for each FUN file. ☞ Page 504 Creating a Function
	(21) Function (POU)	Data that composes a program of a function
	(22) Local label	Label data that can be used only in defined functions
	(23) Program body	Function data that is created in Ladder Diagram language. This data is referred to as a 'FUN program' in this manual.
	(24) Worksheet (Program body)	Function data that is created in Structured Text or Function Block Diagram/Ladder Diagram language. Multiple worksheets can be created in a function. In addition, the execution order can be set (☞ Page 261 Worksheet execution order setting). This data is referred to as a 'FUN program' in this manual.
	(25) FUN file (For safety)	A file that manages functions of safety programs

**Point**

When a label or a program body is set to be hidden, a program block, function block, and function is displayed at the lowermost layer (i.e. the layer of them in the tree is not displayed). Therefore, some data items, which are usually displayed on the lower part of the tree, can be seen without scrolling.

- Select "No" for "Display Labels" and "Display the Program Body" from [Tool] ⇒ [Options] ⇒ "Project" ⇒ "Navigation" ⇒ "Display Setting."

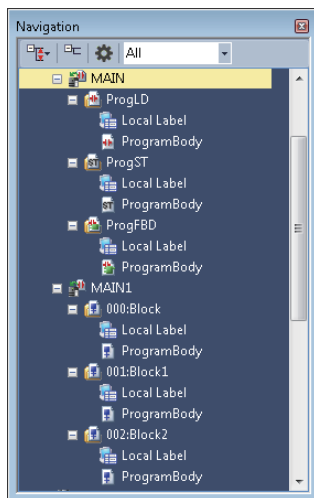

Display Labels: Yes  
Display the Program Body: Yes

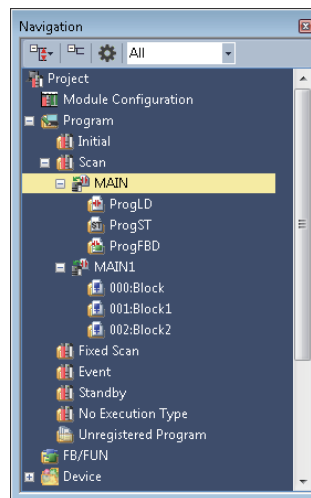

Display Labels: No  
Display the Program Body: No

## Label data

Creation method: [Page 128 Creating Data](#)

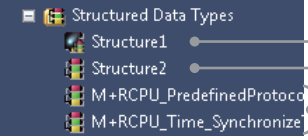
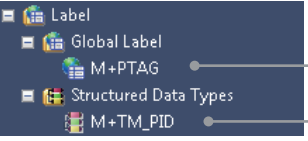
Image	Item	Description
	(1) Global label	A label that can be accessed from all program blocks and function blocks in a project <a href="#">Page 227 Registering Labels</a>
	(2) Module label	A label that is used to access an I/O signal or buffer memory of a module <a href="#">Page 248 Registering Module Labels</a>
	(3) Safety global label	A global label for safety programs
	(4) Standard/safety shared label	A global label that can be used in both standard programs and safety programs
	(5) System structure definition	A structure registered in the system label database
	(6) Structure definition	Data that defines structure as a data type. This can be used as a data type of all labels which can be defined in a project except for a recursive definition in the defined structure.
	(7) Structure definition required for module labels	Data that automatically registers a structure required for a module label
	(8) Global label used for the process control extension	A global label that is automatically created as "M+PTAG" at the time of registration of tag FBs. A tag FB instance and tag data are registered. <a href="#">Page 249 Registering Tag FBs</a>
	(9) Structure definition of tag data	Structure definition of tag data that is automatically registered at the time of registration of tag FBs

## Device data

Creation method: [Page 128 Creating Data](#)

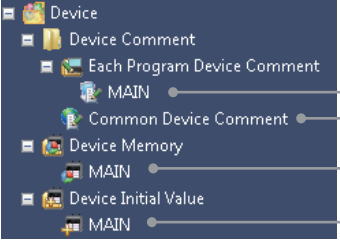
Image	Item	Description
	(1) Each program device comment	Data of device comments that can be used in a program file with the same name as this data <a href="#">Page 400 Registering Device Comments</a>
	(2) Common device comment	Data of device comments that can be used in multiple programs <a href="#">Page 400 Registering Device Comments</a>
	(3) Device memory	Data that includes a value to be written to/read from a device in a CPU module <a href="#">Page 434 SETTING DEVICE MEMORY</a>
	(4) Initial device value	Data that defines a value which is set to a device when a CPU module is in RUN <a href="#">Page 441 INITIAL DEVICE VALUE SETTING</a>

## Parameter data

The structure of the tree and the creation methods: [Page 199 Setting Parameters](#)



## 3.2 Creating a Project File

This section explains the methods for some operations such creating, opening, and or saving a project.

### Creating a project

The following explains the creation methods of a new project.

For a safety project, a user registration is required. (Page 104 Adding a new user)

3

#### Window

Select [Project] ⇒ [New] ( ).

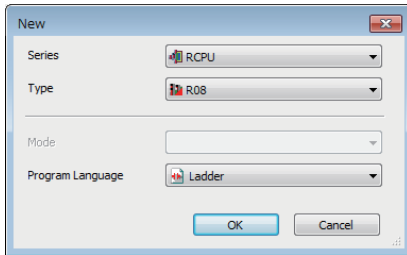

#### Operating procedure

Select each item and click the [OK] button.

#### Precautions

When creating a safety project, set a screen saver in Windows to lock the personal computer automatically if the non-operated state has been continued for a certain time.

For details, refer to Windows Help and Support.

#### ■Selecting a QCPU (Q mode), an LCPU, or an FXCPU

When a QCPU (Q mode), an LCPU, or an FXCPU is selected, GX Works3 starts in the Q/L/FX series compatibility mode.

It will automatically start up only when GX Works2 Version 1.566Q or later is installed in the personal computer.

If it is not installed, execute "setup.exe" in the installation DVD (Disk2) of GX Works3.

#### ■Creating a project for an RnENCPU

An RnENCPU consists of the two slots; CPU part and network part.

The CPU part only is placed after creating a new project.

Place the network part any of the following methods.

- Place a CPU extension module (\_RJ71EN71) in the "Module Configuration" window.
- Set a CPU extension module (\_RJ71EN71) in "I/O Assignment Setting" in "System Parameter."

#### ■Creating a project for an LHCPU

When a new project for an LHCPU is created, a CPU extension module (\_IO) is automatically set for "I/O Assignment Setting" in "System Parameter."

#### ■Specifying the specific model name of FX5CPU

The specific model name of an FX5CPU can be specified by any of the following methods.

- Right-click a CPU module on the module configuration diagram, then click [Change CPU Model Name] from the shortcut menu.
- Select the specific model name of a CPU module in "I/O Assignment Setting" on the [I/O Assignment] tab of the "System Parameter" screen.

## Adding a new user

When creating a new safety project, a user registration is required in the "Add New User" screen.

### Window

1. Select an RnPSFCPU or an RnSFPCPU for "Type" in the "New" screen.
2. Click the [OK] button.

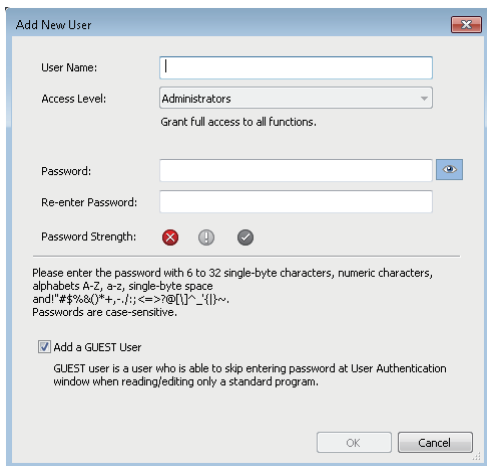

### Operating procedure

1. Set each item and click the [OK] button.  
To register a guest user, select the checkbox of "Add a GUEST User." (☞ Page 684 Guest user)
2. Set each item in the "Save as" screen and click the [Save] button.

## Creating a new project by reading data read from a programmable controller

When data is read from a programmable controller without creating a new project, a new project is created based on the data from a CPU module and intelligent function module.

When a QCPU (Q mode), an LCPU, or an FXCPU is selected, GX Works3 is started in the Q/L/FX series compatibility mode and a new project can be created.

When user information is registered to a project, user authentication is required. (☞ Page 690 Logging on to CPU module)

### Operating procedure

1. Start GX Works3 and select [Online] ⇒ [Read from PLC] (📄).
2. Select the series to be read in the "Series Selection" screen, and click the [OK] button.
3. Set the communication route to access the CPU module in the "Specify Connection Destination" screen, and click the [OK] button.
4. Read data in the "Online Data Operation" screen.

For reading data in the "Online Data Operation" screen, refer to the following:

☞ Page 589 Reading data from a programmable controller

### Precautions

When parameters are not read from the programmable controller with data to create a new project, default parameters will be set. Check the parameter setting.

# Opening a project

Read a project saved on a personal computer or another data storage device.

When user information is registered to a project, user authentication is required. (Page 690 Logging on to CPU module)

## Window

Select [Project] ⇒ [Open] ( ).

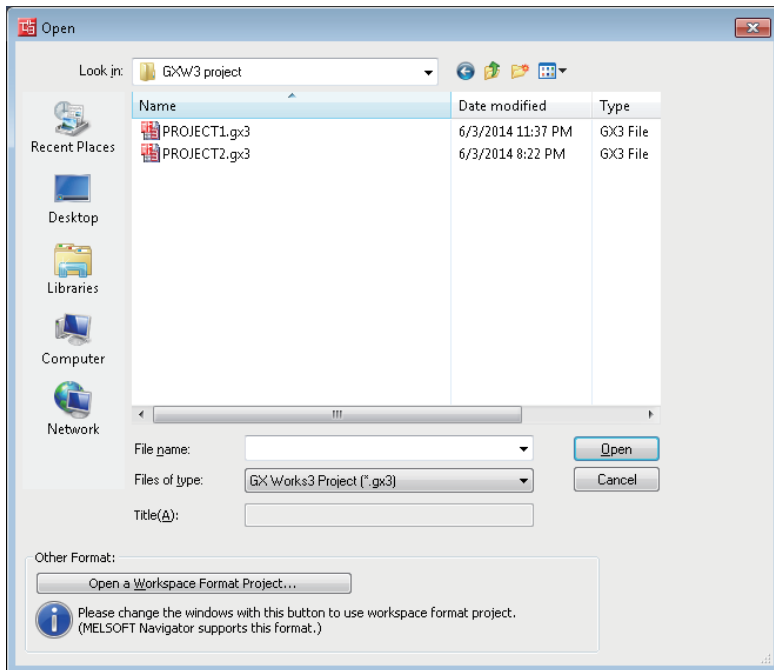

3

## Operating procedure

Set each item and click the [Open] button.

## Precautions

### ■ Changing workspace names and folder configuration

Do not change a storage location and a file name for folders and files of a workspace/project by using an application such as Windows Explorer.

### ■ Opening a project being edited by another user

The project can be opened as a read-only project. However, the following functions cannot be used.

- Overwriting projects
- Changing the module type and operation mode

### ■ Projects saved on a network drive or removable media

Do not open the project directly. Open it after saving it to a personal computer.

### ■ Opening a safety project

Set the screen saver in Windows to lock a personal computer when no operation has been performed for a certain time.

For details, refer to Windows Help and Support.

### ■ Opening a project for a QCPU (Q mode), an LCPU, or an FXCPU

When one of the following project is selected, the project is opened with the Q/L/FX series compatibility mode in GX Works3.

- GX Works2 project saved as a single file format
- GX Works2 project saved in a workspace format
- GX Works3 project created in the Q/L/FX series compatibility mode which was saved as a single file format

When opening a project which was compressed in GX Works2, decompress the project in GX Works2 in advance.

## Opening another format project

---

Projects created in other engineering tools can be opened and used in GX Works3.

In this manual, projects created in other engineering tools are referred to as other format projects; GX Works3 projects replaced with the project data are referred to as GX Works3 format projects.

When opening another format project in GX Works3, the CPU module type is changed to one which can be used in GX Works3.

This makes it possible to retain the project data of different CPU module series.

For details on the methods to open each 'other format project' and the data replacement, refer to the following:

Other format project	Reference	
GX Works2	Page 107 Opening a GX Works2 format project	Page 900 Replacement of a GX Works2 format project
PX Developer	Page 110 Opening a PX Developer format project	Page 918 Replacement of a PX Developer format project
GX IEC Developer	Page 115 Opening a GX IEC Developer format project	
GX Developer	Page 124 Opening a GX Developer format project	Page 924 Replacement of a GX Developer format project

## Opening a GX Works2 format project

A project created in GX Works2 (GX Works2 format project) can be opened and used in GX Works3.

This function is supported in projects for the following modules only:

- Universal model QCPU
- High-speed universal model QCPU
- Universal model process CPU
- Redundant CPU
- LCPU
- FXCPU (FX3S, FX3U, FX3UC, FX3G, FX3GC)

The following shows the module type to be changed.

Before change	After change <sup>*1</sup>
Universal model QCPU	R120CPU
High-speed universal model QCPU	
Universal model process CPU	R120PCPU (process mode)
Redundant CPU	R120PCPU (redundant mode)
LCPU	<ul style="list-style-type: none"> <li>• When opening a project in GX Works3 Version 1.087R or earlier: L16HCPU</li> <li>• When opening a project in GX Works3 Version 1.090U or later: L32HCPU</li> </ul>
FXCPU (FX3S, FX3G, FX3GC, FX3U, FX3UC)	FX5SCPU <sup>*2</sup> , FX5UCPU, FX5UCCPU <sup>*3</sup> , FX5UJCPU

\*1 The new module type can be set in the "Select the New Module Type/Conversion Method" screen when opening a project for an FXCPU.

\*2 Cannot be changed from an FX3U and FX3UC.

\*3 To change the module type to an FX5UCCPU, set "Type" to "FX5U" in the "Select the New Module Type/Conversion Method" screen. After a project is opened, set the module name of an FX5UCCPU, and the project can be used as a project for the FX5UCCPU.

( Page 103 Specifying the specific model name of FX5CPU)

The supported versions of GX Works3 differs depending on the CPU module type set for a GX Works2 format project.

For details, refer to the following:

( Page 777 Additions and Changes from Previous Version)

For details on the data replacement which is necessary to use a GX Works2 format project in the GX Works3 format, refer to the following:

( Page 900 Replacement of a GX Works2 format project)

To use this function, the latest GX Works2 is required to be installed in a personal computer.

### Operating procedure

1. Select [Project] ⇒ [Open Other Format File] ⇒ [GX Works2 Format] ⇒ [Open Project].
2. Select a project and click the [Open] button.
3. Read the displayed message, and click the [OK] button. <sup>\*1</sup>

The changes in project data are displayed in the "Output" window.

\*1 The procedure differs when opening a project for an FX5CPU in GX Works3 Version 1.040S or later.

For details, refer to the following:

( Transition from MELSEC FX3G, FX3U, FX3UC Series to MELSEC iQ-F Series Handbook)

### Precautions

A project which satisfies any of the following conditions cannot be opened in GX Works3. Check them and take corrective actions in GX Works2 in advance.

- A program where an error occurs in compiling exists: Check if the program can be compiled.
- User management settings or access authority settings are configured: Clear the settings.
- A project file is compressed (\*.gwz): Decompress it.

The check function at a conversion of GX Works3 is enhanced compared to GX Works2. Therefore a conversion error may occur in a program in GX Works3 even if it does not occur in GX Works2. In that case, check the error content and correct the program.

## Data to be changed

Some data is changed depending on the CPU module type set for a GX Works2 format project.

Data in a module which cannot be replaced with a module in MELSEC iQ-R series, MELSEC iQ-L series, or MELSEC iQ-F series will be deleted.

The following table shows data to be retained, returned to the default, or deleted.

Operation in opening	Setting item in GX Works2	Remarks	
Changing in accordance with the target module type	• PLC parameter <sup>*1</sup>	PLC name <sup>*3</sup>	Check the settings in GX Works3.
		PLC system <sup>*2,*3</sup>	
		PLC file <sup>*2</sup>	
		PLC RAS <sup>*2,*3</sup>	
		Boot file	
		Program <sup>*3</sup>	
		SFC <sup>*5</sup>	
		Device <sup>*2</sup>	
		I/O assignment <sup>*2,*3,*4</sup>	
		Multiple CPU <sup>*2</sup>	
		Built-in Ethernet port <sup>*2,*3</sup>	
	• Redundant parameter <sup>*2</sup>	Operation mode	
		Tracking <sup>*3</sup>	
	• Network parameter	CC-Link IE Field <sup>*1,*3</sup>	
		CC-Link IE Control <sup>*1,*3</sup>	
		Ethernet <sup>*1,*2,*3</sup>	
		CC-Link <sup>*2,*3,*6</sup>	
		MELSECNET/H <sup>*3</sup>	
		MELSECNET/10 <sup>*3</sup>	
	• Intelligent function module parameter <sup>*1</sup>	Input	
		Output	
		I/O	
		Multiple input	
		Interrupt input	
		Analog input	
		Analog output	
		Analog I/O	
		Temperature input	
		Temperature control	
		Simple motion	
		Positioning	
		Counter	
		Channel isolated pulse input	
		AnyWireASLINK	
	Serial communication		
	• FB/FUN <sup>*7</sup> • Ladder program <sup>*8</sup> • ST programs • Structured ladder/FBD programs <sup>*9</sup> • SFC programs <sup>*3,*5</sup> • Device comments for devices other than special relays (SM) and special registers (SD) <sup>*10</sup> • Device memory (only when the module type is changed to an FX5UCPU or an FX5UCCPU) • Device/label automatic-assign		

Operation in opening	Setting item in GX Works2		Remarks
Returning to the default/ deleting the data	<ul style="list-style-type: none"> <li>Options (other than "Reference/Reflection Target for Device Comment")</li> <li>System labels</li> <li>Device comments for special relays (SM) and special registers (SD)</li> <li>Remote password</li> </ul>		Set them in GX Works3.
Changing to the state in which a project was newly created	Connection destination		
Deleting	PLC parameter	Communication head	Not supported by GX Works3.
		Built-in I/O function	
		Serial communication	
		Built-in serial	
		Adapter serial	
		Memory capacity	
		Special function block	
		Positioning	
		Operation	
	<ul style="list-style-type: none"> <li>Programs of user library that are not registered to the program setting</li> <li>Task</li> <li>Project revision</li> </ul>		

\*1 When opening a project for an FXCPU, the data returns to the default or is deleted.

\*2 The items which are not supported by GX Works3 are deleted.

\*3 Some setting items return to the default or the data is changed or deleted. Check and set them in GX Works3 after opening the project.

\*4 When opening a project for a redundant CPU, settings for a base unit are deleted.

\*5 To retain SFC programs in a project for an RCP, GX Works2 Version 1.535H or later is required to be installed in a personal computer.  
To retain SFC programs in a project for an FX5CPU, GX Works2 Version 1.585K or later is required to be installed in a personal computer.

\*6 When a local station is set in the "CC-Link Configuration," it will be changed to an intelligent device station. Check the station type.

\*7 The ladder programs in function blocks that satisfy all of the following conditions are deleted.

·The function blocks are not used in other programs.

·An undefined FB instance or an FB instance whose definition is unclear exists.

\*8 The ladder programs that satisfy any of the following conditions are deleted.

·1000 or more lines of statements are consecutively placed.

·An incorrect ladder exists. (Example: AND instruction is used at the top of the ladder block.)

\*9 To retain Structured Ladder/FBD programs, GX Works2 Version 1.519R or later is required to be installed in a personal computer.

\*10 When device comments are set in an FXCPU project, devices of M8000 and later will be replaced with SM8000 and later, and devices of D8000 and later with SD8000 and later; therefore, their device comments will be applied to that of the devices after the replacement.

For details, refer to the following:

 Transition from MELSEC FX3G, FX3U, FX3UC Series to MELSEC iQ-F Series Handbook

# Opening a PX Developer format project

PX Developer format projects created in PX Developer (PX Developer projects and GX Works2 projects) can be opened and used in GX Works3.

This function is supported in projects for the following modules only:

- Universal model process CPU
- Redundant CPU

The following shows the module type to be changed.

Before change	After change
Universal model process CPU	R120PCPU (process mode)
Redundant CPU	R120PCPU (redundant mode)

For details on the replacement of data which is necessary to use a PX Developer format project in the GX Works3 format, refer to the following:

 Page 918 Replacement of a PX Developer format project



To use this function, the latest PX Developer and GX Works2 are required to be installed in a personal computer.

## Operating procedure

1. Select [Project] ⇒ [Open Other Format File] ⇒ [PX Developer Format] ⇒ [Open Project].
2. Select a project and click the [Open] button.
3. Read the displayed message, and click the [OK] button.
4. Read the displayed message, and select whether to read the initial values of FB properties.

The changes in project data are displayed in the "Output" window.

## Precautions

- The following projects are opened in GX Works3:
  - Selected PX Developer project
  - GX Works2 project in the folder where the selected PX Developer project is stored (If multiple GX Works2 projects exist in the file, only the one with the same name as the PX Developer project is opened.)
- To open a project for which GX Developer is specified as the GX project type, change the project type to a GX Works2 project with the function to open a project of PX Developer Programming Tool. For details, refer to the following:  
 PX Developer Version 1 Operating Manual (Programming Tool)
- To open a project for a process CPU, change the PLC type of the project to a universal model process CPU or a redundant CPU with the PLC type change function of PX Developer Programming Tool. For details, refer to the following:  
 PX Developer Version 1 Operating Manual (Programming Tool)



## Data to be changed (PX Developer)

Some data is changed depending on the CPU module type set for a PX Developer format project.

Some units of PX Developer project data are not supported by GX Works3. Set them in GX Works3 after opening the project.

For details, refer to the following:

 Page 918 Replacement of a PX Developer format project

The following table shows data to be retained or deleted.

Operation in opening	Setting item in PX Developer	Remarks
Changing in accordance with the target module type	Tag FB <sup>*1</sup>	Check and set them in GX Works3.
	Global variable <sup>*2</sup>	
	GX Works2 label assignment <sup>*3,*4</sup>	
	Program <sup>*5,*6</sup>	
	User-defined FB <sup>*5,*6</sup>	
	User-defined tag FB <sup>*5,*6,*7</sup>	
	User-defined structure	
	Program execution setting <sup>*5,*8,*9</sup>	
	Inline ST part	
	Function element/FB element <sup>*10</sup>	
	Project parameter <sup>*11</sup>	
	Initial value of an FB property <sup>*12</sup>	
Deleting	Module FB declaration <sup>*13</sup>	Set them in GX Works3.
	I/O simulation setting	

\*1 The tag FB setting is not applied in the following cases. Click the [Check] button on the tag FB setting editor in GX Works3, then check and set the data.

- A tag name which cannot be set in GX Works3 is used.
- Any one of "PFC\_INT," "PFC\_SF," or "PFC\_SS" is used for the tag type.

\*2 Converted into the global label "Global\_PX" of GX Works3.

\*3 Converted into the global label "GXW2LabelAssignment\_PX" of GX Works3.

\*4 Replace a global label name used in GX Works2 in a program with a global variable name used in PX Developer.

\*5 The execution condition settings of a program and an FBD sheet are converted into comment elements of a program editor. A comment element is displayed in the installed PX Developer language.

\*6 The color set in the "Color and Font" screen of GX Works3 is applied to comment elements.

\*7 The tag type "PFC\_INT," "PFC\_SF," and "PFC\_SS" are not supported.

\*8 A process control function block is added to a project.

\*9 A program to execute the interrupt pointer is converted into a program the execution type of which is "No Execution Type."

\*10 The following process functions in a PX Developer project are read as function blocks.

P\_HS, P\_HS\_E, P\_LS, P\_LS\_E, P\_MID, P\_MID\_E, P\_AVE, P\_AVE\_E, P\_ABS, P\_ABS\_E

\*11 The items which are not supported by GX Works3 are deleted.

\*12 When the initial values of FB properties are not read, the initial values of the FB properties will be returned to default.

\*13 A module FB element in an FBD program is changed to a module FB in an FBD/LD program of GX Works3; however the data cannot be used.

After opening the project, delete the module FB in the FBD/LD program.

## ■Registration destination of a program

For a program of a PX Developer project, the registration destination in GX Works3 differs depending on the execution state and the execution type set for the program.

Setting content in PX Developer		Registration destination in GX Works3		
Execution state	Execution type	Execution type	Setting for "Use the process control extension"	Program file name
Execute/execute conditionally	Timer execution (scan)	Scan	No	Program name + '_PX'
	Timer execution (high-speed/normal speed/low-speed)	Scan	Yes	MAIN_PX
	Fixed scan execution	Fixed scan	Yes	Program name + '_PX'
	Interrupt pointer execution <sup>*1</sup>	No execution type	No	Program name + '_PX'
Do not execute	—	No execution type	No	Program name + '_PX'

\*1 An interrupt pointer set in PX Developer is added to a title of a program file. (Page 136 Title)

**Ex.**

The following figure shows a registration example.

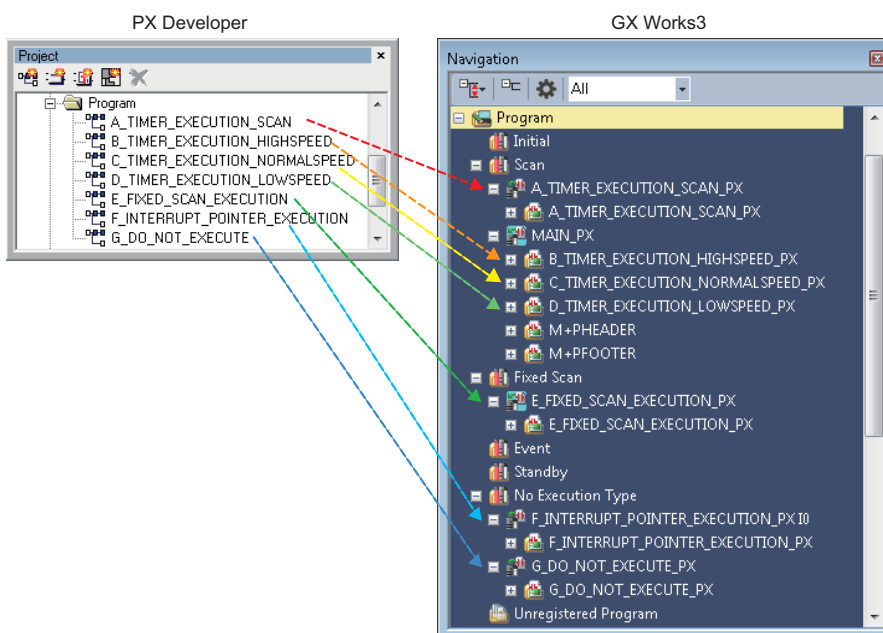

### ■ Execution condition settings

The execution condition settings of a program and an FBD sheet are converted into comment elements.

(1) Execution condition setting of a program

It is converted into the comment element (A) on the upper left of the first worksheet.

**Ex.**

The following figure shows a conversion example.

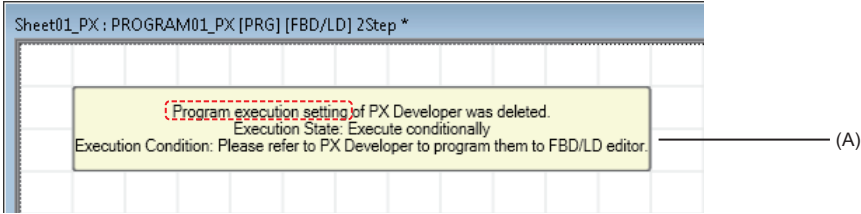

(2) Execution condition setting of an FBD sheet

It is converted into the comment element (B) on the upper left of a worksheet.

**Ex.**

The following figure shows a conversion example.

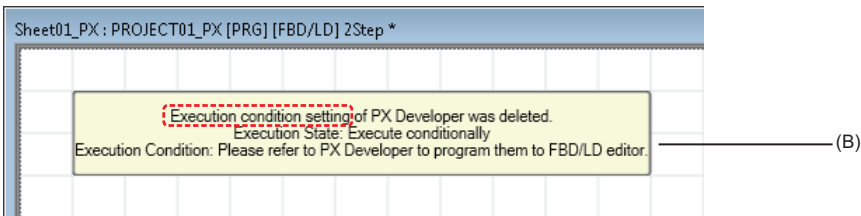

When both (1) and (2) are set, (B) is displayed under (A).

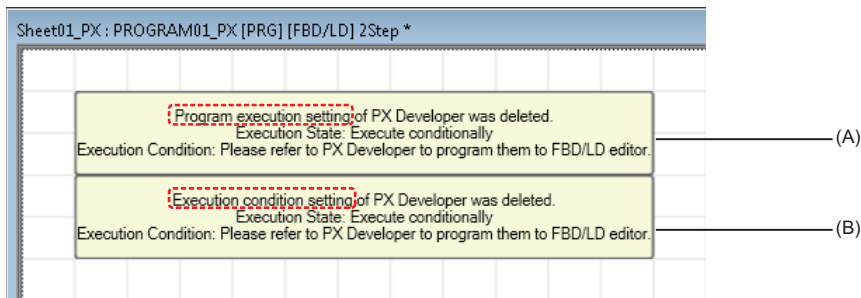

## Label area capacity

The following data is applied to "Label Area Capacity" or "Latch Label Area Capacity" in the CPU parameters of a GX Works3 format project.

Parameter in GX Works3	Capacity
Label area capacity	Capacity that is calculated based on the capacity in a PX Developer project <sup>*1</sup> + Capacity that is calculated based on the capacity in a GX Works2 project <sup>*2</sup>
Latch label area capacity	Capacity that is calculated based on the capacity in a PX Developer project <sup>*1</sup> + Capacity that is calculated based on the capacity in a GX Works2 project <sup>*3</sup>

- \*1 Capacity that is calculated based on the number of points for file registers and timers set in the system resource of the project parameter in a PX Developer project.
- \*2 Capacity that is calculated based on the total number of points for each device (for VAR) set in the device/label automatic-assign in a GX Works2 project
- \*3 Capacity that is calculated based on the total number of points for each device (for VAR\_RETAIN) set in the device/label automatic-assign in a GX Works2 project

## Precautions

When a PX Developer format project is opened in GX Works3, "0 K Word" may be set for "Label Area Capacity" and "Latch Label Area Capacity."

For details, refer to the following:

 Page 923 Label area capacity

## Data to be changed (GX Works2)

To retain data in a GX Works2 project used in a PX Developer format project, refer to the following:

 Page 108 Data to be changed

Data satisfying the following conditions are deleted.

Condition	Data to be deleted
The data name starts with "#FBDQ."	Program file
	Program block
	Program setting
The data name matches "#FBDQ."	Global label

## Considerations

### Tag names that cannot be set in GX Works3

Some tag names set in a PX Developer format project are not applied to a tag FB setting in GX Works3; therefore, the FB property initial value is returned to the default.

In that case, change the tag name in PX Developer to the one available in GX Works3.

After changing the tag name, open the PX Developer format project in GX Works3 again.

For details, refer to the following:

 Page 922 Tag names that cannot be set in GX Works3

### Data name duplication

Data names of a PX Developer format project are changed when opening the project in GX Works3.

Therefore, a data name may be duplicated and the project data changes may be canceled. In this case, correct the data name in PX Developer and open the project in GX Works3 again.

For details, refer to the following:

 Page 923 Data name duplication

## Opening a GX IEC Developer format project

---

A project created in GX IEC Developer (GX IEC Developer format project) can be opened and used in GX Works3. This function can be used for an ASCII format file and an SUL format file created in GX IEC Developer version 7.04 is supported.

Enabling this function is required for opening a GX IEC Developer format project:

Log on to a personal computer as a user with the administrator authority, then execute "GIDImport.exe" in the installation DVD (Disk1\GXW3\Others) of GX Works3 without starting GX Works3.

### Operating procedure

#### ■If a GX Works3 format project is open

1. Select [Project] ⇒ [Open Other Format File] ⇒ [GX IEC Developer Format] ⇒ [Open ASC Format File].
2. Select a project and click the [Open] button.
3. Read the displayed message, and click the [OK] button.

The GX IEC Developer format project data is imported to the open GX Works3 format project.

#### ■If a GX Works3 format project is not open

1. Select [Project] ⇒ [Open Other Format File] ⇒ [GX IEC Developer Format] ⇒ [Open ASC Format File].
2. Select a project and click the [Open] button.
3. Read the displayed message, and click the [OK] button.

The "New" screen appears.

4. Set each items in the "New" screen, and click the [OK] button.

The GX IEC Developer format project data is imported to the newly created GX Works3 format project.

#### Point

- The changes in project data are displayed in the "Progress" window and the "Output" window. Check the logic of the project and the program before and after the change, and modify the data as necessary.
  - "Imported from GX IEC Developer project: "(name of an ASCII format file).asc"" is entered on the [Comment] tab in the "Properties" screen of a GX Works3 format project.
-

## Precautions

- If the CPU module type set for a GX Works3 format project does not support Sequential Function Chart language, POUs created in the language are not imported.

- Devices and instructions which are not supported by GX Works3 may not be converted properly.

Refer to the following manuals to change them to equivalent elements supported by GX Works3 and correct a program.

 GX IEC Developer Version7 Reference Manual

 User's manual of each module

 MELSEC iQ-R Programming Manual (CPU Module Instructions, Standard Functions/Function Blocks)

 MELSEC iQ-R Programming Manual (Module Dedicated Instructions)

- Devices in address representation (such as %MX0.1) will be converted into device representation. Inconvertible devices into address representation will be read as they are.
- If the CPU module type set for a GX Works3 format project does not support functions or function blocks used in a GX IEC Developer format project, these elements will be converted into ones whose definitions are unclear.
- When an IL/MELSEC IL program is converted into an FBD/LD program of GX Works3, the numbers of parameters of functions may not match between the GX IEC Developer format project and the GX Works3 format project.  
In this case, the functions keep the number of parameters of the GX IEC Developer format project and are converted into ones whose definition is unclear.
- Module type change will be canceled if the [Cancel] button in the progress dialog, which is displayed during the processing, is clicked.

Data which has already been replaced in a GX Works3 format project before the cancellation will not be deleted.

## Data to be changed

Some data is changed depending on the module type set in a GX IEC Developer format project.

The following table shows data to be retained, returned to the default, or deleted.

Operation in opening	Setting item in GX IEC Developer	Remarks
Changing in accordance with the target module type	Program POU <sup>*1</sup>	Check the settings after the change.
	Function POU <sup>*1</sup>	
	Function Block POU <sup>*1</sup>	
	POU (FBD)	
	POU (LD)	
	POU (ST)	
	POU (SFC) <sup>*2</sup>	
	POU (IL/MELSEC IL)	
	SFC action (FBD) <sup>*2</sup>	
	SFC action (LD) <sup>*2</sup>	
	SFC action (ST) <sup>*2</sup>	
	SFC action (IL/MELSEC IL) <sup>*2</sup>	
	SFC transition (FBD) <sup>*2</sup>	
	SFC transition (LD) <sup>*2</sup>	
	SFC transition (ST) <sup>*2</sup>	
	SFC transition (IL/MELSEC IL) <sup>*2</sup>	
Data Unit Type/Structured Data Type <sup>*1</sup>	To create a GX Works3 format library from a GX IEC Developer format library, refer to the following:  Page 509 Creating a GX Works3 format library from a GX IEC Developer format library	
Global variables <sup>*3</sup>		
Task <sup>*1</sup> /Program File		
Returning to the default/ deleting the data	User Library	
	CPU Parameter	Set them in GX Works3.
	System Parameter	
	Network Parameter	
	Module Parameter	
	Connection Settings	
	Entry Data Monitor/Watch	
Options		

\*1 If the same data name exists in a GX Works3 format project, the name of the data in the GX IEC Developer format project to be imported is incremented. (Example: Item\_1→Item\_2)

\*2 Data is deleted if the CPU module type set for a GX Works3 format project does not support Sequential Function Chart language.

\*3 The global variables of GX IEC Developer are defined as global labels in "Global" only when no global label exists in "Global (Global Label Setting)" in a GX Works3 format project.

When any global label exists in "Global," a new global label setting is created.

## IL/MELSEC IL programs

An IL/MELSEC IL program is converted into an FBD/LD program of a GX Works3 format project, and the character string "Imported from GX IEC Developer (IL/MELSEC IL)" is inserted as a comment element on the upper left of the first worksheet. Each element used in the program is converted as shown below.

### ■Network header

A network label which was set in the IL/MELSEC IL program (1) is converted into a jump label element. The title of the network header (2) is converted into a comment element.

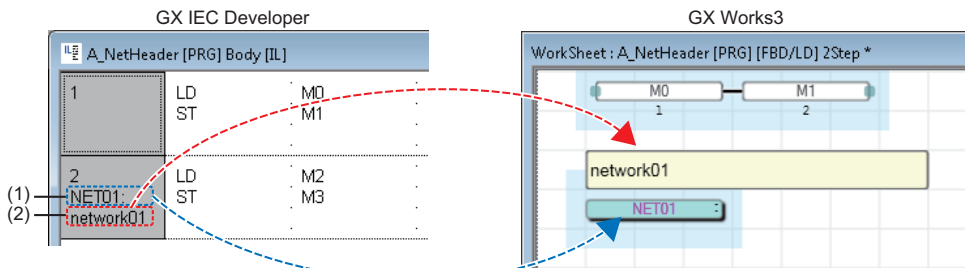

### ■Comment

A comment described in the same row as the instruction (1) is converted into a comment element and placed on a variable element.

Sequential comments in a network (2) are combined into a single comment element.

At the time, '(\*' and '\*)' enclosing a comment are deleted. (Example: (\*Comment\*) → Comment)

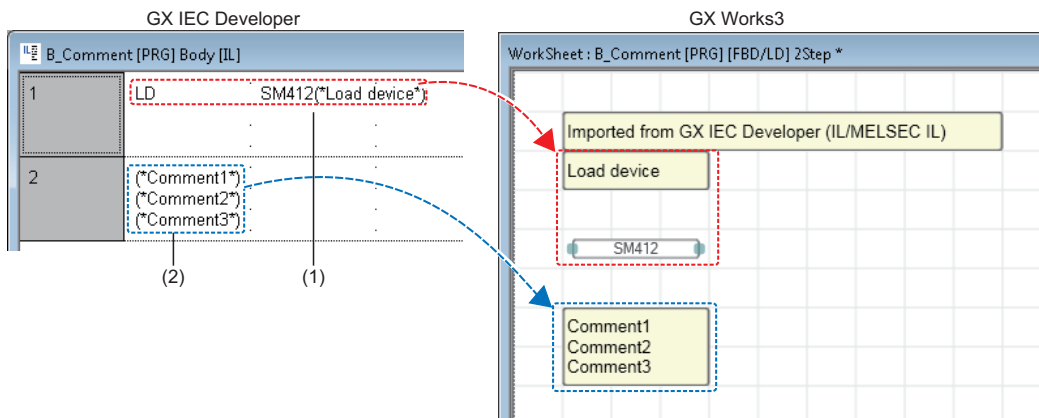



### ■ Programming instructions

Program instructions used in a GX IEC Developer format project are converted into the ones available in GX Works3. The following figures show a conversion example of programming instructions.

- IEC programming instructions

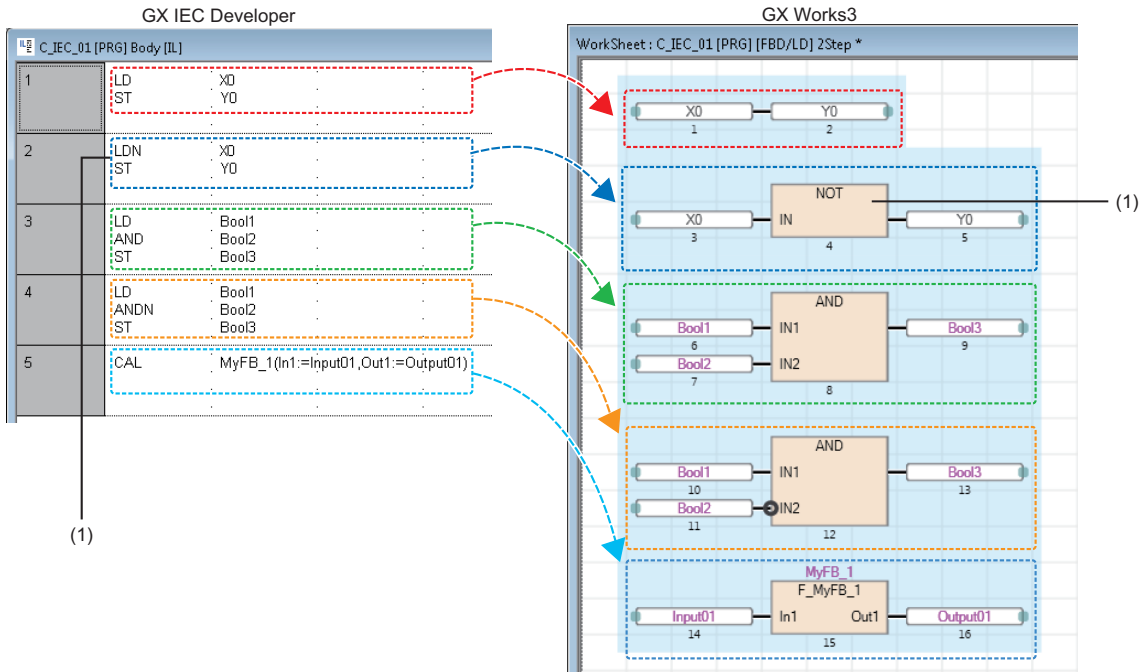

(1) LDN instruction: the function 'NOT' is added only when an output variable is connected to an instruction.

- MELSEC programming instructions

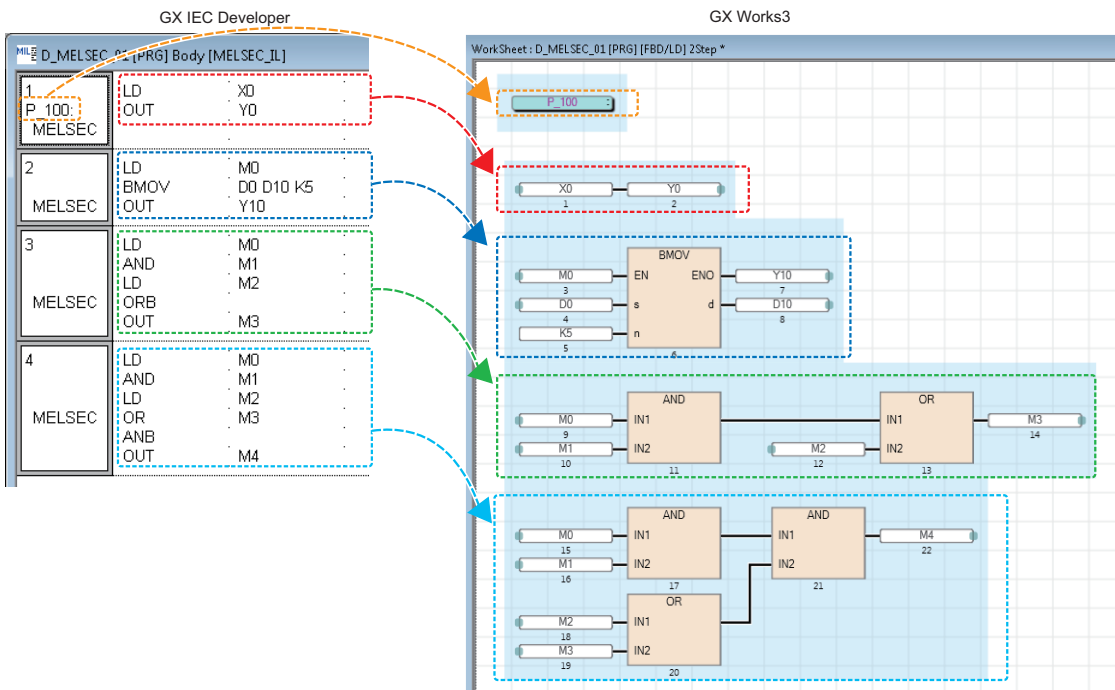

## Precautions

When an error occurs in a program, POU's may not be converted properly.

Correct the program in GX Works3.

- When there is no operand and variable of a programming instruction, the instruction is converted into a comment element (1) and an undefined POU (2).

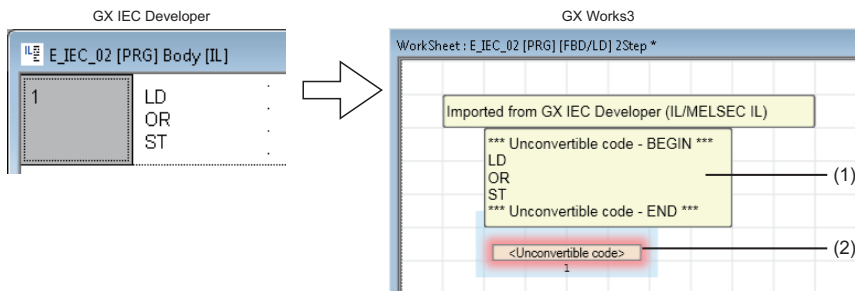

- When there is a CALC/CALCN instruction, a label (1) and a temporary variable element (2) are automatically registered as local labels.

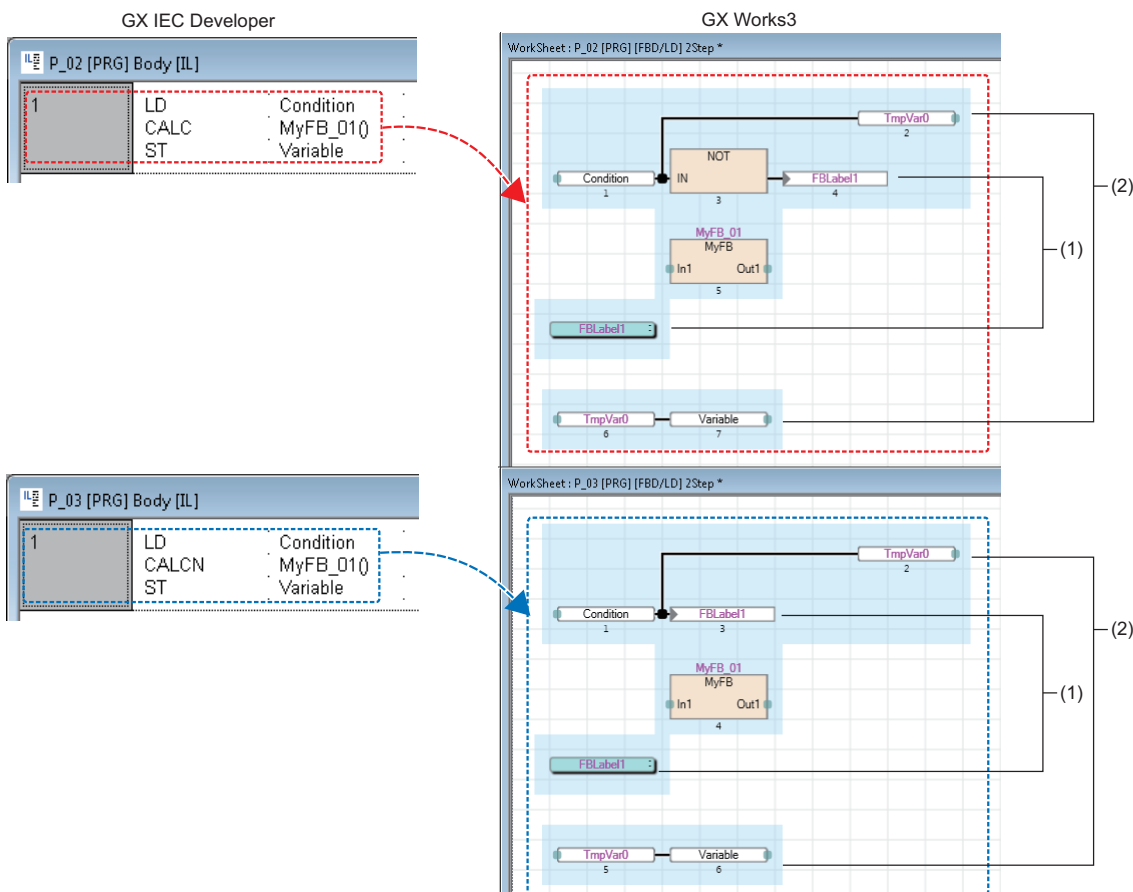

## Actions/transitions (IL/MELSEC IL)

Actions and transitions of an SFC program created in IL/MELSEC IL language are converted into ones of an SFC program created in Function Block Diagram/Ladder Diagram language.

To convert actions/transitions created in IL/MELSEC IL language, the following instructions are required at the end of the program.

- IL language: ST instruction that a transition name or the SFC dedicated instruction "TRAN" is used for the variable
- MELSEC IL language: OUT instruction that the SFC dedicated instruction "TRAN" is used for the variable

The programs of the actions/transitions are converted into ones to call the function "TRAN."

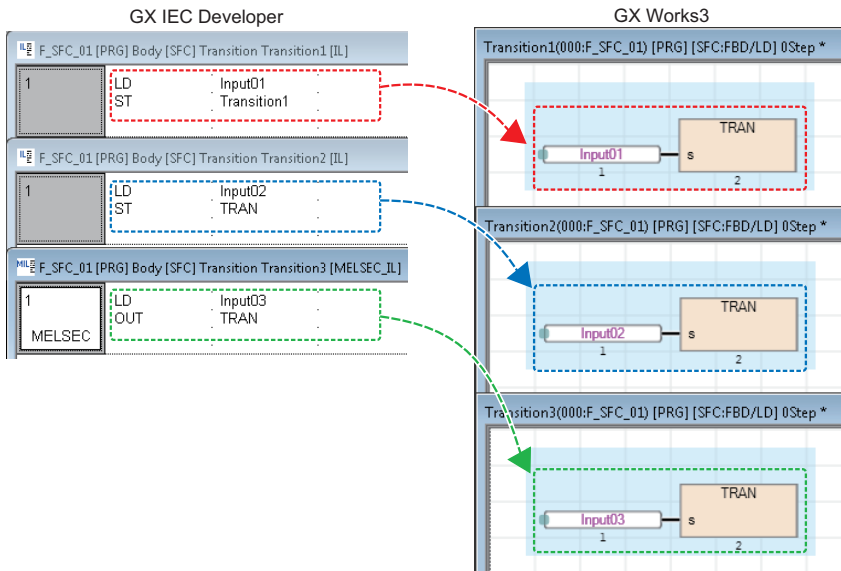

## Global variables

Global variables in a GX IEC Developer format project are converted into global labels of a GX Works3 format project only when no global label exists in "Global (Global Label Setting)" in a GX Works3 format project.

When a global label exists in "Global," a new global label setting is created; however, it is not converted into a global label of the GX Works3 format project.

Add the global variables set in a GX IEC Developer format project to the global label setting in GX Works3 by the following procedure.

### Operating procedure

1. In GX IEC Developer, export "Global\_Vars" to an ASCII format file.
2. Open the file exported in step 1 in GX Works3.  
Up to 20479 global variables are added to the global label setting in GX Works3.  
To add 20480 or more global variables to the global label setting of GX Works3, follow the procedure below.
3. Change the name of the global label setting added in step 2. (Example: Global→Global\_1)
4. Open the file exported in step 1, and delete 20480 global variables which were added to the global label setting of GX Works3.
5. Open the file exported in step 4 in GX Works3.

## Function

Functions used in a GX IEC Developer format project are converted into the ones available in GX Works3.

The order and position of input/output arguments may differ between a GX IEC Developer format project and a GX Works3 format project.

The changes in each function can be checked in the information in the "Output" window.

The following figures show a conversion example of functions used in "Ladder Diagram(LD)" in GX IEC Developer.

- Functions of MELSEC-Q series

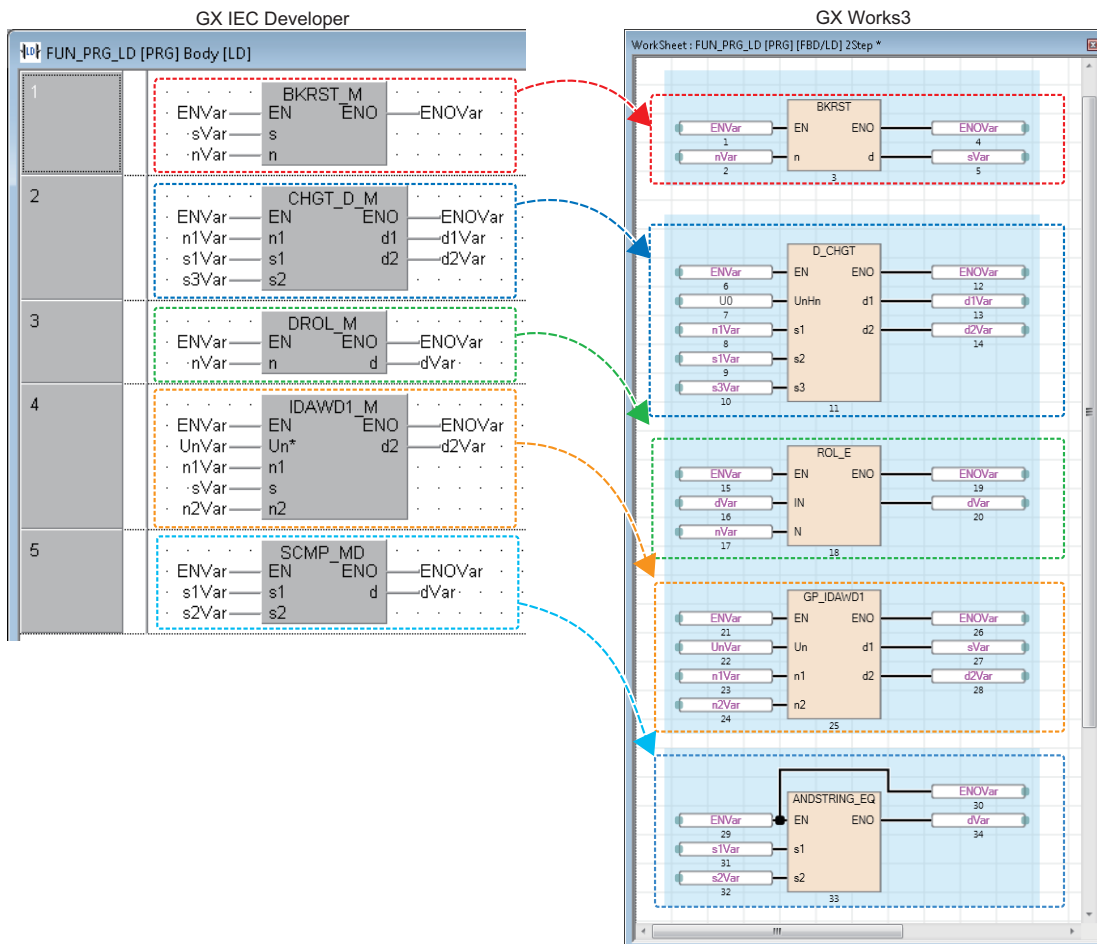

- Functions of MELSEC iQ-F series

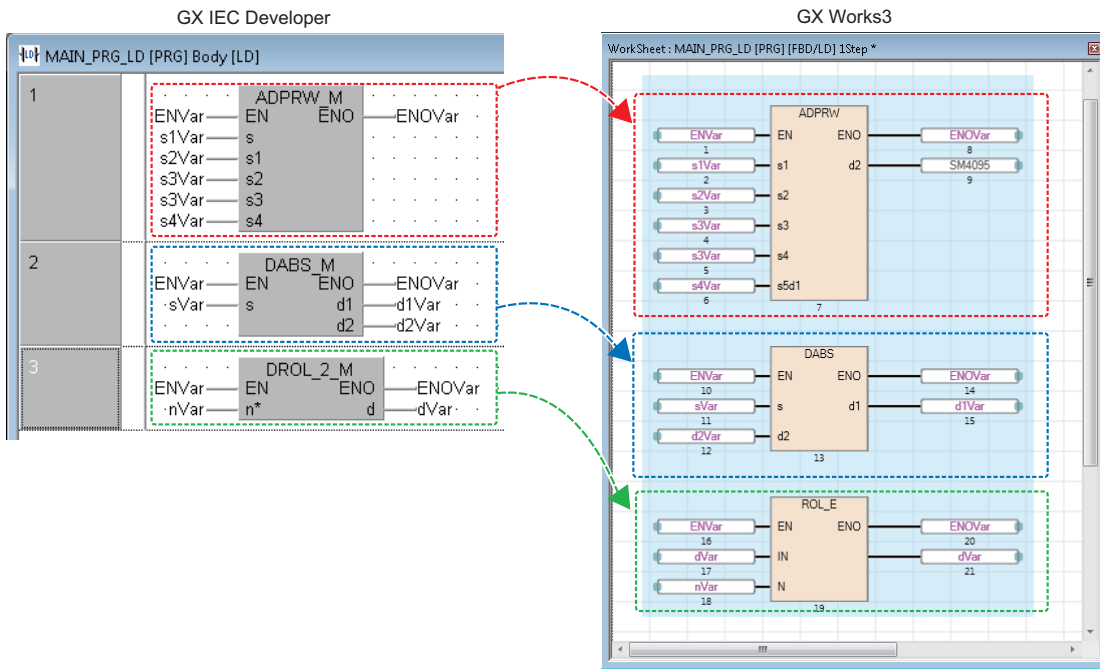

# Opening a GX Developer format project

A project created in GX Developer (GX Developer format project) can be opened and used in GX Works3.

This function can be used in a project for QSCPU only.

The following shows the module type to be changed.

Before change	After change
QSCPU	R120SFCPU

For details on the replacement of data which is necessary to use a GX Developer format project in the GX Works3 format, refer to the following:

 Page 924 Replacement of a GX Developer format project

## Operating procedure

1. Select [Project] ⇒ [Open Other Format File] ⇒ [GX Developer Format] ⇒ [Open QSCPU Series Project].
2. Select a project and click the [Open] button.
3. Enter the user name and password of a GX Developer format project in the "User Authentication (Project)" screen, and click the [OK] button.
4. Read the displayed message, and click the [OK] button.
5. Register a new user in a GX Works3 format project. ( Page 104 Adding a new user)
6. Read the displayed message, and click the [OK] button.

The changes in project data are displayed in the "Output" window.

## Data to be changed

The following table shows data to be changed when opening a GX Developer format project. Data of modules that cannot be replaced with MELSEC iQ-R series modules will be deleted.

Operation in opening	Setting item in GX Developer		Remarks
Changing in accordance with the target module type	PLC parameter	PLC name	Check the settings in GX Works3.
		PLC system	
		PLC RAS	
		Device	
		I/O assignment <sup>*1,*2</sup>	
		Safety setting <sup>*3</sup>	
	Network parameter <sup>*1</sup>	Ethernet <sup>*3</sup>	
		CC IE Control(Normal station)	
CC IE Field (Local station)			
<ul style="list-style-type: none"> <li>• Ladder program<sup>*4</sup></li> <li>• Device comments for devices other than special relays (SM) and special registers (SD)</li> <li>• Device memory<sup>*1</sup></li> <li>• User-defined FB<sup>*5</sup></li> <li>• Structure</li> <li>• Global variables</li> <li>• Local labels</li> </ul>			
Deleting the definition <sup>*6</sup>	Safety FB	Redefine them in GX Works3.	
Returning to the default/ deleting the data	PLC parameter	Boot file setting	Set them in GX Works3.
	Network parameter	CC IE Field(Master station [Safety])	
		CC IE Field(Local station [Safety])	
		CC-Link	
	<ul style="list-style-type: none"> <li>• Options (other than "Reference/Reflection Target for Device Comment")</li> <li>• Device comments for special relays (SM) and special registers (SD)</li> <li>• Remote password</li> <li>• User information (user name/password/access level)</li> </ul>		
Changing to the state in which a project was newly created	Connection destination		

\*1 Some setting items return to the default or the data is deleted. Check and set them in GX Works3 after opening the project.

\*2 When switch settings are configured without setting network parameters, the switch settings are deleted.

\*3 The items which are not supported by GX Works3 are deleted.

\*4 Replaced with a standard program.

\*5 Replaced with a standard FB.

\*6 Data on a ladder program is not deleted.

## Saving a project

Save the project on the personal computer or another data storage device.

Depending on the setting for "MELSOFT iQ AppPortal information file output when saving project," an iQ AppPortal information file can be output when saving a project.

For details, refer to the following:

☞ Page 137 Settings for MELSOFT iQ AppPortal

## Saving projects under the specified name

### Window

Select [Project] ⇒ [Save As].

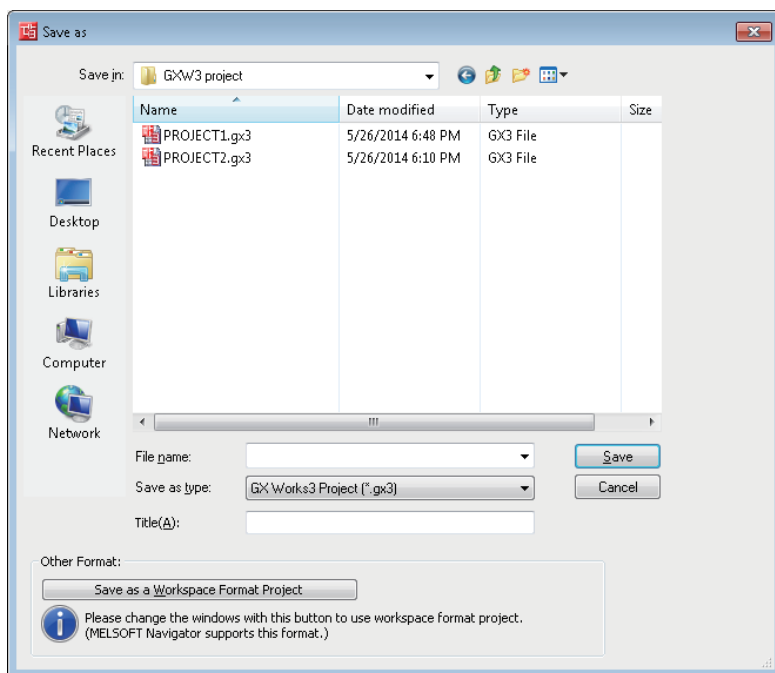

When saving the project with the workspace format, click the [Save as a Workspace Format Project] button to switch the screen.

### Operating procedure

Set each item and click the [Save] button.

#### Point

When saving a project that has been opened in the Q/L/FX series compatibility mode in GX Works3, any of the following format can be selected in "Save as type" in the "Save as" screen.

- GX Works3 Project (\*.gx3)
- GX Works2 Project (\*.gxw)

### Precautions

For the unusable character strings for a project, workspace, or path name, refer to the following:

☞ Page 885 Unusable Character Strings (Reserved Words)



## Overwriting projects

### Operating procedure

Select [Project] ⇒ [Save] (💾).

#### Point

A project can be automatically overwritten by setting the following option:

- [Tool] ⇒ [Options] ⇒ "Project" ⇒ "Save" ⇒ "Auto-save Execution Setting"/"Auto-save Operational Setting"

### ■ Registering a revision

A project revision can be registered when the project is overwritten.

For details, refer to the following:

📖 Page 161 Registering a revision when a project is overwritten

## Deleting a project

Delete a project saved on the personal computer or another data storage device.

### Window

Select [Project] ⇒ [Delete].

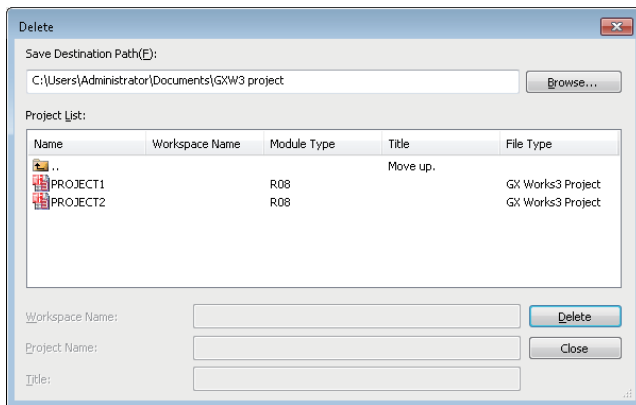

### Operating procedure

Select a project (📁) to be deleted, and click the [Delete] button.

### Precautions

When a project file does not exist after deleting a workspace format project, the message appears to confirm whether to delete the workspace itself. If the project is deleted, the workspace folder is deleted, but 'workspacelist.xml' remains. In addition, when deleting a project, the corresponding iQ AppPortal information file is also deleted.

# 3.3 Creating Data

This section explains the creation method of each data.

## Data

### ■Unusable character strings

Refer to the following:

☞ Page 885 Unusable Character Strings (Reserved Words)

### ■Maximum number of units of data that can be created in one project (RCPU/LHCPU/FX5CPU)

The following table shows the maximum number of units of data that can be created for each data type.

Data type	RCPU				LHCPU		FX5CPU
	R00CPU R01CPU	R02CPU	R04CPU	Others	L04HCPU	L08HCPU L16HCPU L32HCPU	
Program file	32	64	124	252	124	252	32
FB file and FUN file	16	32	64	128	64	128	15
Function block and function	4096			8192	4096	8192	960
Initial device value	800						1
Program block	2048						
Common device comment	1						
Each program device comment	800						
Global label							
Structure							
Device memory							

## Precautions

For data names, use characters in the Unicode Basic Multilingual Plane.

If an input language is different from the language set in the regional settings on Windows, some functions may not operate properly. In that case, unify these languages.

If the characters outside the Unicode Basic Multilingual Plane are specified, the program may not operate properly.

# Creating data

Create new data in a project.

## Window

1. Select data in the navigation window.
2. Select [Project] ⇒ [Data Operation] ⇒ [New Data] (📄).  
Alternatively, right-click it and select [New Data] (📄) from the shortcut menu.

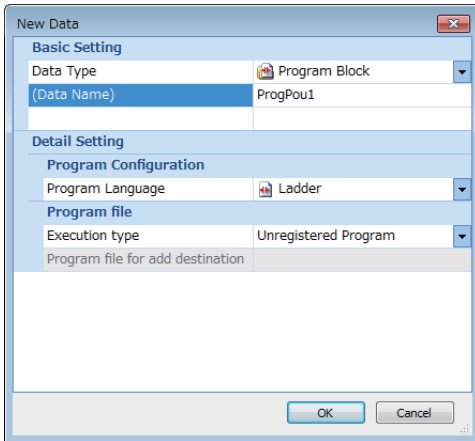

In a safety project, the "Category" column to select "Standard," "Safety," or "Standard/Safety Shared" is displayed. For details on the data to select, refer to the following:

📖 Page 30 Safety system

## Operating procedure

Set each item and click the [OK] button.

For the setting items when "Function Block" or "FB File" is selected for "Data Type," refer to the following:

📖 Page 485 Creating a new function block

For the setting items when "Function" is selected for "Data Type," refer to the following:

📖 Page 504 Creating a function

## Precautions

- When function block and function data are added by the above method, the FB file and FUN file will be in the unconverted state.
- SFC data and program blocks written in programming languages except for SFC (Ladder, ST, FBD/LD) cannot exist in a same program file.

# Editing data

---

## Changing a data name

---

### Operating procedure

1. Select the data to change its name in the navigation window.
2. Select [Project] ⇒ [Data Operation] ⇒ [Rename], or right-click in the navigation window and select [Rename] from the shortcut menu.
3. Change the data name and press the  key.

## Copying and pasting data





---

Utilize the data of project being edited or other projects.

Elements can be pasted only to the place where is able to create the same type of data.

Data may cannot be pasted to a project with a different series or module type of a CPU module.

### Operating procedure

1. Select the data of the copy source in the navigation window.
2. Select [Project] ⇒ [Data Operation] ⇒ [Copy Data] () , or right-click in the navigation window and select [Copy Data] () from the shortcut menu.
3. Select a folder to paste the data (one-level upper hierarchy of the copy source data) in the navigation window or other projects.
4. Select [Project] ⇒ [Data Operation] ⇒ [Paste Data] () , or right-click in the navigation window and select [Paste Data] () from the shortcut menu.

If the same data name exists in the folder where the data is to be pasted, the pasted data is named automatically.

### Point

If data cannot be pasted with this function, it can be utilized by opening each editor and copy the corresponding data.

---

## Precautions

- The pasted program will be in the unconverted state.
- Structures and function blocks used in the global label are not copied.  
If the same structure or function block name does not exist in the paste destination, the data type of the global label will be changed to an undefined one.
- Pasting of global label data is canceled when the maximum number of labels (20480) is exceeded. Adjust the number of global labels in the copy destination and the copy source, and retry pasting data.

### ■Program file

A program block under the selected program file is copied when copying a program file.

A common device comment can also be copied by setting the following option when pasting the data to other projects.

Set it in the project of a copy source.

- [Tool] ⇒ [Options] ⇒ "Edit" ⇒ "Copy" ⇒ "Operational Setting"

### ■Copying a program body

For an ST program and FBD/LD program, a program body can be copied and pasted onto the data created in the same programming language.

Even if the data type of a copy destination and source differ, the program can be pasted.

## ■Module FB

When copying and pasting a program block including a module FB to another project, the definition of the module FB is automatically added in the navigation window of the paste destination.

### Precautions

- When pasting a program block, a module FB on a ladder program is pasted as a function block whose definition is unclear.
- If a module FB does not exist in the element selection window of the paste destination, the definition of the module FB is not added in the navigation window.

In this case, import the module FB in the project, then drag and drop the module FB from the element selection window onto the navigation window. (☞ Page 500 Importing module FBs in a project, Page 503 Adding the definition of a module FB)

## ■CPU module type combinations

The following table shows the combinations of the module types in which data can be copied and pasted.

○: Can be copied and pasted, ×: Cannot be copied and pasted

Copy source	Copy destination										
	RnCPU	RnENCPU	RnPCPU	RnSF CPU	RnPS FCPU	Remote head module	LHCPU	FX5UCPU FX5UCCPU	FX5U JCPU	FX5 SCU	NCCPU
RnCPU	○*1	○*2	×	×	×	×	×	×	×	×	×
RnENCPU	○*2	○	×	×	×	×	×	×	×	×	×
RnPCPU	×	×	○	×	×	×	×	×	×	×	×
RnSF CPU	×	×	×	○	×	×	×	×	×	×	×
RnPSFCPU	×	×	×	×	○	×	×	×	×	×	×
Remote head module	×	×	×	×	×	○	×	×	×	×	×
LHCPU	×	×	×	×	×	×	○	×	×	×	×
FX5UCPU FX5UCCPU	×	×	×	×	×	×	×	○	○	○	×
FX5UJ	×	×	×	×	×	×	×	○	○	○	×
FX5S	×	×	×	×	×	×	×	○	○	○	×
NCCPU	×	×	×	×	×	×	×	×	×	×	○

\*1 For R00CPU, R01CPU, and R02CPU, data can be copied and pasted only in the following combinations:

- R00CPU and R00CPU
- R01CPU and R02CPU

\*2 Excluding R00CPU, R01CPU, and R02CPU.

## ■When CPU module types are different

Only the following data can be copied and pasted:

- Program file
- Program block
- Worksheet
- Folder
- FB file
- Function block
- FUN file
- Function
- Global label
- Structure

## Adding worksheets

A worksheet (program body) of a POU (program block, function block, and function) can be added. This operation is applied to a POU used in an ST program and FBD/LD program.

### Operating procedure

1. Select a POU to which the worksheet is to be added in the navigation window.
2. Select [Project] ⇒ [Data Operation] ⇒ [Add New Worksheet], or right-click in the navigation window and select [Add New Worksheet] from the shortcut menu.

## Deleting data

Data can be deleted from the open project.

### Operating procedure

1. Select data to delete in the navigation window.
2. Select [Project] ⇒ [Data Operation] ⇒ [Delete Data], or right-click in the navigation window and select [Delete Data] from the shortcut menu.

## Importing data

Import the following data from an XML file output with Simulink® PLC Coder™ to a project.

- POU (program block, function block, function)
- Global label
- Structure

### Operating procedure

1. Select [Project] ⇒ [Import File] ⇒ [Simulink PLC Coder XML Format].
2. Select a file to be imported in the screen for importing a file.
3. Specify "XML (\*.xml)" for a file type, and click the [Open] button.

### Precautions

- Only an XML file output with Simulink PLC Coder can be imported.
- Do not edit an XML file output with Simulink PLC Coder. Otherwise, the file may not be imported properly.
- When a program is being monitored or simulated, a file cannot be imported.

## Associating data with a help file

Data can be associated with a help file (such as PDF file and e-Manual).

The associable data is listed below.

- Project
- POUs (program block, function block, function)
- Global labels, structures

Associated help files can be opened from the navigation window, element selection window, and a program editor.

### Setting for a help file

The path information of a help file can be set for data by the following procedure.

#### Operating procedure

1. Select a project or data in the navigation window, then select [Project] ⇒ [Data Operation] ⇒ [Properties] (🔗), or right-click it and select [Properties] (🔗) from the shortcut menu.
2. Specify a location of a help file using either an absolute path or a relative path in "Help Path Information," and click the [OK] button.

#### ■Using different help files among multiple languages

To use different help files among multiple languages, suffix the file names with the following character strings. (Example: help\_ja-JP.pdf, help\_en-US.pdf)

Language	Character string
Japanese	_ja-JP
English	_en-US
Simplified Chinese	_zh-CN
Korean	_ko-KR
Traditional Chinese	_zh-TW

For the "Help Path Information" in the property, specify the file name with no text described above. (Example: c:\library\help.pdf)

#### ■Specifying a help file using the relative path

When a help file is specified using the relative path, GX Works3 will search for the file in the following order.

- Installation folder of GX Works3 → folder where the project file currently opened is included

#### ■Associating data with an e-Manual

To associate data with a user-created e-Manual, the e-Manual must satisfy all the following conditions:

Condition
The e-Manual is created with e-Manual Create <sup>*1</sup> .
The e-Manual is registered in e-Manual Viewer.
The character string same as the name of data to be associated with the e-Manual is written in the e-Manual. <sup>*2*3</sup>

\*1 Software to convert a Word file or CHM file into an e-Manual.

To obtain e-Manual Create, please contact your local Mitsubishi Electric sales office or representative.

\*2 To associate the e-Manual with a project or user library, the character string same as its title must be written.

\*3 To associate the e-Manual with a function or function block, the instruction style must be set for the function name or function block name in a Word file or CHM file.

Create an e-Manual, Word file, and CHM file by following e-Manual Create Help.

## Opening a help file

A help file associated with data can be opened from each screen.

### Operating procedure

#### ■Navigation window

1. Select a project or data in the navigation window.
2. Press the **F1** key.

#### ■Element selection window

1. Select an element in the element selection window.
2. Press the **F1** key.

#### ■Program editor



1. Select a function or function block on a program editor.
2. Press the **F1** key.



# Properties

Display the properties of data such as a folder, parameter, and program.  
A title and comment can be added to each data.

## Window

1. Select data in the navigation window.
2. Select [Project] ⇒ [Data Operation] ⇒ [Properties] (  ).  
Alternatively, right-click it and select [Properties] (  ) from the shortcut menu.

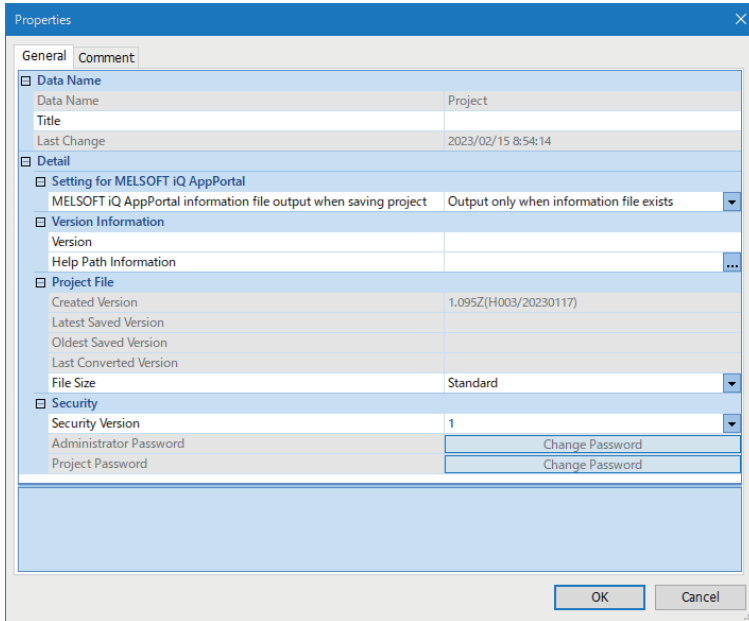

## Operating procedure

Set each item and click the [OK] button.

## Title

A title set to data is displayed with a data name in the navigation window.

The title is also displayed in the "Online Data Operation" screen when writing/reading data to/from the programmable controller.

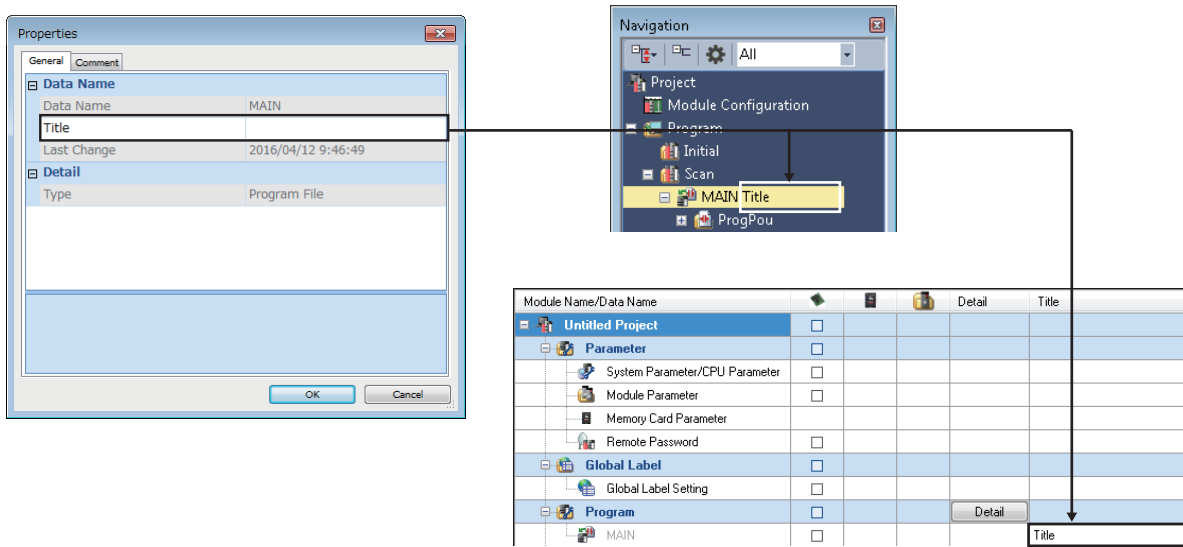

## Compressing a project file

When saving a project, whether or not to compress data can be set in the following procedure.

### Operating procedure

1. Select a project in the navigation window, then select [Project] ⇒ [Data Operation] ⇒ [Properties] (🔑), or right-click it and select [Properties] (🔑) from the shortcut menu.
2. Select "Compression" or "Standard" for "File Size" and click the [OK] button.  
A project is saved according to the setting.  
By selecting "Compression" for "File Size," the project file size decreases.

### Precautions

- A compressed project cannot be opened in GX Works3 Version 1.047Z or earlier.
- A compressed project may not be used in MELSOFT products other than GX Works3.  
In that case, change the setting to "Standard," or use another version of MELSOFT products which support that project.  
The following table shows the applicable version of each product and support date (as of October 2022).

Product name	Version	Date
MELSOFT Navigator	2.54G	—
MT Works2	1.150G	—
CW Configurator	1.012N	—

- When a security version of a project is set to "2" in GX Works3 Version 1.096A or later, "Standard" cannot be set for the project, and "Compression" is automatically set.

## Settings for MELSOFT iQ AppPortal

An iQ AppPortal information file can be output by setting the following item.

It is output when saving a project or exporting a library.

For iQ AppPortal, refer to the following:

📖 iQ AppPortal Operating Manual

### Operating procedure

1. Select a project in the navigation window, then select [Project] ⇒ [Data Operation] ⇒ [Properties] (🔑), or right-click it and select [Properties] (🔑) from the shortcut menu.
2. Select "Always output" for "MELSOFT iQ AppPortal information file output when saving project," and click the [OK] button.

## 3.4 Searching the Navigation Window

---

Data in the navigation window can be searched for, and the results can be displayed.

For the search method, refer to the following:

 Page 78 Quick Search

## 3.5 Changing the Module Type and Operation Mode of Projects

The module type and operation mode of a project can be changed to another while editing the project.

Revisions registered in the project revision history are retained after changing the module type and operation mode.

For a project whose security version is '2,' a project password and administrator password are retained after changing the module type and operation mode.

For RnPCPUs, the operation mode only can be changed.

For remote head modules, both module type and operation mode cannot be changed.

3

### Window

Select [Project] ⇒ [Change Module Type/Operation Mode].

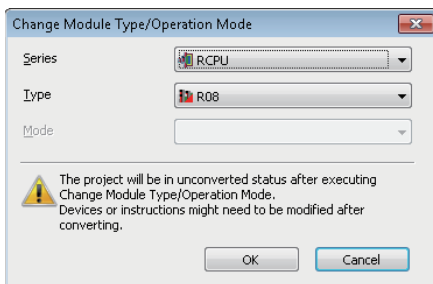

### Operating procedure

1. Select a new module type and operation mode, and click the [OK] button.
2. Compare the projects before and after the change to check the changed contents.
3. Edit each data according to the new module type and operation mode.

### Precautions

- Since data cannot be restored after changing the module type and operation mode, the project data needs to be saved in advance.  
Note that, the project status after the change is changed to unsaved state.
- A module label of a CPU module, used before the module type change, is deleted, and a module label after the change is added. Therefore, the program may need to be modified after the change.

## Combinations of CPU series that module types are changeable

○: Changeable, △: Changeable (restricted), ×: Not changeable

For the restricted contents, refer to the displayed message.

CPU series before change	CPU series after change						
	RnCPU	RnPcCPU	RnSFcCPU	RnENCPU	RnPSFcpU	FX5CPU	LHCPU
RnCPU	○	○	○	△	△	×	×
RnPcCPU	○	○	○	△	△	×	×
RnSFcCPU	×	×	○	×	△	×	×
RnENCPU	△	△	△	○	△	×	×
RnPSFcpU	×	×	△	×	○	×	×
FX5CPU	○ <sup>*1</sup>	×	×	×	×	○	×
LHCPU	×	×	×	×	×	×	○

\*1 Only FX5UCPUs and FX5UCCPUs can be changed to R04CPU.

### Point

To utilize data to a different module type of CPU module, open each editor and copy the data.

## Considerations for combinations of CPU series

### ■ Changing the module type from an RnENCPU to a CPU module that occupy one slot

When the setting items in "I/O Assignment Setting" on the [I/O Assignment] tab of the "System Parameter" screen were set, the network part is not placed and the same network type module "RJ71EN71" is placed after changing the module type.

### ■ Changing the module type from a CPU module that occupies one slot to an RnENCPU

When the setting items in "I/O Assignment Setting" on the [I/O Assignment] tab of the "System Parameter" screen were set, any of the following modules is required to be placed on the right side of the CPU module (slot No.0.)

- RJ71EN71 (CCIEC)
- RJ71EN71 (CCIEF)
- RJ71EN71 (E+CCIEC)
- RJ71EN71 (E+CCIEF)

After changing the module types, these modules will be deleted from the setting contents of I/O Assignment Setting. Instead, the same network type CPU extension module '\_RJ71EN71' will be placed on slot No.0.

#### Ex.

The following shows the procedure for changing R08CPU to R08ENCPU.

### Operating procedure

1. In "I/O Assignment Setting" on the [I/O Assignment] tab of the "System Parameter" screen, place RJ71EN71 on the right side of the CPU module (slot No.0).

RJ71EN71 is displayed in the navigation window.

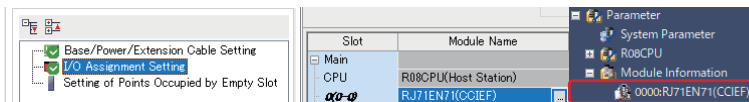

2. Change the module type. (Refer to Page 139 Changing the Module Type and Operation Mode of Projects)

RJ71EN71 that was placed on slot No.0 is deleted, then \_RJ71EN71 is placed on the slot.

In addition, the start I/O number of RJ71EN71 displayed in the navigation window is changed to "Unset."

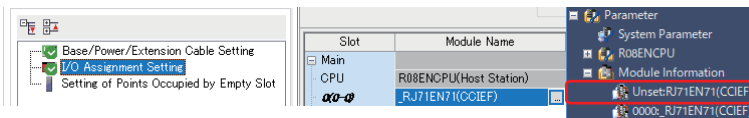

## ■ Changing the module type from an RnPCPU and an RnPSFCPU to another CPU module

The following contents related to process control set for an RnPCPU and an RnPSFCPU are deleted.

- Tag FB setting
- "Use the process control extension" set in the "Properties" screen of a program file
- "Execution Interval"/"Phase" set in the "Properties" screen of a program block
- "Execution Interval"/"Phase" set in the "Program File Setting" screen
- For a function block, the setting which was set for "Use as Tag FB"/"Tag Type" in the "Properties" screen
- [Tool] ⇒ [Options] ⇒ "Convert" ⇒ "Process Control Extension Setting"
- System header and system footer
- Global label setting 'M+PTAG'

## ■ Changing the module type from an FX5CPU to an RCPU

By changing the module type from an FX5CPU to an RCPU, a project revision history is deleted.

Project data needs to be saved in advance.

For details on other modifications that are required before and after module type change, refer to the following:

☞ Page 929 Considerations for Changing from FX5CPUs to RCPUs

## Combinations of changeable operation modes

For the restricted contents, refer to the displayed message.

○: Changeable, △: Changeable (restricted)

Operation mode before change	Operating mode after change		
	No specification	Process	Redundant
No specification	○	○	△
Process	△	○	△
Redundant	△	○	○



## 3.6 Verifying Projects

The project currently opened can be verified with data of another project.

By verifying projects, the consistency and changes can be checked.

Projects can be verified between different module types of a same series.

A project of a remote head module cannot be verified with that of a CPU module.

When user information is registered to a project, user authentication is required. (☞ Page 684 Logging on to a project)

### Verification

3

#### Window

Select [Project] ⇒ [Project Verify].

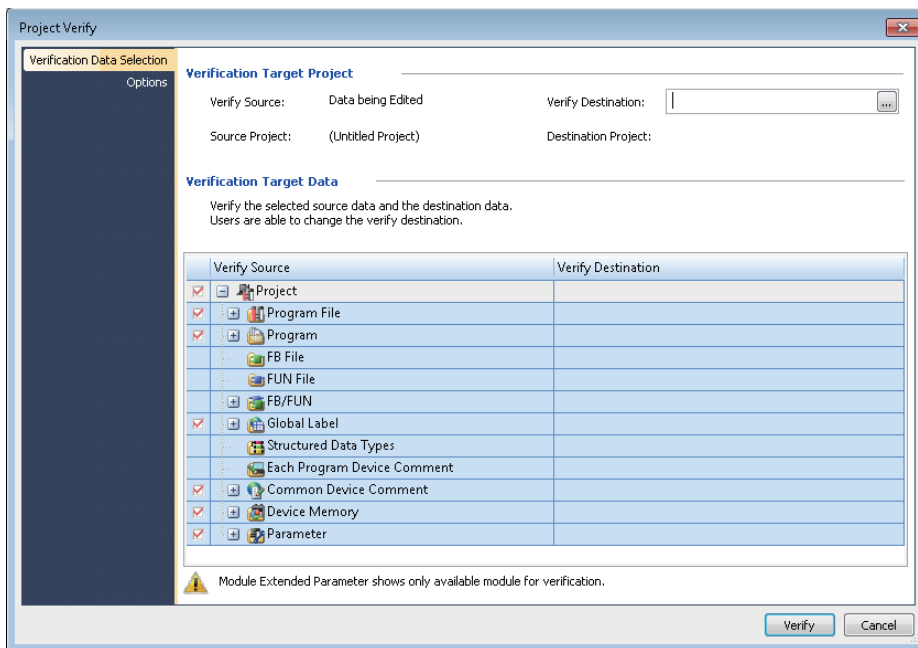

#### Operating procedure

1. Specify a project for "Verify Destination" on the [Verification Data Selection] tab.
2. Select the data to be verified, and click the [Verify] button.

A verification result is displayed in the "Verify Result" window.

#### Point

The target project file can be specified by dragging and dropping.

By selecting "Yes" for the following option, the label memory can be verified. (☞ Page 148 Program file/FB file/FUN file)

- "Other Editor" ⇒ "Label Editor Common" ⇒ "Verify" ⇒ "Include Label memory as Verify Target"

#### Precautions

- A GX Works2 or GX Developer project cannot be verified.
- A project for which a security is set can be verified when both data of the verification source and verification destination are not read-protected.

## Parameters

### ■Module parameters

In a project for FX5CPUs, parameters for the following modules can be verified.

Module					
FX5-232ADP	FX5-485ADP	FX5-4AD-ADP	FX5-4AD-PT-ADP	FX5-4AD-TC-ADP	FX5-4DA-ADP
FX5-4A-ADP	FX5-16ET/ES-H	FX5-16ET/ESS-H	FX5-4LC	FX5-4LC(FX3)	FX5-8AD
FX5-8AD(FX2N)	FX5-40SSC-S	FX5-80SSC-S	FX5-40SSC-G(S)	FX5-80SSC-G(S)	FX5-20PG-P
FX5-20PG-D	FX5-ENET	FX5-ENET/IP	FX5-OPC	FX5-CCLIEF	FX5-CCL-MS
FX5-CCLGN-MS	FX5-ASL-M	FX5-4AD	FX5-4AD(FX3)	FX5-4DA	FX5-4DA(FX3)
FX5-SF-MU4T5	—	—	—	—	—

### ■Module extended parameters

Module extended parameters are not verified.

However, the module extended parameters of the following modules can be verified:

- Simple motion module
- CC-Link IE TSN compatible motion module (simple motion mode)

### ■AnyWireASLINK configuration setting

The AnyWireASLINK configuration setting that includes any of the following modules is not verified.

- CC-Link-AnyWireASLINK bridge module
- CC-Link IE Field-AnyWireASLINK bridge module
- CC-Link IE TSN-AnyWireASLINK bridge module

### ■Verifying only specific intelligent function modules

The procedure to verify only specific intelligent function modules is as follows:

#### Operating procedure

1. After projects are verified, select "Module Parameter" in the result list in the "Verify Result" window, then double-click it or press the  key.
2. Click the [Stop] button in the "Verification Progress" screen immediately after verification starts.
3. Select a module to verify in the [Module Parameter] tab in the "Verify Result" screen, and double-click it or press the  key.

### ■Unmatched module parameters

When verifying module parameters, the following message may appear.

- Message: Module parameters created through different versions are verified. For some items, mismatch results might be shown even if the same settings were set on the setting window.

To match the module parameters, perform the following operations to the projects of the verification destination and source, and then verify once again.

#### Operating procedure

1. Change the corresponding setting item in the parameter editor, and then restore it.
2. Save the project.

# Checking a verification result

A verification result can be checked in the "Verify Result" window or the detailed display (diagram/table format) screen. In the detailed display (diagram/table format) screen, the details of a project verification result are displayed in a diagram or table format.

No.	Name	Description	Reference
(1)	Verification result	Result list A tab in which the verification results of each data are displayed. By double-clicking data including multiple units of data such as FBD/LD program, the verification result of those data is displayed in a new tab.	—
(2)		Detailed display A tab in which the details of mismatched data are displayed. By double-clicking the data displayed in the result list, the verification result is displayed according to the data type.	Page 147 Detailed display (program file) Page 150 Detailed display (program) Page 152 Detailed display (other data)
(3)	Detailed display (diagram/table format)	A screen in which verification results of programs, labels, structures, and device comments are displayed in a diagram or table format. This screen appears by double-clicking any of the rows where the following character strings are displayed in the "Type" column of the result list. <ul style="list-style-type: none"> <li>• Program: Program, Zoom</li> <li>• Label: Global Label, Program (Local Label), FB/FUN (Local Label)</li> <li>• Structure: Structured Data Types</li> <li>• Device comment: Each Program Device Comment, Common Device Comment</li> </ul>	Page 154 Detailed display (diagram/table format)

**Ex.**  
FBD/LD program

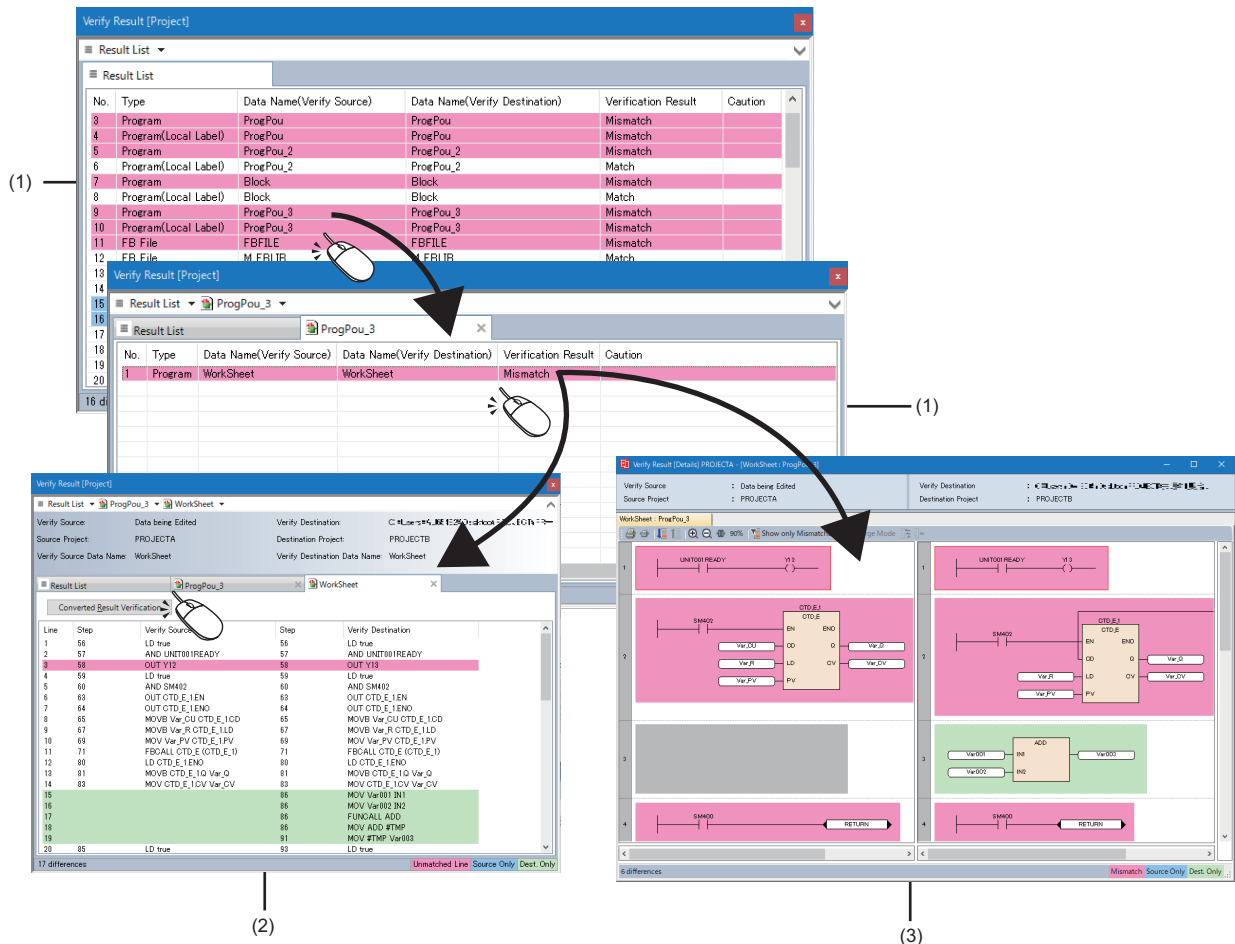

---

Font and the font and background color in the "Verify Result" window can be changed. (  Page 81  
Checking and Changing Colors and Fonts)

Only mismatched data can be displayed by using the following menu while the detailed display tab in the "Verify Result" window is displayed.

- [View] ⇒ [Show only Mismatches] (  )

In addition, a verification result can be exported to a file by using the following menu.

- Select [Edit] ⇒ [Export to File] (  ).
- 

## Precautions

Data inconsistency may be detected in a global label, local label, or structure.

In that case, there is a possibility that the inconsistency will be solved by performing the following operations in the editor where the data is defined.

- 1.** Export data of the corresponding label or structure to a CSV file.
- 2.** Import the file exported in step 1.

Then, in a global label editor, check the setting contents in the "Assign (Device/Label)" column. (For a global label and structure only)

## Detailed display (program file)

The details of the verification result of a program file, FB file, and FUN file can be checked in the detailed display tab.

### Window

Select and double-click data in the result list in the "Verify Result" window.

Ex.

Program file

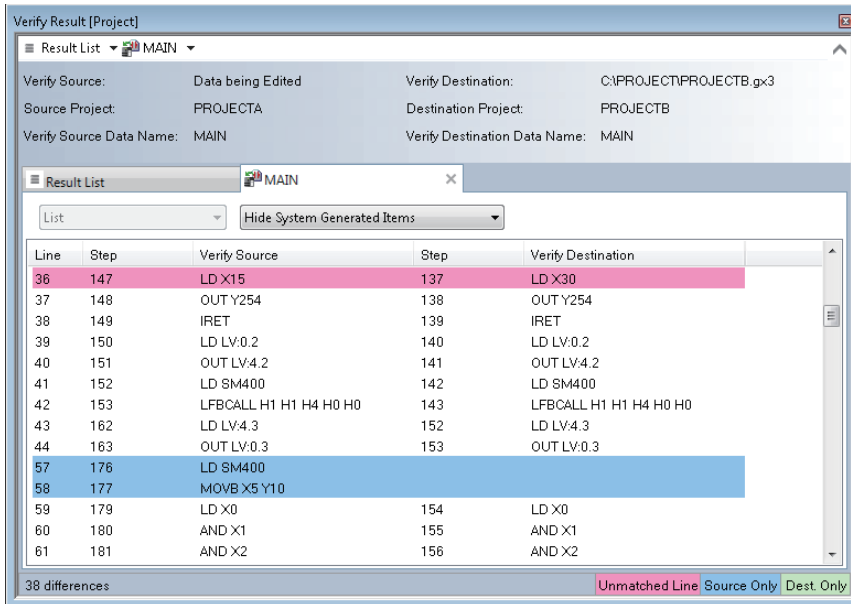

### ■ Searching for mismatched data

By selecting [Find/Replace] ⇨ [Next Mismatch] (🔍) / [Previous Mismatch] (🔍), mismatched data can be searched for.

### ■ Jumping to an editor

By double-clicking the displayed data, the cursor jumps to the corresponding data in each editor.

Point

After modifying mismatched data, double-click the data in the result list. By doing so, a verification result using the latest data of the verification source can be checked.

## Precautions

### ■Program file/FB file/FUN file

- When "Hide System Generated Items" is selected from the pull-down list of a Verify Result screen (detailed display), the following instruction codes are omitted in display.  
\_TMALLOC, \_TMFREE, JMPO, NOP H0, EXEFBDUMMY, FBRET, NOP, LD TMP, OUT TMP
- The label memory assigned to a label may be displayed in a verification result. For the types of displayed label memory, refer to the following:  
☞ Page 898 Label Memory Types
- When either verification destination or source satisfies all of the following conditions, its memory reserved area is changed. Therefore, difference is generated in the internal data between these projects; a mismatch may be detected between their program files, FB files, or FUN files.

No.	Condition
(1)	All programs have been converted (reassigned) after a value of any of the following items was changed in the "Properties" screen of a function block. <ul style="list-style-type: none"> <li>Label Reserved Area</li> <li>Latch Label Reserved Area</li> <li>Signal Flow Reserved Area</li> </ul>
(2)	The FB instance of a function block whose reserved area capacity has been changed is used in a program or a subroutine type function block.

- When either verification destination or source satisfies all of the following conditions, its memory reserved area is changed. Therefore, difference is generated in the internal data between these projects; a mismatch may be detected between their program files or FB files.

No.	Condition
(1)	All programs have been converted (reassigned) after the value of "Reserved area" in the "Properties" screen of a structure definition was changed.
(2)	A global label or a local label specified a structure definition, whose reserved area capacity has been changed, as the data type is used in the program.

### ■When the versions of GX Works3 that converted program files/FB files/FUN files are different

For verification of program files/FB Files/FUN files, when the versions of GX Works3 that converted the program files of a verification source and verification destination are different, there may be a difference in the conversion result, and the verification result also may be mismatched. In this case, convert all programs in both verification source and verification destination with the same version of GX Works3, then verify them again.

### ■When a function block with EN/ENO is used in a ladder program

When a project that satisfies all of the following conditions, the verification results of program files, FB files, or FUN files in a ladder or SFC program may be mismatched. In this case, convert (reassigned) all programs in both verification source and verification destination with the same version of GX Works3, and verify them again.

- A function block, where "Yes" is selected for "Use EN/ENO" on the "Properties" screen, is used in a ladder program or Zoom created in Ladder Diagram language.
- After reading a project that contains a program described above from a CPU module, all of the programs are converted (retained).

### ■When the cursor jumps to an output argument of a macro type function block

If the cursor jumps to the output argument (2) connected to the macro type function block (1) when double-clicking data, the corresponding data may actually exist in a program of the macro type function block (1).

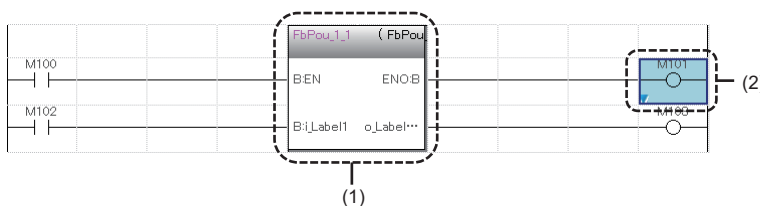

### ■When a security is set for a program file

When a program file, FB file, or FUN file that contains a program file, for which a security is set, is specified as a verification destination, the detailed verification result screen of each file does not appear.

The detailed verification result screen of each file appears by changing the setting of the locked program file to accessible. (☞ Page 674 Procedure for making locked program files accessible)

### ■Considerations for program file verification

- When program files are mismatched but programs in the program files are matched, it may be caused by a difference of the execution order of the programs in the program files. Check the program file setting.
- In a program including a subroutine type function block, the arguments of FBCALL instructions (LFBCALL, LSAFBCALL) may be mismatched.

The FBCALL instructions are automatically created to call a subroutine type function block by a system.

The arguments of the FBCALL instructions indicate an FB file of a function block to be called, POU, and addresses of memory reserved area (label area, latch label area, signal flow area).

Therefore, even if a project configurations are the same, the arguments of the FBCALL instructions may differ depending on the order to create programs. However, operations of a verification source and verification destination have no difference.

### ■When a block password is set for a program

- When a program file, FB file, or FUN file that contains a program, for which a block password is set, is specified as a verification destination, the program with a block password cannot be displayed in the verification result.

If a block password is set only for a program of the verification source, the program with a block password can be displayed in the verification result by unlocking the password. (☞ Page 672 Authenticating a block password)

- When a program file, FB file, or FUN file that contains a program, for which a block password is set, is specified as a verification destination, the detailed verification result screen of each file does not appear.

If a block password is set only for a program of the verification source, the screen appears by unlocking the password. (☞ Page 672 Authenticating a block password)

### ■When a function is used

Even if the project configurations of a verification source and verification destination are the same, the program files/FUN files may be mismatched due to the difference of the order in which a function was added.

### ■When verifying projects of which the system locales are different

When the system locale (or display language) for a project differs between the verification source and verification destination, the verification result of program files/FB files/FUN files may be mismatched.

The system locales for projects of the verification destination and verification source need to be matched to verify their data.

## Detailed display (program)

The details of a program verification result can be checked in the detailed display tab. In the detailed display tab, the details of a verification result is displayed in a list.

### Window

1. Select and double-click data in the result list in the "Verify Result" window.
2. Click the [Converted Result Verification] button in the detailed display tab.

Ex.

FBD/LD program

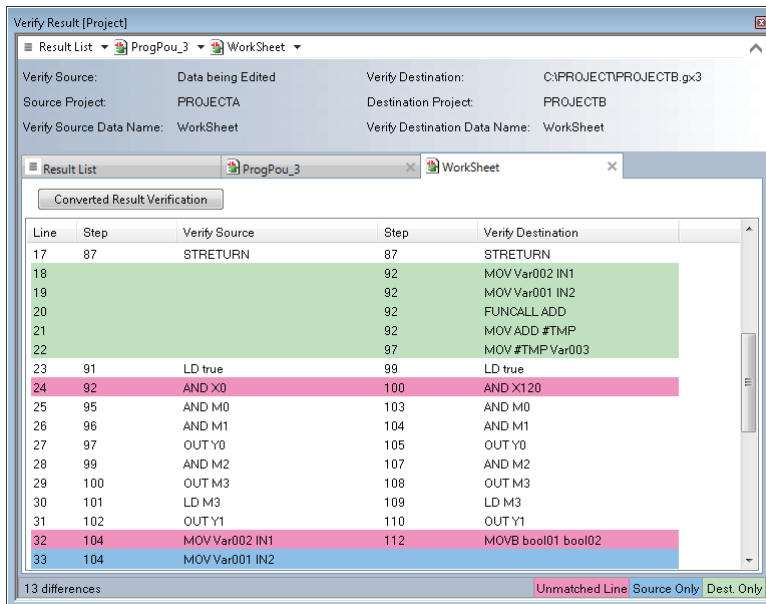

### ■ Searching for mismatched data

By selecting [Find/Replace] ⇄ [Next Mismatch] (🔍)/[Previous Mismatch] (🔍), mismatched data can be searched for.

### ■ Jumping to an editor

By double-clicking the displayed data, the cursor jumps to the corresponding data in each editor.

### Point

After modifying mismatched data, double-click the data in the result list. By doing so, the latest verification result can be checked.



## Precautions

### ■ Ladder program

- When there is no program in a macro type function block, the cursor jumps to the top of the ladder block.
- When programs containing an inline structured text program are verified, "STB" is displayed on the row of the inline structured text program.

The cursor jumps to the corresponding row of the inline structured text program by double-clicking the "STB."

- When programs containing a functions and/or function blocks are verified, the result is displayed as follows:  
Function: row from ";FUN BLK START" to ";FUN BLK END"  
Function block: row from ";FB BLK START" to ";FB BLK END"

### ■ FBD/LD program

- When the versions of GX Works3 used for editing programs of a verification destination and source are different, the verification result may be mismatched due to the difference of position information of elements. In this case, edit, convert, and save the programs in both the verification source and the verification destination with a same version of GX Works3, and perform the verification again<sup>\*1</sup>.

- When programs containing a functions and/or function blocks are verified, the result is displayed as follows:

Function: row from ";FUN BLK START" to ";FUN BLK END"

Function block: row from ";FB BLK START" to ";FB BLK END"

It can be hidden by setting the following option.

[Tool] ⇒ [Options] ⇒ "Program Editor" ⇒ "FBD/LD Editor" ⇒ "Verify" ⇒ "Verify Setting" ⇒ "Minimize the Detailed Display (List Format)"

- In any of the following cases, "-" is displayed in the "Step" column.
  - A project and the data in a CPU module were verified by using the [Verify with PLC] menu.
  - A verification was performed without converting any or all programs which were read from a CPU module.
- When programs containing an inline structured text program are verified, "STB" is displayed on the row of the inline structured text program.

The cursor jumps to the corresponding row of the inline structured text program by double-clicking the "STB."

- \*1 When verifying with a programmable controller, perform the "Write to PLC" or "Online Program Change" in advance.

### ■ ST program

- When programs containing a functions and/or function blocks are verified, the result is displayed as follows:

Function: row from ";FUN BLK START" to ";FUN BLK END"

Function block: row from ";FB BLK START" to ";FB BLK END"

It can be hidden by setting the following option.

[Tool] ⇒ [Options] ⇒ "Program Editor" ⇒ "ST Editor" ⇒ "Verify" ⇒ "Verify Setting" ⇒ "Minimize the Detailed Display (List Format)"

### ■ SFC program

- Even if displayed SFC diagrams of the verification destination look totally same as those of the verification source, the verification result may be mismatched due to a difference of the internal data which is generated depending on the creation procedure.
- "-" is displayed in the "Step" columns of the verification destination and source.

## Detailed display (other data)

The details of the verification result of data other than a program file and program can be checked in the detailed display tab.

### Window

Select and double-click data in the result list in the "Verify Result" window.

Ex.

CPU parameters (R04CPU)

The screenshot shows the 'Verify Result [Project]' window. At the top, it displays 'Result List' and 'CPU Parameter'. Below this, there are fields for 'Verify Source: Data being Edited', 'Verify Destination: C:\PROJECT\PROJECTA.gx3', 'Source Project: (Untitled Project)', 'Destination Project: PROJECTA', 'Verify Source Data Name: CPU Parameter', and 'Verify Destination Data Name: CPU Parameter'. The main area is a table with the following data:

Group Name	Category Name	Item Name	Verification Result
Memory/Device Setting	Device/Label Memory Area Setting	Device Area Capacity	Mismatch
Memory/Device Setting	Device/Label Memory Area Setting	Label Area Capacity	Mismatch
Memory/Device Setting	Device/Label Memory Area Setting	Latch Label Area Capacity	Mismatch
Memory/Device Setting	Device/Label Memory Area Setting	File Storage Area Capacity	Mismatch

At the bottom left, it says '4 differences'. At the bottom right, there are buttons for 'Unmatched Line', 'Source Only', and 'Dest. Only'.

### ■ Searching for mismatched data

By selecting [Find/Replace] ⇨ [Next Mismatch] (🔍) / [Previous Mismatch] (🔍), mismatched data can be searched for.

### ■ Jumping to an editor

By double-clicking the displayed data, the cursor jumps to the corresponding data in each editor.



After modifying mismatched data, double-click the data in the result list. By doing so, a verification result using the latest data of the verification source can be checked.

## Precautions

### ■ Device memory

- Device memory data can be verified even if their names are different.
- For a verification result of device memories, only mismatched devices are displayed.

### ■ Parameters

- When the same profiles are not registered to the verification destination and source, the verification result may be mismatched.

### ■ When the number of mismatched parameters exceeds 1000

Up to 1000th mismatched parameters are displayed in the detailed verification result screen, and verification for 1001st or later is interrupted.

To verify parameters after interruption, correct the mismatched data before verifying again.

### **Restriction**

---

The following restrictions apply when a parameter item was added to the verification destination with upgrade of an intelligent function module.

- The added parameter item is excluded from a verification because the verification source that has not been upgraded cannot identify the item. Therefore, other parameters will be verified, and when those parameters matched, it is applied to the verification result in each module.
-

## Detailed display (diagram/table format)

Details on a verification result of the following data can be checked in the detailed display (diagram/table format) screen.

- Program (ladder program, ST program, FBD/LD program, SFC program)
- Label (global label, local label)
- Structure
- Device comment

In the detailed display (diagram/table format) screen, the details on a verification result are displayed in a diagram or table format.

In this section, elements connected using connection lines are referred to as 'verification block.'

## Window

Select and double-click data in the result list in the "Verify Result" window.

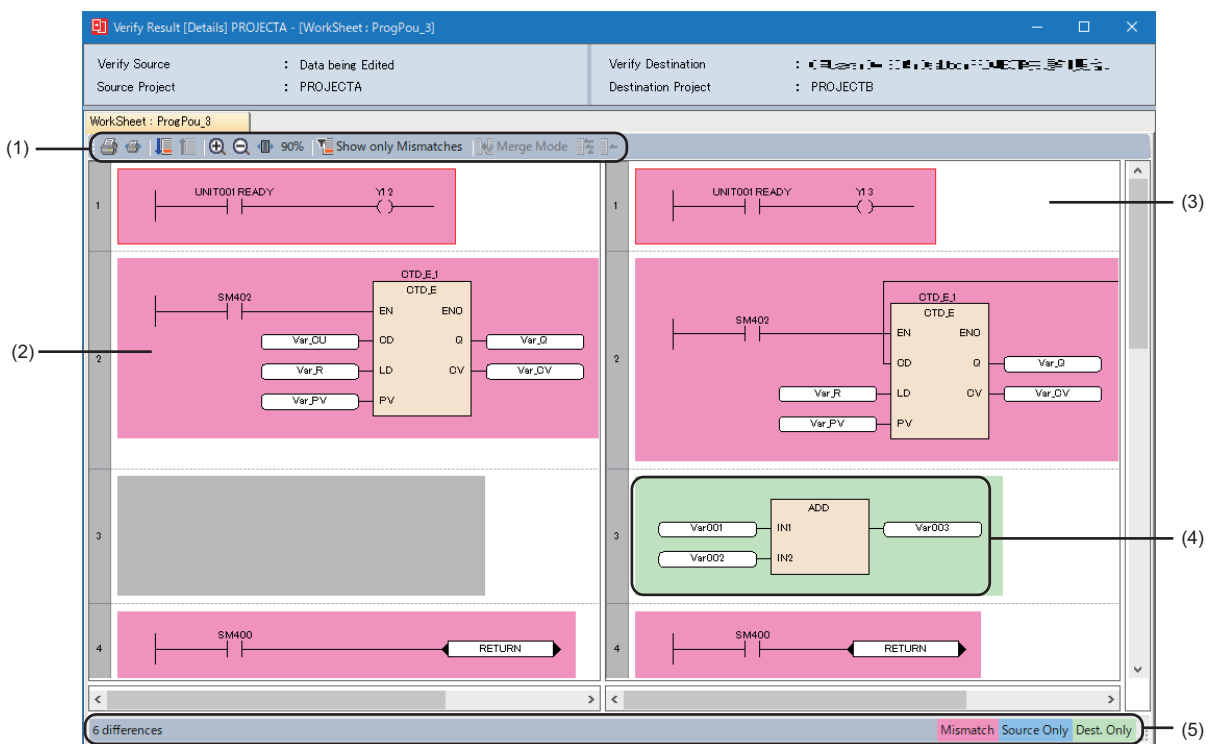

**Ex.**  
FBD/LD program



- (1): Toolbar
- (2): Verification result display area (verification source)
- (3): Verification result display area (verification destination)
- (4): Verification block
- (5): Status bar

When displaying a verification result of any of the following data, the display of either verification source or destination whose magnification is higher is zoomed in or out according to the width of the one with lower magnification by clicking  (Zoom to Page Width).

- Ladder program
- FBD/LD program
- SFC program
- Label
- Structure
- Device comment

When displaying a verification result of ST programs, data in the selected range can be copied by pressing the  +  keys.

### ■Label, structure, and device comment

For a verification result of global labels, local labels, structures, or device comments, only mismatched data is displayed. Moreover, a verification result can be filtered.

An operation method for filtering is the same as that in the cross reference window. For details, refer to the following:

 Page 462 Filtering display

### ■Searching for mismatched data

By clicking  (Next Mismatch) or  (Previous Mismatch) on the toolbar, mismatched data can be searched for.

- Ladder program: Mismatched data is displayed for each cell.
- FBD/LD program and SFC program: Mismatched data is displayed for each verification block.
- ST program: Mismatched data is displayed for each row.

### ■Displaying mismatched data only

Only the mismatched data can be displayed by clicking  (Show only Mismatches) on the toolbar.

## ■ Merging mismatched data into a verification source

When the verification result of a ladder program or ST program is displayed, mismatched data can be merged into a program of the verification source. (Excluding a Zoom and an inline structured text program used in an FBD/LD program)

The following table shows the procedures for merging data.

Data to be merged	Operating procedure		
	Procedure	Shortcut key	Icon on the toolbar
Any mismatched data	① Switch to the merge mode.	keys	(Merge Mode)
	② Move to the data to be merged.	keys keys	(Next Mismatch) (Previous Mismatch)
	③ Merge data in the selected range into a program of the verification source.	keys	(Merge the Selected Range)
All mismatched data	① Switch to the merge mode.	keys	(Merge Mode)
	② Apply all data to a program of the verification source.	keys	(Reflect All)

## Precautions

- Once data is merged, it cannot be undone or redone.
- Data cannot be merged in the following cases:
  - A read-only project is verified.
  - A ladder program in the read mode or monitor read mode is verified.
  - Histories are verified with each other by using the project revision history function or project version management function.
  - Specific data in a master project is verified with that in a local project by using the project version management function.
  - All programs are matched.
- Only a program body is merged. The following data cannot be merged:
  - Global label
  - Local label
  - Structure definition
  - Function block
  - Function
  - Device comment

## ■ Jumping to an editor

By double-clicking displayed data, the cursor jumps to the following data in each editor.

Editor	Data
Ladder editor Structure definition Device comment editor	Double-clicked data
FBD/LD editor SFC editor	Data which is found first by searching a verification block from the upper left to lower right
ST editor	Data in the same row number as the one where the selected data is
Label editor	Double-clicked data <sup>*1</sup>

\*1 For a label or structure member assigned to a label, the cursor jumps to the data in the "Assign (Device/Label)" column.

## ■ Printing

The following shows the procedure for printing a verification result.

### Operating procedure

1. Click  (Print) on the toolbar.

In the "Print Preview" screen, an image is displayed in the case of using a printer which is set in [Use Always] of Windows.

2. Click  (Print) in the "Print Preview" screen.

### Point

When printing a verification result of any of the following data, the screen zoomed out according to the widest verification block in the verification source and destination will be displayed in the print preview by clicking  (Print to Page Width) on the toolbar.

- Ladder program
- FBD/LD program
- SFC program
- Label
- Structure
- Device comment

## ■ Exporting to a file

The following shows the procedure for exporting a verification result to a file.

### Operating procedure

1. Right-click in the verification result display area, and select [Export to File] from the shortcut menu.

2. Set each item and click the [Save] button.

## Precautions

### ■ Differences from a program editor

Displayed data differs between the detailed display (diagram/table format) screen and program editor.

Data not to be verified is not displayed in the detailed display (diagram/table format) screen.

In addition, characters displayed in a program editor may not be displayed in the detailed display (diagram/table format) screen. In that case, check it by moving the cursor to the editor.

### ■ Ladder program

- Even when instructions which are not displayed in a ladder program such as NOP are mismatched, the result cannot be checked in the detailed display (diagram/table format) screen. Check it in the detailed display tab, instead. (  Page 150 Detailed display (program))
- Programs are verified in the state where all collapsed ladder blocks, notes, and statements displayed.
- When jumping to data in a ladder program, notes and statements are displayed on an ladder editor regardless of the display format of the editor.



### ■ FBD/LD program and SFC program

- Verification blocks are arranged vertically in window. This order differs from the actual execution order of programs.
- When the heights of function elements and function block elements are not matched, they are displayed as mismatches.

### ■ FBD/LD program

- When function elements/function block elements are displayed as mismatches even though their display contents are matched between the verification source and the verification destination, the hidden arguments may not be matched. (  Page 331 Hiding arguments)
- An inline structured text program is not displayed in the preview display area of inline structured text elements in the detailed display (diagram/table format) screen.

### ■ SFC program

The search cannot be performed for each element even by clicking  (Next Mismatch)/  (Previous Mismatch) on the toolbar but for each verification block.

### ■ Data not to be verified

The following table shows the data not to be verified.

Program	Data
Ladder program	Comment and device displayed by using the following menu • [View] ⇒ [Comment Display]/[Display Device]
	Background color of cells
	Step number
FBD/LD program SFC program	Device displayed by using the following menu • [View] ⇒ [Device Display]
	Program display format changed by using the following menu • [View] ⇒ [Display Step/Transition]/[Switch Ladder Display]
	Link setting, background color, and text layout of POUs
	Automatic connector
FBD/LD program	Comment displayed by using the following menu • [View] ⇒ [Comment Display] ⇒ [Device/Label Comment] • [View] ⇒ [Comment Display] ⇒ [Switch FB/FUN Argument]
	SFC program
	Jump element



### ■Color and font

Font and the font and background color in the detailed display (diagram/table format) screen cannot be changed.

### ■Verify result window

While the "Print Preview" screen is displayed, a verification result is not displayed properly in the Result List tab and the detailed display tab in the "Verify Result" window.

After closing the "Print Preview" screen, redisplay the tab.

### ■Label comment for an array element or bit-specified label

If the data type of a label is changed after the verification result is displayed, the cursor may not be able to jump to the label comment for an array element or bit-specified label from the verification result.

## 3.7 Project Revision History

---

This function manages the revision history of a project by recording changes in the project. By using this function, a past project can be restored based on a revision.

### Registering a revision

---

To record changes in a project, registering a revision in the "Register Revision" screen is required.

#### Window

Select [Project] ⇒ [Project Revision] ⇒ [Register Revision].

Register the following information as revisions.	
PC Type	R08
User	
Version	1.010L
Title	Title A

Comment(C)

OK Cancel

#### Operating procedure

Set each item and click the [OK] button.

#### Precautions

For a project whose security version is '2,' it may take time to register a revision.

## Registering a revision when a project is overwritten

By setting options, a project revision can be registered when the project is overwritten.

This prevents that the project is overwritten without registering the revision.

The procedure to register a revision is shown below.

### Operating procedure

1. Set "Yes" for the following option. (When the option has been set, this operation is not required.)
  - [Tool] ⇒ [Options] ⇒ "Project" ⇒ "Revision" ⇒ "Operational Setting" ⇒ "Register to the Revision When Saving Project"A confirmation message showing whether to register a revision appears when overwriting a project.
2. Read the message, and click the [Yes] button.
3. Set each item in the "Register Revision" screen, and click the [OK] button.

### Point

By selecting "Yes" for the following option, a revision title is set automatically. Therefore, the "Register Revision" screen explained in step 3 does not appear.

- [Tool] ⇒ [Options] ⇒ "Project" ⇒ "Revision" ⇒ "Operational Setting" ⇒ "Automatically Set Revision Titles"

In addition, by selecting "No" for the following option, the message explained in step 2 does not appear.

- [Tool] ⇒ [Options] ⇒ "Project" ⇒ "Revision" ⇒ "Operational Setting" ⇒ "Display Confirmation Message Showing Whether to Register Revision"

By selecting "Yes" for the following option, revision information is optimized when the revision is registered so that the file size of the project in which a label is used is reduced.

- [Tool] ⇒ [Options] ⇒ "Project" ⇒ "Revision" ⇒ "Operational Setting" ⇒ "Optimize Revision Information to Reduce File Size"

# Revision list screen

Registered revisions can be checked in the "Revision List" screen.  
Revisions can be registered, restored, deleted, and verified in this screen.

## Window

Select [Project] ⇒ [Project Revision] ⇒ [Revision List].

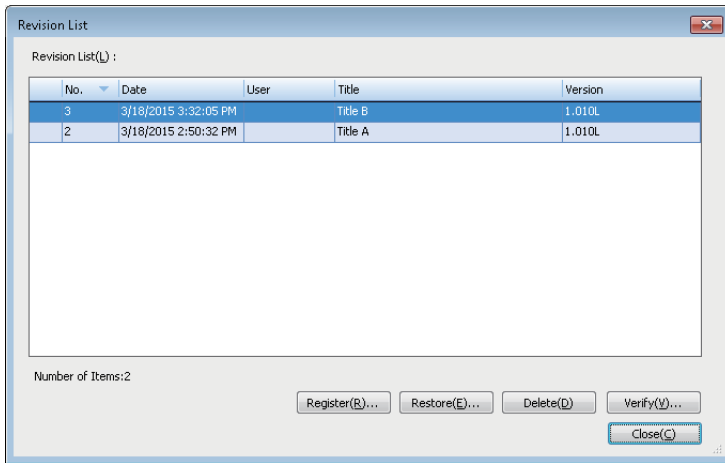

Select and right-click a revision, then select [Details] from the shortcut menu; the "Detailed Revision Information" screen appears, and the information such as comments entered at the registration can be checked.

## Registering a revision

A project revision can be registered by clicking the [Register] button.  
This time, information for iQ AppPortal is not registered.

## Precautions

- It may take time to register a revision of a large project if the size of its project file exceeds 10 MB.
- For a project whose security version is '2,' it may take time to register a revision.

## Restoring a revision

A past project can be restored based on a registered revision.

## Operating procedure

1. Select a project revision to be restored, and click the [Restore] button.
  2. Click the [OK] button in the "Restore Revision" screen.
- ✔ will be displayed at the head of the revision selected in step 1 after the project restoration is completed.

## Precautions

- Before restoring a project, register a revision of the project being edited. Otherwise, the project before the restoration is overwritten when the project restored based on another revision is saved.
- The added/changed/deleted user information is not restored.
- For a project whose security version is '2,' it may take time to restore a revision.

## Deleting a revision

A registered revision can be deleted.

### Operating procedure

Select a revision to be deleted, and click the [Delete] button.

## Verifying a revision

A revision can be verified with another revision or a project being edited.

### Operating procedure

Select a revision to be verified, and click the [Verify] button.

If only one revision is selected for verification, it is verified with a project being edited. To verify revisions, select two revisions. The operation method for displaying the verification result is the same as that of project verification. For more details, refer to the following:

 Page 145 Checking a verification result

### Precautions

For a project whose security version is '2,' it may take time to verify a revision.

## 3.8 Project Version Management

This function manages the update revision history of a project for each data by recording changes in the project with a version management system\*1. (Changes not only in an entire project but also in each data can be recorded.)

\*1 Manages the update revision history of a file that is created and edited on a personal computer.

### Overview

A created project can be registered in a version management system and the project can be edited by acquiring it from the system.

When an edited project is registered in the system again, the project that has been registered in the system is updated, and the changes are recorded as an update revision.

Consequently, the edited project is automatically merged into the project that has been registered in the system, and the update revision can be managed.

Moreover, past data can be restored based on an update revision.

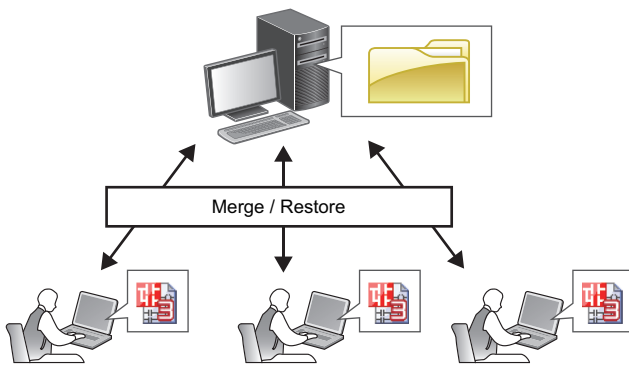



### ■Features

The following shows features of this function.

- The update revision history of a project on a server can be managed for each data. (Changes in each data can be recorded individually.)
- Data created by multiple developers are automatically merged into one project. (Only specific data can be merged.)
- Only specific data can be restored based on a revision of data. (Only data with an error can be restored.)

### ■Update revision history

Changes in data are recorded as an update revision by either of the following operations.

- Register a project in a version management system. (  Page 168 Registering a project)
- Register local project data in a version management system. (  Page 173 Registering a project file and data)

## Master project and local project

By registering a project in a version management system, a project (folder format) in which changes are recorded is created. This project is referred to as a 'master project' in this manual.

The following projects can be merged into a master project.

- Original project of one registered in a version management system (single file format)
- Project acquired from the version management system (single file format)

These projects are referred to as 'local projects' in this manual.

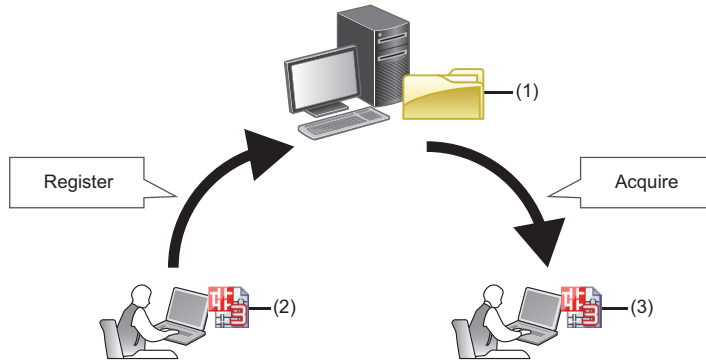

(1): Master project

(2): Local project (original project of one registered in a version management system)

(3): Local project (project acquired from the version management system)

For each operation method, refer to the following:

☞ Page 168 Registering/acquiring/editing/deleting a project

## Differences from iQ AppPortal

Both iQ AppPortal and GX Works3 have a function to manage changes in a project file.

The following explains differences (features and usage examples) of each function.

### ■Function of iQ AppPortal

Feature	Usage example	Reference
Single or multiple project files used in a system can be managed. (Managed in a server.)	Understanding the parent-child relationships between a newly created project file and its source and the timing of derivation when creating a new project file by utilizing one registered in iQ AppPortal	☞iQ AppPortal Operating Manual

### ■Project version management function of GX Works3

Feature	Usage example	Reference
Changes in data (such as a program, label, or parameter) in one project file can be managed. (Managed in a version management system.)	Managing changes per program when creating programs to be used in one project file with multiple developers	Page 164 Project Version Management

### ■Project revision history function of GX Works3

Feature	Usage example	Reference
Changes in a project file can be managed. (Managed in a project file.)	Backing up a project file by recording changes automatically when overwriting a project	Page 160 Project Revision History

## Operation flow

The following figure shows an operation flow to manage the update revision history of a project.

**Ex.**

Multiple developers (A, B, and C) assign tasks to one another and create one project:

Tasks assigned to each developer are as follows:

- A: Creating a new project and an own assigned program (ProgPou\_A)
- B: Creating an assigned program (ProgPou\_B) based on the project created by A
- C: Debugging programs in a master project

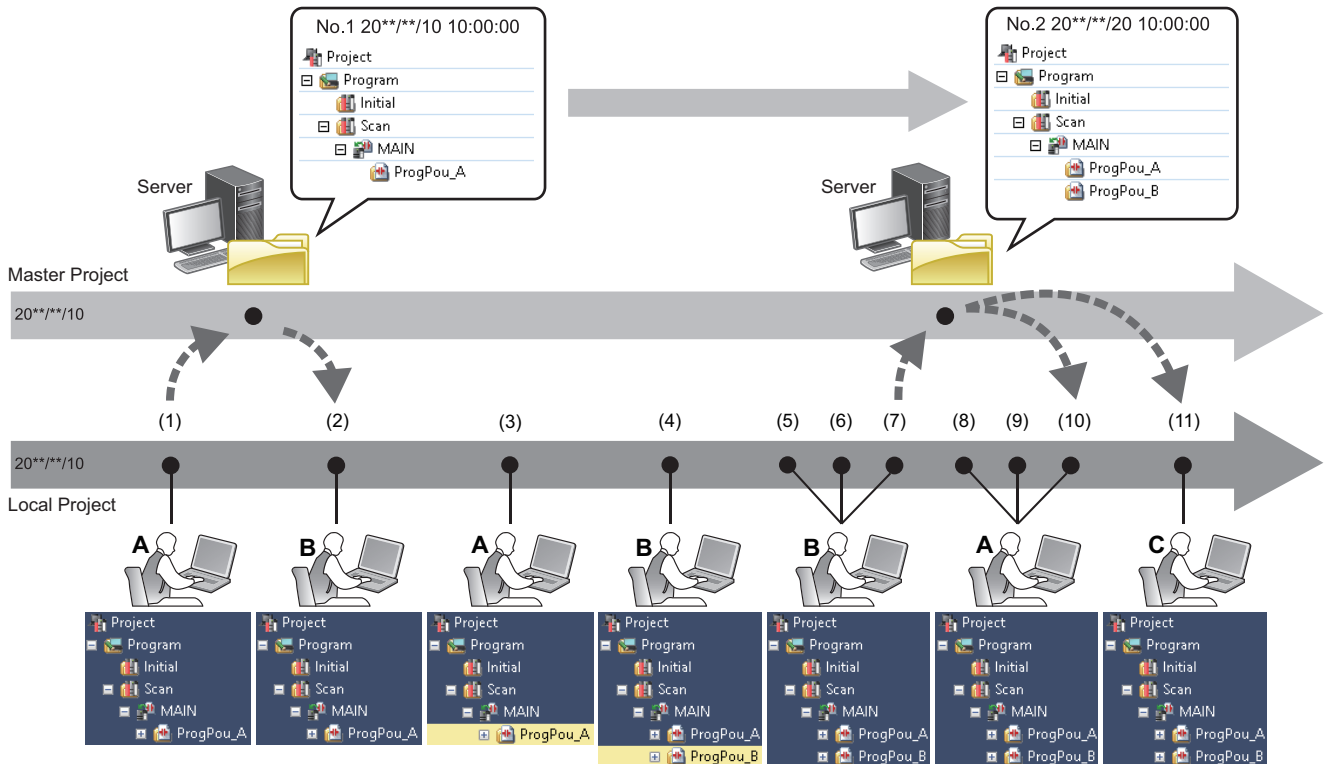



No.	Developer	Purpose	Operation	Reference
(1)	A	To create a master project	Register a project in a version management system.	Page 168 Registering a project
(2)	B	To create a local project	Acquire a project from the version management system.	Page 169 Acquiring a project
(3)	A	To edit 'ProgPou_A'	Edit their respective local projects.	Page 169 Editing a project
(4)	B	To create 'ProgPou_B'		
(5)	B	To merge 'ProgPou_B' into the master project	To check if the master project has been updated	Page 170 Update Revision screen
(6)	B		To check differences between the local project and the master project	Page 178 Verifying a project file or data
(7)	B		To merge 'ProgPou_B'	Register 'ProgPou_B' in the version management system. ('ProgPou_B' is merged into the master project, and changes are recorded.)
(8)	A	To merge 'ProgPou_B' into the own local project	To check if the master project has been updated	Page 170 Update Revision screen
(9)	A		To check changes in updated 'ProgPou_B'	Page 180 Checking detailed information
(10)	A		To merge 'ProgPou_B'	Acquire only 'ProgPou_B' from the version management system. (Only 'ProgPou_B' is merged into the local project. 'ProgPou_A' is not changed.)
(11)	C	To debug the programs in the master project	Acquire a project from the version management system. (Debug the programs in the acquired project.)	Page 169 Acquiring a project

# Registering/acquiring/editing/deleting a project

The following explains the methods for registering, acquiring, editing, and deleting a project.

## Registering a project

The procedure to register a project in a version management system is as follows.

Only projects saved as a single file format can be registered in a version management system.

### Operating procedure



1. Select [Tool] ⇒ [Configuration Management] ⇒ [Register Project].

If a project is not opened, select the project to be registered in the displayed screen.

2. Specify the path to a folder to manage a master project in the "Register Project" screen, and click the [OK] button. (Up to 256 characters)
3. Enter a title and comment in the "Register Project" screen, and click the [OK] button. (Title: up to 128 characters, Comment: up to 5120 characters)

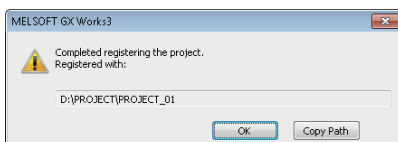
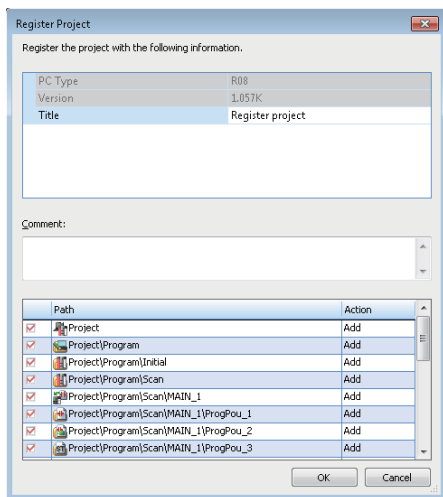

A folder (master project) with the same name as the project name is created in the specified folder.

### Precautions

- A project cannot be registered in the following cases:
  - The project is saved as a workspace format.
  - The project file name has more than 80 characters.
  - The project is logged on to as a user whose access level is 'Users.'
- For a project whose security version is '2,' it may take time to register a project.

## Acquiring a project

The procedure to acquire a project from a version management system is as follows.

### Operating procedure

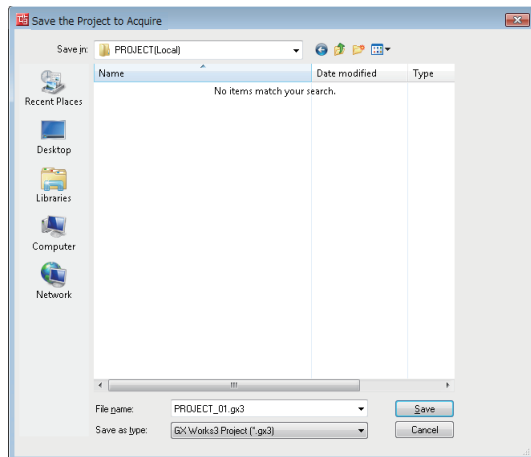
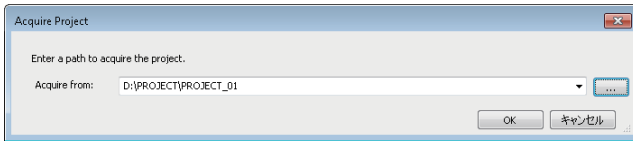

1. Select [Tool] ⇒ [Configuration Management] ⇒ [Acquire Project].
2. Specify the path to the folder where a master project is managed in the "Acquire Project" screen. (Up to 256 characters)
3. Set each item in the "Save the Project to Acquire" screen and click the [Save] button.

3

### Precautions

- An acquired project is in the unconverted state.
- For a project whose security version is '2,' it may take time to acquire a project.

## Editing a project

A local project can be edited in the same manner as a normal project.

### Precautions

Once either of the following is changed, the project data cannot be registered in or acquired from a version management system:

- A module type or operation mode set in a project
- A security version set in a project

## Deleting a master project

To delete a master project, delete the folder created when the project was registered in a version management system (the one with the same name as the project name).

# Update Revision screen

The update revision history of a project can be checked in the "Update Revision" screen.

The following operations can also be performed in this screen.

- Page 173 Registering a project file and data
- Page 176 Acquiring a project file and data
- Page 178 Verifying a project file or data
- Page 180 Checking detailed information



## Window

Select [Tool] ⇒ [Configuration Management] ⇒ [Update Revision] (  ).

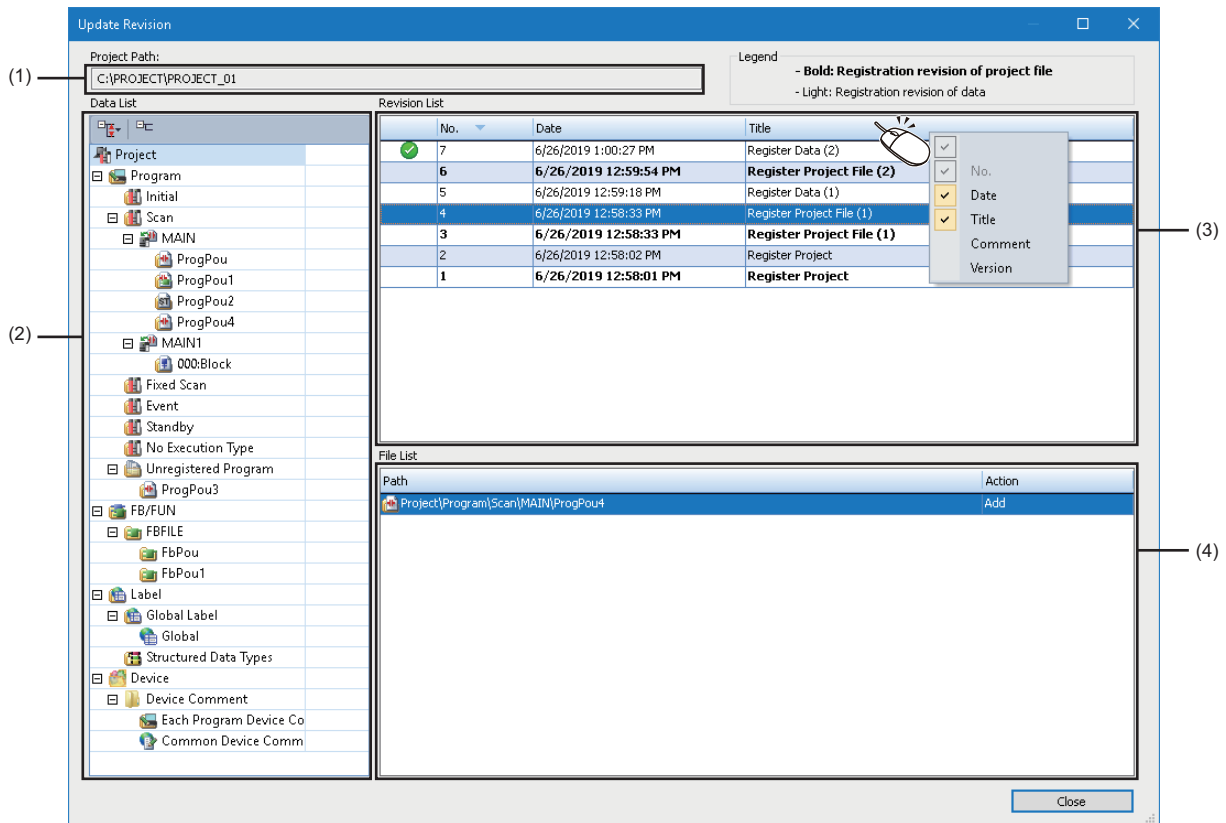
If a project is not opened, select the project in the screen displayed by selecting this menu.



## Displayed items

Item	Description
(1) Project Path	The path to a folder where a master project is managed is displayed.
(2) Data List	<p>The following data is displayed in a tree format.</p> <ul style="list-style-type: none"> <li>• Master project data (including data that does not exist in a local project)</li> <li>• Data that exists only in a local project</li> </ul> <p>An icon that indicates data status is displayed on the right side of each data. (  Page 171 Icons in the data list)</p> <p>By clicking  (Display the Deleted Data), data which is deleted from a master project and also does not exist in a local project can be displayed. (In gray)</p>
(3) Revision List	<p>The update revisions of data selected in the data list is displayed.</p> <p>If data containing lower hierarchy data is selected in the data list, the revisions of both the selected data and its lower hierarchy data are displayed.</p> <p>Revisions of a project file are displayed in bold.</p> <p> is displayed on the left side of a revision of data locally acquired.</p> <p>Items to be displayed can be selected by right-clicking on the column header.</p>
(4) File List	Data associated with a revision selected in the revision list is displayed.

## ■ Management targets of an update revision history

An update revision history of the following data and settings can be managed. The table below shows whether each menu in the "Update Revision" screen is available for each data or setting.

○: Available, ×: Not available

data/setting	Menu	
	[Register/Acquire Data] <sup>*1</sup>	[Register/Acquire Project File] <sup>*2</sup>
Program block <sup>*3</sup> , FB folder <sup>*3</sup> , FUN folder <sup>*3</sup> , common device comment, each program device comment	○	○
Project, module configuration diagram <sup>*4</sup> , program folder, execution type folder, program file, folder, FB/FUN folder, FB file, FUN file, label folder, global label folder, global label, structured data types folder, structure, device folder, device comment folder, each program device comment folder, device memory folder <sup>*4</sup> , device memory <sup>*4</sup> , device initial value folder <sup>*4</sup> , device initial value <sup>*4</sup> , parameter <sup>*4</sup> , unused ladder program, data and settings which are not displayed in the navigation window (for example: program file setting)	×	○

\*1 Displayed by selecting and right-clicking data in the data list in the "Update Revision" screen.

\*2 Displayed by selecting and right-clicking "Project" in the data list in the "Update Revision" screen.

\*3 Includes local labels, program body, and worksheet.







\*4 Not displayed in the "Update Revision" screen.

For the following data and settings, the update revision history cannot be managed.

Shortcut key, color and font, display setting for the system monitor, element selection window (including library), docking window, favorite setting in the online data operation screen, display language, profile, toolbar, status bar, each screen state (size, displayed items, content being entered, etc.), conversion state of each data, project revision history

## ■ Icons in the data list

The following table shows the icons displayed in the data list.

Icon	Name	Description
None	—	No icon is displayed if there is no difference between master project data and local project data.
	Change	This icon is displayed when local project data is newer than master project data. In some cases, however, this icon is not displayed even if local project data is edited. (☞ Page 172 Operations for which an icon is not displayed)
	Old	This icon is displayed when local project data is older than master project data.
	Conflict	This icon is displayed when data that is older than the latest master project data is edited in a local project. (Example: When data edited in a local project is older than the latest master project data edited by another user, this icon is displayed on the right side of the data.)
	Add	This icon is displayed when data is added in a local project.
	To be deleted	This icon is displayed when data is deleted from a local project.
	Old data to be deleted	This icon is displayed when data that is older than the latest master project data is deleted from a local project. (Example: When data deleted from a local project is older than the latest master project data edited by another user, this icon is displayed on the right side of the data.)
	Changes in lower hierarchy data	This icon is displayed when lower hierarchy data is changed in a local project. (Example: When a program block is added, this icon is displayed on the right side of a program file including the program block.)

## ■Operations for which an icon is not displayed

When certain operations are performed in the following screens,  (Change) is not displayed on the right side of each data in the data list.

To apply changes in each screen to a master project, register a project file to a version management system. ( Page 173 Project file)

Screen	Operation
Work window	Changing display state (example: arranging work windows)
Navigation	Filtering data Sorting data Changing the name of a function block or function
Option Print Multiple Comments Display Setting Input the Configuration Detailed Information Tag FB Setting Specify Connection Destination Online Data Operation	Changing settings
Label editor	Clicking the [Simple Display] or [Detailed Display] button
Program editor SFC Block List	Switching whether to display or hide comments
FB Property Management (Offline)	Changing an initial value
Device Comment Device Memory	Searching for a device
Device Memory	Changing the display format
Find and Replace Device List	Changing the search location of a device or label
Cross Reference	Selecting the following menu: • [Display] ⇒ [Display Hierarchically]
Device/Buffer Memory Batch Monitor	Closing the window after searching for a device
Watch	Registering a device or label
Intelligent Function Module Monitor	Changing a module registered in the window

## Registering a project file and data

### ■ Project file

To merge all data in a local project into a master project, register the project file in a version management system. The following shows the procedure to register a project file.

### Operating procedure

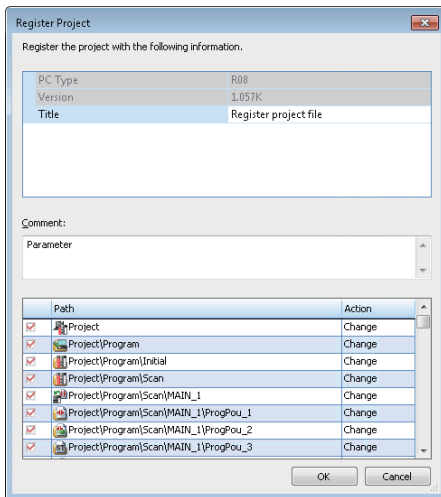
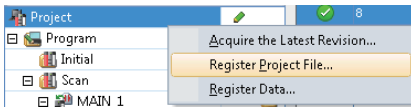

1. Select "Project" in the data list.
2. Right-click it and select [Register Project File] from the shortcut menu.
3. Enter a title and comment in the "Register Project" screen, and click the [OK] button.  
(Title: up to 128 characters, Comment: up to 5120 characters)

3

## ■Data

To merge only specific data in a local project into a master project, register only the data in a version management system. The following shows the procedure to register only specific data.

### Operating procedure

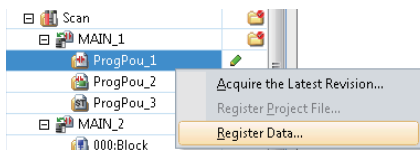

1. Select data in the data list. (Multiple selections allowed.)
2. Right-click it and select [Register Data] from the shortcut menu.
3. Enter a title and comment in the "Register Data" screen. (Title: up to 128 characters, Comment: up to 5120 characters)
4. Select the checkbox of data to be registered, and click the [OK] button.

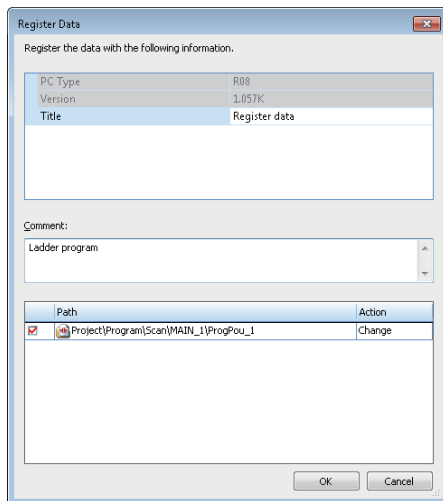

### Point

- Data to be registered can be verified with the latest data in a master project by performing any of the following operations in the "Register Data" screen:
  - Double-click data to be registered.
  - Select and right-click data to be registered, then select [Verify with the Latest Revision] from the shortcut menu.
- Content set for each of following items can be copied by selecting and right-clicking the item in the "Register Data" screen, then selecting [Copy] from the shortcut menu.
  - PC Type
  - Version
  - Title



## Precautions

### ■Cases in which registering a project file is required

If any of the following conditions is satisfied, a project file needs to be registered.

- Content of properties for a project was changed.
- A module was added or deleted.
- The start I/O number of a module was changed.
- A global label or structure was edited.
- A module label, module FB, library, or sample library was added in a project.
- Any of the operations below was performed to a program file, FB file, FUN file, or folder.
  - Adding new data
  - Deleting data
  - Renaming
  - Changing content of properties
- The execution type or order for program blocks was changed.
- A device memory or initial device value was added or deleted, or its name was changed.
- A parameter of a module was changed.
- User information or a security key was changed. (👉 Page 181 User information and security key)
- A tag FB whose tag FB type or tag type does not exist in a project was registered in the "Tag FB Setting" screen.

### ■Security version

For a project whose security version is '2,' it may take time to register a project file or data.

## Acquiring a project file and data

### ■Project file

To merge all data in a master project into a local project, acquire the project file from a version management system. The following shows the procedure to acquire a project file.

#### Operating procedure

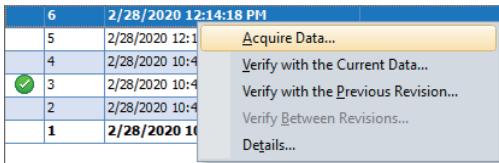
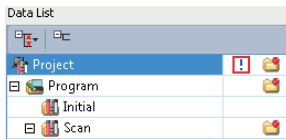

1. Select "Project" in the data list.

2. Select a revision in the revision list.

3. Right-click it and select [Acquire Data] from the shortcut menu.

When selecting a revision of data, data associated with the following revisions will be acquired.

- Selected revision of data
- Latest revision of a project file among the revisions registered earlier than the selected revision of data

### ■Data

To merge only specific data in a master project into a local project, acquire only the data from a version management system. The following shows the procedure to acquire only specific data.

#### Operating procedure

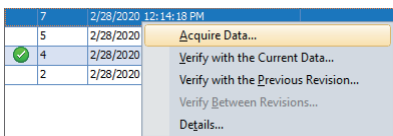
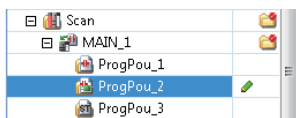

1. Select data in the data list.

2. Select a revision in the revision list.

3. Right-click it and select [Acquire Data] from the shortcut menu.

If selected data contains lower hierarchy data or multiple data is selected, the "Acquire Data" screen appears.

4. Check the content in "Title" and "Comment."

5. Select the checkbox of data to be acquired, and click the [OK] button.

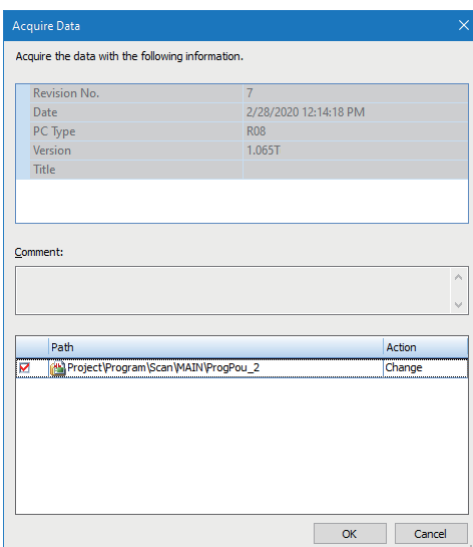

- The latest data can be acquired by selecting [Acquire the Latest Data] from the shortcut menu after selecting and right-clicking "Project" or each data in the data list of the "Update Revision" screen.
- Content set for each of following items can be copied by selecting [Copy] from the shortcut menu after selecting and right-clicking the item in the "Acquire Data" screen.
  - Revision No.
  - Date
  - PC Type
  - Version
  - Title

## Precautions

- Acquired data is in the unconverted state.
- A local project after data acquisition is in the unsaved state.
- The execution order of program blocks may be changed by acquiring data. Check their execution order in the "Program File Setting" screen. ( Page 260 Program execution order setting)
- When acquiring a ladder program including a temporarily changed ladder block, the temporary change of the ladder block will be canceled. However, it will be retained if the ladder program was registered in a version management system at the registration of a project file.
- The following setting is overwritten with the setting of when data to be acquired was registered in a version management system:
  - Editable/non-editable setting for a library
- For a project whose security version is '2,' it may take time to acquire a project file or data.

## Verifying a project file or data

To check differences between project files or data, verify the project files or the data.

### ■ Project file

The following shows the procedure to verify the project file of a master project and the one of a local project.

#### Operating procedure

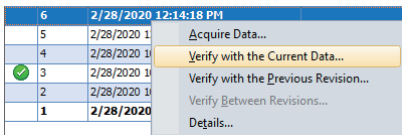
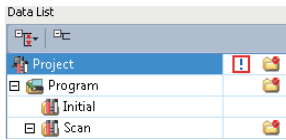

1. Select "Project" in the data list.
2. Select a revision in the revision list.
3. Right-click it and select [Verify with the Current Data] from the shortcut menu.
4. Click the [Verify] button in the "Revision Verify" screen.

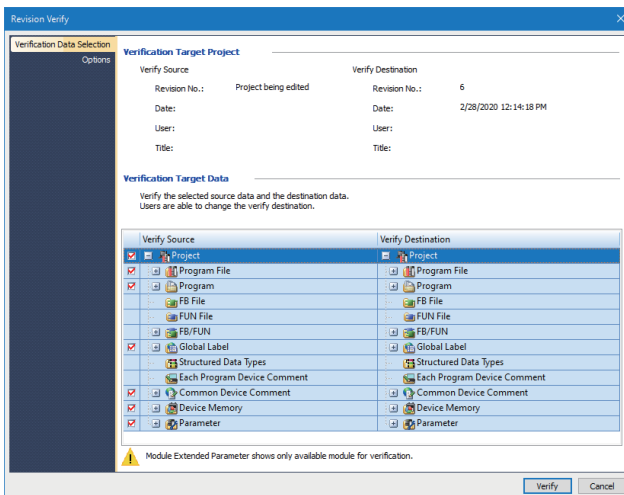

- By selecting and right-clicking a revision in the revision list, then selecting [Verify with the Previous Revision] from the shortcut menu, project files associated with the following two revisions can be verified with each other.
  - Verification source: a selected revision
  - Verification destination: a revision registered one before the selected oneIf a revision of data is selected between the revisions of data and project file which were registered at the same time, a verification destination will be a project file associated with a revision registered one before the revision of project file.
- By selecting two revisions in the revision list, then right-clicking and selecting [Verify Between Revisions] from the shortcut menu, project files associated with the selected revisions can be verified with each other.

## ■Data

The following shows the procedure to verify specific data in a master project and that in a local project.

### Operating procedure

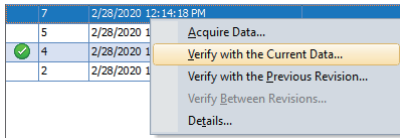
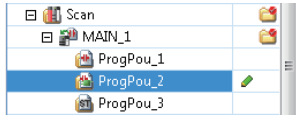

1. Select data in the data list.
2. Select a revision in the revision list.
3. Right-click it and select [Verify with the Current Data] from the shortcut menu.

3

### Point

- By selecting and right-clicking a revision in the revision list, then selecting [Verify with the Previous Revision] from the shortcut menu, data associated with the following two revisions can be verified with each other.
  - Verification source: a selected revision
  - Verification destination: the revision registered one before the selected one
- By selecting two revisions in the revision list, then right-clicking and selecting [Verify Between Revisions] from the shortcut menu, data associated with the selected revisions can be verified with each other.

### Precautions

- When selecting "Project" in the data list then a revision of data in the revision list, data associated with the following two revisions which were registered one before the selected revision will be set as verification destinations:
  - Revision of a project file
  - Selected revision of data
- When specific data in a master project and that in a local project are verified, the cursor does not jump to the corresponding data in each editor even by double-clicking data displayed in the detailed display (diagram/table format) screen.
- For a project whose security version is '2,' it may take time to verify a project file or data.

## ■Verification result

The operation method for displaying the verification result is the same as that of project verification. For more details, refer to the following:

☞ Page 145 Checking a verification result

## ■Verifiable data

Data can be verified only when any of the following data is selected in the data list.

- Project
- Program block (standard, safety)
- FB folder (standard, safety)
- FUN folder (standard, safety)
- Global device comment
- Local device comment

## ■Unverifiable data

The following data cannot be verified.

- Data that exists only in the verification source
- Data that exists only in the verification destination
- Data whose program language differs between the verification source and the verification destination

If the following passwords are not authenticated, data cannot be verified:

- Block password set for a POU
- Password set in the editable/non-editable setting for a library

## Checking detailed information

Details on an update revision of a master project can be checked in the "Details" screen.

The following shows the operating procedure to display the "Details" screen.

### Operating procedure

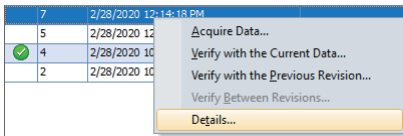
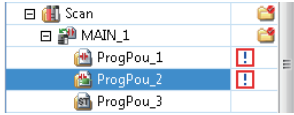

1. Select data in the data list.
2. Select a revision in the revision list.
3. Right-click it and select [Details] from the shortcut menu.

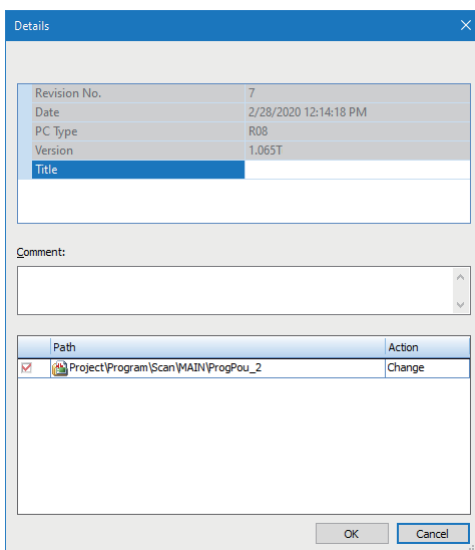

The "Details" screen appears.

### Point

- In the "Details" screen, the title and comment for a revision can be changed.
- Content set for each of the following items can be copied by selecting and right-clicking the item in the "Details" screen, then selecting [Copy] from the shortcut menu.
  - Revision No.
  - Date
  - PC Type
  - Version
  - Title

### Precautions

If the title or comment of a revision of a project file is changed, the one of the revisions of data that were created at the same time as the revision of the project file will be changed as well.

## Considerations

The following shows the considerations for using the project version management function.

### ■User information and security key

When acquiring data, settings for the user information and security key in a local project are overwritten with the ones in a master project, and the settings that are not registered in a version management system will be deleted.

A project is closed after data acquisition. Log on to the project with the latest settings when opening it again.

### ■Access level

Depending on the access level, operations that can be performed differ.

○: Can be performed ×: Cannot be performed

Operation	Access level			
	Administrator	Developers	Assistant Developers	Users
Acquiring a project	○	○	○	○
Registering a project	○	○	○	×
Checking an update revision history	○	○	○	○
Acquiring data	○	○	○	○
Registering data	○	○*1	○*1	×
Verifying with the latest revision	○	○	○	○
Verifying with current data	○	○	○	○
Verifying with the previous revision	○	○	○	○
Verifying between revisions	○	○	○	○
Checking detailed information	○	○	○	○

\*1 A program file cannot be registered.

### ■Block password

When acquiring data for which a block password is set, the block password of a local project is overwritten with the one of a master project.



In addition, data for which a block password is set cannot be registered or verified if the block password does not match between a local project and master project.

If the block password of a master project is acquired in registering or verifying data, the block password of a local project is overwritten with the one of the master project; therefore, the password authentication will be required.

### ■Data reading from a programmable controller

When writing a local project to a programmable controller and then reading the project, an unexpected icon may be displayed in the "Update Revision" screen.

**Ex.**

When writing data in a local project, which matches to the latest data in a master project, to a programmable controller and then reading the project,  (Past) is displayed on the right side of the following data in the "Update Revision" screen.  is not displayed in the revision list.

- Program block
- Folder
- FB folder
- FUN folder
- Global label
- Structure
- Data of which the name is prefixed with 'M+', 'M\_', 'P+', or 'P\_'.

### ■Data writing to a programmable controller and online program change

The following shows the considerations when writing a local project to a programmable controller, acquiring a project file or data from the version management system, and then writing the file or data to the programmable controller again.

- Data writing to a programmable controller: Can be performed but a program needs to be converted before it is written to a programmable controller.
- Online program change: Cannot be performed.

### ■Project revision history

The revision history of a local project is not deleted even if a project file is acquired from a version management system.

### ■Functions of Subversion

Subversion (SVN) is embedded in GX Works3 to use the project version management function.

However, do not use the functions of Subversion for a master project.



# Troubleshooting

The following tables show messages displayed while using the project version management function and corrective actions.

## Registering a project

Message	Cause	Corrective action	
Unable to register the project version management information to the specified path. Please specify a path again.	A path where project information cannot be registered is specified.	Respecify a path, then register the project again.	Page 168 Registering a project
Failed to register the project. Please execute Register Project again.	A project cannot be registered in a version management system.	Check the following contents, then register the project again: <ul style="list-style-type: none"> <li>• Is the personal computer connected to a network?</li> <li>• Is there sufficient free space on the personal computer (server)?</li> <li>• Is the specified path correct?</li> <li>• Does a user have the access right for the directory of specified path?</li> </ul>	
	A version management system cannot be connected.		
	An update revision cannot be recorded.		
	A directory of specified path cannot be accessed.		
An unconverted ladder was found. Please execute the operation after converting the program.	A ladder program is not converted.	Convert the ladder program, then register the project again.	
A project whose user access level is 'Users' was specified. Unable to register the project. Please specify a project other than the one whose user access level is 'Users.'	A project is logged on to as a user whose access level is 'Users.'	Log on to the project as a user with an access level other than 'Users,' then register the project again.	

## Acquiring a project

Message	Cause	Corrective action	
GX Works3 project version management information does not exist in the specified path. Please specify the path to get the management information from.	A path where project information does not exist is specified.	Respecify the path, then acquire the project again.	Page 169 Acquiring a project
Failed to acquire the project. Saved project before acquiring the project is opened if it is found. Please execute Acquire Project again.	A local project cannot be created.	Check the following contents, then acquire the project again: <ul style="list-style-type: none"> <li>• Is the personal computer connected to a network?</li> <li>• Is there sufficient free space on the personal computer (server)?</li> <li>• Is the specified path correct?</li> <li>• Does a user have the access right for the directory of specified path?</li> </ul>	
	An update revision cannot be recorded.		

## Checking an update revision history

Message	Cause	Corrective action	
Failed to show the update revision dialog because the project version management information cannot be acquired. Please execute Register Project again.	GX Works3 is forcibly terminated.	Perform the following operations, then check the update revision history: ① Create a local project again.*1 ② If the history is not displayed properly even after performing step ①, delete the master project and then register the project again.*2	Page 169 Acquiring a project Page 169 Deleting a master project Page 168 Registering a project
	A network is disconnected.		
	A master project is deleted.	Register the project again, then check the update revision history.	
	The name of a master project is changed.	Perform either of the following operations, then check the update revision history: <ul style="list-style-type: none"> <li>• Change the name back to the original.</li> <li>• Register the project again.</li> </ul>	
The specified project has not been controlled by a project version management. Please execute Register Project or Acquire Project.	A selected project is not a local project.	Select a local project in the screen displayed after selecting the following menu. • [Tool] ⇒ [Configuration Management] ⇒ [Update Revision] Alternatively, select this menu after opening a local project.	Page 170 Update Revision screen

\*1 Data which was edited before the acquisition will be deleted since a new local project is acquired.

\*2 A new update revision history will be created since a new project is registered.

## Registering a project file and data

Message	Cause	Corrective action	
Unable to register data because data inconsistency occurs. The following are the possible causes. Please check a manual for corrective actions for causes. <ul style="list-style-type: none"> <li>• The same named data exists in the same type of the project to register</li> <li>• Program language data of SFC and other ones are included</li> <li>• Block No. which is used in another block is used as the Block No. of SFC</li> </ul>	Data with the same execution type and the same name as data to be registered exists in a master project.	Change the data name, and then register the data again.	Page 173 Registering a project file and data
	Data created in Sequential Function Chart language and data created in another language exist in a same program file of a master project.	Register the data created in Sequential Function Chart language and the data created in another language separately.	
	A block number of an SFC block is duplicating with that of another SFC block.	Change the block number, then register the data again.	
Unable to execute because another user is registering data. Please execute it again after a while.	Another user is registering data in a version management system.	Register the data again after a while.	
Failed to register the data. Please execute Register Data again.	A version management system cannot be connected.	Check the following contents, then register the data again: <ul style="list-style-type: none"> <li>• Is the personal computer connected to a network?</li> <li>• Can a folder where the master project is managed be accessed?</li> </ul>	
	An update revision cannot be recorded.		
Unable to register some data because the maximum number of creatable data is exceeded. Please correct so that it does not exceed the maximum number of creatable data.	There is a data type including pieces of data which exceeds its maximum number that can be created.	Reduce the number of pieces of data to be registered, then register the data again.	
The entire project is required to be registered for the selected data. Unable to register the entire project by the users other than Administrators. Please execute it again after logging on as Administrators.	A project is logged on to as a user whose access level is other than 'Administrator.'	Log on to the project as a user with the access level 'Administrator,' then register the data again.	

## Acquiring a project file and data

Message	Cause	Corrective action	
<p>Unable to acquire data because data inconsistency occurs. The following are the possible causes. Please check a manual for corrective actions for causes.</p> <ul style="list-style-type: none"> <li>• The same named data exists in the same type of the project to be acquired from</li> <li>• Program language data of SFC and other ones are included</li> <li>• Block No. which is used in another block is used as the Block No. of SFC</li> </ul>	Data with the same execution type and the same name as data to be acquired exists in a local project.	Change the data name, then acquire the data again.	Page 176 Acquiring a project file and data
	Data created in Sequential Function Chart language and data created in another language exist in a same program file of a local project.	Acquire the data created in Sequential Function Chart language and the data created in another language separately.	
	A block number of an SFC block is duplicating with that of another SFC block.	Change the block number, then acquire the data again.	
<p>Failed to acquire the data. Please execute Acquire Data again.</p>	A version management system cannot be connected.	Check the following contents, then acquire the data again:	
	An update revision cannot be recorded.	<ul style="list-style-type: none"> <li>• Is the personal computer connected to a network?</li> <li>• Can a folder where the master project is managed be accessed?</li> </ul>	
<p>Unable to acquire data because data inconsistency occurs. The following is the possible cause. Please acquire data so that data inconsistency does not occur.</p> <ul style="list-style-type: none"> <li>• Some data causes a circular reference.</li> </ul>	There is data which will cause a circular reference if acquired.	<p>Modify data so that a circular reference does not occur.</p> <p>Then, acquire the data again.</p>	

## 3.9 Managing Profiles

---

The registration status of a profile (such as CSP+\*<sup>1</sup>) can be managed.

A profile is data that stores information of a connected device (such as a model name.)

A profile is managed by each personal computer, and shared within GX Works3 and other MELSOFT products. Therefore, a profile registered in GX Works3 is applied to other MELSOFT products.

Before registering/deleting a profile, log on to a personal computer as a user with the administrator authority, and close the project in advance.

\*1 For CSP+, refer to the CC-Link Partner Association website ([www.cc-link.org](http://www.cc-link.org)).

### Registration

---

A profile can be registered in GX Works3.

#### Operating procedure

1. Select [Tool] ⇒ [Profile Management] ⇒ [Register].
2. Select a file in the "Register Profile" screen, and click the [Register] button.

#### Precautions

A profile is a compressed file (such as \*.zip, \*.ipar, and \*.cspp). Register a profile without decompressing.

### Deletion

---

A profile registered in GX Works3 can be deleted.

#### Operating procedure

1. Select [Tool] ⇒ [Profile Management] ⇒ [Delete].
2. Select the checkbox of a model name to be deleted in the "Profile Delete" screen, then click the [Delete] button.

# 4 CREATING MODULE CONFIGURATION DIAGRAM AND SETTING PARAMETERS

In GX Works3, parameters of a programmable controller can be set in the "Module Configuration" window, as if to configure the actual system.

Parameters can also be set in the navigation window in the same manner as GX Works2.

## Module configuration window

The following operations can easily be performed in the "Module Configuration" window.

Item	Reference
Displaying the configuration of an actual programmable controller system visually <sup>*1</sup>	Page 188 Creating a Module Configuration Diagram
Setting the parameters of various modules <sup>*1</sup>	Page 193 Setting parameters on the module configuration diagram
Entering the start XY in a batch <sup>*2</sup>	Page 198 Inputting the start XY in a batch
Entering the default points in a batch <sup>*2</sup>	Page 198 Inputting default points in a batch
Checking the power supply capacity and I/O points <sup>*1</sup>	Page 198 Checking the power supply capacity and I/O points
Checking a system configuration <sup>*1</sup>	Page 198 Checking a system configuration

\*1 LHCPUs do not support it.

\*2 LHCPUs and FX5CPUs do not support it.

## Parameter settings

Parameters can be set by any of the following methods.

Method	Reference
Setting parameters in the "Input the Configuration Detailed Information" window that is displayed from the "Module Configuration" window. <sup>*1</sup>	Page 193 Setting parameters on the module configuration diagram
Setting parameters in a parameter editor that is displayed from the navigation window.	Page 199 Setting Parameters

\*1 LHCPUs do not support it.

# 4.1 Creating a Module Configuration Diagram

A module part (object) can be placed in the "Module Configuration" window in the same configuration as an actual system. In the "Module Configuration" window of GX Works3, a module configuration diagram can be created in the range of a system that is controlled by a CPU module in a project.

## Editor configuration when creating a module configuration diagram

### Point

The display setting can be changed by setting the following option.  
[Tool] ⇒ [Options] ⇒ "Other Editor" ⇒ "Module Configuration Diagram"

### Window

Double-click "Module Configuration" in the navigation window.

■Toolbar



■"Module Configuration" window

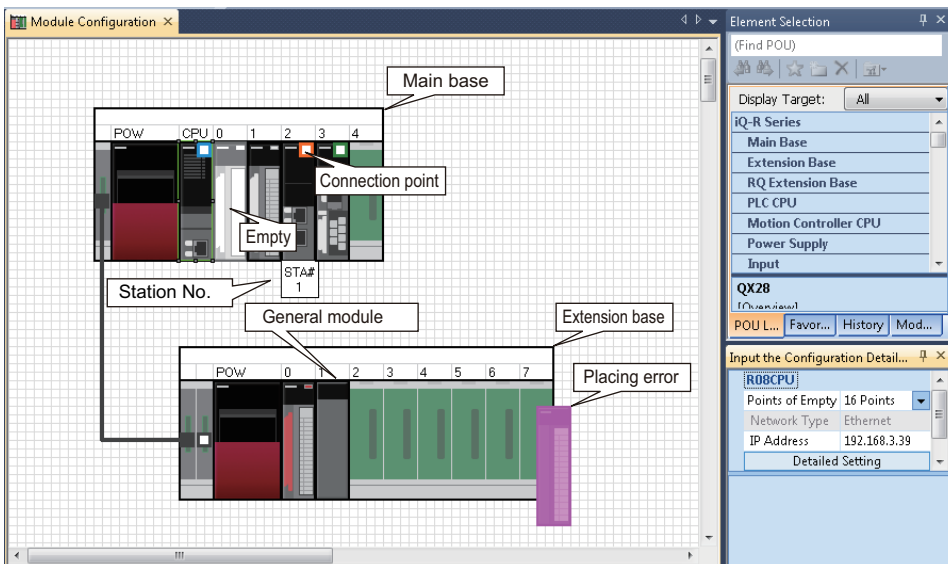

## Displayed items

Window name	Item	Description
Module Configuration	iQ-R series	An object of a MELSEC iQ-R series module supported by GX Works3
	FX5 series	An object of a MELSEC iQ-F series module supported by GX Works3
	Q series	An object of a MELSEC-Q series module supported by GX Works3
	General module	An object of a module for which the start XY and point can be set arbitrarily for each module type. The same points as empty slot points will be assigned to an initial value. Select this when using a module which is not included in the element selection window.
	Figure (Straight Line, Rectangle, Ellipse, Text Box)	An object that is used when adding information such as description on the module configuration diagram
	Connection line	An object of a bus cable to be connected to a base unit
	Connection point	A point to be connected with a connection line. The connection point located at the upper right on a module is used when importing a project in MELSOFT Navigator. It is not used in GX Works3.
	Module status setting (empty)	A module to set when running a system only on the module configuration diagram without using actual modules. A module placed on the module configuration diagram and its related parameters will also be set as 'Empty.' (Reserved status)
	Object placement error	A module object which is not placed properly is highlighted.
	Station No.	The station number set for a module is displayed. The station number of the following modules is not displayed. <ul style="list-style-type: none"> <li>• A remote head module on a standby system</li> <li>• A module controlled by another CPU module</li> </ul>
Element Selection	A list of objects which can be used on the module configuration diagram	
Input the Configuration Detailed Information	A window to enter the information such as start XY or station number of the module placed on the module configuration diagram	

# Placing objects

## Placing module objects

### Operating procedure

1. Select a main base unit in the element selection window, and drag and drop it onto the "Module Configuration" window.
2. Select a module in the element selection window, and drag and drop it onto the base unit placed in step 1.

The available locations are highlighted while dragging the module.

### Point

The names of module objects can be changed in the "Properties" screen. It makes easy to distinguish modules with the same model names.

### Precautions

- The following are not supported: GOT2000/GOT1000 series, general modules, image diagrams, and link files supported by MELSOFT Navigator
- Only bus cables are available. Network connection and serial connection are not available.
- For FX5CPUs, select a module directly and drag and drop it onto the "Module Configuration" window.

### ■Moving placed modules

If a module is removed from the main base unit or extension base unit, the object information such as start I/O and parameter information is retained. Therefore, when the removed module is placed on the base unit again, the retained parameter information will be set automatically.

A module removed from the base unit will be deleted in "I/O Assignment Setting" of "System Parameter."

For FX5CPU, the setting cannot be fixed in the state where a module has been removed from the CPU module.

### ■Deleting placed modules

When a module is deleted, the module information displayed in the navigation window after fixing parameters will be deleted as well.

For a single CPU configuration, a CPU module object cannot be deleted.

For a multiple CPU configuration, the host CPU cannot be deleted.

### ■Copying and pasting modules

Copy source parameter information is utilized.

If a CPU module placed on the base unit in a multiple CPU configuration is copied, the CPU number will be unknown.

The objects can be copied to the "Module Configuration" window of other projects.

## Placing figure objects

A figure and text box can be placed in the "Module Configuration" window.

A figure placed in the "Module Configuration" window is not written to a CPU module. It is saved only in a project.

### Operating procedure

The font and color of a figure object can be changed in the "Properties" screen.

Select a figure in "Figure" in the element selection window, and drag and drop it onto the "Module Configuration" window.



## Changing the model name of a CPU module

The model name of a CPU module placed on the module configuration diagram can be changed.  
RCPUs do not support this change.

### Operating procedure

1. Select and right-click a placed CPU module, then select [Change CPU Model Name] from the shortcut menu.
2. Select the model name after the change in the "Change CPU" screen.

### Precautions

The model name cannot be changed to the one of different module type.

## Module status setting (empty)

Set this when operating a system without mounting actual modules.  
The module is highlighted in a pale color.  
FX5CPUs do not support this setting.

### Operating procedure

Select a module to be set to empty, and [Edit] ⇒ [Module Status Setting (Empty)].

## Reading the module configuration from an actual system

The module configuration diagram can be configured by using the information read from a CPU module.  
For an FX5CPU, a module, the model name of which cannot be identified, is placed as a general module on the module configuration diagram.  
If a module except for CPU No.1 is set as the connection destination when reading information from a remote head module in a redundant system configuration, the CPU No.1 is read as the host module.

### Operating procedure

Select [Online] ⇒ [Read Module Configuration from PLC].

### Precautions

The module configuration cannot be read when the number of extension base units was set incorrectly.

# Checking the module information

## Checking on a balloon help

Place the cursor on an object (such as module or figure) to display the balloon help on the "Module Configuration" window.

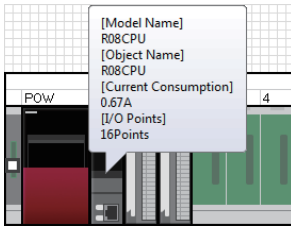

## Displaying model names on module objects

### Operating procedure

Select [Edit] ⇒ [Display Module Information] (  ).

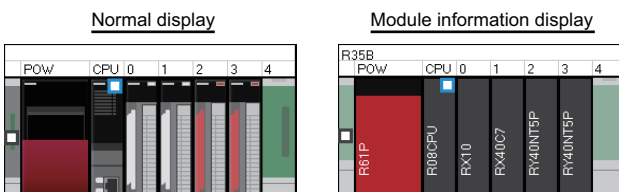

## Checking in the property screen

A model name, object name, and outline specification of a module can be checked in the "Properties" screen. Additionally, a comment can be entered.

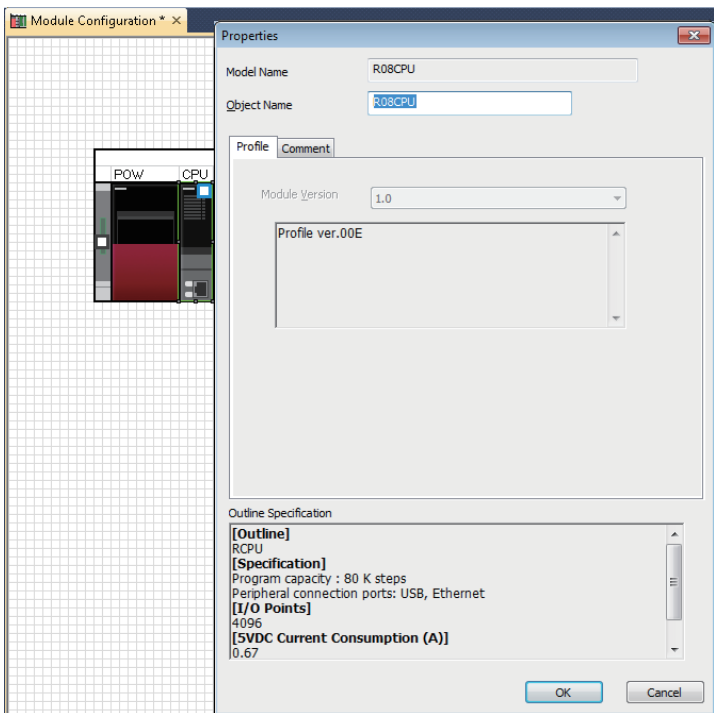

### Operating procedure

Select and right-click a module object on the module configuration diagram, then select [Properties] from the shortcut menu.

# Setting parameters on the module configuration diagram

Parameters of a module placed onto a module configuration diagram can be set in the "Input the Configuration Detailed Information" window.

## Operating procedure

1. Select a module object to edit the parameters.
2. Click [Edit] ⇒ [Parameter] ⇒ [Input Detailed Configuration Information Window] (📄).
3. Set each item in the "Input the Configuration Detailed Information" window.
4. Select [Edit] ⇒ [Parameter] ⇒ [Fix] (🔧).

To set details of the module, click the [Detailed Setting] button in the "Input the Configuration Detailed Information" window and set details in the parameter editor displayed.

4

## Operations that make parameters unfixed

When an object is edited in the "Module Configuration" window, the status of parameters may be unfixed.

The following shows the list of operations that make parameters unfixed.

- Connecting modules
- Setting module status (empty)
- Undoing/redoing
- Entering the start XY in a batch
- Entering the default points in a batch
- Operations in the "Input the Configuration Detailed Information" window
- Adding or deleting a module
- Cutting and pasting modules
- Changing the property of a module
- Removing a module, or placing the same module to the slot of a base unit again  
(For FX5CPU, removing a module or connecting the same module to a CPU module)

## Data updated after fixing parameters

The following data is updated after fixing parameters.

- Navigation window  
(When parameters of a newly placed module are fixed, the parameters of the module are added under "Module Information" in the navigation window.)
- Parameter editor
- "I/O Assignment Setting" of "System Parameter"

## Application of parameter information

The parameter information of a cut or copied module object can be utilized by pasting the module object onto the "Module Configuration" window and fixing the parameters.

### Precautions

Parameter information cannot be utilized by the following operations. The parameter information of the pasted module object is returned to the default.

- Paste a cut or copied module object onto the "Module Configuration" window in another project.
- Before fixing parameters, change the station type of the module object in the "Input the Configuration Detailed Information" window.

## List of the changed location of start XY number

When the start XY number of a module is changed on the module configuration diagram, the list of data which will be affected by the change is displayed in the "Module Start I/O No. Related Area" window. Check the details and correct the data.

- Affected data: Program, FB program, system parameter, CPU parameter, module parameter, global label (including a structure), and module label
- Affected device: Start XY devices specified for the arguments of FROM(P), DFROM(P), TO(P), DTO(P), TYPERD, or TYPERDP instructions

FX5CPUs do not support this function.

# Multiple CPU configuration

RnPCPUs (redundant mode), RnPSFCPUs, FX5CPUs, and remote head modules cannot be used for configuring a multiple CPU system.

## Display for a multiple CPU configuration

The multiple CPU configuration can be set on the module configuration diagram.

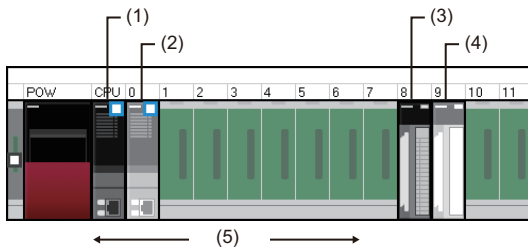

Item	Description
(1) Host CPU module	For a multiple CPU configuration, only one project which is set as a host CPU can be set.
(2) Another CPU module	Set a CPU module which is not set as a host CPU to another station. The module is highlighted in a pale color, same as when the module status setting (empty) is set.
(3) Module controlled by the host CPU module	A module that is controlled by the CPU module set as a host CPU
(4) A module controlled by another CPU module	A module that is controlled by the CPU module set as another CPU. The module is highlighted in a pale color, same as when the module status setting (empty) is set.
(5) Available slots for CPU modules	Up to four CPU modules can be placed on the CPU slot and slot 0 to 6. The placed CPU modules are assigned a number, CPU No.1 to CPU No.4 starting from the left.

## Settings of the multiple CPU configurations

In a multiple CPU configuration, place two or more CPU modules on the base unit.

The control CPU module of a module can be changed in the "Input the Configuration Detailed Information" window.

The following explains the method for changing a single CPU configuration to/from a multiple CPU configuration.

### ■ Changing a single CPU configuration to a multiple CPU configuration

Drag and drop a CPU module from the element selection window in a single CPU configuration (a state where one CPU is placed on the base unit), and place the second CPU module on the base unit.

### ■ Changing a multiple CPU configuration to a single CPU configuration

Delete one CPU module (or remove it from the slot) in a multiple CPU configuration (a state where two or more CPU modules are placed on the base unit), and keep only one CPU module on the base unit.

## Changing CPU number of the CPU module set as a host CPU

For a multiple CPU configuration, the CPU number of a CPU module placed on the base unit is set in order from the left. To change the CPU number, change the position of the CPU module.

### ■Operation for single CPU configuration

Move the CPU module placed on the CPU slot to an empty slot, and place a new CPU module on the empty slot.

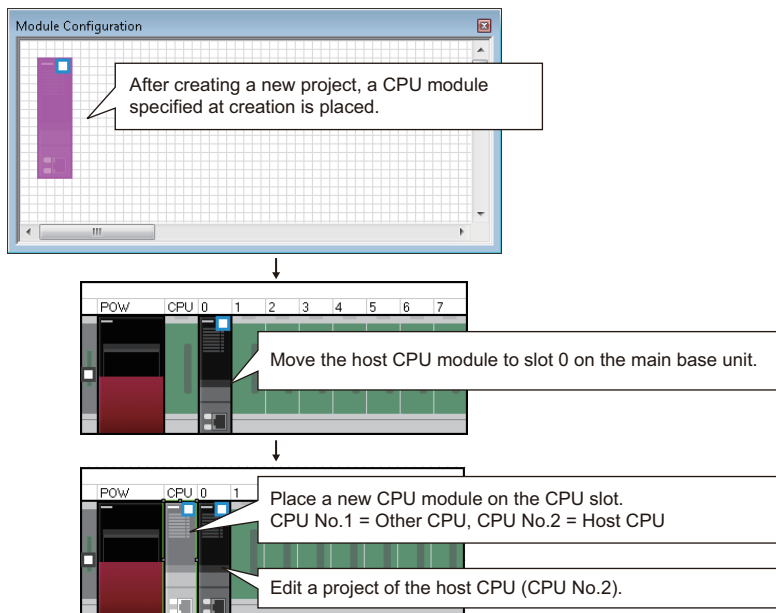

### ■Operation for multiple CPU configurations

Exchange the CPU module on the CPU slot and the CPU module on other slot.

Since the parameter information of the modules removed from the base unit is retained, the retained information is succeeded when the removed modules are placed again.

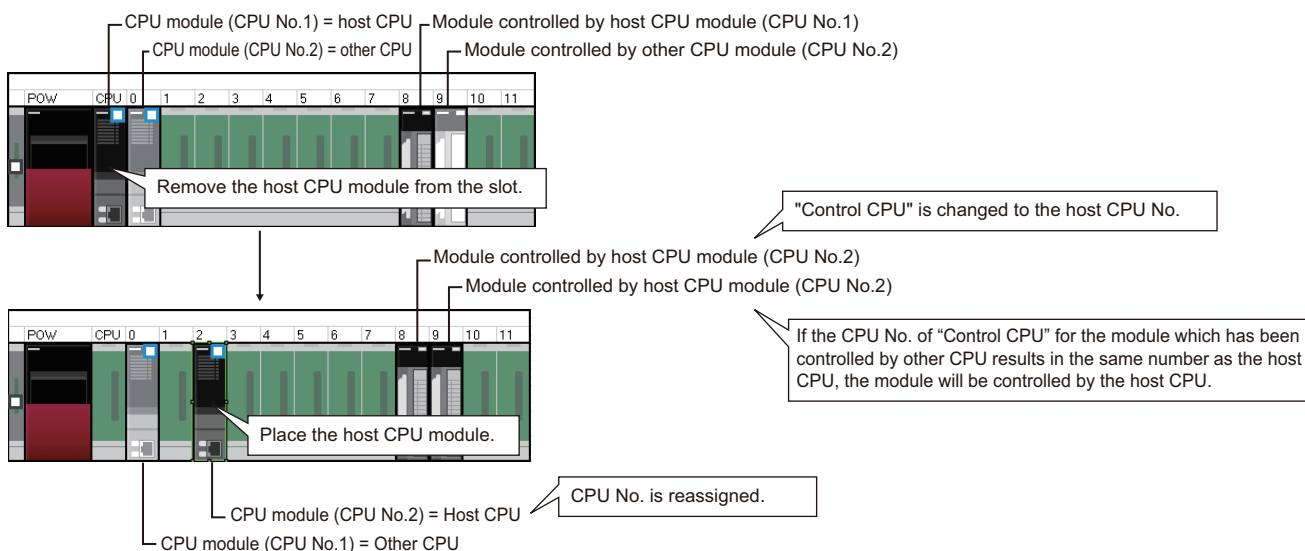

## Display for a multiple CPU configuration using an RnENCPU

When constructing a multiple CPU system where an RnENCPU is set as CPU No.1, the display of the configuration on the module configuration diagram in GX Works3 differs from the actual module configuration.

For details on the multiple CPU configuration using an RnENCPU, refer to the following:

📖 MELSEC iQ-R Module Configuration Manual

# Redundant system configurations

## Display for an RnPCPU (redundant mode) configuration

For an RnPCPU (redundant mode) configuration, the configuration of either the control system or standby system can be created on the module configuration diagram.

When an RnPCPU (redundant mode) and a redundant function module (R6RFM) are placed on the module configuration diagram, "Redundant" is displayed at the bottom left of the base unit to indicate that it is a redundant system.

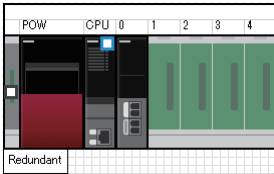

## Display for an RnPSFCPU configuration

For an RnPSFCPU configuration, the configuration of either the control system or standby system can be created on the module configuration diagram.

When an RnPSFCPU, a SIL2 function module (R6PSFM), and a redundant function module (R6RFM) are placed in this order, "Redundant" is displayed at the bottom left of the base unit to indicate that it is a redundant system.

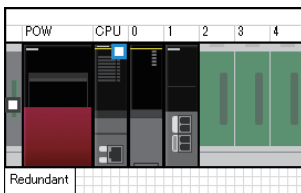

## Display for a remote head module configuration

For a redundant system configuration of remote head modules, two remote head modules need to be placed onto the CPU slot and slot 0 of a main base unit on the module configuration diagram.



## Display for a redundant extension base unit configuration

In the following cases, two extension cables are regarded as the same model and displayed with a double line on the module configuration diagram:

- A redundant extension base unit is connected to a main base unit on which a redundant function module (R6RFM) is placed.
- Redundant extension base units are connected to each other.

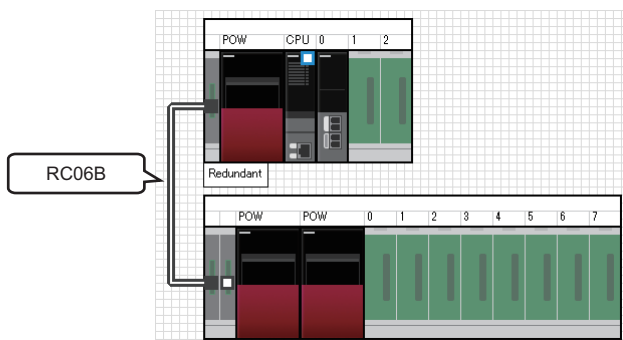

## Inputting the start XY in a batch

---

The start XY of each module can be set in order of the slot number in a batch.  
FX5CPUs do not support this.

### Operating procedure

Select [Edit] ⇒ [Start XY Batch Input] ()

## Inputting default points in a batch

---

For all modules and empty slots on the module configuration diagram, points including empty slots and on the empty slot side (for a module which occupies two or more slots) can be changed to the default in a batch.  
FX5CPUs do not support this.

### Operating procedure

Select [Edit] ⇒ [Default Points Batch Input].

## XY assignment display

---

Input and output number assignment for each module can be displayed.  
RCPUs do not support this.

### Operating procedure

Select [Edit] ⇒ [XY Assignment Display].

## Checking the power supply capacity and I/O points

---

Whether the power supply capacity and I/O points in the configuration on the module configuration diagram exceed the upper limit can be checked.

### Operating procedure

1. Select [Edit] ⇒ [Check] ⇒ [Power Supply Capacity and I/O Points] ()
2. Check the result displayed on the "Result of Power Supply Capacity and I/O Points Check" window.

## Checking a system configuration

---

Whether the place of each module on the module configuration diagram is correct can be checked. The result is displayed on the "Output" window.

### Operating procedure

1. Select [Edit] ⇒ [Check] ⇒ [System Configuration] ()
2. Check the result displayed on the "Output" window.

## Operation for Write to PLC/Read from PLC

---

Only parameters of the modules in the information of the module configuration diagram can be read/written.  
After reading data from a programmable controller, the coordinate position of the modules on the module configuration diagram is displayed by default status.  
The figure information is deleted.



## 4.2 Setting Parameters

The following shows the parameter settings displayed in the navigation window.

To operate a programmable controller, setting parameters for the modules is required.

### Project for an RCPULHCPU/FX5CPU

Image	Item	Description	Reference
<p>(Example) Project for an R08CPU</p>	(1) System parameters	<p>Parameters to set the items required to configure a system such as a module configuration.</p> <p>The term 'System' here indicates the following contents.</p> <ul style="list-style-type: none"> <li>R08CPU: A series of system which consists of a main base unit, an extension base unit, and an RQ extension base unit which are connected with extension cables</li> <li>FX5CPU: A system which consists of modules and adapters which are attached to a CPU module</li> </ul>	Page 202 Setting system parameters
	(2) Parameters for a control CPU	<p>Parameters to set the self operation function of a CPU module.</p> <p>This includes the file setting, memory/device setting, and program setting.</p>	Page 204 Setting parameters of control CPU
	(3) Module information	<p>Parameters for modules. There are two types, module parameters and module extended parameters.</p> <ul style="list-style-type: none"> <li>Module parameters: Parameters for each module. The initial setting values and refresh settings of each module are included.</li> <li>Module extended parameters: Parameters for specific intelligent function modules and network modules. These are read and written separately with module parameters.</li> </ul> <p>For AnyWireASLINK master modules, "AnyWireASLINK Configuration" to configure a network and connection for target devices is displayed.</p>	Page 205 Setting parameters of modules Page 208 Setting network configuration and target devices
	(4) Remote password	<p>By setting a password for each communication route to a CPU module, the communication route is protected; thus, access to the CPU module from an external device without password authentication is prohibited.</p>	Page 699 Restricting Access from Other Than Specific Communication Route (Remote Password)
	(5) Recording setting	<p>Setting data for the recording function</p>	Page 732 Settings of the recording function

## Guidance flow function

The setting procedure of parameters can be checked in a flow.

In addition, the cursor can jump to a setting item from each item on the flow.

Only FX5CPUs support this function.

### Window

Select [View] ⇒ [Docking Window] ⇒ [Guidance Flow].

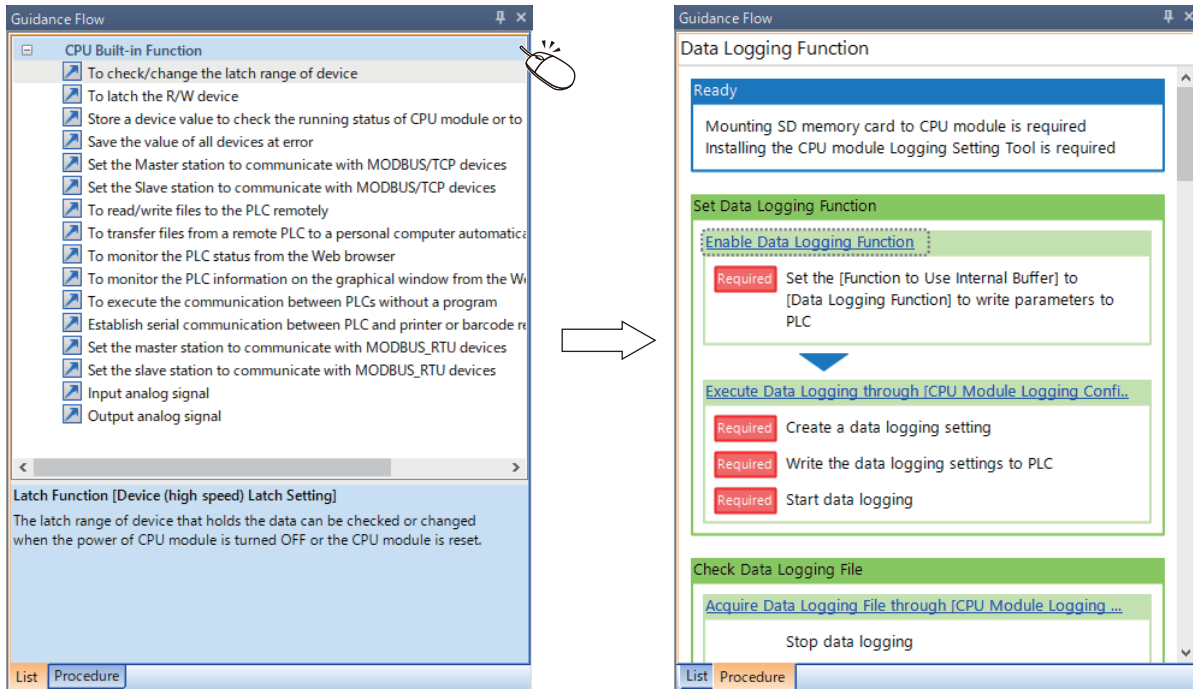

The following table shows the icons displayed in the [List] tab.

Icon	Description
	Indicates that a flow of the guidance can be displayed.
	Indicates that a flow of the guidance is being displayed.

### Operating procedure

1. Double-click the guidance according to the purpose in the [List] tab.
2. Set parameters by following a flow displayed on the [Procedure] tab.

By clicking a link on the flow, the cursor can jump to a parameter item, setting screen, or setting tool that required to be set.

#### Point

In the "Ready" column of the flow, an operation that needs to be performed in other than GX Works3 is displayed.

# Common operations for parameter settings

## Operation for a parameter editor

The items of the system parameter, control CPU parameter, and module information are displayed. Set each item by referring to the information displayed in "Explanation."

**Status color [color/ background color]**

- No errors  
Default setting: Blue/White  
Other than default: Black/White
- With errors: White/Red
- No settings required: Black/Gray

**Status icons**

- ✓ Changed from default
- ✗ Error

**Point**

By entering a keyword, setting items and explanations can be searched.

## Checking parameters





There are two methods for checking whether there is any error in parameters as follows:

Purpose	Operating procedure
Checking if an input error occurs in a parameter editor	Click the [Check] button in the parameter editor.
Checking if an error related to the parameter settings in a project occurs	Select [Tool] ⇒ [Check Parameter].

## Setting system parameters

Set the parameters relating to whole system such as the I/O assignment setting, the multiple CPU setting, and the inter-module synchronization setting.

For details on the setting items of the parameters, refer to the following:

Parameter	Reference
I/O assignment setting	 MELSEC iQ-R Module Configuration Manual  MELSEC iQ-F FX5 User's Manual (Application)
Multiple CPU setting <sup>*1</sup>	 MELSEC iQ-R CPU Module User's Manual (Application)
Inter-module synchronization setting <sup>*2</sup>	 MELSEC iQ-R Inter-Module Synchronization Function Reference Manual

\*1 RnPCPUs (redundant mode), RnPSFCPUs, LHCPUs, FX5CPUs, and remote head modules do not support it.

\*2 Remote head modules in the redundant system configuration, RnPCPUs (redundant mode), RnPSFCPUs, LHCPUs, and FX5CPUs do not support it.

## Setting parameters

### Operating procedure

1. Double-click "Parameter" ⇨ "System Parameter" in the navigation window.
2. Select the items to be set in the [I/O Assignment] tab, [Multiple CPU Setting] tab, or [Inter-module Synchronization Setting] tab.
3. Set each item and click the [OK] button.

#### ■When a module is deleted in the I/O assignment setting

"Unset" is displayed for the parameter of the deleted module in the navigation window. To restore the settings (to display them in the I/O assignment setting again), select the mounting position in the "Properties" screen.

#### ■When the I/O assignment setting is read from the read mounting status

For an extension base unit in which the number of extension bases was set incorrectly, the mounting status (number of CPU modules, the I/O assignment setting (module name/point), and the base/power/extension cable setting) cannot be read properly.

#### Point

The mounting status can be read to the I/O assignment setting by clicking the [Read Mounting Status] button. (RCPUs only)

When I/O assignment has been set, the settings are changed as follows:

- I/O assignment setting: The setting is overwritten with a mounted module. An existing module is deleted.
- Navigation window: A mounted module is newly added. The start I/O number of an existing module is changed to "Unset."

## Utilizing system parameters

System parameters of other projects created in GX Works3 and CW Configurator can be utilized.

However, utilizing system parameters of another project is not allowed for a project of an RnPCPU (redundant mode), RnPSFCPU, LHCPU, or FX5CPU.

### Operating procedure

1. Double-click "Parameter" ⇒ "System Parameter" in the navigation window.
2. Click the [System Parameter Diversion] button.
3. Read the displayed message, and click the [OK] button.
4. Select a project and click the [Open] button.

### ■ Utilizing system parameters in a project for an R00CPU, an R01CPU, or an R02CPU





To utilize the system parameters of a project for an RnCPU (R04CPU, R08CPU, R16CPU, R32CPU, or R120CPU), change the module type to an R00CPU, R01CPU, or R02CPU and save the project.

By doing so, the system parameters can be utilized from the saved project to a project for an R00CPU, an R01CPU, or an R02CPU.

# Setting parameters of control CPU

Set the parameters related to a CPU module (the host CPU for a multiple CPU configuration).

For details on the setting items of the parameters, refer to the following:

Parameter	Reference
CPU parameter	 MELSEC iQ-R CPU Module User's Manual (Application)  MELSEC iQ-F FX5 User's Manual (Application)  MELSEC iQ-R CC-Link IE Field Network Remote Head Module User's Manual (Application)
Memory card parameter	 MELSEC iQ-R CPU Module User's Manual (Application)
Module parameter	 MELSEC iQ-F FX5 User's Manual (Application)

## Setting parameters

### Operating procedure

1. Double-click "Parameter" ⇨ "(CPU model name of the project)" ⇨ "CPU Parameter"/"Module Parameter"/"Memory Card Parameter" in the navigation window.
2. Set each item in the parameter editor.
3. Click the [Apply] button or [OK] button.

### Point

The setting screen can also be opened by double-clicking the object of a module on the module configuration diagram.

### Precautions

For the setting values of the parameters, use characters in the Unicode Basic Multilingual Plane.

If an input language is different from the language set in the regional settings on Windows, some functions may not operate properly. In that case, unify these languages.

If the characters outside the Unicode Basic Multilingual Plane are specified, the program may not operate properly.

- File register setting of the file setting: file name
- Initial value setting of the file setting: name of an initial value file of global labels
- Program setting of the program setting: program name
- FB/FUN file setting of the program setting: FB/FUN file name

# Setting parameters of modules

Set parameters of an I/O module, intelligent function module, and network module of the following series supported by GX Works3.

- MELSEC iQ-R
- MELSEC iQ-L
- MELSEC iQ-F
- MELSEC-Q

## Adding a module

Add a module in the "Add New Module" screen in advance to set parameters of the module.

### Window

1. Select "Parameter" ⇒ "Module Information" in the navigation window.
2. Select [Project] ⇒ [Data Operation] ⇒ [Add New Module].  
Alternatively, right-click it and select [Add New Module] from the shortcut menu.

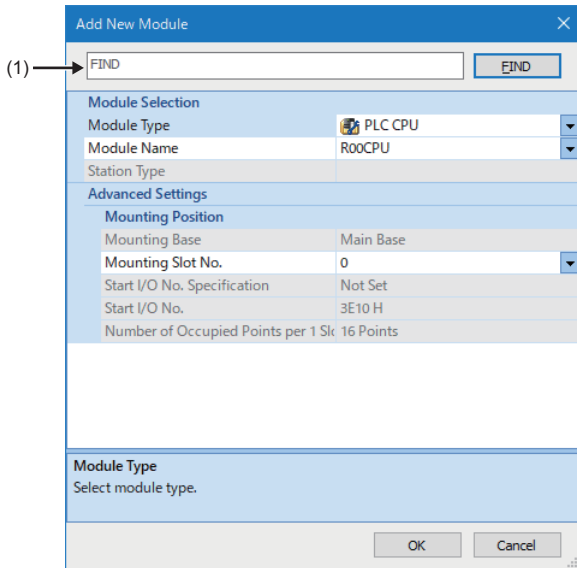

(1): Text box

### Operating procedure

Select each item and click the [OK] button.

#### Point

By selecting "Yes" for the following option, when adding an intelligent function module to a project, the sample comments for the module are automatically applied to the device comment editor of "Common Device Comment." (☞ Page 409 Reading sample comments)

- [Tool] ⇒ [Options] ⇒ "Project" ⇒ "Add New Module" ⇒ "Operation Setting" ⇒ "Read Sample Comment"

## ■ Searching for a module

The following shows the procedure to search for a module in the "Add New Module" screen.

### Operating procedure

1. Enter any of the following keywords in the text box in the "Add New Module" screen, and click the [FIND] button.
  - Module type
  - Module name
  - Characteristics of a module
2. Select the module in the "Find Module" screen, and click the [OK] button.

### Point

In the "Characteristics" column, a character string shown in the [POU List] tab is displayed.

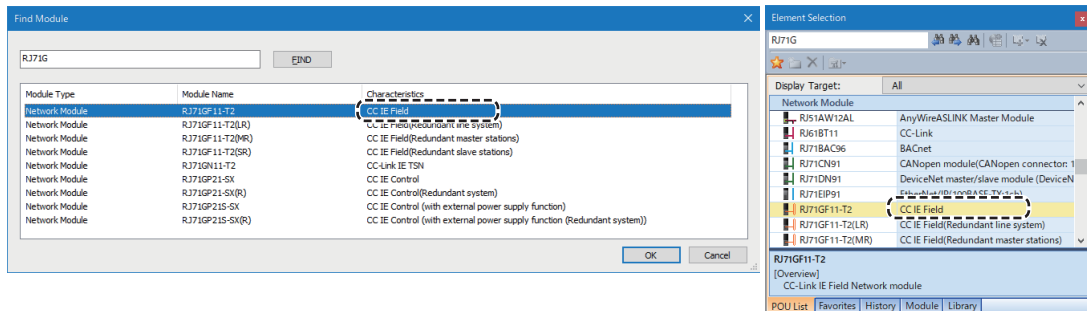



## Setting parameters

Set parameters of a module in a parameter editor.

The switch settings and refresh settings of a MELSEC-Q series module can also be set in a parameter editor.

For details on the parameter items, refer to the user's manual of each module.

For details on the MELSEC iQ-F series high speed pulse input/output modules, refer to the following:

 MELSEC iQ-F FX5 User's Manual (Application)

 MELSEC iQ-F FX5 User's Manual (Positioning Control - CPU module built-in, High-speed pulse input/output module)

### Operating procedure

1. Double-click "Parameter" ⇒ "Module Information" ⇒ "(module name)" ⇒ "(module parameter)" or "(module extended parameter)" in the navigation window.
2. Set each item in the parameter editor.
3. Click the [Apply] button or [OK] button.

For operations in a parameter editor, refer to the following:

 Page 201 Common operations for parameter settings

#### Point

For some modules, "(module parameter)" and "(module extended parameter)" may not be displayed in the navigation window.

In that case, double-click "(module name)."

### Precautions

The following table shows the modules in which a parameter error occurs by default.

Series	Module type	Model name
MELSEC-Q	Temperature control	Q64TCRTBWN
		Q64TCRTN
		Q64TCTTBWN
		Q64TCTTN
	Interrupt input	QI60
MELSEC-L	Temperature control	L60TCTT4
		L60TCTT4BW
		L60TCRT4
		L60TCRT4BW

## Setting network configuration and target devices

Set the network configuration and the connection configuration for a target device in each configuration window.

For details on the settings, refer to each user's manual.

### Window

The following shows the operations to display each network configuration window.

Network type	Operation
Ethernet (CPU module)	<ol style="list-style-type: none"> <li>① Double-click "Parameter" ⇒ "(CPU model name of the project)" ⇒ "Module Parameter" in the navigation window.*1</li> <li>② Double-click "Basic Settings" ⇒ "External Device Configuration" ⇒ "&lt;Detailed Setting&gt;" in the parameter editor.</li> </ol>
Ethernet (Ethernet module)	<ol style="list-style-type: none"> <li>① Double-click "Parameter" ⇒ "Module Information" ⇒ "(module name)" ⇒ "(module parameter)" in the navigation window.</li> <li>② Double-click "Basic Settings" ⇒ "External Device Configuration" ⇒ "&lt;Detailed Setting&gt;" in the parameter editor.</li> </ol>
AnyWireASLINK	Double-click "Parameter" ⇒ "Module Information" ⇒ "(module name)" ⇒ "AnyWireASLINK Configuration" in the navigation window.
CC-Link IE TSN (master station)*2	<ol style="list-style-type: none"> <li>① Double-click "Parameter" ⇒ "Module Information" ⇒ "(module name)" or "Module Parameter (Network)" in the navigation window.</li> <li>② Double-click "Basic Settings" ⇒ "Network Configuration Settings" ⇒ "&lt;Detailed Setting&gt;" in the parameter editor.</li> </ol>
CC-Link IE Field (master station)*3	<ol style="list-style-type: none"> <li>① Double-click "Parameter" ⇒ "Module Information" ⇒ "(module name)" in the navigation window.</li> <li>② Double-click "Basic Settings" ⇒ "Network Configuration Settings" ⇒ "&lt;Detailed Setting&gt;" in the parameter editor.</li> </ol>
CC-Link IE Field Network Basic*4	<ol style="list-style-type: none"> <li>① Double-click "Parameter" ⇒ "(CPU model name of the project)" ⇒ "Module Parameter" in the navigation window.</li> <li>② Double-click "Basic Settings" ⇒ "CC-Link IEF Basic Settings" ⇒ "Network Configuration Settings" ⇒ "&lt;Detailed Setting&gt;" in the parameter editor.</li> </ol>
CC-Link (master station)	<ol style="list-style-type: none"> <li>① Double-click "Parameter" ⇒ "Module Information" ⇒ "(module name)" in the navigation window.</li> <li>② Double-click "Basic Settings" ⇒ "Network Configuration Settings" ⇒ "&lt;Detailed Setting&gt;" in the parameter editor.</li> </ol>

\*1 For FX5CPUs, set in the parameter setting ("Module Parameter") for a control CPU.

\*2 RnCPUs, RnENCPUs, RnSFCPU, FX5UCPU, FX5UCCPU, and LHCPU support it.

\*3 FX5CPUs do not support it.

\*4 RnCPU, RnENCPU, FX5CPU, LHCPU support it.

Ex.

The following screen is an example for the CC-Link IE TSN configuration setting.

No.	Model Name	STA#	Station Type	RX Setting Points	RY Setting Points	RWr Setting Points	RWw Setting Points	Parameter Automatic Setting
0	Host Station	0	Master Station					
1	RJ71GN11-T2	1	Local Station	32	32	16	16	
2	GT27**-X	2	Local Station	32	32	16	16	
3	MR-J5-G	3	Remote Station			24	20	<input type="checkbox"/> <Detail Setting>

## Precautions

### ■AnyWireASLINK configuration setting

The AnyWireASLINK configuration setting is not written to a programmable controller.



Therefore, the AnyWireASLINK configuration setting returns to the default after reading a module parameter from a programmable controller.

### ■iQ Sensor Solution functions

The following functions can be used for devices supporting iQSS.

- Automatic detection of connected devices
- Verification of connected devices and configurations
- Reflection of the communication setting
- Sensor parameter read/write
- Sensor/device monitor
- Data backup/restoration
- Useful function: Linkage with dedicated tools (association with properties), command execution to device stations

For details, refer to the following:

Network	Reference
<ul style="list-style-type: none"><li>• AnyWireASLINK (RCPU)</li><li>• CC-Link</li><li>• CC-Link-AnyWireASLINK bridge</li><li>• CC-Link IE Field Network</li><li>• CC-Link IE Field-AnyWireASLINK bridge</li><li>• Ethernet (CPU module)</li><li>• CC-Link IE TSN</li><li>• CC-Link IE TSN-AnyWireASLINK bridge</li><li>• CC-Link IE TSN-CC-Link IE Field Network bridge</li></ul>	 iQ Sensor Solution Reference Manual
<ul style="list-style-type: none"><li>• AnyWireASLINK (FX5CPU)</li></ul>	 MELSEC iQ-F FX5 User's Manual (AnyWireASLINK)
<ul style="list-style-type: none"><li>• CC-Link IE Field Network Basic</li></ul>	 CC-Link IE Field Network Basic Reference Manual

### ■Properties

The image diagram can be changed using "Properties" for the particular selected module. Right-click and select [Properties] from the shortcut menu.

Configuration applications, setting files, and manuals can be linked to the modules. Double-click the added module to open the linked application or file.

### ■Unmatched profile

When displaying a network configuration window, an error message may appear if the following two profiles do not match:

- Profile of a device used in a project
- Profile of a device registered in GX Works3

In this case, contact the manufacturer of the device for the profile that corresponds to "File Version" and "Device Version" displayed in the "Output" window.

An error can be cleared by restarting GX Works3 after registering an obtained profile to GX Works3.

( Page 186 Managing Profiles)

### ■Module with no profile

For a module with no profile, place a general module instead. Alternatively, register a profile. ( Page 186 Managing Profiles)

## Checking refresh devices assigned to a module

Display the refresh devices assigned to a module that uses CC-Link or CC-Link IE TSN in a list.

Set the network configuration for each module in advance. (☞ Page 208 Setting network configuration and target devices)

### Window

Select [View] ⇒ [Docking Window] ⇒ [Device Assignment Confirmation] (☞).

**Ex.**

When selecting the start I/O number of the CC-Link system master/local module

■Device station list

STA#	Model/Obj Name	Station Type	# of STA Occupied	Extended Cyclic	Remote STA Points	RS VD/Err Invalid STA	Remote Input(RX)	
							Refresh Device	Buffer Mem.(DEC.)
1/1	RJ61BT11	Local Station	1Occupied Station	Single Setting	32 Points	No Setting		224 to 225
2/2	AJ65VBTC3-8D	Remote I/O Station	1Occupied Station	Single Setting	32 Points	No Setting		226 to 227
3/3	GT27**-X	Intelligent Device Station	1Occupied Station	Single Setting	32 Points	No Setting		228 to 229
4/4	SC-GU3-01	Remote Device Station	1Occupied Station	Single Setting	32 Points	No Setting		230 to 231

■Link device list

Host STA(Master)			Target STA		
Refresh Device	Link Device	Buffer Mem.(DEC.)	STA#	Link Device	Explanation
	RX0	224.b0	1 <=	RY0	
	RX1	224.b1		RY1	
	RX2	224.b2		RY2	
	RX3	224.b3		RY3	
	RX4	224.b4		RY4	
	RX5	224.b5		RY5	
	RX6	224.b6		RY6	

Host STA(Master)			Target STA		
Refresh Device	Link Device	Buffer Mem.(DEC.)	STA#	Link Device	Explanation
	RY0	352.b0	1 ==>	RX0	
	RY1	352.b1		RX1	
	RY2	352.b2		RX2	
	RY3	352.b3		RX3	
	RY4	352.b4		RX4	
	RY5	352.b5		RX5	
	RY6	352.b6		RX6	

"Displayed Content for Model Name" and "Buffer Memory Display Format" can be selected by clicking the [Display Option] button.

### Displayed items

Item	Description
Start I/O No./Mounting Position No.	<ul style="list-style-type: none"> <li>RCPU and LHCPU: "Start I/O No." is shown.</li> <li>Select the start I/O number of the master station or a local station to be displayed on the list.</li> <li>FX5CPU: "Mounting Position No." is shown.</li> <li>Select the mounting position number of the master station or an intelligent device station to be displayed on the list.</li> </ul>
Device Station List	Displays the information of the device stations and the range of the refresh devices assigned to the own station. Multiple devices are displayed in accordance with the link refresh settings of the Module Parameter. When refresh devices are not assigned, the cells of the refresh device range will be blank.
Link Device List	Displays the assignment status of refresh devices on the own station and link devices on the target station. When link devices are not assigned, the cells of the link device range will be blank. The cells of "Explanation" will be blank when profile is not registered.

### Precautions

When selecting the start I/O number of a CC-Link IE TSN Plus master/local module, this function is available only for a device station on the CC-Link IE TSN port.

- Any device station can be displayed on top of the cell by right-clicking on the list of link devices and selecting [Select Device Station] from the shortcut menu.

The screenshot shows a software interface with two main tables: 'Remote Input (RX)' and 'Remote Output (RY)'. Both tables have columns for 'Host STA', 'Refresh Device', 'STA#', 'Link Device', and 'Explanation'. A context menu is open over the 'Link Device' column of the 'Remote Output (RY)' table, with the option 'Select Device Station' highlighted. A mouse cursor is pointing at this option. Below the menu, a list of device stations is shown, with '05:AJ65SBT2B-64DA' selected. An arrow points from this selection to a second table on the right. This second table, titled 'Remn', has columns for 'Host STA', 'Refresh Device', and 'STA#'. The 'STA#' column contains the number '5', which is highlighted in blue. Below the '5' are symbols '<==='.

Select the station number 5 of the device station.

The station number 5 is displayed at the top.

- The "Device/Buffer Memory Batch Monitor" window appears by selecting and right-clicking a refresh device or buffer memory in the link device list, then selecting [Device/Buffer Memory Batch Monitor] from the shortcut menu.

## ■Applying explanations to device comments

Apply the contents in the "Explanation" column displayed in the link device list of a device station on CC-Link IE TSN to the device comments for each refresh device.

### Window

Right-click on the link device list, and select [Reflect explanation to device comment] from the shortcut menu.

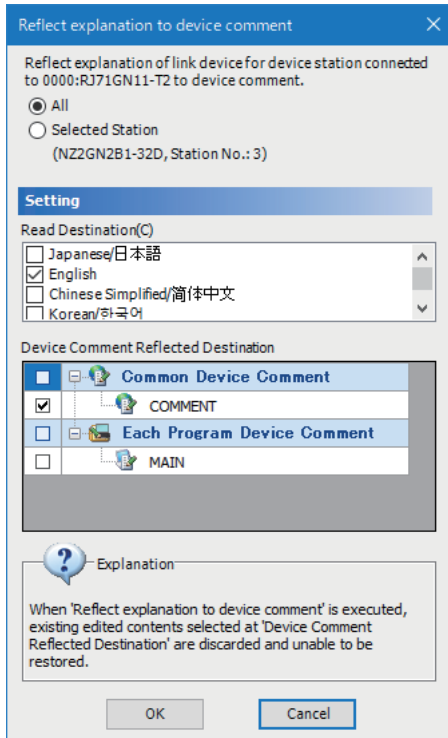

### Operating procedure

Set each item and click the [OK] button.

### Precautions

- The explanation for the first device in the "Link Device" column on the link device list is applied to the device comment for the first device in the "Refresh Device" column.
- If the multiple comment display has been enabled, the contents in the "Explanation" column are applied to device comments in the language selected for "Read Destination" in the "Reflect explanation to device comment" screen.

## Checking/changing the number of intelligent function module parameters

Display the setting information of the start XY addresses, initial settings, and auto refresh settings of intelligent function modules in a list.

After intelligent function module parameters are written to a CPU module, the following operations are performed.

- Initial setting: The parameters of the individual intelligent function module data are set as an initial setting. The data is registered in a CPU module parameters and written to the intelligent function module automatically when the CPU module changed to RUN.
- Auto refresh: For the buffer memory of an intelligent function module set to auto refresh, the data is written to/read from the specified devices automatically when the END instruction is executed on the CPU module.

### Window

- Select [Project] ⇒ [Intelligent Function Module] ⇒ [Module Parameter List].
- Select "Parameter" ⇒ "Module Information" in the navigation window, then right-click it and select [Module Parameter List] from the shortcut menu.

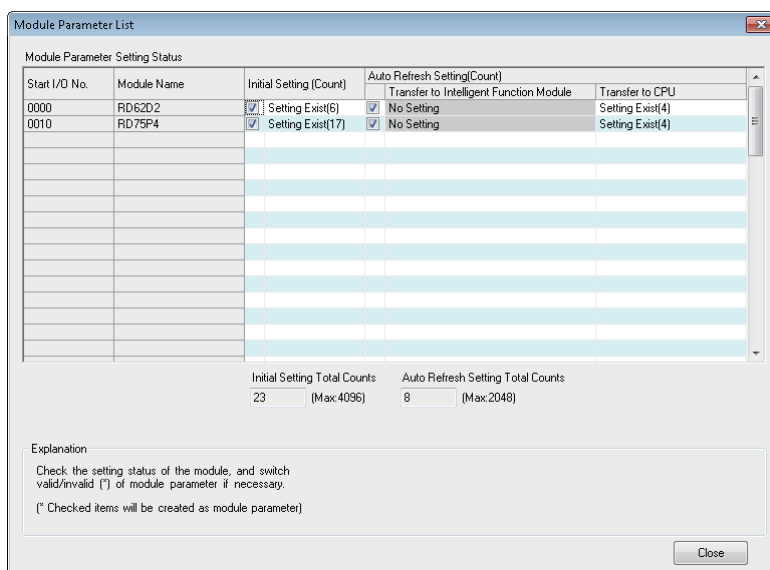

### Enabling/disabling parameters

Set whether to enable/disable the initial setting and auto refresh of intelligent function module parameter.

The number of parameters that can be set has limits depending on the intelligent function module to be used. Check the setting information using this function and accordingly enable/disable the parameters so that the number of set parameters is within the allowable range.

For details on the number of the parameter settings, refer to the manuals of relevant intelligent function module.

### Operating procedure

Set each item and click the [Close] button.

Item	Description
Initial Setting (Count)	Unselect the item if it is not set as an intelligent function module parameter. For a module with no initial settings, "-" is displayed.
Auto Refresh Setting (Count)	Unselect the item if it is not set as an intelligent function module/CPU module parameter. For a module for which auto refresh is not set, "No Setting" is displayed.
Initial Setting Total Counts	Displays the number of initial settings set as intelligent function module parameters.
Auto Refresh Setting Total Counts	Displays the number of auto refreshes set as intelligent function module parameters.



## Checking property information

Check the setting information of an intelligent function module.

By this operation, the mounting slot number, start I/O number, and title (up to 32 characters) for RCPU, and the mounting position number and title (up to 32 characters) for FX5CPU can be changed.

### Window

1. Select "Parameter" ⇒ "Module Information" ⇒ "(module name)" in the navigation window.
2. Select [Project] ⇒ [Data Operation] ⇒ [Properties] (🔗).  
Alternatively, right-click it and select [Properties] (🔗) from the shortcut menu.

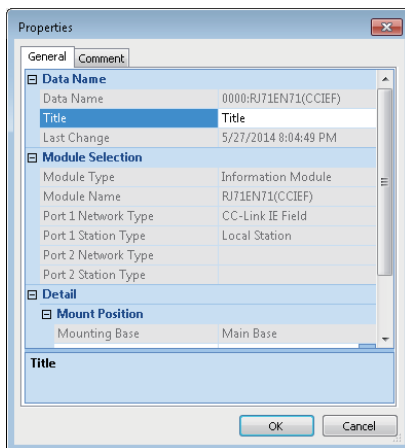

### Operating procedure

Set each item and click the [OK] button.

## Setting link side devices in a batch (CC-Link IE TSN)

Link side devices of either of the following modules can be set in a batch in the "Link Side Device Batch Setting" screen.

- CC-Link IE TSN module
- CC-Link IE TSN Plus master/local module (the CC-Link IE TSN port only)

### Window

1. Double-click "Basic Settings" ⇒ "Refresh Setting" ⇒ "<Detailed Setting>" in the parameter editor for either of the following modules:
  - CC-Link IE TSN module
  - CC-Link IE TSN Plus master/local module (the CC-Link IE TSN port only)
2. Right-click on the "Setting Item" column, and select [Link Side Device Batch Setting] from the shortcut menu.

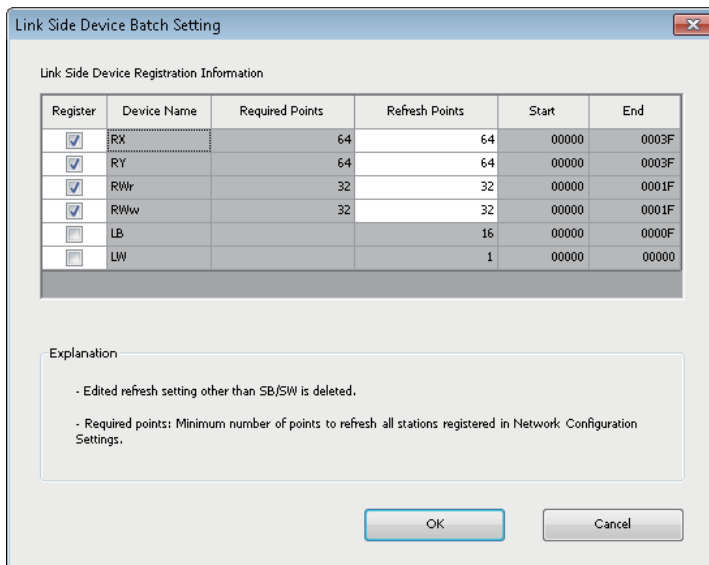

### Operating procedure

Set each item and click the [OK] button.

### Precautions

Adding another device station after setting refresh points may cause a shortage of the points.

In that case, the refresh points need to be set again; therefore, setting larger numbers in advance is recommended.

## Auto-refresh batch setting/points batch setting (EtherNet/IP)

The setting values of module extended parameters of a CC-Link IE TSN Plus master/local module can be applied to the refresh setting.

### Operating procedure

1. Double-click "Basic Settings" ⇒ "Refresh Setting" ⇒ "<Detailed Setting>" in the parameter editor for a CC-Link IE TSN Plus master/local module (the EtherNet/IP port):
2. Select "Device" from the pull-down list of "Target."
3. Right-click on the "Setting Item" column, and select [Auto-refresh Batch Setting]/[Points Batch Setting] from the shortcut menu.

### Precautions

To use this function, EtherNet/IP Configuration tool Version 1.04E or later is required to be installed.

For details on the EtherNet/IP Configuration tool, refer to the following:

📖 MELSEC iQ-R CC-Link IE TSN Plus Master/Local Module User's Manual

## Module-specific menus for editing parameters

Depending on the setting items of each module, the input format and device assignment method can be selected from one of the following menus.

- [Edit] ⇒ [IP Address Input Format] ⇒ [Decimal]/[Hexadecimal]
- [Edit] ⇒ [Device Assignment Method] ⇒ [Start/End]/[Points/Start]
- [Edit] ⇒ [Word Device Setting Value Input Format] ⇒ [Decimal]/[Hexadecimal]

## Registering a simple device communication library

A simple device communication library describes the information on a communication destination and protocol to use the simple device communication function.

By registering a simple device communication library in GX Works3, a device that can communicate with a module can be added without updating the module firmware and GX Works3.

An added communication destination can be set in "Simple Device Communication Setting" of the module parameter for a module that supports the simple device communication function.

For details on the simple device communication function and simple device communication library, refer to the following:

📖 MELSEC iQ-R Ethernet User's Manual (Application)

The following shows the procedure to register a simple device communication library.

Make sure to log on to a personal computer as a user with the administrator authority and close the project in advance.

### Operating procedure

1. Select [Tool] ⇒ [Register Simple Device Communication Library].
2. Select a simple device communication library file (\*.sdcl) in the displayed screen, and click the [Open] button. (Multiple selections allowed.)

## Parameter interaction with MELSOFT Navigator

By using the parameter interaction function of MELSOFT Navigator, the parameter consistency can be ensured between MELSOFT Navigator and GX Works3.

This function is operated in MELSOFT Navigator. For details, refer to MELSOFT Navigator Help.

## 4.3 Other Settings of Intelligent Function Modules

The settings except for the parameter setting of an intelligent function module can be configured with a module tool or dedicated tool.

### Setting with a module tool/drive tool

#### Displaying the module tool list

##### Window

Select [Tool] ⇒ [Module Tool List].

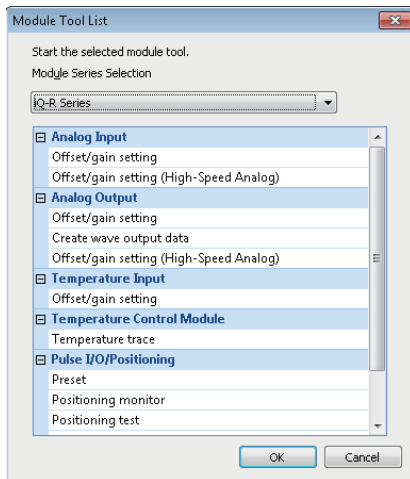

For the functions of each module tool, refer to the user's manual of a target module.

#### Displaying the drive tool list

##### Window

Select [Tool] ⇒ [Drive Tool List].

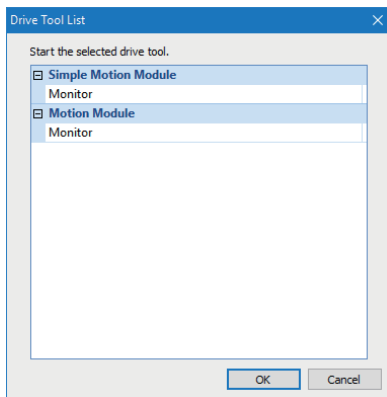

For the functions of the drive tool, refer to the user's manual of a target module.

## Simple motion module setting function

This function is used to set parameters and positioning data of the following modules:

- Simple motion module
- CC-Link IE TSN compatible motion module (simple motion mode)

For details on the operation methods and setting items, refer to Help for the simple motion module setting function.

The following shows the operating procedure to start this function.

### Operating procedure

1. Select "Parameter" ⇒ "Module Information" in the navigation window.
2. Select [Project] ⇒ [Data Operation] ⇒ [Add New Module].
3. Select "Simple Motion" or "Motion Module" from the pull-down list of "Module Type" in the "Add New Module" screen.
4. Set each item and click the [OK] button.

If selecting "Motion Module" in step 3, set the module name to which '(S)' is added for "Module Name." (Example: FX5-40SSC-G(S))

5. Double-click the created "Simple Motion Module Setting (Module Extended Parameter)" or "Module Extended Parameter."

### Point

By saving a GX Works3 project, contents set with this function are saved.

## Motion control setting function

This function is used to set parameters of a motion module.

To set parameters of a CC-Link IE TSN compatible motion module (simple motion mode), use the simple motion module setting function. ( Page 219 Simple motion module setting function)

FX5CPUs do not support it.

For details on the operation methods and setting items, refer to Help for the function.

The following shows the operating procedure to start this function.

### Operating procedure

1. Select "Parameter" ⇒ "Module Information" in the navigation window.
2. Select [Project] ⇒ [Data Operation] ⇒ [Add New Module].
3. Select "Motion Module" from the pull-down list of "Module Type" in the "Add New Module" screen.
4. Set each item and click the [OK] button.
5. Double-click the created "Module Extended Parameter."

### Point

By saving a GX Works3 project, contents set with this function are saved.

## 4.4 Predefined Protocol Support Function

Start the Predefined Protocol Support Function from GX Works3, and set the protocol and read/write data from/to a module. For details, refer to the following:

📖 MELSEC iQ-R Serial Communication Module User's Manual(Application)

📖 MELSEC iQ-R Ethernet User's Manual (Application)

📖 MELSEC iQ-F FX5 User's Manual (Serial Communication)

📖 MELSEC iQ-F FX5 User's Manual (Ethernet Communication)

For RnPCPUs (redundant mode), this function can be used when the modules are in the separate mode and "Not Specified" is selected for "Specify Redundant CPU."

For RnPSFCPUs, this function can be used only when "Not Specified" is selected for "Specify Redundant CPU."



The files saved in GX Works2 can be read using the Predefined Protocol Support Function of GX Works3.

### Start and End

Start and end the predefined protocol support function.

#### Start

##### Operating procedure

1. Select GX Works3 menu [Tool] ⇒ [Predefined Protocol Support Function].
2. Set each item in the "Predefined Protocol Support Function" screen and click the [OK] button.

#### End

##### Operating procedure

Select [File] ⇒ [Exit] in the protocol setting screen.

# 4.5 Circuit Trace Function

Trace the send/receive data and communication control signal between C24 and a target device.

For details, refer to the following:

📖 MELSEC iQ-R Serial Communication Module User's Manual(Application)

FX5CPUs do not support this function.

## Window

Select [Tool] ⇨ [Circuit Trace].

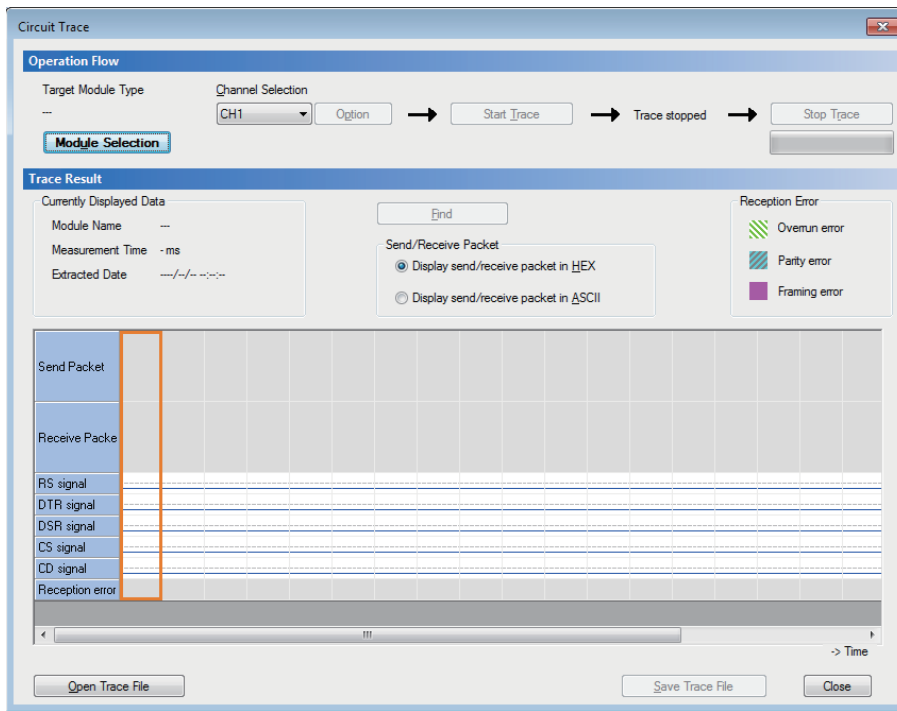

# 4.6 Change Module

This function changes the module type set in a GX Works3 project.

The module type, module name, and station type of a module set in a project can be changed to data for another module.

## Module

The module types, module names, and station types that can be changed for each of the following modules are as follows:

### ■Another CPU module

Module type	Module name
PLC CPU	R00CPU, R01CPU, R02CPU, R04CPU, R08CPU, R16CPU, R32CPU, R120CPU
Process CPU	R08PCPU, R16PCPU, R32PCPU, R120PCPU
Safety CPU	R08SFPCPU, R16SFPCPU, R32SFPCPU, R120SFPCPU
Motion CPU	R16MTCPU, R32MTCPU, R64MTCPU
NCCPU	R16NCCPU
Robot CPU	R16RTCPU

### ■CC-Link IE built-in Ethernet module

Module type	Module name	Station type
Information module	RJ71EN71 (E+CCIEC)	Control station, normal station, extended mode (control station), extended mode (normal station)
	RJ71EN71 (E+CCIEF)	Master station, local station, sub-master station
	RJ71EN71 (E+E)	—

### ■CPU extension module

Module type	Module name	Station type
CPU extension	_RJ71EN71 (E+IEC)	Control station, normal station, extended mode (control station), extended mode (normal station)
	_RJ71EN71 (E+IEF)	Master station, local station, sub-master station

### ■Simple motion module/motion module (simple motion mode)

Module type	Series	Module name
Simple motion	iQ-R <sup>*1,2</sup>	RD77MS2, RD77MS4, RD77MS8, RD77MS16, RD77GF4, RD77GF8, RD77GF16, RD77GF32
	iQ-F <sup>*1</sup>	FX5-40SSC-S, FX5-80SSC-S
Motion module (simple motion mode) <sup>*3</sup>	iQ-R <sup>*1</sup>	RD78G4(S), RD78G8(S), RD78G16(S)
	iQ-F <sup>*1</sup>	FX5-40SSC-G(S), FX5-80SSC-G(S)
	iQ-L <sup>*1</sup>	LD78G4(S), LD78G16(S)
	L <sup>*4</sup>	LD77MS2, LD77MS4, LD77MS16

\*1 Cannot be changed to a module of a different series.

\*2 Cannot be changed from an RD77GF4, RD77GF8, RD77GF16, and RD77GF32 to an RD77MS2, RD77MS4, RD77MS8, and RD77MS16.

\*3 Cannot be changed to a simple motion module.

\*4 Can be changed to LD77MS2, LD77MS4, LD77MS16, LD78G4(S), or LD78G16(S) only.

### ■CC-Link IE TSN compatible motion module

Module type	Module name
Motion Module	RD78G4 <sup>*1</sup> , RD78G8 <sup>*1</sup> , RD78G16 <sup>*1</sup> , RD78G32 <sup>*1</sup> , RD78G64 <sup>*1</sup> , RD78GHV <sup>*2</sup> , RD78GHW <sup>*2</sup>

\*1 Cannot be changed to an RD78GHV and RD78GHW.

\*2 Cannot be changed to an RD78G4, RD78G8, RD78G16, RD78G32, and RD78G64.





## Operating procedure

1. Select "Parameter" ⇒ "Module Information" ⇒ "(module name)" in the navigation window.
2. Right-click the selected module, and select [Change Module] from the shortcut menu.  
A change module screen appears.
3. Set each item in the change module screen, and click the [OK] button.

## Precautions

### ■When changing a CC-Link IE built-in Ethernet module or CPU extension module

- A module controlled by another CPU module cannot be changed.
- After changing a module,  (required settings unchecked) appears in the navigation window.  
Select [Tool] ⇒ [Check Parameter] to check parameters. (  Page 201 Checking parameters)

## Data to be changed

The following tables show the data that is changed by changing a module.

For the changes on simple motion modules and motion modules, refer to Help for the simple motion module setting function and for the motion control setting function respectively.

### ■Another CPU module

Item	Description
"Parameter" ⇒ "Module Information" in the navigation window	The settings are updated according to the changed module.
Module configuration diagram	
System parameter	I/O assignment setting
	Multiple CPU setting
Properties	Title
	Comment
	Others

### ■CC-Link IE built-in Ethernet module

Item	Description
"Parameter" ⇒ "Module Information" in the navigation window	The settings are updated according to the changed module. <ul style="list-style-type: none"> <li>• Module parameter (port 1): Applied.</li> <li>• Module parameter (port 2): Returned to the default.</li> </ul>
Module configuration diagram	The settings are updated according to the changed module.
Module label	Deleted. Besides, the data types and classes of global labels assigned to module labels are also deleted.  Registered as a global label depending on the contents of the following settings. <ul style="list-style-type: none"> <li>• [Tool] ⇒ [Options] ⇒ "Project" ⇒ "Module Label" ⇒ "Operational Setting" ⇒ "Use Module Label"</li> <li>• [Tool] ⇒ [Options] ⇒ "Project" ⇒ "Module Label" ⇒ "Message" ⇒ "Show the confirmation message in adding module"</li> </ul>
Module FB	The module FB definition used before the module type change is deleted from the navigation window. Added to the element selection window according to the changed module.
System parameter	I/O assignment setting
	Multiple CPU setting
	Redundant module group setting
Module Parameter	Interlink transmission settings
Properties	Title
	Comment
	Others

## ■CPU extension module

Item		Description
"Parameter" ⇒ "Module Information" in the navigation window		The settings are updated according to the changed module. <ul style="list-style-type: none"> <li>• Module parameter (port 1): Applied.</li> <li>• Module parameter (port 2): Returned to the default.</li> </ul>
Module configuration diagram		The settings are updated according to the changed module.
Module label		Deleted. Besides, the data types and classes of global labels assigned to module labels are also deleted.  Registered as a global label depending on the contents of the following settings. <ul style="list-style-type: none"> <li>• [Tool] ⇒ [Options] ⇒ "Project" ⇒ "Module Label" ⇒ "Operational Setting" ⇒ "Use Module Label"</li> <li>• [Tool] ⇒ [Options] ⇒ "Project" ⇒ "Module Label" ⇒ "Message" ⇒ "Show the confirmation message in adding module"</li> </ul>
Module FB		The module FB definition used before the module type change is deleted from the navigation window.  Added to the element selection window according to the changed module.
System parameter	I/O assignment setting	The settings are updated according to the changed module.
	Multiple CPU setting	The settings are applied.
Module parameter	Interlink transmission settings	Returned to the default.
Properties	Title	The settings are applied.
	Comment	
	Others	The settings are updated according to the changed module.

# 5 REGISTERING LABELS

This chapter explains the overviews and registration methods of labels.

## 5.1 About Labels

There are four types of label; labels registered on label editors (global label and local label), a module label which is prepared as the dedicated label for each module (global label), and a system label which is interacted with MELSOFT Navigator. Global labels can be registered as system labels.

Type	Description	Creation method	Number of creatable labels	Reference
Local label	Labels that can be used in each program	Create them on a local label editor.	• 5120 in a program file (maximum)	Page 227 Registering Labels
Global label	Labels that can be used in all programs in a project. There are two types of global label; global labels that can be used either in standard programs or in safety programs, and standard/safety shared labels that can be used in both programs.	Create them on a global label editor.	• 20480 in a file (maximum) • 16384000 in a project (maximum)	
System label	Labels that can be shared among iQ Works supported products. These labels are controlled by MELSOFT Navigator.	Register standard global labels as system labels on a global label editor.		Page 254 Registering System Labels
Module label	Labels in which the I/O signals and buffer memory of a module to be used are already defined. By using module labels, an easy-to-reuse program can be created without considering the internal address of the module. These labels can be used in standard programs only.	Add module labels when adding the module information. These labels are created as standard global labels.		Page 248 Registering Module Labels

### • Numbers of characters of labels and label comments

Type	Number of characters of a label	Number of characters of a label comment
Local label	256 (maximum)	1024 (maximum)
Global label		
System label		
Module label	Not changeable	Not available

For details on the label types, classes, and data types, refer to the following:

 MELSEC iQ-R CPU Module User's Manual (Application)

 MELSEC iQ-F FX5 Programming Manual (Program Design)

## Auto refresh and direct access for module labels

There are two types of module labels for each purpose: auto refresh and direct access. For direct access, '\_D' is added to a label name.

The difference between auto refresh and direct access is as follows.

Type	Description	Access timing
Auto refresh	The value written to/read from a module label is applied to a module in a batch when auto refresh is performed. By using the auto refresh, the execution time of a program can be shortened. To use the auto refresh, select "Module Label" in "Target" under the refresh setting of the module parameter.	When auto refresh is performed
Direct access	The value written to/read from a module label is immediately applied to a module. Compared with the auto refresh, the execution time of a program will be extended; however, responsiveness will be increased. To use the direct access, select the item other than "Module Label" in "Target" under the refresh setting of the module parameter. When "Module Label" is selected in "Refresh," values of module labels are overwritten by a refresh when an END processing is executed or a program in which a refresh timing is specified is executed.	When reading from/writing to a module label

# 5.2 Registering Labels

This section explains the registration methods of global labels and local labels.

A global label can be created maximum 20480 in a file and maximum 16384000 in a project. A local label can be registered maximum 5120 in a program file.

## Configuration of a label editor

This section explains the configuration of a label editor.

The editor to be displayed will differ depending on the label types.



The display format and details of operation settings for each function can be set by setting the following option.

[Tool] ⇒ [Options] ⇒ "Other Editor" ⇒ "Label Editor Common"

### Window

#### Global label

Select "Label" ⇒ "Global Label" ⇒ "(global label)" in the navigation window.

#### Local label



Select "Program" ⇒ "(execution type)" ⇒ "(program file)" ⇒ "(program block)" ⇒ "Local Label" in the navigation window.

#### Toolbar



#### Label editor (global label editor)

Label Name	Data Type	Class	Assign (Device/Label)	Initial Value	Constant	English(Display Target)
1 bLabel1	Bit	VAR_GLOBAL				
2 udLabel2	Double Word [Unsigned]/Bit String [32-bit]	VAR_GLOBAL				
3 wLabel3	Word [Signed]	VAR_GLOBAL				
4 CTD_1	CTD	VAR_GLOBAL				
5 stLabel5	STRUCT1(0..1)	VAR_GLOBAL	Detailed Setting			
6 uLabel6	Word [Unsigned]/Bit String [16-bit](0..2)	VAR_GLOBAL				Comment_1

- The items in the label list (1), extension display area (2), and system label area (3) can be displayed or hidden in the "Display Setting" screen that appears by clicking the [Display Setting] button or in the following options:
  - [Tool] ⇒ [Options] ⇒ "Other Editor" ⇒ "Label Editor Common" ⇒ "Display Setting" ⇒ "Detailed Display Setting"
  - [Tool] ⇒ [Options] ⇒ "Other Editor" ⇒ "Label Editor Common" ⇒ "Extended Display Setting" ⇒ "Extended Display Area"
  - [Tool] ⇒ [Options] ⇒ "Other Editor" ⇒ "Label Editor Common" ⇒ "Extended Display Setting" ⇒ "System Label Setting Display Area"The settings changed in the "Options" screen are applied to all label editors.
- Click the [Check] button to check errors before converting programs.
- When the data type is structure or function block, the hierarchy of labels is displayed in the extension display area.
- If a label comment is set for an array element or bit-specified label, a red square is displayed at the upper right of the cell ( ) in the comment column.  
The label comment for the array element or bit-specified label can be checked in the "Label Comment" window. ( Page 243 Setting a label comment)
- The "Label Comment" window appears by selecting a cell then performing either of the following operations:
  - Right-click it and select [Open Label Comment Setting] from the shortcut menu.
  - Press the  +  keys.However, these operations are not available when selecting a blank row or a cell in the extension display area.
- Font color, background color, and font can be changed.  
 Page 81 Checking and Changing Colors and Fonts

## Precautions

In a label editor, perform any other operations after fixing current changes by pressing the  key.

## Editing a row

### ■ Adding a row

When selecting [New Declaration (After)], a row is inserted right under the selected row. In the new row, the label in the selected row is copied with a value appended at the end of the label name.

If a value is already appended after the label name, the data is copied with an incremented value.

When devices are set for global labels, the data is copied with an incremented device number.

For adding blank rows or setting increment regulation (decimal/hexadecimal), set the following option.

- [Tool] ⇒ [Options] ⇒ "Other Editor" ⇒ "Label Editor Common" ⇒ "Editor Setting"

### Operating procedure

Select [Edit] ⇒ [New Declaration (Before)]().

If a label comment is set for an array element or bit-specified label of the label in a selected row, the label comment is also copied.

### ■ Deleting rows (deleting labels)

#### Operating procedure

Select [Edit] ⇒ [Delete Row]().

### ■ Deleting a blank row



A blank row automatically is deleted and the following row moves upward on a label editor.

#### Operating procedure

Select [Edit] ⇒ [Delete Blank Rows]. ()

### ■ Sorting labels

Labels can be sorted by clicking a title name of label editor.

For ascending order,  is displayed, and as for descending order,  is displayed in the title name.

### ■ Filtering display

- A wild card (such as '\*' and '?') is not applied as a filtering condition. A character string including the wild card is displayed.
- When filtering columns by selecting "Access from External Device," specify '1' after selecting "Access from External Device." As for it is not selected, specify '0.'

# Entering information

## Label name

Set a name with avoiding the following conditions:

- Label name including a space
- Label name starting with a number
- Same label name as one for a device

For the characters that cannot be used for a label name, refer to the following:

☞ Page 887 Unusable character strings for a label name

## Precautions

For label names, constants, and initial device values, use characters in the Unicode Basic Multilingual Plane.

If an input language is different from the language set in the regional settings on Windows, some functions may not operate properly. In that case, unify these languages.

The label names and constants that specifies the characters other than the Unicode Basic Multilingual Plane cannot be used in programs.

A program including an initial value using the characters outside the Unicode Basic Multilingual Plane may not operate properly.

## Alias

By entering an existing label name in the "Assign (Device/Label)" column of a label editor, it can be set as an alternative label name of the existing label.

A label to which an existing label is assigned is referred to as 'alias.'

An existing label that is assigned to an alias is referred to as 'alias source.'

The following information of an alias source will be succeeded: data types, classes, initial values, and constants.

For an alias, a label in the same category (standard, safety, and standard/safety shared) as an alias source can only be set.

**Ex.**

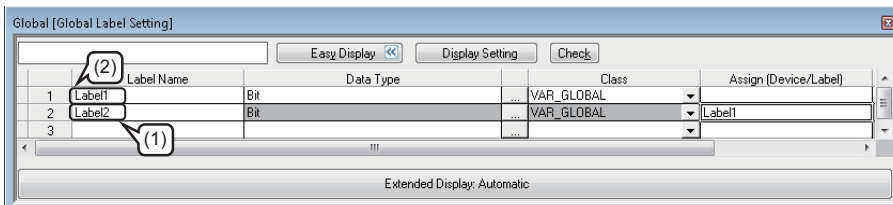

(1): Alias

(2): Alias source



## Precautions

- For an alias, do not assign an instance of a function block or module FB.
- Enter the same character in the "Assign (Device/Label)" column of an alias as the one which was entered in the "Label Name" column of the alias source.
- For an alias, a structure member and a label in a function block can not be assigned.
- The following error occurs at conversion when a structure member or a label used in a function block is entered in the "Assign (Device/Label)" column of an alias and the alias is used in a program editor.  
Content: An invalid device or an invalid constant is being used.  
Error code: 0x12011067
- When using an alias in a project in which 20000 or more labels are included, the operability of a label editor may be deteriorated.  
In that case, assign the same device to two labels instead of alias, or set another name of a label as a label comment.

### Ex.

When using 'Label2' as another name of 'Label1':

- (1) Assign 'M120' to 'Label1' and 'Label2.'
- (2) Set the comment of 'Label1' to 'Label2,' and display the comment in a program editor.

Label Name	Data Type	Class	Assign (Device/Label)
Label1	Bit	VAR_GLOBAL	
Label2	Bit	VAR_GLOBAL	Label1

Label Name	Data Type	Class	Assign (Device/Label)
Label1	Bit	VAR_GLOBAL	M120
Label2	Bit	VAR_GLOBAL	M120

(1)

Label Name	Data Type	Class	Assign (Device/Label)	Comment
Label1	Bit	VAR_GLOBAL		Label2

(2)

- When setting an alias, set it so as not to cause a circular reference.  
For example, make sure a circular reference will not occur before copying and pasting a global label in the same project or from another project.

The following shows an example that a circular reference occurs.

### Ex.

If 'Label3' is assigned to 'Label1' while the alias (Label2) of 'Label1' and the one (Label3) of 'Label2' have been set, an error occurs since the assignment causes a circular reference.

Label Name	Data Type	Class	Assign (Device/Label)
Label1	Bit	VAR_GLOBAL	
Label2	Bit	VAR_GLOBAL	Label1
Label3	Bit	VAR_GLOBAL	Label2

Label Name	Data Type	Class	Assign (Device/Label)
Label1	Bit	VAR_GLOBAL	Label3
Label2	Bit	VAR_GLOBAL	Label1
Label3	Bit	VAR_GLOBAL	Label2

## ■ Automatic naming rule

By setting the data type and the class when the label name is blank, a label name will be set automatically.

Set the automatic naming rules in the following option setting.

- [Tool] ⇒ [Options] ⇒ "Other Editor" ⇒ "Label Editor Common" ⇒ "Editor Setting"

The automatic naming rules are as follows.

- Defined characters

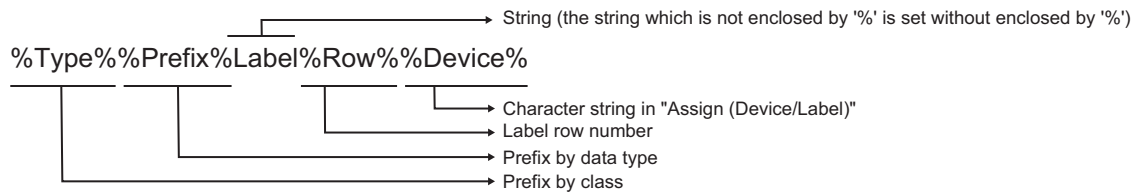

\*The character other than the defined one enclosed by '%' will be blank.

The prefixes for each data type are as follows.

Data type	Prefix
Bit	b
Word [Unsigned]/Bit String [16-bit]	u
Double Word [Unsigned]/Bit String [32-bit]	ud
Word [Signed]	w
Double Word [Signed]	d
FLOAT [Single Precision]	e
FLOAT [Double Precision]	le
Time	tm
String	s
String [Unicode]	ws
Pointer	pd
Timer	td
Counter	cd
Long Counter	lcd
Retentive Timer	std
Long Retentive Timer	lstd
Long Timer	ltd
Structure	st
FB	fb

The prefixes that are added depending on the selected class are as follows.

Class	Prefix
VAR_GLOBAL	G_
VAR_GLOBAL_RETAIN	GR_
VAR_GLOBAL_CONSTANT	GC_
VAR	Not added.
VAR_RETAIN	r_
VAR_CONSTANT	c_
VAR_INPUT	i_
VAR_OUTPUT	o_
VAR_IN_OUT	io_
VAR_OUTPUT_RETAIN	or_
VAR_PUBLIC	pb_
VAR_PUBLIC_RETAIN	pbr_

#### ■Setting example

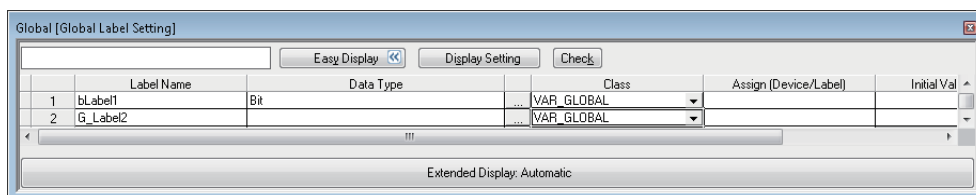

- When "Bit" is selected in the "Data Type" column: bLabel1  
Prefix 'b' that indicates the bit type + character string 'Label' + label row number '1'
- When "VAR\_GLOBAL" is selected in the "Class" column: G\_Label2  
Prefix 'G\_' that indicates the class + character string 'Label' + label row number '2'
- When "D0" is specified in the "Assign (Device/Label)" column: Label3  
Character string 'Label' + label row number '3'

#### ■Automatic synchronization

When a label name or alias name is changed on a label editor, the label name or alias name used on program editors such as ST editor, FBD/LD editor, and SFC editor will also be replaced automatically.

- Select "Yes" for "Track label name automatically in program editor" from [Tool] ⇒ [Options] ⇒ "Other Editor" ⇒ "Label Editor Common" ⇒ "Operational Setting"

The labels are distinguished between global labels and local labels in the automatic synchronization. (☞ Page 259 Entering global labels/local labels)

However, in either of the following cases, the label name or alias name is not replaced:

- A character string that cannot be used for a label name is included in the label name or alias name.
- The same label name or alias name exists in a label editor.

(If a global label name is changed, the label is checked if the same label name or alias name exists in any of the global label settings.)

The programs in which the replaced label is used will be in the unconverted state.

If labels name or alias name is changed, check if the change affects control programs using the cross reference function.

#### ■Label synchronization

The contents edited on a global label editor are immediately applied on a ladder editor by setting the following option. When labels undefined on the ladder editor are newly added on the label editor, they will be in the defined state.

- Set "Synchronize" for "Operation on Editing Label Editor" in [Tool] ⇒ [Options] ⇒ "Program Editor" ⇒ "Ladder Editor" ⇒ "Label Synchronization" ⇒ "Operational Setting."

Local labels always synchronize with the data on a label editor regardless of the option setting.

## ■ Duplicating a structure type global label

Structure type global labels can be duplicated including the setting of a device assigned to a global label. The following shows the procedure to duplicate a structure type global label.

### Operating procedure

1. Select a structure type global label on a global label editor.
2. Select [Edit] ⇒ [Duplicate Structured Data Type Label]().
3. Select a global label and line number of the duplication destination in the "Duplicate Structured Data Type Label" screen, and click the [OK] button.

### Precautions

Only standard global labels and safety global labels can be duplicated.

The following labels cannot be duplicated:

- Global labels to which a device is not assigned
- Global labels whose data type is other than structure
- Standard/safety shared labels
- Module labels
- Tag FB instances
- Read-only labels
- Global labels to which a structure type global label is assigned (alias)

## Data type

A data type can be selected in the "Data Type Selection" screen displayed by clicking [...] in the "Data Type" column on each label editor as well as the direct input.

There are three kinds of data types: "Simple Types," "Structured Data Type," and "Function Block." A data type that can be selected for each kind differs.

An array can be set for the selected data type.

For details on the data types, structures, and arrays, refer to the following:

📖 MELSEC iQ-R CPU Module User's Manual (Application)

📖 MELSEC iQ-F FX5 Programming Manual (Program Design)

### ■ Simple types

Data types that can be set for each label are as follows.

○: Available, ×: Not available

Data type	Standard label	Safety label	Standard/safety shared label
Bit	○	○	○
Word [Unsigned]/Bit String [16-bit]	○	○	○
Double Word [Unsigned]/Bit String [32-bit]	○	○	○
Word [Signed]	○	○	○
Double Word [Signed]	○	○	○
FLOAT [Single Precision]	○	×	×
FLOAT [Double Precision]	○	×	×
Time	○	○	○
String	○	×	×
String [Unicode]	○	×	×
Pointer	○	×	×
Timer	○	○	○
Counter	○	○	○
Long Counter	○	×	×
Retentive Timer	○	○	○
Long Retentive Timer	○	×	×
Long Timer	○	×	×

### Point

The data length for the String or String [Unicode] type can be changed by editing the value in "( )" directly.

	Label Name	Data Type	Class
1	L_string1	String(32)	VAR
2	L_string2	String(16)	VAR
3			

↑  
Change these values directly.

The initial value of the data length for the String or String [Unicode] type can be set in the option setting.

- [Tool] ⇒ [Options] ⇒ "Other Editor" ⇒ "Label Editor Common" ⇒ "Data Type Setting"

When "( )" is deleted from the name for the String or String [Unicode] type, the data length in the option described above is regarded as being set.

## ■ Structure

When specifying a structure data as a data type, creating a definition of the structure is required in advance. (🔍 Page 242 Creating a defined structure)

After creating a defined structure, specify the structure name in "Data Type."

## ■ Function block

When specifying a function block data as a data type, creating a function block is required in advance.

For details, refer to the following:

🔍 Page 484 Creating a Function Block

After creating a function block, specify the function block name in "Data Type."

## ■ Setting arrays for data type

An array can be set for the data type by selecting the checkbox of "ARRAY."

The following shows setting examples of an array.

**Ex.**

One-dimensional array with eight elements

Enter '8' in "Element (1 dimension)."

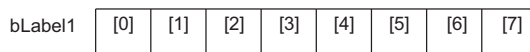

Array Element

ARRAY

Element (1 dimension) 8

Element (2 dimensions) 0

Element (3 dimensions) 0

**Ex.**

Two-dimensional array with 4 × 8 elements

Enter values as shown below:

- Element (1 dimension): 4
- Element (2 dimensions): 8

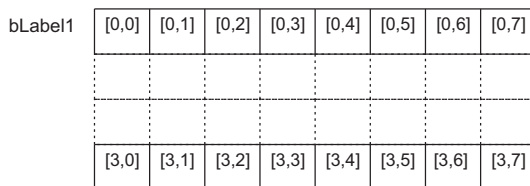

Array Element

ARRAY

Element (1 dimension) 4

Element (2 dimensions) 8

Element (3 dimensions) 0

**Ex.**

Three-dimensional array with 3 × 4 × 8 elements

Enter values as shown below:

- Element (1 dimension): 3
- Element (2 dimensions): 4
- Element (3 dimensions): 8

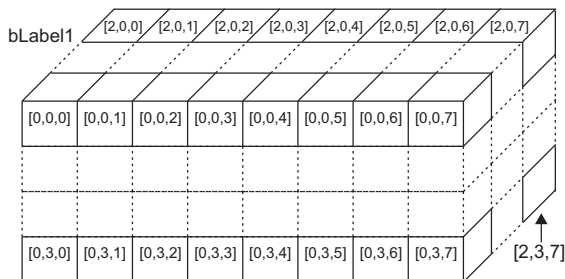

Array Element

ARRAY

Element (1 dimension) 3

Element (2 dimensions) 4

Element (3 dimensions) 8

## Point

A value other than '0' (minus value, for example) can be specified as an offset ([array start value]...[array end value]).

	Label Name	Data Type	Class
1	Initial_Setting_A	Bit(-5..2)	VAR_GLOBAL
2	Initial_Setting_B	Bit(2..6)	VAR_GLOBAL
3	Initial_Setting_C	String(32)	VAR_GLOBAL

## Class

Select a class from the pull-down list of "Class."

Safety global labels, standard/safety shared labels, local labels of a safety program, and local labels of a safety FB do not support latch type classes ('RETAIN' is included in a name).

For details on the classes, refer to the following:

 MELSEC iQ-R CPU Module User's Manual (Application)

 MELSEC iQ-F FX5 Programming Manual (Program Design)

## Assignment (devices/labels)

Set this item when assigning an arbitrary device or label to a global label.

Devices and labels that can be assigned vary depending on the assignment target label.

The following devices and labels can be assigned to a global label.

- Digit-specified bit devices (example: K4M0)
- Bit-specified word devices (example: D0.1)
- Module labels

However, a device name with a device type specifier suffixed (D0: U, for example) cannot be assigned.

If not assigning a device/label to a label, the label memory is assigned instead. For details on the label memory, refer to the following:

 Page 898 Label Memory Types

 MELSEC iQ-R CPU Module User's Manual (Application)

 MELSEC iQ-F FX5 User's Manual (Application)

### Point

By using the assigned device check function, assigned devices can be checked if they are assigned to other labels.

 Page 241 Duplication check

When a device assigned to a global label is deleted automatically due to specific operations (such as changing the data type of the label or adding/deleting/editing a structure member), that can be reported in the "Output" window by selecting "Yes" for the following option:

- [Tool] ⇒ [Options] ⇒ "Other Editor" ⇒ "Label Editor Common" ⇒ "Operational Setting" ⇒ "Notify when assigned device is deleted"

## Precautions

- When specifying a timer or counter device to "Assign (Device/Label)," the assigned device is regarded as a contact (TS, STS, CS) if a bit type device is specified to "Data Type."  
When the data type is a word type, the specified device is regarded as a current value (TN, STN, CN).
- An assigned device may not be displayed automatically on a program editor when it is changed to another device. The change is applied to a program editor by converting any or all programs.
- In projects for an RCPU and LHCPU, if a step relay (S) which does not specify a block number (BL□) is specified in "Assign (Device/Label)," the assigned label operates in the same manner as a step relay (S) which does not specify a block number (BL□).

Therefore, the same label operates differently depending on the location of use.

For details on a step relay (S), refer to the following:

 MELSEC iQ-R Programming Manual (Program Design)

- In projects for an FX5CPU where "Use" is set in "To Use or Not to Use SFC" of the CPU parameter, if a step relay (S) which does not specify a block number (BL□) is specified in "Assign (Device/Label)," the assigned label operates in the same manner as a step relay (S) which does not specify a block number (BL□).

Therefore, the same label operates differently depending on the location of use.

For details on a step relay (S), refer to the following:

 MELSEC iQ-F FX5 Programming Manual (Program Design)

### ■ Safety project

Devices and labels that can be assigned vary depending on the assignment target label.

○: Can be assigned, ×: Cannot be assigned

Global label to be assigned	Assignment target				
	Standard device	Standard global label	Safety device	Safety global label	Standard/safety shared label
Standard global label	○	○	×	×	×
Safety global label	×	×	○	○	×
Standard/safety shared label	×	×	×	×	○

### ■ When data type is structure

A device can be assigned for each structure member in the "Structure Device Setting" screen displayed by clicking the "Detailed Setting" button.

(The color of "Detailed Setting" is displayed in pink when no setting exists, and is displayed in blue when the settings have been done.)

When structure array is set for the data type of a label, a device can be assigned to the member of every elements in the structure array with a specific interval by specifying "Structure Array Offset Value" in the "Structure Device Setting" screen. When '0' is entered for "Structure Array Offset Value," a device assigned to the head of the member of the element is assigned to all the members of the element.

#### Point

Devices assigned to structure members can be deleted in a batch by selecting  ⇒ [Batch Delete of Assigned Device] in the extension display area.

Moreover, the cursor jumps to the following option by selecting  ⇒ [Change Item Name in Hierarchy Display Area].

- "Other Editor" ⇒ "Label Editor Common" ⇒ "Extended Display Setting" ⇒ "Item Name to Show in Hierarchy Display Area"

## Precautions

If a structure member is changed after assigning devices to the structure member, the assignment status of devices may be changed.

In that case, assign devices to the structure member in the "Structure Device Setting" screen or in the extension display area of a label editor.



## Initial value

Set the initial value of a label.

The availability of initial values differs depending on the data types and classes.

The entry method of an initial values is the same as that of the constants of labels. For details, refer to the following:

📖 MELSEC iQ-R CPU Module User's Manual (Application)

FX5CPUs do not support this setting.

### ■Applicable range

Initial values of labels will be set when the CPU module is at STOP to RUN. If the values of labels are changed by program, the program operates with the changed initial values.

### ■Initial values of label of which data type is array

Different initial values for the respective array elements cannot be set. When setting the different values for each array, set the initial value by program.

## Precautions

- An initial value cannot be set for a safety global label, local label in a safety program, and standard/safety shared label.
- A global label to which a device is assigned does not operate with the initial label value.  
Use the assigned device check function to check if an initial value is set for any global label to which a device is assigned.  
(👉 Page 241 Initial value check)

## Constant

Constant can be set when "VAR\_GLOBAL\_CONSTANT" or "VAR\_CONSTANT" is specified to the class.

The availability of the constants differs depending on the data type and class.

For details on how to enter the constants, refer to the following:

📖 MELSEC iQ-R CPU Module User's Manual (Application)

📖 MELSEC iQ-F FX5 Programming Manual (Program Design)

## Comment

Set a label comment for a defined label.

When entering a label comment, a line feed can be inserted in a cell by pressing the **Ctrl** + **Enter** keys. (A line feed is counted as two characters.)

Multiple label comments can be set for one label. (👉 Page 82 Display setting for multiple comments)

To set a label comment for an array element or bit-specified label, use the "Label Comment" window. (👉 Page 243 Setting a label comment)

### ■Displaying all lines or first line of comments

For the "Comment" columns, data can be entered in multiple lines.

Double-click "+" or "-" to switch the display between all lines or only the first line.

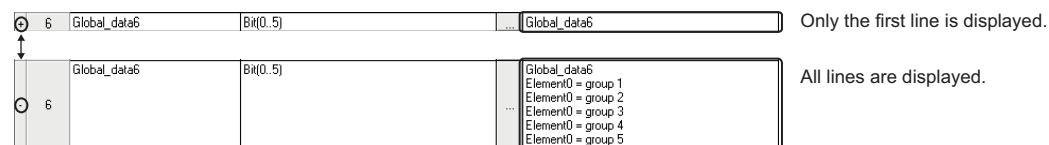

### ■Copying a device comment

The device comment of a device assigned to a selected label can be copied as the label comment.

When a device is assigned to an array element or bit-specified label, the device comment can be copied as the label comment for the array element or bit-specified label.

However, the device comment of a device assigned to an alias source cannot be copied.

## Operating procedure

Select [Edit] ⇒ [Copy Device Comment] (📄).

## ■Deleting a label comment

A label comment can be deleted by selecting a cell in the comment column in a label editor and pressing the  key. However, the label comment for an array element or bit-specified label remains.

To delete the label comment for an array element or bit-specified label, perform any of the following operations:

- Delete the row.
- Change the number of dimensions of the array type label.
- Change the data type of the bit-specified label to other than the word type.

## Accessing from external devices

Select this to monitor devices/labels from external devices connected to a CPU module.

If the selection status of "Access from External Device" is changed, the change will not be reflected to the assigned devices/labels.

An error occurs when accessing from an external device to the CPU module in any of the following condition.

- Data type is pointer type/FB
- Class is "VAR\_GLOBAL\_CONSTANT"
- Index-modified devices

This setting is not available for safety global labels nor standard/safety shared labels.

FX5CPUs do not support this setting.

# Checking assigned devices

## Duplication check

Devices assigned to global labels are checked if they are assigned to other labels.

Devices duplicated by the array or data type can also be detected.

Moreover, devices satisfied the following conditions can be checked.

Condition	Duplication example	
	Device	Data type
The digit specification or bit specification is used.	K4X0	Word type
	X2	Bit type
Multiple points are assigned.	D0	Double-word type
	D1	Word type
Other than the start of the array is assigned.	D20	Word (0..2) type
	D21	Word type
A structure member is assigned.	M1	Structured data type
	M1	Bit type

### Operating procedure

1. Select [Tool] ⇒ [Check the Assigned Device of Global Label].
2. Select the checkbox of "Duplication Check" in the "Check the Assigned Device of Global Label" screen.
3. Click the [Execute] button.

When devices are duplicated, an error message appears in the "Output" window.

#### Point

Select the checkbox of "Include Bit Specification" to check bit-specified devices as well.  
(Example: 'D0' and 'D0.0')

## Initial value check

Global labels to which devices are assigned are checked if initial values are set for the labels.

### Operating procedure

1. Select [Tool] ⇒ [Check the Assigned Device of Global Label].
2. Select the checkbox of "Initial Value Check" in the "Check the Assigned Device of Global Label" screen.
3. Click the [Execute] button.

When an initial value is set for any of the global labels, an error message appears in the "Output" window.

## Creating a defined structure

A structure member (local label) can be added to a structure definition.

Up to 5120 structure members can be added.

Be sure to create data of a defined structure in advance. (  Page 129 Creating data)

### Window

Select "Label" ⇒ "Structured Data Types" ⇒ "(structure)" in the navigation window.

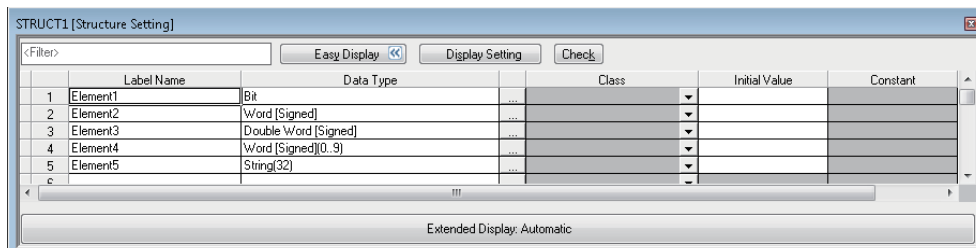

- Click the [Display Setting] button to select the items to be displayed.
- Click the [Check] button to check errors before converting programs.

## Setting reserved area capacities

Reserve area capacities for structure members can be set for each structure definition.

To apply the set reserved area capacities for programs, all the programs are required to be converted (reassigned).

For details on reserved area capacities, refer to the following:

 MELSEC iQ-R Programming Manual (Program Design)

 MELSEC iQ-F FX5 Programming Manual (Program Design)

### Operating procedure

1. Select "Yes" for the following option.  
[Tool] ⇒ [Options] ⇒ "Convert" ⇒ "Basic Setting" ⇒ "Operational Setting" ⇒ "Structured Data Type" ⇒ "Enable to Set Reserved Area"
2. Select a structure definition in the navigation window.
3. Select [Project] ⇒ [Data Operation] ⇒ [Properties].
4. Set a reserved area capacity in "Reserved Area" of the "Properties" screen, and click the [OK] button.
5. Convert (reassign) all the programs.

### Precautions

The reserved area capacities of the following structure definitions cannot be changed.

- System structure definition
- Structure definition necessary for module labels

## Exporting/importing structure definitions to/from a file

Structure definitions can be exported to a CSV file or an XML file. Moreover, data in a CSV file can be imported as structure definitions.

The operating procedures and file format are the same as that for a label editor.

For details, refer to the following:

 Page 245 Exporting/importing a label

## Setting a label comment

A label comment can be set in a label editor or the "Label Comment" window.

This section explains the method for setting a label comment in the "Label Comment" window.

To set a label comment in a label editor, refer to the following:

 Page 239 Comment

In the "Label Comment" window, a label comment can be set for the following data:

- Label
- Array type label
- Array element
- Bit-specified label
- Structure type label
- Structure member

However, an undefined label is not displayed in the "Label Comment" window.

### Window

Select [View] ⇒ [Docking Window] ⇒ [Label Comment] .

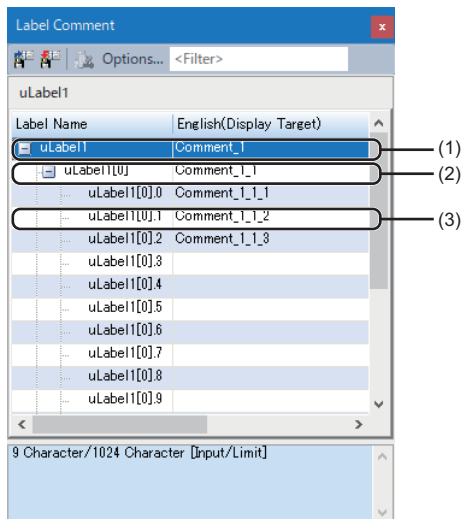

(1): Label comment

(2): Label comment for an array element

(3): Label comment for a bit-specified label

### Operating procedure





**1.** Open a label editor or program editor, and select a label.

The label comment of the selected label is displayed in the "Label Comment" window.

When selecting an array type label or bit-specified label, array elements and labels with bit numbers are displayed in a tree format.

**2.** Enter a label comment in the comment column.

#### Point



- When entering a label comment, a line feed can be inserted in a cell by pressing the  +  keys. (A line feed is counted as two characters.)
- Multiple label comments can be set for one label. ( Page 82 Display setting for multiple comments)
- A label editor appears by selecting a cell then performing either of the following operations:
  - Right-click it and select [Open Label Setting] from the shortcut menu.
  - Press the  +  keys.

## Precautions

A label comment can be set for up to 1024 array elements in the "Label Comment" window.

To set a label comment for 1025 or more array elements, use one array type label for every 1024 array elements, or enter comments in a ladder editor.

The following table shows the methods for entering a comment for 1025 or more array elements in a ladder editor.

Method	Operating procedure
Entering a comment after entering a label	<ol style="list-style-type: none"><li>1 Select "Yes" for the following option:<ul style="list-style-type: none"><li>• [Tool] ⇒ [Options] ⇒ "Program Editor" ⇒ "Ladder Editor" ⇒ "Enter ladder" ⇒ "Operational Setting" ⇒ "Enter label comment and device comment"</li></ul></li><li>2 Select a cell to enter a comment for, then double-click it or press the  key.</li><li>3 Click the [OK] button in the element entry dialog, or press the  key.</li><li>4 Enter a comment in the "Input Device Comment" screen.</li></ol>
Entering a comment directly	<ol style="list-style-type: none"><li>1 Select the following menu to display comments in a ladder editor:<ul style="list-style-type: none"><li>• [View] ⇒ [Comment Display]</li></ul></li><li>2 Select a cell and press the  key twice.</li><li>3 Enter a comment directly.</li></ol>

## Copying a device comment

The device comment of a device assigned to a selected label can be copied as the label comment.

The device comment of a device assigned to an alias source can also be copied.

### Operating procedure

Right-click a label and select [Copy Device Comment] () from the shortcut menu.

## Exporting/importing label comments to/from a file

Label comments can be exported to a CSV file. In addition, label comments in a CSV file can be imported into the "Label Comment" window.

### Operating procedure

1. Open the "Label Comment" window.
2. Right-click on the window and select [Export to File] () / [Import File] () from the shortcut menu.

### ■ CSV file format

The column titles (Label Name and comment) in the "Label Comment" window and header names in a CSV file are linked.

Contents in the "Label Name," "Data Type," and "Assignment (device)" columns in a CSV file are not exported.

Data can be imported even when the column order in a CSV file does not match with that in the "Label Comment" window.

# Exporting/importing a label

Data in a label editor can be exported to a CSV file or an XML file. Moreover, data in a CSV file can be imported into a label editor.

## Operating procedure

### ■Exporting data

1. Open a label editor.
2. Select [Edit] ⇒ [Export to File] ()
3. Select the checkbox of either of the following items in the "Export to File" screen, and click the [Execute] button.
  - Export to CSV File. (Exclude comment for array element/bit specification and assignment device of structures.)
  - Export to XML File. (Include comment for array element/bit specification and assignment device of structures and structure arrays.)

### ■Importing data

1. Open a label editor.
2. Select [Edit] ⇒ [Import File] ()

## CSV file

### ■Format

The column titles (Class, Label Name, Data Type, etc.) in a label editor and header names in a CSV file are linked.

- In a label editor, only the data of which column titles match with header names in a CSV file is imported. To exclude the specific data, delete the column from the CSV file.
- To import data from a CSV file exported in GX Works3 with a different language, edit the header names in the CSV file to match with the column titles displayed in the label editor of the import target GX Works3.
- Data can be imported even when the column order in a CSV file does not match with that in a label editor.
- When "Access from External Device" is selected, '1' is output. As for it is not selected, '0' is output. When editing a CSV file, set '1' or '0.'

### Point

The files exported from GX Works2 can be imported to GX Works3.

Before importing a CSV file exported from GX Works2, edit the header names in the CSV file to match the column titles in a label editor of GX Works3.

## XML file

Devices assigned to structure members can also be exported to an XML file.

The assigned devices can be checked in a list by opening this file in another application such as Excel.

**Ex.**

The following shows the method to export data in a label editor to an XML file and check the devices assigned to structure members in Excel.

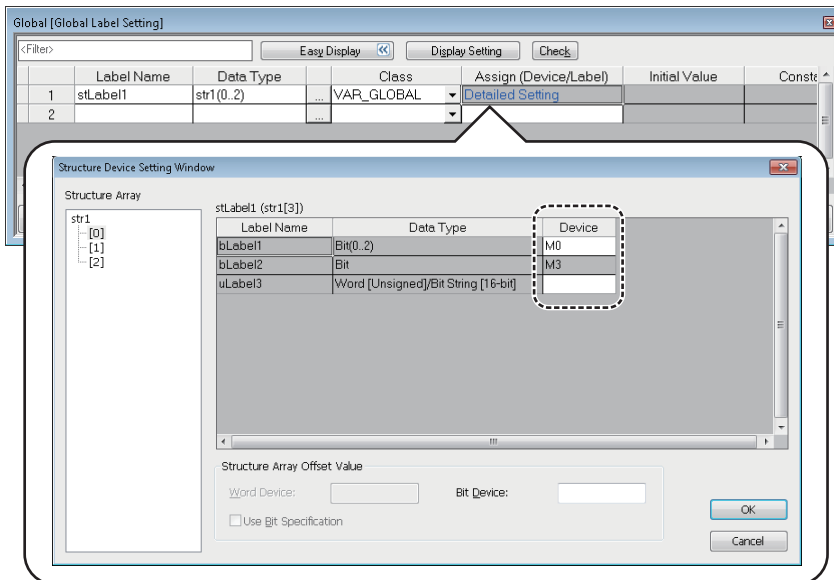

## Operating procedure

1. Export data of a label editor. (☞ Page 245 Exporting data)
2. Start Excel.
3. Drag and drop the XML file onto Excel.
4. Select the checkbox of "As an XML table" in the "Open XML" screen, and click the [OK] button.

The opened file is displayed as follows:

	Q	R	V	AA	AB	AC	AD
1	name7	name8	name9	index	name11	address12	
2	Global	stLabel1	str1				
3	Global	stLabel1	str1	0	bLabel1	M0	
4	Global	stLabel1	str1	0	bLabel2	M3	
5	Global	stLabel1	str1	0	uLabel3	GV:0A000	
6	Global	stLabel1	str1	1	bLabel1	M4	
7	Global	stLabel1	str1	1	bLabel2	M7	
8	Global	stLabel1	str1	1	uLabel3	GV:0A004	
9	Global	stLabel1	str1	2	bLabel1	M8	
10	Global	stLabel1	str1	2	bLabel2	M11	
11	Global	stLabel1	str1	2	uLabel3	GV:0A008	

- (1): Data names of the global labels
- (2): Label names
- (3): Data type (structured data type)
- (4): Structure member names
- (5): Assigned devices



# Registering an undefined label

---

An undefined label can be registered on a label editor.

## Operating procedure

### ■ Ladder editor, FBD/LD editor

1. Enter the name of a label to be registered on an editor.
2. Set each item in the "Undefined Label Registration" screen and click the [OK] button.

### ■ ST editor

1. Enter the name of a label to be registered on an editor.
2. Select the token of a label name, and select [Edit] ⇒ [Register Label] (.
3. Set each item in the "Undefined Label Registration" screen and click the [OK] button.

## 5.3 Registering Module Labels

This section explains the registration methods of module labels.

### Registering as global labels

Module labels are registered when the module setting has been set as "Module Label: Use" in the confirmation screen displayed after performing either of the following operations.

- Place a module on the module configuration diagram and fix parameters.
- Add a new module in the navigation window.

The registered module labels are displayed in "Global Label" in the navigation window and in the [Module] tab in the element selection window.

To use a module label in a program, enter a module label name directly or drag and drop it from the element selection window.



To use a module label under arbitrary name, set alias to the module label.

### Precautions

#### ■ Considerations when registering module labels

Since all the registered module labels are written to a CPU module, the memory capacity of the CPU module may be exceeded. In this case, perform any of the following operations.

- Change the write target of the global labels to SD memory card.
- For FX5CPU, the writable capacity is the same as that of the CPU module even when data is written to an SD memory card.

#### ■ Module label with the name that starts with 'zReserve'

Do not write data to the module label with the label name that starts with 'zReserve' among the module labels. Doing so may cause malfunction of the programmable controller systems.

**Ex.**

'Instance name'\_'Module number'.'Label name' GF11\_1.zReserveAreaSB00007

#### ■ Registering public labels set with the motion control setting function

Public labels can be registered in global labels of GX Works3 as module labels by selecting the following menu using the motion control setting function.

- [Convert] ⇒ [Reflect Public Labels]

After registering the labels, the global labels of GX Works3 and the program in which the global labels are used will be in the unconverted state. For details on public labels, refer to Help for the motion control setting function.

### Editing module labels

A module label (M+Global) which is registered as a global label can only be deleted by selecting a row on a label editor. Do not edit and add a label on the label editor.

### Re-registering deleted module labels

To register the module labels which got deleted from a global label editor again, select and right-click a module name displayed in the [Module] tab in the element selection window, then select [Add Module Label] from the shortcut menu.

### Editing structures

Once module labels are registered, the definitions of the structures in the module labels are registered into "Structured Data Types" in the navigation window.

A defined structure can be copied in the navigation window. The copied defined structure of the module label is changed from "+" to "\_".

## 5.4 Registering Tag FBs

In projects for an RnPCPU and an RnPSFCPU, tag FBs can be used in an FBD/LD program with the process control extension enabled.

To use tag FBs, they are required to be registered on the tag FB setting editor in advance.

Enter a tag name, tag FB type, and comment, then click the [Apply] button.

Up to 1000 tag FBs can be registered into a project.

For details on tag FBs, refer to the following:

📖 MELSEC iQ-R Programming Manual (Process Control Function Blocks/Instructions)

### Precautions

To use tag FBs, it is recommended to register and apply them on the tag FB setting editor before adding data of a program block, function block, function, global label, and structure definition.

When a lot of data mentioned above is registered in a project, it may take time to apply the tag FB setting.

## Configuration of the tag FB setting editor

The following shows the screen configuration of the tag FB setting editor.

### Window

Click  (Tag FB Setting) on the toolbar.

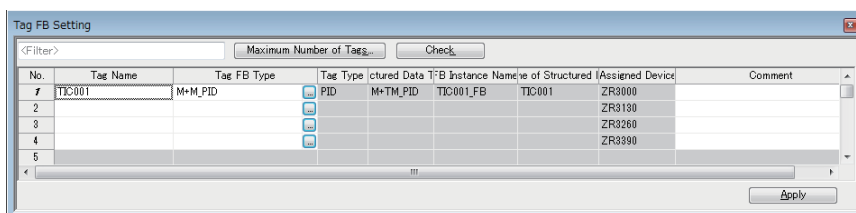



### Displayed items

Item	Description
Filter	Data can be filtered. A wild card (such as '*' and '?') is not applied as a filtering condition. A character string including the wild card is displayed.
[Maximum Number of Tags] button	Click this to check and set the following option: • [Tool] ⇒ [Options] ⇒ "Convert" ⇒ "Process Control Extension Setting" ⇒ "Tag FB" ⇒ "Maximum Number of Tags"
[Check] button	Click this to check if there are any errors.

### ■ Setting items

○: Editable, ×: Not editable

Item	Editability	Description
Tag Name	○	Enter a tag FB name.
Tag FB Type	○	Select the tag FB type of a tag FB instance.
Tag Type	×	The tag type of a tag FB instance is displayed.
Structured Data Type	×	A structure definition name of tag data is displayed.
FB Instance Name	×	A tag FB instance name is displayed.
Label Name of Structured Data Type	×	A tag data name is displayed.
Assigned Device	×	The following device is assigned. • The start device of a system resource + 3000 + ((row number - 1)*130) Set the system resource in [Tool] ⇒ [Options] ⇒ "Convert" ⇒ "Process Control Extension Setting" ⇒ "System Resource" ⇒ "File Register: ZR."
Comment	○	Enter a comment that is applied to a comment of a tag FB instance and tag data.

- By clicking the [Check] or [Apply] button, the versions of tag data and a process control function block in a project can be checked whether they are supported in GX Works3 where the project is open. To update the versions, click the [Yes] button in the confirmation message appeared.  
For additions and changes in a process control function block with a version upgrade, refer to 'Version Upgrade' in the following manual:  
 MELSEC iQ-R Programming Manual (Process Control Function Blocks/Instructions)
- Converting (reassigning) all programs may be required after updating the version of tag data or a process control function block.
- The initial values of FB properties return to the default after updating the version of tag data or a process control function block. However, the initial values can easily be set again by exporting the values in the "FB Property Management (Offline)" screen before updating the version, then importing them after the update.  
( Page 397 FB property management (offline))

## Editing a row

### ■ Adding a row

A row can be added above a selected row. (Multiple selections allowed.)

Assigned devices in each tag FB setting is changed after the addition.

### Operating procedure

Select [Edit] ⇒ [New Declaration (Before)]().

### ■ Deleting a row

A selected row can be deleted. (Multiple selections allowed.)

Assigned devices in each tag FB setting is changed after the deletion.

### Operating procedure

Select [Edit] ⇒ [Delete Row]().

### ■ Copying a row

By clicking the [Apply] button after copying or cutting a row and pasting, the initial value of the FB property in the copy source is retained. However, it will not be retained if the tag FB type is changed after pasting.

### ■ Setting an applicable/inapplicable row

The number of rows set in [Tool] ⇒ [Options] ⇒ "Convert" ⇒ "Process Control Extension Setting" ⇒ "Tag FB" ⇒ "Maximum Number of Tags" will be applicable and other rows will be inapplicable as follows:

- Applicable row: Included in checking and applying the tag FB setting
- Inapplicable row: Excluded from checking and applying the tag FB setting. In addition, the information cannot be edited.

The option can be checked and set by clicking the [Maximum Number of Tags] button on the tag FB setting editor.

# Entering information

## Tag name

Set a name with avoiding the following conditions:

- Label name starting with a number
- Same label name as one for a device
- Label name including an unusable character (reserved word) (  Page 887 Unusable character strings for a label name)

Use only alphanumeric characters when monitoring data on a faceplate or exporting an assignment information database file.

## Tag FB type

Select a tag FB in the "Select Tag FB Type" screen displayed by clicking the [...] button in the "Tag FB Type" column.

For details on manufacturer-defined tag FB types, refer to the following:

 MELSEC iQ-R Programming Manual (Process Control Function Blocks/Instructions)

For details on user-defined tag FBs, refer to the following:

 Page 497 Creating a user-defined tag FB

## Comment

Use only alphanumeric characters when monitoring data on a faceplate or exporting an assignment information database file.

## Online program change

The following table shows whether to perform the online program change and initialize data with change for tag FBs.

○: Performed, ×: Not performed

Change for tag FBs		Online program change	Initialization
FB property	Changing an initial value	○	Not initialized
Tag FB setting	adding a tag FB	○	Initialized
	Changing a tag name <sup>*1</sup>	○	Not initialized
	Changing the tag FB type <sup>*1</sup>	× <sup>*2</sup>	—
	Changing a tag type <sup>*1</sup>	× <sup>*2</sup>	—
	Changing a declaration position <sup>*1</sup>	× <sup>*2</sup>	—
	Changing a comment <sup>*1</sup>	○	Not initialized
	Deleting the tag FB setting <sup>*1</sup>	○	Not initialized

\*1 For change for an applied tag FB

\*2 When changing data, all programs are required to be converted (reassigned).

# Data to be added with tag FB registration

By applying the data after entering a tag name and selecting the tag FB type on the tag FB setting editor, the tag FB instance and tag data are created in "M+PTAG" under "Global Label."

The definition of a tag FB and the structure definition of tag data are added in the navigation window as a read-only definition.

**Ex.**

When the tag name is 'TIC001' and the tag FB type is 'M+M\_PID'

Data/definition to be added	Name	Location
Tag FB instance	TIC001_FB	"Label" ⇒ "Global Label" ⇒ "M+PTAG" in the navigation window
Definition of a tag FB	M+M_PID	FB/FUN ⇒ (FB file name) in the navigation window
Tag data	TIC001	"Label" ⇒ "Global Label" ⇒ "M+PTAG" in the navigation window
Structure definition of tag data	M+TM_PID	"Label" ⇒ "Structured Data Types" in the navigation window
Definition of a function block referred from tag FB	M+P_MCHG M+P_IN M+P_PHPL M+P_PID M+P_OUT1	FB/FUN ⇒ (FB file name) in the navigation window

## Precautions

If the definition of a tag FB, the structure definition of tag data, and the definition of a user-defined tag FB are deleted in the navigation window, a project may become incorrect.

Before deleting these definitions, search a project for the FB definition names and structure name by using the character string search function to check that they are not used.

## Tag FB instance and tag data registered in "M+PTAG"

Only the initial value can be set for a tag FB instance registered in the global label setting "M+PTAG."

## Window

Select "Label" ⇒ "Global Label" ⇒ "M+PTAG" in the navigation window.

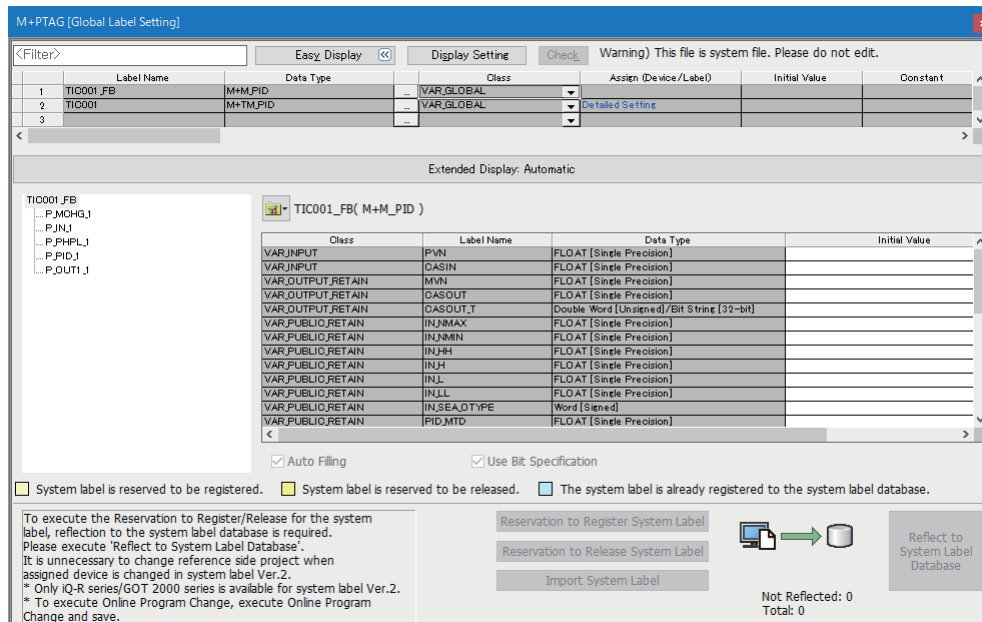

## Precautions

Do not delete "M+PTAG" from a project.

## Display/setting an FB property

The initial value of a tag FB instance can also be set in the "FB Property" window.

The display contents in the "FB Property" window is linked with the contents in the selected row on the FB setting editor.

For details on the "FB Property" window, refer to the following:

 Page 375 Display/setting an FB property

In the "FB Property" window, the initial value of a tag FB instance which has already been applied on the tag FB editor is displayed. A tag FB which is not applied, excluded from applying, or for which setting contents are changed after application is not displayed.

# 5.5 Registering System Labels

This section explains the method to register global labels as system labels. Only standard global labels support system labels.

## About system labels

Using the system labels controlled by MELSOFT Navigator enables programming with the same label names among the iQ Works supported products (GX Works3, MT Developer2, GT Designer3).

Once a workspace is saved with MELSOFT Navigator, a database to manage system labels is created in the workspace.

System labels cannot be used in a workspace without the system label database.

For details on MELSOFT Navigator, refer to MELSOFT Navigator Help.

### Precautions

Since module labels are read only, they cannot be registered as system label.

### System label version

There are two types of system labels for MELSOFT Navigator: system label ver.1 and system label ver.2.

FX5CPUs only support system label ver.1.

LHCPUs do not support either of the system labels.

For more details on the differences between system label ver.1 and system label ver.2, and creation methods of each system label database, refer to MELSOFT Navigator Help.

### Configuration of a label editor

#### Window

Select "Label" ⇨ "Global Label" ⇨ "(global label)" in the navigation window.

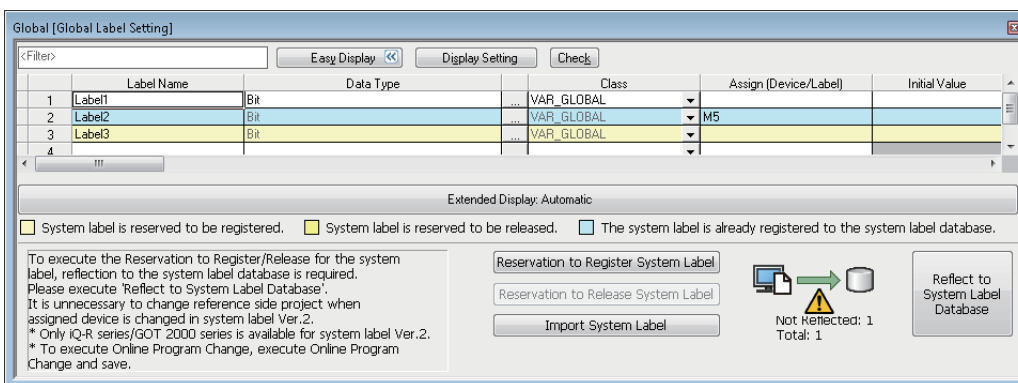

#### Displayed items

Item	Description
System Label Relation	Displays the relation between the global label and the system label. <ul style="list-style-type: none"> <li>• Disclose: The status in which the global labels are open as the system labels</li> <li>• Reference: The status in which the system labels opened by other projects are imported in the global labels</li> <li>• Blank: The status in which the global labels is not related to the system labels</li> </ul>
System Label Name	Displays the system label name related to the global labels.
Attribute	Displays the attribute of the system label which is related to the global labels.



## Registering labels in system label database

---

Disclose standard global labels created with GX Works3 as system labels.

When registering in a system label database for the first time, create a workspace with MELSOFT Navigator and save a GX Works3 project in the workspace in advance.

### Operating procedure

1. Display a global label editor.
2. Select labels to be registered as system labels, and click the [Reservation to Register System Label] button.
3. Click the [Reflect to System Label Database] button.  
The "Check before registering in system label database" screen appears.
4. Check the list of labels to be registered, and click the [Register] button.

### Precautions

- The structure array type global labels for which "Structure Array Offset Value" has been set cannot be registered in the system label database.
- Label comments for array elements and bit-specified labels cannot be registered in the system label database.

## Importing system labels in system label database to GX Works3

---

Import the system labels registered with MELSOFT Navigator or other projects to a project.

### Operating procedure

1. Display a global label editor.
2. Click the [Import System Label] button.  
The "Import System Labels to Project" screen appears.
3. Select system labels to be imported, and click the [Import] button.

## Releasing system labels

---

Release the relation with the system label database, and restore system labels to normal global labels.

### Operating procedure

1. Display a global label editor.
2. Select the labels of which relation is to be released from the labels registered as system labels.
3. Click the [Reservation to Release System Label] button.
4. Click the [Reflect to System Label Database] button.  
The "Check before registering in system label database" screen appears.
5. Check the list of labels to be released, and click the [Register] button.

## Verifying system label information

---

Compare the system label information of GX Works3 projects to the system label database, and check if there is any difference.

If differences exist, correct the system label information of the GX Works3 projects, and synchronize the information with the system label database.

### Operating procedure

1. Select [Edit] ⇒ [System Label] ⇒ [Execute Verification Synchronous with System Label].
2. Check and correct information in the "Execute Verify and Synchronize with system label" screen.
3. Click the [Reflection] button.

## Importing the changes of system label database

---

Import the changed contents to the GX Works3 projects when the system labels used in a project have been changed in other projects.

### Importing the changes automatically

---

#### Operating procedure

Click the [Yes] button on the message to confirm whether or not import the changed contents, which appears when any of the following operations is performed in a state where a system label change notification has been received.

- Opening a project
- Saving a project
- Applying labels to system label database
- Displaying the "Online Data Operation" screen
- Starting a simulation

Click the [No] button to import them after checking the changed contents. ( Page 256 Importing after checking the changes)

### Importing after checking the changes

---

When the system label information in the GX Works3 projects is different from the system label database, the icon to notify the changes is displayed at the lower-left corner of the GX Works3 screen.

Check the contents that have been changed when the icon is displayed. In addition, import the changed contents to the GX Works3 projects.

#### Operating procedure

1. Select [Edit] ⇒ [System Label] ⇒ [Check the changes of the System Label Database]().
2. Check the information in the "Import Change Contents of System Label Database" screen.
3. Click the [Import] button.

# PART 3 PROGRAMMING

This part explains the functions in editors for editing sequence programs and setting of the device memory and initial values.

6 CREATING PROGRAMS

---

7 SETTING DEVICE MEMORY

---

8 INITIAL DEVICE VALUE SETTING

---

9 SEARCHING FOR DATA

---

10 SEGMENTING PROGRAMS

---

# 6 CREATING PROGRAMS

This chapter explains the creation method of a program.  
Remote head modules do not support creating a program.

## 6.1 Programming Function

### Features and types of programming language

The following table shows the programming languages supported by GX Works3.

Programming language	Name	Description	Creation method of a program	Language specification
Ladder* <sup>1</sup>	Ladder Diagram	A graphic language using ladder programs composed of contacts and coils. The inline structured text functions to edit ST programs on a ladder editor can be used.	Page 264 Creating a Ladder Program	MELSEC iQ-R Programming Manual (Program Design) MELSEC iQ-F FX5 Programming Manual (Program Design)
ST	Structured Text	Control syntax such as selection branch by conditional syntax or repetitions by iterative syntax can be controlled, as in the high-level language such as C language. By using these syntax, concise programs can be written.	Page 309 Creating an ST Program	
FBD/LD	Function Block Diagram/Ladder Diagram	A graphic language for creating a control program only by placing and connecting an element. The inline structured text functions to edit ST programs on an FBD/LD editor can be used.	Page 319 Creating an FBD/LD Program	
SFC	Sequential Function Chart	A graphic language for clarifying the execution order and the execution condition of a program	Page 342 Creating an SFC Program	

\*1 Safety programs are supported.

### Features and the type of POU

The following table shows the usable POU in a program.

POU	Description	Reference
Function block	An element that has the internal memory and output an operation result according to values in the memory and the input value	Page 484 Creating a Function Block
Function	An element that has no internal memory and output always the same operation result for an same input value	Page 504 Creating a Function

## Entering global devices/local devices

To use global devices and local devices individually, enter the devices as follows:

- Standard global device: Enter a device name (Example: D10)  
Safety global device: Prefix 'SA\' to the device name (Example: SA\D10)
- Standard local device: Prefix '#' to the device name (Example: #D10)  
Safety local device: Prefix 'SA\#' to the device name (Example: SA#D10)

For details of the global device/local device, refer to the following:

📖 MELSEC iQ-R CPU Module User's Manual (Application)

Note that FX5CPUs do not support local devices.

## Entering global labels/local labels

When a label with the same name exists in both global labels and local labels, the label in a program is handled as follows:

- After a global label and a local label are registered, the label names are entered in the program: Treated as a local label.
- After a global label is registered, the label name is entered in the program, and then a local label with the same name is registered: Treated as a local label.
- After a local label is registered, the label name is entered in the program, and then a global label with the same name is registered: Treated as a local label.

The global labels and local labels can be distinguished by setting the different color in the "Color and Font" screen.

## Creation procedure

1. Create data of a program block. (📖 Page 129 Creating data)
2. Set the execution order and the execution type. (📖 Page 260 Program Execution Order and Execution Type Settings)
3. Create a program. (📖 Page 264 Creating a Ladder Program, Page 309 Creating an ST Program, Page 319 Creating an FBD/LD Program, Page 342 Creating an SFC Program)
4. Check the created program. (📖 Page 416 Checking a Program)
5. Convert the program. (📖 Page 420 Converting Programs)

## 6.2 Program Execution Order and Execution Type Settings

This section explains the setting method of the execution order and the execution type of a program.

### Program execution order setting

Set the execution order for program blocks in a program file.

An SFC program is executed according to the block numbers. Check the block numbers in an SFC block list.

To change the execution order for the SFC program, change the block numbers in the "Properties" screen of each SFC block. Refer to the following to set the execution order of a program file of the scan execution type with the process control extension enabled.

☞ Page 262 Execution order

#### Window

- Select [Convert] ⇒ [Program File Setting].
- Select a program file in the navigation window, then right-click it and select [Program File Setting] from the shortcut menu.

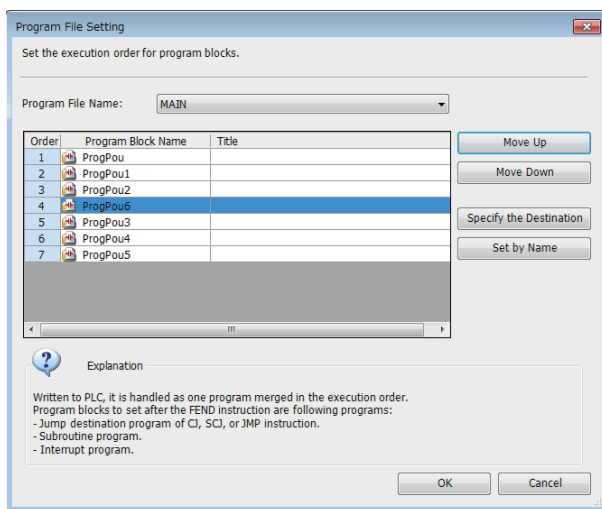

#### Operating procedure

1. Select a program file name.
2. Set an execution order for program blocks, then click the [OK] button.

#### Point

Program files can be sorted in the execution order specified in the program file setting. Select and right-click a file in the navigation window, then select [Sort] ⇒ [Execution Order] from the shortcut menu.

## Worksheet execution order setting

When multiple program bodies are included in a POU, the execution order for the program bodies can be set. This setting is allowed to POU's used in an ST program and FBD/LD program.

### Window

- Select [Convert] ⇒ [Worksheet Execution Order Setting].
- Select a POU in the navigation window, then right-click it and select [Worksheet Execution Order Setting] from the shortcut menu.

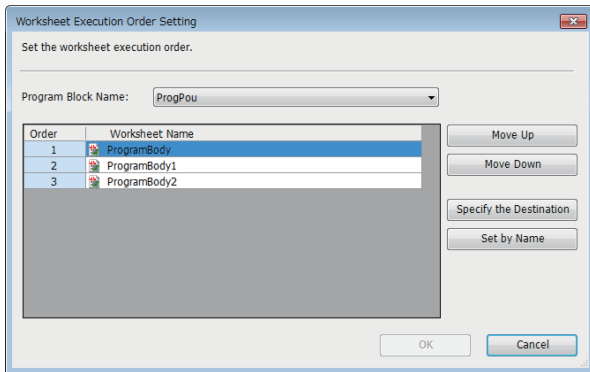

### Operating procedure

1. Select a program body.
2. Set the execution order for programs, then click the [OK] button.

#### Point

Program bodies can be sorted in the execution order specified in the worksheet execution order setting. Select and right-click a POU in the navigation window, then select [Sort] ⇒ [Execution Order] from the shortcut menu.

## Program execution type change

One of the following execution types can be specified to a program: Initial, Scan, Fixed Scan, Event, Standby, or No Execution Type.

For details, refer to the following:

📖 MELSEC iQ-R CPU Module User's Manual (Application)

📖 MELSEC iQ-F FX5 User's Manual (Application)

Only 'Fixed Scan' can be specified in safety programs.

### Setting method

To set the execution type, right-click on a target program in the navigation window and select [Register Program] from the shortcut menu, or drag the program and drop it onto the target execution type.

The set execution type will be applied to "Program Setting" of "CPU Parameter."

# Execution control of an FBD/LD program for process control

---

The following explains the setting methods for the execution control of an FBD/LD program for process control.

## Executing method

---

There are two methods to execute an FBD/LD program for process control: timer execution and interrupt execution (fixed scan). Select either of the execution methods in accordance with the intended use of the program.

For details, refer to the following:

 MELSEC iQ-R Programming Manual (Process Control Function Blocks/Instructions)

## Execution order

---

Set execution order for a program file of the scan execution type with the process control extension enabled in the "Program File Setting" screen.

### Operating procedure

1. Click  (Program File Setting) on the toolbar.  
Alternatively, select and right-click a program file in the navigation window, then select [Program File Setting] from the shortcut menu.
2. Set an execution order for program blocks, then click the [OK] button.

### Point

- For details on the "Program File Setting" screen, refer to the following:
    -  Page 263 Program File Setting screen
  - Program files can be sorted in the execution order specified in the program file setting. Select and right-click a file in the navigation window, then select [Sort] ⇨ [Execution Order] from the shortcut menu.
-



## Execution interval and phase

Execution interval and phase of an FBD/LD program for process control can be set in either of the following screens.

- "Properties" screen of an FBD/LD program for process control (Page 135 Properties)
- "Program File Setting" screen

For details on the execution interval and phase, refer to the following:

MELSEC iQ-R Programming Manual (Process Control Function Blocks/Instructions)

The following explains the "Program File Setting" screen.

### Program File Setting screen

In the "Program File Setting" screen, the execution intervals and phases of program blocks in a program file with the process control extension enabled can be set in a batch.

### Window

- Click  (Program File Setting) on the toolbar.
- Select a program file in the navigation window, then right-click it and select [Program File Setting] from the shortcut menu.

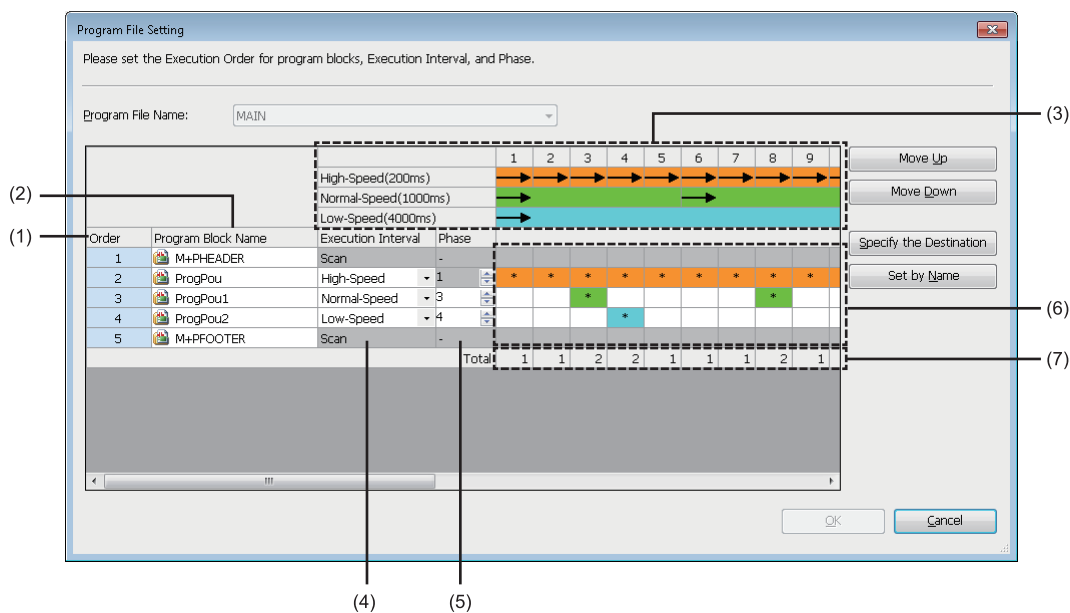

### Displayed items

Item	Description
(1) Order	Displays the execution order for program blocks.
(2) Program Block Name	Displays program block names.
(3) Execution interval (header)	Display contents are changed according to the value set for the following option. • [Tool] ⇒ [Options] ⇒ "Process Control Extension Setting" ⇒ "Program Execution" ⇒ "Execution Interval"
(4) Execution Interval	Displays the execution interval of each program. Execution intervals can be changed from the pull-down list.
(5) Phase	Displays the phase of each program. Phases can be changed by entering a value.
(6) Execution timing	Displays the timing to execute each program. (** indicates the program execution.) ** is displayed only for the program blocks created in Function Block Diagram/Ladder Diagram language.
(7) Total	Displays the total numbers of programs executed at each execution timing (total number of ** displayed in each column of 'Execution timing'). If no program block is executed, '0' is displayed.

# 6.3 Creating a Ladder Program

This section explains the creation method of a ladder program.

Detailed specifications of a ladder program are described in the following manuals. Please read them in advance.

📖 MELSEC iQ-R Programming Manual (Program Design)

📖 MELSEC iQ-F FX5 Programming Manual (Program Design)

**Point** 🔍

The display format and detailed operation settings for each function can be set by setting the following option.  
 [Tool] ⇒ [Options] ⇒ "Program Editor" ⇒ "Ladder Editor"

## Configuration of a ladder editor

### Window

Select "Program" ⇒ "(execution type)" ⇒ "(program file)" ⇒ "(program block)" ⇒ "ProgramBody" in the navigation window.

■ Toolbar

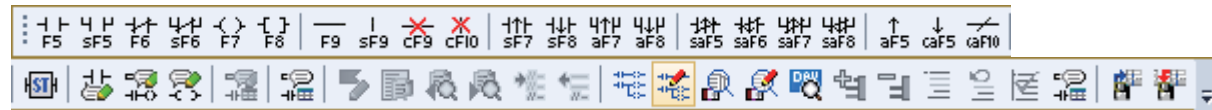



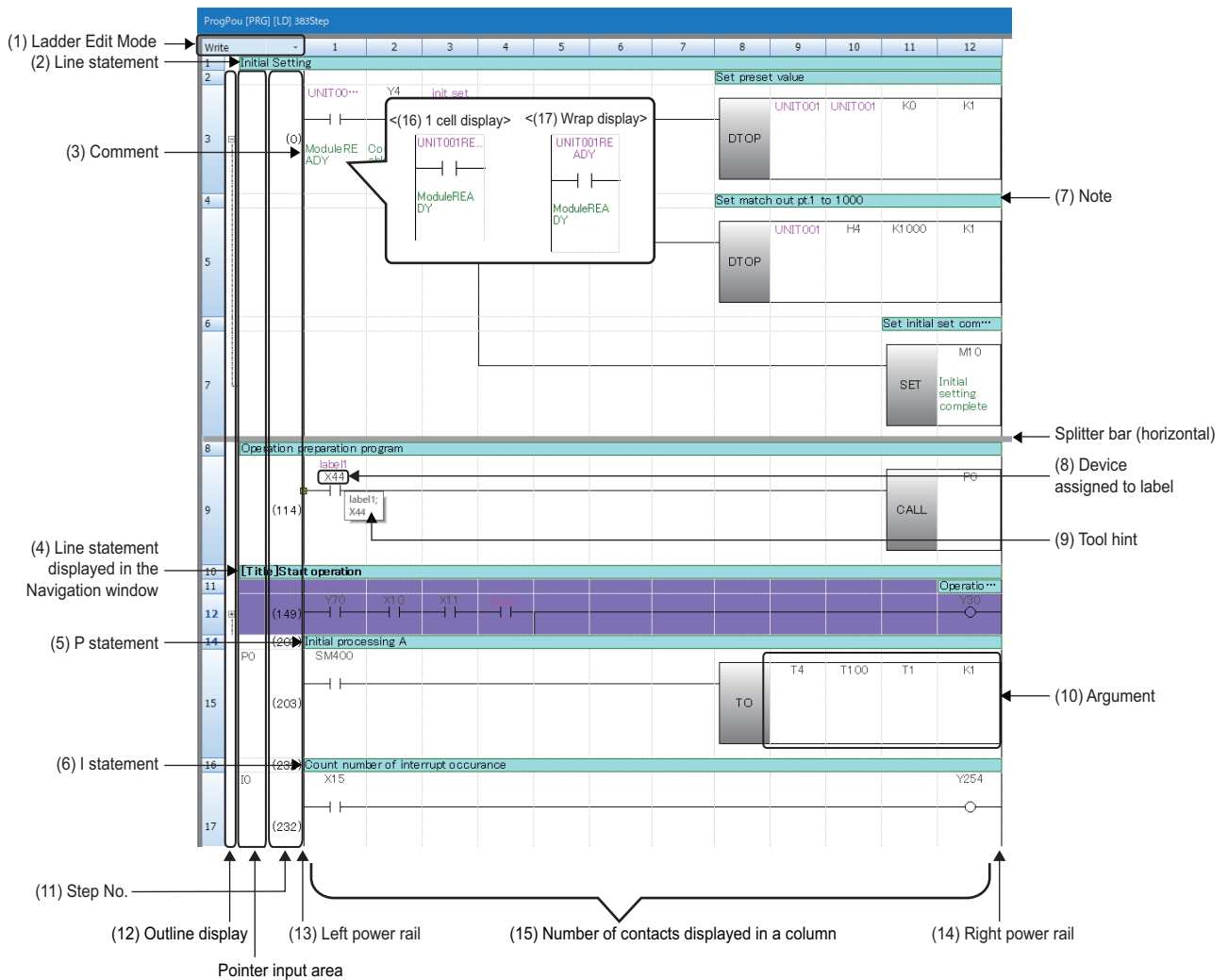

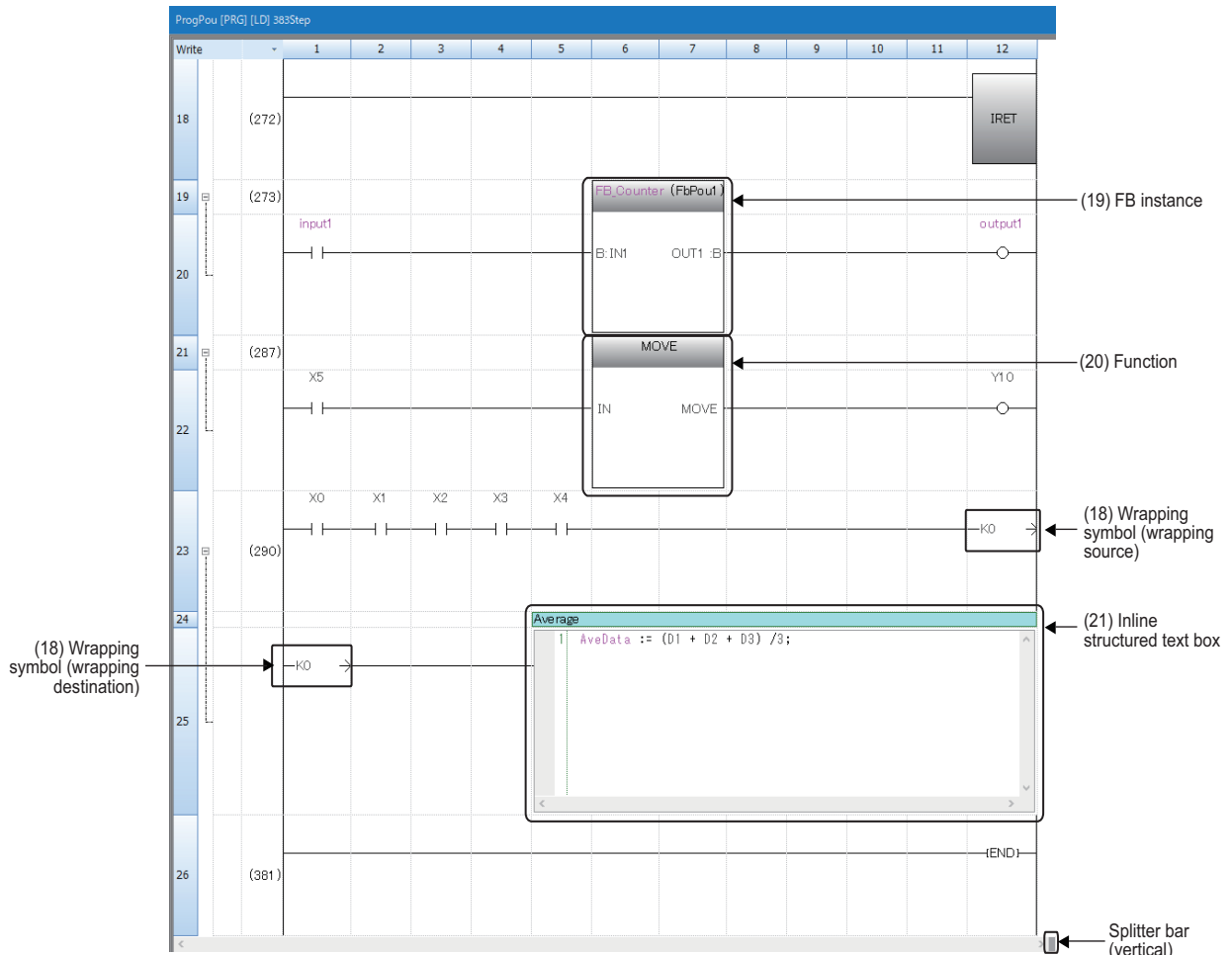
■ Ladder editor





### Displayed items

Item	Description	Related operation
(1) Ladder edit mode	An area that displays the ladder edit mode: Write, Read, Write Mntr (monitor write), or Read Mntr (monitor read)	<ul style="list-style-type: none"> <li>Switching mode</li> <li>Page 268 Switching the ladder edit mode (read/write/monitor read/monitor write)</li> </ul>
(2) Line statement	A comment that is appended to a ladder block	<ul style="list-style-type: none"> <li>Entering elements</li> <li>Page 284 Entering comments/statements/notes</li> </ul>
(3) Comment	A comment set to a device/label	<ul style="list-style-type: none"> <li>Show/Hide</li> </ul>
(4) Line statement displayed in the navigation window	A line statement that is displayed in the tree in the navigation window	<ul style="list-style-type: none"> <li>[View] ⇒ [Comment Display]/[Statement Display]/[Note Display]</li> </ul>
(5) P statement	A comment that is appended to a pointer number	<ul style="list-style-type: none"> <li>Hierarchy display setting for structure comments</li> </ul>
(6) I statement	A comment that is appended to an interrupt pointer number	<ul style="list-style-type: none"> <li>[Tool] ⇒ [Options] ⇒ "Other Editor" ⇒ "Label Editor Common" ⇒ "Display Setting" ⇒ "Hierarchy Display Setting for Structures Comment"</li> </ul>
(7) Note	A comment that is appended to a coil/application instruction in the program	<ul style="list-style-type: none"> <li>Label comments for a structure and its member can be displayed together by setting this option to "In Order of Instance -&gt; Member" or "In Order of Member -&gt; Instance."</li> </ul>
(8) Device assigned to label	<p>A device assigned to a label. Only labels displayed on a ladder editor can be edited, searched for and replaced.</p> <p>A device with any of the following conditions is not displayed.</p> <ul style="list-style-type: none"> <li>A device that is assigned by converting the program</li> <li>A device that is assigned to a label used for an array index</li> <li>A device that is assigned to a structure type label</li> </ul>	<ul style="list-style-type: none"> <li>Settings</li> <li>Page 227 Registering Labels</li> <li>Show/Hide</li> <li>[View] ⇒ [Display Device] (  )</li> </ul>
(9) Tool hint	The information on device/label where the mouse cursor is placed over is displayed	<ul style="list-style-type: none"> <li>Changing display contents</li> <li>[Tool] ⇒ [Options] ⇒ "Program Editor" ⇒ "Ladder Editor" ⇒ "Tool Hint"</li> </ul>
(10) Argument	A value or label name/device name to be operated	—

Item	Description	Related operation
(11) Step No.	The start Step No. of a ladder block	—
(12) Outline display	A symbol that indicates the status (collapse/expand) of a ladder block	<b>■Show/Hide</b> • [Tool] ⇒ [Options] ⇒ "Program Editor" ⇒ "Ladder Editor" ⇒ "Ladder Diagram" ⇒ "Display Format" • [View] ⇒ [Outline] ⇒ [Show/Hide of Outlines]
(13) Left power rail	The power rails of a ladder program	—
(14) Right power rail		
(15) Number of contacts displayed in a column	The maximum number of cells which are occupied with contacts, coils, and instructions. When the maximum number of contacts is exceeded, the line will be wrapped automatically.	<b>■Changing number of contacts</b> [Tool] ⇒ [Options] ⇒ "Program Editor" ⇒ "Ladder Editor" ⇒ "Ladder Diagram" ⇒ "Display Format"
(16) 1 cell display	The rest of a device/label name is omitted by ellipses "..." in order for the name to be fit in one cell.	<b>■Switching display</b> [View] ⇒ [Change Display Format of Device/Label Name] ⇒ [1 Cell Display]/[Wrapping Ladder Display]
(17) Wrap display	A long device/label name is wrapped to be fit in one cell. If the label name still cannot be displayed in one cell, the rest of the name is omitted by ellipsis "...".	
(18) Wrapping symbols	The wrapping symbols are displayed at wrapping source and wrapping destination. The same numbers (serial numbers) are assigned to the wrapping source symbol and the wrapping destination symbol that are created in pairs. Wrapping symbols cannot be connected to the output circuits of an FB instance or a function.	—
(19) FB instance	An entity of a function block used in a ladder program	<b>■Insertion</b>  Page 272 Inserting a function block
(20) Function	An entity of a function used in a ladder program	<b>■Insertion</b>  Page 279 Inserting a function
(21) Inline structured text box	An area where an ST program can be edited on a ladder editor	<b>■Insertion</b>  Page 281 Inserting an inline structured text box

### Point

Font color, background color, and font can be changed.

 Page 81 Checking and Changing Colors and Fonts

By using the following menu, the display magnification of a ladder editor is automatically adjusted according to the window width.

- [View] ⇒ [Zoom] ⇒ [Fit the editor width to the window width] 

By using the following menu or option, the character size is automatically adjusted according to the display magnification of a ladder editor.

- [View] ⇒ [Text Size] ⇒ [Autofit]
- [Tool] ⇒ [Options] ⇒ "Program Editor" ⇒ "Ladder Editor" ⇒ "Ladder Diagram" ⇒ "Display Format" ⇒ "Autofit Text Size"

By performing the following operation, the "Column Width" screen appears and a column width can be changed:

- Select and right-click a column, then select [Column Width] from the shortcut menu.

In addition, by setting the following option to "Set to Optimized Width," a column width can be adjusted to the optimal width according to the elements within the range displayed in an editor when double-clicking the column header border:

- [Tool] ⇒ [Options] ⇒ "Program Editor" ⇒ "Ladder Editor" ⇒ "Ladder Diagram" ⇒ "Edit Operation" ⇒ "Operation in adjusting column width by mouse"

## Splitting a ladder editor

The following show the procedures for splitting a ladder editor.

### ■Horizontal split

#### Operating procedure

Drag the splitter bar (horizontal) downward or double-click it.

In another way, use the following menu.

- Select [Window] ⇒ [Split].

### ■Vertical split

#### Operating procedure

Drag the splitter bar (vertical) to the left or double-click it.

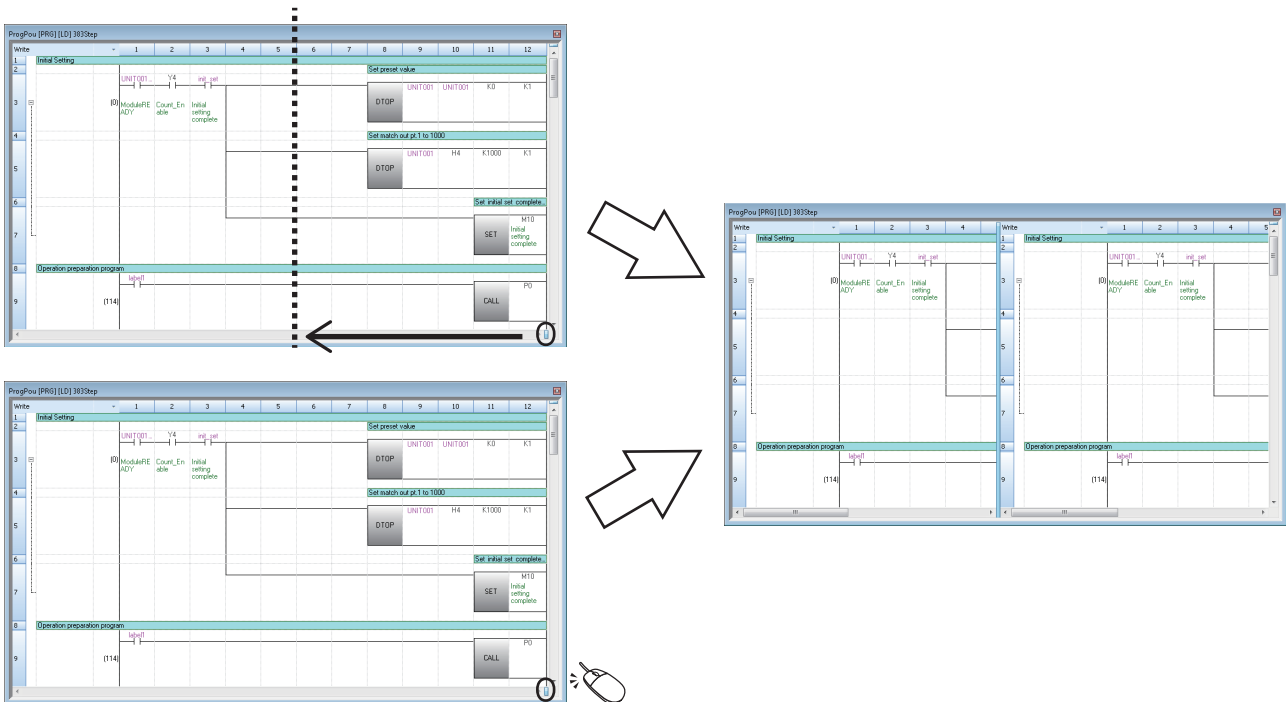

### Point

Since split ladder editors can be scrolled separately, programs which are described in different parts can be displayed at once.

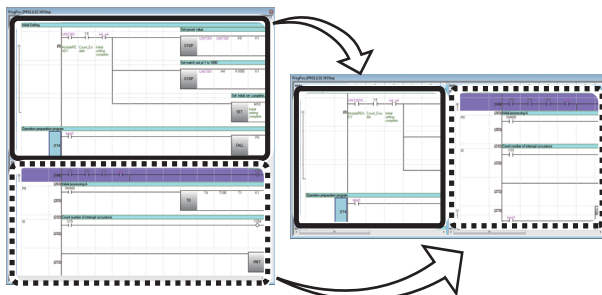

In addition, editors displayed vertically can synchronously be scrolled by using the following menu.

- [Window] ⇒ [Split Window Operation] ⇒ [Synchronous Scrolling in Side by Side]

## Switching the ladder edit mode (read/write/monitor read/monitor write)

The ladder edit mode of a ladder editor (including a Zoom) can be switched by selecting any of the following menus:

Menu	Editor where the mode switches
[Edit] ⇒ [Ladder Edit Mode]	
⇒ [Read Mode]	Active ladder editor
⇒ [Write Mode]	
⇒ [Read Mode (All Windows)] <sup>*1,*2</sup>	All open ladder editors
⇒ [Write Mode (All Windows)] <sup>*2</sup>	
⇒ [Read Mode (All Ladder Programs Elements)] <sup>*1</sup>	All ladder editors that exist in a project
⇒ [Write Mode (All Ladder Programs Elements)]	

\*1 If there is an unconverted program, the mode will be switched to the read mode while the program remains unconverted.

\*2 When the following option is set to "Open Single in Project" or "Open Single in Project," the mode of a Zoom which has been opened even once also switches.

"Program Editor" ⇒ "SFC Diagram Editor" ⇒ "Action/Transition" ⇒ "Display Format" ⇒ "Window Display Method"

### Point

- The mode can also be changed from the pull-down list for the ladder edit mode, which is in the upper left of a ladder editor.
- When "No" is selected in the following option, a ladder editor can be edited directly same as the write mode in the read mode.

[Tool] ⇒ [Options] ⇒ "Program Editor" ⇒ "Ladder Editor" ⇒ "Ladder Diagram" ⇒ "Edit Operation" ⇒ "Use the Switching Ladder Edit Mode (Read, Write, Monitor, Monitor (Write))"

## Precautions

### ■ Read mode/monitor read mode

The program cannot be edited directly when the mode is switched to the read mode or monitor read mode.

However, performing any of the following operations changes the programs.

- The name of source function block is changed or the function block is deleted.
- Input/output labels of source function block are changed and converted.
- Devices/labels are replaced in a batch by specifying the whole project with the replacement function.

To prohibit editing the program, use the security function.

### ■ Monitor write mode

By selecting the checkbox of the following item in the screen which appears when switching to the monitor write mode, whether a program between in GX Works3 and in a programmable controller match can be checked before actually switching the mode.

- Check the consistency between the editing target program file in GX Works3 and the one in PLC.

However, it cannot be checked during a simulation or when a project is logged on as a user whose access level is 'Users.'

(The checkbox of the above item cannot be selected.)

# Entering ladders

This section explains the entering method of a ladder.

For details of ladder symbols, refer to the following:

📖 MELSEC iQ-R Programming Manual (Program Design)

📖 MELSEC iQ-F FX5 Programming Manual (Program Design)

## Inserting contacts, coils, instructions, arguments

### Operating procedure

#### ■ Inserting from the element entry dialog

1. Select a cell to add or edit an element, then double-click it or press the **Enter** key.

For the "Insert mode" (press the **Insert** key to switch to the Overwrite mode), instructions are inserted on the cursor position. Therefore, if an instruction is already inserted in the selected cell, the existing instruction will be moved back.

2. Enter an instruction and argument in the element entry dialog.

#### Point

The following operations are possible in the element entry dialog.

- Moving the cursor on a ladder editor by pressing the **Ctrl** + **←** / **→** / **↑** / **↓** keys
- Selecting an instruction/argument in the dialog by pressing the **Alt** + **←** / **→** keys.
- Displaying options of instructions/labels by pressing the **Ctrl** + **Space** keys.

In addition, by selecting "Yes" for the following option, when entering the description of a device comment, label comment, or instruction, ones for which the data has been set can be displayed as options.

- [Tool] ⇒ [Options] ⇒ "Edit" ⇒ "Instruction/Device/Label Candidacy Display" ⇒ "Candidate Display Setting" ⇒ "Display the Corresponding Device in Entering Device Comment"

#### ■ Inserting from the "Enter Ladder" screen with description

1. Click the [Extd Dspl] button in the element entry dialog.

2. Select an instruction and enter an argument in the "Enter Ladder" screen.

#### Point

A frequently used instruction can be added as a favorite in the "Enter Ladder" screen.

To add an instruction as a favorite, select and right-click the instruction, then select [Add to Favorites] from the shortcut menu.

Instructions added as favorites can be checked by selecting "Favorites" that is at the bottom of the pull-down list of "List."

#### ■ Inserting from the menu or on the toolbar

1. Select a cell to add an element in a ladder editor.

2. Select [Edit] ⇒ [Ladder Symbol] ⇒ [(element)]. Alternatively, select the ladder symbol icon on the toolbar.

#### ■ Inserting from the element selection window

1. Drag and drop a contact, coil, or instruction displayed in the element selection window onto a ladder editor.

2. Edit the argument of each element.

#### ■ Editing arguments directly

Select a cell where an argument is entered, and press the **F2** key.

## ■Displaying a global label entered by using an assigned device

By entering a device which was assigned as a global label to a program, the global label of the device can be displayed in the program.

Note that, only global labels whose data type is the simple type with no array can be displayed.

Enter an assigned device after changing the entering method by one of the following option, then the global label is displayed.

- [Edit] ⇒ [Edit Mode] ⇒ [Use Assigned Device for Label Input] (🔍)
- [Tool] ⇒ [Options] ⇒ "Program Editor" ⇒ "Common Item" ⇒ "Enter Element" ⇒ "Operational Setting" ⇒ "Use assigned device for label input"

### Point

When inserting an instruction without entering an argument, '?' is set automatically. ('?' can be entered as an argument.)

Arguments can also be entered later.

## ■Increment/decrement of device number and label number

By pressing the [Alt] + [↑] / [↓] keys, a device number or a label number can be incremented (+1) or decremented (-1.)

The target to increment (+1) or decrement (-1) can be changed by setting the following option.

- [Tool] ⇒ [Options] ⇒ "Program Editor" ⇒ "Ladder Editor" ⇒ "Ladder Diagram" ⇒ "Edit Operation" ⇒ "Target Device No./Label Name to Increment"

By changing the target for increment or decrement, device names and label names are changed as follows.

Target	Device number (example)	Label name (example)
Device/Array Element	X0Z0→X1Z0	bLabel_1[0,0]→bLabel_1[0,1]
Device/Label Name	X0Z0→X1Z0	bLabel_1[0,0]→bLabel_2[0,0]
Index Modification/Array Element	X0Z0→X0Z1	bLabel_1[0,0]→bLabel_1[0,1]
Index Modification/Label Name	X0Z0→X0Z1	bLabel_1[0,0]→bLabel_2[0,0]

## ■Switching methods for contacts/instructions

Select a contact/instruction to be switched, and select [Edit] ⇒ [Easy Edit] ⇒ [Switch Ladder Symbol Invert]/[Switch Pulse/Switch SET and RST Instruction] or follow the methods shown below.

Switching contacts and instructions	Shortcut key	Pull-down list
Switching open/close contact, raising/falling pulse		<p>Select a symbol from the pull-down list displayed when clicking the blue triangle at the bottom left in the cell.*1</p>
Switching operation result rising/falling pulse		
Switching SET/RST instructions		

\*1 Whether to enable or disable the ladder editing by mouse operation can be switched by setting the following option.

[Tool] ⇒ [Options] ⇒ "Program Editor" ⇒ "Ladder Editor" ⇒ "Ladder Diagram" ⇒ "Edit Operation" ⇒ "Enable the ladder editing by mouse operation"



## Drawing a line

A line can be drawn in the program by the operations shown in the table below.

If a line has already been drawn, the line will be deleted.

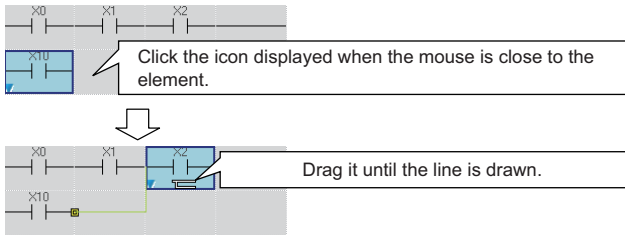
Operation	Drawing a line
Drag and drop <sup>*1</sup>	
Keyboard	<p><b>Ctrl</b> + <b>←</b> / <b>→</b> / <b>↑</b> / <b>↓</b> keys</p> <p>Press the <b>Ctrl</b> + <b>Shift</b> + <b>←</b> / <b>→</b> keys to enter horizontal lines consecutively from a cursor position to the next contact/coil/line connection point.</p>

\*1 Whether to enable or disable the ladder editing by mouse operation can be switched by setting the following option.  
 [Tool] ⇒ [Options] ⇒ "Program Editor" ⇒ "Ladder Editor" ⇒ "Ladder Diagram" ⇒ "Edit Operation" ⇒ "Enable the ladder editing by mouse operation"

## Inserting a function block

The following shows the procedure for pasting a function block as an element, naming its FB instance name, and inserting it into a sequence program.

For the creation method of a program in a function block, refer to the following:

☞ Page 484 Creating a Function Block

### Operating procedure

1. Drag a function block element in the navigation window or element selection window and drop it onto any cell in the sequence program.
2. Select the local label or global label from the pull-down list in the "FB Instance Name" screen, and enter an FB instance name\*1.

When the function block is pasted, the FB instance name is automatically registered as a label in the selected label setting screen.

3. Connect the input and output to the FB instance.

\*1 If the definition name of the function block includes any of the following symbols, the symbol is replaced with an underscore (\_): plus sign (+), minus sign (-), exclamation mark (!), left round bracket ((), right round bracket()), or backquote (`).

### Point

- A function block can also be inserted by entering its FB instance name in the element entry dialog.
- By entering 'fb.' in the element entry dialog, options of function block elements or FB instances are displayed.
- To insert a function block between two consecutive FB instances, select [Edit] ⇒ [Insert Row] above the second FB instance first, and then insert the function block on the inserted row.

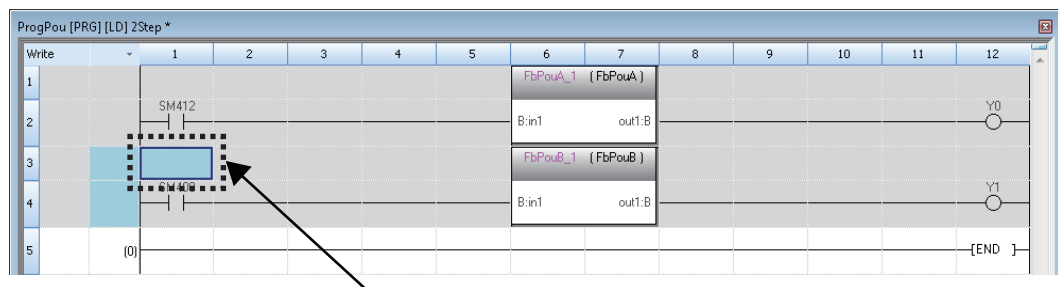

Place the cursor in the row on which the second FB instance exists, and insert a row.

- To insert a row above an FB instance, select the cell of a row where the FB instance name is displayed, and select [Edit] ⇒ [Insert Row].

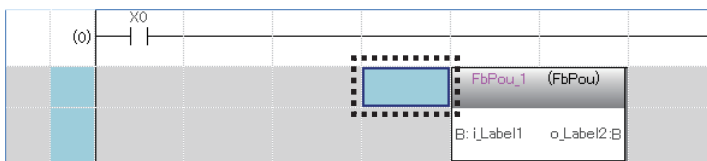

- To insert a row above an FB instance that is connected to an input argument or output argument whose data type is other than BOOL, change the data type of the argument to BOOL and insert a row, then change the data type to the original one.
- By selecting "Yes" for the following option, a column width is automatically adjusted so that the text of an input/output label (argument) does not get cut when inserting a function block:
  - [Tool] ⇒ [Options] ⇒ "Program Editor" ⇒ "Ladder Editor" ⇒ "FB/FUN" ⇒ "Operational Setting" ⇒ "Automatically adjust column width in creating"
- By selecting "Yes" for the following option, the "FB Instance Name" screen appears when pasting a function block:
  - [Tool] ⇒ [Options] ⇒ "Program Editor" ⇒ "Ladder Editor" ⇒ "FB/FUN" ⇒ "Operational Setting" ⇒ "Show FB Instance Name Window in Pasting Ladder"

## Precautions

Pasting a function block to a sequence program causes the file size to increase.

Pasting the same function blocks to one sequence program repeatedly also causes the size increase of the sequence program in accordance with the number of pasted function blocks.

### ■Display of an FB instance

The following shows the contents displayed in the pasted FB instance.

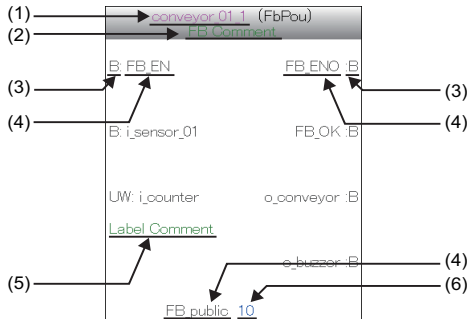

- (1): FB instance name
- (2): Label comment of an FB instance or title of a function block
- (3): Data type of an input/output variable
- (4): Label name of an input/output variable
- (5): Label comment of an input/output variable
- (6): Initial value of an input/output variable

Each data type is displayed as follows:

Data type	
B	Bit
UW	Word [Unsigned]/Bit String [16-bit]
UD	Double Word [Unsigned]/Bit String [32-bit]
W	Word [Signed]
D	Double Word [Signed]
E	FLOAT [Single Precision]
L	FLOAT [Double Precision]
TM	Time
S	String
US	String [Unicode]
DUT	Structure

## Precautions

- The initial values set in a label editor when creating an FB program are displayed. The initial values set to each FB instance are not displayed.
- When both a label comment of an FB instance and a title of a function block are set, the label comment is displayed.

### ■Changing an FB instance name

#### Operating procedure

1. Select an FB instance.
2. Select [Edit] ⇒ [Edit FB Instance].
3. Enter a new FB instance name.

#### Point

In another way, FB instance names can be changed by any of the following operation.

- Press the **[F2]** key with an FB instance being selected.
- Double-click an FB instance name.

## ■ Replacing an FB instance

### Operating procedure

1. Select an FB instance.
2. Select [Edit] ⇒ [Change FB/FUN Data], or press the  key.
3. Scroll the displayed screen and select the function block to be replaced, and click the [OK] button.

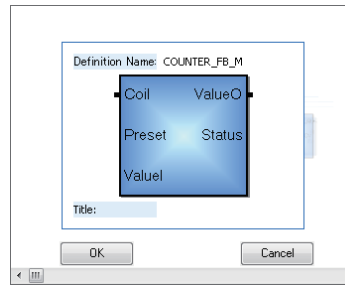

## ■ Creating input and output circuit parts of an FB instance

The following shows the method for creating the input circuits (1) and output circuits (2) of an FB instance pasted to a sequence program.

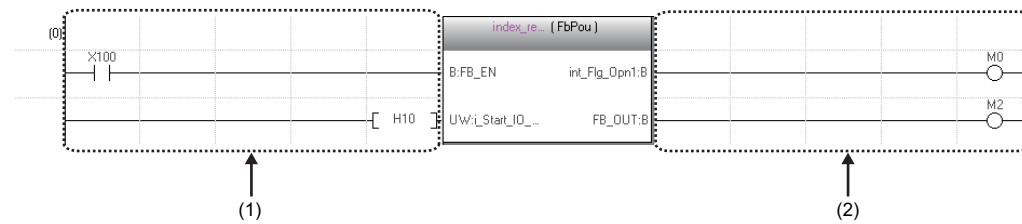

The number of cells occupied by input circuits or output circuits of an FB instance differs depending on the setting of the following option.

- [Tool] ⇒ [Options] ⇒ "Program Editor" ⇒ "Ladder Editor" ⇒ "Ladder Diagram" ⇒ "Display Format" ⇒ "Display Connection of Ladder Diagram"

Setting of the number of displayed contacts	Number of cells in input circuit	Number of cells in output circuit
9 contacts	4 cells	4 cells
11 contacts	5 cells	5 cells
13 contacts	6 cells	6 cells
17 contacts	8 cells	8 cells
21 contacts	10 cells	10 cells
33 contacts	16 cells	16 cells
45 contacts	22 cells	22 cells

Instructions that exceed the number of cells occupied by input circuits or output circuits cannot be entered.

When instructions cannot be placed by changing the number of displayed contacts, the ladder block may not be displayed properly.

## Operating procedure

1. Select [Convert] ⇒ [Convert] (  ).

The ladder block is converted, and lines are connected to the input and output labels of the FB instance.

2. Edit the input circuits.

Enter an element to the input circuit in the same manner as creating normal ladder programs. Create a program in accordance with the data type of input variable.

3. Enter elements to the output circuit in the same manner as the input circuit.

Edit the program other than function blocks as well. After complete editing, convert the program.

### Point

A parallel circuit can be created in an input circuit on an FB instance.

To add an element between a parallel circuits, select a cell under the second row in the input circuit as shown below, and select [Edit] ⇒ [Insert Row] to enter an element in the added row.

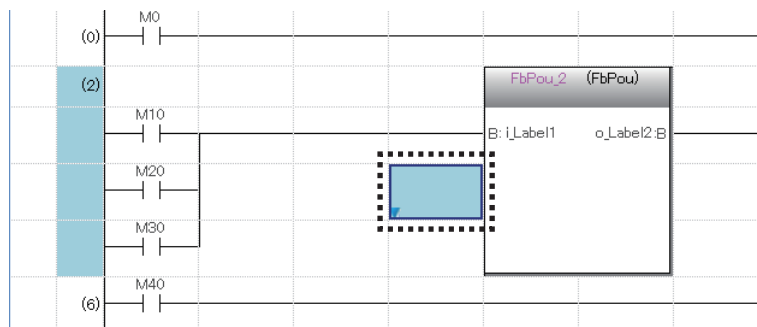

## ■Function block whose definition is unclear

Once the definition of a function block is deleted or changed, the function block is used as one whose definition is unclear and an error occurs when it is converted. The following shows a display example of a function block whose definition is unclear.

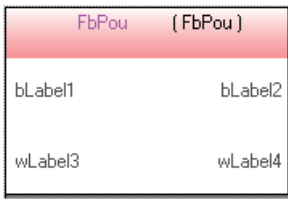

When the definition of a function block is changed, select the function block, then select [Edit] ⇒ [Update FB/FUN] and update the definition information.

When the definition of a function block does not exist, select the function block, then select [Edit] ⇒ [Change FB/FUN Data] and change the data.

## ■Considerations for using function block

- A single function block can be pasted to a single ladder block.
- The output of an FB instance cannot be directly connected to the input of another FB instance.

To connect function blocks, use a coil to initially receive the output of a single function block, and then connect the contact of the coil to the input of the other function block.

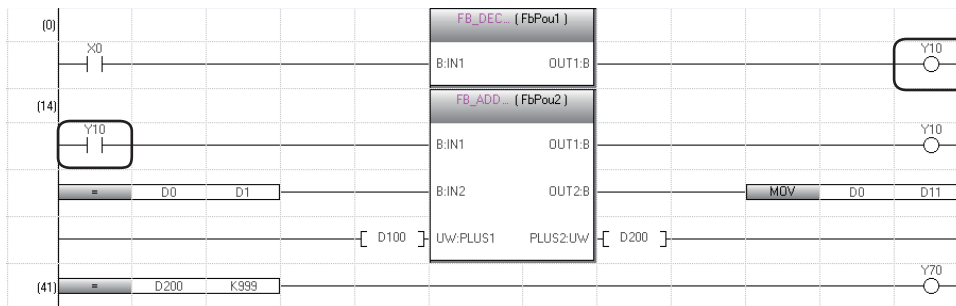

- When the label settings of a function block is changed, convert the program or all programs.

## ■ Considerations for using function block that the class of label is "VAR\_IN\_OUT"

- If the version of GX Works3 is 1.011M or earlier, use the same device/label for both the input and output which are connected to a "VAR\_IN\_OUT" class label; otherwise, the program does not operate properly.

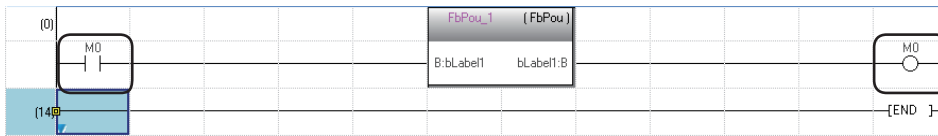

- If a project includes a function block that satisfies all the following conditions and if all programs in the project are converted in two different versions of GX Works3 (version 1.011M or earlier and version 1.015R or later), the verification result between the two converted projects will be mismatched. In that case, convert all programs using the same version of GX Works3.
  - The function block is of a subroutine type.
  - Different devices/labels are used for the input and output connected to a "VAR\_IN\_OUT" label.
- For GX Works3 version 1.015R or later, a conversion error occurs when one or more instructions or coils are set to the left side of "VAR\_IN\_OUT" of a function block.

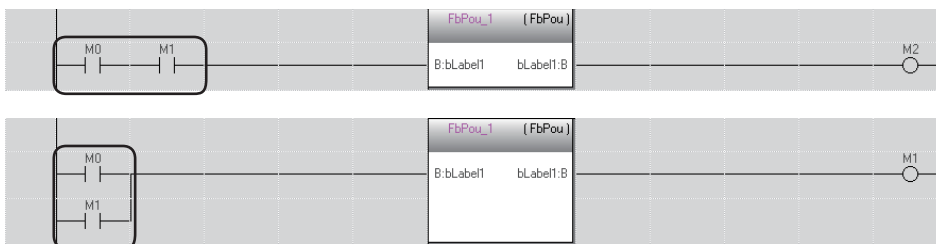

### ■Consideration when an FB instance is connected directly to the left power rail

In the input circuit of an FB instance, if an EN or input variable (bit type) is directly connected to the left power rail, the ON/OFF state will not be changed.

To change the ON/OFF status of an EN and input variable (bit type), use a contact or an instruction equivalent to a contact.

### ■Displaying/setting FB properties

FB properties can be displayed and set in the "FB Property" window.

For details, refer to the following:

 Page 375 Display/setting an FB property

### ■FB property management (offline)

Initial values of FB properties saved in a project can be exported to a CSV file in the "FB Property Management (Offline)" screen. In addition, the initial values of FB properties can be imported from the CSV file, and the values can be applied to the initial values of FB properties in the project.

For details, refer to the following:

 Page 397 FB property management (offline)



## Inserting a function

The following shows the procedure for inserting a function in a ladder program.

For the creation method of a function, refer to the following:

☞ Page 504 Creating a Function

### Operating procedure

1. Drag a function element in the navigation window or element selection window and drop it onto any cell in the sequence program.
2. Connect an input and an output to the function.

#### Point

- By entering 'fun.' in the element entry dialog, the options of function elements are displayed. A function element can be entered by selecting it from the options.
- To insert a row above a function, select the cell of a row where the function name is displayed, and select [Edit] ⇒ [Insert Row].

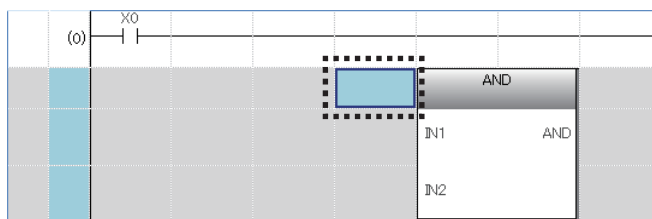

- To insert a row above a function that is connected to an input argument or output argument whose data type is other than BOOL, change the data type of the argument to BOOL and insert a row, then change the data type to the original one.
- By selecting "Yes" for the following option, a column width is automatically adjusted so that the text of an input/output label (argument) does not get cut when inserting a function:  
· [Tool] ⇒ [Options] ⇒ "Program Editor" ⇒ "Ladder Editor" ⇒ "FB/FUN" ⇒ "Operational Setting" ⇒ "Automatically adjust column width in creating"

### ■ Adding/deleting arguments

Only for a function of which the number of arguments can be changed, an argument can be added/deleted.

### Operating procedure

1. Move the cursor on a function.
2. Select [Edit] ⇒ [I/O Argument] ⇒ [Increment Argument] (➕)/[Delete Argument] (➖).

## ■ Replacing functions

### Operating procedure

1. Move the cursor on a function.
2. Select [Edit] ⇒ [Change FB/FUN Data].
3. Scroll the screen and select the function block to be replaced, and click the [OK] button.

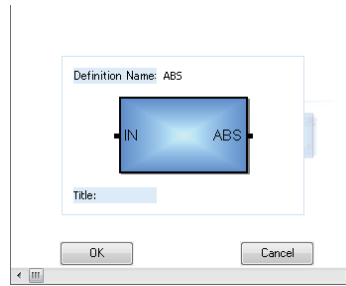

### ■ Function whose definition is unclear

Once the definition of a function is deleted or changed, the function is used as one whose definition is unclear and an error occurs when it is converted. The following shows a display example of a function whose definition is unclear.

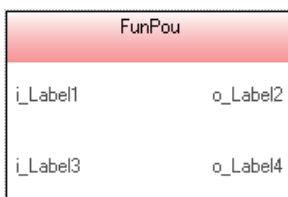

When the definition of a function is changed, select the function, then select [Edit] ⇒ [Update FB/FUN] and update the definition information.

When the definition of a function does not exist, select the function, then select [Edit] ⇒ [Change FB/FUN Data] and change the data.

## Inserting an inline structured text box

Inline structured text is a function to edit or monitor an ST program by creating an inline structured text box, which displays an ST program, at the coil instruction area in a ladder editor.

With this function, a numeric value operation or a character string process can be created easily in the ladder program.

Note that this function cannot be used in a safety program and a safety FB/FUN.

In this manual, the ST program in an inline structured text box is referred to as an 'inline structured text program.'

Up to 20,000 characters can be entered in an inline structured text program. (A line feed is counted as two characters.)

### Operating procedure

Select [Edit] ⇒ [Inline Structured Text] ⇒ [Insert Inline Structured Text Box] (  ).

The editing method of the inline structured text program is the same as that of ST program. (  Page 312 Entering programs)

#### Point

- Enter 'STB' on the element entry dialog to insert an inline structured text box.
- When inserting an inline structured text box as a parallel circuit, draw lines for the parallel circuit first, and then insert an inline structured text box.

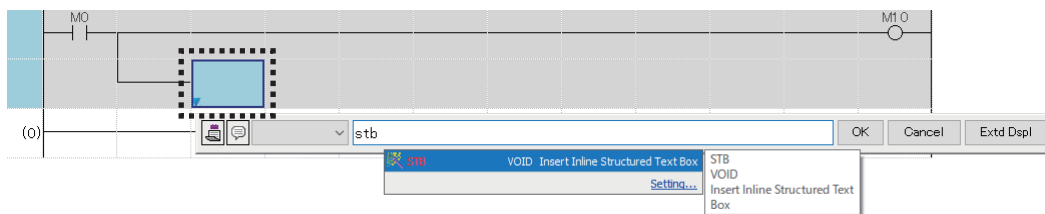

### Precautions

- Of the FB instance, function, and inline structured text box, only one can be placed in a single row.
- An inline structured text box cannot be connected to the input and output circuit parts of an FB instance or a function.
- The label of which data type is pointer cannot be used in the inline structured text program.
- When a row including an inline structured text box is deleted, the whole ladder block is deleted.
- When inserting an inline structured text box in a wrapping destination ladder, a jump destination of an error message may be the top of a ladder block if a conversion error occurs in inline structured text.

### ■ Instructions which do not run properly in an inline structured text program

The following instructions may not run properly in an inline structured text program.

Instruction	
Contact instruction	LDP, LDF, ANDP, ANDF, ORP, ORF, LDPI, LDFI, ANDPI, ANDFI, ORPI, ORFI
Association instruction	MEP, MEF, EGP, EGF
Output instruction	OUT, OUTH, SET F, RST F, PLS, PLF, FF
Instruction with 'P'	□P (such as INCP and MOV P), SP.□, ZP.□, GP.□, JP.□, DP.□, MP.□
Other instructions	UDCNT1, UDCNT2, TTMR, STMR, RAMPQ, SPD, PLSY, PWM, MTR, SORTD(_U), DSORTD(_U), LEDR, DUTY, LOGTRG, LOGTRGR, TIMCHK, HOURM, DHOURM, PID, XCALL, SCJ

## ■ Changing the number of rows to display

The height of an inline structured text box depends on the number of rows to display.

The following shows the procedure to change the number of rows to display.

### Operating procedure

1. Select an inline structured text box or a row including the inline structured text box. (Multiple selections allowed.)
2. Select [View] ⇒ [Height Setting of Inline Structured Text].  
The "Height Setting of Inline Structured Text" screen appears.
3. Set each item and click the [OK] button.

### Point

- By selecting "Yes" for the following option, the height of an inline structured text box is automatically adjusted for each line feed.  
· [Tool] ⇒ [Options] ⇒ "Program Editor" ⇒ "Ladder Editor" ⇒ "Inline Structured Text" ⇒ "Operational Setting" ⇒ "Automatically Adjust Inline Structured Text Height"
- The "Height Setting of Inline Structured Text" screen appears also by selecting [Height Setting of Inline Structured Text] from the shortcut menu after right-clicking on an inline structured text box or a ladder editor.

### Precautions

- Once the number of rows to display in an inline structured text box is changed, the following menu is not available to turn the number back to the previous setting:  
· [Edit] ⇒ [Undo]/[Redo]  
Use the "Height Setting of Inline Structured Text" screen to change it.
- The number of rows to display may not be changed if the cell height of the contact of an inline structured text is taller than the one of the inline structured text box.

### Ex.

The following lists examples of option settings which affect the cell height of a contact:

- [Tool] ⇒ [Options] ⇒ "Program Editor" ⇒ "Ladder Editor" ⇒ "Comment" ⇒ "Display Format" ⇒ "Row"
- [Tool] ⇒ [Options] ⇒ "Program Editor" ⇒ "Ladder Editor" ⇒ "Ladder Diagram" ⇒ "Display Format" ⇒ "Number of Wrapping Rows for Device/Label Name"
- [Tool] ⇒ [Options] ⇒ "Monitor" ⇒ "Ladder Editor" ⇒ "Display Setting" ⇒ "Display Lines for Monitoring Current Value"

## Pasting from each screen

A device/label can be pasted by dragging and dropping its name from each screen such as a label editor, "Label Comment" window, and device comment editor.

By dragging and dropping a device/label onto a blank cell, a contact is inserted automatically and its device/label name is displayed.

When dropping onto the right end of the cell, a coil is inserted automatically and its device/label name is displayed.

Additionally, a device/label can be pasted by dragging and dropping onto the argument of an instruction.

## Registering an undefined label

When entering an undefined label, the "Undefined Label Registration" screen appears and the label can be registered in a label editor. (☞ Page 247 Registering an undefined label)

## Checking the duplicated coils

When entering a coil in a program, whether coils are duplicated in the same program can be checked.

Whether to check the duplication can be set by setting the following option.

- [Tool] ⇨ [Options] ⇨ "Program Editor" ⇨ "Ladder Editor" ⇨ "Enter Ladder" ⇨ "Operational Setting"

For the check target instructions/devices of duplicated coils, refer to the following:

☞ Page 418 Target of duplicated coil check

## Displaying MC/MCR instructions

When the MC instruction is inserted to a ladder program, the double-line symbol is displayed on the left vertical line. As for MCR instruction, the left vertical line is delimited.

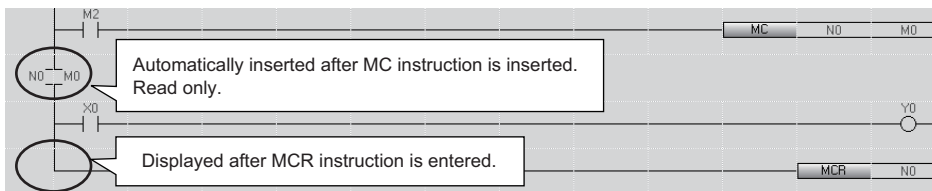

# Entering comments/statements/notes

This section explains the basic operations for editing comments, statements, and notes.

## Entering/editing comments







A device/label comment can be entered and edited by the methods shown in the table below.

The display status of the comments can be switched in the following menu:

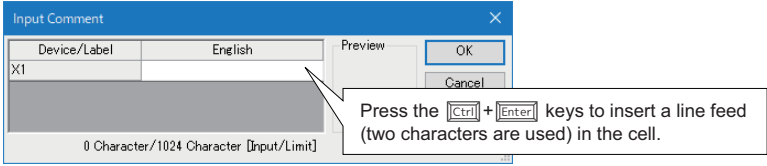
- [View] ⇒ [Comment Display]/[Comment/Statement/Note Batch Display]

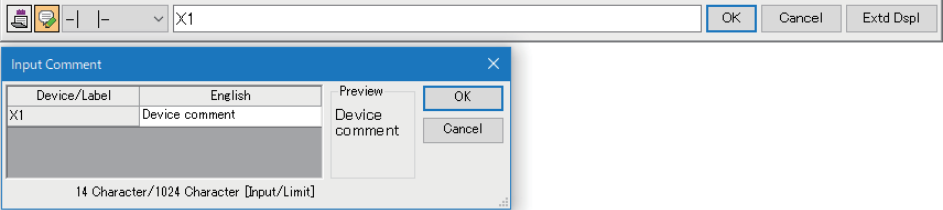
The device comments edited or added on a ladder editor are applied to the device comments set to the following option.

- [Tool] ⇒ [Options] ⇒ "Project" ⇒ "Device Comment Reference/Reflection Target"

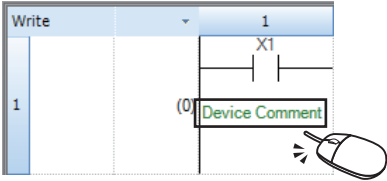
Entering/editing method	Operating procedure
<p>In the "Input Device Comment" screen</p>	<ol style="list-style-type: none"> <li>1. Select [Edit] ⇒ [Documentation] ⇒ [Edit Device/Label Comment] (  ).</li> <li>2. Select the cell and press the <b>[Enter]</b> key or double-click it.</li> <li>3. Enter a comment in the "Comment" column.</li> </ol>  <p>After entering comments is completed, select [Edit] ⇒ [Documentation] ⇒ [Edit Device/Label Comment] (  ) again.</p>
<p>On the element entry dialog</p>	<ol style="list-style-type: none"> <li>1. Select a cell and press the <b>[Enter]</b> key.</li> <li>2. Click  on the element entry dialog and click the [OK] button.</li> <li>3. Enter the comment to "Comment" column.</li> </ol> 
<p>With the keyboard</p>	<ol style="list-style-type: none"> <li>1. Display the comments.</li> <li>2. Select the cell and press the <b>[F2]</b> key twice.</li> <li>3. Enter a comment directly.</li> </ol>
<p>From each editor</p>	<ul style="list-style-type: none"> <li>• Label editor:  Page 227 Configuration of a label editor</li> <li>• "Label Comment" window:  Page 243 Setting a label comment</li> <li>• Device comment editor:  Page 404 Creating device comments</li> </ul>
<p>With the mouse</p>	<ol style="list-style-type: none"> <li>1. Double-click a comment.</li> <li>2. Enter the comment directly.</li> </ol> 

## Entering/editing statements

Add a comment to a ladder block using the statement (line statement, P statement, or I statement) in order to make the processing flow easy to understand.

The display status of the statements can be switched in the following menu:

- [View] ⇒ [Statement Display]/[Comment/Statement/Note Batch Display]

For details on the statements, refer to the following:

📖 MELSEC iQ-R Programming Manual (Program Design)

📖 MELSEC iQ-F FX5 Programming Manual (Program Design)

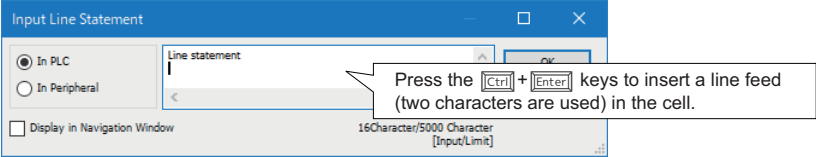
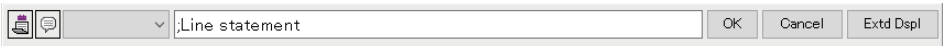
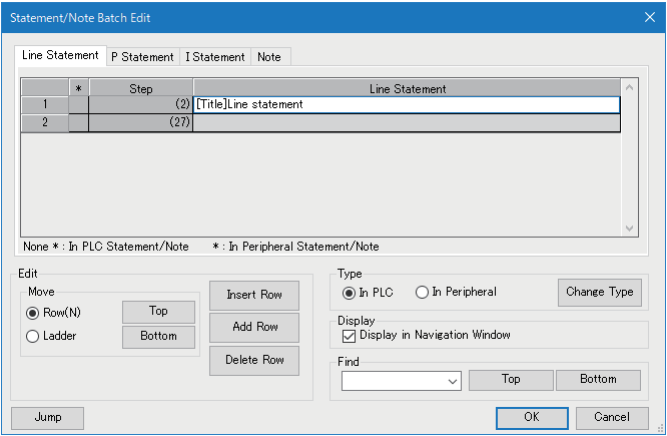
Entering/editing method	Operating procedure
In the Enter Statement screen	<ol style="list-style-type: none"> <li>1. Select [Edit] ⇒ [Documentation] ⇒ [Edit Statement] (🔗).</li> <li>2. Select the cell and press the <b>[Enter]</b> key or double-click it.</li> <li>3. Enter a statement.</li> </ol> <p>Before entering P statement/I statement, select the cell of a pointer number or interrupt pointer number.</p>  <p>When "Display in Navigation Window" is selected, "[Title]" is added in front of the line statement. After entering statements is completed, select [Edit] ⇒ [Documentation] ⇒ [Edit Statement] (🔗) again.</p>
On the element entry dialog	<ol style="list-style-type: none"> <li>1. Select a cell and press the <b>[Enter]</b> key.</li> <li>2. Enter a statement after entering ';' for 'In PLC' and ';*' for 'In Peripheral.'</li> </ol> <p>When displaying a statement in the navigation window, enter [Title] after ';' or ';*'. For P statement/I statement, enter a statement following the entry of the displayed pointer number or interrupt pointer number.</p> 
In the "Statement/Note Batch Edit" screen	<ol style="list-style-type: none"> <li>1. Select [Edit] ⇒ [Documentation] ⇒ [Statement/Note Batch Edit] (🔗).</li> <li>2. Enter a statement.</li> </ol>  <p>[Insert Row] button: Inserts a row above the cursor position. [Add Row] button: Inserts a row below the cursor position.</p>
With the keyboard	<ol style="list-style-type: none"> <li>1. Select the cell of a statement, and press the <b>[F2]</b> key.</li> <li>2. Enter a statement directly.</li> </ol>

## Precautions

';' cannot be prefixed to a line statement.

## ■Editing statements

After editing a statement, the same as when a ladder program is edited, the program will be in unconverted state.

If any statement is edited in an FB program body or FUN program body, a program part where the edited function block or function is used may also be in unconverted state.

For details on the conversion of a function block or function, refer to the following:

☞ Page 487 Converting function blocks

☞ Page 505 Converting functions

## ■Displaying a list

Line statements used in a ladder program are displayed in a list format.

The cursor jumps from the list to a location where the selected line statement is used.

Only line statements inserted automatically with temporary ladder change can be displayed.

For details on temporary ladder change, refer to the following:

☞ Page 293 Changing ladder blocks temporarily

## Window

Select [Find/Replace] ⇨ [Line Statement List] (☞).

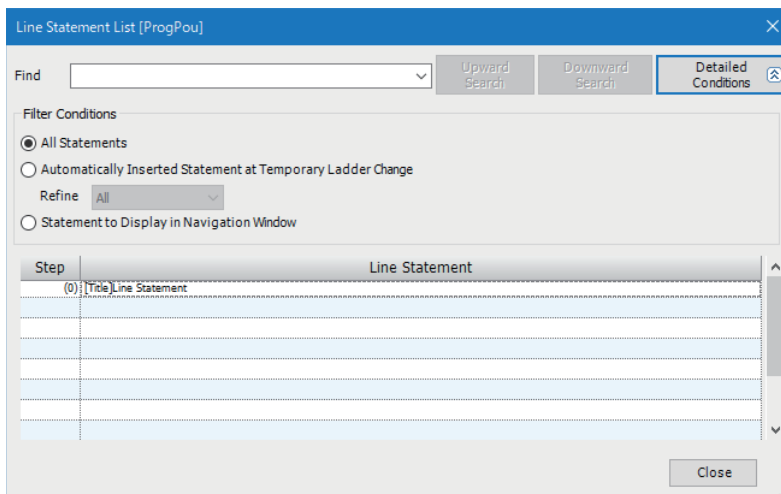



## ■Line statement to be displayed in the navigation window

It can be switched to show or hide a line statement in the navigation window by specifying the line statement and selecting [Edit] ⇒ [Documentation] ⇒ [Hide of Navigation Window].

By double-clicking a line statement in the navigation window, only corresponding ladder blocks can be displayed.

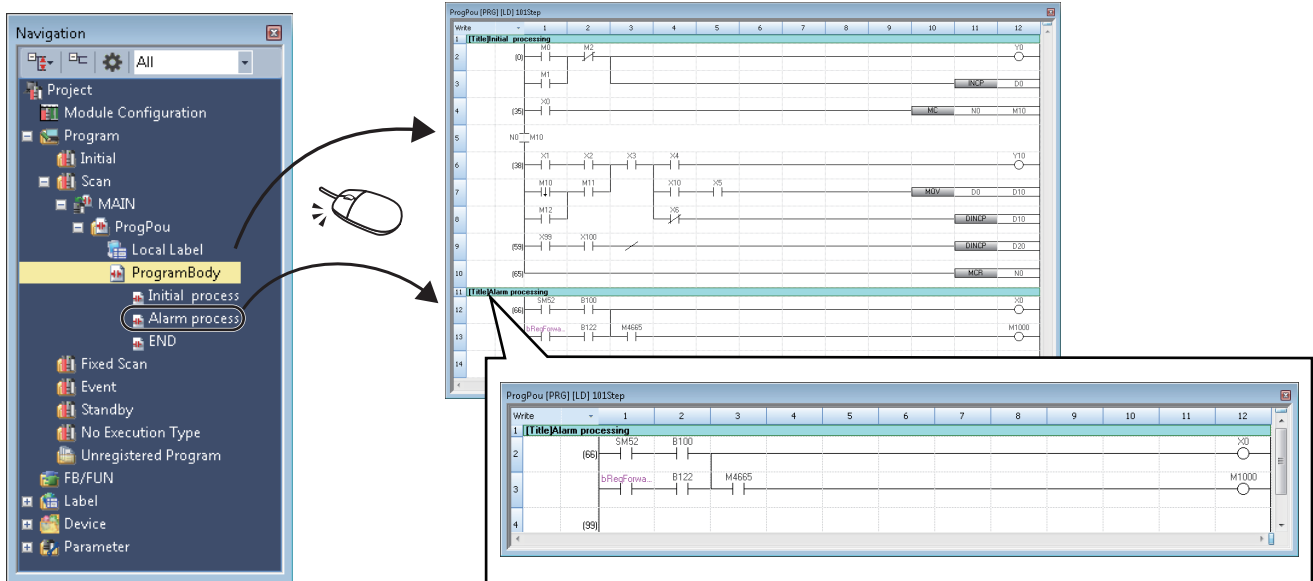

## Precautions

By double-clicking a line statement in the navigation window when all of the following conditions are satisfied, the cursor jumps to the head of the corresponding block while displaying the whole program.

(Displaying only corresponding ladder blocks is not applicable.)

- A ladder editor is vertically split into two screens.
- The menu [Window] ⇒ [Split Window Operation] ⇒ [Synchronous Scrolling in Side by Side] is not selected.

When copying or deleting a line statement displayed in the navigation window, the ladder blocks between the selected line statement and the next statement are copied or deleted.

## Entering/editing notes

Append a comment to coils/application instructions using Note in the program in order to make it easier to understand the content of program.

The display status of the notes can be switched in the following menu:

- [View] ⇒ [Note Display]/[Comment/Statement/Note Batch Display]

For details on the notes, refer to the following:

📖 MELSEC iQ-R Programming Manual (Program Design)

📖 MELSEC iQ-F FX5 Programming Manual (Program Design)

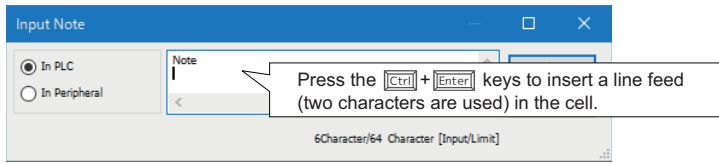
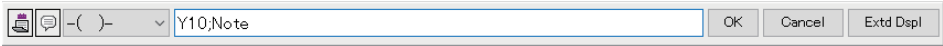
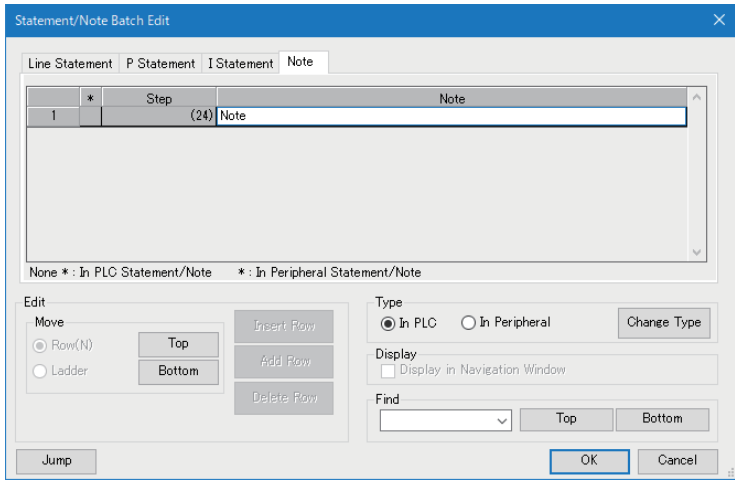
Entering/editing method	Operating procedure
In the "Enter Note" screen	<ol style="list-style-type: none"> <li>1. Select [Edit] ⇒ [Documentation] ⇒ [Edit Note] (📝).</li> <li>2. Select the cell and press the <b>[Enter]</b> key or double-click it.</li> <li>3. Enter a note.</li> </ol>  <p>After entering notes is completed, select [Edit] ⇒ [Documentation] ⇒ [Edit Note] (📝) again.</p>
On the element entry dialog	<ol style="list-style-type: none"> <li>1. Press the <b>[Enter]</b> key.</li> <li>2. Enter notes following the displayed device/instruction after entering ';' for 'In PLC' and ';*' for 'In Peripheral.'</li> </ol> 
In the "Statement/Note Batch Edit" screen	<ol style="list-style-type: none"> <li>1. Select [Edit] ⇒ [Documentation] ⇒ [Statement/Note Batch Edit] (📝).</li> <li>2. Enter a note.</li> </ol> 
With the keyboard	<ol style="list-style-type: none"> <li>1. Select the cell of a note, and press the <b>[F2]</b> key.</li> <li>2. Enter a note directly.</li> </ol>

### ■ Edit

After editing a note, the same as when a ladder program is edited, the program will be in unconverted state.

If any note is edited in an FB program or FUN program, a POU where the edited function block or function is used may also be in unconverted state.

For details on the conversion of a function block or function, refer to the following:

📖 Page 487 Converting function blocks

📖 Page 505 Converting functions

## Inserting/deleting NOP instruction

Insert or delete a NOP instruction to adjust Step No. of a program.

The Step No. changed by the NOP instruction is applied to a ladder editor after converting the program.

### Operating procedure

#### ■Batch insertion

1. Select a cell to be insert.
2. Select [Edit] ⇒ [NOP Batch Insert].
3. Set the number of NOPs in the "NOP Batch Insert" screen and click the [OK] button.

#### ■Batch deletion

Select [Edit] ⇒ [NOP Batch Delete].

## Changing TC setting values

The setting value of a timer and a counter used in a ladder program can be changed in a batch.

When a setting value is changed, the program will be in the unconverted state.

By selecting the checkbox of "Write the Changed Program to PLC," a program is converted after changing a setting value and the online program change is performed.

An inline structured text of a ladder program is not supported.

### Window

Select [Edit] ⇒ [Change TC Setting Value].

Change TC Setting Value

Please set a data name under the program file to set through Change TC Setting Value.

Data Name: ProgPou

Position	Device/Label	Setting Value before Change	Setting Value after Change
( 1) T0		K200	
( 6) T1		K100	
( 11) T2		K100	

Write the Changed Program to PLC

Explanation

- \*1. As for the double coil, the first setting value is the target.
- \*2. If you changed the setting value of FB program, it is also changed in FB instance.

Execute Close

### Operating procedure

1. Set the items in the screen.

When performing the online program change after changing the setting value, select the checkbox of "Write the Changed Program to PLC."

2. Click the [Execute] button.

## Precautions

### ■When an error occurs during the online program change

The TC setting value of a program is changed but it is not written to a programmable controller.

### ■When specifying "MELSAP-L (Instruction Format)" for the display format of an SFC program

The TC setting value of an SFC (Zoom) cannot be changed in the following settings:

- [Tool] ⇒ [Options] ⇒ "Program Editor" ⇒ "SFC Diagram Editor" ⇒ "Action/Transition" ⇒ "Display Format" ⇒ "Ladder Display Method"
- [View] ⇒ [Switch Ladder Display]

## Targets for changing TC setting values

### ■Target instruction

The following shows the instructions that can be set in the "Change TC Setting Value" screen.

- OUT: Timer/retentive timer output, long timer/long retentive timer output, counter/long counter output
- OUTH: High-speed timer/high-speed retentive timer
- OUTHS: High-speed timer/high-speed retentive timer<sup>\*1</sup>

\*1 RCPUs do not support it.

### ■Target device

The following table shows the devices that can be set in the "Change TC Setting Value" screen.

Instruction argument	Device	Global device	Local device
Timer/counter/retentive timer	T, ST, LT, LST, C, LC, SA\T, SA\ST, SA\C	<input type="radio"/>	<input type="radio"/>
Setting value	D, SD, W, SW, J□\W, J□\SW, U□\G, U3E□\G, U3E□\HG, RD, R, ZR, K, FD, SA\D, SA\SD, SA\W	<input type="radio"/>	<input type="radio"/>

## Copying and pasting a ladder

### Cutting/coping

Select an instruction, range, or ladder block, and cut/copy it.

Select a row when copying a function/function block.

### Pasting

Paste a cut/copied ladder.

For 'Insert mode' (press the  key to switch to 'Overwrite mode'), one row will be inserted above the line where the cursor placed over and the copied ladder will be pasted.

Even in 'Overwrite mode,' a row/column will be inserted automatically and the copied ladder will be pasted by selecting [Edit] ⇒ [Insert and Paste].

## Precautions

If the range to cut/copy is selected on a ladder as shown below, the vertical line on the right side cannot be pasted.

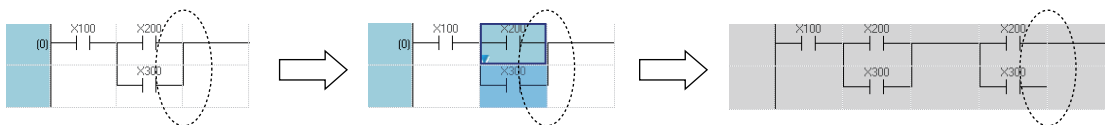

In this case, draw a vertical line after the pasting.

## Pasting device numbers or label names consecutively

Paste device numbers or label names that exist in the cut/copied ladder consecutively while incrementing the numbers (+1). The menu [Edit] ⇒ [Continuous Paste] is not available for pasting device names and label names onto the input and output circuit parts of a function/function block.

This section shows the operating procedure to paste labels consecutively by using the example of the following program.



- Label name: bLabel1[0,0]
- Data type: Bit (0..3,0..3)

### Operating procedure

1. Select an instruction or ladder block to be pasted continuously, and cut or copy it.



2. Move the cursor to the start position of the continuous paste, and select [Edit] ⇒ [Continuous Paste].

3. In the "Continuous Paste" screen, set each item and click the [Execute] button.

Continuously paste the selected range downward from current cursor position with device No. increments which is included in cut or copied ladder.

Number of Continuous Pastings (1 to 99):  Number

Increment Position of Label Name:  ▾

Display Comment Increment Value Batch Setting

Type	Copy Source	After Increment	Increment Value
Local Label	bLabel1[0,0]	>> bLabel1[0,1]	
Local Label	bLabel1	>> bLabel1	0
	0	>> 0	0
	0	>> 1	1
Device	Y1	>> Y2	1

\*Setting range for increment value is -999999 to 999999 (DEC).  
\*Real constants, members, and devices in inline structured text will not be incremented.  
 Edit additional information of the labels registered in label editor after registering label information.  
 Register a label at the last row.

Pasting Direction:  ▾

- Number of Continuous Pastings: 3
- Increment Value: 1
- Pasting Direction: Down

The instruction or ladder block can be pasted continuously.

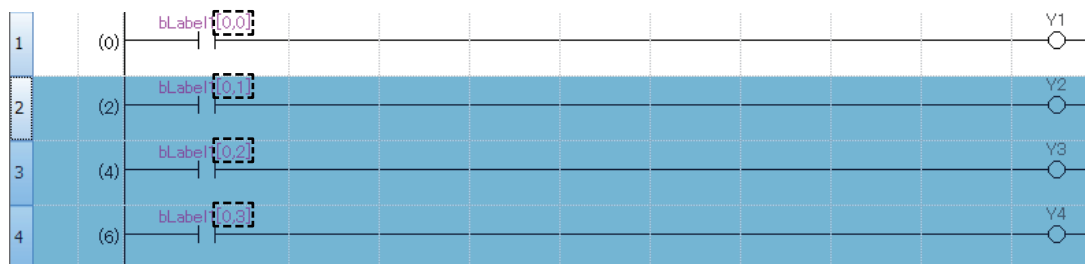

## Precautions

The following data cannot be incremented.

- The number of digits of digit-specified bit device
- Dummy device
- Local label used in a function block
- Structure member
- Some constant (boolean value, real number, character string, time)
- Wrapping symbol
- EN/ENO of a function block or function
- Return value of a function

## Returning ladder diagrams to the condition before editing

---

A ladder diagram being edited can return to the condition before starting editing.

Among the following operations, it returns to the operation that was performed just before editing the program.

- Opening a project
- Overwriting a project or saving a project with a new name
- Deleting a label
- Closing the ladder editor
- Converting a program

## Operating procedure

Select [Edit] ⇨ [Revert to Start Editing Circuit].

# Changing ladder blocks temporarily

The operation of a specific ladder block can temporarily be changed.

Using the Temporarily Change Ladders function, the program for debugging can be changed without losing the source program, therefore the debug process will be improved efficiently.

This function can be used only for a standard program created in Ladder Diagram language (excluding a Zoom).

FX5CPUs do not support this function.

## Precautions

When opening a project, that contains a temporarily changed ladder program, in GX Works3 Version 1.008J or earlier, the background color of disabled ladder block is not changed. Besides, 'Apply the Changes' and 'Restore the Changes' cannot be performed.

## Temporary changing

### Operating procedure

1. Select the ladder block to change, then select [Edit] ⇒ [Temporarily Change Ladders] ⇒ [Temporarily Change Ladders] (☰).

2. Enter a pointer or pointer type label to be used.

A peripheral statement, JMP instruction, NOPLF instruction, or pointer device (or pointer type label) is automatically inserted as shown below.

The selected ladder block is disabled and a copy of the selected ladder blocks is inserted immediately below the disabled ladder block.

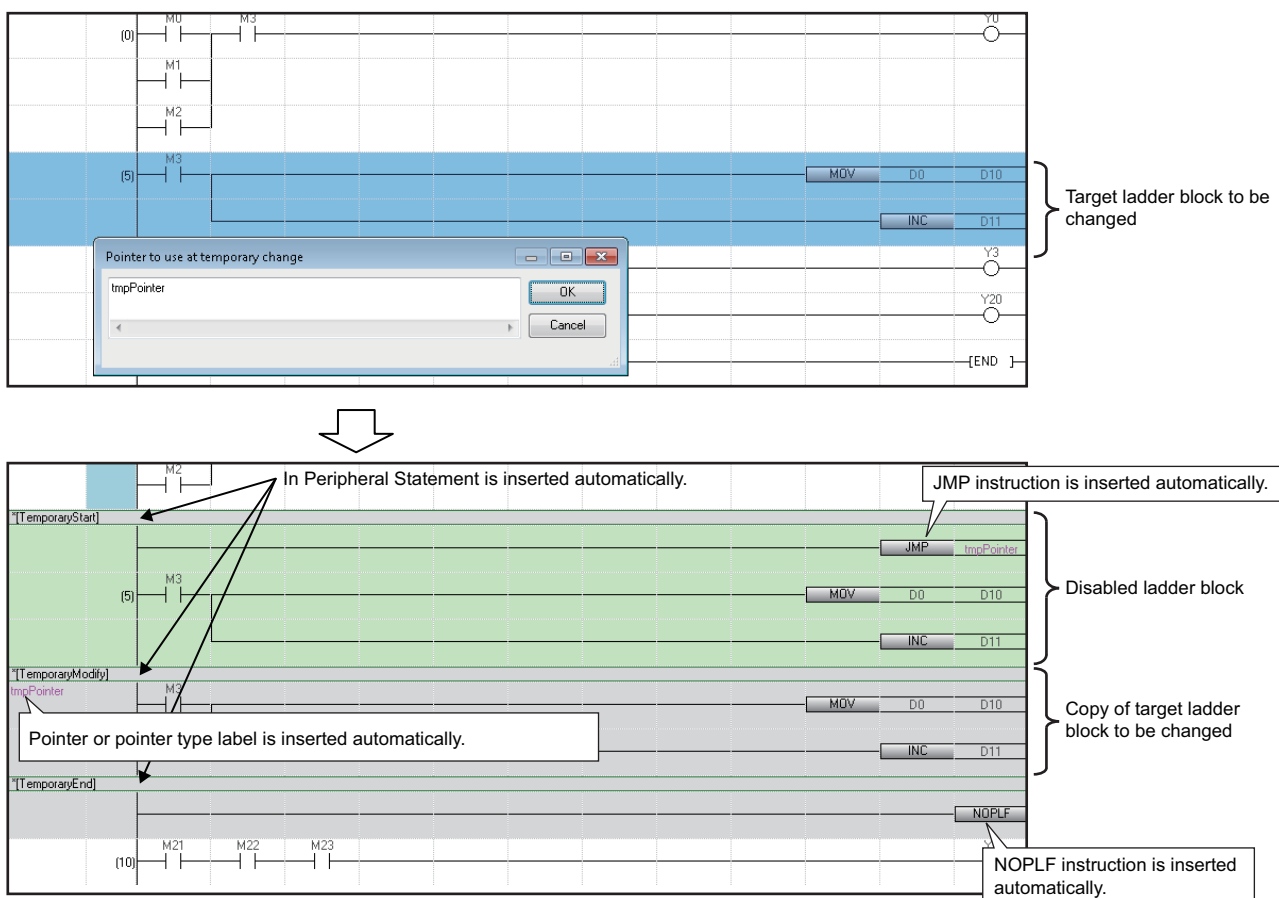

### 3. Edit the copied ladder block.



#### Point

By changing the copied ladder block to the NOPLF instruction, the specified ladder block is disabled temporarily.

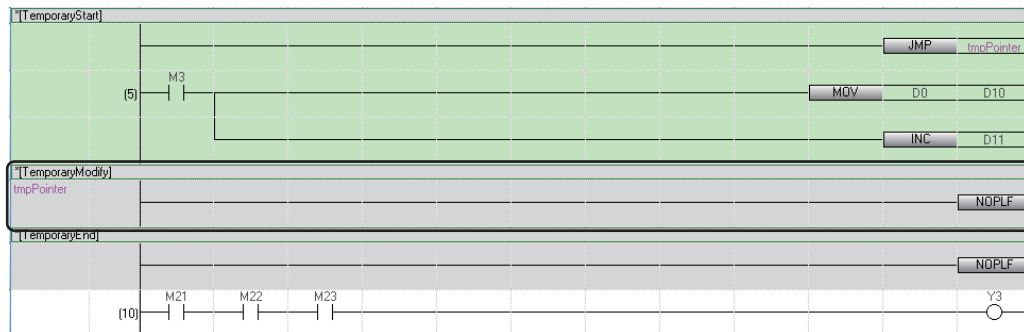

### Precautions

In a program of function/function block, a pointer device cannot be used temporarily. Only pointer type label is applicable.

### Applying/restoring the changes

The changed ladder program is applied if no problem is found with the operation. If any problems are found, the change is restored.

### Operating procedure

Select the ladder block from [TemporaryStart] statement to [TemporaryEnd] statement, and then select [Edit] ⇒ [Temporarily Change Ladders] ⇒ [Apply the Changes] ( )/[Restore the Changes] ( ).

### Displaying ladder blocks changed temporarily in a list

The list of ladders changed temporarily can be displayed on the active ladder editor.

### Operating procedure

Select [Edit] ⇒ [Temporarily Change Ladders] ⇒ [Temporarily Changed Ladder List] ( ).

Only the statements inserted automatically by changing a ladder block temporarily are displayed in the "Line Statement List" screen.



## Considerations for editing ladder blocks changed temporarily

When the temporarily changed ladder block was edited with the contents listed in the following table, the program may not be performed normally.

Description	
Statement	Delete/cut a statement.
	Insert a ladder block between the [TemporaryModify] statement row and the ladder block changed temporarily (which is the row setting a pointer).
	Delete the [TemporaryEnd] statement row and NOPLF instruction.
	Insert a ladder block/a statement/NOPLF instruction between the [TemporaryEnd] statement row and NOPLF instruction.
	Insert a statement before and after the [TemporaryStart] statement row.
JMP instruction, Pointer	Edit/delete a JMP instruction or a pointer.
Ladder block	Edit a disabled ladder block.
	Delete a ladder block disabled/changed temporarily.
	Copy and paste a ladder block disabled/changed temporarily.

## Searching for/replacing data in a program

The search functions that can be used in a ladder editor are as follows.

Function name	Description	Reference
Simple search	To search for instructions, devices, labels, statements, and notes.	Page 295 Simple search
Jump	To move the cursor onto a specified step No.	Page 296 Jump
Cross reference	To check a declaration location and a reference location of a device and a label in a list.	Page 445 SEARCHING FOR DATA
Device list	To check the usage of devices being used.	
Find and replace	<ul style="list-style-type: none"> <li>To search for and replace a device name, label name, instruction name, and character string.</li> <li>To change contacts between open contact and close contact</li> <li>To replace devices in a batch.</li> </ul>	

### Simple search

Instructions, devices, labels, statements, and notes can be searched for by entering a text in the "Find" screen.

#### Operating procedure

1. Press the  key on a ladder editor.
2. Enter a text, and click the [Find] button in the "Find" screen.

#### Point

By using the following menu, the cursor jumps forward or backward from the current position to the positions where search was applied.

- [Find/Replace] ⇨ [Previous] /[Next] 

### Search options

A search option can be set by adding the following commands at the end of a text for search.

Command	Item name in the find/replace window	Description
/K (Example: M0/K)	Digit	The entered device and digit-specified bit devices that include the entered device are searched for.
/D (Example: D0/D)	Multiple Word	The entered device and the double-word format word devices that include the entered device are searched for.
; (Example: ;statement)	—	Statements or notes are searched for.

For the device search examples using a search option, refer to the following:

 Page 449 Examples of device search

## Jump

The cursor jumps on a ladder editor by specifying a step number.

### Operating procedure

1. Select [Find/Replace] ⇒ [Jump].
2. Specify a Step No. in the "Jump" screen, and click the [OK] button.

### Point

On a ladder editor, pressing a numeric key on the keyboard enables to display the "Jump" screen.

By using the following menu, the cursor jumps forward or backward from the current position to the positions where search was applied.

- [Find/Replace] ⇒ [Previous] (🔍) / [Next] (🔍)

## Displaying instruction help

The instructions used in a ladder program can be checked in e-Manual Viewer.

To check the instructions, the file of the corresponding manual must be registered in e-Manual Viewer.

### Operating procedure

1. Select the cell where the target instruction is entered.
2. Press the **F1** key.

### Point

If a help file is associated with a function or function block, the help file opens. (📖 Page 133 Associating data with a help file)

## Copying an image to the clipboard

The range selected in a ladder editor can be copied to the clipboard as an image by using the image clip function.

The following shows the procedure to copy a ladder program to the clipboard.

### Operating procedure

1. Select a range to be copied in a ladder editor.
2. Select [Edit] ⇒ [Image Clip].

When selecting cells, only the selected range is copied.

When selecting rows, the range including the row headers and column headers is copied.

### Precautions

Up to 80 rows of ladders can be copied as an image to the clipboard.

However, ladders may not be copied correctly if the image size exceeds 15 MB.

# Importing/exporting ladder programs

A ladder program can be imported from a CSV file and exported to a CSV file, HTML file, or text file.

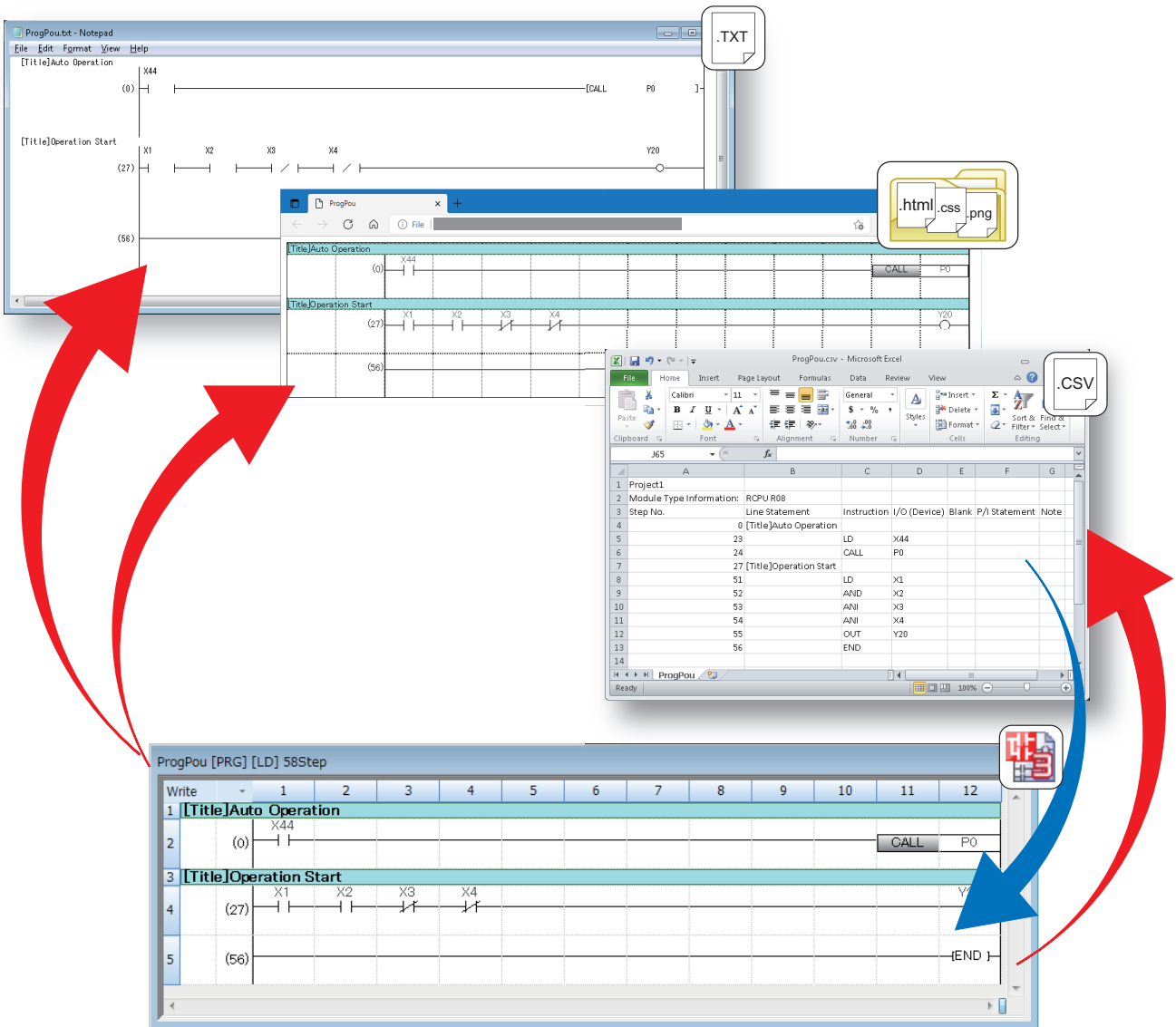

## Importing from a CSV file

Listed instructions in a CSV file can be imported into a ladder program.

When importing from the CSV file, the program will be in the unconverted state.

### Operating procedure

1. Open a ladder editor, and select [Edit] ⇒ [Import File]()
2. Select a file to import in the "Import File" screen.
3. Specify "CSV (tab delimited)(\*.csv)" for the file type, and click the [Open] button.
4. Select "Convert to 'OUT SM4095'" or "Convert to line statement" for "Conversion Method for Incorrect Instruction" in the screen to confirm import, and click the [Yes] button.

### Precautions

- When a program is being monitored or simulated, a file cannot be imported.
- When an import destination satisfies any of the following condition, the program needs to be converted (reassigned) after importing a file.
  - There are multiple programs in the program file.
  - The program is the one of function blocks or functions.
- When a label of 'VAR' class of an FB instance is included in a CSV file, a conversion error occurs after import.

### ■ Restrictions on data to be imported

The following restrictions apply to data to be imported.

- Data in the eighth column or later in a CSV file is not imported.
- When a language of data to be imported is different from that of a project, some characters may be garbled.
- When data is imported, the existing program in the import destination is deleted.

### ■ Import of a program in which a function block or function is used

When importing a program including a function block or function, the function block, function, and FB instance are imported as undefined elements.

### ■ Import of a program in version 1.038Q or earlier



In version 1.038Q or earlier, an error occurs when importing a program including the following elements from a CSV file.

Import a program in version 1.040S or later.

- Label
- Inline structured text
- Function block and function

## ■ File format

For the file formats when importing, follow the formats listed below:

Item	Format	Example																																															
Header	A project name and a module type are displayed. The header of each column is also displayed.	<table border="1"> <tr> <td colspan="7">Project1</td> </tr> <tr> <td colspan="7">Module Type Information: RCPU R08</td> </tr> <tr> <td>Step No.</td> <td>Line Statement</td> <td>Instruction</td> <td>I/O (Device)</td> <td>Blank</td> <td>P/I Statement</td> <td>Note</td> </tr> </table>	Project1							Module Type Information: RCPU R08							Step No.	Line Statement	Instruction	I/O (Device)	Blank	P/I Statement	Note																										
Project1																																																	
Module Type Information: RCPU R08																																																	
Step No.	Line Statement	Instruction	I/O (Device)	Blank	P/I Statement	Note																																											
Instruction and argument (4 formats)	<ol style="list-style-type: none"> <li>Describe an instruction and an argument in each column, and multiple arguments in the I/O (device) column in a different row.</li> <li>Describe an instruction and an argument in the same instruction column.</li> <li>Describe multiple arguments in the same I/O (device) column.</li> <li>Describe arguments in the instruction column and the I/O (device) column separately.</li> </ol>	<table border="1"> <tr> <td rowspan="2">① {</td> <td>0</td> <td>MOV</td> <td>D0</td> <td></td> <td></td> <td></td> </tr> <tr> <td>1</td> <td></td> <td>D1</td> <td></td> <td></td> <td></td> </tr> <tr> <td>② —</td> <td>2</td> <td>MOV D0 D1</td> <td></td> <td></td> <td></td> <td></td> </tr> <tr> <td>③ —</td> <td>3</td> <td>MOV</td> <td>D0 D1</td> <td></td> <td></td> <td></td> </tr> <tr> <td>④ —</td> <td>4</td> <td>MOV D0</td> <td>D1</td> <td></td> <td></td> <td></td> </tr> </table>	① {	0	MOV	D0				1		D1				② —	2	MOV D0 D1					③ —	3	MOV	D0 D1				④ —	4	MOV D0	D1																
① {	0	MOV		D0																																													
	1		D1																																														
② —	2	MOV D0 D1																																															
③ —	3	MOV	D0 D1																																														
④ —	4	MOV D0	D1																																														
Statement <sup>*1, *2</sup> (2 formats)	<ol style="list-style-type: none"> <li>Describe a statement in the line statement column.</li> <li>Describe a statement with ";" in the instruction column.</li> </ol>	<table border="1"> <tr> <td>① —</td> <td>5</td> <td>*state</td> <td></td> <td></td> <td></td> <td></td> </tr> <tr> <td>② —</td> <td>6</td> <td></td> <td>;state</td> <td></td> <td></td> <td></td> </tr> </table>	① —	5	*state					② —	6		;state																																				
① —	5	*state																																															
② —	6		;state																																														
PI statement <sup>*1</sup> (4 formats)	<ol style="list-style-type: none"> <li>Describe a pointer or interrupt pointer in the instruction column, and a PI statement in the PI statement column in the next row.</li> <li>Describe a PI statement in the PI statement column in the same row as a described pointer or interrupt pointer.</li> <li>Describe a PI statement with ";" following a described pointer or interrupt pointer.</li> <li>Describe a pointer or interrupt pointer in the instruction column, and a PI statement with "[" in the instruction column in the next row.<sup>*3</sup></li> </ol>	<table border="1"> <tr> <td rowspan="2">① {</td> <td>7</td> <td>P0</td> <td></td> <td></td> <td></td> <td></td> </tr> <tr> <td>8</td> <td></td> <td></td> <td></td> <td>P!state</td> <td></td> </tr> <tr> <td>② —</td> <td>9</td> <td>P0</td> <td></td> <td></td> <td>P!state</td> <td></td> </tr> <tr> <td>③ —</td> <td>10</td> <td>P0;P!state</td> <td></td> <td></td> <td></td> <td></td> </tr> <tr> <td rowspan="2">④ {</td> <td>11</td> <td>P0</td> <td></td> <td></td> <td></td> <td></td> </tr> <tr> <td>12</td> <td>[P!state</td> <td></td> <td></td> <td></td> <td></td> </tr> </table>	① {	7	P0					8				P!state		② —	9	P0			P!state		③ —	10	P0;P!state					④ {	11	P0					12	[P!state											
① {	7	P0																																															
	8				P!state																																												
② —	9	P0			P!state																																												
③ —	10	P0;P!state																																															
④ {	11	P0																																															
	12	[P!state																																															
Note <sup>*1</sup> (5 formats)	<ol style="list-style-type: none"> <li>Describe the last argument of an instruction in the I/O (device) column, and a note in the note column in the next row.</li> <li>Describe the last argument of an instruction in the I/O (device) column, and a note in the note column in the same row.</li> <li>Describe a note with ";" following a described instruction and argument in the instruction column.</li> <li>Describe a note with "&gt;" following a described argument in the I/O (device) column.</li> <li>Describe an instruction in the instruction column, and a note with "&lt;" in the instruction column in the next row.<sup>*4</sup></li> </ol>	<table border="1"> <tr> <td rowspan="2">① {</td> <td>13</td> <td>OUT</td> <td>Y0</td> <td></td> <td></td> <td></td> </tr> <tr> <td>14</td> <td></td> <td></td> <td></td> <td></td> <td>note</td> </tr> <tr> <td>② —</td> <td>15</td> <td>OUT</td> <td>Y0</td> <td></td> <td></td> <td>note</td> </tr> <tr> <td>③ —</td> <td>16</td> <td>OUT Y0;note</td> <td></td> <td></td> <td></td> <td></td> </tr> <tr> <td>④ —</td> <td>17</td> <td>MOV</td> <td>D0 D1;note</td> <td></td> <td></td> <td></td> </tr> <tr> <td rowspan="2">⑤ {</td> <td>18</td> <td>OUT Y0</td> <td></td> <td></td> <td></td> <td></td> </tr> <tr> <td>19</td> <td>&lt;note</td> <td></td> <td></td> <td></td> <td></td> </tr> </table>	① {	13	OUT	Y0				14					note	② —	15	OUT	Y0			note	③ —	16	OUT Y0;note					④ —	17	MOV	D0 D1;note				⑤ {	18	OUT Y0					19	<note				
① {	13	OUT		Y0																																													
	14					note																																											
② —	15	OUT	Y0			note																																											
③ —	16	OUT Y0;note																																															
④ —	17	MOV	D0 D1;note																																														
⑤ {	18	OUT Y0																																															
	19	<note																																															
Inline structured text	Refer to the following:  Page 302 Format for inline structured text program																																																
FB/FUN	Refer to the following:  Page 303 Format for function and function block For the format of a listed instruction for input circuits and output circuits, refer to the listed instruction in a CSV file exported from a program in which the same FB/FUN is used.																																																
END instruction	Make sure to describe the END instruction at the end of listed instructions.	<table border="1"> <tr> <td></td> <td>20</td> <td>END</td> <td></td> <td></td> <td></td> <td></td> </tr> </table>		20	END																																												
	20	END																																															

\*1 "\*" representing a peripheral statement or a peripheral note can be used.

\*2 "[Title]" displayed in the navigation window can be used.

\*3 "]" at the end is not imported.

\*4 ">" at the end is not imported.

- '\t' (A tab) or ',' (a comma) can be used for delimiting items.
- Enclose an item including a delimiter or a line feed code with double quotes.
- When importing a program including a ladder block changed temporarily, the temporary change of the ladder block will be canceled.

- The range of a character string in a line statement to be imported differs depending on a line feed format in a CSV file.

Line feed format	Import in GX Works2	Import in GX Works3
Line feed character "\r\n" is used	A character string in a single row including the line feed character "\r\n" is imported as a statement.	A character string in which a line feed is inserted is imported as a statement.
A CSV file is edited directly and a line feed is inserted in a character string	A character string up to the first line feed is imported as a statement.	

- Constants are imported as they are; however, a single quote in a string constant is replaced with a double quote. (Example: 'ABC' → "ABC")

## Exporting to a CSV file

A ladder program can be converted into a listed instruction format and exported to a CSV file.

### Operating procedure

1. Open a ladder editor, and select [Edit] ⇒ [Export to File] ( ).
2. Enter a file name to export in the "Export to File" screen.
3. Specify "CSV (tab delimited)(\*.csv)" for the file type, and click the [Save] button.

### Precautions

Programs including an unconverted ladder cannot be exported.

If more than 5000 inline structured text boxes exist in a program, an error will occur.

### File format

A saved CSV file opened in spreadsheet software is displayed as follows:

Project						
Module Type Information: RCPUR08						
Step No.	Line Statement	Instruction	I/O (Device)	Blank	P/I Statement	Note
0	[Title]Auto Operation					
23		LD	X44			
24		CALL	P0			
27	[Title]Operation Start					
51		LD	X1			
52		AND	X2			
53		ANI	X3			
54		ANI	X4			
55		OUT	Y20			
56		END				

The following describes the detailed formats of a CSV file.

- The file format is Unicode (UTF-16 Little Endian with BOM).
- Items are delimited by '\t' (a tab).
- Each item is enclosed with "" (double quotes).
- When "" (a double quote) is included in an item, "" (two double quotes) are displayed for each "" (double quote) in the item.
- A line feed in a line statement is converted into '\r\n' (a line feed character).
- A line feed is inserted at the end of a row. The line feed code is CR+LF.
- The items for the module type information (1) and the header (2) are exported in a language set for the display language of GX Works3. ( Page 50 Display Language Switching)

## Format for inline structured text program

A saved CSV file which includes an inline structured text program is displayed in spreadsheet software as follows:

Step No.	Line Statement	Instruction	I/O (Device)	Blank	P/I Statement	Note
0		LD	X0			
1		AND	X1			
2		AND	X2			
3		AND	X3			
4		AND	X4			
5		STB1				
						Average
91		END				
<STB1> AveData := (D1 + D2 + D3) / 3; </STB1>						

No.	Item	Description	Format
(1)	Instructions for inline structured text	The position of an inline structured text box and the inline structure text number*1 (1 to 5000) in the program are displayed.	STB (inline structured text number)
(2)	Title of an inline structured text	The title of an inline structured text box is displayed.	(Text of an inline structured text title)
(3)	Texts of an inline structured text	Inline structured text programs are displayed.	<STB (inline structured text number)> (Inline structured text program) </STB (inline structured text number)>

\*1 Indicates the number that is added to each inline structured text in order from the top in a program.



## ■Format for function and function block

The display example of CSV file in the format of function blocks is as follows.

When opening an exported CSV file that includes a function block in spreadsheet software, the data is displayed as follows:

Step No.	Line Statement	Instruction	I/O (Device)	Blank	P/I Statement	Note
0	*FB BLK START					(1)
1		LD	input1			(2)
2		OUT	FB Counter.IN1			(3)
2		FBCALL FbPou (FB Counter)				(4)
		IN1_IN:BOOL				(5)
		OUT1_OUT:BOOL				(6)
12		LD	FB Counter.OUT1			(7)
13		OUT	output1			
14	*FB BLK END					
14		END				

No.	Item	Description	Format	
(1)	Starting position	The starting position of a ladder block in which a function block is used is displayed.	*;FB BLK START	
		The starting position of a ladder block in which a function is used is displayed.	*;FUN BLK START	
(2)	Input circuit part	An input circuit of an FB instance or a function is displayed.	Depends on an instruction (listed instruction format) ☞ Page 299 File format	
(3)	FB instance/ function	Program starting position	The starting position of an FB program is displayed.	FBCALL (FB data name)(FB instance name)
			The starting position of the program of a function is displayed.	FUNCALL (FUN data name)
(4)		Input label definition	A label name, IN, and data type of an input label is displayed.	(Label name) IN: (data type)
(5)		Output label definition	A label name, OUT, and data type of an output label is displayed.	(Label name) OUT: (data type)
(6)	Output circuit part	The output circuit of an FB instance or a function is displayed.	Depends on an instruction (listed instruction format) ☞ Page 299 File format	
(7)	End position	The end position of a ladder block in which a function block is used is displayed.	*;FB BLK END	
		The end position of a ladder block in which a function is used is displayed.	*;FUN BLK END	

## Exporting to an HTML file

A ladder diagram of a ladder program can be exported to an HTML file.

Data in an HTML file cannot be imported in a ladder program.

### Operating procedure

1. Open a ladder editor, and select [Edit] ⇒ [Export to File]()
2. Enter a file name to export in the "Export to File" screen.
3. Specify "HTML(\*.html)" for the file type, and click the [Save] button.

### Precautions

Programs including an unconverted ladder cannot be exported.

The number of displayed rows (height) of an inline structured text box is not applied in an HTML file.

The following items are not exported:

- Line number of an inline structured text program
- "\*" added when entering a peripheral statement
- Data type of an argument of a function/function block

### Operating environment

The following table shows the operating environment.

Item		Description
Operating system	Tablet, smartphone	Android® 4.0 or later iOS® 8 or later
	Personal computer	Microsoft® Windows 11 Microsoft Windows 10
Browser	Tablet, smartphone	A browser supporting HTML5 and CSS3 The following browsers are recommended. <ul style="list-style-type: none"><li>• Google Chrome® (for Android) (version 4.3 or later)</li><li>• Safari 8.0 or later</li></ul>
	Personal computer	A browser supporting HTML5 and CSS3 The following browsers are recommended. Microsoft Edge® Internet Explorer® 11 or later Safari 8.0 or later Google Chrome 4.3 or later

An HTML file to which a ladder diagram is exported may not open properly in a web browser not supporting HTML5.

### File configuration

A ladder diagram is exported to an HTML file in the following file configuration.

Folder	Subfolder	File name	Description
Folder specified in the "Export to File" screen	—	(character strings specified in the "Export to File" screen).html	The following information on ladder elements of a ladder diagram is exported. <ul style="list-style-type: none"><li>• Picture name to be displayed</li><li>• Label/device name</li><li>• Character strings of comment/statement/note</li><li>• Tag for assigning style information in a css file</li></ul>
	css	(character strings specified in the "Export to File" screen)BaseStyle.css	The following style information is exported. <ul style="list-style-type: none"><li>• Color and font settings configured when exporting</li><li>• Layout information to display as a ladder diagram</li></ul>
	img	(ladder element name).png	A same picture as that of a ladder diagram displayed on a ladder editor is exported.*1

\*1 The conditions for exporting are as follows:

- A ladder element in a ladder diagram displayed on the selected editor is exported as a picture.
- A cell width set individually on a ladder editor is not applied.
- A wrapped row of the first column and an icon row of the second column are not exported.

## ■ File format

A saved HTML file opened in a web browser is displayed as follows:

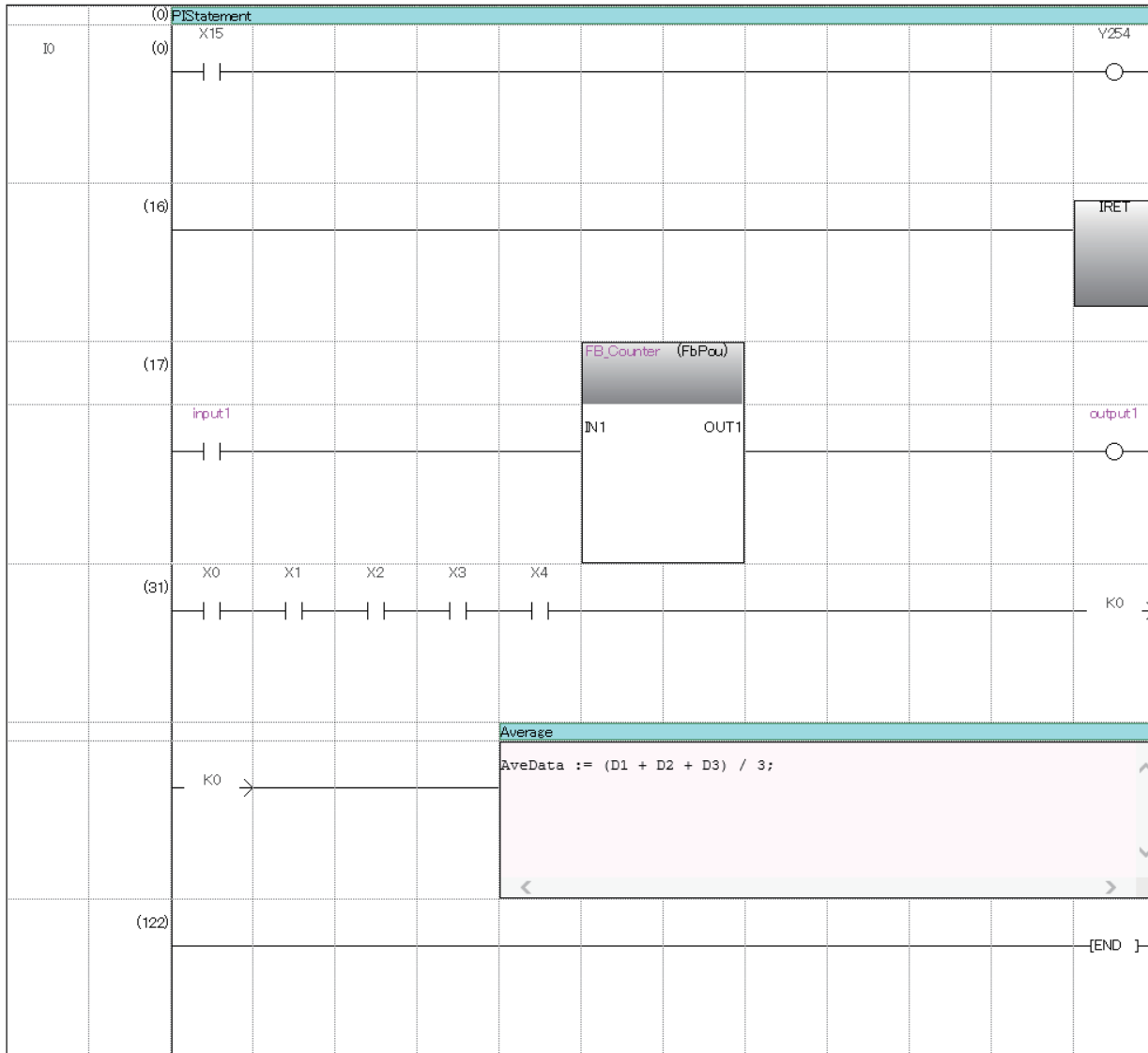

- A line feed is not inserted for statements and comments.
- When closing ladder blocks in an outline display, they are exported in the closed state.
- Ladder blocks displayed in an editor can only be exported. (Example: When only a ladder block including a line statement is displayed)

## Precautions

- When the magnification of a character in a web browser is not same, a file is not displayed properly.
- Some texts may get cut depending on the fonts used in a web browser.
- The number of characters and rows to display the character string data, such as a device name and a comment, may not match between a ladder editor and a web browser.
- When displaying a program with a large number of steps in an inline structured text box, the line of the left ladder may be cut off.
- The position of a command name may differ between a ladder editor and a web browser.
- When character strings are not displayed all, "... " is added to the end for a device, data name of a function/function block, FB instance name, statement, note, VAR\_PUBLIC, and VAR\_PUBLIC\_RETAIN.
- The font color and background color of inline statements that are displayed in the navigation window are the same as the ones of other inline statements.

## Exporting to a text file

A ladder diagram of a ladder program can be exported to a text file.

Data in a text file cannot be imported in a ladder program.

This function supports programs within 260 KB.

### Operating procedure

1. Open a ladder editor, and select [Edit] ⇒ [Export to File]().
2. Enter a file name to export in the "Export to File" screen.
3. Specify "Text (\*.txt)" for the file type, and click the [Save] button.

### Precautions

Programs including an unconverted ladder cannot be exported.

The number of displayed rows (height) of an inline structured text box is not applied in a text file.

In addition, the following items are not exported also.

- Line number of an inline structured text program

### ■Operating environment

When characters are not displayed on the text editor or the display width of ladder diagrams is not uniform, check the operating environment.

It is considered to occur in the following cases.

- A non-Japanese version of operating system is used.
- Japanese fonts are not installed.
- Fonts that are not supported by Shift JIS are used.

To display an exported text file normally, set the following settings.

- Install Japanese fonts and set the system locale as Japanese.
- Set the used fonts to monospaced fonts on the text editor.

## ■File format

A saved text file opened on the text editor is displayed as follows:

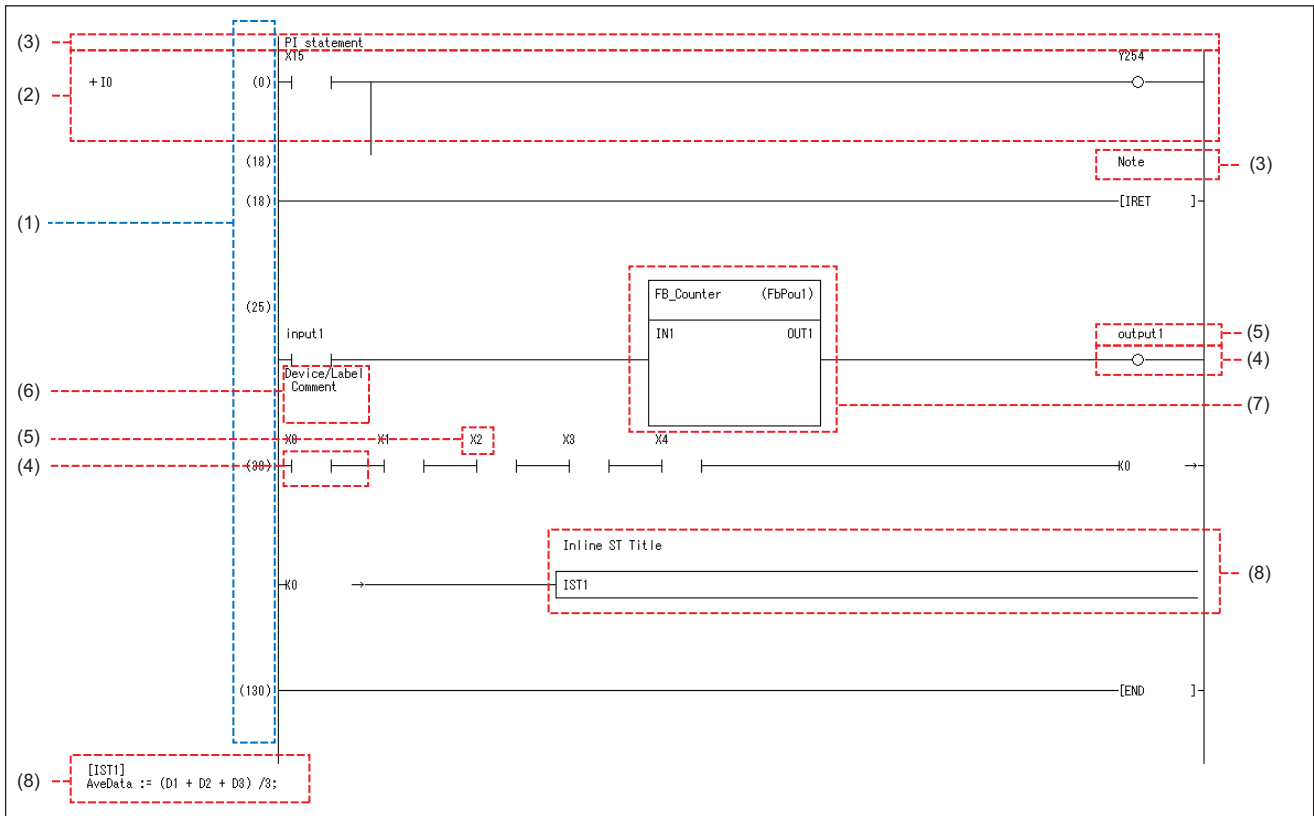

No.	Item	Description
(1)	Step No.	Step numbers are displayed. When do not output step No. select "No" in the following option. • [Tool] ⇒ [Options] ⇒ "Program Editor" ⇒ "Ladder Editor" ⇒ "Export to File" ⇒ "Text Format" ⇒ "Output Step No."
(2)	Outline display	When closing a ladder block in an outline display, "+" is displayed in the beginning of the row. Functions/function blocks closed in an outline display, only the function names or the label names of function blocks are displayed.
(3)	Statement <sup>*1</sup>	No line feed: It is displayed in one line.
	PI statement <sup>*1</sup>	Line feed used: The line feed is applied.
	Note <sup>*1</sup>	The following option is not applied. • [Tool] ⇒ [Options] ⇒ "Program Editor" ⇒ "Ladder Editor" ⇒ "Ladder Diagram" ⇒ "Display Format" ⇒ "Contact Display Width"
(4)	Contact/coil	Contacts/coils in a ladder program are displayed.
(5)	Device/label <sup>*2,*3</sup>	It is displayed in six lines for one cell. The number of rows to display differs depending on the following option. • [Tool] ⇒ [Options] ⇒ "Program Editor" ⇒ "Ladder Editor" ⇒ "Ladder Diagram" ⇒ "Display Format" ⇒ "Numbers of Wrapping Rows for Device/Label Name"
(6)	Device comment <sup>*2</sup>	It is displayed in four lines under the ladder diagram. The following option is not applied. • [Tool] ⇒ [Options] ⇒ "Program Editor" ⇒ "Ladder Editor" ⇒ "Comment" ⇒ "Display Format" ⇒ "Number of Characters"
(7)	Function	The names and the titles of functions are displayed.
	Function block	The label names of function blocks and the function block names are displayed.
(8)	Inline structured text box	Inline structured text boxes in a ladder program are displayed as the character string 'ISTn' <sup>*4</sup> . The titles of inline structured text boxes are displayed one line upper than the ones for the character string 'ISTn.'
	Inline structured text program	Inline structured text programs are displayed under the row for the END instruction.

- \*1 For peripheral statements or peripheral notes, '\*' is added in the beginning of the character strings.
- \*2 Up to 12 characters are displayed per row.
- \*3 Characters exceeding the display range are displayed as '...'.  
\*4 'n' indicates an integer that is added in the output order of inline structured text boxes.

## Precautions

- Up to 12 characters for one cell, and up to 14 characters for one line
- The file format is Unicode (UTF-16 Little Endian with BOM).
- Grids are not displayed.
- Ladder blocks displayed in an editor can only be exported. (Example: When only a ladder block including a line statement is displayed)

## Exporting to all files

The following explains the procedure to export ladder programs to a CSV file, HTML file, and text file simultaneously.

For the format of each file and a method to export ladder programs to each format file, refer to the following:

☞ Page 301 Exporting to a CSV file

☞ Page 304 Exporting to an HTML file

☞ Page 306 Exporting to a text file

## Operating procedure

1. Open a ladder editor, and select [Edit] ⇒ [Export to File]().
2. Enter a file name to export in the "Export to File" screen.
3. Specify "All File Formats(\*.csv;\*.html;\*.txt)" for the file type, and click the [Save] button.

# 6.4 Creating an ST Program

This section explains the creation method of an ST program.

The details on the specification of ST program are described in the following manual. Please read it in advance.

📖 MELSEC iQ-R Programming Manual (Program Design)

📖 MELSEC iQ-F FX5 Programming Manual (Program Design)

## Point

The display format and detailed operation settings for each function can be set by setting the following option.  
 [Tool] ⇒ [Options] ⇒ "Program Editor" ⇒ "ST Editor"

## Configuration of an ST editor

ST editor is a language editor in text format for creating programs in Structured Text.

Spaces, tabs, and line feeds can be entered between keywords and variable names of a control syntax.

Terms and symbols that configure the program is referred to as a token.

### Window

Select "Program" ⇒ "(execution type)" ⇒ "(program file)" ⇒ "(program block)" ⇒ "ProgramBody" in the navigation window.

■ Toolbar



■ ST editor

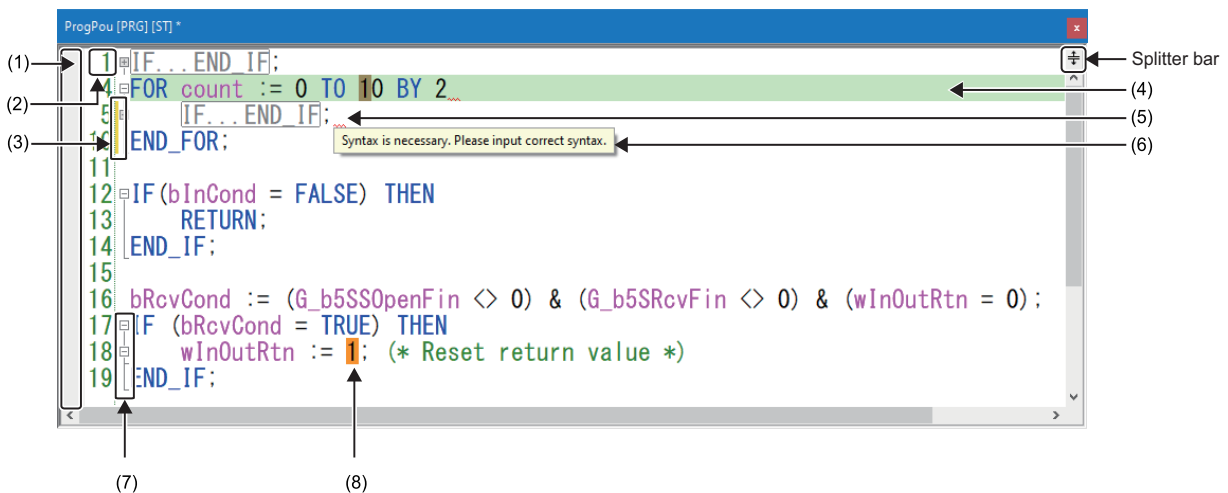

### Displayed items

Item	Description	Related operation
(1) Icon display area	The area to display icons	■ Icon type 📖 Page 310 Icon type
(2) Line number	The line numbers of a program	■ Changing display contents [Tool] ⇒ [Options] ⇒ "Program Editor" ⇒ "ST Editor" ⇒ "Editor Display Items"
(3) Change tracking	The head of a line where the program has been changed is highlighted.	
(4) Highlighted display	The line on which the cursor is placed is highlighted.	
(5) Error display	A syntax error of the program is displayed.	

Item	Description	Related operation
(6) Tool hint	Information where the mouse cursor is placed over is displayed.	<ul style="list-style-type: none"> <li>■ Changing display contents [Tool] ⇒ [Options] ⇒ [Program Editor] ⇒ "ST Editor" ⇒ "Tool Hint"</li> <li>■ Hierarchy display setting for structure comments [Tool] ⇒ [Options] ⇒ "Other Editor" ⇒ "Label Editor Common" ⇒ "Display Setting" ⇒ "Hierarchy Display Setting for Structures Comment"</li> </ul> By setting this option to "In Order of Instance -> Member" or "In Order of Member -> Instance," label comments for a structure and structure member can be displayed together when selecting a range of the structure member.
(7) Outline display	Symbols to display/hide the text blocks are displayed. (Outlines can be nested up to 130 levels.)	<ul style="list-style-type: none"> <li>■ Show/Hide               <ul style="list-style-type: none"> <li>• [Tool] ⇒ [Options] ⇒ "Program Editor" ⇒ "ST Editor" ⇒ "Editor Display Items"</li> <li>• [View] ⇒ [Outline] ⇒ [Show/Hide of Outlines]</li> </ul> </li> </ul>
(8) Incremental search	A searched keyword is highlighted.	<ul style="list-style-type: none"> <li>■ Find               <ul style="list-style-type: none"> <li>• Page 317 Incremental search</li> </ul> </li> </ul>

**Point**

- An ST editor can horizontally be split into two screens by either of the following operations:
  - Select [Window] ⇒ [Split].
  - Drag the splitter bar downward or double-click it.
 To restore the split, drag the splitter bar to the top/bottom of the ST editor.
- A screen can be scrolled horizontally by scrolling the mouse wheel while pressing the **[Shift]** key.
- "Insert mode" and "Overwrite mode" can be switched by selecting the following menu:
  - [Edit] ⇒ [Switch Insert/Overwrite mode]

**Colors of programs (default)**

Figure	Description	Default color
<pre> 1 IF M12 THEN 2   g_btn01 := TRUE; 3 ELSE 4   g_btn01 := FALSE; 5 END_IF 6 7 FbPou_1 ( 8   mot1 := hoo1; 9   mot2 := K1; 10  mot3 := "ABC"; 11 ); 12 (* LDFB1 Function block *)           </pre>	(1) Control syntax	Blue
	(2) Device	Black
	(3) Operator	Black
	(4) Global label	Magenta
	(5) Error	Red
	(6) Local label	Magenta
	(7) Constant	Black
	(8) String constant	Black
	(9) Incremental search highlight	Light orange
	(10) Comment	Green
	(11) Change tracking	Yellow

**Point**

Font color, background color, and font can be changed.  
 Page 81 Checking and Changing Colors and Fonts

**Icon type**

Icon	Description
	This icon is displayed on the line jumped from the cross reference window.
	This icon is displayed on the error line jumped from the "Output" window.



## ■ Keywords for collapse and automatic indent

A line can be outlined and displayed collapsed by using the keywords shown below.

Additionally, pressing the  key in a control syntax inserts an indent automatically.

Category	Start	End	Automatic indent
Comment texts	(*	*)	×
	/*	*/	×
Selection statement	IF	END_IF	○
	CASE	END_CASE	○
While loop	FOR	END_FOR	○
	WHILE	END_WHILE	○
	REPEAT	END_REPEAT	○

## Entering programs

This section explains the entering method of an ST program.

For the functions/instructions used in ST programs, refer to the following:

📖 MELSEC iQ-R Programming Manual (Program Design)

📖 MELSEC iQ-F FX5 Programming Manual (Program Design)

### Point

- By pressing **Ctrl** + **Shift** + **=** keys, an assignment operator (:=) can be entered.
- By selecting a row, then pressing the **Shift** + **Alt** + **↑**/**↓** keys or dragging the mouse while pressing the **Alt** key, multiple rows can rectangularly be selected.  
They also can be edited simultaneously. (👉 Page 316 Editing multiple rows simultaneously)
- By pressing the **Ctrl** + **Shift** + **↑**/**↓** keys, a row of the cursor position can be moved upward or downward.

### Precautions

When an ST editor is set to read-only or monitoring, the program cannot be edited.

### Inserting instructions, functions, and control syntax

There are two methods for entering instructions, functions, and control syntax: entering texts using keyboard<sup>\*1</sup> and dragging and dropping them in the element selection window.

The input control syntax, operators, devices, and TRUE/FALSE are changed to the upper-case characters automatically, and a program will be in the unconverted state.

However, when multiple rows are rectangularly selected and edited, they are not changed to the upper-case characters.

Labels can be entered with aliases.

\*1 Options of instructions/labels are displayed by pressing the **Ctrl** + **Space** keys.

In addition, by selecting "Yes" for the following option, when entering the description of a device comment, label comment, or instruction, ones for which the data has been set can be displayed as options.

[Tool] ⇒ [Options] ⇒ "Edit" ⇒ "Instruction/Device/Label Candidacy Display" ⇒ "Candidate Display Setting" ⇒ "Display the Corresponding Device in Entering Device Comment"

### ■ Specification method for data type of device

The data type of a word device is normally handled as INT (Word [Signed]) on an ST editor.

By adding a device type specifier, which indicates a device type, to a device name, a device storing 32-bit integer or real number can be described directly in an operation formula.

For details, refer to the following:

📖 MELSEC iQ-R Programming Manual (Program Design)

📖 MELSEC iQ-F FX5 Programming Manual (Program Design)

## Inserting a function block

The following shows the procedure for inserting a function block to an ST program.

For the creation method of a program in a function block, refer to the following:

📖 Page 484 Creating a Function Block

### Operating procedure

1. Drag and drop a function block from the navigation window or element selection window onto any position in an ST editor.
2. Enter the information of a label (FB instance)<sup>\*1</sup> in the "Undefined Label Registration" screen.
3. Enter the values for the input variables and output variables.

\*1 If the definition name of the function block includes any of the following symbols, the symbol is replaced with an underscore (\_) in the "Label Name" column: plus sign (+), minus sign (-), exclamation mark (!), left round bracket ((), right round bracket()), or backquote (`).

#### Ex.

When the defined function block is "MYTIMER"

[Details of defined function block]

Label name: FB\_MYTIMER

Input variable: Setting\_value\_1\_second, Setting\_value\_10\_seconds, Setting\_value\_100\_seconds, Timer\_Start, Timer\_Stop

Output variable: In\_operation, Timer\_up\_1, Timer\_up\_2

The example of entering ST program are shown below.

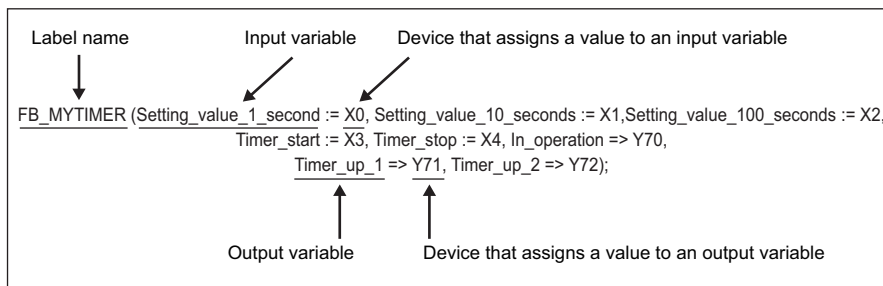

The output of the function block can be obtained by specifying the output variable name with a period (.) suffixed to the function block name.

Enter an instruction to obtain the output after performing the function block call.

```
Y70 := FB_MYTIMER.In operation;
```

### ■ Displaying/setting FB properties

FB properties can be displayed and set in the "FB Property" window.

For details, refer to the following:

📖 Page 375 Display/setting an FB property

### ■ FB property management (offline)

Initial values of FB properties saved in a project can be exported to a CSV file in the "FB Property Management (Offline)" screen. In addition, the initial values of FB properties can be imported from the CSV file, and the values can be applied to the initial values of FB properties in the project.

For details, refer to the following:

📖 Page 397 FB property management (offline)

## Inserting a function

The following shows the procedure for inserting a function in an ST program.

For the creation method of a FUN program, refer to the following:

 Page 504 Creating a Function

### Operating procedure

1. Drag and drop a function from the navigation window or element selection window onto any position in an ST editor.
2. Enter the arguments.

## Inserting an indention

A tab is inserted as an indentation at the head of a new line automatically when a line feed is inserted during program editing.

The tabulator length can be set in the following option setting.

- [Tool] ⇒ [Options] ⇒ "Program Editor" ⇒ "ST Editor" ⇒ "Edit Operation"

## Inserting comments

Enter a comment which does not affect the program processing. Or, comment out/uncommented the already entered programs in a batch.

### Operating procedure

#### ■ Entering comments

- When the line is one: Enter a comment after entering slashes '//'.  
• When specifying the range: Enclose the comment in '/\*' and '\*/', or '(\*' and '\*).'

#### ■ Batch comment out/uncomment of a program

1. Select a range to be commented out or uncommented. (Multiple lines can be selected.)
2. [Edit] ⇒ [Comment Out of the Selected Range] ()/[Disable Comment Out of Selected Range] ()

## Registering an undefined label

When entering an undefined label, the "Undefined Label Registration" screen appears and the label can be registered in a label editor. (  Page 247 Registering an undefined label)

## Displaying syntax templates

'Syntax template' is the format of control syntax and data types of arguments which are defined in each instruction, function, and operator.



In an ST editor, the syntax template of inserted instructions and others can be displayed.

### Operating procedure

1. Select the token of which syntax template is to be displayed.
2. Select [Edit] ⇒ [Display Template] (.
3. Enter the arguments in accordance with the displayed template.

Delete the data type name enclosed with '?,' and enter a label name or device corresponding to its data type.

### Point

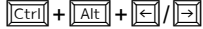
- Select [Edit] ⇒ [Mark Template (Left)] ()/[Mark Template (Right)] () , or press the  keys to select an argument of the template one by one.
- By selecting "Yes" for the following option, a syntax template is displayed with the arguments aligned vertically.
  - "Program Editor" ⇒ "ST Editor" ⇒ "Edit Operation" ⇒ "Vertically Align Arguments for Displaying Template"

## Editing multiple rows simultaneously

By selecting multiple rows rectangularly, they can be edited simultaneously.

The following uses a procedure to change a value, to be substituted to a device, as an example.

**Ex.**

Changing a value to be substituted from 100 to 500.

### Operating procedure

1. Select multiple rows rectangularly by either of the following operations:
  - Press the **Shift** + **Alt** + **↑**/**↓** keys, then press the **Shift** + **←**/**→** keys.
  - Drag the mouse while pressing the **Alt** key.

```
1 IF wLabel1 = 20 THEN
2     D1:=100;
3     D0:=100;
4     D2:=100;
5     D3:=100;
6 END_IF;
```

2. Enter '5.'

```
1 IF wLabel1 = 20 THEN
2     D1:=500;
3     D0:=500;
4     D2:=500;
5     D3:=500;
6 END_IF;
```

### Point

When selecting multiple rows rectangularly without including a character string, the operation differs depending on the edit mode.

Example: When placing the cursor between operators and '100' and selecting rectangularly, then entering '5'

- Insert mode

```
1 IF wLabel1 = 20 THEN
2     D1:=100;
3     D0:=100;
4     D2:=100;
5     D3:=100;
6 END_IF;
```

```
1 IF wLabel1 = 20 THEN
2     D1:=5100;
3     D0:=5100;
4     D2:=5100;
5     D3:=5100;
6 END_IF;
```

- Overwrite mode

```
1 IF wLabel1 = 20 THEN
2     D1:=100;
3     D0:=100;
4     D2:=100;
5     D3:=100;
6 END_IF;
```

```
1 IF wLabel1 = 20 THEN
2     D1:=500;
3     D0:=500;
4     D2:=500;
5     D3:=500;
6 END_IF;
```

# Searching for/replacing data in a program

The search functions that can be used in ST editor are as follows.

Function name	Description	Reference
Jump	To specify a line number on an ST editor, and move to the corresponding line.	Page 317 Jump
Incremental search	To highlight a searched keyword.	Page 317 Incremental search
Cross reference	To check a declaration location and a reference location of a device* <sup>1</sup> and a label in a list.	Page 445 SEARCHING FOR DATA
Device list	To check the usage of devices being used* <sup>1</sup> .	
Find and replace	<ul style="list-style-type: none"> <li>To search for and replace a device name*<sup>1</sup>, label name, instruction name, and character string.</li> <li>To change contacts between open contact and close contact</li> <li>To replace devices in a batch.</li> </ul>	

\*1 It is searched with a device name excluding a device type specifier.

## Jump

Specify a line number and move the cursor on an ST editor.

### Operating procedure

1. Select [Find/Replace] ⇒ [Jump].
2. Enter a line number of the program in the "Jump" screen, and click the [OK] button.

## Incremental search

Specify a keyword to highlight it.

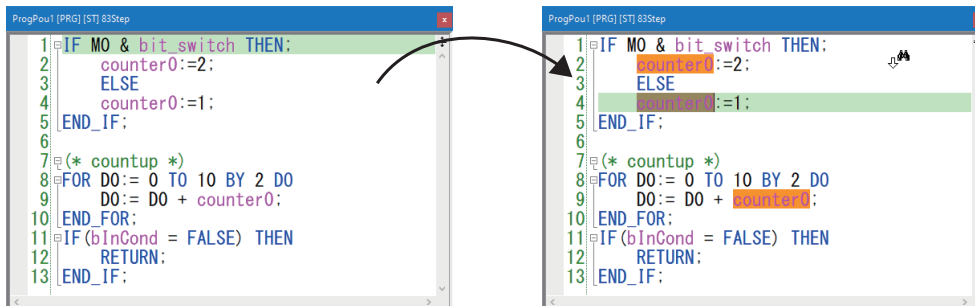

### Operating procedure

1. Press the **Ctrl** + **F** keys.  
The icon of the mouse cursor changes to , and an ST editor is switched to the incremental search mode.
2. Enter a keyword to be highlighted directly.  
The corresponding location to the entered keyword is highlighted. (Up to 3000 keywords)
3. Press the **Ctrl** + **F** keys to jump to a lower keyword.  
Press the **Shift** + **Ctrl** + **F** keys to jump to an upper keyword.
4. Press the **Esc** key to end the incremental search mode.

### Point

Searching and jumping can also be performed by using the following menus:

- ST editor: [Find/Replace] ⇒ [Incremental Search] ⇒ [Search Down]/[Search Up]
- Inline structured text in a ladder editor: [Find/Replace] ⇒ [Inline Structured Text] ⇒ [Incremental Search] ⇒ [Search Down]/[Search Up]

# Displaying instruction help

---

The instructions used in an ST program can be checked in e-Manual Viewer.

To check the instructions, the file of the corresponding manual must be registered in e-Manual Viewer.

The applicability of help display is shown below.

○: Applicable, ×: Not applicable

Token type	Applicability
Operator	×
Control syntax	×
Function	○
Function block	○
Constant, variable, comment	×

## Operating procedure

1. Place the cursor on the token of the target instruction.
2. Press the  key.

### Point

If a help file is associated with a function or function block, the help file opens. ( Page 133 Associating data with a help file)

---



# 6.5 Creating an FBD/LD Program

This section explains the creation method of an FBD/LD program.

The details on the specification of FBD/LD program are described in the following manual. Please read it in advance.

📖 MELSEC iQ-R Programming Manual (Program Design)

📖 MELSEC iQ-F FX5 Programming Manual (Program Design)

In the FBD/LD program with the process control extension enabled, the process control function blocks can be used.

For details, refer to the following:

📖 Page 24 Settings for using process control functions

## Point

The display format and detailed operation settings for each function can be set by setting the following option.  
 [Tool] ⇒ [Options] ⇒ "Program Editor" ⇒ "FBD/LD Editor"

## Configuration of an FBD/LD editor

FBD/LD editor is a graphical language editor to create programs by combining Function Block Diagram language with Ladder Diagram language.

Programs can be created only by placing the prepared elements vertically and horizontally, and connecting them.

### Window

Select "Program" ⇒ "(execution type)" ⇒ "(program file)" ⇒ "(program block)" ⇒ "(worksheet)" in the navigation window.

■ Toolbar



■ FBD/LD editor

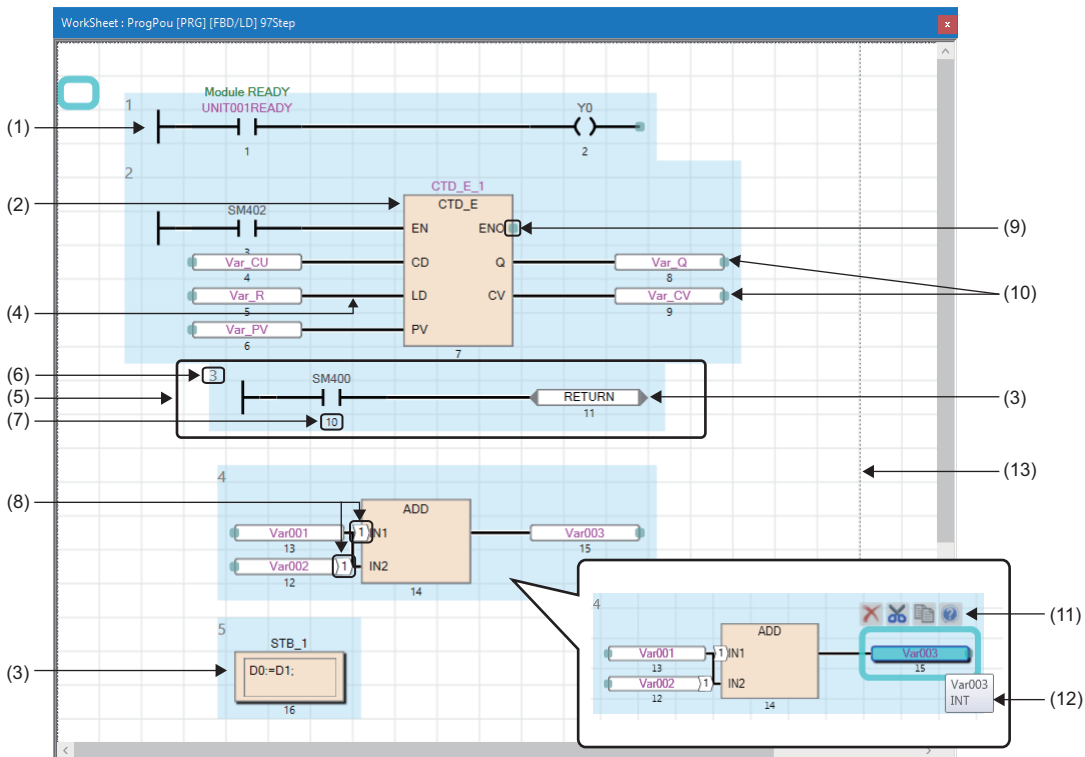

## Displayed items

Item	Description	Editing operation
(1) LD element	An element that constitutes a ladder program ☞ Page 321 LD element	■Editing method: Page 325 Entering programs
(2) FBD element	An element that constitutes an FBD program ☞ Page 322 FBD element	
(3) Common element	A common element that helps creating an FBD/LD program ☞ Page 323 Common element	
(4) Connection line	A line that connects the connection points between elements. It is displayed by placing an element to be connected closer to the connection point on the connection target.	■Editing method: Page 327 Common operations of elements
(5) FBD network block	A single FBD network block composed of all elements connected each other or elements that perform any processing independently (such as a function block and a jump label). Maximum 4096 FBD network blocks can be created in a program.	■Release from an FBD network block: Select an element to be released, and move it with the <b>[Shift]</b> key held down. ■Layout adjustment: Page 335 Layout correction
(6) FBD network block No. <sup>*1,*2</sup>	A number assigned for each FBD network block in order from upper left to lower right on the editor is displayed.	—
(7) Execution order <sup>*1,*2</sup>	The program execution order is displayed.	—
(8) Automatic connector	It is automatically displayed when a connection line cannot be displayed due to the positions of elements. Elements with same number indicates that they are connected.	—
(9) Connection point	A terminal point of when connecting elements with a connection line. By adding an element while a connection point is being selected, the element can be added with it connected already.	■Inverting: Page 326 Switching methods for contacts/ instructions
(10) Grid <sup>*1,*2</sup>	A grid line that serves as makers to place the elements	—
(11) Smart tag <sup>*2</sup>	An operation button displayed around the selected element. Relevant functions can be performed by clicking the button.	—
(12) Tool hint <sup>*2</sup>	The information on device/label and FB/FUN where the mouse cursor is placed over is displayed.	—
(13) Page break <sup>*1</sup>	A line that indicates a page break for printing (☞ Page 95 Printing FBD/LD programs)	—

\*1 Shown or hidden by selecting in the [View] menu.

\*2 Shown or hidden according to the setting in [Tool] ⇒ [Options] ⇒ "Program Editor" ⇒ "FBD/LD Editor."

### Point

Font color, background color, and font can be changed.

However, for a comment element, only font color and background color can be changed.

☞ Page 81 Checking and Changing Colors and Fonts

By pressing the **[Ctrl]** + **[↑]** / **[↓]** / **[→]** / **[←]** keys, the cursor can be moved on the editor without selecting elements.

## Elements

The following tables show the usable elements in an FBD/LD program.

### ■LD element

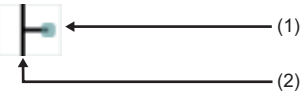
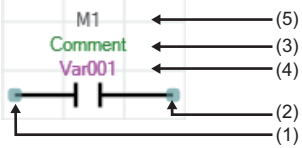
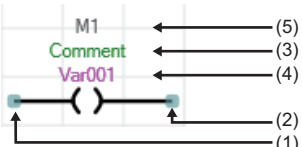

Element	Name of each part	Description
Left power rail element 	(1) Output connection point (2) Left power rail	The position of a left power rail can be placed at will, and it will be the starting point for creating a ladder program.
Contact element 	(1) Input connection point (2) Output connection point (3) Label comment/device comment <sup>*1,*2,*3</sup> (4) Device/label <sup>*3</sup> (5) Assigned device <sup>*1,*2</sup> (Only for global labels to which devices are assigned)	Specify the device/label. It transmits the ON/OFF signal according to the specified information. For details on the element, refer to the following: ■MELSEC iQ-R Programming Manual (Program Design) ■MELSEC iQ-F FX5 Programming Manual (Program Design)
Coil element 		Specify the device/label. It outputs the signal to the specified device/label according to the transmitted ON/OFF signal. For details on the element, refer to the following: ■MELSEC iQ-R Programming Manual (Program Design) ■MELSEC iQ-F FX5 Programming Manual (Program Design)

\*1 Shown or hidden by selecting in the [View] menu.

\*2 Shown or hidden according to the setting in [Tool] ⇒ [Options] ⇒ "Program Editor" ⇒ "FBD/LD Editor."

\*3 A comment or others can be wrapped according to the setting in [Tool] ⇒ [Options] ⇒ "Program Editor" ⇒ "FBD/LD Editor."

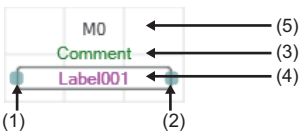
## ■ FBD element

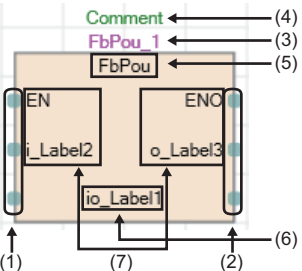
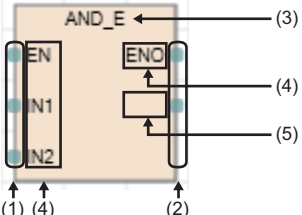
Element	Name of each part	Description
Variable element 	(1) Input connection point (2) Output connection point (3) Label comment/device comment <sup>*1,*2,*3</sup> (4) Device/label (5) Assigned device <sup>*1</sup> (Only for global labels to which devices are assigned)	Specify the device/label. Information can be obtained/stored in the specified device/label. It is switched to a constant element by entering a constant.
Constant element 	(1) Output connection point (2) Constant value	Specify a constant. The specified constant can be output. It is switched to a variable element by entering a device/label.
Function block element 	(1) Input connection point (2) Output connection point (3) FB instance name (label) <sup>*5</sup> (4) Label comment <sup>*1,*2</sup> (5) Data type (6) Input/output label (VAR_IN_OUT) <sup>*4</sup> (7) Input/output label (other than VAR_IN_OUT) <sup>*4</sup>	Indicates a block for function corresponding to the data type. It is used with an FB instance name assigned to each element. For details on the element, refer to the following: ☞ Page 482 SEGMENTING PROGRAMS The width of an element can be changed. (☞ Page 332 Changing the element size) The height of an element can be changed. (☞ Page 334 Changing the height of an element)
Function element 	(1) Input connection point (2) Output connection point (3) Data type (4) Input/output label (argument) <sup>*4</sup> (5) Return value	Indicates a block for function corresponding to the data type. The name is not displayed in the return value. For details on the element, refer to the following: ☞ Page 482 SEGMENTING PROGRAMS The width of an element can be changed. (☞ Page 332 Changing the element size) The height of an element can be changed. (☞ Page 334 Changing the height of an element)

\*1 Label comments of FB instances can be displayed by selecting the following menu:

[View] ⇒ [Comment Display] ⇒ [Device/Label Comment]

They can also be displayed by setting "Yes" for the following option:

[Tool] ⇒ [Options] ⇒ "Program Editor" ⇒ "FBD/LD Editor" ⇒ "Comment" ⇒ "Display Item" ⇒ "Display Label/Device Comment"

\*2 A comment or others can be wrapped according to the setting in [Tool] ⇒ [Options] ⇒ "Program Editor" ⇒ "FBD/LD Editor."

\*3 Label comments for a structure and its member can be displayed together by setting this option to "In Order of Instance -> Member" or "In Order of Member -> Instance":

[Tool] ⇒ [Options] ⇒ "Other Editor" ⇒ "Label Editor Common" ⇒ "Display Setting" ⇒ "Hierarchy Display Setting for Structures Comment"

\*4 The display format for Input/output labels can be changed to their label comments by selecting the following menu:

[View] ⇒ [Comment Display] ⇒ [Switch FB/FUN Argument]





They can also be changed by setting "Yes" for the following option:

[Tool] ⇒ [Options] ⇒ "Program Editor" ⇒ "FBD/LD Editor" ⇒ "Comment" ⇒ "Display Item" ⇒ "Switch FB/FUN Argument to Comment"

\*5 An FB instance name can be changed by double-clicking the name.

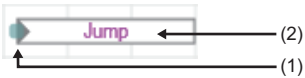
### Common element

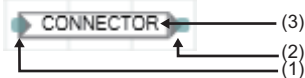
For a jump element and a return element, inverting contact on its connection point is not available.

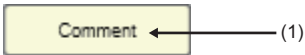
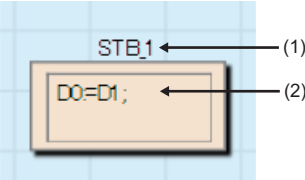
Element	Name of each part	Description
Jump element 	(1) Input connection point (2) Label*1	It is used to jump the execution processing from a jump element to a jump label element.
Jump label element 	(1) Label*1	Enter a label to be specified as the jump destination.
Connector element 	(1) Input connection point (2) Output connection point (3) Connector label	It is used instead of a connection line when placing an FBD network block in the display range or print range on an editor. The same connector label indicates that they are connected.
Return element 	(1) Input connection point (2) Character string, "RETURN" (Not editable)	It is used to suspend the processing in the middle of processing.
Comment element 	(1) Comment display area	It is used to enter a comment. Up to 2000 characters can be entered in a comment element. The frame size of a comment can be adjusted automatically according to the comment length by double-clicking the frame. It can be changed manually as well. (☞ Page 332 Changing the element size)
Inline structured text element 	(1) Data name (2) Preview display area	It is used to create an inline structured text program. For details on the element, refer to the following: ☞ Page 328 Inserting an inline structured text element The size of an element can be changed. (☞ Page 332 Changing the element size)

\*1 Only local label that "Pointer" is selected for "Data Type" can be used. In addition, the members of a structure cannot be used.

#### Point

The settings of the comment element color and text layout can individually be changed by using smart tags.

- To set the font color, click the smart tag (1).
- To set the background color, click the smart tag (2).
- To set the text layout, click a smart tag (4) to (9).
- To return the settings of colors and text layout which were individually changed to the default, click the smart tag (3).

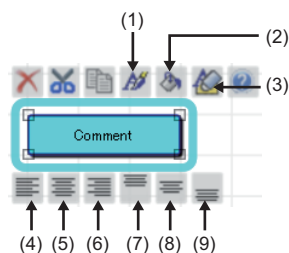

- (1): Font Color
- (2): Background Color
- (3): Clear Format
- (4): Align Left
- (5): Align Center
- (6): Align Right
- (7): Align Top
- (8): Align Middle
- (9): Align Bottom

## Precautions

When the following contents are changed by using a menu or setting an option, the display of a label name, device, comment, or assigned device of an element may overlap with those of another element. In that case, arrange the position of those elements.

- Whether or not to display an assigned device
- Whether or not to display a device/label comment
- Number of rows to display a device/label comment
- Number of wrapping rows for device/label name
- Number of cells for device/label name
- Number of wrapping rows for instance name
- Number of cells for instance name

# Entering programs

This section explains the entering method of an FBD/LD program.

## Adding elements

### Operating procedure

#### ■Using the edit box

Select<sup>\*1</sup> a cell that the element is to be added, then enter a label name or data type of FB/FUN directly.

An element name and label name can be edited directly by selecting a placed element and pressing the **F2** key.

The following items can be entered:

- Device
- Label/assigned device (  Page 327 Displaying a global label entered by using an assigned device)
- Constant
- FB/FUN
- Instruction
- Data name of an inline structured text element

\*1 Options of instructions/labels are displayed by pressing the **Ctrl** + **Space** keys.

In addition, by selecting "Yes" for the following option, when entering the description of a device comment, label comment, or instruction, ones for which the data has been set can be displayed as options.

[Tool] ⇒ [Options] ⇒ "Edit" ⇒ "Instruction/Device/Label Candidacy Display" ⇒ "Candidate Display Setting" ⇒ "Display the Corresponding Device in Entering Device Comment"

#### ■Inserting from the menu or on the toolbar

Select a cell to which an element is to be added on an FBD/LD editor, then select [Edit] ⇒ [Add Element (Ladder Symbol)] ⇒ [(element)]. It can also be added by selecting from the toolbar.

#### ■Inserting from the element selection window

Select an element in the element selection window, and drag and drop it onto an FBD/LD editor.

#### ■Inserting a function block

1. Drag and drop a function block from the navigation window or element selection window onto any position in an FBD/LD editor.
2. Enter the information of a label (FB instance)<sup>\*1</sup> in the "Undefined Label Registration" screen.
3. Connect variable elements to input/output arguments.

For the creation method of a program in a function block, refer to the following:

 Page 484 Creating a Function Block

\*1 If the definition name of the function block includes any of the following symbols, the symbol is replaced with an underscore (\_): plus sign (+), minus sign (-), exclamation mark (!), left round bracket ((), right round bracket()), or backquote (`).

## Switching methods for contacts/instructions

Select a contact/instruction to be switched, and select [Edit] ⇒ [Easy Edit] ⇒ [Invert Contact (Open/Close)](🔄)/[Switch Pulse](⏏)/[Switch SET and RST](⚙️) or follow the methods shown below.

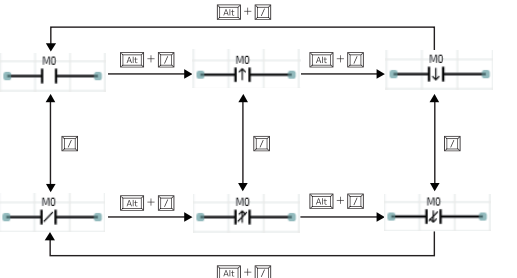
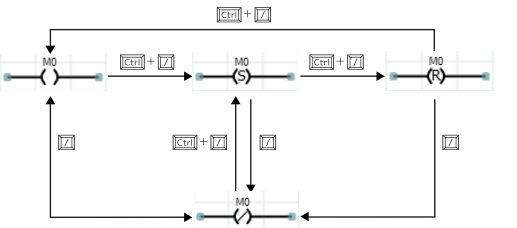
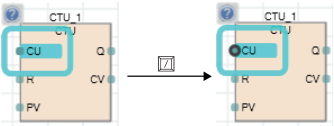
Switching contacts and instructions	Shortcut key	Remarks
Switching open/close contact, raising/falling pulse		—
Inverting contact, switching SET/RST instructions		—
Inverting contact on connection point of FB/FUN		<p>Only when the data type of the connection point is one of the following:</p> <ul style="list-style-type: none"> <li>• Bit</li> <li>• Word [Unsigned]/Bit String [16-bit]</li> <li>• Double Word [Unsigned]/Bit String [32-bit]</li> <li>• ANY_BIT</li> <li>• ANY_BOOL</li> </ul>



## ■Displaying a global label entered by using an assigned device

By entering a device which was assigned as a global label to a program, the global label of the device can be displayed in the program.

Note that, only global labels whose data type is the simple type with no array can be displayed.

Enter an assigned device after changing the entering method by one of the following option, then the global label is displayed.

- [Edit] ⇒ [Edit Mode] ⇒ [Use Assigned Device for Label Input]()
- [Tool] ⇒ [Options] ⇒ "Program Editor" ⇒ "FBD/LD Editor" ⇒ "Enter Element" ⇒ "Operational Setting" ⇒ "Use assigned device for label input"

## ■Specification method for data type of device





































In an FBD/LD editor, data type can be specified for a word device by adding a device type specifier, which indicates a data type, to a device name.

For details, refer to the following:

 MELSEC iQ-R Programming Manual (Program Design)

 MELSEC iQ-F FX5 Programming Manual (Program Design)

## Common operations of elements

Operation		Operating procedure	
		Mouse	Keyboard
Select	To select a single element	Click an element to be selected.	Move the cursor on an element to be selected.
	To select multiple elements	<ul style="list-style-type: none"> <li>• Click multiple elements with the  /  key held down.</li> <li>• Click the background of an FBD/LD editor, and drag the mouse diagonally around all elements to be selected.</li> </ul>	Select multiple elements by moving the cursor with the  key held down.
	To select an FBD network block <sup>*1</sup>	Click an element, and select [Edit] ⇒ [Select FBD Network Block].	Select an element and press the  +  +  keys.
	To select all elements	The operation is the same as that for selecting multiple elements.	Press the  +  keys.
Change a name		Double-click an element of which the name is to be changed, and enter a new name.	Select an element of which the name is to be changed, and press the  <sup>*2</sup> or  key, then enter a new name.
Move		Drag and drop an element. (By moving an element with the  key held down, it can be separated moved from the FBD network block. The elements that were connected to the moved element are automatically connected. <sup>*3</sup> )	Select the element to be moved, and press the  +  +  /  /  /  keys.
Copy		Drag and drop an element to be copied with  held down.	Press the  +  keys, then select the copy destination and press the  +  keys. (Copy + paste)
Delete		—	Select an element to delete, and press the  key. The elements that were connected to the deleted elements are automatically connected. <sup>*3</sup> )
Connection line	To connect	Click a connection point, and drag it to a target connection point.	Select a connection point or selection line. Then, move the cursor to a target connection point by pressing the  +  /  /  /  keys.
	To connect automatically <sup>*3</sup>	Click an element to be connected, and drag it closer to a target connection point. However, even if an element gets closer to another element when changing the size of the element, they are not connected.	—
	To replace	Select a connection line with the  key held down, and drag and drop it on the connection point of an element.	Select a connection point or selection line. Then, move the cursor to a target connection point by pressing the  +  +  /  /  /  keys.
	To insert an element	Click an element, and drag and drop it to a connection line with the  key held down. (Only an element which has a connection point on the same level at the input/output side)	—
	To adjust manually	Click a connection line with the  key held down, and drag it to any position.	—

- \*1 Multiple FBD network blocks can be selected by selecting an FBD network block after selecting multiple elements. For an element which is not connected another element, the selection is canceled.
- \*2 For function element and function block element, this follows the operation for double-clicking, which is selected from [Tool] ⇒ [Options] ⇒ "Program Editor" ⇒ "FBD/LD Editor."
- \*3 A function to connect elements automatically using a connection line. Enabling or disabling this function can be changed in the following menu, [Edit] ⇒ [Edit Mode] ⇒ [Element Auto-connect]()

## Inserting an inline structured text element

Inline structured text is a function to edit or monitor an ST program by creating an inline structured text element that displays an ST program in an FBD/LD editor.

With this function, a numeric value operation or a character string process can be created easily in the FBD/LD program. In this manual, the ST program in an inline structured text element is referred to as an 'inline structured text program.'



### Operating procedure

1. Select [Edit] ⇒ [Add Element (Ladder Symbol)] ⇒ [Inline Structured Text] ()
2. Double-click the inserted inline structured text element.
3. Enter an inline structured text program in the displayed ST editor.

The display contents and editing method of the inline structured text program are the same as those of ST program.

( Page 309 Creating an ST Program)

### Point

- By entering '@STB' or 'STB' on the edit box, an inline structured text element can be inserted. ( Page 325 Using the edit box)
- Inline structured text elements can be copied and deleted in the same manner as other elements. ( Page 327 Common operations of elements)
- In an inline structured text program, a local label of an FBD/LD program using the inline structured text program can be used.
- An inline structured text program displayed in an ST editor can be switched by clicking another inline structured text element.

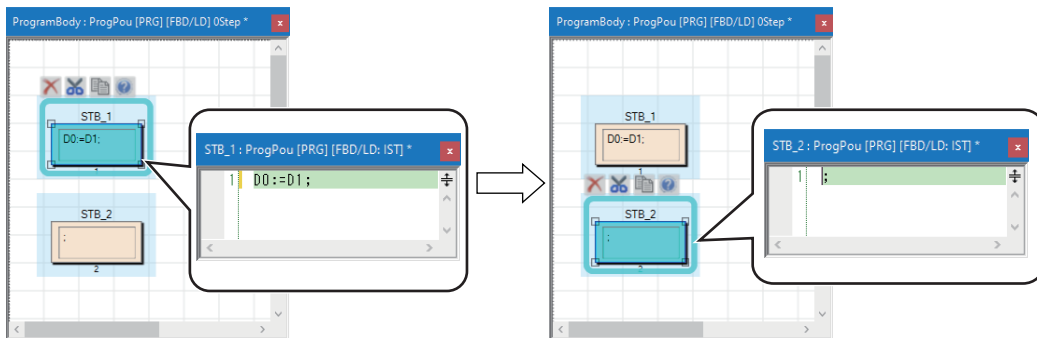

- When performing any of the following operations while an inline structured text program is displayed in an ST editor, the ST editor is displayed in gray:
  - Deleting an inline structured text element
  - Closing an FBD/LD editor in which an inline structured text element exists
  - Deleting an FBD/LD program in which an inline structured text element exists

## Precautions

- When copying and pasting an inline structured text element to the same FBD/LD editor, it is pasted with a different data name.
- A conversion error occurs in the following cases:
  - An inline structured text element with the data name of "???" exists.
  - 65 or more inline structured text elements exist in one program block.
- Highlighting for the change tracking of an inline structured text program is cleared in the following cases:
  - An inline structured text element is deleted.
  - The data name of an inline structured text element is changed to "???" by undoing/redoing.
- The label of which data type is pointer cannot be used in the inline structured text program.

## Displaying/setting FB properties

FB properties can be displayed and set in the "FB Property" window.

For details, refer to the following:

 Page 375 Display/setting an FB property

## FB property management (offline)

Initial values of FB properties saved in a project can be exported to a CSV file in the "FB Property Management (Offline)" screen. In addition, the initial values of FB properties can be imported from the CSV file, and the values can be applied to the initial values of FB properties in the project.

For details, refer to the following:

 Page 397 FB property management (offline)

## Replacing function elements/function block elements

### Operating procedure

1. Select a function element/function block element.
2. Select [Edit] ⇒ [Change FB/FUN Data], and enter the data type to be changed.

### Point



An element can also be replaced by dragging it from the element selection window and dropping it onto the element to be replaced.

For function elements, similarly, the data type can be changed by selecting a function element and entering a new data type directly.

## Adding/deleting arguments

Only for a function of which the number of arguments can be changed, an argument can be added or deleted.

### Operating procedure

1. Move the cursor on a function element.
2. Select [Edit] ⇒ [I/O Argument] ⇒ [Increment Argument] ()/[Delete Argument] ()

## Hiding arguments

Arguments (input/output labels) of function elements/function block elements can be hidden.

The arguments that can be hidden are as follows:

- Arguments of a function element: ENO, VAR\_OUTPUT
- Arguments of a function block element: ENO, VAR\_INPUT, VAR\_OUTPUT, VAR\_OUTPUT\_RETAIN

The following shows the operating procedure to hide arguments by using smart tags.

### Operating procedure

**1.** Select an argument to be hidden, and click  (Mark as Hidden). (Multiple selections allowed.)

The argument is set as a hidden target, and the color of its name is changed.

**2.** Select a function element/function block element, and click  (Hide Argument).

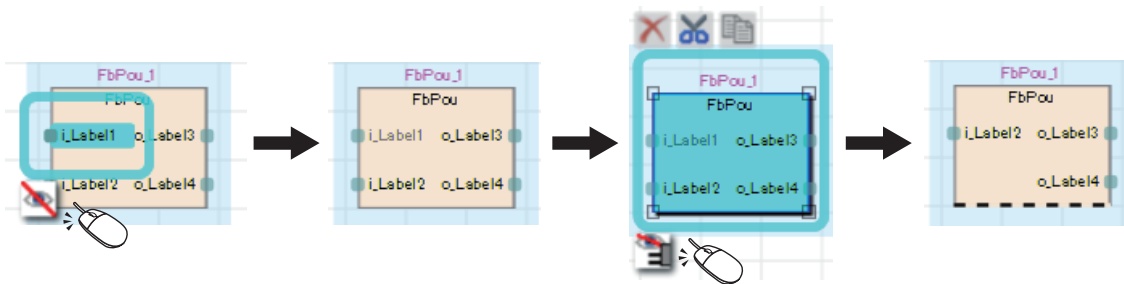

The argument which is set as a hidden target and also not connected to an element is hidden.

In addition, a dashed line is displayed under the function element/function block element.



6

### Point

- An argument can be excluded from hidden targets by selecting the argument and clicking  (Unmark as Hidden).
- A hidden argument can be displayed again by selecting the function element/function block element and clicking  (Show Argument).
- Arguments can also be displayed or hidden by using the following menus:
  - [Edit] ⇒ [I/O Argument] ⇒ [Mark as Hidden]
  - [Edit] ⇒ [I/O Argument] ⇒ [Unmark as Hidden]
  - [Edit] ⇒ [I/O Argument] ⇒ [Hide Argument]
  - [Edit] ⇒ [I/O Argument] ⇒ [Show Argument]
- When there is no argument set as the hidden target, all arguments which are not connected to an element are hidden by clicking  (Hide Argument).

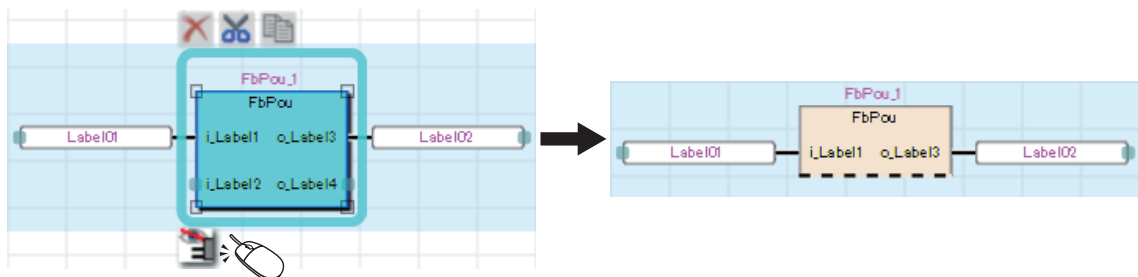

### Precautions

- When switching whether to display or hide arguments, the program will be in the unconverted state. In this case, the program execution order may be changed.
- When changing data of a function element/function block element or updating the definition information after hiding arguments, all arguments are displayed.

In addition, the argument displayed in the same position as the one marked as hidden before changing/updating is set as the hidden target. (Excluding arguments which cannot be hidden)

## FB/FUN whose definition is unclear

Once the definition of a function block element or function element is deleted or changed, the element is used as one whose definition is unclear and an error occurs when it is converted. The following shows a display example of a function block element whose definition is unclear.

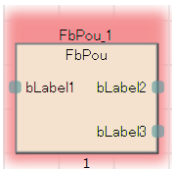

When the definition of an element is changed, select the element, then select [Edit] ⇒ [Update FB/FUN] and update the definition information.

When the definition of an element does not exist, select the element, then select [Edit] ⇒ [Change FB/FUN Data] and change the data.

## Adjusting position automatically

When an element is added or moved, the position is adjusted automatically to avoid the overlap with others.

When a rectangular area of an FBD network block (area added one cell for each directions, top, bottom, left, and right, of element connected using a connection line) overlaps with another area, the position is automatically arranged so that the entire blocks do not overlap.

However, comment elements can be superimposed since it is not subject for the automatic adjustment.

## Changing the element size

Grips (1) are displayed as shown below by selecting a comment element, inline structured text element, function element, or function block element, or by placing the cursor on the frame of an element. The size of each element can be changed by using the grips.

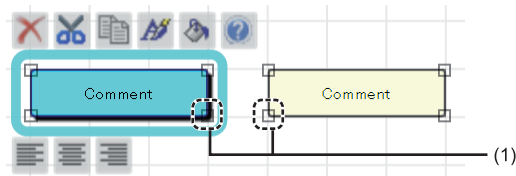

### Operating procedure

#### ■ Comment element/inline structured text element

**1.** Place the cursor on the frame of an element where the grips are displayed.

The icon of the cursor changes.

**2.** Move the cursor vertically and horizontally with the frame being held.

(For a comment element, the height and width must be one cell minimum, but there is no limitation on the maximum size.)

(For an inline structured text element, the height must be between 2 and 20 cells, and the width between 3 and 30 cells.)

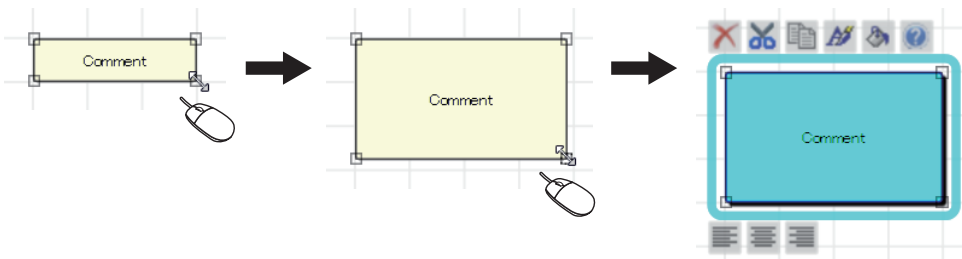

## ■Function element/function block element

1. Place the cursor on the frame of an element where the grips are displayed.  
The icon of the cursor changes.
2. Move the cursor vertically and horizontally with the frame being held. (Width: 3 cells minimum, 30 cells maximum)  
The operation can be canceled by pressing the **[Esc]** key while moving the cursor.

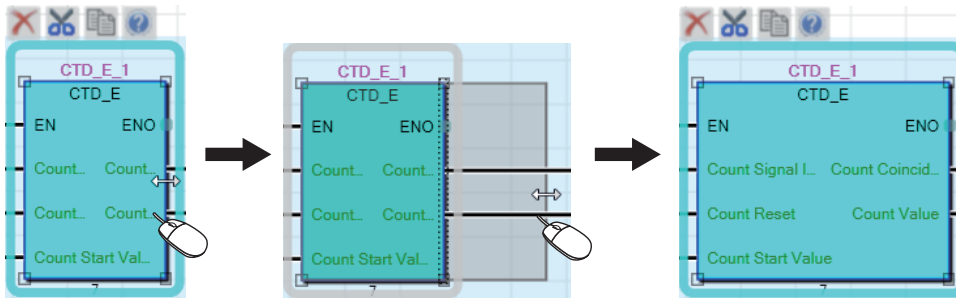

### Point

The size of an element can be adjusted automatically by double-clicking the frame of the element with its grips being displayed. (For a function element or function block element, the size will be adjusted so that the character strings of its data type and input/output labels are fully displayed.)

## Precautions

Once the size of an element is changed, the program will be in the unconverted state.

## Changing the height of an element

The space between input/output labels and variable elements can be adjusted, and the heights of function elements and function block elements can be changed.

The height can be selected from the following two types.

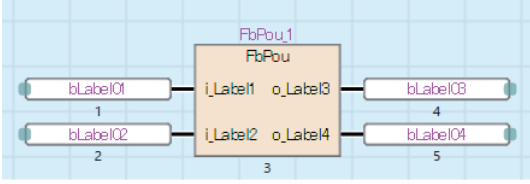
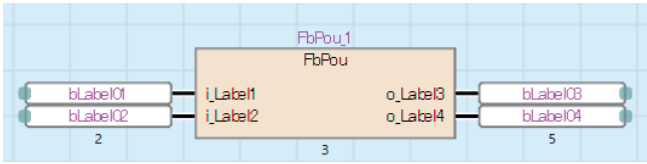
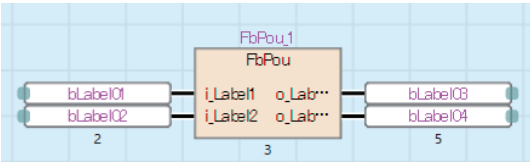
Type	Description	Display example
Normal	Input/output labels and variable elements are displayed with the default spacing.	
Compact	Input/output labels and variable elements are displayed with less spacing than the default.	<ul style="list-style-type: none"> <li>• When adapting the width according to the input/output labels</li> </ul>  <ul style="list-style-type: none"> <li>• When keeping the width according to the input/output labels</li> </ul> 

The following shows the operating procedure to change the height of a function element and a function block element.

### Operating procedure

1. Select a function element or a function block element. (Multiple selections allowed.)
2. Right-click it and select [Edit] ⇒ [Toggle FB/FUN Height] ⇒ [Adapt Width]/[Keep Width] from the shortcut menu.

#### Point

In an FBD/LD editor, the height can also be changed by selecting the following menu:

- [Edit] ⇒ [Toggle FB/FUN Height] ⇒ [Adapt Width]/[Keep Width]

By setting "Normal" or "Compact" for the following options, the height of a function element and a function block element to be added can be set in advance.

- [Tool] ⇒ [Options] ⇒ "Program Editor" ⇒ "FBD/LD Editor" ⇒ "Enter Element" ⇒ "Operational Setting" ⇒ "FB/FUN height"
- [Tool] ⇒ [Options] ⇒ "Program Editor" ⇒ "SFC Diagram Editor" ⇒ "Enter Element" ⇒ "Operational Setting" ⇒ "FB/FUN height"

### Precautions

If switching to the compact height, the execution order number may be hidden depending on the position of variable elements.

## Order of comment elements

When comment elements are overlapped, the comment element added later is displayed at the front.

The order of comment elements can be changed in [Edit] ⇒ [Order Comment] ⇒ [Bring to Front]/[Bring Forward]/[Send Backward]/[Send to Back].

After changing the order of comment elements, the elements will be in the unconverted state.



## Layout correction

### Operating procedure

#### ■Inserting a row

Select a cell in a row to be inserted, then select [Edit] ⇒ [Layout] ⇒ [Insert Row].

A new row is inserted on the selected cell.

#### ■Deleting a row

Select a cell in a row to be deleted, then select [Edit] ⇒ [Layout] ⇒ [Delete Row].

The row including the selected cell is deleted. When the row includes any elements, the row cannot be deleted.

#### ■Inserting/deleting a column

Move the cursor onto an FBD network block in which a column will be inserted/deleted, then select [Edit] ⇒ [Layout] ⇒ [Insert Column(in FBD network block)]/[Delete Column(in FBD network block)].

A column is inserted/deleted in the range of the FBD network block.

#### ■Inserting multiple rows

Select a cell in a row to be inserted, then select [Edit] ⇒ [Layout] ⇒ [Insert Multiple Rows].

Enter the number of rows to be inserted in the "Insert Multiple Rows" screen.

A new row is inserted on the selected cell.

#### ■Deleting multiple rows

Select a cell in a row to be deleted, then select [Edit] ⇒ [Layout] ⇒ [Delete Multiple Rows].

Enter the number of rows to be deleted in the "Delete Multiple Rows" screen.

The number of rows that has been set above is deleted from the row under the selected cell.

When the rows to be deleted include any element, a row upper than the row in which the element exists is deleted.

#### ■Correcting layout in an FBD network block

Select an FBD network block including elements to be corrected, and select [Edit] ⇒ [Layout] ⇒ [Layout Correction in FBD Network Block].

The layout in the selected FBD network block is corrected.

#### ■Correcting layout in an FBD network block in a batch

Select [Edit] ⇒ [Layout] ⇒ [Batch Correction of Layout in FBD Network Block].

The layout of all the FBD network blocks in the worksheet is corrected.

#### ■Deleting a blank row between FBD network blocks

Select [Edit] ⇒ [Layout] ⇒ [Delete the Blank Row Between FBD Network Blocks].

The row between an FBD network block or elements will be deleted.

#### ■Aligning FBD network blocks to the left side in a batch

Select [Edit] ⇒ [Layout] ⇒ [Batch Alignment of All FBD Network Blocks to the Left].

All FBD network blocks can be aligned to the left side of an FBD/LD editor.

When multiple FBD network blocks are included on the same line, the blank column between the blocks are retained.

#### Point

The details of 'Layout Correction in FBD Network Block' and 'Batch Correction of Layout in FBD Network Block' can be set in the following option.

- [Tool] ⇒ [Options] ⇒ "Program Editor" ⇒ "FBD/LD Editor" ⇒ "FBD Network Block" ⇒ "Layout Correction in FBD Network Block"

## Precautions

### ■ Execution order after correcting layout

When 'Layout Correction in FBD Network Block' or 'Batch Correction of Layout in FBD Network Block' is performed, the size or position of FBD network blocks is changed and that may cause the change of execution order.

Display the execution order to check if the order is changed before and after the layout change.

If the execution order is changed, move the position of the elements manually.

### ■ Situations where the layout cannot be corrected

Depending on the position of elements or option settings, 'bent connectors' and 'variable element that is connected to a function block or function' may not be arranged even when 'Layout Correction in FBD Network Block' or 'Batch Correction of Layout in FBD Network Block' is performed.

If the layout is not corrected after 'Layout Correction in FBD Network Block' is performed repeatedly, the elements should be moved manually.

A variable element\*1 is not corrected in the following situations.

- Another element was already placed in the position where an element is to be moved.

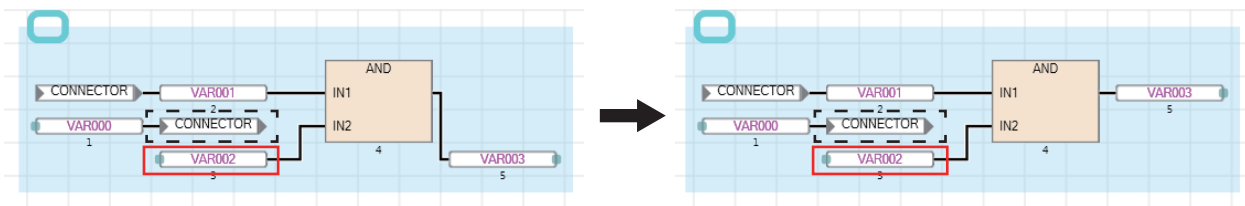

- Two or more variable elements are connected to one input or output argument.

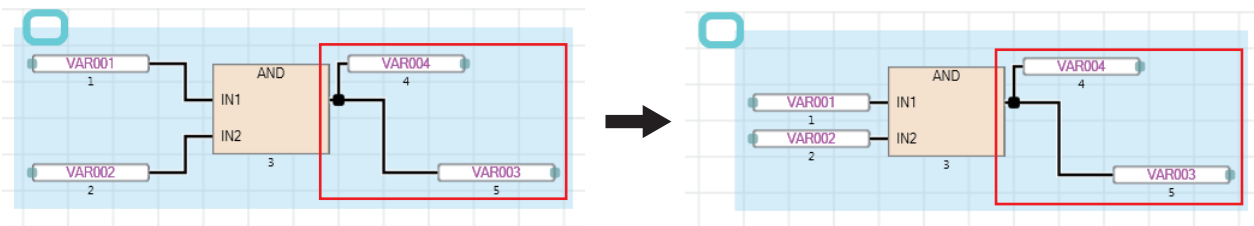

\*1 Whether or not to move a variable element can be set in the following option.

[Tool] ⇒ [Options] ⇒ "Program Editor" ⇒ "FBD/LD Editor" ⇒ "FBD Network Block" ⇒ "Layout Correction in FBD Network Block" ⇒ "Move the Position of Variable Elements to Connect to FB/FUN"

## Pasting from each screen

A label name/device name can be pasted by dragging and dropping in a label editor and device comment editor.

## Registering an undefined label

When entering an undefined label, the "Undefined Label Registration" screen appears and the label can be registered in a label editor. (Page 247 Registering an undefined label)

## Utilizing a tag FB

This section explains the method for utilizing a tag FB in an FBD/LD program for process control.

A tag FB is required to be registered on the tag FB setting editor in advance.

For details on registration of tag FBs, refer to the following:

☞ Page 249 Registering Tag FBs

### Operating procedure

1. Select an FB instance in the element selection window, then drag and drop it onto an FBD/LD editor.
2. Connect the tag FB instance to an input variable and an output variable.

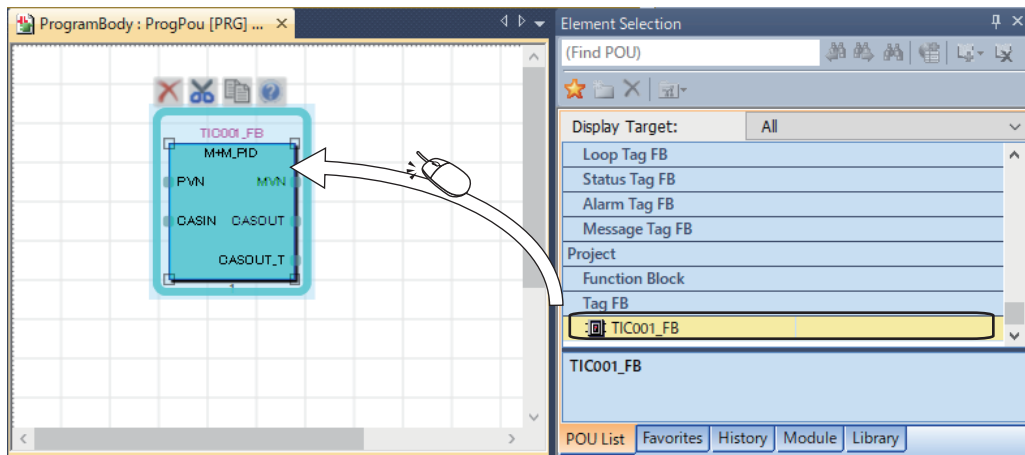

## Linking a comment

---

A comment element is simultaneously moved with an element by linking them.

A comment link can be set for an element except for a connection line, input/output argument of an FB/FUN, and comment element.

Multiple comment elements can be linked with a single element.

The link of a comment element can be set only for a single element.

To change the link of a comment element to another, release the link first.

### Linking a comment element with a single element

---

Set a link between a comment element and an element.

#### Operating procedure

1. Select a comment element and a single element. (Multiple selections allowed only for comment elements.)
2. Select [Edit] ⇒ [Easy Edit] ⇒ [Link Comment] ().

After this setting, the background of the linked comment element is changed.

### Releasing links

---

Releasing the links between a comment element and an element.

All links can be released by selecting an element linking with multiple comment elements and releasing them.

#### Operating procedure

1. Select a comment element linking with an element.
2. Select [Edit] ⇒ [Easy Edit] ⇒ [Unlink Comment] ().

After the setting, the link between a comment element and an element is released and the background color of the comment element is restored.

## Linking comment elements and elements in a batch

Set the links of unlinked comment elements in a batch in the active FBD/LD editor.

### Operating procedure

Select [Edit] ⇒ [Easy Edit] ⇒ [Comment Batch Link].

After this setting, the background of the linked comment element is changed.

### ■Conditions for determining the link target of a comment in a batch linking

In a batch linking, a comment element is automatically linked with an element that satisfies the following conditions in the order mentioned below.

1. The link is set to the closest element that is found by searching in the red frame (range with a width of one comment element and five cells to the right and the depth of the comment element and five cells downward). It is searched from the upper left of the range to lower right.
2. When no element is found in the procedure above, the link is set to the closest element that is found by searching in the blue frame (range with five cells to the left from one comment element and a depth of the comment element and five cells downward). It is searched from the upper right of the range to lower left.

Any link is not set if no element that is to be the link target is found in the conditions above.

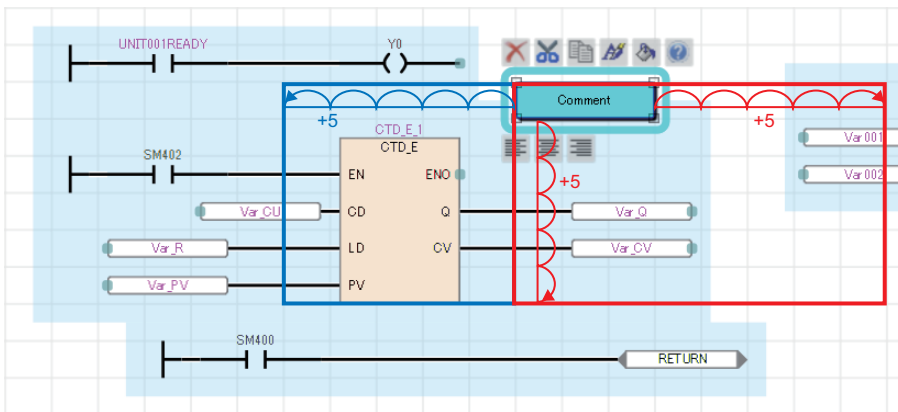

### Operation when linking comments

#### ■Selecting a single element in ones with links

By selecting an element with a link, all elements linking with it are selected.

To select one element without releasing the link, click the target element twice or select it with **Ctrl** held down.

#### ■Editing an element with a link

When copying a comment element and element that link each other, the link is remained after the copy.

When deleting a comment element or element that link each other, the link is released.

#### ■Correcting the element layout

When arranging the element layout by the following menu, the comment element linking with the element does not synchronize with it.

- [Edit] ⇒ [Layout] ⇒ [Insert Row]
- [Edit] ⇒ [Layout] ⇒ [Delete Row]
- [Edit] ⇒ [Layout] ⇒ [Insert Column(in FBD Network Block)]
- [Edit] ⇒ [Layout] ⇒ [Delete Column(in FBD Network Block)]
- [Edit] ⇒ [Layout] ⇒ [Insert Multiple Rows]
- [Edit] ⇒ [Layout] ⇒ [Delete Multiple Rows]

# Displaying FBD network blocks in a list

FBD network blocks in the active FBD/LD editor are displayed in a list.

To display a comment in the FBD network block list, the comment needs to link with the element of the FBD network block.

For details on the link of comments, refer to the following:

☞ Page 338 Linking a comment

## Window

Select [Find/Replace] ⇒ [FBD Network Block List].

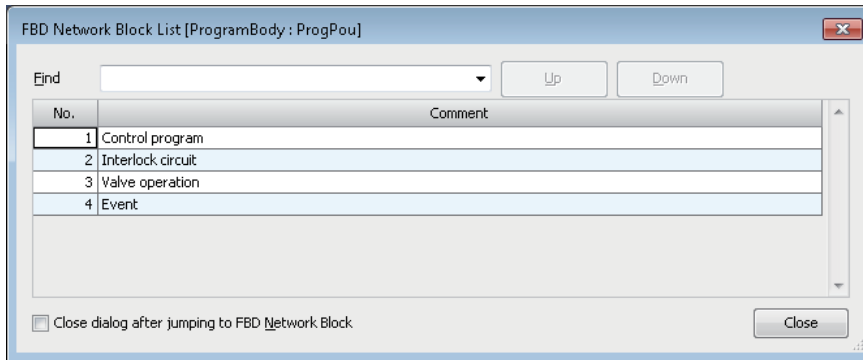

## Displayed items

Item	Description
No.	An FBD network block number*1 is displayed.
Comment	An element in the FBD network block and a comment linking with the element are displayed. When multiple comments are set to the linking element, the comment placed at the uppermost in the left side is displayed. Up to 500 characters can be displayed.

\*1 Select the following menu to display an FBD network block number on an FBD/LD editor.  
[View] ⇒ [FBD Network Block No. Display]

## Operating procedure

### ■ Jumping to an FBD network block

Double-click the row of an FBD network block to jump.

To close the "FBD Network Block List" screen after the jump, select the checkbox of "Close dialog after jumping to Network."

### ■ Searching for an FBD network block

Enter an FBD network block No. or a comment to search for, click the [Upward Search]/[Downward Search] button.

## Searching for/replacing data in a program

The search functions that can be used in FBD/LD editor are as follows.

Function name	Description	Reference
Cross reference	To check a declaration location and a reference location of a device and a label in a list.	Page 445 SEARCHING FOR DATA
Device list	To check the usage of devices being used.	
Find and replace	<ul style="list-style-type: none"><li>• To search for and replace a device name, label name, instruction name, and character string.</li><li>• To change contacts between open contact and close contact</li><li>• To replace devices in a batch.</li></ul>	

## Displaying Help

The elements used in an FBD/LD program can be checked in e-Manual Viewer.

To check the elements, the file of the corresponding manual must be registered in e-Manual Viewer.

### Operating procedure

1. Select the element to be checked.
2. Press the  key.

#### Point

If a function block or function is associated with a help file, the help file opens. ( Page 133 Associating data with a help file)

## 6.6 Creating an SFC Program

This section explains the creation method of SFC program.

The details on the specification of SFC program are described in the following manual. Please read it in advance.

 MELSEC iQ-R Programming Manual (Program Design)

 MELSEC iQ-F FX5 Programming Manual (Program Design)

### Point

The display format and detailed operation settings for each function can be set by setting the following option.  
[Tool] ⇒ [Options] ⇒ "Program Editor" ⇒ "SFC Diagram Editor"



### Creation procedure

1. Set the point of step relay (S) in "Device Setting" of "CPU Parameter." (The default is set as 0 points.)
2. Create new SFC data. ( Page 129 Creating data)
3. Configure the following settings if needed.
  - "SFC Setting" in CPU parameters
  - 'Act at Block Multi-Activated' which is set for a program file
  - 'SFC information device' which is set for a block (block information)

For details, refer to the following:

 MELSEC iQ-R Programming Manual (Program Design)

 MELSEC iQ-F FX5 Programming Manual (Program Design)

4. Open an SFC diagram editor, then create an SFC diagram. ( Page 350 Creating SFC diagrams)
5. Edit a program of action/transition. ( Page 369 Creating/displaying Zooms (action/transition))



# Configuration of an SFC diagram editor

An SFC diagram editor is a graphical language editor to show a sequence control as a state transition diagram. By simply inserting the prepared SFC elements along the operation flow, the each element is connected automatically and a program can be created.

## Window

Select "Program" ⇒ "(execution type)" ⇒ "(program file)" ⇒ "(block)" ⇒ "ProgramBody" in the navigation window. Immediately after creating a program, SFC elements that are necessary to create a program such as an initial step and end step are placed.

■Toolbar



■SFC diagram editor

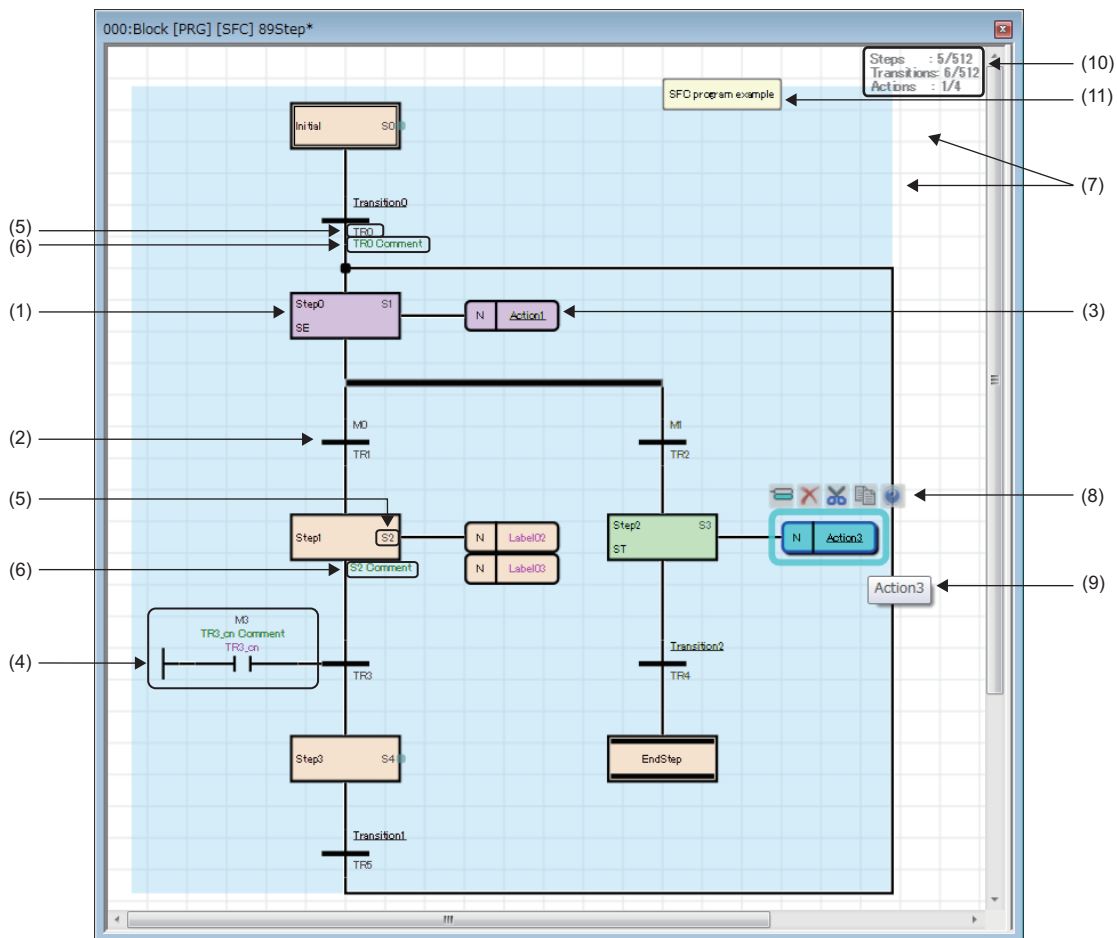

## Displayed items

Item		Description	Editing operation
SFC element	(1) Step	Indicates one processing of a program.	<ul style="list-style-type: none"> <li>■Entering: Page 350 Inserting initial steps, Page 351 Inserting/editing normal steps</li> <li>■Displaying a start destination block: [View] ⇨ [Open Zoom/Start Destination Block]</li> </ul>
	(2) Transition	Indicates a condition (transition conditions) to move to the next step. Transitions are written in a Zoom or on an SFC diagram, and they can be displayed in multiple formats. For details, refer to the following: ☞ Page 347 Display format of action/transition	<ul style="list-style-type: none"> <li>■Entering: Page 353 Inserting/editing transitions</li> <li>■Displaying a start destination block: [View] ⇨ [Open Zoom/Start Destination Block]</li> </ul>
	(3) Action <sup>*1,*2</sup>	Indicates an assigned operation output to a step. Actions are written in a Zoom or an SFC diagram, and they can be displayed in multiple formats. For details, refer to the following: ☞ Page 347 Display format of action/transition	<ul style="list-style-type: none"> <li>■Entering: Page 354 Inserting/editing actions</li> <li>■Displaying a start destination block: [View] ⇨ [Open Zoom/Start Destination Block]</li> </ul>
(4) FBD/LD element		An FBD/LD element that can be used only for a transition. ☞ Page 321 Elements The elements that can be used on an SFC diagram differs from the one for an FBD/LD editor. For details, refer to the following: 📖 MELSEC iQ-R Programming Manual (Program Design) 📖 MELSEC iQ-F FX5 Programming Manual (Program Design)	<ul style="list-style-type: none"> <li>■Editing method: Page 325 Entering programs</li> </ul>
(5) Step No./Transition No. <sup>*1</sup>		An assigned number to a step/transition automatically by conversion. A step relay (S) of a CPU module is assigned to a step. A step No. (S□) is used for SFC control instructions, the current value change with the monitor function or in a watch window, and the data logging/memory dump function. The assigned number can be changed.	<ul style="list-style-type: none"> <li>■Changing an assigned number: Page 368 Editing Step No./Transition No.</li> </ul>
(6) Device comment <sup>*1</sup>		The device comment of a Step No. (S□)/Transition No. (TR□) is displayed. The device/label comment which was set to transitions/actions is not displayed.	<ul style="list-style-type: none"> <li>■Entering: Page 351 Entering comments of Step No., Page 354 Entering comments of Transition No.</li> </ul>
(7) Grid <sup>*1</sup>		A grid line that serves as makers to place the elements	—
(8) Smart tag <sup>*2</sup>		An operation button displayed around a selected element. Relevant functions can be performed by clicking the button.	—
(9) Tool hint <sup>*2</sup>		Information where the mouse cursor is placed over is displayed.	—
(10) Information area		"Number of used/maximum number" of SFC elements are displayed. The font color is changed in red when the number of used reached to the maximum number. SFC elements cannot be created once the number reached to the maximum number. In that case, arrange the number of elements, for example, by deleting.	—
(11) Comment element		Comments can be put on an SFC editor. The comments does not affect to the program. The frame size of a comment can be adjusted for the comment length by placing the mouse cursor on the frame and double-clicking it.	—

\*1 Shown or hidden by selecting in the [View] menu.

\*2 Shown or hidden according to the setting in [Tool] ⇨ [Options] ⇨ "Program Editor" ⇨ "SFC Diagram Editor."

### Point

Font color, background color, and font can be changed.

However, for a comment element, only font color and background color can be changed.

☞ Page 81 Checking and Changing Colors and Fonts

By pressing the **Ctrl** + **↑** / **↓** / **→** / **←** keys, the cursor can be moved on the editor without selecting elements.

## Precautions

When the following contents are changed by using a menu or setting an option, the display of a label name, device, comment, or assigned device of an element may overlap with those of another element. In that case, arrange the position of those elements.

- Whether or not to display a device/label comment
- Number of rows to display a device/label comment
- Number of cells for device/label name
- Whether or not to display an assigned device
- Number of rows to display a device/label name by wrapping it around





## SFC element

The following shows elements which can be used in an SFC program.

For details on creatable numbers of block/each element, action, and each element, refer to the following:

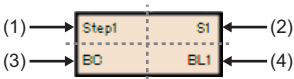
📖 MELSEC iQ-R Programming Manual (Program Design)

📖 MELSEC iQ-F FX5 Programming Manual (Program Design)

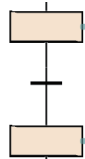
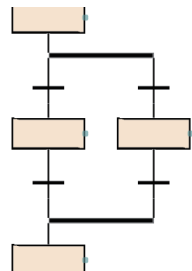
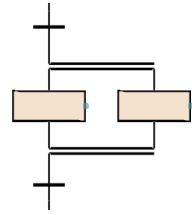
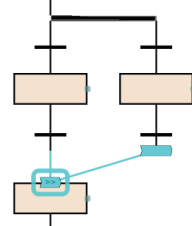
Item	Description
<p>Step</p>  <p>(1) Step name (2) Step No. (S□) (3) Step attribute (4) Step attribute target</p>	<p>■Initial step</p>  <p>■Normal step</p>  <p>■End Step</p>  <p>Indicates the head of a block. One initial step is necessary for a block. Multiple initial steps can be created to perform multiple processes in parallel. The operation of a step can be changed by specifying the step attribute. For details, refer to the following:  📖 MELSEC iQ-R Programming Manual (Program Design)  📖 MELSEC iQ-F FX5 Programming Manual (Program Design)</p> <p>Once a transition that places under a step is satisfied, the next step is activated. The operation of a step can be changed by specifying the step attribute. For details, refer to the following:  📖 MELSEC iQ-R Programming Manual (Program Design)  📖 MELSEC iQ-F FX5 Programming Manual (Program Design)</p> <p>Indicates the end of a block.  Step No. is not assigned to an end step.</p>
<p>Transition</p>  <p>(1) Transition name (2) Transition No. (TR□)</p>	<p>■Series transition</p>  <p>■Selection branch</p>  <p>■Simultaneous branch</p>  <p>■Jump</p>  <p>Moves the processing to a next step.</p> <p>Indicates a branch displayed with a single line for selecting one processing.</p> <p>Indicates a branch displayed with a double line and performs multiple processes in parallel.</p> <p>Makes the execution processing jump to the specified step in the same SFC block. A jump and a connection line can be switched.</p>

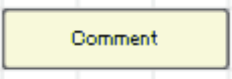
Item	Description
<p>Action</p>  <p>(1) N: Qualifier (2) Action name</p>	<p>Once the steps are activated, the assigned action will be executed. 'N' indicates that an action perform when the step is activated. Other than 'N' cannot be set.</p>
<p>Comment element</p> 	<p>It is used to enter a comment. Up to 2000 characters can be entered in a comment element. The frame size of a comment can be adjusted for the comment length by placing the mouse cursor on the frame and double-clicking it. For setting color for individual comment elements, refer to the following: ☞ Page 323 Common element</p>

## Display format of action/transition

There are multiple display formats (types) for actions/transitions on an SFC editor in GX Works3.

Programs can be shown in the equivalent display formats to MELSAP3, MELSAP-L (instruction format), and MELSAP-L (start condition format) in GX Works2 by changing the display formats (type).

Target SFC element	Display format in GX Works3 (type)			Display format in GX Works2	Reference
Action, transition	Detailed expression (create a Zoom)	Ladder* <sup>1</sup>	Detailed expression	MELSAP3	Page 353 Creating a transition Page 354 Creating an action
			MELSAP-L (instruction format)* <sup>2</sup>	MELSAP-L (instruction format)	
		ST, FBD/LD	—		
	Label/device	MELSAP-L (start condition format)			
Transition	Direct expression			—	

\*1 Switch in [View] ⇔ [Switch Ladder Display].

\*2 FX5CPUs do not support it.

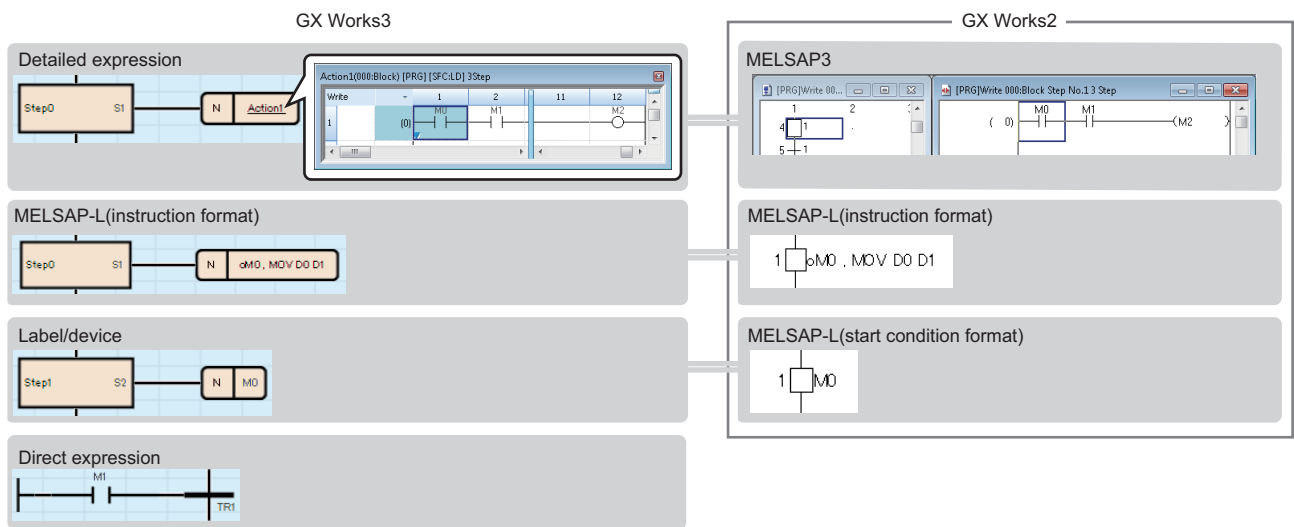

- Action name/transition name is underlined when selecting the detailed expression in the switch ladder display.
- For the direct expression, "\*" is displayed to the transition name that an FBD/LD element is not connected.
- When changing from "Detailed Expression" to "MELSAP-L (Instruction Format)" in [Switch Ladder Display], "?????????" is displayed for an instruction which cannot be treated in MELSAP-L (instruction format).
- When a Zoom does not exist in MELSAP-L (instruction format), "?" is displayed.

## ■ Changing the display format (type) of a transition

The file size of a project can be reduced by changing the display format of a transition (Zoom) created in Ladder Diagram language.

The following shows the procedure to change the display format.

### Operating procedure

1. Open an SFC diagram editor.
2. Select [Edit] ⇒ [Change Type of Transition].
3. Set each item in the "Change Type of Transition" screen, and click the [OK] button.

The display format of a transition (Zoom) that consists only of one open contact and 'TRAN' or of one close contact and 'TRAN' is changed as follows:

Before change	After change
Detailed expression	Label/device
MELSAP-L (instruction format)	

The display format of a transition (Zoom) without contacts is changed as follows:

Before change	Setting content for type change	After change	
		Type	Description
A ladder block without contacts	Use TRUE	Label/device	TRUE
	Use SM400		SM400

### Precautions

- The display format of an unused Zoom will not be changed.
- If the display format is changed, a Zoom will be deleted and an SFC program will be in the unconverted state. Convert all the unconverted SFC programs.
- If a security is set for a program file, the display format of a transition cannot be changed. However, it can be changed if the security is disabled.
- If an SFC block is read-only or unconverted, the display format of a transition cannot be changed.



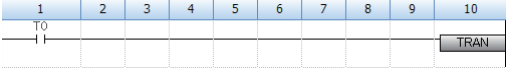
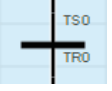
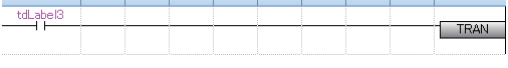
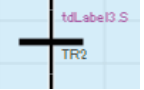
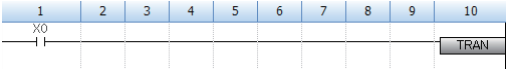
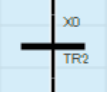
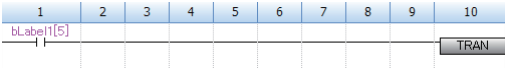
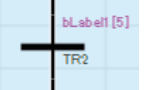

**Ex.**

The following table shows examples of how open contacts are changed:

Type	Description	Example	
		Before change	After change
Timer device Counter device	They will be changed to the following devices: • T→TS • ST→STS • LT→LTS • LST→LSTS • C→CS • LC→LCS	Timer device: T0 	TS0 
Timer type or counter type label	The label name will be suffixed with '.S.'	Timer type label: tdLabel3 	tdLabel3.S 
Other devices	Only the display format will be changed. No change will be made in the device name.	Bit type device: X0 	X0 
Other labels	Only the display format will be changed. No change will be made in the label name.	Bit type label: bLabel1[5] 	bLabel1[5] 

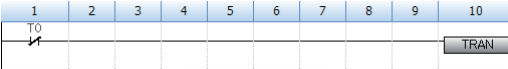
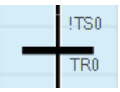
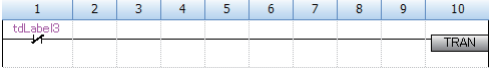
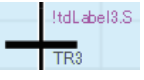
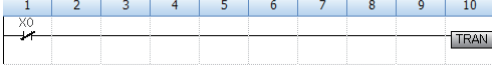
**Ex.**

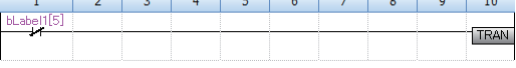
The following table shows examples of how close contacts are changed:

Type	Description	Example	
		Before change	After change
Timer device Counter device	They will be changed to the following devices: The device name will be prefixed with '!.' <ul style="list-style-type: none"> <li>• T→!TS</li> <li>• ST→!STS</li> <li>• LT→!LTS</li> <li>• LST→!LSTS</li> <li>• C→!CS</li> <li>• LC→!LCS</li> </ul>	Timer device: T0 	!TS0 
Timer type or counter type label	The label name will be prefixed with '!' and suffixed with '.S.'	Timer type label: tdLabel3 	!tdLabel3.S 
Other devices	The device name will be prefixed with '!.'	Bit type device: X0 	!X0 
Other labels	The label name will be prefixed with '!.'	Bit type label: bLabel1[5] 	!bLabel1[5] 

# Creating SFC diagrams

This section explains the creation method of an SFC diagram.

Elements which can be inserted differ depending on selected places.

Since the size or place of each element/connection line are placed automatically, it cannot be freely changed.

## Precautions

When the contents shown below were entered/selected, a red frame appears in the edit box and the settings cannot be configured.

- Duplicate step name/Step No./Transition No.
- Unusable step attribute
- Step name which cannot be specified as a jump destination

## Inserting initial steps

An initial step is inserted when creating a new SFC program.

Add an initial step to perform multiple processes in parallel.

FX5CPUs do not support this addition of an initial step.

### ■ Adding initial steps

Select [Edit] ⇒ [Insert] ⇒ [Step] (  ) on a blank cell.

An SFC diagram that consists of an initial step, transition, and end step is inserted.

When connecting multiple SFC diagrams (A, B), perform the following operation.

1. Select the transition in the SFC diagram (B), and select [Edit] ⇒ [Modify] ⇒ [Switch between Jump Symbol and Connection Line].
2. Select the step name to be connected on the SFC diagram (A).
3. Select a jump, then select [Edit] ⇒ [Modify] ⇒ [Switch between Jump Symbol and Connection Line].

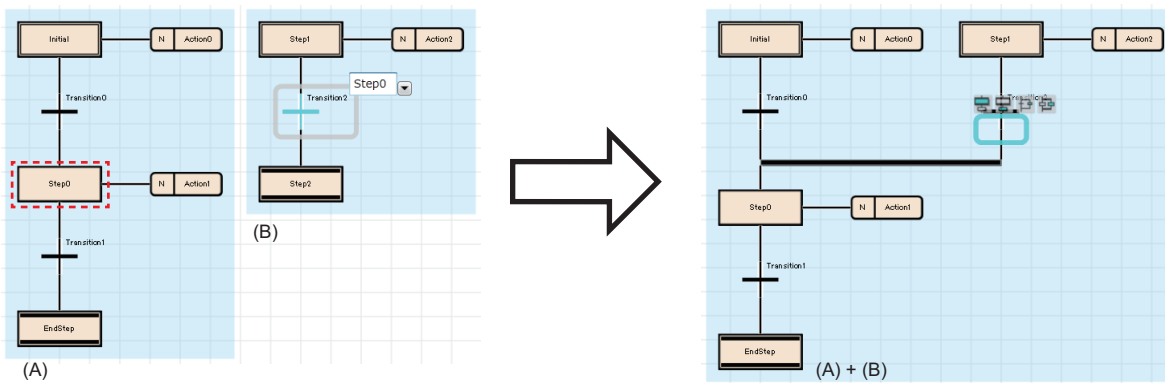

For the connection method to a simultaneous branch, refer to the following:

 Page 355 Inserting/editing jumps (connection lines)

For the editing method of steps, refer to the following:

 Page 351 Inserting/editing normal steps



## Inserting/editing normal steps

### ■ Inserting a normal step

Select a step/transition/jump, then select [Edit] ⇒ [Insert] ⇒ [Step] ( ).

### ■ Changing a step name/step No./step attribute/step attribute target

- Using a shortcut key (Step names only can be changed):  
Select a step, and press the **F2** key.
- In the "Step Properties" screen:  
Select a step, then select [Edit] ⇒ [Properties].
- From the menu:  
Select a step, then select [Edit] ⇒ [Modify] ⇒ [(each item)].
- Double-click:  
Double-click a step. The target to be changed differs depending on the place double-clicked ( Page 346 SFC element).

#### Point

By entering a Step No./number to the edit box for changing a step name, the entered number is set as the step name or the Step No.

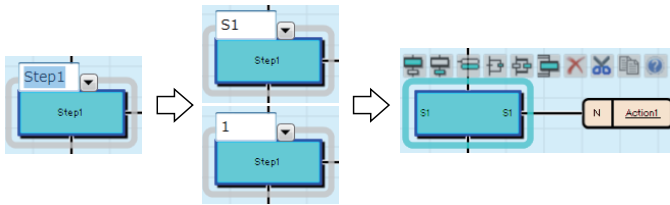

### ■ Changing a normal step to an end step

Select a step to be changed, then select [Edit] ⇒ [Modify] ⇒ [End Step/Jump].

All SFC diagram written below the changed step are deleted.

### ■ Entering comments of Step No.

Enter a comment in the "Step Properties" screen or in a device comment editor.

### ■Creating a step that makes another block activated

A step that activates another block when a step was activated (block start step) is creatable.

1. Insert a step.
2. Specify 'BC' or 'BS' for the step attribute.
3. Specify a block No. to be activated for the step attribute target.

To check the step, which is to be the specification source, from the block specified as the step attribute target, select [View] ⇒ [Open Start Source Block].

For details on the performance of step attribute (BC/BS), refer to the following:

 MELSEC iQ-R Programming Manual (Program Design)

 MELSEC iQ-F FX5 Programming Manual (Program Design)

### ■Creating a step that makes a step being held deactivated

A step that deactivates a step being held when a step was activated (reset step) is creatable.

1. Insert a step.
2. Specify 'R' for the step attribute.
3. Specify a step name of which the step is to be deactivated for the step attribute target.

When 'S999' is specified, all steps being held in the block are the target.

For details on the performance of step attribute (R), refer to the following:

 MELSEC iQ-R Programming Manual (Program Design)

 MELSEC iQ-F FX5 Programming Manual (Program Design)

## Inserting/editing transitions

### ■ Inserting a transition

Select a step/transition/jump, then select [Edit] ⇒ [Insert] ⇒ [Transition] (☰).

### ■ Changing a transition name/Transition No.

- Using a shortcut key (Transition names only can be changed):  
Select a transition, and press the **[F2]** key.
- In the "Transition Properties" screen:  
Select a transition, then select [Edit] ⇒ [Properties].
- From the menu:  
Select a transition, then select [Edit] ⇒ [Modify] ⇒ [Name]/[Device].
- Double-click:  
By double-clicking a Transition No. (☞ Page 346 SFC element), it can be changed. By double-clicking a transition name, the Zoom is created/displayed.

For a transition that a Zoom has been created, the data name of Zoom will not be changed if the transition name was changed.

Modify the data name to match with the transition name in the "Zoom List" screen. (☞ Page 371 Displaying a Zoom list)

#### Point

By entering a Transition No./number to the edit box of which the transition name is to be changed, the entered values are set as the transition name and the transition No.

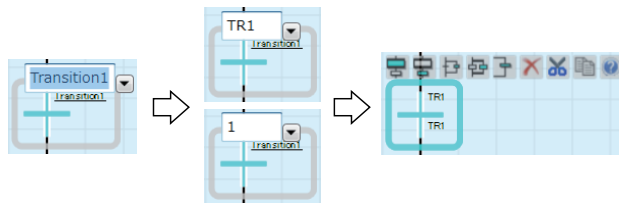

### ■ Creating a transition

There are five ways of creation methods of a transition.

Each transition has a different type. The type can be checked in the "Transition Properties" screen.

"Detailed Expression" or "MELSAP-L (Instruction Format)" for the ladder display method can be switched in [View] ⇒ [Switch Ladder Display].

Creation method	Type	Operating procedure
Create a condition with a program (ladder, ST, FBD/LD). Describe a program in a Zoom.	Detailed expression	☞ Page 369 Creating Zooms (detailed expression)
Create a condition with a program (instruction format of a ladder). Describe a program in the properties.	Detailed expression	☞ Page 370 Creating Zooms (MELSAP-L (instruction format))
Use TRUE/FALSE as conditions. Describe a transition on an SFC diagram.	Label/device	Select a transition, then enter TRUE/FALSE in the transition name.
Use ON/OFF of bit device/bit type label as conditions. Describe a transition on an SFC diagram.	Label/device	Select a transition, then enter the name of any of the following devices and label as the transition name.*1 <ul style="list-style-type: none"> <li>• Bit device</li> <li>• Bit-specified word device</li> <li>• Bit type label</li> </ul>
Create a condition with an FBD/LD element. Describe a transition on an SFC diagram.	Direct expression	Select [Edit] ⇒ [Modify] ⇒ [Direct Expression for Transition], then connect with an FBD/LD element.

\*1 A device/label can be used as a close contact by prefixing the device/label name with '!'.  
 (Example: Enter '!X0' to use X0 as a close contact.)

When changing the transition type from the direct expression to the detailed expression, the data name of the transition is assigned automatically.

The data name may not be returned when changing the transition type from the detailed expression to the direct transition and changing to the detailed expression again.

(Example: Detailed expression (TRAN1) → direct expression (\*) → detailed expression (Transition5))

In this case, select [Edit] ⇒ [Undo], or set the data name again.

### ■ Entering comments of Transition No.

Enter a comment in the "Transition Properties" screen or in a device comment editor.

#### Point

When a comment of transition No. overlaps with a jump symbol or connection line, the size of the transition can be changed by selecting the following menu with one or more transitions being selected.

- [Edit] ⇒ [Modify] ⇒ [Toggle Transition Size]

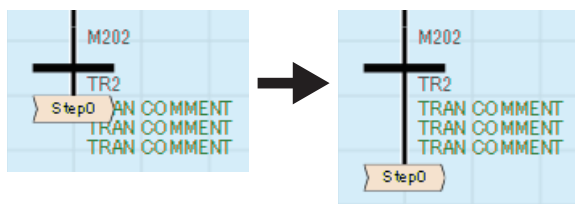

## Inserting/editing actions

### ■ Inserting an action

Select a step/an action, then select [Edit] ⇒ [Insert] ⇒ [Action] (.

Multiple actions can be inserted in a step.

#### Point

If all actions in a step are deleted, a transition is only checked all the time while a step is activated. Once the transition was satisfied, the next step is activated.

Steps without actions can be used when synchronizing the steps that are performing simultaneously etc.

### ■ Changing an action name

Click the action, then select [Edit] ⇒ [Modify] ⇒ [Name]/press the  key.

For an action that a Zoom has been created, the data name of Zoom will not be changed if the action name was changed.



Change the data name to match with the action name in the "Zoom List" screen. ( Page 371 Displaying a Zoom list)

### ■ Creating an action

There are three ways of creation methods of an action.

Each action has a different type. The type can be checked in the "Action Properties" screen.

"Detailed Expression" or "MELSAP-L (Instruction Format)" for the ladder display method can be switched in [View] ⇒ [Switch Ladder Display].

Creation method	Type	Operating procedure
Create an action with a program (ladder, ST, FBD/LD). Describe a program in a Zoom.	Detailed expression	 Page 369 Creating Zooms (detailed expression)
Create an action with a program (instruction format of a ladder). Describe a program in the properties.	Detailed expression	 Page 370 Creating Zooms (MELSAP-L (instruction format))
Use ON/OFF of bit device/bit type label as an action. Describe an action on an SFC diagram.	Label/device	Select an action, then enter a bit device/bit-specified word device, or a bit type label in the action name.

## Inserting/editing jumps (connection lines)

### ■ Inserting a jump

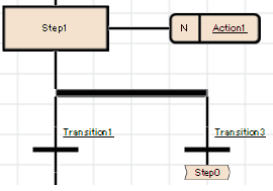
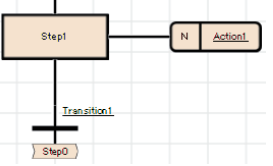
Insertion position	Operating procedure
	<ol style="list-style-type: none"><li>1. Select a transition, then select [Edit] ⇒ [Insert] ⇒ [Jump] (⌘J).</li><li>2. Select a step name of jump destination.</li></ol>
	<ol style="list-style-type: none"><li>1. Select a transition, then select [Edit] ⇒ [Modify] ⇒ [Switch between Jump Symbol and Connection Line].</li><li>2. Select a step name of jump destination.</li></ol> <p>All SFC diagram written below the inserted jump are deleted.</p>

### ■ Changing a jump destination

1. Select the transition which is immediately before the jump, then select [Edit] ⇒ [Modify] ⇒ [Switch between Jump Symbol and Connection Line].  
Alternatively, select the jump, and press the **F2** key.
2. Select the step name of jump destination which is to be changed.

### ■ Switching a jump/connection line

Select a jump, then select [Edit] ⇒ [Modify] ⇒ [Switch between Jump Symbol and Connection Line].

To restore a connection line to a jump, select the connection line, then select [Edit] ⇒ [Modify] ⇒ [Switch between Jump Symbol and Connection Line].

## Precautions

When multiple initial steps are included, a jump cannot be inserted in a step of a simultaneous branch.

To connect a jump with a simultaneous branch, connect it immediately before the simultaneous branch according to the following procedure.

1. Insert a step before a simultaneous branch.
2. Select a transition, then select [Edit] ⇒ [Modify] ⇒ [Switch between Jump Symbol and Connection Line].
3. Select the name of the inserted step.
4. Select a jump, then select [Edit] ⇒ [Modify] ⇒ [Switch between Jump Symbol and Connection Line].
5. Delete the inserted step.

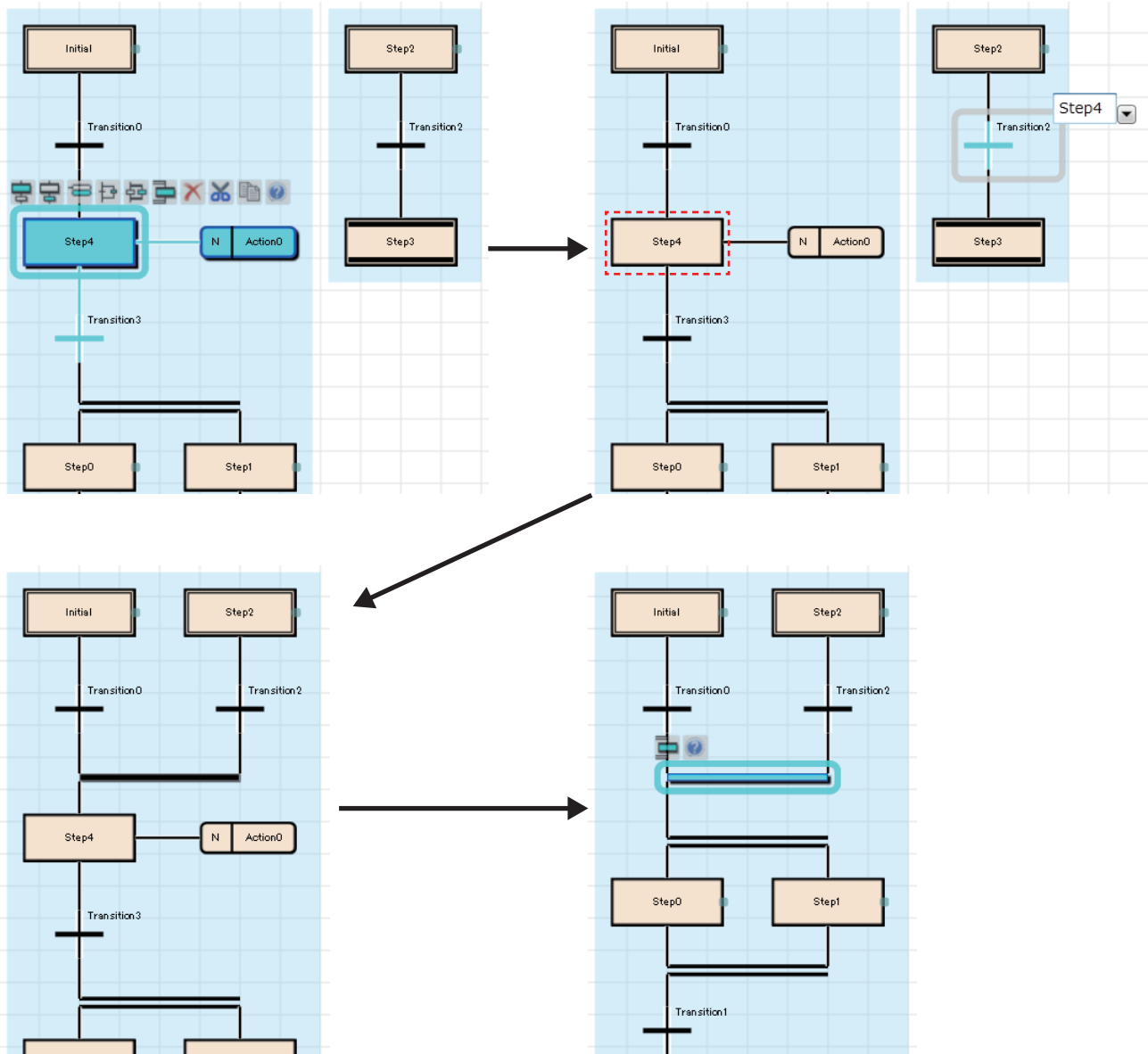

## Inserting/adding selection branches and simultaneous branches

### ■ Inserting a branch below a step/transition

Select a step/transition, then select [Edit] ⇒ [Insert] ⇒ [Selection Branch] (⇨)/[Simultaneous Branch] (⇨).

When a selection branch/simultaneous branch was inserted, the lacking SFC elements are inserted automatically to make it be a proper SFC diagram.

### ■ Adding a selection branch on the right side of a transition/selection condition

Select a transition/selection branch to which a new one will be added, then select [Edit] ⇒ [Insert] ⇒ [Selection Branch Leg] (⇨). (Multiple selections allowed.)

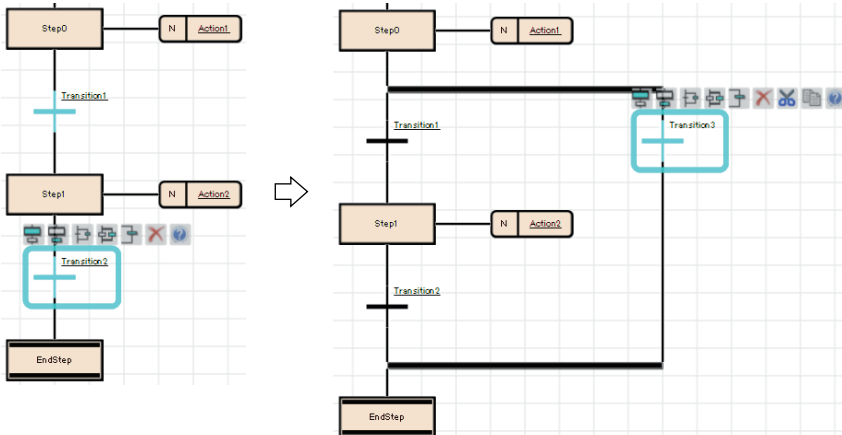

6

### ■ Adding a simultaneous branch on the right side of a step/simultaneous branch

Select a step/simultaneous branch to which a new one is added, then select [Edit] ⇒ [Insert] ⇒ [Simultaneous Branch Leg] (⇨). (Multiple selections allowed.)

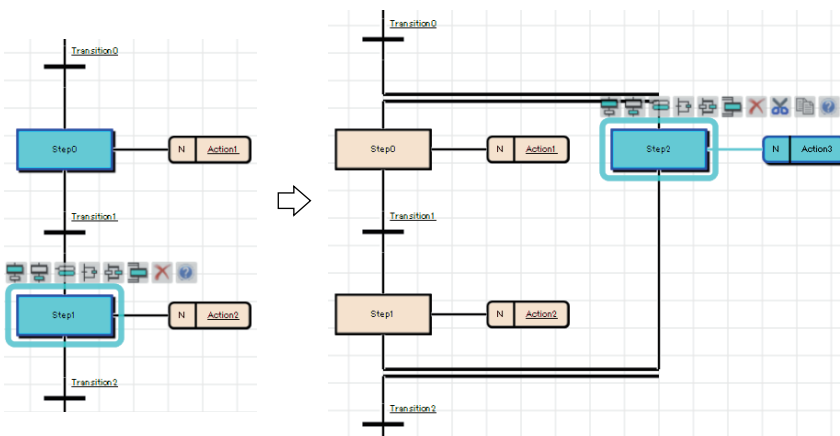

## Common operations of SFC elements

Operation		Operating procedure	
		Mouse	Keyboard
Select	To select a single element	Click an element to be selected.	Move the cursor on an element to be selected.
	To select multiple elements	<ul style="list-style-type: none"> <li>Click multiple elements with the <b>[Shift]</b> key held down.</li> <li>Click the background of an SFC diagram editor, and drag the mouse diagonally around all elements to be selected.</li> </ul>	Select multiple elements by moving the cursor with the <b>[Shift]</b> key held down.
	To select an SFC network block	Click an element, then select [Edit] ⇒ [Select SFC Network Block].	Select an element, then press the <b>[Ctrl]</b> + <b>[Shift]</b> + <b>[A]</b> keys.
	To select whole elements	The operation is the same as that for selecting multiple elements.	Press the <b>[Ctrl]</b> + <b>[A]</b> keys.
Move		Drag and drop an element. *1	—
Copy		Drag and drop an element to be copied with <b>[Ctrl]</b> held down. *1	Press the <b>[Ctrl]</b> + <b>[C]</b> keys, then select the copy destination and press the <b>[Ctrl]</b> + <b>[V]</b> keys. (Copy + paste)

\*1 Copying a Zoom is followed as the option setting.

## Deleting/cutting/copying/pasting/moving SFC elements

Some elements cannot be used by itself on an SFC editor. When SFC elements were deleted/cut/pasted, the other elements, that is not the target for this change, may be deleted/pasted to make a normal SFC diagram.

For the following elements, the previous elements of them also are deleted. For other elements, the next elements are deleted together.

- End step
- Step/transition that are placed immediately before a branch
- The last step/jump in a branch

A selected element cannot be pasted onto the other place where is not connected with a line on an SFC diagram.

For copying FBD/LD elements between editors, only pasting from an FBD/LD editor to an SFC diagram editor is available.

### Point

By setting the following, a Zoom can be copied when copying a transition or an action to other blocks or projects. However, when copying them by dragging and dropping, the Zoom is not deleted even if the following has been set.

- [Tool] ⇒ [Options] ⇒ "Program Editor" ⇒ "SFC Diagram Editor" ⇒ "Action/Transition" ⇒ "Operational Setting" ⇒ "Include Zoom in Copying"

When copying a Zoom from other projects, set the following setting in a project of a copy source.

In addition, by setting the following option, the device comment of a step relay with block specification (BL□\S) or SFC transition device with block specification (BL□\TR) can also be copied when copying a step/transition.

- [Tool] ⇒ [Options] ⇒ "Program Editor" ⇒ "SFC Diagram Editor" ⇒ "Action/Transition" ⇒ "Operational Setting" ⇒ "Include Device Comment in Copying"



## ■ Step

- When deleting an end step, the transition placed immediately before the end step also is deleted. Thereby, the step that connects to the above transition is changed to an end step. If the element above of the end step is a branch, the branch also is deleted.
- The following shows the operation example of cutting and pasting.  
If the step (1) is cut, the next transition (2) will be deleted together. If the cut step is pasted with selecting the step (3), the lacking transition (4) of the step (3) will be inserted.

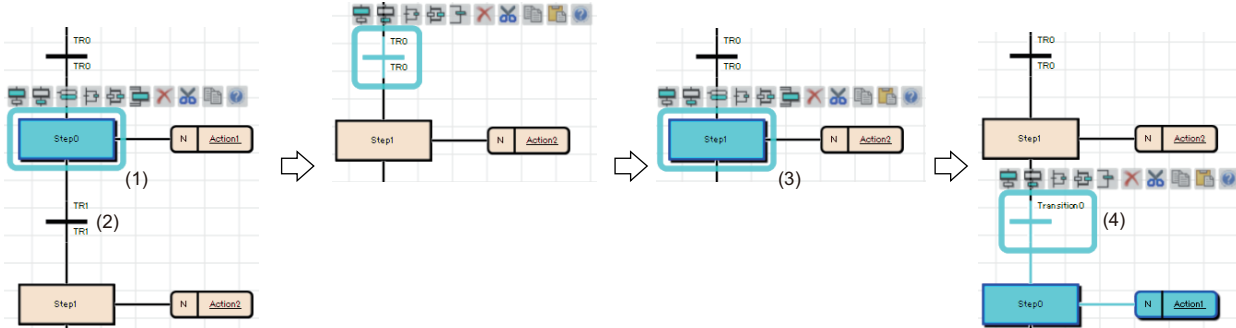

- The same step names and step numbers cannot be set in a same SFC diagram. When copying a step, the name and number of the copied step are automatically changed and pasted to the copy destination.

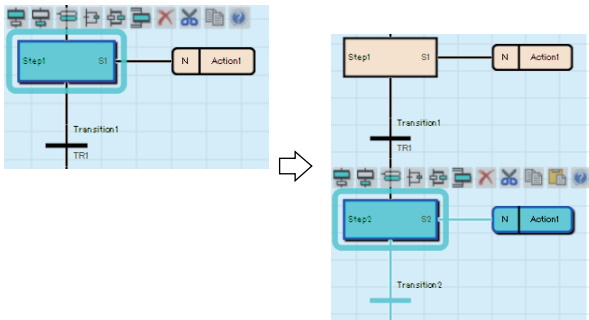

A step can be moved by dragging and dropping (Also, It can be copied with **Ctrl** held down). Note that the operations differ depending on the place where it is dropped.

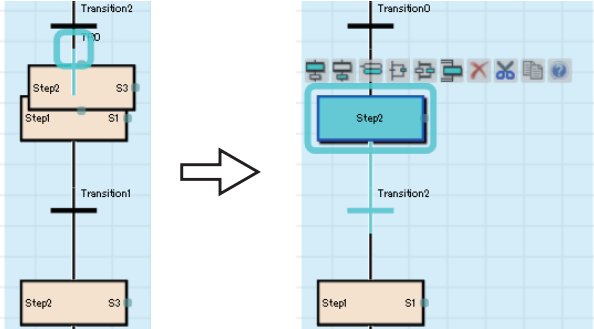
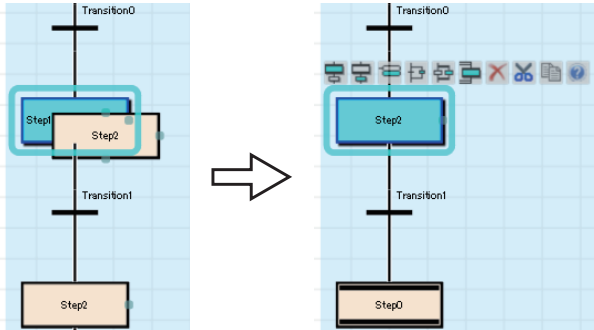
Operation	Example
<p>Drag and drop a step (Step2) onto the connection line. The step (Step2) is moved there.</p> <p>When an action is connected with a step, the action is moved together.</p>	
<p>Drag and drop a step (Step2) onto another step (Step1). The step (Step1) is replaced.</p> <p>When an action is connected to the dragged step, The step is inserted under the dropped destination.</p>	

An initial step cannot be dragged and dropped. Copy it at a keyboard.

## Transition

Same Transition No. cannot be set in a same SFC diagram.

When copying a transition, the number of the copied transition is automatically changed and pasted to an SFC diagram in the same block.

When a Zoom has already been created, the Zoom is not deleted even if the transition is deleted on an SFC diagram. Delete it in the "Zoom List" screen. (Page 371 Displaying a Zoom list)

A transition can be moved by dragging and dropping (Also, It can be copied with **Ctrl** held down). Note that the operations differ depending on the place where it is dropped.

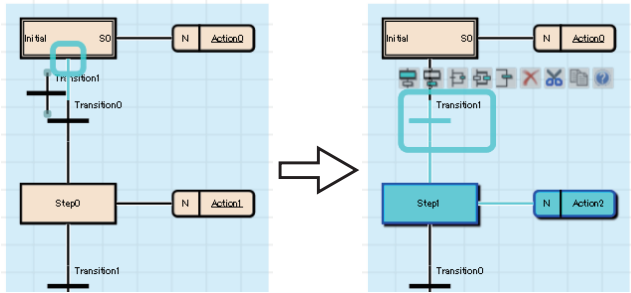
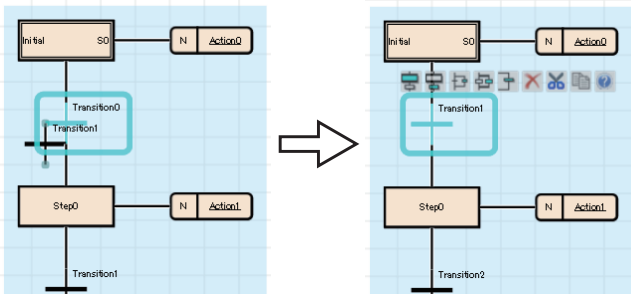
Operation	Example
<p>Drag and drop a transition (Transition1) onto the connection line. The transition (Transition1) is moved there.</p> <p>When a transition of the direct expression connects with an FBD/LD element such as a contact, the FBD/LD element can be moved together.</p>	
<p>Drag and drop a transition (Transition1) onto another transition (Transition0). The transition (Transition0) is replaced.</p> <p>When the dropped destination is the direct expression that connects with an FBD/LD element, the connected FBD/LD element is disconnected when replacing it.</p> <p>When the dragged transition is the direct expression that connects with an FBD/LD element, it cannot be moved.</p>	

**Point**

When copying a transition, the transition name of a copy source is copied.

When copying and pasting a transition in a same block, a same Zoom is shared between a copy source and a copy destination.

For copying a transition with a different transition name from that of a copy source, set the following option.

- [Tool] ⇒ [Options] ⇒ "Program Editor" ⇒ "SFC Diagram Editor" ⇒ "Action/Transition" ⇒ "Operational Setting" ⇒ "Paste Data with Different Data Name"

## ■Action

Cut/copy an action, and paste it selecting a step/action of the destination.

An action can be moved by dragging and dropping (Also, It can be copied with **Ctrl** held down). Note that the operations differ depending on the place where it is dropped.

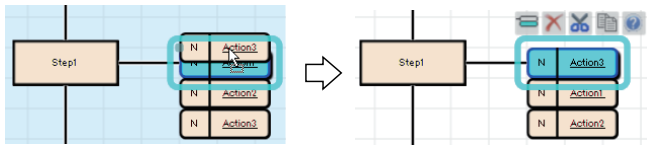
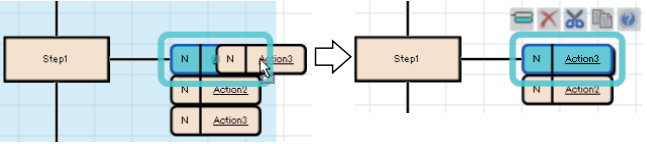
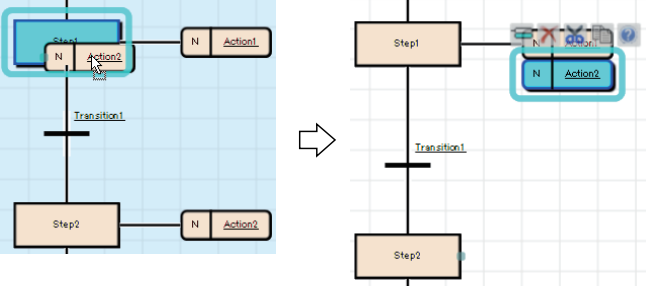
Operation	Example
Drag and drop an action (Action3) onto a target action (Action1). The orders of those actions will be switched.	 <p>The diagram shows two states of a step named 'Step1'. In the initial state, the step contains a list of actions: Action2, Action1, Action4, and Action3. A blue box highlights the top two actions, Action2 and Action1. An arrow points to the final state where the order of these two actions has been swapped, resulting in Action3, Action1, Action4, and Action2.</p>
Drag and drop an action (Action3) onto the same height of a target action (Action1). The action (Action1) is replaced.	 <p>The diagram shows two states of a step named 'Step1'. In the initial state, the step contains a list of actions: Action2, Action1, Action4, and Action3. A blue box highlights Action1 and Action3. An arrow points to the final state where Action1 has been replaced by Action3, resulting in Action2, Action3, Action4, and Action3.</p>
Drag and drop an action (Action2) onto a target step (Step1). The action (Action2) will be moved.	 <p>The diagram shows two states of a sequence of steps. In the initial state, Step1 contains Action1 and Step2 contains Action2. A transition labeled 'Transition1' connects Step1 to Step2. A blue box highlights Action2 in Step2. An arrow points to the final state where Action2 has been moved to Step1, and Step2 is now empty.</p>

When a Zoom has already been created, the Zoom will not be deleted if an action is deleted on an SFC diagram. Delete it in the "Zoom List" screen. (☞ Page 371 Displaying a Zoom list)

### Point

When copying an action, the action name of a copy source is copied.

When copying and pasting an action in a same block, a same Zoom is shared between a copy source and a copy destination.

For copying an action with a different action name from that of a copy source, set the following option.

- [Tool] ⇒ [Options] ⇒ "Program Editor" ⇒ "SFC Diagram Editor" ⇒ "Action/Transition" ⇒ "Operational Setting" ⇒ "Paste Data with Different Data Name"

## Jump

- Deleting a jump only is not applicable. Switch the jump to a connection line first. (☞ Page 367 Changing a jump to a selection branch (connection))
- It is not applicable to copy a jump only. Copy a jump source and a jump destination, and paste them. The following is an example image when selecting and pasting a transition (Transition0). When selecting an end step, it is pasted as well.

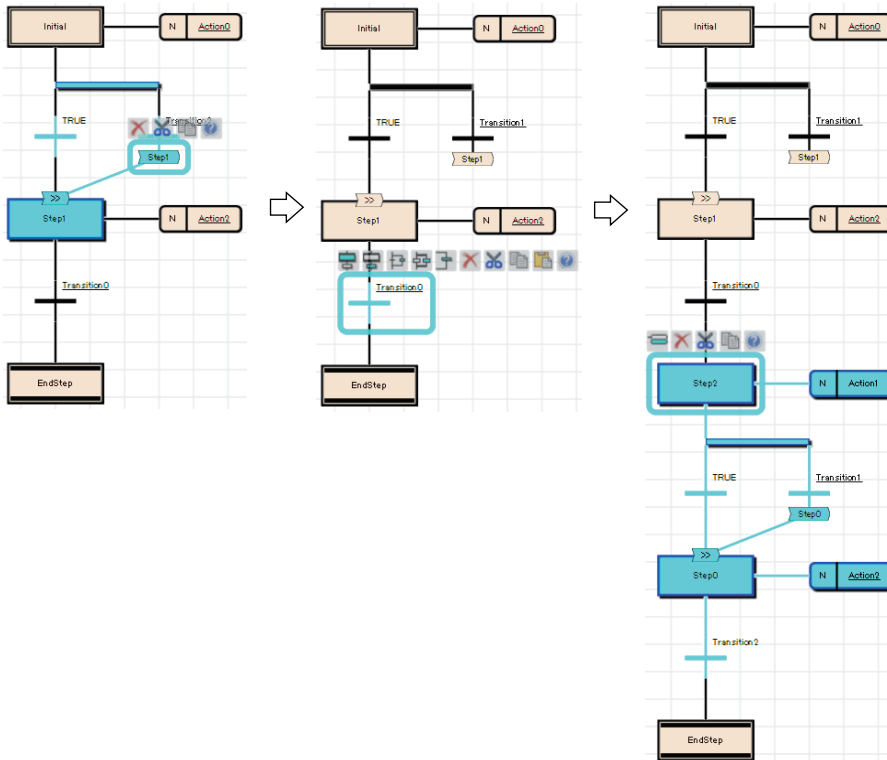

### ■ Selection branch

Drag and drop a step or a transition onto the left/right side of a selection branch. The orders of those branches is switched.

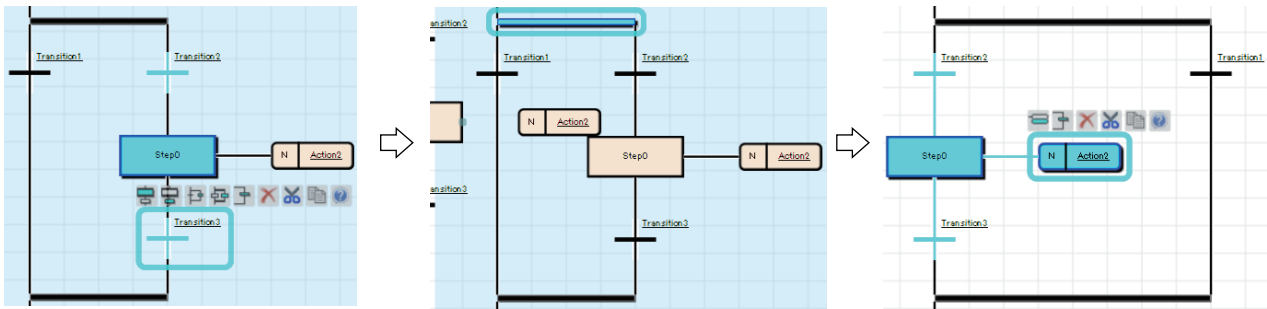

### Precautions

The left side of transition is given priority to perform when both side of transitions were satisfied at a same time. Check the operation of SFC program before switching branches.

### ■ Simultaneous branch

Drag and drop a step and a transition onto the simultaneous branch. The orders of those branch will be switched.

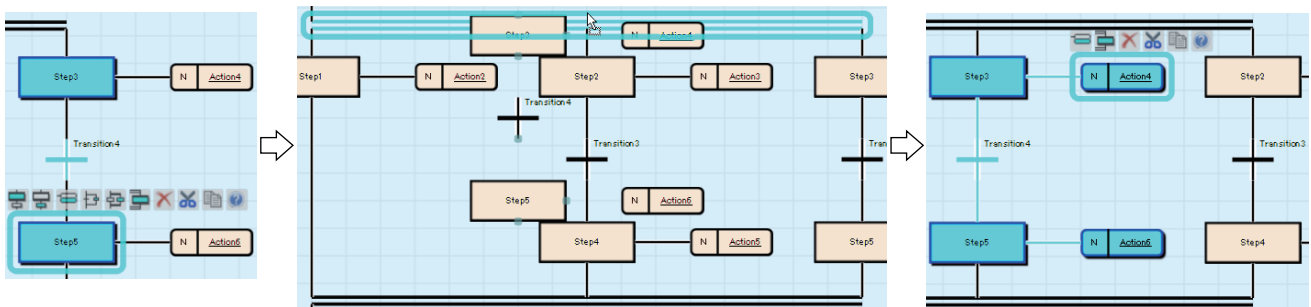

### ■ SFC network block

Elements in an SFC network block can be deleted/copied/cut in a batch by selecting the SFC network block.

When the leftmost SFC network block includes multiple initial steps, the SFC network block cannot be copied and cut. Copy and cut for each element.

## Changing an SFC element

### ■ Changing an end step to a normal step

For restoring a step which has been changed to an end step (example: Step1) once to a normal step, switch it to a jump, then switch the jump symbol to a connection line.

**Ex.**

1. Select an end step (Step1), and select [Edit] ⇒ [Modify] ⇒ [End Step/Jump]. Then select a step name (Step2) which has been placed under the branch before changing.
2. Select the added jump, then select [Edit] ⇒ [Modify] ⇒ [Switch between Jump Symbol and Connection Line].

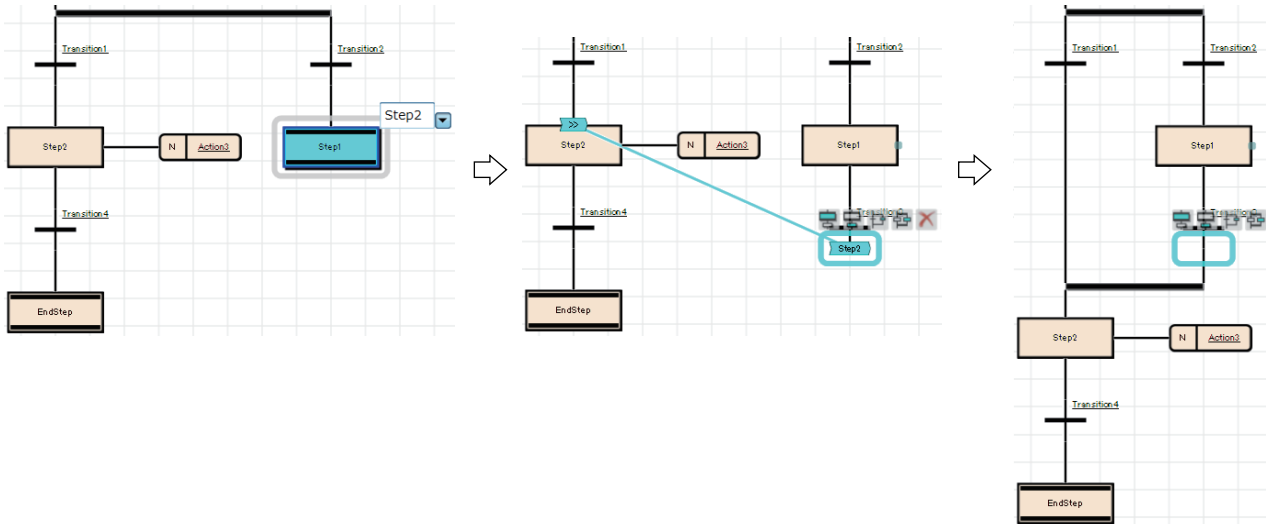

## ■ Changing an end step to a jump

After switching an end step to a jump on the selection branch, delete the unnecessary step.

**Ex.**

1. Select an end step to be changed (Step3), and select [Edit] ⇒ [Modify] ⇒ [End Step/Jump]. Then select a jump destination (Step0).
2. Delete the unnecessary step (Step3).

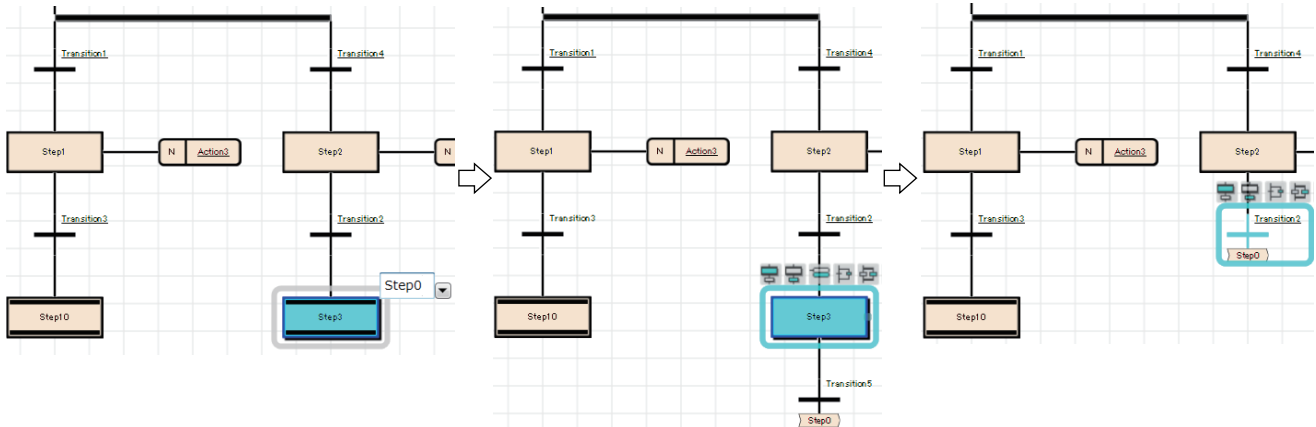

## ■ Changing a jump to an end step

**Ex.**

Select a step which places before a jump, then select the [Edit] ⇒ [Modify] ⇒ [End Step/Jump].

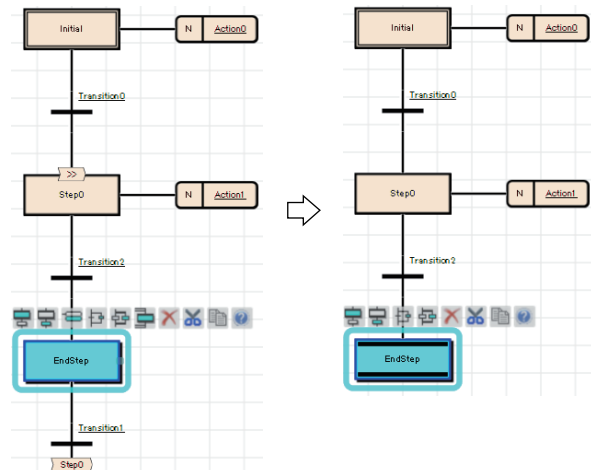



For a jump on a selection branch, insert a step before a jump to be changed, and change the step to an end step.

**Ex.**

1. Insert a step (Step3) before a jump to be changed.
2. Select the inserted step, then select [Edit] ⇒ [Modify] ⇒ [End Step/Jump].

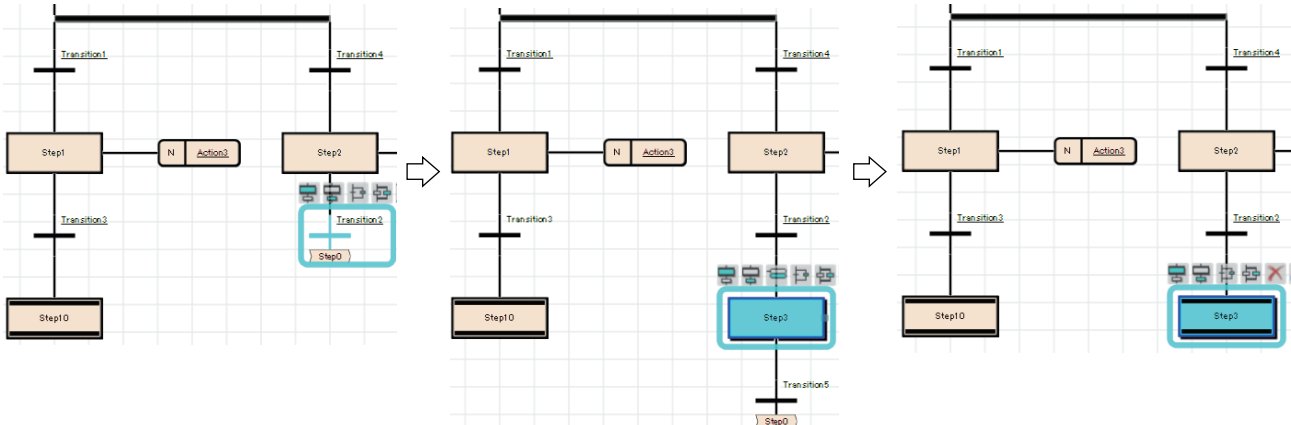

### ■ Changing a jump to a selection branch (connection)

Change a jump destination to the step which is immediately after the branch to be connected, then switch it to a connection line.

**Ex.**

1. Select the transition (Transition5) that places immediately before a jump to be changed, and select [Edit] ⇒ [Modify] ⇒ [Switch between Jump Symbol and Connection Line]. Then, select the step (Step4) which will be connected with the connection line.
2. Select a jump, then select [Edit] ⇒ [Modify] ⇒ [Switch between Jump Symbol and Connection Line].

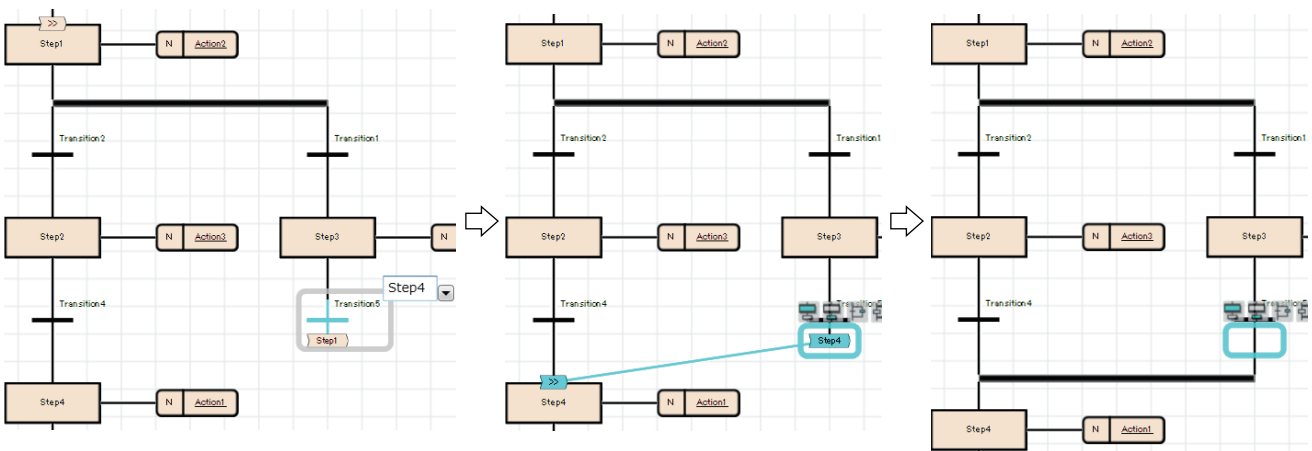

## Linking a comment

A comment element is simultaneously moved with an element by linking them.  
The link of a comment can be set for an SFC element and an FBD/LD element.  
It cannot be set for a selection blanch, simultaneous branch, and jump symbol.  
For the method for operating a link, refer to the following:

 Page 338 Linking a comment

### ■Method for moving only a comment element linking with an SFC element

By selecting an element with a link, all elements linking with it are selected.  
To move a comment element linking with an SFC element without releasing the link, click the target element twice or select it with **Ctrl** held down.

In addition, a comment element can be moved by clicking and dragging it.

### ■Editing an element with a link

When copying a comment element and element that link each other, the link is remained after the copy.  
However, the link of a comment element and an SFC element is released even though they are copied together.  
When deleting a comment element or element that link each other, the link is released.

### ■Change of a position for a comment with an SFC element insertion/deletion

With an SFC element insertion or deletion, the position of a comment element with a link is moved.  
As a result, if a comment element is not likely to be displayed within the frame of an SFC editor, it is displayed in the first line or the first row.

## Converting a block

Whether there is any problem on an active SFC diagram can be checked. The program in a Zoom will not be checked.

### Operating procedure

Select [Convert] ⇒ [Convert Block].

## Editing Step No./Transition No.

Step No. (S□)/Transition No. (TR□) in a block and its device comments can be checked/changed in a list.

### Window

Select [Edit] ⇒ [Edit Step/Transition].

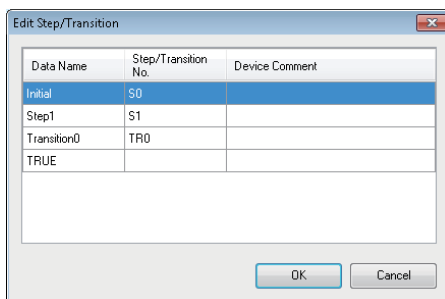

Data Name	Step/Transition No.	Device Comment
Initial	S0	
Step1	S1	
Transition0	TR0	
TRUE		

### Operating procedure

To change a device, select the cell in the "Step/Transition No." column and click the [OK] button.

# Creating/displaying Zooms (action/transition)

## Creating Zooms (detailed expression)

Programs of actions/transitions can be created in languages corresponding to contents.

The entering method of a program is the same as the one for creating a program body. Some instructions cannot be used for an action/transition. For details, refer to the following:

📖 MELSEC iQ-R Programming Manual (Program Design)

📖 MELSEC iQ-F FX5 Programming Manual (Program Design)

To display the SFC diagram which is to be the start source, select [View] ⇨ [Open Zoom Source Block].

## Operating procedure

1. Double-click an action name/transition name on an SFC diagram.
2. Set each item in the "New Data" screen, then click the [OK] button.
3. Enter a program in a Zoom by using Ladder Diagram, Structured Text, or Function Block Diagram/Ladder Diagram language.

## Precautions

When creating a Zoom in Function Block Diagram/Ladder Diagram language, inline structured text elements cannot be used.

## Creating Zooms (MELSAP-L (instruction format))

A program of an action/transition can be created in MELSAP-L (instruction format) of a ladder.

Enter a program in the property screen.

FX5CPUs do not support this Zoom creation in MELSAP-L (instruction format).

**Ex.**

Action properties screen

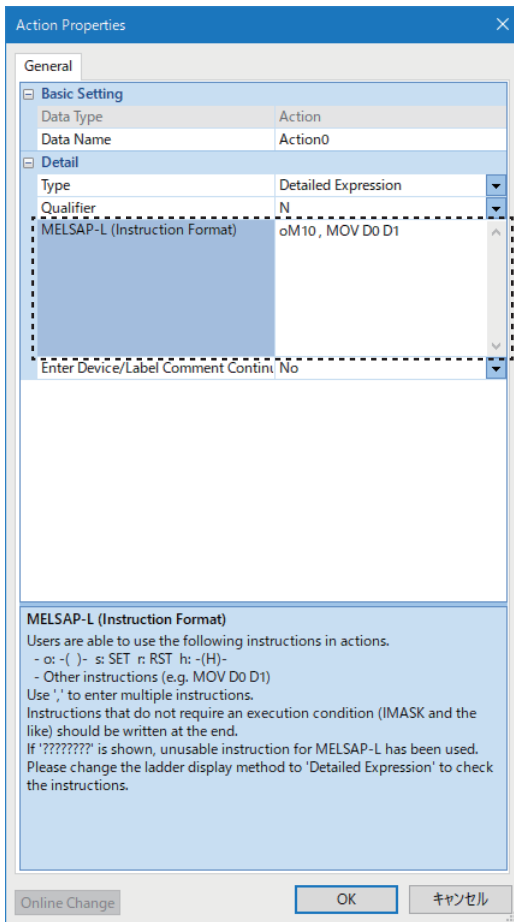

For details on MELSAP-L (instruction format), refer to the following:

📖 MELSEC iQ-R Programming Manual (Program Design)

### Operating procedure

1. Double-click an action name/transition name on an SFC diagram.
2. Enter a program in MELSAP-L (instruction format) in the "MELSAP-L (Instruction Format)" column of the displayed "Action Properties" screen or "Transition Properties" screen.
3. Click the [OK] button.

The created program is retained as one for a Zoom.

By selecting "Yes (TRUE)" or "Yes (SM400)" for the following option, then clicking the [OK] button while the "MELSAP-L (Instruction Format)" column in the "Transition Properties" screen is blank, a transition is automatically set.

- [Tool] ⇒ [Options] ⇒ "Program Editor" ⇒ "SFC Diagram Editor" ⇒ "Action/Transition" ⇒ "Operational Setting" ⇒ "Automatically Set Transition to TRUE/SM400"

The transition is set as follows:

- Data name: TRUE or SM400 (depends on the option value)
- Type: Label/Device

By clicking the [Online Change] button, the transition is also automatically set.

## ■ Performing the online program change after editing a program in MELSAP-L (instruction format)

The online program change can be performed for the edited program in the property screen. The shortcut key for conversion, online program change, and all program conversion can be used in the property screen.

Only contents changed in the property screen are written. The online program change can be performed only while the property screen is opened.

The online program change cannot be performed when closing the screen by clicking the [OK] button after editing.

## ■ Editing a device comment and label comment

By selecting "Yes" for the following item or option, the "Edit Device/Label Comment" screen appears when clicking the [OK] button in the property screen:

- "Enter Device/Label Comment Continuously" in the property screen
- [Tool] ⇒ [Options] ⇒ "Program Editor" ⇒ "SFC Diagram Editor" ⇒ "Action/Transition" ⇒ "Operational Setting" ⇒ "Enter label comment and device comment continuously"

In the "Edit Device/Label Comment" screen, the comments for a device and label that are used in an action/transition in MELSAP-L (instruction format) can be edited.

In addition, multiple comments can be set for one device/label. (☞ Page 82 Display setting for multiple comments)

## Displaying a Zoom list

Created Zooms can be displayed in a list.

Displaying/deleting/changing name of Zoom is possible in a list.

### Window

- Open the target SFC diagram editor, then select [View] ⇒ [Open Zoom List].
- Select "Program" ⇒ "(execution type)" ⇒ "(program file)" ⇒ "(block)" in the navigation window, then right-click it and select [Open Zoom List] from the shortcut menu.

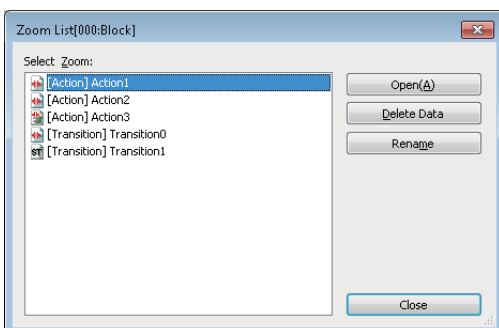

# Displaying an SFC block list

The data names, titles, conversion statuses, and block information (SFC information devices) of blocks in a program file can be displayed in a list.

For details on the SFC information device, refer to the following:

📖 MELSEC iQ-R Programming Manual (Program Design)

## Window

- Open the target SFC diagram editor, then select [View] ⇨ [Open SFC Block List].
- Select "Program" ⇨ "(execution type)" ⇨ "(program file)" in the navigation window, then right-click it and select [Open SFC Block List] from the shortcut menu.

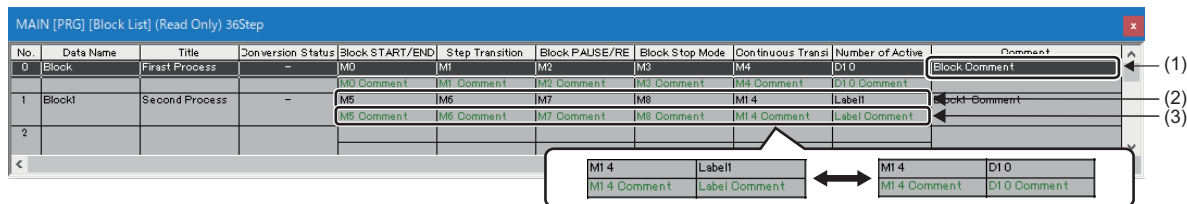

## Displayed items

Item	Description	Related operation
(1) Block comment	Comments set in the "Properties" screen of block are displayed.	—
(2) Device/label	Devices/labels set to the block information (SFC information devices) in the "Properties" screen of block are displayed. Devices assigned to labels are also displayed.	<input checked="" type="checkbox"/> Show/Hide of devices assigned to labels [View] ⇨ [Display Device] *1
(3) Device/label comment	Comments for devices/labels which were set to the block information (SFC information devices) in the "Properties" screen of block are displayed.	<input checked="" type="checkbox"/> Show/Hide of comments [View] ⇨ [SFC Block List Comment]

\*1 By selecting this menu, labels are switched to devices assigned to the labels. (When a device is not assigned, blank is displayed.) In addition, all devices are displayed in blue.

## Displaying SFC diagrams

Display an SFC diagram of block, which is pointed with the cursor, from an SFC block list.

### Operating procedure

1. Move the cursor on a block to be displayed.
2. Select [View] ⇨ [Open SFC Body], or double-click a block to be displayed.

### Point

By double-clicking a blank row, a new block can be created and the SFC diagram of the block is displayed.

## Copying blocks

A block can be copied on an SFC block list.

### Operating procedure

1. Select a block to copy, and select [Edit] ⇒ [Copy] (📄).
2. Select a block to past the copied block, and select [Edit] ⇒ [Paste] (📄).
3. Select whether to change or overwrite its block number in the confirmation screen, and click the [OK] button.
4. Select an item to be pasted in the "Contents to Paste" screen, and click the [OK] button.

### Point

Blocks copied in the navigation window can be pasted on a block list.  
In that method, multiple blocks can be selected and copied in the navigation window.

### Precautions

If "Step/Transition Comment" is selected in the "Contents to Paste" screen, steps/transition comments in the device comment will be pasted after pasting all copied data. Therefore, the steps/transition comments may not be pasted when the [Cancel] button is clicked during the processing even if data pasting has been already completed.

## Search

### ■ Searching for block information

Search for block information (device/label) on an SFC block list.

FX5CPUs do not support this search.

### Operating procedure

1. Select [Find/Replace] ⇒ [Block Information Find Device].
2. Enter a device/label to be searched for, then click the [Find Next] button.

### ■ Jump

Specify a block number or a data name, and move the cursor on an SFC block list.

### Operating procedure

1. Select [Find/Replace] ⇒ [Jump].
2. Specify a block number or a data name in the "Jump" screen, then click the [OK] button.

### Point

The "Jump" screen can be displayed by pressing a numeric key of the keyboard on an SFC block list.

## Displaying local label editor

Display a local label editor of block, which is pointed with the cursor, from an SFC block list.

### Operating procedure

1. Move the cursor on a block to be displayed.
2. Select [View] ⇒ [Open Label Setting].

# Searching for/replacing data in a program

The search functions that can be used in an SFC diagram editor as follows:

Function name	Description	Reference
Cross reference	To check a declaration location and a reference location of a device and a label in a list.	Page 445 SEARCHING FOR DATA
Device list	To check the usage of devices being used.	
Find and replace	<ul style="list-style-type: none"><li>• To search for and replace a device name, label name, instruction name, and character string.</li><li>• To change contacts between open contact and close contact</li><li>• To replace devices in a batch.</li></ul>	

## Precautions

- When a Zoom has been created, the data name of Zoom will not be changed if the character strings of transition name/action name are replaced on an SFC diagram. Change them in the "Zoom List" screen. (☞ Page 371 Displaying a Zoom list)

## Displaying Help

The elements used in an SFC program can be checked in e-Manual Viewer.

To check the elements, the file of the corresponding manual must be registered in e-Manual Viewer.

## Operating procedure

1. Select a check target element.
2. Press the **F1** key.



# 6.7 Setting Initial Values of FB Properties

## Display/setting an FB property

Display and set initial values of FB properties in the "FB Property" window.

For tag FBs, the initial label values in the structure members of tag data can be displayed and set.

Initial values in the "FB Property" window synchronize with ones in the label editor for each label.

Initial values changed in the "FB Property" window are applied only for the project data. To change the initial values in an actual CPU module, use the watch function.

### Configuration of the FB property window





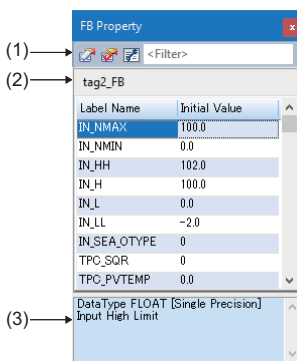

The following shows the screen configuration of the "FB Property" window.

#### Window

Select [View] ⇒ [Docking Window] ⇒ [FB Property] (  ).



#### Displayed items

Item	Description		
(1) Toolbar		Initialize	Click this to initialize all initial values of FB properties with the manufacturer-defined ones.
		Check	Click this to check the initial values set in the FB property list. If an error is found in the check result, the background color of the item will be highlighted in red.
		FB Property Page	Click this to display the "FB Property Page" screen. (  Page 377 Displaying the FB property page)
		Filter	Label names can be filtered.
(2) FB instance name	The FB instance name of a target FB or tag FB are displayed.		
(3) Explanation column	The data type of a label selected in the FB property list and a label comment is displayed. A label comment can be displayed in the explanation column by setting the comment title of the comment as the display target in the "Multiple Comments Display Setting" screen*1. (  Page 82 Displaying and Reading Comments)		

\*1 The "Multiple Comments Display Setting" screen will appear by selecting the following menu.  
[View] ⇒ [Multiple Comments] ⇒ [Display Setting]

## Displaying an FB property

The FB property of the element (FB or tag FB) selected in the following editors is displayed.

Editor	Element
Ladder editor <sup>*1</sup>	FB instance
Inline structured text box on a ladder editor <sup>*1</sup>	Token of an FB instance name
ST editor <sup>*1</sup>	Token of an FB instance name
FBD/LD editor <sup>*1</sup>	FB element
Tag FB setting editor	Tag FB

\*1 Only when elements in the editor in a program block are selected, the FB properties can be displayed.

When an initial value is blank on a label editor, the manufacturer-defined initial value is displayed in the "FB Property" window.

When the manufacturer-defined initial value is blank, the default initial value of each data type is displayed.

In the explanation column, the data type and comment of a selected FB property are displayed.

### ■Data type displayed in the "FB Property" window

The following table shows whether labels of each data type are displayed in the "FB Property" window.

○: Displayed, ×: Not displayed

Data type	Display	Default initial value
Bit	○	FALSE
Word [Unsigned]/Bit String [16-bit]	○	0
Double Word [Unsigned]/Bit String [32-bit]	○	0
Word [Signed]	○	0
Double Word [Signed]	○	0
FLOAT [Single Precision]	○	0.0
FLOAT [Double Precision]	○	0.0
Time	○	T#0d0h0m0s0ms
String	○	"
String [Unicode]	○	"
Pointer	×	—
Timer	×	—
Counter	×	—
Long counter	×	—
Retentive Timer	×	—
Long Retentive Timer	×	—
Long timer	×	—
Structure	×	—
FB	×	—
Array	×	—

## Changing initial values

Values displayed in the "Initial Value" column can be changed.

When initial values differ from the manufacturer-defined ones<sup>\*1</sup>, they will be displayed in bold in the "FB Property" window.

When initial values input in the "FB Property" window are the same as manufacturer-defined ones, the cell in "Initial Value" column corresponding to the labels will be blank in a label editor.

\*1 Initial values displayed in the "FB Property" window and the manufacturer-defined ones are compared as character strings. (Example: 1.0 and 1.00 are considered as different values. FALSE and 0 are also considered as different values.)

# Displaying the FB property page

The FB property page is a screen which categorizes FB properties by each setting. The initial values of FB properties can be checked and changed. In addition, settings for a function generator can be checked with a graph.

For details on FB properties, refer to the following:

☞ Page 375 Display/setting an FB property

The following function blocks are supported in the FB property page:

Category	Function block
Tag FB	Loop tag
	Status tag
	Alarm tag
	Message tag
Standard process FB	M+P_FG
	M+P_IFG
User-defined tag FB	—

## Tag FB and standard process FB

The following explains the "FB Property Page" screen of tag FBs and standard process FBs.

### Window

1. Select a function block or tag FB in an FBD/LD editor or tag FB setting editor.
2. Depending on the editor, perform either of the following operations:
  - FBD/LD editor: Right-click it and select [FB Property] ⇒ [FB Property Page] from the shortcut menu.
  - Tag FB setting editor: Right-click it and select [FB Property Page] ⇒ [FB Property Page] from the shortcut menu.

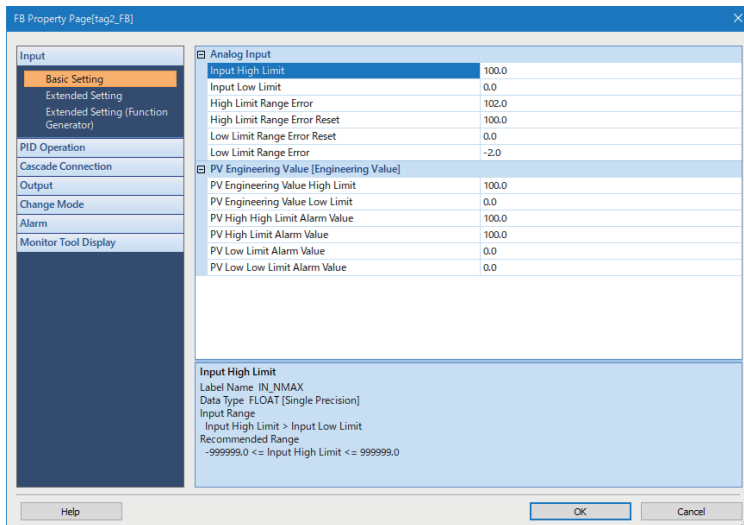



### Operating procedure

Change the initial value of each item, and click the [OK] button.

### Precautions

If an initial value is changed, a label editor in which the corresponding label is defined will be in the unconverted state.

- The "FB Property Page" screen can also be displayed by clicking the  button in the "FB Property" window.
- The manual describing a selected FB property can be opened from the "FB Property Page" screen. Place the cursor on the cell for an FB property, then click the [Help] button or press the  key. If there is no description of the FB property, the page for the selected function block will be displayed.

## ■Checking a line graph

Settings for a function generator of FB properties can be checked with a graph.

The following uses the tag FB type "M+M\_2PIDH\_" as an example.

### Window

1. Open the FB property page.
2. Select "Input" ⇒ "Extended Settings (Function Generator)."

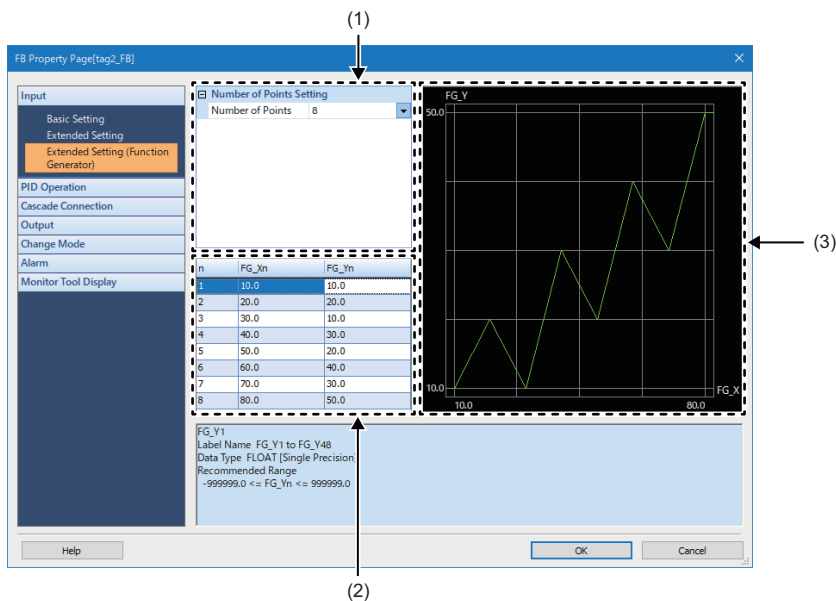

### Displayed items

Item	Description
(1) FB property list	Set the number of coordinates for a line graph to be drawn.
(2) FB property list (coordinates)	Set the coordinates of a line graph. FB properties that link to the graph coordinates are displayed for the number set in "Number of Points."
(3) Graph display area	A graph is displayed based on the coordinate settings.

### Operating procedure

1. Set "Number of Points" in the FB property list.
2. Set the coordinates of a line graph in the FB property list (coordinates).
3. Click the [OK] button.

## User-defined tag FB

The following explains the "FB Property Page" screen of user-defined tag FBs.

The "FB Property Page" screen of user-defined tag FBs is displayed based on the contents of a setting file.

Therefore, a template file needs to be edited in advance to create a setting file.



### Window

1. Set the path to a folder that saves a setting file in the following option:
  - [Tool] ⇒ [Options] ⇒ "Project" ⇒ "Process Control Extension Setting" ⇒ "FB Property Page" ⇒ "Setting File Save Destination"
2. Select a user-defined tag FB in the navigation window. (Multiple selections allowed.)
3. Right-click it and select [FB Property Page Setting] ⇒ [Create Template File] from the shortcut menu.
4. Check the displayed message, and click the [OK] button.
5. Edit a template file and create a setting file. (☞ Page 381 Creating a setting file)
6. Select a user-defined tag FB on an FBD/LD editor or tag FB setting editor.
7. Depending on the editor, perform either of the following operations:
  - FBD/LD editor: Right-click it and select [FB Property] ⇒ [FB Property Page] from the shortcut menu.
  - Tag FB setting editor: Right-click it and select [FB Property Page] ⇒ [FB Property Page] from the shortcut menu.

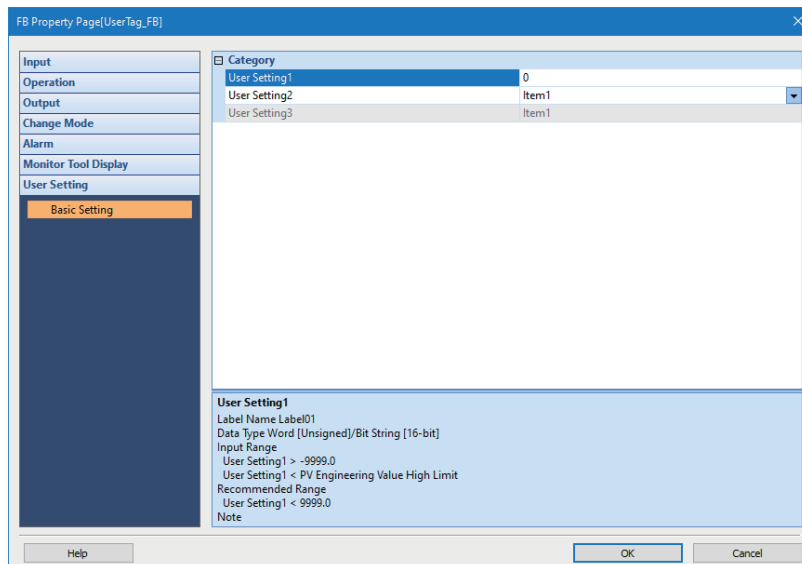
The "FB Property Page" screen is displayed based on the contents of the created setting file.



### Point

- If a setting file with the same name exists in the save destination, the file is overwritten.
- The "FB Property Page" screen can also be displayed by clicking the  button in the "FB Property" window. If a setting file does not exist in the save destination, a template file is also created.
- If a setting file already exists, a template file does not need to be created.
- The manual describing a selected FB property or manual set in the setting file can be opened from the "FB Property Page" screen. Place the cursor on the cell for an FB property, then click the [Help] button or press the  key.

### Operating procedure

Change the initial value of each item, and click the [OK] button.

## Precautions

- If an initial value is changed, a label editor in which the corresponding label is defined will be in the unconverted state.
- An FB property of the following data types is not displayed in the "FB Property Page" screen.
  - Time
  - String
  - String [Unicode]
- A user-defined category and FB property cannot be displayed on a line graph.

## Creating a setting file

The "FB Property Page" screen of user-defined tag FBs is displayed based on the contents of a setting file. The following explains the formats and correction methods of a setting file.

### File format

Item	Description
Extension	.csv
File name	"(User-defined tag FB name)".csv
Character code	Unicode (UTF-16 Little Endian with BOM).
Line feed code	CRLF
Delimiter	Tab

### Precautions

Surrogate pair characters cannot be used.

# Component

The following explains the components of a setting file.

**Ex.**

Template file

```
[Window Configuration]<CRLF>
#Hierarchy 1 <TAB> Hierarchy 2 <TAB> Label Name <TAB> Display Character Strings <TAB> Parent Category <TAB> Note <TAB> Input Format<CRLF>
#Input <TAB> Basic Setting <TAB> <TAB> PV Engineering Value [Engineering Value] <TAB> <CRLF>
#Input <TAB> Basic Setting <TAB> RH <TAB> PV Engineering Value High Limit <TAB> PV Engineering Value [Engineering Value]<CRLF>
#Input <TAB> Basic Setting <TAB> RL <TAB> PV Engineering Value Low Limit <TAB> PV Engineering Value [Engineering Value]<CRLF>
#Input <TAB> Basic Setting <TAB> HH <TAB> PV High High Limit Alarm Value <TAB> PV Engineering Value [Engineering Value]<CRLF>
#Input <TAB> Basic Setting <TAB> PH_ <TAB> PV High Limit Alarm Value <TAB> PV Engineering Value [Engineering Value]<CRLF>
#Input <TAB> Basic Setting <TAB> PL <TAB> PV Low Limit Alarm Value <TAB> PV Engineering Value [Engineering Value]<CRLF>
#Input <TAB> Basic Setting <TAB> LL <TAB> PV Low Low Limit Alarm Value <TAB> PV Engineering Value [Engineering Value]<CRLF>
#Input <TAB> Extended Setting <TAB> <TAB> PV Engineering Value <TAB> <CRLF>
#Input <TAB> Extended Setting <TAB> ALPHA <TAB> PV Filter Coefficient <TAB> PV Engineering Value<CRLF>
#Input <TAB> Extended Setting <TAB> HS <TAB> PV High/Low Limit Alarm Hysteresis [%] <TAB> PV Engineering Value<CRLF>
#Input <TAB> Extended Setting <TAB> <TAB> Variation Rate Check <TAB> PV Engineering Value<CRLF>
#Input <TAB> Extended Setting <TAB> DPL <TAB> Variation Rate Alarm Value [%] <TAB> Variation Rate Check<CRLF>
#Input <TAB> Extended Setting <TAB> CTIM <TAB> Variation Rate Alarm Check Time [s] <TAB> Variation Rate Check<CRLF>

#Alarm <TAB> Basic Setting <TAB> MLL <TAB> Output Low Limit Alarm Level <TAB> Alarm Level Setting<CRLF>
#Alarm <TAB> Basic Setting <TAB> DMLL <TAB> Output Variation Rate Limit Alarm Level <TAB> Alarm Level Setting<CRLF>
#Alarm <TAB> Basic Setting <TAB> OOL <TAB> Output Open Alarm Level <TAB> Alarm Level Setting<CRLF>
#Monitor Tool Display <TAB> Basic Setting <TAB> <TAB> Unit Setting <TAB> <CRLF>
#Monitor Tool Display <TAB> Basic Setting <TAB> UNIT <TAB> Index No. <TAB> Unit Setting<CRLF>
#Monitor Tool Display <TAB> Basic Setting <TAB> <TAB> Number of digits after the decimal point Setting <TAB> <CRLF>
#Monitor Tool Display <TAB> Basic Setting <TAB> N_ <TAB> Number of digits after the decimal point <TAB> Number of digits after the decimal point Setting<CRLF>
"Public Variable" <TAB> "Public Variable1" <TAB> "" <TAB> "Category" <TAB> "" <TAB> "" <TAB> "0"<CRLF>
"Public Variable" <TAB> "Public Variable1" <TAB> "Label01" <TAB> "Label01" <TAB> "Category" <TAB> "" <TAB> "0"<CRLF>
"Public Variable" <TAB> "Public Variable1" <TAB> "Label02" <TAB> "Label02" <TAB> "Category" <TAB> "" <TAB> "0"<CRLF>
"Public Variable" <TAB> "Public Variable1" <TAB> "Label03" <TAB> "Label03" <TAB> "Category" <TAB> "" <TAB> "0"<CRLF>
"Public Variable" <TAB> "Public Variable1" <TAB> "Label04" <TAB> "Label04" <TAB> "Category" <TAB> "" <TAB> "0"<CRLF>
"Public Variable" <TAB> "Public Variable1" <TAB> "Label05" <TAB> "Label05" <TAB> "Category" <TAB> "" <TAB> "0"<CRLF>
[Check Error]<CRLF>
#Error Type <TAB> Label Name <TAB> Conditions <TAB> Comparison Target<CRLF>
[Editable/Non-editable]<CRLF>
#Label Name <TAB> Setting Value <TAB> Label Name to Switch <TAB> Editable/Non-editable<CRLF>
[Combo Box]<CRLF>
#Label Name <TAB> Item Name<CRLF>
[Help Reference]<CRLF>
#Label Name <TAB> Help Reference<CRLF>
[Hidden Item]<CRLF>
#Label Name<CRLF>
```

No.	Component	Description
❶	Section	This consists of one section name and '0' or more rows. The first section must be the [Window Configuration] section. The order of subsequent sections can be changed. Same section cannot be set two or more times. Characters after ']' at the end of a section name are skipped.
❷	Row	This consists of one or more columns, a delimiter, and line feed indicating the end. The required number of columns differs depending on the section. Columns after the required number of columns are skipped.
❸	Column	This consists of '0' or more characters enclosed with " (double quotes) from the beginning to the end.
❹	Comment	When the beginning of a row is '#', the row is treated as a comment. The contents of a comment is skipped.

## Section list

Section name	Description	Required/ optional	Reference
[Window Configuration]	Configuration information of the "FB Property Page" screen	Required	Page 385 [Window Configuration] section
[Check Error]	Definition of the check contents	Optional	Page 388 [Error Check] section
[Editable/Non-editable]	Definition of the editable/non-editable		Page 390 [Editable/Non-editable] section
[Combo Box]	Definition of the display items in a combo box		Page 392 [Combo Box] section
[Help Reference]	Setting of a help reference		Page 393 [Help Reference] section
[Hidden Item]	Definition of the items not to be displayed		Page 395 [Hidden Item] section



## Template file

The following shows a template file and FB property page displayed based on the contents of the template file.

**Ex.**

When creating a template file from the following user-defined tag FB:

- Tag type: PID
- User-defined FB property: Label01, Label02, Label03, Label04, Label05

Template file

```
[Window Configuration]
#Hierarchy 1 Hierarchy 2 Label Name Display Character Strings Parent Category Note Input Format
#Input Basic Setting PV Engineering Value [Engineering Value]
#Input Basic Setting RH PV Engineering Value High Limit PV Engineering Value [Engineering Value]
#Input Basic Setting RL PV Engineering Value Low Limit PV Engineering Value [Engineering Value]
#Input Basic Setting HH PV High High Limit Alarm Value PV Engineering Value [Engineering Value]

#Monitor Tool Display Basic Setting Unit Setting
#Monitor Tool Display Basic Setting UNIT Index No. Unit Setting
#Monitor Tool Display Basic Setting Number of digits after the decimal point Setting
#Monitor Tool Display Basic Setting N_ Number of digits after the decimal point Number of digits after the decimal point Setting
"Public Variable" "Public Variable1" "" "Category" "" "" "0"
"Public Variable" "Public Variable1" "Label01" "Label01" "Category" "" "" "0"
"Public Variable" "Public Variable1" "Label02" "Label02" "Category" "" "" "0"
"Public Variable" "Public Variable1" "Label03" "Label03" "Category" "" "" "0"
"Public Variable" "Public Variable1" "Label04" "Label04" "Category" "" "" "0"
"Public Variable" "Public Variable1" "Label05" "Label05" "Category" "" "" "0"
[Check Error]
#Error Type Label Name Conditions Comparison Target
[Editable/Non-editable]
#Label Name Setting Value Label Name to Switch Editable/Non-editable
[Combo Box]
#Label Name Item Name
[Help Reference]
#Label Name Help Reference
[Hidden Item]
#Label Name
```

FB property page

Category	Value
Label01	0
Label02	0
Label03	0
Label04	0
Label05	0

**Label01**  
Label Name Label01  
Data Type Word [Unsigned]/Bit String [16-bit]

## ■Output content

A section name is output in the first row of each section.

A column name is output as a comment in the second row of each section.

For the [Window Configuration] section, the following contents are also output:

- Window configuration of the tag data
- Default setting of a user-defined FB property

**Ex.**

When creating a template file from the following user-defined tag FB:

- Tag type: PID
- User-defined FB property: Label01, Label02, Label03, Label04, Label05

```

[Window Configuration]
#Hierarchy 1 Hierarchy 2 Label Name Display Character Strings Parent Category Note Input Format
#Input Basic Setting PV Engineering Value [Engineering Value]
#Input Basic Setting RH PV Engineering Value High Limit PV Engineering Value [Engineering Value]

"Public Variable" "Public Variable1" "" "Category" "" "" "0"
"Public Variable" "Public Variable1" "Label01" "Label01" "Category" "" "0"
"Public Variable" "Public Variable1" "Label02" "Label02" "Category" "" "0"
"Public Variable" "Public Variable1" "Label03" "Label03" "Category" "" "0"
"Public Variable" "Public Variable1" "Label04" "Label04" "Category" "" "0"
"Public Variable" "Public Variable1" "Label05" "Label05" "Category" "" "0"

```

❶ Window configuration of the tag data: The contents of the 'Hierarchy 1' column, 'Hierarchy 2' column, 'Label Name' column, 'Display Character Strings' column, and 'Parent Category' column are output as a comment.

❷ Default setting of a user-defined FB property: The following contents are output:

Column name	Description	Remarks
Hierarchy 1	"Public Variable"	When the number of items in a hierarchy reaches the upper limit, the end number of the public variable is added by one, as "Public Variable2, 3...". If a hierarchy with the same name already exists, the end number is also added by one.
Hierarchy 2	"Public Variable1"	
Label Name	Label name	—
Display Character Strings	"Category, " label name	
Parent Category	Category name	
Note	Label comment	
Input Format	"0"	

## Precautions

- Among the window configurations of the tag data, the one of an FB property list (coordinates) in the window which displays a line graph is not output.
- An FB property of the following data types is not output:
  - Time
  - String
  - String [Unicode]

## [Window Configuration] section

This section describes the window configuration information of the FB property page (such as character strings to be displayed and FB properties to be associated).

One category or the window configuration information of one FB property is described per row.

### Example

Setting file

```
[Window Configuration]
#Hierarchy 1 <TAB> Hierarchy 2 <TAB> Label Name <TAB> Display Character Strings <TAB> Parent Category <TAB> Note <TAB> Input Format
"User Setting" <TAB> "Basic Setting" <TAB> "" <TAB> "Category" <TAB> "" <TAB> "" <TAB> ""
"User Setting" <TAB> "Basic Setting" <TAB> "Label01" <TAB> "User Setting1" <TAB> "Category" <TAB> "Note" <TAB> "0"
"User Setting" <TAB> "Basic Setting" <TAB> "Label02" <TAB> "User Setting2" <TAB> "Category" <TAB> "Note" <TAB> "1"
"User Setting" <TAB> "Basic Setting" <TAB> "Label03" <TAB> "User Setting3" <TAB> "Category" <TAB> "Note" <TAB> "1"
```



FB property page

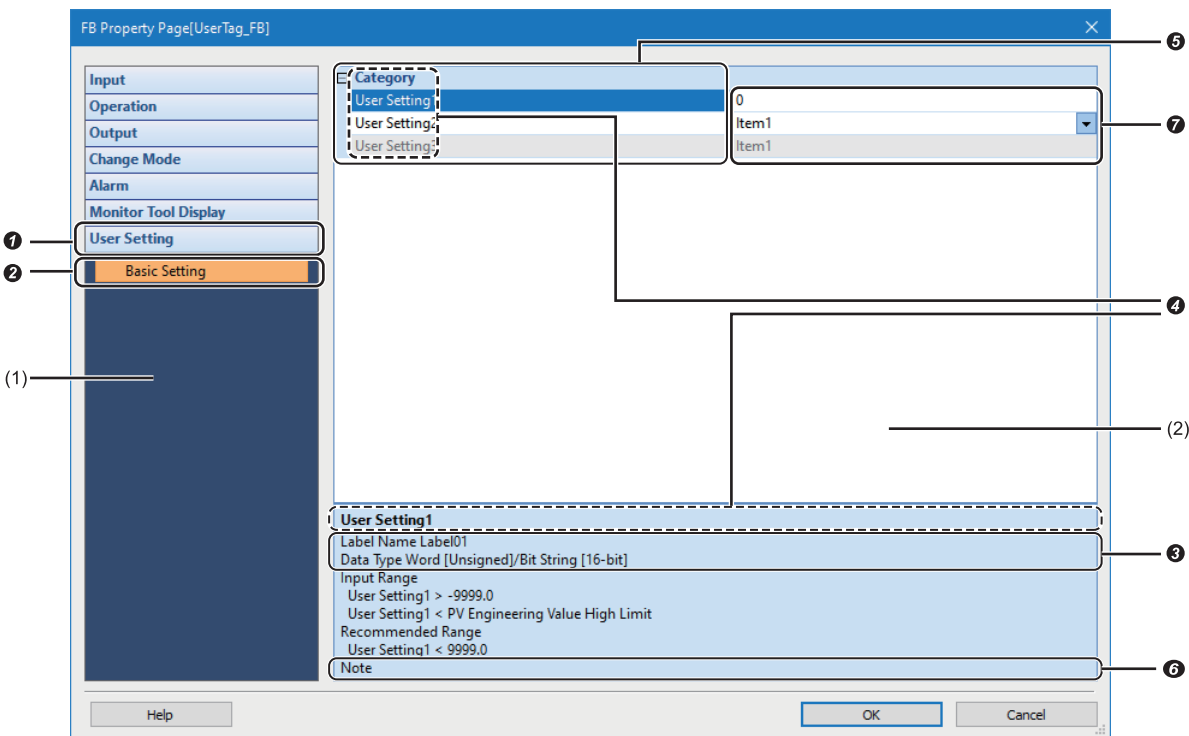

- (1): Setting item tab
- (2): FB property list

No.	Column name	Description	Restriction
1	Hierarchy 1 <sup>*1</sup>	Set a character string to be displayed in the first hierarchy of the setting item tab. A hierarchy of the tag data and user-defined hierarchy can be set.	<ul style="list-style-type: none"> <li>• Maximum number of characters: 128</li> <li>• Maximum number of hierarchy 1: 100</li> </ul>
2	Hierarchy 2 <sup>*1</sup>	Set a character string to be displayed in the second hierarchy of the setting item tab. A hierarchy of the tag data and user-defined hierarchy can be set.	<ul style="list-style-type: none"> <li>• Maximum number of characters: 128</li> <li>• Maximum number of hierarchy 2 (within one hierarchy 1): 10</li> <li>• Maximum number of items within hierarchy 2 (categories + FB properties): 200</li> </ul>
3	Label Name	Set a label name of a user-defined FB property to be associated. The set name and data type of the label are displayed in the 'Note' column of the FB property. An FB property of the tag data cannot be set. For a category, set a null character.	—
4	Display Character Strings	Set a character string to be displayed in an item in the FB property list (category name and setting item name). Null characters cannot be set. The set content is displayed in the 'Note' column of the FB property.	Maximum number of characters: 256



## Precautions

- Multiple rows cannot be set for one FB property.
- A category with the same name cannot be set in the hierarchy 2. (It can be set in a different hierarchy.)
- A row is read in order from the top in a file; therefore, a category defined in a row below an FB property cannot be set as a parent category.
- When setting a window configuration of an FB property of the following data types, "FB property does not exist" is displayed in the FB property page.
  - Time
  - String
  - Sting [Unicode]

### ■Error condition

The following shows the conditions that cause a format error of the [Window Configuration] section when reading a setting file.

- Unsupported escape sequence is used in the 'Note' column.
- A null character is set in the 'Display Character Strings' column.
- The maximum number of characters is exceeded.
- Either of the following exceeds the maximum number:
  - Hierarchy 1
  - Hierarchy 2 (within one hierarchy 1)
- The maximum number of items in the hierarchy 2 (categories + FB properties) is exceeded.
- A hierarchy in which a line graph is displayed is set.
- Multiple window configurations are set for one FB property.
- A category with the same name is defined in the hierarchy 2.
- A parent category is not set in an FB property.
- The name of a non-existent category is set as a parent category.
- The maximum number of hierarchies is exceeded.
- Unsettable value is set in the 'Input Format' column.

## [Error Check] section

This section sets the error check contents for FB properties.

One error check content can be set per row.

### Example

Setting file

```
[Check Error]
#Error Type <TAB> Label Name <TAB> Conditions <TAB> Comparison Target
"Error" <TAB> "Label01" <TAB> ">" <TAB> "-9999.0"
"Error" <TAB> "Label01" <TAB> "<" <TAB> "RH"
"Warning" <TAB> "Label01" <TAB> "<" <TAB> "9999.0"
```

①
②
③
④

FB property page

```
User Setting1
Label Name Label01
Data Type Word [Unsigned]/Bit String [16-bit]
Input Range
(1) { User Setting1 > -9999.0
      User Setting1 < PV Engineering Value High Limit
(2) { Recommended Range
      User Setting1 < 9999.0
Note
```

(1): Error

(2): Warning

No.	Column name	Description
①	Error Type	Set either of the following error types: <ul style="list-style-type: none"> <li>• Error</li> <li>• Warning</li> </ul>
②	Label Name	Set a label name of an FB property to be checked. An FB property of the tag data cannot be set. A label name of a user-defined FB property that is not set in the [Window Configuration] section cannot be set.
③	Conditions	Set a condition with any of the following symbols: <ul style="list-style-type: none"> <li>• &lt;, &gt;, &lt;=, &gt;= (comparison)</li> <li>• = (match)</li> <li>• &lt;&gt; (mismatch)</li> </ul>
④	Comparison Target	Set a value or label name to be compared. For a label name, a label name of an FB property of the tag data and the one of a user-defined FB property can be set. A label name of a user-defined FB property that is not set in the [Window Configuration] section cannot be set.

### Point

- Up to 10 error check items can be set for one FB property.
- When the input format of an FB property is a combo box, the set error check contents are not applied to the FB property page.
- The set error check contents are displayed in the 'Note' column of the FB property according to the order in which rows are listed.  
An error is displayed in "Input Range" and a warning is displayed in "Recommended Range."
- The order in which rows are listed does not affect the error check contents.

## ■ Check method

An error is checked with the conditional expression in which the following values are set: the setting value of a label set for the 'Label Name' column is on the left-hand side, and the value or setting value of a label set for the 'Comparison Target' column is on the right-hand side.

When the check result is not satisfied, an error of the type set in the 'Error Type' column occurs.

When multiple error checks are set for one FB property, an error occurs if even one check result is not satisfied.

### Ex.

For the following example, an error occurs when a value '0' or less or a value greater than the setting value of RH is set for the initial value of "Label," and a warning occurs when a value 1000 or more is set.

```
[Check Error]
#Error Type <TAB> Label Name <TAB> Conditions <TAB> Comparison Target
"Error"      <TAB> "Label"      <TAB> ">"      <TAB> "0"
"Error"      <TAB> "Label"      <TAB> "<"      <TAB> "RH"
"Warning"    <TAB> "Label"      <TAB> "<"      <TAB> "1000"
```

## ■ Error condition

The following shows the conditions that cause a format error of the [Check Error] section when reading a setting file.

- Unsettable value is set in the 'Error Type' column.
- A label name of a user-defined FB property that is not set in the [Window Configuration] section is set in the 'Label Name' column or 'Comparison Target' column.
- The maximum number of error conditions that can be set for one FB property is exceeded.
- Unsettable value is set in the 'Conditions' column.

## [Editable/Non-editable] section

This section sets whether an initial value can be edited or not for FB properties.

### ■ Example

The following shows the label names to be used in the example and their setting item names.

- Label01: User setting 1
- Label02: User setting 2
- Label03: User setting 3

Setting file

```
[Editable/Non-editable]
#Label Name <TAB> Setting Value <TAB> Label Name to Switch <TAB> Editable/Non-editable
"Label01" <TAB> "0" <TAB> "Label03" <TAB> "0"
"Label01" <TAB> "1" <TAB> "Label03" <TAB> "1"
"Label01" <TAB> "2" <TAB> "Label03" <TAB> "1"
"Label02" <TAB> "0" <TAB> "Label03" <TAB> "0"
"Label02" <TAB> "1" <TAB> "Label03" <TAB> "1"
```

FB property page

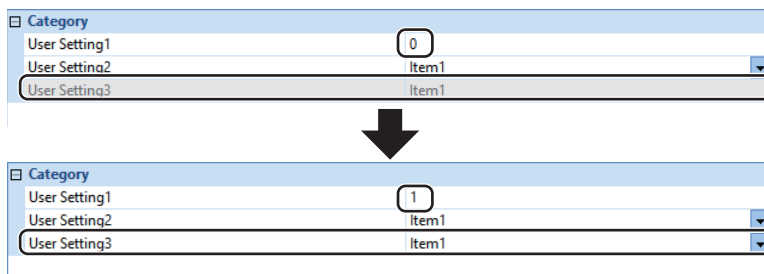

No.	Column name	Description	Restriction
①	Label Name	Set a label name of an FB property which is the switching condition. A label name of an FB property of the tag data and the one of a user-defined FB property can be set. A label name of a user-defined FB property that is not set in the [Window Configuration] section cannot be set.	—
②	Setting Value <sup>*1</sup>	When the setting value of a label set for ① becomes the value set for this column, whether a label set in ③ can be edited is switched to the state set in ④.	Maximum number of characters: 100
③	Label Name to Switch	Set a label name of an FB property to be switched. An FB property of the tag data cannot be set. A label name of a user-defined FB property that is not set in the [Window Configuration] section cannot be set.	—
④	Editable/Non-editable	Set whether a label can be edited or not as either of the following values: • 0: Non-editable • 1: Editable	—

\*1 When a device/label name is set for ②, it is treated as a character string, and an initial value of the device/label is not set.  
(Example) For the following case, when the initial value of "Label" is Label2 (character string), Label3 is non-editable.

```
[Editable/Non-editable]
#Label Name <TAB> Setting Value <TAB> Label Name to Switch <TAB> Editable/Non-editable
"Label" <TAB> "Label2" <TAB> "Label3" <TAB> "0"
```



- For one FB property which is the switching condition, up to 100 'Editable/Non-editable' settings can be set.
- When a label is non-editable, the item of the FB property page is masked.
- For an FB property that is set as a switching target of the editable/non-editable setting in multiple items, it cannot be edited only when it is set to non-editable in all items.  
For the above example, Label03 cannot be edited only when the setting value of Label01 and Label02 is '0.'  
When the setting value of Label01 is one or two, or when the value of Label02 is one, Label03 can be edited.
- The order in which rows are listed does not affect the operation.

## Precautions

Two or more rows whose contents of the 'Label Name' column, 'Setting Value' column, and 'Label Name to Switch' column are the same cannot be set.

### ■ Error condition

The following shows the conditions that cause a format error of the [Editable/Non-editable] section when reading a setting file.

- A label name of a user-defined FB property that is not set in the [Window Configuration] section is set in the 'Label Name' column or 'Label Name to Switch' column.
- The maximum number of settings that can be set for one FB property which is the switching condition is exceeded.
- The maximum number of characters in the 'Setting Value' column is exceeded.
- Two or more rows whose contents of the 'Label Name' column, 'Setting Value' column, and 'Label Name to Switch' column are the same are set.
- Unsettable value is set in the 'Editable/Non-editable' column.

## [Combo Box] section

This section sets the display items in a combo box for FB properties.

One display item in a combo box can be set per row.

### ■Example

Setting file

```
[Combo Box]
#Label Name <TAB> Item Name
"Label02" <TAB> "Item1"
"Label02" <TAB> "Item2"
"Label02" <TAB> "Item3"
"Label03" <TAB> "Item1"
"Label03" <TAB> "Item2"
"Label03" <TAB> "Item3"
```

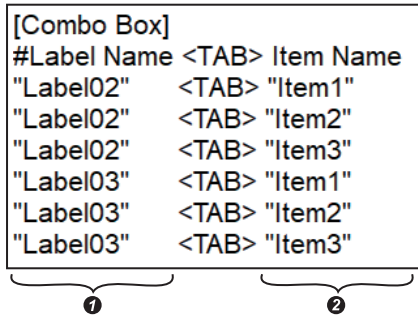

FB property page

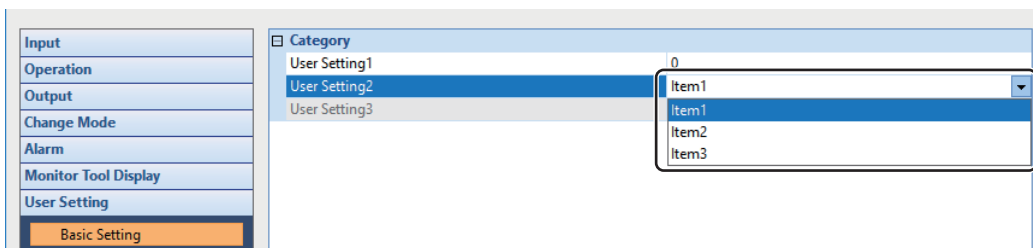

No.	Column name	Description	Restriction
❶	Label Name	Set a name of a label whose input format is set to combo box in the [Window Configuration] section. A name of other labels cannot be set.	—
❷	Item Name	Set an item name in a combo box.	Maximum number of characters: 100

### Point

- Up to 100 combo boxes can be set.
- The items in a combo box are displayed according to the order in which rows are listed.
- The setting value is set as 0, 1, 2.. in order from the top item.

## Precautions

Two or more items with the same name cannot be set for one combo box.

### ■Error condition

The following shows the conditions that cause a format error of the [Combo Box] section when reading a setting file.

- A name of a label whose input format is not set to combo box in the [Window Configuration] section is set in the 'Label Name' column.
- The maximum number of items in a combo box is exceeded.
- Items with the same name are defined for one combo box.
- The maximum number of characters of a combo box is exceeded.
- The setting of an FB property whose input format is set to combo box in the [Window Configuration] section does not exist in the [Combo Box] section.



Tag type	Tag FB
MVAL1	M+M_MVAL1
MVAL2	M+M_MVAL2
TIMER1	M+M_TIMER1
TIMER2	M+M_TIMER2
COUNT1	M+M_COUNTER1
COUNT2	M+M_COUNTER2
PB	M+M_PB_
ALM	M+M_ALARM
ALM_64PT	M+M_ALARM_64PT_
MSG	M+M_MESSAGE
MSG_64PT	M+M_MESSAGE_64PT_

## Precautions

Multiple rows cannot be set for one FB property.

### ■ Error condition

The following shows the conditions that cause a format error of the [Help Reference] section when reading a setting file.

- Multiple help references are set for one FB property.
- A label name of a user-defined FB property that is not set in the [Window Configuration] section is set in the 'Label Name' column.
- A page ID of the manual other than the following is specified:  
 MELSEC iQ-R Programming Manual (Process Control Function Blocks/Instructions)

## [Hidden Item] section

This section sets an FB property not to be displayed on the FB property page.

### ■ Example

Setting file

```
[Hidden Item]
#Label Name
"Label04"
"Label05"
```



No.	Column name	Description
❶	Label Name	Set a label name of an FB property not to be displayed on the FB property page. An FB property of the tag data cannot be set. A label name of a user-defined FB property set in the [Window Configuration] section cannot be set.

### ■ Error condition

The following shows the condition that causes a format error of the [Hidden Item] section when reading a setting file.

- A label name of an FB property set in the [Window Configuration] section is set.

## Common considerations for all sections

### ■When the language of a setting file is different from the display language of GX Works3

A template file is created according to the display language of GX Works3.

When the language of a section name in a setting file and the one of 'Error Type' in the [Check Error] section is different from the display language of GX Works3 in which the FB property page is displayed, reading the setting file fails.

The FB property page can be displayed by correcting a section name in the setting file and 'Error Type' in the [Check Error] section to the section name in the template file created in GX Works3 in which the FB property page is displayed.

When the [Help Reference] section is set, change the help reference to the page ID of a manual whose language is same with the display language of GX Works3.

### ■When an FB property of the tag data and a user-defined FB property with the same name exist

When an FB property of the tag data cannot be set, it is treated as a user-defined FB property.

When an FB property of the tag data and user-defined FB property can be set, the user-defined FB property is prioritized.

### ■When the same user-defined FB property exists

An FB property displayed higher in the "FB Property" window is set.

### ■The number of items that can be set in each section

The maximum number of items that can be set in each section includes the user-defined settings and settings of the tag data.

### ■Error condition

The following shows the conditions common to all sections that cause a format error when reading a setting file.

- The [Window Configuration] section is not set as the first section.
- A non-existent section is set (including a case in which the language of a section name is different from the display language of GX Works3 in which the FB property page is displayed).
- Same section is set two or more times.
- The number of columns is less than the required number.
- A line feed is not inserted at the end of a row.
- The begging and end of a column are not enclosed with " (double quotes).

# FB property management (offline)

In the "FB Property Management (Offline)" screen, initial values of FB properties saved in a project can be exported to a CSV file.

In addition, the initial values of FB properties can be imported from the CSV file, and the values can be set as the initial values of FB properties in the project.

For details on FB properties, refer to the following:

☞ Page 375 Display/setting an FB property

## FB Property Management (Offline) screen

The following explains the "FB Property Management (Offline)" screen.

### Window

#### ■ Updating the initial value of a selected FB property

1. Select a function block or tag FB in any of the following editors:

- Ladder editor
- ST editor
- FBD/LD editor
- Tag FB setting editor

2. Right-click it and select [FB Property] ⇨ [FB Property Management (Offline)] from the shortcut menu.

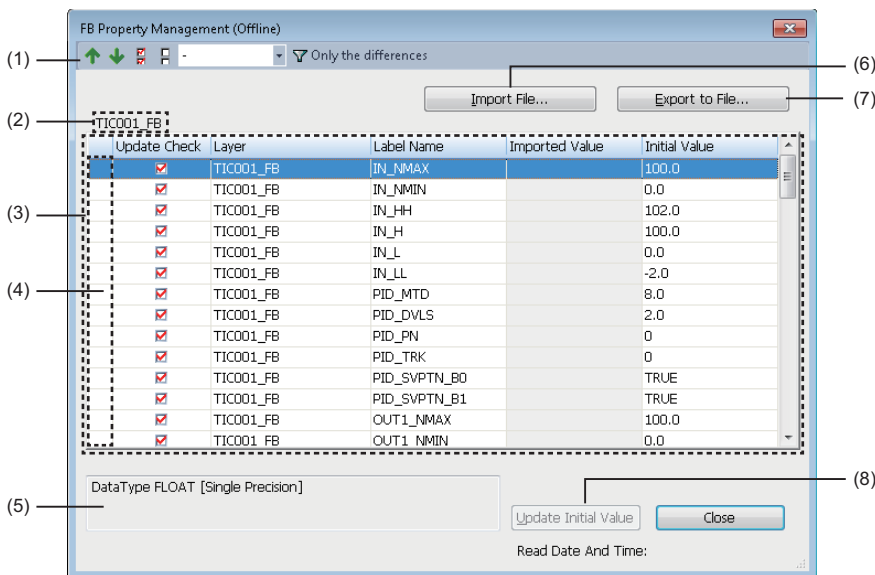

### Point

The "FB Property Management (Offline)" screen can be displayed in the following cases only.

- Ladder editor: An FB instance is selected.
- ST editor: The cursor is placed on a token, or the whole token is selected.

```
FbPou_1_1();
FbPou_1_1();
```

- FBD/LD editor: A whole function block is selected.

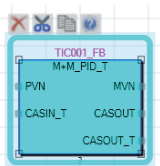



## ■Managing the initial values of all FB properties

Select [Tool] ⇒ [FB Property Management (Offline)].

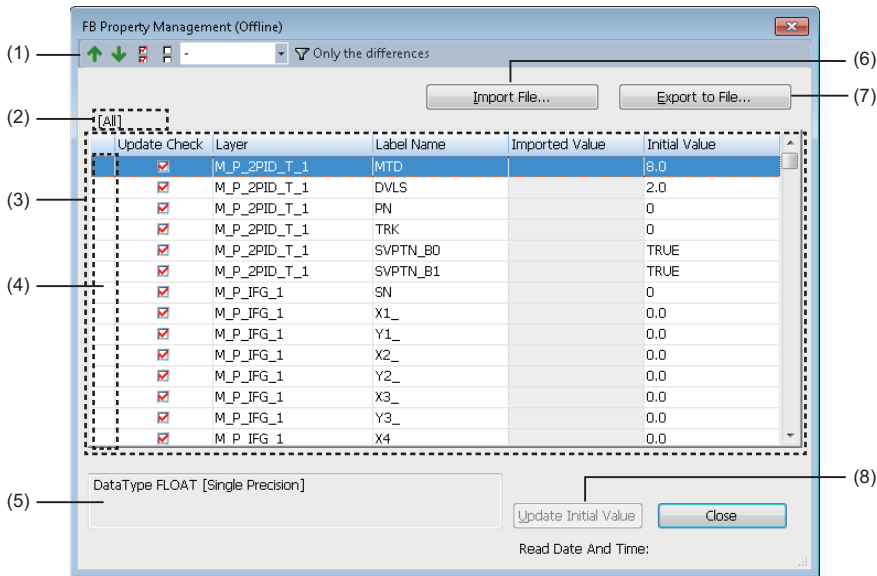
Alternatively, select  (FB Property Management) ⇒ [FB Property Management (Offline)] on the tool bar.



### Displayed items

Item	Description
(1) Toolbar	The displayed items are the same as the ones displayed in the "FB Property Management (Online)" screen.* <sup>1</sup>
(2) FB instance name	For details, refer to the displayed items in the "FB Property Management (Online)" screen.
(3) FB property list	 Page 666 FB Property Management (Online) screen
(4) Header	
(5) Explanation column	
(6) [Import File] button	Click this to import the initial values of FB properties in a CSV file.
(7) [Export to File] button	Click this to export the initial values of FB properties displayed in the FB property list to a CSV file.
(8) [Update Initial Value] button	For details, refer to the displayed items in the "FB Property Management (Online)" screen.  Page 666 FB Property Management (Online) screen

\*1 "Current Value" in the "FB Property Management (Online)" screen is displayed as "Imported Value" in the "FB Property Management (Offline)" screen.

### Point

Once the initial value is updated, a program related to a label of which the initial value was updated will be in the unconverted state.



## Format

The following shows the CSV file formats.

### ■Exported CSV file

A saved CSV file opened in spreadsheet software is displayed as follows:

PROJECT01			
Exported Date	2019/3/4 11:59		
Update Check	Layer	Label Name	Initial Value
1	TIC001_FB	IN_NMAX	100
1	TIC001_FB	IN_NMIN	0
1	TIC001_FB	IN_HH	102
1	TIC001_FB	IN_H	100
1	TIC001_FB	IN_L	0
1	TIC001_FB	IN_LL	-2
1	TIC001_FB	PID_MTD	8
1	TIC001_FB	PID_DVLS	2
1	TIC001_FB	PID_PN	0
1	TIC001_FB	PID_TRK	0

(1): Header

(2): Data segment

The following describes the detailed formats of a CSV file.

- The file format is Unicode (UTF-16 Little Endian with BOM).
- Items are delimited by '\t' (a tab).
- Each item is enclosed with " (double quotes).
- When " (a double quote) is included in an item, "" (two double quotes) are displayed for each " (double quote) in the item.
- A line feed is inserted at the end of a row. The line feed code is LF.
- The character strings which match with the column titles in the "FB Property Management (Offline)" screen are displayed in the header (1).
- Item names in the header (1) are exported in a language set for the display language of GX Works3. (☞ Page 50 Display Language Switching)
- For FB properties whose checkbox in the "Update Check" column in the "FB Property Management (Offline)" screen is selected, '1' is displayed in the "Update Check" column of the CSV file. For ones whose checkbox is not selected, '0' is displayed.

### ■CSV file to be imported

Edit an exported CSV file according to the following formats:

- Enclose an item including a line feed code with " (double quotes).
- Enter the header (1) in the third row.
- Edit the header (1) to match the item names and order with the header (1) in the exported CSV file.
- To import data from a CSV file exported in GX Works3 with a different language, edit the character strings of header (1) in the CSV file to match with the column titles in the import target "FB Property Management (Offline)" screen.
- Enter '1' in the "Update Check" column in the CSV file so that the checkbox for the FB property, for which '1' was entered, in the "Update Check" column in the "FB Property Management (Offline)" screen will be selected. Enter '0' so that the checkbox will not be selected.
- In the "Initial Value" column, enter values which can be entered in the "Initial Value" column in a label editor of GX Works3. The values which cannot be entered will not be imported.
- A row can be added to later than 'E' column; however, the row can will not be imported.

# 6.8 Registering Device Comments

This section explains the features and setting methods for device comments.

## Device comments

Two types of device comments can be created: one that can be set in common and one that can be set for each program. The following shows device comments of GX Works2 and GX Developer corresponding to each device comment of GX Works3.

GX Works3	GX Works2	GX Developer
Common device comment	Global device comment	Common comment
Each program device comment	Local device comment	Device comment by program

Up to 16 device comments can be set for one device. (  Page 82 Displaying and Reading Comments)

Comments can be set in Japanese, English, Chinese or other languages, and the display language in GX Works3 can be switched among these languages.

### ■ Difference between a device comment and a label comment

'Device comment' refers to a comment that is added to devices, and also 'data' read from/written to a CPU module.

'Label comment' refers to a comment that is added to a defined label.

## Common device comment

'Common device comment' refers to a device comment that can be used in multiple program files. (It can also be used in only one program file.)

When creating a new project, "Common Device Comment" is automatically created in the navigation window.

Only the device comments set in this data can be used as common device comments.

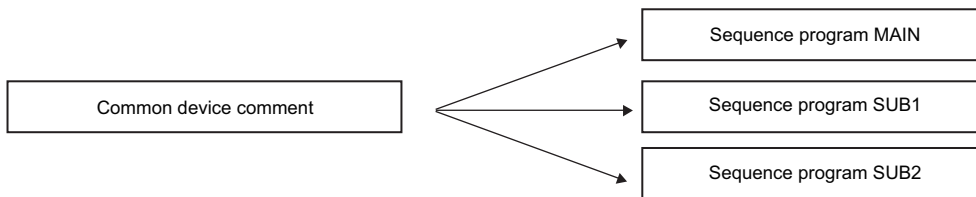

## Each program device comment

'Each program device comment' refers to a device comment that can be used only in one program file.

To use each program device comments, create data for setting device comments in "Each Program Device Comment" in the navigation window. (  Page 129 Creating data)

Only the device comments set to data with the same name as a program file can be used as each program device comments for the program file.

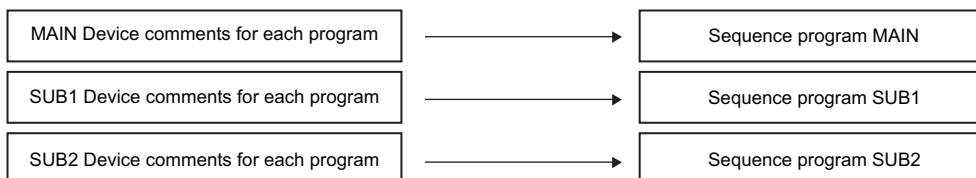

## Precautions

- Device comments set in "Each Program Device Comment" cannot be written to an FX5CPU.
- Remote head modules do not support each program device comments.

## ■Setting an each program device comment

When comments are set both in "Common Device Comment" and in "Each Program Device Comment," specify the comment to be displayed on a program editor by setting the following option:

- [Tool] ⇒ [Options] ⇒ "Project" ⇒ "Device Comment Reference/Reflection Target"

**Ex.**

When different device comments are set for the same device (M)

Common device comment (COMMENT)

Device Name	Comment
M0	
M1	Initial Start 1
M2	Initial Start 2

Device comments for each program (MAIN)

Device Name	Comment
M0	
M1	Stop Device 1
M2	Stop Device 2

The display differs as shown below according to the option setting.

●When the reference of the device M in the sequence program MAIN is set to the common device comment <Options>

Reference/Reflection Target for Device Comment	
Reference/Reflect the Other Device Comment When S Yes	
MAIN	Mixed
M	Common

↓

<Sequence program MAIN>

The global device comment, 'Initial Start 1', is displayed as a device comment for M1.

●When the reference of the device M in the sequence program MAIN is set to the device comment for each program <Options>

Reference/Reflection Target for Device Comment	
Reference/Reflect the Other Device Comment When S Yes	
MAIN	Mixed
M	Each Program

↓

<Sequence program MAIN>

The local device comment, 'Stop Device 1', is displayed as a device comment for M1.

When any comments do not exist in the reference that was set in "Reference/Reflection Target for Device Comment," the other comment is displayed.

## Applicable devices

For the device types and comment setting availability, refer to the following:

📖 Page 889 Applicable Devices in GX Works3

# Configuration of a device comment editor

## Window

- Common device comment: Select "Device" ⇒ "Device Comment" ⇒ "Common Device Comment" in the navigation window.
- Each program device comment: Select "Device" ⇒ "Device Comment" ⇒ "Each Program Device Comment" ⇒ "(data name)" in the navigation window.

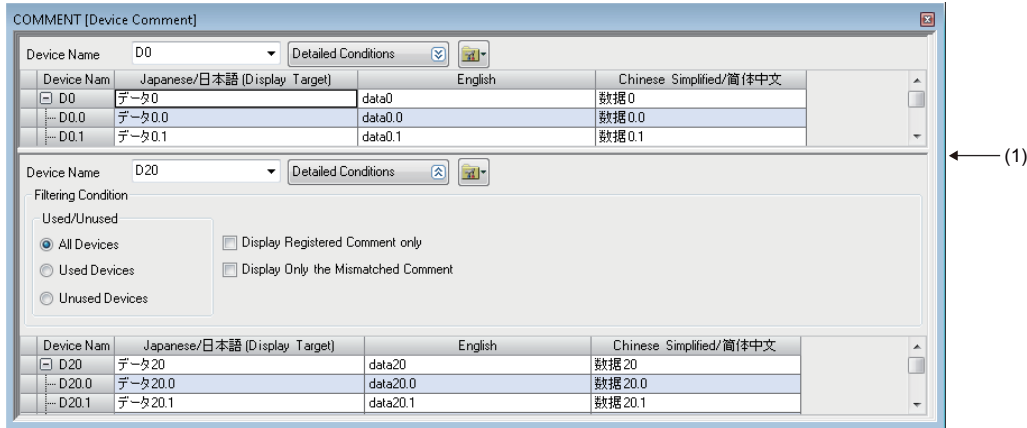

(1): Splitter bar

A device comment editor can vertically or horizontally be split into two screens by using any of the following menus.

- Select [Window] ⇒ [Split]. (Vertical split only)
- Right-click on the screen, and select [Split] from the short-cut menu ⇒ [Vertical Split]/[Horizontal Split]
- Click , and select [Split] ⇒ [Vertical Split]/[Horizontal Split]

## Point

- Pressing the **[Ctrl] + [Enter]** keys creates a line break in a comment column.
- The hidden comment is displayed by double-clicking + in the device name column.



- When linefeed comments are set in multiple lines, the comments can be displayed in a batch by using the following menu:
  - [Edit] ⇒ [Show All Linefeed Comments]
- Fonts can be changed. (  Page 81 Checking and Changing Colors and Fonts)

## Displaying a device comment editor from a program editor

A device comment editor can be displayed from a program editor.

The device comment editor to be displayed depends on the setting in the following option:

- [Tool] ⇒ [Options] ⇒ "Project" ⇒ "Device Comment Reference/Reflection Target"

When any comments do not exist in the reference that was set in "Reference/Reflection Target for Device Comment," the other comment editor is displayed.

### Operating procedure

1. Open a program editor.
2. Select [View] ⇒ [Open Device Comment Setting] ⇒ [Open in Front]/[Tile Horizontally].

### Precautions

When selecting a device on a program editor, the device comment editor corresponding to the selected device will appear.

For an ST editor, place the mouse cursor over a device to select.

When using the menu without selecting a device, the device comment editor to set common device comments will appear.

#### **Point**

In another way to display a program editor and device comment editor vertically, press **Ctrl** + **Alt** + **C** keys.

# Creating device comments

Comments can be created for each device in a device comment editor.

Adding device comments make it easy to understand the content of program processing.

To create each program device comments, create data for the device comments in advance. (📖 Page 129 Creating data)

The comments can be entered on a ladder editor. For details, refer to the following:

📖 Page 284 Entering/editing comments

## Operating procedure

1. Enter the device of which comment is to be set in "Device Name."
2. Enter a comment for "Comment."

### Point

- Up to 1024 characters can be entered for one comment.
- Setting a smaller number for the number of characters for a comment can reduce in size of data to be written to a CPU module.  
The number of characters can be set in the following option.  
[Tool] ⇒ [Options] ⇒ "Other Editor" ⇒ "Device Comment Editor" ⇒ "Number of Editing/Displaying Characters" ⇒ "Number of Device Comment Editing/Displaying Characters"
- By selecting two or more consecutive cells in which the comment with number is inserted, and dragging the '+' symbol displayed at the lower right corner of the cell, the data of which number is incremented can be entered.
- When cutting/copying the hidden bit-specified word device comments, select the range and [Edit] ⇒ [Cut the Range Including Hidden Bit Specification Information]/[Copy the Range Including Hidden Bit Specification Information].  
The bit-specified comments can also be pasted regardless of the setting of display/hidden by selecting [Edit] ⇒ [Paste the Range Including Hidden Bit Specification Information].

## Precautions

For device comments, use characters in the Unicode Basic Multilingual Plane.

## Creating multiple comments and setting display target

For details, refer to the following:

📖 Page 82 Displaying and Reading Comments

## Detecting devices with empty cell

When comments are set in the multiple rows, detect the devices with empty cells.

## Operating procedure

### ■ Detecting comments from device data being displayed on a device comment editor

Select the checkbox of "Display Only the Mismatched Comment" in the filter condition on a device comment editor.

### ■ Detecting comments from all device data in the device comment data

Select [Edit] ⇒ [Detect the Mismatched Comment].

Double-click "NG" in the displayed "Detect the Matched Comment of All Devices" screen to edit a device comment editor.

## Device comment including @

By selecting "Yes" for the following option and using '@' for device comments, options of devices can be refined when searching for/replacing a device, inputting it in a program, or registering it in a watch window.

- [Tool] ⇒ [Options] ⇒ "Edit" ⇒ "Instruction/Device/Label Candidacy Display" ⇒ "Candidate Display Setting" ⇒ "Display the Corresponding Device in Entering Device Comment"

Moreover, by applying the explanations of link devices to the device comments of refresh devices which are assigned to a device station on CC-Link IE TSN in advance, the refresh devices can be refined with their device comments.

### Ex.

The following explains the method to refine refresh devices with a device comment when inputting a refresh device on a device station of CC-Link IE TSN (FR-A800-GN) in a program.

## Operating procedure

1. Apply the explanations of link devices for FR-A800-GN to the device comments of refresh devices. (  Page 213 Applying explanations to device comments)

Each character string delimited by @ indicates the following:

- Start I/O number of a CC-Link IE TSN module (Example: 0000)
- Station number of FR-A800-GN (Example: St5)
- Explanation of the link device (Example: Fault record (output current))

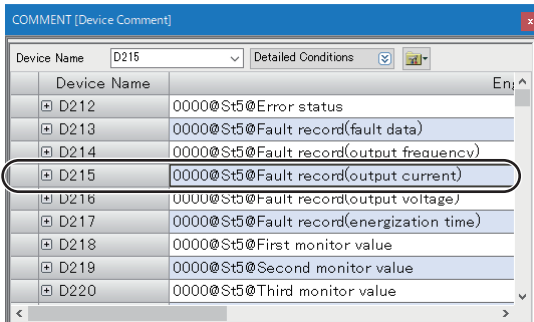

2. Display the element entry dialog in a ladder editor. (  Page 269 Inserting from the element entry dialog)
3. Enter "0000@" in the element entry dialog to search refresh devices of the device station whose start I/O number is '0000.'

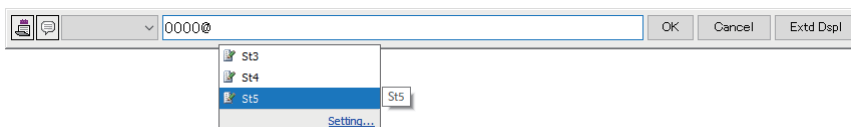

4. Double-click "St5" from the options, then enter '@' to search refresh devices of the device station whose station number is '5.'

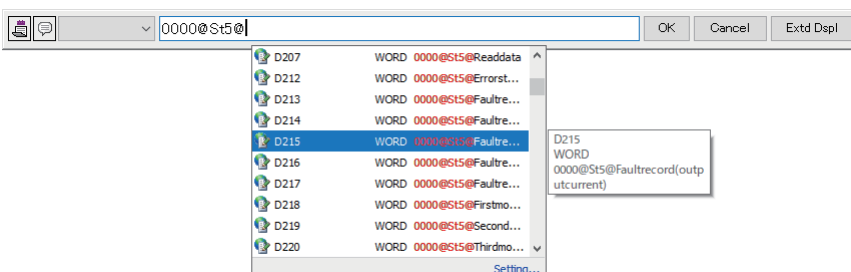

5. Double-click the device for which the comment matching the intended use in the program is set. The device is applied to the element entry dialog.

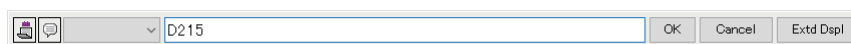

## Deleting unused device comments

---

Unused comments in a program can be deleted in a batch. To delete the comments, open a device comment editor in advance.

### Operating procedure

Select [Edit] ⇒ [Delete Unused Device Comment].

### Deletion target

Device comment type	Deletion target
Common device comment	Unused device comments in all programs
Each program device comment	Unused device comments in the corresponding program
	Device comments in all programs

## Clearing all device comments

---

The comments set to device comment data can be deleted in a batch.

### Operating procedure

#### ■Deleting all device data in the device comment data

Select [Edit] ⇒ [Clear All (All Devices)].

#### ■Deleting device data being displayed on a device comment editor

Select [Edit] ⇒ [Clear All (Displayed Devices)].



# Importing/exporting device comments

---

Device comments can be imported/exported from/to a CSV file.

When multiple comments are set, the comments of which the checkboxes in the "Available" column are selected in the "Multiple Comments Display Setting" screen are output.

## Importing

---

Import a comment in a CSV file to a device comment.

When importing one file only, it will be imported in the selected device comment.

When importing multiple files, they will be imported in the device comments which have the same file names.

If a device comment, which has a same file name, does not exist, a new device comment will be created.

## Operating procedure

1. According to the number of files to be imported, perform the following operation.
  - One file: Select and right-click a device comment to import a file in the navigation window, then select [Import File] from the shortcut menu.
  - Multiple files: Select "Device" ⇔ "Device Comment" in the navigation window, then right-click it and select [Import Multiple Files] from the shortcut menu.
2. Set the extended setting as necessary, then click the [Yes] button.
3. Select a file(s) to be installed in the "Import File" screen, and click the [Open] button.

### Point

---

Files exported for each device type can be imported in a batch by selecting [Import Multiple Files] from the shortcut menu.

---

## Precautions

- When exporting files by splitting them for each device type, a device symbol is added to each file name. When importing them, devices defined in the files are read regardless of the device symbols of file names.
- When importing multiple files, they are read in ascending order of the file names. When the same device exist in multiple files, the comment in the file read later are applied.

## Exporting

Write a device comment to a CSV file.

When exporting one file only, the CSV file needs to be saved with an arbitrary name.

When exporting multiple files, CSV files are saved with the same name as device comments in an arbitrary folder.

### Operating procedure

1. According to the number of files that will store device comments, perform the following operation.
  - One file: Select and right-click a device comment to export in the navigation window, then select [Export to File] from the shortcut menu.
  - Multiple files: Select "Device" ⇨ "Device Comment" in the navigation window, then right-click it and select [Export to Multiple Files] from the shortcut menu.
2. Set the extended setting as necessary, then click the [Yes] button.
3. Select a folder that will store the exported file(s) in the "Export to File" screen/"Specify Folder to Export" screen, and click the [Save] or [OK] button.

### Point

By selecting "Write comment data to different files sorted by target device types." in the extended setting, files split for each device type can be output.

The file name of an output file is "(data name)" + "(device symbol)" + ".CSV". When "\" is included in a device symbol, it is replaced to "\_".

### Precautions

- When a device comment, that exceeds the applicable number of characters, is set in a device comment editor, a warning message appears in the "Output" window and the excessive characters are deleted.
- When an error occurs during import or export of multiple files, the processing will terminate with saving the device comments imported/exported until then.
- When no device comment is set for all devices, a file(s) is not output by exporting a device comment(s).

## CSV file format

The column titles in a device comment editor and header names in a CSV file are linked.

- In a device comment editor, only the data of which column titles match with header names in a CSV file is imported.
- Data can be imported even when the column order in a CSV file does not match with that in a device comment editor.
- To import data from a CSV file exported in GX Works3 with a different language, edit the header names in the CSV file to match with the column titles displayed in a device comment editor of the import target GX Works3.

### Point

The CSV files exported with GX Works2 can be imported in GX Works3.

When multiple comment display is set, edit the header names in a CSV file exported from GX Works2 to match with the column titles in a device comment editor of GX Works3, and then import the file.

## Searching for device comments

To search for a device comment, refer to the following:

 Page 451 Searching for/Replacing Character Strings

# Reading sample comments

The sample comments of system devices (special relays/special registers), CPU buffer memory access devices, and intelligent function modules can be applied to a device comment editor automatically.

## Operating procedure

1. Open a device comment editor.
2. Select [Edit] ⇒ [Read from Sample Comment].
3. Set each item in the "Read from Sample Comment" screen, and click the [OK] button.

The sample comments are applied to a device comment editor.

**Ex.**

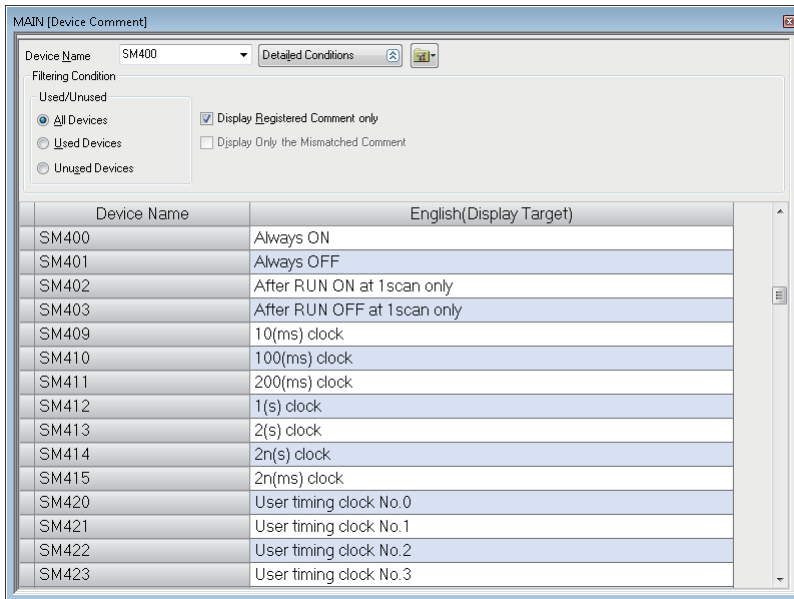

## Precautions

When reading sample comments of an intelligent function module, the data size may exceed the memory capacity of the CPU module and data may not be written. In this case, prepare an SD memory card.

The writable capacity of an SD memory card installed in an FX5CPU is the same as that of the FX5CPU module itself.

FX5CPUs do not support sample comments of CPU buffer memory.

### Point

By selecting "Yes" for the following option, when adding an intelligent function module to a project, the sample comments for the module are automatically applied to the device comment editor of "Common Device Comment."

- [Tool] ⇒ [Options] ⇒ "Project" ⇒ "Add New Module" ⇒ "Operation Setting" ⇒ "Read Sample Comment"

# 6.9 Checking/Editing the Relation between Programs

This section explains the method for checking the relation between the following data in a project with a diagram and editing the data on the diagram:

- Program block
- Function block
- Function

## Window

Select [Tool] ⇒ [Program Configuration Diagram].

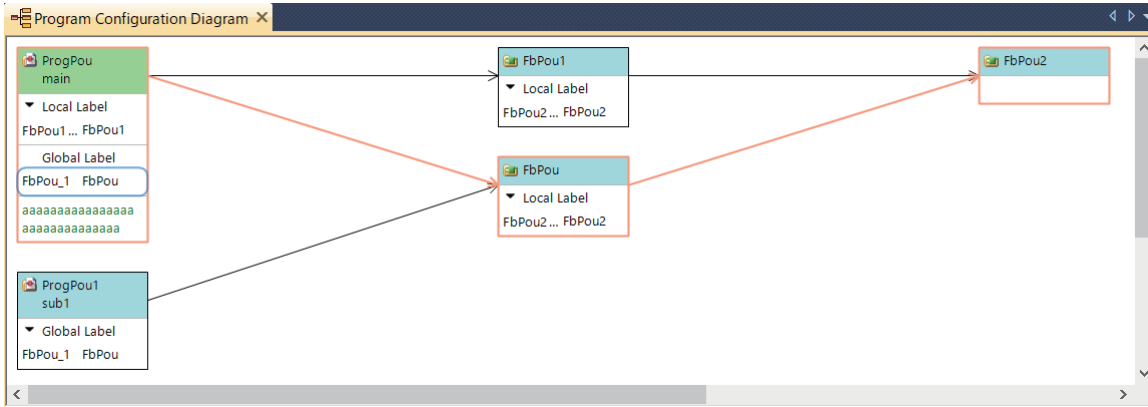

Data in a project is displayed as a block, and the associated data is connected to each other with a connection line.

## Operating procedure

Switch the display mode/edit mode according to the intended use of a program configuration diagram.

Mode	Purpose	Operation	Reference
Display mode	To check a program configuration diagram	Select [Edit] ⇒ [Mode] ⇒ [Display Mode].	Page 411 Display mode
Edit mode	To edit a program configuration diagram	Select [Edit] ⇒ [Mode] ⇒ [Edit Mode].*1	Page 414 Edit mode

\*1 When the displayed program configuration diagram is old, the mode cannot be switched to the edit mode. In this case, update the program configuration diagram. (☞ Page 411 Updating a program configuration diagram)

# Display mode

This mode is used to check a program configuration diagram.

By selecting a block or label on a block in the display mode, the selected block and associated block with the selected block or label are marked with orange frames.

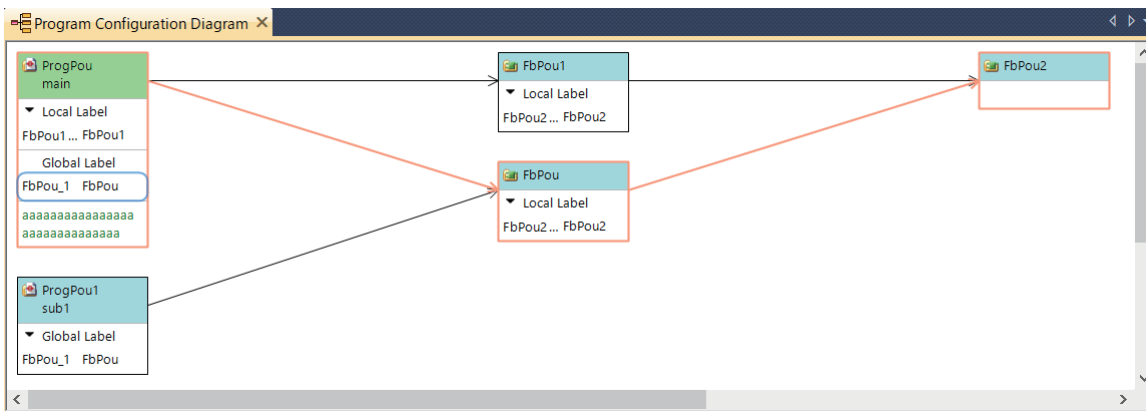

## Operating procedure

### ■Selecting a block from the navigation window

By selecting data in the navigation window, then right-clicking and selecting [Select in Program Diagram] from the shortcut menu, the cursor can be placed on the block of the selected data.

### ■Expanding/collapsing a block

By selecting a block in "Program Configuration Diagram," then right-clicking and selecting [Expand/Collapse] from the shortcut menu, the display status of the selected block can be changed.

To change the display status of all blocks, select [Edit] ⇒ [Expand/Collapse All].

### ■Filtering a block

By selecting a block in "Program Configuration Diagram" or selecting a label on a block then right-clicking and selecting [Filter] from the shortcut menu, only the blocks that are associated with the selected block or label can be filtered.

### ■Updating a program configuration diagram

By right-clicking in "Program Configuration Diagram" and selecting [Update Configuration Diagram] from the shortcut menu, the display contents of the program configuration diagram can be updated.



Whether to retain the position or size of a block at the update can be set by setting the following option:

- [Tool] ⇒ [Options] ⇒ "Other Editor" ⇒ "Program Configuration Diagram" ⇒ "Update Configuration Diagram" ⇒ "Keep Element Arrangement"

## Precautions

If "Program Configuration Diagram" has been opened even once, the contents cannot be updated even if "Program Configuration Diagram" is closed after editing data and then opened again. Update the contents manually by following the procedure in this section.

### ■Displaying a label editor

By selecting a block in "Program Configuration Diagram," then right-clicking and selecting [Open Label Setting of Selected Element] ⇒ [Open in Front]/[Tile Horizontally] from the shortcut menu, a local label editor of the selected block can be displayed.

- A label editor can also be displayed by double-clicking a local label or global label on a block. In this case, the cursor is placed on the double-clicked label on the label editor.
- A global label editor can be displayed by selecting a global label on a block, then right-clicking and selecting [Open Label Setting of Selected Element] ⇒ [Open in Front]/[Tile Horizontally] from the shortcut menu.

## Information to be displayed

### Relation between data

In a program configuration diagram, a block of the source data (1) is placed on the left, and a block of the associated data (2) is placed on the right.

The relations between the displayed data are as follows:

- (3): An associated function block and function (2) are called from the program body of the source data (1).
- (4): Associated data (2) is used in the program body of the source data (1).
- (5): A label of the data type for the associated data (2) is registered in a label editor of the source data (1).

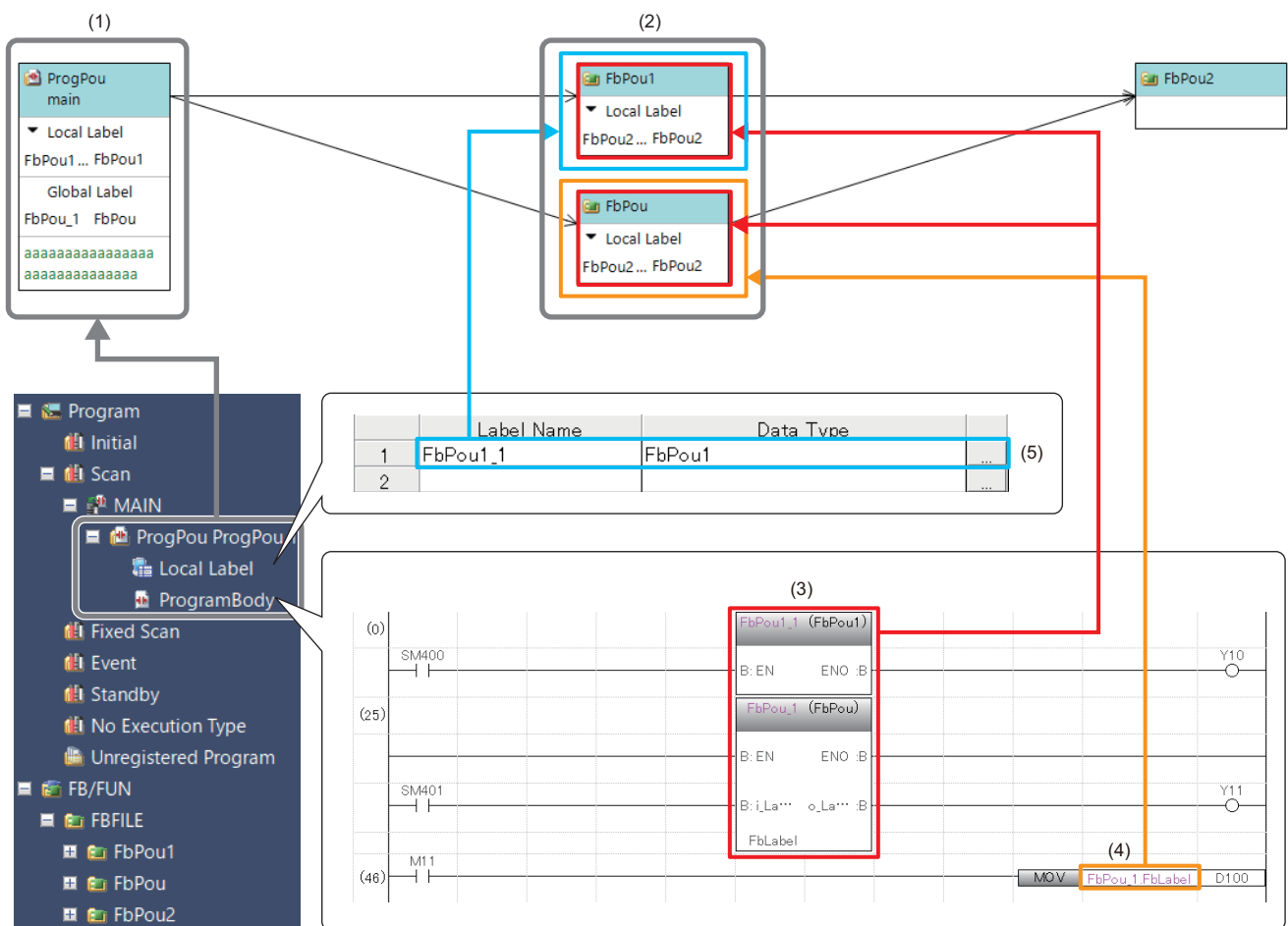

### ■Local label and global label

A label of the data type for the associated data is displayed on a block among the labels registered to a label editor.

### ■Data name and comment

- Data names and comments set to a program block, function block, and function are displayed in a block.
- By selecting [View] ⇒ [Display Title]/[Display comment], it can be switched to show or hide the data name or comment in a block.

### ■Setting data to be displayed in a configuration diagram

Data to be displayed in a program configuration diagram can be set in the following option:

- [Tool] ⇒ [Options] ⇒ "Other Editor" ⇒ "Program Configuration Diagram" ⇒ "Update Configuration Diagram" ⇒ "Auto-generation Target"

When updating a program configuration diagram after setting the above option to "No," an element which is no longer generated automatically is deleted from the program configuration diagram, and editing information such as a position of the element is discarded.

## Information not to be displayed

The following data may not be displayed in a program configuration diagram:

- Data protected by security
- Instructions in a ladder
- Manufacturer-provided function blocks/functions that do not have the source data
- Manufacturer-provided function blocks/functions associated with other manufacturer-provided function blocks/functions

## Considerations

If a program is in the unconverted state, a program configuration diagram may not be displayed properly.

# Edit mode

This mode is used to edit a program configuration diagram.

By editing the data on the program configuration diagram, the edited contents are accordingly reflected to a project.

## Window

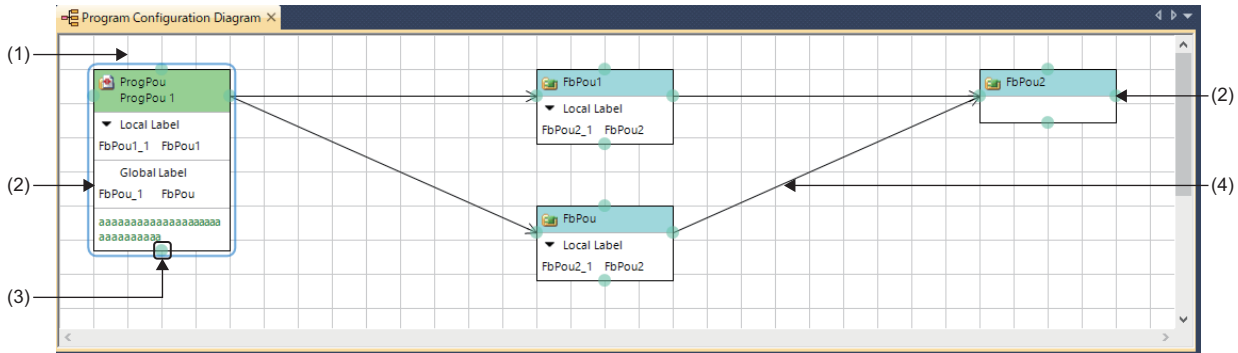

## Displayed items

Item	Description
(1) Grid	A grid line that serves as markers to place the blocks.
(2) Block	The following data in a project is displayed: <ul style="list-style-type: none"> <li>• Program block</li> <li>• Function block</li> <li>• Function</li> </ul>
(3) Connection point	A terminal point of when connecting blocks with a connection line. <ul style="list-style-type: none"> <li>• Blue: Can be connected</li> <li>• Red: Cannot be connected</li> </ul>
(4) Connection line	A line that indicates the relation between data. For details, refer to the following: ☞ Page 412 Information to be displayed When a connection line is changed, the label of the data type before the change used in the relation source block is changed to the label of the target data type.

## Operating procedure

### ■ Adding a block

The following explains the procedure to add a program block and function block.

1. Perform any of the operations:

Operation	Operating procedure
Enter from an edit box	Select a cell to which a block is to be added, then enter a data name directly.
Insert from a menu	Select [Edit] ⇒ [Element] ⇒ [Program Block]/[Function Block].
Insert from the toolbar	Select  (Program Block)/ (Function Block).

2. Set each item in the "Add New Data" screen, then click the [OK] button.

### ■ Adding a label

The following explains the procedure to add a label to a block.

1. Connect a block to which a label is to be added (source block) to an associated block. (☞ Page 415 Common operations of elements)

2. Set each item in the "Undefined Label Registration" screen and click the [OK] button.



## Common operations of elements

Operation		Operating procedure
Change	To change a name	<ul style="list-style-type: none"> <li>• Double-click an element of which the name is to be changed, and enter a new name in the edit box.</li> <li>• Select an element of which the name is to be changed, and press the <b>[F2]</b> key, then enter a new name in the edit box.</li> </ul>
	To change the size	<ol style="list-style-type: none"> <li>1 Place the cursor on the frame of a block of which size is to be changed. The icon of the cursor changes.</li> <li>2 Move the cursor vertically with the frame being held.</li> </ol>
Move		<ul style="list-style-type: none"> <li>• Drag and drop a block to be moved.</li> <li>• Select a block to be moved, and press the <b>[Ctrl] + [Shift] + [←] / [→] / [↑] / [↓]</b> keys.</li> </ul>
Copy <sup>*1*2</sup>		<ul style="list-style-type: none"> <li>• Select a block to be copied, and select <b>[Edit] ⇨ [Copy]</b>.</li> <li>• Select a block to be copied, and press the <b>[Ctrl] + [C]</b> keys.</li> </ul>
Paste		<ul style="list-style-type: none"> <li>• Select a block to be pasted, and select <b>[Edit] ⇨ [Paste]</b>.</li> <li>• Select a block to be pasted, and press the <b>[Ctrl] + [V]</b> keys.</li> </ul>
Delete <sup>*3</sup>		<ul style="list-style-type: none"> <li>• Select an element to be deleted, and select <b>[Edit] ⇨ [Delete]</b>.</li> <li>• Select an element to delete, and press the <b>[Delete]</b> key.</li> </ul>
Connection line <sup>*4</sup>	To connect	Click a connection point, and drag it to a target connection point.
	To replace	Click a connection point of the replacement source while a connection line is selected, and drag and drop it to a connection point of the replacement target.

\*1 Multiple blocks cannot be copied at the same time.

\*2 The following data, a label used in the following data, and a global label cannot be copied.

- Manufacturer-provided function block
- Tag FB
- Function

\*3 The following data, a label used in the following data, and a global label cannot be deleted.

- Manufacturer-provided function block
- Tag FB

\*4 In any of the following cases, data cannot be connected or the connection target cannot be replaced:

- A source (connection source) block is a manufacturer-provided function block
- An associated (connection target) block is a program block.
- The data is a tag FB or function.
- A circular reference occurs.

## Correcting the layout

Operation	Operating procedure
Insert a row	Select a cell in a row to be inserted, then select <b>[Edit] ⇨ [Layout] ⇨ [Insert Row]</b> . A new row is inserted on the selected cell.
Delete a row	Select a cell in a row to be deleted, then select <b>[Edit] ⇨ [Layout] ⇨ [Delete Row]</b> . The row including the selected cell is deleted.
Insert a column	Select a cell in a column to be inserted, then select <b>[Edit] ⇨ [Layout] ⇨ [Insert Column]</b> . A new row is inserted on the left of the selected cell.
Delete a column	Select a cell in a column to be deleted, then select <b>[Edit] ⇨ [Layout] ⇨ [Delete Column]</b> . The column including the selected cell is deleted.

## Precautions

- The following menu cannot be used in a program configuration diagram:  
**[Edit] ⇨ [Undo]/[Redo]**
- If the data displayed in a program configuration diagram is different from the actual data, such as when the data is edited in a program editor, the mode switches automatically from the edit mode to the display mode.

## 6.10 Checking a Program

This section explains the method for checking whether an error exists in a created program.

The following table shows the differences of check contents in a program check and a syntax check.

○: Checked, ×: Not checked

Check point	Syntax check	Program check
Ladder block check (ladder program, FBD/LD program)	○	×
Program syntax check (ST program)	○	×
Use of undefined label check	○	×
Data type of argument check	○	×
Duplicated coils check	×	○
Use of out-of-range device check	×	○
Incorrect pointer check	×	○
Instructions, used in pairs, check (such as (FOR/NEXT, MC/MCR)	×	○

### Syntax check

This is for checking the validity of the program syntax.

This can be performed for ladder, ST, and FBD/LD programs.

Remote head modules do not support this check.

#### Operating procedure

##### ■Checking all programs

Select [Convert] ⇒ [Check Syntax] ⇒ [ALL POU].

##### ■Checking programs on activated program editors

Select [Convert] ⇒ [Check Syntax] ⇒ [Current POU].

When an error is found in the check result, the error message appears in the "Output" window. Take corrective actions according to the displayed contents.

When multiple worksheets exist, all programs in the POU are checked in this check.

#### Precautions

- After a syntax check is completed, the former operations cannot be undone or redone on a ladder editor.
- When a return element is used in an FBD/LD program, the local label may be changed to the unconverted state and the project may also be changed to the unsaved state.

# Program check

This is for checking improper input and program inconsistency.  
Remote head modules do not support this check.

## Window

Select [Tool] ⇨ [Check Program].

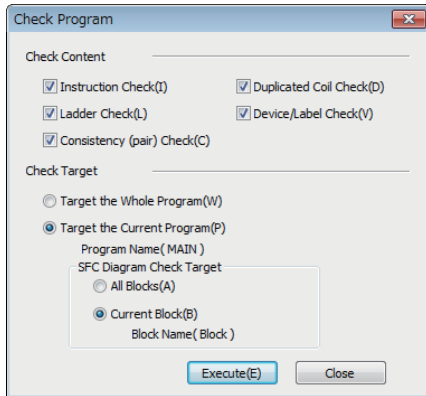

When an error is found in the check result, the error message appears in the "Output" window. Take corrective actions according to the displayed contents.

## Precautions

### ■When a macro type function block is used

When an error occurs in a program of a macro type function block, the cursor may jump to a location where the corresponding error does not exist even if the error message displayed in the "Output" window is double-clicked.

In that case, identify the location where the error has occurred by any of the following methods.

No.	Method
1	Search for the name of a device, label, or instruction given in the error message. (☞ Page 445 SEARCHING FOR DATA)
2	<ul style="list-style-type: none"><li>① Back up the project.</li><li>② Change the type of the function block to the subroutine type. (☞ Page 486 Changing the type of a function block)</li><li>③ Convert all programs.</li><li>④ Double-click a displayed error message, and check the jump destination.</li></ul> If an error does not occur after converting all programs, check a ladder where an input argument, output argument, or input/output argument of the macro type function block is used.

## Target of duplicated coil check

### ■Instruction

The following instructions are checked as the target.

- RCPU and LHCPU: EGP, EGF, OUT, OUTH, SET, PLS, PLF, FF, DELTA, DELTAP, SFT, SFTP, MC, pointer, BLKMOV<sup>\*1</sup>, BLKMOVBP<sup>\*1</sup>, MOV<sup>\*1</sup>, MOVBP<sup>\*1</sup>, CMLB<sup>\*1</sup>, CMLBP<sup>\*1</sup>
- FX5CPU: OUT, OUTH, SET, PLS, PLF, FF, SFT, SFTP, MC, pointer, BLKMOV<sup>\*1</sup>, BLKMOVBP<sup>\*1</sup>, MOV<sup>\*1</sup>, MOVBP<sup>\*1</sup>, CMLB<sup>\*1</sup>, CMLBP<sup>\*1</sup>, OUTHS, UDCNTF

\*1 Not checked when any of the following devices is used:

- Timer (T)
- Retentive timer (ST)
- Long timer (LT)
- Long retentive timer (LST)
- Counter (C)
- Long counter (LC)

### ■Device

The following devices are checked as the target.

For the available devices in a CPU module, refer to the user's manual of each module.

- RCPU and LHCPU

Check range	Type	Device
Check in a project	Device	M, SM, L, F, V, S, TR, X, Y, B, SB, DX, DY, D, SD, R, ZR, RD, W, SW, T(TC), T(TS), T(TN), C(CC), C(CS), C(CN), ST(STC/SC), ST(STS/SS), ST(STN/SN), LT(LTC), LT(LTS), LT(LTN), LC(LCC), LC(LCS), LC(LCN), LST(LSTC/LSC), LST(LSTS/LSS), LST(LSTN/LSN), P, I, BL, GLP
	Link direct device	J□\X, J□\Y, J□\B, J□\SB, J□\W, J□\SW
	Module access device	U□\G, U□\HG
	Safety device	SA\M, SA\SM, SA\X, SA\Y, SA\B, SA\B, SA\ID, SA\ID, SA\W, SA\T(TC), SA\T(TS), SA\T(TN), SA\C(CC), SA\C(CS), SA\C(CN), SA\ST(STC/SC), SA\ST(STS/SS), SA\ST(STN/SN)
	Step No./ Transition No. in an SFC program	BL□\S, BL□\TR
Check in file only	Device	#M, #V, #D, #T(TC), #T(TS), #T(TN), #C(CC), #C(CS), #C(CN), #ST(STC/SC), #ST(STS/SS), #ST(STN/SN), #LT(LTC), #LT(LTS), #LT(LTN), #LC(LCC), #LC(LCS), #LC(LCN), #LST(LSTC/LSC), #LST(LSTS/LSS), #LST(LSTN/LSN), #P, #LLP
	Safety device	SA\#M, SA\#D, SA\#T(TC), SA\#T(TS), SA\#T(TN), SA\#C(CC), SA\#C(CS), SA\#C(CN), SA\#ST(STC/SC), SA\#ST(STS/SS), SA\#ST(STN/SN)

- FX5CPU

Check range	Type	Device
Check in a project	Device	M, SM, L, F, S, X, Y, B, SB, DX, DY, D, SD, R, W, SW, T(TC), T(TS), T(TN), C(CC), C(CS), C(CN), ST(STC/SC), ST(STS/SS), ST(STN/SN), LC(LCC), LC(LCS), LC(LCN), P, I, BL
	Module access device	U□\G
	Step No./ Transition No. in an SFC program	BL□\S

## ■Label

The following labels are checked as the target.

- Local label
- Global label

The devices assigned to labels are also checked.

## Precautions

Labels used in the following programs are excluded from the check target.

- Inline structured text program
- Function
- Function block

A selection function (SEL) used in a ladder editor and FBD/LD editor is a duplicated coil even if inconsistency does not occur.

# 6.11 Converting Programs

This section explains the method for converting a created program into a code that can be executed.

A data name displayed in red in the navigation window indicates that the data is unconverted. The data is required to be converted.

A data name displayed in light blue in the navigation window indicates that the data is unused. The data is not converted.

The name of unused data that is not converted is displayed in red. After the data is converted successfully, it will be displayed in light blue. If a conversion error occurs, all the unused data will be displayed in red.

## Converting any or all programs

The program in a project can be converted and a label can be assigned. The program is also checked at conversion.

The differences in operation between "Convert" and "Rebuild All" are shown below:

Item	Conversion target	Assignment of labels	Program check
Convert <sup>*1</sup>	Newly added or changed program and label	The memory is assigned to the newly added and changed label.	Whether to perform a program check can be specified in "Basic Setting" by selecting [Tool] ⇒ [Options] ⇒ "Convert."
Rebuild All	All programs and labels in a project (regardless if changed or not)	Retain: Converts a program without changing the memory assigned to a defined label <sup>*2</sup> . A newly added label and a label, of which the label name, data type, class, and initial value etc. have been changed, are reassigned again. Reassignment: Converts a program with assigning the memory to all labels. The memory usage can be optimized.	Whether to perform a program check can be specified in the "Rebuild All" screen. <sup>*3</sup>

\*1 Remote head modules do not support it.

\*2 A label of which the label name, data type, class, and initial value etc. have not been changed after reassigning the memory in previous conversion of any or all programs.

\*3 The instruction check cannot be performed if "No" is selected for the following option or if the project is for an FX5CPU:  
[Tool] ⇒ [Options] ⇒ "Convert" ⇒ "Basic Setting" ⇒ "Operational Setting" ⇒ "Use Phase Processing Instructions"

### Operating procedure

1. Select [Convert] ⇒ [Convert] <sup>\*1</sup> (📄)/[Rebuild All] (📄).
2. To convert all programs, specify each item for "Label Assignment" and "Check Program"<sup>\*2</sup> in the "Rebuild All" screen, and click the [OK] button.

\*1 When "Yes" is selected in the following option setting, the online program change is performed instead.

[Tool] ⇒ [Options] ⇒ "Convert" ⇒ "Online Program Change" ⇒ "Operational Setting" ⇒ "Execute Online Program Change in Converting"



\*2 If there is no program, the check is not performed even if the check box for "Check Program" is selected.

#### Point



The unconverted data can be checked. Select and right-click a global label, POU, or program file in the navigation window, then select [Expanded/Collapse Tree] ⇒ [Open Unconverted Data] from the shortcut menu.

## ■Operations that requires a conversion for all programs

When one of the following operation is performed, converting all programs is required.



- Changing the module type/operation mode
- Changing the system parameter (Fixed Scan Communication Area Setting)
- Changing CPU parameters (File Register Setting, Device/Label Memory Area Setting, Index Register Setting, Refresh Memory Setting, Pointer Setting, Program Setting, FB/FUN File Setting, Refresh Setting (At I45 Exe))
- Changing CPU parameters (Program Capacity Setting, To Use or Not to Use SFC) of an FX5CPU
- Changing the option setting ("Other Editor" ⇨ "Label Editor Common" ⇨ "Data Type Setting," "Convert" ⇨ "Basic Setting" ⇨ "Operational Setting")
- Adding a label, of which the data type is the function block, to a local label of converted function block
- Changing the type of a function block in the "Properties" screen of an FB file (  Page 486 Changing the type of a function block)
- Importing a ladder program from a CSV file
- Changing reserved area capacities in the "Properties" screen of a function block. (  Page 487 Setting reserved area capacities)
- Adding a label which exceeds the reserved area capacity<sup>\*1</sup> to a local label of converted function block
- Changing reserved area capacities in the "Properties" screen of a structure definition (  Page 242 Setting reserved area capacities)
- Adding a structure member which exceeds the reserved area capacity<sup>\*1</sup> to a converted structure definition
- Changing the tag FB setting (tag FB type, tag type, declaration position) in projects for an RnPCPU and an RnPSFCPU
- Changing a security version of a project and project password
- Changing the security key setting (for a project whose security version is '2' only)

\*1 For details, refer to the following:

-  MELSEC iQ-R Programming Manual (Program Design)
-  MELSEC iQ-F FX5 Programming Manual (Program Design)

## Considerations for conversion

For details on the conversion of a function block and function, refer to the following:

-  Page 487 Converting function blocks
-  Page 505 Converting functions

## Considerations for conversion or conversion for all programs

### ■When canceling a conversion

A conversion is canceled for each program file. Even though the [Cancel] button is clicked during a conversion, it will not be canceled until the conversion for one program file is completed.

Note that a large-scale program file with multiple FBs/FUNs may require a longer time to cancel the conversion.

### ■When creating a sequence program including multiple instructions

'LD SM400' may be added in the beginning of the program in order to execute the program.

### ■When no program is included in a project

Program check is not performed.

### ■When an inline structured text is used in a ladder program

When an inline structured text box is placed in a wrapping destination ladder, a jump destination of an error message may be the top of a ladder block if a conversion error occurs in an inline structured text. Change the layout of the inline structured text box, or perform a conversion after change the number of displayed contacts so that the inline structured text box is not placed in a wrapping destination ladder.

## ■When the warning for the error code '0x120C2010' or '0x120C2011' is displayed

A warning message appears when converting a program containing an unused POU in which any of the following data is used.

- Function block
- Function
- Standard function block
- Structure

An example using a function block is explained below.

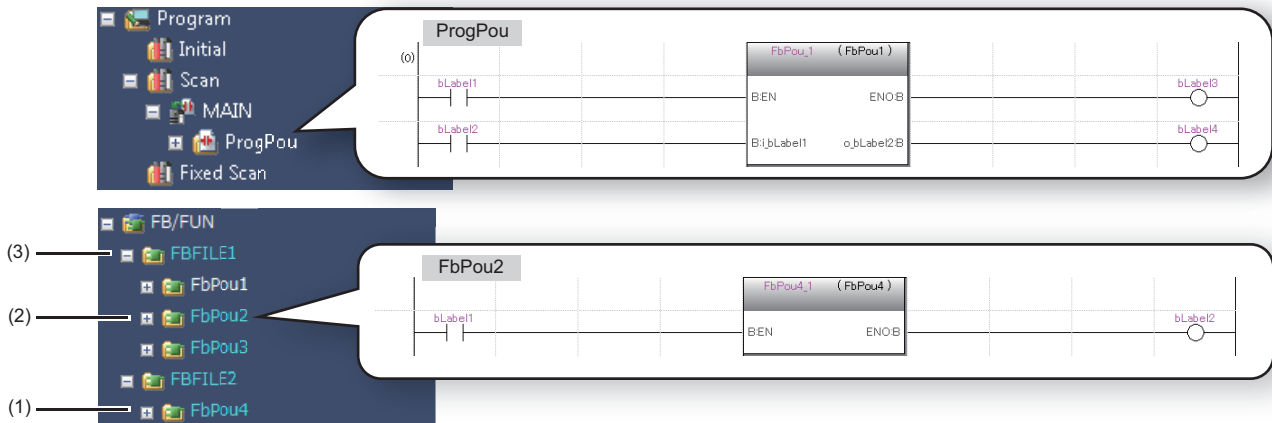

When writing the program (3) to a CPU module while a warning message is displayed, the POU (2) is written but the data (1) is not.

Therefore, an error will occur when reading the POU (2) from the CPU module to a new project in order to use it in a program and converting the created program because the data (1) is not included.

To avoid this error, take the following measures before writing the program (3) to the CPU module.

Data	Measure
Function block Function	<p>Move a function block or function into an FB file or FUN file including a converted POU and convert the program again.</p>
Standard function block	Use a standard function block in a converted program and convert the program again.
Structure	Register one or more structure type labels into a label editor in which the assigned label is included and convert the program including the label again.



**■When an error code '0x120110A2' or '0x120110A4' is displayed**

A conversion error occurs when either of the following global labels is bit-specified or digit-specified in a program.

- Global label to which a digit-specified bit device is assigned (word type)
- Global label to which a bit-specified word device is assigned (bit type array)

Change the program as follows.

Changing method	Program example								
<p>❶ Transfer the current value of the global label to another device or label.</p> <p>❷ Specify a bit or digit for the device or label.</p>	<p>Example: Global label to which a digit-specified bit device is assigned (G_uLabel1)</p> <table border="1"> <thead> <tr> <th>Label Name</th> <th>Data Type</th> <th>Class</th> <th>Assign (Device/Label)</th> </tr> </thead> <tbody> <tr> <td>G_uLabel1</td> <td>Word [Unsigned]/Bit String [16-bit]</td> <td>... VAR_GLOBAL</td> <td>K4X0</td> </tr> </tbody> </table> <p>An error occurs when converting a program where 'G_uLabel1' is bit-specified.</p> <p>This program can be converted properly by changing it to the program where another label that the value of 'G_uLabel1' is transferred to (L_uLabel1) is bit-specified.</p>	Label Name	Data Type	Class	Assign (Device/Label)	G_uLabel1	Word [Unsigned]/Bit String [16-bit]	... VAR_GLOBAL	K4X0
Label Name	Data Type	Class	Assign (Device/Label)						
G_uLabel1	Word [Unsigned]/Bit String [16-bit]	... VAR_GLOBAL	K4X0						

**■When an error code '0x120110A3' or '0x120110A5' is displayed**

A conversion error occurs when either of the following Input/output labels is bit-specified or digit-specified in a program of a macro type function block.

- Input/output label using a digit-specified bit device as its argument (word type)
- Input/output label using a global label to which a bit-specified word device is assigned as its argument (bit type array)

Change the program as follows.

Changing method	Program example
<p>❶ Transfer the current value of the digit-specified bit device or the global label to another device or label.</p> <p>❷ Use the device or label as the argument of an input/output label of a macro type function block.</p>	<p>Example: Input/output label using the digit-specified bit device (K4M0) as its argument (uLabel1)</p> <p>An error occurs when converting a program using 'K4M0' as the argument of 'uLabel1.'</p> <p>This program can be converted properly by changing it to the program using another label that the value of 'K4M0' is transferred to (L_uLabel1) as the argument.</p>

## Considerations after converting any or all programs (Retain)

A newly added label and a label of which the data type etc. have been changed are reassigned again.

The current (initial) label value can be reassigned by any of the following methods.

- Register the label to a watch window, and set the current value.
- Set the initial value on a label editor.\*1

\*1 FX5CPU does not support the setting for initial values of labels.

When the current value of a local label needs to be retained, perform the online program change.

For details, refer to the following:

📖 MELSEC iQ-R CPU Module User's Manual (Application)

## Considerations after converting all programs (Reassignment)

When all programs are converted (reassigned), the label memory area is reassigned to all POU's. If all the converted programs are written to the CPU module and RUN as they are, the programs may be processed with the device values set before the program change.

After converting all programs, initialize the labels by the following procedure.

### Operating procedure

1. Switch the CPU module to STOP.
2. Select "Device/Label Memory" in the "CPU Memory Operation" screen displayed by selecting [Online] ⇒ [CPU Memory Operation] to clear the values.
3. Select [Online] ⇒ [Write to PLC] (📄) to write the changed program files. When the initial values of labels used in the program are set, write the initial label value file as well.
4. Reset the CPU module.

It can also be reset by selecting [Online] ⇒ [Remote Operation].

The labels are set to '0' or initialized with the values set in the initial label value file.

## Converting a program file with the process control extension enabled

### Point

Operations of a program with the process control extension enabled can be set in the following option setting.  
[Tool] ⇒ [Options] ⇒ "Convert" ⇒ "Process Control Extension Setting"

### ■ Adding/changing the program processing while the system is operating

For process control, when changing/adding the program processing while the system is operating, the current value of a registered label needs to be retained and the current value of a newly added/changed label needs to be initialized to keep the system operating.

However, labels newly added/changed after writing a programmable controller only cannot be initialized by converting any or all programs when writing them to the programmable controller next time.

To initialize only the current value of a newly added/changed label, perform the online program change.

In addition, set the following option so as not to convert (retain) any or all program after creating a new project.

- [Tool] ⇒ [Options] ⇒ "Convert" ⇒ "Basic Setting" ⇒ "Conversion Operation" ⇒ "Enable Conversion"

### ■ System header and system footer

When creating a program file with the process control extension enabled, the system data for the process control extension is generated at conversion.

A program file of the scan execution type with the process control extension enabled, the system header POU (M+PHEADER) and system footer POU (M+PFOOTER) are created in the program file after conversion.

At conversion, the execution order of the system header is set to the start of the program file. As for the system footer, it is set to the end of the program file. (The order can be checked in the program file setting.)

When the process control extension is disabled or the execution type other than scan is set, the system header and system footer will be deleted from the program file at conversion.

### ■ Increase of the number of steps used

The number of steps used increases in a program with the process control extension enabled.

The following table shows the number of extra steps used.

Program execution type	Program block name	Number of extra steps used
Scan	M+PHEADER	Approx. 1400 steps
	M+PFOOTER	Approx. 30 steps
	Others	Approx. 10 steps
Fixed scan	All	Approx. 60 steps

### ■ Device memory

When a program with the process control extension enabled exists and "Use Common File Register in All Programs" is set for "File Register Setting" of "CPU Parameter," the device memory is created at conversion.

In addition, the data in the range set in the following option is overwritten to the device memory.

- [Tool] ⇒ [Options] ⇒ "Convert" ⇒ "Process Control Extension Setting" ⇒ "System Resource"

## Converting a project with the process control extension enabled

Note the following for projects used for CPU modules in a redundant system configuration with the process control extension enabled.

### ■Tracking setting

The following parameters are automatically set when converting a program.

Parameter	Setting content
• "CPU Parameter" ⇒ "Redundant System Settings" ⇒ "Tracking Setting" ⇒ "Tracking Device/Label Setting"	The settings in "Detail Setting" are configured.
• "CPU Parameter" ⇒ "Redundant System Settings" ⇒ "Tracking Setting" ⇒ "Tracking Device/Label Setting" ⇒ "Device/Label Detailed Setting"	The range of a file register that was set in the following option is set for the trucking block No.64 <sup>*1</sup> . • [Tool] ⇒ [Options] ⇒ "Convert" ⇒ "Process Control Extension Setting" ⇒ "System Resource" ⇒ "File Register: ZR"

\*1 A trucking block number that was set in the following option:

[Tool] ⇒ [Options] ⇒ "Convert" ⇒ "Process Control Extension Setting" ⇒ "Redundant Setting" ⇒ "Tracking Block No."

The following device data must be set manually since it is not automatically set in "Device/Label Detailed Setting" of "CPU Parameter."

- Device data other than file registers used for FBD/LD programs for process control
- Device data used for programs other than FBD/LD programs for process control

When setting the device data described above, set them to a trucking block number other than No.64 in "Device/Label Detailed Setting" of "CPU Parameter"

### Precautions

The contents of the tracking block No.64 in "Device/Label Detailed Setting" of "CPU Parameter" cannot be changed manually since they are automatically set when converting a program.

SD1670.F automatically turns ON at scanning while a CPU module is running in the backup mode since the set contents of the tracking block No.64 is transferred (tracked); do not turn SD1670.F OFF during the scan.

When reading parameters from a CPU module after converting a program, if the parameter is overwritten with a different content from the one that was automatically set as above, convert the program again.

## Memory assignment of labels (RCPU/LHCPU/FX5CPU)

When converting/converting all programs, the labels declared in a label editor are assigned to the memory in a packing block (which is classified as type and data type, and set them in consecutive order of line numbers) unit. Since it is assigned in POU units, the start position of POU will be 64-bit address boundary.

Ex.

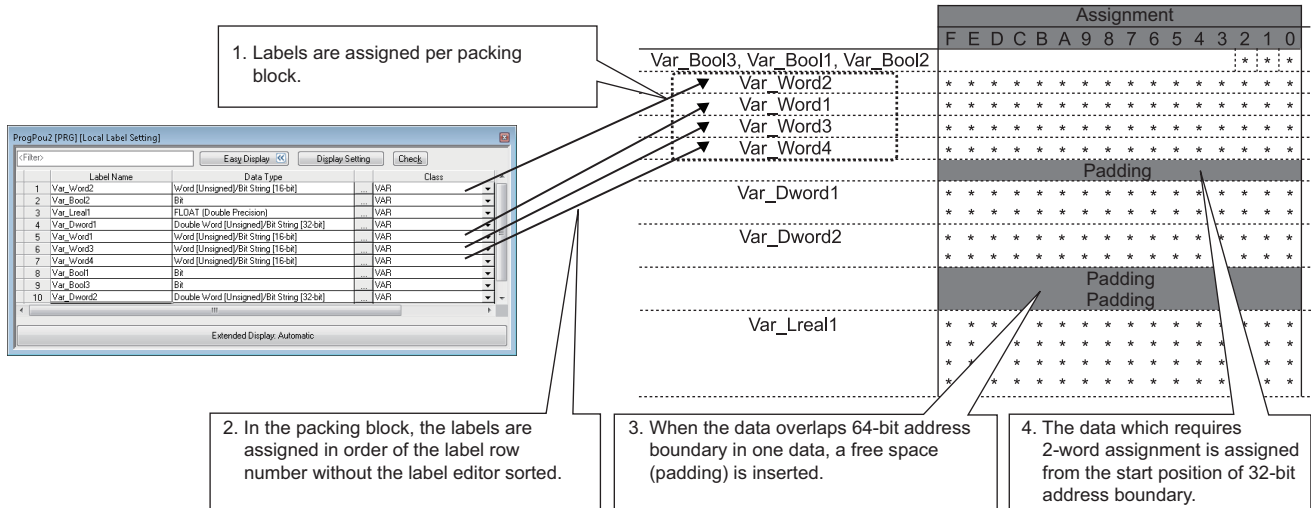

The types of packing blocks and assignment order is shown below.

They are arranged in ascending order due to minimize the useless space.

Assignment order	Packing block	Data type	Remarks
1	Bit	Bit	☞ Page 428 Assignment of bit type
2	Word	Word [Unsigned]/Bit String [16-bit] Word [Signed]	—
3	String	String	Padding is not inserted because a packing block is assigned per one word unit, though the assignment amount differs depending on the number of character strings.
4	String [Unicode]	String [Unicode]	
5	Double Word	Double Word [Unsigned]/Bit String [32-bit] Double Word [Signed]	—
6	Time	Time	—
7	FLOAT [Single Precision]	FLOAT [Single Precision]	—
8	Timer	Timer	☞ Page 429 Assignment of timer/retentive timer/counter
9	Retentive Timer	Retentive Timer	
10	Counter	Counter	
11	FLOAT [Double Precision]	FLOAT [Double Precision]	—
12	Long Timer	Long Timer	☞ Page 429 Assignment of timer/retentive timer/counter
13	Long Retentive Timer	Long Retentive Timer	
14	Long Counter	Long Counter	
15	Array	All	☞ Page 428 Assignment of array
16	Structure/FB instance	All	☞ Page 428 Assignment of structure

## ■Assignment of bit type

If the number of bit type labels exceeds 16, the labels will be assigned to the next memory area consecutively. For FB instances, the area of EN/ENO is assigned to each head of the FB instances.

Ex.

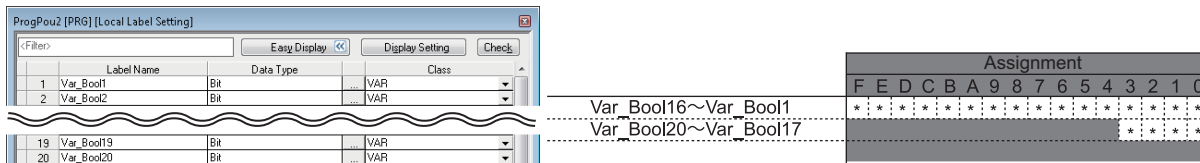

## ■Assignment of array

For a bit type array, the memory is assigned from the start address (0 bit) of the array, and continuous bits for one-dimensional element are assigned in word unit. As for the two-dimensional element or later, the same area as the one-dimensional element is assigned for the number of the dimensional elements continuously.

For an array other than bit type, the area which is required for the element is assigned for the memory of the data type continuously. A padding is not inserted between the array elements.

Ex.

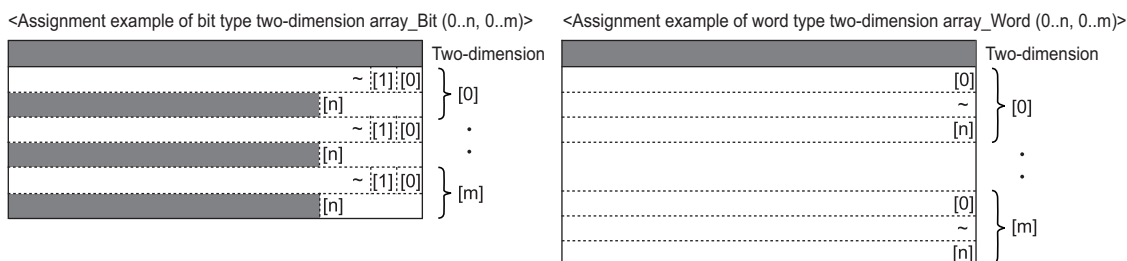

## ■Assignment of structure

A member of structure is assigned according to the assignment order of packing blocks. When a structure is declared in the member of structure, it will be assigned in a packing block according to the order noted previously. It will be assigned from the start position of 64-bit address boundary.

Ex.

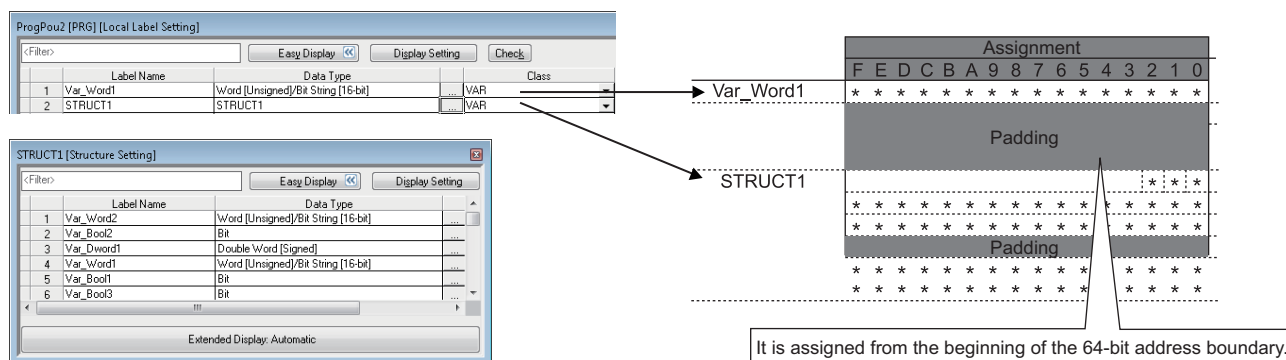

### ■Assignment of timer/retentive timer/counter

● Timer, retentive timer, counter

The data types of the timer, retentive timer and counter are structures that have a contact, coil, and current value.

The following table shows the member configuration of each data type.

Type	Member	Data type	Description
Timer	S	Bit type	The operation is the same as the contact (TS) of the timer device.
	C	Bit type	The operation is the same as the coil (TC) of the timer device.
	N	Word [Unsigned]/Bit String [16-bit]	The operation is the same as the current value (TN) of the timer device.
Retentive timer	S	Bit type	The operation is the same as the contact (STS) of the retentive timer device.
	C	Bit type	The operation is the same as the coil (STC) of the retentive timer device.
	N	Word [Unsigned]/Bit String [16-bit]	The operation is the same as the current value (STN) of the retentive timer device.
Counter	S	Bit type	The operation is the same as the contact (CS) of the counter device.
	C	Bit type	The operation is the same as the coil (CC) of the counter device.
	N	Word [Unsigned]/Bit String [16-bit]	The operation is the same as the current value (CN) of the counter device.

Each of timer, retentive timer, and counter requires 2 words.



● Long timer, long retentive timer, long counter

The data types of the long timer, long retentive timer and long counter are structures that have a contact, coil, and current value.

The following table shows the member configuration of each data type.

Type	Member	Data type	Description
Long timer	S	Bit type	The operation is the same as the contact (LTS) of the timer device.
	C	Bit type	The operation is the same as the coil (LTC) of the timer device.
	N	Double Word [Unsigned]/Bit String [32-bit]	The operation is the same as the current value (LTN) of the timer device.
Long retentive timer	S	Bit type	The operation is the same as the contact (LSTS) of the retentive timer device.
	C	Bit type	The operation is the same as the coil (LSTC) of the retentive timer device.
	N	Double Word [Unsigned]/Bit String [32-bit]	The operation is the same as the current value (LSTN) of the retentive timer device.
Long counter	S	Bit type	The operation is the same as the contact (LCS) of the counter device.
	C	Bit type	The operation is the same as the coil (LCC) of the counter device.
	N	Double Word [Unsigned]/Bit String [32-bit]	The operation is the same as the current value (LCN) of the counter device.

Each of long timer, long retentive timer, and long counter requires 4 words.

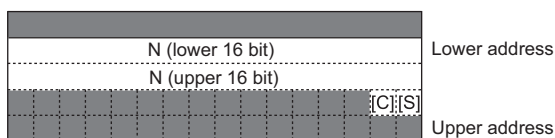

### ■Assignment of FB instances

For details of the FB instances, refer to the following:

- 📖 MELSEC iQ-R Programming Manual (Program Design)
- 📖 MELSEC iQ-F FX5 Programming Manual (Program Design)

## Converting character codes

---

### ■ Considerations for using an instruction not supporting Unicode

To set a string constant or string type label as an argument of an instruction not supporting Unicode, check that the language set in the following option matches with that for the initial values of the string constant or string type label before converting a program.

- [Tool] ⇒ [Options] ⇒ "Convert" ⇒ "Basic Setting" ⇒ "Operational Setting" ⇒ "Language for Instruction Conversion of Character String Operation and Label Initial Value"

Unify the language used in a project to set a string constant or string type label as an argument of an instruction.

The data type of an instruction not supporting Unicode is "string," "ANYSTRING\_SINGLE," or

"ANYSTRING\_SINGLE\_ARRAY" mentioned in the following manual.

 MELSEC iQ-R Programming Manual (CPU Module Instructions, Standard Functions/Function Blocks)

 MELSEC iQ-R Programming Manual (Process Control Function Blocks/Instructions)

 MELSEC iQ-R Programming Manual (Module Dedicated Instructions)

## Performing the online program change simultaneously at conversion

---

For the operation method for performing the online program change simultaneously at conversion, refer to the following:

 Page 597 Writing Programs While a CPU Module is in the RUN State



# Checking for errors and warnings

When the program is converted, the target programs and label settings are checked and the result is displayed in the "Output" window.

The corresponding error location can be referred in the "Output" window.

## Operating procedure

1. Double-click the error/warning message displayed in the "Output" window.
2. Check the corresponding error location and modify the error as instructed by the error/warning message.

## Considerations

The cursor may jump to a location where the corresponding error does not exist even if the error message displayed in the "Output" window is double-clicked. The following shows corrective actions for this case.

### ■When a program includes an unconverted state ladder

Identify the location where the error has occurred by following the procedure below.

1. Convert all the programs.
2. Double-click a displayed error message, and check the jump destination.

### ■When a macro type function block is used

Identify the location where the error has occurred by either of the following methods.

No.	Method
1	Search for the name of a device, label, or instruction given in the error message. (🔍 Page 445 SEARCHING FOR DATA)
2	<ol style="list-style-type: none"><li>1 Back up the project.</li><li>2 Change the type of the function block to the subroutine type. (🔍 Page 486 Changing the type of a function block)</li><li>3 Convert all programs.</li><li>4 Double-click a displayed error message, and check the jump destination.</li></ol> <p>If an error does not occur after converting all programs, check a ladder where an input argument, output argument, or input/output argument of the macro type function block is used.</p>

# 6.12 Calculating Memory Size

This section shows how to calculate offline a memory size required when writing data in a project to a CPU module. Remote head modules do not support this function.

## Window

Select [Tool] ⇒ [Confirm Memory Size (Offline)].

**Ex.**  
R08CPU

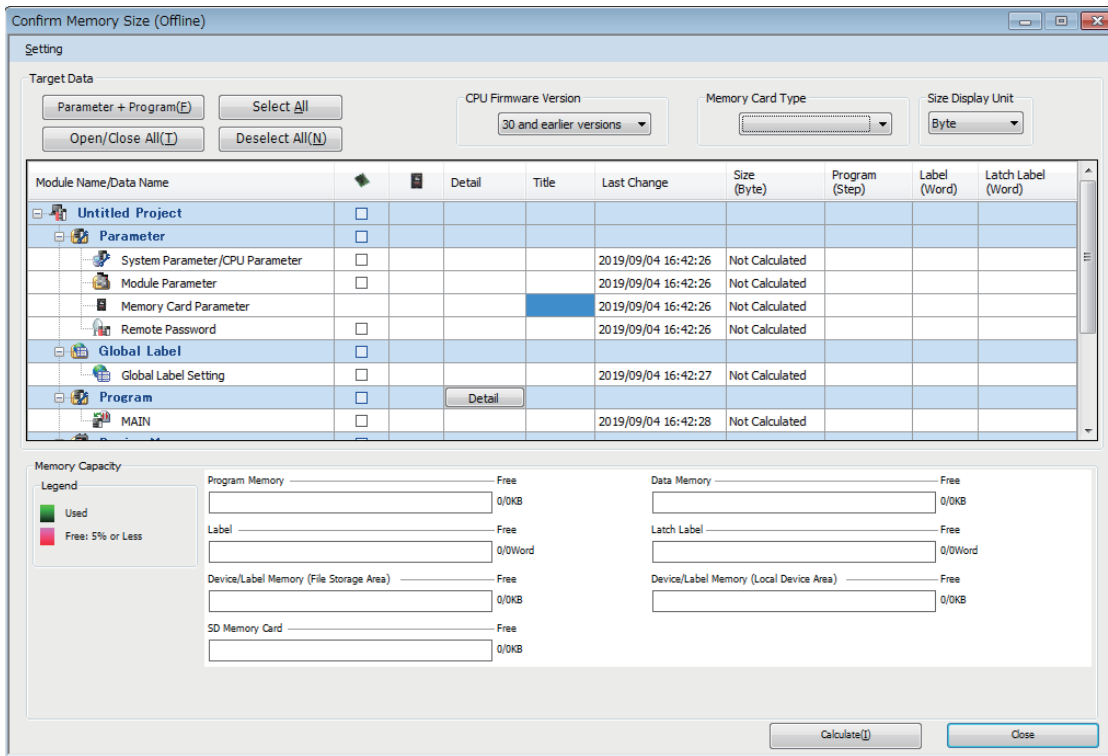

## Operating procedure

1. Select a version from the pull-down list of "CPU Firmware Version."<sup>\*1</sup>
2. Select "Byte" or "Step" from the pull-down list of "Size Display Unit."
3. When the data to be written to an SD memory card is included, select the corresponding SD memory card from the pull-down list of "Memory Card Type."
4. Select the file to be written, then click the [Calculate] button.

\*1 A version can be displayed in projects for RnCPUs (R04CPU, R08CPU, R16CPU, R32CPU, and R120CPU), RnENCPUs, RnPCPUs, and RnSFCPUs.

The setting methods for the details of a target file and each data are the same as those in the "Online Data Operation" screen. Refer to the following:

📖 Page 577 WRITING/READING DATA TO CPU MODULE

Depending on the CPU parameter setting, the used capacity may be displayed after calculation even if any file is not selected. (Example: File Register Setting)

## Point

- The items displayed in "Memory Capacity" differ depending on a CPU module.
- When using a project for an FX5CPU, the capacity of an SD card is displayed by selecting the model name of the SD memory card from the pull-down list of "Memory Card Type."
- The firmware version of a CPU module can be checked in the "Product Information List" screen which can be displayed from the system monitor. ( Page 704 Check of the module firmware version and product information)

## Precautions

- Capacity which is displayed in the "Label" column and "Latch label" column, and is enclosed with () is included in the one for the program or global labels using the data; therefore, the capacity enclosed with () is not included in the one for labels and latch labels.
- When writing data by using the [Online Program Change] menu, the size of global label assignment information displayed in the "Confirm Memory Size (Offline)" screen may differ from the actual size of data to be written to a CPU module.

# 7 SETTING DEVICE MEMORY

This chapter explains the setting methods for the device memory.

## 7.1 Device Memory

The device memory in GX Works3 is data to read/write values from/to the device memory in a CPU module.

By reading device memory, its state in a CPU module can be checked, and the device memory can be used for offline debugging as well.

In addition, the current values of device memory in a CPU module can be changed in a batch by writing the device memory to a CPU module.

### Applicable devices

For the devices that can be set in a device memory editor and their input method, refer to the following:

 Page 889 Applicable Devices in GX Works3

### Difference between global devices and local devices

A device memory is not distinguished between a global device or local device.

Depending on the name of a device memory, it is classified into the following two kinds of devices when writing it to a CPU module.

- Device memory with a different name from that of the program file: Global device
- Device memory with a same name as that of the program file: Local device

FX5CPUs do not support local devices.

### Considerations when the process control extension is enabled

Do not change the value of a device memory in the range set for the system resource in the following option.

- [Tool] ⇒ [Options] ⇒ "Convert" ⇒ "Process Control Extension Setting" ⇒ "System Resource"

# 7.2 Configuration of a Device Memory Editor

This section explains the screen configuration of a device memory editor.

## Window

Select "Device" ⇒ "Device Memory" ⇒ "(data name)" in the navigation window.

■Toolbar



■Device memory editor

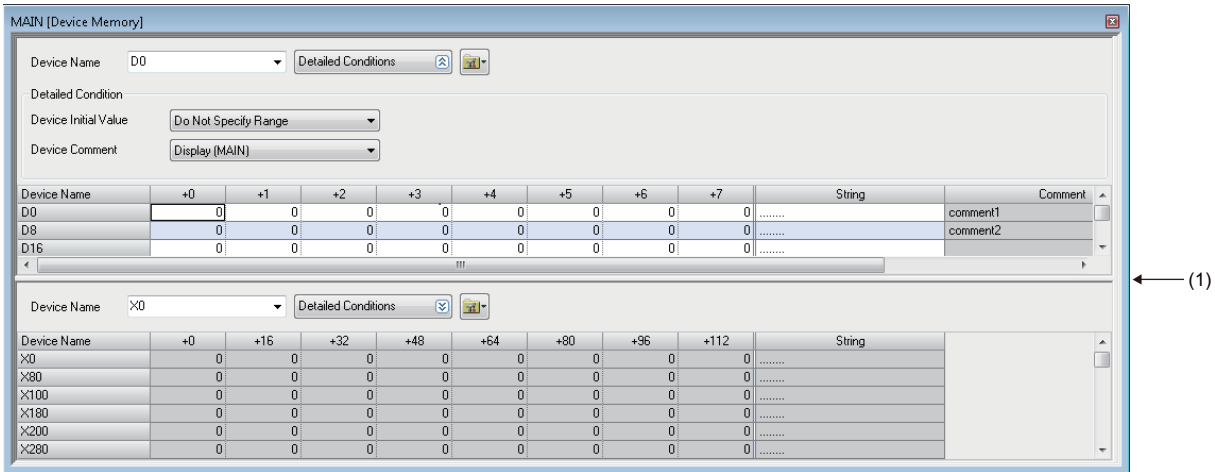

(1): Splitter bar

A device memory editor can horizontally or vertically be split into two screens by using any of the following operations.

- Select [Window] ⇒ [Split]. (Horizontal split only)
- Right-click on the screen, and select [Split] from the short-cut menu ⇒ [Vertical Split]/[Horizontal Split]
- Click , and select [Split] ⇒ [Vertical Split]/[Horizontal Split]

By selecting "Specify Range" from the pull-down list of "Device Initial Value," only the initial device values in the specified range can be displayed.

### Point

Fonts can be changed. (👉 Page 81 Checking and Changing Colors and Fonts)

## Setting the display format

Set the display format (Display Unit Format, Data Display Format, String Display Format, Value, Bit Order, Switch No. of Points) of the device value being displayed.

### Operating procedure

1. Select [View] ⇒ [Display Format Detailed Setting] ().
2. Set each item in the "Display Format" screen and click the [OK] button.

The setting can also be performed in the toolbar.

### Point

When displaying a device value in binary, set the following:

- [View] ⇒ [Display Format Detailed Setting]() ⇒ "Display Unit Format" ⇒ "Bit and Word"

## 7.3 Setting Device Memory

This section explains the setting method of devices and device values.

### Precautions

- If a deletion is executed after selecting a cell, the device value is cleared to '0.'
- The entering method by prefixing '#' to a device name to regard it as a local device is not supported.  
Select global labels or local labels when reading the device memory from a CPU module.

### Setting a value for each point

Set a device and device value for each point.

**Ex.**

Set the following values in a word multi-point format.

Device: D2, Device value: 12

### Operating procedure

1. Set the display format. (☞ Page 435 Setting the display format)
2. Enter 'D2' in "Device Name."
3. Enter '12' to the device 'D2.'

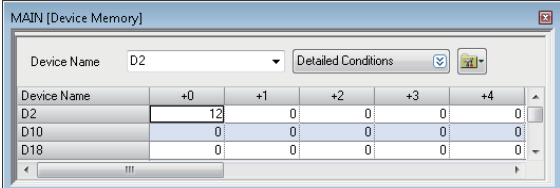

The screenshot shows a window titled "MAIN [Device Memory]". At the top, there is a "Device Name" dropdown menu set to "D2" and a "Detailed Conditions" button. Below this is a table with the following structure:

Device Name	+0	+1	+2	+3	+4
D2	12	0	0	0	0
D10	0	0	0	0	0
D18	0	0	0	0	0

### Copying and pasting

When copying and pasting a value in a device memory editor, the value being displayed is copied and pasted as a tab-delimited character string.

A line feed code is inserted according to the column width displayed on the device memory.

For character strings other than numerical values (decimal, hexadecimal, and real number), "0" is pasted.

When pasting a value to Excel, select "Text" on the [Number] tab of "Format Cells" in Excel to display a copied character string as is.

### Point

When the display unit format is bit, the device value can be changed by double-clicking a cell.

# Setting values in batch

Set the same value to consecutive devices.

**Ex.**

Set the following values in a word multi-point format.

Device: D8 to D11, Device value: 1234

## Operating procedure

1. Set the display format. (☞ Page 435 Setting the display format)
2. Enter 'D8' to "Device Name," and select the range of the device value to be set.
3. Select [Edit] ⇒ [FILL] (🔍).
4. Set each item in the "FILL" screen and click the [OK] button.

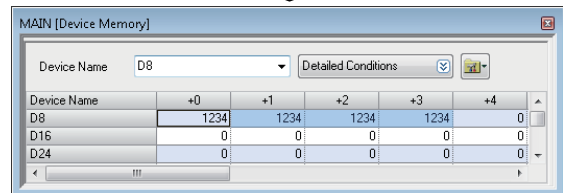
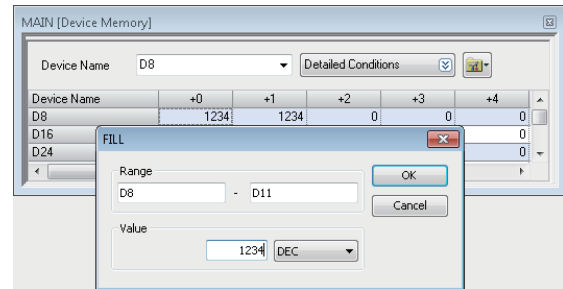

# Setting character strings

Set a character string to a device.

**Ex.**

Set the following values in a word multi-point format.

Device: D20, Character string: Device memory

## Operating procedure

1. Set the display format. (☞ Page 435 Setting the display format)
2. Enter 'D20' to "Device Name," and select [Edit] ⇒ [Enter Character String].
3. Enter a character string in the "Enter Character String" screen, and click the [OK] button.

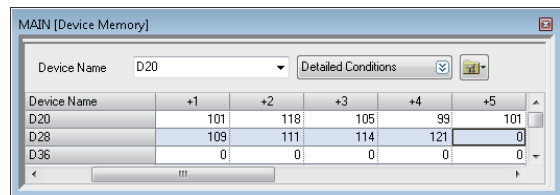
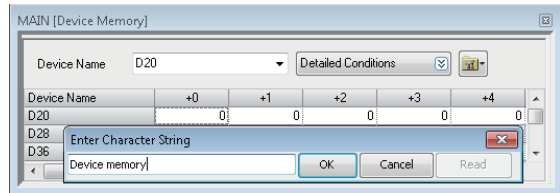

## Point

- Character string can be entered to "String" column directly.
- Click the [Read] button in the "Enter Character String" screen to read the set device values (string) one by one.

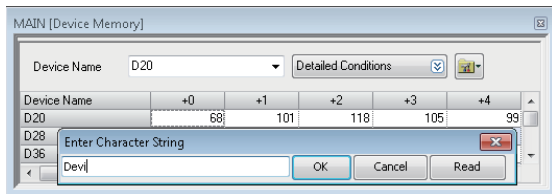

## Precautions

For device memory, use characters in the Unicode Basic Multilingual Plane.

If a character outside the Unicode Basic Multilingual Plane is specified, it may not be displayed properly in the program.

# Clearing whole memory of device memory

Clear the data set to device memory data to '0' in batch in the project.

## Operating procedure

### ■Deleting all data in the device memory data

Select [Edit] ⇒ [Clear All (All Devices)].

### ■Deleting the devices displayed in a device memory editor

Select [Edit] ⇒ [Clear All (Displayed Devices)].



## Linkage with initial device values

The values in the device memory can be registered as the initial values of devices. In addition, the initial device values can also be imported for values in the device memory.

Initial device value data to register should be created in advance.

Remote head modules do not support this linkage.

### Operating procedure

1. Click the [Detailed Conditions] button.
2. Select "Specify Range" in the detailed conditions of "Device Initial Value."
3. Select [Edit] ⇒ [Register/Import Device Initial Value].

An initial device value editor appears. For details on the operations in the initial device value editor, refer to the following:

- Registering the values in the device memory as the initial device values: [Page 444 Setting initial device values](#)
- Importing the initial device values as values in the device memory: [Page 444 Registering in the device memory](#)



## 7.4 Writing/Reading Data to/from CPU Module

This section explains the method to write/read only the values within the selected range in a device memory editor to/from a CPU module.

To write/read all data in the device memory, use the "Online Data operation" screen. ([Page 577 Writing/Reading Programmable Controller Data](#))

7

### Window

1. Select the writing/reading range in a device memory editor.
2. Select [Online] ⇒ [Device Memory] ⇒ [Read Selected Range] ()/[Write Selected Range] ().

The following screen is an example when writing data.

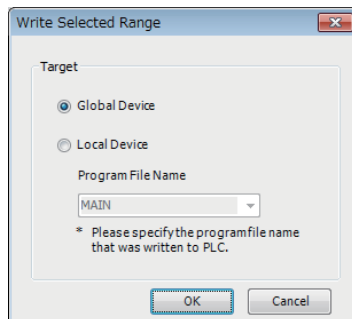

### Operating procedure

Select the device to be written/read, and click the [OK] button.

## 7.5 Exporting Device Memory Data

---

This section shows the operating procedure to export device memory data to a CSV file.

To export the data, selecting "Word Multi-point" for "Display Unit Format" in the "Display Format" screen is required in advance. (  Page 435 Setting the display format)

### Operating procedure

1. Select the range of devices to be exported in a device memory editor.
2. Select [Edit] ⇒ [Export to File] (  ).
3. Select the range for export in the "Export Setting" screen.

When selecting "Specify Range," enter the start and end device numbers of the range for export.

4. Select the checkbox of "Export only the rows in which devices already set are included" as necessary, and click the [OK] button.
5. Set each item in the "Export to File" screen, and click the [Save] button.

### Point

---

Device memory data is exported to a CSV file according to the display format of the device values. Set the display format as necessary; however, selecting "Word Multi-point" for "Display Unit Format" is required.

For the method to set the format, refer to the following:

 Page 435 Setting the display format

---

# 8 INITIAL DEVICE VALUE SETTING

This chapter explains how to set the initial device values.

## 8.1 Initial Device Values

The initial device values which are managed in GX Works3 refer to data to be written to and read from the devices in a CPU module.

For details on initial device values, refer to the following:

 MELSEC iQ-R CPU Module User's Manual (Application)

 MELSEC iQ-F FX5 User's Manual (Application)

Remote head modules do not support these values.

### Applicable devices

For the devices which can be set in an initial device value editor, refer to the following:

 Page 889 Applicable Devices in GX Works3

### Writing of the initial device values to global/local devices

Initial device values are not distinguished between a global device or local device.

When writing initial device values to a CPU module, write them to each device according to the following methods.

- Global device: Create initial device value data with a different name from that of the program file, and write it to a CPU module.
- Local device: Create initial device value data with the same name as that of the program file, and write it to a CPU module.

Devices which cannot be used as local devices are not written even if their initial values are set.

FX5CPUs do not support local devices.

## 8.2 Configuration of an Initial Device Value Editor

This section shows the configuration of an initial device value editor.

### Window

Select "Device" ⇒ "Device Initial Value" ⇒ "(data name)" in the navigation window.

Points	Start	End	Comment
1			
2			
3			
4			
5			
6			
7			
8			
9			
10			
11			
12			
13			
14			
15			
16			
17			
18			
19			
20			

The device range and the device data that is set above will be written to CPU as initial value. Users are required to execute "Device Memory Diversion" operation if the device initial range setting is changed.

Setting Method

Start/End

Points/Start

Device Memory Register Diversion

Device Memory for Register Diversion

Register to Device Memory

Device Memory Diversion

OK Cancel



When editing a value in "Start"/"Last"/"Comment" column, the shortcut menu is displayed by pressing the **[Shift] + [F10]** keys.

# 8.3 Initial Device Value Settings

This section explains the methods for setting device values which was set in the device memory as the initial device values.

## Setting procedure of initial device values

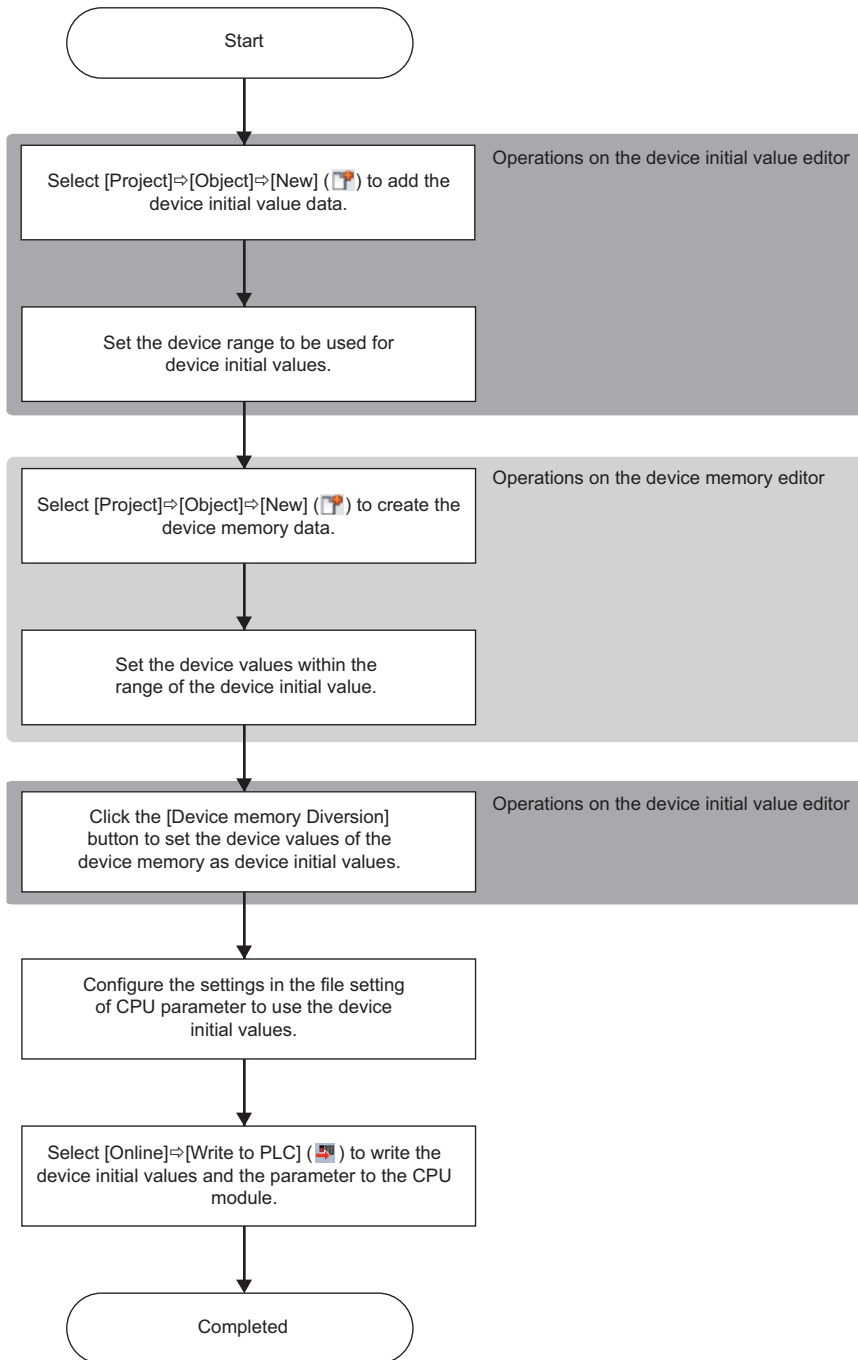

## Setting initial device values

The following shows the procedure for setting device values which was set in the device memory as the initial device values. Initial device value data should be created in advance. (  Page 129 Creating data)

### Operating procedure

1. Set each item in an initial device value editor.
2. Select the data to import from the pull-down list of "Device Memory for Register Diversion," and click the [Register to Device Memory] button.
3. Click the [OK] button.

### ■Using initial device values

To use each device value in the set range as the initial value when starting a CPU module, specify the name of the file to use in "File Setting" of "CPU Parameter."

### ■Device range

Device initial values can be set only for the devices in the range set in the following items in CPU Parameters:

- "File Setting" ⇨ "File Register Setting"
- "Memory/Device Setting" ⇨ "Device/Label Memory Area Setting" ⇨ "Device/Label Memory Area Detailed Setting" ⇨ "Device Setting"

## Registering in the device memory

Data in the range of the initial values which was set in an initial device value editor is registered in the device memory.

### Operating procedure

1. Select data from the pull-down list of "Device Memory for Register Diversion."
2. Click the [Register to Device Memory] button.

If the registered data is modified on the device memory, it will not be applied to the initial device values. Click the [Device Memory Diversion] button in an initial device value editor again.

### Point

To check the initial device values, create a new device memory and perform "Register to Device Memory" to it.

This chapter explains operations for searching for and replacing character strings, devices, labels, instructions, etc. in each screen.

Function	Supported screen	Purpose	Reference
Device/label search Device/label replacement	<ul style="list-style-type: none"> <li>• Ladder editor</li> <li>• ST editor</li> <li>• FBD/LD editor</li> <li>• SFC diagram editor</li> <li>• Label editor</li> </ul>	To search for/replace devices or labels in a program.	Page 448 Searching for/ Replacing Devices and Labels
Instruction search/ replacement	<ul style="list-style-type: none"> <li>• Ladder editor</li> <li>• ST editor</li> <li>• FBD/LD editor</li> <li>• SFC diagram editor</li> </ul>	To search for/replace instructions in a program.	Page 450 Searching for/ Replacing Instructions
Character string search/ replacement	<ul style="list-style-type: none"> <li>• Ladder editor</li> <li>• ST editor</li> <li>• FBD/LD editor</li> <li>• SFC diagram editor</li> <li>• Device comment editor</li> <li>• Label editor</li> <li>• Label comment window</li> </ul>	To search for/replace character strings used in a program, label, and device comment.	Page 451 Searching for/ Replacing Character Strings
Open/close contact change	<ul style="list-style-type: none"> <li>• Ladder editor</li> <li>• FBD/LD editor</li> <li>• SFC diagram editor</li> </ul>	To switch the contact type of a specified device in a program from an open contact to a close contact, or from a close contact to an open contact.	Page 453 Changing Contacts between Open Contact and Close Contact
Device batch replacement	<ul style="list-style-type: none"> <li>• Ladder editor</li> <li>• ST editor</li> <li>• FBD/LD editor</li> </ul>	To replace devices and labels in a program in a batch.	Page 454 Batch Replacing of Devices and Labels
Cross reference	<ul style="list-style-type: none"> <li>• Ladder editor</li> <li>• ST editor</li> <li>• FBD/LD editor</li> <li>• SFC diagram editor</li> <li>• Label editor</li> <li>• Parameter editor</li> </ul>	To check a declaration location and a reference location of a device and label, or a label, which is not used in a program, in a list.	Page 457 Displaying cross reference information
Device list	<ul style="list-style-type: none"> <li>• Ladder editor</li> <li>• ST editor</li> <li>• FBD/LD editor</li> <li>• SFC diagram editor</li> <li>• Parameter editor</li> </ul>	To check the usage of devices.	Page 465 Displaying Device Usage
Program search/ replacement	• Ladder editor	To search for devices and labels, or to move to the corresponding row by specifying a step No. in a ladder program.	Page 295 Searching for/replacing data in a program
	• ST editor	To move to the corresponding row by specifying a line number on an ST editor.	Page 317 Searching for/replacing data in a program
	• SFC diagram editor	To search for devices and labels, or to move to the corresponding row by specifying a block number or block name in an SFC block list.	Page 374 Searching for/replacing data in a program
Block information device search	• SFC block list	To search for block information (devices/labels) in an SFC block list.	Page 373 Searching for block information
Data flow analysis	<ul style="list-style-type: none"> <li>• Ladder editor</li> <li>• ST editor</li> <li>• FBD/LD editor</li> <li>• Parameter editor</li> <li>• Event history (offline monitor) window</li> </ul>	To check a range affected by/affecting a specified device or label with a data flow diagram.	Page 467 Displaying a Range Affected by/Affecting a Device/ Label
Bookmark	<ul style="list-style-type: none"> <li>• Ladder editor</li> <li>• ST editor</li> <li>• FBD/LD editor</li> <li>• Dataflow analysis window</li> </ul>	To register position information of a program.	Page 479 Registering a Bookmark

- The "Find and Replace" window can also be opened by selecting [View] ⇒ [Docking Window] ⇒ [Find/Replace] (  ).
- 'Find' and 'Replace' can be switched from the pull-down list of the "Find and Replace" window.
- To replace a label, a device which can be replaced is for one point.
- The search starts from the top of the program in the inline structured text box regardless of the cursor position.

## Precautions

- The program will be in the unconverted state after the replacement.
- To replace a label name, check whether a name to be replaced has been already used.
- Data cannot be replaced during monitoring unless a ladder editor is in the monitor write mode. Replace it after ending the monitoring.
- Read-protected data cannot be searched for or replaced. Change the setting for the data so that it can be edited (disabling the security, for example).

## Range specification in editors

In a ladder editor, FBD/LD editor, and device comment editor, the target range for the all find function or replace all function can be specified.

A range that can be specified differ depending on an operation in the editor.

Operation	Range
<ul style="list-style-type: none"> <li>• Ladder editor/device comment editor: only one cell is selected</li> <li>• FBD/LD editor: only one element is selected</li> </ul>	All cells or elements in the editors
<ul style="list-style-type: none"> <li>• Ladder editor: multiple cells are selected</li> <li>• FBD/LD editor: multiple elements are selected</li> <li>• Device comment editor: a row or multiple cells are selected</li> </ul>	Selected cells, elements, or rows
<ul style="list-style-type: none"> <li>• Device comment editor: a column is selected</li> </ul>	Selected row (including undisplayed bit specification information)
<ul style="list-style-type: none"> <li>• Device comment editor: All the cells are selected (by  )</li> </ul>	All (excluding columns which are not displayed in multiple comment display)

- Multiple cells or elements can be selected by selecting them with the  held down.
- When multiple device comments are selected by dragging in a device comment editor, bit specification information that is not displayed in the editor are also searched or replaced.



## Displaying results and error logs

After the all find/replace all function is executed, the results and error logs are displayed.

### Window

Click the [All Find] button/[Replace All] button in "Find and Replace" window.

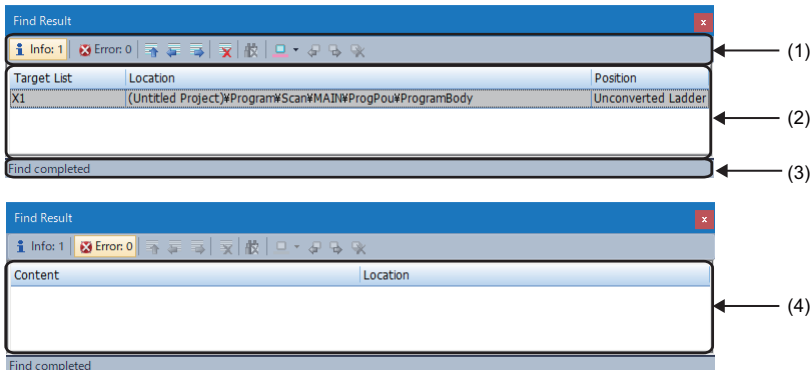

### Displayed items

Item	Description
(1) Status	Displays the number of error logs and the search error.
(2) Search/replace results	Displays the position information to specify the location where data was searched for/replaced.
(3) Sub status bar	Displays the search/replace result.
(4) Error logs	Displays the errors in search/replace results.

### Point

The jump function is used to jump from any row of search/replace results or logs to the corresponding character strings.

To jump, select and right-click a row and select [Jump to the Selected Location]/[Jump to the Previous Location]/[Jump to the Next Location] from the shortcut menu, or double-click a row.

A row displayed in the "Find Result" screen can be highlighted.

☞ Page 462 Highlighting display

# 9.1 Searching for/Replacing Devices and Labels

Search for/replace devices or labels in a program.

Supported editor: Ladder editor\*<sup>1</sup>, ST editor, FBD/LD editor\*<sup>1\*2</sup>, SFC diagram editor\*<sup>1</sup>, and label editor

\*<sup>1</sup> Assigned devices which are set to display in the following menu are not searched for/replaced.  
 [View] ⇒ [Device Display]

\*<sup>2</sup> The preview display area of inline structured text elements is not supported.

When searching a device name, it is also searched on the global editor where the device is assigned.

## Window

Select [Find/Replace] ⇒ [Find Device/Label] (  )/[Replace Device/Label].

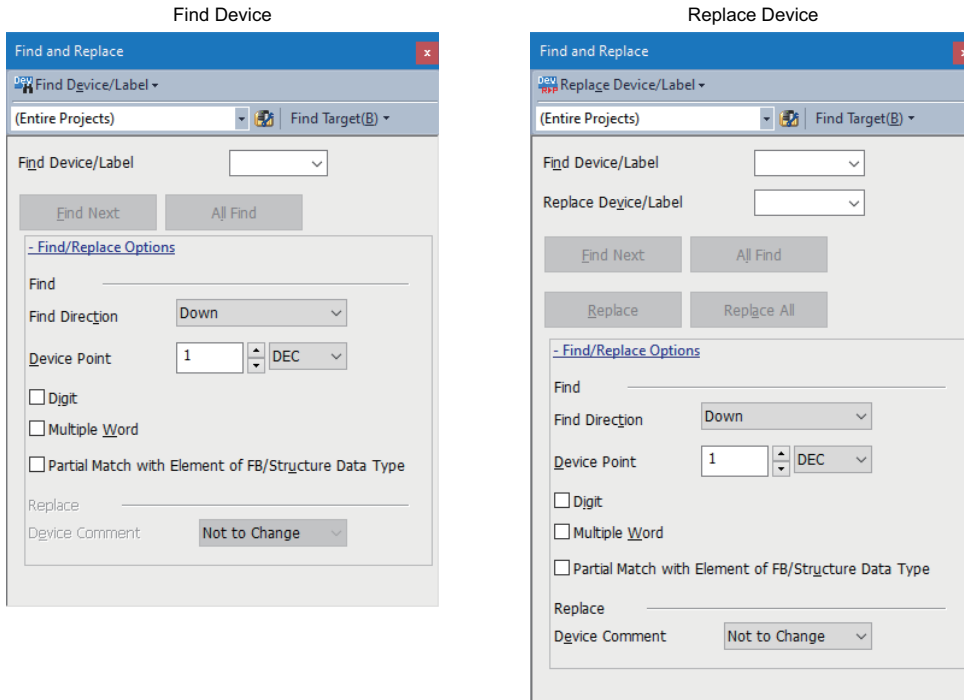

## Operating procedure

Set each item on the screen and click the [Find Next] button.

Item		Description	
Find/Replace Options	Find	Device Point	Enter the number of points to be searched for/replaced, counted from the device entered in the "Find Device/Label" field. When a label is entered for "Find Device/Label" or "Replace Device/Label," enter 1. Example) When X50 for "Find Device," X100 for "Replace Device," 3 for "Device Point," and "DEC" for entered value are set The devices are replaced as follows: X50→X100, X51→X101, X52→X102
		Digit	Select this checkbox to search for the entered device and digit-specified bit devices that include the entered device.
		Multiple word	Select this checkbox to search for the entered device and the double-word format word devices that include the entered device.
	Partial Match with Element of FB/ Structure Data Type <sup>1</sup>	Select this checkbox to search for the target used for arguments of function blocks <sup>2</sup> , arguments of functions <sup>2</sup> , and structure members in a program.	
	Replace	Device comment	Select this to copy or move a device comment in "Find Device/Label" to "Replace Device/Label" (excluding step relays (S) and SFC transition devices (TR)).

\*<sup>1</sup> Even when the checkbox of this item is selected, the input/output labels of FB instances are not searched for or replaced if "Include the input/output label of FB instance" under "Find Target" is not selected.

\*<sup>2</sup> A label whose class is "VAR\_INPUT", "VAR\_OUTPUT," "VAR\_OUTPUT\_RETAIN," "VAR\_IN\_OUT," "VAR\_PUBLIC," or "VAR\_PUBLIC\_RETAIN" is searched.

When entering a label name, options will be displayed.

They can also be displayed by any of the following operations.

- Enter '.' at the end of a label name of structure type or an instance name.
- Press the **Ctrl** + **Space** keys.

In addition, by selecting "Yes" for the following option, when entering a common device comment or a label comment, devices and labels for which the comment has been set can be displayed as options.

- [Tool] ⇒ [Options] ⇒ "Edit" ⇒ "Instruction/Device/Label Candidacy Display" ⇒ "Candidate Display Setting" ⇒ "Display the Corresponding Device in Entering Device Comment"

By using the following menu, the cursor jumps forward or backward from the current position to the positions where search or replacement was applied.

- [Find/Replace] ⇒ [Previous] ()/[Next] ()

By selecting "Include the input/output label of FB instance" under "Find Target," the input/output labels of FB instances in a ladder program or FBD/LD program are also searched for or replaced.

## Examples of device search

### ■ Options

- Option: None

Device specification	Search result
M0	<u>M0</u> , <u>K4M0</u> , <u>M0Z0</u> , <u>K4M0Z0</u>
K4M0	<u>K4M0</u> , <u>K4M0Z0</u>
D0	<u>D0</u> , <u>D0Z0</u> , <u>D0.1</u>
D0.1	<u>D0.1</u>
J1\B0	<u>J1\B0</u> , <u>J1\B0Z0</u> , <u>J1Z0\B0</u> , <u>J1Z0\B0Z0</u> , <u>J1\K4B0</u> , <u>J1\K4B0Z0</u> , <u>J1Z0\K4B0</u> , <u>J1Z0\K4B0Z0</u>

- Option: Digit

Device specification	Search result
X0 to X3	K1X0
X0 to X0F	K4X0
X0 to X1F	K8X0
X0Z0	X0Z0, K1X0Z0, K4X0Z0, K8X0Z0

- Option: Multiple words

Device specification	Search result
D0 to D1	DMOV K1 <u>D0</u> , EMOV E1 <u>D0</u> , DMOV K1 <u>@D0</u>
D0 to D9	BMOV <u>D0</u> D100 K10
J1\W0 to J1\W1	DMOV K1 <u>J1\W0</u>
@D0 to @D1	DMOV K1 <u>@D0</u>
T0 to T1	DMOV K1 <u>T0</u>
D0 to D1	D0:D, D0:DU, D0:E
D0 to D3	D0:ED

### ■ Device with device type specifier (for ST editor, FBD/LD editor, and SFC diagram editor only)

Device specification	Search result	Remarks
D100	<u>D100</u> : = 1; <u>D100</u> : D: = 1; <u>D100</u> : E:= 0.1;	Devices are searched regardless of device type specifier.
D100: D	D100: = 1; <u>D100</u> : D: = 1; <u>D100</u> : E := 0.1;	Only devices with a specified device type specifier are searched.

## 9.2 Searching for/Replacing Instructions

Search for/replace instructions in a program.

Supported editor: Ladder editor, ST editor, and FBD/LD editor (LD element and FBD element (FB/FUN) only), and SFC diagram editor

The NOP instructions used in a ladder program cannot be searched.

The following application instructions can also be searched as output instructions.

SET, RST, PLS, PLF, FF, SFT, SFTP, and MC

### Window

Select [Find/Replace] ⇒ [Find Instruction] (🔍) / [Replace Instruction] (🔄) / [Find Contact or Coil] (🔍).

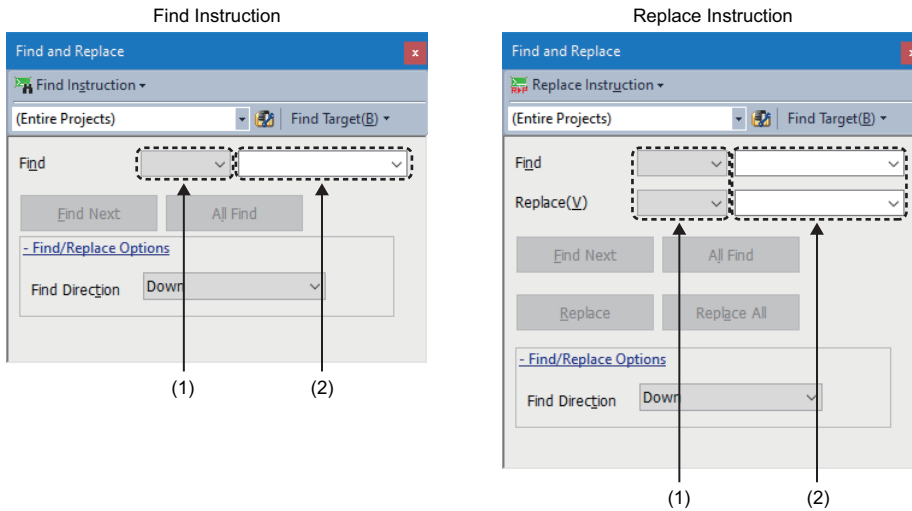

- (1): Element selection field  
 (2): Device instruction input field

### Operating procedure

Set each item on the screen and click the [Find Next] button.

#### Point

By using the following menu, the cursor jumps forward or backward from the current position to the positions where search or replacement was applied.

- [Find/Replace] ⇒ [Previous] (🔍) / [Next] (🔍)

By selecting "Include the input/output label of FB instance" under "Find Target," the input/output labels of FB instances in a ladder program or FBD/LD program are also searched for or replaced.

### Examples of instruction search

Example of instruction specification *1	Search result
MOV	<u>MOV</u> , <u>MOVP</u>
MOVP	<u>MOVP</u>
MOV D0 K4Y0	<u>MOV D0 K4Y0</u> , <u>MOVP D0Z1 K4Y0</u> , <u>MOV D0 K4Y0Z1</u> , <u>MOVP D0Z1 K4Y0Z1</u>
MOVP D0 J1W0	<u>MOVP D0 J1W0</u> , <u>MOVP D0Z1 J1W0</u> , <u>MOVP D0 J1Z1W0Z1</u> , <u>MOVP D0Z1 J1Z1W0Z1</u>

\*1 The search specifying an argument can only be performed in ladder programs.

## 9.3 Searching for/Replacing Character Strings

Search for/replace character strings of the data in the project.

Editor	Searchable character string	Replaceable character string
Ladder editor	Character strings except for the following <sup>*1</sup> • Assigned devices displayed on the editor <sup>*2</sup>	Character strings except for instruction names
ST editor	Character strings except for the following • Monitoring part (displayed on the right side of the screen during monitoring) • The omitted portion of the collapsed display (example: IF...END_IF)	
FBD/LD editor	Character strings except for the following • Assigned devices displayed on the editor <sup>*2</sup> • Inline structured text programs displayed in the preview display area of inline structured text elements	Character strings except for the following • Data type of a function • Data type of a function block • Input/output label of FB/FUN • Character string, "RETURN" of a return element • Assigned devices displayed on the editor by setting the option <sup>*2</sup> • Inline structured text programs displayed in the preview display area of inline structured text elements
SFC diagram editor	Character strings except for the following • Assigned devices displayed on the editor <sup>*2</sup>	Character strings except for the following • Qualifier • Comment of Step No./Transition No. • Step name specified to the jump destination
Label editor	Character strings except for class name	Character strings except for the following • Class name, data type, device name
Device comment editor	Character strings in the comment column	
Label comment window		

\*1 The NOP instructions used in a ladder program cannot be searched.

\*2 An assigned device is shown or hidden by setting in the following menu.

[View] ⇒ [Device Display]

### Window

Select [Find/Replace] ⇒ [Find String]/[Replace Character String].

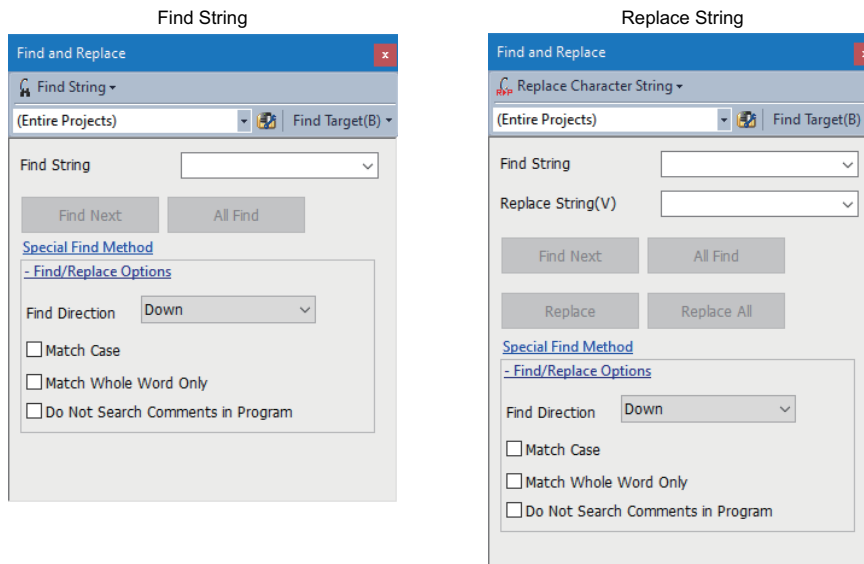

### Operating procedure

Set each item on the screen and click the [Find Next] button.

By using the following menu, the cursor jumps forward or backward from the current position to the positions where search or replacement was applied.

- [Find/Replace] ⇨ [Previous] /[Next] 

A note, P statement, and I statement in a ladder editor can be searched or replaced if a coil, instruction, pointer, or interrupt pointer, to which the note or statement is added, is selected.

By entering '@STB' or '@IST,' an inline structured text box or inline structured text element can be searched for.

## Precautions

When searching for a comment in a program by using the character string search function, it may take time to display the result. When searching for character strings excluding a comment in a program, select the following checkbox:

- "Find/Replace Options" ⇨ "Do Not Search Comments in Program"

## Searching for/replacing data by matching whole word only

The whole word means a string delimited by the break characters.

The character string which is completely match with the character string entered in "Find String" is searched for.

Break characters are shown as below.

- Space
- Tab
- Line feed
- Operator on ST editor

**Ex.**

Search for a device comment 'abc ; def' by the following character strings.

String to be searched for	Search result	
	Unselected	Selected
a	<u>abc</u> ; def	Nothing is found.
abc	<u>abc</u> ; def	<u>abc</u> ; def
bc	<u>abc</u> ; def	Nothing is found.
abc ; def	<u>abc</u> ; def	<u>abc</u> ; def

## 9.4 Changing Contacts between Open Contact and Close Contact

Change contact types from open contact to close contact, and vice versa.

Supported editor: Ladder editor, FBD/LD editor<sup>\*1</sup>, and SFC diagram editor

\*1 The preview display area of inline structured text elements is not supported.

### Window

Select [Find/Replace] ⇨ [Change Open/Close Contact].

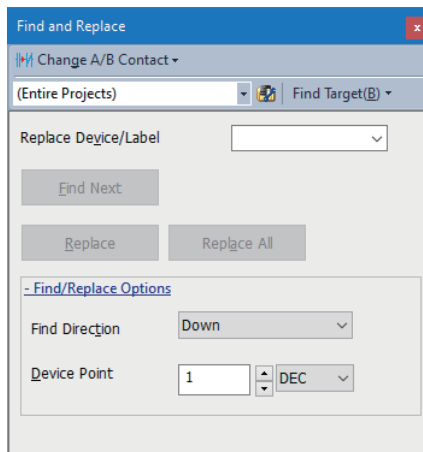

### Operating procedure

1. Set each item on the screen and click the [Find Next] button.

Item		Description
Find/Replace Options	Device Point	Enter the number of points to be replaced, counted from the device/label entered in the "Replace Device/Label" field. When a label is entered for "Replace Device/Label," enter 1. Example) When X100 for "Replace Device," 3 for "Device Point," and "DEC" for entered value are set The open/close contact of X100, X101, and X102 will be replaced.

2. Click the [Replace] or [Replace All] button to change the contact type.

### Point

When entering a label name, options will be displayed.

They can also be displayed by any of the following operations.

- Enter '.' at the end of a label name of structure type or an instance name of a function block.
- Press the **Ctrl** + **Space** keys.

In addition, by selecting "Yes" for the following option, when entering a common device comment or a label comment, devices and labels for which the comment has been set can be displayed as options.

- [Tool] ⇨ [Options] ⇨ "Edit" ⇨ "Instruction/Device/Label Candidacy Display" ⇨ "Candidate Display Setting" ⇨ "Display the Corresponding Device in Entering Device Comment"

By using the following menu, the cursor jumps forward or backward from the current position to the positions where search or replacement was applied.

- [Find/Replace] ⇨ [Previous] (🔍) / [Next] (🔍)

# 9.5 Batch Replacing of Devices and Labels

Replace devices and labels in a program in a batch.

Supported editor: Ladder editor, ST editor, FBD/LD editor\*1, and SFC diagram editor, label editor (for replacing labels)

\*1 The preview display area of inline structured text elements is not supported.

## Window

Select [Find/Replace] ⇨ [Device Batch Replace].

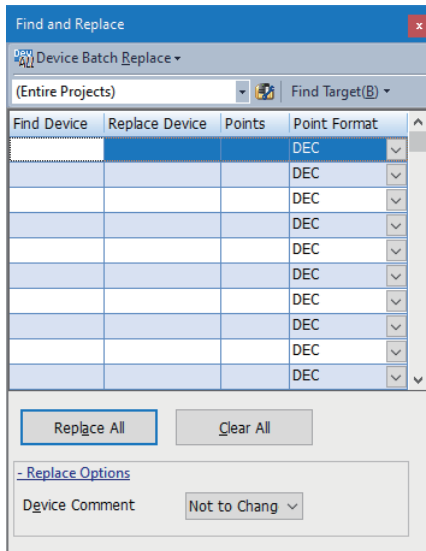

## Operating procedure

Set each item on the screen, and click the [Replace All] button.

Item	Description
Find Device, Replace Device	Enter a device name and label name which are to be searched and replaced. To replace a structure type label, enter a text including the structure member for "Find Device" or "Replace Device." To replace an array type label, enter a text including an array index for "Find Device" or "Replace Device."
Points, Point Format	Enter the number of points to be replaced from the device specified in the "Find Device." Example) When X0 for "Find Device," X10 for "Replace Device," 5 for "Points," and "DEC" for "Point Format" are set The devices are replaced as: X0 → X10, X1 → X11, X2 → X12, X3 → X13, X4 → X14 When a label is entered for "Find Device" or "Replace Device," it will be treated as '1' entered even if a point other than '1' is entered.
Replace Options	Device Comment
	Select whether to copy/move a device comment in "Find Device" to "Replace Device" (excluding S/TR).

### Point

Select a range of device/label on a ladder editor by a drag-and-drop operation to register multiple devices/labels in batch.

When entering a label name, options will be displayed.

They can also be displayed by any of the following operations:

- Enter '.' at the end of a label name of structure type or an instance name of a function block.
- Press the **[Ctrl]** + **[Space]** keys.

In addition, by selecting "Yes" for the following option, when entering a common device comment or a label comment, devices and labels for which the comment has been set can be displayed as options.

- [Tool] ⇨ [Options] ⇨ "Edit" ⇨ "Instruction/Device/Label Candidacy Display" ⇨ "Candidate Display Setting" ⇨ "Display the Corresponding Device in Entering Device Comment"



## Precautions

When specifying a step relay (S) or SFC transition device (TR) for "Find Device" and select "(Entire Projects)" for the target, the step relay (S) or SFC transition device (TR) of all blocks are replaced. (Example: when replacing 'TR0,' 'BL0\TR0' and 'BL1\TR0' also are replaced.)

When copying and pasting a device to be searched for or replaced from other applications such as Excel into the "Device Batch Replace" screen, the default value '1' is entered to a cell in which no point is entered.

## 9.6 Displaying Device and Label Reference Information

A project can be searched to identify where a selected device/label is used, and the information is displayed in a list. A cross reference window is displayed horizontally when it is docked on the top or bottom of the main frame, and displayed vertically when it is docked on the left or right of the main frame.

### Point

The display format and detailed operation settings for each function can be set by setting the following option.  
[Tool] ⇒ [Options] ⇒ "Find/Replace" ⇒ "Cross Reference"

### Target data for creating cross reference information

Cross reference information is created based on devices used in the following data.

- Ladder programs
- ST programs
- FBD/LD programs
- SFC programs
- Global label
- Local label
- Structure
- Multiple CPU refresh setting in CPU parameters
- Refresh setting in module parameters
- Simple CPU communication setting in module parameters

In a project for an FX5CPU, the cross reference information of devices used for both the CPU built-in functions and the parameter settings of extension modules and communication adapters are created.

## Displaying cross reference information

Create and display the cross reference information of the devices/labels used in the project.

Supported editors: ladder editor, ST editor, FBD/LD editor, SFC diagram editor, label editor<sup>\*1,\*2</sup>, and parameter editor<sup>\*2</sup>

\*1 When "Yes" is selected in the following option setting, data on a label editor is used for this operation.

[Tool] ⇒ [Options] ⇒ "Find/Replace" ⇒ "Cross Reference" ⇒ "Find Condition" ⇒ "Find Label Definition"

\*2 When "(Current Window)" is specified, data in a label editor is not used for this operation.

### Window

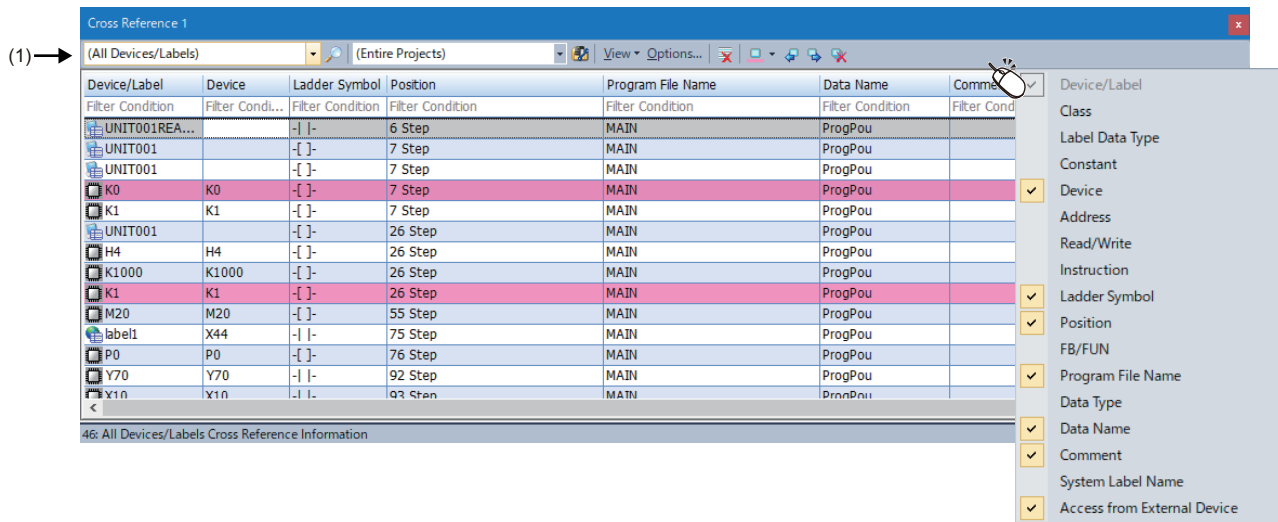

Select [View] ⇒ [Docking Window] ⇒ [Cross Reference 1/Cross Reference 2] (  ).



Up to two cross reference windows can be displayed at once.

















Up to 79999 pieces of cross reference information is displayed in each cross reference window.

### Operating procedure

1. To specify a range to be searched, select the search location of a device/label by clicking  in the toolbar (1). (Multiple selections allowed.)
2. Enter a device name or a label name to search for in the column in which "(All Devices/Labels)" is displayed.
3. Click .

If searching for devices/labels while "(All Devices/Labels)" is displayed in the column, the cross reference information of all devices/labels is displayed.

To clear the displayed cross reference information, click .

- 
- By selecting a row in the result list and performing any of the following operations, the cursor jumps to the position where the selected device or label is used.
    - Double-click the row.
    - Right-click the row, and select [Jump] from the shortcut menu.
    - Press the  key.
  - After the cursor jumped from a cross reference window to a program editor, label editor, or SFC block list, by using the following menu, the cursor jumps forward or backward from the current position to positions where were searched before.
    - [Find/Replace] ⇒ [Previous] ()/[Next] ()
  - Cross reference information can also be created by selecting and right-clicking a device/label on a program editor, then selecting [Cross Reference] from the shortcut menu.
  - By pressing the  key ( + ), the focus will move between the editor and a cross reference window.
  - By pressing the  key ( + ) /  +  keys ( +  + ), the cursor in a cross reference window will move to the previous/next row.
  - By selecting "No" for the following option, the cursor remains in a cross reference window even when jumping to each editor from the window. Therefore, the cursor can move to the previous/next row in the window by pressing the  /  key after the jump.
    - [Tool] ⇒ [Options] ⇒ "Find/Replace" ⇒ "Cross Reference" ⇒ "Operational Setting" ⇒ "Jump with cursor in jumping"
-

## ■ Device/label options

Device or label options can be displayed in the input field by setting the following options as shown below.

Option	Value
[Tool] ⇒ [Options] ⇒ "Find/Replace" ⇒ "Cross Reference" ⇒ "Operational Setting" ⇒ "Auto-fill device/label name to display based on input history"	No
[Tool] ⇒ [Options] ⇒ "Edit" ⇒ "Instruction/Device/Label Candidacy Display" ⇒ "Operational Setting" ⇒ "Instruction/Device/Label name Prediction"	Yes

After setting these options, device or label options are displayed by any of the following operations:

- Enter a device or label name in the input field.
- Enter '.' at the end of a label name of structure type or an instance name of a function block.
- Press the **Ctrl** + **Space** keys.

In addition, by selecting "Yes" for the following option, when entering a common device comment or a label comment, devices and labels for which the comment has been set can be displayed as options.

- [Tool] ⇒ [Options] ⇒ "Edit" ⇒ "Instruction/Device/Label Candidacy Display" ⇒ "Candidate Display Setting" ⇒ "Display the Corresponding Device in Entering Device Comment"

## ■ Label type and range specification method

By entering a label name, to which a character string such as a program block name is appended, in the input field, the type and range of the label to be searched for can be specified.

When entering a label name, refer to the following example.

Example name		Type of label to be searched	Search range <sup>*1</sup>
Label name	bLabel1	Global label	Entire project
Program block name/Label name	ProgPou/bLabel1	Local label	Program block the name of which is the same as the entered one
Function block name/Label name	FbPou/bLabel1		<ul style="list-style-type: none"> <li>• Program body of a function block whose name is the same as the entered one</li> <li>• Program body in which an FB instance or function block element whose name is the same as the entered one is used</li> </ul>
Function name/Label name	FunPou/bLabel1	Global label <sup>*2</sup> Local label	Program body of a function whose name is the same as the entered one
Program file name/label name	MAIN/bLabel1	Global label Local label	Program file whose name is the same as the entered one
FB file name/label name	FBFILE1/bLabel1		FB file whose name is the same as the entered one
FUN file name/label name	FUNFILE1/bLabel1	Global label <sup>*2</sup> Local label	FUN file whose name is the same as the entered one
/Label name	/bLabel1	Global label	Entire project

\*1 When the following option is set to "Yes," a label editor is included in the search range.

[Tool] ⇒ [Options] ⇒ "Find/Replace" ⇒ "Cross Reference" ⇒ "Find Condition" ⇒ "Find Label Definition"

\*2 Not searched for if a function is created in Ladder Diagram language.

## ■ Device assigned to a label

Global labels and devices assigned to the global labels can be searched for at the same time.

In the following option, whether or not to search for assigned devices can be selected.

- [Option] in the toolbar ⇒ "Find Condition" ⇒ "Include Assigned Device in Finding Label Name"

## ■ Array

In the following option, a constant label used as an array index can be analyzed, and whether or not to search for a label considering a constant value can be selected.

- [Option] in the toolbar ⇒ "Find Condition" ⇒ "Analyze and Find Constant in Find When Constant Label is Specified in Array Element"

## ■Automatic synchronization

This function automatically creates the cross reference information of a device or label selected on an editor.

The cross reference window used for displaying the automatic synchronization result can be specified by selecting "Options" in the window and setting the items in "Operational Setting" on the "Option" screen.

In addition, when performing an automatic synchronization, the timing of cross reference information update can be specified.

Note that this function cannot be used in a parameter editor.

## ■Local label selected in an editor



When displaying a cross reference window while a local label is selected in a program editor, the names of both the program in which the label is used and the label are automatically entered in the input field. (Example: When displaying a cross reference window while selecting the label 'bLabel1' which is used in the program file 'ProgPou,' 'ProgPou/bLabel1' is automatically entered in the input field.)

## ■Device or label selected in an editor

When selecting a device or label, which is displayed in the search result of a cross reference window, in any of the following editors, the row of the device or label in the search result is also selected.

- Ladder editor
- ST editor
- FBD/LD editor
- SFC diagram editor
- Label editor

In an ST editor, select the entire name of a device or label by any of the following operations.

- Double-click the device or label.
- Drag the mouse cursor from left to right on the device or label.
- Place the mouse cursor on the device or label and press the  +  keys.

## Precautions

Even if a device or label is selected in an editor when "Not Auto-tracking" is selected for the following option, the corresponding row in the search result will not be selected.

- [Tool] ⇒ [Options] ⇒ "Find/Replace" ⇒ "Cross Reference" ⇒ "Operational Setting" ⇒ "Display Destination of Auto-tracking Result"

## Information to be displayed

### ■Array

When searching for a label using a character other than number (such as a constant or a device) for an array index, a device that is assigned to the first element within the array element set for the data type of this label is displayed in the "Device" column.

### ■Displaying data types of arguments of an FB/FUN

For FBD/LD programs or SFC programs (FBD/LD elements), the data type of an FB/FUN using devices/labels as arguments can be displayed in the "FB/FUN" column.

Contacts, coils, and variable elements are displayed.

Up to 10 data types of an FB/FUN can be displayed for one element.

### ■Displaying and editing comments

- For a ladder, the comments specified in [Tool] ⇨ [Options] ⇨ "Project" ⇨ "Device Comment Reference/Reflection Target" are displayed as device comments.
- To edit a comment, open the editor where the comment is defined by selecting and right-clicking a row arbitrarily in the search result in a cross reference window, then selecting [Comment Edit] from the shortcut menu.

 Page 400 Device comments

### ■Device assigned to a label

When searching for a label definition by entering the name of the device which is assigned to labels, only labels that the assigned device name matches completely with the entered name are displayed in a search result. (Example: By entering 'D0' to search for a label definition, only the labels to which 'D0' is assigned are displayed in a search result. Labels to which an index-modified device such as 'D0Z0' is assigned are not displayed.)

## Information not to be displayed

The following data is not displayed in a cross reference window:

- Data protected by security
- Devices/labels set in module parameters of an unmounted module

## Incorrect cross reference information is displayed

- When deleting data after converting, and displaying cross reference information, the deleted data may be displayed in the search result. To display the latest information, convert again and display the cross reference information.
- If a program or the option setting is changed, cross reference information does not correspond with the program. In order to update the cross reference information, display it again.

## Filtering display

Cross reference information being displayed can be filtered.

### Operating procedure

Enter or select a filtering condition, and press the  key.

#### ■ Filtering condition

The previously entered keywords can be selected from the pull-down list.

For "Data Name" and "Program File Name," search results can also be selected from the list as well as previously entered keywords.

#### ■ Tree display of filtering condition

Only data of which components match with the filtering conditions are displayed in the tree format when filtering display is performed for the structure data names or the instance names of the function block.

#### ■ Deleting a filtering condition

Filtering of a column can be cleared by deleting the keyword entered as a filtering condition for the column.

#### ■ Keywords for a filtering condition

The following table shows the wild cards that can be set as keywords in filtering conditions to search for a character string.

 Ex.

When setting a filtering condition for the device/label column

Wild card	Target	Example	Result
*	Any character string	*30*	ready301, K4X30, K1Y30, K4Y30
?	Any one character	K4?30	K4X30, K4Y30
[ ]	Any one of specified characters	[XY]8	X8, Y8
[!]	Any one character except for one in the brackets	K4X[!3]0	K4X40
[-]	Character strings within the range in the brackets	D[0-2]	D0, D1, D2

## Hierarchical display

A structure/array/function block can be displayed hierarchically.

If a device uses two or more points in an instruction, devices after the start device can also be displayed.

### Operating procedure

Select the checkbox of "Display Hierarchically" under the [View] menu on the toolbar.

## Sorting display

The columns can be sorted in ascending/descending order by clicking the column header. However, they cannot be sorted if a structure/array/function block is hierarchically displayed.



## Highlighting display



A displayed row can be highlighted.

### Operating procedure

Select a row and click  (Set/Clear Highlight) on the toolbar.

#### Point

The color of a row to be highlighted can be selected by clicking  next to  (Set/Clear Highlight) on the toolbar. Rows can be color-coded with this function.

Moreover, by clicking  (Previous Highlight) or  (Next Highlight), the cursor jumps to the previous or next highlighted row.



## Displaying a list of unused labels

The following labels which are not used in a project can be displayed in a cross reference window.

- Global labels which are not used in all POUs
- Local labels which are not used in POUs in a search range

Displayed labels can also be deleted in the window.

Supported editor: Label editor

### Window

Select [Find/Replace] ⇒ [Unused Label List].

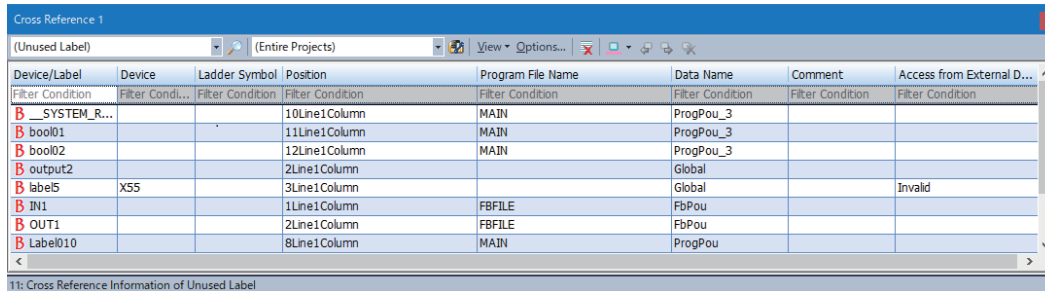

Device/Label	Device	Ladder Symbol	Position	Program File Name	Data Name	Comment	Access from External D...
B __SYSTEM_R...			10Line1Column	MAIN	ProgPou_3		
B bool01			11Line1Column	MAIN	ProgPou_3		
B bool02			12Line1Column	MAIN	ProgPou_3		
B output2			2Line1Column		Global		
B label5	X55		3Line1Column		Global		Invalid
B IN1			1Line1Column	FBFILE	FbPou		
B OUT1			2Line1Column	FBFILE	FbPou		
B Label010			8Line1Column	MAIN	ProgPou		

11: Cross Reference Information of Unused Label



### ■ Search without specifying a range

#### Operating procedure

Click .

### ■ Search with specifying a range

#### Operating procedure

1. Click .
2. Select the checkbox of data to be searched in the "Reference Tree for Find In" screen. (Multiple selections allowed.)
3. Click .

#### Point

After the cursor jumped from a search result to a program editor, label editor, or SFC block list, by using the following menu, the cursor jumps forward or backward from the current position to the positions where search was applied.

- [Find/Replace] ⇒ [Previous] ()/[Next] ()

### Precautions

- Function blocks, functions, and structures which are not utilized in a program are not searched for.
- A label used in "Block Information" in the "Properties" screen of an SFC block as an array index is regarded as an unused label if it is not used in a program.
- Labels specified as aliases are not detected as unused labels even when these are not used in a program.

## Deleting unused labels

Unused labels can be deleted in a cross reference window.

### Operating procedure

1. Select a label in a search result list. (Multiple selections allowed.)
2. Right-click the label and select [Delete Label] from the shortcut menu.

### Precautions

- When a label is deleted, the program related to the deleted label will be in the unconverted state.
- When utilizing a function block/function in a program, an input argument and an output argument which are not used in the function block/function are treated as unused ones. Note that the definition of a function block/function is changed when deleting an input argument and an output argument.
- When VAR\_PUBLIC and VAR\_PUBLIC\_RETAIN are not used in the function block of the definition source, these are detected as unused labels even when used in a program other than the function block of the definition source.
- When a label name of an input/output argument of a function block utilized in an ST program corresponds to a local label name in the ST program, it is not detected as an unused label.

## 9.7 Displaying Device Usage

Display the usage of the specified devices.

Supported editor: Ladder editor, ST editor, FBD/LD editor, SFC diagram editor, and parameter editor\*<sup>1</sup>

\*<sup>1</sup> When "(Current Window)" is specified, data in the parameter editor is not used for this operation.

### Window

Select [Find/Replace] ⇒ [Device List].

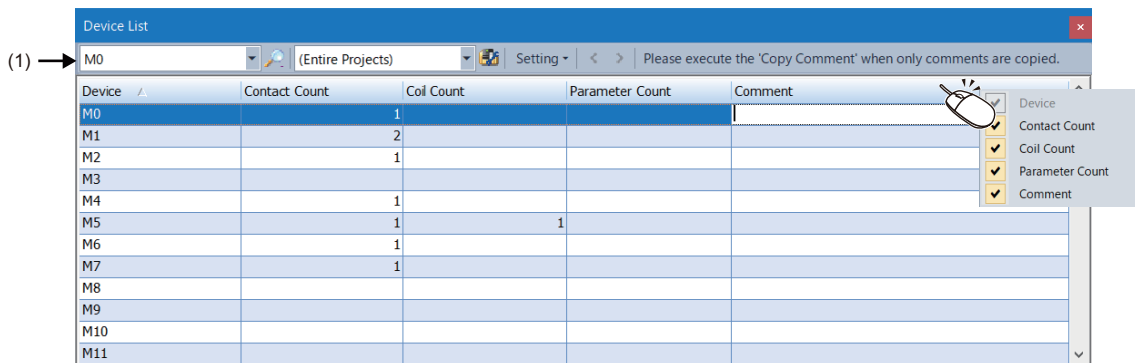

### Operating procedure

Set each item and press the  key.

To specify the range to be searched, select the search location of a device/label by clicking  in the toolbar (1). (Multiple selections allowed.)

To set the display format, set it in the screen displayed by selecting [Setting] ⇒ [Batch Setting] in the tool bar (1).

### Point

- A device comment can be entered or edited in the Device List. Enter a comment in "Comment" column and press the  key.
- By any of the following operations, only comment can be copied or pasted.
  - Right-click and select [Copy Comment] from the shortcut menu.
  - Right-click and select [Paste Comment] from the shortcut menu, alternatively, press the  +  keys.
- The editor where the comment is defined is opened by selecting and right-clicking a row in the Device List, then selecting [Comment Edit] from the shortcut menu.

### Considerations

#### ■ Searching for coil instructions

As output instructions, the following application instructions can also be searched for:

SET, RST, PLS, PLF, FF, SFT, SFTP, and MC

#### ■ Searching for assigned devices

The following devices cannot be searched for even when they are assigned to labels:

- Double-word device (LT, LST, LC, and LZ)
- Indirect-specified device
- Digit-specified device (used in an editor except for a ladder editor)

#### ■ Searching for file registers (R/ZR)

File registers (R) and (ZR) are distinguished when searching the device list.

Specify them separately when searching for R devices or ZR devices.

FX5CPUs do not support file registers (ZR).

#### ■ Searching for step relays (S)

when searching for a step relay (S), specify a step relay with block specification (BL□\S).

## ■ Searching for devices set in module parameters

Devices set in module parameters of an unmounted module cannot be searched for.

## ■ Checking the locations of devices used



The locations of devices used can be checked by opening a cross reference window from the device list. Select a row in the list and perform any of the following operations to open a cross reference window:

- Press the **Ctrl** + **E** keys or press the **Enter** key.
- Double-click the row.
- Right-click and select [Cross Reference] from the shortcut menu.

For details on the cross reference function, refer to the following:

 Page 456 Displaying Device and Label Reference Information

## ■ Displaying and editing comments

- When searching data by selecting one program, comments specified in [Tool] ⇒ [Options] ⇒ "Project" ⇒ "Device Comment Reference/Reflection Target" are displayed. ( Page 400 Device comments)
- When searching data by selecting multiple programs, common device comments are displayed.
- By entering a comment while one program is selected and searched, the device comment is applied to the device comment set in the following option. ( Page 400 Device comments)
  - [Tool] ⇒ [Options] ⇒ "Project" ⇒ "Device Comment Reference/Reflection Target"

## 9.8 Displaying a Range Affected by/Affecting a Device/Label

The data flow analysis function shows a range affected by/affecting a specified device or label (analysis target) with a data flow diagram where the target is set as the base point.

A range affected by/affecting a specified device or label can be checked visually, which makes it easier to specify a cause when an error occurs.

### Target range of data flow analysis

Devices/labels/constants used in the following locations can be analyzed:

- Ladder programs
- ST programs
- FBD/LD programs
- Zooms (action/transition)<sup>\*1</sup> in SFC programs
- Event history (offline monitor)<sup>\*2,\*3</sup>
- Multiple CPU refresh setting in CPU parameters
- Refresh setting in module parameters<sup>\*4</sup>
- Simple CPU communication setting in module parameters<sup>\*4</sup>
- Simple device communication setting in module parameters<sup>\*4,\*5</sup>

For a project for an FX5CPU, devices/labels/constants used in the following locations can also be analyzed:

- CPU built-in functions
- Parameter settings of extension modules and communication adapters

\*1 Actions and transitions displayed in MELSAP-L (instruction format) are not analyzed.

\*2 An event history displayed from the following menu is not analyzed: [Diagnostics] ⇒ [Module Diagnostics (CPU Diagnostics)]/[System Monitor] ⇒ [Event History].

\*3 Only modify value events are analyzed.

\*4 Devices/labels set in the module parameter of an unmounted module are not analyzed.

\*5 The following devices are analyzed: the ones that are set in the "Received Data Verification Result" and "Device" columns of the "Protocol Setting" screen for enabled communication destination settings.

### Displaying a data flow diagram

In a data flow diagram, an analysis target (base point) and range affected by/affecting the target are displayed graphically.

The data flow analysis function is available in the following screens:

- Program editors (ladder, ST, FBD/LD, and SFC)
- Label editor
- Device list window
- Watch window<sup>\*1</sup>
- Intelligent function module monitor window<sup>\*1</sup>
- Event history (offline monitor) window<sup>\*1</sup>







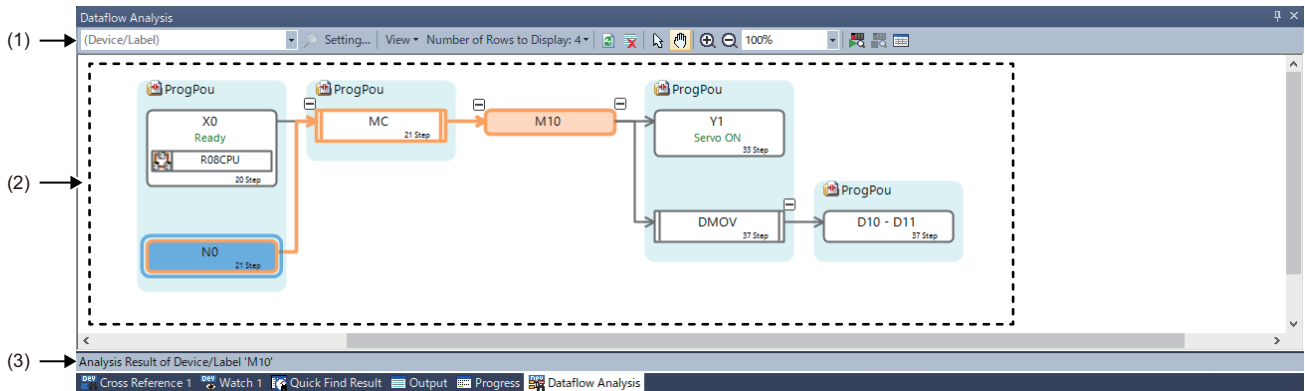







\*1 When selecting a local label used in a function block in this window for an analysis, the label is not analyzed. To display the local label in a data flow diagram, start an analysis by specifying its label name in the "Dataflow Analysis" window.





## Window

Select [View] ⇒ [Docking Window] ⇒ [Dataflow Analysis] (  ).

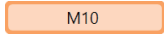
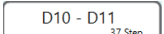
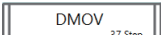

## Displayed items

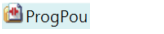
Item	Description
(1) Toolbar	<div style="border: 1px solid gray; padding: 2px; margin-bottom: 5px;">(Device/Label) <span style="float: right;">▼</span></div> <p>Analysis target device/label</p> <p>Specify a device/label to be analyzed. The device/label type and range to analyze can be specified by entering a device/label to which a character string such as a program file name is appended. (  Page 470 Device/label type and analysis range specification method)</p>
	Click this to analyze a specified device/label.
	Select this to set an item to be included in an analysis range.
	Select this to set an item to be displayed in a data flow diagram.
	Select this to set the number of rows for a device, label, and comment displayed in a device/label block and process block. (Up to four rows) If the checkbox of "Display Device/Label and Comment" is selected in the pull-down list of the [View] menu, only the following number can be selected:
	<ul style="list-style-type: none"> <li>• 2</li> <li>• 4</li> </ul>
	Click this to update a data flow diagram with specified analysis conditions (analysis target, setting, view, and number of rows to display).
	Click this to clear an analysis result (data flow diagram).
	Click either of the icons to switch the mouse cursor.
	<ul style="list-style-type: none"> <li>• Select: An element can be selected, expanded, or collapsed. In addition, the cursor can jump to a location in which the selected element is used.</li> <li>• Panning Hand: The display position of a data flow diagram can be moved.</li> </ul>
	Click this to zoom in and out a data flow diagram.
	
 100% <span style="float: right;">▼</span>	Specify the magnification of a data flow diagram.
	Click this to start the monitor mode.
	Click this to stop the monitor mode.
	Click this to specify an FB instance to be monitored.

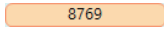
Item	Description	
(2) Data flow diagram	An analysis result is displayed with a data flow diagram.	
	 Device/label block (base point)	A device/label specified as an analysis target (base point)
	 Device/label block (related)	A device/label/constant related to a device/label block (base point)
	 Process block (instruction/FUN/FB) <sup>*1</sup>	An instruction/function/function block related to a device/label block (base point)
	 Extended block <sup>*2</sup>	This block is displayed when the following functions affect on a device/label block (base point): <ul style="list-style-type: none"> <li>• Event history (offline monitor)<sup>*3</sup></li> <li>• Parameter</li> </ul> Example) If 'X0' is specified in any parameters, an extended block indicating the parameter is displayed in the device/label block of 'X0.'
	 Program block	A program block/function block/function which includes the analysis target or related item is displayed.
	 Loop	This icon is displayed when a device/label block or process block in a same location is repeated. If this icon is displayed on a block, the block cannot be expanded. Example) This icon is displayed if a same device is used for a contact and a coil.
 Monitor value display area	The monitor value of a device/label is displayed when monitoring in the "Dataflow Analysis" window.	
(3) Status bar	To display information of an analysis target.	

\*1 Not displayed for an instruction with no argument such as 'GOEND' or 'TRAN.'

\*2 Not displayed for the following label/device:

- Local label used in a function block.
- Analysis target (base point) device/label with multiple definitions

\*3 An extended block is displayed only during offline monitoring which uses a recording file.

## Analyzing a device/label

The following shows the procedure for analyzing a device/label and displaying a data flow diagram.

### Operating procedure

1. Select a device or label to be analyzed in a screen such as a program editor.
2. Right-click it and select [Dataflow Analysis] from the shortcut menu.

The "Dataflow Analysis" window appears, which displays an analysis result as a data flow diagram.

### Point

- A data flow diagram can be displayed by pressing the **[Ctrl] + [Shift] + [E]** keys after selecting a device/label.
- A device/label can be analyzed from a block displayed in a data flow diagram.  
 Select and right-click any of the following blocks, then select [Dataflow Analysis] from the shortcut menu:
  - Device/label block
  - Process block (function block only)

### Precautions

When there is no item related to a device/label which is specified as an analysis target, a data flow diagram is not displayed.

## ■Device/label type and analysis range specification method

The device/label type and analysis range can be specified by entering a device/label name, to which a character string such as a program file name is appended, in the input field.

When entering a label or device name, refer to the following example.

Example name		Type of device/label to be analyzed	Analysis range
Label name	bLabel1	Global label	Entire project
Program block name/label name	ProgPou/bLabel1	Local label	Program block the name of which is the same as the entered one
Function block name/label name	FbPou/bLabel1		Function block the name of which is the same as the entered one
Function name/label name	FunPou/bLabel1		Function the name of which is the same as the entered one
Program file name/label name	MAIN/bLabel1		Program file whose name is the same as the entered one
FB file name/label name	FBFILE1/bLabel1		FB file whose name is the same as the entered one
FUN file name/label name	FUNFILE1/bLabel1	Global label* <sup>1</sup> Local label	FUN file whose name is the same as the entered one
/Label name	/bLabel1	Global label	Entire project
Local device name	#D10	Local device	Entire project
Program file name/local device name	MAIN/#D10		Program file whose name is the same as the entered one
FB file name/local device name	FBFILE1/#D10		FB file whose name is the same as the entered one
FUN file name/local device name	FUNFILE1/#D10		FUN file whose name is the same as the entered one

\*1 Not searched for if a function is created in Ladder Diagram language.

## ■Analyzable device range

When analyzing a device from a program editor, the device can be analyzed with the range which it uses.

(Example: When analyzing a device used in a DMOV instruction, the device range used as an argument is handled as two words.)

Ex.

Analyzing a device (D0-D1) used in a DMOV instruction

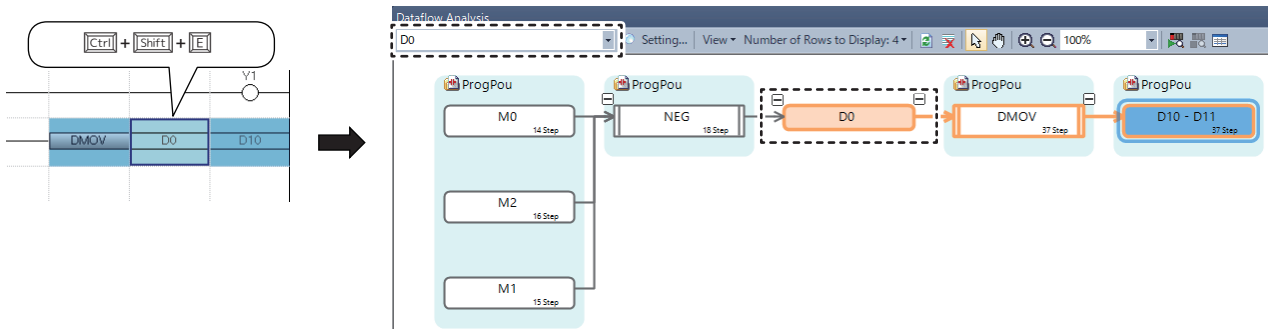



## ■Analyzing an index-modified device

Only during offline monitoring, an index-modified device is analyzed with the device value to which the index value is applied. The following table shows the combinations of index modifications and analysis examples of index-modified devices.

Combination of index modifications			Device example	Analysis example (when the value of Z0 is '1')
Index modification	—	—	X0Z0	X1
			#M0Z0	#M1
			D0Z0	D1
Index modification	Digit specification	—	K4M0Z0	K4M1
			K4#M0Z0	K4#M1
Index modification	Bit specification	—	D0Z0.0	D1.0
Index modification	Indirect specification	—	@D0Z0	@D1
Bit specification	Index modification	—	D0.0Z0	D0.1
Index modification	Indirect specification	Bit specification	@D0Z0.0	@D1.0
Indirect specification	Bit specification	Index modification	@D0.0Z0	@D0.1

## Precautions

- When analyzing the following data, the value of an index register is not applied to the device value:
  - Device modified with a local index register
  - Index-modified device used as an array element of an array type label
  - 32-bit index modification with ZZ expression
  - Index register (Z, LZ, ZZ)
- '-' (A hyphen) is displayed if a device cannot be analyzed with the device value to which the index value is applied.

## ■Unanalyzable device/label

- In a ladder program, a ladder in which a conversion error has occurred cannot be analyzed.
- Some devices/labels cannot be analyzed if the following devices/labels are specified:

Specified device/label	Unanalyzable device/label/constant
Bit-specified device/label	Device/label a bit of which is not specified
Local label in a function block or structure member	FB instance or structure type label name
Digit-specified device/label	Device/label the digits of which are not specified
Label including an array element	Label which does not completely match with the one in a program
—	<ul style="list-style-type: none"> <li>• Device/label specified as an array element</li> <li>• Device/label/constant used in a conditional expression of control syntax in a ST program</li> </ul>

## Information displayed in a data flow diagram

### ■Block layout

The following shows the layout of blocks in a data flow diagram.

In a data flow diagram, an analysis target (base point) is placed in the center, blocks (1) that affect the target on the left, and blocks (2) that are affected by the target on the right.

When selecting a device/label block (placing the cursor on it), the selected block (3), the base point (4), and the block (5) that is on the route between the selected block (3) and base point (4) are marked with orange frames. When selecting multiple device/label blocks, the frame is not displayed for the block (6) that is not on the route between the block (3) on which the cursor is placed and the base point (4).

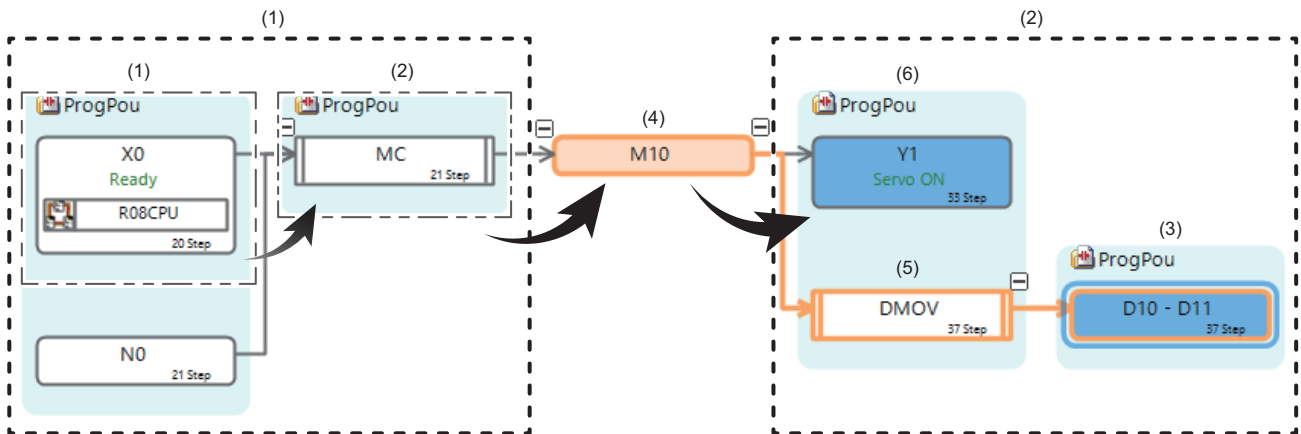

### Point

Each block is placed in a data flow diagram according to the display order in the navigation window. When analyzing a device/label again after sorting data displayed in the navigation window, the layout of each block in the data flow diagram will be updated.

### ■Displaying comments

- For a device/label block and a process block, comments set in the following option or screen are displayed:
  - [Tool] ⇒ [Options] ⇒ "Project" ⇒ "Device Comment Reference/Reflection Target"
  - [Tool] ⇒ [Options] ⇒ "Other Editor" ⇒ "Label Editor Common" ⇒ "Display Setting" ⇒ "Hierarchy Display Setting for Structures Comment"
  - "Multiple Comments Display Setting" screen
- Comments which are set when an analysis starts are displayed. If a comment is edited or a setting is changed in the "Multiple Comment Display Setting" screen after the analysis starts, execute the analysis again to display the latest comments.
- Some comments may not be displayed when the following conditions are satisfied:

Condition	Comment display
One of sequential devices is specified as an analysis target. (Example: device used in a DMOV instruction)	Only a comment set for the start device is displayed.
An analysis target (base point) device/label has multiple definitions.	<ul style="list-style-type: none"> <li>• Device: A common device comment is displayed.</li> <li>• Label: A comment is not displayed.</li> </ul>

### ■Data protected by security

Data protected by security is not displayed in a data flow diagram.

## Operations in a data flow diagram

### ■ Selecting multiple elements

Multiple elements can be selected by any of the following operations:

- Drag the mouse cursor.
- Press the **Ctrl** + **A** keys. (To select all elements)
- Select an element, then press the **Shift** + **←** / **→** / **↑** / **↓** keys.
- Select a block with the **Ctrl** / **Shift** key held down.

### ■ Jumping to a location in which a device/label is placed



By selecting a device/label in a data flow diagram and performing any of the following operations, the cursor jumps to a location in which the device/label is placed:

- Double-click the device/label.
- Right-click on the diagram, and select [Jump] from the shortcut menu.
- Press the **Enter** key.

### Precautions



- The cursor cannot jump if the mouse cursor is  (Panning Hand).
- The jump function is not available for the following items:
  - Device/label block (base point)
  - Extended block (event history (offline monitor))

### Point

- By using the following menu, the cursor jumps forward or backward from the current position to the positions where search was applied:
  - [Find/Replace] ⇔ [Previous] () / [Next] ()
- By pressing the **Shift** + **Enter** keys, jumping is possible while the cursor remains in the "Dataflow Analysis" window.

### ■ Expanding/collapsing an element

By selecting an element in a data flow diagram and performing any of the following operations, the element can be expanded or collapsed:

- Click  / .
- Right-click on the diagram, and select [Expand/Collapse] from the shortcut menu.
- Press the **Space** key.

### Precautions

An element cannot be expanded or collapsed if the mouse cursor is  (Panning Hand).

### ■ Moving to a device/label block (base point)

The cursor can move to a device/label block (base point) by any of the following operations:

- Right-click on the diagram, and select [Move to Base Point] from the shortcut menu.
- Press the **Home** key.

### ■ Displaying a device/label in a waveform

For the method for displaying a device/label in a waveform in GX LogViewer, refer to the following:

 Page 754 Starting GX LogViewer

## Considerations

### ■ When including an event history (offline monitor) in the analysis range

Note the following when including an event history (offline monitor) in the analysis range:

- Use a project written to a programmable controller. An extended block may not be displayed correctly if an analysis is executed with the following projects: a project different from the one written in the programmable controller, and a program in which a label assignment is changed.
- An extended block is not displayed when analyzing a local label of a function block.

## Monitoring devices/labels

Devices/labels displayed with a data flow diagram can be monitored, and changes in their current values can be checked.

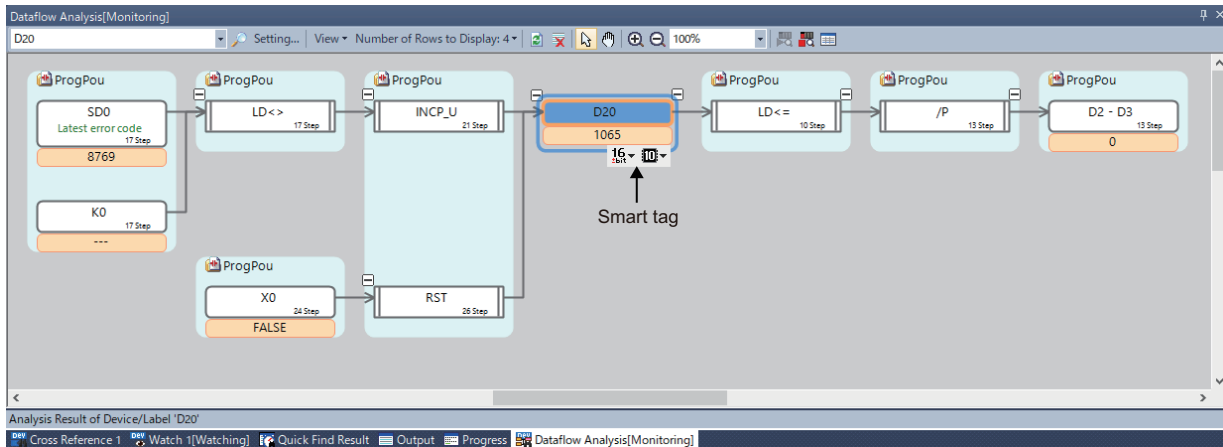

### Starting/stopping monitoring

By starting monitoring, the monitor values of analyzed devices/labels can be displayed in a data flow diagram.

#### Starting monitoring

##### Operating procedure

Right-click on a data flow diagram and select [Monitor] ⇒ [Start Monitoring] from the shortcut menu.

#### Stopping monitoring

##### Operating procedure

Right-click on a data flow diagram and select [Monitor] ⇒ [Stop Monitoring] from the shortcut menu.

#### Point

When selecting a program with the specified program monitor function, the values after the selected program was executed are displayed as the monitor values. In this case, "[Monitoring (Running Specified Program Monitor)]" is added to the title of the "Dataflow Analysis" window.

For details on the specified program monitor function, refer to the following:

☞ Page 613 When monitoring devices/labels in a specified program

### Precautions

- If a device/label block satisfies either of the following conditions, its monitor value is not displayed:
  - Local label used in a macro type function block or in a program body of a FUN
  - Local device used in an unregistered program or in a program body of an FB/FUN
- When a device/label cannot be monitored, an indefinite value or "----" is displayed in the monitor value display area.
- If an index-modified device is displayed in either of the following data display formats, an indefinite value is displayed in the monitor value display area:
  - 64-bit Integer [Signed]
  - 64-bit Integer [Unsigned]
- For sequential devices, only the monitor value of start device is displayed.

## Displaying the monitor value of an FB instance

The monitor value of a local label used in a program body of a subroutine type function block can be displayed by specifying an FB instance to be monitored in the "Register FB Instance" screen.

### Window

Double-click a program block of a function block on a data flow diagram.

Alternatively, right click it and select [Monitor] ⇒ [Register FB Instance] from the shortcut menu.

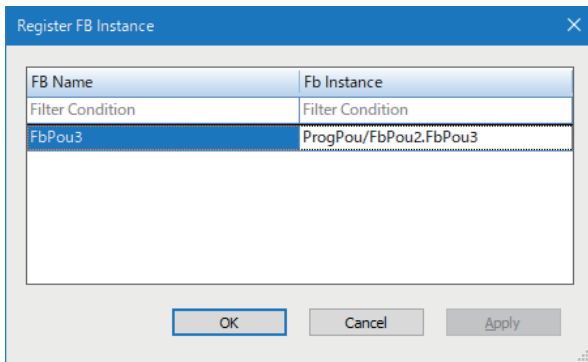

### Operating procedure

1. Select an FB instance to display its monitor value, and click the [Apply] button.
2. Click the [OK] button.

### ■Filtering display

The list of FB instances displayed in the "Register FB Instance" screen can be filtered.

### Operating procedure

Enter or select a filtering condition, and press the  key.

To clear filtering, delete the keyword entered as a filtering condition.

### Point

The previously entered keywords can be selected from the pull-down list.

## Setting the display format

The display format (data display format, display value) of a monitor value can be set for each of the displayed word devices and double-word devices.

### Operating procedure

1. Select a device/label block of a word device or double-word device.
2. Click either of the following smart tags to set the display format:
  - Data Display Format (16)
  - Display Value (10)

### Precautions

- The display format settings are saved in a project and not written to a programmable controller.
- Up to 10,000 display format settings can be retained. If the number of settings exceeds 10,000, they will be deleted in chronological order. However, note that if there are any data display format settings imported from a CSV file, the settings will be deleted from the one in the bottom row of the CSV file.

### Exporting the data display format

The data display formats of monitor values can be exported to a CSV file.

Only the data display formats the settings of which have been changed are exported.

A saved CSV file opened in spreadsheet software is displayed as follows:

//Start Device	Points	Data Type
D0	5	DINT
J1 ¥WO	2	REAL
T3	1	LREAL

(1): Header

(2): Data segment

The following describes the detailed formats of a file.

- The file format is Unicode (UTF-16 Little Endian with BOM).
- Items are delimited by '\t' (a tab).
- Each item is enclosed with " (double quotes).
- When " (a double quote) is included in an item, "" (two double quotes) are displayed for each " (double quote) in the item.
- A line feed is inserted at the end of a row. The line feed code is LF.
- Item names in the header (1) are exported in a language set for the display language of GX Works3. (Page 50 Display Language Switching)

### Operating procedure

Right-click on the data flow diagram, and select [Monitor] ⇒ [Device Data Type Setting] ⇒ [Export to File] from the shortcut menu.

## ■ Importing the data display format

The data display formats for monitor values can be imported from a CSV file.

For a CSV file to be imported, follow the formats listed below:

- The header (1) is not mandatory.
- Use '\t' (a tab) for delimiting items.
- Add '/' (two slashes) at the head of the first column in a row to not be imported.
- Notation in the "Data Type" column is as follows:

Data display format to be set	Notation
16-bit Integer [Signed]	INT
16-bit Integer [Unsigned]	WORD
32-bit Integer [Signed]	DINT
32-bit Integer [Unsigned]	DWORD
64-bit Integer [Signed] <sup>*1</sup>	QINT
64-bit Integer [Unsigned] <sup>*1</sup>	QWORD
FLOAT [Single Precision]	REAL
FLOAT [Double Precision] <sup>*1</sup>	LREAL
String	STRING
String [Unicode]	WSTRING

\*1 Cannot be imported in an FX5CPU.

Devices that can be imported are as follows:

Device
T <sup>*1</sup> , ST <sup>*1</sup> , LT <sup>*1,*2</sup> , LST <sup>*1,*2</sup> , C <sup>*1</sup> , LC <sup>*1</sup> , D, W, SW, SD, J□W <sup>*2</sup> , J□SW <sup>*2</sup> , U□G, U3E□G <sup>*2</sup> , U3E□HG <sup>*2</sup> , Z, LZ, R, ZR <sup>*2</sup> , RD <sup>*2</sup>

\*1 Imported as the current value information.

\*2 FX5CPUs do not support it.

## Operating procedure

Right-click on the data flow diagram, and select [Monitor] ⇒ [Device Data Type Setting] ⇒ [Import File] from the shortcut menu.

## Precautions

- A CSV file with more than 10,000 rows of data cannot be imported.
- When different data types are set for one device in multiple rows, the setting in the most upper row in the CSV file is imported.



## 9.9 Registering a Bookmark



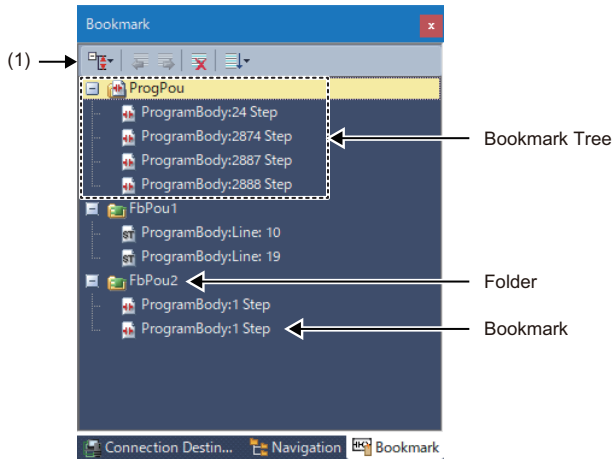

The bookmark function registers position information of a program in a project. Specific data in a program can be referenced to quickly by using a bookmark.

### Window

Select [View] ⇒ [Docking Window] ⇒ [Bookmark] (  ).



### Displayed items

Item	Description
(1) Toolbar	
 Expand/Collapse Tree	To expand or collapse a bookmark tree.
 Jump to Previous Bookmark (in Execution Order)	To jump to the bookmark that is previous to a selected one in the execution order.
 Jump to Next Bookmark (in Execution Order)	To jump to the bookmark that is next to a selected one in the execution order.
 Clear All	To clear all registered bookmarks.
 Sort	To sort bookmarks in each folder by name or execution order.

### Registering a bookmark

Position information of a program can be registered in a project. Up to 100 bookmarks can be registered.

### Operating procedure

Right-click on any of the following screens, and select [BookMark] from the shortcut menu.

- Ladder editor
- Inline structured text box in a ladder editor
- ST editor
- FBD/LD editor
- Inline structured text element in an FBD/LD editor
- Dataflow analysis window

### Point

- A bookmark can also be registered by selecting [Find/Replace] ⇒ [Bookmark].
- Position information of a Zoom (action/transition) in an SFC program can also be registered; however, excluding an action/transition displayed in MELSAP-L (instruction format).

## Precautions

A bookmark cannot be registered if any of the following conditions is satisfied:

- The position information of a target is already registered as a bookmark.
- 100 bookmarks are already registered.
- The mouse cursor in the "Dataflow Analysis" window is  (Panning Hand).
- A registration was attempted in any of the following locations:

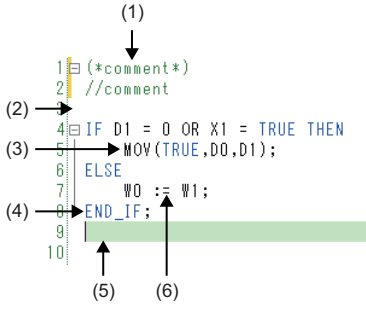
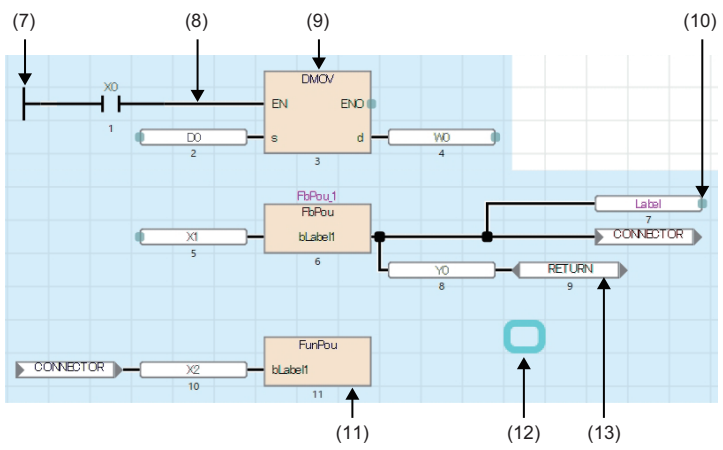
Screen	location where the operation was attempted	
ST editor	(1) Comment (2) Blank row (3) Instruction (4) Instruction template (example: END_IF) (5) Blank where no token exists (6) Expression	
FBD/LD editor	(7) Left power rail (8) Connection line (9) Element (10) Input/output connection point of the following elements: <ul style="list-style-type: none"> <li>• LD element</li> <li>• Variable element</li> <li>• Constant element</li> <li>• Jump element</li> <li>• Connector element</li> <li>• Return element</li> </ul> (11) FunPou (12) Location where no element exists (13) Return element	

## Jumping to a program

The cursor can jump to a program position that is registered as a bookmark.

### Operating procedure

Select a bookmark, then perform any of the following operations:

- Double-click the bookmark.
- Right-click the bookmark, and select [Jump] from the shortcut menu.
- Press the  key.

## Deleting a bookmark

A bookmark can be deleted from a project.

### Operating procedure

Select a bookmark or folder, then perform either of the following operations:

- Right-click the bookmark, and select [Delete] from the shortcut menu.
- Press the  key.

## Changing a bookmark name

A bookmark name can be changed from the default (program name + position information).

### Operating procedure

Select a bookmark, then perform either of the following operations:

- Right-click the bookmark, and select [Change the Bookmark Name] from the shortcut menu.
- Press the **F2** key.

### Considerations

#### ■Editing or converting a program after bookmark registration

If a program is edited or converted after bookmark registration, position information registered as a bookmark will not be matched with the program. To update the bookmark, delete and register the bookmark again.

#### ■Changing the module type and operation mode

If a new project is created due to the series change in changing the module type and operation mode of a project, bookmarks registered in the previous project will be deleted.

# 10 SEGMENTING PROGRAMS

By segmenting a process program which is used repeatedly in a program into an element, it can be used in a sequence program.

Efficient program development reduces a program error, thus program quality will be improved.

A segmented program file is referred to as 'POU' (☞ Page 100 Data configuration).

Besides, multiple POUs can be collected into a different file from a project. The file is referred to as 'library.'

## POU

There are two types of POUs which can repeatedly be used; function blocks and functions.

Remote head modules do not support them.

### ■Function block

'Function block' is a program component (POU) created by segmenting a program, which outputs an operation result in accordance with a value of the internal memory and an input value, into components.

It is classified into the following three types.

POU	Description	Reference
Function block	A function block which is created by a user. In projects for an RnPCPU (process mode/redundant mode) and an RnPSFCPU, a function block in which the process control processing of a manufacturer-defined tag FB is customized (user-defined tag FB) can be created.	Page 484 Creating a Function Block Page 497 Creating a user-defined tag FB
Standard function block	A function block which can be used in general. It is prepared in GX Works3 in advance.	Page 57 Element selection window
Process control function block	A function block for process control. It can be used in the following programs. It is prepared in GX Works3 in advance. In addition, process control function blocks can be used in the following program. <ul style="list-style-type: none"> <li>• FBD/LD program for process control</li> <li>• FB program of a function block placed in an FBD/LD program (FBD/LD program)</li> <li>• FB program of a user-defined tag FB placed in an FBD/LD program (FBD/LD program)</li> </ul>	Page 57 Element selection window
Module FB	A function block which is created by segmenting a dedicated processing for a module. It is prepared in GX Works3 in advance.	Page 500 Using a module FB

### ■Function

'Function' is a program component (POU) created by segmenting a program, which has no internal memory and outputs the same operation result to the same input value always.

It is classified into the following two types.

POU	Description	Reference
Function	A function which is created by a user	Page 504 Creating a Function
Standard function	A function which can be used in general. It is prepared in GX Works3 in advance.	Page 57 Element selection window

## Library

'Library' is an element collection of multiple POU's and structures. Elements in a library can be used in multiple projects.

### ■User library

'User library' is an element collection which is composed of created POU's and structures.

For details, refer to the following:

☞ Page 506 Enhancing Use of User Library

### ■Application library/MELSOFT Library (sample library)

'MELSOFT Library' (Sample Library) is an element collection provided by a manufacturer.

To obtain the application library/sample library (MELSOFT Library), please contact your local Mitsubishi Electric sales office or representative.

For details, refer to the following:

☞ Page 515 Enhanced Use of Application Library/MELSOFT Library

Remote head modules do not support this library.

# 10.1 Creating a Function Block

---

This section explains the method to create a sequence program using function blocks.

## Function block

---

For details on function blocks, refer to the following:

📖 MELSEC iQ-R Programming Manual (Program Design)

📖 MELSEC iQ-F FX5 Programming Manual (Program Design)

### Procedure to use

---

#### ■ Creating a new function block

1. Create new function block data. (👉 Page 485 Creating new data)
2. Register a local label to use in a program body of a function block. Up to 5120 local labels can be registered in a function block. (👉 Page 486 Setting labels)
3. Create a program body by using a label. (👉 Page 486 Creating a program)
4. Paste a function block into a sequence program.  
(Ladder program: 👉 Page 272 Inserting a function block, ST program: Page 313 Inserting a function block)

#### ■ Creating a function block from an existing ladder block

A function block can be created by selecting a ladder block in a program editor. (👉 Page 489 Creating a function block from an existing ladder block)

A created function block is automatically inserted in a sequence program.

This method is supported only in a ladder program.

# Creating a new function block

The following explains the method to create a new function block.





For the number of creatable function blocks, refer to the following:

 Page 128 Maximum number of units of data that can be created in one project (RCPU/LHCPU/FX5CPU)

However, the maximum number of data that can be created may not be reached depending on the configuration of FB files and FUN files.

## Creating new data

A function block data can be created in a project on the "New Data" screen.

Item		Description	
Detail Setting	Inherent Property	Use MC/MCR to Control EN <sup>*1</sup>	For "Yes," the MC/MCR instructions are used to control 'EN.' For "No," the CJ instruction is used to control 'EN.' Select "Yes" when the raising/falling instructions are used in an FB. The operations of a timer/counter and the OUT instruction used in an FB differ depending the selected item. For details, refer to the following:  MELSEC iQ-R Programming Manual (Program Design)  MELSEC iQ-F FX5 Programming Manual (Program Design)
		Use EN/ENO	For "Yes," a function block with EN/ENO is created, and EN/ENO labels can be used in a program without registering as local labels. For "No," a function block without EN/ENO is created. For details on EN/ENO, refer to the following:  MELSEC iQ-R Programming Manual (Program Design)  MELSEC iQ-F FX5 Programming Manual (Program Design)
FB File	FB File of Add Destination	Select a storage destination file of a function block to be created. A new storage destination file can be created by entering a file name directly.	
	FB Type	For "Macro Type," the program body of a function block is stored in an FB file that will be the storage destination of the call source program block or program body of the function block. For "Subroutine Type," the program body of a function block is stored in an FB file.	

\*1 For the conditions under which "Yes" can be selected, refer to the following:

 Page 485 Conditions to select "Yes" for "Use MC/MCR to Control EN"

### ■Conditions to select "Yes" for "Use MC/MCR to Control EN"

When all of the following conditions are applied, "Yes" can be selected for "Use MC/MCR to Control EN."

Condition	
1	"Yes" is selected for "Use EN/ENO."
2	Any of the following settings is set. • "Macro Type" is selected for "FB Type." • "Yes" is selected for the following option and "Subroutine Type" is selected for "FB Type." [Tool] ⇒ [Options] ⇒ "Convert" ⇒ "Basic Setting" ⇒ "Operational Setting" ⇒ "Function Block" ⇒ "Enable to Use MC/MCR to Control EN"
3	A CPU module and GX Works3 supporting this setting are used. For the versions supporting this setting, refer to the following:  MELSEC iQ-R CPU Module User's Manual (Application)

## Precautions

- If the function block in which the MC/MCR instruction is used is not executed, the outputs and the current values of timers in the function block will be reset. (If the instruction is not used, the current values are retained).
- When "Yes" is selected for "Use MC/MCR to Control EN," the system uses 'N0' (nesting) for MC/MCR instructions in an FB. Therefore, do not use 'N0' for the MC/MCR instructions in the same FB.

## Setting labels

Set a label to use in a program body on a label editor.

The operations in the editor are the same as that in other label editors. For details, refer to the following:

 Page 227 Registering Labels

### Operating procedure

Select "FB/FUN" ⇒ "(file name)" ⇒ "(FB)" ⇒ "Local Label" in the navigation window.

### Precautions

Do not assign the instance of a function block to an alias. ( Page 230 Alias)

## Creating a program

Create the program body of a function block by using labels.

Both local labels and global labels of a function block can be used.

The method for entering programs is the same as that of each program.

### Operating procedure

1. Select "FB/FUN" ⇒ "(file name)" ⇒ "(FB)" ⇒ "ProgramBody" in the navigation window.
2. Configure the programs.

## Changing the type of a function block

Change the type of a function block (macro type/subroutine type).

### Operating procedure

1. Select "FB/FUN" ⇒ "(file name)" in the navigation window.
2. Select [Project] ⇒ [Data Operation] ⇒ [Properties].
3. Set the type of the function block for "FB Type" in the "Properties" screen, and click the [OK] button.



## Setting reserved area capacities

Set the reserved area capacities of FB instances for each function block.

To apply the set reserved area capacities for programs, all the programs are required to be converted (reassigned).

For details on reserved area capacities, refer to the following:

📖 MELSEC iQ-R Programming Manual (Program Design)

📖 MELSEC iQ-F FX5 Programming Manual (Program Design)

### Operating procedure

1. Select "Yes" for the following option.  
[Tool] ⇒ [Options] ⇒ "Convert" ⇒ "Basic Setting" ⇒ "Operational Setting" ⇒ "Function Block" ⇒ "Enable to Set Reserved Area"
2. Select "FB/FUN" ⇒ "(file name)" ⇒ "(FB)" in the navigation window.
3. Select [Project] ⇒ [Data Operation] ⇒ [Properties].
4. Set a reserved area capacity for "Label Reserved Area," "Latch Label Reserved Area," or "Signal Flow Reserved Area," then click the [OK] button in the "Properties" screen.
5. Convert (reassign) all the programs.

### Precautions

- In a project for an FX5CPU, the reserved area capacities of function blocks cannot be changed.
- Only for subroutine type function blocks, the reserved area capacity for "Signal Flow Reserved Area" can be set.

## Converting function blocks

- Function blocks (POUs) will not be converted even if a conversion was attempted as long as FB instances have not been created, or FB instances have been created only in unregistered programs.
- When a function block is edited, all the programs in which the FB file and the function block are used will be in unconverted state.

### ■ When editing only the program body of a subroutine type function block

By setting the following option, only the edited FB program or FB file will be in the unconverted state.

- [Tool] ⇒ [Options] ⇒ "Convert" ⇒ "Basic Setting" ⇒ "Operational Setting" ⇒ "Convert, Online Program Change Target Setting"

When an unconverted function block is converted after changing the option from "High-Speed" to "Low-Speed," a POU including the function block is also converted.

### Precautions

If the option is set to "High-speed" and any one of the following instruction is used in a subroutine type function block, a conversion error may occur. A conversion is successfully completed by converting the program again or performing the online program change.

- Rising instruction
- Falling instruction
- SCJ instruction
- STMR instruction

## Considerations when creating FB programs

### ■Use of devices

Using labels is recommended for creating FB programs.

If an FB program which uses devices (X10, Y10, etc.) is used at multiple locations, the program may not operate normally. In addition, if an FB program which uses devices for the OUT instruction is used at multiple locations, duplicated coil is resulted. Duplicated coil can be avoided with the SET/RST instruction.

### ■When using master control instructions

When using a master control instruction in an FB program, use the MC instruction and the MCR instruction together.

### ■When using function blocks for a sequence program to be executed multiple times in a single scan

If a function block, which contains a rising instruction/falling instruction, or an instruction that requires multiple scans before the execution completion, is used in a sequence program to be executed multiple times in a single scan, the program may not operate normally.

Item	Description
Program type to be executed multiple times in a single scan	<ul style="list-style-type: none"><li>• Periodic execution type program</li><li>• Interrupt program</li><li>• Subroutine program</li><li>• FOR-NEXT instruction program</li></ul>
Unusable instructions for FBs which are used for above programs	Instructions which require multiple scans before the execution completion (JP.READ/JP.WRITE instruction, SORT instruction, SP.FREAD/SP.FWRITE instruction, etc.)
	Rising instruction (□P instruction (such as MOVP instruction), PLS, etc.)
	Falling instruction (PLF, LDF, ANDF, ORF, MEF, FCALLP, EFCALLP, etc.)

# Creating a function block from an existing ladder block

The following explains the method to create a function block by using a ladder block in a sequence program. This method is supported only in a ladder program.

For the number of creatable function blocks, refer to the following:

☞ Page 128 Maximum number of units of data that can be created in one project (RCPU/LHCPU/FX5CPU)

However, the maximum number of data that can be created may not be reached depending on the configuration of FB files and FUN files.

## Usage example

### ■To segment a ladder block into an element

By segmenting an existing ladder block that is used repeatedly in a program into an element, it can be used in a program.

■Before creating an FB

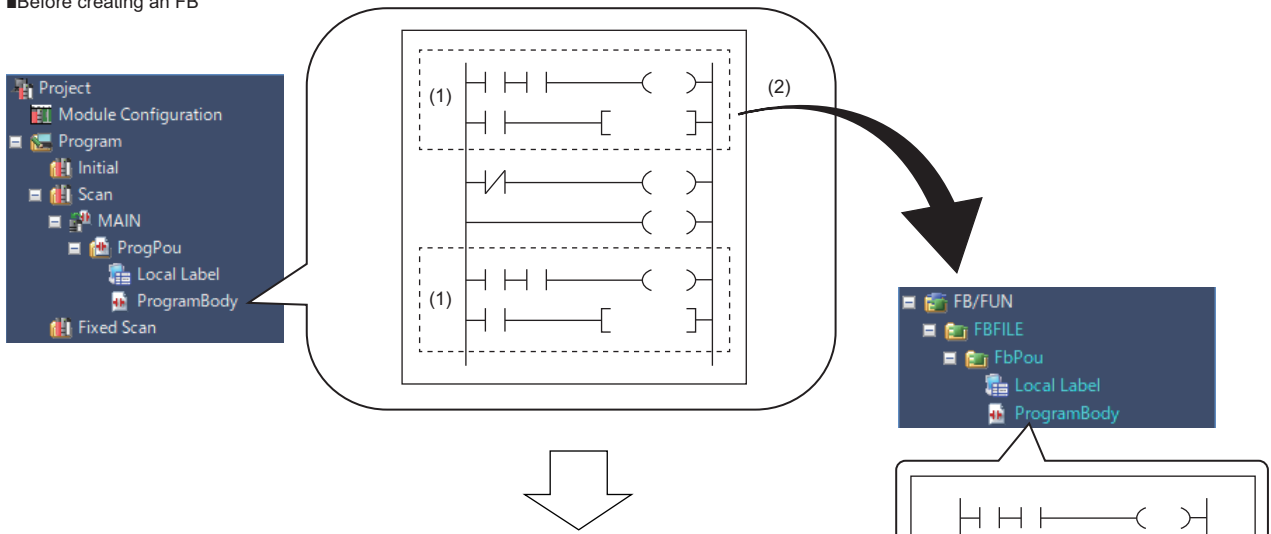

■After creating an FB

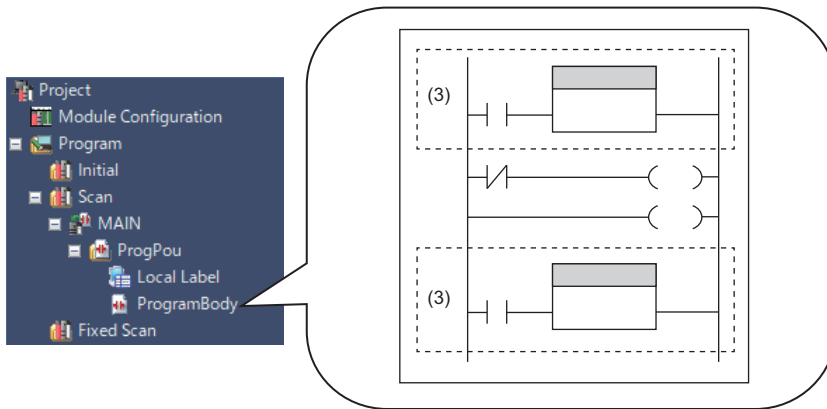

- (1) Ladder block used repeatedly in a program
- (2) Segment the ladder into an element (create a function block).
- (3) Utilize the created function block.

## ■ To turn processing into a function

A program can be shortened by turning long processing in a ladder program into a function.

### ■ Before creating an FB

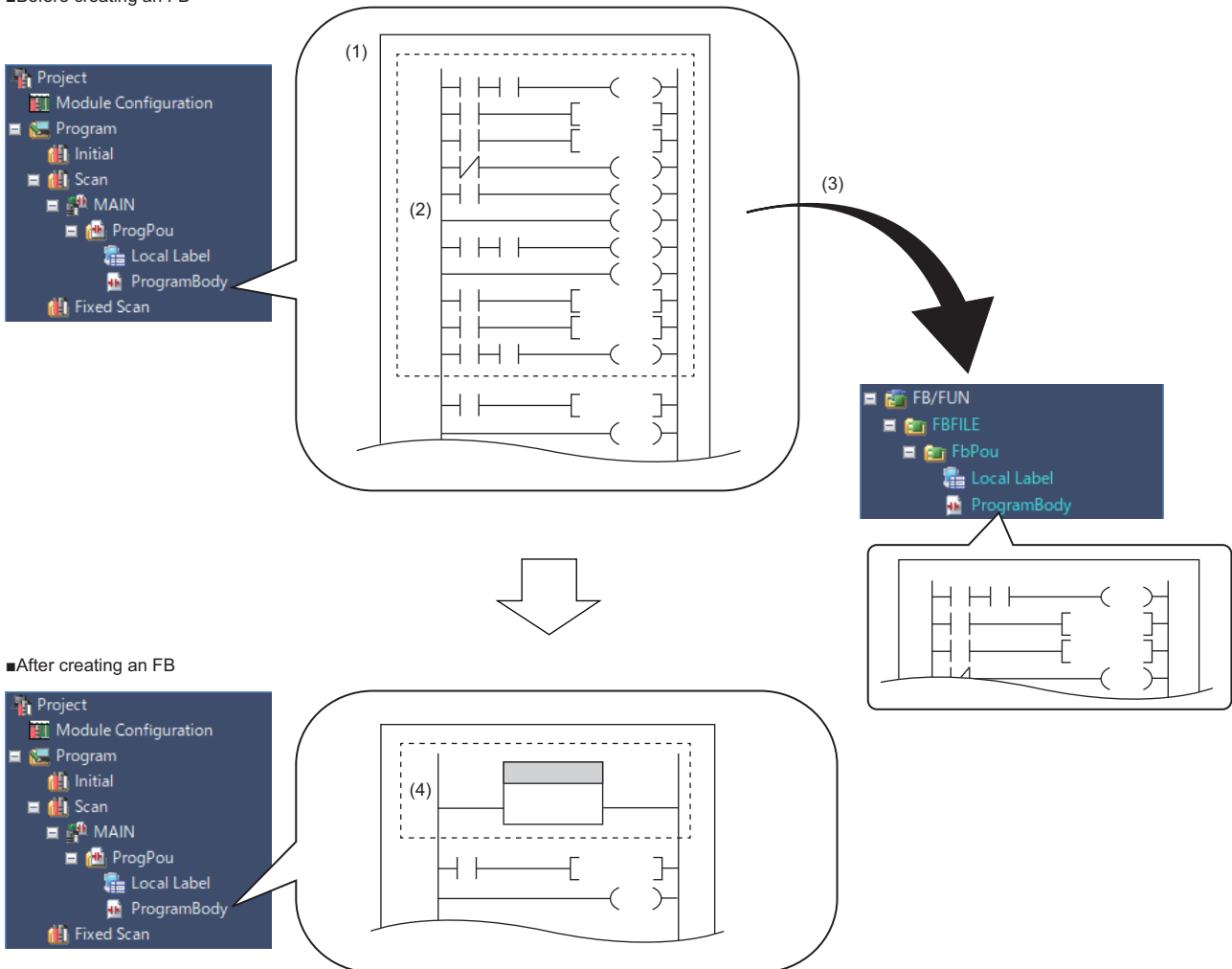

- (1) Long ladder program
- (2) Ladder block to be separated as one function
- (3) Turn the ladder block into a function (create a function block).
- (4) Utilize the created function block.

## Creation method

The following shows the procedure for creating a function block from an existing ladder block.

### Operating procedure

1. Select a ladder block to change it to a function block in a program editor.

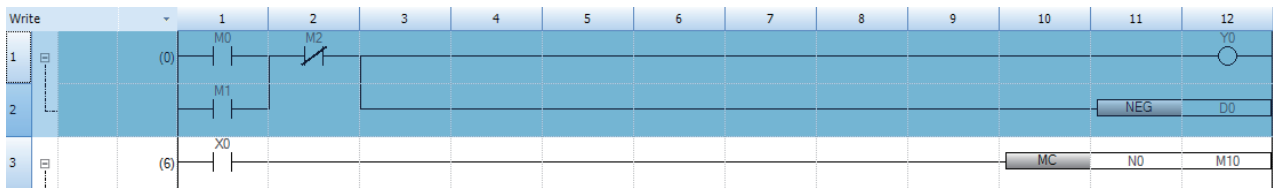

2. Select [Edit] ⇒ [Create FB].
3. Set each item in "Basic Setting" and "Detail Setting" of the "Create FB" screen, and click the [OK] button.

For details on the setting items, refer to the following:

☞ Page 485 Creating new data

The "Create FB" dialog box is shown with the following settings:

- Basic Setting**
  - Data Type: Function Block
  - (Data Name): FbPou
- Detail Setting**
  - Program Configuration**
    - Program Language: Ladder
  - Inherent Property**
    - Use MC/MCR to Control EN: No
    - Use EN/ENO: Yes
  - FB File**
    - FB File of Add Destination: <Same as data name>
    - FB Type: Subroutine Type

4. Set each item in "Set FB Instance" and "Local Label Definition Setting of FB," and click the [Execute] button.

For details on "Local Label Definition Setting of FB," refer to the following:

☞ Page 493 Local label definition setting for a function block

The "Create FB" dialog box is shown with the "Local Label Definition Setting of FB" tab selected. The settings are as follows:

- Set FB Instance: FB Instance Name: FbPou\_1
- Local Label Definition Setting of FB
  - Define all devices/labels as labels of FB:
  - Table:

Device/Label Name	Label Name	Data Type	Class
<input checked="" type="checkbox"/> M0	>> v_bM0	Bit	VAR
<input checked="" type="checkbox"/> M1	>> v_bM1	Bit	VAR
<input checked="" type="checkbox"/> M2	>> v_bM2	Bit	VAR
<input checked="" type="checkbox"/> Y0	>> v_bY0	Bit	VAR
<input checked="" type="checkbox"/> D0	>> v_wD0	Word [Signed VAR]	

A function block is created and inserted above the ladder block selected in step 1.

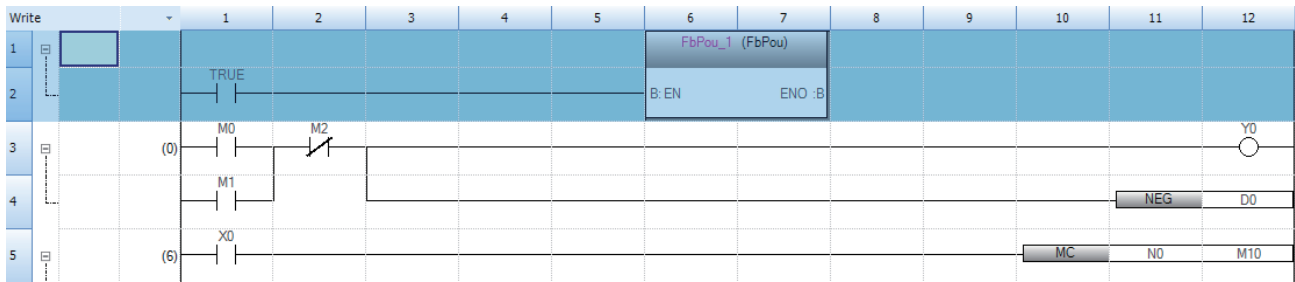

**5.** Convert the program.

If a conversion error occurs, take corrective actions described in the following:

Page 495 Troubleshooting

**6.** Delete the ladder block selected in step 1 from the program.

**Point**

When creating a function block from a ladder block for which a statement is set, operation will be as follows, regardless of whether the statement is selected:

- A created function block is inserted above the statement.
- The statement is added in the program of the created function block.

**Label automatic naming rule**

A label name is set according to the automatic naming rules.

For the automatic naming rules and prefixes to be added, refer to the following:

Page 232 Automatic naming rule

If the class is set to "VAR" in "Local Label Definition Setting of FB" in the "Create FB" screen, 'v\_' is added as a prefix.

In addition, symbols are converted into character strings.

Symbol	Character string
#	sh_
@	at_
\	-
[	-
]	"" (Null character)
,	-
.	-

### Local label definition setting for a function block

The following shows a setting example of "Local Label Definition Setting of FB" in the "Create FB" screen.

**Ex.**

Segmenting a ladder block into an element

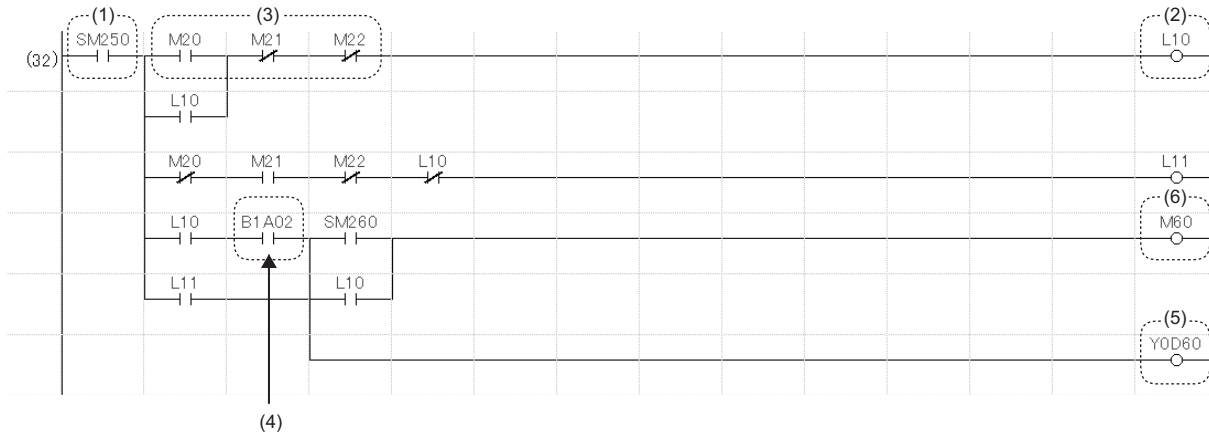

No.	Description	Setting item	Setting content
(1)	Device that is always ON	Device/Label Name	Unselect the checkbox. (Use the device as is.)
(2)	Device that is used only in a selected ladder block	Class	VAR
(3)	Device that is used before and/or after a selected ladder block		VAR_INPUT
(4)	Device that is used as a contact		
(5)	Device that is used only as a coil		VAR_OUTPUT
(6)	Device that is used as a coil and is also used before and/or after a selected ladder block		VAR_IN_OUT

**Ex.**

Turning processing into a function

Processing can be turned into a function as is by unselecting the checkbox of "Define all devices/labels as labels of FB." in "Local Label Definition Setting of FB" of the "Create FB" screen. (  Page 491 Creation method)

## Considerations when creating a function block

### ■ Conversion state of a program

If a program is in the unconverted state, the "Create FB" screen cannot be opened.

### ■ Device settings

The following devices cannot be set as input, output, or input/output arguments.

- Timer
- Retentive timer
- Long timer
- Long retentive timer
- Counter
- Long counter

Change the corresponding device to a global label to which the device is assigned before creating a function block.

Alternatively, unselect the checkbox of the device in "Local Label Definition Setting of FB" in the "Create FB" screen.

Local Label Definition Setting of FB

Define devices/labels extracted from a program to replace them as labels to use in a FB program.  
\*Information other than 'Data Type' of devices/labels is not inherited to labels of FB.  
\*If defining the extracted devices/labels as labels of FB is not required, please uncheck the checkbox for Device/Label Name.

Define all devices/labels as labels of FB.

Device/Label Name	Label Name	Data Type	Class
<input type="checkbox"/> T10	>> v_tdT10	Timer	VAR
<input checked="" type="checkbox"/> M1	>> v_bM1	Bit	VAR
<input checked="" type="checkbox"/> M13	>> v_bM13	Bit	VAR

Manual Back to Execute Cancel

### Point

By unselecting the checkbox of a device in "Local Label Definition Setting of FB" in the "Create FB" screen, the device/label can be used as is in the program of a function block.

### ■ Use of module labels

A conversion error may occur if a module label is set as an argument of a subroutine type function block.

Use a macro type function block.

### ■ Instructions with a string type argument

When creating a function block, a device that is specified as an argument in an instruction using the string data type is defined as a string type label with the data length of "32."

To change the data length, follow the procedure below:

### Operating procedure

1. Open a local label editor of a function block.
2. Change the data length in the "Data Type" column for an added label.



## Troubleshooting

A conversion error may occur if a certain device, instruction, function block, or function is used in a selected ladder block. The following table explains corrective actions for an conversion error for each device, instruction, function block, and function.

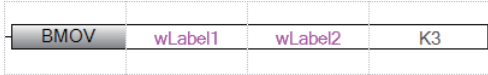
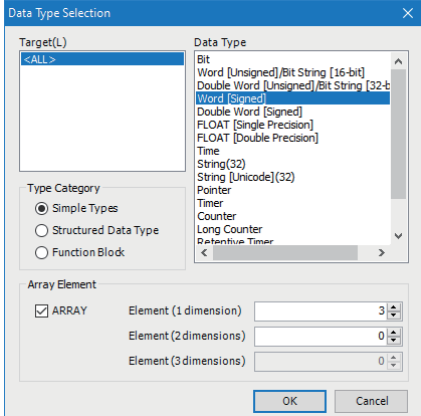
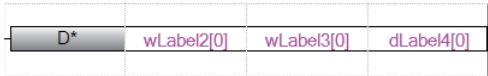
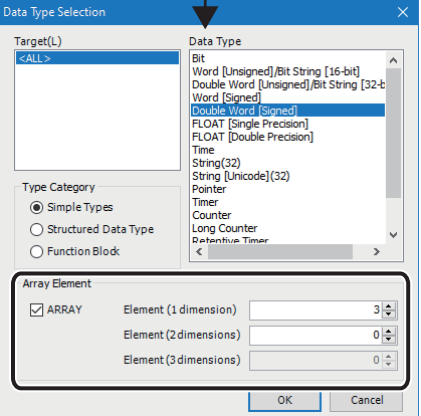
Device/instruction/function block/function	Corrective action																		
<p>Instruction that specifies the number of device/label points to access with its argument (Example: BMOV)</p>	<p>Set the data type by an array. The following figure shows a correction example. (Example) BMOV</p>  <ol style="list-style-type: none"> <li>Open the local label editor for a function block.</li> <li>Click [...] in the "Data Type" column that is blanked out, and set "Data Type" and "Array Element."</li> </ol> <table border="1" data-bbox="687 629 1390 757"> <thead> <tr> <th></th> <th>Label Name</th> <th>Data Type</th> </tr> </thead> <tbody> <tr> <td>1</td> <td>v_bM10</td> <td>Bit</td> </tr> <tr> <td>2</td> <td>v_wLabel1</td> <td></td> </tr> <tr> <td>3</td> <td>v_wLabel2</td> <td></td> </tr> <tr> <td>4</td> <td></td> <td></td> </tr> </tbody> </table> 		Label Name	Data Type	1	v_bM10	Bit	2	v_wLabel1		3	v_wLabel2		4					
	Label Name	Data Type																	
1	v_bM10	Bit																	
2	v_wLabel1																		
3	v_wLabel2																		
4																			
<p>Instruction with an argument for which only devices or array labels are available (Example: D*)</p>	<p>Set the data type by an array. The following figure shows a correction example. (Example) D*</p>  <ol style="list-style-type: none"> <li>Open the local label editor for a function block.</li> <li>Click [...] in the "Data Type" column for an array type label, and set "Array Element."</li> </ol> <table border="1" data-bbox="687 1451 1390 1599"> <thead> <tr> <th></th> <th>Label Name</th> <th>Data Type</th> </tr> </thead> <tbody> <tr> <td>1</td> <td>v_bM10</td> <td>Bit</td> </tr> <tr> <td>2</td> <td>v_wLabel2_0</td> <td>Word [Signed]</td> </tr> <tr> <td>3</td> <td>v_wLabel3_0</td> <td>Word [Signed]</td> </tr> <tr> <td>4</td> <td>v_dLabel4_0</td> <td>Double Word [Signed]</td> </tr> <tr> <td>5</td> <td></td> <td></td> </tr> </tbody> </table> 		Label Name	Data Type	1	v_bM10	Bit	2	v_wLabel2_0	Word [Signed]	3	v_wLabel3_0	Word [Signed]	4	v_dLabel4_0	Double Word [Signed]	5		
	Label Name	Data Type																	
1	v_bM10	Bit																	
2	v_wLabel2_0	Word [Signed]																	
3	v_wLabel3_0	Word [Signed]																	
4	v_dLabel4_0	Double Word [Signed]																	
5																			

Device/instruction/function block/function	Corrective action																				
Function block/function with an generic data type argument (Example: ADD)	Set the correct data type. Open the local label editor for a function block, and correct the setting in the "Data Type" column. <table border="1" data-bbox="687 275 1249 371"> <thead> <tr> <th></th> <th>Label Name</th> <th>Data Type</th> <th></th> </tr> </thead> <tbody> <tr> <td>1</td> <td>v_wD0</td> <td>Double Word [Unsigned]/Bit String [32-bit]</td> <td>...</td> </tr> <tr> <td>2</td> <td>v_udLabel2</td> <td>Double Word [Unsigned]/Bit String [32-bit]</td> <td>...</td> </tr> <tr> <td>3</td> <td>v_wD2</td> <td>Double Word [Unsigned]/Bit String [32-bit]</td> <td>...</td> </tr> <tr> <td>4</td> <td></td> <td></td> <td>...</td> </tr> </tbody> </table>		Label Name	Data Type		1	v_wD0	Double Word [Unsigned]/Bit String [32-bit]	...	2	v_udLabel2	Double Word [Unsigned]/Bit String [32-bit]	...	3	v_wD2	Double Word [Unsigned]/Bit String [32-bit]	...	4			...
	Label Name	Data Type																			
1	v_wD0	Double Word [Unsigned]/Bit String [32-bit]	...																		
2	v_udLabel2	Double Word [Unsigned]/Bit String [32-bit]	...																		
3	v_wD2	Double Word [Unsigned]/Bit String [32-bit]	...																		
4			...																		
Instruction with an argument for which only devices are available (Example: EGP)	Take either of the following corrective actions: <ul style="list-style-type: none"> <li>• Unselect the checkbox of the corresponding device in "Local Label Definition Setting of FB" in the "Create FB" screen when creating a function block.</li> </ul>																				
Any of the following devices: <ul style="list-style-type: none"> <li>• Timer</li> <li>• Retentive timer</li> <li>• Long timer</li> <li>• Long retentive timer</li> <li>• Counter</li> <li>• Long counter</li> </ul>	<div data-bbox="687 495 1283 936"> <p>Local Label Definition Setting of FB</p> <p>Define devices/labels extracted from a program to replace them as labels to use in a FB program.  <small>* Information other than 'Data Type' of devices/labels is not inherited to labels of FB.            * If defining the extracted devices/labels as labels of FB is not required, please uncheck the checkbox for Device/Label Name.</small></p> <p><input type="checkbox"/> Define all devices/labels as labels of FB.</p> <table border="1"> <thead> <tr> <th>Device/Label Name</th> <th>Label Name</th> <th>Data Type</th> <th>Class</th> </tr> </thead> <tbody> <tr> <td><input type="checkbox"/> T10</td> <td>&gt;&gt; v_tdT10</td> <td>Timer</td> <td>VAR</td> </tr> <tr> <td><input checked="" type="checkbox"/> M1</td> <td>&gt;&gt; v_bM1</td> <td>Bit</td> <td>VAR</td> </tr> <tr> <td><input checked="" type="checkbox"/> M13</td> <td>&gt;&gt; v_bM13</td> <td>Bit</td> <td>VAR</td> </tr> </tbody> </table> <p>Manual      Back to      Execute      Cancel</p> </div> <ul style="list-style-type: none"> <li>• Change the corresponding device to a global label to which the device is assigned.</li> </ul>	Device/Label Name	Label Name	Data Type	Class	<input type="checkbox"/> T10	>> v_tdT10	Timer	VAR	<input checked="" type="checkbox"/> M1	>> v_bM1	Bit	VAR	<input checked="" type="checkbox"/> M13	>> v_bM13	Bit	VAR				
Device/Label Name	Label Name	Data Type	Class																		
<input type="checkbox"/> T10	>> v_tdT10	Timer	VAR																		
<input checked="" type="checkbox"/> M1	>> v_bM1	Bit	VAR																		
<input checked="" type="checkbox"/> M13	>> v_bM13	Bit	VAR																		

## ■Returning a program to the state before a function block was created

If an conversion error occurs, a program can be returned to the state before a function block was created by the following procedure.

### Operating procedure

1. Delete a function block inserted in a program.
2. Delete the added labels of the function block in the local label editor of the program.
3. Select "FB/FUN" in the navigation window and delete the added FB file.

## Creating a user-defined tag FB

The control processing of a manufacturer-defined tag FB can be customized by creating a user-defined tag FB.

In the FB program of a user-defined tag FB, the tag data can be referenced by using a tag access FB of a process control function block and a structure label for tag data reference.

A user-defined tag FB can be used only in an FBD/LD program for process control in projects for an RnPCPU (process mode/redundant mode) and an RnPSFCPU.

### Procedure to use

1. Create new function block data. (☞ Page 497 Creating data)
2. Create a program body of a user-defined tag FB. (☞ Page 497 Creating a program)
3. Register a tag FB for which a user-defined tag FB has been specified on the tag FB setting editor. (☞ Page 249 Registering Tag FBs)
4. Create an FBD/LD program for process control by using a tag FB instance of a registered user-defined tag FB.
5. Set the initial value of an FB property. (☞ Page 375 Display/setting an FB property)
6. Write the program to the programmable controller. (☞ Page 580 Writing data to a programmable controller)
7. Monitor and debug the program by displaying a faceplate. (☞ Page 662 Checking Tag Data)
8. Apply the initial value of the FB property. (☞ Page 666 FB Property Management (Online) screen)

### Precautions

If the definition of a user-defined tag FB is deleted in the navigation window, a project may become incorrect.

Before deleting a user-defined tag FB, search a project for the FB definition name by using the character string search function and check that it is not used.

### Creating data

A function block data can be created in a project on the "New Data" screen.

Item		Description	
Detail Setting	Program Configuration	Program Language	Select a programming language to be used in a function block. When creating a user-defined tag FB, select "FBD/LD."
		Use as Tag FB	Select whether to use a function block as a tag FB. When creating a user-defined tag FB, select "Yes."
		Tag Type	Select a tag type.
FB File	FB File of Add Destination	FB File of Add Destination	Select a storage destination file of a function block to be created. A new storage destination file can be created by entering a file name directly.
		FB Type	When creating a user-defined tag FB, "Subroutine Type" is selected automatically.

### Creating a program

Create a program body of a user-defined tag FB by combining a function and a function block.

The method for entering programs is the same as that of an FBD/LD program.

### Precautions

- Do not use the EI instruction in a user-defined tag FB or a function and function block which is called from a user-defined tag FB
- User-defined tag FBs cannot be copied to other project.

## ■Tag access FB

Tag access FBs can be used in a user-defined tag FB.

However, if a tag access FB to use does not support the tag type of a user-defined tag FB type, the tag access FB cannot be used.

For details on the tag types and their corresponding tag access FBs, refer to 'Correspondence table of tag types and tag access FBs' in the following manual:

📖MELSEC iQ-R Programming Manual (Process Control Function Blocks/Instructions)

## ■Structure label for tag data reference

When using a tag data value (such as the SV value, PV value, MV value) in a program of a user-defined tag FB, use a structure label for tag data reference.

Structure labels for tag data reference can only be used in the FB program of a user-defined tag FB.

For details on the structure labels for tag data reference that can be used in each tag type, refer to 'Tag type list' in the following manual:

📖MELSEC iQ-R Programming Manual (Process Control Function Blocks/Instructions)

## Precautions

When the global label setting "M+PTAG" or tag data structure in a project is deleted, a structure label for tag data reference is also deleted. Add a structure label for tag data reference in the FB program of a user-defined tag FB.

- [Edit] ⇒ [Process Control Extension] ⇒ [Add Structured Data Type Label for Tag Data Reference]

## ■Usage example of tag data

To use the member of tag data of a user-defined tag FB in an FBD/LD program for process control, create a variable element with a name '(label name of the tag data).(member name of the tag data).'

**Ex.**

When using the MV value of user-defined tag FB 'TIC021\_FB,' create a variable element with the name 'TIC021.MV.'

- Label name of tag data: TIC021
- Member name of tag data: MV

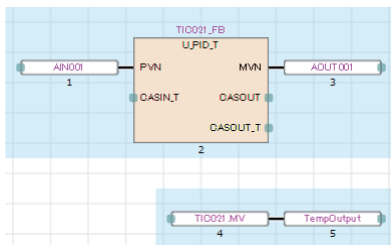

## ■Usage example of a structure label for tag data reference

To use the member of tag data of a user-defined tag FB in the FB program of a user-defined tag FB, create a variable element with a name '(name of a structure label for tag data reference. member name of the tag data).'

**Ex.**

When using the MV value of a user-defined tag FB (tag type: PID), create a variable element with the name '\_PID.MV.'

- Structure label for tag data reference: \_PID (tag type: PID)
- Member name of tag data: MV

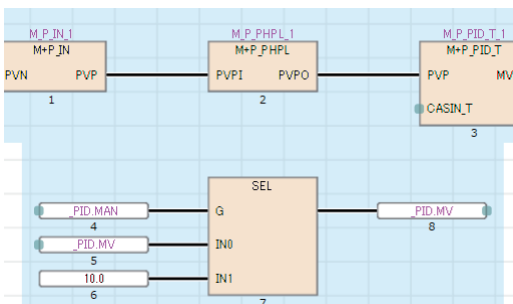

## Method for having an operation constant to a user-defined tag FB

The following shows the procedure for directly setting an initial value such as that of an operation constant of a tag access FB used in an user-defined tag FB from the user-defined tag FB in a program.

For details on operation constants, refer to the following:

MELSEC iQ-R Programming Manual (Process Control Function Blocks/Instructions)

### Operating procedure

1. Register a label of 'VAR\_PUBLIC' class or 'VAR\_PUBLIC\_RETAIN' class to a local label of a user-defined tag FB.
2. Substitute the registered label (step 1) for an operation constant.

To substitute a label for an operation constant of a tag access FB, use a variable element.

Example)

When substituting a label for the operation constant 'MTD' with the tag access FB (label name: M\_P\_2PID\_1), define a variable element with the label name 'M\_P\_2PID\_1.MTD.' Connect the label registered in step 1 and the variable label with the name "M\_P\_2PID\_1.MTD."

3. Register a user-defined tag FB on the tag FB setting editor.
4. Place the user-defined tag FB (step 3) on an FBD/LD program.
5. Select the placed user-defined tag FB.

The registered label (in step 1) is displayed in the "FB Property" window.

For details on the "FB Property" window, refer to the following:

Page 375 Display/setting an FB property

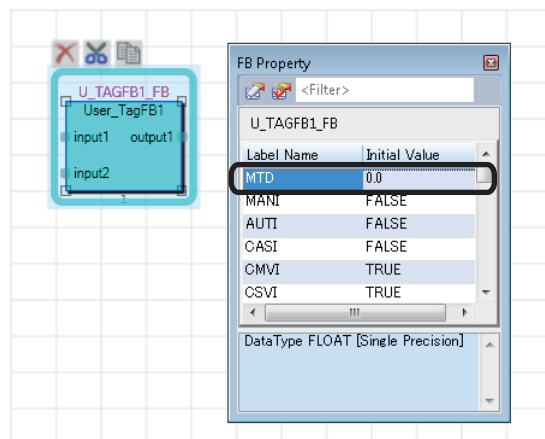
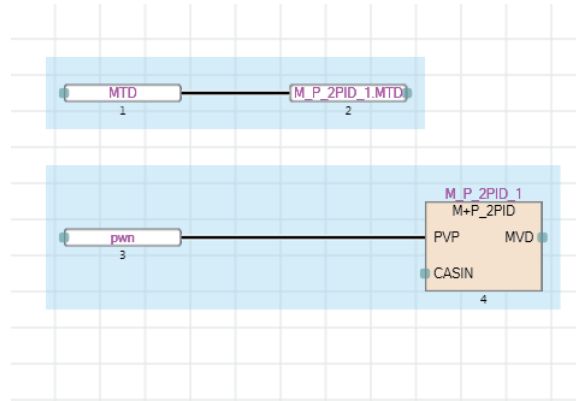

## Using a module FB

---

In GX Works3, 'Module FB,' which is composed of the segmented processing for each module (function block), is provided. By using the module FBs, the operation settings can easily be performed without programming the processing of each module.

Note that the module FBs cannot be used in safety programs.

### Importing module FBs in a project

---

Module FBs are displayed in the [Module] tab in the element selection window when one of the following operations is performed.

- Place a module on the module configuration diagram and fix parameters.
- Add a new module in the navigation window.

#### Point

The manual of module FBs can be opened from the element selection window. Select and right-click a module FB, then select [Help] from the shortcut menu.

---

### Using a module FB in a program

---

#### Operating procedure

1. Drag a module FB in the [Module] tab in the element selection window and drop it onto a program.
2. Select the local label or global label from the pull-down list in the "FB Instance Name" screen, and enter an FB instance name.

The FB instance is inserted into the program.

In addition, the definition of the module FB is added to "M\_FBLIB" in the navigation window.

#### Precautions

- When using a module FB, registering a module label in advance (at creation of new project) is recommended. Otherwise, it may take time when using the module FB.
- Do not assign the instance of a module FB to an alias. ( Page 230 Alias)

- An error occurs when converting a program, such as (1) in the following figure, which is created by using a transfer instruction or assignment statement in order to pass the value of a module label to the member of an FB instance of a module FB. Modify the program so that the module label is connected to the input variable of the FB instance of the module FB such as (2).

**Ex.**

The following shows a program example. The elements used in the program are as follows:

- Module label: RCPU
- Module FB: M\_RCPU\_ConnectionOpen\_00C\_1
- FB instance: M\_RCPU\_ConnectionOpen\_00C\_1
- Member (input variable): i\_stModule

Ladder program

**Program in which a conversion error occurs**

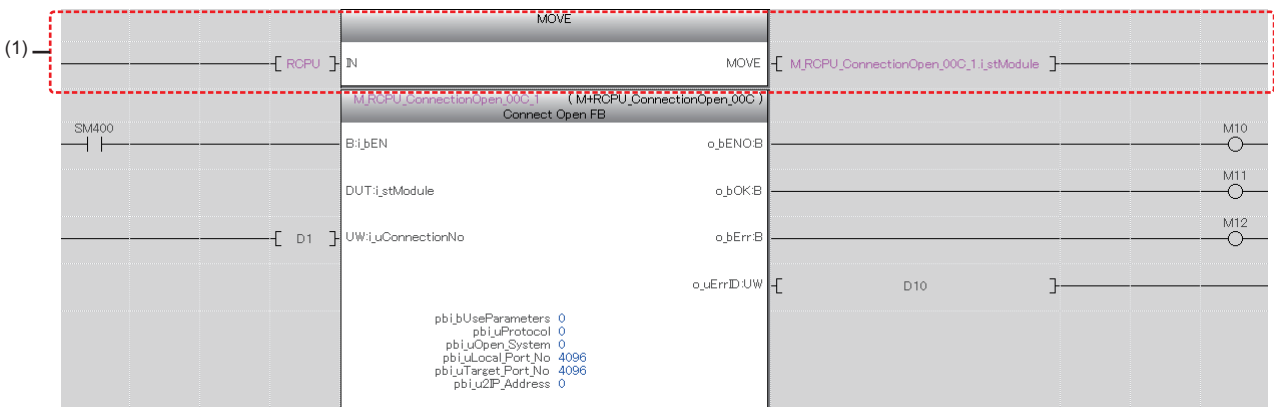

**Modification example**

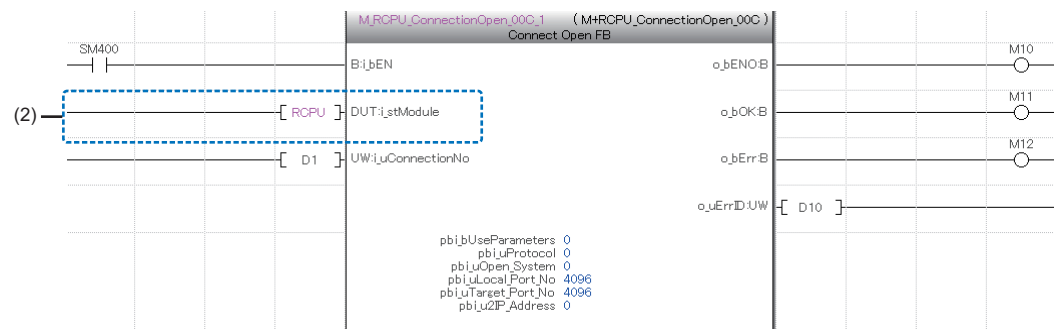

ST program

Program in which a conversion error occurs	Modification example
<p>(1) — <code>M_RCPU_ConnectionOpen_00C_1.i_stModule := RCPU;</code></p> <pre> M_RCPU_ConnectionOpen_00C_1(   i_bEN:= SM400 ,   i_uConnectionNo:= D1 ,   o_bENO=&gt; M10 ,   o_bOK=&gt; M11 ,   o_bErr=&gt; M12 ,   o_uErrID=&gt; D10 );                     </pre>	<p>(2) — <code>M_RCPU_ConnectionOpen_00C_1(i_bEN:= SM400, i_stModule:= RCPU, i_uConnectionNo:= D1, o_bENO=&gt; M10, o_bOK=&gt; M11, o_bErr=&gt; M12, o_uErrID=&gt; D10);</code></p>

## ■Using a library associated with a module

Depending on a module (simple motion module), a library that is associated with a module can be used.

The following shows the procedure to use the library.

### Operating procedure

1. In the [Module] tab in the element selection window, double-click "(module name)" under the tree of "Module FB."
2. Read the message, and click the [Yes] button.\*1  
A message with "Environment Setup Procedure" described in is displayed.
3. Obtain a library by following the message.
4. Register the library to the library list. (☞ Page 511 Registering user libraries in the library list)  
A shortcut to the library is added as a child item of "(module name)" in the tree expanded (double-clicked) in step 1.
5. Double-click the shortcut to the library.
6. Utilize an element from the library to a project. (☞ Page 512 Utilizing an element)

\*1 The message may not appear depending on the module.

### Precautions

#### ■When a library has already been registered

When a library associated with a module has already been registered in the library list, step 3 and 4 in the procedure above are not required.

According to the operations after step 1, data to be displayed as a child item of "(module name)" is determined.

The following shows each operation and data to be displayed.

Operation	Data to be displayed
Check the displayed message, and click the [Yes] button.	A shortcut to the library only
Check the displayed message, and click the [No] button.	A shortcut to the library and a module FB
No operation (No message is displayed.)	A module FB only

#### ■Redisplay of a shortcut to a library

A shortcut to the library disappears once the project is closed.

When opening the project next time, select a module in which a library associated with the module is used.

By clicking the [Yes] button after reading the message\*1, a shortcut to the library is displayed again.

\*1 The message may not appear depending on the module.

#### ■Redisplay of a module FB

To redisplay module FBs that are not displayed in the tree, perform any one of the following operations.

No.	Operation
1	Delete the library that is associated with a module from the library list. (☞ Page 511 Deleting libraries/updating display information)
2	<ol style="list-style-type: none"><li>① Open the project again.</li><li>② In the [Module] tab of the element selection window, double-click "(module name)" under "Module FB" in the tree.</li><li>③ Click the [No] button in the confirmation message appeared.</li></ol>



## Setting the operation parameters for a module FB

### Operating procedure

**1.** Open the label editor where the FB instance of a module FB is registered (local label or global label in a program where the module FB is used).

**2.** Select the FB instance and enter the initial value of a label within the extension display area.

However, the initial value of a label whose operation parameter is array cannot be set in a label editor. Set an initial value in a program.

When the operation parameter of a module FB which is set using the initial label value is changed in a program, the module FB operates with the changed value. Before changing the label values of a module FB, check the affect of the change using the cross reference function.

### Editing a module FB

A local label and a program body of a module FB cannot be edited.

However, a module FB can be copied in the navigation window and the copied one can be edited.

'+' of the copied module FB names will be replaced with '\_'.

### Adding the definition of a module FB

The definition of a module FB can be added to the navigation window by dragging and dropping the module FB from the [Module] tab in the element selection window onto "FB/FUN" in the navigation window.

# 10.2 Creating a Function

This section explains the method to create a sequence program using functions.

## Functions

For details of the functions, refer to the following:

📖 MELSEC iQ-R Programming Manual (Program Design)

📖 MELSEC iQ-F FX5 Programming Manual (Program Design)

### Procedure to use

1. Create new function data. (👉 Page 504 Creating data)
2. Register a local label to be used in a FUN program. Maximum 5120 local labels can be registered in a function. (👉 Page 504 Setting labels)
3. Create a FUN program using labels. (👉 Page 505 Creating a program)
4. Paste the function into a sequence program.  
(Ladder program: 👉 Page 279 Inserting a function, ST program: Page 314 Inserting a function)

## Creating a function

The following explains the method to create a function.

For the number of creatable functions, refer to the following:

👉 Page 128 Maximum number of units of data that can be created in one project (RCPU/LHCPU/FX5CPU)

However, the maximum number of data that can be created may not be reached depending on the configuration of FB files and FUN files.

### Creating data

A function block data can be created in a project on the "New Data" screen.

Item			Description
Detail Setting	Use EN/ENO	Yes	Become a function with EN/ENO. EN/ENO labels can be used in a program without registering as local labels. For details on EN/ENO, refer to the following: 📖 MELSEC iQ-R Programming Manual (Program Design) 📖 MELSEC iQ-F FX5 Programming Manual (Program Design)
		No	Become a function without EN/ENO.
	FUN File of Add Destination		Select the storage destination file of a function to be created. A new storage destination file can be created by entering a file name directly.

### Setting labels

Set a label to use in a program body on a label editor.

The operations in the editor are the same as that in other label editors. For details, refer to the following:

👉 Page 227 Registering Labels

### Operating procedure

Select "FB/FUN" ⇒ "(file name)" ⇒ "(Function)" ⇒ "Local Label" in the navigation window.

## Creating a program

Create a program body of a function by using a label.

The labels set to the local label of the function can be used.

The method for entering programs is the same as that of each program.

### Operating procedure

1. Select "FB/FUN" ⇒ "(file name)" ⇒ "(function)" ⇒ "ProgramBody" in the navigation window.
2. Configure the programs.

## Converting functions

- Functions (POUs) will not be in the converted state even if the conversion was attempted as long as functions are not used in the program, or functions are used only in unregistered programs.
- When a function is edited, all the programs in which the FUN file and the function are used will be in unconverted state.

### ■When editing only the program body of a function

By setting the following option, only an edited FUN program or FUN file will be in unconverted state.

- [Tool] ⇒ [Options] ⇒ "Convert" ⇒ "Basic Setting" ⇒ "Operational Setting" ⇒ "Convert, Online Program Change Target Setting"

When an unconverted function is converted after changing the option from "High-speed" to "Low-speed," a POU including the function is also converted.

## 10.3 Enhancing Use of User Library

This section explains the method to store a created element in a library file and utilize it to a sequence program. In this section, the user library is explained as a library.

### User library

The user library collects the elements which are used generally in multiple projects to make them easy to utilize. It can be used by importing elements of a library into each project.

The following data can be registered in the user library.

- POU (program block, function block, function)
- Global labels, structures
- Module labels, module FBs
- Each program device comments, common device comments

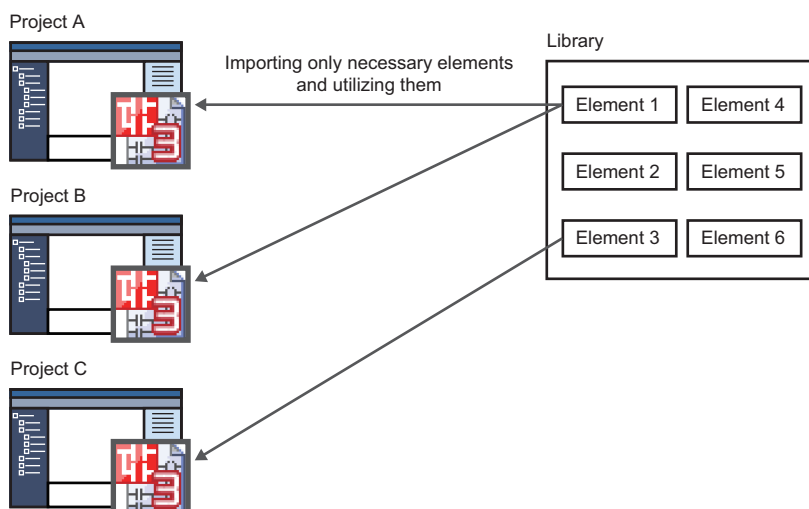

### Procedure to use

1. Create a library file. (☞ Page 507 Creating a library)
2. Register a library in GX Works3. (☞ Page 511 Registering user libraries in the library list)
3. Utilize elements from a library to projects. (☞ Page 512 Utilizing an element)

### Precautions

When using the library file which is on a network drive or a removable media, save the file in the hard disk of a personal computer before using.

# Creating a library

The following explains the operations such as the creation and editing methods of a library.

## Preparing a source project for library

To create a library, a source project is required.

Prepare an existing project or a project that collects the elements to be registered in a library.

### Precautions

After registering a library, the registered elements are displayed in the [Library] tab in the element selection window. However, the information of global labels (such as label name, and data type) is not displayed.

When creating a library that includes multiple global labels, set comments to distinguish them on the "Properties" screen of global labels.

## Creating a library file

A library file can be created by exporting a project as a library file (\*.usl).

The library file is a file that stores the data related with elements in a project.

To prevent libraries and elements from falsification, set a password when exporting them.

### Operating procedure

1. After creating elements in a project, select [Project] ⇒ [Library Operation] ⇒ [Export Library].
2. Click the [OK] button in the confirmation screen appeared.

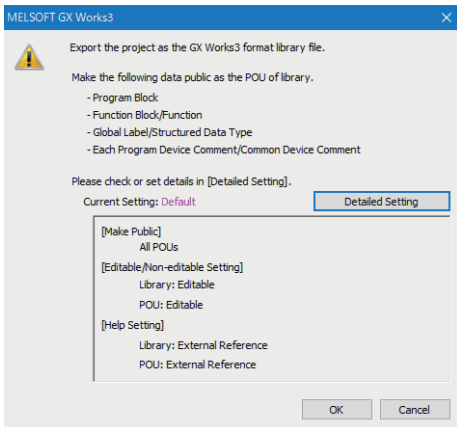

By clicking the [Detailed Setting] button on the screen above, the following can be set on the "Library Export Detailed Settings" screen.

Item	Description
Make Public	Set whether to release or close the data to users who use the library.
Editable/Non-editable Setting	Set whether to set a password to edit to the exported library. When setting a password, the applicability of editing (editable/read-only/read-protected) can be set for each element. Additionally, an individual password can be set to a read-protected POU. By selecting the checkbox of "Disable Password Authentication," editing of a read-protected POU can be disabled. (☞ Page 508 POU's whose password authentication is disabled)
Help Setting	Set whether to import the help file to the library or refer it externally.

## Precautions

- When "Compression" is selected for "File Size" in the "Properties" screen, the project cannot be exported as a library file. Select "Standard" for the setting in advance.  
(☞ Page 137 Compressing a project file)
- When "2" is selected for "Security Version" in the "Properties" screen, the project cannot be exported as a library file. Select "1" for the setting in advance.  
(☞ Page 697 Preventing Illegal Access to/Falsification of Data (Security Version))
- For read-only or read-protected elements utilized from other libraries, the reading applicability of the elements cannot be changed when exporting them.
- For the characters that cannot be used for a library name, refer to the following:  
(☞ Page 885 Unusable character strings for a name of a project/work space/library)

### ■POUs whose password authentication is disabled

When disabling password authentication for a read-protected POU, note the following on a library file in which a read-protected POU has been registered, and on a project in which the library file was created.

- Do not delete them; otherwise, the POU cannot be opened.
- It may not be determined if they are the latest ones.

To prevent this, before creating a library file, setting version information to the library file or a project in which the library file is to be created is recommended.

The operating procedure for setting version information is shown below.

Item	Operating procedure
Project	1. Select "Project" in the navigation window. 2. Right-click it and select [Properties] from the shortcut menu. 3. Enter a text for "Version" in the "Properties" screen. 4. Click the [OK] button. 5. Save the project.
Library file	1. Enter a text for "Version" in the "Export Library" screen which appears when creating a library file. (☞ Page 507 Creating a library file) 2. Click the [Save] button.

## Creating a GX Works3 format library from a GX Works2 format library

Remote head modules do not support this function.

### Operating procedure

1. Select [Project] ⇒ [Open Other Format File] ⇒ [GX Works2 Format] ⇒ [Open User Library], and specify the library to be converted into a GX Works3 project.
2. Select the series in the confirmation screen displayed, then click the [OK] button.
3. Check the contents of the project after changing the module type, and edit the project as necessary.
4. Export the project as a library file.

## Creating a GX Works3 format library from a GX IEC Developer format library

This function is supported for the SUL format files which are created with GX IEC Developer version 7.04.

### Operating procedure

#### ■A GX Works3 project is open

1. Select [Project] ⇒ [Open Other Format File] ⇒ [GX IEC Developer Format] ⇒ [Open SUL Format User Library], and specify a library to convert to GX Works3 project.
2. Read the displayed message, and click the [OK] button.
3. Check the contents of the project after changing the module type, and edit the project as necessary.
4. Export the project as a library file.

#### ■A GX Works3 project is not open

1. Select [Project] ⇒ [Open Other Format File] ⇒ [GX IEC Developer Format] ⇒ [Open SUL Format User Library], and specify a library to convert to GX Works3 project.
2. Read the displayed message, and click the [OK] button.

The "New" screen appears.

3. Set each items in the "New" screen, and click the [OK] button.
4. Check the contents of the project after changing the module type, and edit the project as necessary.
5. Export the project as a library file.

#### ■Import of some library POU

1. Create a GX Works3 format library from a GX IEC Developer format library. (☞ Page 509 Creating a GX Works3 format library from a GX IEC Developer format library)
2. Open a GX IEC Developer format project in a GX Works3 project by changing the module type. (☞ Page 115 Opening a GX IEC Developer format project)
3. Register the user library exported in step 1 in the library list. (☞ Page 511 Registering user libraries in the library list)
4. Copy the library POU to the GX Works3 project.
5. Repeat step 1 to step 4 for each GX IEC Developer format library.

### Precautions

When a password is set for the user library, entering password is required when importing library elements.

However, when the following option is set in GX IEC Developer, entering a password is not necessary.

- [Edit] ⇒ [User Library] ⇒ [Change Password] ⇒ "Change Password (user library name)" ⇒ "Allow read access for closed library"

## Editing libraries

Elements in a library file can be edited, added and deleted same as projects.

The password authentication is required when editing the library protected by password. Besides, the user registration is required for the library file exported from a safety project. (☞ Page 685 User management)

For details on the number of creatable pieces of data, refer to the following:

☞ Page 128 Maximum number of units of data that can be created in one project (RCPU/LHCPU/FX5CPU)

### Operating procedure

1. Select [Project] ⇒ [Open Other Format File] ⇒ [GX Works3 Format] ⇒ [Open User Library].
2. Edit POUs.

The editing method is the same manner as elements of the project.

## Enhanced use of libraries

An element in a library can be utilized by registering the library in the library list.

The reference to the library file is registered in the library list.

The information of library file is saved not in a project unit but in a logon user unit on personal computer.

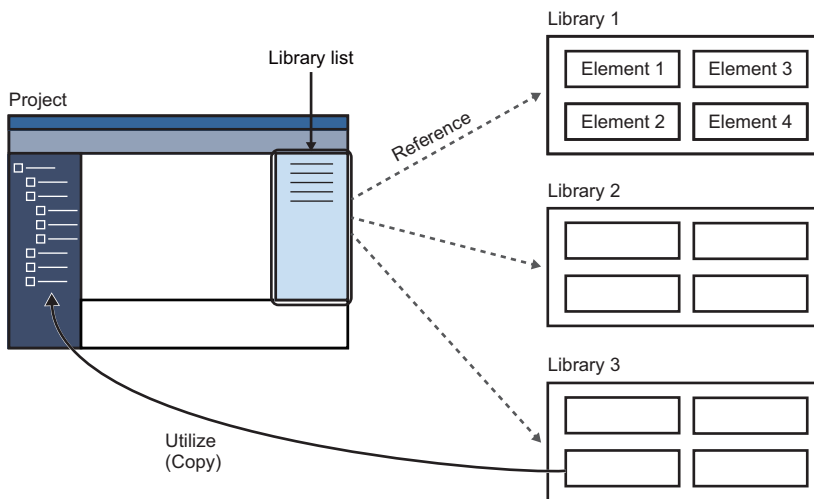

For the considerations for utilizing the library file created in the different version of GX Works3, refer to the following:

☞ Page 868 Using a Project in a Different Version



## Registering user libraries in the library list

Register a library containing elements to be utilized in the list.

Up to 64 libraries can be registered.

When the registered library file was edited while GX Works3 is running, updating the display information of library is necessary.

### Operating procedure

#### ■Registering libraries to be referenced

1. Select [Project] ⇒ [Library Operation] ⇒ [Register to Library List] ⇒ [User Library].
2. Select a file in the "Register Library to Library List" screen, then click the [Open] button.

For the library/element which is protected by password, the icon will be displayed in a pale color on the [Library] tab.

#### ■Deleting libraries/updating display information

1. Select the [Library] tab in the element selection window.
2. Select the library to be deleted/updated, then select [Project] ⇒ [Library Operation] ⇒ [Delete from Library List] (✕)/ [Update the Display Information of Library].

#### ■Displaying Help

1. Select the [Library] tab in the element selection window.
2. Select a library or element, and select [Project] ⇒ [Library Operation] ⇒ [Help] or right-click [Help] from the shortcut menu.

#### ■Displaying program files/FB files/FUN files

1. Select the [Library] tab in the element selection window.
2. Select [Project] ⇒ [Library Operation] ⇒ [Show Program/FB/FUN File].

## Utilizing an element

A library POU registered in the element selection window can be utilized in other projects.

To utilize POUs which were set the read-protection when exporting the library, the password is required before editing.

### Operating procedure

#### ■Pasting elements onto the navigation window

1. Select an element in the [Library] tab in the element selection window. (Multiple selections allowed.)
2. Drag and drop the element onto the navigation window.

Elements can be dropped onto the place which is able to create the same kind of data only.

Read-protected POUs are displayed in the navigation window as follow.



#### ■Pasting elements into a program editor (function block/function only)

1. Drag an element from the [Library] tab in the element selection window and drop it onto a sequence program.
2. For a function block, select the local label or global label from the pull-down list in the "FB Instance Name" screen, and enter an FB instance name.

#### ■Making the read-protected POUs editable

1. Select and right-click a POU which was utilized and read-protected, and select [Enter the Password to Edit] from the shortcut menu.
2. Enter the password in the "Password Authentication" screen, and click the [OK] button.

The element will be editable until the project is closed.

#### ■Copy of utilized elements

- When the data name of a utilized element has "+," it will be replaced with "\_ " after a copy.
- A read-protected element cannot be copied. However, it can be copied by entering password to edit.
- For an edit-protected element, the copy of the element can only be editable.

## Precautions

### ■ Utilizing multiple elements

If there is any of the following combinations in the selected elements, none of the selected elements can be utilized to a project; utilize the following elements individually.

- Different kinds of elements (Example: POU and global label)
- Elements from different libraries
- An SFC program and a program created in a programming language other than Sequential Function Chart language
- A standard program and a safety program
- A standard FB/FUN and a safety FB/FUN
- Global labels in different categories (standard, safety, or standard/safety shared)

### ■ Module label, structure, and module FB

A module label, structure, and module FB cannot be utilized. Therefore, if utilizing an element in which any of the data is used, the module label and structure will be an undefined label, and the module FB will be changed to an undefined function block. To use these undefined data in the utilization destination program as a module label, structure, and/or module FB, add the module label, structure, and/or module FB to the utilization destination program.

In the following cases, set an alias in the project of utilization destination and set the label name same as the one of the utilized element. (  Page 230 Alias)

- An alias is used in a module label and/or structure of an utilized element
- An instance name differ between a module label and/or structure in a utilized element and an added module label and/or structure in a utilization destination

### ■ POU's whose password authentication is disabled



A read protected POU whose password authentication is disabled cannot be edited in the utilization destination project.

When editing the POU, edit a library file in which this POU is included or data in a project in which the library file was created.

(  Page 510 Editing libraries)

Additionally, the edited POU can be utilized to a project again by the following procedure.

## Operating procedure

1. Export a library or project in which a POU is edited as a library file. (  Page 507 Creating a library file)
2. Register the library file created in step 1 to the library list of the project to be utilized. (  Page 511 Registering user libraries in the library list)
3. Utilize the POU to a project from the registered library. (  Page 512 Utilizing an element)

## Updating library POU's

Update the elements of a library imported to a project.

Multiple libraries and elements can be updated at once.

In addition, an element (call destination element) that is called from a selected element will also be updated at the same time. When updating them, if an element with the same name does not exist in the project, the elements of the call destination will be added.

### Window

1. Select a library or library POU to update in the [Library] tab in the element selection window.
2. Select [Project] ⇒ [Library Operation] ⇒ [Update Library POU].

Alternatively, right-click a library element, and select [Update Library POU] from the shortcut menu.

By updating library POU's, set contents such as the execution order of program blocks, initial label values, or assigned devices may be changed; check these setting contents after the update.

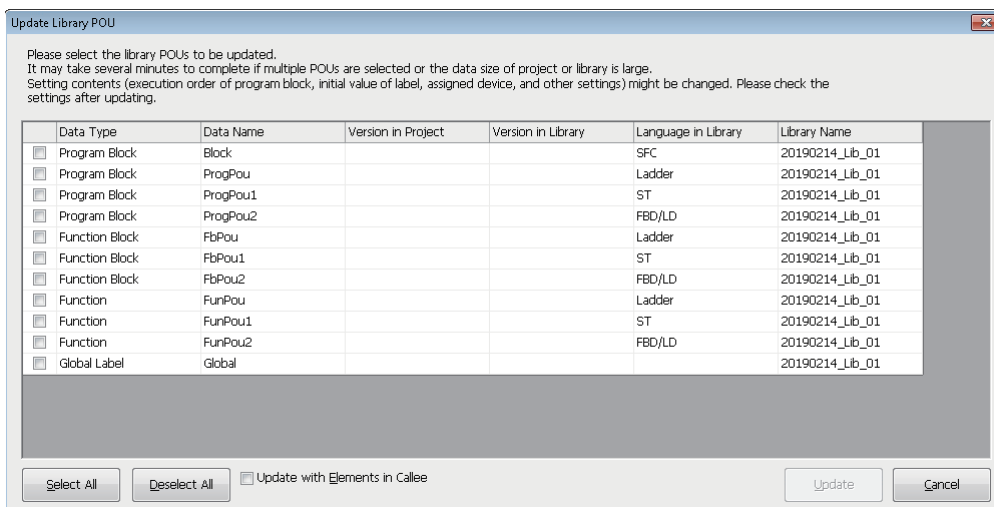

### Operating procedure

Set each item and click the [Update] button.

#### ■ Call destination element

'Call destination element' refers to as an element used in a POU. (Example: A function block used in a program block)

The data types of call destination elements are as follows:

- Function block (Standard and safety)
- Function (Standard and safety)
- Structure
- Global label (standard, safety, and standard/safety shared)

### Checking for library updates automatically

By selecting "Yes" in the following option, whether or not user libraries are updated is automatically checked.

- [Tool] ⇒ [Options] ⇒ "Project" ⇒ "Element Selection" ⇒ "Update Check" ⇒ "Check User Library Date"

# 10.4 Enhanced Use of Application Library/MELSOFT Library

The application library/MELSOFT Library (sample library) are the element collection of program/function block/function/structure that composed of specific processing.

In this section, the application library/MELSOFT Library (sample library) are explained as a library.

An element in a library can be utilized by registering the library in the library list.

The elements are imported into a project with by registering a library.

The registration method of a library differs depending on the file extension (\*.gx3s, \*.mslm).

To obtain the library, please contact your local Mitsubishi Electric sales office or representative.

Remote head modules do not support these libraries.

## Precautions

Before registering a library, confirm that the module type of the current project (CPU module) supports the library.

## Registering libraries of which file extensions are 'gx3s'

### Operating procedure

1. Select [Tool] ⇒ [Register Sample Library].
2. Select a file in the "Open Sample Library" screen, and click the [Open] button.

The function block of the library is added in the following FB files displayed in the navigation window.

- M\_FBLIB: Mitsubishi Electric FA products
- P\_FBLIB: partner's products

## Registering libraries of which file extensions are 'mslm'

### Operating procedure

#### ■Registering libraries to be referenced

1. Select [Project] ⇒ [Library Operation] ⇒ [Register to Library List] ⇒ [Library].
2. Select a file in the "Register Library to Library List" screen, then click the [Open] button.

The registered library is displayed on the library list.

#### ■Deleting libraries

1. Select the [Library] tab in the element selection window.
2. Select the library to be deleted, then select [Project] ⇒ [Library Operation] ⇒ [Delete from Library List] (✕).

#### ■Updating libraries

To update a library, refer to the following:

☞ Page 514 Updating library POUs

## Precautions

A safety FB library is automatically registered when installing GX Works3 for the first time.

However, once the safety FB library is deleted on the [Library] tab in the element selection window, the library needs to be registered manually.

To obtain the safety FB library, please contact your local Mitsubishi Electric sales office or representative.



# PART 4

# DEBUGGING AND OPERATION

This part explains the communication route setting to access a CPU module, reading/writing data, and monitoring the execution status.

11 PROGRAM SIMULATION

---

12 SETTING ROUTE TO CPU MODULE

---

13 WRITING/READING DATA TO CPU MODULE

---

14 CHECKING OPERATION OF PROGRAMS

---

# 11 PROGRAM SIMULATION

This chapter explains the method for debugging a program offline by using the simulation function.  
For modules supporting the simulation function, refer to the following:

☞ Page 933 Using the Simulation Function

## 11.1 Simulation Function

The Simulation function debugs programs using a virtual programmable controller on a personal computer.

GX Simulator3 is used for the Simulation function.

This function is useful to check programs before operating them actually since it enables debugging without the connection with CPU module.

The following five simulations can be performed in GX Simulator3.

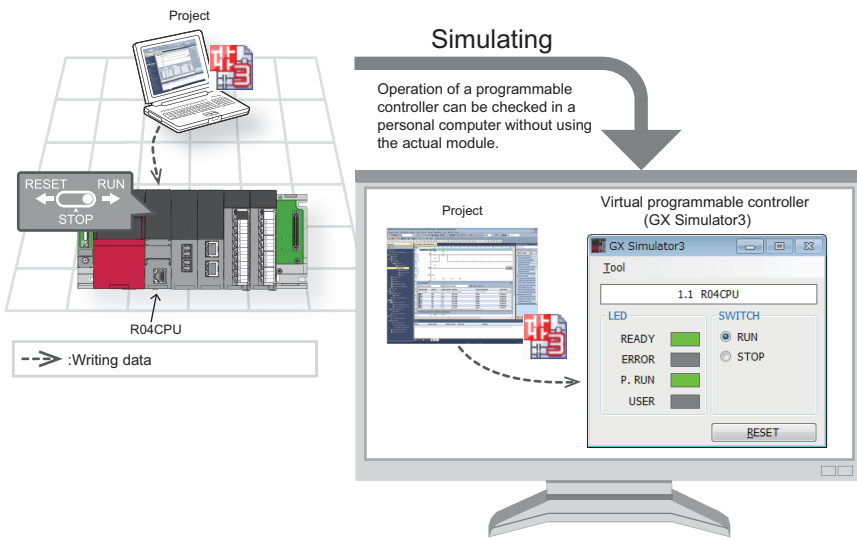
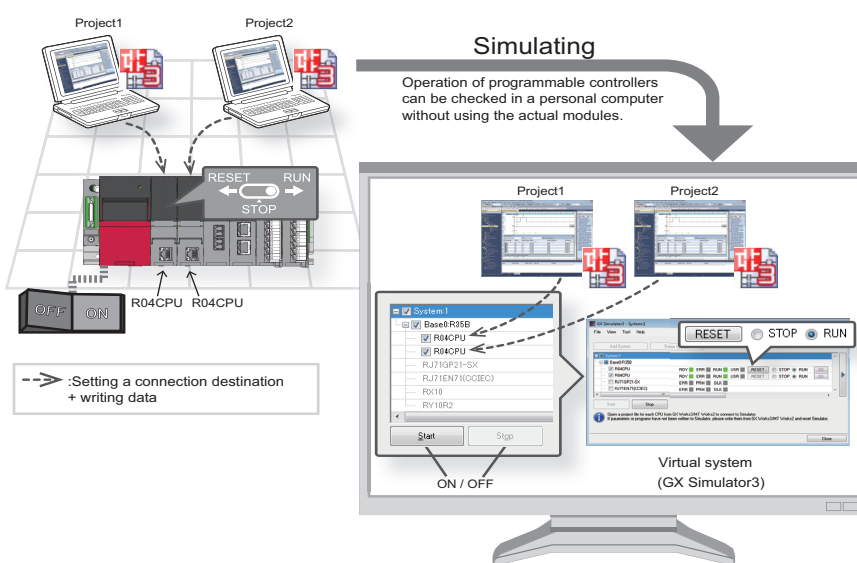
Purpose	Reference
<p>Simulation of a CPU module (host CPU)</p> 	<p>Page 522 Simulation of a CPU module</p>
<p>Simulation of a multiple CPU system</p> 	<p>Page 529 Multiple CPU system</p>

FX5CPUs do not support it.



**Purpose**

Simulation of a multiple CPU system including a programmable controller CPU and a motion CPU

**Reference**

Page 532 Programmable controller CPU and motion CPU

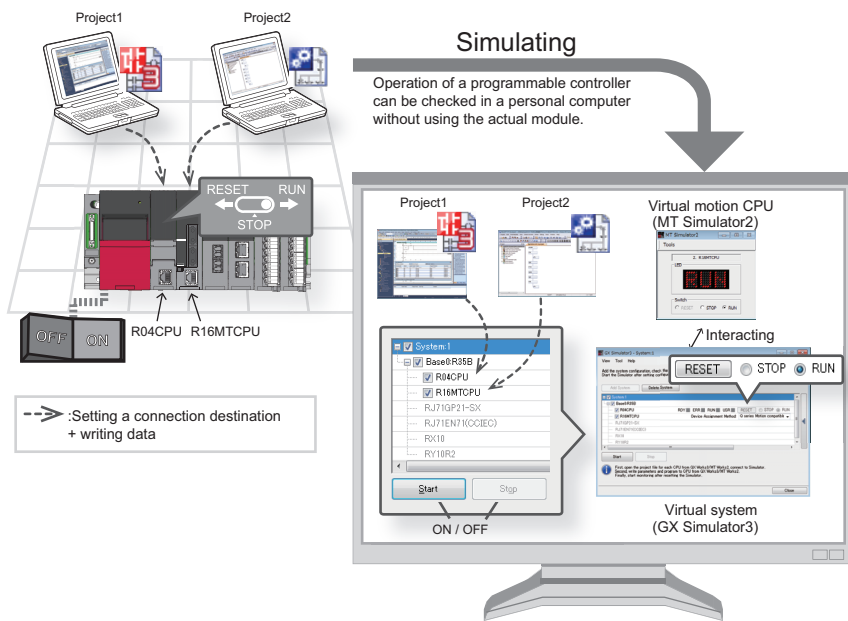

FX5CPUs do not support it.

Simulation of a system including a simple motion module

Page 536 Simple motion module/ motion module

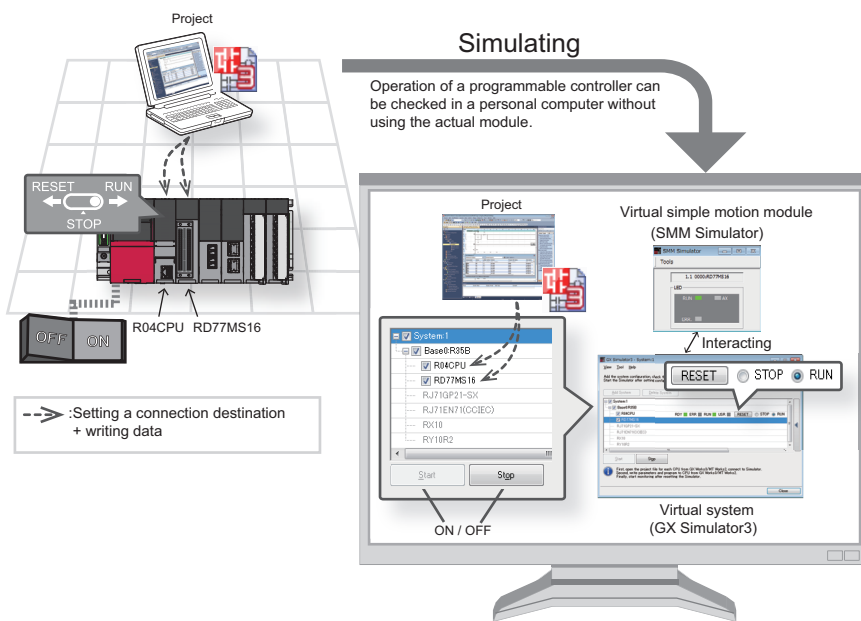

**Purpose**

Simulation of a system including a CC-Link IE TSN compatible motion module

**Reference**

Page 536 Simple motion module/  
motion module

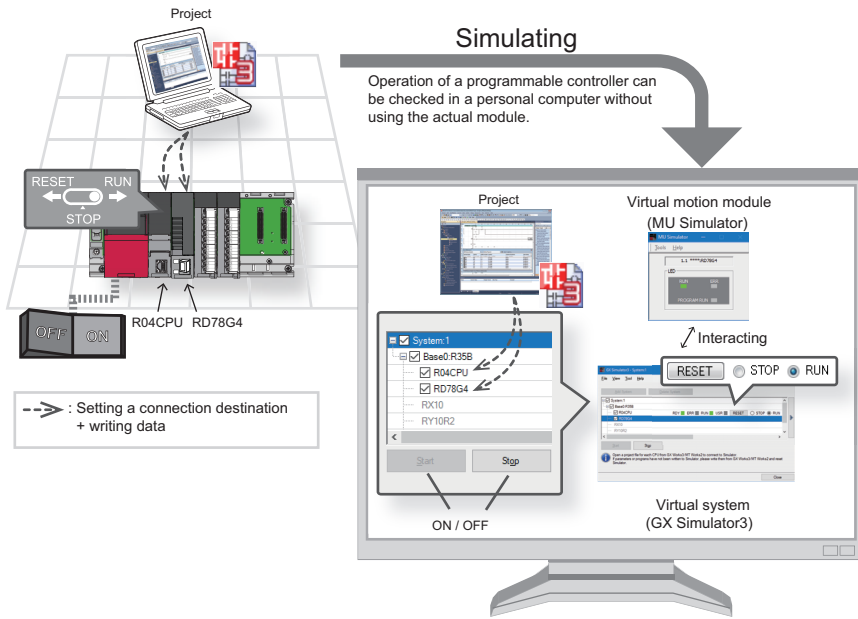

FX5CPUs do not support it.

Simulation of multiple systems including network modules that perform cyclic transmission or transient transmission

Page 538 Network modules

(Example) Simulation of multiple systems performing cyclic transmission

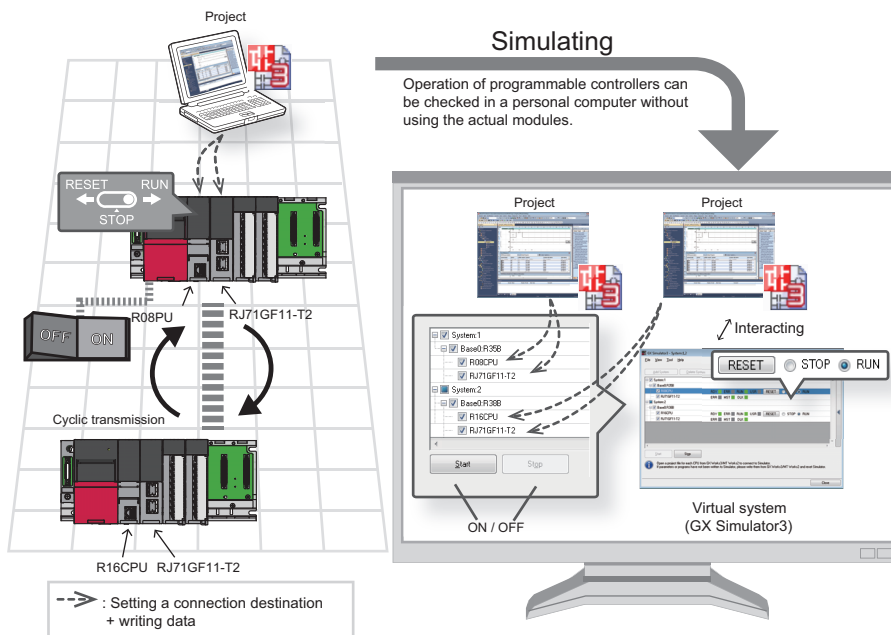

For the considerations for using the simulation function, refer to the following:

📖 Page 974 Considerations

# Safety and handling consideration

---

## CAUTION

- The Simulation function simulates the actual module to debug a created sequence program. However, this function does not guarantee the operation of the debugged program.
- The Simulation function uses the memory for simulation to input and output data to/from an I/O module and intelligent function module. Some instructions/functions and device memory are not supported. Therefore, the operation results obtained with the virtual programmable controller may differ from those obtained using the actual module.

After debugging programs using the Simulation function, the normal program debugging, which is performed with the module connected before the actual operation, is required.

## 11.2 Simulation

---

This section explains the simulation methods.

During the simulation, GX Simulator3 is set as a connection destination and "Simulation ((system number).(CPU number))" is displayed in the status bar.

### Simulation of a CPU module

---

This can be used when performing the simulation to a CPU module.

#### Starting a simulation

##### Window

Select [Debug] ⇒ [Simulation] ⇒ [Start Simulation] (  ).

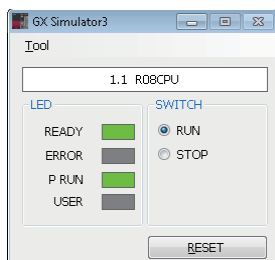

##### Operating procedure

Select the checkbox of the data to be written on the "Online Data Operation" screen, and click the [Execute] button.

## ■Simulation of an RnPCPU (redundant mode)

A simulation runs with the following conditions:

- Operation mode: Separate mode
- Control system/standby system: Control system
- System A/B setting: System A
- Tracking transfer: No execution
- Extension cables of a redundant extension base unit: Single configuration

## ■Simulation of an RnPSFCPU

A simulation runs with the following conditions:

- Operation mode: Backup mode
- Control system/standby system: Control system
- System A/B setting: System A
- Tracking transfer: No execution

### Point

By selecting "Yes" for the following option, parameters and programs are automatically written to GX Simulator3 when simulation is started. In this case, the "Online Data Operation" screen does not appear.

- [Tool] ⇒ [Options] ⇒ "Simulation" ⇒ "Start Simulation" ⇒ "Operational Setting" ⇒ "Automatically write programs and parameters when starting simulation."

In addition, if the checkbox in the "Select Favorites Button" column of optional data is selected in the "Set Favorites" screen, the data is also automatically written. ( Page 578 Set favorites screen)

## Precautions

The following shows the considerations when simulating an RnPCPU (redundant mode) or an RnPSFCPU.

- The following function cannot be performed during simulation.  
[Online] ⇒ [Redundant PLC Operation]
- Set the model name of a base unit and its number of slots in the base setting of the system parameter before simulation. Otherwise, a redundant system configuration abnormal error occurs.

## Ending a simulation

### Operating procedure

Select [Debug] ⇒ [Simulation] ⇒ [Stop Simulation] (.

# 11.3 System Simulation

System simulation can be performed to simulate programs by interacting with other CPU modules and simple motion modules.

Functions using an SD memory card can also be simulated. (☞ Page 542 SD memory card)

## Window

Select [Debug] ⇒ [Simulation] ⇒ [System Simulation] ⇒ [Start System Simulation] (🖱️).

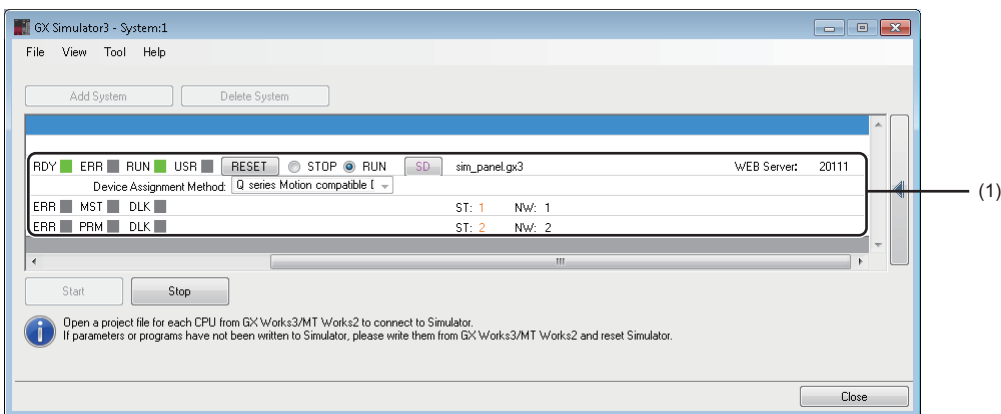
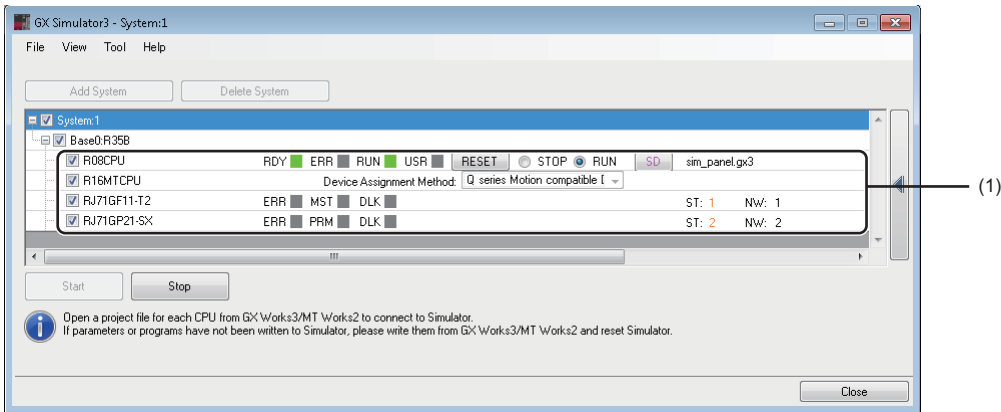

Item	Description
(1) Panel	The operating status of each module is displayed. Additionally, an operation for each module can be performed.

## Operating procedure

For operating procedures for the system simulation, refer to the following:

- Multiple CPU: ☞ Page 529 Multiple CPU system
- Programmable controller CPU and motion CPU: ☞ Page 532 Programmable controller CPU and motion CPU
- CPU module and simple motion module: ☞ Page 536 Simple motion module/motion module
- Cyclic transmission: ☞ Page 538 Network modules

## Display contents on a panel

Operating status can be checked and an operation can be changed in a panel for each module in GX Simulator3. The following shows the display content on the panel of a CPU module and a network module.

### Window

#### ■Programmable controller CPU

Ex.

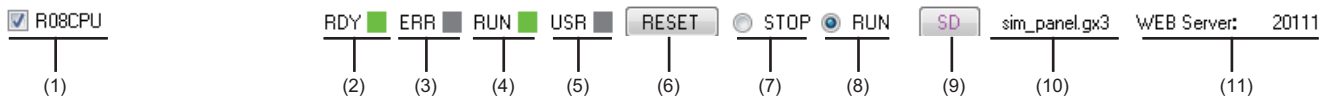

Item	Description
(1) Module name	Indicates the model name of the CPU module.
(2) RDY	Indicates the 'READY' LED on the front of the CPU module.
(3) ERR	Indicates the 'ERROR' LED on the front of the CPU module.
(4) RUN	Indicates the 'PROGRAM RUN' LED on the front of the CPU module.
(5) USR	Indicates the 'USER' LED on the front of the CPU module.
(6) RESET	A button which behaves as RESET switch.
(7) STOP	Behaves as STOP switch.
(8) RUN	Behaves as RUN switch.
(9) SD	A button used for setting a virtual SD memory card file. The color of 'SD' differs depending on whether a file is set or not. <ul style="list-style-type: none"> <li>• Pink: No file is set.</li> <li>• Blue: A file is set.</li> </ul>
(10) Project name	The project name is displayed.
(11) Port number	The port number of GX Simulator3 is displayed. This number is used when simulating the web server function.

#### ■Motion CPU

Ex.

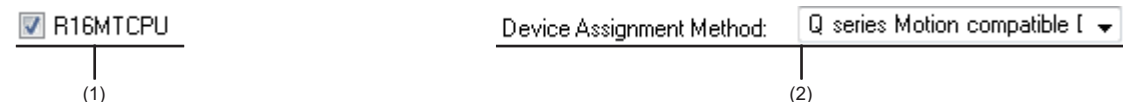

Item	Description
(1) Module name	Indicates the model name of the CPU module.
(2) Device Assignment Method	Select a device assignment method for a motion CPU. <ul style="list-style-type: none"> <li>• Q series Motion compatible Device assignment</li> <li>• MELSEC iQ-R Motion Device assignment</li> </ul>

#### ■Network module

Ex.



Item	Description
(1) Module name	Indicates the model name of the network module.
(2) ERR	Indicates the 'ERROR' LED on the front of the module.
(3) MST	Indicates the 'MST' LED on the front of the module.
(4) DLK	Indicates the 'D LINK' LED on the front of the module.
(5) ST	Indicates the dot matrix LED of the module. Only a station number is displayed on the panel of GX Simulator3.
(6) NW	Indicates a network number set in the network parameter.

## Simulation connection destination setting

A connection destination CPU (GX Simulator3) can be set in the "Specify Simulation Connection Destination" screen.

### Window

Select [Debug] ⇒ [Simulation] ⇒ [System Simulation] ⇒ [Connect Simulation].

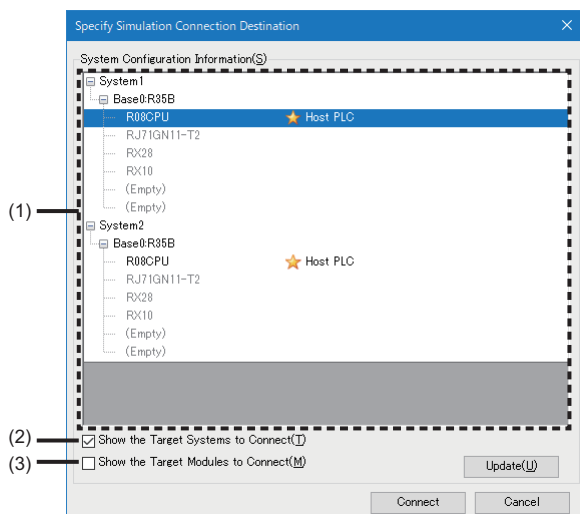

### Displayed items

Item	Description
(1) System Configuration Information	Systems added in the GX Simulator3 screen are displayed in a list.
(2) Show the Target Systems to Connect	Select this checkbox to display only a system that matches with the system configuration of a project opened in GX Works3 in the system configuration information. By unselecting this checkbox, a system that is different from the system configuration of the project is also displayed.
(3) Show the Target Modules to Connect	Select this checkbox to display only a connectable CPU module, base unit on which the CPU module is placed, and system in the system configuration information.

### Operating procedure

For the operation of the "Specify Simulation Connection Destination" screen, refer to the following:

- Multiple CPU: [Page 529 Multiple CPU system](#)
- Programmable controller CPU and motion CPU: [Page 532 Programmable controller CPU and motion CPU](#)
- CPU module and simple motion module: [Page 536 Simple motion module/motion module](#)
- Cyclic transmission: [Page 538 Network modules](#)



### ■ Display contents in the system configuration information

The contents displayed in the system configuration information are switched depending on the selection status of "Show the Target Systems to Connect" and "Show the Target Modules to Connect."

**Ex.**

When simulating the systems of (1) to (4)

(1) Project for R08CPU	(2) Project for R08CPU	(3) Project for R08CPU	(4) Project for R16CPU
	<p>Same system configuration with (1)</p>	<p>Different system configuration from (1)</p>	

The following shows the combinations of the selection status and display contents in the system configuration information by using the example of the case when displaying the "Specify Simulation Connection Destination" screen in GX Works3 where the project (1) is opened.

○: Selected, ×: Unselected

Show the Target Systems to Connect	Show the Target Modules to Connect	Display contents in the system configuration information	Display example
○	○	Among the systems that match with the system configuration of a project opened in GX Works3, only the system in which a CPU module whose model name is the same with a CPU module (host CPU) exists is displayed.	Only the system numbers, base units, and CPU modules of (1) and (2) are displayed.
○	×	The system that matches with the system configuration of a project opened in GX Works3 is displayed.	The systems of (1) and (2) are displayed.
×	○	Among all systems, only the connectable CPU module is displayed. Among the systems that do not match with the system configuration of a project opened in GX Works3, the system in which a CPU module whose model name is the same with a CPU module (host CPU) exists is also displayed.	The system numbers, base units, and CPU module of (1) to (3) are displayed.

Show the Target Systems to Connect	Show the Target Modules to Connect	Display contents in the system configuration information	Display example
x	x	All systems are displayed.	<p>All systems of (1) to (4) are displayed.</p> <p>The screenshot shows a tree view with the following structure:</p> <ul style="list-style-type: none"> <li>System1       <ul style="list-style-type: none"> <li>Base0:R33B           <ul style="list-style-type: none"> <li>R08CPU (marked with a star and 'Host PLC')</li> <li>RJ71GN11-T2</li> <li>RX28</li> <li>RX10</li> </ul> </li> </ul> </li> <li>System2       <ul style="list-style-type: none"> <li>Base0:R33B           <ul style="list-style-type: none"> <li>R08CPU (marked with a star and 'Host PLC')</li> <li>RJ71GN11-T2</li> <li>RX28</li> <li>RX10</li> </ul> </li> </ul> </li> <li>System3       <ul style="list-style-type: none"> <li>Base0:R33B           <ul style="list-style-type: none"> <li>R08CPU</li> <li>RJ71GN11-T2</li> <li>RX10</li> <li>RY10R2</li> </ul> </li> </ul> </li> <li>System4       <ul style="list-style-type: none"> <li>Base0:R33B           <ul style="list-style-type: none"> <li>R08CPU</li> <li>RJ71GN11-T2</li> <li>RX10</li> <li>RY10R2</li> </ul> </li> </ul> </li> </ul> <p>Warning messages for System 3 and System 4:</p> <ul style="list-style-type: none"> <li>System 3: The system configuration is different from the one for the GX Works3.</li> <li>System 4: The system configuration is different from the one for the GX Works3.</li> </ul>

# Multiple CPU system

This section shows the operation to simulate a multiple CPU system by using the example of the following system configuration.

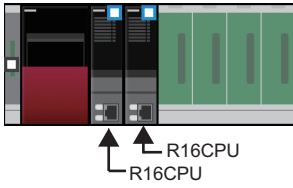

## Operating procedure

### Starting GX Simulator3

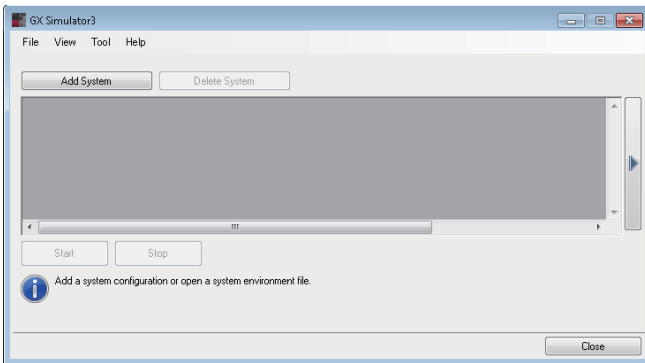

1. Start GX Simulator3. (Page 524 System Simulation)
2. In the GX Simulator3 screen, click the [Add System] button.

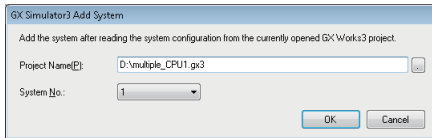

3. In the "GX Simulator3 Add System" screen, set a project name and a system number.

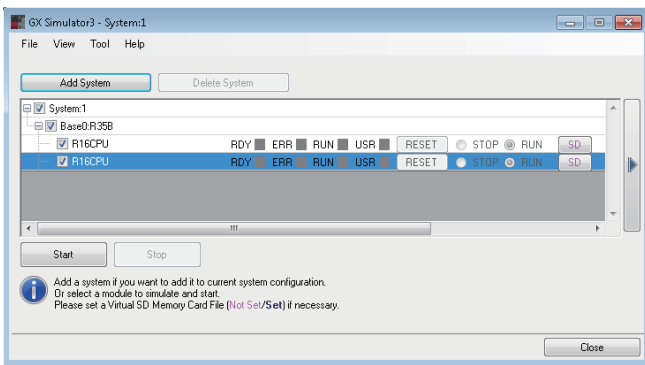

4. In the GX Simulator3 screen, select the checkboxes of the CPU modules to simulate, and click the [Start] button.

For the CPU modules that can be simulated, refer to the following:

Page 937 Modules supported by GX Simulator3 (System simulation)

## ■Connecting to the CPU No.1 and writing data

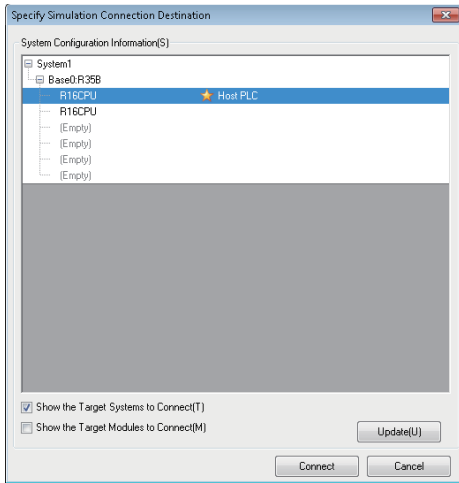

1. Select [Debug] ⇒ [Simulation] ⇒ [System Simulation] ⇒ [Connect Simulation].
2. In the "Specify Simulation Connection Destination" screen, select the CPU No.1, and click the [Connect] button.

"Simulation ((system number).(CPU number)) will be displayed in the status bar.

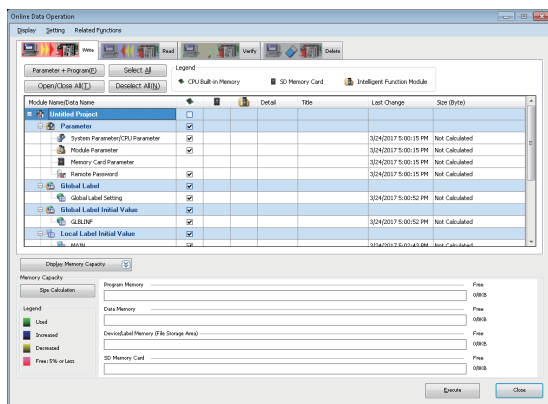

3. Select [Online] ⇒ [Write to PLC] to write parameters and programs in GX Simulator3.

## ■Connecting to the CPU No.2 and writing data

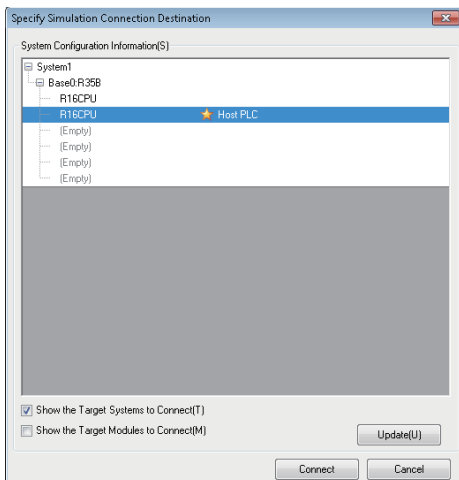

1. Start another GX Works3, and open the project of CPU No.2.
2. Select [Debug] ⇒ [Simulation] ⇒ [System Simulation] ⇒ [Connect Simulation].
3. In the "Specify Simulation Connection Destination" screen, select the CPU No.2, and click the [Connect] button.

"Simulation ((system number).(CPU number))" will be displayed in the status bar of GX Works3.

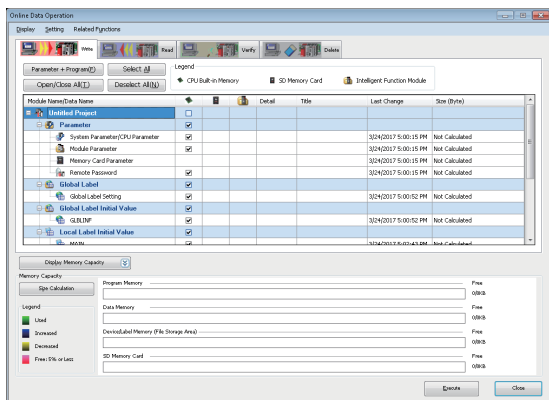

4. Select [Online] ⇒ [Write to PLC] to write parameters and programs in GX Simulator3.

## ■ Simulating

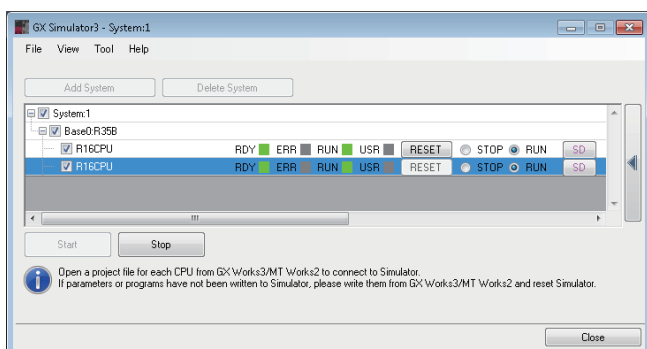

1. In the GX Simulator3 screen, click the [RESET] button in the row of the CPU No.1.
2. Select "RUN" in the row of each CPU.
3. Select [Online] ⇒ [Monitor] ⇒ [Start Monitoring].  
The system simulation starts.

# Programmable controller CPU and motion CPU

This section shows the operation to simulate a system including a programmable controller CPU and a motion CPU by using the example of the following system configuration.

To use this function, MT Works2 Version 1.140W or later is required to be installed.

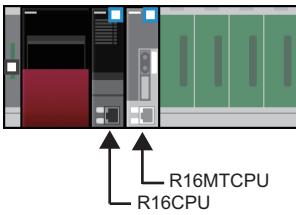

## Operating procedure

### ■ Starting GX Simulator3 and MT Simulator2

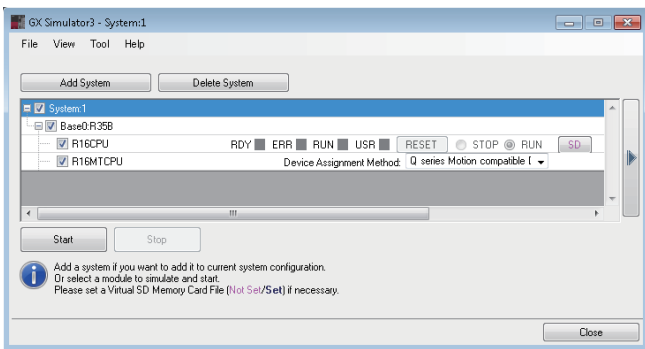
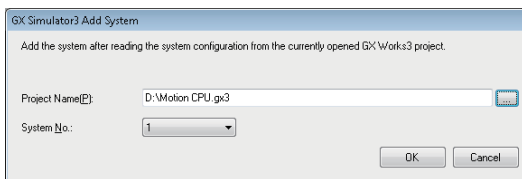
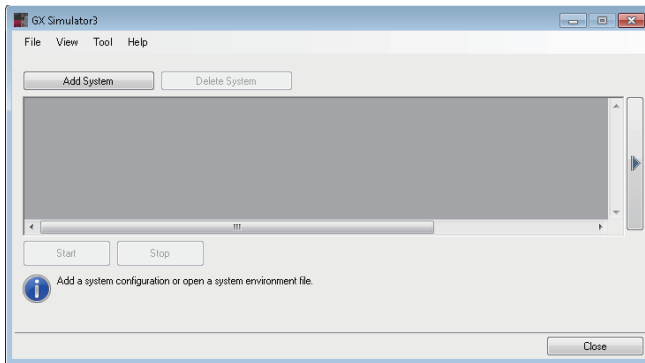

1. Start GX Simulator3. (☞ Page 524 System Simulation)
2. In the GX Simulator3 screen, click the [Add System] button.

3. In the "GX Simulator3 Add System" screen, set a project name and a system number.

4. In the GX Simulator3 screen, select the checkboxes of a programmable controller CPU and a motion CPU to simulate.

For the programmable controller CPUs and motion CPUs that can be simulated, refer to the following:

☞ Page 937 Modules supported by GX Simulator3 (System simulation)

5. Select "Q series Motion compatible Device assignment" or "MELSEC iQ-R Motion Device assignment" for "Device Assignment Method" of the motion CPU, and click the [Start] button.

For details on the device assignment method, refer to the following:

☞ MELSEC iQ-R Motion Controller Programming Manual (Common)

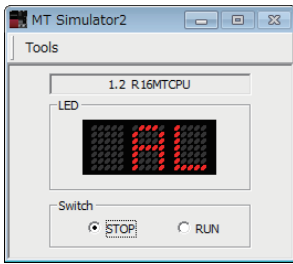

MT Simulator2 starts.

**■Connecting to a programmable controller CPU and writing data**

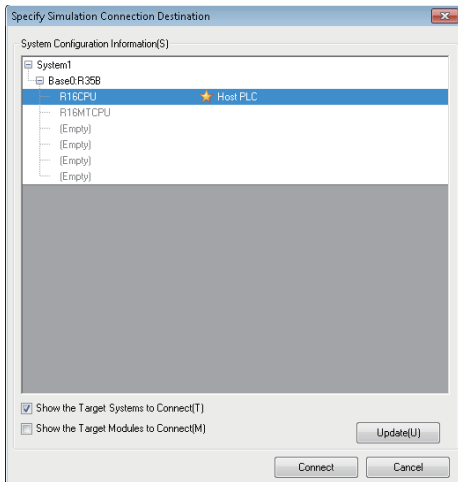

1. Select [Debug] ⇒ [Simulation] ⇒ [System Simulation] ⇒ [Connect Simulation].
2. In the "Specify Simulation Connection Destination" screen, select the programmable controller CPU, and click the [Connect] button.  
 "Simulation ((system number).(CPU number))" will be displayed in the status bar of GX Works3.

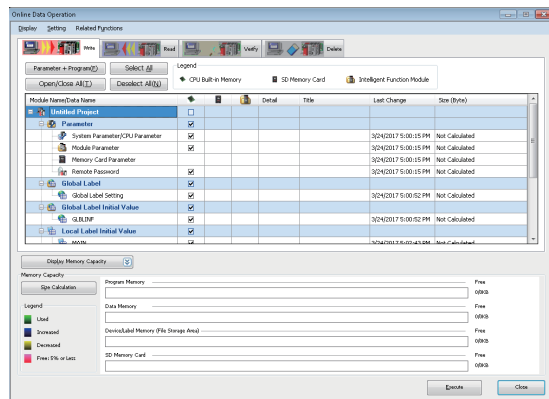

3. Select [Online] ⇒ [Write to PLC].  
 Write the parameters and programs to GX Simulator3.

## ■Connecting to a motion CPU and writing data

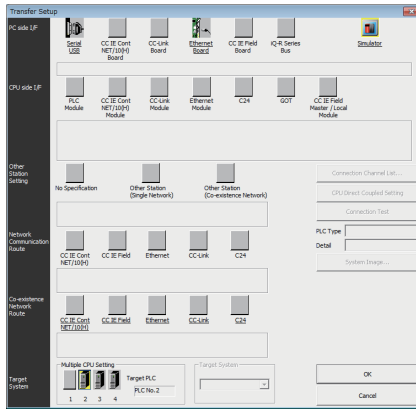

1. Start MT Developer2, and open the project of a motion CPU to simulate.
2. Select [Online] ⇒ [Transfer Setup].
3. In the "Transfer Setup" screen, double-click "Simulator" for "PC side I/F."
4. In the "System No. Setting" screen, specify the system number, which was set in the step 3, for "System No."
5. In the "Transfer Setup" screen, specify the motion CPU number for "Multiple CPU Setting."
6. In the "Transfer Setup" screen, click the [OK] button. MT Simulator2 already started is connected.

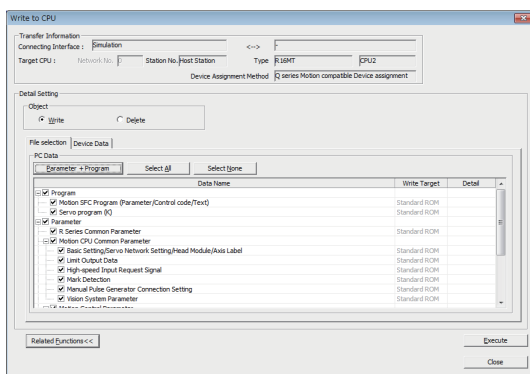

7. Select [Online] ⇒ [Write to Motion].
- Write the parameters and programs to MT Simulator2.

## ■Simulating

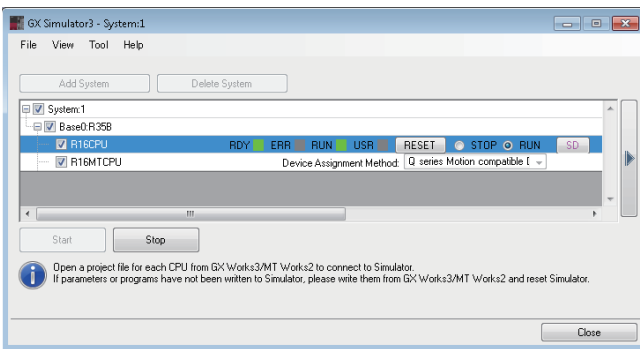

1. In the GX Simulator3 screen, click the [RESET] button in the row of a programmable controller CPU.
2. In the GX Simulator3 screen, select "RUN" in the row of a programmable controller CPU.

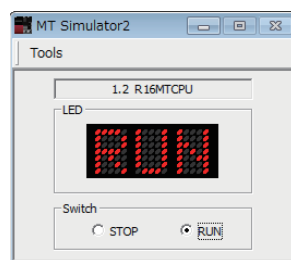

3. In the "MT Simulator2" screen, select "RUN."



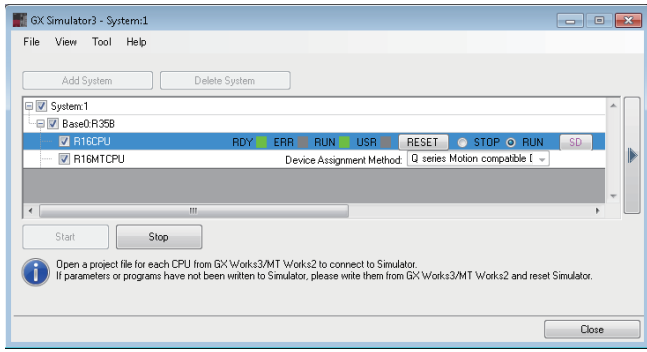

4. Select [Online] ⇒ [Monitor] ⇒ [Start Monitoring] on GX Works3.  
The system simulation starts.

## Precautions

In the simulation of a multiple CPU system where an RnENCPU is set as CPU No.1, the place of modules in the "System Parameter" screen and in the GX Simulator3 screen are differently displayed.

"System Parameter" screen

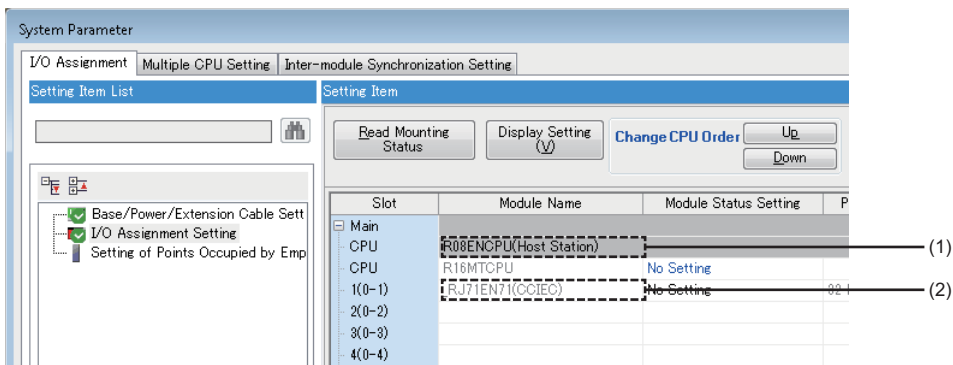

GX Simulator3 screen

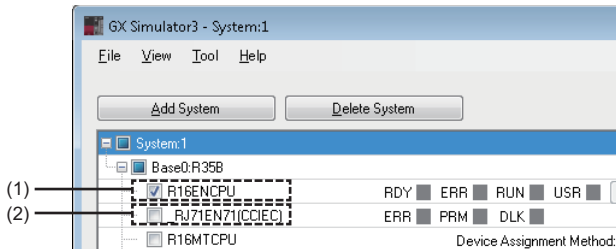

- (1): RnENCPU(CPU part)
- (2): RnENCPU (network part)

For details on the multiple CPU configuration using an RnENCPU, refer to the following:

📖 MELSEC iQ-R Module Configuration Manual

# Simple motion module/motion module

This section shows the operation to simulate a system including a simple motion module or a CC-Link IE TSN compatible motion module by using the example of the following system configuration.

**Ex.**

System including a simple motion module

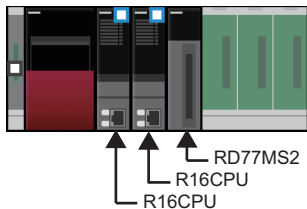

## Operating procedure

### ■ Starting GX Simulator3

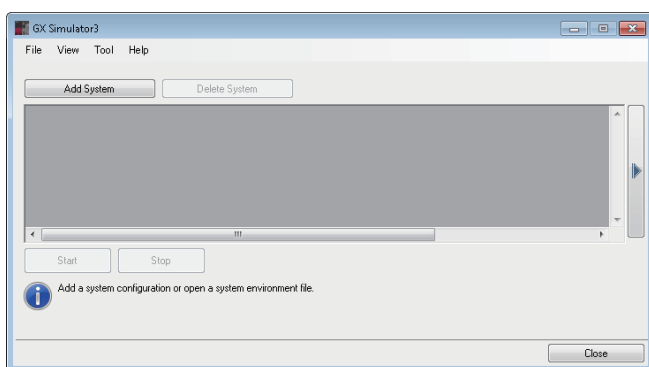

1. Start GX Simulator3. (☞ Page 524 System Simulation)
2. In the GX Simulator3 screen, click the [Add System] button.

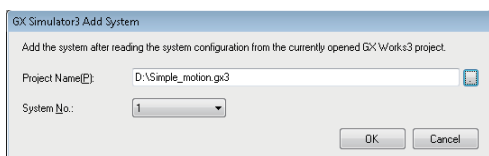

3. In the "GX Simulator3 Add System" screen, set a project name and a system number.

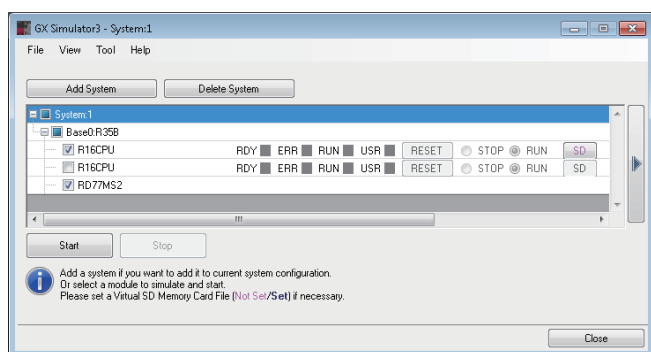

4. In the GX Simulator3 screen, select the checkboxes of the following modules to simulate, and click the [Start] button.

- CPU module
- Simple motion module/CC-Link IE TSN compatible motion module

For the modules that can be simulated, refer to the following:  
☞ Page 937 Modules supported by GX Simulator3 (System simulation)

## ■ Starting SMM Simulator, connecting to a CPU module, and writing data

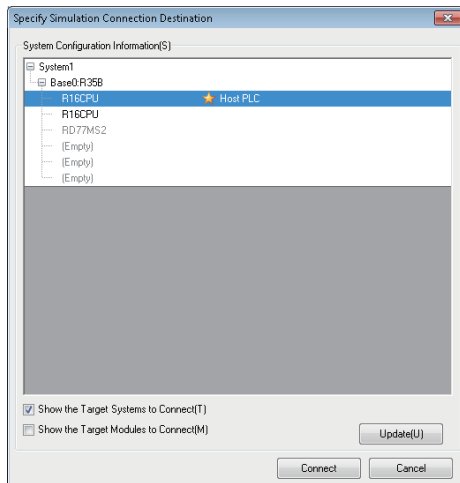

1. Select [Debug] ⇒ [Simulation] ⇒ [System Simulation] ⇒ [Connect Simulation].
2. In the "Specify Simulation Connection Destination" screen, select the CPU module the checkbox of which was selected in the GX Simulator3 screen, and click the [Connect] button.

"Simulation ((system number).(CPU number))" will be displayed in the status bar of GX Works3.

SMM Simulator (simulator of a simple motion module) starts. If the checkbox of a CC-Link IE TSN compatible motion module is selected in the GX Simulator3 screen, MU Simulator starts.

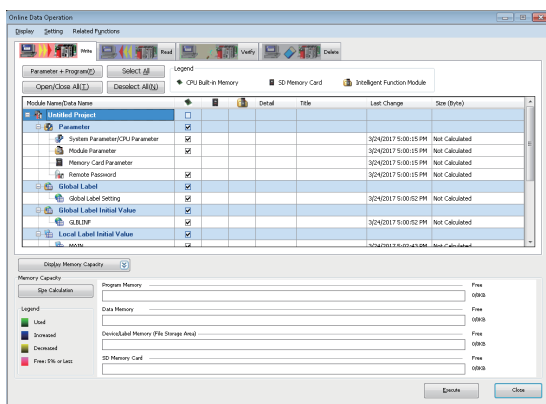

3. Select [Online] ⇒ [Write to PLC].
4. Write the following data to GX Simulator3.
  - Parameters
  - Programs
  - Module parameters of a simple motion module/CC-Link IE TSN compatible motion module

## ■ Simulating

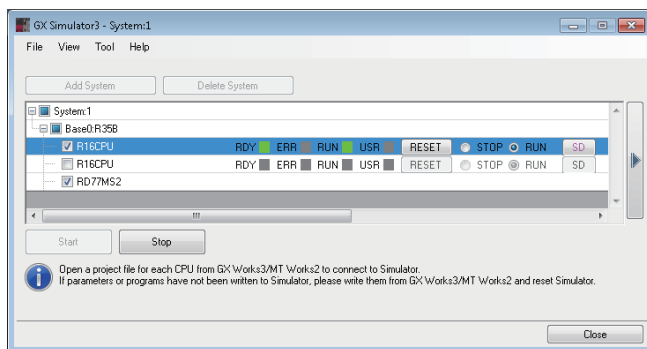

1. In the GX Simulator3 screen, click the [RESET] button in the row of a CPU module.
2. In the GX Simulator3 screen, select "RUN" in the row of a CPU module.
3. Select [Online] ⇒ [Monitor] ⇒ [Start Monitoring]. The system simulation starts.

# Network modules

This section shows the operation to simulate multiple systems including network modules, which perform cyclic transmission or transient transmission, by using the example of the following system configuration.

**Ex.**

Module configuration diagram

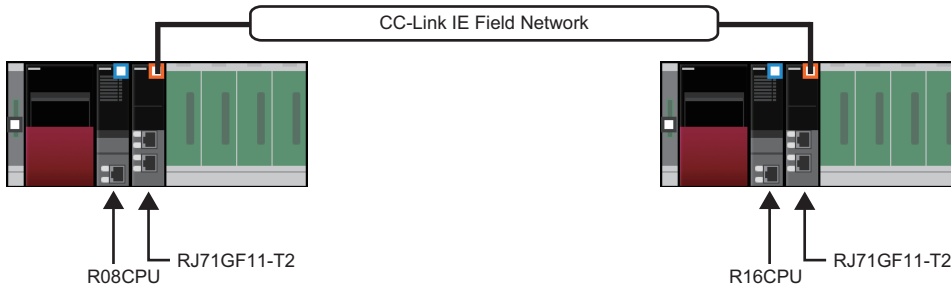

"I/O Assignment Setting" of "System Parameter"

Slot	Project of master station	Project of local station
CPU	R08CPU (host CPU)	R16CPU (host CPU)
0	RJ71GF11-T2	RJ71GF11-T2
1	Empty	Empty
2	Empty	Empty
3	Empty	Empty
4	Empty	Empty

To simulate network modules, set the module parameters of the network modules to link each other.

## Operating procedure

### Starting GX Simulator3

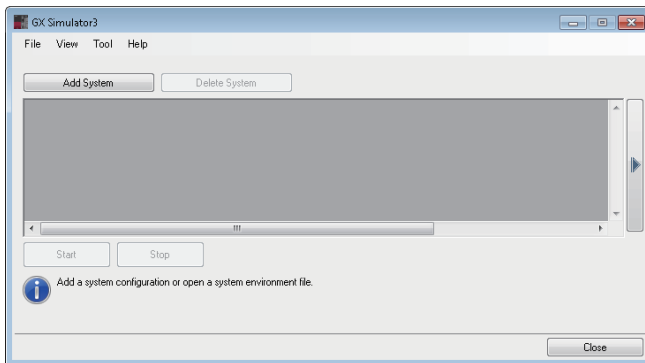

1. Open the project of a master station in GX Works3.
2. Start GX Simulator3. (Page 524 System Simulation)
3. In the GX Simulator3 screen, click the [Add System] button.

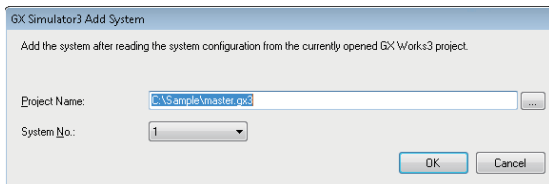

4. In the "GX Simulator3 Add System" screen, set a project name and a system number.

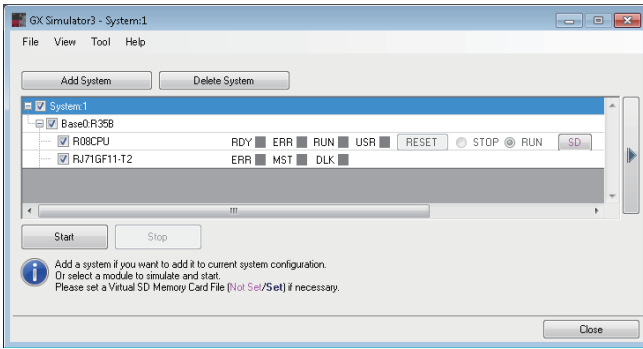

5. Start another GX Works3, and open the project of a local station.
6. In the GX Simulator3 screen, click the [Add System] button.

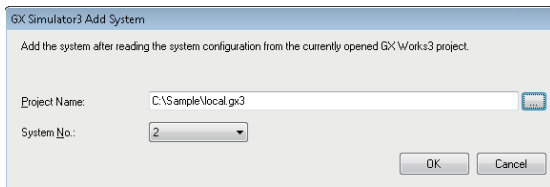

7. In the "GX Simulator3 Add System" screen, set a project name and a system number.

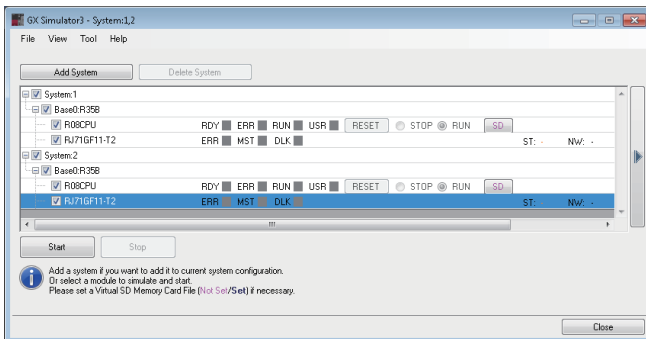

8. In the GX Simulator3 screen, select the checkboxes of the CPU modules and network modules to simulate, and click the [Start] button.

For the CPU modules and network modules that can be simulated, refer to the following:

☞ Page 937 Modules supported by GX Simulator3 (System simulation)

## ■Connecting to a programmable controller CPU and writing data

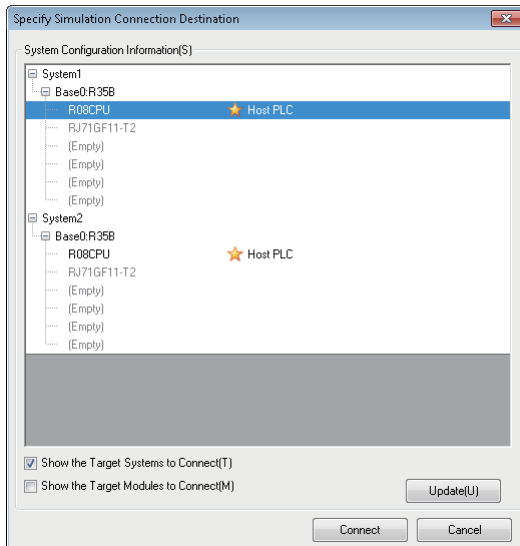

1. In GX Works3 used in step 1, select [Debug] ⇒ [Simulation] ⇒ [System Simulation] ⇒ [Connect Simulation].
2. In the "Specify Simulation Connection Destination" screen, select the CPU module of the master station, and click the [Connect] button.

"Simulation ((system number).(CPU number))" will be displayed in the status bar of GX Works3.

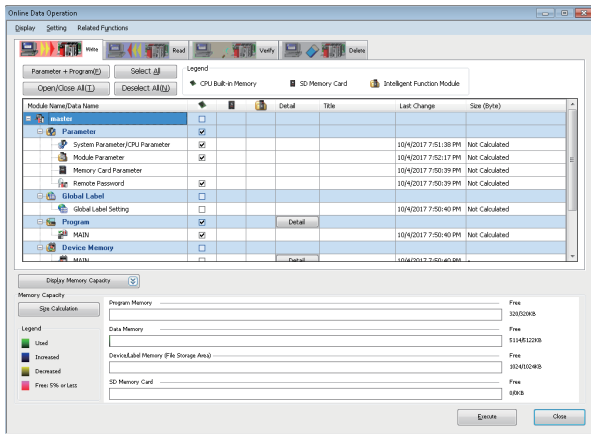

3. Select [Online] ⇒ [Write to PLC] to write parameters and programs in GX Simulator3.

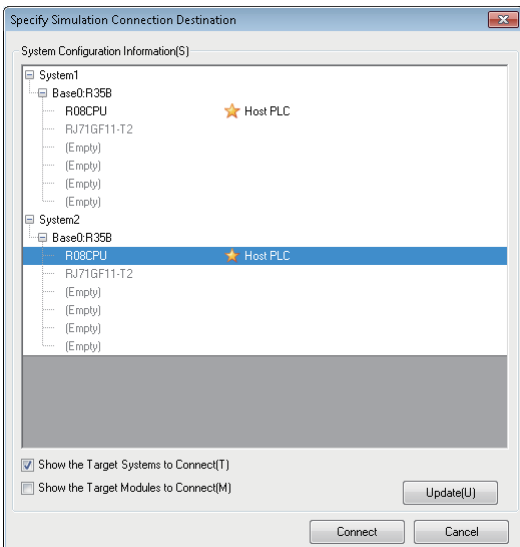

4. In GX Works3 used in step 5, select [Debug] ⇒ [Simulation] ⇒ [System Simulation] ⇒ [Connect Simulation].
  5. In the "Specify Simulation Connection Destination" screen, select the CPU module of a local station, and click the [Connect] button.
- "Simulation ((system number).(CPU number))" will be displayed in the status bar of GX Works3.

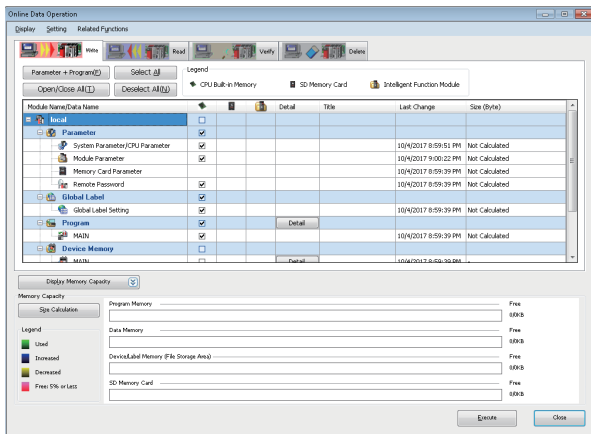

6. Select [Online] ⇒ [Write to PLC] to write parameters and programs in GX Simulator3.

## ■ Simulating

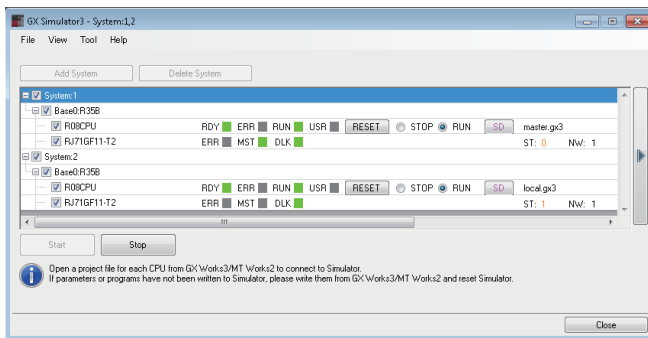

1. In the GX Simulator3 screen, click the [RESET] button in the row of the CPU module of a local station.
2. In the GX Simulator3 screen, select "RUN" in the row of the CPU module of a local station.
3. In the GX Simulator3 screen, click the [RESET] button in the row of the CPU module of the master station.
4. In the GX Simulator3 screen, select "RUN" in the row of the CPU module of the master station.
5. In both GX Works3 projects which control each of the master station and the local station, select [Online] ⇒ [Monitor] ⇒ [Start Monitoring].

The system simulation starts.

## Precautions

For the considerations for a simulation of network modules, refer to the following:

☞ Page 979 Simulation of network modules

# SD memory card

Functions using an SD memory card can be simulated by creating a 'virtual SD memory card file (\*.gxsc).'

'Virtual SD memory card file' refers a file which is used as an SD memory card during a simulation.

Data saved in an SD memory card or any folders can be copied in a virtual SD memory card file. Copy files necessary for a function to be simulated.

## Operating procedure

### ■Creating a virtual SD memory card file

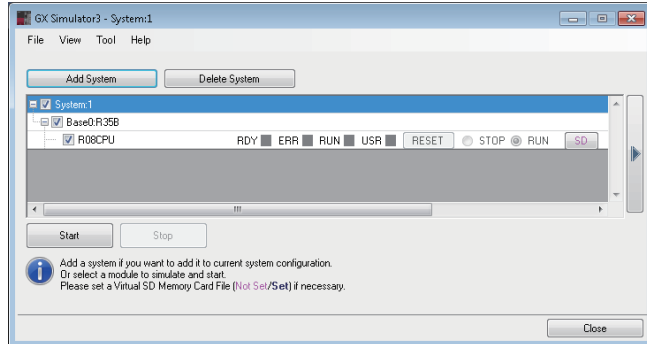

1. Start GX Simulator3. (Page 524 System Simulation)
2. Click the [SD] button of a CPU module in which a virtual SD memory card file is used.

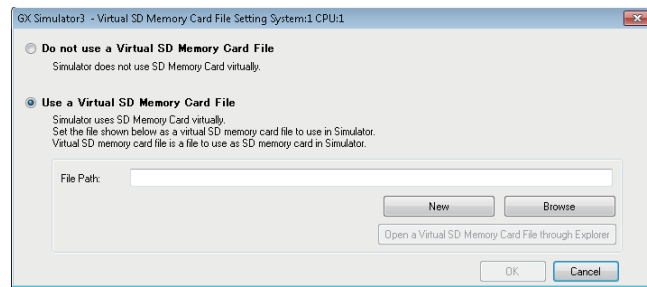

3. In the "Virtual SD Memory Card File Setting" screen, select "Use a Virtual SD Memory Card File."
4. Click the [New] button.

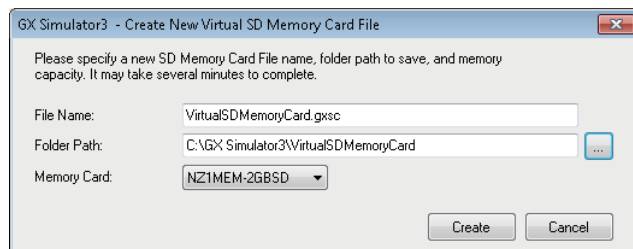

5. In the "Create New Virtual SD Memory Card File" screen, set each item.
6. Click the [Create] button.

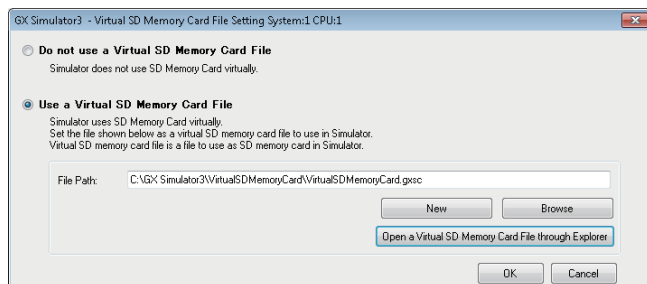

7. In the "Virtual SD Memory Card File Setting" screen, check that the file path of the virtual SD memory card file is displayed.
8. Click the [OK] button.



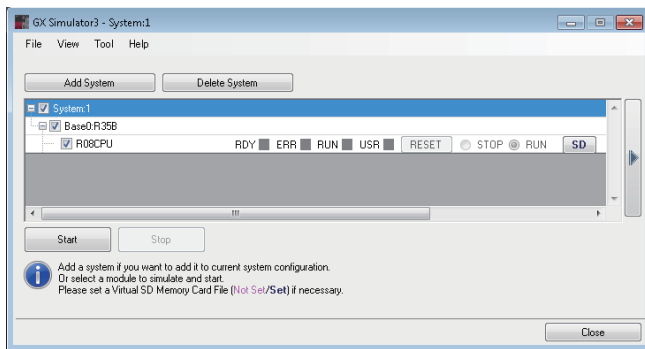

- In the GX Simulator3 screen, select the checkbox of the CPU module to simulate, and click the [Start] button.

## ■Using a created virtual SD memory card file

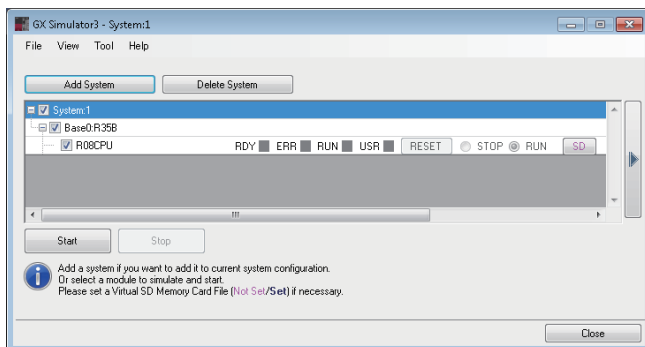

- Start GX Simulator3. (☞ Page 524 System Simulation)
- Click the [SD] button of a CPU module in which a virtual SD memory card file is used.

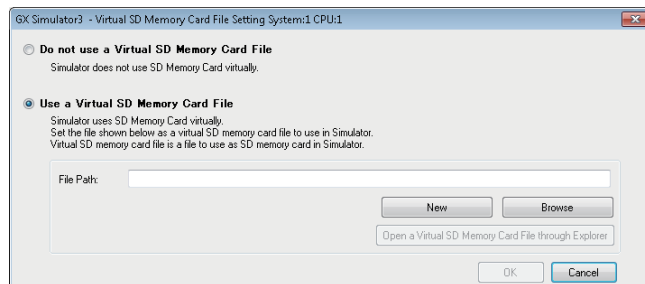

- In the "Virtual SD Memory Card File Setting" screen, select "Use a Virtual SD Memory Card File."
- Click the [Browse] button.

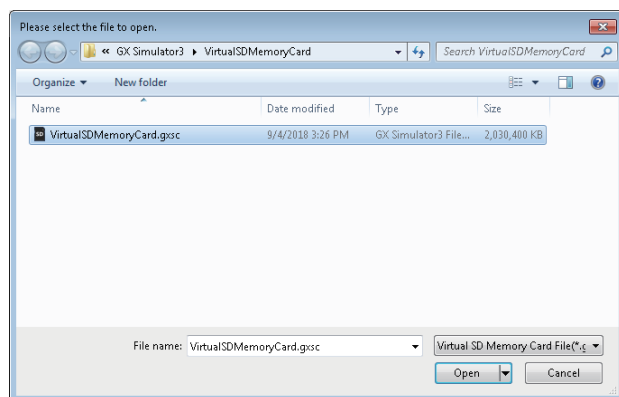

- In the displayed screen, select a file and click the [Open] button.

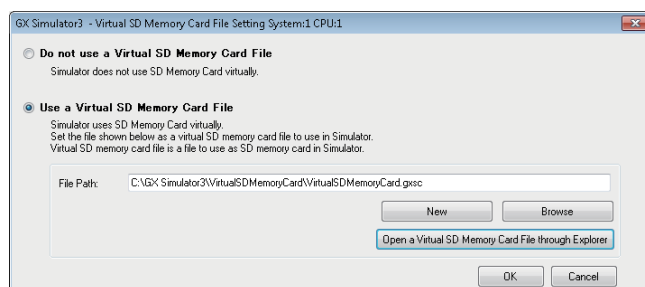

- In the "Virtual SD Memory Card File Setting" screen, check that the file path of the virtual SD memory card file is displayed.
- Click the [OK] button.

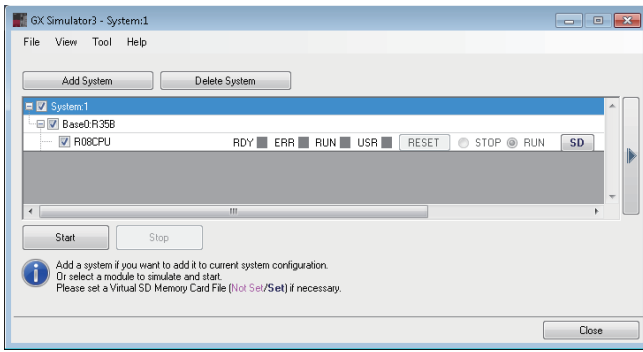

8. In the GX Simulator3 screen, select the checkbox of the CPU module to simulate, and click the [Start] button.

### Restriction

The maximum size of a creatable virtual SD memory card file depends on the combination of the version of Windows and the file system of the disk.

Therefore, it may fail to create a virtual SD memory card file regardless of the free space on the disk.

### Point

A virtual SD memory card file can be opened on the explorer by clicking the [Open a Virtual SD Memory Card File through Explorer] button in the "Virtual SD Memory Card File Setting" screen.

In the opened file, data that cannot be written or read by operating in the "Online Data Operation" screen, such as the user web page created by using the web server function, can be saved.

# Saving a simulation environment file

The system configuration added to the system simulation and data written in GX Simulator3 can be saved as a simulation environment file.

Before saving data, stop all simulations.

## Window

Select [File] ⇒ [Save Simulation Environment] in the GX Simulator3 screen.

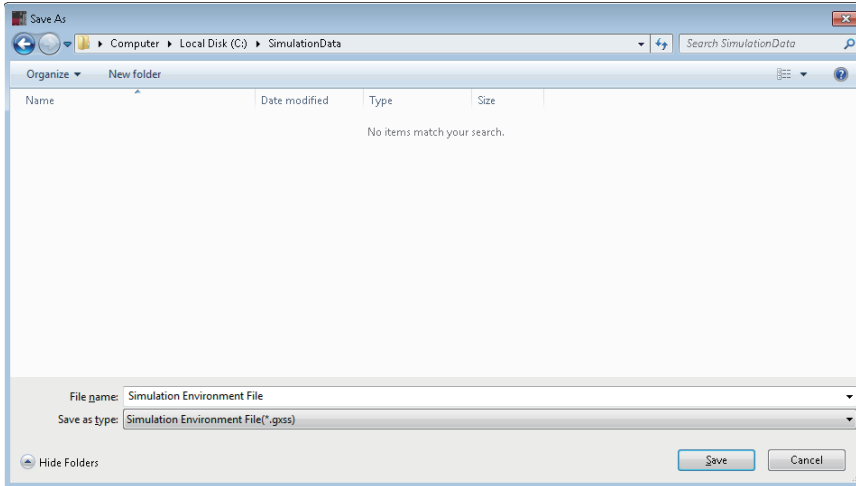

## Operating procedure

Set each item and click the [Save] button.

## Data list

The following data written to GX Simulator3 is saved as a simulation environment file.

Module type	Data
PLC CPU	System parameter, CPU parameter, module parameter, module extended parameter, remote password, global label setting, global label assignment information, program file, FB file, FUN file, initial label value file, file register, initial device value, device comment, device/label within a latch range, event history, device data storage file
Motion CPU	Program, parameter, backup data, history of current value, event history, device within a latch range
Simple motion	Positioning data, block start data, parameter, servo parameter (RD77MS, FX5-40SSC-S, and FX5-80SSC-S only), mark detection, synchronous control parameter, cam data, backup data
CC-Link IE TSN compatible motion module	Motion program, FB/FUN, CLASS, motion program execution condition, label setting, label default value setting, interface type definition, structure type definition, enumeration type definition, operation profile (csv format), operation profile (zip format), project control data for engineering tool, motion event history, position data history file, boot log, boot log (at previous startup), module extended parameter open information, logging setting file (json format), logging data file (csv format), logging data file (json format), axis absolute position data
CC-Link IE TSN compatible motion module (simple motion mode)	Positioning data, block start data, parameter, mark detection, synchronous control parameter, cam data, backup data, event history, label setting, global label assignment information, label default value setting

## Opening a simulation environment file

---

A simulation environment can be restored by opening a saved simulation environment file.

### Window

Select [File] ⇒ [Open Simulation Environment] in the GX Simulator3 screen.

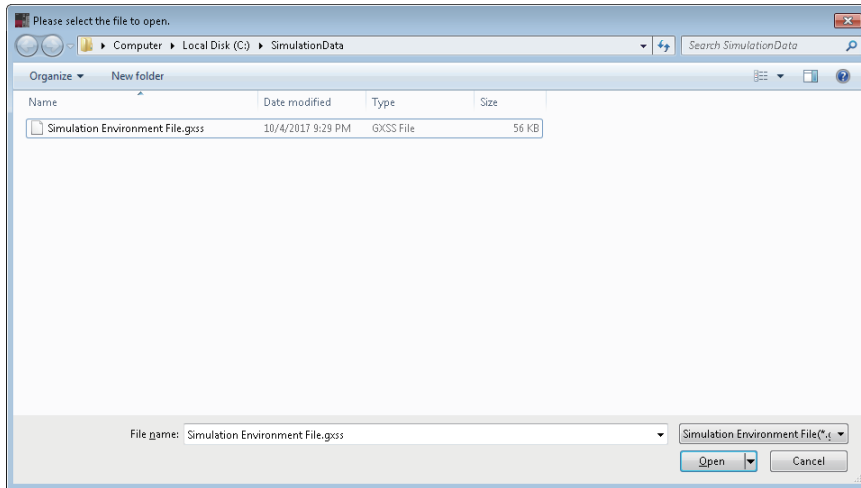

### Operating procedure

Select a simulation environment file to open, and click the [Open] button.

### Precautions

If the contents of the restored simulation environment and the project connected do not match, an error may occur in GX Simulator3.

After opening a simulation environment file, check if the data of GX Simulator3 and the project match by using the verification function.

When the verification result is a mismatch, data in GX Simulator3 and the project data can be matched using 'Read from PLC.'

## Ending a system simulation

---

### Operating procedure

Click the [Close] button in the GX Simulator3 screen.

#### Point

To disconnect with the virtual system without closing the GX Simulator3 screen, perform the following operation.

- [Debug] ⇒ [Simulation] ⇒ [System Simulation] ⇒ [Disconnect Simulation]

When restarting the system simulation, perform the following operation.

- [Debug] ⇒ [Simulation] ⇒ [System Simulation] ⇒ [Connect Simulation]

# 11.4 Simulation of External Device Operations

This section explains the method for debugging a program using the 'I/O System Setting' function.

## I/O System Setting function

The I/O System Setting is a function to enable a debug by simulating operations of input/output devices (without changing a program.)

11

### Precautions

- When the simulator is in STOP, the 'I/O System Setting' function does not run. At the timing of STOP to RUN, it starts performing from the beginning of the conditions described in the I/O system setting data.
- Since a label is acquired from a project being open at the first execution time of the I/O System Setting, the label that edited and written to the simulator after startup is not applied. Close the "I/O System Setting" screen and start it again.

## Execution procedure of I/O System Setting function

1. Start GX Simulator3. (☞ Page 522 Simulation)
2. Set GX Simulator3 to "STOP."
3. Display the "I/O System Setting" screen. (☞ Page 548 Executing I/O System Setting function)
4. Output the template file of the setting data. (☞ Page 549 Outputting the template of setting data)
5. Edit the outputted file. (☞ Page 550 Creating setting data)
6. Register devices/labels to monitor in a watch window. (☞ Page 637 Checking Current Values by Registering Devices/Labels)
7. Open the edited file. (☞ Page 554 Opening setting data)
8. The following shows the procedure to run an I/O system. (☞ Page 554 Executing the I/O system)
9. Set GX Simulator3 to "RUN."

# Executing I/O System Setting function

Set the devices to be used in the I/O System Setting, then execute the simulation.

## Window

### ■Simulation of a CPU module

Select [Tool] ⇒ [I/O System Setting] in the GX Simulator3 screen.

### ■System simulation

1. Select [Tool] ⇒ [Start I/O System Setting] in the GX Simulator3 screen.

The "GX Simulator3 I/O System Setting" screen appears.

2. Set each items in the "GX Simulator3 I/O System Setting" screen, and click the [OK] button.

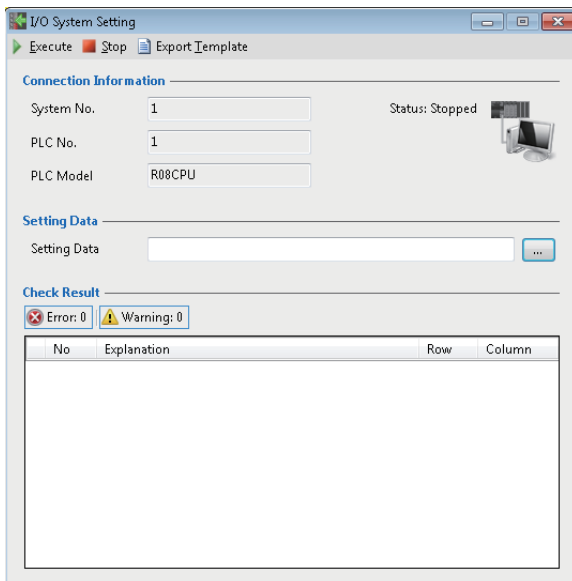

## Outputting the template of setting data

The following shows the procedure to output a template for I/O system setting data.

### Operating procedure

Select the [Export Template] on the "I/O System Setting" screen.

The template for I/O system setting data is output as a CSV format file (template file).

### ■ Template file

#### Window

(1)	//I/O System Setting Data					
	//Control Record					
	//Record Type	Comment	GX Works3 Project Path	PLC No.	Reserve	
		1	C:\Users\PROJECT1.gx3			
(2)	//Data Record					
	//Record Type	Setting No.	Conditions	Timer (ms)	Output	Reserve
	//2	1	Y0=TRUE AND (Y1=TRUE OR LDP(TRUE, Y2))	100	X0=TRUE	
	//2	1			D0=100	
	//2	2	Label1=TRUE AND Label2=TRUE	50	Label3=TRUE	
	//2	2			Label4=200	
	//2	3	LDF(TRUE, Y3)	0	X1=TRUE	
	//2	3			D10=10	
	//2	4	INIT	1000	X101=TRUE	
	//2	5	Y0=TRUE	100	X0.10=TRUE	
(3)	//End Record					
	//Record Type	Reserve				
		3				

### Displayed items

Item	Description		
		Output	Edit*1
(1) Control record	Record Type	'1' (value indicating the control record) is output.	Enter '1.' (Required)
	Comment	A comment is output.	Enter a comment (Up to 50 characters).
	GX Works3 Project Path	The path of the GX Works3 project running a simulator is output.	Enter the path of the GX Works3 project running a simulator.
	PLC No.	A CPU number (1 to 8) is output.	Enter a CPU number (1 to 8).
	Reserve	—	
(2) Data record	Record Type	'2' (value indicating the data record) is output.	Enter '2.'
	Setting No.	A number (1 to 1023) set for a condition is output in ascending order.	Enter a number (1 to 1023) for a condition in ascending order. (Required) When setting multiple pieces of output for one condition, enter the same number to each of them.
	Conditions	Conditions delimited by a space are output.	Enter a condition (up to 256 characters) delimited by a space. (Required only for the first cell) Up to six conditions can be combined in logical operation.
	Timer (ms)	The delay time (-1 to 1000) from when a condition is satisfied to when an instruction is executed is output.	Enter the delay time (-1 to 1000) from when a condition is satisfied to when an instruction is executed. (Required only for the first row) • When entering both 'CONTINUE' as a condition and '-1' as an input timer, the output differs for every scan under the same condition.*2 • When using a process response operation, enter '*'.*
	Output	An output formula is output (up to 100 characters).	Enter an output formula (up to 100 characters). (Required) When setting multiple pieces of output for one condition, enter the second or subsequent output formula to the next line. Up to 50 output formulas can be entered for each setting number.
	Reserve	—	

Item		Description	
		Output	Edit*1
(3) End record	Record Type	'3' (value indicating the end record) is output.	Enter '3.' (Required)
	Reserve	—	

\*1 When creating setting data by editing the template file, edit the file by following the descriptions in this column.

\*2 The following shows the description example when combining 'CONTINUE' and '-1.'

- 2,1,Y0=TRUE, 1, X0:=TRUE (Only the first scan is performed.)
- 2,2,CONTINUE, -1, X1:=FALSE (Only the second scan is performed.)
- 2,3,CONTINUE, -1, X2:=FALSE (Only the third scan is performed.)

## Creating setting data

The following shows the procedure to create setting data by editing the template file.

### Operating procedure

Open the template file output in spreadsheet software or the like, and directly edit the items in the file. (Page 549 Template file)

For devices/labels available in editing a template file, refer to the following:

Page 555 Available devices/labels

**Ex.**

Example for editing a template file

//I/O System Setting Data					
//Control Record					
//Record Type	Comment	GX Works3 Project Path	PLC No.	Reserve	
1		C:\Users\PROJECT1_gx3			
//Data Record					
//Record Type	Setting No.	Conditions	Timer (ms)	Output	Reserve
//2	1	Y0=TRUE AND (Y1=TRUE OR LDP(TRUE, Y2))	100	X0:=TRUE	
//2	1			D0:=100	(1)
//2	2	Label1=TRUE AND Label2=TRUE	50	Label3=TRUE	
//2	2			Label4=200	(2)
//2	3	LDF(TRUE, Y3)	0	X1:=TRUE	
//2	3			D10:=10	(3)
//2	4	INIT	1000	X101:=TRUE	
//2	4				(4)
//2	5	Y0=TRUE	100	X0.10:=TRUE	
//2	5				(5)
//2	6	CONTINUE	1000	D100.D=D100.D+65536	
//2	6				(6)
//2	7	M0	0	D20.E=INT_TO_REAL(wLabel5)	
//2	7				(7)
//2	8	M0	*	D22.E=LAG_DED(0,100,0,100,60,0,D20.E)	
//2	8				(8)
//2	9	M0	0	eLabel6=D22.E	
//2	9				(9)
//End Record					
//Record Type	Reserve				
3					

Item	Example	Notation in a template file
(1) Basic device setting	When 'Y0' is turned ON and 'Y1' is also turned ON, or 'Y0' is turned ON and 'Y2' rises, after 100 milliseconds, 'X0' turns ON. '100' is assigned to 'D0'	2,1,"Y0=TRUE AND (Y1=TRUE OR LDP(TRUE, Y2))",100,X0:=TRUE, 2,1,,,D0:=100,
(2) Label specification	When 'Label1' is turned ON and 'Label2' is also turned ON, after 50 milliseconds, 'Label3' turns ON. '200' is assigned to 'Label4.'	2,2,Label1=TRUE AND Label2=TRUE,50,Label3:=TRUE, 2,2,,,Label4:=200,
(3) Instant specification	When 'Y3' falls, 'X1' turns ON immediately. '10' is assigned to 'D10.'	2,3,"LDF(TRUE, Y3)",0,X1:=TRUE, 2,3,,,D10:=10,
(4) After initialization specification	After 1 second from execution, 'X101' turns ON.	2,4,INIT,1000,X101:=TRUE,
(5) Successive bit device output	When 'Y0' is turned ON, after 100 milliseconds, 'X0' to 'X10' turn ON.	2,5,Y0=TRUE,100,X0..10:=TRUE,
(6) Timing chart 32-bit integer addition output	'65536' is added to 'D100' after 1 second from the above pattern.	2,6,CONTINUE,1000,D100.D:=D100.D+65536,
(7) Conversion from 16-bit integer to double precision	When 'M0' is ON, the data type of 'wLabel5' is converted from 16-bit integer to single precision. The converted value is assigned to 'D20.'	2,7,M0,0,D20.E:=INT_TO_REAL(wLabel5),
(8) Process response operation	LAG_DED operation is executed every one second. • D20: Input value • D22: Output value	2,8,M0,*,"D22.E:=LAG_DED(0,100,0,100,60,0,D20.E)",
(9) Substitution of a device value to a label value	The value of 'D22' is assigned to 'eLabel6.'	2,9,M0,0,eLabel6:=D22.E,





Set the conditions by using the following character strings and symbols.

○: Available, ×: Not available

Category	String/Symbol	Description	Availability				Usage example
			Condition	Output	Device		
					Bit	Word	
Instruction	CONTINUE <sup>*1,*2</sup>	Keeps the previous condition	○	×	×	×	2,1,Y0=TRUE,1,X0:=TRUE 2,2,CONTINUE,1,X0:=FALSE 2,3,CONTINUE,1,LOOP
	LOOP <sup>*1,*3</sup>	Repeats (It is used with "CONTINUE")	×	○	×	×	
	INIT <sup>*1,*4</sup>	Executes after initialization only one time	○	×	×	×	
	LDP <sup>*5</sup>	LDP function	○	×	○	×	LDP(TRUE,Y0)
	LDF <sup>*5</sup>	LDF function	○	×	○	×	LDF(TRUE,Y0)
	DIRECT <sup>*6</sup>	Process response operation: direct connection	×	○	×	○	D22:E := DIRECT(0, 100, 0, 100, D20:E)
	REVERSE <sup>*6</sup>	Process response operation: direct connection (output inversion)	×	○	×	○	D22:E := REVERSE(0, 100, 0, 100, D20:E)
	LAG_DED <sup>*6</sup>	Process response operation: primary delay + dead time	×	○	×	○	D22:E := LAG_DED(0, 100, 0, 100, 60, 0, D20:E)
	LAG_DED_REV <sup>*6</sup>	Process response operation: primary delay + dead time (output inversion)	×	○	×	○	D22:E := LAG_DED_REV(0, 100, 0, 100, 60, 0, D20:E)
	INT_TO_REAL <sup>*6</sup>	Converts 16-bit integer to single precision	×	○	×	○	D0:E:=INT_TO_REAL(1) D0:E:=INT_TO_REAL(W0) D0:E:=INT_TO_REAL(wLabel1)
	REAL_TO_INT <sup>*6,*7</sup>	Converts single precision to 16-bit integer	×	○	×	○	D0:=REAL_TO_INT(1.5) D0:=REAL_TO_INT(W0:E) D0:=REAL_TO_INT(eLabel1)
	DINT_TO_REAL <sup>*6</sup>	Converts 32-bit integer to single precision	×	○	×	○	D0:E:=DINT_TO_REAL(1) D0:E:=DINT_TO_REAL(W0:D) D0:E:=DINT_TO_REAL(dLabel1)
	REAL_TO_DINT <sup>*6,*7</sup>	Converts single precision to 32-bit integer	×	○	×	○	D0:D:=REAL_TO_DINT(1.5) D0:D:=REAL_TO_DINT(W0:E) D0:D:=REAL_TO_DINT(eLabel1)
Operator	:= <sup>*8,*9</sup>	Assigns	×	○	○	○	Bit X0:=TRUE
			Word D0:=1				
			Device D0:=D10				
			Label D0:=wLabel1				
	+ <sup>*8</sup>	Adds	×	○	×	○	D0:=D0+1 D0:=D0+D1 D0:=D1+wLabel1 D0:U:=1+D1:U
	- <sup>*8</sup>	Subtracts	×	○	×	○	D0:=D0-1 D0:=D0-D1 D0:=D1-wLabel1 D0:U:=1-D1:U
	> <sup>*9,*10</sup>	Compares	○	×	×	○	D0>0
	< <sup>*9,*10</sup>		○	×	×	○	D0<0
	>= <sup>*9,*10</sup>		○	×	×	○	D0>=0
	<= <sup>*9,*10</sup>		○	×	×	○	D0<=0
	= <sup>*9,*10,*11</sup>		○	×	○	○	D0=0
	<> <sup>*9,*10,*11</sup>		○	×	○	○	D0<>0
	AND		Combines conditions using 'AND'	○	×	×	×
OR	Combines conditions using 'OR'	○	×	×	×	Y0=TRUE OR Y1=FALSE	

Category	String/Symbol	Description	Availability				Usage example	
			Condition	Output	Device			
					Bit	Word		
Device type specifier <sup>*12</sup>	:U	Uses a device as a 16-bit non-negative integer	○	○	×	○	Condition	D0:U=0
							Output	D0:U:=0
	:D	Uses a device as a 32-bit integer	○	○	×	○	Condition	D0:D=0
							Output	D0:D:=0
	:UD	Uses a device as a 32-bit non-negative integer	○	○	×	○	Condition	D0:UD=0
							Output	D0:UD:=0
	:E	Uses a device as FLOAT [Single Precision]	○	○	×	○	Condition	D0:E=0
							Output	D0:E:=0
	:ED	Uses a device as FLOAT [Double Precision]	○	○	×	○	Condition	D0:ED=0
							Output	D0:ED:=0
Symbol	.. <sup>*11,*13,*14</sup>	Specifies device range Example: X10..20	×	○	○	×	X10..20:=TRUE X10..20:=X0 X10..20:=Label1	
	( <sup>*15</sup>	Open bracket	○	×	○	○	Y0=TRUE AND (Y1=TRUE OR Y2=FALSE)	
	) <sup>*15</sup>	Close bracket	○	×	○	○		
Constant	TRUE <sup>*16</sup>	Turns ON a bit device	○	○	○	×	Condition	Y0=TRUE
							Output	X0:=TRUE
	FALSE	Turns OFF a bit device	○	○	○	×	Condition	Y0=FALSE
							Output	X0:=FALSE

- \*1 Original description methods in the I/O system setting.
- \*2 An error occurs if the character is written at the top of a data record.
- \*3 When it is used without combining with "CONTINUE," an error does not occur but "LOOP" is ignored. An error occurs if "LOOP" is written at the top of a data record.
- \*4 The timing that the execution transition of "INIT" is enabled are as follows:
  - The I/O system setting was executed while the simulator is running
  - The simulator was switched to RUN state while the I/O System Setting is executing
- \*5 Use both instructions according to the Structured Text notation.  
 MELSEC iQ-R Programming Manual (CPU Module Instructions, Standard Functions/Function Blocks)
- \*6 If the data type of devices or labels used for arguments or output destination does not match with the ones specified by an instruction, an error will occur.
- \*7 For operations when a specific value is specified for an instruction argument, refer to the following:  
 Page 553 When an invalid value is specified for an instruction argument
- \*8 If devices or labels with different data type are set to the terms of substitution expression, addition expression, or subtraction expression, an error will occur.
- \*9 A device whose data type is not specified can be calculated with the Word [Signed] type constant or Word [Unsigned] type constant. In that case, the data type of the device is determined according to the data type of the constant.
- \*10 To compare devices or labels each other, data types need to be consistent.
- \*11 To compare bit type devices using a sign of equality or inequality, device and constant must be a set.
- \*12 For devices to which a device type specifier can be added, refer to the following:  
 MELSEC iQ-R Programming Manual (Program Design)
- \*13 A range for an assignment source cannot be specified.
- \*14 'A' to 'F' can be entered as device numbers for a device written in hexadecimal format. However, an error will occur if the order of the device numbers is changed in descending order. (Example: X10..2)
- \*15 There is no limit to the number of brackets if the combination of open brackets and close brackets matches.
- \*16 Only bit devices such as 'Y0' can be used for conditions. (When only 'Y0' is described, the 'Y0' will be 'TRUE'.)

**■When an invalid value is specified for an instruction argument**

If an invalid value is specified for an instruction argument, the value of the argument will be changed as follows.

Instruction	Argument	Incorrect value	Changed value
REAL_TO_INT	Device/label	-0	0
		Denormalized number	
		NaN	
		$\pm\infty$	
	Constant	E32768 or more	32767
	Device/label	32768 or more	
	Constant	E-32769 or less	-32768
	Device/label	-32769 or less	
REAL_TO_DINT	Device/label	-0	0
		Denormalized number	
		NaN	
		$\pm\infty$	
	Constant	E2147483648 or more	2147483647
	Device/label	2147483648 or more	
	Constant	E-2147483649 or less	-2147483648
	Device/label	-2147483649 or less	

**Precautions**

A row starting with '/' is regarded as a comment, and therefore it is skipped.

## Opening setting data

The following shows the procedure to open created setting data.

### Operating procedure

1. Click the [...] button in the setting data column on the "I/O System Setting" screen.
2. Select a file, then click the [Open] button.

### Precautions

Language-specific characters of the operating system are included in the setting data.

If the language font to display is not installed on the personal computer, some characters may be garbled.

## Executing the I/O system

The following shows the procedure to run an I/O system after checking the setting data.

### Operating procedure

Select [Execute] on the "I/O System Setting" screen.

If an error is included in the check result, correct the setting data and run the system again.

### Precautions

If a function, device, or label which is not supported by the 'I/O System Setting' function in GX Works3 is included in the setting data, an error will occur.

## Stopping the I/O system

The following shows the procedure to stop an I/O system.

### Operating procedure

Select [Stop] on the "I/O System Setting" screen.

# Available devices/labels

## Device

The following devices are available.

Category	Device name	Symbol	
User device	Input	X	
	Output	Y	
	Internal relay	M	
	Latch relay	L	
	Link relay	B	
	Annunciator	F	
	Link special relay	SB	
	Timer	T	TS
			TN
			T
	Retentive timer	ST	STS
			STN
			ST
	Long timer	LT	LTS
			LTN
			LT
	Long Retentive Timer	LST	LSTS
			LSTN
			LST
	Counter	C	CS
CN			
C			
Long counter	LC	LCS	
		LCN	
		LC	
Data register	D		
Link register	W		
Link special register	SW		
System device	Special relay	SM	
	Special register	SD	
Link direct device	Link input	J□X	
	Link output	J□Y	
	Link relay	J□B	
	Link special relay	J□SB	
	Link register	J□W	
	Link special register	J□SW	
Module access device	Module access device	U□G	
CPU buffer memory access device	CPU buffer memory access device	U3E□G	
		U3E□HG	
File register	File register	R	
		ZR	
Refresh data register	Refresh data register	RD	
Constant	Decimal constant	K	
	Hexadecimal constant	H	
	Real constant	E	

Category	Device name	Symbol	
Safety device	Safety input	SAIX	
	Safety output	SAIY	
	Safety internal relay	SAIM	
	Safety link relay	SAIB	
	Safety special relay	SAISM	
	Safety data register	SAID	
	Safety link register	SAIW	
	Safety special register	SAISD	
	Safety timer	SAIT	TS
			TN
			T
	Safety retentive timer	SAIST	STS
			STN
			ST
Safety counter	SAIC	CS	
		CN	
		C	

## Precautions

The following devices are not available:

- Local device
- Digit-specified bit device
- Bit-specified word device

In addition, a constant device cannot be used as the destination for a device value in an assignment statement.

## Label

The following labels are available.

- Global label
- Module label
- Labels of which class is "VAR\_GLOBAL"/"VAR\_GLOBAL\_RETAIN"
- Labels except for string (32)/string [Unicode] (32)/pointer type

## Precautions

- A label to which a device unavailable for outputs or conditions for data record is assigned cannot be used when creating setting data. (Page 555 Device)
- For the labels of timer/retentive timer/counter type, a contact/coil/current value need to be specified as same as devices.
- A device and label cannot be used as an array index.

# 12 SETTING ROUTE TO CPU MODULE

This chapter explains the setting method of connection destination for accessing a CPU module from a personal computer with GX Works3.

## 12.1 Specification of Connection Destination

This section explains the setting method of communication routes, including the interfaces both the personal computer and CPU module, and the routing networks, for accessing a CPU module in the "Specify Connection Destination" screen.

Up to 128 settings for connection destinations is created.

The same module type is required to be set for both a project and a CPU module to be accessed.

### Changing connection destination settings

#### Window

Select data in the connection destination window and double-click it.

In another way, select [Online] ⇒ [Current Connection Destination] and change the current connection destination.

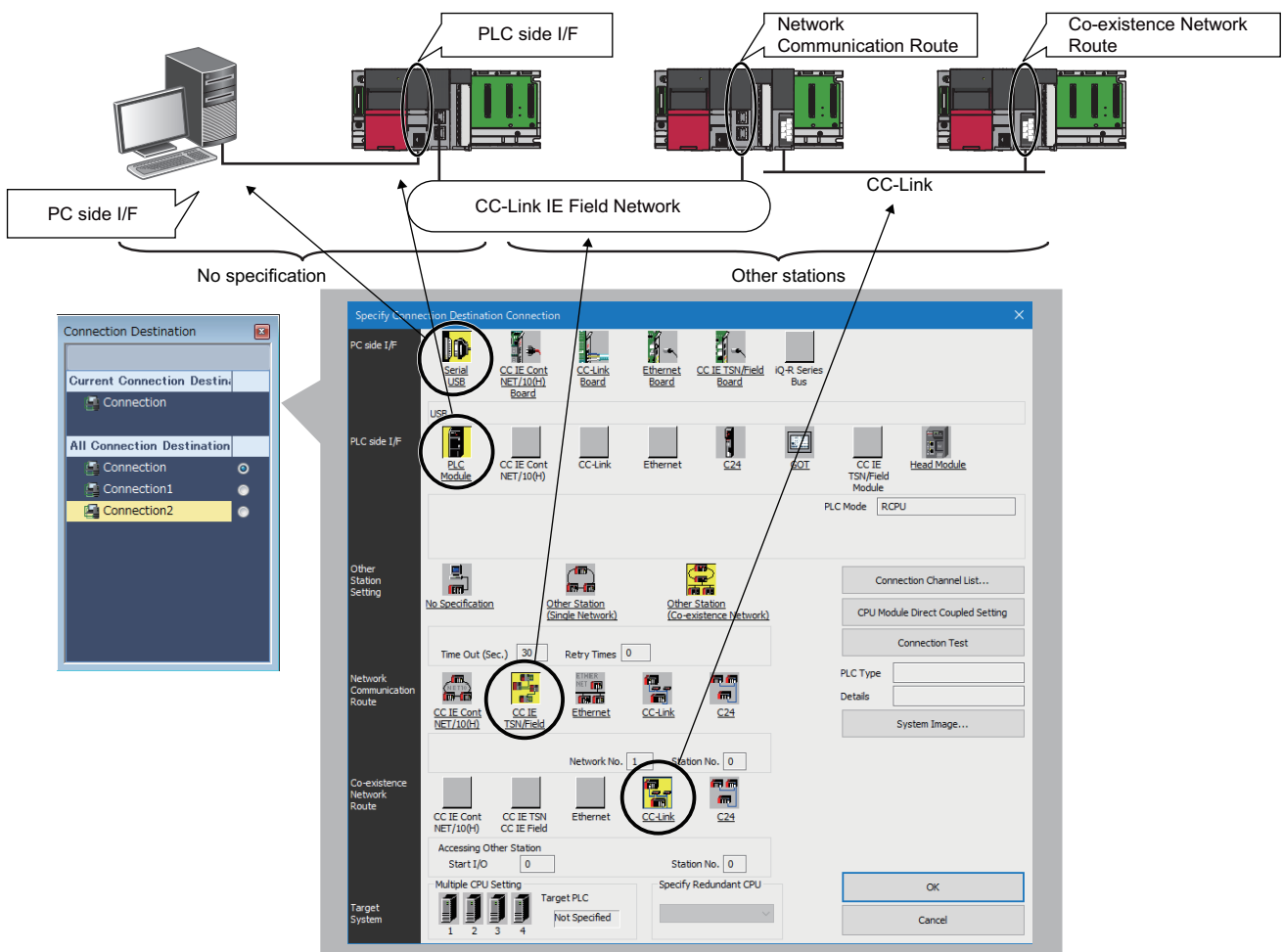

- Double-click the items underlined on the screen to set the details of each item.
- The icons colored yellow indicate that the settings have been applied.
- For FX5CPU, the icons of the unsettingable connection destination route are not displayed.
- When "Yes" is selected for the following option in a project for an FX5CPU, the "Connection Destination Simple Setting" screen appears before the "Specify Connection Destination" screen.  
 [Tool] ⇒ [Options] ⇒ "Online" ⇒ "Operational Setting" ⇒ "Show the Connection Destination Simple Setting window"

## Displayed items

Item		Description
Other Station Setting	No Specification	Specify this to access a CPU module directly connected to a personal computer.
	Other Station (Single Network) *1	Specify this to access a CPU module on another station via only one kind of network (including a multi-tier system). Ethernet, CC-Link IE Controller Network, and CC-Link IE Field Network are regarded as the same kind. When accessing a system in which those are mixed, specify "Single Network."
	Other Station (Co-existence Network) *1	Specify this to access the CPU module on another station via two kinds of network.
Network Communication Route		Select the network type, network number, station number, and start I/O number of the network to be routed through to access another station. The setting items differ depending on the selected network type.
Co-existence Network Route		Select the network type, network number, station number, and start I/O number of the network to be accessed. The setting items differ depending on the selected network type.
Target System		<ul style="list-style-type: none"><li>• Multiple CPU Setting: Specify an access destination in a multiple CPU system.</li><li>• Specify Redundant CPU: Select a system of a CPU module to be connected.</li></ul>

\*1 To specify the own station, select "No Specification."

## Precautions

- Only connection destinations that can be set in the "Specify Connection Destination" screen are acceptable.
- For the considerations when using a MELSECNET/H network module, refer to the following:

📖 MELSEC iQ-R Module Configuration Manual

## Adding connection destination settings

Add a new setting of a connection destination.

### Operating procedure

1. Right-click in the connection destination window and select [Create New Connection Destination] from the shortcut menu.
2. Set each item and click the [OK] button.

## Switching connection destinations

Switch a connection destination used as the default.

### Operating procedure

1. Select a connection destination under "All Connection Destination" in the connection destination window.
2. Right-click the connection destination and select [Set as Default Connection] from the shortcut menu.

## Displaying an image of the set connection route

Click the [System Image] button to display the set connection route in an image and check the route.

## Precautions

LHCPUs do not support this display.



# 12.2 Direct Connection

This section explains the setting method for accessing the CPU module directly connected to a personal computer. Click the [CPU Module Direct Coupled Setting] button on the "Specify Connection Destination" screen to change the settings to direct connection.

## USB connection

The following shows the setting example for accessing a CPU module on the own station with a USB from a personal computer.

FX5UCPUs and FX5UCCPUs do not support this connection.



No.	Item	Item to be selected	Internal setting	Input value
(1)	PC side I/F	Serial/USB	USB	—
(2)	PLC side I/F	PLC Module	PLC Mode	RCPU
	Other Station Setting	No Specification	Check at Communication Time	30 seconds
			Retry Times	0 time

## Ethernet connection

The following shows the setting example for accessing a built-in Ethernet CPU with Ethernet from a personal computer. Remote head modules do not support this connection.

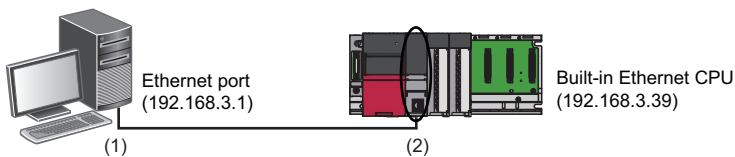

No.	Item	Item to be selected	Internal setting	Input value
(1)	PC side I/F	Ethernet Board	Adapter*1	Not Specified
			Network No.	—
			Station No.	—
			Protocol	UDP
(2)	PLC side I/F	PLC Module	Ethernet Port Direct Connection	—
	Other Station Setting	No Specification	Check at Communication Time	30 seconds
			Retry Times	0 time

\*1 No setting items for FX5CPUs

## Specifying the Ethernet adapter on the personal computer side

The Ethernet adapter on the personal computer side, which is used when directly connecting to an Ethernet port, can be specified.

If there are multiple Ethernet adapters, make sure that the Ethernet adapter that is used for communication is specified.

### Operating procedure

1. Click the [CPU Module Direct Coupled Setting] button in the "Specify Connection Destination" screen.
2. Select an adapter in the "CPU Module Direct Coupled Setting" screen, and click the [Yes] button.

The following screen is a screen example for RCPUs.

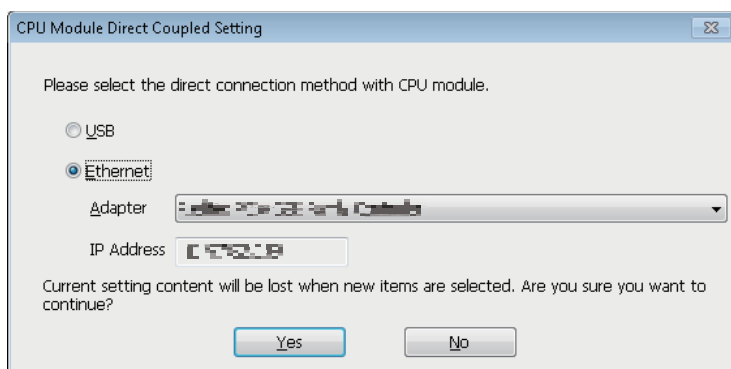

### Point

- For RCPUs and LHCPUs, the IP address assigned to a specified Ethernet adapter is saved in a project file. Even after changing adapters, if the IP address set for the adapter after the change is the same, the adapter name is applied to the settings.
- For FX5CPUs, the adapter setting is saved for each logon user of the personal computer (not saved in a project file).

### Precautions

#### ■When a warning message appears

A warning message may appear, which indicates that a function of GX Works3 is blocked by the Windows firewall.

Click the [Allow access] button, and continue the operation.

#### ■When the same IP addresses are displayed

When the [Find] button is clicked in the "PLC side I/F Detailed Setting of PLC Module" screen, the same IP addresses may be displayed in the list of the connection destination CPU.

In that case, select an adapter in the "CPU Module Direct Coupled Setting" screen. (☞ Page 560 Specifying the Ethernet adapter on the personal computer side)

### ■When communication with GX Works3 is not allowed by the Windows firewall

When the Windows firewall is enabled and communication with GX Works3 is not allowed, a timeout may occur.

To allow the communication, refer to the following procedure.

When using other software with a firewall function, refer to the manual of the software and allow the communication with GX Works3.

#### Operating procedure

1. Select [System and Security] ⇒ [Allow an app through Windows Firewall] in the control panel of Windows.
2. Click the [Change settings] button, and click the [Allow another app] button.
3. Click the [Browse] button in the "Add an app" screen, and select "GXW3.exe" in the folder where GX Works3 is installed, then click the [Add] button.

When an installation folder is not changed at the installation, the installation folder is as follows:

- 64-bit version operating system: C:\Program Files (x86)\MELSOFT\GPPW3
- 32-bit version operating system: C:\Program Files\MELSOFT\GPPW3

4. Select "Domain," "Private," and "Public" of GX Works3\*<sup>1</sup> added in the list.

\*<sup>1</sup> 'gwx3' may be displayed when a CPU/Ethernet module is searched for on the network and access through the Windows firewall is set to allow before Ethernet port direct connection.

### ■When connecting GX Works3 to an RCP/LHCPU

The settings for the specified Ethernet adapter are not applied to other MELSOFT products.

When opening a project specifying an Ethernet adapter in another personal computer, the set content for "Adapter" in the "PC side I/F Detailed Setting of Ethernet Board" screen is changed to "Not Specified."

Set the connection destination again.

When an adapter name is not displayed on the pull-down list of "Adapter," the following causes can be considered:

- An Ethernet adapter has been disabled in "Change Adapter Settings" on Windows.
- A LAN cable is not connected.
- An error has occurred in the power supply.
- A failure or malfunction has been detected.

Take corrective actions such as checking the setting contents, Ethernet board connection, and the power supply status, or replacing the Ethernet board.

## ■When connecting GX Works3 to an FX5CPU

Communication may not be established even when the connection destination has been set in the screen displayed by clicking the [CPU Module Direct Coupled Setting] button.

Set the IP address of a personal computer according to the following procedure.

### Operating procedure

1. Select [Network and Internet] ⇒ [Network and Sharing Center] ⇒ [Change adapter settings] in the control panel of Windows.
2. Select and right-click [Local Area Connection], then select [Properties] from the shortcut menu.
3. Select "Internet Protocol Version 4 (TCP/IPv4)" in the "Local Area Connection Properties" screen, and click the [Property] button.

The "Internet Protocol Version 4 (TCP/IPv4) Properties" screen appears.

4. Set the same value for the network portion of the IP addresses for a personal computer on which GX Works3 is installed and an FX5CPU.

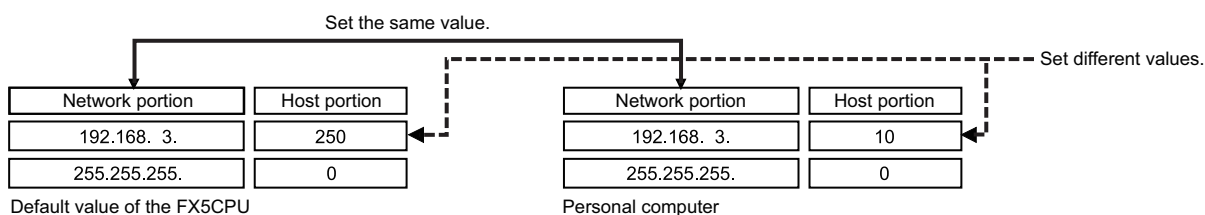

5. Restart the personal computer to enable the network setting.

## Serial connection

The following shows the setting example for accessing a CPU module on the own station via a serial port of a personal computer.

RCPUs, LHCPUs, and remote head modules do not support this connection.

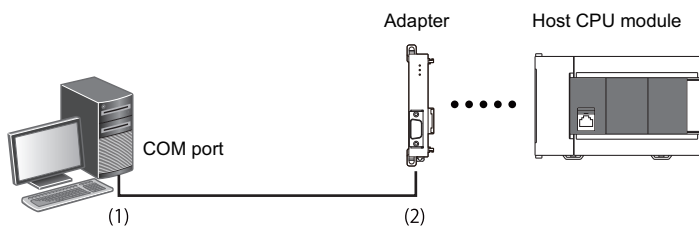

No.	Item	Item to be selected	Internal setting	Input value
(1)	PC side I/F	Serial/USB	RS-232C	—
			COM port	COM1
			Transmission Speed	115.2 Kbps
(2)	PLC side I/F	PLC Module	PLC Mode	FX5CPU
	Other Station Setting	No Specification	Check at Communication Time	30 seconds
			Retry Times	0 time

## 12.3 Accessing via Network (Single Network)

This section shows the setting example for accessing a CPU module on another station via a single network after accessing a built-in Ethernet CPU from a personal computer.

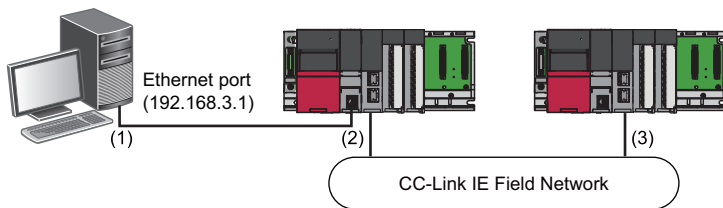

No.	Item	Item to be selected	Internal setting	Input value		
(1)	PC side I/F	Ethernet Board	Adapter <sup>*1</sup>	Not Specified		
			Network No.	—		
			Station No.	—		
			Protocol	UDP		
(2)	PLC side I/F	PLC Module	Ethernet Port Direct Connection	—		
			Other Station Setting	Other Station (Single Network)	Check at Communication Time	30 seconds
			Retry Times		0 time	
(3)	Network Communication Route	CC IE TSN CC IE Field	Network No.	1		
			Station No.	0		

\*1 No setting items for FX5CPUs

## Access via Ethernet module

The following shows the setting example for accessing a CPU module via a CC-Link IE built-in Ethernet module from a personal computer.

It is the same settings when accessing a CPU module via the network part of RnENCPU.

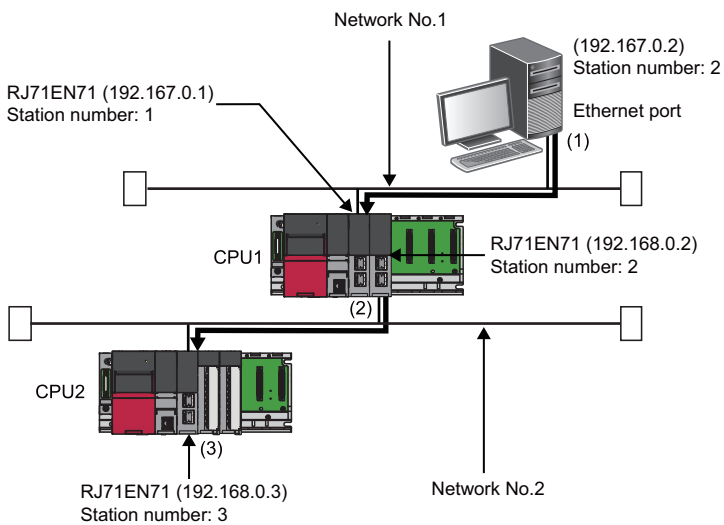

No.	Item	Item to be selected	Internal setting	Input value
(1)	PC side I/F	Ethernet Board	Adapter <sup>*1</sup>	Not Specified
			Network No.	1
			Station No.	2
			Protocol	TCP
(2)	PLC side I/F	Ethernet Module	PLC Type	RJ71EN71
			Network No.	—
			Station No.	1
			IP Address	192.167.0.1
			IP Input Format	DEC
			Station No. <-> IP Information <sup>*1</sup>	Automatic Response System
	Other Station Setting	Other Station (Single Network)	Check at Communication Time	30 seconds
		Retry Times	0 time	
(3)	Network Communication Route	Ethernet	Other station in the same loop or access to multilevel system <sup>*1</sup>	Network No. 2
				Station No. 3

\*1 No setting items for FX5CPUs

### Precautions

- To communicate with multiple personal computers where GX Works3 is running by connecting them to a single CPU module, use TCP/IP or UDP/IP communication.
- For a multiple network system, setting the network dynamic routing is required. (RCPUs only)

MELSEC iQ-R Ethernet User's Manual (Application)

#### ■When the same IP addresses are displayed

When the [Find] button is clicked in the "PLC side I/F Detailed Setting of Ethernet Module" screen, the same IP addresses may be displayed in the list of the connection destination Ethernet modules.

In that case, select an adapter in the "PC side I/F Detailed Setting of Ethernet Board" screen.

# 12.4 Accessing via Network (Co-existence Network)

The following shows the setting example for accessing a CPU module via a co-existence network from a personal computer. LHCPUs and FX5CPUs do not support this access.

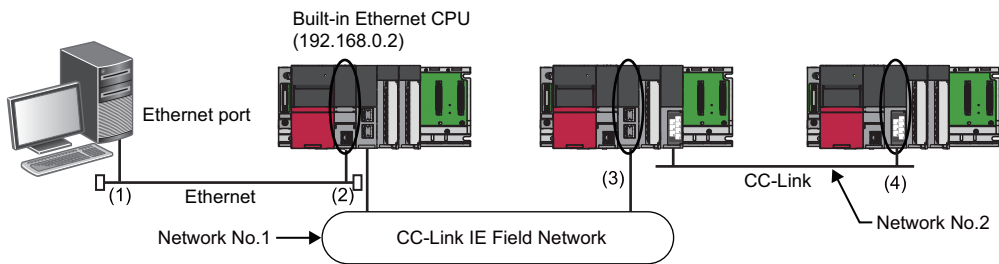

No.	Item	Item to be selected	Internal setting	Input value	
(1)	PC side I/F	Ethernet Board	Adapter	Not Specified	
			Network No.	1	
			Station No.	1	
			Protocol	TCP	
(2)	PLC side I/F	PLC Module	Connection via HUB	IP Address	192.168.0.2
				Response Wait Time	2 seconds
	Other Station Setting	Other Station (Co-existence Network)	Check at Communication Time		30 seconds
			Retry Times		0 time
(3)	Network Communication Route	CC IE TSN	Network No.	1	
		CC IE Field	Station No.	0	
(4)	Co-existence Network Route	CC-Link	Start I/O	20	
			Station No.	1	



# 12.5 Accessing via Serial Communication Module

This section explains the setting method for accessing a CPU module on the own station or on another station via a serial communication module.

LHCPUs and FX5CPUs do not support this access.

## Connection on a 1:1 basis

The following shows the setting example for accessing a CPU module by connecting a personal computer and a serial communication module.

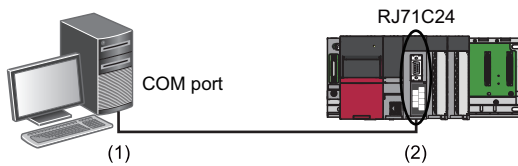

No.	Item	Item to be selected	Internal setting	Input value
(1)	PC side I/F	Serial/USB	COM port	COM1
			Transmission Speed	115.2 Kbps
(2)	PLC side I/F	C24	PLC Type	RJ71C24
			Station No.*1	—
			Parity	—
			Sum Check	—
	Other Station Setting	No Specification	Check at Communication Time	—
			Retry Times	—

\*1 Set the same station number as RJ71C24.  
Set the station number on the Module Parameter screen.

## Connection on a 1:n basis

The following explains the method for accessing a CPU module on another station from a personal computer in a system composed of multiple CPU modules.

### Access via a serial communication module

The following shows the setting example for accessing a CPU module on another station via a serial communication module. When connecting via serial communication module, the module parameter for MELSOFT connection is required. For details, refer to the following:

📖 MELSEC iQ-R Serial Communication Module User's Manual(Application)

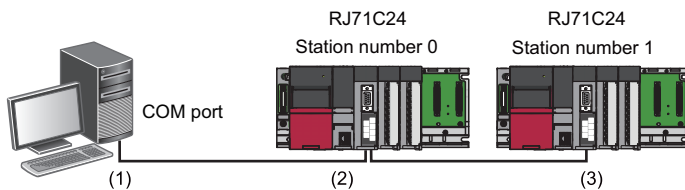

No.	Item	Item to be selected	Internal setting	Input value
(1)	PC side I/F	Serial/USB	COM port	COM1
			Transmission Speed	115.2 Kbps
(2)	PLC side I/F	C24	PLC Type	RJ71C24
			Station No.	0
			Parity	Odd
			Sum Check	—
			Other Station Setting	Other Station (Single Network)
			Retry Times	0 time
(3)	Network Communication Route	C24	Start I/O	20
			Station No.	1

### Direct connection of a CPU module

The following shows the setting example for accessing a CPU module on another station via a serial communication module by connecting a personal computer and a CPU module directly.

A programmable controller CPU on another station can be accessed only with CH2 of a serial communication module. Access to an LHCPU is not available.

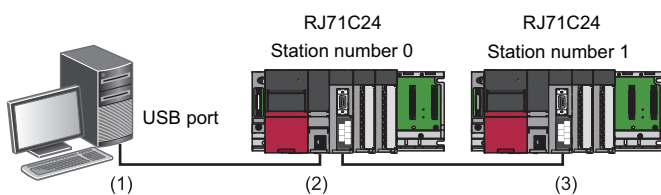

No.	Item	Item to be selected	Internal setting	Input value		
(1)	PC side I/F	Serial/USB	USB	—		
(2)	PLC side I/F	PLC Module	PLC Mode	RCPU		
			Other Station Setting	Other Station (Single Network)	Check at Communication Time	30 seconds
					Retry Times	0 time
(3)	Network Communication Route	C24	Start I/O	20		
			Station No.	1		

# 12.6 Accessing via GOT (GOT Transparent Function)

This section explains the setting method for accessing a CPU module from a personal computer using the GOT transparent function.

## Precautions

### ■When performing online operations from a personal computer

During the online operation from a personal computer to a CPU module using the GOT transparent function, do not perform online operations (such as downloading project data) on GOT from GT Designer2 or GT Designer3.

### ■When GOT does not monitor normally

The GOT transparent function cannot be used in the following cases.

- When a GOT does not perform normal monitoring due to CPU module errors or communication errors between the CPU module and the GOT
- During the period of time between turning ON or resetting the CPU module or GOT and the start of GOT monitoring

Check the following items if monitoring on GOT is not normal.

Item	Reference
Does the CPU module operate normally?	Page 708 Module Diagnostics
Is the CPU module connected to GOT normally?	Manual of GOT used

## Access via a GOT

A personal computer (GX Works3) can access a CPU module via a GOT.

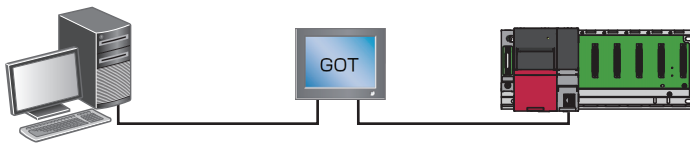

The connection availability and the specification method of connection destination differ depending on a GOT series and the connection condition between a personal computer and a GOT.

For details, refer to the following:

📖 GOT2000 Series Connection Manual (Mitsubishi Products) For GT Works3 Version1

📖 GOT1000 Series Connection Manual (Mitsubishi Products) for GT Works3

## Accessing via a GOT and a module

A personal computer can access a CPU module via a GOT and another module (serial communication module, CC-Link IE Controller Network module, CC-Link IE Field Network module, Ethernet module, and CC-Link IE TSN module).



The connection availability and the specification method of connection destination differ depending on a GOT series and the connection condition between a personal computer and a GOT.

For details, refer to the following:

📖 GOT2000 Series Connection Manual (Mitsubishi Products) For GT Works3 Version1

📖 GOT1000 Series Connection Manual (Mitsubishi Products) for GT Works3

# 12.7 Accessing via QCPU (Q mode)

This section explains the setting method for accessing a CPU module from a personal computer via a QCPU (Q mode). Neither an LHCPU nor an FX5CPU can be accessed via a QCPU (Q mode).

The QCPUs (Q mode) that can be used as a PLC side I/F are as follows.

Item	Available QCPU (Q mode)
PC side I/F: Serial communication (USB)	Built-in USB port QCPU (Q mode) Note that remote I/O modules (QJ72LP25 and QJ72BR15) are excluded.
PC side I/F: Ethernet board	Built-in Ethernet CPU

The following shows the setting example for accessing an RCPU via a QCPU (Q mode) from a personal computer.

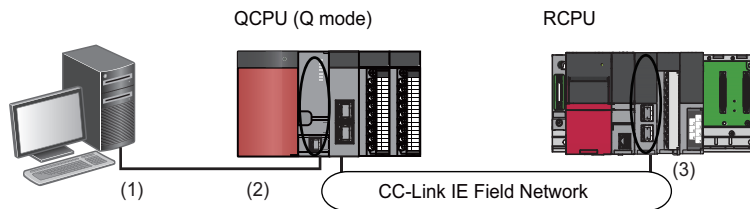

No.	Item	Item to be selected	Internal setting	Setting content
(1)	PC side I/F	Serial/USB	USB	—
(2)	PLC side I/F	PLC Module	PLC Mode	QCPU (Q mode)
	Other Station Setting	Other Station (Single Network)	Check at Communication Time	30 seconds
			Retry Times	0 time
(3)	Network Communication Route	CC IE TSN CC IE Field	Network No.	1
			Station No.	0

## Precautions

- An RCPU cannot be accessed via a MELSECNET/10 network module or a MELSEC-Q series MELSECNET/H network module.
- A remote password that has been set for the Ethernet port of a QCPU (Q mode) cannot be unlocked in GX Works3. Delete the remote password using GX Works2 in advance.

# 12.8 Accessing via QJ71E71-100

This section explains the setting method for accessing a CPU module from a personal computer via QJ71E71-100. Neither an LHCPU nor an FX5CPU cannot be accessed via QJ71E71-100.

The QCPUs (Q mode) that can be used as a PLC side I/F are as follows.

- Universal model QCPU
- Universal model process CPU
- High-speed universal model QCPU

The following shows the setting example for accessing an RCPU via QJ71E71-100 from a personal computer.

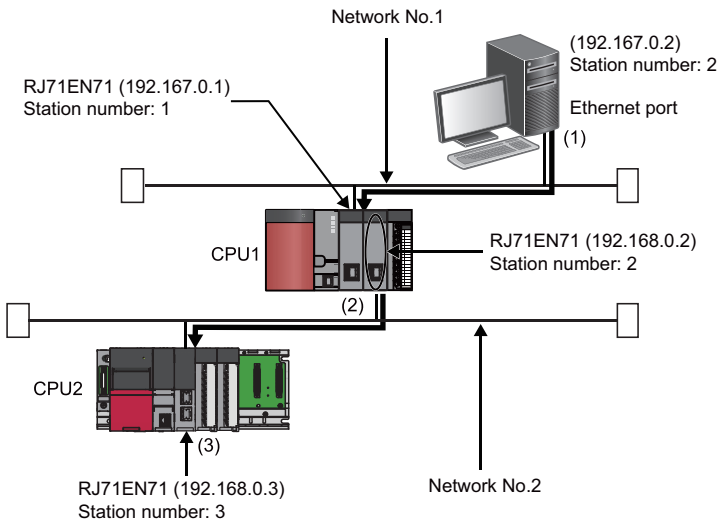

No.	Item	Item to be selected	Internal setting	Input value
(1)	PC side I/F	Ethernet Board	Adapter	Not Specified
			Network No.	1
			Station No.	2
			Protocol	TCP
(2)	PLC side I/F	Ethernet Module	PLC Mode	QCPU (Q mode)
			PLC Type	QJ71E71-100
			Network No.	—
			Station No.	1
			IP Address	192.167.0.1
			IP Input Format	DEC
			Station No. <-> IP Information	Automatic Response System
			Other Station Setting	Other Station (Single Network)
			Retry Times	0 time
	(3)	Network Communication Route	Ethernet	Other station in the same loop or access to multilevel system
				Station No. 3

## Precautions

- An RCPU cannot be accessed via a MELSECNET/10 network module or a MELSEC-Q series MELSECNET/H network module.
- A remote password that has been set for the Ethernet port of QJ71E71-100 cannot be unlocked in GX Works3. Delete the remote password using GX Works2 in advance.
- To communicate with multiple personal computers where GX Works3 is running by connecting them to a single CPU module, use TCP/IP or UDP/IP communication.
- For a multiple network system, setting the network dynamic routing is required.

📖 MELSEC iQ-R Ethernet User's Manual (Application)

📖 MELSEC-Q/L Ethernet Interface Module User's Manual (Application)

## 12.9 Connection to the Multiple CPU System

This section explains the setting method for accessing the CPU module (host CPU) directly connected to the personal computer or another CPU module (another CPU) in the multiple CPU system.

The setting method for accessing the multiple CPU system on another station via a network is also explained.

LHCPUs, FX5CPUs, and remote head modules do not support this connection.

### Accessing host CPU

The setting for accessing the host CPU is the same as that for accessing the CPU module on the own station. (  Page 559 Direct Connection)

### Accessing another CPU

To access a CPU module, which is not directly connected to a personal computer, in the multiple CPU system, the CPU number (CPU No.1 to 4) of the access target needs to be specified in "Multiple CPU Setting."

The following shows the setting example for accessing a CPU No.4 by connecting a personal computer to CPU No.1.

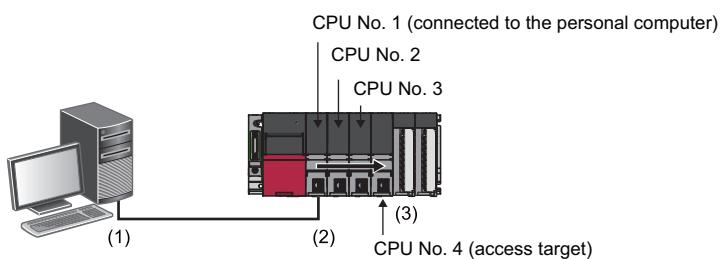

No.	Item	Item to be selected	Internal setting	Input value
(1)	PC side I/F	Serial/USB	USB	—
(2)	PLC side I/F	PLC Module	PLC Mode	RCPU
	Other Station Setting	No Specification	Check at Communication Time	30 seconds
(3)	Target System	Multiple CPU Setting	Retry Times	0 time
			Target PLC	PLC No. 4

## Accessing via network

The following explains the setting methods for accessing a CPU module in a multiple CPU system on another station via a network.

### Relay station

Set the parameters so that the module mounted on the relay station is controlled by the same CPU module. (In the figure below, the CPU No.2 is the control CPU.)

### Access target station

Set the CPU number in "Multiple CPU Setting" on the "Specify Connection Destination" screen when the access target station is the multiple CPU system.

The following shows the setting example for accessing a CPU No.4 in a multiple CPU system on the access target station via a network.

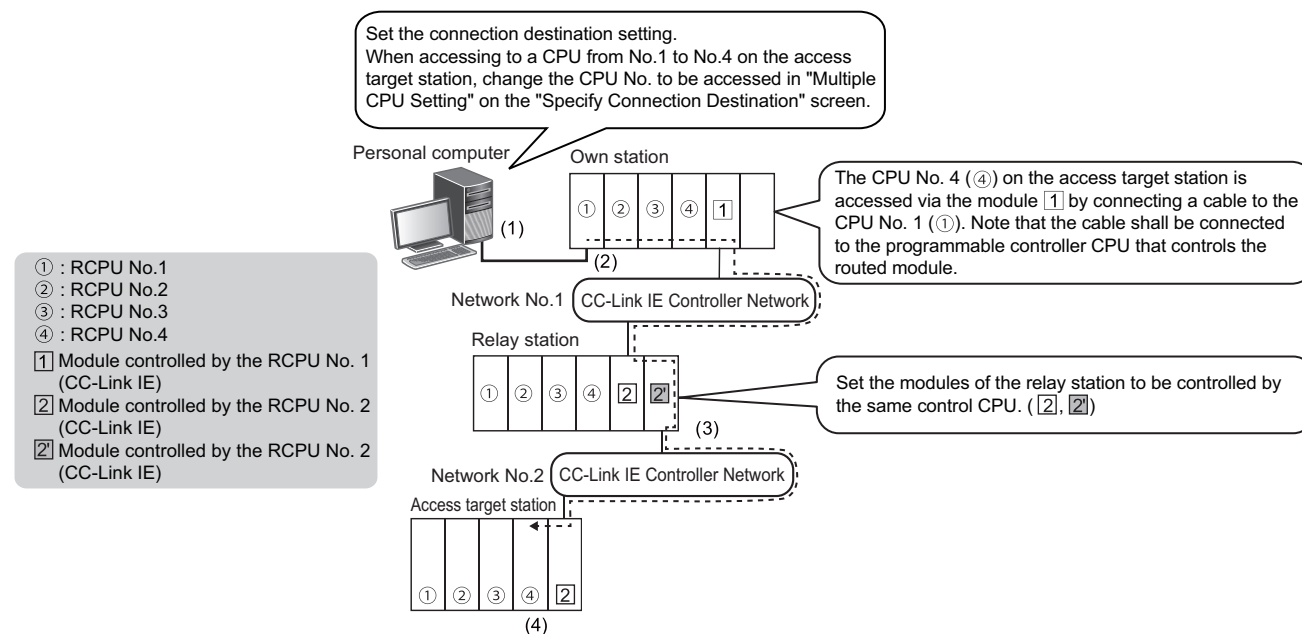

No.	Item	Item to be selected	Internal setting	Input value
(1)	PC side I/F	Serial/USB	USB	—
(2)	PLC side I/F	PLC Module	PLC Mode	RCPU
		Other Station Setting	Other Station (Single Network)	Check at Communication Time
(3)	Network Communication Route	CC IE Cont NET/10(H)	Network No.	2
			Station No.	0
(4)	Target System	Multiple CPU Setting	Target PLC	PLC No. 4

## 12.10 Connection to the Redundant System

This section explains the setting method for accessing a CPU module by specifying a system in the redundant system. Only RnPCPUs (redundant mode), RnPSFCPUs, and remote head modules support this connection.

### CPU module redundant system

To access a CPU module in a redundant system configuration, the system of access target (no specification/control system/standby system/system A/system B) needs to be specified in "Specify Redundant CPU."

The following shows the setting example for accessing a standby system via the system A of an RnPCPU (redundant mode) that is connected to a personal computer.

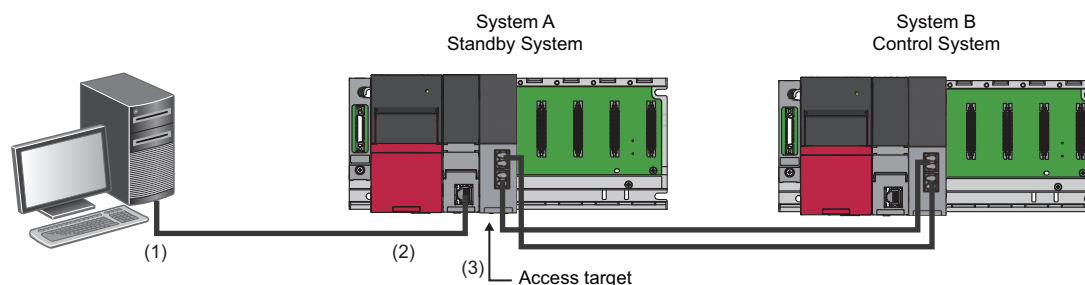

No.	Item	Item to be selected	Internal setting	Input value
(1)	PC side I/F	Serial/USB	USB	—
(2)	PLC side I/F	PLC Module	PLC Mode	RCPU
	Other Station Setting	No Specification	Check at Communication Time	30 seconds
			Retry Times	0 time
(3)	Target System	Specify Redundant CPU	Standby System	—

When "Not specified" is selected in "Specify Redundant CPU," the access target is set as follows:

- Direct connection: connective system
- Connection via a module mounted on a main base unit: CPU module on the station on which the network module, with the station number specified for the network communication route, is mounted
- Connection via a module mounted on an extension base unit: CPU module in the control system

For the considerations for accessing a CPU module via a module on a redundant extension base unit, refer to the following:

MELSEC iQ-R Module Configuration Manual



## Remote head module redundant system

To access a remote head module in a redundant system configuration, the access target (CPU No.1/CPU No.2/no specification/control system/standby system) needs to be specified in "Multiple CPU Setting" or "Specify Redundant CPU." The setting for either "Multiple CPU Setting" or "Specify Redundant CPU" can be set.

The following shows the setting example for accessing a remote head module (single line) from a personal computer using a USB connection.

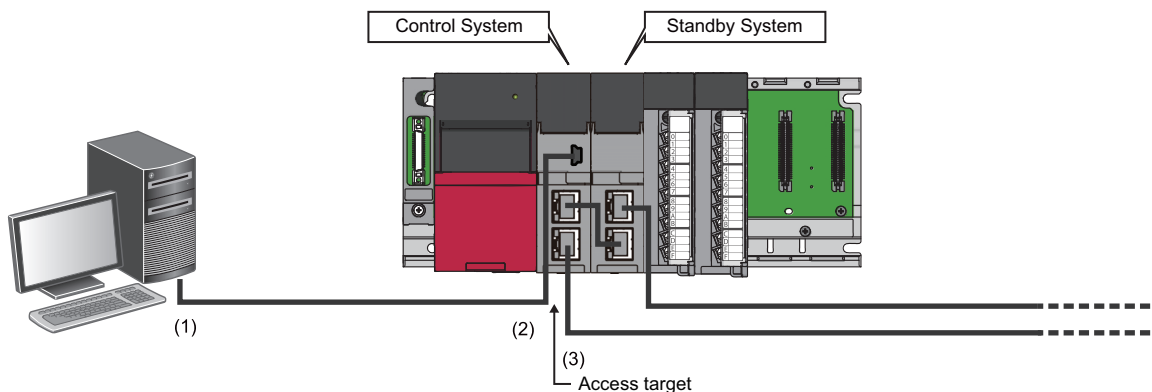

No.	Item	Item to be selected	Internal setting	Input value
(1)	PC side I/F	Serial/USB	USB	—
(2)	PLC side I/F	Head module	RJ72GF15-T2	—
	Other Station Setting	No Specification	Check at Communication Time	30 seconds
			Retry Times	0 time
(3)	Target System	Specify Redundant CPU	Control System	—

When "Not specified" is selected in "Specify Redundant CPU," the access target is set as follows:

- Direct connection: remote head module that is directly connected to a personal computer
- Connection via a module mounted on a main base unit: remote head module No.1 (mounted on a CPU slot) on the station on which the network module, with the station number specified for the network communication route, is mounted
- Connection via a module mounted on an extension base unit: remote head module No.1 (mounted on a CPU slot)

# 12.11 Considerations of Communication with a CPU module

This section explains the considerations of communication with a CPU module.

Refer to the considerations described in each section as well as the descriptions in this section.

## Communication via network system (single/multiple)

When accessing an RCPU via a network system, all the connected stations must be RCPUs or QCPUs (Q mode).

In that case, an RCPU must be used for a relay station.

Connected station: Station directly connected from a personal computer

Relay station: Stations to be routed on network system

## Communication with the CPU module using a USB cable

### ■Connecting/disconnecting a USB cable, resetting a CPU module, and turning the power ON or OFF

A communication error may occur and it may not be recovered if connecting and disconnecting a USB cable, resetting the CPU module, or turning the power ON or OFF is performed frequently during communication with a CPU module.

Therefore, set GX Works3 to offline as much as possible during these operations. 'Offline' indicates the state other than below.

- Write to PLC/Read from PLC, Monitor, and PLC diagnostics

If the operation is not recovered from an error, remove the USB cable. Then, connect it again after five or more seconds.

(Even after this operation, an error may occur at initial communication. However, communication will be successful after that.)

Click the [OK] button on the warning message, and remove a USB cable from the personal computer.

### ■Combination of personal computer models and USB cables

A communication error may occur depending on the combination of personal computer models and USB cables.

If an error occurs, take appropriate actions in accordance with the message displayed on the screen.

## Other considerations

### ■High-speed communication using an RS-232 cable

Communication may fail depending on the performance of the personal computer when high-speed communication is attempted by changing the transmission speed at the serial port of the personal computer (personal computer side interface).

Communication speed may also slow down due to communication retries.

Decrease the transmission speed if high-speed communication cannot be performed normally.

### ■Resume function, suspend setting, power saving function, and standby mode of the personal computer

A communication error may occur during communication with the CPU module when any of the settings shown above is enabled.

Disable these settings for communication with the CPU module.

# 13 WRITING/READING DATA TO CPU MODULE

This chapter explains the following operations: writing, reading, and deleting data to/from a CPU module or an SD memory card, and verifying projects.

For the methods for writing the clock setting to a CPU module, refer to the following:

☞ Page 758 Clock Setting in a CPU Module

## 13.1 Writing/Reading Programmable Controller Data

Read/write the created data to/from a CPU module or an SD memory card in the "Online Data Operation" screen.

### Configuration of the online data operation screen

#### Window

Select [Online] ⇒ [Write to PLC] (📁)/[Read from PLC] (📂)/[Delete PLC Data].

**Ex.**

The following screen is an example when writing data to an R01CPU.

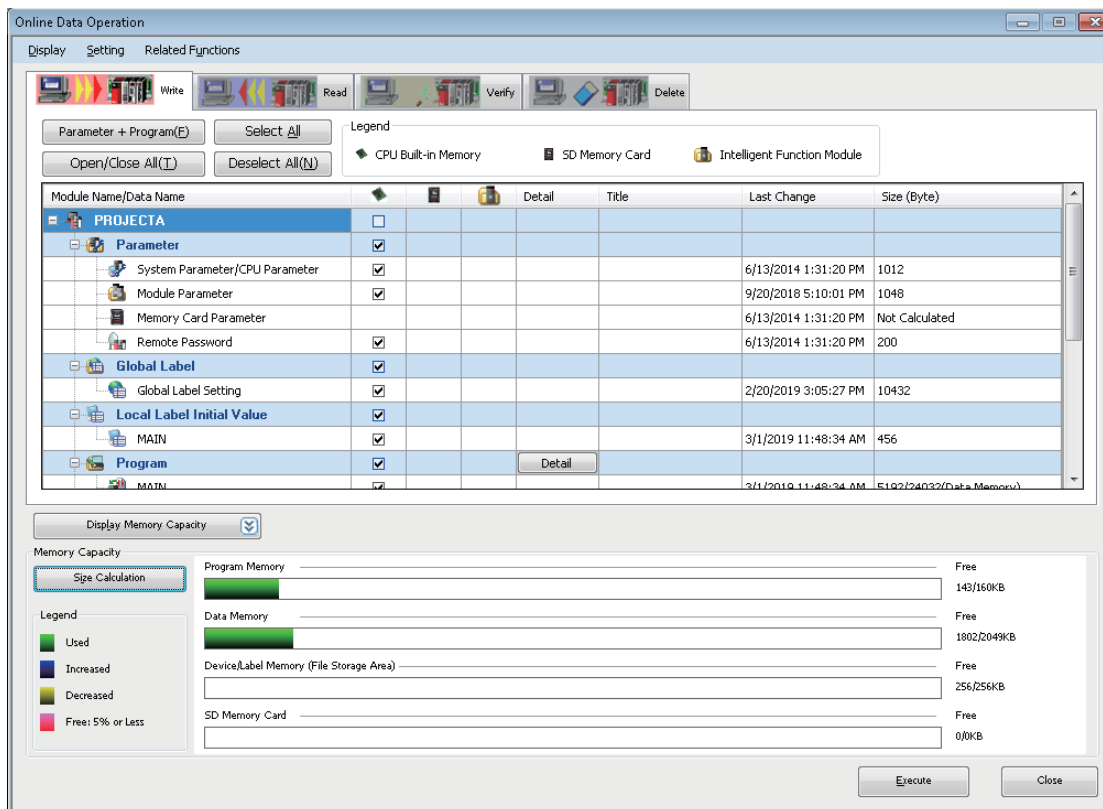

- The data name in gray indicates that it is in the unconverted state.
- When a data is written to a programmable controller, the target memory capacity may be displayed smaller than the actual file size.
- Graphs for each memory capacity can be updated by clicking the [Size Calculation] button.
- The following menus are available in the "Online Data Operation" screen:

Menu	Description	Reference
[Display] ⇨ [Display File Size]	To display the size of data to be written in the "Size (Byte)" column and in graphs for memory capacity.	Page 578 How to check the data size to be written Page 578 Graph display of memory capacity
[Setting] ⇨ [Set Favorites]	To set data to be displayed in the "Online Data Operation" screen. In addition, data to be selected by clicking the [Select Favorites] button can be set.	Page 578 Set favorites screen
[Related Functions] ⇨ [CPU Memory Operation]	To initialize a memory or clear it to zero.	Page 771 Initializing/Clearing a Memory
[Related Functions] ⇨ [Remote Operation]	To change execution statuses of a CPU module and remote head module.	Page 759 Remote Operation
[Related Functions] ⇨ [Redundant Operation]	To operate the redundant function of a CPU module and remote head module in a redundant system configuration.	Page 761 Redundant Programmable Controller Operations
[Related Functions] ⇨ [Set Clock]	To set the clock on a CPU module.	Page 758 Clock Setting in a CPU Module

### ■How to check the data size to be written

The file size display can be enabled by selecting the following menu in the "Online Data Operation" screen:

- [Display] ⇨ [Display File Size]

The size of write data can be displayed in the "Size (Byte)" column by enabling the file size display.

For program files, FB files, and FUN files, the size of program restoration information can be checked.

Display example: Size of an execution program/size of program restoration information (data memory)

### ■Graph display of memory capacity

The display content differs depending on the setting file size display.

Disabled: The current capacity of memory for writing on target is displayed.

Enabled: The capacity of memory to which the size of data to be written/deleted is displayed.

### ■Set favorites screen

The "Set Favorites" screen appears by selecting the following menu in the "Online Data Operation" screen:

- [Setting] ⇨ [Set Favorites]

Only data for which the checkbox in the "Show" column is selected is displayed in the "Online Data Operation" screen.

The [Parameter + Program] button in the "Online Data Operation" screen is switched to the [Select Favorites] button if the checkbox in the "Select Favorites Button" column of optional data is selected.

By clicking the [Select Favorites] button, data that is frequently used such as the system parameters, CPU parameters, and programs can easily be selected.

## ■Data to be written and writing destinations

The following table shows writing destinations and whether each data can be written to the destinations.

○: Writable, ×: Not writable

Data name		Writing destination		
		CPU built-in memory	SD memory card <sup>*1</sup>	Intelligent function module
System parameter/CPU parameter		○	○	×
Module parameter		○	○	×
Module extended parameter		○ <sup>*2</sup>	○ <sup>*2</sup>	○ <sup>*3</sup>
Memory card parameter <sup>*1</sup>		×	○	×
Remote password		○	○	×
Device station setting <sup>*4,*5</sup>		○	○	×
Recording setting <sup>*6</sup>		○	○	×
Global label	Global label setting	○	○	×
	Global label assignment information <sup>*7</sup>	○	○	×
Program file <sup>*5</sup>		○	○	×
FB file/FUN file <sup>*5</sup>		○	○	×
Initial label value file <sup>*7</sup>	Global label initial value file	○	○	×
	Local label initial value file	○	○	×
Device memory (file register <sup>*7</sup> )		○	×	×
Extended file register <sup>*8</sup>		×	○	×
Initial device value <sup>*5</sup>		○	○	×
Device comment <sup>*9</sup>		○	○	×

\*1 R00CPU and remote head modules do not support it.

\*2 For LHCPUs, data is written to the flash ROM in the module.

\*3 Module extended parameters of a camera recorder module cannot be written to the intelligent function module.

\*4 RnCPUs, RnENCPU, RnSFCPU, FX5UCPU, and FX5UCCPU support it.

\*5 Remote head modules do not support it.

\*6 RnCPUs (R04CPU, R08CPU, R16CPU, R32CPU, and R120CPU), RnENCPU, and RnSFCPU support it.

\*7 FX5CPUs do not support it.

\*8 Only FX5CPUs support it.

\*9 FX5CPUs and remote head modules support common device comments only; therefore, each program device comments are not supported.

For the details on the availability of writing safety data, refer to the following:

📖 MELSEC iQ-R CPU Module User's Manual (Application)

## Precautions

### ■Safety project and safety operation mode of a CPU module

The safety data and device memory of a safety project can only be written when the safety operation mode of an RnPSFCPU or an RnSFCPU is in the test mode. If the module is in the safety mode, switch the mode to the test mode.

📖 Page 764 Safety operation mode switching

# Writing data to a programmable controller

---

Write data to a CPU module.

For the considerations for writing, refer to the following:

 Page 593 Considerations for Online data operation

## Operating procedure

1. Select the [Write] tab on the "Online Data Operation" screen.
2. Select data to be written and a write destination.
3. Click the [Detail] button to set the details such as a range to be written.
4. Click the [Execute] button.

After writing a safety program or a parameter to an RnPSFCPU or an RnSF CPU, manuals are displayed to clarify the information that needs to be confirmed by users for using a safety project safely.

### Point

When more than one program is written to the CPU module, the programs categorized as "No Execution Type" will never be executed on the CPU module. For saving the memory capacity of the CPU module, removing them from the target data at writing data is recommended.

---

## ■ Program restoration information

Whether to write program restoration information can be selected when performing 'Write to PLC.'

Program restoration information is used for restoring a GX Works3 project read from a programmable controller. This information includes the rendering information of programs and the definition information of local labels.

By setting the following option, whether or not to write the program restoration information can be selected in the "Online Data Operation" screen.

- [Tool] ⇒ [Options] ⇒ "Online" ⇒ "Program Restore Information" ⇒ "Operational Setting" ⇒ "Enable the setting to write/not to write program restore information"

Only the program restoration information can be written to a CPU module by selecting "Write a Program Restore Information (Target Data to Write: Program Restore Information)" for "Program Restore Information" in the "Online Data Operation" screen.

When writing a safety program, safety FB, and safety FUN, the program restoration information is written to an RnSF CPU even if "Do not Write a Program Restore Information (Target Data to Write: Program)" has been selected for "Program Restore Information."

When a program is written without writing the program restoration information, the data cannot be read with 'Read from PLC,' and the detailed verification result screen cannot be displayed with 'Verify with PLC.'

For CPU modules that do not support this function, whether to write the program restoration information cannot be selected even when the option is set.

### ■Skip overwriting data

When writing data to a CPU module, writing data that is not changed from the previous writing can be skipped, and that can shorten the time required for writing.

### Operating procedure

1. Click the [Execute] button in the "Online Data Operation" screen.
2. Check the message and select the checkbox of "Skip writing for the files that have not been changed."

### Precautions

The following table shows the data that is overwritten every writing.

- Device memory
- File register

If the following specific conditions are satisfied, the following data will be overwritten regardless of whether the checkbox of "Skip writing for the files that have not been changed." is selected.

Data	Condition
Program file	The program restoration information is written to a CPU module where it is not written yet.
FB file (including SlibFbFile)	
FUN file	
Global label assignment information	Writing the global label setting is not skipped.
Initial global label value	
Initial local label value	Writing program files is not skipped.

In any the following cases, data is overwritten even if no changes are applied.

- The program restoration information of an RnPCPU (redundant mode) exists only in the control system or standby mode.
- An intelligent function module is selected as the writing destination.

### ■POU duplication check

When performing 'Write to PLC,' the program is checked whether a POU name is duplicated in the program and in a program in the CPU module.

When using a CPU module in a redundant system configuration and writing a program to both systems, the program is checked whether a POU name is duplicated in the both systems.

Whether to check the duplication can be set by setting the following option.

- [Tool] ⇒ [Options] ⇒ "Online" ⇒ "Write to PLC" ⇒ "Operational Setting" ⇒ "Duplication Check for POU"

## ■ Operations when using CPU modules in a redundant system configuration

For an RnPCPU (redundant mode), the operations differ depending on the operation modes.

An RnPSFCPU operates only when selecting the backup mode for the operation mode.

Operation mode	Operation
Separate mode	Applied to the CPU module in the connective system.
Backup mode	Applied to both systems (order: control system → standby system). If an error occurs in the control system while writing data, it is not written to the standby system. If an error occurs in the standby system while writing data, the data of control system cannot be restored to its former condition.

### Point

Data allocations are changed by updating a firmware version from 30 or earlier to 31 or later for the R04CPU, R08CPU, R16CPU, R32CPU, or R120CPU.

For details on the operation, refer to the following:

 MELSEC iQ-R CPU Module User's Manual (Application)

This may cause a lack of free space in the program memory when data backed up is written to the CPU module. In this case, perform any of the following operations and write the data again.

- Reduce the setting value of "Allocate Memory for Online Program Change." (Default: 500 steps)
- Reduce the number of program steps.



## Parameter

Write parameters according to the operations and changes of the system.

### ■Relation between module parameters in the navigation window and module parameters in a CPU module

Module parameters are written to a CPU module as the data which integrates the parameters displayed in the navigation window into one file.

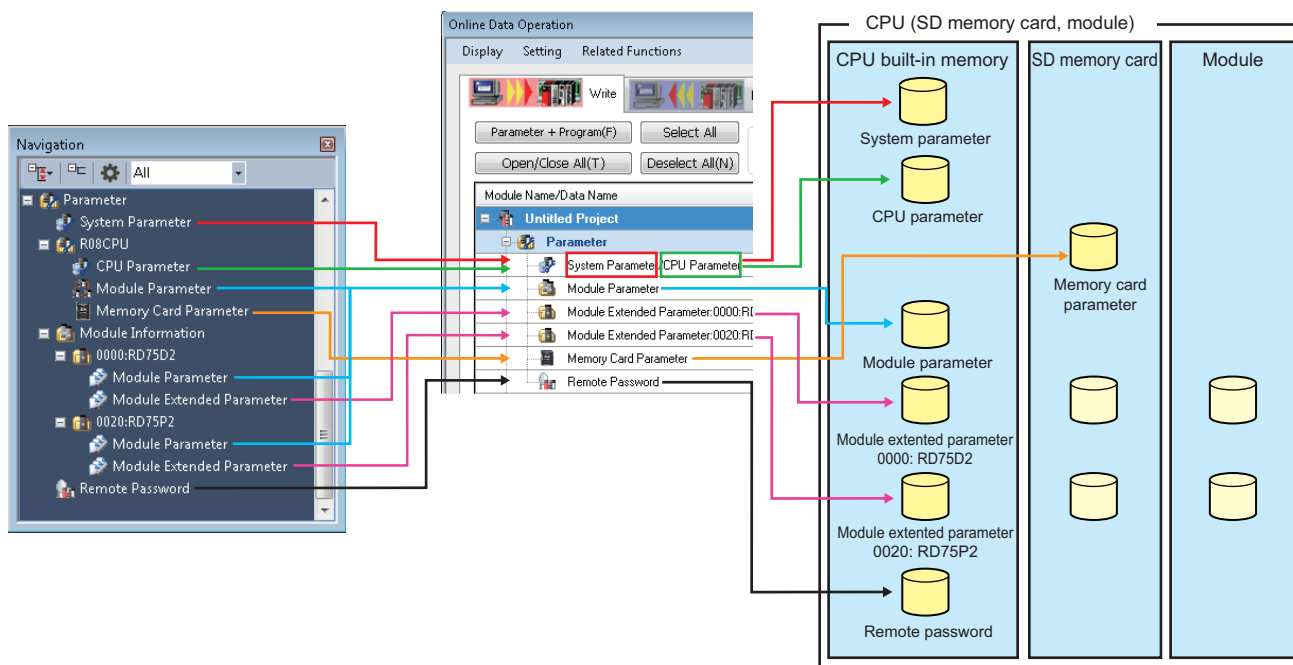

13

When a module parameter exists in a CPU module, the parameter file is overwritten.

#### Ex.

When writing four module parameters to a CPU module in which module parameters of five modules exist; the settings of five modules are overwritten with the settings of four modules, and one setting that does not exist in the project will be deleted.

### ■Consistency of parameters

When writing a part of the parameters additionally or writing modified parameters, the consistency of the parameters are required. Consistency means matching the information such as the I/O assignment setting (start I/O number, slot number, etc.) between the system parameters and each parameter.

There are two methods to keep the consistency.

- Read a system parameter and each parameter and change them. After that, write them to a CPU module. The CPU module needs to be reset to change the system parameter.
- Read each parameter to be changed, and change them to be consistent with the system parameters in the project. After that, write the changed parameters only to the CPU module. Basically, the CPU module does not need to be reset, however, some modules are required to reset the CPU module after changing parameters. For details, refer to the manual of the module used.

### ■Modules with start I/O number unset

The unset module parameters cannot be written to a programmable controller.

### ■Parameters of a remote I/O module (device station) on CC-Link IE Field Network

Parameters can be written to a device station in the "CC IE Field Configuration" window. For details, refer to the manual of each remote I/O module.

## ■Parameters of a remote I/O module (device station) on CC-Link IE TSN

When writing parameters of a device station to a CPU module, the parameters can be set to the device station by the following operations.

### Operating procedure

1. Select the checkbox in the "Parameter Automatic Setting" column for a device station and configure items in "<Detail Setting>" in the "CC-Link IE TSN Configuration" window.
2. Select the checkbox of "Device Station Setting"/"Device Station Setting (Safety)" under "CC-Link IE TSN Configuration" in the "Online Data Operation" screen.
3. Click the [Detail] button.
4. Select a device station to be written the parameters to in the "CC-Link IE TSN Configuration - Device Station Setting" screen.

For details on "Parameter Automatic Setting," refer to the following:

- 📖 MELSEC iQ-R CC-Link IE TSN User's Manual (Application)
- 📖 MELSEC iQ-R CC-Link IE TSN Plus Master/Local Module User's Manual
- 📖 MELSEC iQ-F FX5 User's Manual (CC-Link IE TSN)
- 📖 MELSEC iQ-R Motion Module User's Manual (Network)
- 📖 MELSEC iQ-F FX5 Motion Module User's Manual (CC-Link IE TSN)

## ■Writing of module extended parameters in a redundant system configuration

The following restrictions apply for writing module extended parameters to an intelligent function module in a redundant system configuration:

- Module extended parameters cannot be written to an intelligent function module via a tracking cable.
- If a CPU module in the connective system is not the one in the control system, the module extended parameters cannot be written to an intelligent function module mounted on a redundant extension base unit.

## ■Data in a motion module

Data in a motion module can be written by selecting the checkbox of the module extended parameters of the motion module and clicking the [Execute] button in the "Online Data Operation" screen.

To use this function, the motion control setting function Version 1.045X or later is required to be installed.

The following table shows the motion modules supporting this function and a write target of the data.

Module	Module name	Write target of data
CC-Link IE TSN compatible motion module	RD78G4 RD78G8 RD78G16 RD78G32 RD78G64 RD78GHV RD78GHW	The storage destination set in the following module parameter: <ul style="list-style-type: none"><li>• "Module Operation Setting" ⇔ "Module Extended Parameter Storage Location Setting"</li></ul>

## Program

When a program (local label, program body) is created, select "Program" to write.

When an initial value is set in the "Initial Value" column in a local label editor, select "Label Initial Value by Program" to write.

When an initial value is not set in the "Initial Value" column, the initial label value file is not displayed. In addition, the initial label value file with the same name in a programmable controller is deleted.

### ■Standard function block

When a standard function block is used in a program, the FB file "SlibFbFile" is automatically written.

However, if the FB file (SlibFbFile) is deleted manually, write the program including the standard function block again.

If all the standard function blocks used in a program are deleted, delete "SlibFbFile" set in "FB/FUN File Setting" of CPU parameter.

### ■Setting the secured steps for online program change

Set the range of program (program file) to be written and secured steps for online program change on the "Program Detail Setting" screen displayed by clicking the [Detail] button of "Program."

FX5CPUs do not support this setting.

Item	Description
Allocate Memory for Online Program Change	<p>Writing programs while the CPU module is running affects scan time due to the change of number of steps.</p> <p>Enter the secured steps for online program change to handle the change of number of steps when performing the online program change.</p> <p>When the number of program steps is changed, the capacity of program files is not changed if the changed number of steps are within the range of the number of the secured steps for online program change.</p>

### ■Operations after writing SFC programs

For SFC programs, the operations performs differently between Ladder, ST, and FBD/LD when changing programs by writing them to a programmable controller. For the details, refer to the following:

📖 MELSEC iQ-R Programming Manual (Program Design)

📖 MELSEC iQ-F FX5 Programming Manual (Program Design)

## Global label

When global labels are set, select "Global Label Setting" to write.

When an initial value is set in the "Initial Value" column in a global label editor, select "Global Label Initial Value" to write.

When an initial value is not set in the "Initial Value" column, the initial label value file is not displayed. In addition, the initial label value file with the same name in a programmable controller is deleted.

When "Access from External Device" is selected in a global label editor, select "Global Label Assignment Information" to write.

FX5CPUs do not support the settings for initial label values and access from external devices.

## Precautions

The sample comments are included in the write target. If the data size to be written exceeds the memory capacity of the CPU module at writing data, prepare an SD memory card.

For FX5CPU, the writable capacity is the same as that of the CPU module even when data is written to an SD memory card.

## Device memory

When setting values in the device memory and writing them to the device memory area of a CPU module, select "Device Memory" to write.

The device memory which has the same name as the program is written to a local device.

In contrast, the device memory which has the different name as the program is written to a global device.

Only one device memory for a global device can be selected.

To write only the values within the range specified in a device memory editor, refer to the following:

 Page 439 Writing/Reading Data to/from CPU Module

### Precautions

FX5CPUs do not support local devices.

The device memory is written to a global device regardless of the consistency or inconsistency with a program name.

#### ■ Setting write target devices and their ranges

Set the type and range of device memory to be written to the CPU module on the "Device Data Detail Setting" screen displayed by clicking the [Detail] button of "Device Memory."

- Writable devices to a CPU module

○: Writable, ×: Not writable, △: Writable only during a simulation, —: No corresponding device

Device	Global device	Local device <sup>*1</sup>
M, V <sup>1</sup> , T, LT <sup>1</sup> , ST, LST <sup>1</sup> , C, LC, D, R <sup>2</sup> , SAIM, SAIT, SAIST, SAIC, SAID	○	○
L, B, F, SB, W, SW, Z, LZ, RD <sup>1</sup> , SAIB, SAIW	○	—
S <sup>3</sup> , SD, SM, SAISD, SAISM	×	—
X, Y, SAIX, SAiy	△	—

\*1 FX5CPUs do not support it.

\*2 RCPUs and LHCPUs do not support it.

\*3 Can be written to only an FX5CPU.

However, a step relay (S) is used as a step relay with block specification (BL□S) to control an SFC program if "Use" is set in "To Use or Not to Use SFC" of the CPU parameter. In this case, the step relay (S) cannot be written to the CPU module.

- Writable devices to a remote head module

○: Writable, —: No corresponding device

Device	Global device	Local device
SB, W, SW, RD	○	—

For details on the devices to be written, refer to the following:

 Page 889 Applicable Devices in GX Works3

## File register

When setting values in the device memory and writing the values as file registers, select "File Register" to write. FX5CPUs do not support this setting.

### ■Setting range to be written

Set the range of file registers to be written to a programmable controller in the "File Register Detail Setting" screen displayed by clicking the [Detail] button of "File Register."

If two or more file registers are selected, the value of each file register is written/read in the same range.

### ■Writing to a programmable controller

When writing file registers, perform the following procedure.

#### Operating procedure

1. Write the CPU parameters to a programmable controller.
2. Reset or cycle the power of the programmable controller.
3. Write file registers.

13

## Extended file register

Values set in the device memory (extension file registers (ER)) of a project can be all written to extended file registers (ER) of an SD memory card in a batch.

It is not available in a project for an RCPU.

### ■Range to be written

Values of the device memory (extension file registers (ER)) of a project are stored in extended file registers (ER) of an SD memory card by selecting "Extend File Register" of the SD memory card and performing writing.

All the points (32768 points) of the device memory of a project are written to extended file registers (ER) of an SD memory card regardless of the number of points of a user device set in file registers (R).

## Initial device value

When an initial device value is set, select "Device Initial Value" to write.

An initial device value with the same name as a program is written as a file for a local device. A device, which cannot be used as a local device, is not written.

An initial device value with a different name from a program is written as a file for a global device.

FX5CPUs do not support local devices. The device memory is written to a global device regardless of the consistency or inconsistency of a program name.

## Device comment

When a device comment is set, select "Common Device Comment" or "Each Program Device Comment" to write. For FX5CPU, 'each program device comment' cannot be written to the CPU module.

### ■Setting range to be written

Set the range of "Common Device Comment"/"Each Program Device Comment" to be written to a CPU module on the "Device Comment Detail Setting" screen displayed by clicking the [Detail] button of "Common Device Comment" or "Each Program Device Comment."

Set this setting to limit the writing range of device comments in cases such as when the CPU module has small free capacity. When the range of device comments is not set, all device comments are written.

Item	Description
Number of characters per 1 comment	Set the maximum number of comments to be written to a CPU module. When the character length of an input value is less than the number of characters of device comment set for the project, the device comment with less number of characters is written to a CPU module. Therefore, mismatched data may be detected when verifying project data.

## Precautions

When the sample comments are read to device comments, all the sample comments are written to the CPU module. Therefore, the data size to be written may exceed the memory capacity of the CPU module. In this case, perform any of the following operations.

- Delete the device comments of unused devices.
- Set the write target of device comments to SD memory card.  
For FX5CPU, the writable capacity of SD memory card is the same as that of CPU module.
- Set the range to be written.

## Tag FB setting

In projects for an RnPCPU (process mode/redundant mode) and an RnPSFCPU, when using a program with the process control extension enabled or for which the tag FB setting is set, write the CPU parameter (only when it is set at the first time or changed) and the global label setting.

File register data in the range assigned to FB properties in a tag FB is written only one time after converting all programs (re-assigning labels).

# Reading data from a programmable controller

Read data from a CPU module.

For the considerations for reading data, refer to the following:

☞ Page 593 Considerations for Online data operation

## Operating procedure

1. Select the [Read] tab on the "Online Data Operation" screen.
2. Select the files to be read and read target.
3. Click the [Detail] button to set the details such as a range to be read.
4. Click the [Execute] button.

### Point

Data can be read even when a project is not open.

☞ Page 104 Creating a new project by reading data read from a programmable controller

13

## ■Writing a program without writing the program restoration information

When a CPU module contains the following data, 'Read from PLC' cannot be performed.

- Execution program that the program restoration information is not written
- Execution program that the program restoration information is not written at the same time

## ■Operations when using CPU modules in a redundant system configuration

Data is read from the CPU module in the connective system.

## ■Standard function block

If a standard function block has been used in the project written to a CPU module, the data cannot be read from the CPU module to a project that satisfies either the No.1 condition or all of the No.2 conditions listed below.

No.	Condition
1	<ul style="list-style-type: none"><li>• A standard function block that has never been used in the project written to the CPU module has been used.</li></ul>
2	<ul style="list-style-type: none"><li>• A standard function block has been used.</li><li>• It is not the project used for writing data to the CPU module.</li><li>• It is not created by reading the project written to the CPU module.</li></ul>

Read data from a CPU module while a project is not opened or the one written to the CPU module is opened.

## Precautions

During the frequent access of an SD memory card with a data logging function or database function, the response to the reading operation from a programmable controller (until the "Online Data Operation" screen is displayed) could be slow.

## Parameters

### ■Unsupported modules

The module parameters that are not supported by GX Works3 cannot be read.

### ■Parameters of a remote I/O module (device station) on CC-Link IE TSN

Whether or not to read parameters of a device station can be selected in the [Read] tab in the "Online Data Operation" screen.

The operating procedure is the same as the one to write parameters of a device station to a CPU module. (  Page 584

Parameters of a remote I/O module (device station) on CC-Link IE TSN)

For details on "Parameter Automatic Setting," refer to the following:

 MELSEC iQ-R CC-Link IE TSN User's Manual (Application)

 MELSEC iQ-R CC-Link IE TSN Plus Master/Local Module User's Manual

 MELSEC iQ-F FX5 User's Manual (CC-Link IE TSN)

 MELSEC iQ-R Motion Module User's Manual (Network)

 MELSEC iQ-F FX5 Motion Module User's Manual (CC-Link IE TSN)

### ■Data in a motion module

Data in a motion module can be read by selecting the checkbox of the module extended parameters of the motion module and clicking the [Execute] button in the "Online Data Operation" screen.

To use this function, the motion control setting function Version 1.045X or later is required to be installed.

The following table shows the motion modules supporting this function and a read source of the data.

Module		Read source of data
CC-Link IE TSN compatible motion module	RD78G4 RD78G8 RD78G16 RD78G32 RD78G64 RD78GHV RD78GHW	The storage destination set in the following module parameter: • "Module Operation Setting" ⇔ "Module Extended Parameter Storage Location Setting"

## Program

When reading a program (local label, program body), read "Program."

### ■Initial local label value

The operation differs between writing to and reading from the programmable controller.

- Writing: Local labels are written by selecting "Label Initial Value by Program."
- Reading: The initial local label values are also read when a program is read.

FX5CPUs do not support this initial value setting.

### ■Execution type which is overwritten at reading program

- When reading CPU parameters and program file at once: The program file is overwritten with the execution type in accordance with the program setting of the read CPU parameter.
- When reading a program file only: The program file is overwritten in accordance with the parameter settings in GX Works3.
- When the CPU parameter setting does not exist in both CPU module and GX Works3: The program file is overwritten with "No Execution Type."

### ■Setting read range

Set the range of a program (program file) to be read from a CPU module on the "Program Detail Setting" screen displayed by clicking the [Detail] button on the "Online Data Operation" screen.

In addition, the secured steps for online program change can be obtained from CPU module.

FX5CPUs do not support this setting.



## Global label

### ■ Initial value, accessing from external device

The operation differs between writing to and reading from the programmable controller.

- Writing: Global labels are written by selecting "Label Initial Value by Program" and "Global Label Assignment Information."
- Reading: The initial global label values and the information on access from external devices are also read when a program is read.

FX5CPUs do not support the settings for initial label values and access from external devices.

#### Restriction

When reading only a program in which global labels are used, the label definitions used in the program may not exist in the project. This may cause the disappearance of the labels on the ladder editor. In this case, read the global label and program together.

## Device memory

The device memory, which have the same name as the program, will be read as a file for a local device.

The device memory, which have the different name as the program, will be read as a file for a global device.

Only one device memory for a global device can be selected.

To read only the values within the range specified in a device memory editor, refer to the following:

 Page 439 Writing/Reading Data to/from CPU Module

FX5CPUs do not support local devices. The device memory is read as a file for global labels regardless of the consistency or inconsistency with the program name.

### ■ Setting read target devices and their read ranges

Set the type and range of device memory to be read from a CPU module on the "Device Data Detail Setting" screen displayed by clicking the [Detail] button.

- Readable devices from a CPU module
- : Readable, —: No corresponding device

Device	Global device	Local device <sup>*1</sup>
M, V <sup>*1</sup> , T, LT <sup>*1</sup> , ST, LST <sup>*1</sup> , C, LC, D, R <sup>*2</sup> , SAIM, SAIT, SAIST, SAIC, SAID	○	○
X, Y, LB, F, SB, S, W, SD, SW, SM, Z, LZ, RD <sup>*1</sup> , SAIX, SAIY, SAIB, SAW, SAISD, SAISM	○	—

\*1 FX5CPUs do not support it.

\*2 RCPUs and LHCPUs do not support it.

- Readable devices from a remote head module

○: Readable, —: No corresponding device

Device	Global device	Local device
X, Y, SB, W, SD, SW, SM, RD	○	—

For details on the devices to be read, refer to the following:

 Page 889 Applicable Devices in GX Works3

#### Point

To read device memory from the following memories, select the checkbox of each memory in the "Device Data Detail Setting" screen.

- Link memory
- CPU buffer memory (U□\G)

However, device memory cannot be read from the fixed scan communication area (U□\HG).

## Device comment

### ■Setting read range

Set the range of Common device comments/Each program device comments to be read from a programmable controller on the "Device Comment Detail Setting" screen displayed by clicking the [Detail] button.

## Initial device value

Even when initial device values read from a CPU module are for local devices, they are not displayed as those for local devices ('#' is not added) in GX Works3.

## Tag FB setting

In projects for an RnPCPU (process mode/redundant mode) and an RnPSFCPU, when using a program with the process control extension enabled or for which the tag FB setting is set, read the global label setting.

Note that FB properties are not read.

To read the current value of an FB property, update the initial value of the FB property.

 Page 666 FB Property Management (Online) screen

# Deleting data in a CPU module

Delete the data such as programs and parameters in the CPU module.

For a safety project, safety data can be deleted when the safety operation mode of a CPU module is in the test mode.

## Operating procedure

1. Select the [Delete] tab on the "Online Data Operation" screen.
2. Select a file to be deleted, and click the [Execute] button.

### ■Operations when using CPU modules in a redundant system configuration

For an RnPCPU (redundant mode), the operations differ depending on the operation modes.

An RnPSFCPU operates only when selecting the backup mode for the operation mode.

Operation mode	Operation
Separate mode	Applied to the CPU module in the connective system.
Backup mode	Applied to both systems (order: control system → standby system). If an error occurs while deleting data from the control system, it is not deleted from the standby system. If an error occurs while deleting data from the standby system, the data of control system cannot be restored to its former condition.

## Considerations for Online data operation

### Unlocking a remote password

The confirmation message for unlocking the remote password is displayed when the remote password is set to the CPU module to be accessed. Unlock the password by following the message.

For details, refer to the following:

 Page 699 Restricting Access from Other Than Specific Communication Route (Remote Password)

### Unusable functions while transferring programs

The following functions cannot be used while transferring a program.

- Writing data to a programmable controller
- Reading data from a programmable controller
- Verifying data with a programmable controller
- Deleting data in a programmable controller
- Reading/writing/deleting user data
- Closing a project
- Changing the module type and operation mode
- Ethernet diagnostics
- CC-Link IE Control diagnostics (optical cable)
- CC-Link IE Control diagnostics (twisted pair cable)
- CC-Link Field diagnostics
- MELSECNET diagnostics
- Changing a connection destination setting
- Circuit trace
- Simulation

### Cases where the option setting is changed

The following option setting may be changed when reading data from a programmable controller.

- [Tool] ⇒ [Options] ⇒ "Convert" ⇒ "Basic Setting" ⇒ "Operational Setting" ⇒ "Convert, Online Program Change Target Setting"

"Low-speed" is set in the option for the following cases:

- When reading data for which "High-speed" is selected to a project for which "Low-speed" is selected
- When reading data for which "Low-speed" is selected to a project for which "High-speed" is selected

## Structures restored by reading data from a programmable controller

When reading data in which structure is used from a CPU module, the definition of the structure is restored to the state where it was written to the CPU module.

Note that if the definition of a structure is edited after writing it to a CPU module and data including the structure is read, it will return to the state before the editing.

Structure can be used in the following data.

- Standard program
- Safety program
- Standard FB
- Safety FB
- Standard FUN
- Safety FUN
- Standard global label
- Standard/safety global label
- Safety global label

## Security version of a project

Depending on a security version of a project and a security version of the data written to a CPU module, the 'Writing data to a programmable controller' function or the 'Reading data from a programmable controller' function may not be performed.

The following table shows whether these functions can be performed or not for each security version.

○: Can be performed , ×: Cannot be performed

Security version		Writing data to a programmable controller	Reading data from a programmable controller
Project currently opened	Data in a CPU module		
1	1	○	○
	2	×	×*1
2	1	×	○
	2	○*2	○*1*2*3

\*1 Data other than the following can be read regardless of the security version:

- Program file
- FB/FUN file setting
- Global label setting file
- Safety global label setting file
- Module parameter
- Device comment

\*2 Data can be written/read when a project password matches.

Note that if a project currently opened differs from the one written to a CPU module, the data cannot be written/read even if a project password matches:

\*3 Password authentication is required.

Note that a security version of the data written to a CPU module cannot be checked from external parties.

Manage and operate the security version properly.

## When changing the safety communication setting

When writing a project in which the following parameter is set to "Use" to an RnSFPCPU or RnPSFPCPU, then writing a project in which the parameter setting is changed to "Not to Use," initialize the memory of the CPU module, then write the project in which the parameter setting is changed.

- "Module Parameter" ⇒ "Safety Communication Setting" ⇒ "To Use or Not to Use the Safety Communication Setting" of a network module.

For the method for initializing the memory, refer to the following:

☞ Page 771 Initializing/Clearing a Memory

## 13.2 Verifying Programmable Controller Data

This section explains the method to verify data between the open project and data in a CPU module.

This verification is used to compare the content of two projects or to locate the changes made in programs.

A project for which a security is set can be verified when both data of the verification source and verification destination are not read-protected.

To verify data between two projects, perform the project verification.

For details, refer to the following:

☞ Page 143 Verifying Projects

### Window

Select [Online] ⇒ [Verify with PLC].

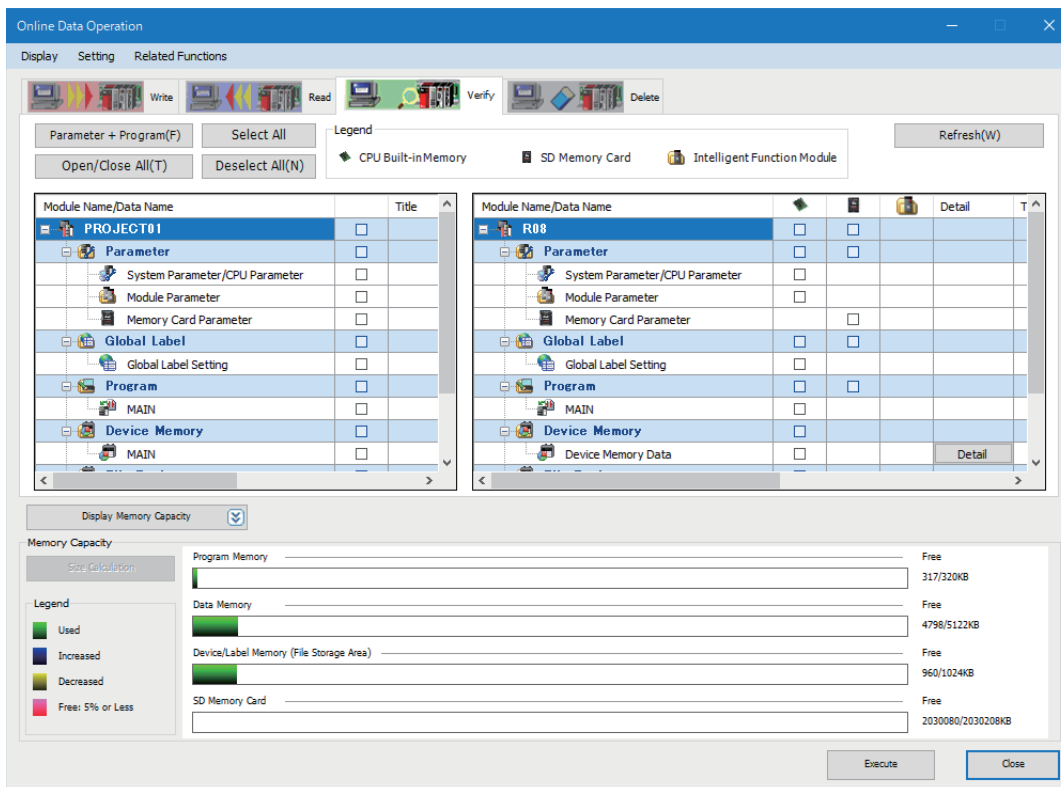

13

### Operating procedure

Select the data to be verified, and click the [Execute] button.

A verification result is displayed in the "Verification Result" window.

However, the verification of program blocks is skipped, and "Verification process was skipped" is displayed in the "Verification Result" column.

To verify program blocks, double click the corresponding line or press the **[Enter]** key.

The operation method for displaying the verification result is the same as that of project verification. For more details, refer to the following:

☞ Page 145 Checking a verification result

### Point

By selecting "No" for the following option, program blocks can be verified without being skipped.

Note that it may take time to display the verification result.

- [Tool] ⇒ [Options] ⇒ "Online" ⇒ "Verify with PLC" ⇒ "Verify the Program and FB/FUN Units Later"

## ■Writing a program without writing the program restoration information

When a CPU module contains the following data, the detailed verification result screen cannot be displayed.

- Execution program that the program restoration information is not written
- Execution program that the program restoration information is not written at the same time

## ■Verification of the control system and the standby system in a CPU module in a redundant system configuration

When verifying data in an RnPCPU (redundant mode) or an RnPSFCPU, the control system or standby system needs to be specified as the verification destination.

When verifying data in the control system and data in the standby system, compare the verification result of the CPU modules in the connective system and the standby system.

## Parameters

### ■Module extended parameters

Module extended parameters are not verified.

However, the module extended parameters of the following modules can be verified if both of the conditions listed below are satisfied: CC-Link IE TSN compatible motion module (simple motion mode) and simple motion module.

- Parameters are written to an intelligent function module.
- The start I/O number and the module name in the project of a verification source match those in the project of a verification destination.

### ■Unmatched module parameters

When verifying module parameters, the following message may appear.

- Message: Module parameters created through different versions are verified. For some items, mismatch results might be shown even if the same settings were set on the setting window.

To match the module parameters, perform the following operation, and then verify once again.

Project	Operation
Verification source	<ol style="list-style-type: none"><li>1 Change the corresponding setting item in the parameter editor, and then restore it.</li><li>2 Save the project.</li></ol>
Verification destination	<ol style="list-style-type: none"><li>1 Start another GX Works3, and read the project from a CPU module. (☞ Page 104 Creating a new project by reading data read from a programmable controller)</li><li>2 Write the read project to the CPU module once again. (☞ Page 580 Writing data to a programmable controller)</li></ol>

## Device memory

In special relays and special registers of FX5CPUs, there are devices for which the values vary when a programmable controller is stopped.

Therefore, the verification result between a programmable controller and device memory may be mismatched.

## Tag FB setting

In projects for an RnPCPU (process mode/redundant mode) and an RnPSFCPU, the tag FB setting is not verified.

## Function/function block

In GX Works3 Version 1.036N to 1.044W, unconverted functions/function blocks in FB files/FUN files are excluded from verification.

To verify unconverted functions/function blocks, install the latest GX Works3 or perform the 'project verification.' (☞ Page 143 Verifying Projects)

# 13.3 Writing Programs While a CPU Module is in the RUN State

This section explains the function to change programs and data while a CPU module is running (online change).

Before using this function, be sure to fully understand the considerations.

For the detailed specifications on the online change function of a CPU module, refer to the following:

📖 MELSEC iQ-R CPU Module User's Manual (Application)

📖 MELSEC iQ-F FX5 User's Manual (Application)

There are the following two types in the online change function:

○: Available, ×: Not available

Type	Description	Supported CPU module/remote head module				
		RnCPU RnENCPU RnPCPU	RnPSFCPU <sup>*3</sup> RnSFPCPU <sup>*4</sup>	LHCPU	FX5CPU	RJ72GF15-T2
Online program change	To partially change and write programs or data while a CPU module is running.	○ <sup>*1*2</sup>	○	○ <sup>*1*2</sup>	○ <sup>*1</sup>	×
File batch online change	To write data for each file while a CPU module is running.	○	○	○	×	○

\*1 The following data in an SFC program can also be written using this function:

- Single SFC block
- Zoom

\*2 This function can be used in the property screen in MELSAP-L (instruction format) display.

\*3 Only standard data can be written.

\*4 Data that can be written differs depending on the safety operation mode.

- Safety mode: standard data only
- Test mode: standard data and safety data

Writing data while a CPU module is running affects scan time due to the change of number of steps. Set the secured steps for online program change on the "Program Detail Setting" screen displayed by clicking the [Detail] button of "Program."

# Considerations

---

## RCPU/LHCPU/FX5CPU

---

- The program execution is suspended during the online program change. The length of down time depends on the number of the changed steps.
- If the online program change is performed for programs which includes the rise instructions, fall instructions, SCJ instructions, and STMR instructions, the system may not operate properly.
- Do not perform the online program change to the same program from multiple pieces of GX Works3 at the same time.
- If failed to perform the online program change, the project will be returned to the previous state before the conversion in order to make it possible to perform the online program change again.
- Make sure that the parameters between in the CPU module and in the project match before performing the online program change.
- Make sure that the writing target file has been written to the CPU module before performing the online program change.
- When "Check at Communication Time" has been set less than 90 seconds, the timeout will be checked in 90 seconds. If an error occurred, extend the timeout time on the "Specify Connection Destination" screen.
- The online program change will be continued if a warning occurs at conversion.
- When the online program change is performed after changing the label names which can be accessed from external devices, the data before the change is remained in the global label assignment information. To delete the remaining data, write the global label assignment information from the "Online Data Operation" screen.
- When global labels are changed, programs using the global labels will be a target of the online program change.
- The online program change cannot be performed when a structure definition is edited (added/deleted/changed). Write a program to a CPU module on the "Online Data Operation" screen. However, it can be performed when a new member is added in the state that there is no member of a structure or when all members of the structure are edited.
- In a ladder with a large number of steps, the online program change may not be performed due to insufficient memory in GX Works3.  
In this case, close all open editors and perform the online program change again.  
Or, convert a program and then perform the file batch online change.
- When the step No. in the writing range has been registered as a condition of a device test with execution conditions, the registration will be canceled.
- When performing the online program change for data including a safety program, the safety program is not executed until writing of the program is completed. Confirm that the system is safely operating before performing the online program change.
- Do not perform the online program change for data including a safety program while switching the safety operation mode of an RnSFCPU to the safety mode.
- If a recording setting exists in a CPU module, write the setting after performing the online program change. Otherwise, a recording setting error may occur when starting recording.

## Design instructions

---

### **WARNING**

■When data change, program change, or status control is performed from a personal computer to a running programmable controller, create an interlock circuit outside the programmable controller to ensure that the whole system always operates safely.

Furthermore, for the online operations performed from a personal computer to a CPU module, the corrective actions against a communication error due to such as a cable connection fault should be predetermined as a system.

---



## Startup/Maintenance Instructions

---

### CAUTION

■The online operations performed from a personal computer to a running CPU module (program change while a CPU module is in RUN state, operating status change such as RUN-STOP switching, and remote control operation) have to be executed after the manual has been carefully read and the safety has been ensured.

When changing a program while the CPU module is in RUN, it may cause a program corruption in some operating conditions. Fully understand the precautions described in this section.

---

# Writing data after changing programs partially while a CPU module is running (Online program change)

This online program change partially overwrites data such as program files in a CPU module. Before changing programs, check that the programs match with ones in the CPU module by verifying data with the programmable controller. If there is no file to be changed, the online change cannot be performed.

The following table shows available data change operations and applicable files for the online program change.

○: Applicable, —: Not applicable

Operation		Applicable file for online program change				
		Program	POU	Initial local label value <sup>*1</sup>	Global label (settings, assignment information <sup>*1</sup> )	Initial global label value <sup>*1</sup>
Global label	Adding/changing global labels	—	—	—	○ <sup>*2</sup>	○ <sup>*3</sup>
Program block	Adding/changing local labels	○	—	○ <sup>*3</sup>	—	—
	Adding/changing/deleting programs	○	—	—	—	—
Function block	Adding/changing local labels	—	○	—	—	—
	Adding/changing/deleting programs	—	○	—	—	—
Function	Adding/changing local labels	—	○	—	—	—
	Adding/changing/deleting programs	—	○	—	—	—

\*1 FX5CPUs do not support it.

\*2 The operation for the assignment information can be performed only when the labels are set to be accessed from external devices.

\*3 The operation for an initial label value file can be performed only when initial label values are set. When the initial values are not applied to labels, the initial label value file with the same name in a programmable controller will be deleted.

## Operating procedure

**1.** Check that programs are matched with ones in a programmable controller.

When some data to be written is mismatched with a program in a CPU module, the online program change cannot be performed. Write each file by using the file batch online change. (➡ Page 605 Writing data for each file while a CPU module is running (file batch online change))

**2.** Modify a program.

**3.** Select [Convert] ⇨ [Online Program Change].

**4.** Select a program to write, and click the [Yes] button.

### Point

Check the processing procedure and precautions for the online program change by clicking the [Precautions] button.

## Online program change of SFC programs

The online program change of an SFC program can be performed by the following methods:

- Performing the online change (SFC block)
- Performing the online program change for a Zoom
- Performing the online program change in the property screen in MELSAP-L (instruction format) display (FX5CPUs do not support this method.)

### ■Deleting an SFC block

To perform the online program change after deleting an SFC block, perform the following operations.

1. Select and right-click an SFC block to be deleted in the navigation window, then select [Delete Data] from the shortcut menu.
2. Select [Convert] ⇒ [Online Program Change].

### Precautions

- The online program change cannot be performed when multiple SFC blocks are edited or an SFC program is deleted. In that case, write data to a CPU module in the "Online Data Operation" screen.
- The online program change cannot be performed when changing the display format (type) of a transition to device/label by the following operations. In that case, write data to a CPU module in the "Online Data Operation" screen after converting all programs.
  1. Select [Edit] ⇒ [Change Type of Transition].
  2. Set each item in the "Change Type of Transition" screen as follows, and click the [OK] button.
    - Target to change: All Blocks
    - Target Contact: All

## Online program change after editing device comments

When the online program change is performed after editing device comments, the device comments are written after writing programs.

The operations below can be chosen for writing device comments by selecting [Tool] ⇒ [Options] ⇒ "Convert" ⇒ "Online Program Change."

Item	Value	Description
Check Device Comment Difference	No	The confirmation message does not appear, and all device comments are written.
	Yes	The confirmation message appears, and whether or not to write device comments can be selected.

Note that the online program change cannot be performed even if only device comments were edited with the program or labels unchanged.

To write only device comments while a CPU module is running, use the "Online Data Operation" screen.

## Online program change for initial label values (version 1.000A only)

After adding/changing labels, the initial label value file needs to be written to a CPU module.

In addition, when clearing all initial values, the initial label value file needs to be deleted from a CPU module.

During the boot operation, an initial label value file needs to be written to the SD memory card in the CPU module. To clear all initial values, the file needs to be deleted from the boot file setting of the memory card parameter. If the file is not written to the CPU module or not deleted, an error occurs when resetting or turning the power of the CPU module OFF and ON, or switching the operating status from STOP to RUN.

## Online program change for initial label values (version 1.032J or later)

When an initial label values are not set, the initial label value file with the same name in a programmable controller will be deleted.

During the boot operation, an initial label value file needs to be written to the SD memory card. By selecting the checkbox of "Reflect Changes to Boot Source" when performing the online program change, an initial label value file is written even if an initial label value is not set.

## Writing range for online program change

The range to be written differs depending on the editing methods of programs.

### ■Ladder program

When a new ladder block is inserted, or a ladder block is deleted, the inserted program is written together with one instruction after the inserted ladder block to the CPU module.

Therefore, the online program change may not be completed at a time depending on the number of program steps before and after addition or deletion. In this case, reduce the number of steps written at a time and perform the online program change in several times.

## Execution of rising/falling instructions after performing online program change

When the raising/falling instructions in the subroutine function block program are modified or added, the instructions do not operate normally immediately after the online program change is performed even if the execution condition is satisfied.

This is the same as the case of the macro type function block in the subroutine function block in the following example of program configuration.

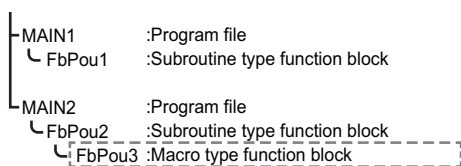

For details, refer to the following:

📖 MELSEC iQ-R CPU Module User's Manual (Application)

## POU duplication check

When performing the online program change, the program can be checked whether a POU name is duplicated in the program and in a program in a CPU module.

Whether to check the duplication can be set by setting the following option.

- [Tool] ⇒ [Options] ⇒ "Convert" ⇒ "Online Program Change" ⇒ "Operational Setting" ⇒ "Duplication Check for POU"

## Program transfer during the online program change

A program can be transferred (i.e. the program restoration information are written and the program memory are transferred) in the background during the online program change.

By doing so, the waiting time until the program becomes editable can be shorten.

The following conditions need to be satisfied to transfer a program in the background.

- "Write in Background" is selected in the following option.

[Tool] ⇒ [Options] ⇒ "Convert" ⇒ "Online Program Change" ⇒ "Operational Setting" ⇒ "Write a Program Restore Information"

- The boot operation is not in process. Or, the boot operation is in process but the checkbox of "Reflect Changes to Boot Source" is not selected when the online program change is performed.

This function is available only in projects for an RnCPU, RnENCPU, RnPCPU, RnSFCPU, and LHCPU.

### Precautions

#### ■ Interruption of writing the program restoration information

When the power-OFF or reset of a CPU module, or cable disconnection is detected while writing the program restoration information, the processing is canceled and a message appears.

For the interruption caused by the power-OFF or reset of a CPU module, write the program restoration information again.

For the interruption caused by the cable disconnection, connect the cable again, and click the [Retry] button on the message.

When the [Cancel] button is clicked, the following error occurs.

- The restoration information is not written. Therefore, an error occurs when reading the data from a programmable controller and it is not read.
- The execution program and the restoration information may be mismatched. Therefore, an error occurs after resetting the programmable controller and the program cannot be executed.

To clear the errors, set the CPU module in the STOP state and write the program again.

## Program restoration information

Whether or not to write program restoration information can be selected when performing the online program change.

By setting the following option, whether or not to write the program restoration information can be selected in the "Online Program Change" screen.

- [Tool] ⇒ [Options] ⇒ "Online" ⇒ "Program Restore Information" ⇒ "Operational Setting" ⇒ "Enable the setting to write/not to write program restore information"

When a program is written without writing the program restoration information, the data cannot be read with 'Read from PLC,' and the detailed verification result screen cannot be displayed with 'Verify with PLC.'

For CPU modules that do not support this function, whether to write the program restoration information cannot be selected even when the option is set.

## Separate writing of a program and program restoration information (FX5CPU only)

When writing data to an FX5CPU by using the online program change function, a program and program restoration information can be written separately by setting "Yes" for the following option:

- [Tool] ⇒ [Options] ⇒ "Convert" ⇒ "Online Program Change" ⇒ "Operational Setting" ⇒ "Divide to Write a Program and Program Restore Information"

By writing a program and program restoration information separately, an error that occurs when the capacity of data to be written to an FX5CPU exceeds the maximum writable capacity may be cleared.

### Precautions

- It may take time to write data when writing a program and program restoration information separately.
- A project is automatically saved with the data writing. Therefore, it is necessary to register the project history in advance.  
( Page 160 Project Revision History)
- If a project is not saved automatically, the data will also not be written to an FX5CPU.
- When writing fails, reset or cycle the power of the FX5CPU. Then, write the data to the FX5CPU in the STOP state.

## Operations when using CPU modules in a redundant system configuration

For an RnPCPU (redundant mode), the operations differ depending on the operation modes.

An RnPSFCPU operates only when selecting the backup mode for the operation mode.

Operation mode	Operation
Separate mode	Applied to the CPU module in the connective system.
Backup mode	Applied to the CPU module in the connective system. A program is transferred to the other system after performed in the connective system.

# Writing data for each file while a CPU module is running (file batch online change)

A program and/or data can be written for each file while a CPU module is running.  
FX5CPUs do not support this function.

## Operating procedure

Select [Online] ⇒ [Write to PLC] while a CPU module is running.

## Precautions

If there is not enough free capacity in the program memory of a CPU module to write the programs, the file batch online change cannot be performed.

If labels and module parameters are not changed when using a module label, writing the module parameter is omitted and the file batch online change of the program can be performed.

## Execution condition

The following table shows the files to which the file batch online change can be performed and the conditions.  
Before writing a file other than the one described in the following table, change the status of the CPU module to STOP/PAUSE.

### ■Projects for an RnCPU, RnENCPU, RnPCPU, and LHCPU

File	Condition
<ul style="list-style-type: none"> <li>Initial global label value</li> <li>Initial local label value</li> <li>Device memory</li> <li>File register</li> <li>Initial device value</li> <li>Common device comment</li> <li>Each program device comment</li> <li>Device station setting</li> </ul>	No condition
<ul style="list-style-type: none"> <li>Program file (A local label/global label/FB/FUN is not used.)</li> </ul>	<ul style="list-style-type: none"> <li>Registered in the program setting of the CPU parameter.</li> <li>Described in Ladder Diagram, Structured Text, or Function Block Diagram.</li> </ul>
<ul style="list-style-type: none"> <li>Program file<sup>*1</sup> (A local label/global label/FB/FUN is used.)</li> </ul>	<ul style="list-style-type: none"> <li>Registered in the program setting of the CPU parameter.</li> <li>Described in Ladder Diagram, Structured Text, or Function Block Diagram.</li> <li>All programs have not been converted since the previous writing of the file to a CPU module.<sup>*2</sup></li> <li>A local label has not been added, changed, or deleted since the previous writing of the file to a CPU module.</li> </ul>
<ul style="list-style-type: none"> <li>FB/FUN file<sup>*1</sup></li> </ul>	<ul style="list-style-type: none"> <li>Registered in the FB/FUN file setting of CPU parameters.</li> <li>All programs have not been converted since the previous writing of the file to a CPU module.<sup>*2</sup></li> <li>A local label has not been added, changed, or deleted since the previous writing of the file to a CPU module.</li> </ul>
<ul style="list-style-type: none"> <li>Global label setting<sup>*1</sup></li> </ul>	<ul style="list-style-type: none"> <li>A global label that can be accessed from an external device is not set.</li> <li>All programs have not been converted since the previous writing of the file to a CPU module.<sup>*2</sup></li> <li>A global label has not been added, changed, or deleted since the previous writing of the file to a CPU module.</li> </ul>

\*1 Before performing the file batch online change, a file to be written must be set in advance by using special relays (SM) and special registers (SD).

For details, refer to the following manual. (RCPU only)  
 MELSEC iQ-R CPU Module User's Manual (Application)

\*2 If "No" is selected for the following option, the file batch online change can be performed even when any or all programs are converted (retained).  
 [Tool] ⇒ [Options] ⇒ "Online" ⇒ "Write to PLC" ⇒ "Operational Setting" ⇒ "Turn PLC to STOP in writing to PLC after executing Rebuild All and execute remote RUN"

## ■ Projects for an RnSF CPU and RnPSF CPU

File	Condition
<ul style="list-style-type: none"> <li>Initial global label value</li> <li>Initial local label value</li> <li>Device memory</li> <li>File register</li> <li>Initial device value</li> <li>Common device comment</li> <li>Each program device comment</li> </ul>	No condition
<ul style="list-style-type: none"> <li>Program file (A local label/global label/FB/FUN is not used.)</li> </ul>	<ul style="list-style-type: none"> <li>Registered in the program setting of the CPU parameter.</li> <li>It is for a standard program.*1</li> <li>Described in Ladder Diagram, Structured Text, or Function Block Diagram.</li> </ul>
<ul style="list-style-type: none"> <li>Program file (A local label/global label/FB/FUN is used.)</li> </ul>	<ul style="list-style-type: none"> <li>Registered in the program setting of the CPU parameter.</li> <li>It is for a standard program.*1</li> <li>Described in Ladder Diagram, Structured Text, or Function Block Diagram.</li> <li>A standard/safety shared label is not used.*1</li> <li>An FB/FUN used in a program has not been edited since the previous writing of the file to a CPU module.</li> <li>A structure has not been edited since the previous writing of the file to a CPU module.</li> <li>All programs have not been converted since the previous writing of the file to a CPU module.*3</li> <li>A local label has not been added, changed, or deleted since the previous writing of the file to a CPU module.</li> <li>A global label has not been added, changed, or deleted since the previous writing of the file to a CPU module.</li> <li>A file to be written with a program file is a global label setting file, FB file (including SlibFbFile), or FUN file.</li> <li>Secured steps for online program change of FB files and FUN files have not been changed.</li> <li>A security setting for an FB file or FUN file has not been changed.</li> </ul>
<ul style="list-style-type: none"> <li>FB/FUN file*2</li> </ul>	<ul style="list-style-type: none"> <li>Registered in the FB/FUN file setting of CPU parameters.</li> <li>It is for a standard FB/FUN.*1</li> <li>All programs have not been converted since the previous writing of the file to a CPU module.*3</li> <li>A local label has not been added, changed, or deleted since the previous writing of the file to a CPU module.</li> </ul>
<ul style="list-style-type: none"> <li>Global label setting*2</li> </ul>	<ul style="list-style-type: none"> <li>It is for a standard global label.*1</li> <li>A global label that can be accessed from an external device is not set.</li> <li>All programs have not been converted since the previous writing of the file to a CPU module.*3</li> <li>A global label has not been added, changed, or deleted since the previous writing of the file to a CPU module.</li> </ul>

\*1 A condition to write the file to an RnPSF CPU.

\*2 Before performing the file batch online change, a file to be written must be set in advance by using special relays (SM) and special registers (SD).

For details, refer to the following:

 MELSEC iQ-R CPU Module User's Manual (Application)

\*3 If "No" is selected for the following option, the file batch online change can be performed even when any or all programs are converted (retained).

[Tool] ⇒ [Options] ⇒ "Online" ⇒ "Write to PLC" ⇒ "Operational Setting" ⇒ "Turn PLC to STOP in writing to PLC after executing Rebuild All and execute remote RUN"



# 13.4 Reading/Writing/Deleting User Data

Read/write/delete user data from/to the CPU built-in memory/SD memory card.

The user data written to the CPU built-in memory/SD memory card can be used in sequence programs.

The files which have a three-character extension (example: csv, txt, bin, xml) can be used as a user data.

However, some extensions and files are not supported. Unsupported files are not displayed on the screen.

For FX5CPUs, a firmware update prohibited file (FWUPDP.SYU) can be written, read, and deleted.

## Window

Select [Online] ⇒ [User Data] ⇒ [Write]/[Read]/[Delete].

The following screen is an example when writing data.

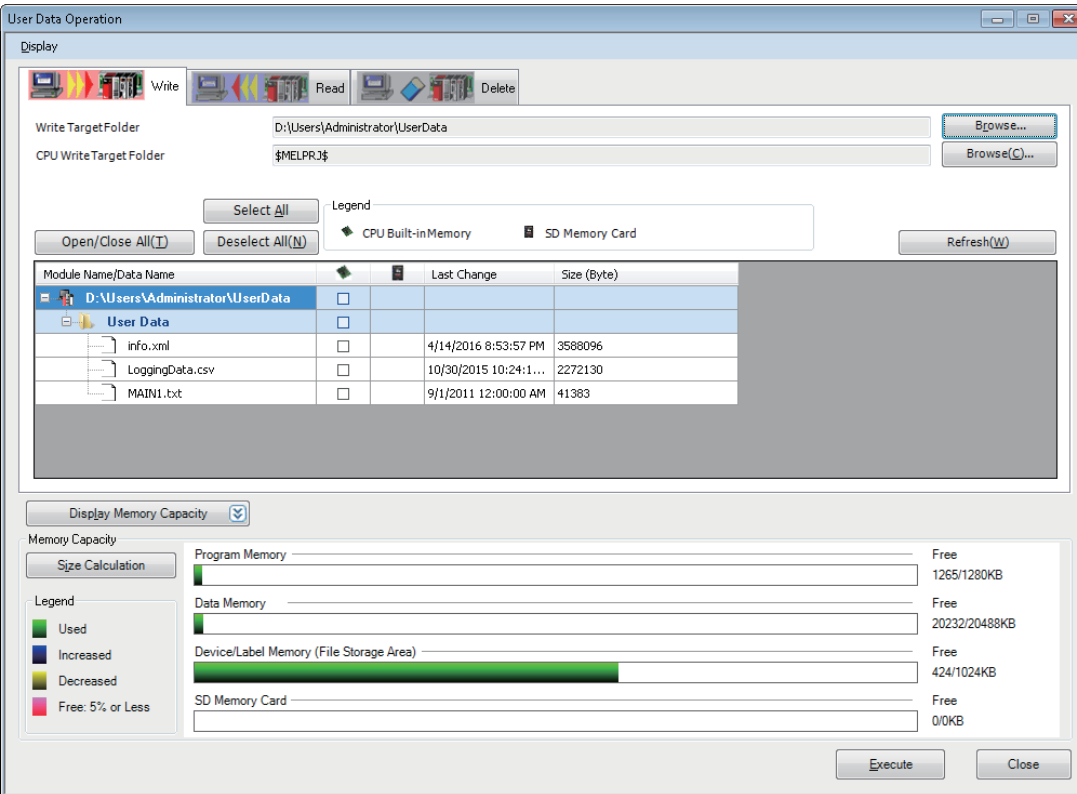

## Operating procedure

1. Select [Write], [Read], or [Delete] tab on the "User Data Operation" screen.
2. Select the target files, and a write target or read source.
3. Click the [Execute] button.

### ■ Operations when using CPU modules in a redundant system configuration

For an RnPCPU (redundant mode), the operations differ depending on the operation modes.

An RnPSFCPU operates only when selecting the backup mode for the operation mode.

Operation mode	Operation
Separate mode	Applied to the CPU module in the connective system.
Backup mode	Applied to both systems (order: control system → standby system).

## Creating/deleting folders, changing folder name

A folder can be created in the CPU built-in memory or SD memory card.

A created folder can be deleted and the folder name can be changed.

Create/delete a folder, or change a folder name on the "Browse Folders" screen displayed by clicking the [Browse] button on the "User Data Operation" screen.

### ■Creating folders

Select a place in which the folder is to be created in the "Browse Folders" screen, right-click it and select [Create Folder] from the shortcut menu.

### ■Deleting folders/changing folder name

Select a folder in the "Browse Folders" screen, right-click it and select [Delete Folder]/[Change Folder Name] from the shortcut menu.

### ■Operations when using CPU modules in a redundant system configuration

For an RnPCPU (redundant mode), the operations differ depending on the operation modes.

An RnPSFCPU operates only when selecting the backup mode for the operation mode.

Operation mode	Operation
Separate mode	Applied to the CPU module in the connective system.
Backup mode	Applied to both systems (order: control system → standby system).

## 13.5 Deleting All Files (Initialization)

Memories can be initialized when using a CPU module and SD memory card for the first time or clearing all data stored in them.

Once the memories are initialized, the following processing is performed on each memory.

- Data memory: All folders/files in the program memory and data memory are deleted.
- Device/label memory: All files in the file storage area in the device/label memory are deleted.
- SD memory card: All folders/files in the SD memory card are deleted.

For the operation methods, refer to the following:

☞ Page 771 Initializing/Clearing a Memory

## 13.6 Reading/Writing the Label Memory

The label memory (current values of labels) can be read from/written to a CPU module.

By reading the label memory from a CPU module in advance, it can be written to the CPU module as necessary.

For the operation methods, refer to the following:

☞ Page 773 Reading/Writing the Label Memory

### Ex.

When writing a program to a CPU module after converting (reassigning) all programs, the values of labels can be restored by writing the label memory that was read in advance to the CPU module.

# 13.7 Writing/Reading Data to/from Memory Card

This section explains the operations for writing/reading data to/from an SD memory card inserted in a personal computer. These operations are used, for example, when data cannot be written to/read from an SD memory card inserted in a CPU module.

However, data of a safety project cannot be written or read.

For details on the writing/reading data to/from a CPU module where an SD memory card is inserted, refer to the following:

☞ Page 577 Writing/Reading Programmable Controller Data

R00CPU and remote head modules do not support this function.

## Configuration of the memory card operation screen

### Window

Select [Tool] ⇒ [Memory Card] ⇒ [Write to Memory Card]/[Read from Memory Card].

The following screen is an example when writing data.

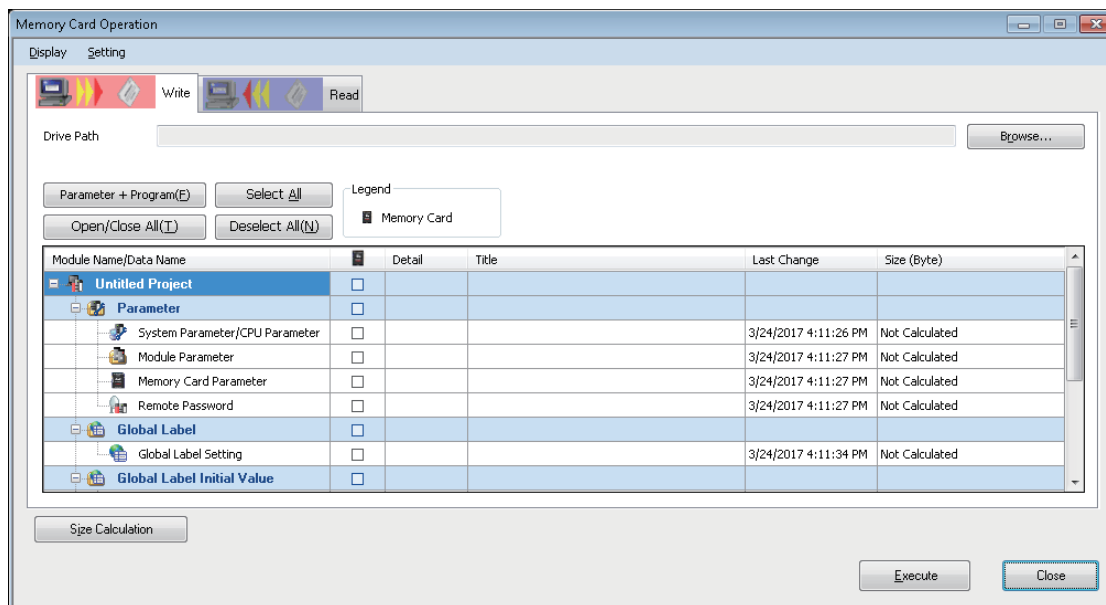

- The data name in gray indicates that it is in the unconverted state.
- Size of the selected data can be displayed in the "Size (Byte)" column by clicking the [Size Calculation] button.

# Writing to/Reading from a memory card

---

Write/Read data to/from an SD memory card.

The file, which is in the '\$MELPRJ\$' folder of the specified drive path, is the target for reading/writing.

## Operating procedure

1. Select the [Write] tab/[Read] tab on the "Memory Card Operation" screen.
2. Set the drive path of the write target/read source, then click the [Execute] button.

## Considerations when reading program files from a memory card

---

Perform the following operations to read program files from an SD memory card.

### ■Parameters have been written with program files when writing to a memory card

Read the parameters with the program files.

### ■Parameters have not been written with program files when writing to a memory card

Before reading the program files, open the project opened when writing to the SD memory card.

Read parameters used when writing to the SD memory card from the CPU module.

## File password function

---

By using the file password function, illegal reading and writing of files in an SD memory card can be prevented.

For details, refer to the following:

☞ Page 692 Preventing Illegal Data Reading/Writing (File Password )

# 14 CHECKING OPERATION OF PROGRAMS

This chapter explains the method for checking the execution status of an intelligent function module and a CPU module connected to a personal computer.

The functions to check the execution status are as follows:

Purpose	Function name	Reference
To check the status of programs being executed on a program editor	Monitor	Page 616 Checking Execution Programs on a Program Editor
To check the current values of devices or buffer memory in a batch	Device/buffer memory batch monitor	Page 633 Checking Device/Buffer Memory in a Batch
To check the current values of devices and labels by registering them	Watch	Page 637 Checking Current Values by Registering Devices/Labels
To check input/output devices, which are registered to a CPU module, to be turned ON/OFF forcibly	Register/cancel forced input/output <sup>*1</sup>	Page 644 Turning Input/Output Devices ON/OFF Forcibly
To check the operation of a program by changing a device or label value at the specified timing	Device test with execution condition <sup>*1</sup>	Page 646 Changing Device/Label Value by Setting Conditions
To set the current values of FB properties as the initial values	FB property management (online) <sup>*1</sup>	Page 666 Setting Current Values of FB Properties as their Initial Values
To check tag data	Faceplate <sup>*2</sup>	Page 662 Checking tag data on the gauge window (faceplate)
	PX Developer Monitor Tool interaction <sup>*2</sup>	Page 665 PX Developer Monitor Tool interaction
To pause and restart the operation of a process control function block in a running program	Pause FB/restart FB <sup>*2</sup>	Page 650 Pausing/Restarting the Operation of Function Blocks
To measure the scan time of any sections in a program	Scan time measurement <sup>*3</sup>	Page 653 Measuring the Scan Time of a Program
To check the processing time of a program being executed.	Program list monitor <sup>*1</sup>	Page 655 Checking the Processing Time of a Program
To check the number of executions of an interrupt program used in a program.	Interrupt program list monitor <sup>*1</sup>	Page 657 Checking Execution Counts of Interrupt Programs
To check the I/O signals and the current value of buffer memory by registering the module information of an intelligent function module.	Intelligent function module monitor	Page 658 Checking Current Values in an Intelligent Function Module
To check the current logging data collected by a CPU module.	Realtime monitor	Page 661 Checking Current Logging Data

\*1 Cannot be used in FX5CPUs.

\*2 Can be used in projects for an RnPCPU (process mode/redundant mode) and an RnPSFCPU with the process control extension enabled.

\*3 Can be used in RnCPUs, RnENCPU, and RnSFPCUs.

## Changing current values

The operation of a module can be checked by changing the current value of devices, labels, and buffer memory using the change current value function.

This function turns bit devices forced ON/OFF on a CPU module. The current values of the word device and buffer memory can also be changed forcibly.

The current values can be changed on the following screens.

- Program editor
- "Device/Buffer Memory Batch Monitor" window
- Watch window
- Intelligent function module monitor window

Safety devices/labels and standard/safety shared labels can be changed only when the safety operation mode of a CPU module is in the test mode.

### Point

- If "Execute END Processing between Programs" is selected for "Device/Label Access Service Processing Setting" in "CPU Parameter," the current values are changed after a program is executed or when the END processing is executed.
- When selecting a program with the specified program monitor function, the current values are changed after executing the selected program. For details on the specified program monitor function, refer to the following:  
☞ Page 613 When monitoring devices/labels in a specified program

## Precautions

When using the write-protect function for device data (from outside the CPU module), the current values of a device to which writing data is prohibited cannot be changed.

For details on the write-protect function for device data (from outside the CPU module), refer to the following:

📖 MELSEC iQ-R CPU Module User's Manual (Application)

### Change history of current value

When the current values of bit device are changed, the change history can be checked.

## Window

Select [Debug] ⇒ [Change History of Current Value].

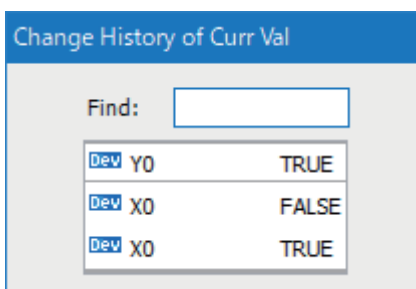





# 14.1 Monitor Status

To check the operating status of a CPU module and an intelligent function module, connect a personal computer to the CPU module and start monitoring.

## Starting/stopping monitoring

Start/stop monitoring by selecting one of the following menus.

- [Online] ⇒ [Monitor] ⇒ [Start Monitoring]()/[Stop Monitoring]()
- [Online] ⇒ [Monitor] ⇒ [Start Monitoring (All Windows)]()/[Stop Monitoring (All Windows)]()
- [Online] ⇒ [Watch] ⇒ [Start Watching]/[Stop Watching]
- Select [Online] ⇒ [Monitor] ⇒ [Monitor Mode] on the active ladder editor

For a ladder editor, start monitoring by selecting a mode from the pull-down list for the ladder edit mode, which is in the upper left of the editor.

### Point

By selecting "Yes" for the following option, monitoring for all the windows are stopped automatically when data is converted or all programs are converted during monitoring.

- [Tool] ⇒ [Options] ⇒ "Convert" ⇒ "Basic Setting" ⇒ "Operational Setting" ⇒ "Stop the Monitor in Executing Convert/Rebuild All"

14

### ■When monitoring multiple projects using a single personal computer

- If a communication error has occurred in one of the projects, the monitoring speed of the other projects may become slow. The operation speed will be back to normal after closing the error message displayed in the project in which the communication error occurred.
- The following functions may not be performed normally:  
Program list monitor, interrupt program list monitor, and scan time measurement

### ■Monitoring buffer memory or link devices

Monitor the ON/OFF state of the buffer memory or link devices (example: U0\G0.1) by setting the following option.

- [Tool] ⇒ [Options] ⇒ "Monitor" ⇒ "Common Item"/"(Program editor)" ⇒ "Operational Setting"

### ■Changing display format of word devices

Select [Online] ⇒ [Monitor] ⇒ [Change Value Format (Decimal)] / [Change Value Format (Hexadecimal)] to change the display format of the monitored values.

### ■FB instance

To monitor the devices/labels in an FB instance, open the FB program and select the FB instance to be monitored from the monitor status bar.

### ■When monitoring devices/labels in a specified program

To monitor devices/labels after executing a specified program, select "Yes" for the following option, then select a program file to be monitored from the monitor status bar.

- [Tool] ⇒ [Options] ⇒ "Monitor" ⇒ "Common Item" ⇒ "Timing to Execute Monitor Function and Modify Value Function" ⇒ "After the execution of specified program"

RnCPUs, RnENCPU, and RnSFCPU support this option.

### Point

When selecting "Use File Register of Each Program" in "File Register Setting" in "CPU Parameter," file registers in a specified program can be monitored by using the specified program monitor function.

For considerations when monitoring file registers, refer to the following:

 Page 619 Considerations when monitoring file registers

## Precautions

During specified program monitoring, local device values in a selected program are displayed as the current values of local devices in other programs.

## Status monitoring

Status is displayed during monitoring on the monitor status bar.

### Window

At the start of monitoring



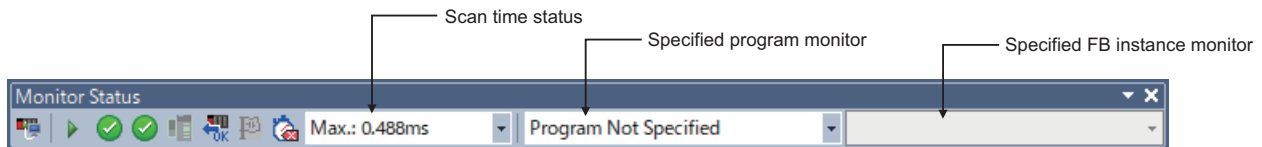

The following screen is an example for an RnCPU project.



### Displayed items

Item	Description	Icon	Detail
Connection status	The connection status with a CPU module is displayed. The "Specify Connection Destination" screen appears by clicking the icon. For details, refer to the following: ☞ Page 557 SETTING ROUTE TO CPU MODULE		When connected to a CPU module
CPU operation status	The CPU module status which is operated by the key switch on a CPU module or remote operation of GX Works3 is displayed. The "Remote Operation" screen appears by clicking the icon. For details, refer to the following: ☞ Page 759 Remote Operation		RUN
			STOP
			PAUSE
ERROR status	The ERROR LED status of a CPU module is displayed. The "Module Diagnostics" screen appears by clicking the icon. For details, refer to the following: ☞ Page 708 Module Diagnostics		ERROR is OFF.
			ERROR is ON.
			ERROR is flashing.
USER status	The USER LED status of a CPU module is displayed. The "Module Diagnostics" screen appears by clicking the icon. For details, refer to the following: ☞ Page 708 Module Diagnostics		USER is OFF.
			USER is ON.
			USER is flashing.
Registration status (Forced input/output)	The registration status of forced input/output is displayed. The "Register/Cancel Forced Input/Output" screen appears by clicking the icon. For details, refer to the following: ☞ Page 644 Turning Input/Output Devices ON/OFF Forcibly		Registered
			Not registered
Registration status (Device test with execution conditions)	The status of a device test with execution conditions is displayed. The "Check/Disable Register Device Test With Execution Condition" screen appears by clicking the icon. For details, refer to the following: ☞ Page 646 Changing Device/Label Value by Setting Conditions		Registered
			Not registered
Control/standby system status	The status (control or standby system) of a CPU module in a redundant system configuration or remote head module is displayed.		Control system
			Standby system
			Not determined
System A/B status	The status (system A or B) of a CPU module in a redundant system configuration is displayed.		System A
			System B
			Not determined
Redundant operation mode	The operation mode of a CPU module in a redundant system configuration is displayed.		Backup mode
			Separate mode
Safety operation mode	The safety operation mode of an RnPSFCPU or an RnSFCPU is displayed. The "Switch Safety Operation Mode" screen appears by clicking the icon. For details, refer to the following: ☞ Page 764 Safety operation mode switching		Safety mode
			Test mode



Item	Description	Icon	Detail
Availability of data reading from a programmable controller	Availability of data reading from a programmable controller is displayed.		Available
			Unavailable
Scan time clear*1	The maximum and minimum values of scan time can be cleared by clicking the icon during monitoring.		Monitoring
			Not monitoring
Scan time status	The current value, maximum value, and minimum value of scan time can be displayed by switching them from the pull-down list.		
Specified program monitor*2	Specify a program file to be monitored.		
Specified FB instance monitor	When monitoring an FB program, select an FB instance to be monitored.		

\*1 LHCPUs do not support it.

\*2 LHCPUs and FX5CPUs do not support it.

## Monitor mode

A ladder editor is switched to the monitor mode during a monitoring.

 Page 264 Configuration of a ladder editor

## Operations when the system is switched in the redundant configuration

When a tracking communication error occurs while monitoring via CC IE Control, CC IE Field, CC-Link, MELSECNET/H, or Ethernet in a redundant configuration, monitoring is continued by switching a communication route (the system to be monitored).

This function performs when specifying any one of control system, standby system, system A, or system B as a connection destination.

Supported monitor function: circuit monitor, watch, device/buffer memory batch monitor, local device monitor

# 14.2 Checking Execution Programs on a Program Editor

Use the monitoring function to check the following execution programs on each program editor.

- Ladder program
- ST program
- FBD/LD program
- SFC program

Open a program editor to be monitored in advance.



The display format and detailed operation settings for each function can be set by setting the following option.  
 [Tool] ⇒ [Options] ⇒ "Monitor"

## Applicable monitoring devices and labels

### ■Applicable devices

The following table shows the devices that can be monitored on a program editor.

For the available devices in a CPU module, refer to the user's manual of each module.

Program editor type	Module type	Device
Ladder, ST, FBD/LD, SFC	RCPU LHCPU	X, Y, M, L, B, F, SB, V, S <sup>*1</sup> , T <sup>*2</sup> , T(TS), T(TC), T(TN), ST <sup>*2</sup> , ST(STS), ST(STC), ST(STN), LT <sup>*2</sup> , LT(LTS), LT(LTC), LT(LTN), LST <sup>*2</sup> , LST(LSTS), LST(LSTC), LST(LSTN), C <sup>*2</sup> , C(CS), C(CC), C(CN), LC <sup>*2</sup> , LC(LCS), LC(LCC), LC(LCN), D, W, SW, FX, FY, SM, SD, J□\X, J□\Y, J□\B, J□\SB, J□\W, J□\SW, U□\G, U3E□\G, U3E□\HG, DX <sup>*3</sup> , DY <sup>*3</sup> , Z, LZ, R, ZR, RD, BL, BL□\S, SAIM, SAISM, SAIX, SAIY, SAIB, SAID, SAISD, SAIW, SAIT(TC), SAIT(TS), SAIT(TN), SAIT, SAIC(CC), SAIC(CS), SAIC(CN), SAIC, SAIST(STC), SAIST(STS), SAIST(STN), SAIST
	FX5CPU	X, Y, M, L, B, F, SB, S, T <sup>*2</sup> , T(TS), T(TC), T(TN), ST <sup>*2</sup> , ST(STS), ST(STC), ST(STN), C <sup>*2</sup> , C(CS), C(CC), C(CN), LC <sup>*2</sup> , LC(LCS), LC(LCC), LC(LCN), D, W, SW, SM, SD, U□\G, Z, LZ, R, BL, BL□\S

- \*1 Can be monitored in a Zoom or on an SFC diagram only. To monitor a step relay (S) in a program editor other than a Zoom, monitor a step relay with block specification (BL□\S).
- \*2 The same value as the current value (N) is displayed.
- \*3 Cannot be monitored on an SFC diagram.

### ■Inapplicable labels

- When a value other than a fixed value is used for an array index, the monitor value of the array is displayed as an indefinite value, or the monitor value is not displayed.
- An indefinite value is displayed as the monitor value of a local label in a function, or the monitor value is not displayed.

### Macro type function block

- Whether or not the input/output label of a macro type function block can be monitored depends on the monitoring status of an element which is connected to the input/output label. When a connected element is in the state where it cannot be monitored, the input/output label also cannot be monitored.
- When one FB instance is used for multiple times and if the input/output label of each FB instance is connected to a different device or label, the monitor values of the input/output label is not displayed properly.
- When a global label (structure type, array type, etc.) is connected with the input/output label of a macro type function block and if the program body of the block is monitored, the monitor values of the input/output label may not be displayed properly.
- When a local label is connected with the input/output label of a macro type function block which is registered as a global label and if the program body of the block is monitored, the monitor values of the input/output label may not be displayed properly.

Ex.

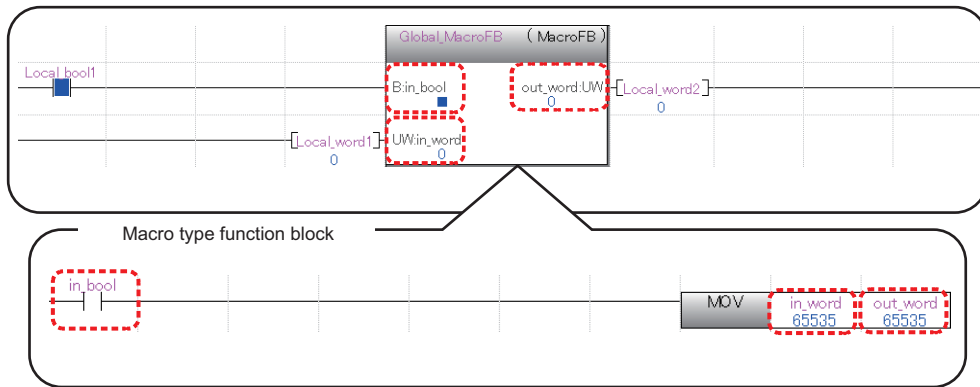

- When a macro type function block is used in a subroutine type function block, the monitor values of the input/output labels of the macro type function block may not be displayed properly. In that case, edit the input and output circuit parts of the macro type function block to change the program status to the unconverted state, then convert the program or perform the online program change. By doing so, the monitor values may be displayed properly.

Ex.

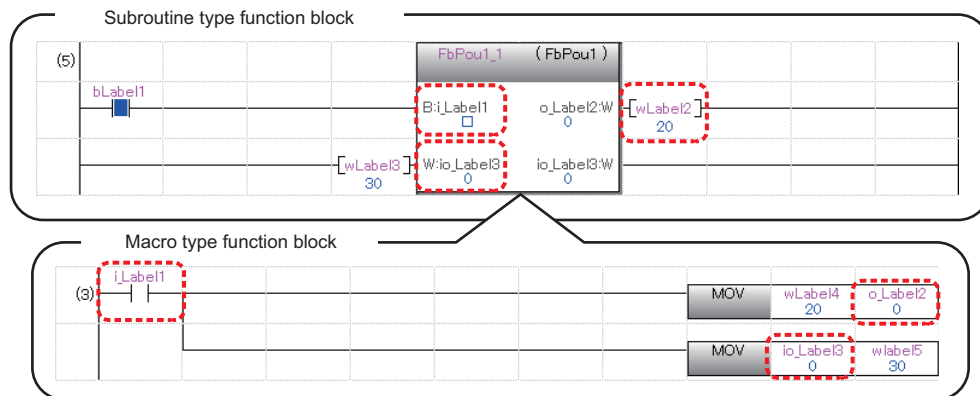

The following shows the procedure for displaying the monitor value properly.

## Operating procedure

1. Delete the line in the input circuit of the macro type function block.
2. Enter a line again.

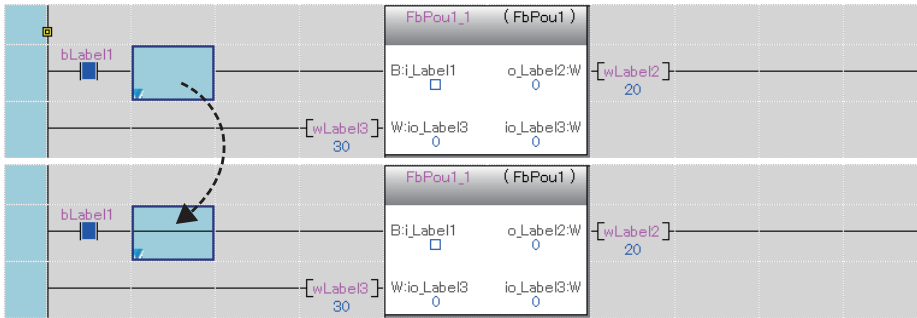

3. Convert the program.

The monitor value of the input/output label of the macro type function block is displayed properly.

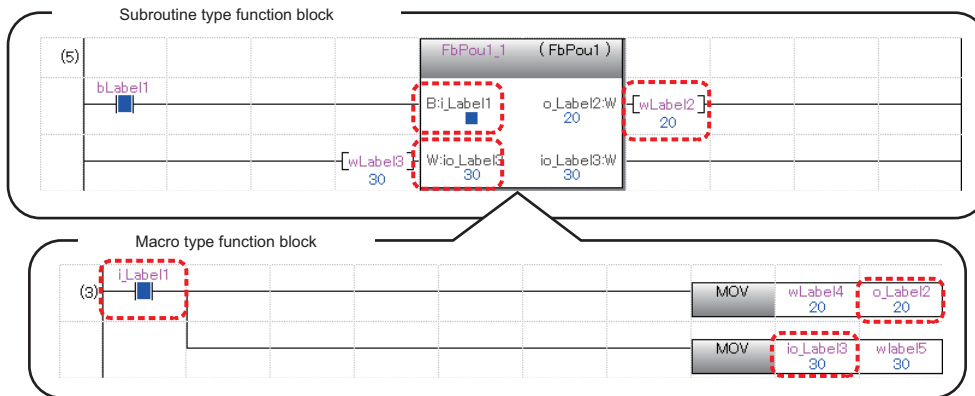

## Considerations when monitoring file registers

To monitor file registers while "Use File Register of Each Program" is selected in "CPU Parameter" ⇒ "File Setting" ⇒ "File Register Setting" ⇒ "Use or Not Setting," select a program to be monitored with the specified program monitor function before starting monitoring.

For the operation method of the specified program monitor function, refer to the following:

☞ Page 613 When monitoring devices/labels in a specified program

### ■When not using the specified program monitor function

When monitoring file registers while "Use File Register of Each Program" is selected without using the specified program monitor function, the operation differs depending on the setting of "Specifying Method" in "Device/Label Access Service Processing Setting."

Specifying method	Operation
Execute END Processing between Programs	FFFFH (-1) will be monitored in the following cases since monitoring is performed between programs or at the END processing. <ul style="list-style-type: none"> <li>Monitoring is requested after a program which is set not to use file registers.</li> <li>The value of a file register with bigger file size is monitored after a program using a file register with smaller file size.</li> </ul>
Others	A file register file that is enabled in the program executed just before the END processing will be monitored. Example: When the execution order of the programs is 'A→B→C→(END processing)→A→B...', the value of the file register at the execution of program C will be monitored. Therefore, FFFFH (-1) will be monitored in the following cases: <ul style="list-style-type: none"> <li>The program just before the END processing is set not to use file registers.</li> <li>The value of a file register with bigger file size is monitored when a file register with smaller file size is used in a program just before the END processing.</li> </ul>

In the following cases, add a program that transfers monitoring target file registers to devices, then monitor the transferred program. Note that the number of steps and scan time will increase for the added program.

- Any of the programs is set not to use file registers.
- File register size differs.

If the file register for which "Use File Register of Each Program" is selected is used as data with no latch (such that the data is set to clear to '0' at the first time), replacing the file registers to local devices avoids increase of number of steps and scan time due to the addition of programs.

## Considerations when monitoring labels

In the data types of instruction arguments (labels), some of them are represented as the genetic data types. In addition, the arguments such as ANY16 or ANY32 may have both attributes, "Signed" and "Unsigned."

The monitor value of the genetic data type is displayed as the specified label data type. Specify the data type according to the instruction specifications\*1.

\*1 For details, refer to the following:

- ☞ MELSEC iQ-R Programming Manual (CPU Module Instructions, Standard Functions/Function Blocks)
- ☞ MELSEC iQ-F FX5 Programming Manual (Instructions, Standard Functions/Function Blocks)

# Ladder

## Circuit monitor

### Operating procedure

Open a ladder editor, and select [Online] ⇒ [Monitor] ⇒ [Start Monitoring] (🟢)/[Stop Monitoring] (🔴).

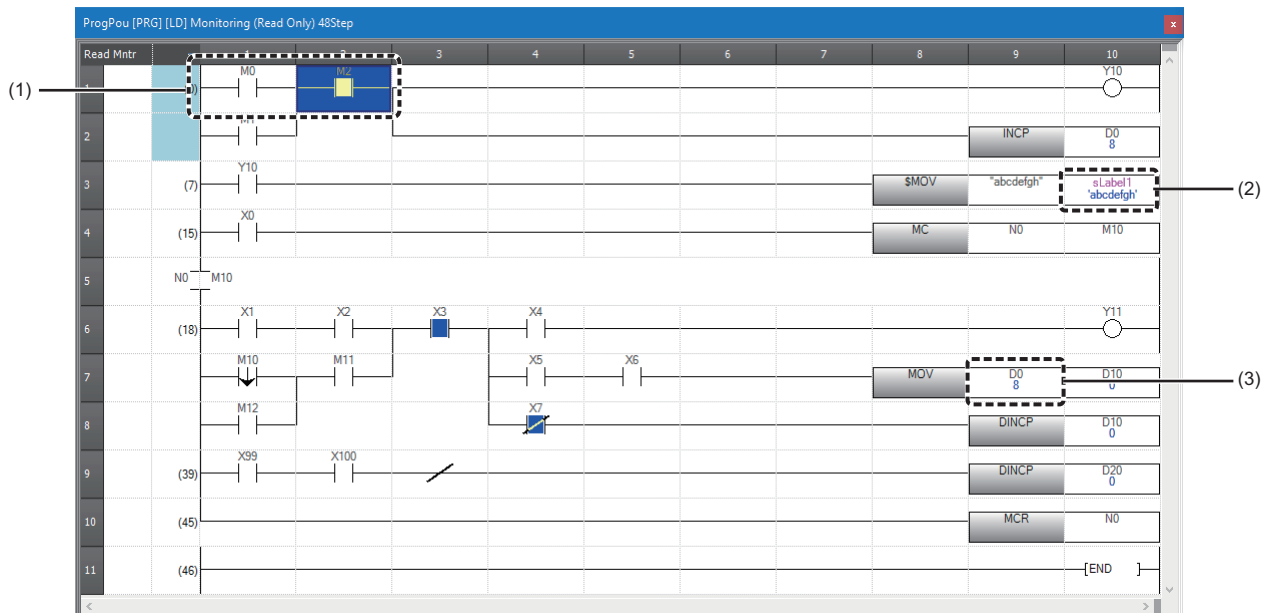

- (1) ON/OFF status of a contact/coil
- (2) Monitor value of a string type label
- (3) Monitor value of a word device

### Point

The color of monitor values or others can be changed.

👉 Page 81 Checking and Changing Colors and Fonts

The number of characters for monitor values (strings) displayed in the monitor screen can be changed with the following option.

- [Tool] ⇒ [Options] ⇒ "Monitor" ⇒ "Ladder Editor" ⇒ "Character String Monitoring Setting" ⇒ "Numbers of Characters to Display"

### ■ON/OFF state display

During monitoring, the ON/OFF state is displayed as shown in the following figure.

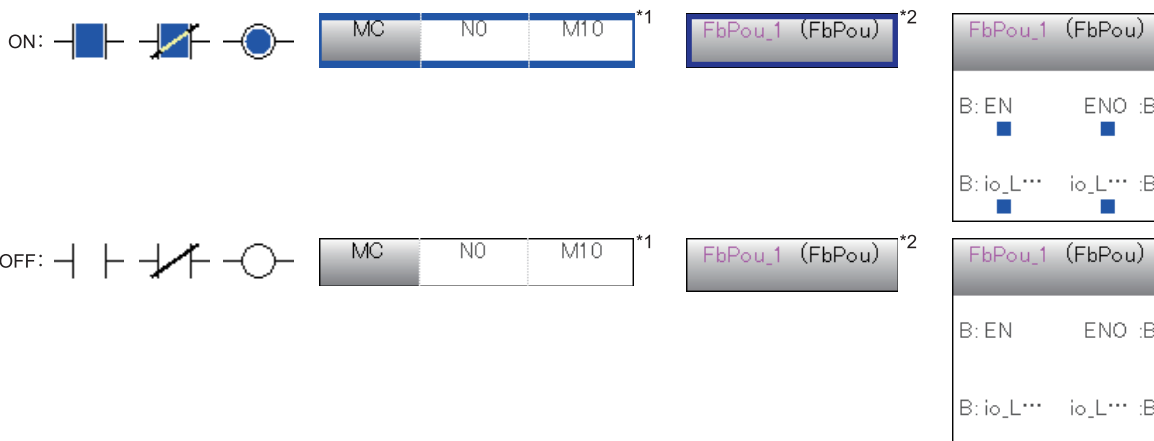

- \*1 Only the following comparison operation instructions that are equivalent to contacts and the instructions that are equivalent to coils are supported.  
 Comparison operation instructions equivalent to contacts: BIN16-bit data comparison, BIN32-bit data comparison, floating-point data comparison, 64-bit float data comparison  
 Instructions equivalent to coils: SET, RST, PLS, PLF, SFT, SFTP, MC, FF, DELTA, DELTAP, OUTHS, STL
- \*2 During monitoring, a function block with EN is displayed according to the ON/OFF state of EN. On the other hand, a function block without EN is always displayed as ON, and an undefined function block is always displayed as OFF.

### Precautions

If two application instructions (such as OUT or INCP instruction) are connected to one output label (bit type) of a function or subroutine type function block with EN/ENO, the value of the output label may not be applied to the device/label of the OUT instruction.

However, it can be avoided by any of the following operations:

- Use a function or subroutine type function block without EN/ENO.
- Use a macro type function block with EN/ENO.
- Add ladders to transfer the value of the output label to another device/label and to transfer the value of the device/label to the two instructions.

### Changing current values

Current values can be changed by the following methods during monitoring.

Target device/label	Operating procedure
Bit type	Select a cell of device/label, then press the <b>Shift</b> + <b>Enter</b> keys.
Word type	Register a device/label in a watch window and change the value. (☞ Page 637 Checking Current Values by Registering Devices/Labels)

# ST

Depending on the data types of a device and a label, the locations where their monitor values are displayed differ.

- Bit type: in a program
- Other than bit type: in the right half of the split window

A monitor value is displayed on the tooltip by placing the cursor on a device/label name.

## Monitor

### Operating procedure

Open an ST editor, and select [Online] ⇒ [Monitor] ⇒ [Start Monitoring] (🟢)/(🔴).

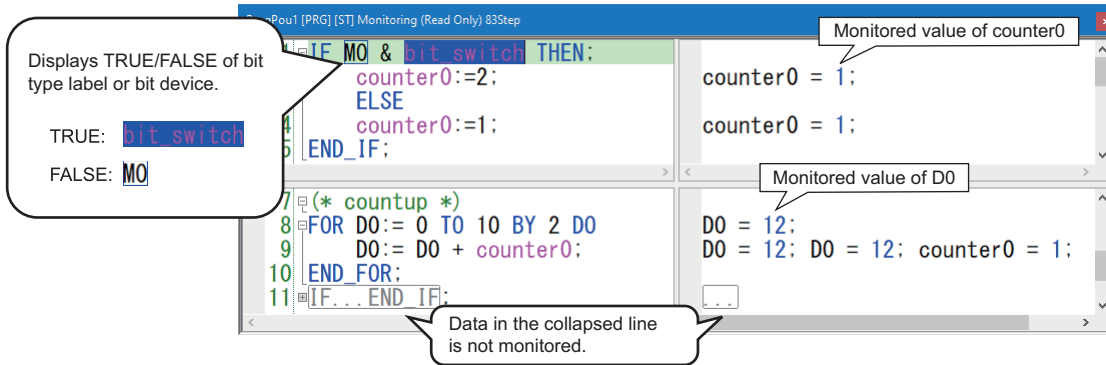

### Point

By using the following menu, the right half of the split window can be displayed or hidden.

- [Monitor] ⇒ [Switch ST Monitor Display (All)]/[Switch ST Monitor Display (Bit Type Only)]

The color of monitor values or others can be changed.

☞ Page 81 Checking and Changing Colors and Fonts

When an array type label or bit-specified label is selected, the monitor value of its array element or bit number is displayed on the tooltip.

Example: Even when 'iArray' of an array type label 'iArray[0]' is selected, the monitor value of 'iArray[0]' is displayed on the tooltip.

## Changing current values

Current values can be changed by the following methods during monitoring.

Target device/label	Operating procedure
Bit type	Select a token of device/label, then press the <b>[Shift] + [Enter]</b> keys.
Word type	Register a device/label in a watch window and change the value. (☞ Page 637 Checking Current Values by Registering Devices/Labels)



# FBD/LD

## Monitor

### Operating procedure

Select [Online] ⇒ [Monitor] ⇒ [Start Monitoring] (🟢)/[Stop Monitoring] (🔴).

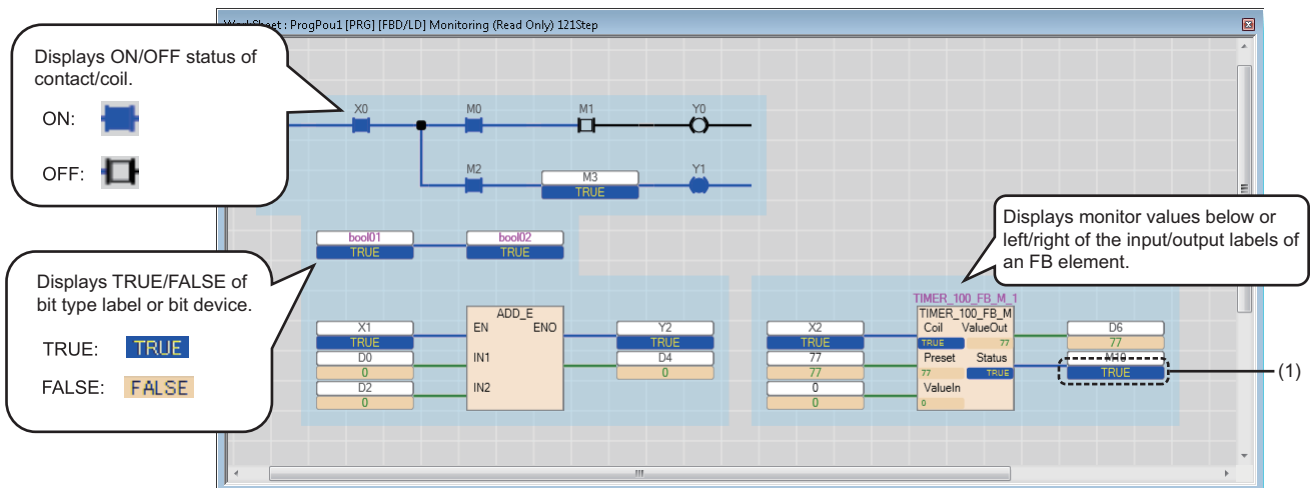

(1): Monitor value display area

When the current value cannot be monitored, "---" is displayed in the monitor value display area.

### Point

The background, text, and other colors of monitor values can be changed.

👉 Page 81 Checking and Changing Colors and Fonts

### Precautions

An inline structured text program cannot be monitored in the preview display area of inline structured text elements. Monitor it on an ST editor.

## Display format

### ■ Contact

The current continuity state can be checked by looking at a contact.

By setting the following option, ON/OFF of a constant can be changed with the current value of a device/label.

- [Tool] ⇒ [Options] ⇒ "Monitor" ⇒ "FBD/LD editor" ⇒ "Display Setting" ⇒ "Use Same Display Format for Contact as Device/Label Current Value"

### ■ Word device

A word device is displayed in Word [Signed].

For a word device with a device type specifier, the word device is displayed in the data type indicated by the device type specifier.

For details on a device type specifier, refer to the following:

📖 MELSEC iQ-R Programming Manual (Program Design)

## Monitor value display area of variable elements

### ■ Changing the position

The following shows the procedure for changing the position of the monitor value display area of a variable element.

#### Operating procedure

1. Select a variable element.
2. Click the smart tag (  ).

Each time the smart tag is clicked, the monitor value display area moves to above, below, left, and right of the variable element.\*1

The monitor value display area is displayed at the changed position until the project is closed.

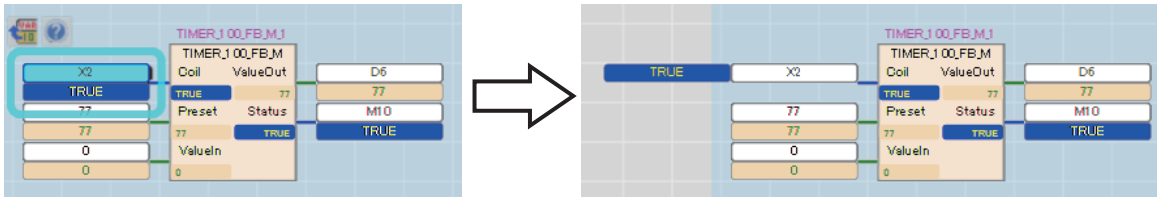

\*1 If the height of a function block element or function element is of the compact type, the monitor value display area moves to above, below, left, and right of the variable element as well as on the element.

#### Point

The positions of the monitor value display areas of variable elements which are connected to a function block element or function element can be changed at once by clicking the smart tag of the element. (  ).

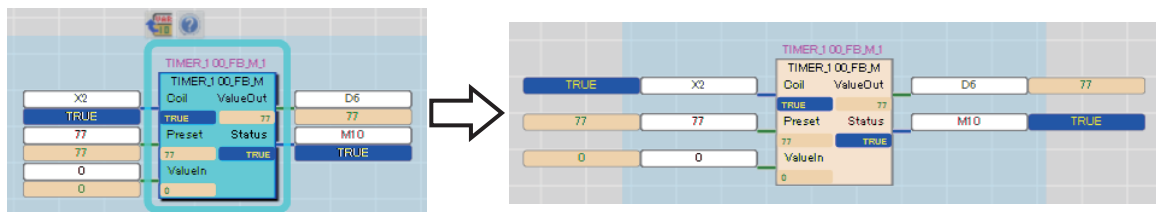

## ■ Enlarging the display

The following shows the procedure for enlarging the monitor value display area of a variable element.

### Operating procedure

Click the monitor value display area of a variable element.

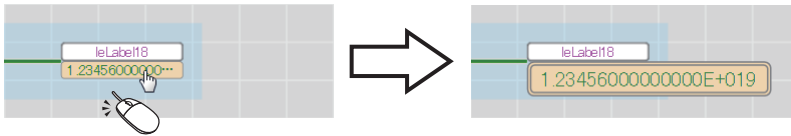

The monitor value display area is enlarged until the project is closed.

To restore it, click the monitor value display area again.

### Precautions

For GX Works3 Version 1.047Z or later, a part of a monitor value may be omitted and displayed.

In that case, all digits of the monitor value can be checked by any of the following operations.

- Register devices and labels in a watch window. ( Page 638 Registering to a watch window)
- Place the cursor on a device or label name. (The monitor value is displayed on the tooltip.)
- Enlarge the monitor value display area. ( Page 625 Enlarging the display)

## Changing current values

Current values can be changed by the following methods during monitoring.

Target device/label	Operating procedure
Bit type	Select an element of a device/label, then press the  +  keys.
Word type	Register a device/label in a watch window and change the value. (  Page 637 Checking Current Values by Registering Devices/Labels)



# SFC

Monitor values of a device and a label of the SFC program that the execution type of the program is set for "Scan."  
SFC program has the monitoring functions shown below.

Purpose	Target editor/function name	Reference
To check the active status of steps and current values of devices on an SFC diagram.	SFC diagram monitor	Page 626 Monitoring an SFC diagram
	SFC auto-scroll	Page 629 Monitoring with the SFC auto-scroll
To check the steps which were activated on an SFC diagram.	SFC activated step monitor	Page 630 Monitoring SFC steps which were activated
To check the current values of devices in a Zoom.	Zoom monitor	Page 629 Monitoring a Zoom
To check block information in a list.	SFC block list monitor	Page 631 Monitoring the SFC block list
To check active status of all blocks in a list.	SFC all blocks batch monitor	Page 632 Monitoring all SFC blocks in batch/active steps
To check active status of steps in a specified block in a list.	Active step monitor	

## Monitoring an SFC diagram

### Operating procedure

Select [Online] ⇒ [Monitor] ⇒ [Start Monitoring] (  )/[Stop Monitoring] (  ).

#### Point

The background, text, and other colors of monitor values can be changed.

 Page 81 Checking and Changing Colors and Fonts

### Detailed expression

The status of an SFC element during monitoring is displayed as shown in the following figure.

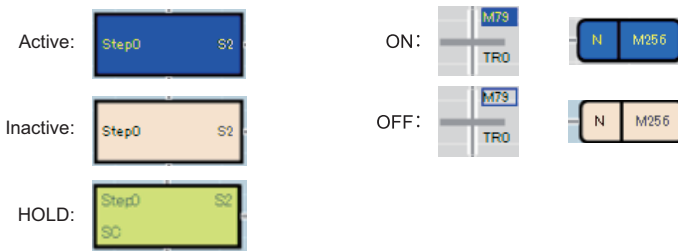

The FBD/LD elements are displayed in the same manner as that on an FBD/LD editor. (  Page 623 FBD/LD )

**Ex.**

The following screen is an example when selecting "Detailed Expression" in "Switch Ladder Display."

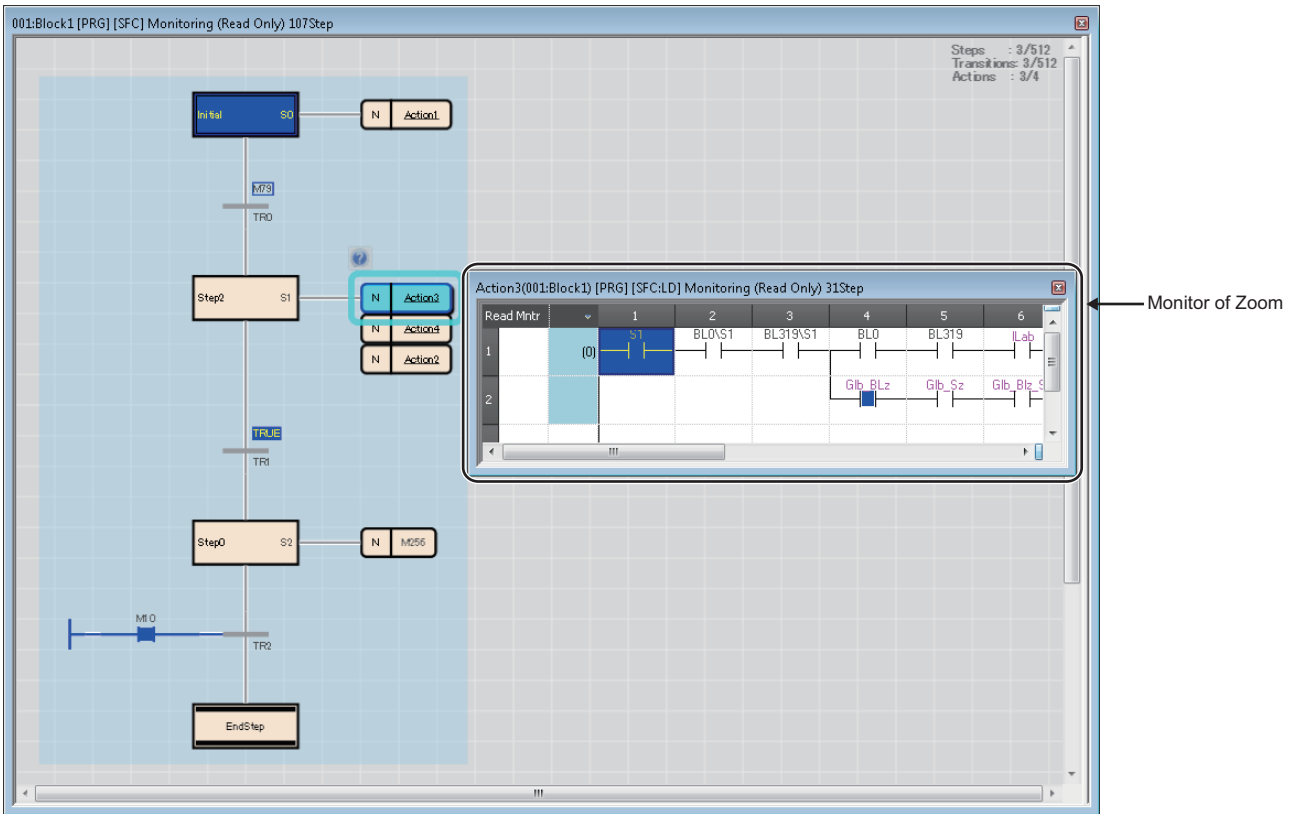

**■MELSAP-L (instruction format)**

For a monitor value of the bit type expressed in MELSAP-L (instruction format), the continuity state is highlighted on an SFC diagram as shown in the following table:

Instruction	Display example when monitoring
Coil output, set output	<b>bY70</b> , <b>sM1 00</b>
Reset output	<b>rM200</b>
At the time of output of a timer/high-speed timer At the time of output of a counter	<b>bTC K1 00</b> , <b>bCC K2 00</b> , <b>hTC K1 00</b>
At the time when a timer/high-speed timer is up At the time when the value of a counter is counted up to the specified value	<b>bTO K1 00</b> , <b>bCO K2 00</b> , <b>hTO K1 00</b>
Open contact/close contact	<b>aX0</b> , <b>bM2</b>
Rising contact/falling contact	<b>pM300</b> , <b>fM400</b>
Comparison operation instruction equivalent to a contact*1	<b>&lt; D1 D100</b>
Bit device in an application instruction*2	<b>ENC.OP M0 D8 K3</b>

\*1 A character string comparison instruction is not highlighted.

\*2 A digit-specified bit device is not highlighted.

A monitor value of a label other than the bit type and a word device is displayed on the right side of the split window.

The following table shows the monitoring availability depending on the data type of a device and a label.

○: Monitored, ×: Not monitored, —: Not applicable

Data type <sup>*1</sup>	Variable		Constant	
	Device	Label <sup>*2</sup>	Device	Label
Bit	×	×	×	×
Word [Unsigned]/Bit String [16-bit]	○	○	×	○
Double Word [Unsigned]/Bit String [32-bit]	○	○	×	○
Word [Signed]	○	○	×	○
Double Word [Signed]	○	○	×	○
FLOAT [Single Precision]	○	○	×	○
FLOAT [Double Precision]	○	○	×	○
Time	—	×	×	×
String	—	○	×	○
Pointer	×	×	—	—
Timer <sup>*3</sup>	○	○	—	—
Retentive timer <sup>*3</sup>	○	○	—	—
Counter <sup>*3</sup>	○	○	—	—
Long timer <sup>*3</sup>	○	○	—	—
Long retentive timer <sup>*3</sup>	○	○	—	—
Long counter <sup>*3</sup>	○	○	—	—

\*1 An instruction other than a comparison operation instruction that is equivalent to a contact is monitored with a device type specifier added according to the data type of an argument.

Devices used for a comparison operation instruction are monitored with a device type specifier added according to each instruction. A label used for a comparison operation instruction is monitored in the data type defined in a label editor.

\*2 When a value other than a fixed value is used for an array index, the monitor value is not displayed in the editor, or displayed as an indefinite value.

\*3 The current value (N) is displayed. When using it as a contact for a transition, the contact (S) is monitored, not the current value (N).

**Ex.**

The following screen is an example when selecting "MELSAP-L (Instruction Format)" in "Switch Ladder Display."

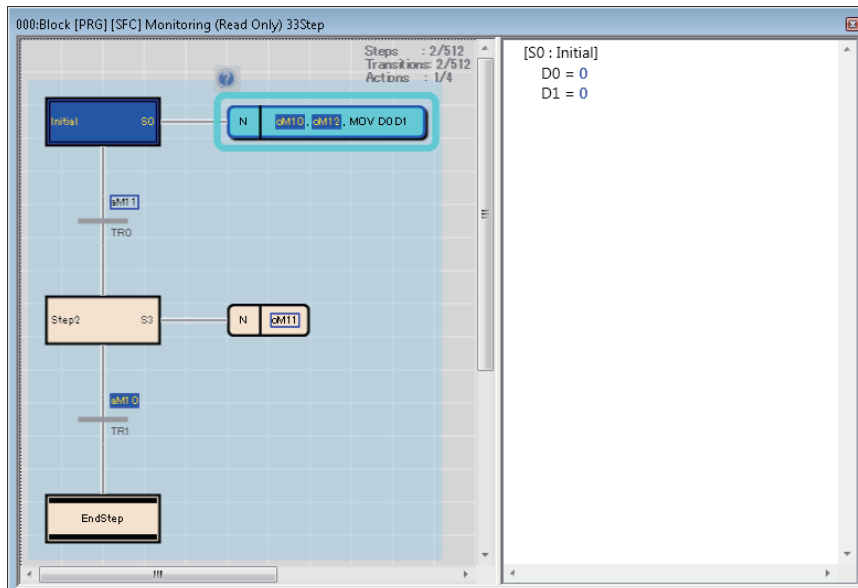

## ■Monitoring a Zoom

Select [View] ⇒ [Open Zoom/Start Destination Block], then open the Zoom to monitor.

The methods for operating/displaying a monitor of Zoom are the same as that of each program editor.

Devices, which can be monitored, are the same as those for each program editor except for special relays (S). Special relays (S)\*1 can be monitored only in a Zoom.

\*1 For RCPUs, the devices may not be monitored properly when a target block is switched by the BRSET instruction.

### Precautions

When monitoring is performed in a scan where a transition is satisfied, a step that was being executed (transition source step) is displayed in inactive state, and the next step connected to a transition (transition destination step) is displayed in active state.

Note that when continuous transition is not set, the transition destination step is executed in the next scan. Therefore, when monitoring the transition destination step and operation output at the same time, the step will be activated, however, the monitor value of the operation output will not be changed.

## Monitoring with the SFC auto-scroll

After starting monitoring of an SFC diagram, select [Online] ⇒ [Monitor] ⇒ [SFC Auto-scroll] (☞).

When a step, which is not displayed on the screen, is activated during monitoring, the screen automatically scrolls to show it.

When multiple steps are activated, the step closer to the row of the initial step will be displayed preferentially.

During monitoring with the SFC auto-scroll, the automatic synchronization of the cross reference function and the automatic registration to a watch window cannot be performed.

## ■Displaying a start destination block during monitoring with the Auto-scroll

When an active step moves to a block start step during monitoring with the auto-scroll, an SFC diagram editor of the start destination block opens automatically and monitoring starts.

Whether to open a start destination block automatically can be set by setting the following option.

- [Tool] ⇒ [Options] ⇒ "Monitor" ⇒ "SFC Diagram Editor" ⇒ "Auto-scroll Monitor Setting" ⇒ "Monitor the Block Start in a New Window"

### Precautions

When the update rate of the active status of a step is higher than the monitoring cycle, the status may not be acquired depending on the timing of monitoring.

In such a case, the step is not displayed by this function.

## Monitoring SFC steps which were activated

While monitoring an SFC program, steps which were activated in the period from the start to the end of a block can be displayed in the specified color.

This makes it possible to easily identify the route on which a program was executed.

By selecting [Online] ⇒ [Monitor] ⇒ [SFC Activated Step Monitor], steps which were activated can be displayed in the specified color.

RnPCPUs and RnPSFCPUs do not support this function.

### ■Displaying steps which were activated

During a monitoring, steps which were activated are displayed as follows:

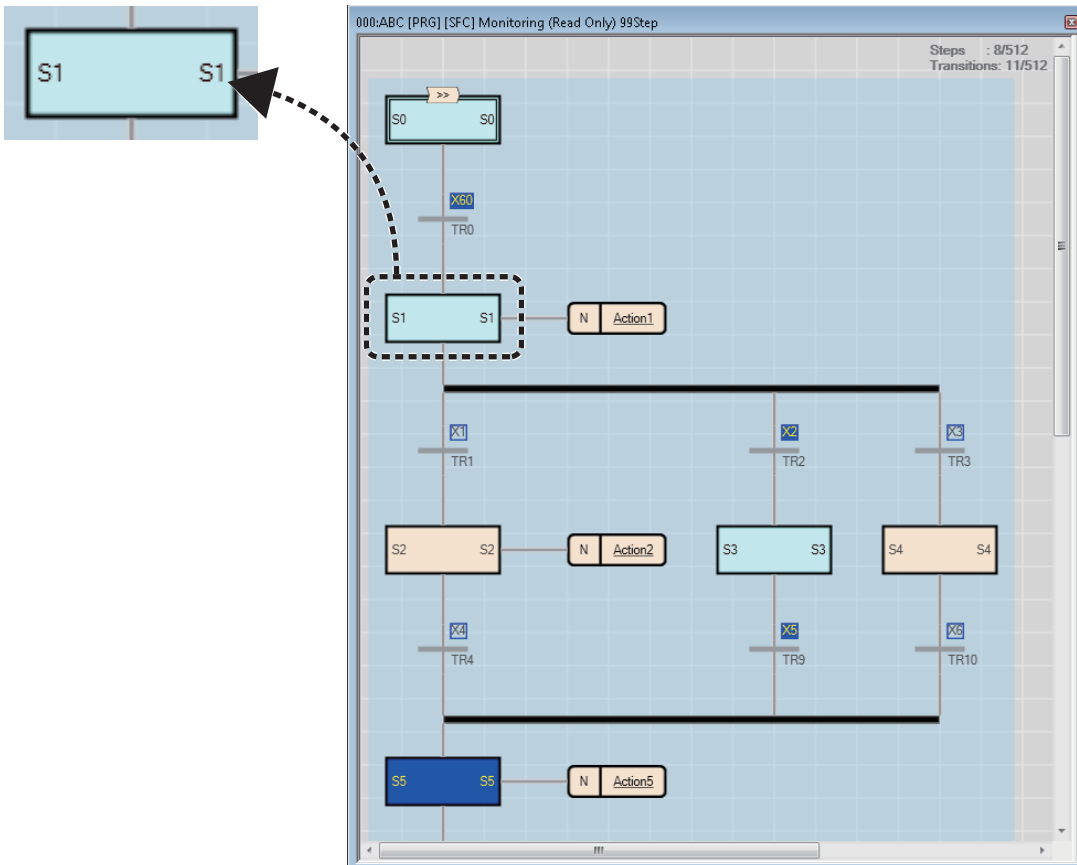

## Precautions

When displaying and monitoring steps which were activated, the monitoring cycle will be longer.

If any of the following operations is performed, steps which were activated will return to the state before being activated.

- Turning the power of a CPU module OFF
- Resetting a CPU module
- Stopping an SFC program using SM321
- Stopping an SFC program using a POFF instruction



## Changing the active status

The active status of blocks/steps can be changed by the following methods during monitoring.

It can be used to check the operation by starting/stopping particular blocks/steps only.

Target	Operation screen	Operation
Block	Each program editor (including a Zoom)	Change the current value (TRUE/FALSE) of an SFC block device (BL). <sup>*1</sup>
	"Device/Buffer Memory Batch Monitor" window	
	Watch window	
Step	SFC diagram editor	Select a step, then select [Debug] ⇒ [Control SFC Steps] ⇒ [Activate the Selected Steps]/[Deactivate the Selected Steps]/[Activate the Selected Steps Only].
	Zoom	Change the current value (TRUE/FALSE) of a step relay (S) or step relay with block specification (BL□\S). <sup>*1</sup>
	Each program editor (excluding a Zoom)	Change the current value (TRUE/FALSE) of a step relay with block specification (BL□\S). <sup>*1</sup>
	"Device/Buffer Memory Batch Monitor" window	
	Watch window	

\*1 A block/step can be activated by changing the current value of a label to which a step relay with block specification (BL□\S) or SFC block device (BL).

### Precautions

- Note that changing the active status of a block or step will affect the operation of a CPU module.
- If the current value of a block is changed during the online program change for an SFC block, the active status of the block cannot be changed.

## Changing current values (device/label)

Current values of the following devices/labels can be changed on an SFC diagram during monitoring. Select a device/label and press the **[Shift]** + **[Enter]** keys.

- Bit devices/bit type labels of transitions/actions on an SFC diagram editor
- Bit devices/bit type labels of FBD/LD elements connected to transition

The methods for changing current values of devices/labels in a Zoom is the same as that of each program editor.

For step relays (S), step relays with block specification (BL□\S), and SFC block devices (BL), refer to the following:

☞ Page 631 Changing the active status

## Monitoring the SFC block list

Display current block information on an SFC block list.

Select [View] ⇒ [Open SFC Block List], then open an SFC block list to monitor.

No.	Data Name	Title	Conversion Status	Block START/END	Step Transition	Block PAUSE/RE	Block Stop Mode	Continuous Transi	Number of Active	Comment
0	Block	FirstProcess	--	M0	M1		M3	M4	1	Block Comment
				M0 Comment	M1 Comment	M2 Comment	M3 Comment	M4 Comment	00 Comment	
1	Block1	Second Process	--	M1 0	M1 1	M1 2	M1 3	M1 4	0	Block1 Comment
				M1 0 Comment	M1 1 Comment	M1 2 Comment	M1 3 Comment	M1 4 Comment	Label comment	
2										



The SFC diagram of specified block can be displayed by double-clicking the block column during monitoring.

## Monitoring all SFC blocks in batch/active steps

Active status of all blocks/steps can be displayed.

Active status of /blocks/steps are not changed if the status of a CPU module is switched from RUN to STOP. Thereby, the active status when the CPU module was changed to STOP state is displayed on a monitor screen.

### Precautions

This monitoring function may not work properly when there is a difference between the program written in a CPU module and program in a project.

### ■Monitoring SFC blocks in batch

Display current active/inactive status of all blocks in a list.

### Window

Select [Online] ⇒ [Monitor] ⇒ [SFC All Blocks Batch Monitoring] (  ).

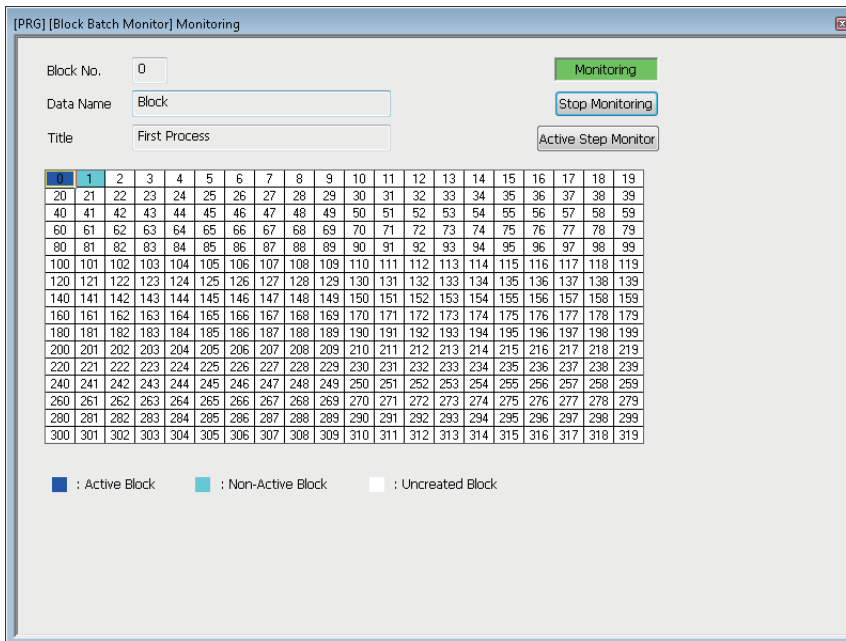

### ■Monitoring active steps

Display current active/inactive status of all steps that exist in a specified block in a list.

Up to five monitor screens can be displayed at once.

### Operating procedure

Move the cursor on a block to be monitored in the "Block Batch Monitor" screen, then click the [Active Step Monitor] button.

# 14.3 Checking Device/Buffer Memory in a Batch

Use the device/buffer memory batch monitor function to check the devices and buffer memory in a batch. If multiple monitoring screens are open, lead time to start monitoring and monitoring intervals may become longer. Multiple CPU shared memory (buffer memory) of multiple CPU system can be monitored only by the device/buffer memory batch monitor function.

## Window

Select [Online] ⇒ [Monitor] ⇒ [Device/Buffer Memory Batch Monitor] (  ).

■Toolbar



■"Device/Buffer Memory Batch Monitor" window

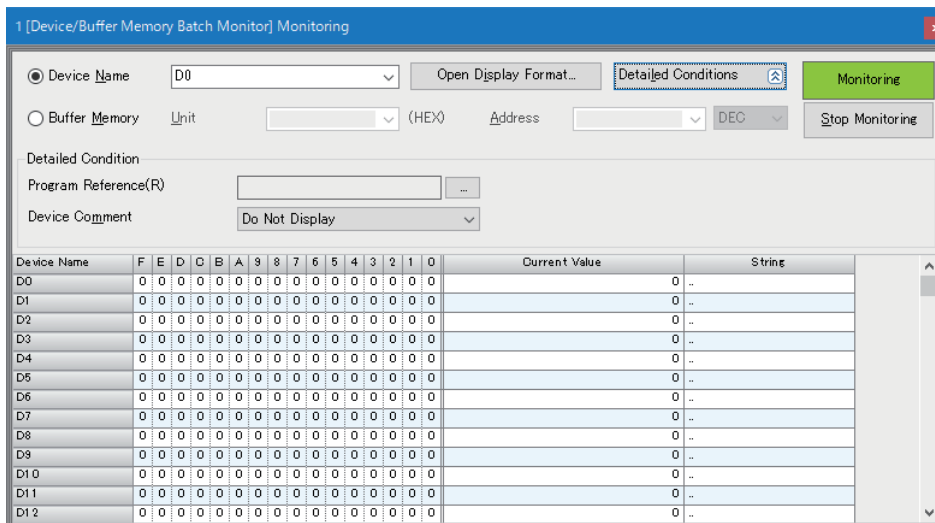

Up to 64 monitoring screens can be displayed at once. The numbers are displayed at the start of the screen title. The display format in the "Device/Buffer Memory Batch Monitor" window can be set in the same manner as in a device memory editor. Refer to the following:

 Page 435 Setting the display format

## Operating procedure

### ■Monitoring devices in a batch

Enter the device (start number) to be monitored in "Device Name."

For the devices that can be entered, refer to the following:

 Page 889 Applicable Devices in GX Works3

- When the target device is local device: Specify "Program Reference."
- When checking the TC setting values: Enter a device of timer, retentive timer, long timer, long retentive timer, counter, or long counter (Example: T10, ST10, LT10, LST10, C10, LC10) and specify "Program Reference."

## ■Monitoring buffer memory in a batch

Enter the start I/O number and address of the intelligent function module.

Item	Description
Unit	Enter the start I/O number of the intelligent function module to be monitored in hexadecimal format. <ul style="list-style-type: none"> <li>• For multiple CPU configuration Specify the CPU module to be monitored. CPU No.1: 3E00, CPU No.2: 3E10, CPU No.3: 3E20, CPU No.4: 3E30</li> </ul>
Address	Enter the address of buffer memory to be monitored in decimal/hexadecimal format.

## ■Monitoring blocks/steps in an SFC program in batch

Enter SFC block devices (BL) in "Device Name" when monitoring blocks, and enter step relays with block specification (BL□\S) there when monitoring steps.



Fonts can be changed.

Page 81 Checking and Changing Colors and Fonts

## Applicable monitoring devices

The following table shows the devices that can be monitored in the "Device/Buffer Memory Batch Monitor" window.

For the available devices in a CPU module, refer to the user's manual of each module.

Module type	Device
RCPU LHCPU	X, Y, M, L, B, F, SB, V, T, T(TS), T(TC), T(TN), ST, ST(STS), ST(STC), ST(STN), LT, LT(LTS), LT(LTC), LT(LTN), LST, LST(LSTS), LST(LSTC), LST(LSTN), C, C(CS), C(CC), C(CN), LC, LC(LCS), LC(LCC), LC(LCN), D, W, SW, FX, FY, SM, SD, FD, J□\X, J□\Y, J□\B, J□\SB, J□\W, J□\SW, U□\G, U□\HG, DX, DY, Z, LZ, R, ZR, RD, BL, BL□\S, SA\M, SA\SM, SA\X, SA\Y, SA\B, SA\D, SA\SD, SA\W, SA\T(TC), SA\T(TS), SA\T(TN), SA\T, SA\C(CC), SA\C(CS), SA\C(CN), SA\C, SA\ST(STC), SA\ST(STS), SA\ST(STN), SA\ST
FX5CPU	X, Y, M, L, B, F, SB, S, T, T(TS), T(TC), T(TN), ST, ST(STS/SS), ST(STC/SC), ST(STN/SN), C, C(CS), C(CC), C(CN), LC, LC(LCS), LC(LCC), LC(LCN), D, W, SW, SM, SD, U□\G, Z, LZ, R, BL, BL□\S
Remote head module	X, Y, SB, W, SW, SM, SD, U□\G, DX, DY, RD

## Changing current values

During monitoring, current values can be changed by one of the following operation.

- Double-click a cell of a device.
- Press the  key.
- Right-click a cell of a device or the "Current Value" column, and select [Modify Value] from the shortcut menu.

### ■For bit devices

The current value is changed.



### ■For word devices

A device is registered in a watch window.

Change the current value in the watch window. ( Page 637 Checking Current Values by Registering Devices/Labels)

Multiple word devices can be registered in a watch window at once by selecting multiple cells of the current values.

## Precautions

- For a timer (T) and counter (C), the contacts and current values can be changed in an RCP; however, only the contacts can be changed in an FX5CPU.
- When "Bit and Word" is selected in "Display Unit Mode" of  (Display Format Detailed Setting), the current value of the following devices can be changed by changing the bit status in the 0 to F column:
  - Direct access input (DX)
  - Direct access output (DY)
  - Function input (FX)
  - Function output (FY)
  - Link input (J□\X)
  - Link output (J□\Y)
  - Link relay (J□\B)
  - Link special relay (J□\SB)
- When "Bit and Word" is selected in "Display Unit Mode" of  (Display Format Detailed Setting), the current value of an index register (Z) cannot be changed even if the bit status in the 0 to F column is changed.
- For a step relay (S), step relay with block specification (BL□\S), and SFC block device (BL), the blocks/steps are activated/deactivated by changing the current values. ( Page 631 Changing the active status)
- When a program is selected with the specified program monitoring function, the function is disabled by selecting "No" for the following option during monitoring:
  - [Tool] ⇒ [Options] ⇒ "Monitor" ⇒ "Common Item" ⇒ "Timing to Execute Monitor Function and Modify Value Function" ⇒ "After the execution of specified program"

## Considerations when monitoring file registers

To monitor file registers while "Use File Register of Each Program" is selected in "CPU Parameter" ⇒ "File Setting" ⇒ "File Register Setting" ⇒ "Use or Not Setting," select a program to be monitored with the specified program monitor function before starting monitoring.

If any of the programs is set not to use file registers or the file register size differs, device/buffer memory batch monitoring may not be started.

For the operation method of the specified program monitor function, refer to the following:

☞ Page 613 When monitoring devices/labels in a specified program

### ■When not using the specified program monitor function

When monitoring file registers while "Use File Register of Each Program" is selected without using the specified program monitor function, the operation differs depending on the setting of "Specifying Method" in "Device/Label Access Service Processing Setting."

Specifying method	Operation
Execute END Processing between Programs	Devices may be out of range in the following cases and thus device/buffer memory batch monitoring may not be started since monitoring is performed between programs or at the END processing. <ul style="list-style-type: none"><li>• Monitoring is attempted after a program which is set not to use file registers.</li><li>• The range of file registers with bigger file size is monitored after a program using a file register with smaller file size.</li></ul>
Others	A file register file that is enabled in the program executed just before the END processing will be monitored. Example: When the execution order of the programs is 'A→B→C→(END processing)→A→B...', the value of the file register at the execution of program C will be monitored. Therefore, device/buffer memory batch monitoring cannot be started in the following cases: <ul style="list-style-type: none"><li>• The program just before the END processing is set not to use file registers.</li><li>• The range of file registers with bigger file size is monitored when a file register with smaller file size is used in a program just before the END processing.</li></ul>

In the following cases, use the watch function. Alternatively, add a program that transfers monitoring target file registers to devices, then monitor the transferred program.

- Any of the programs is set not to use file registers.
- File register size differs.

Note that the number of steps and scan time will increase for the added program.

If the file register for which "Use File Register of Each Program" is selected is used as data with no latch (such that the data is set to clear to '0' at the first time), replacing the file registers to local devices avoids increase of number of steps and scan time due to the addition of programs.

## Specifying reference target of program

Specify the monitoring target program when monitoring the setting values of timer devices and counter devices, or local devices.

### Operating procedure

1. Click the [Detailed Conditions] button, then click the [...] button of "Program Reference" in the "Device/Buffer Memory Batch Monitor" window.
2. Set each item in the "Program Reference" screen, and click the [OK] button.

# 14.4 Checking Current Values by Registering Devices/Labels

To check the current values by registering devices or labels, use the watch function. Registering devices or labels to be checked in a watch window is required.

By specifying a range, multiple devices or labels can be registered at once.

Once devices/labels are registered and the project is saved, the registered devices/labels are displayed in the registered state when the project is opened again.

## Window

Select [View] ⇒ [Docking Window] ⇒ [Watch 1] to [Watch 4] (Dev).

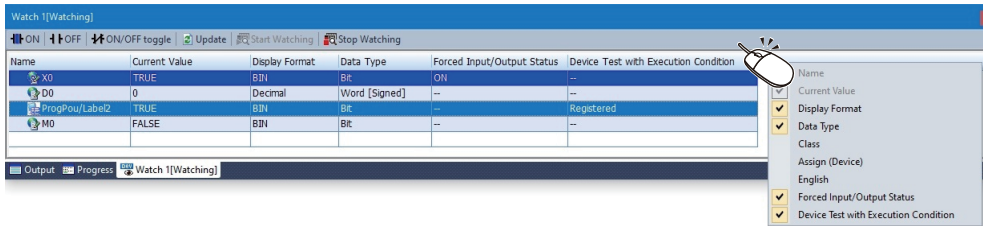

The display format can be selected per row from the pull-down list displayed when selecting the display format.

## Operating procedure

1. Register devices/labels to be monitored. (Page 638 Registering to a watch window)
2. Select [Online] ⇒ [Watch] ⇒ [Start Watching].

During monitoring, "[Watching]" is added in the title of the watch window.

### Point

When selecting a program with the specified program monitor function, the value after the selected program was executed is displayed as the current value. In this case, "[Watching (Running Specified Program Monitor)]" is added to the title of a watch window.

For details on the specified program monitor function, refer to the following:

Page 613 When monitoring devices/labels in a specified program

## Operating a watch window

### ■Updating the display

If data is changed by editing or converting <sup>\*1</sup> program, the change will not be applied to a watch window.

After changing data, update the display of a watch window by clicking . <sup>\*2</sup>

\*1 Example: A comment is edited in a label editor.

\*2 Label names, program names, and POU names are not updated. To update these items, register them in the watch window again.

### ■Other operations

The following operations can be performed from the shortcut menu.

Operation	Shortcut menu
Changing a title	Change Title
Switching the display format for the current value of a bit device (TRUE/FALSE↔ON/OFF)	ON/OFF Display
Editing a comment	Comment Edit
Changing the display format for a device and label <sup>*1</sup>	Change the Display Format of the Selected Device/Label
Changing the data type of a device <sup>*2</sup>	Change the Data Type of the Selected Device

\*1 The display format of a device or a label for which '-' is displayed in the "Display Format" column cannot be changed.

\*2 Timer devices and counter devices are the only bit type devices whose data type can be changed.

### Operating procedure

1. Select a row in a watch window, then right-click it.
2. Select the shortcut menu according to the operation to be performed.

## Registering to a watch window

Register devices/labels to be monitored in the watch window.

### Operating procedure

#### ■Registering devices/labels by entering them manually

1. Open a watch window.
2. Enter a device/label to be registered in the "Name" column, and press the  key.

The input format of devices/labels are as follows:

- Global device: Device name
- Local device: Program name/#Device name ('#' is not necessary for index register (Z))
- Global label: Label name
- Local label: Program block name/label name
- Step relay: Step relay with block specification (BL□\S)

For structures, function blocks, and arrays, enter the items by referring to the following table.

Type	Target	Input format
Structure	Label (Structure)	Label name
	Structure member	Label name.member name
Function block	Label (Function block)	Label name
	Label in the function block	Label name.Label name in the function block
Array	Label (Array)	Label name excluding array notation
	Array index and the specific dimension part of array (more than two-dimensional array)	Label name[three-dimensional index] [two-dimensional index] [one-dimensional index]
Structure array	Label (Structure array)	Label name
	Specific member	Label name[three-dimensional index] [two-dimensional index] [one-dimensional index].member name





Type	Target	Input format
Nested function block	Label (Nested function block)	Label name
	Labels in the nested function block	Label name. label name in the function block. label name in the nested function block When nesting labels for one or more level deeper, the lower part of the label name which are delimited by a dot '.' is regarded as a label name. (Example: MAIN_PRG_LD/FB0_1.FB1_1.FB2_1.INOUT)
	When a function block includes array labels or structured labels	Follow the specification method of the array or structure.

### Point

When entering a label name, options will be displayed.

They can also be displayed by any of the following operations.

- Enter '/' after entering a program block name.
- Enter '.' at the end of a label name of structure type or an instance name of a function block.
- Press the  +  keys.

In addition, by selecting "Yes" for the following option, when entering a common device comment or a label comment, devices and labels for which the comment has been set can be displayed as options.

- [Tool] ⇒ [Options] ⇒ "Edit" ⇒ "Instruction/Device/Label Candidacy Display" ⇒ "Candidate Display Setting" ⇒ "Display the Corresponding Device in Entering Device Comment"

When comments have been set in the following device comments, those local devices are displayed as options by entering '/' at the end of a program file name.

- Common device comment
- Each program device comment with the same name as the program file name

## ■Registering devices/labels from program editor/label editor

1. In a program editor or a label editor, select a device or label to register in the watch window.
2. Select [Online] ⇒ [Watch] ⇒ [Register to Watch Window] ⇒ [Watch 1] to [Watch 4].

A device/label can also be registered by dragging and dropping it onto a watch window.

Editor	Operating procedure
Ladder editor <sup>*1*2</sup>	Select a cell of device/label, and then drag the border of the selected cell and drop it onto a watch window.
ST editor <sup>*1*2</sup>	Select a token of a device/label, and then drag and drop it onto a watch window.
FBD/LD editor <sup>*1*2*3</sup>	Select an element of a device/label, and then drag and drop it onto a watch window with pressing the  key.
SFC diagram editor	Select a step or a transition/action for which a device/label is set, and then drag and drop it onto a watch window.
Label editor	Select the header of a label, and then drag and drop it onto the watch window

\*1 For RCPUs and LHCPUs, step relays (S) used in programs other than a Zoom cannot be registered.

Step relays (S) are registered as step relays with block specification (BL□\S□) automatically in a Zoom.

\*2 For FX5CPUs, step relays (S) used in a Zoom are registered as step relays with block specification (BL□\S) automatically.

\*3 Devices/labels cannot be registered from the preview display area of inline structured text elements.

### Point

- When rectangular selection is made on an ST editor, only the devices/labels in the selected range can be registered.
- When registering a label for which a value other than a fixed value is used as an array index, if a device/label that can be monitored is used as an array index, the index can be extracted and registered as another watch item. (  Page 641 Registering an array index)
- When the following menu is selected while a program editor is active, all devices/labels used in the program can be registered in a batch.  
[Online] ⇒ [Watch] ⇒ [Batch Register to Watch Window] ⇒ [(Watch Window 1 to 4 (Batch Register))]

## ■Registering devices/labels from the "Label Comment" window

1. Select a label name to be registered in a watch window in the "Label Comment" window.
2. Drag and drop it onto the watch window.

The label is registered in the watch window.

## ■Registering devices/labels from a cross reference window

1. Select a row in a cross reference window.
2. Right-click it and select any of [Register to Watch 1] to [Register to Watch 4] from the shortcut menu.

The device/label is registered in the watch window.

## ■Registering devices/labels from the event history (offline monitor) window

1. Select a modify value event in the event history (offline monitor) window.
2. Right-click it and select [Register to Watch Window] ⇒ any of [Watch 1] to [Watch 4] from the shortcut menu.

The device/label is registered in the watch window.

## ■ Registering an array index

The following shows the procedure to register an array index in a watch window.

1. Check that a program is converted.
2. Select a label to be registered in a watch window in the program editor.
3. Select [Online] ⇒ [Watch] ⇒ [Register to Watch Window] ⇒ [(watch window 1 to 4)].

### Precautions

#### ■ Inapplicable labels

- When a value other than fixed value is used for an array index, the monitor value is not displayed or displayed as an indefinite value in a watch window.
- The monitor values of a local label used in a function are not displayed, or displayed as indefinite values in a watch window.

#### ■ Device test with execution conditions

When the ranges overlaps between a device whose the value was changed by the device test function with execution conditions and a device which was registered in a watch window, "Registered" is displayed in the "Device Test with Execution Condition" column of the watch window.

#### Ex.

When the double word [signed] type 'D0' is set in the "Register Device Test with Execution Condition" screen, the word (signed) type 'D1' is also registered in a watch window.

## Automatic registration to watch windows

Devices and labels in a selected range in a program editor are automatically registered in a watch window.

Devices and labels in a watch window are updated every time when the specific range is changed.

The following table shows the range of automatic registration for each programming language.

Programming language	Range	Remarks
Ladder	Device/label on a ladder block containing the selected cell	A device/label in an FB and an inline structured text program is excluded.
Ladder (Inline structured text)	Device/label in a selected row with the inline structured text program selected	It follows the option settings for a ladder editor.
ST	Device/label on which the cursor is placed	When multiple rows are selected, only a device/label in the row on which the cursor is placed is registered. A device/label of an inline structured text program used in an FBD/LD program is also registered.
FBD/LD	Device/label in an FBD network block containing the element on which the cursor is placed	When multiple FBD network blocks are selected, only the device/label in the block containing the element on which the cursor is placed is registered. A device/label displayed in the preview display area of inline structured text elements is excluded.
SFC	Device, label, and FBD element contained in the element on which the cursor is placed (including a device/label in a Zoom)	—

### Operating procedure

1. Set the following option.

Select one of [Watch 1] to [Watch 4] in [Tool] ⇒ [Options] ⇒ "Monitor" ⇒ "Ladder Editor"/"ST Editor"/"FBD/LD Editor"/"SFC Diagram Editor" ⇒ "Setting for Automatic Registration to Watch Window" ⇒ "Set Automatic Registration Destination."

2. During monitoring, select a range of devices/labels to be registered to a watch window in a program editor.

#### Point

For a label for which a value other than a fixed value is used as an array index, the index is extracted and registered as another watch item.

This applies only when a device/label that can be monitored is used as an index.

## Applicable monitoring devices

The following table shows the devices that can be monitored in a watch window.

For the available devices in a CPU module, refer to the user's manual of each module.

Module type	Device
RCPU LHCPU	X, Y, M, L, B, F, SB, V, T, T(TS), T(TC), T(TN), ST, ST(STS), ST(STC), ST(STN), LT, LT(LTS), LT(LTC), LT(LTN), LST, LST(LSTS), LST(LSTC), LST(LSTN), C, C(CS), C(CC), C(CN), LC, LC(LCS), LC(LCC), LC(LCN), D, W, SW, FX, FY, SM, SD, FD, J□\X, J□\Y, J□\B, J□\SB, J□\W, J□\SW, U□\G, U□\HG, DX, DY, Z, LZ, R, ZR, RD, BL, BL□\S, SAIM, SAISM, SAIX, SAIY, SAIB, SAID, SAISD, SAIW, SAIT(TC), SAIT(TS), SAIT(TN), SAIT, SAIC(CC), SAIC(CS), SAIC(CN), SAIC, SAIST(STC), SAIST(STS), SAIST(STN), SAIST
FX5CPU	X, Y, M, L, B, F, SB, S <sup>*1</sup> , T, T(TS), T(TC), T(TN), ST, ST(STS/SS), ST(STC/SC), ST(STN/SN), C, C(CS), C(CC), C(CN), LC, LC(LCS), LC(LCC), LC(LCN), D, W, SW, SM, SD, U□\G, Z, LZ, R, BL, BL□\S
Remote head module	X, Y, SB, W, SW, SM, SD, U□\G, DX, DY, RD

\*1 Its current value cannot be changed.

## Changing current values

Directly enter a value for "Current Value" during monitoring.

For a bit device, select a row and double-click with pressing the **Shift** key or press the **Shift** + **Enter** keys to change the current value.

For a step relay (S), step relay with block specification (BL□\S), and SFC block device (BL), the blocks/steps are activated/deactivated by changing the current values. (☞ Page 631 Changing the active status)

### Precautions

- When "Use File Register of Each Program" is selected in "File Setting" of "CPU Parameter," a file register file that is available at the END will be changed. Therefore, changing the current values by specifying a file register file for each program is not available.
- For bit type array global labels that are specified in digit specification, the current values can be changed when devices have been assigned to them.  
the current values of global labels to which devices are assigned and local labels cannot be changed.
- When the label name of a label registered in a watch window is changed in a label editor, the label name before the change is displayed as a character string. To check the current value, register the changed label name.

## Importing to/exporting from file

Information displayed in a watch window can be exported to and imported from a file.

### Operating procedure

Select a row in a watch window, then right-click it and select [Import File] or [Export to File].

## Monitoring in a binary format

The current value of a label can be displayed in a binary format during monitoring. Select a row of the label, then right-click and select [Add the Selected Label to Binary Watch Window] from the shortcut menu to display it.

### ■Adding a label

To add a label to the "Binary Watch" screen, select a row of the label while the "Binary Watch" screen is opened, then right-click and select [Add the Selected Label to Binary Watch Window] from the shortcut menu.

### ■Setting the display format

The display format (display unit format, data display format, string display format, value, bit order, and switch No. of points) of the monitoring value of the label being displayed can be set.

### Operating procedure

1. Click the [Open Display Format] button.
2. Set each item in the "Display Format" screen and click the [OK] button.

### ■Changing current values

Current values can be changed by any of the following operations:

- Double-click a cell of a label.
- Press the  key.
- Select and right-click a cell of a label or the "Current Value" column, then select [Modify Value] from the shortcut menu.



# 14.5 Turning Input/Output Devices ON/OFF Forcibly

While GX Works3 and a CPU module are connected, input/output devices can be turned ON/OFF forcibly without being affected by the input from an external device or by a program operation result.

Input/output devices refer to inputs (X) or outputs (Y).

RnCPUs, RnENCPU, RnPCPU, RnSF CPU, LH CPU, and FX5 CPU support this function.

## Window

Select [Debug] ⇒ [Register/Cancel Forced Input/Output](/).

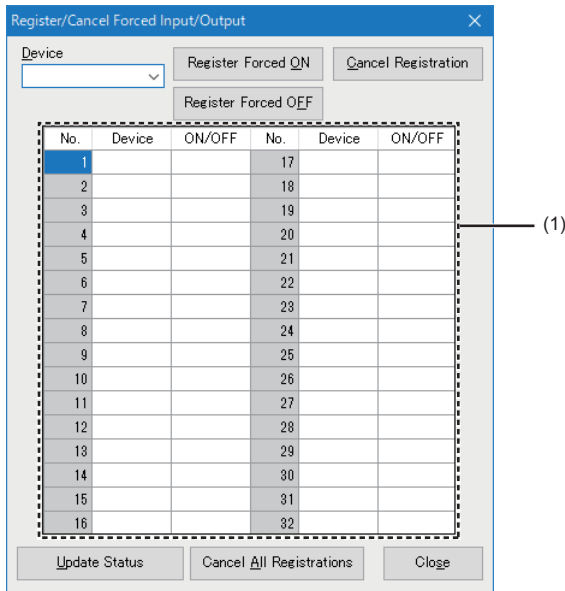

(1) Registration status display area

## Forced ON/OFF registration

Forced ON/OFF of a device can be registered in a CPU module.

### Operating procedure

1. Enter the device name of an available input (X) or output (Y) in the "Device" column.
2. Click the [Register Forced ON] button or the [Register Forced OFF] button.

The registered device turns ON/OFF until the registration is canceled.

## Registration cancellation

The registration of devices for forcibly turning ON/OFF can be canceled.

### Operating procedure

1. Enter the device name of a registered input (X) or output (Y) in the "Device" column.
2. Click the [Cancel Registration] button.

## Registration status reading

The latest registration status can be read from a CPU module, and can be displayed in the 'Registration status display area.'

### Operating procedure

Click the [Update Status] button.

## Batch cancellation of registration

All the registered devices for forcibly turning ON/OFF can be canceled.

### Operating procedure

Click the [Cancel All Registrations] button.

### Considerations

- This function is not controlled exclusively on a CPU module side. The registered contents may be changed by a peripheral device connected via another station.
- Even when forcibly turning devices ON/OFF by using the 'Modify Value' function, a current value of the device for which forced ON/OFF is registered is not changed.

#### ■RnPCPUs (redundant mode)

When GX Works3 is connected to an RnPCPU (redundant mode), a type of the system (control system or standby system) of the connected CPU module on the connected system is displayed in the title of the "Register/Cancel Forced Input/Output" screen.

The following table shows the availability of the buttons in the "Register/Cancel Forced Input/Output" screen for each system of the CPU module on a connected system.

○: Available, ×: Not available

System	Button				
	Register Forced ON	Register Forced OFF	Cancel Registration	Update Status	Cancel All Registrations
Control system (Other system: standby system)	○	○	○	○ <sup>*1</sup>	○
Control system (Other system: other than standby system)	×	×	×	×	×
Standby system	×	×	×	○ <sup>*1</sup>	×
Not specified	×	×	×	×	×

\*1 Only the registration status of the CPU module on the connected system is read.

# 14.6 Changing Device/Label Value by Setting Conditions

To change a device or label value according to the conditions which were set in advance, use the device test function with execution conditions.

By using this function, the operation of the specific ladder block can be checked without changing the program (standard program).

For details on a device test with execution conditions, refer to the following:

📖 MELSEC iQ-R CPU Module User's Manual (Application)

In this section, execution conditions, a device or label value, and the processing to be registered into a CPU module are referred to as a 'device test with execution conditions.'

This function can be used in projects for an RnCPU, RnENCPU, RnPCPU, RnSFCPU in the test mode, and LHCPU.

For RnPCPUs (redundant mode), registration, registration cancellation, and registration status update of a device test with execution conditions are performed only in the connective system.

For RnSFCPUs in the safety mode, a device test with execution conditions cannot be registered or cancelled.

## Registration of a device test with execution conditions

The following shows the registration method of a device test with execution conditions.

### Window

Select [Debug] ⇒ [Device Test with Execution Condition] ⇒ [Register].

■ Bit device and bit type label

The screenshot shows a dialog box titled "Register Device Test with Execution Condition". It contains the following fields and controls:

- Device/Label:** A dropdown menu with "X0" selected.
- Data Type:** A dropdown menu with "Bit" selected.
- Forced ON / Forced OFF:** Two buttons.
- Execution Condition:**
  - Program Block:** A dropdown menu with "ProgPou" selected. Below it, the text "Only ladder blocks can be selected (except for Zoom)." is displayed.
  - Step No.:** A text input field containing "20".
  - Execution Timing:** A dropdown menu with "Before executing instruction" selected.
- Close:** A button in the top right corner.

■ Word device and word type label

The screenshot shows a dialog box titled "Register Device Test with Execution Condition". It contains the following fields and controls:

- Device/Label:** A dropdown menu with "D10" selected.
- Data Type:** A dropdown menu with "Word [Signed]" selected.
- Setting Value:** A text input field containing "100".
- Setting:** A button next to the Setting Value field.
- Execution Condition:**
  - Program Block:** A dropdown menu with "ProgPou" selected. Below it, the text "Only ladder blocks can be selected (except for Zoom)." is displayed.
  - Step No.:** A text input field containing "37".
  - Execution Timing:** A dropdown menu with "Before executing instruction" selected.
- Close:** A button in the top right corner.



## Operating procedure

### 1. Set each item.

Item		Description
Device/Label		Set a device or label whose value is to be changed. The settable devices and labels are as follows: <ul style="list-style-type: none"> <li>• Global device</li> <li>• Global label</li> <li>• Local device usable in a program block specified as an execution condition</li> <li>• Local label usable in a program block specified as an execution condition</li> </ul> Note that when a set label name is used for both a global label and local label, the local label is set.
Data Type		Select the data type of the set device or label.
Setting Value		Set a device or label value when the data type other than the bit type is set.
Execution Condition	Program Block	Select a program block name. Note that ladder program only can be selected.
	Step No.	Set a step in the set program block.
	Execution Timing	Select the timing of the change to the set value either before or after execution of the instruction in the set step No.

### 2. Click the [Forced ON]/[Forced OFF]/[Setting] button.

The device test with execution conditions is registered into a CPU module.

#### Point

By registering a device test with execution conditions into a CPU module, the instruction in the step specified as an execution condition is framed.



## Precautions

The registration of a device test with execution conditions is canceled by performing an operation such as resetting or cycling the power of the programmable controller, or writing a program to the CPU built-in memory.

For details, refer to the following:



📖 MELSEC iQ-R CPU Module User's Manual (Application)

# Displaying a registered device test with execution conditions

The following operations can be performed to a registered device test with execution conditions.

- Page 649 Registration check
- Page 649 Registration cancellation
- Page 649 Batch registration
- Page 649 Batch registration cancellation
- Page 649 Data writing to a file
- Page 649 Data reading from a file

## Window

Select [Debug] ⇒ [Device Test with Execution Condition] ⇒ [Check/Disable Register] (  /  ).

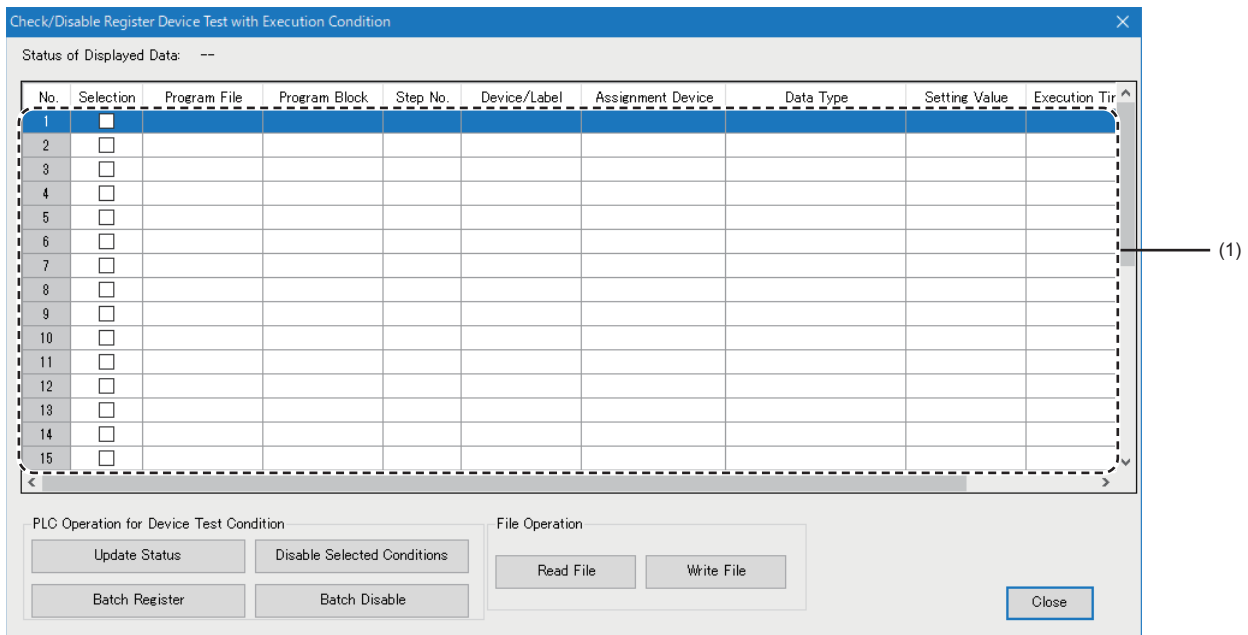

(1): Registration content list

## Displayed items

Item	Description
Status of Displayed Data	The status of data in the registration content list is displayed. —: Indicates that a device test with execution conditions is not read yet. Update Status: Indicates that a device test with execution conditions which was read from a CPU module is displayed. Read File: Indicates that a device test with execution conditions which was read from a file is displayed.
Registration content list	The read device test with execution conditions is displayed.

## Registration check

The following shows the procedure for checking a device test with execution conditions registered into a CPU module.

### Operating procedure

Click the [Update Status] button.

## Registration cancellation

The following shows the procedure for canceling the registration of a device test with execution conditions displayed in the registration content list.

### Operating procedure

1. Select the checkbox(s) of a device test with execution conditions to cancel the registration.
2. Click the [Disable Selected Conditions] button.

## Batch registration

The following shows the procedure for registering a device test with execution conditions displayed in the registration content list to a CPU module in a batch.

### Operating procedure

Click the [Batch Register] button.

## Batch registration cancellation

The following shows the procedure for canceling a device test with execution conditions registered into a CPU module in a batch.

### Operating procedure

Click the [Batch Disable] button.

### Point

In another way, the registration can be canceled in a batch by using the following menu.

- Select [Debug] ⇒ [Device Test with Execution Condition] ⇒ [Batch Disable]

## Data writing to a file

The following shows the procedure for writing a device test with execution conditions displayed in the registration content list to a file.

### Operating procedure

1. Click the [Write File] button.
2. Set each item and click the [Save] button.

## Data reading from a file

The following shows the procedure for reading a device test with execution conditions from a file to the registration content list.

### Operating procedure

1. Click the [Read File] button.
2. Set each item and click the [Open] button.

# 14.7 Pausing/Restarting the Operation of Function Blocks

While running a program, the operation of a process control function block in an FBD/LD editor can be paused or restarted. The operation of a program can be checked by pausing the operation of the preceding process control function block and changing the current value of the output variable of the paused process control function block. Moreover, paused process control function blocks can be checked in a list.

## Function blocks that can be paused or restarted

The operation of the following process control function blocks can be paused or restarted.

- Standard process FBs (excluding standard process FBs for 'Analog Value Selection/Average')
- Tag access FB
- Tag FB

## Application example of this function

The following explains the method for changing the current value of the input variable of the FB2 in the following figure to check the operation of the program.

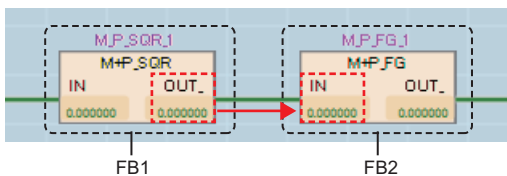

Even if the current value of the input variable (IN) of the FB2 is changed using the change current value function, the value will be overwritten with the current value of the output variable (OUT\_) of the FB1 because the FB1 is in operation. To change the current value of the input variable of the FB2, pause the operation of FB1 first, and then change the current value of the output variable of the FB1.

### Operating procedure

1. Pause the operation of the FB1. (👉 Page 651 Pause)
  2. Change the current value of the output variable (OUT\_) of the FB1. (👉 Page 612 Changing current values)
- The changed current value is stored to the input variable (IN) of the FB2.

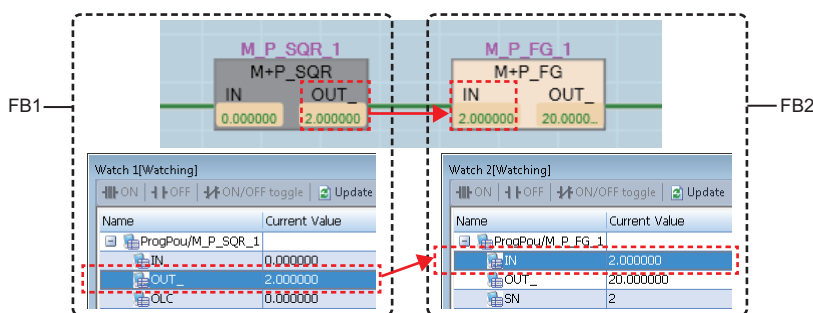

# Pause

The following shows the procedure to pause the operation of a process control function block.

## Operating procedure

1. Monitor an FBD/LD program for process control. (☞ Page 623 Monitor)
2. Select a process control function block in the program editor.
3. Click the smart tag (🔑).  
Alternatively, select [Debug] ⇒ [Process Control Extension] ⇒ [Pause FB].

The operation of the process control function block is paused.

### Point

By setting 'automatic registration to watch windows,' when the operation of a process control function block is paused, devices and labels used for the paused process control function block are automatically registered to a watch window and that makes it easy to change current values of input and output variables used for the process control function block.

For details on 'automatic registration to watch windows,' refer to the following:

☞ Page 641 Automatic registration to watch windows

## Precautions

- After checking the operation of a program, restart the operation of all the paused process control function blocks. (☞ Page 652 Restart, Page 652 List display)
- When one FB instance is used for multiple programs in a project, if the operation of any one of the FB instance is paused, all of the other operations of FB instances will be paused as well.

## Display in pausing

The background color of a paused process control function block is displayed in gray.

Ex.

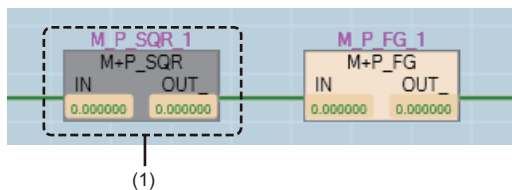

(1): Paused process control function block

### Point

The background color of a paused process control function block can be changed in the "Color and Font" screen. (☞ Page 81 Checking and Changing Colors and Fonts)

## Restart

---

The following shows the procedure to restart the operation of a paused process control function block.

### Operating procedure

1. Select a paused process control function block in a program editor.
2. Click the smart tag (  ).  
Alternatively, select [Debug] ⇒ [Process Control Extension] ⇒ [Restart FB].

The operation of the process control function block is restarted.

## List display

---

The following shows the procedure to display paused process control function blocks in a list.

### Operating procedure

Select [Debug] ⇒ [Process Control Extension] ⇒ [Paused FB List].

Paused process control function blocks are displayed in the "Output" window.

### Point

By selecting a row in the "Output" window and performing any of the following operations, the cursor jumps to the position where an FB instance of the process control function block is used.

- Double-click the row.
- Right-click the row, and select [Jump] from the shortcut menu.
- Press the  key.

### Precautions

- After checking the operation of a program, check that all the process control function blocks are running.
- Function blocks in a program that is protected by a security key or block password are not displayed.

# 14.8 Measuring the Scan Time of a Program

To measure the scan time of any sections in a ladder program (including a Zoom) and SFC program, use the scan time measurement function.

This function can also measure the processing time of a subroutine program or interrupt program.

For details on the scan time measurement function, refer to the following:

📖 MELSEC iQ-R CPU Module User's Manual (Application)

## Window

Select [Debug] ⇒ [Scan Time Measurement].

**Ex.**

Screen displayed when a ladder editor is active

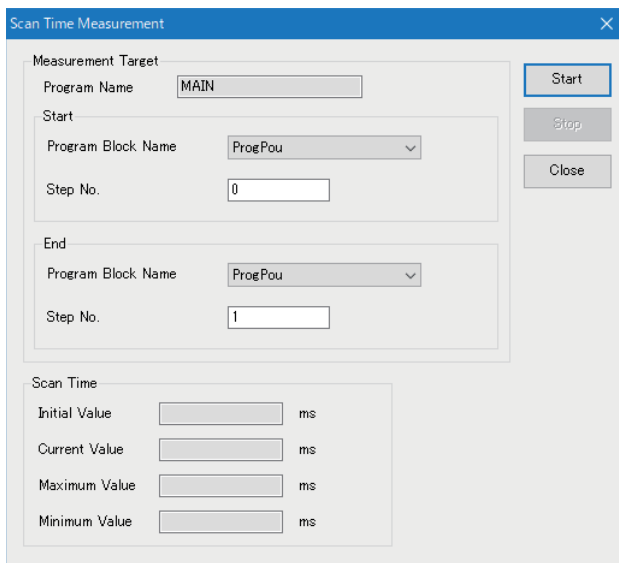

## Operating procedure

1. Set each item.

Item	Description		
Measurement Target	Program Name	The name of an open program is displayed.	
	Start*1	Program Block Name	A program block name is displayed.
		Step No.	Set a start step.
	End*1	Program Block Name	A program block name is displayed.
		Step No.	Set an end step.
	Block Name*2	An SFC block name is displayed.	
Step Name*2	Set a start step name.		

\*1 Displayed when a ladder editor is active or an action is selected on an SFC diagram.

\*2 Displayed when an SFC diagram editor is active without an action selected.

2. Click the [Start] button.

The initial value, current value, maximum value, and minimum value are measured.

Time can be measured in 0.001 ms.

## Point

- When the "Scan Time Measurement" screen is opened while a ladder block is selected in a ladder editor, the selected range is entered in "Step No." automatically.
- For a ladder program, when the specified start or end step is in the middle of a ladder block, the step is set in a unit of the ladder block including the selected range.

## Precautions

- A scan time cannot be measured in a safety program.
- A scan time cannot be measured depending on the specified start or end step.

For details, refer to the following:

 MELSEC iQ-R CPU Module User's Manual (Application)



# 14.9 Checking the Processing Time of a Program

To check the processing time of a program being executed, use the program list monitor. FX5CPUs and remote head modules do not support this function.

## Window

Select [Online] ⇒ [Monitor] ⇒ [Program List Monitor].

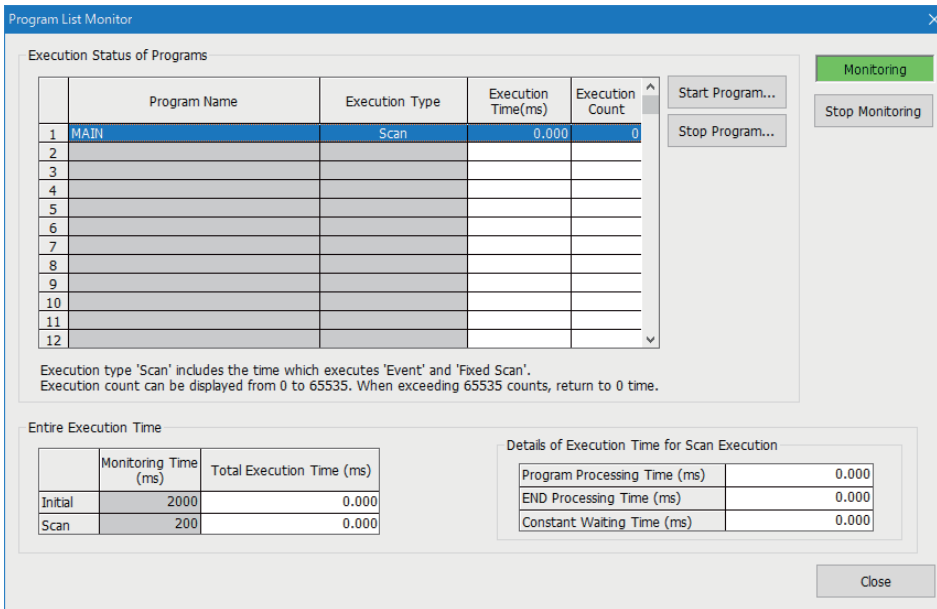

## Displayed items

Item	Description	
Execution Status of Programs	Execution Time (ms)	Displays the actual scan time (current value). The display contents are differ depending on the program execution type. At the program stop (standby) state: 0.000 ms
	Execution Count	Displays the number of executions, counted from '0' at the point of turning the CPU module to the RUN state. It is stored even after the program stops.
Entire Execution Time	Monitoring Time (ms)	Displays the program execution monitoring time set in "PLC RAS" of "CPU Parameter."
	Total Execution Time (ms)	Displays the total scan time of the programs executed in the CPU module.
Details of Execution Time for Scan Execution	Program Processing Time (ms)	Displays the total execution time of scan execution type program.
	END Processing Time (ms)	Displays the END processing time.
	Constant Waiting Time (ms)	Displays the waiting time of the constant scan when the constant scan is set.
[Start Program] button	Click this to start a desired program. (☞ Page 656 Starting a program)	
[Stop Program] button	Click this to stop a desired program. (☞ Page 656 Stopping a program)	

## Starting a program

The following shows the procedure for starting a desired program.

A program of which the execution type is "Standby" can be started when a CPU module is in the RUN state.

Programs with the execution types other than "Standby" cannot be started.

### Operating procedure

1. Click the [Start Program] button.
2. Set each item in the "Start Program" screen, and click the [Execute] button.

## Stopping a program

The following shows the procedure for stopping a desired program.

A program of which the execution type is "Scan" can be stopped when a CPU module is in the RUN state.

Programs with the execution types other than "Standby" cannot be stopped.

### Operating procedure

1. Click the [Stop Program] button.
2. Set each item in the "Stop Program" screen, and click the [Execute] button.

### Point

The operations when stopping a program differ as follows depending on the item selected in "Stop Mode" of the "Stop Program" screen.

- Stop output after stop: The OUT instructions turn OFF at the next scan of the program. In the subsequent scans, the program execution type is changed to "Standby." (Same operations as the POFF instruction)
- Hold output after stop: The program execution type is changed to "Standby," and the output of OUT instructions is retained. (Same operations as the PSTOP instruction)

### Precautions

If the system is switched when stopping a program of an RnPCPU (redundant mode), the execution type of the stopped program is applied to the control system after switching.

# 14.10 Checking Execution Counts of Interrupt Programs

To check the execution count of interrupt programs used in a program, use the interrupt program list monitor function. FX5CPUs and remote head modules do not support this function.

## Window

Select [Online] ⇒ [Monitor] ⇒ [Interrupt Program List Monitor].

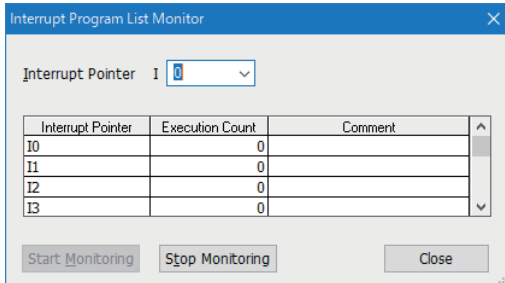

## Operating procedure

Input the interrupt pointer number of which execution counts are to be displayed in "Interrupt Pointer."

## Displayed items

Item	Description
Execution Count	Starts counting when the CPU module turns to the RUN state and displays the execution counts. When reaching 65536, it returns to 0.

# 14.11 Checking Current Values in an Intelligent Function Module

To check the current value of I/O signals and buffer memory of an intelligent function module, use the intelligent function module monitor.

## Window

Select [View] ⇒ [Docking Window] ⇒ [Intelligent Function Module Monitor] ⇒ [Intelligent Function Module Monitor 1] to [Intelligent Function Module Monitor 10].

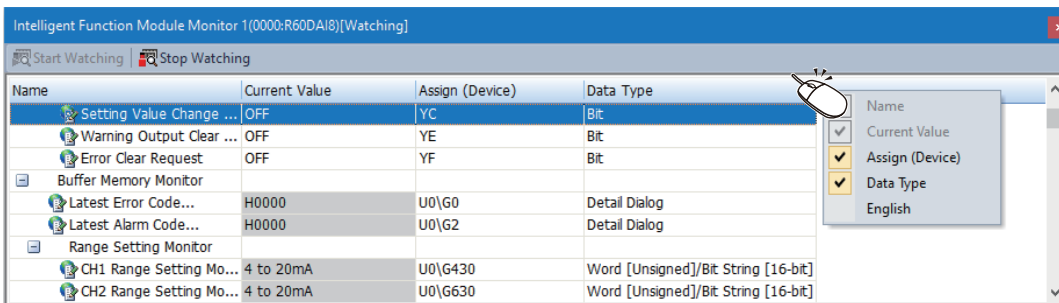

## Operating procedure

1. Register an intelligent function module to be monitored. (☞ Page 659 Registration of an intelligent function module)
2. Select [Online] ⇒ [Watch] ⇒ [Start Watching].

During monitoring, "[Watching]" is added in the title of the "Intelligent Function Module Monitor" window.

### Point

Select and right-click the module information, and then select [Copy] from the shortcut menu to paste it to a text file.

## Detailed display of monitor items

### ■ Detailed display of log information

The details of log information can be displayed during monitoring.

Double-click a row in which "Detail Dialog" is displayed in "Data Type" column, or right-click and select [Detailed Dialog] from the shortcut menu.

When the menu is not selectable, it is not supported by the module.

### ■ Detailed display of error codes/alarm codes

The details of an error code/alarm code can be displayed in the "Intelligent Function Module Monitor" window and the detailed dialog.

Double-click a row in which an error code/alarm code is displayed, or right-click and select [Detail Display] from the shortcut menu.

## Precautions

The intelligent function module monitor updates current values only within the range displayed on the window for monitoring acceleration.

When performing operation such as copy and paste on Excel, "--" or the previously monitored current value is displayed for the data outside the range displayed on the window.

## Registration of an intelligent function module

The following shows the procedures to register an intelligent function module to be monitored in the "Intelligent Function Module Monitor" window.

### Operating procedure

#### ■ Drag-and-drop (from the navigation window)

1. In the navigation window, select a module to be registered.
2. Drag and drop it onto the "Intelligent Function Module Monitor" window.

#### ■ Shortcut menu (in the navigation window)

1. In the navigation window, select a module to be registered in the "Intelligent Function Module Monitor" window.
2. Right-click it and select [Register to Intelligent Function Module Monitor] from the shortcut menu.

#### ■ Shortcut menu (in the "Intelligent Function Module Monitor" window)

1. Right-click on the "Intelligent Function Module Monitor" window and select [Register Module Information] from the shortcut menu.
2. Select a module to be registered in "Module List," and click the [OK] button.

When a positioning module is selected in "Module List," select the item displayed in "Monitor Item Category List."

#### Point

Module information can be copied and pasted to a file such as a text file by right-clicking any module information and selecting [Copy] from the shortcut menu in the "Intelligent Function Module Monitor" window.

## Registration of a device station

The following shows the procedures to register a device station on CC-Link IE TSN to be monitored in the "Intelligent Function Module Monitor" window.

FX5CPUs do not support this.

### Operating procedure

#### ■ Drag-and-drop (from the navigation window)

1. In the navigation window, select a master station.
2. Drag and drop it onto the "Intelligent Function Module Monitor" window.
3. Select the master station in "Module List" and a device station in "Monitor Item Category List," then click the [OK] button.

### ■Shortcut menu (in the navigation window)

1. In the navigation window, select a master station.
2. Right-click it and select [Register to Intelligent Function Module Monitor] from the shortcut menu.
3. Select the master station in "Module List" and a device station in "Monitor Item Category List," then click the [OK] button.

### ■Shortcut menu (in the "Device Assignment Confirmation" screen)

1. In the "Device Assignment Confirmation" screen, select a device station to be registered in the "Intelligent Function Module Monitor" window.
2. Right-click it and select [Register to Intelligent Function Module Monitor] from the shortcut menu.
3. Select the master station in "Module List" and a device station in "Monitor Item Category List," then click the [OK] button.

### ■Shortcut menu (in the "Intelligent Function Module Monitor" window)

1. Right-click on the "Intelligent Function Module Monitor" window and select [Register Module Information] from the shortcut menu.
2. Select the master station in "Module List" and a device station in "Monitor Item Category List," then click the [OK] button.

### Precautions

Match the network configuration settings and parameters for refresh devices between the actual system and a project. Otherwise, the refresh devices and buffer memory addresses are not set correctly in the intelligent function module monitor and a device station cannot be monitored properly.

# 14.12 Checking Current Logging Data

Logging data collected by a CPU module can be checked with the trend graph function in GX LogViewer.

To check the current logging data, display the data on the realtime monitor graph.

For details, refer to the following:

 GX LogViewer Version 1 Operating Manual

## Procedure for using the realtime monitor

When registering the data name and data type of a selected device/label automatically to the "Realtime Monitor Setting" screen of GX LogViewer, start the operation from step 1. When not registering the data name and data type automatically, start from step 2.

### Operating procedure

**1.** Select a device/label in any of the following windows of GX Works3:

- Ladder editor
- ST editor
- FBD/LD editor
- Watch window

**2.** Perform either of the following operations in GX Works3:

- Select [Tool] ⇒ [Realtime Monitor Function].
- Right-click the device/label and select [Wave Display (Realtime Monitor)] from the shortcut menu.

"Realtime Monitor Setting" screen of GX LogViewer appears.

**3.** Configure the monitoring settings in the "Realtime Monitor Setting" screen, and click the [Monitor Start] button.

For the operation methods of GX LogViewer, refer to the following:

 GX LogViewer Version 1 Operating Manual

### Point

The following information is applied to GX LogViewer when the "Realtime Monitor Setting" screen of GX LogViewer appears:

- Module type information of a project
- Current connection destination of a project
- Display language
- Data name and data type of a device/label

### Precautions

- For an RCPU project and an LHCPU project, the data name and data type of a device/label are registered automatically only when using GX Works3 Version 1.080J or later and GX LogViewer Version 1.124E or later.
- For an FX5CPU project, the data name and data type of a label are not registered automatically.

# 14.13 Checking Tag Data

## Checking tag data on the gauge window (faceplate)

'Faceplate' is a screen to display the image of a device such as a controller. The contents of tag data of a tag FB is displayed on it.

The status of the corresponding process can be monitored and a condition can be set by accessing the tag data.

A faceplate displays data and allows to manipulate the values of each tag data item as well.

Up to four faceplates can be displayed simultaneously.

For details on tag FBs, refer to the following:

📖 MELSEC iQ-R Programming Manual (Process Control Function Blocks/Instructions)

### Window

1. Start monitoring an FBD/LD program for process control.
2. Select a tag FB on the FBD/LD editor.
3. Select [Online] ⇒ [Monitor] ⇒ [Faceplate].

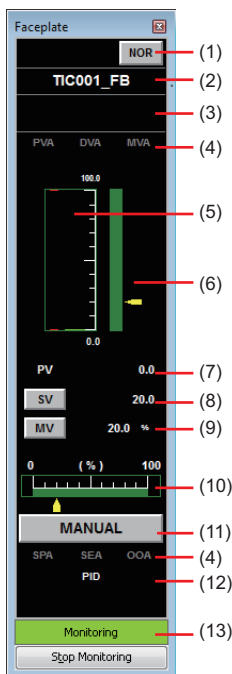

A faceplate can be displayed only while monitoring the call source program. Therefore, a faceplate will be closed if the monitoring is stopped due to an error such as a communication error.

### Displayed items

Item	Description
(1) I/O mode display area	When the tag type is a loop tag or status tag, the current I/O mode is displayed. The "Change I/O Mode" screen appears by clicking this button. The I/O mode is classified into the following four types. • NORMAL(NOR) • SIMULATION(SIM) • OVERRIDE(OVR) • TAG STOP(TSTP) The I/O mode can be changed only when the control mode is MANUAL mode.
(2) Tag name display area	A tag name is displayed.
(3) Tag comment display area	A comment defined on the tag FB setting editor is displayed.
(4) Alarm display area	A tag alarm is displayed.



Item	Description
(5) PV value bar display area	The current PV value is displayed in a bar format. A graph in the range of the upper and lower limits of the PV engineering value is displayed. An alarm bar is displayed if any of the following is set; PV high high limit alarm value, PV high limit alarm value, PV low limit alarm value, and PV low low limit alarm value.
(6) SV value bar display area	The range of the SV high limit value and the SV low limit value is displayed with the green bar. The current SV value is displayed with the yellow pointer.
(7) PV value setting/display area	The current PV value is displayed in a numerical value. The button is displayed only when the I/O mode is OVERRIDE mode. Click the button to display the PV value setting dialog.
(8) SV value setting/display area	The current SV value is displayed in a numerical value. Click the button to display the SV value setting dialog.
(9) MV value setting/display area	The current MV value is displayed in a numerical value. (Unit: %) Click the button to display the MV value setting dialog.
(10) MV value bar display area	The range of the MV high limit value and the MV low limit value is displayed with the green bar. The current MV value is displayed with the yellow pointer.
(11) [Control mode change] button	When the tag type is a loop tag or status tag, the current control mode is displayed. Click the button to display the control mode change dialog. The control mode is classified into the following six types. <ul style="list-style-type: none"> <li>• MANUAL(MAN)</li> <li>• AUTO(AUT)</li> <li>• CASCADE(CAS)</li> <li>• COMPUTER MV(CMV)</li> <li>• COMPUTER SV(CSV)</li> <li>• CASCADE DIRECT(CASDR)</li> </ul> When OVERRIDE mode is set for the I/O mode, the control mode cannot be changed from MANUAL mode to another one.
(12) Tag type display area	The tag type is displayed.
(13) Monitor status display area	The current monitor status is displayed.

## ■ Tag alarm

- PVA, DVA, MVA, SVA display area

Classification	Displayed character <sup>*1</sup>	Description	
Loop tag	PVA	PV-related	Positive/negative variation rate Input high high/high/low/low low limit
	DVA	DV-related	Large deviation
	MVA	MV-related	Output variation rate limit Output high/low limit
	SVA	SV-related	SV variation rate limit SV high/low limit
Status tag	AL1	Time-out-related	Time-out over
	AL2	Trip-related	Current and overload trip
Other tags	(Nothing displayed)		

\*1 An alarm which is not including for the corresponding tag type is not displayed.

- SPA, SEA (or HBOA), OOA display area

Classification	Displayed character	Description
Loop tag	SPA	Stop alarm <ul style="list-style-type: none"> <li>• When SPA turns ON, the 'SPA' part changes to a button.</li> <li>• Click the button to reset SPA.</li> </ul>
	SEA or HBO <sup>*1</sup>	Sensor error (SEA) <ul style="list-style-type: none"> <li>• SEA turns ON when a sensor error occurs.</li> </ul> Heater failure (HBOA) <ul style="list-style-type: none"> <li>• HBOA turns ON when a failure occurs in a heater.</li> </ul>
	OOA	Output open alarm <ul style="list-style-type: none"> <li>• OOA turns ON when output disconnection is detected in a user program.</li> </ul>
Other tags	(Nothing displayed)	

\*1 HBOA is displayed as 'HBO.'

A smart tag(1) is displayed on the bottom left of a tag FB selected while monitoring a program.  
By clicking a smart tag(1), a faceplate can be displayed.

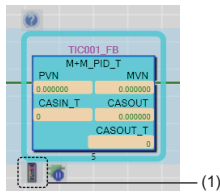

## Details on the parts displayed on a faceplate

On a faceplate, the image of a part such as a lamp and the push button are displayed according to the tag data content to display.

Displayed parts are the same as the ones displayed on a faceplate for PX Developer. For details, refer to the following:

 PX Developer Version 1 Operating Manual (Monitor Tool)

The manual above can be read by the following methods.

- Start PX Developer Monitor Tool, then select [Display operating manual] ⇒ [Monitor Tool] on the help menu.

## When a tag FB monitor value is incorrect

The corresponding display area on a faceplate is filled with black.

In that case, close the faceplate and take the following corrective action. After that, display the faceplate again.

Case that a monitor value regarded as incorrect	Corrective action
The project is not written to the programmable controller.	Convert (reassign) all programs, and write the project to the programmable controller.
The file register setting is not set.	Set the following items in "File Register Setting" of "CPU Parameter," and write the project to a programmable controller. <ul style="list-style-type: none"> <li>• Use Or Not Setting: Use Common File Register in All Programs</li> <li>• Capacity: Specify the required size.</li> <li>• File name: Specify a device memory name to use.</li> </ul>
A file register is not set for the latch (2).	Set the file register 'ZR (R)' for the latch (2) in "Device/Label Memory Area Detailed Setting" of "CPU Parameter," and write the project to a programmable controller. (  Page 24 CPU parameter setting)
CPU parameters and the global label setting (file register)*1 are written simultaneously.	Write CPU parameters first, and turn the power of a CPU module OFF and ON or reset the CPU module. Then, write the global label setting (file register)*1 to the programmable controller.

\*1 When writing the global label setting to a CPU module, data of file registers in the range set in the following option is automatically written.

[Tool] ⇒ [Options] ⇒ "Convert" ⇒ "Process Control Extension Setting" ⇒ "System Resource" ⇒ "File Register: ZR"

## Precautions

When using a faceplate in GX Works3, the latest PX Developer is required to be installed.

Only alphanumeric characters can be used to enter a tag name and a tag comment in the tag FB setting for using a faceplate.

# PX Developer Monitor Tool interaction

An FBD/LD program for process control created in GX Works3 can be managed, monitored, and controlled in PX Developer Monitor Tool.

Moreover, a GOT screen project can be created using the GOT screen generator of PX Developer Monitor Tool.

To use this function, follow the procedure in the table below.

No.	Procedure	Reference
1	Export an assignment information database file in GX Works3.	Page 665 Exporting an assignment information database file
2	Set the assignment information database file in PX Developer.	☞PX Developer Version 1 Operating Manual (Monitor Tool)
3	Monitor FBD/LD programs for process control in PX Developer Monitor Tool. Create a GOT screen project in PX Developer Monitor Tool.	☞PX Developer Version 1 Operating Manual (GOT Screen Generator)

## Exporting an assignment information database file

The following shows the procedure to export the assignment information database file of a GX Works3 project.

### Operating procedure

1. Open a GX Works3 project where an FBD/LD program for process control is used.
2. Click  (Export Assignment Information Database File) in the toolbar.
3. Click the [Save] button in the "Export Assignment Information Database File" screen.
4. Check the displayed message, and select whether or not to use the GOT screen generator of PX Developer Monitor Tool.

The assignment information database file (\*.FADB) is exported.

### Point

By selecting "Yes" for the following option, an "\_" (underscore) at the end of a tag name is deleted when exporting an assignment information database file.

- [Tool] ⇒ [Options] ⇒ "Convert" ⇒ "Process Control Extension Setting" ⇒ "Tag FB" ⇒ "PX Developer Monitor Tool Interaction" ⇒ "Remove Underscore at the End of Tag Name"

### Precautions

- When exporting an assignment information database file, only alphanumeric characters are available for a tag name and tag comment in the tag FB setting.
- When using the GOT screen generator of PX Developer Monitor Tool, export an assignment information database file in GX Works3 Version 1.045X or later.
- In PX Developer Monitor Tool Version 1.50C or earlier, an assignment information database file exported in GX Works3 Version 1.050C or later can be used, but set the value for the following option to '480' or lower before exporting. In that case, click the [Apply] button in the tag FB setting editor.  
[Tool] ⇒ [Options] ⇒ "Convert" ⇒ "Process Control Extension Setting" ⇒ "Tag FB" ⇒ "Maximum Number of Tags"

# 14.14 Setting Current Values of FB Properties as their Initial Values

In the "FB Property Management (Online)" screen, the current values of FB properties can be read from a programmable controller, and the values can be set as the initial values of the FB properties in the project.

For details on FB properties, refer to the following:

☞ Page 375 Setting Initial Values of FB Properties

## FB Property Management (Online) screen

The following explains the details on the "FB Property Management (Online)" screen.

### Window

#### ■ Updating the initial value of a selected FB property

1. Select a function block or tag FB in any of the following editors:

- Ladder editor
- ST editor
- FBD/LD editor
- Tag FB setting editor

2. Right-click it and select [FB Property] ⇒ [FB Property Management (Online)] from the shortcut menu.

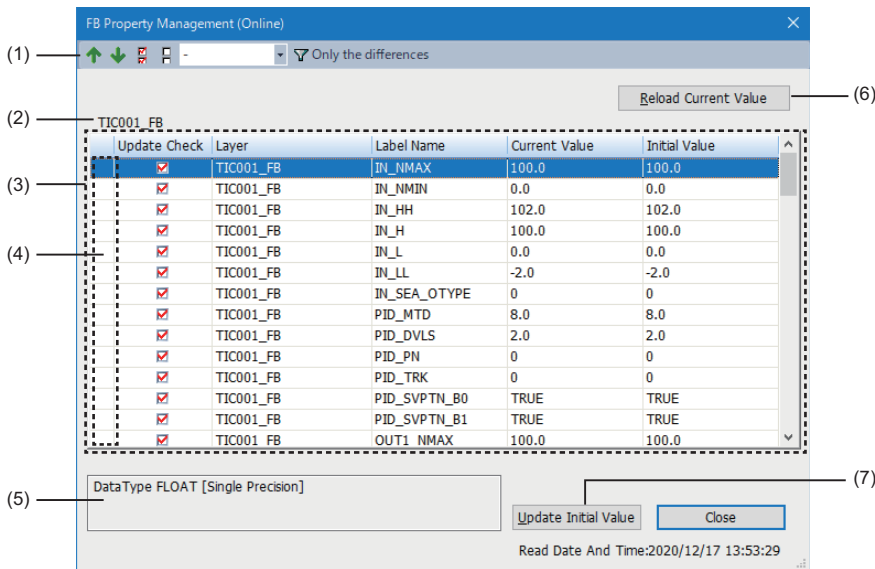

### Point

The "FB Property Management (Online)" screen can be displayed only in the following cases:

- Ladder editor: An FB instance is selected.
- ST editor: The cursor is placed on a token, or the whole token is selected.

```
FbPou_1_1();
```

```
FbPou_1_1();
```

- FBD/LD editor: A whole function block is selected.

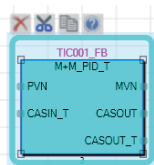





## ■Managing the initial values of all FB properties

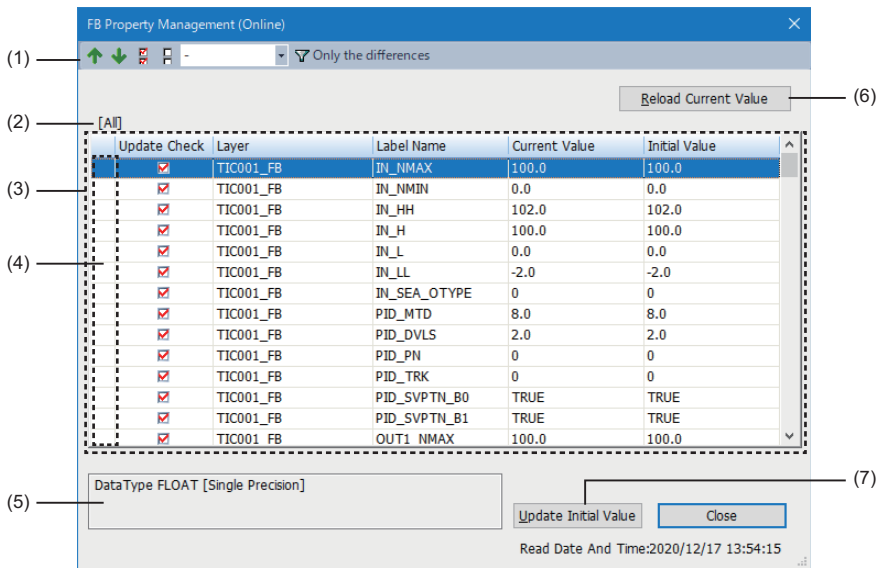

Select [Online] ⇒ [FB Property Management (Online)].

Alternatively, select  (FB Property Management) ⇒ [FB Property Management (Online)] on the tool bal.



### Displayed items

Item	Description		
(1) Toolbar		Previous difference	Click this to jump the cursor to the row with a difference in values (the row where the current value and initial value are different) before the current cursor position in the FB property list. (Always available)
		Next difference	Click this to jump the cursor to the row with a difference in values after the current cursor position in the FB property list. (Always available)
		Select All	Click this to select all selectable FB property items in the FB property list. (Always available)
		Deselect All	Click this to unselect all selected FB property items in the FB property list. (Always available)
	-	Number of digits after decimal point specification	Specify the number of digits after decimal point for the current value of which the data type is single precision or double precision. *1 <ul style="list-style-type: none"> <li>Without specification: —</li> <li>With specification: 1 to 14</li> </ul> The number of digits can be specified only when a row with a difference in values is not specified. If filtering a row with a difference in values when the number of digits after the decimal point are specified, the row is filtered by keeping the setting. (Available only for the current value)
		Only the differences	Click this to display only a row with a difference by filtering or to clear the filtering. Filtering will be cleared when the current value is reloaded while filtering.
(2) FB instance name	The FB instance name of a selected function block or tag FB is displayed. "All" is displayed when reading the current values of all function blocks or tag FBs registered in a project.		

Item	Description										
(3) FB property list	<p>The FB properties of a specified FB is displayed in a list when displaying the "FB Property Management (Online)" screen. FB properties of the following function blocks and tag FBs are displayed when displaying the "FB Property Management (Online)" screen by selecting [Online] ⇒ [FB Property Management (Online)].</p> <ul style="list-style-type: none"> <li>• FB instance set for a global label</li> <li>• FB instance set for a local label in a program</li> </ul>										
	<table border="1"> <tr> <td>Update Check</td> <td> <p>Select whether to set the current value as the initial value when the [Update Initial Value] button is clicked.</p> <ul style="list-style-type: none"> <li>• Selected: The current value is set as the initial value.</li> <li>• Not selected: The current value is not set as the initial value.</li> </ul> <p>The selection state is saved in a project for each FB instance.</p> </td> </tr> <tr> <td>Layer</td> <td> <p>The layer of the target function block and tag data are displayed. The display contents of each function block are as follows:</p> <ul style="list-style-type: none"> <li>• Function block (local label definition): POU name/FB label name in a program</li> <li>• Function block (global label definition), tag FB: FB label name</li> <li>• Tag data: label name of tag data</li> </ul> </td> </tr> <tr> <td>Label Name</td> <td> <p>The FB property item name in a target function block is displayed.</p> </td> </tr> <tr> <td>Current Value</td> <td> <p>The current value of an FB property acquired from a programmable controller is displayed. When the values between the current value and the initial value differ, the character string is displayed in red.*2</p> </td> </tr> <tr> <td>Initial Value</td> <td> <p>The initial value of an FB property acquired from a project is displayed. When the values between the current value and the initial value differ, the character string is displayed in red.*2</p> </td> </tr> </table>	Update Check	<p>Select whether to set the current value as the initial value when the [Update Initial Value] button is clicked.</p> <ul style="list-style-type: none"> <li>• Selected: The current value is set as the initial value.</li> <li>• Not selected: The current value is not set as the initial value.</li> </ul> <p>The selection state is saved in a project for each FB instance.</p>	Layer	<p>The layer of the target function block and tag data are displayed. The display contents of each function block are as follows:</p> <ul style="list-style-type: none"> <li>• Function block (local label definition): POU name/FB label name in a program</li> <li>• Function block (global label definition), tag FB: FB label name</li> <li>• Tag data: label name of tag data</li> </ul>	Label Name	<p>The FB property item name in a target function block is displayed.</p>	Current Value	<p>The current value of an FB property acquired from a programmable controller is displayed. When the values between the current value and the initial value differ, the character string is displayed in red.*2</p>	Initial Value	<p>The initial value of an FB property acquired from a project is displayed. When the values between the current value and the initial value differ, the character string is displayed in red.*2</p>
Update Check	<p>Select whether to set the current value as the initial value when the [Update Initial Value] button is clicked.</p> <ul style="list-style-type: none"> <li>• Selected: The current value is set as the initial value.</li> <li>• Not selected: The current value is not set as the initial value.</li> </ul> <p>The selection state is saved in a project for each FB instance.</p>										
Layer	<p>The layer of the target function block and tag data are displayed. The display contents of each function block are as follows:</p> <ul style="list-style-type: none"> <li>• Function block (local label definition): POU name/FB label name in a program</li> <li>• Function block (global label definition), tag FB: FB label name</li> <li>• Tag data: label name of tag data</li> </ul>										
Label Name	<p>The FB property item name in a target function block is displayed.</p>										
Current Value	<p>The current value of an FB property acquired from a programmable controller is displayed. When the values between the current value and the initial value differ, the character string is displayed in red.*2</p>										
Initial Value	<p>The initial value of an FB property acquired from a project is displayed. When the values between the current value and the initial value differ, the character string is displayed in red.*2</p>										
(4) Header	<p>An error icon (  ) is displayed when the current value cannot be set as the initial value.</p>										
(5) Explanation column	<p>The data type of a label selected in the FB property list and a label comment are displayed. A label comment can be displayed in the explanation column by setting the comment as the display target on the "Multiple Comments Display Setting" screen*3. (  Page 82 Displaying and Reading Comments )</p>										
(6) [Reload Current Value] button	<p>Click this to read the current values of FB properties from the programmable controller again.</p>										
(7) [Update Initial Value] button	<p>Click this to set the read current values of FB properties as the initial values.</p>										

\*1 When the digits after the decimal point are more than seven digits, the value is applied only for the item of the double precision. For the item of the single precision, six digits are applied.

\*2 The current value and the initial value in the FB property list are compared in binary. (Example: 1.0 and 1.00 is considered as the same value.)

\*3 Appears by selecting the following menu:  
[View] ⇒ [Multiple Comments] ⇒ [Display Setting]

### Point

Once the initial value is updated, a program related to a label of which the initial value was updated will be in the unconverted state.

This part explains the maintenance and inspection methods such as a function to protect data (prevent from falsification and data leakage) and display the system status of the CPU module.

15 PROTECTING DATA

---

16 MODULE DIAGNOSTICS

---

17 COLLECTING/REPRODUCING DATA

---

18 CHECKING/CHANGING MODULE OPERATION

---

# 15 PROTECTING DATA

This chapter explains the method for protecting data in a project.

The following table shows the functions to protect data.

Purpose	Target	Function name	Reference
To prevent a program from being illegally accessed (for each POU) (Using a password)	Project	Block password	Page 671 Preventing Illegal Access to Programs (Block Password)
To prevent a program from being illegally accessed (for each program file) (Using a security key)	Project	Security key authentication for a project	Page 673 Preventing Illegal Access to Programs (Security Key)
To prevent a program from being illegally executed (Using a security key)	CPU module	Security key authentication for a CPU module	Page 680 Preventing Illegal Program Execution (Security Key)
To prevent a project from being illegally accessed (Using a password)	Safety project	User authentication for a project	Page 683 Preventing Illegal Access to Project (User Authentication)
To prevent a CPU module from being illegally accessed (Using a password)	CPU module (RnPSFCPU and RnSFCPU)	User authentication for a CPU module	Page 686 Preventing Illegal Access to CPU Module (User Authentication)
To prevent a file from being illegally read/written (Using a password)	CPU module SD memory card	File password	Page 692 Preventing Illegal Data Reading/Writing (File Password)
To restrict access from a communication route other than specific one (Using a password)	CPU module	Remote password	Page 699 Restricting Access from Other Than Specific Communication Route (Remote Password)
To prevent data from being illegally accessed and falsified (Using a password)	Project	Security version	Page 697 Preventing Illegal Access to/ Falsification of Data (Security Version)
To prevent data from being illegally accessed and falsified from a file in a CPU module (Using a password)	CPU module		
To block access from an illegal IP address by identifying the IP address of an external device via Ethernet or CC-Link IE TSN (Setting in "Module Parameter")	CPU module	IP filter <sup>*1</sup>	<a href="#">MELSEC iQ-R Ethernet User's Manual (Application)</a> <a href="#">MELSEC iQ-F FX5 User's Manual (Ethernet Communication)</a>

\*1 Even when using the IP filter, illegal access may not be prevented completely. Take additional security measures system-wide, such as setting up a firewall for the network.

## Operations when using CPU modules in a redundant system configuration

For RnPCPUs, the operations differ depending on the operation modes when executing the functions that the target is a CPU module.

RnPSFCPUs operate in the backup mode when executing the functions that the target is a CPU module.

Operation mode	Operation
Separate mode	Applied to the CPU module in the connective system.
Backup mode	Applied to both systems (order: control system → standby system). If an error occurs in the control system while performing any functions above, that is not performed to the standby system. If an error occurs in the standby system while performing any functions above, the status of control system is not restored to that before changed.



# 15.1 Preventing Illegal Access to Programs (Block Password)

To prevent illegal access to a program (in a POU unit) by setting a password, use the Block password function.

## Block password function

Operations are restricted by registering a password for a POU.

- Restricted operation: Accessing to a POU (The operations will be allowed while the program is authenticated even if a password has been registered.)
- Target data: Program blocks, function blocks, and functions (☞ Page 100 Data configuration)

## Procedure for using the block password function

### Procedure for making a security enable

1. Set a block password for a POU. (☞ Page 671 Setting block password)
2. Save a project. (☞ Page 126 Saving a project)

After closing a project in which the block password is set, the POU cannot be accessed when the file is opened next time.

### Procedure for making locked POU's accessible

Authenticate the block password set to the POU. (☞ Page 672 Authenticating a block password)

The POU can be accessed while the project is open.

## Setting block password

The following shows the screen for registering a block password to a POU.

### Window

- Select [Project] ⇒ [Security] ⇒ [Block Password Setting].
- Select a POU in the navigation window, then right-click it and select [Block Password Setting] from the shortcut menu.

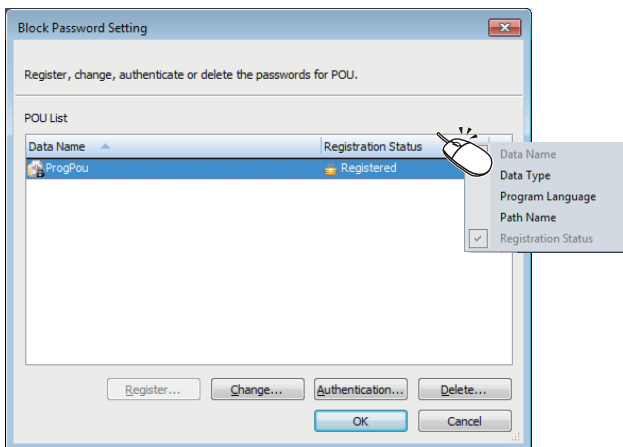

## Registering/changing a block password

The following shows the procedure for registering/changing a block password for a POU.

### Operating procedure

1. Select a POU to set a block password and click the [Register]/[Change] button.
2. Enter each item in the "Register Password" screen/"Change Password" screen, and click the [OK] button.

When a block password is registered, the icons in the navigation window will be displayed as shown below.

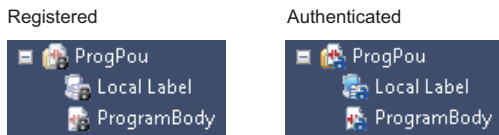

### Point

By selecting multiple POUs in "Data Name," a block password can be registered to the selected POUs in batch.

## Authenticating a block password

The following shows the procedure for unlocking a POU temporarily by authenticating the password which has been set to the POU.

Once the password is authenticated, the data can be accessed until the project is closed.

### Operating procedure

1. Select a POU to authenticate the block password, and click the [Authentication] button.
2. Enter the password in the "Password Authentication" screen, and click the [OK] button.

## Deleting a block password

The following shows the procedure for deleting a block password registered to a POU.

### Operating procedure

1. Select a POU to delete the block password, and click the [Delete] button.
2. Enter the password in the "Delete Password" screen, and click the [OK] button.

## Consideration

For a project whose security version is '2,' the data will be in the unconverted state by registering, changing or deleting a block password.

# 15.2 Preventing Illegal Access to Programs (Security Key)

To prevent illegal access to a program (in a program file unit) with a key, use the security key authentication function.

## Security key authentication function for a project

The operations can be restricted by using a security key.

Security key setting target:

Target	Purpose
<p>■Program files (Program file, FB file, FUN file) (☞ Page 100 Data configuration)</p> <p>A security key can be registered for each program file, however, all program files in a project will be set the same security key.</p>	<ul style="list-style-type: none"> <li>• To restrict the access for program files in a project.</li> <li>• To restrict the execution of programs by a CPU module.</li> </ul>
<p>■Personal computer</p> <p>Multiple security keys can be registered in one personal computer.</p>	To make the access for program files protected by a security key enabled.

The following operation can be restricted:

### Access to programs (Program file, FB file, FUN file)

Restrict the operations by detecting mismatches of the security key between the program file and personal computer.

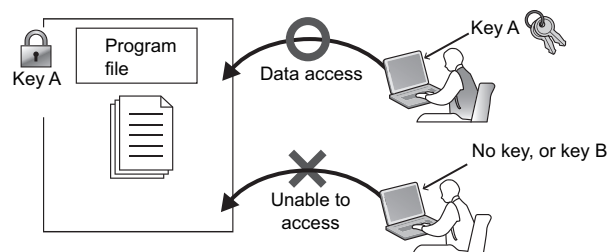

Copy of security key: The security key registered to a personal computer can be copied by exporting/importing it from/to other personal computer. In addition, the expiration date of the security key can be set.

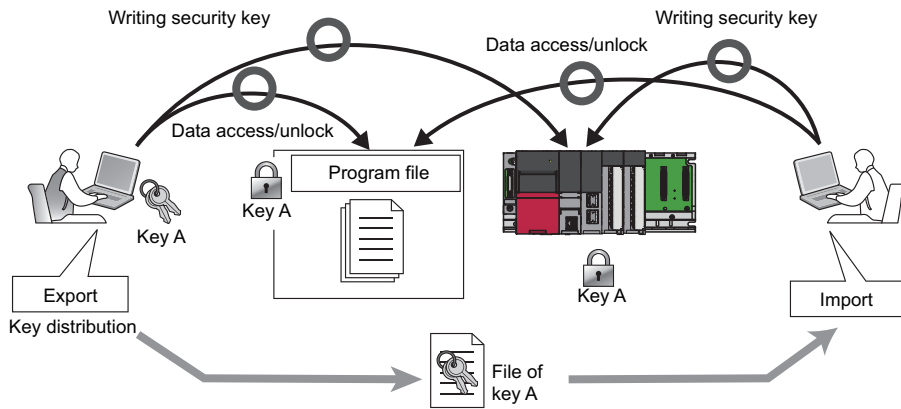

Setting method: ☞ Page 677 Copying a security key

### Precautions

The security key registered to a personal computer is not deleted even if GX Works3 is uninstalled. Delete the security key on the "Security Key Management" screen.

# Procedure for using the security key authentication function for a project

---

## Procedure for making a security enable

1. Create a security key. (📖 Page 675 Creating/deleting a security key)
2. Register the security key in a program file. (📖 Page 678 Registering a security key in a program file)
3. Save a project. (📖 Page 126 Saving a project)

A personal computer which does not have the same security key as the one registered in the project cannot be accessed.

## Procedure for making locked program files accessible

1. Copy the same security key as the protected program file. (📖 Page 677 Exporting a security key)
2. Register the security key in a personal computer from which the program file is to be accessed. (📖 Page 677 Importing a security key)
3. Open the program file. (📖 Page 105 Opening a project)

The program file can be accessed when the security key matches between the program file and the personal computer.

The operations shown above are not required for the personal computer with which a security key is registered in a program file. However, the above operations are required when the security key is deleted.

# Creating/deleting a security key

A security key can be created or deleted in the "Security Key Management" screen.

## Window

Select [Project] ⇒ [Security] ⇒ [Security Key Management].

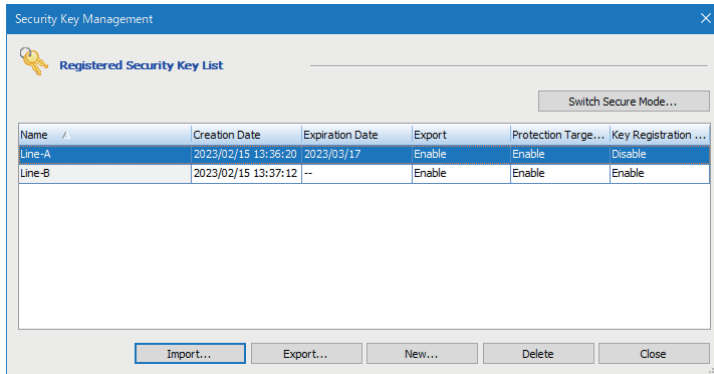

## Displayed items

Item	Description
Creation Date	The date and time when a security key was registered is displayed.
Expiration Date	The expiration date that is set when exporting the security key is displayed.
Export	Whether re-exporting the security key is enabled/disabled, which was set when exporting the security key, is displayed.
Protection Target Selection	Whether selecting data to be protected is enabled/disabled, which was set when exporting the security key, is displayed.
Key Registration to CPU	Whether writing data to CPU module is enabled/disabled, which was set when exporting the security key, is displayed.

## Secure mode

The following shows the procedure for enabling or disabling the secure mode of a security key. By enabling the secure mode, the risk for the vulnerability can be reduced.

### Operating procedure

1. Confirm that a security key is not registered in a personal computer in advance. If a security key is registered, delete the key. (☞ Page 676 Deleting a security key)
2. Click the [Switch Secure Mode] button in the "Security Key Management" screen.
3. Enable or disable the secure mode.
4. Click the [OK] button.

## Creating a security key

The following shows the procedure for creating a security key and registering it to a personal computer. Number of security keys that can be registered: The security keys can be created for each logon user. Up to 128 security keys, including the created security keys and the imported ones, can be registered for each logon user.

### Operating procedure

1. Click the [New] button.
2. Enter a security key name in the "New Security Key" screen and click the [OK] button.

### Precautions

All information can no longer be accessed if the security key that locks a CPU module and project is accidentally deleted or lost.

Set a sufficient validity period for a security key file when exporting, and carefully manage the exported file.

## Deleting a security key



The following explains the procedure for deleting a security key that is registered in a personal computer.

If a security key that locks a project is deleted, the locked data in the project can no longer be accessed or edited.

Deactivating a security key is recommended before deleting it.

A security key can be deactivated by deleting it in the "Security Key Setting" screen.

For details, refer to the following:

- To deactivate a security key registered in a program file:  Page 679 Deleting a security key
- To deactivate a security key written in a CPU module:  Page 682 Deleting a security key

After deleting the security key, even when the security key with the same name as the deleted one is recreated, it will not be the same security key as the deleted one. Take extra caution when deleting a security key.

### Operating procedure

- 1.** Select a security key to be deleted in the "Security Key Management" screen.
- 2.** Click the [Delete] button.

# Copying a security key

A security key can be copied (imported/exported) in the "Security Key Management" screen.

## Exporting a security key

The following shows the procedure for exporting a security key registered to a personal computer to a file (\*.ity, \*.ity2) where the security key can be imported.

Expiration date and restrictions for operations can be added to the security key to be exported.

### Operating procedure

1. Select a security key to be exported in the "Security Key Management" screen.
2. Click the [Export] button.
3. Set the following items in the "Export" screen.

Item	Description
Restriction	Set whether to add restrictions to the security file to be exported.
Expiration Date	Set the expiration date for the security key to be exported.
Export	Set whether to allow exporting the security key after importing the exported security key.
Protection Target Selection	Set whether to allow registering the security key for the program files using the exported security key.
Key Registration to CPU	Select whether to allow writing the security key to the CPU module using the exported security key.

4. Set the password to be required when importing the security key, and click the [Export] button.

### Precautions

- The exported security key files must be managed carefully.
- The security key files created with GX Works3 are not compatible with that of GX Works2.

#### Point

The extension of a security key file to be exported differs as follows depending on whether the secure mode is enabled or disabled.

- When the secure mode is enabled: \*.ity2
- When the secure mode is disabled: \*.ity

## Importing a security key

The following shows the procedure for importing an exported security key file in a personal computer to register the security key.

### Operating procedure

1. Click the [Import] button in the "Security Key Management" screen.
2. Select a file (\*.ity, \*.ity2) in the "Import Security Key" screen, and click the [Open] button.
3. Enter the password set when exporting the security key in the "Password Authentication" screen, and click the [OK] button.

### ■Expiration date

- If the expiration date of the security key registered in a personal computer is expired, accessing programs, re-exporting security keys, registering security keys in program files, and writing security keys to CPU module cannot be performed.
- To use the same security key after the expiration date, export the security key from the exported personal computer again, and import it to the personal computer.

### Precautions

A security key file with the '\*.ity2' extension can be imported only while the secure mode is enabled.

# Registering a security key in a program file

A security key must be created in the "Security Key Management" screen in advance.

A security key can be registered for each program file, however, all program files in a project will be set the same security key.

## Window

Select [Project] ⇒ [Security] ⇒ [Security Key Setting].

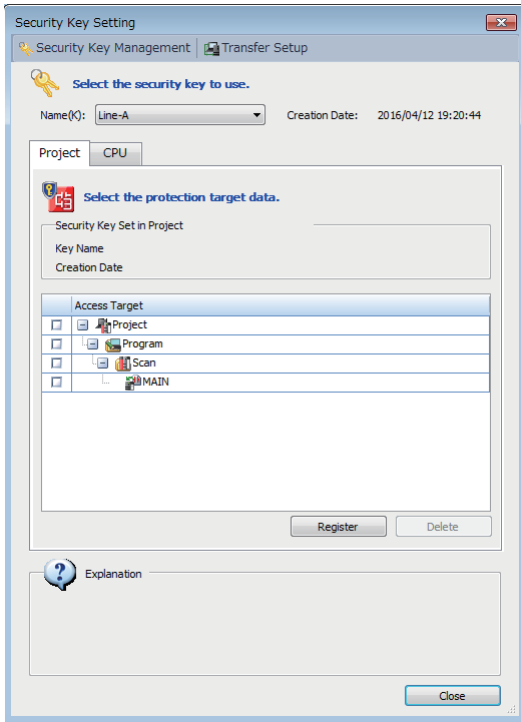

## Registering a security key

### Operating procedure

1. Select a security key to be registered to a program file from "Name."
2. Select a program file to lock from the [Project] tab, and click the [Register] button.

The security key registered to program files will be enabled after saving the project.

When a security key is registered, the icons in the navigation window will be displayed as shown below.

When the security keys between in the personal computer and the project does not match

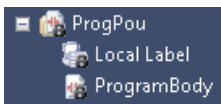

When the security keys between in the personal computer and the project matches

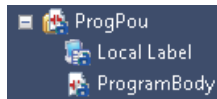



### ■ Security key lock for a FB file

If the program, in which the function block of FB file locked with a security key is used, is opened on the personal computer with no corresponding security key exists, the FB program cannot be opened.

However, the instances of the locked FB can be created in the program on the personal computer in which the security key is not registered.

## Deleting a security key

### Operating procedure

Click the [Delete] button in the [Project] tab.

### Consideration

For a project whose security version is '2,' the project will be in the unconverted state by clicking the [Register]/[Delete] button in the [Project] tab.

# 15.3 Preventing Illegal Program Execution (Security Key)

To prevent an illegal execution for programs (STOP/PAUSE → RUN) written in a CPU module, use the security key authentication function.

## Security key authentication function for a CPU module

The execution of a program can be restricted by using a security key.

Security key setting target:

Target	Purpose
■ CPU module Only one security key can be written to one CPU module.	To make the execution of a program restricted by a security key enabled.

The following operation can be restricted:

### Execution of programs in CPU module (STOP/PAUSE → RUN)

Restrict the operations by detecting mismatches of the security key between the program file written in a CPU module and CPU module.

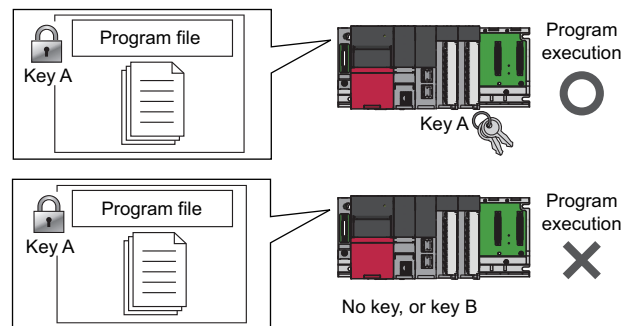

The programs are not executed if any of the programs of which security key is unmatched in the CPU module exists. The security key written in the CPU module is retained after powering OFF.

## Procedure for using the security key authentication function for a CPU module

### Procedure for making a security enable

1. Create a security key. (↖ Page 675 Creating/deleting a security key)
2. Register the security key in the program file to be written to the CPU module. (↖ Page 678 Registering a security key in a program file)
3. Write the program files to the CPU module. (↖ Page 580 Writing data to a programmable controller)

A CPU module which does not have the same security key as the one registered in the program file cannot execute the programs.

### Procedure for making locked programs executable

1. Set the Specify Connection Destination to access to the CPU module. (↖ Page 557 Specification of Connection Destination)
2. Write the same security key as the protected program file to the CPU module. (↖ Page 681 Writing/deleting security key to/from CPU module)

The programs can be executed unless otherwise the security key set to the program file or CPU module is changed.

# Writing/deleting security key to/from CPU module

By writing the same security key as a project to the CPU module, the execution of the programs can be permitted.

A security key can be written to any of the following.

- CPU module
- Cassette (extended SRAM cassette <sup>\*1</sup> or battery-less option cassette <sup>\*2</sup>)

\*1 An extended SRAM cassette cannot be attached to R00CPUs, R01CPUs, R02CPUs, LHCPUs, FX5CPUs, and remote head modules.

\*2 A battery-less option cassette cannot be attached to R00CPUs, R01CPUs, R02CPUs, RnPCPUs, RnPSFCPUs, RnSFCPUs, LHCPUs, FX5CPUs, and remote head modules.

Additionally, one security key can be written to multiple CPU modules.

When writing a security key, create a key on the "Security Key Management" screen and connect a personal computer and a CPU module in advance. (Only when a CPU module is in STOP state, a security key can be written and deleted.)

For a safety project, the security key can be written/deleted when the safety operation mode of a CPU module is in the test mode.

## Window

Select [Project] ⇒ [Security] ⇒ [Security Key Setting].

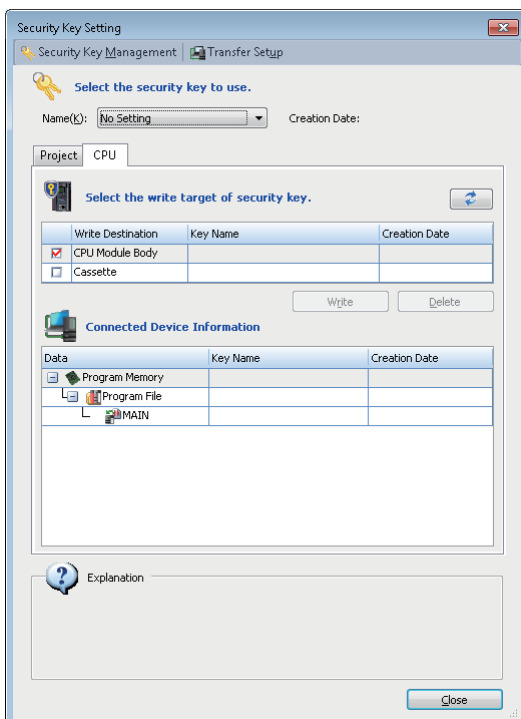

## Writing security key

### Operating procedure

1. Select the security key to be written from "Name."
2. Select the target to be written in the [CPU] tab, and click the [Write] button.

### ■When a security key is written to a cassette

A security key can be succeeded to the replaced CPU module only by replacing a cassette (extended SRAM cassette or battery-less option cassette). Writing the security key from the personal computer in which the security key is registered is unnecessary.

### ■Write target of a security key in a multiple CPU system

In a multiple CPU system, write a security key to each CPU module. Additionally, the security key set in CPU No.1 can be used in CPU No.2 to CPU No.4.

### ■Operations when using CPU modules in a redundant system configuration

When "Write to CPUs of both systems" is selected for an RnPCPU (redundant mode), the operations differ depending on the operation modes.

When "Write to CPUs of both systems" is selected for an RnPSFCPU, the module operates in the backup mode.

Operation mode	Operation
Separate mode	Applied to the CPU module in the connective system.
Backup mode	Applied to both systems (order: control system → standby system). If an error occurs in the control system during writing, that is not performed to the standby system. If an error occurs in the standby system during writing, the status of control system is not restored to that before changed.

## Deleting a security key

The security key written in the CPU module can be deleted on the personal computer in which the security key is not registered.

However, the program of which security key is registered in the CPU module exists, the security key cannot be deleted.

### Operating procedure

Select the security key to be deleted from the [CPU] tab, then click the [Delete] button.

# 15.4 Preventing Illegal Access to Project (User Authentication)

To prevent an illegal access to a safety project from a user with no authority, use the user authentication function for a project. RnPSFCPU and RnSFCPU support this function.

## User authentication function for a project

Operations are restricted by registering a user name/password for a project.

The following operation can be restricted:

### User authentication for a project

To access to a project, logging on with the registered user information (user name/password) is required.

Logged-on user



Data access

Project



Unlogged-on user



Data access



User information

### Access level

Access level is an operation privilege that is given to a user who logs on to a project and/or CPU module.

The operations allowed for each access level are as follows.

Access level	Operation authority
Higher ↑ ↓ Lower	Administrators (Administrator level) All operations including user management of projects and CPU modules
	Developers (Developer level) Operations except for user management and security setting Writing of data on a standard program and safety program to a CPU module
	Assistant Developers (Developer level) Operations except for user management, security setting, writing of safety programs and parameters Writing of data on a standard program to a CPU module
Users (Operator level) Referencing of a project and monitoring of CPU modules	

## Functions that require user authentication

Depending on an access level, some functions are restricted in a project.

The functions restricted by each access level are as follows.

○: Available, ×: Not available

Function	Access level			
	Administrators	Developers	Assistant Developers	Users
Overwriting	○	○	○	×
User management	○	×	×	×
Deleting the user information of a project	○	×	×	×
Project revision history	○	○	○	×
Changing the module type and operation mode	○	×	×	×
Online program change	○	○	○*1	×
Writing data to a programmable controller	○	○	○*1	×

\*1 Only data on a standard program can be written to a CPU module. (☞ Page 688 Operation)

## Guest user

The 'guest user' has an authority to log on to a project and a CPU module without entering the user name and the password in the "User Authentication" screen. (Its access level is 'Assistant Developers' or 'Users'.)

To log on as a guest user, add a guest user in the "Add New User" screen or enable a guest user in the "User Management" screen.

For details, refer to the following:

☞ Page 104 Adding a new user

☞ Page 685 User management

After the logon, the user can read and edit only standard programs.

## Procedure for using the user authentication function for a project

1. Create a safety project, and add a user of Administrators to the project. (☞ Page 103 Creating a project)
2. Add a user who is allowed to operate the project. (☞ Page 685 User management)
3. Save a project. (☞ Page 126 Saving a project)

Once the above procedure has done, logging on is necessary to access to the projects.

## Logging on to a project

For a project that user information is registered, logon is required to perform operations such as opening the project.

Enter a user name and password, that are registered in the project, to log on.

To log on as a guest user, click the [Log on as a GUEST] button on the "User Authentication" screen.

## Changing a password of the logon user

The following shows the procedure for changing a password of a user who is logging on to a project.

### Operating procedure

Select [Project] ⇒ [Security] ⇒ [Change User Password].

# User management

The following shows the screen for managing the user registration status of a project to which a security is set. A user of Administrators can change all user's passwords.

## Window

Select [Project] ⇒ [Security] ⇒ [User Management].

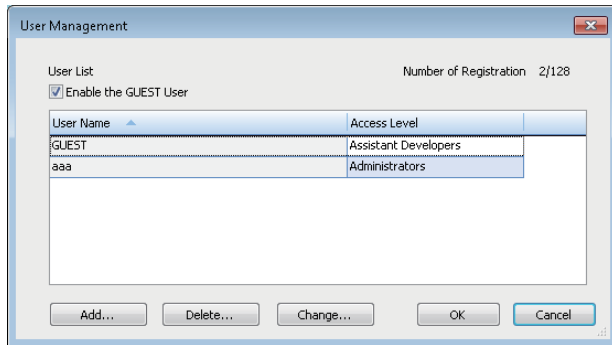

## Adding/changing user information

The following shows the procedure for adding/changing user information (user name/password) in a project.

15

### Operating procedure

1. Click the [Add]/[Change] button.
2. Set each item in the "Add New User" screen/"Change User" screen, and click the [OK] button.

## Deleting user information

The following shows the procedure for deleting user information registered in a project.

### Operating procedure

Select a user name to be deleted, and click the [Delete] button.

## Enabling a guest user

By selecting the checkbox of "Enable the GUEST User," the guest user information is displayed in the list.

The following table shows whether guest user information is changeable or not.

○: Changeable, ×: Not changeable

User information		Change
Item	Description	
User name	GUEST	×
Access level	Assistant Developers	○*1
Password	GUEST1234	×

\*1 The access level cannot be changed except for 'Assistant Developers' and 'Users.'

# 15.5 Preventing Illegal Access to CPU Module (User Authentication)

To prevent an illegal access to the data such as a program or parameters written to a CPU module, use the user authentication function for a CPU module.

RnPSFCPU and RnSFCPU support this function.

## User authentication function for a CPU module

Operations are restricted by registering a user name/password for a CPU module.

The following operation can be restricted:

### User authentication for a CPU module

To access to a CPU module, logging on with the registered user information (user name/password) is required.

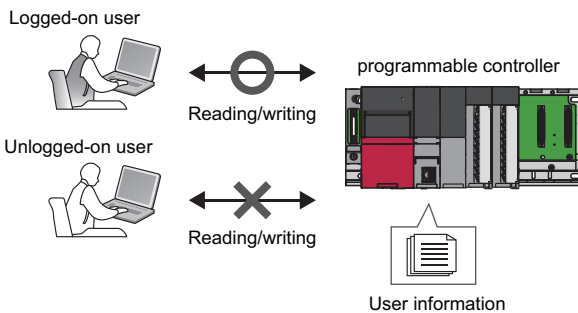

#### Point

- The user information registered in a CPU module needs to match with the user information of a project.
- The vulnerability measures are enhanced in RnSFCPU (firmware version 27 or later), and the following functions are changed partially:
  - Functions and operations that require user authentication
  - Writing user information to a CPU module
  - Logging on to a CPU module

In addition, the vulnerability measures are also enhanced in GX Works3 (version 1.087R or later).

By using RnSFCPU (firmware version 27 or later) and GX Works3 (version 1.087R or later), communication with enhanced vulnerability measures can be performed.

For RnPSFCPU, whether the user authentication function can be executed for both systems (the connective system and the other system) and the other system depends on each function.

○: Executable, —: Not executable

User authentication function	Both systems	Connective system
Logon to a programmable controller	○	○
Logoff from a programmable controller	○	○
Logoff of all users from a programmable controller	○	○
Password change of a programmable controller	—	○
User information reading from a programmable controller	—	○
User information writing to a programmable controller	—	○
User information copy to a programmable controller in the other system	—	○
Initializing all information of a programmable controller	—	○



## Functions and operations that require user authentication

### ■Function

Depending on the access level, some functions are restricted in a CPU module.

The functions restricted by each access level are as follows.

For CPU modules that support each function, refer to the following:

📖 MELSEC iQ-R CPU Module User's Manual (Application)

○: Available, ×: Not available

Function		Access level			
		Administrators	Developers	Assistant Developers	Users
File operation	Write to PLC	○ <sup>*1</sup>	○ <sup>*1</sup>	○ <sup>*1</sup>	×
	Read from PLC	○ <sup>*1</sup>	○ <sup>*1</sup>	○ <sup>*1</sup>	○ <sup>*1</sup>
	Verify with PLC	○ <sup>*1</sup>	○ <sup>*1</sup>	○ <sup>*1</sup>	○ <sup>*1</sup>
	Delete data in a programmable controller	○ <sup>*1</sup>	○ <sup>*1</sup>	○ <sup>*1</sup>	×
Redundant programmable controller operation	Memory copy	○ <sup>*2</sup>	×	×	×
CPU memory operation	Data memory initialization	○	○	×	×
	Device/label memory initialization	○	○	○	×
	Zero clear of file registers (all files)	○	○	○	×
	Zero clear of file registers (file specification)	○	○	○	×
	Label memory read/write	○	○	○	○
Change program	Online program change	○	○	○	×
	File batch online change	○	○	○	×
Security	Write/delete a security key	○	×	×	×
	Register/change/delete file password	○	×	×	×
	Authenticate file password	○	○	○	○
	Add/delete/change new user	○	×	×	×
	Read/write user data	○	×	×	×
Diagnostics	Change user password	○	○	○	○
	All clear event history	○	○	×	×
Test	Register device test with execution conditions	○ <sup>*3</sup>	○ <sup>*3</sup>	○ <sup>*3</sup>	○ <sup>*3</sup>
Safety	Safety operation mode switching	○	○	×	×
	Identification check for safety data	○ <sup>*4</sup>	○ <sup>*4</sup>	○ <sup>*4</sup>	○ <sup>*4</sup>
User authentication	Logoff from a programmable controller	○ <sup>*2</sup>	○ <sup>*2</sup>	○ <sup>*2</sup>	○ <sup>*2</sup>
	Logoff of all users from a programmable controller	○ <sup>*2</sup>	×	×	×
	User information copy to a programmable controller in the other system	○ <sup>*2</sup>	×	×	×
Operation	FB property management (online)	○	○	○	○

\*1 User authentication is not required to write/read a device memory (except for the file register).

\*2 Only RnPSFCPU support it.

\*3 User authentication is required for changing values of the following devices and labels.

- Local device
- Local label
- Index register
- Index-modified device

\*4 It is available only when using GX Works3 Version 1.087R or later and RnSFPCPU with the firmware version 27 or later in combination.

## ■Operation

Depending on the access level, the operations (read, write, delete, verify) that can be performed for data in a CPU module differ.

The operations restricted by each access level are as follows.

○: Available, ×: Not available

Data	Administrator	Developers	Assistant Developers		Users	
	Read/Write/Delete/Verify		Read/Verify	Write/Delete	Read/Verify	Write/Delete
Sequence program	○		○	○	○	×
Safety sequence program	○		○	×	○	×
FB file	○		○	○	○	×
Safety FB file	○		○	×	○	×
CPU parameter	○		○	×	○	×
Safety CPU parameter	○		○	×	○	×
System parameter	○		○	×	○	×
Module parameter	○		○	×	○	×
Safety module parameter	○		○	×	○	×
Module extended parameter	○*1		○*1	×	○*1	×
Memory card parameter	○		○	×	○	×
Device comment	○		○	○	○	×
Initial device value	○		○	○	○	×
Global label setting file	○		○	○	○	×
Safety global label setting file	○		○	×	○	×
Standard/safety shared label setting file	○		○	×	○	×
Initial global label value	○		○	○	○	×
Initial local label value	○		○	○	○	×
Global label assignment information file for an access from an external device	○		○	○	○	×
File register	○		○	○	○	×
Remote password file	○		○	×	○	×
Device memory	○		○	○	○	×
Parameter of a device station	○		○	○	○	○
Parameter of a safety device station	○		○	○	○	○
Recording setting file	○		○	○	○	○

\*1 For some modules, module extended parameters can be read or written only in their own configuration tools.

# Procedure for using the user authentication function for a CPU module

1. Register the user information in the project which is to be written to a CPU module. (☞ Page 685 User management)
2. Write the user information to a CPU module. (☞ Page 689 Writing user information to a CPU module)
3. For RnPSFCPU, copy the user information to the other system. (☞ Page 691 Copying user information to the other system)
4. Write programmable controller data to a CPU module. (☞ Page 580 Writing data to a programmable controller)

Once this procedure has done, logging on is required to access to the CPU module in advance.

## Writing user information to a CPU module

The following shows the procedure for writing user information registered in a project to a CPU module.

By writing user information to a CPU module for the first time, the user authentication of a programmable controller is enabled. When using RnSFCPU (firmware version 27 or later) and GX Works3 (version 1.087R or later) in which vulnerability measures are enhanced, the confirmation screen to enable the setting to communicate with only GX Works3 with enhanced security measures appears. By clicking the [Yes] button in the screen, communication with enhanced vulnerability measures can be performed, and the risk for the vulnerability can be reduced.

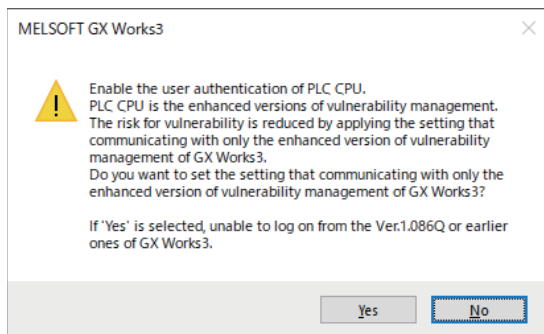

### Operating procedure

Select [Online] ⇒ [User Authentication] ⇒ [Write User Information to PLC].

## Reading user information from a CPU module

Read the user information registered in a CPU module, and overwrite the existing project.

### Operating procedure

Select [Online] ⇒ [User Authentication] ⇒ [Read User Information from PLC].

### Precautions

When reading user information from a CPU module to GX Works3 Version 1.044W or earlier, the access label "Assistant Developers" is changed to "Users."

# Logging on to CPU module

---

Logging on is required to access to a CPU module in which the user information is registered.

Enter a user name and password, that are registered in a CPU module, to log on.

For RnPSFCPUs, users can log on to both systems or the connective system.

After logging on, the user is automatically logged off if the CPU module has no access within the logoff judgment time or user information are written.

## Operating procedure

1. Select [Online] ⇒ [User Authentication] ⇒ [Log on to PLC]
2. Set each item in the "User Authentication" screen and click the [OK] button.  
To log on as a guest user, click the [Log on as a GUEST] button on the "User Authentication" screen.

## Precautions

- If password authentication fails for a certain number of times, it is rejected (locked out) for a fixed period of time. In RnSFCPUs (firmware version 27 or later) in which the vulnerability measures are enhanced, it is locked out for 60 minutes when input error exceeds five times.
- RnSFCPUs (firmware version 27 or later) with enhanced vulnerability measures may not be logged on from GX Works3 (Version 1.086Q or earlier) in which the vulnerability measures are not enhanced. In this case, check the error code and take corrective actions.

For details on error codes, refer to the following:

 MELSEC iQ-R CPU Module User's Manual (Application)

### ■When a user name and a password used in the user authentication function are lost

Initialize the user information, the programmable controller data, and the security keys in the CPU module by performing the following operation.

- Select [Online] ⇒ [User Authentication] ⇒ [Initialize all PLC Data]

Rewrite the user information, the programmable controller data, and security keys (optional) to the CPU module after initialization.

If the power of the CPU is turned OFF and ON or the CPU module was reset, the allocation for the device/label memory is back to the initial status. (Each area has the default capacity.)

## Changing a password

---

The following shows the procedure for changing a password for a CPU module to the one set to a project.

### Operating procedure

Select [Online] ⇒ [User Authentication] ⇒ [Change the Password of PLC]

## Authentication destination setting in the online function

---

The following shows the procedure for selecting either both systems or the connective system as the target of the user authentication when performing the online function.

Only RnPSFCPU support it.

### Operating procedure

Select [Online] ⇒ [User Authentication] ⇒ [Authentication Destination] ⇒ [Both Systems]/[Connective System].

## Logging off from a CPU module

---

The following shows the procedure for logging off from a CPU module.

Only RnPSFCPU support it.

Users can log off from both systems or the connective system.

### Logging off

Log off from a logged on CPU module.

### Operating procedure

Select [Online] ⇒ [User Authentication] ⇒ [Log off from PLC].

### Logging off all users

Log off all users from a logged on CPU module.

### Operating procedure

Select [Online] ⇒ [User Authentication] ⇒ [Log off All Users from PLC].

## Copying user information to the other system

---

The following shows the procedure for copying user information from the CPU module in the connective system to the CPU module in the other system.

Only RnPSFCPU support it.

### Operating procedure

Select [Online] ⇒ [User Authentication] ⇒ [Copy User Information to Other System PLC].

# 15.6 Preventing Illegal Data Reading/Writing (File Password )

To prevent files in a CPU module or SD memory card from being illegally reading and writing, use the file password function.

## File password function

By using this function to register a password for a file in a CPU module or SD memory card, the file reading and writing can be prohibited.

It is possible to prohibit either file reading or writing, or both.

### File

The following table shows the files for which the passwords can be registered.

○: Available, ×: Not available

File name	Availability
System parameter, CPU parameter, module parameter, module extended parameter, memory card parameter	○
Remote password	×
Global label setting	○
Global label assignment information	×
Initial global label value	×
Initial local label value	×
Program file	○
POU (FB file/FUN file)	○
File register	×
Initial device value	○
Common device comment	○
Each program device comment	○
Firmware update prohibited file	○*1
Faulty database check file	×
System file for backing up CPU module data	×
Backup data file for backing up CPU module data	×
Device/label data file for backing up CPU module data	×
System file for the iQ Sensor Solution data backup/restoration function	×
Backup data file for the iQ Sensor Solution data backup/restoration function	×
ODBC server setting file	×
Database path file	×

\*1 A password cannot be registered for a file in an SD memory card inserted in a personal computer.

## Password authentication

By registering a password for a file, password authentication is required when performing an online operation. The following table shows the online operations requiring password authentication.

○: Required, —: Not required



Online operation	Applicability	Password to be set
Reading data from a programmable controller	○	Read-protected password
Writing data to a programmable controller	○	Write-protected password
Performing online change (Online program change, file batch online change)	○	Write-protected password
Verifying data with a programmable controller	○	Read-protected password
Setting a file password (registration/change/authentication/deletion)	○	Read-protected password, write-protected password
Deleting data in a programmable controller	○	Write-protected password
Operating CPU memory (initialization)	—	—

## Precautions

If password authentication fails for a certain number of times, it is rejected (locked out) for a fixed period of time.

## Access from an external device

Password authentication is required when accessing a file with a password in an RCPUCPU by using a function other than one in GX Works3 such as the FTP server function or MC protocol. For details, refer to the following:

Function	Reference
FTP server	 MELSEC iQ-R Ethernet User's Manual (Application)
MC protocol	 MELSEC iQ-R Serial Communication Module User's Manual (Application)

## Considerations

- Keep passwords safe.

When the registered password is lost or the protection of a file to which "Permanent PLC Lock" is set is need to be released, initialize the CPU module (  Page 769 Checking Memory Usage) and write the project newly to the CPU module.



# Procedure for using the file password function

---

## Procedure for making a security enable

### ■CPU module/SD memory card inserted in a CPU module

#### Operating procedure

1. Connect a personal computer and a CPU module. (  Page 557 Specification of Connection Destination)
2. Register a password for a file. (  Page 695 Setting a file password)

### ■SD memory card inserted in a personal computer



#### Operating procedure

Register a password for a file. (  Page 695 Setting a file password)

## Procedure for making a locked file readable/writable

### ■CPU module/SD memory card inserted in a CPU module

#### Operating procedure

1. Connect a personal computer and a CPU module. (  Page 557 Specification of Connection Destination)
2. Obtaining the authentication of the password registered for a file. (  Page 695 Setting a file password)

### ■SD memory card inserted in a personal computer

#### Operating procedure

Obtaining the authentication of the password registered for a file. (  Page 695 Setting a file password)



# Setting a file password

The following operations, password registration, change, authentication, and deletion, can be performed for a file.

Operation	Description
Registration	To register a password for a file to prohibit reading and/or writing. A password registered for a file in the transfer source memory during the boot operation is registered for the file in the file transfer destination memory. A password registered for a file is applied after closing and reopening the project including the file.
Change	To change the password registered for a file.
Authentication	To obtain a password authentication for a file and release the protection of the file temporarily. After password authentication, the file can be read or written until the project is closed. A password can also be authenticated in the "File Password Setting" screen displayed when accessing a file with a password.
Deletion	To delete the password registered for a file.

## Window

### ■CPU module/SD memory card inserted in a CPU module

Select [Project] ⇒ [Security] ⇒ [File Password Setting].

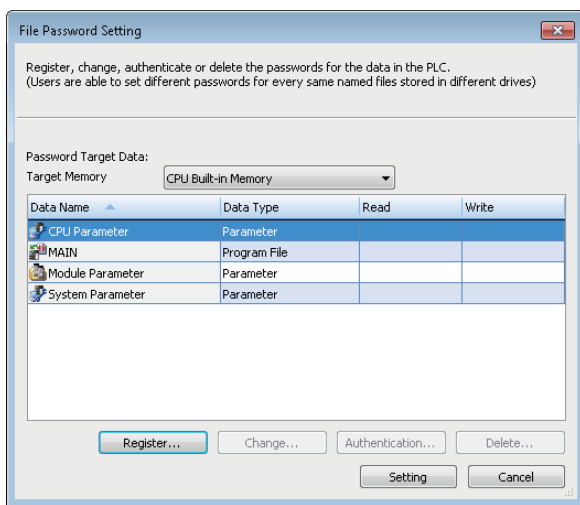

### ■SD memory card inserted in a personal computer

Select [Setting] on the "Memory Card Operation" screen ⇒ [File Password Setting].

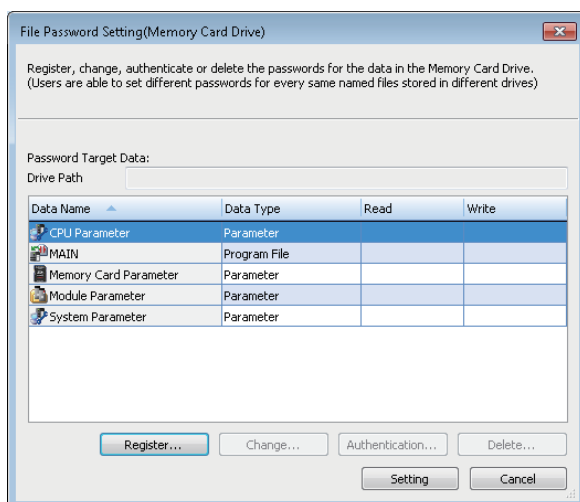

## Operating procedure

1. Select a file and click the [Register]/[Change]/[Authentication]/[Delete] button.
2. Set each item in the displayed screen and click the [Completed] button.
3. Click the [Setting] button on the "File Password Setting" screen.

### ■Protection that cannot be released (FX5CPU)

For a file in an FX5CPU, reading and writing can be prohibited without registering a password. However, the protection cannot be released after prohibiting the operations.

To set the protection, select the checkbox of "Permanent PLC Lock" in the "Register Password" screen.

For applicable files, refer to the following:

☞ Page 692 File

## Precautions

- When a project for an FX5CPU is opened, the password cannot be registered for a file in the SD memory card inserted in a personal computer. In addition, changing or deleting a password and obtaining a password authentication cannot also be performed.
- When registering a password for a file in a CPU module or the SD memory card inserted in a CPU module, connect a personal computer and CPU module in advance.
- Operation that can be performed depends on the safety operation mode of a CPU module.  
Test mode: All operations  
Safety mode: Authentication only
- Both reading and writing can be prohibited for a file by selecting the checkbox of "Permanent PLC Lock" However, if the prohibition has already been set for either one operation, the other one cannot be prohibited later.

# 15.7 Preventing Illegal Access to/Falsification of Data (Security Version)

To prevent an illegal access and falsification to/of the data in a project, use a security version.

## Security version

There are two types of security versions: "1" or "2."

A project password can be registered by setting a security version to "2." By registering a project password, operations can be restricted for a project and the data in a CPU module.

In addition, by setting the security mode to "2," whether the data is falsified can be checked automatically when operating the data.

## Project authentication

The project password authentication is required when performing an operation or function for the following:

- A project in which a security version is set to "2"
- Data written to a programmable controller from a project in which a security version is set to "2"



The following table shows the target functions and operations:

Function/operation	Remarks
Opening a project	—
Project verification	
Reading data from a programmable controller	
Verifying data with a programmable controller	
Reading data from an SD memory card	
Utilizing system parameters	
Utilizing module parameters (safety communication setting)	
Reading a recording file	
Starting offline monitoring	When monitoring a recording file, the authentication screen appears if a project whose security version is '2' is opened.
Project version management	When acquiring a project, the authentication screen appears. The authentication screen also appears if the latest project password does not exist in a local project.

A project password can be registered when setting a security version of a project to "2." (📄 Page 698 When changing a security version from "1" to "2")

# Procedure for using a security version



## When changing a security version from "1" to "2"

1. Select a project in the navigation window, then select [Project] ⇒ [Data Operation] ⇒ [Properties] (  ), or right-click it and select [Properties] (  ) from the shortcut menu.
2. Select "2" for "Security Version" in "Security," and click the [OK] button.
3. Read the displayed message, and click the [Yes] button.
4. Set an administrator password and project password in the "Register Password" screen, then click the [OK] button.



### Point

- An administrator password is used to change a security version from "2" to "1."

## When changing a security version from "2" to "1"

1. Select a project in the navigation window, then select [Project] ⇒ [Data Operation] ⇒ [Properties] (  ), or right-click it and select [Properties] (  ) from the shortcut menu.
2. Select "1" for "Security Version" in "Security," and click the [OK] button.
3. Read the displayed message, and click the [Yes] button.
4. Enter an administrator password in the "Administrator Authentication" screen, then click the [OK] button.

## When changing an administrator password/project password

1. Select a project in the navigation window, then select [Project] ⇒ [Data Operation] ⇒ [Properties] (  ), or right-click it and select [Properties] (  ) from the shortcut menu.
2. Click the [Change Password] button of a password to be changed in "Security."
3. Enter a password in the "Change Administrator Password" screen/"Change Project Password" screen, then click the [OK] button.

## Considerations

### ■ Changing a security version and project password

If a security version and project password are changed, a project will be in the unconverted state.

### ■ Other MELSOFT products

For a project whose security version is '2,' some functions may not be used depending on the version of the following MELSOFT products:

- Motion control setting function
- MELSOFT Navigator
- iQ AppPortal
- GT Designer3
- GENESIS64
- CPU Module Logging Configuration Tool
- GX LogViewer

For details, refer to the manuals or Help of each product.

# 15.8 Restricting Access from Other Than Specific Communication Route (Remote Password)

To restrict the access from other than specific communication route, use the Remote password function.

## Remote password function

When accessing a CPU module via any of the following modules, by setting a password for each communication route, access to the CPU module from an external device without password authentication can be prohibited.

- Ethernet interface module (RJ71EN71)
- Serial communication module
- Built-in Ethernet CPU module
- CC-Link IE TSN module
- CC-Link IE TSN Plus master/local module

For the modules that support remote password setting and details on the remote password setting, refer to the user's manual used.

## Procedure for using the remote password function

### Procedure for making a security enable

1. Set the remote password. (☞ Page 700 Setting remote password)
2. Specify "Remote Password" and write the data to the CPU module. (☞ Page 580 Writing data to a programmable controller)

The access to the CPU module will be restricted.

### Procedure for accessing a locked CPU module

Entering the password is required in order to access the CPU module. The access is permitted when the entered password is correct.

1. Access to the CPU module (writing or reading operation). (☞ Page 580 Writing data to a programmable controller, Page 589 Reading data from a programmable controller)
2. Unlock the remote password by following the message. (☞ Page 700 Setting remote password)

When the entered password is correct, the access to the CPU module will be permitted.

# Setting remote password

The remote password can be set for up to 8 modules. (Up to 8 CPU modules for a multiple CPU configuration)

## Window

Select "Parameter" ⇒ "Remote Password" in the navigation window.

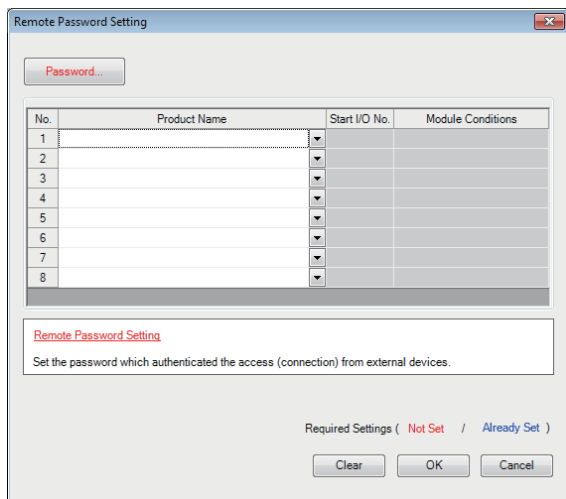

## Operating procedure

1. Click the [Password] button.
2. Set each item in the "Register Password" screen and click the [OK] button.

Item	Description
Product Name	Select the module of which remote connection is to be enabled. For CPU modules integrated network module (such as RnENCPU), select the following to use the CPU part and the network part as a separate module. <ul style="list-style-type: none"><li>• CPU part: CPU Module (Built-in Ethernet Function)</li><li>• Network part: CC-Link IE Built-in Ethernet I/F Module</li></ul>
Start I/O No.*1	Enter the start I/O number*1. (The specification using module labels is applicable.)
Module conditions	Set the remote password to enable/disable for the user connection number or system connection.

\*1 For FX5CPU, "Intelligent Module No." is displayed.

# 16 MODULE DIAGNOSTICS

This function displays the status of modules, networks, and entire system. At the time of error, it displays the error contents and the corrective action.

The diagnostics functions of GX Works3 are as follows:

Function	Reference
System monitor	Page 702 Module Status Check of a System
Sensor/device monitor	Page 705 Sensor/Device Status Check
Recording monitor	Page 707 Recording Status Check
Module diagnostics	Page 708 Module Diagnostics
Network diagnostics	Page 714 Ethernet diagnostics
	Page 715 CC-Link IE Controller Network diagnostics
	Page 717 CC-Link IE TSN/CC-Link IE Field Network diagnostics
	Page 719 CC-Link IE Field Network Basic diagnostics
	Page 720 MELSECNET diagnostics
	Page 721 CC-Link diagnostics
	Page 722 Simple CPU communication diagnostics

# 16.1 Module Status Check of a System

The system monitor function displays the module configuration of the system in operation and detailed information of each module.

In addition, the error status can be checked and the module in which the error occurred can be diagnosed.

## Window

Select [Diagnostics] ⇒ [System Monitor].

**Ex.**  
RCPU

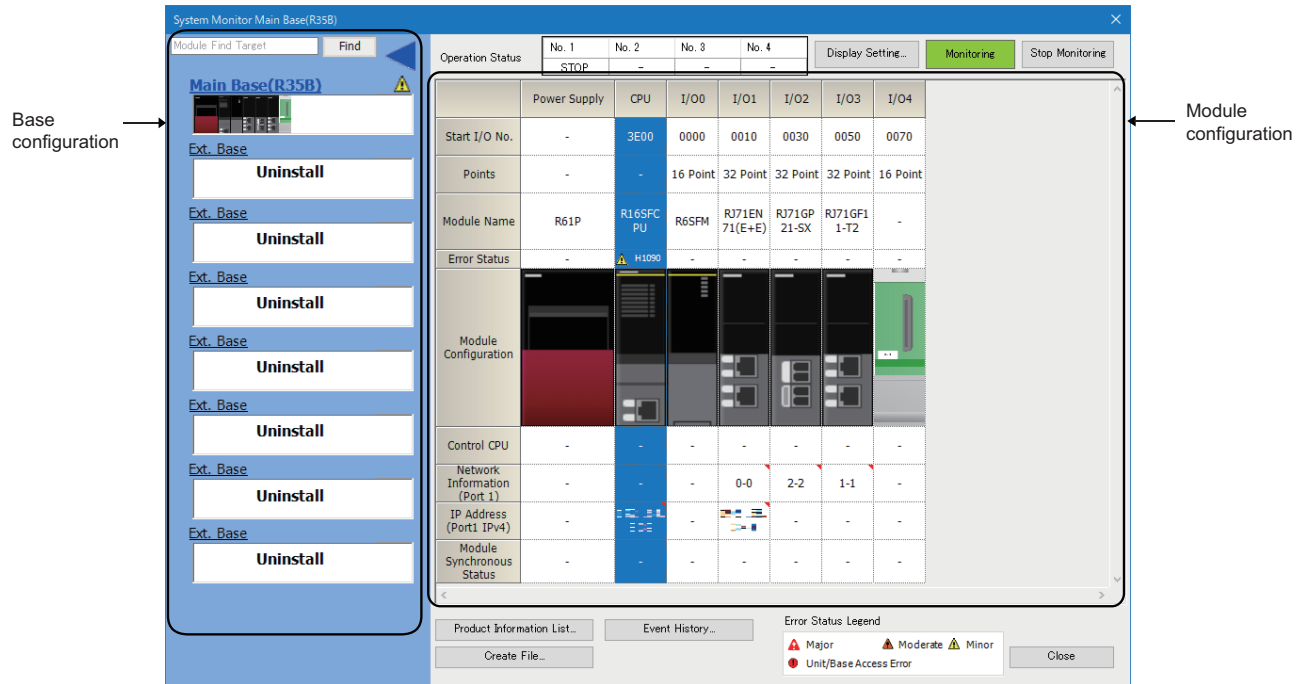

### ■Display setting

Click the [Display Setting] button for the following operations:

- Displaying the network information and IP address of port 2 of a module having two ports
- Switching the display format of an error code

### ■Contents not displayed

Some contents are not displayed depending on the module series. The following table shows undisplayed contents for each series.

Series	Contents not displayed
MELSEC-Q, MELSEC-L, and MELSEC-iQ-L	Module name of a power supply module
MELSEC-Q	Network information and IP address of each module
MELSEC-L	Control CPU, port 1 IP address, port 2 network information, and port 2 IP address of each module
MELSEC-iQ-L	Control CPU, port 2 network information, and port 2 IP address of each module



## ■When '?' appears on the image of a module

'?' appears on the image of a module when the connected module is in the following statuses.

- A connected module is broken.
- The mounting status differs from the I/O assignment setting of the system parameter.
- The control CPU is not mounted.
- A profile is not registered.

For the following modules, '?' may appear on their images depending on their operating statuses:

- MELSEC-Q series module used in a MELSEC iQ-R series system
- MELSEC-L series module used in a MELSEC iQ-L series system

## ■Redundant system configuration

When a CPU module in a redundant system configuration is used, the following items are displayed in the base unit configuration.

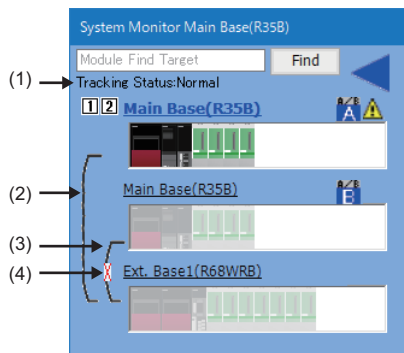

No.	Item	Description
(1)	Tracking Status	Any of the following statuses is displayed: <ul style="list-style-type: none"> <li>• Normal</li> <li>• Error</li> <li>• Copying memory</li> <li>• Copying memory completed</li> <li>• Failed to copy memory</li> </ul>
(2)	Extension cables (connection routes) <sup>*1</sup>	The extension cable connected to 'IN1' of a redundant extension base unit is displayed.
(3)		The extension cable connected to 'IN2' of a redundant extension base unit is displayed.
(4)	Connection status <sup>*1</sup>	The connection status of an extension cable is displayed as follows: <ul style="list-style-type: none"> <li>• Solid line: active</li> <li>• Dotted line: not active</li> <li>• × : error</li> </ul>

\*1 Displayed only when a redundant extension base unit and main base unit are connected with extension cables.

### Point

When a redundant extension base unit is used, the connection routes of extension cables connected to the base unit and their status can be displayed in the "Product Information List" screen by clicking the [Product Information List] button.

## Precautions

- If the number of extension base units is set incorrectly, the base unit configuration will not be displayed in the order of the connection.
- For a CPU module in a redundant system configuration, the connected destination is switched at the time of selecting a base unit, which is used for the other system, regardless of the contents in the connection destination setting. Therefore, if the other system is selected in the system monitor, functions that are not supported by the other system cannot start.
- If a redundant extension base unit is not connected to a main base unit when the power of a CPU module is turned ON, the base unit will not be displayed.
- If communication with a redundant extension base unit cannot be established when the power of a CPU module is turned ON, the base unit will be displayed as unmounted module. In addition, (Unit/Base Access Error) will be displayed for an unmounted module only when a personal computer is connected to a CPU module in the control system.

## Automatic diagnostics function

This function starts up the system monitor function automatically when connecting CPU module and a personal computer by USB connection.

Set whether to start up automatically on the task tray.

FX5UCPUs and FX5UCCPUs do not support this function.

## Check of the module firmware version and product information

The firmware version and product information can be checked in the "Product Information List" screen which is displayed after [Product Information List] button is clicked.

## File creation function

Information displayed on the system monitor can be output to a CSV file.

## Check of the specification method for a network No., station No., and IP address

Whether the IP address change function is used for a network number, station number, and IP address can be checked on the tooltip.

The tooltip appears by placing the mouse cursor on each item in the "Network Information" and "IP Address" columns.

For details on the IP address change function, refer to the following:

 MELSEC iQ-R Ethernet User's Manual (Application)

## 16.2 Sensor/Device Status Check

The status and the current value of a sensor/device connected to a network can be displayed.

Supported network: Ethernet (CPU module), AnyWireASLINK, CC-Link IE Field Network, CC-Link

### Window

1. Select [Diagnostics] ⇒ [Sensor/Device Monitor].
2. Select a master module or master station in the "Module Selection (Sensor/Device Monitor)" screen, and click the [OK] button.

The following image is a screen example displayed when selecting a master station in CC-Link IE Field Network.

No.	Model Name	Station Type	RX/RX Setting			RWw/RWr Setting			Refresh Device			
			Points	Start	End	Points	Start	End	RX	RY	RWw	RWr
0	Host Station	Master Station										
1	RJ71GF11-T2	Local Station	32	0000	001F	16	0000	000F	X1000 (16 points)	Y1F60 (32 points)	W300 (16 points)	W1300 (16 points)

Link Device	Current Value
RX0	OFF(0)
RX1	OFF(0)
RX2	OFF(0)
RX3	OFF(0)
RX4	OFF(0)
RX5	OFF(0)
RX6	OFF(0)
RX7	OFF(0)
RX8	OFF(0)

16

### Operating procedure

Select a target device supporting iQSS to be monitored in the list of stations (1) or the device map area (2) of the sensor/device monitor screen.

The status of a selected device supporting iQSS is displayed in the "Monitoring Information" window (3).

#### Point

- Check the error status of a device supporting iQSS by using the network diagnostics function.
- The sensor/device monitor function reads a large volume of information from a CPU module at once. Therefore, the processing speed of the sensor/device monitor function may decrease depending on the set communication route.

### Precautions

When a MELSEC-Q/L series network module is included in a communication route, the sensor/device monitor function cannot be started for the following modules:

- Built-in Ethernet CPU
- CC-Link IE Field Network module

## Checking the status of a sensor/device connected to a bridge module

To check the status of a sensor/device connected to a CC-Link IE TSN-AnyWireASLINK bridge module, the sensor/device monitor screen can be displayed by the following procedure:

FX5CPUs do not support this screen.

### Operating procedure

1. Select [Diagnostics] ⇒ [CC-Link IE TSN/CC-Link IE Field Diagnostics].
2. Select a CC-Link IE TSN-AnyWireASLINK bridge module in the "CC-Link IE TSN/CC-Link IE Field Diagnostics" screen.
3. Right-click it, and select [AnyWireASLINK Sensor/Device Monitor] from the shortcut menu.

For details, refer to the following:

 iQ Sensor Solution Reference Manual

# 16.3 Recording Status Check

The operating status of the recording function can be displayed.

In addition, data can be collected and saved as a recording file by using the recording function.

For details, refer to the following:

📖 MELSEC iQ-R System Recorder User's Manual (Application)

RnCPUs (R04CPU, R08CPU, R16CPU, R32CPU, and R120CPU), RnENCPU, and RnSFCPU support this monitoring.

## Window

Select [Diagnostics] ⇒ [Recording Monitor].

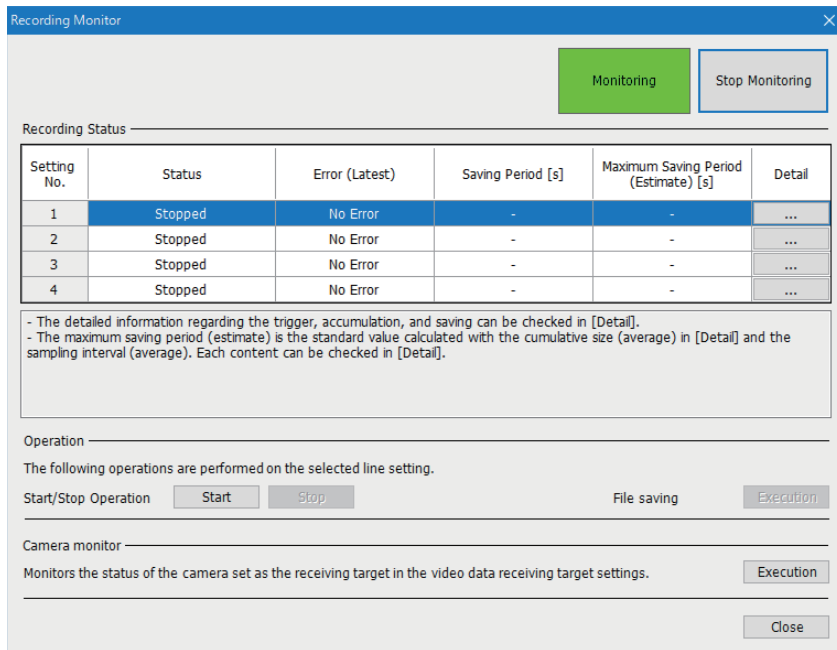

# 16.4 Module Diagnostics

This section explains the method for displaying the module status and the error information.

When using an FX5CPU, the FX5CPU and the following modules can be diagnosed.

- FX5-20PG-P, FX5-20PG-D, FX5-ENET, FX5-ENET/IP, FX5-CCLGN-MS, FX5-SF-MU4T5, FX5-SSC-G(S), FX5-OPC

When using an LHCPU, the following modules cannot be diagnosed.

- L6EXB, L6EXE, L6EC, L6EC-ET

## Window

### ■CPU module and remote head module diagnostics

Select [Diagnostics] ⇒ [Module Diagnostics (CPU Diagnostics)].

In both a CPU module and a remote head module in a redundant system configuration, a module specified as the current connection destination is diagnosed. When diagnosing the other system, change the connection destination or specify the module to diagnose on the system monitor.

### ■I/O module and intelligent function module diagnostics

Select the module to be diagnosed from the module configuration of the "System Monitor" screen and double-click one of the cells on the same column to display the "Module Diagnostics" screen.

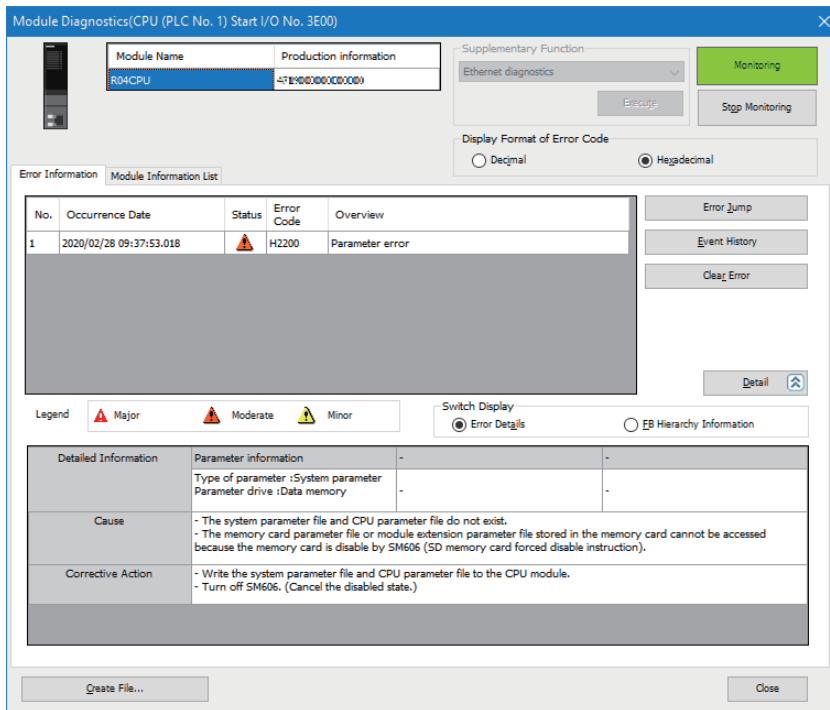

## Precautions

Monitoring stops if a program in the project is converted. When the conversion completed, the monitoring resumes.

# Error information

Information of errors registered in a diagnostics target module is displayed in the [Error Information] tab.

## Window

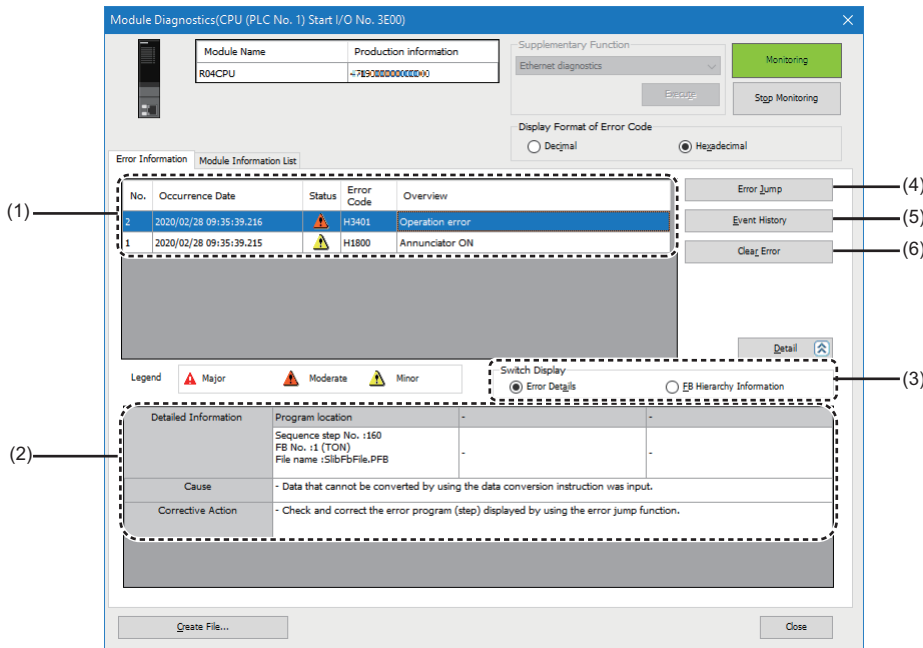

## Displayed items

Item	Description
(1) Error list	Current error information is displayed in a list. Displayed error information differs depending on the module. • CPU module: Information of up to 16 current errors are displayed in the order of occurrence. The one of the 17th and succeeding errors are not displayed.*1 • Other than CPU module: Information of up to 16 most recent current errors are displayed.
(2) Detailed information	Detailed information of an error selected in the error list is displayed. Displayed contents are switched according to the item selected in the "Switch Display."
(3) Switch Display*2	Error Details Select this to display the detailed information, cause, and corrective action on the error in the detailed information field. (Page 710 Error detailed information)
	FB Hierarchy Information Select this to display the FB hierarchy information of the function block with the error in the detailed information field. (Page 711 FB hierarchy information)
(4) [Error Jump] button	Click this to jump to the following locations (Page 713 Error jump): • Location in which the error selected in the error list or the detailed information field (Error Details) has occurred • Jump destination of the row selected in the detailed information field (FB Hierarchy Information)
(5) [Event History] button	Click this to display the error information and operation history of the module, and the system information history. (Page 723 Error History/Operation History Check)
(6) [Error Clear] button	Click this to clear all the current errors in a batch. In addition, the error information is deleted from the error list.*3 If all the errors are cleared, an LED indicating the error status, which is on the front of the module, turns OFF.

\*1 For a MELSEC-Q/L series module, '-' is displayed in "Occurrence Date," "Status," and "Detailed Information."

\*2 Displayed only when diagnosing an RnCPU, an RnENCPU, or an RnPCPU.

\*3 For a MELSEC-L series module, error information cannot be deleted.

## Precautions

- The occurrence date depends on the time zone selected in "Clock Related Setting" of "Operation Related Setting" of "CPU parameter." Therefore, the time shown in the screen may be different from the one on the personal computer in use.
- If a same error with error code has occurred which has already been displayed, then display content will not be updated.

## Error detailed information

When "Error Details" is selected for "Switch Display," the detailed information, the cause, and the corrective action on the error are displayed in the detailed information field.

By clicking the [Error Jump] button after selecting any of the items, the cursor jumps to the location in which the error has occurred.

### Ex.

An display example of the detailed information field for the following error is as shown below:

- Error Code: H3401
- Overview: Operation Error

Detailed Information	Program location	-	-
	Sequence step No. :160 FB No. :1 (TON) File name :SlibFbFile.PFB	-	-
Cause	- Data that cannot be converted by using the data conversion instruction was input.		
Corrective Action	- Check and correct the error program (step) displayed by using the error jump function.		

## Displayed items

Item		Description
Detailed Information	Error location information*1	Information on the location in a program, such as a step No., is displayed.
Cause		The error cause is displayed.
Corrective Action		The corrective action for the error code is displayed.

- \*1 Displayed items differ depending on the error code.  
If there is no detailed information, "-" is displayed in each item.  
For details on error codes, refer to the user's manual of each module.



## FB hierarchy information

FB hierarchy information expresses the order of the data calling function blocks by hierarchies in a program in which a function block is called from another function block.

FB hierarchy information of the function block with an error is displayed in the detailed information field by selecting "FB Hierarchy Information" for "Switch Display."

By selecting a row and clicking the [Error Jump] button or double-clicking the row, the cursor can jump to the jump destination of the selected row.

By selecting this item, the calling sources of a function block with an error can be displayed in a list. Therefore, the cursor can jump to the sources, which makes it easier to specify the error cause.

FX5CPUs do not support this information.

The following figures show an display example of FB hierarchy information.

### Ex.

When 'FbPou2' is called from 'ProgPou,' 'FbPou3' from 'FbPou2,' and any of the following function blocks from 'FbPou3':

- Function block: FbPou4

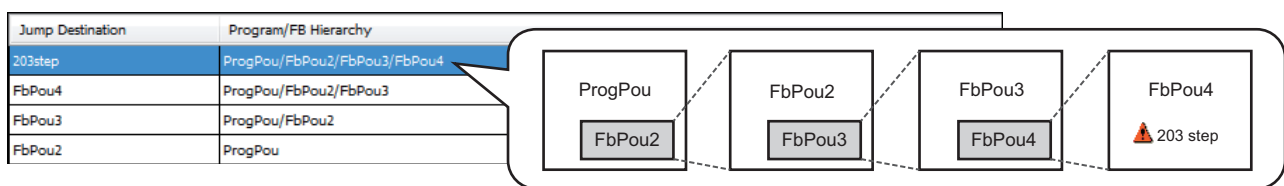

- Standard function block: TON\_1

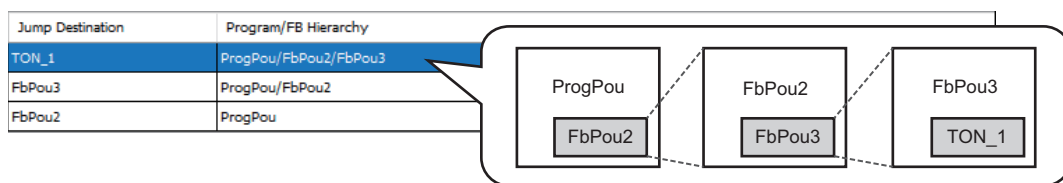

## Displayed items

Item	Description	
Jump Destination	First row	The step No. of the location in which an error has occurred is displayed. If the error has occurred in a standard function block, its FB instance name is displayed.
	Second and later rows	The FB instance name of either of the following function blocks is displayed. <ul style="list-style-type: none"> <li>• Function block in which a ladder of the step No. in the first row exists</li> <li>• Function block calling the function block displayed in the one row above</li> </ul>
Program/FB Hierarchy	The FB hierarchy information of the function block with an error is displayed. FB hierarchy information is displayed separately for each jump destination.	

## Precautions

- Whether or not FB hierarchy information can be displayed depends on the firmware of a CPU module. For information on the firmware versions with which the FB hierarchy information can be displayed, refer to the following:  
📖 MELSEC iQ-R CPU Module User's Manual (Application)
- When diagnosing a module other than the host CPU module in a multiple CPU system, FB hierarchy information cannot be displayed. ("FB Hierarchy Information" cannot be selected for "Switch Display.")
- When clearing an error by either of the following operations, its FB hierarchy information display is also cleared:
  - Clicking the [Error Clear] button in the module diagnostics screen
  - Turning SM50 (error reset) ON
- FB hierarchy information can be displayed only when an error has occurred in the following data:
  - Function
  - Standard function block
  - Subroutine type function block
  - Macro type function block called from a subroutine type function block
- When an error has occurred in the function block called from an interrupt program or a subroutine program, the FB hierarchy information from the program to the function block with the error is displayed.
- In the following cases, FB hierarchy information may not be displayed or the cursor may not jump to the location from which a function block is called:
  - Contents of a project opened in GX Works3 are different from the ones written in a CPU module.
  - The block password or security key for a program written in a CPU module is not authenticated.
  - An error has occurred in the instruction using a bit device which automatically turns ON at the processing completion as an argument, or in the one used by a system interrupt (PLSY instruction or PWM instruction, for example).
  - An error has occurred in the function called from an interrupt program or a subroutine program.
- FB hierarchy information can be displayed only in the module diagnostics screen of GX Works3.  
Even when diagnosing a CPU module with the web server function (CPU diagnostic), the FB hierarchy information is not displayed in the system web page.

## Error jump

The cursor jumps to the following locations by clicking the [Error Jump] button.

- Location in which the error selected in the error list or the detailed information field (Error Details) has occurred
- Jump destination of the row selected in the detailed information field (FB Hierarchy Information)

The cursor can jump to programs, function blocks, and parameters only.

However, it cannot jump to some parameters. The parameters to which it can jump differ depending on the module.

For an inline structured text program in a ladder editor, the cursor will jump to the head line of the inline structured text program regardless of the line that error occurs.

## Precautions

### ■ Jump destination

In the following conditions, an error may not be found at the jump destination.

- When the open project does not match with the data on the CPU module.
- When diagnosing programmable controller other than the one set as a connection destination in the project.

When the cursor jumps to the output argument (2) connected to the macro type function block (1), an error may actually exist not in the output argument (2) but in the macro type function block (1).

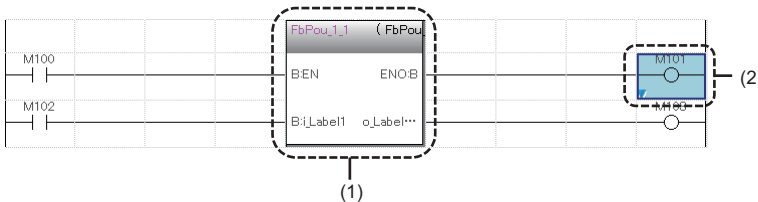

### ■ Program file with the process control extension enabled

When an error occurs in the system data such as the system header or system footer created in a program file with the process control extension enabled, the cursor will not jump to that data.

If an error occurs, it may be due to any of the following option settings. Check the setting contents.

- The module which has been set in "Convert" ⇒ "Process Control Extension Setting" ⇒ "Event Notification" does not exist or the setting contents is not correct.
- The capacity in the range of the file register which has been set in "Convert" ⇒ "Process Control Extension Setting" ⇒ "System Resource" ⇒ "File Register: ZR" exceeds that of the file register which has been set in "File Register Setting" of "CPU Parameter."

## Module information list

The current LED information and switch information of a target module are displayed in the [Module Information List] tab.

# 16.5 Network Diagnostics

This section explains the method to diagnose various networks.

## Ethernet diagnostics

Check the status of each connection, status of each protocol, and connection status.

For details, refer to the following:

- MELSEC iQ-R Ethernet User's Manual (Application)
- MELSEC iQ-F FX5 User's Manual (Ethernet Communication)
- MELSEC iQ-F FX5-ENET User's Manual

### Window

Select [Diagnostics] ⇒ [Ethernet Diagnostics].

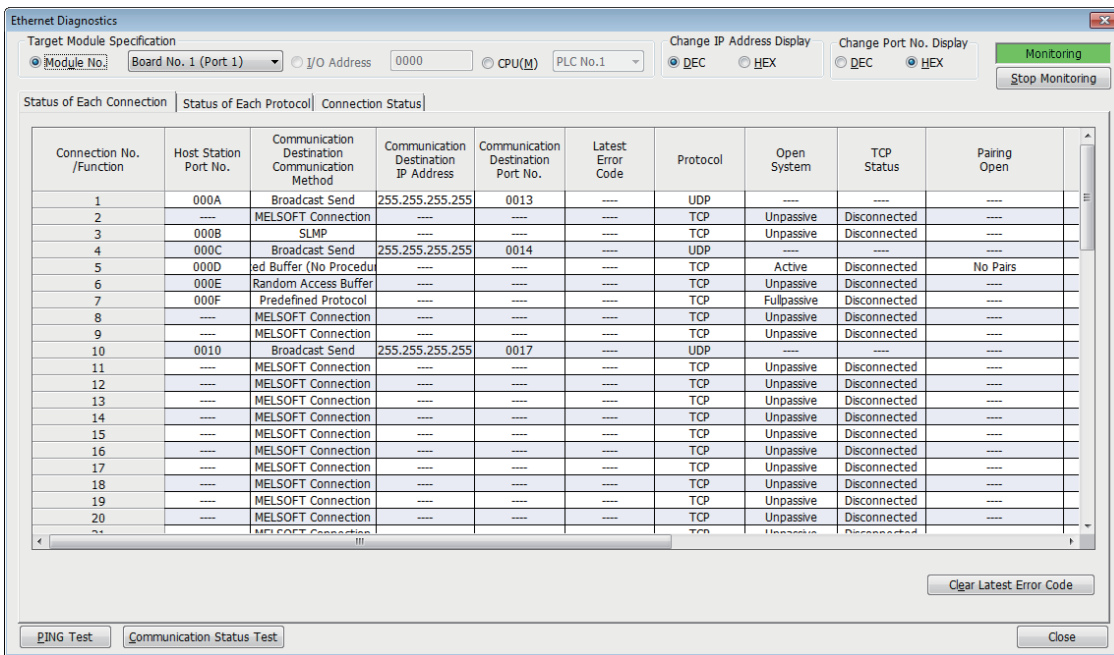

### Precautions

When an Ethernet interface module (LJ71E71-100) is used in a system of an LHCPU, do not perform a diagnosis in GX Works3 Version 1.090U or earlier. Otherwise, GX Works3 may not operate properly.

# CC-Link IE Controller Network diagnostics

A network status can be monitored, diagnosed, and tested.

For details, refer to the following:

📖 MELSEC iQ-R CC-Link IE Controller Network User's Manual (Application)

LHCPUs, FX5CPUs, and remote head modules do not support this function.

## Window

### ■Optical cable

Select [Diagnostics] ⇒ [CC-Link IE Control Diagnostics (Optical Cable)].

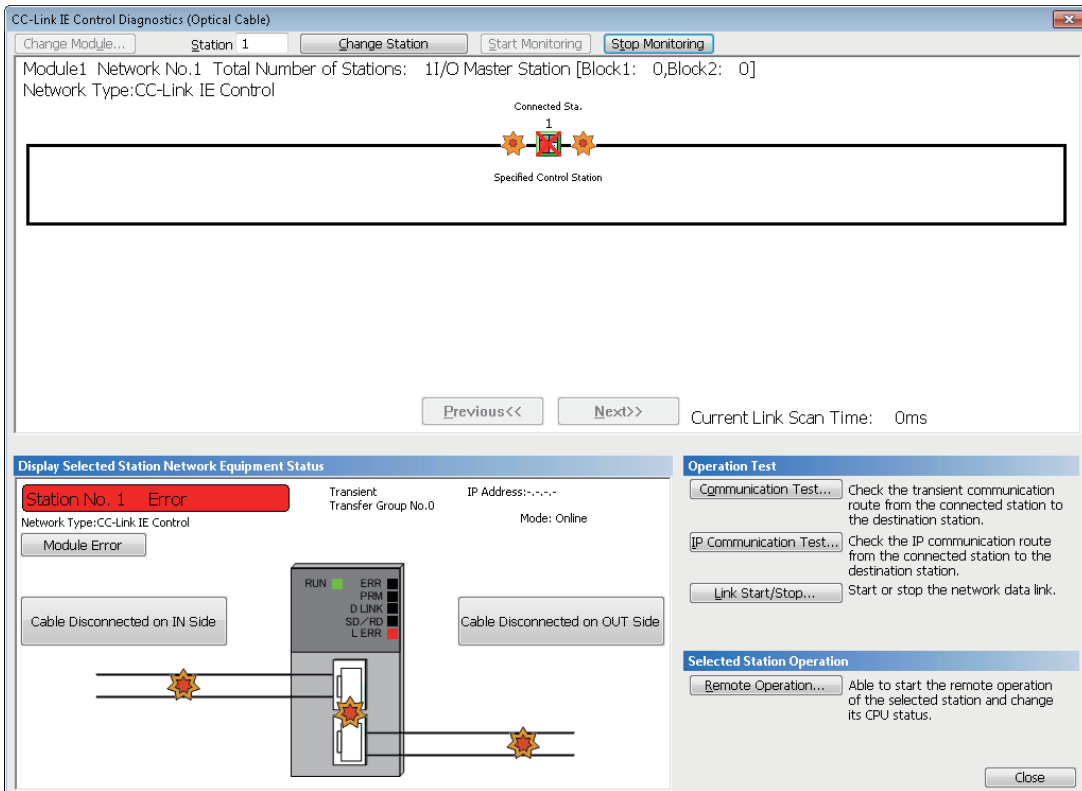

## ■ Twisted pair cable

Select [Diagnostics] ⇒ [CC-Link IE Control Diagnostics (Twisted Pair Cable)].

The screenshot displays the 'CC-Link IE Control Diagnostics (Twisted Pair Cable)' software window. The interface is divided into several sections:

- Select Diagnostics Destination:** Shows 'Module 1 (Network No. 1)' and 'Station No. 1' selected.
- Network Status:** Displays network parameters: Total No. of Stations (Parameter) 120, Total No. of Stations (Connected) 3, Current Link Scan Time 2 ms, Number of Station Errors Detected 0, and Constant Link Scan Setting Value 0 ms. It also shows I/O Master Station Block 1 and Network Type CC-Link IE Control.
- Monitor Status:** Includes 'Monitoring' buttons (Start Monitoring, Stop Monitoring) and a 'Delete Disconnected Station' button.
- Connected Sta.:** A network diagram showing 'Specified Control Sta. P1' connected to 'Normal Sta.:3' and 'Normal Sta.:2'. A 'Data Unlinked' list on the right shows 'Sta. No. 4', 'Sta. No. 5', and 'Sta. No. 6'.
- Selected Station Communication Status Monitor (RJ71EN71):** Shows 'Sta. No. 1' with 'No Error' and 'Mode: Online'. It lists 'Network Type: CC-Link IE Control' and 'Transient Transfer Group No.: 0'. A status panel includes indicators for RUN, EFR, NST/PRM, D/LNK, SD/RO, and IEG/P EFR.
- Operation Test:** Contains buttons for 'Communication Test...', 'IP Communication Test...', 'Cable Test...', and 'Link Start/Stop...' with corresponding descriptions.
- Selected Station Operation:** Includes a 'Remote Operation...' button with a description of changing CPU status.

A 'Close' button is located at the bottom right of the window.

# CC-Link IE TSN/CC-Link IE Field Network diagnostics

A network status can be monitored, diagnosed, and tested.

For details, refer to the following:

- 📖 MELSEC iQ-R CC-Link IE Field Network User's Manual (Application)
- 📖 MELSEC iQ-F FX5 User's Manual (CC-Link IE)
- 📖 MELSEC iQ-R CC-Link IE TSN User's Manual (Application)
- 📖 MELSEC iQ-R CC-Link IE TSN Plus Master/Local Module User's Manual
- 📖 MELSEC iQ-F FX5 User's Manual (CC-Link IE TSN)
- 📖 MELSEC iQ-R Motion Module User's Manual (Network)
- 📖 MELSEC iQ-F FX5 Motion Module User's Manual (CC-Link IE TSN)
- 📖 CC-Link IE TSN—CC-Link IE Field Network Bridge Module User's Manual

## Window

Select [Diagnostics] ⇒ [CC-Link IE TSN/CC-Link IE Field Diagnostics].

Ex.

CC-Link IE Field Network

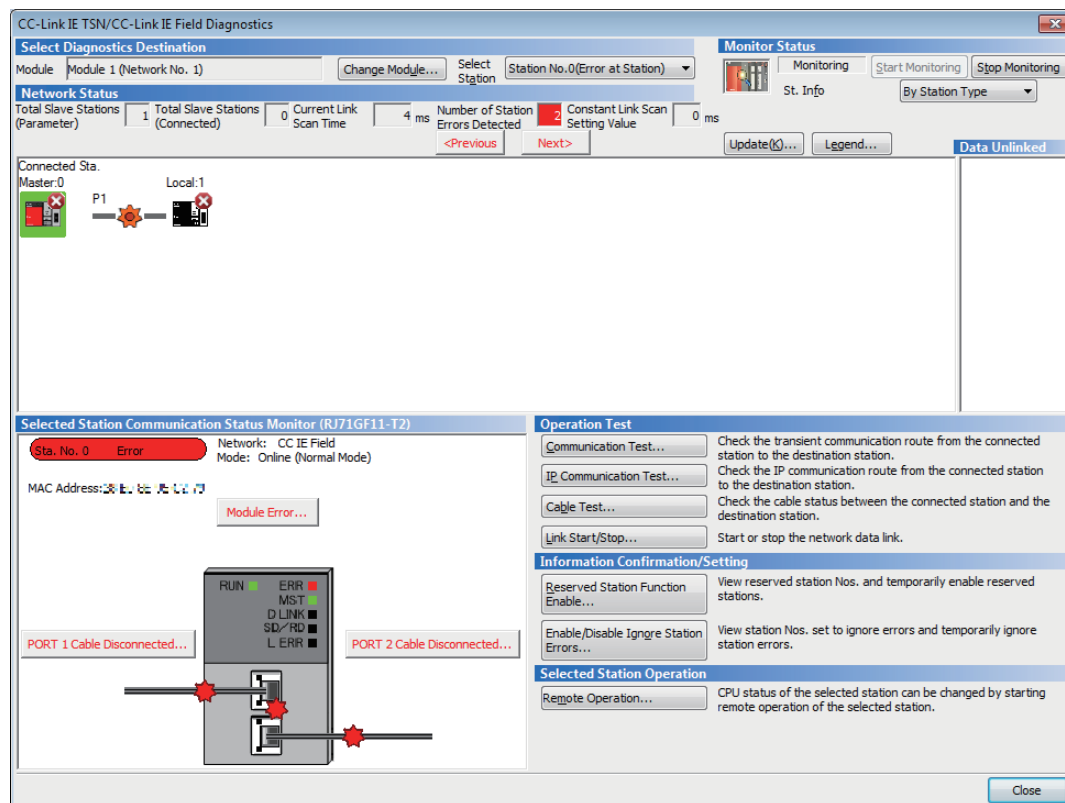

## ■Displaying product information

The product information of a module can be checked by the following operation.

- Select and right-click a module, and select [Production Information] from the shortcut menu.

Note that this function cannot be used when a selected module does not support displaying the product information or an error occurs on a connected station.

For details, refer to the manual of each module.

## ■Displaying an error history

An error history in a device station can be checked by the following operation.

- CC-Link IE TSN diagnostics: Select and right-click a module, then select [Error/Event History] from the shortcut menu.
- CC-Link IE Field diagnostics: Select and right-click a module, then select [Error History] from the shortcut menu.

This function is available only when a remote device station or intelligent device station which can read an error history is selected.

## ■Displaying the sensor/device monitor screen

The sensor/device monitor screen can be displayed by the following operation. (For a CC-Link IE TSN-AnyWireASLINK bridge module only)

FX5CPUs do not support this screen.

- Select and right-click a CC-Link IE TSN-AnyWireASLINK bridge module in the CC-Link IE TSN Diagnostics screen, then select [AnyWireASLINK Sensor/Device Monitor] from the shortcut menu.

For details, refer to the following:

 iQ Sensor Solution Reference Manual

## ■Displaying the CC-Link IE Field Diagnostics screen

The CC-Link IE Field Diagnostics screen can be displayed by the following operation. (For CC-Link IE TSN-CC-Link IE Field Network bridge modules only)

RnPCPUs, RnPSFCPUs, LHCPUs, and FX5CPUs do not support this screen.

- Select and right-click a CC-Link IE TSN-CC-Link IE Field Network bridge module in the CC-Link IE TSN Diagnostics screen, then select [CC-Link IE Field Diagnostics] from the shortcut menu.

For details, refer to the following:

 CC-Link IE TSN—CC-Link IE Field Network Bridge Module User's Manual

## ■Considerations

When a CC-Link IE Field Network master/local module (LJ71GF11-T2) is used in a system of an LHCPU, do not perform a diagnosis in GX Works3 Version 1.090U or earlier. Otherwise, GX Works3 may not operate properly.



# CC-Link IE Field Network Basic diagnostics

Monitoring and diagnosing of network status can be performed.

For details, refer to the following:

CC-Link IE Field Network Basic Reference Manual

RnCPUs, RnENCPU, LHCPUs, FX5CPUs, and FX5-ENET support this function.

## Window

Select [Diagnostics] ⇒ [CC-Link IEF Basic Diagnostics].

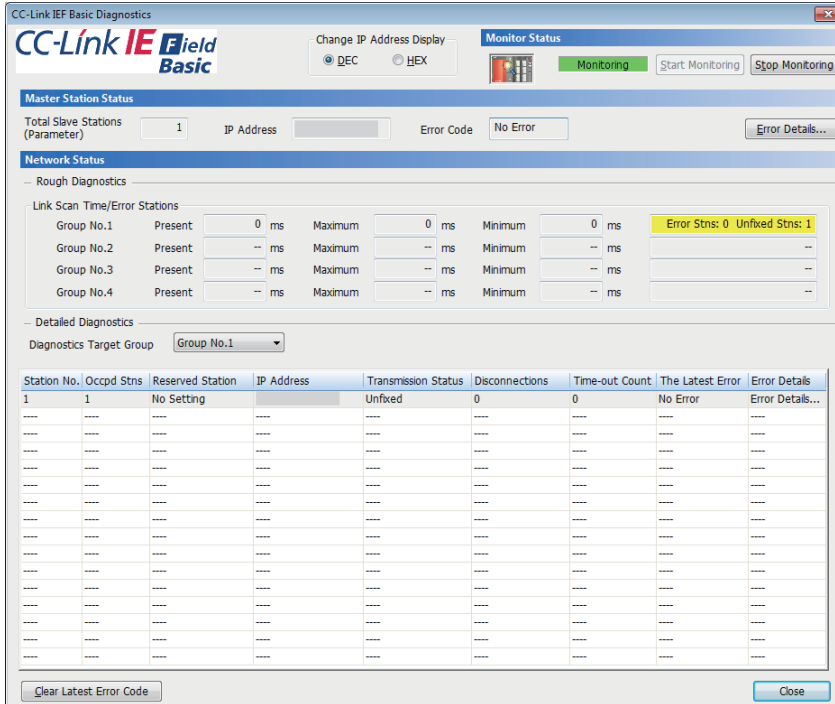

# MELSECNET diagnostics

A network status of each station can be monitored, diagnosed, and tested.

Considerations for using MELSECNET/H network module when performing the MELSECNET diagnostics, refer to the following manual.

 MELSEC iQ-R Module Configuration Manual

For the operation methods, refer to the following:

 MELSEC iQ-R MELSECNET/H Network Module User's Manual (Application)

RnPSFCPU, LHCPUs, FX5CPUs, and remote head modules do not support this function.

## Window

Select [Diagnostics] ⇒ [MELSECNET Diagnostics].

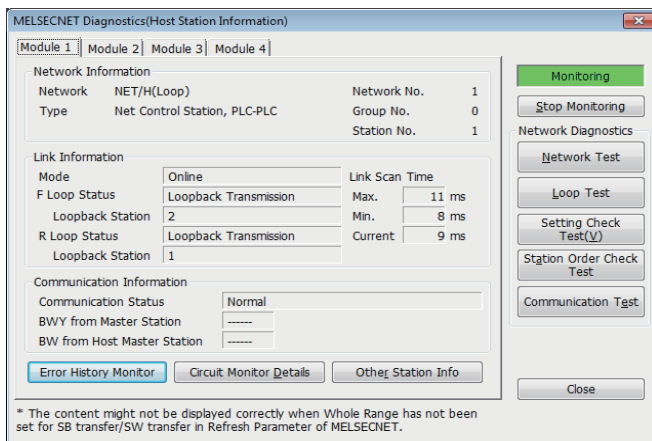

# CC-Link diagnostics

A network status of each station can be monitored, diagnosed, and tested.

For details, refer to the following:

📖 MELSEC iQ-R CC-Link System Master/Local Module User's Manual (Application)

📖 MELSEC iQ-F FX5 User's Manual (CC-Link)

## Window

Select [Diagnostics] ⇒ [CC-Link Diagnostics].

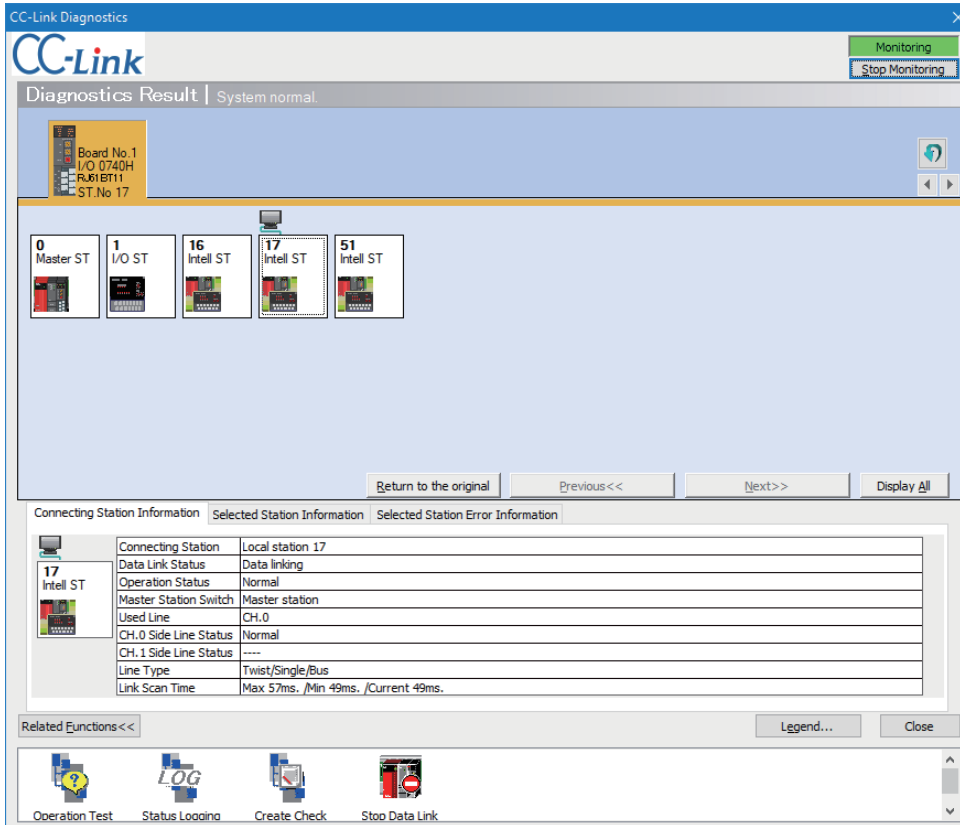

# Simple CPU communication diagnostics

A network status can be diagnosed.

For details, refer to the following:

MELSEC iQ-R Ethernet User's Manual (Application)

MELSEC iQ-F FX5 User's Manual (Ethernet Communication)

## Window

Select [Diagnostics] ⇒ [Simple CPU Communication Diagnostics].

The screenshot displays the 'Simple PLC Communication Diagnostics' window. At the top, the 'Host Station Status' section shows 'Number of Settings' as 1 and 'IP Address' as 192.168.3.39. The 'Target Module Specification' section has 'CPU(M)' selected. The 'Monitor Status' section includes a green 'Monitoring' button. The central table, 'Communication Destination Network Status', has the following columns: Set No., Comm Path, Comm Set, Comm Dest, Status, IP Address, Port No., Tgt. PLC No., Exe Intvl[ms](Prnt), Exe Intvl[ms](Max), Exe Intvl[ms](Min), Norm Compl, Err Compl, Retries, Latest Err, and Err Det... The first row shows Set No. 1, Comm Path Read, Comm Set Fixed Intrvl, Comm Dest ----, Status Prepg, IP Address 10.97.19.111, Port No. ----, Tgt. PLC No. Not Spec, and various timing and completion values of 0. Below the table is a 'Clear Latest Error Code' button on the left and a 'Close' button on the right.

# 16.6 Error History/Operation History Check

The module's error information, history of operation, and system information can be displayed using the event history function. The detailed information of the error history can be displayed when a CPU module and an intelligent function module supports the module error history collection function.

For the versions of modules that support this function, refer to the user's manual of each module.

## Window

Select [Diagnostics] ⇒ [Module Diagnostics (CPU Diagnostics)] or [System Monitor], and click the [Event History] button.

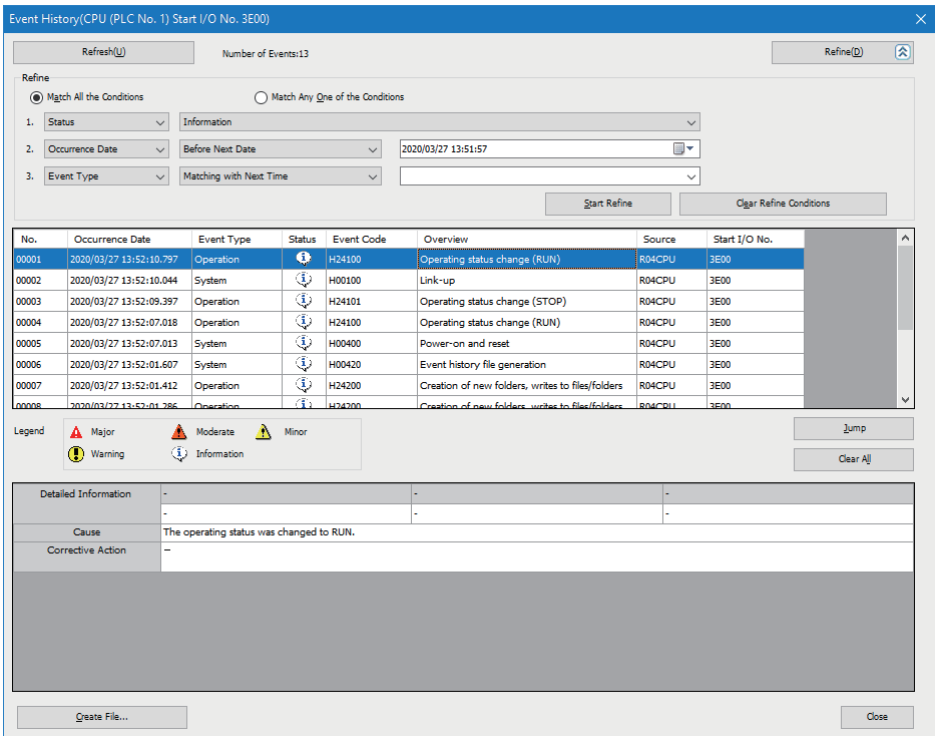

For MELSEC-Q/L series modules, '-' is displayed in the "Status" column.

## Operating procedure

### ■Event history refinement

1. Select either "Match All the Conditions" or "Match Any One of the Conditions."
2. Set the conditions.
3. Click the [Start Refine] button.

**Ex.**

Display an event of the major error that occurred between 9:00 am and 12:00 pm in April 4th

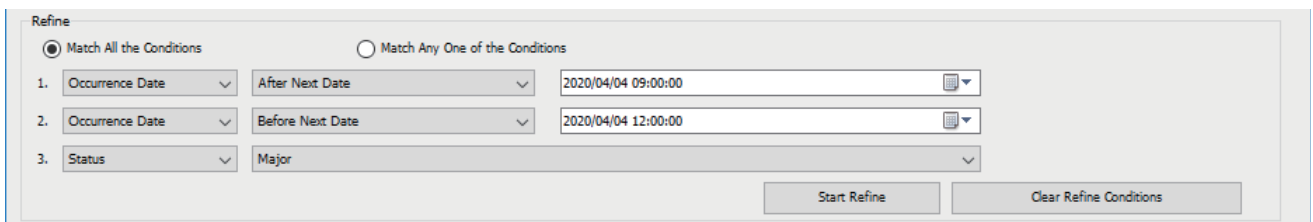

## ■ Jump to a location in which an error occurred

Click the [Jump] button.

Target items are a program, function block, and each parameter.

## ■ Event history clearing

Click the [Clear All] button.

All event histories are deleted.

## Precautions

- The occurrence date on the event history depends the time zone selected in "Clock Related Setting" of "Operation Related Setting" of "CPU parameter." Therefore, the time shown in the screen may be different from the one on the personal computer in use.
- The event, success to lock/unlock the remote password, is registered more than once when performing any of the following operations for a CPU module for which a remote password has been set; writing/reading data to/from a programmable controller or diagnosing the CPU module.
- If the entire information is not displayed in "Detailed Information," check it in the tooltip.  
The tooltip can be displayed by mouse-overing each item in "Detailed Information."
- When changing a current value of a label, an event recorded in a module differs depending on the product (GX Works3 or external device) used for changing the value.

The following table shows an event recorded in a module and contents displayed in the "Event History" screen for each product used:

Product used for changing a current value	Recorded event	Content displayed in the "Event History" screen
GX Works3 Version 1.065T or later	Modify value event for a label	Program name Label name Device/label memory assigned to a label
GX Works3 Version 1.063R or earlier External device	Modify value event for a device	Program name Device/label memory assigned to a label

For the label memory types, refer to the following:

 Page 898 Label Memory Types

For details on events, refer to the following:







 MELSEC iQ-R CPU Module User's Manual (Application)

 MELSEC iQ-F FX5 User's Manual (Application)

# 17 COLLECTING/REPRODUCING DATA

This chapter shows the methods for collecting and reproducing data by using the memory dump function, data logging function, and recording function.

The functions to collect and reproduce data are shown in the following table.

Function name	Overview	Reference
Memory dump	To save device values in a CPU module to a personal computer at any timing.	Page 726 Memory Dump Function  MELSEC iQ-R CPU Module User's Manual (Application)  MELSEC iQ-F FX5 User's Manual (Application)
Data logging	To collect data in a CPU module at a specified interval or any timing.	Page 730 Data Logging Function  MELSEC iQ-R CPU Module User's Manual (Application)  MELSEC iQ-F FX5 User's Manual (Application)
Recording	To collect data specified as a recording target from a control CPU module and save the data by using a recorder module or camera recorder module.	Page 732 Recording Function  MELSEC iQ-R System Recorder User's Manual (Application)  MELSEC iQ-R System Recorder Co-recording Function Reference Manual
Offline monitor	To check data collected from a programmable controller in the monitor screen of GX Works3. Moreover, to check the data by displaying it in a waveform in GX LogViewer.	Page 736 Checking Collected Data on Program Editor  GX LogViewer Version 1 Operating Manual

# 17.1 Memory Dump Function

Device values of a CPU module can be checked at any timing with the memory dump function of a CPU module.

By setting the trigger conditions, the data at a time when the conditions have been satisfied are collected and saved to the SD memory card. The saved device values can be checked with GX Works3.

For details on the memory dump function of CPU modules, refer to the following:

📖 MELSEC iQ-R CPU Module User's Manual (Application)

📖 MELSEC iQ-F FX5 User's Manual (Application)

R00CPU and remote head modules do not support this function.

## Procedure for using the memory dump function

1. Set the internal buffer capacity of the CPU module to use the memory dump function. (📖 Page 726 Setting the internal buffer capacity for the memory dump function)
2. Write the memory dump setting file. (📖 Page 727 Writing memory dump settings)  
Once it is written, the memory dump result file is saved to an SD memory card when the set trigger conditions are satisfied.
3. Read the memory dump result file to the personal computer. (📖 Page 728 Reading memory dump results)
4. Check the read memory dump result file. (📖 Page 729 Displaying memory dump results)

## Setting the internal buffer capacity for the memory dump function

### RCPU and LHCPU

The internal buffer capacity for the memory dump function can be set in "Internal Buffer Capacity Setting" of "Memory/Device Setting" of "CPU Parameter." After the setting, write the CPU parameters to a CPU module.

However, when using the data logging function, the memory dump function, and the realtime monitor function of a CPU module at the same time, set the capacity within the range that meets the following conditions.

The total of data logging buffer capacities + memory dump buffer capacity + realtime monitor buffer capacity  $\leq$  3072 KB

Each buffer capacity can be checked with the following:

- Data logging buffer capacity, Memory dump buffer capacity: CPU parameter
- Realtime monitor buffer capacity: The realtime monitor setting of GX LogViewer

### FX5CPU

Whether to use the memory dump function can be set in "Function to Use Internal Buffer" of "Memory/Device Setting" of "CPU Parameter."

When using the memory dump function, the internal buffer capacity cannot be changed.

After the setting, write the CPU parameters to a CPU module.

### Precautions

The data logging function and the memory dump function cannot be used at the same time.



## Writing memory dump settings

Once the memory dump setting file is written, the memory dump function is started and waits for a trigger.

If the memory dump setting file has already been stored, the memory dump function is started by powering ON the CPU module.

### Window

Select [Debug] ⇒ [Memory Dump] ⇒ [Setting].

The following screen is an example when opening a project for an RCPU.

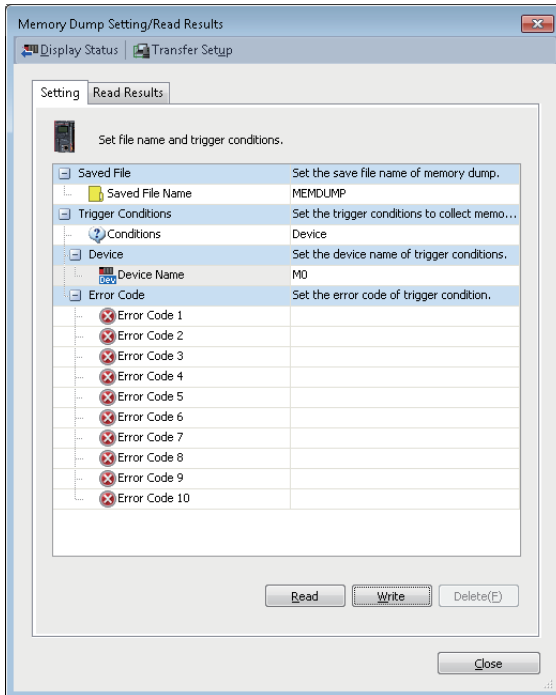

### Operating procedure

Set each item and click the [Write] button.

Item	Description
Saved File	Set a name of a file to be output when the memory dump function is performed. A number, '00' to '99' is added to the end of the set name for the file name to be output actually.
Trigger Conditions	Specify the trigger conditions to collect memory dump. <ul style="list-style-type: none"> <li>■ Trigger condition that can be set (RCPU and LHCPU)               <ul style="list-style-type: none"> <li>• Device: Specify this to set the timing when the bit data of a specified device turns from OFF to ON as the trigger condition.</li> <li>• Error Code: Specify this to set an error code of CPU module as the trigger condition.</li> <li>• Device/Error Code: Specify this to set a device/error code as the trigger condition. The memory dump function is performed when any of the conditions is satisfied.</li> </ul> </li> <li>■ Trigger condition that can be set (FX5CPU)               <ul style="list-style-type: none"> <li>• Device: Specify this to set the timing when the bit data of a specified device turns from OFF to ON as the trigger condition.</li> <li>• On Error: Specify this to set the timing when an error occurs on a CPU module as the trigger condition.</li> <li>• Device/On Error: Specify this to set the timing either when the bit data of a specified device turns from OFF to ON or when an error occurs on a CPU module as the trigger condition. The memory dump function is performed when any of the conditions is satisfied.</li> </ul> </li> </ul>
Device	Specify a device to be set as the trigger condition. Only global devices can be specified. <ul style="list-style-type: none"> <li>■ Device representation that can be specified (RCPU and LHCPU)               <ul style="list-style-type: none"> <li>• Bit device: X, Y, M, L, F, SM, V, B, SB, T (enter 'TS'), ST (enter 'SS/STS'), C (enter 'CS'), LT (enter 'LTS'), LST (enter 'LSS/LSTS'), LC (enter 'LCS'), FX, and FY</li> <li>• Word device (bit specification): D, SD, W, SW, R, ZR, FD, RD</li> </ul> </li> <li>■ Device representation that can be specified (FX5CPU)               <ul style="list-style-type: none"> <li>• Bit device: X, Y, M, L, F, SM, B, SB, T (enter 'TS'), ST (enter 'STS'), C (enter 'CS'), LC (enter 'LCS')</li> <li>• Word device (bit specification): Not applicable</li> </ul> </li> </ul>
Error Code*1	Specify a 4-digit error code to be set as the trigger condition in hexadecimal. The wild card, '*' can be specified for the 1st digit of an error code only.

\*1 FX5CPUs do not support it.

The number for annunciator cannot be specified as the error code to be set as the trigger condition. Use the device name in order to specify the number of annunciator.

## Considerations for memory dump setting

- Before writing the memory dump setting, check that the trigger condition has not already satisfied.
- When a file register is specified as the trigger condition, do not change the file register file name and the file register block No. once the memory dump setting has been written.

## Reading memory dump results

To check a memory dump result file in GX Works3, the file is required to be read from an SD memory card inserted in a CPU module and saved to a personal computer in advance.

### Window

Select [Debug] ⇒ [Memory Dump] ⇒ [Read Results].

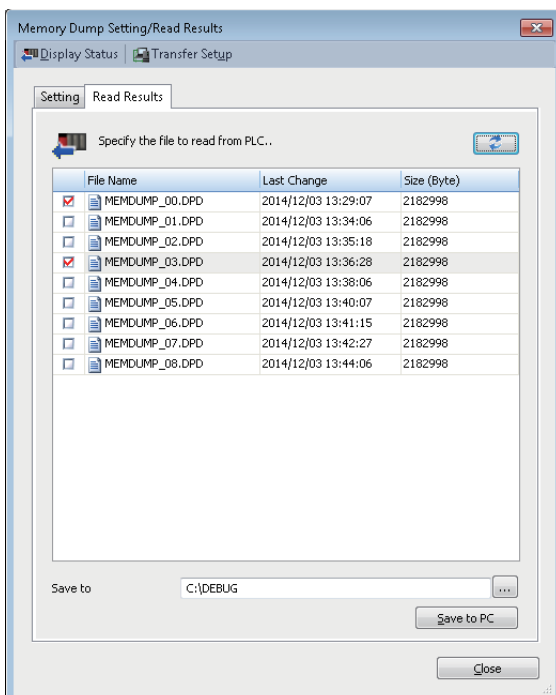

The current execution status of the memory dump function can be checked by selecting [Display Status].

### Operating procedure

1. After clicking , specify the memory dump result file to be read.
2. Specify "Save Destination," and click the [Save to PC] button.

## Displaying memory dump results

A memory dump result file saved in a personal computer can be displayed.

### Window

Select [Debug] ⇒ [Memory Dump] ⇒ [Display Result].

The following screen is an example when opening a project for an RCPU.

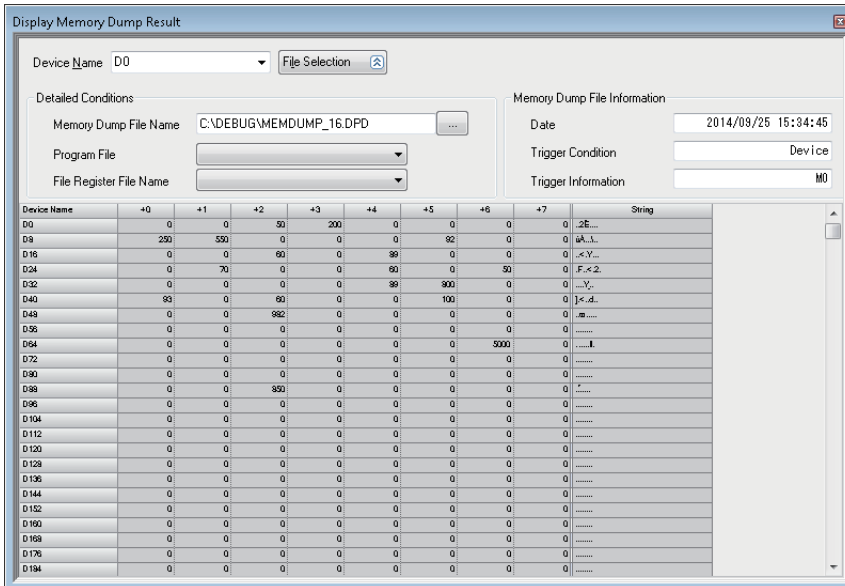

### Operating procedure

Enter the path for the memory dump result file to be displayed in "Memory Dump File Name."

- To specify a local device for "Device Name," select the program file to be referred in "Program File."
- To specify 'R' or 'ZR' for "Device Name," select the file register to be referred in "File Register File Name." When 'R' is specified, the device for the first block is displayed.
- To specify 'Z' or 'LZ' for "Device Name," select the program file to be referred in "Program File."

### Precautions

For FX5CPUs, both "Program File" and "File Register File Name" are not available.

## Deleting memory dump results

A memory dump result file in an SD memory card inserted in a CPU module can be deleted.

By following the procedure below, delete the folder in which a memory dump result file is saved.

### Operating procedure

1. Select [Online] ⇒ [User Data] ⇒ [Delete].
2. Click the [Browse] button for "SD Delete Target Folder."
3. Select and right-click the folder in which a memory dump result file is saved (example: MEMDUMP), then select [Delete Folder] from the shortcut menu.

## 17.2 Data Logging Function

---

Data can be collected at a specified timing with the data logging function of a MELSEC-iQ-R series, MELSEC iQ-L series, or MELSEC iQ-F series CPU module.

For details on the data logging function, refer to the following:

📖 MELSEC iQ-R CPU Module User's Manual (Application)

📖 MELSEC iQ-F FX5 User's Manual (Application)

For R00CPU, the data logging function is not available.

### Procedure for using the data logging function

---

1. Set the internal buffer capacity of the CPU module, which is used for the data logging function. (👉 Page 731 Setting internal buffer capacity for the data logging function)
2. Configure the data logging settings with CPU Module Logging Configuration Tool, and write the setting to the CPU module.
3. Start data logging with CPU Module Logging Configuration Tool.
4. Check the data logging results (logging data) in GX LogViewer.

For the operation methods of CPU Module Logging Configuration Tool, refer to the following:

📖 MELSEC iQ-R CPU Module User's Manual (Application)

📖 MELSEC iQ-F FX5 User's Manual (Application)

For the operation methods of GX LogViewer, refer to the following:

📖 GX LogViewer Version 1 Operating Manual

---

#### **Point**

Following menus start each tool.

- [Tool] ⇒ [Logging Configuration Tool]
  - [Tool] ⇒ [Realtime Monitor Function]  
(GX LogViewer starts and "Realtime Monitor Setting" screen appears.)
-

## Setting internal buffer capacity for the data logging function

### RCPU and LHCPU

The internal buffer capacity for the data logging function can be set in "Internal Buffer Capacity Setting" of "Memory/Device Setting" of "CPU parameter." After the setting, write the CPU parameters to a CPU module.

However, when using the data logging function, the memory dump function, and the realtime monitor function of a CPU module at the same time, set the capacity within the range that meets the following conditions.

The total of data logging buffer capacities + memory dump buffer capacity + realtime monitor buffer capacity  $\leq$  3072 KB

Each buffer capacity can be checked with the following:

- Data logging buffer capacity, memory dump buffer capacity: CPU parameter
- Realtime monitor buffer capacity: the realtime monitor setting of GX LogViewer

### FX5CPU

Whether to use the data logging function can be set in "Function to Use Internal Buffer" of "Memory/Device Setting" of "CPU Parameter."

The internal buffer capacity for the data logging function can be set in "Internal Buffer Capacity Setting" of "Memory/Device Setting" in "CPU parameter."

After the setting, write the CPU parameters to a CPU module.

However, set the capacity in the range that satisfies the following condition.

The total of data logging buffer capacities  $\leq$  320 KB

For FX5SCPU and FX5UJCPU, the internal buffer capacity cannot be changed from the default.

### Precautions

The data logging function and the memory dump function cannot be used at the same time.

## 17.3 Recording Function

Data specified as a recording target can be collected from a control CPU module and saved as a recording file in the destination specified in a recording setting by using the recording function of a recorder module and camera recorder module. For details on the recording function, refer to the following:

📖 MELSEC iQ-R System Recorder User's Manual (Application)

📖 MELSEC iQ-R System Recorder Co-recording Function Reference Manual

The recording function is available in projects for RnCPUs (R04CPU, R08CPU, R16CPU, R32CPU, and R120CPU), RnENCPU, and RnSFCPU.

### Procedure for using the recording function

1. Add a recorder module or camera recorder module to a project.
2. Open "Recording Setting" screen, and configure settings of the recording function. (👉 Page 732 Settings of the recording function)
3. Write the project to a CPU module. (👉 Page 577 WRITING/READING DATA TO CPU MODULE)
4. Read a recording file and check the recording results with the offline monitor function. (👉 Page 734 Reading/deleting a recording file, Page 740 Checking a recording file)

### Settings of the recording function

Settings of the recording function except for parameter settings can be configured in the "Recording Setting" screen. For details on the operations and setting items in the "Recording Setting" screen, refer to the following:

📖 MELSEC iQ-R System Recorder User's Manual (Application)

#### Creating/editing a recording setting

The following shows the procedure to create or edit a recording setting.

##### Operating procedure

##### ■ Creating a new setting

1. Select "Parameter" ⇒ "Module Information" in the navigation window.
2. Select [Project] ⇒ [Data Operation] ⇒ [Add New Module].
3. Select "Information Module" from the pull-down list of "Module Type" in the "Add New Module" screen, then select a recorder module or camera recorder module from the pull-down list of "Module Name."
4. Set each item and click the [OK] button.
5. Select [Recording] ⇒ [Recording Setting] ⇒ [New].
6. Set each item and click the [OK] button.

##### Point

A new recording setting can also be created by the following operation after adding a recorder module or camera recorder module to a project:

- Select "Parameter" ⇒ "Recording Setting" in the navigation window, then right-click it and select [New] from the shortcut menu.

## ■Editing a setting

1. Select [Recording] ⇒ [Recording Setting] ⇒ [Edit].
2. Select a recording setting from the pull-down list of "Select Recording Setting" in the "Edit" screen.
3. Set each item and click the [OK] button.

### Point

A recording setting can also be edited by the following operation:

- Double-click "Parameter" ⇒ "Recording Setting" ⇒ "(recording setting)" in the navigation window.

## Deleting a recording setting

The following shows the procedure to delete a recording setting.

### Operating procedure

1. Select "Parameter" ⇒ "Recording Setting" ⇒ "(recording setting)" in the navigation window.
2. Right-click it and select [Delete Data] from the shortcut menu.
3. Read a displayed message, and click the [Yes] button.

### Point

All recording settings are deleted in the following cases:

- All recorder modules and camera recorder modules are deleted from a project.
- A recorder module or camera recorder module is no longer controlled by a host CPU.
- The CPU module type is changed to one which is not supported by a recorder module or camera recorder module.

# Reading/deleting a recording file

To check recording results in GX Works3, a recording file is required to be read from an SD memory card inserted in a recorder module or camera recorder module.

A recording file can be read or deleted in the "Recording File Reading" screen.

Before opening the "Recording File Reading" screen, connect a personal computer to a CPU module and a recorder module or camera recorder module.

This operation is not required when a recording file is saved in a file server.

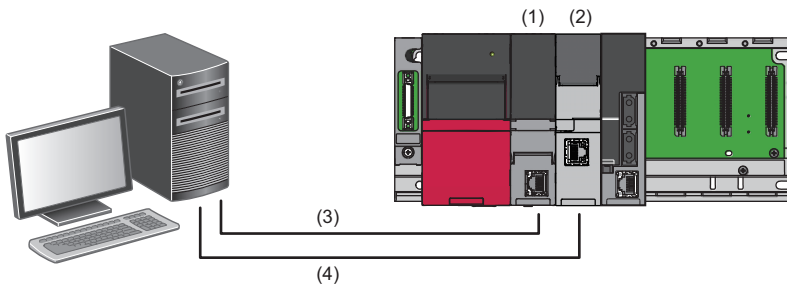

- (1) CPU module
- (2) Recorder module or camera recorder module
- (3) USB cable or Ethernet
- (4) Ethernet

## Operating procedure

1. Select [Recording] ⇒ [Read Recording File].
2. Read a displayed message, and click the [OK] button.
3. Read a recording file to a personal computer in the "Recording File Reading" screen.

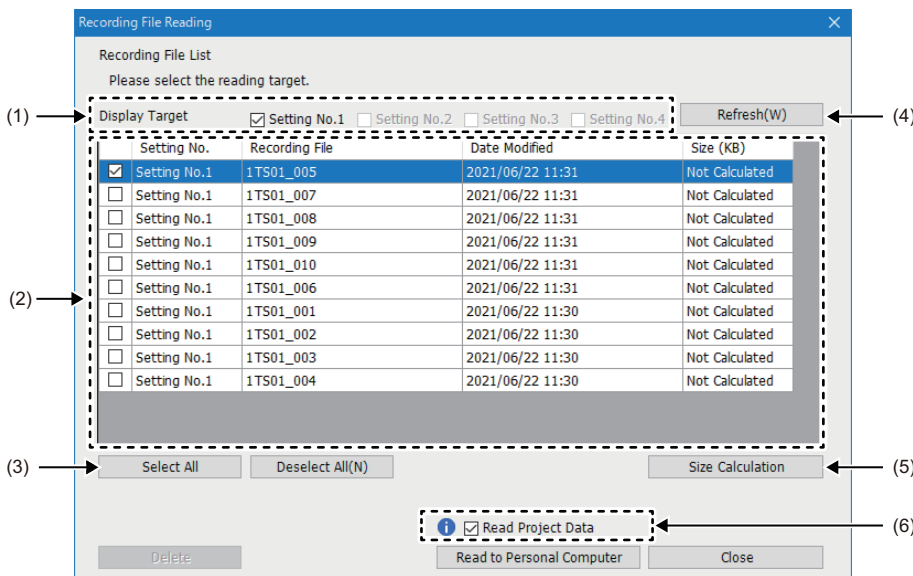

## Displayed items

Item	Description
(1) Display Target	Select the checkbox of a recording setting to be displayed in "reading target."
(2) Reading target	A recording file which is saved in a recording setting selected in "Display Target" is displayed.
(3) [Select All]/[Deselect All] buttons	<ul style="list-style-type: none"> <li>• [Select All] button: Click this to select the checkboxes of all recording files in "reading target."</li> <li>• [Deselect All] button: Click this to unselect the checkboxes of all recording files in "reading target."</li> </ul>
(4) [Refresh] button	Click this to acquire a list of recording files from a connected module. (Up to 1000 files)
(5) [Size Calculation] button	Click this to display the size of a recording file. <sup>1)</sup>



Item	Description
(6) Read Project Data	Select the checkbox to read project data used for recording at the same time as a recording file. <sup>*2</sup> Unselect the checkbox not to read project data.

\*1 The project data size is not included in the displayed size regardless of the selection status of "Read Project Data."

\*2 Project data is read as a GX Works3 project (\*.gx3).

## Reading a recording file

### Operating procedure

1. Select the checkbox of a recording setting in "Display Target."

A recording file saved in the recording setting is displayed in the screen.

2. Select the checkbox of a recording file to be read, and click the [Read to Personal Computer] button.

### Point

A video file generated by using a camera recorder module is included in a read recording file.

### Precautions

User authentication is required for reading project data from an RnSF CPU. (☞ Page 690 Logging on to CPU module)

## Deleting a recording file

A recording file can be deleted from a recorder module or camera recorder module in the "Recording File Reading" screen.

### Operating procedure

Select the checkbox of a recording file, and click the [Delete] button.

## 17.4 Checking Collected Data on Program Editor

Data collected from a programmable controller can be displayed in GX Works3 by using the offline monitor function. It is possible to check control data of when a trouble occurred in the monitor screen even from a remote location and investigate the cause.

For the method for collecting data, refer to the following:

☞ Page 726 Memory Dump Function

☞ Page 730 Data Logging Function

☞ Page 732 Recording Function

R00CPU, RnPSFCPU, and remote head modules do not support the offline monitor function.

### Checking memory dump results

Snapshot data saved in a memory dump result file can be displayed in the monitor screen of GX Works3.

When switching a memory dump result file to be monitored, a monitor value in GX Works3 is changed accordingly.

LHCPUs do not support it.

### Selecting a target monitor

#### Window

Select [Recording] ⇒ [Start Offline Monitor] ⇒ [Memory Dump].

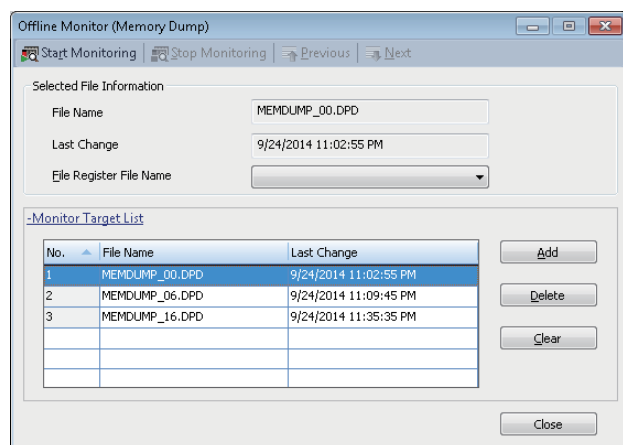

#### Operating procedure

1. Open a program editor to be monitored.
2. Click the [Add] button on the "Offline Monitor (Memory Dump)" screen.
3. Select the memory dump result file in the "Open File" screen, then click the [Open] button. (Multiple selections allowed.)

## Starting offline monitoring

### Operating procedure

1. Select a file to monitor from the list on the "Offline Monitor (Memory Dump)" screen, then select [Start Monitoring].
2. Switch a file by selecting [Previous]/[Next] during the offline monitoring.

The device value of the selected file is displayed on the monitor of GX Works3.

### ■Online operation during offline monitoring

The following online functions are available during offline monitoring:

- Monitor on a program editor
- Device/buffer memory batch monitor
- Watch

## Stopping offline monitoring

### Operating procedure

Select [Stop Monitoring] on the "Offline Monitor (Memory Dump)" screen.

Offline monitoring is all stopped.

## Considerations when monitoring files

### ■A monitor value cannot be displayed properly

When the following conditions are satisfied, a monitor value is not displayed properly.

Condition	Displayed value
A device value to be monitored does not exist in a selected file.	<ul style="list-style-type: none"> <li>• Bit device, bit-specified word device: FALSE (0)</li> <li>• Word device, double-word device, FLOAT [Double Precision]: -1</li> </ul>
An indirectly specified device is monitored.	
An index-modified device is monitored.	A device value excluding the index modification part is displayed. (Example: "D0" is displayed for "D0Z0.")

### ■Active status of blocks/steps in an SFC program

Active status is not displayed on an SFC diagram editor.

All blocks are displayed as "Uncreated Block" on all SFC blocks batch monitor.

# Checking logging data

---

Data values collected with the data logging function can be monitored in GX Works3.

This function only supports a logging file (\*.bin) acquired from a CPU module.

The screens where this function is available are only as follows:

- Program editors (ladder (including a Zoom), ST, and FBD/LD)
- Device/buffer memory batch monitor
- Watch window

## Applicable devices

---

For devices that can be monitored offline, refer to the following:

 Page 740 Applicable devices

## Starting offline monitoring

---

### Operating procedure

1. Open a project to be monitored.
2. Select [Recording] ⇒ [Start Offline Monitor] ⇒ [Logging File].
3. Select a logging file (\*.bin), then click the [Open] button.
4. Click a button by following a displayed message.

The "Seek Bar" window appears and offline monitoring is started. ( Page 743 Operating the seek bar)

For displaying data in a waveform in GX LogViewer, refer to the following:

 Page 754 Displaying waveform data

### Restriction

Multiple error messages may appear if starting offline monitoring while either of the following windows is displayed:

- Device/buffer memory batch monitor
- Intelligent function module monitor
- Program list monitor
- Interrupt program list monitor

However, the shown errors do not affect offline monitoring.

Click the [OK] button to close the error messages.

---

## Stopping offline monitoring

---

### Operating procedure

Select [Recording] ⇒ [Stop Offline Monitor].

Monitoring is stopped in all screens in GX Works3, and the "Seek Bar" window is closed. ( Page 743 Operating the seek bar)

## Considerations

### ■Data type and output type of a logging file

When setting the data logging function, match the type between a data type and output type.

If the data type and output type of a logging file (\*.bin) to be monitored do not match, data may not be monitored properly.

For the setting method of the data logging function, refer to the following:

📖 MELSEC iQ-R CPU Module User's Manual (Application)

### ■Monitoring a macro type function block

Input/output labels of a macro type function block cannot be monitored.

### ■Duplicate devices

When multiple same devices exist in a logging file (\*.bin), the value of the device which has the earliest "No." in the "Data" setting screen of CPU Module Logging Configuration Tool is displayed in the monitor screen of GX Works3.

### ■A monitor value cannot be displayed properly

When the following conditions are satisfied, a monitor value may not be displayed properly.

Check settings.

Condition	Displayed monitor value
An unrecorded device/label is monitored.	An indefinite value is displayed.
A project used for monitoring is different from the one which was written in a CPU module when data was output.	The following possibilities can be considered: <ul style="list-style-type: none"> <li>• The monitor value of a device/label does not match with the parameters being monitored or the device/label status in a program.</li> <li>• The data type of a device/label monitor value is different.</li> </ul>

### ■Data protected by security

A POU locked with a security key or block password is not displayed.

### ■Monitoring a file saved on a network drive

Offline monitoring may be stopped if a file cannot be accessed due to an error such as a network disconnection during offline monitoring.

### ■File saved on a removable media

To start offline monitoring, save a file to a personal computer first, then open it.

# Checking a recording file

Data values collected with the recording function can be monitored in GX Works3.

RnCPUs (R04CPU, R08CPU, R16CPU, R32CPU, and R120CPU), RnENCPU, and RnSFPCPU support this monitoring.

The screens where this function is available are only as follows:

- Program editor
- Device/buffer memory batch monitor
- Watch window
- SFC block list monitor\*<sup>1</sup>
- SFC all blocks batch monitor\*<sup>1</sup>

\*<sup>1</sup> RnCPUs (R04CPU, R08CPU, R16CPU, R32CPU, and R120CPU), RnENCPU support it.

## Applicable devices

The following shows devices that can be monitored offline.

Device
X, Y, M, L, B, F, SB, V, T, ST, LT, LST, C, LC, D, W, SW, SM, SD, J□\X, J□\Y, J□\B, J□\SB, J□\W, J□\SW, U□\G, U3E□\G, U3E□\HG, Z, LZ, R, ZR, RD, BL* <sup>1</sup> , BL□\S, #M, #V, #T, #ST, #LT, #LST, #C, #LC, #D, SAIX, SAIY, SAIM, SAIB, SAIT, SAIST, SAIC, SAID, SAIW, SAISM, SAISD

\*<sup>1</sup> Only data collected with the recording function can be monitored.

## Precautions

Index-modified devices and indirectly specified devices cannot be monitored.

## Starting offline monitoring

### Operating procedure

1. Select [Recording] ⇒ [Start Offline Monitor] ⇒ [Recording File].
2. Select a recording file (\*.melrc), then click the [Open] button.
3. Click a button by following a displayed message.

The "Seek Bar" window appears and offline monitoring is started. (☞ Page 743 Operating the seek bar)

For displaying data in a waveform in GX LogViewer, refer to the following:

☞ Page 754 Displaying waveform data

### Restriction

Multiple error messages may appear if starting offline monitoring while either of the following windows is displayed:

- Device/buffer memory batch monitor
- Intelligent function module monitor
- Program list monitor
- Interrupt program list monitor

However, the shown errors do not affect offline monitoring.

Click the [OK] button to close the error messages.

### Point

A video file included in a recording file can be played in GX VideoViewer.

For details on GX VideoViewer, refer to the following.

☞ GX VideoViewer Version 1 Operating Manual

## Precautions

- Using project data that is read at the same time as a recording file is recommended.  
For the method to read project data and a recording file at the same time, refer to the following:  
 Page 734 Reading/deleting a recording file
- When monitoring a recording file including more than 5,232,645 records, the 5,232,646th and older records are not displayed.
- A project saved in a recording file cannot be opened in GX Works3 started from MELSOFT Navigator. Start offline monitoring with a project currently opened in GX Works3.  
To use a project saved in a recording file, do not start offline monitoring in GX Works3 started from MELSOFT Navigator but in the standalone GX Works3.
- When a recording file is saved in a file server by the following recorder module or camera recorder module, open the project used when the recording setting was written to a CPU module, then start offline monitoring.
  - Recorder module with the firmware version '03' or '04'
  - Camera recorder module with the firmware version '01'

## Stopping offline monitoring

For details on the operating procedure, refer to the following:

 Page 738 Stopping offline monitoring

When stopping offline monitoring, monitoring is stopped in all screens in GX Works3, and the "Seek Bar" window and the "Event History (Offline Monitor)" window are closed.

## Considerations

The following shows the considerations for checking a recording file.

For considerations common to logging data, refer to the following:

 Page 739 Considerations

### ■Devices that cannot be monitored

- Index registers (Z) and long index registers (LZ) cannot be monitored if a recording file satisfies the following conditions: it links to the recording setting written to a CPU module in GX Works3 Version 1.065T or 1.066U, and it does not have project data read at the same time.
- Local index registers cannot be monitored offline.

### ■Indefinite value

When monitoring an unrecorded device/label, an indefinite value may be displayed.

Whether a recorded device/label is actually being monitored can be checked in the "Recording Setting" screen.

For details on the "Recording Setting" screen, refer to the following:

 MELSEC iQ-R System Recorder User's Manual (Application)

### ■Monitoring a recording file that includes a safety project

A safety project included in a recording file is opened without user authentication and logged on as a guest user. ( Page 684 Guest user)

Note the following:

- Even if a guest user is not added to a project, user authentication is skipped and the project is opened as a guest user.
- User authentication of a safety project included in a recording file cannot be performed again.
- When saving a safety project included in a recording file, a password for user authentication is not set for the saved project; therefore, the project can be logged on only as a guest user.

## ■Monitoring a recording file in an SFC diagram editor

The following shortcut menus are not available:

- Wave Display (Offline Monitor)
- Find Changed Point

The following monitors are not available:

- SFC auto-scroll
- SFC-activated step monitor

For considerations during monitoring, refer to the following:

 Page 626 Monitoring an SFC diagram

## ■Monitoring a step relay with block specification

When monitoring a step relay with block specification (BL□\S) that satisfies all the following conditions, a monitor value is displayed as 'TRUE,' and the active status of steps is displayed as 'Activated.'

- A step relay with block specification (BL□\S) is not used in an SFC program.
- A step relay with block specification (BL□\S) is collected from "Specify from the Device/Label List" or "Specify the Device Range" in a recording setting.



# Operating the seek bar

The "Seek Bar" window appears when starting offline monitoring.

The seek bar is a function which specifies the index (sequential serial number recorded in a recording file in each scan) of data to be monitored.

An index specified with the seek bar or a monitor value at the index can be displayed in a monitor screen, "Event History (Offline Monitor)" window, and GX LogViewer which are linking with the seek bar.

## Screen configuration

### Window

Select [Recording] ⇒ [Start Offline Monitor] ⇒ [Recording File]/[Logging File].

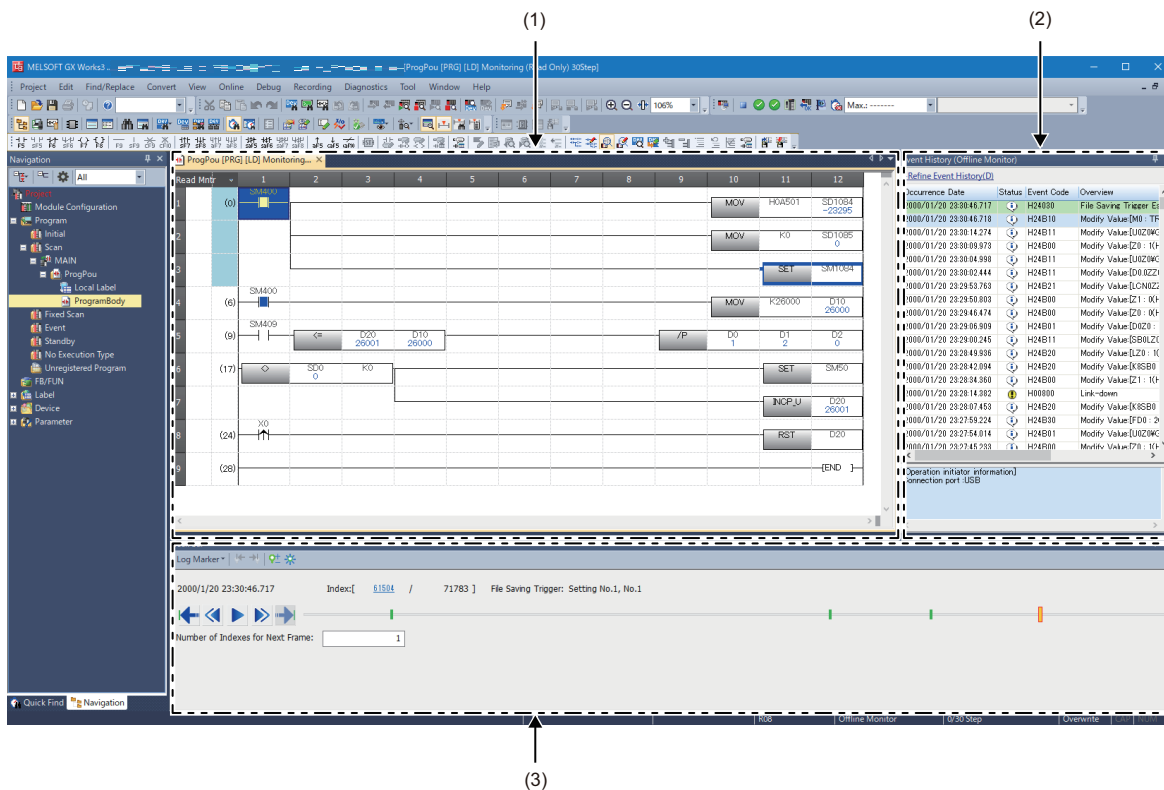

### Displayed items

Item	Description
(1) Monitor screen of a program editor	Check data collected from a programmable controller.
(2) "Event History (Offline Monitor)" window	Check event information stored in a recording file being monitored. For details, refer to the following: ☞ Page 749 Checking an event history (offline monitor)
(3) "Seek Bar" window	Specify an index by moving the slider on the seek bar.

## ■ Seek bar

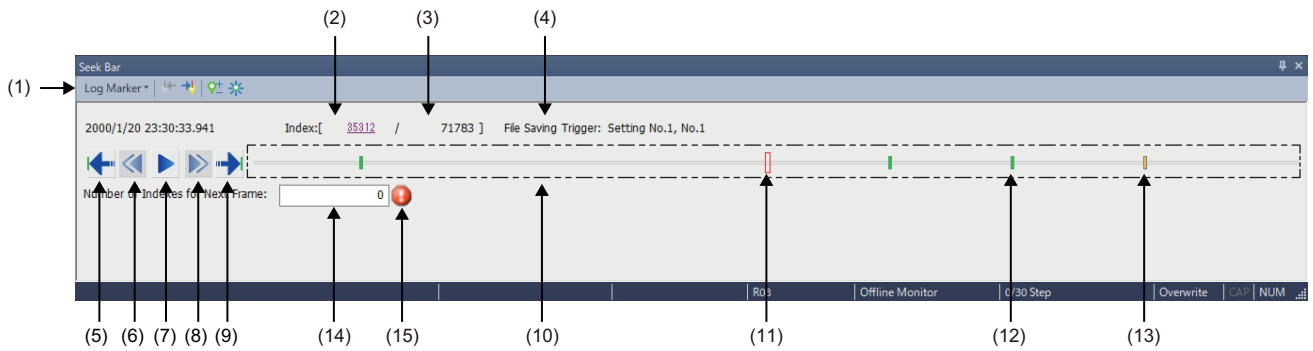





## Displayed items

Item	Description															
(1) Toolbar	<table border="1"> <tr> <td rowspan="3">Log Marker</td> <td>Read</td> <td>Select this to read a log marker information file (*.lms, *.lmcs, *.vms). (☞ Page 748 To read a specified log marker information file)</td> </tr> <tr> <td>Read from GX VideoViewer</td> <td>Select this to read log markers added to a video file. (☞ Page 748 To read log markers in a video file)</td> </tr> <tr> <td>Edit Comment/Color</td> <td>Select this to perform either of the following operations to a log marker: <ul style="list-style-type: none"> <li>Adding a comment (☞ Page 747 Editing a comment/color)</li> <li>Changing a color (☞ Page 747 Editing a comment/color)</li> </ul> </td> </tr> <tr> <td>Previous Trigger</td> <td>Click this to move the slider to the previous trigger position.</td> </tr> <tr> <td>Next Trigger</td> <td>Click this to move the slider to the next trigger position.</td> </tr> <tr> <td>Add/Delete Log Marker</td> <td>Click this to add or delete a log marker. (For adding: ☞ Page 747 Adding a log marker, for deleting: ☞ Page 747 Deleting a log marker)</td> </tr> <tr> <td>Delete All Log Markers</td> <td>Click this to delete all log markers on the seek bar.</td> </tr> </table>	Log Marker	Read	Select this to read a log marker information file (*.lms, *.lmcs, *.vms). (☞ Page 748 To read a specified log marker information file)	Read from GX VideoViewer	Select this to read log markers added to a video file. (☞ Page 748 To read log markers in a video file)	Edit Comment/Color	Select this to perform either of the following operations to a log marker: <ul style="list-style-type: none"> <li>Adding a comment (☞ Page 747 Editing a comment/color)</li> <li>Changing a color (☞ Page 747 Editing a comment/color)</li> </ul>	Previous Trigger	Click this to move the slider to the previous trigger position.	Next Trigger	Click this to move the slider to the next trigger position.	Add/Delete Log Marker	Click this to add or delete a log marker. (For adding: ☞ Page 747 Adding a log marker, for deleting: ☞ Page 747 Deleting a log marker)	Delete All Log Markers	Click this to delete all log markers on the seek bar.
Log Marker	Read		Select this to read a log marker information file (*.lms, *.lmcs, *.vms). (☞ Page 748 To read a specified log marker information file)													
	Read from GX VideoViewer		Select this to read log markers added to a video file. (☞ Page 748 To read log markers in a video file)													
	Edit Comment/Color	Select this to perform either of the following operations to a log marker: <ul style="list-style-type: none"> <li>Adding a comment (☞ Page 747 Editing a comment/color)</li> <li>Changing a color (☞ Page 747 Editing a comment/color)</li> </ul>														
Previous Trigger	Click this to move the slider to the previous trigger position.															
Next Trigger	Click this to move the slider to the next trigger position.															
Add/Delete Log Marker	Click this to add or delete a log marker. (For adding: ☞ Page 747 Adding a log marker, for deleting: ☞ Page 747 Deleting a log marker)															
Delete All Log Markers	Click this to delete all log markers on the seek bar.															
(2) Current index	A current index of data being monitored is displayed. The "Specify Index to Display" screen appears by clicking this item.															
(3) Total number of records	The total number of records being monitored is displayed.															
(4) File Saving Trigger	The following information is displayed: <ul style="list-style-type: none"> <li>Recording setting in which a file saving trigger is set</li> <li>Setting number of a file saving trigger setting</li> </ul> The above information is not displayed for a logging file or a recording file that satisfies any of the following conditions: <ul style="list-style-type: none"> <li>"Recording Startup Trigger + File Saving Trigger" is set for "Recording Method," and a file is saved after specified time elapses from recording completion.</li> <li>A file is saved by a camera event.</li> <li>A file is saved by detecting a CPU stop error.</li> <li>A file is saved in the recording monitor screen.</li> </ul>															
(5) Previous Log Marker	Click this to move the slider to the previous log marker.															
(6) Previous Frame	Click this to move the index to the previous frame for the setting value in "Number of Indexes for Next Frame." The slider moves according to the index.															
(7) Play/Pause	Click this to play (forward) or pause a recording file and logging file. (Pause) is displayed while playing a file. (Play) is displayed while pausing a file.															
(8) Next Frame	Click this to move the index to the next frame for the setting value in "Number of Indexes for Next Frame." The slider moves according to the index.															
(9) Next Log Marker	Click this to move the slider to the next log marker.															
(10) Seek bar	A range where the slider can move is indicated.															
(11) Slider	A current index of data being monitored is indicated. This item is displayed in red on the seek bar. By dragging the slider to the left or right, it can be moved to an index at which the monitor value is to be checked.															
(12) Log marker	A position where a log marker is added is indicated. This item is displayed in a specified color on the seek bar. (Default color: green)															
(13) Trigger position marker	A position where a trigger occurs is indicated. This item is displayed in yellow on the seek bar.															

Item	Description
(14) Number of Indexes for Next Frame	Set the value to move the index in "Previous Frame"/"Next Frame." The minimum value/maximum value that can be set are as follows: <ul style="list-style-type: none"> <li>• Minimum value: 1</li> <li>• Maximum value: Maximum index value -1</li> </ul>
(15)  Error	This icon is displayed when the setting value in "Number of Indexes for Next Frame" is invalid.

### Point

- The slider moves to the left or right by pressing the  +  /  +  keys.
- If a logging file (\*.bin) does not contain time information, "-" is displayed for the time information in the "Seek Bar" window.

## ■ Specifying an index manually

An index can be specified manually by dragging the slider to the left or right, or alternatively by the following procedure.

### Operating procedure

1. Click a current index in the "Seek Bar" window.
2. Enter an index in the "Specify Index to Display" screen, and click the [OK] button.

## Function linking with the seek bar

The move of slider on the seek bar links with each editor, "Event History (Offline Monitor)" window, and GX LogViewer.

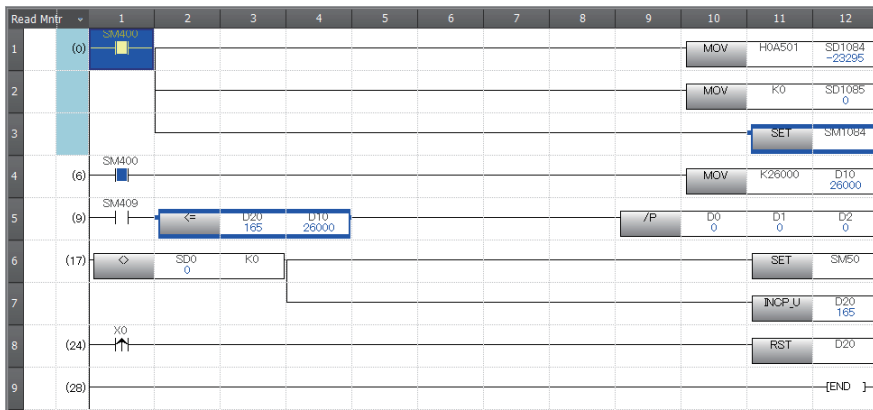

Slider movement is reflected in an editor being monitored offline.

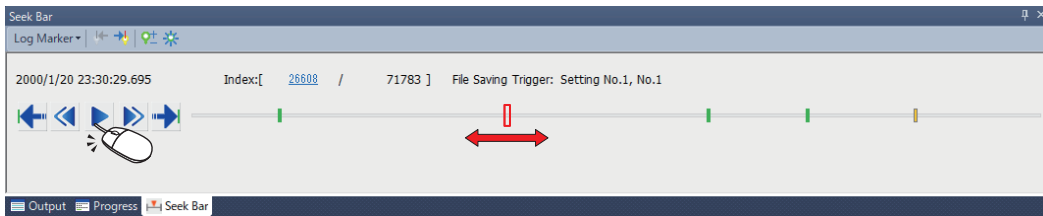

As the slider is moved, the red cursor moves.



As the red cursor is moved, the slider moves.

As the slider is moved, the cursor moves to the event at a specified index.



As an event is selected, the slider moves to the corresponding index.

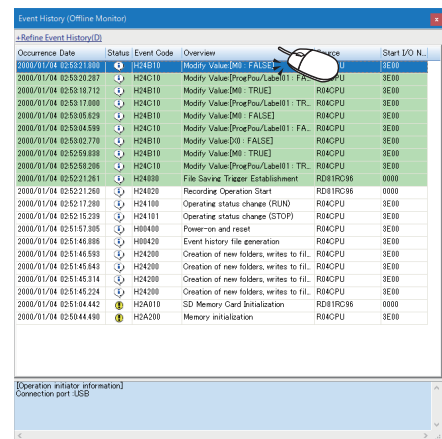
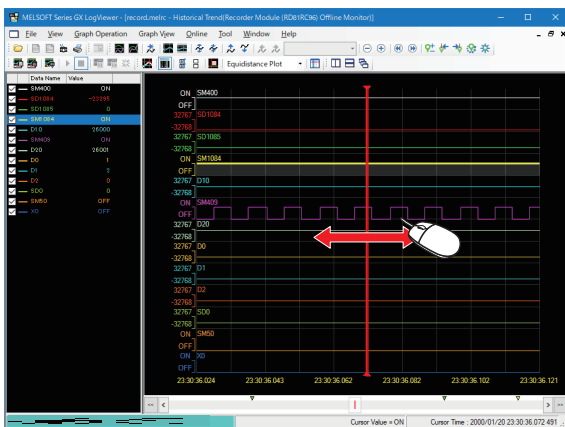

## Adding a log marker

During offline monitoring, a log marker can be added to any index by using the log marker function. Up to 100 log markers can be added to a unit of data (a recording file or logging file).

### Adding a log marker

#### Operating procedure

1. Move the slider to any index on the seek bar.
2. Click  (Add/Delete Log Marker).

### Deleting a log marker

#### Operating procedure

1. Move the slider to any log marker on the seek bar.
2. Click  (Add/Delete Log Marker).

### Editing a comment/color

#### Window

Select [Log Marker] ⇨ [Edit Comment/Color] on the toolbar in the "Seek Bar" window.

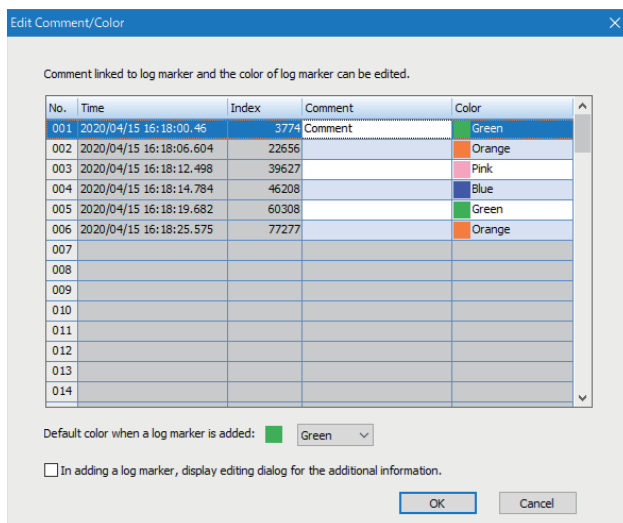

#### Displayed items

Item	Description
Comment	Add a comment for a log marker. The added comment is displayed by placing the mouse cursor on the log marker.
Color	Change the color of a log marker.
Default color when a log marker is added	Set the default color of a new log marker.
In adding a log marker, display editing dialog for the additional information.	Select this checkbox to display the "Edit Comment/Color" screen every time adding a log marker.

#### Operating procedure

1. Add a comment (up to 256 characters) in the "Comment" column for a log marker.
2. Select a color for the log marker from the pull-down list of "Color."
3. Click the [OK] button.

## Reading a log marker information file

Log markers added to data are saved as a log marker information file in a folder where a recording file or logging file is stored. The extension of a log marker information file differs depending on the tool used to add log markers.

Extension	Tool	Version of the tool
*.lms	GX Works3	Version 1.065T and 1.066U
	GX LogViewer	Version 1.106K
*.lmcs	GX Works3	Version 1.070Y or later
	GX LogViewer	Version 1.112R or later
*.vms	GX VideoViewer	Version 1.006G or later

When selecting data that includes a log marker information file (\*.lms, \*.lmcs) and starting offline monitoring, log markers are automatically read and displayed on the seek bar.

Alternatively, log markers can be read by following the procedure below.

### Operating procedure

#### ■ To read a specified log marker information file

1. Click [Log Marker] ⇒ [Read] on the toolbar in the "Seek Bar" window.
2. Select a log marker information file (\*.lms, \*.lmcs, \*.vms) and click the [Open] button.

#### ■ To read log markers in a video file

Click [Log Marker] ⇒ [Read from GX VideoViewer] on the toolbar in the "Seek Bar" window.

Either of the following is read: log markers in a video file that is opened in GX VideoViewer, or a log marker information file (\*.vms) that is included in a recording file monitored offline.

### Precautions

- Log marker information files (\*.lmcs) created in GX Works3 Version 1.070Y or later and GX LogViewer Version 1.112R or later cannot be opened in GX Works3 Version 1.065T and 1.066U.
- Even if a log marker information file is read, the comments and colors of log markers that are already added will not be overwritten.

## Linking with GX LogViewer

While monitoring same data at the same time in GX Works3 and GX LogViewer, log markers added, deleted, or edited in one tool are reflected in the other tool.

For details on the log marker function of GX LogViewer, refer to the following:

 GX LogViewer Version 1 Operating Manual

The following table shows the method to synchronize log markers between each version of GX Works3 and GX LogViewer.

GX Works3	GX LogViewer	Synchronization method
Version 1.065T and 1.066U	Version 1.106K	Read a log marker information file (*.lms) in the application destination tool.
Version 1.070Y or later	Version 1.112R or later	Log markers are automatically synchronized. (No operation is required.)

## Linking with GX VideoViewer

Log markers added to a video file can be applied to a recording file or logging file by reading a log marker information file (\*.vms) of GX VideoViewer in GX Works3. ( Page 748 To read log markers in a video file)

In addition, log markers added in GX Works3 can be displayed in GX VideoViewer.

For details on the log marker function of GX VideoViewer, refer to the following:

 GX VideoViewer Version 1 Operating Manual

## Consideration

The log marker function is not available if a logging file does not contain time information.

# Checking an event history (offline monitor)

The following event information that is stored in a recording file during monitoring can be checked: error information, operation history, system information, and change history of a current value.

RnCPUs (R04CPU, R08CPU, R16CPU, R32CPU, and R120CPU), RnENCPU, and RnSFCPU support this function.

## Window

Select [View] ⇒ [Docking Window] ⇒ [Event History (Offline Monitor)].

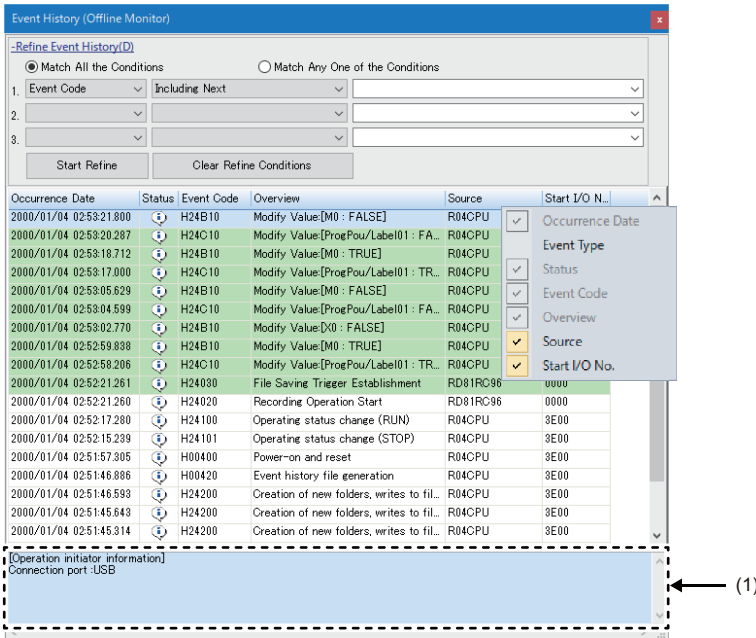

(1): Event details

Event information which can be specified with the seek bar is displayed with a pale green background.

## Status icon legend

Status icon	
	Major error
	Moderate error
	Minor error
	Warning
	Information

## Operating procedure

1. Start offline monitoring. (Page 740 Starting offline monitoring)
2. Place the cursor on any event information in the "Event History (Offline Monitor)" window, and check the event details.

## Event history sorting

Events can be sorted in ascending/descending order by clicking each column header.

## Event history refinement

Events can be refined by setting a condition for ones to be displayed.

Click "Refine Event History" to set a condition.

The operations are the same as that in the "Event History" screen. (Page 723 Event history refinement)

However, unlike in the "Event History" screen, single-byte and double-byte characters are distinguished in searching for an event.

## ■ Linking with the seek bar

Event information at a specified index can be checked by operating the slider on the seek bar.

In addition, by selecting event information with a pale green background, the slider on the seek bar is moved to the corresponding index, and a monitor value at the index is displayed in the monitor screen.

### Precautions

- If a recording file does not contain an event history, the "Event History (Offline Monitor)" window does not appear even when offline monitoring is started.
- When linking with the seek bar, the following cases may occur:
  - An occurrence date of event information and a date displayed in the "Seek Bar" window are different in milliseconds.
  - Even if selecting event information with a pale green background, the slider on the seek bar is not moved to the corresponding index.
- If the time setting in a programmable controller is changed while updating an event history or recording, the background color of event information may not be displayed in pale green.



# Checking a device/label value

During offline monitoring, devices/labels that match specified conditions can be searched for. In addition, the date and time and indexes when their values changed can be displayed.

## Window

Select [View] ⇒ [Docking Window] ⇒ [Find Changed Point(Offline Monitor)]/[Changed Point List(Offline Monitor)].

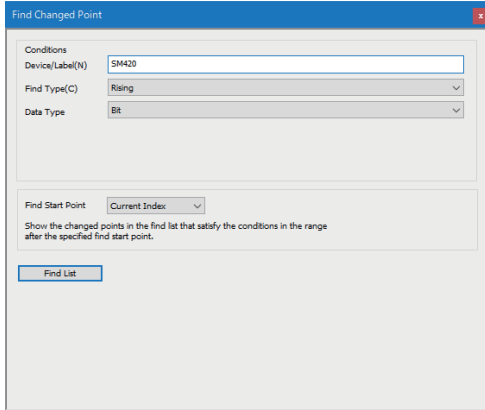

"Find Changed Point" window

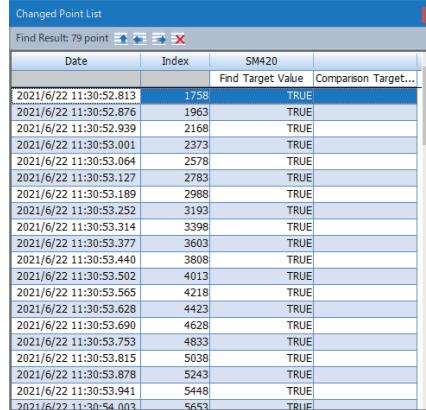

"Changed Point List" window

Item	Description
Jump to the Current Location	Click this to move the slider on the seek bar to the index of a selected changed point.
Jump to the Previous Location	Click this to move the slider on the seek bar to the index of the changed point that is one above a selected one.
Jump to the Next Location	Click this to move the slider on the seek bar to the index of the changed point one below a selected one.
Clear All	Click this to clear the search results.

### Point

The "Find Changed Point" window appears also by right-clicking in any of the following editors or in a watch window and selecting [Find Changed Point] from the shortcut menu:

- Ladder editor
- Inline structured text box in a ladder editor
- FBD/LD editor
- ST editor

When selecting a device/label in an editor or in a watch window, the device/label is automatically entered in the "Device/Label" column of the "Find Changed Point" window.

## Operating procedure

1. Set conditions and the start point of search in the "Find Changed Point" window.
2. Click the [Find List] button.
3. Double-click a search result displayed in the "Changed Point List" window.

The slider on the seek bar moves to the index of the selected search result, and the monitor value at the index is applied to each screen that is linking with the seek bar.

### ■ Search result sorting

Search results can be sorted in ascending/descending order by clicking each column header in the "Changed Point List" window.

## ■ Search type

The following table shows the details on the options that can be set for "Find Type" in the "Find Changed Point" window.

Item	Description	Target data type
Rising	Indexes at which a device/label is turned from OFF to ON are searched for.	Bit
Falling	An index at which a device/label is turned from ON to OFF for the first time is searched for.	Bit
Rising/Falling	Indexes at which a device/label is turned from OFF to ON or from ON to OFF are searched for.	Bit
Maximum value	An index at which a device/label has the maximum value is searched for.	<ul style="list-style-type: none"> <li>• Word</li> <li>• Double Word</li> <li>• FLOAT [Single Precision]</li> <li>• FLOAT [Double Precision]</li> </ul>
Minimum value	An index at which a device/label has the minimum value is searched for.	<ul style="list-style-type: none"> <li>• Word</li> <li>• Double Word</li> <li>• FLOAT [Single Precision]</li> <li>• FLOAT [Double Precision]</li> </ul>
Local maximum value	Indexes at which a device/label has a local maximum value are searched for. A local maximum value refers to a value of a device/label at the point where the value that has been increasing starts to decrease.	<ul style="list-style-type: none"> <li>• Word</li> <li>• Double Word</li> <li>• FLOAT [Single Precision]</li> <li>• FLOAT [Double Precision]</li> </ul>
Local minimum value	Indexes at which a device/label has a local minimum value are searched for. A local minimum value refers to a value of a device/label at the point where the value that has been decreasing starts to increase.	<ul style="list-style-type: none"> <li>• Word</li> <li>• Double Word</li> <li>• FLOAT [Single Precision]</li> <li>• FLOAT [Double Precision]</li> </ul>
Conditions	Indexes at which a specified condition is satisfied are searched for.	<ul style="list-style-type: none"> <li>• Bit</li> <li>• Word</li> <li>• Double Word</li> <li>• FLOAT [Single Precision]</li> <li>• FLOAT [Double Precision]</li> </ul>

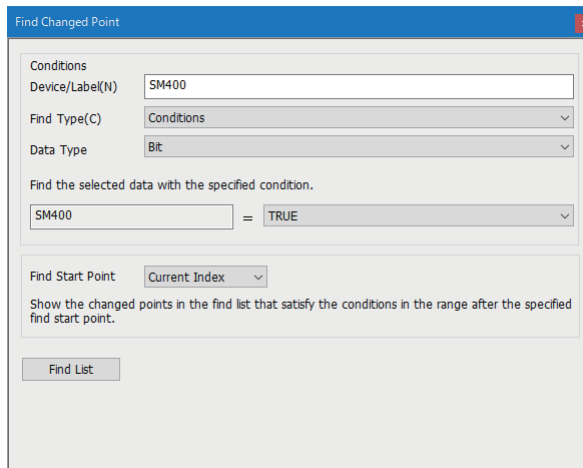

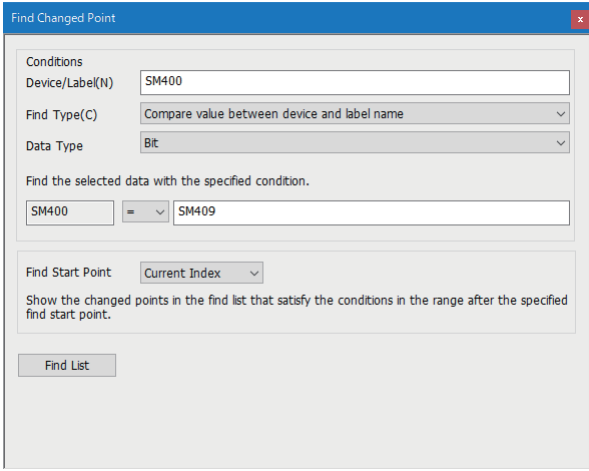
Item	Description	Target data type
<p>Compare value between device and label name</p>	<p>Indexes at which a condition specified for the value between a device/label and comparison data is satisfied are searched for.</p> 	<ul style="list-style-type: none"> <li>• Bit</li> <li>• Word</li> <li>• Double Word</li> <li>• FLOAT [Single Precision]</li> <li>• FLOAT [Double Precision]</li> </ul>

# Displaying waveform data

A device/label selected in the monitor screen of the offline monitor function can be displayed in a graph format in GX LogViewer.

To use this function, GX LogViewer Version 1.106K or later is required to be installed.

For the operation methods of GX LogViewer, refer to the following:

GX LogViewer Version 1 Operating Manual

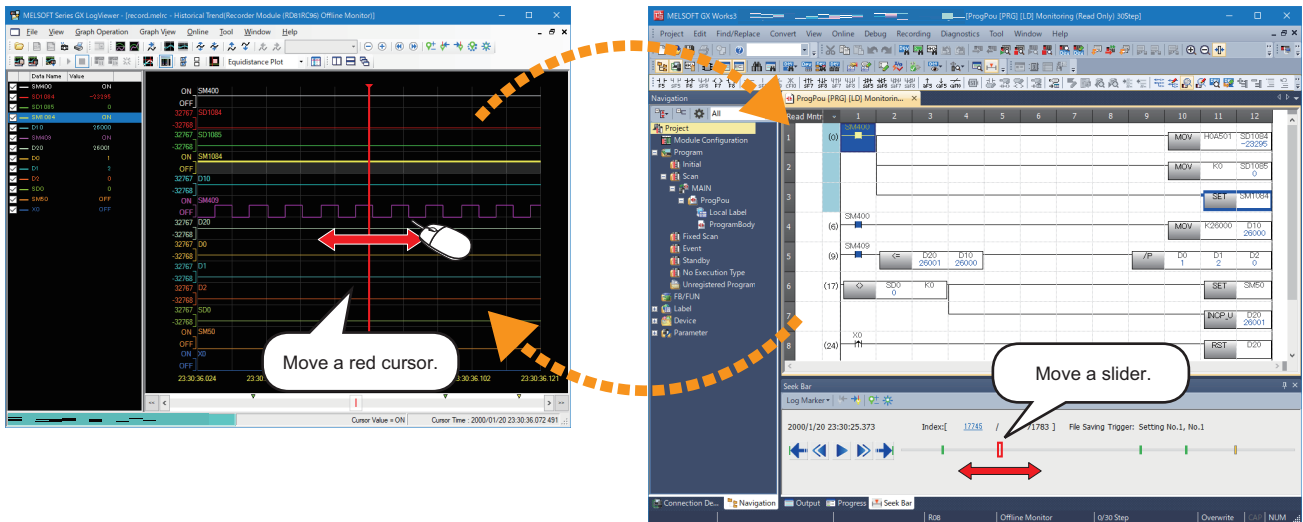

## Starting GX LogViewer

1. Start offline monitoring.  
(Logging data: Page 738 Starting offline monitoring, recording file: Page 740 Starting offline monitoring)
2. Select a device/label in a program editor, watch window, or "Dataflow Analysis" window.
3. Perform either of the following operations depending on the screen.
  - Program editor and watch window: Right-click the device/label and select [Wave Display (Offline Monitor)] from the shortcut menu.
  - "Dataflow Analysis" window: Right-click the device/label and select [Monitor] ⇒ [Wave Display (Offline Monitor)] from the shortcut menu.

The "Historical Trend" window of GX LogViewer appears.

## Precautions

- In GX LogViewer, up to 32 devices/labels can be displayed at once.
- Only devices that are supported by each logging function can be displayed in a waveform. For the unsupported devices, refer to the following:

- MELSEC iQ-R CPU Module User's Manual (Application)
- MELSEC iQ-F FX5 User's Manual (Application)
- MELSEC iQ-R System Recorder User's Manual (Application)

## Point

- When performing step 3 again with another device/label selected after displaying a device/label in a waveform, whether to add the waveform of the selected device/label in the graph that is already displayed or to display it in a new graph can be selected.
- The seek bar in GX Works3 and the red cursor in GX LogViewer link with each other. The red cursor in GX LogViewer moves when moving the slider on the seek bar in GX Works3, and vice versa.

## Displaying the GOT offline monitor

Logging data of a device/label selected in the monitor screen of GX Works3 can be displayed in the GOT offline monitor. To use this function, GT Designer3 Version 1.236W or later is required to be installed.

This function does not support a logging file.

For the operation methods of GT Designer3, refer to the following:

📖 GT Designer3 (GOT2000) Screen Design Manual

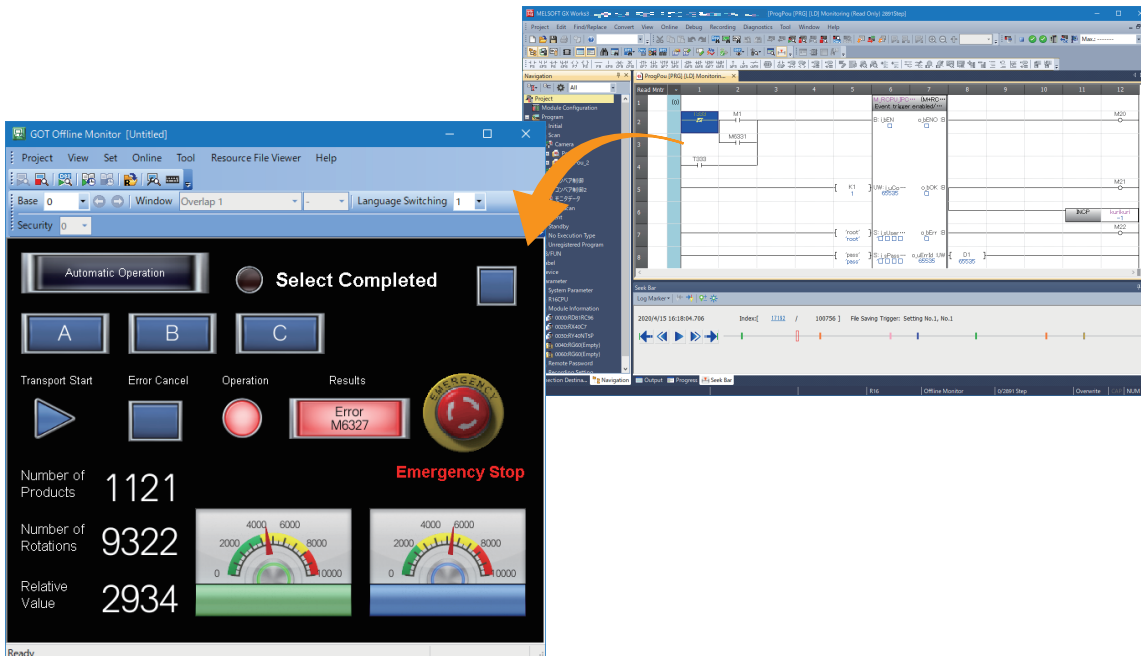

## Starting the GOT offline monitor

### Operating procedure

1. Select a recording file, and start offline monitoring. (👉 Page 740 Starting offline monitoring)
2. Select [Recording] ⇒ [GOT Offline Monitor] ⇒ [Start].
3. Select a GT Designer3 project file, and click the [Open] button.

## Stopping the GOT offline monitor

### Operating procedure

Select [Recording] ⇒ [GOT Offline Monitor] ⇒ [End].

## Playing a video

A video file generated by using a camera recorder module or Camera Recording Package can be played in GX VideoViewer. To use this function, GX VideoViewer is required to be installed.

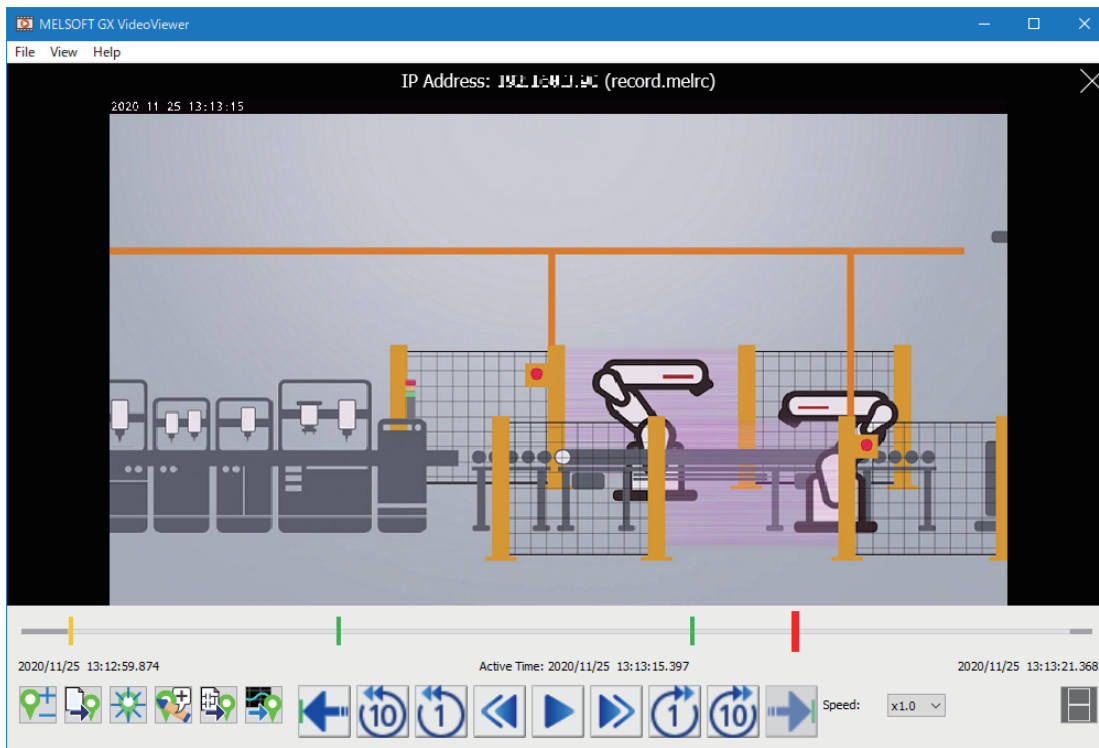

For the operation methods of GX VideoViewer, refer to the following:

 GX VideoViewer Version 1 Operating Manual



## Starting GX VideoViewer

### Operating procedure

1. Start offline monitoring.  
(Logging data:  Page 738 Starting offline monitoring, recording file:  Page 740 Starting offline monitoring)
2. Select [Tool] ⇒ [GX VideoViewer].
3. Select a video file and click the [Open] button.

# 18 CHECKING/CHANGING MODULE OPERATION

The operation of each module can be checked and changed in GX Works3.

## CPU module

Purpose	Function name	Reference
To set the clock on a CPU module	Clock setting	Page 758 Clock Setting in a CPU Module
To switch the operation status of a CPU module connected to GX Works3 to RUN/STOP/PAUSE/RESET	Remote operation	Page 759 Remote Operation
To perform the functions of CPU modules in a redundant system configuration	System switching Operation mode change Memory copy Control system forced start while waiting for the other system started Redundant function module communication test System A/B setting	Page 761 Redundant Programmable Controller Operations
To perform the functions of RnPSFCPU and RnSFCPU	Safety operation mode switching Identification check for safety data Safety module operation	Page 764 Safety Programmable Controller Operations
To check the usage of data memory	CPU memory operation	Page 769 Checking Memory Usage
To clear values in data memory	Clear value	Page 771 Initializing/Clearing a Memory
To read the label memory To write the read label memory	Label memory read/write	Page 773 Reading/Writing the Label Memory
To update the firmware of a module	Firmware update	Page 776 Firmware Update

## Remote head module

Purpose	Function name	Reference
To switch the operation status of a remote head module connected to GX Works3 to the RUN/STOP/PAUSE/RESET status	Remote operation	Page 759 Remote Operation
To perform the functions of remote head modules in a redundant system configuration	System switching	Page 761 Redundant Programmable Controller Operations
To check the usage of data memory	CPU memory operation	Page 769 Checking Memory Usage
To clear values in data memory	Clear value	Page 771 Initializing/Clearing a Memory

## Other modules

Purpose	Function name	Reference
To update the firmware of a module	Firmware update	Page 776 Firmware Update

# 18.1 Clock Setting in a CPU Module

This section explains the setting method of the clock on a CPU module.  
Remote head modules do not support this function.

## Window

Select [Online] ⇒ [Set Clock].

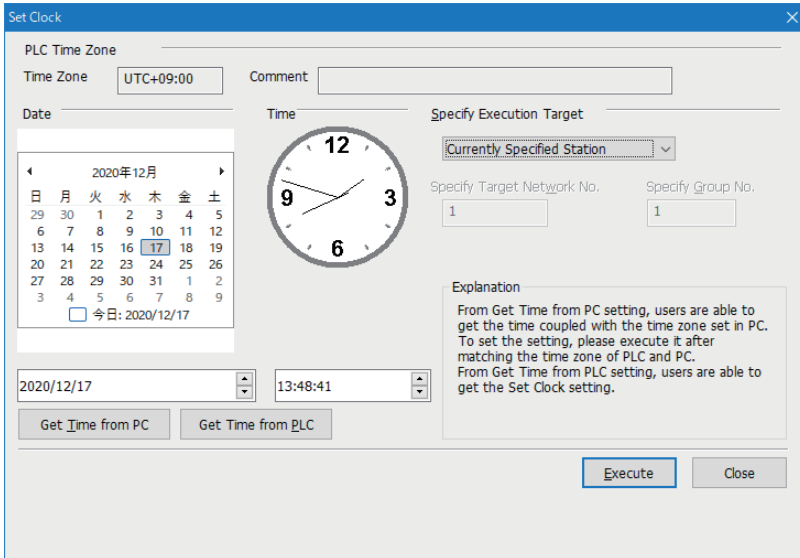

## Operating procedure

Set the following items and click the [Execute] button.

Execution target	Description
Currently Specified Station	Select this to set the clock only upon the station specified in the connection destination setting.
All Stations Specified <sup>*1</sup>	Select this to perform the clock setting on the station specified in the connection destination setting and all the stations on the same network. Set a target network with "Specify Target Network No.".
Specify Group No. <sup>*1</sup>	Select this to perform the clock setting on the station specified in the connection destination setting and each station of the specific group on the specified network. Set a target network in "Specify Target Network No.", and set a group number in "Specify Group No.". The clock setting cannot be performed for CC-Link IE Field Network because it does not have group number.

\*1 FX5CPUs do not support it.

## ■Operations when using CPU modules in a redundant system configuration

For an RnPCPU (redundant mode), the operations differ depending on the operation modes.

An RnPSFCPU operates only when selecting the backup mode for the operation mode.

Operation mode	Operation
Backup mode	Applied to both systems (order: control system → standby system).
Separate mode	Applied to the CPU module in the connective system.

## Precautions

- The clock in a CPU module can be set regardless of the ON/OFF state of the clock setting device 'SM210.'  
Note that the ON/OFF state of 'SM210' does not change upon the clock setting.
- In the clock setting, a time-lag may occur due to the transfer time.
- The same time is set even if different time zones are specified between a connected station and another station.



# 18.2 Remote Operation

This section explains the method for switching the operating status (RUN/STOP/PAUSE/RESET) of a CPU module and remote head module with their RUN/STOP/RESET switches placed in the RUN position.

Use this function to change the status of a CPU module to RUN/STOP with an external signal when the module is located in an inaccessible place such as in the control panel.

To change the status to RESET by a remote operation, the remote reset needs to be enabled in the CPU parameter in advance.

For details, refer to the following:

📖 MELSEC iQ-R CPU Module User's Manual (Application)

In this section, the "Remote Operation" screen is used.

## Window

Select [Online] ⇒ [Remote Operation].

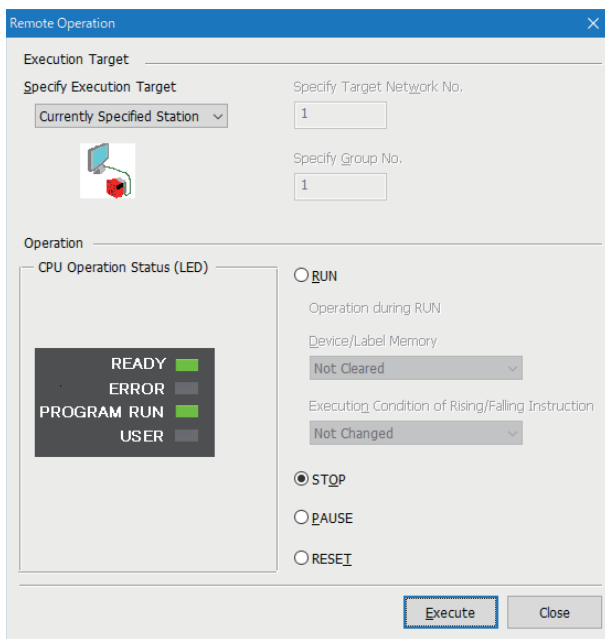

The screen above is an example when connecting with an RnCPU.

## Operating procedure

Set the following items and click the [Execute] button.

Execution target	Description
Currently Specified Station <sup>*1</sup>	<ul style="list-style-type: none"> <li>■ CPU module Select this to perform the remote operation only on the station specified in the connection destination setting.</li> <li>■ Remote head module in a redundant system configuration                             <ul style="list-style-type: none"> <li>• When starting from [Online] ⇒ [Remote Operation]: the remote operation is performed on the system of the remote head module specified as the connection destination.</li> <li>• When starting from the "CC IE Field Diagnostics" screen: the remote operation is performed on the system of the remote head module specified as the diagnostics target.</li> </ul> </li> </ul>
All Stations Specified <sup>*2</sup>	Select this to perform the remote operation on the station specified in the connection destination setting and all the stations on the same network. Set a target network in "Specify Target Network No."
Specify Group No. <sup>*2</sup>	Select this to perform the remote operation on the station specified in the connection destination setting and each station of the specific group on the specified network. Set a target network in "Specify Target Network No.", and set a group number in "Specify Group No." The remote operation cannot be performed for CC-Link IE Field Network because it does not have group number.
Specify Both Systems <sup>*2</sup>	Select this to perform the remote operation on the both systems (control/standby) on the route specified on the "Specify Connection Destination" screen. This setting is applied for a CPU module in a redundant system configuration.

\*1 When resetting a CPU module in a redundant system configuration and a remote head module, "Currently Specified Station/Specify Both Systems" is displayed.

\*2 FX5CPUs and remote head modules do not support it.

## Remote operation and RUN/STOP switch

When the operation to the CPU module differs by the remote operation, RUN/STOP switch, or remote RUN/PAUSE contact, the CPU module operates according to the priority shown below:

Operation to CPU module	Priority
STOP	1
PAUSE	2
RUN	3

The operating status after RUN/STOP switching on the CPU module or remote RUN/STOP contact operation are as follows.

Remote operation	CPU module switch		Remote RUN/STOP contact is ON (The CPU module is in STOP.)
	RUN	STOP	
RUN	RUN	STOP	STOP
STOP	STOP	STOP	STOP
PAUSE <sup>*1</sup>	PAUSE	STOP	STOP
RESET <sup>*2</sup>	Inoperable <sup>*3</sup>	RESET	RESET

\*1 Remote head modules do not support it.

\*2 Remote reset is required to be enabled in "Operation Related Setting" of "CPU Parameter."

\*3 Operable when the CPU module is switched to STOP by remote operation.

### ■Operations when using CPU modules in a redundant system configuration

For an RnPCPU (redundant mode), the operations differ depending on the operation modes.

An RnPSFCPU operates only when selecting the backup mode for the operation mode.

Operation mode	Operation
Backup mode	<ul style="list-style-type: none"> <li>■STOP Applied to both systems (order: control system → standby system).</li> <li>■RUN, PAUSE Applied to both systems (order: control system → standby system).</li> <li>■RESET Control system (specified): applied to both systems (order: control system → standby system). Standby system (specified): applied to the standby system only.</li> </ul>
Separate mode	Applied to the CPU module in the connective system.

# 18.3 Redundant Programmable Controller Operations

This section explains the method for operating redundant functions of both a CPU module and a remote head module in a redundant system configuration.

○: Supported, —: Not supported

Function name	RnPCPU (redundant mode)	RnPSFCPU	Remote head module
System switching	○	○	○
Operation mode change	○	—	—
Memory copy	○	○	—
Control system forced start while waiting for the other system started	○	○	—
Redundant function module communication test	○	○	—
System A/B setting	○	○	—

## Window

Select [Online] ⇒ [Redundant PLC Operation] ⇒ [Redundant Operation].

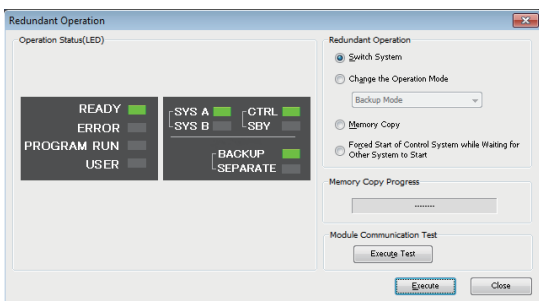

## System switching

The system of the current connection destination can be switched (control system → standby system).

This is allowed when the current connection destination is the control system, and the manual change permission flag (SM1646) is turned ON.

For details on the operation, refer to the following:

📖 MELSEC iQ-R CPU Module User's Manual (Application)

📖 MELSEC iQ-R CC-Link IE Field Network Remote Head Module User's Manual (Application)

### Operating procedure

Select "Switch System" in the "Redundant Operation" screen, and click the [Execute] button.

## Operation mode change

The operation mode of the current connection destination can be changed (backup mode or separate mode.)

This is allowed when the current connection destination is the control system.

For details on the operation, refer to the following:

📖 MELSEC iQ-R CPU Module User's Manual (Application)

### Operating procedure

1. Select "Change the Operation Mode" in the "Redundant Operation" screen.
2. Select a new operation mode ("Backup Mode" or "Separate Mode"), and click the [Execute] button.

## Memory copy from the control system to the standby system

---

To make the memory contents of the CPU modules in the control system and standby system consistent, the parameters and program etc. of the CPU module in the control system are transferred to the CPU module in the standby system.

For details on the operation, refer to the following:

📖 MELSEC iQ-R CPU Module User's Manual (Application)

### Operating procedure

Select "Memory Copy" in the "Redundant Operation" screen, and click the [Execute] button.

### Precautions

For the control system, the following operations and functions cannot be performed during memory copy; initialization of CPU memory operation, data writing to a programmable controller (including an operation while a CPU module is in RUN), memory copy, online program change, system switching, and operation mode change.

## Control system forced start while waiting for the other system started

---

The CPU module, which is waiting the other system to start, can start as the control system.

For details on the operation, refer to the following:

📖 MELSEC iQ-R CPU Module User's Manual (Application)

### Operating procedure

Select "Forced Start of Control System while Waiting for Other System to Start" in the "Redundant Operation" screen, and click the [Execute] button.

## Redundant function module communication test

---

A communication test can be performed only for a redundant function module (R6RFM) on a standby system.

This function is available only when a CPU module on a standby system is directly connected to a personal computer.

For details on the operation, refer to the following:

📖 MELSEC iQ-R CPU Module User's Manual (Application)

### Operating procedure

Click the [Execute Test] button in the "Redundant Operation" screen.

# System A/B setting

Either the system A or system B can be set for the connected CPU module.

For details on the operation, refer to the following:

📖 MELSEC iQ-R CPU Module User's Manual (Application)

## Window

Select [Online] ⇒ [Redundant PLC Operation] ⇒ [System A/B Setting].

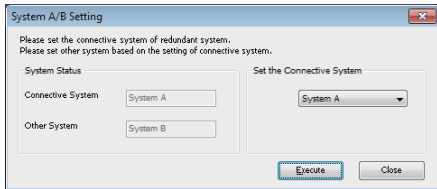

## Operating procedure

Select the system, which is set for the connective system, in "Set the Host System," then click the [Execute] button.

# 18.4 Safety Programmable Controller Operations

This section explains the method to perform the functions of an RnPSFCPU and an RnSFCPU.

## Safety operation mode switching

The safety operation modes (safety mode or test mode) of a CPU module can be switched.

For details on the operation, refer to the following:

📖 MELSEC iQ-R CPU Module User's Manual (Application)

### Window

Select [Online] ⇒ [Safety PLC Operation] ⇒ [Switch Safety Operation Mode].

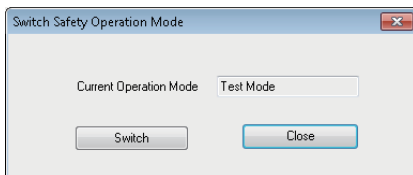

### Point

The safety operation mode of a running CPU module can be checked in the [Module Information List] tab on the "Module Diagnostics" screen.

### Precautions

#### ■ Unmatched data

The safety operation mode cannot be switched to the safety mode if project data in GX Works3 and that in an RnSFCPU or RnPSFCPU do not match. Whether data matches is checked by using their file identifiers; data is considered as a match if the file identifiers match.

If data does not match, perform either of the following operations. The safety operation mode becomes switchable to the safety mode.

- Writing data in GX Works3 to the CPU module
- Reading data from the CPU module

## Considerations before switching the safety operation mode

### CAUTION

- Test the programs fully on the system level for all safety loops before switching the mode to the safety mode.
- Before switching to the safety mode, ensure that the programs and parameters of the intended safety project have been written properly by the following operation.

18

### Operating procedure

1. Save an edited safety project in the personal computer. (Hereinafter called 'Project A')
2. Start GX Works3, and write the programs and parameters of a safety project to CPU module. (Page 580 Writing data to a programmable controller)
3. Start another GX Works3, and read the programs and the parameters from a CPU module. (Page 589 Reading data from a programmable controller) (Hereinafter called 'Project B')
4. Visually check that there is no difference between Project A and Project B. (Page 765 Checking programs, Page 765 Checking module parameters (Safety Communication Setting), Page 766 Checking parameters of safety remote I/O modules)
5. Test the programs fully in the application environment.

### Checking programs

To check whether intended programs were written properly, select "Project A" as the verification destination in Project B. Then, compare the verification source data the details of which are displayed in the "Verify Result" window with the project A data in a program editor.

Edited safety project (Project A)

Safety project in the CPU module (Project B)

Line	Step	Verify Source	Step	Verify Destination
1	0	LD SA1X0		LD SA1X0
2	1	OUT SA1Y0	1	OUT SA1Y0
3	2	LD SA1X10		LD SA1X10
4	3	OUT SA1Y10	3	OUT SA1Y10
5	4	END	4	END

Visual check

### Checking module parameters (Safety Communication Setting)

To check whether intended parameters were written properly, output the module parameters in "Safety Communication Setting" of "Module Parameter" to a file. Then, compare the saved CSV file with the project A data in the "Safety Communication Setting" window.

Edited safety project (Project A)

Safety project in the CPU module (Project B)

No.	Communication Destination	Network No.	Station No.	Station Type	Model Name	Communication Destination	Open System	Sending Interval Monitoring Time [ms]	Safety Refresh Monitoring Time [ms]
1	Local Network	1	1	Remote Device Station	NZ2GFSS2-32D	R08SFCPU	Active	30.0	60.0
2	Local Network	1	2	Local Station			Active	24.0	60.0

Visual check

The figure above is a screen example in which Excel is used. CSV files can also be checked by using other text editors.

## ■Checking parameters of safety remote I/O modules

Check the following for all of the safety remote I/O modules (device stations on CC-Link IE TSN and CC-Link IE Field Network) in Project B.

Read the parameters from the safety remote I/O modules in Project B. Export the read parameters to a file. Compare the saved CSV file with the data in the "Parameter Processing of Device Station" screen of Project A. Whether the intended parameters was written properly can be checked.

Edited safety project (Project A)

Safety project in the CPU module (Project B)

Station No.	Parameter ID	Checkbox	Name	Initial Value
1	CommfAdd1.StationParam.P_TransIntervalMonitorTime	FALSE	Transmission interval monitoring time	35
4	CommfAdd1.BasicUnitParam.loVoleOperate	FALSE	Operation setting of external power supply voltage error detection	0: Stop safety communication
5	CommfAdd1.BasicUnitParam.InputWiringSelection	FALSE	Wiring selection of input	0: Not used
6	CommfAdd1.BasicUnitParam.InputWiringSelection		Wiring selection of input X0	0: Not used
7	CommfAdd1.BasicUnitParam.InputWiringSelection		Wiring selection of input X1	0: Not used
8	CommfAdd1.BasicUnitParam.InputWiringSelection		Wiring selection of input X2	0: Not used
9	CommfAdd1.BasicUnitParam.InputWiringSelection		Wiring selection of input X3	0: Not used
10	CommfAdd1.BasicUnitParam.InputWiringSelection		Wiring selection of input X4	0: Not used
11	CommfAdd1.BasicUnitParam.InputWiringSelection		Wiring selection of input X5	0: Not used
12	CommfAdd1.BasicUnitParam.InputWiringSelection		Wiring selection of input X6	0: Not used
13	CommfAdd1.BasicUnitParam.InputWiringSelection		Wiring selection of input X7	0: Not used
14	CommfAdd1.BasicUnitParam.InputWiringSelection		Wiring selection of input X8	0: Not used
15	CommfAdd1.BasicUnitParam.InputWiringSelection		Wiring selection of input X9	0: Not used
	CommfAdd1.BasicUnitParam.InputWiringSelection		Wiring selection of input XA	0: Not used
	CommfAdd1.BasicUnitParam.InputWiringSelection		Wiring selection of input XB	0: Not used
	CommfAdd1.BasicUnitParam.InputWiringSelection		Wiring selection of input XC	0: Not used
	CommfAdd1.BasicUnitParam.InputWiringSelection		Wiring selection of input XD	0: Not used
	CommfAdd1.BasicUnitParam.InputWiringSelection		Wiring selection of input XE	0: Not used
	CommfAdd1.BasicUnitParam.InputWiringSelection		Wiring selection of input XF	0: Not used
	CommfAdd1.BasicUnitParam.InputWiringSelection		Wiring selection of input X10	0: Not used

The figure above is a screen example in which Excel is used. CSV files can also be checked by using other text editors.



## Identification check for safety data

In the "Check Safety Data Identity" screen, project data in GX Works3 can be checked if it is the same as that in an RnSFCPU or an RnPSFCPU. By this function, a user can check if a program operated in the safety mode is the data written by the user. For considerations when using this function, refer to the following:

📖 MELSEC iQ-R Safety Application Guide

### Window

Select [Online] ⇒ [Safety PLC Operation] ⇒ [Check Safety Data Identity].

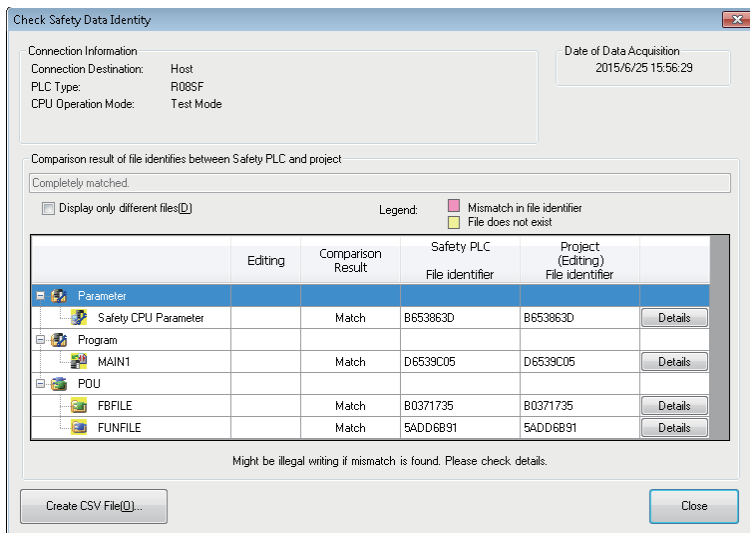

### Checking whether the data in the project and in the CPU module are consistent

Check the result of compared data.

### Checking whether the CPU module is running with the intended data

1. Save the information of Check Safety Data Identity in the CPU module as a CSV file using GX Works3 when the mode is changed to the safety mode after writing programs/parameters to the CPU module.
2. At a later date, perform the Check Safety Data Identity function with GX Works3, and check whether the "File identifier" in the saved CSV file and the one in the result are consistent.

If the data is not consistent, the data in the CPU module may not be the one written by the user. In this case, do not use the data in the actual operation.



The file identifier is added at conversion.

## Safety backup/restoration function

This function restores the backup data to a CPU module automatically.

### Automatic restoration setting

#### Operating procedure

Select [Online] ⇒ [Safety PLC Operation] ⇒ [Automatic Restore Setting] ⇒ [Enable]/[Disable].

# Safety module operation

The safety communication function can be enabled or disabled for a module used in a system using an RnSFCPU or RnPSFCPU.

## Window

1. Select [Online] ⇒ [Safety PLC Operation] ⇒ [Safety Module Operation].
2. Select a module to operate in the "Safety Module Operation - Select Module" screen, and click the [OK] button. (For an RnPSFCPU only)

**Ex.**

System using an RnPSFCPU

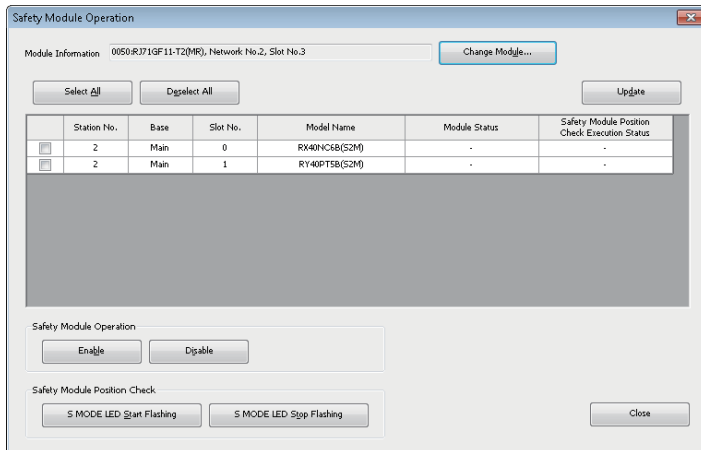

## Checking the position of a module

Check the mounting position of a module before enabling or disabling.

### Operating procedure

1. Select a module to check the position.
2. Click the [S MODE LED Start Flashing] button.

After checking that the S MODE LED of the selected module is flashing, click the [S MODE LED Stop Flashing] button.

## Enabling or disabling the safety communication function

The safety communication function can be switched to enable or disable for a module used in a system using an RnSFCPU or RnPSFCPU.

RnSFCPU do not support disabling the safety communication function.

### Operating procedure

1. Select a module to enable or disable the safety communication function.
2. Click the [Enable] or [Disable] button.
3. Reset the remote head module, or turn the power OFF and ON.

# 18.5 Checking Memory Usage

This section explains the method for checking the usage of the following memories:

- Data memory built in a CPU module
- Device/label memory built in a CPU module
- SD memory card inserted in a CPU module

## CPU memory operation screen

Each memory usage can be checked in the "CPU Memory Operation" screen.

### Window

Select [Online] ⇒ [CPU Memory Operation].

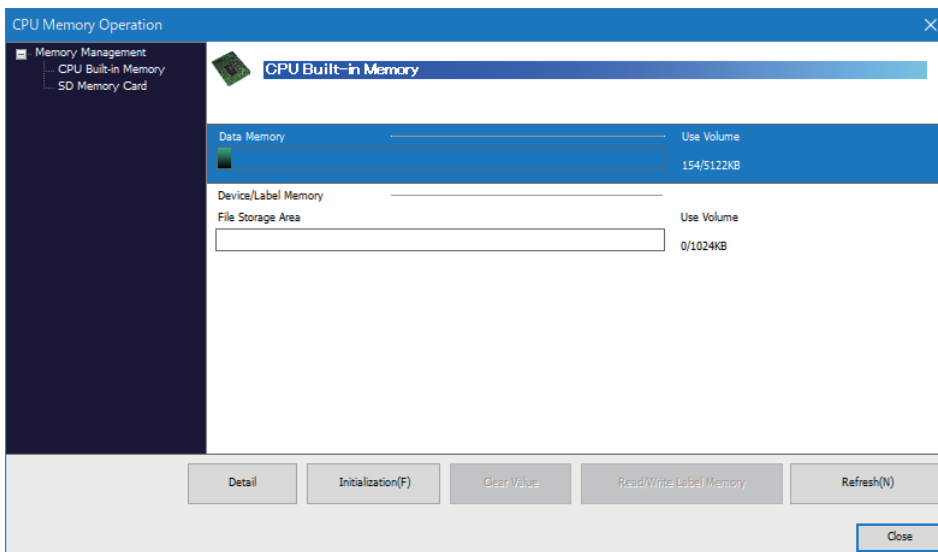

## Detailed memory usage screen

Details on each memory usage can be checked in the "Data Memory Details in Status of Use" screen.

### Window

Click the [Detail] button in the "CPU Memory Operation" screen.

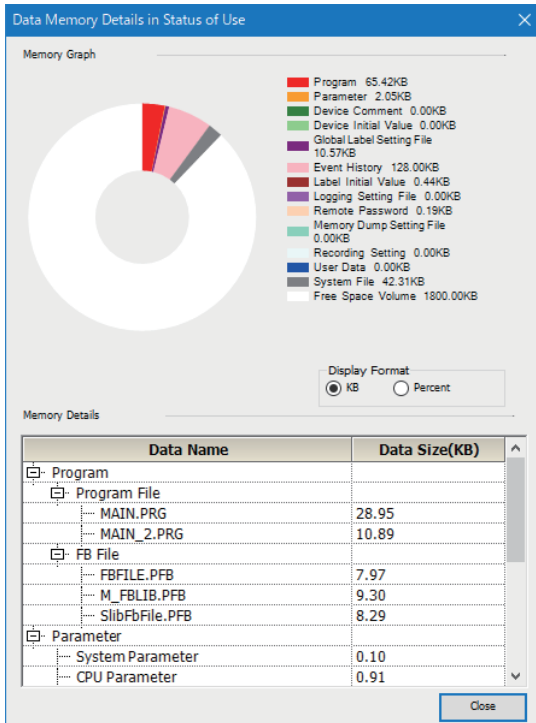

# 18.6 Initializing/Clearing a Memory

This section explains the methods for operating memories (such as initialization and zero clear) in a CPU module. For content initialized by the memory operations, refer to the following:

- 📖 MELSEC iQ-R CPU Module User's Manual (Application)
- 📖 MELSEC iQ-F FX5 User's Manual (Application)

## Initializing data

Delete files in the data memory/device memory/label memory of the CPU module, or folders/files stored in the SD memory card.

Note that the information for the user authentication will not be deleted. To delete the information, initialize all information. (👉 Page 690 When a user name and a password used in the user authentication function are lost)

After initializing, rewrite the programmable controller data to the CPU module.

If the power of the CPU is turned OFF and ON or the CPU module was reset, the allocation for the device/label memory is back to the initial status. (Each area has the default capacity.)

### Operating procedure

1. Select [Online] ⇒ [CPU Memory Operation]. (👉 Page 769 Checking Memory Usage)
2. Select "Data Memory" or "File Storage Area" in the "CPU Memory Operation" screen, and click the [Initialization] button. When initializing an SD memory card, select "SD Memory Card" displayed on the left of the screen.

### Precautions

Initialize an SD memory card to be inserted in a CPU module by using this function.

If an SD memory card is initialized by the function such as the Windows format function, it may be unavailable in a CPU module.

### ■Operations when using CPU modules in a redundant system configuration

For an RnPCPU (redundant mode), the operations differ depending on the operation modes.

An RnPSFCPU operates only when selecting the backup mode for the operation mode.

Operation mode	Operation
Separate mode	Applied to the CPU module in the connective system.
Backup mode	Applied to both systems (order: control system → standby system).

## Clearing values

Clear the values of devices, labels, and file registers to '0', and perform latch clear operation.

### Operating procedure

1. Select [Online] ⇒ [CPU Memory Operation]. (  Page 769 Checking Memory Usage)
2. Select "Device/Label Memory" in the "CPU Memory Operation" screen, and click the [Clear Value] button.
3. Set each item in the "Clear Value" screen and click the [Execute] button.

### Point

When the initial device value file or initial label value file is written to a CPU module, the initial values are initialized by resetting the CPU module.

### ■ Operations when using CPU modules in a redundant system configuration

For an RnPCPU (redundant mode), the operations differ depending on the operation modes.

An RnPSFCPU operates only when selecting the backup mode for the operation mode.

Operation mode	Operation
Separate mode	Applied to the CPU module in the connective system.
Backup mode	Applied to both systems (order: control system → standby system).

# 18.7 Reading/Writing the Label Memory

This section explains the methods for reading the label memory (current label values) from a CPU module and for writing the read label memory to the CPU module.

FX5CPUs do not support this function.

## Conditions

The label memory can be read/written only when all the following conditions are satisfied:

Operation	Condition
Reading the label memory	A label of which the label memory can be read exists in a project. (☞ Page 774 Availability of reading the label memory)
	All programs in a project are converted.
	System parameters and CPU parameters match between the following data: <ul style="list-style-type: none"> <li>• Project data opened in GX Works3</li> <li>• Data in a CPU module</li> </ul> For an RnSF CPU and an RnPSF CPU, the safety CPU parameters must match between the above data.
	A project or CPU module is logged on to as a user with any of the following access levels. (For an RnSF CPU and an RnPSF CPU only) <ul style="list-style-type: none"> <li>• Administrators</li> <li>• Developers</li> <li>• Assistant Developers</li> </ul>
Writing the label memory	All programs in a project are converted.
	A CPU module is in the STOP state.
	The module type and operation mode of a CPU module match between when reading and writing the label memory.
	A CPU module is in the test mode. (For an RnSF CPU and an RnPSF CPU only)
	System parameters and CPU parameters match between the following data: <ul style="list-style-type: none"> <li>• Data when reading the label memory</li> <li>• Data in a CPU module</li> </ul> For an RnSF CPU and an RnPSF CPU, the safety CPU parameters must match between the above data.
	A project or CPU module is logged on to as a user with any of the following access levels. (For an RnSF CPU and an RnPSF CPU only) <ul style="list-style-type: none"> <li>• Administrators</li> <li>• Developers</li> <li>• Assistant Developers</li> </ul>

## Reading the label memory

The following shows the procedure for reading the label memory from a CPU module.

Before reading the label memory, check if any function such as the change current value function is being performed to a CPU module.

If the current value is changed while reading, the value after the change is read.

### Operating procedure

1. Select [Online] ⇒ [CPU Memory Operation].
2. Select "Device/Label Memory" in "CPU Built-in Memory" of the "CPU Memory Operation" screen.
3. Click the [Read/Write Label Memory] button.
4. Specify the storage destination for the label memory in "File Storage Destination" of the "Read/Write Label Memory" screen.
5. Select "Read from Label Memory" and click the [Execute] button.

The "BackupData" folder is generated in the storage destination specified in step 4, and the label memory is stored as a file in the folder.

## Precautions

- Do not reset a CPU module or turn the power of the CPU module OFF while reading the label memory. Doing so cancels reading the label memory. (Page 774 When reading the label memory is canceled)
- If the "BackupData" folder is already in the storage destination for the label memory, the folder and all the data in the folder are deleted, and a new "BackupData" folder and each unit of data are generated.
- When reading the label memory from an RnPCPU (redundant mode), the memory is read from the connected system.

### ■Availability of reading the label memory

The following table shows whether the label memory can be read for each label class.

○: Readable, ×: Not readable

Label	Class	Availability
Global label	VAR_GLOBAL	○
	VAR_GLOBAL_CONSTANT	×
	VAR_GLOBAL_RETAIN	○
Local label	VAR_INPUT	○
	VAR_OUTPUT	○
	VAR_OUTPUT_RETAIN	○
	VAR	○
	VAR_CONSTANT	×
	VAR_RETAIN	○
	VAR_IN_OUT	○
	VAR_PUBLIC	○
	VAR_PUBLIC_RETAIN	○

The label memory cannot be read for the following labels:

- Pointer type label
- Label to which a device is assigned
- Alias
- Function
- FB instance of a macro type function block
- FB instance of a standard function block
- FB instance of a module FB
- Program set as "No Execution Type"
- Local label in an unregistered program

### ■When reading the label memory is canceled

Reading the label memory is canceled in the following cases:

- A CPU module is reset while reading.
- The power of a CPU module is turned OFF while reading.
- Reading is canceled.
- The label memory cannot be read. (For example, free space on the read destination is insufficient or the access right to the read destination is not granted.)

When reading the label memory is canceled, the "BackupData" folder and all the files in the folder are deleted.



## Writing the label memory

The following shows the procedure for writing the label memory to a CPU module.

### Operating procedure

1. Select [Online] ⇒ [CPU Memory Operation].
2. Select "Device/Label Memory" in "CPU Built-in Memory" of the "CPU Memory Operation" screen.
3. Click the [Read/Write Label Memory] button.
4. Specify the folder in which "BackupData" folder was generated when reading the label memory in "File Storage Destination" of the "Read/Write Label Memory" screen.
5. Select "Write to Label Memory" and click the [Execute] button.

### Point

By selecting "Save" for the following CPU parameter, the operation of writing the label memory is displayed as an event of 'Write Device...(n points)' or 'Write Label...(n points)' in the "Event History" screen.

- "CPU Parameter" ⇒ "RAS Setting" ⇒ "Event History Setting" ⇒ "Save Device/Label Operations"

### Precautions

- Do not turn the power of a CPU module OFF or reset the CPU module while writing the label memory. Doing so cancels writing the label memory.
- Do not edit a file in the "BackupData" folder. Doing so may prevent the label memory from being written properly.
- Characters in a label name are case-sensitive.
- The label memory of a label to which a device is assigned is not written.
- If any of the following items of a label is edited from when reading the label memory until when writing it again, the label memory of the label is not written.
  - Label name
  - Data type
  - Number of dimensions of the array

In addition, if a program name is edited, the label memory of local labels used in the program is not written.
- If the number of array elements is changed from when reading the label memory until when writing it again, it is required to write data to a programmable controller before writing the label memory to a programmable controller.
 

In addition, when writing the label memory, the label memory is written only for the number of elements before the change.
- If writing the label memory while monitoring a program, monitoring pauses and it starts again after writing the label memory is completed.
- When monitoring a program in an engineering tool other than GX Works3, the monitor value may be changed when writing the label memory is completed.
- When writing the label memory to an RnPCPU (redundant mode), the memory is written to the connected system.

# 18.8 Firmware Update

The firmware of a module can be updated using GX Works3.

This section explains the method to display the "Update Firmware" screen.

For the method to update a firmware and the considerations, refer to the following:

📖 MELSEC iQ-R Module Configuration Manual

📖 MELSEC iQ-F FX5 User's Manual (Application)

## Window

Select [Tool] ⇒ [Update Firmware].

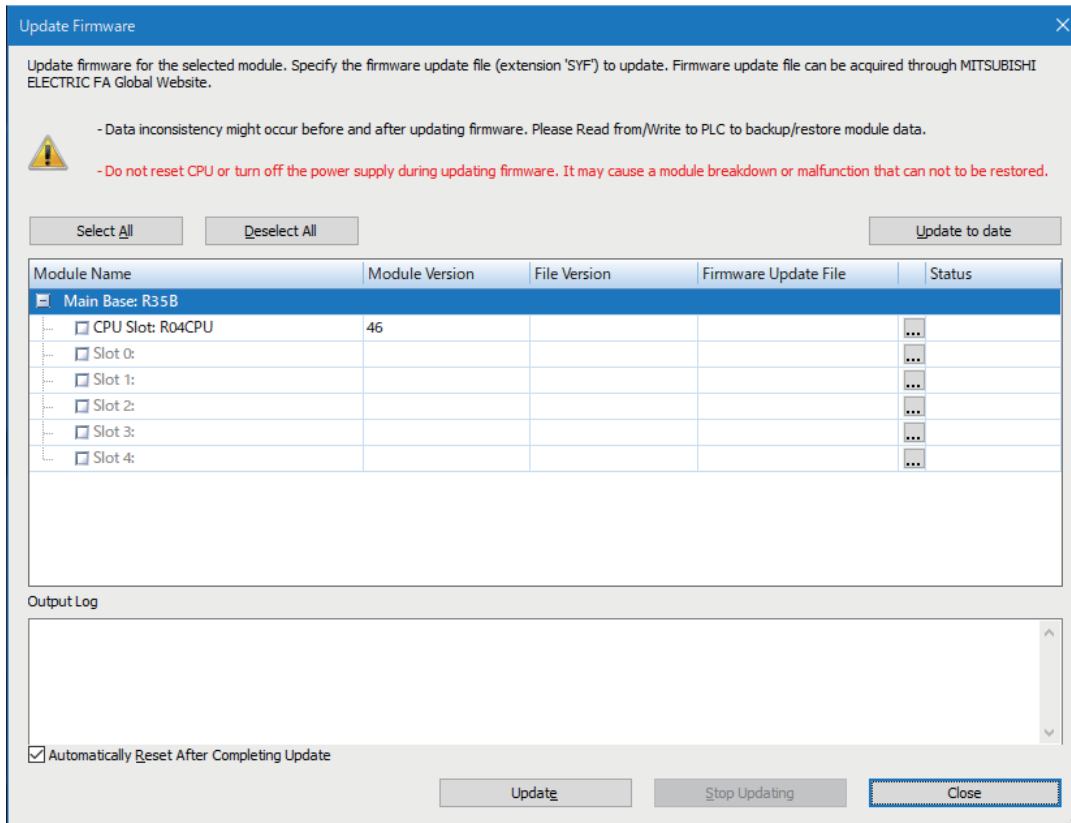

# APPENDIX

## Appendix 1 Additions and Changes from Previous Version

This section shows the additions and changes with upgrade.

For additions and changes in a process control function block with a version upgrade, refer to 'Version Upgrade' in the following manual:

📖 MELSEC iQ-R Programming Manual (Process Control Function Blocks/Instructions)

### Functions, operability, and performance

#### Version 1.001B

Item	Description	Reference
Online program change	<ul style="list-style-type: none"> <li>Online program change on an instruction basis in ladder programs is supported.</li> <li>Online program change for ST programs is supported.</li> <li>Online program change after changing or deleting initial label values is supported.</li> </ul>	Page 597 Writing Programs While a CPU Module is in the RUN State
Monitoring	<ul style="list-style-type: none"> <li>When using a constant label for an input argument of a function block, a constant value is displayed in monitoring.</li> <li>When display language in GX Works3 is changed, the language in an intelligent function module monitor window is also changed.</li> </ul>	Page 616 Checking Execution Programs on a Program Editor

#### Version 1.005F

Item	Description	Reference
Display language switching	<ul style="list-style-type: none"> <li>Display in Simplified Chinese is supported.</li> </ul>	Page 50 Display Language Switching
Printing	<ul style="list-style-type: none"> <li>Printing the product information list is supported.</li> </ul>	Page 92 Printing Data
Module tool list	<p>The following settings are available.</p> <ul style="list-style-type: none"> <li>"Offset/gain setting" under "Temperature Input" for "iQ-R Series"</li> <li>"Q61LD Two-Point Calibration Setting" under "Analog Module" for "Q Series"</li> <li>"Q61LD Default Setting" under "Analog Module" for "Q Series"</li> </ul>	Page 218 Other Settings of Intelligent Function Modules
Interaction with iQ Works <sup>*1</sup>	<ul style="list-style-type: none"> <li>System labels are supported.</li> <li>The parameter reflection function of MELSOFT Navigator and the parameter import function are supported.</li> </ul>	Page 225 REGISTERING LABELS
Program check	<ul style="list-style-type: none"> <li>The program check function is supported.</li> </ul>	Page 416 Checking a Program
Diagnostics <sup>*4</sup>	<ul style="list-style-type: none"> <li>The CC-Link IE Controller Network diagnostics (twisted pair cable) is supported.</li> </ul>	Page 715 CC-Link IE Controller Network diagnostics
Memory dump <sup>*3</sup>	<ul style="list-style-type: none"> <li>The memory dump function is supported.</li> </ul>	Page 726 Memory Dump Function

#### Version 1.007H

Item	Description	Reference
Module tool list	<ul style="list-style-type: none"> <li>"Analog input - Offset/gain setting" under "Analog Adapter" for "FX5 Series" is supported.</li> <li>"Analog output - Offset/gain setting" under "Analog Adapter" for "FX5 Series" is supported.</li> </ul>	Page 218 Other Settings of Intelligent Function Modules
Simple motion module setting function	<ul style="list-style-type: none"> <li>The advanced synchronous control setting can be set on one screen, and the monitor function is supported.</li> </ul>	Page 219 Simple motion module setting function
System label	<ul style="list-style-type: none"> <li>A system label change notification can be received automatically.</li> </ul>	Page 256 Importing after checking the changes
Creating a program	<ul style="list-style-type: none"> <li>Function Block Diagram/Ladder Diagram language is supported. <sup>*3</sup></li> </ul>	Page 319 Creating an FBD/LD Program
Reading sample comments	<ul style="list-style-type: none"> <li>Sample comments are supported for a project in which an RD77MS is used.</li> </ul>	Page 409 Reading sample comments

A

Item	Description	Reference
Simulation	Simulations in the following projects are supported. <ul style="list-style-type: none"> <li>• Project for an RnCPU</li> <li>• Project in which RD77MS is used (It can interact with the simulation function of a project for an RnCPU.)</li> </ul>	Page 518 PROGRAM SIMULATION
Others	<ul style="list-style-type: none"> <li>• Connected devices on the CC-Link IE Field Network can automatically be detected.</li> </ul>	—

## Version 1.008J

Item	Description	Reference
Event history	<ul style="list-style-type: none"> <li>In the event history of an R12CCPU-V, script position information is added to the detailed information of the error code (3044h: program fault).</li> </ul>	Page 723 Error History/Operation History Check

## Version 1.010L

Item	Description	Reference
Options	<p>The following option is added:</p> <ul style="list-style-type: none"> <li>"Convert" ⇒ "Online Program Change" ⇒ "Operational Setting" ⇒ "Write device comment"</li> </ul>	Page 84 Option Settings for Each Function
Opening a GX Works2 format project	<ul style="list-style-type: none"> <li>Projects for universal model process CPUs are supported.</li> </ul>	Page 107 Opening a GX Works2 format project
Verification	<ul style="list-style-type: none"> <li>Labels can be verified.</li> </ul>	Page 143 Verifying Projects
Project revision history	<ul style="list-style-type: none"> <li>The project revision history function is supported.</li> </ul>	Page 160 Project Revision History
Temporary ladder change	<ul style="list-style-type: none"> <li>An operation of a ladder block can temporarily changed in a ladder program.</li> </ul>	Page 293 Changing ladder blocks temporarily
Search	<ul style="list-style-type: none"> <li>As one of the search functions, a function to search a global device and a local device individually is added.</li> </ul>	Page 448 Searching for/ Replacing Devices and Labels
Library management	<ul style="list-style-type: none"> <li>A user library is supported.</li> </ul>	Page 506 Enhancing Use of User Library
Simulation	<ul style="list-style-type: none"> <li>A project for an RnPCPU can be simulated.</li> </ul>	Page 518 PROGRAM SIMULATION
Diagnostics	<ul style="list-style-type: none"> <li>The MELSECNET diagnostics is supported for a project in which a MELSEC-Q series MELSECNET/H network module is used.</li> </ul>	Page 720 MELSECNET diagnostics







## Version 1.015R

Item	Description	Reference
Element selection window	<ul style="list-style-type: none"> <li>Elements of RnCPUs and RnPCPUs are displayed in order by their capacity.</li> </ul>	Page 57 Element selection window
Options	<p>The following option is added:</p> <ul style="list-style-type: none"> <li>"Convert" ⇒ "Basic Setting" ⇒ "Operational Setting" ⇒ "Optimize the Number of Steps."</li> </ul>	Page 84 Option Settings for Each Function
Opening a GX Works2 format project	<p>The following items can be imported:</p> <ul style="list-style-type: none"> <li>The boot file setting, SFC setting, and multiple CPU setting of PLC parameters</li> <li>A structured ladder program, FBD program, and device memory of an FXCPU (FX3U/FX3UC)</li> <li>The settings of CC-Link IE Field and CC-Link IE Control of network parameters</li> <li>The setting of a QD75 type positioning module in intelligent function modules.</li> </ul> <p>For considerations when reading a GX Works2 format SFC program in GX Works3, refer to the technical bulletin FA-A-0192.</p>	Page 107 Opening a GX Works2 format project
Verification	<ul style="list-style-type: none"> <li>Differences of a ladder diagram can be checked in the detailed display of a ladder program (ladder diagram format).</li> </ul>	Page 145 Checking a verification result
Reading a module configuration	<ul style="list-style-type: none"> <li>Module configuration can be read from the actual module in a project for an FX5CPU.</li> </ul>	Page 191 Reading the module configuration from an actual system
Module tool list	<ul style="list-style-type: none"> <li>Temperature control modules (R60TCTRT2TT2, R60TCTRT2TT2BW, R60TCRT4, R60RCRT4BW) are supported.</li> </ul>	Page 218 Other Settings of Intelligent Function Modules
Creating an SFC program	<ul style="list-style-type: none"> <li>Module labels of an RnCPU and sample comments are supported for an SFC program.</li> </ul>	Page 248 Registering Module Labels Page 409 Reading sample comments
Execution order setting	<ul style="list-style-type: none"> <li>The execution order of program blocks can be set.</li> </ul>	Page 260 Program Execution Order and Execution Type Settings
Creating a program	<ul style="list-style-type: none"> <li>Sequential Function Chart language is supported in projects for an RnCPU and an RnENCPU. *3</li> </ul>	Page 342 Creating an SFC Program
Memory size calculation	<ul style="list-style-type: none"> <li>A memory size can be calculated offline.</li> </ul>	Page 432 Calculating Memory Size
I/O system setting	<ul style="list-style-type: none"> <li>Operations of an input/output device can be simulated by using this function.</li> </ul>	Page 547 Simulation of External Device Operations

A

Item	Description	Reference
Writing data to an SD memory card Reading data from an SD memory card	<ul style="list-style-type: none"> <li>Data can be written to/read from an SD memory card inserted into a personal computer.</li> </ul>	Page 609 Writing/Reading Data to/from Memory Card
Diagnostics	<p>The following statuses are displayed in the CC-Link IE Field Network diagnostics.</p> <ul style="list-style-type: none"> <li>Network connection status</li> <li>Parameter setting status</li> <li>Station type match status</li> <li>Network number match status</li> <li>Station number duplication occurrence status</li> </ul> <p>In addition, the error frame reception status is displayed in three stages according to the frequency.</p> <p>The following modules can be diagnosed:</p> <ul style="list-style-type: none"> <li>CC-Link IE Field Network safety remote I/O modules (NZ2GFSS2-32D, NZ2EXSS2-8TE)</li> <li>CC-Link IE Field Network remote I/O modules (NZ2GF2B1N1-16D/T/TE, NZ2GFCF1-32D/T/DT)</li> </ul>	Page 717 CC-Link IE TSN/CC-Link IE Field Network diagnostics
Offline monitor	<ul style="list-style-type: none"> <li>Device data collected with the memory dump function can be monitored on a program editor.</li> </ul>	Page 736 Checking Collected Data on Program Editor
Others	<ul style="list-style-type: none"> <li>The high-speed remote net mode of CC-Link IE Field is supported.</li> <li>The receive buffer full detection signal is supported for a project in which an RJ71EN71 using Ethernet communication is used.</li> </ul>	—
Safety system	<ul style="list-style-type: none"> <li>The safety communication function is available in an RnSFCPU project in which a CC-Link IE Field Network module is used.</li> </ul>	

## Version 1.020W

Item	Description	Reference
Navigation window	<ul style="list-style-type: none"> <li>Scan programs can be sorted by execution order.</li> <li>A parameter editor opens and displays "Program Setting" in "CPU Parameter" by selecting a program execution type in the navigation window and right-clicking [Program Setting] in the shortcut menu.</li> </ul>	Page 54 Navigation window
Options	<p>The following option is added:</p> <ul style="list-style-type: none"> <li>"Convert" ⇒ "Basic Setting" ⇒ "Conversion Operation" ⇒ "Enable Rebuild All (Reassignment)"/"Enable Rebuild All (Retain)"/"Enable Conversion"</li> </ul>	Page 84 Option Settings for Each Function
Opening a project	<ul style="list-style-type: none"> <li>When opening a project, the process to open the work windows that were opened in the previous project can be cancelled by pressing the  + [Pause Break] key.</li> </ul>	Page 105 Opening a project
Opening a GX Works2 format project	<p>The following items can be imported:</p> <ul style="list-style-type: none"> <li>Structured ladder program used for an FXCPU (FX3U/FX3UC)</li> <li>Setting for the CC-Link and Ethernet of network parameters</li> <li>Setting of an analog module and a high-speed counter module of intelligent function modules</li> <li>The boot file setting, SFC setting, and multiple CPU setting of PLC parameters</li> </ul>	Page 107 Opening a GX Works2 format project
Verification	<ul style="list-style-type: none"> <li>An FBD/LD program and an SFC program can be verified with ones in a CPU module.</li> <li>The verification result of an SFC program and a Zoom can be checked in the detailed display.</li> </ul>	Page 150 Detailed display (program) Page 595 Verifying Programmable Controller Data
Ladder editor	<ul style="list-style-type: none"> <li>When a contact is moved with a drag and drop operation while pressing the  key, lines are automatically drawn and the program of the original ladder block is completed.</li> <li>After selecting a range by pressing the  +     keys, when the mouse cursor is moved back to the original position, the selected range is deselected.</li> </ul>	Page 269 Entering ladders
Temporary ladder change	<ul style="list-style-type: none"> <li>Only a ladder block changed temporarily can be displayed in the "Line Statement List" screen.</li> <li>When changing the operation of a specific ladder block temporarily, an unused pointer device can be entered.</li> <li>When a character string is entered, it can be registered as a pointer type label.</li> </ul>	Page 294 Displaying ladder blocks changed temporarily in a list
Creating a program	<ul style="list-style-type: none"> <li>Sequential Function Chart language is supported in a project for an RnPCPU.<sup>73</sup></li> </ul>	Page 342 Creating an SFC Program

Item	Description	Reference
FBD/LD editor	<ul style="list-style-type: none"> <li>When registering a label by entering a label name in an editor, a suitable data type for the label in the location where the element is to be added is displayed in the "Undefined Label Registration" screen.</li> <li>A blank row between FBD network blocks and a blank column in the FBD network blocks can be deleted.</li> <li>Multiple undefined FBs/FUNs can be updated in a batch.</li> <li>Multiple rows can be inserted/deleted at the same time.</li> <li>An element can be edited by pressing the <b>[Enter]</b> key or <b>[E2]</b> key on an editor.</li> <li>During monitoring, the background color of values of BOOL type labels and the power flow of a connection line can be set.</li> </ul>	Page 325 Adding elements
Creating an SFC program	<p>The following are improved in an SFC program.</p> <ul style="list-style-type: none"> <li>Multiple initial steps can be edited on an SFC editor.</li> <li>A jump can be edited on an SFC editor.</li> <li>A Zoom can be copied on an SFC editor.</li> <li>SFC Auto-scroll monitor can be used.</li> <li>Block information can be searched and replaced.</li> </ul>	Page 350 Inserting initial steps Page 355 Inserting/editing jumps (connection lines) Page 629 Monitoring with the SFC auto-scroll
Import/export of device comments	<ul style="list-style-type: none"> <li>Multiple device comments can be imported/exported in a batch.</li> </ul>	Page 407 Importing/exporting device comments
Program check	<ul style="list-style-type: none"> <li>The program check function is supported in a project for an FX5CPU.</li> </ul>	Page 417 Program check
Library management	<ul style="list-style-type: none"> <li>A user library is supported for a project used for an FX5CPU.</li> </ul>	Page 507 Creating a library file
Library	<ul style="list-style-type: none"> <li>A library POU to be exported can be selected individually.</li> <li>Multiple library POUs can be selected in the library list.</li> <li>A help file can be set and opened from the library list.</li> </ul>	Page 507 Creating a library Page 510 Enhanced use of libraries
Simulation	<p>Simulations in the following projects are supported.</p> <ul style="list-style-type: none"> <li>Project for multiple CPUs</li> <li>Project for an RnSFCPU</li> <li>Project for an RnENCPU</li> </ul> <p>In addition, the following are supported by the simulation function.</p> <ul style="list-style-type: none"> <li>SFC program execution in a project for an RnCPU</li> <li>Simulation of a project in which multiple RD77MSs are used (SMM Simulator2)</li> <li>I/O system setting (process response operation)</li> </ul>	Page 524 System Simulation
Specifying a connection destination	<ul style="list-style-type: none"> <li>Multiple connection destination settings can be created.</li> </ul>	Page 557 Specification of Connection Destination
Online data operation	<ul style="list-style-type: none"> <li>The selection status of data can be changed for each data in the [Write] tab of the "Online Data Operation" screen.</li> </ul>	Page 577 Configuration of the online data operation screen
Diagnostics	<p>The following modules can be diagnosed:</p> <ul style="list-style-type: none"> <li>CC-Link IE Field Network remote I/O modules (NZ2GFCF1-32D, NZ2GFCF1-32T, NZ2GFCF1-32DT)</li> </ul>	Page 717 CC-Link IE TSN/CC-Link IE Field Network diagnostics
Monitor	<ul style="list-style-type: none"> <li>When an FB program is opened while monitoring a program, the FB instance starts monitoring.</li> </ul>	Page 613 Starting/stopping monitoring
Installation of a USB driver	<ul style="list-style-type: none"> <li>A USB driver is installed simultaneously with the installation of GX Works3.</li> </ul>	Page 984 USB Driver Installation Procedure
Others	<ul style="list-style-type: none"> <li>The amplifier-less operation function of positioning modules (RD75D2, RD75D4, RD75P2, and RD75P4) is supported.*4</li> <li>Sample comments and the intelligent function module monitor are supported for a project in which an MES interface module (RD81MES96) is used.</li> <li>Daylight saving time can be adjusted for the following modules.               <ul style="list-style-type: none"> <li>RnCPU (R04CPU, R08CPU, R16CPU, R32CPU, R120CPU)</li> <li>RnENCPU (R04ENCPU, R08ENCPU, R16ENCPU, R32ENCPU, R120ENCPU)</li> </ul> </li> </ul>	—

## Version 1.022Y

Item	Description	Reference
Options	<p>The following option is added:</p> <ul style="list-style-type: none"> <li>"Program Editor" ⇒ "Ladder Editor" ⇒ "Verify" ⇒ "Verify Setting" ⇒ "Detailed Result Verification Selection"</li> </ul>	Page 84 Option Settings for Each Function
Creating an FBD/LD program	<ul style="list-style-type: none"> <li>A function to align an FBD network block on an FBD/LD editor to the left side is supported.</li> </ul>	Page 335 Layout correction
Program check	<ul style="list-style-type: none"> <li>The syntax check function is supported in a project for an RnCPU.</li> </ul>	Page 416 Syntax check
Writing data to a programmable controller	<ul style="list-style-type: none"> <li>In projects for an RnCPU, an RnENCPU, and an RnSFCPU, whether to check the duplication of POU names can be selected.*3</li> </ul>	Page 580 Writing data to a programmable controller Page 602 POU duplication check
Online program change	<ul style="list-style-type: none"> <li>The program restoration information can be written in the background process.*3</li> </ul>	Page 603 Program transfer during the online program change

Item	Description	Reference
Conversion	<ul style="list-style-type: none"> <li>• In a project for an RnCPU, the free space of the label memory area can be displayed in the "Output" window when the following processes are completed: converting any or all programs, or performing the online program change.</li> </ul>	—
Others	<p>The following are supported for a project in which an RD77GF is used.</p> <ul style="list-style-type: none"> <li>• Linear servo motor control mode/direct drive motor control mode/fully closed loop control mode</li> <li>• Synchronous encoder via a servo amplifier</li> </ul>	



## Version 1.025B

Item	Description	Reference
Operating environment (operating system)	<ul style="list-style-type: none"> <li>Windows 10 is supported.</li> </ul>	—
Specifying a connection destination	In a project used for an RCPUCPU and remote head module, connection via a following network interface board is supported. <ul style="list-style-type: none"> <li>CC-Link IE Controller Network interface board</li> <li>CC-Link IE Field Network interface board</li> <li>CC-Link Ver.2 board</li> </ul>	Page 46 Connection through I/F boards
	<ul style="list-style-type: none"> <li>The GOT transparent function performed via CC-Link IE Control Network is supported.*4</li> </ul>	Page 569 Accessing via GOT (GOT Transparent Function)
Printing	<ul style="list-style-type: none"> <li>This function is improved to print a selected page.</li> </ul>	Page 92 Printing Data
Opening a GX Works2 format project	<ul style="list-style-type: none"> <li>A function to open a GX Works2 user library is supported in a project for an FX5CPU.</li> </ul>	Page 107 Opening a GX Works2 format project
Project management Exporting libraries	<ul style="list-style-type: none"> <li>An iQ AppPortal information file can be output.</li> </ul>	Page 126 Saving a project
Changing the module type/ operation mode	<ul style="list-style-type: none"> <li>The module type can be changed from an FX5CPU to an R04CPU.</li> </ul>	Page 139 Changing the Module Type and Operation Mode of Projects
Verification	<ul style="list-style-type: none"> <li>Module parameters of a CPU module can be verified.</li> </ul>	Page 144 Parameters
XY assignment display	<ul style="list-style-type: none"> <li>A function to display XY assignment information on the module configuration diagram and in the navigation window is supported.</li> </ul>	Page 198 XY assignment display
Module tool list	<ul style="list-style-type: none"> <li>A remote head module (RJ72GF15-T2) is supported (creation of wave output data).</li> </ul>	Page 218 Other Settings of Intelligent Function Modules
Creating an ST program Creating an FBD/LD program	The following are supported. <ul style="list-style-type: none"> <li>Registering devices/labels in the watch window automatically</li> <li>Displaying 'Warning' when type conversion is performed automatically</li> <li>Changing the display color of devices, labels and comments</li> <li>Creating multiple worksheets</li> </ul>	Page 132 Adding worksheets Page 309 Creating an ST Program Page 319 Creating an FBD/LD Program
Execution order setting	<ul style="list-style-type: none"> <li>The execution order of multiple worksheets can be set.</li> </ul>	Page 261 Worksheet execution order setting
Creating a ladder program	The following are supported. <ul style="list-style-type: none"> <li>Switching showing or hiding grids, and setting the grid color</li> <li>Displaying a comment in the continuous pasting function</li> <li>Returning to an edited ladder program to the state before the edition.</li> <li>Replacing a ladder program in the read mode</li> <li>Adjusting the size of an editor to the width of a window</li> </ul>	Page 264 Creating a Ladder Program
FBD/LD editor SFC editor	<ul style="list-style-type: none"> <li>An editor is zoomed in and out on the cursor position.</li> </ul>	Page 319 Creating an FBD/LD Program Page 342 Creating an SFC Program
Device comment	<ul style="list-style-type: none"> <li>Device comments can be exported to a file for each device type.</li> </ul>	Page 408 Exporting
Program check	<ul style="list-style-type: none"> <li>The syntax check function is supported in a project for an FX5CPU.</li> </ul>	Page 416 Syntax check
Search/replacement	<ul style="list-style-type: none"> <li>In a ladder editor, a range for search or replacement can be specified.</li> </ul>	Page 446 Range specification in editors
Device batch replacement	<ul style="list-style-type: none"> <li>When a character string is pasted onto the cell in the "Replace Device" row, the value set for "Points" will be remained.</li> </ul>	Page 454 Batch Replacing of Devices and Labels
Cross reference	<ul style="list-style-type: none"> <li>The current window can be specified as a search target.</li> </ul>	Page 457 Displaying cross reference information
Cross reference Watch	<ul style="list-style-type: none"> <li>A comment can be edited using a shortcut menu.</li> </ul>	Page 457 Displaying cross reference information Page 637 Checking Current Values by Registering Devices/Labels
Unused label list	<ul style="list-style-type: none"> <li>A function to display unused labels in the list format is supported.</li> </ul>	Page 463 Displaying a list of unused labels
Library management	<ul style="list-style-type: none"> <li>Libraries using a module label and/or structure can be exported.</li> <li>A sample library is supported in a project for an FX5CPU.</li> </ul>	Page 507 Creating a library file Page 512 Utilizing an element
Simulation	<ul style="list-style-type: none"> <li>A project for an FX5CPU can be simulated.</li> </ul>	Page 518 PROGRAM SIMULATION

Item	Description	Reference
Writing data to a programmable controller Online program change	<ul style="list-style-type: none"> <li>In a project used for an RnPCPU (process mode/redundant mode), whether or not to check the duplication of POU names can be selected.*<sup>3</sup></li> </ul>	Page 580 Writing data to a programmable controller Page 602 POU duplication check
Device/buffer memory batch monitor	<ul style="list-style-type: none"> <li>Bit visibility is improved.</li> </ul>	Page 633 Checking Device/Buffer Memory in a Batch
Watch	<ul style="list-style-type: none"> <li>Visibility of bit devices and bit type labels are improved.</li> </ul>	Page 637 Checking Current Values by Registering Devices/Labels
Diagnostics	<p>The following modules can be diagnosed:</p> <ul style="list-style-type: none"> <li>CC-Link IE Field Network remote I/O modules (NZ2GF2B1N1-16D, NZ2GF2B1N1-16T, NZ2GF2B1N1-16TE)</li> </ul>	Page 717 CC-Link IE TSN/CC-Link IE Field Network diagnostics
Project management	<ul style="list-style-type: none"> <li>Labels, function blocks, and functions can be hidden in the navigation window.</li> </ul>	—
Conversion	<ul style="list-style-type: none"> <li>In a project for an FX5CPU, the free space of the label memory area is displayed on the "Output" window when the following processes are completed: converting any or all programs, or performing the online program change.</li> </ul>	
Parameter	<p>The following functions for RnCPUs and RnENCPU are available:</p> <ul style="list-style-type: none"> <li>File transfer function (FTP client)</li> <li>CPU module data backup/restoration function</li> <li>iQ Sensor Solution data backup/restoration function</li> </ul>	
Module label	<ul style="list-style-type: none"> <li>Module labels can easily be updated.</li> </ul>	
Others	<ul style="list-style-type: none"> <li>An RnPCPU (redundant mode) is supported.</li> <li>The high-speed logging mode of an analog module (Q64ADH) is supported.</li> <li>A redundant power supply system is supported in projects for an RnCPU, an RnENCPU, and an RnPCPU (process mode/redundant mode).</li> </ul> <p>A redundant power supply system is supported for a project in which the following modules are used.</p> <ul style="list-style-type: none"> <li>CC-Link system master/local module (RJ61BT11)</li> <li>CC-Link IE Field Network modules (RJ71GF11-T2(MR), RJ71GF11-T2(SR), RJ71GF11-T2(LR))</li> <li>CC-Link IE Controller Network-equipped module (RJ71GP21-SX(R))</li> <li>Ethernet interface module (RJ71EN71)</li> </ul> <ul style="list-style-type: none"> <li>The initial label value application setting function for RnPCPUs is available.</li> </ul>	

## Version 1.030G

Item	Description	Reference
Navigation window	<p>Even if labels, functions, and function blocks are hidden, the following data is displayed.</p> <ul style="list-style-type: none"> <li>A statement for which "Display in Navigation Window" is selected in the "Input Line Statement" window.</li> <li>Multiple worksheets</li> </ul>	Page 54 Navigation window
Options	<p>The following options are added:</p> <ul style="list-style-type: none"> <li>"Program Editor" ⇒ "Ladder Editor" ⇒ "Ladder Diagram" ⇒ "Edit Operation" ⇒ "Enable the ladder editing by mouse operation"</li> <li>"Convert" ⇒ "Basic Setting" ⇒ "Operational Setting" ⇒ "Language Used by Instruction Conversion of String Operation"</li> </ul>	Page 84 Option Settings for Each Function
Opening a GX Works2 format project	<p>Parameters of the following modules can be imported in a project for an RCPU.</p> <ul style="list-style-type: none"> <li>Serial communication module</li> <li>Temperature input module</li> <li>Temperature control module</li> <li>Simple motion module</li> <li>Input module</li> <li>Output module</li> <li>I/O module</li> <li>Interrupt module</li> </ul>	Page 107 Opening a GX Works2 format project
Opening a GX IEC Developer format project	<ul style="list-style-type: none"> <li>An ASCII format file exported in GX IEC Developer can be opened.</li> </ul>	Page 115 Opening a GX IEC Developer format project
Verification	<ul style="list-style-type: none"> <li>A device comment and device memory can be verified in project verification.</li> <li>CPU module parameters can be verified in a project for an FX5CPU.</li> </ul>	Page 143 Verifying Projects
AnyWireASLINK configuration window	<ul style="list-style-type: none"> <li>In a project for an RnCPU, an AnyWireASLINK system can be configured using this window.</li> </ul>	Page 208 Setting network configuration and target devices
CC-Link IEF Basic configuration window	<ul style="list-style-type: none"> <li>In projects for an RnCPU, an RnENCPU, and an FX5CPU, a CC-Link IE Field Network Basic system can be configured using this window.</li> </ul>	

Item	Description	Reference
System parameter	<ul style="list-style-type: none"> <li>When opening a system parameter, other screens, such as a parameter editor and module configuration diagram, are closed.</li> </ul>	Page 202 Setting system parameters
Ladder editor	<ul style="list-style-type: none"> <li>A statement can be set for an END instruction.</li> </ul>	Page 264 Creating a Ladder Program
Importing/exporting ladder programs	<p>The following are supported.</p> <ul style="list-style-type: none"> <li>Import/export of a CSV file</li> <li>Export to a HTML file</li> </ul>	Page 297 Importing/exporting ladder programs
Creating an FBD/LD program	<p>The following are supported.</p> <ul style="list-style-type: none"> <li>Displaying devices assigned to labels on an FBD/LD editor.</li> <li>Using devices assigned to global labels for label input.</li> <li>Wrapping a comment and a label name to display.</li> <li>Displaying the "Undefined Label Registration" screen for labels with member notation '.' and array notation '[' ]'.</li> <li>Searching or replacing a target by specifying a range</li> </ul>	<p>Page 319 Configuration of an FBD/LD editor</p> <p>Page 325 Entering programs</p> <p>Page 319 Configuration of an FBD/LD editor</p>
Creating an SFC program	<p>The following are supported.</p> <ul style="list-style-type: none"> <li>MELSAP-L (instruction format) display</li> <li>Displaying devices assigned to labels of an FBD/LD element</li> <li>Opening a new window in a block start step during monitoring with the SFC auto-scroll</li> </ul>	<p>Page 347 Display format of action/transition</p> <p>Page 343 Configuration of an SFC diagram editor</p> <p>Page 629 Monitoring with the SFC auto-scroll</p>
Memory size calculation	<ul style="list-style-type: none"> <li>"Byte" or "Step" can be selected from "Display Unit" in the "Confirm Memory Size (Offline)" screen.</li> </ul>	Page 432 Calculating Memory Size
Cross reference	<ul style="list-style-type: none"> <li>In an FBD/LD program, the data type of an FB/FUN using devices/labels as arguments can be displayed.</li> <li>MELSAP-L (instruction format) is supported.</li> </ul>	Page 456 Displaying Device and Label Reference Information
Unused label list	<ul style="list-style-type: none"> <li>A function to delete a label from the unused label list is supported.</li> </ul>	Page 463 Displaying a list of unused labels
Simulation	<p>The following are supported.</p> <ul style="list-style-type: none"> <li>Simulation of a project used for an RnPCPU (redundant mode)</li> <li>Simulation of a project in which an RnMTCPU is used (MT Simulator2)</li> <li>Simulation of a project in which an RD77GF is used (SMM Simulator2)</li> <li>The I/O system setting of a project for an FX5CPU</li> <li>Label initialization control function of RnPCPUs</li> </ul>	Page 518 PROGRAM SIMULATION
Specifying a connection destination	<ul style="list-style-type: none"> <li>The GOT transparent function via CC-Link IE Field Network is supported in a project for an RnCPU.*4</li> <li>The GOT transparent function via CC-Link IE Control Network is supported for a project used for an RnPCPU (redundant mode) and remote head module.*4</li> </ul>	Page 569 Accessing via GOT (GOT Transparent Function)
Writing data to a programmable controller	<ul style="list-style-type: none"> <li>A project with no labels can individually be written to a CPU module.</li> </ul>	Page 580 Writing data to a programmable controller
Writing data to an SD memory card Reading data from an SD memory card	<ul style="list-style-type: none"> <li>Data can be written to or read from an SD memory card in a project for an FX5CPU.</li> </ul>	Page 610 Writing to/Reading from a memory card
Monitor	<ul style="list-style-type: none"> <li>The visibility of a ladder editor with a low magnification is improved.</li> </ul>	Page 611 CHECKING OPERATION OF PROGRAMS
Registering/canceling forced input/output*3	<ul style="list-style-type: none"> <li>When GX Works3 is connected to an RnCPU or an RnENCPU, input/output devices can forcibly be turned ON/OFF.</li> </ul>	Page 644 Turning Input/Output Devices ON/OFF Forcibly
Intelligent function module monitor	<ul style="list-style-type: none"> <li>The intelligent function module monitor function is supported in a project for an FX5CPU.</li> </ul>	Page 658 Checking Current Values in an Intelligent Function Module
Diagnostics	<p>The following modules can be diagnosed:</p> <ul style="list-style-type: none"> <li>Multiple input module (NZ2GF2S-60MD4)</li> <li>Analog input modules (NZ2GFCE-60ADI8, NZ2GFCE-60ADV8)</li> <li>Analog output modules (NZ2GFCE-60DAI8, NZ2GFCE-60DAV8)</li> <li>DC input modules (NZ2GF12A4-16D, NZ2GF12A4-16DE)</li> <li>Transistor output modules (NZ2GF12A2-16T, NZ2GF12A2-16TE)</li> <li>DC input transistor output combined module (NZ2GF12A42-16DT, NZ2GF12A42-16DTE)</li> <li>Servo amplifier (MR-J4-GF)</li> </ul>	Page 717 CC-Link IE TSN/CC-Link IE Field Network diagnostics
	<ul style="list-style-type: none"> <li>The CC-Link IE Field Network Basic diagnostic is supported in projects for an RnCPU, an RnENCPU, and an FX5CPU.</li> </ul>	Page 719 CC-Link IE Field Network Basic diagnostics
Offline monitor	<ul style="list-style-type: none"> <li>Values of logging data displayed in GX LogViewer can be monitored on a program editor during offline monitoring.</li> </ul>	Page 882 Checking logging data in version 1.063R or earlier
Others	<ul style="list-style-type: none"> <li>When installing GX Works3, GX LogViewer and CPU Module Logging Configuration Tool can be installed at the same time.</li> </ul>	GX Works3 Installation Instructions

Item	Description	Reference
FX5CPU	The following functions are available: <sup>*3</sup> <ul style="list-style-type: none"> <li>• Event history</li> <li>• Data logging</li> <li>• File transfer function (FTP server)</li> </ul>	Page 723 Error History/Operation History Check Page 730 Data Logging Function
	<ul style="list-style-type: none"> <li>• A device connected with GX Works3 on Ethernet can automatically be detected.</li> <li>• Parameters for FX5CPU built-in functions can be verified.</li> </ul>	—
	<ul style="list-style-type: none"> <li>• Assignment of global labels are retained in a project for an FX5CPU.</li> </ul>	—

## Parameters

Category	Module type	Module	Parameter <sup>*3*4</sup>	Description
CPU parameter	FX5CPU		"Memory/Device Setting" ⇔ "Device/Label Memory Area Setting"	The "Device/Label Memory Area Detailed Setting" screen is added. Parameters can easily be set and displayed in this screen.

## Version 1.032J

Item	Description	Reference
Process control function	<ul style="list-style-type: none"> <li>• A process control system is supported for a project used for an RnPCPU (process mode/redundant mode).</li> </ul>	Page 23 Process Control System
Element selection window	<p>Data selected in the [Library] tab in the element selection window can be added to a project using the following menu.</p> <ul style="list-style-type: none"> <li>• Right-click data and select [Add to Project] from the shortcut menu.</li> </ul>	Page 57 Element selection window
Options	<p>The following options are added:</p> <ul style="list-style-type: none"> <li>• "Convert" ⇔ "Basic Setting" ⇔ "Conversion Operation" ⇔ "Enable Rebuild All (Reassignment)"/"Enable Rebuild All (Retain)"/"Enable Conversion"</li> <li>• "Monitor" ⇔ "FBD/LD editor" ⇔ "Display Setting" ⇔ "Use Same Display Format for Contact as Device/Label Current Value"</li> </ul>	Page 84 Option Settings for Each Function
Opening a PX Developer format project	<ul style="list-style-type: none"> <li>• A PX Developer format project created in PX Developer can be opened.</li> </ul>	Page 110 Opening a PX Developer format project
Verification	<ul style="list-style-type: none"> <li>• FB files and FUN files can be verified.</li> <li>• A device comment, device memory, and file register written in a CPU module can be verified.</li> <li>• After verifying program files, the details of the result can be checked.</li> <li>• Consistent ladder blocks are not displayed in a verification result of a ladder program.</li> </ul>	Page 143 Verifying Projects Page 595 Verifying Programmable Controller Data Page 145 Checking a verification result
System configuration	<ul style="list-style-type: none"> <li>• An RnENCPU and a motion control CPU can be used together in a multiple CPU system.</li> </ul>	Page 195 Multiple CPU configuration
Creating a ladder program	<ul style="list-style-type: none"> <li>• The setting values of a timer and a counter used in a ladder can be changed in a batch.</li> </ul>	Page 289 Changing TC setting values
Creating an FBD/LD program	<ul style="list-style-type: none"> <li>• A link can be set between a comment element and an element.</li> <li>• FBD Network Blocks can be displayed in a list.</li> </ul>	Page 338 Linking a comment Page 340 Displaying FBD network blocks in a list
Creating an SFC program	<ul style="list-style-type: none"> <li>• A link can be set between a comment element and an element.</li> </ul>	Page 368 Linking a comment
Online data operation	<p>Data to display in the "Online Data Operation" screen can be selected by setting the following menu.</p> <ul style="list-style-type: none"> <li>• [Setting] ⇔ [Set Favorites]</li> </ul>	Page 577 Configuration of the online data operation screen
Writing data to a programmable controller	<ul style="list-style-type: none"> <li>• When a module label is not used in "Refresh Setting" of "Module Parameter," the checkbox of "Module Parameter" is not selected even when "Global Label" is selected in the "Online Data Operation" screen.</li> </ul>	Page 580 Writing data to a programmable controller
Registering/canceling forced input/output	<ul style="list-style-type: none"> <li>• The "Register/Cancel Forced Input/Output" screen can be displayed using the icon in the monitor status bar.</li> </ul>	Page 614 Status monitoring
Monitor	<ul style="list-style-type: none"> <li>• When "MELSAP-L (Instruction Format)" is used as the display format of an SFC diagram editor, the monitor value where the cursor is placed is highlighted in monitoring.</li> </ul>	Page 627 MELSAP-L (instruction format)
Diagnostics	<ul style="list-style-type: none"> <li>• The sensor/device monitor function is supported.</li> </ul>	Page 705 Sensor/Device Status Check
	<p>The following modules can be diagnosed:</p> <ul style="list-style-type: none"> <li>• CC-Link IE Field Network remote I/O modules (NZ2GF2B1-32D, NZ2GF2B1-32DT, NZ2GF2B1-32DTE, NZ2GF2B1-32T, NZ2GF2B1-32TE)</li> </ul>	Page 717 CC-Link IE TSN/CC-Link IE Field Network diagnostics
Simulation	<ul style="list-style-type: none"> <li>• The latch function is available.</li> </ul>	Page 942 Supported CPU module functions

Item	Description	Reference
Others	<ul style="list-style-type: none"><li>When a constant or bit device (X, Y, M, L, SM, F, B, SB) is set for the second argument of the dedicated function 'G(P).OFFGAN,' a conversion error occurs.</li></ul>	—



## Version 1.035M

Item	Description	Reference
Options	The following options are added: <ul style="list-style-type: none"> <li>• "Project" ⇒ "Save" ⇒ "Operational Setting" ⇒ "Save project after conversion"/"Save project after Write to PLC"/"Save project after Online Program Change"/"Save project after changing TC Setting Value and writing to PLC"</li> <li>• "Find/Replace" ⇒ "Common Item" ⇒ "Operational Setting" ⇒ "Distinguish DX/DY device from X/Y device when X/Y device is specified"</li> </ul>	Page 84 Option Settings for Each Function
Printing	An FBD/LD program can be printed according to the setting in the following option. <ul style="list-style-type: none"> <li>• "Program Editor" ⇒ "FBD/LD Editor" ⇒ "Element (Ladder Symbol)" ⇒ "Display Format" ⇒ "Numbers of Wrapping Rows for Device/Label Name"</li> </ul>	Page 92 Printing Data
Opening a GX Works2 format project	<ul style="list-style-type: none"> <li>• The parameters of a triac output module (QY22) can be imported.</li> </ul>	Page 107 Opening a GX Works2 format project
Opening a GX IEC Developer format project	<ul style="list-style-type: none"> <li>• An IL/MELSEC IL program created in GX IEC Developer can be opened.</li> </ul>	Page 115 Opening a GX IEC Developer format project
Help file	<ul style="list-style-type: none"> <li>• A help file can be linked to a function or function block.</li> </ul>	Page 133 Associating data with a help file
Verification	<ul style="list-style-type: none"> <li>• Module extended parameters of a simple motion module can be verified.</li> <li>• The module information of an intelligent function module can be verified.</li> </ul>	Page 143 Verifying Projects Page 595 Verifying Programmable Controller Data
Module tool list	<ul style="list-style-type: none"> <li>• Multiple input modules (FX5-8AD) are supported.</li> <li>• Temperature control modules (FX5-4LC) are supported.</li> <li>• Positioning modules (FX5-20PG-P) are supported.</li> </ul>	Page 218 Other Settings of Intelligent Function Modules
Importing/exporting ladder programs	<ul style="list-style-type: none"> <li>• Ladder programs can be exported to a text file.</li> </ul>	Page 306 Exporting to a text file
Creating a ladder program	<ul style="list-style-type: none"> <li>• Pasting to the input and output circuit parts of a function block and function is supported.</li> <li>• A device comment editor can be opened from a program editor with the menu or shortcut key.</li> <li>• The width of all the selected columns can be changed.</li> <li>• Lines remain after deleting an instruction in "Insert mode."</li> <li>• When an element is pasted to the position where a line cannot be pasted, only the element is pasted.</li> <li>• After pressing the <b>[F2]</b> key to edit a device name, the edit can be cancelled by pressing the <b>[Esc]</b> key.</li> </ul> <p>The display magnification of all ladder editors can be set in a batch by setting the following menu.</p> <ul style="list-style-type: none"> <li>• [View] ⇒ [Zoom] ⇒ [Set Zoom Factor]</li> </ul> <p>The following menu is available when editing a ladder program of a function or function block:</p> <ul style="list-style-type: none"> <li>• [Edit] ⇒ [Documentation] ⇒ [Statement/Note Batch Edit]</li> </ul>	Page 403 Displaying a device comment editor from a program editor
Creating an ST Program	<ul style="list-style-type: none"> <li>• Usable instructions in an ST program are added.</li> <li>• A device comment editor can be opened from a program editor with the menu or shortcut key.</li> </ul>	Page 403 Displaying a device comment editor from a program editor
Creating an FBD/LD program	<ul style="list-style-type: none"> <li>• Connecting elements automatically can be disabled.</li> <li>• A device comment editor can be opened from a program editor with the menu or shortcut key.</li> <li>• The display order of comment elements can be changed.</li> </ul>	Page 327 Common operations of elements Page 403 Displaying a device comment editor from a program editor
Creating an SFC program	<ul style="list-style-type: none"> <li>• A device comment editor can be opened from a program editor with the menu or shortcut key.</li> <li>• The display order of comment elements can be changed.</li> </ul>	Page 403 Displaying a device comment editor from a program editor
Creating a function block and function	<ul style="list-style-type: none"> <li>• "Use MC/MCR to Control EN" can be set for a subroutine type function block in projects for an RnCPU and an RnENCPU.*3</li> </ul>	Page 485 Creating new data
Online program change	<ul style="list-style-type: none"> <li>• When only one program file that is set as "No Execution Type" exists in a project, the data can be written to a CPU module by using the "Online Program Change" function.</li> </ul> <p>The following data can be written to a CPU module using this function.</p> <ul style="list-style-type: none"> <li>• A single SFC block*3</li> <li>• SFC inactive block</li> </ul> <p>• After writing a project to a running RnPCPU (process mode), program restoration information can be written in the background process.*3</p>	Page 597 Writing Programs While a CPU Module is in the RUN State  Page 601 Online program change of SFC programs

Item	Description	Reference
Diagnostics	In the following diagnostics, the diagnostics screen can be displayed when another station was specified as the connection destination. <ul style="list-style-type: none"> <li>• CC-Link IE Controller Network diagnostics</li> <li>• CC-Link IE Field Network diagnostics</li> </ul>	Page 715 CC-Link IE Controller Network diagnostics Page 717 CC-Link IE TSN/CC-Link IE Field Network diagnostics Page 719 CC-Link IE Field Network Basic diagnostics
	The following settings are available in the CC-Link IE Field Network Basic diagnostics. <ul style="list-style-type: none"> <li>• Group setting of a remote station (No.1 to 4)</li> <li>• Setting of the number of connected stations (up to 64 stations)</li> </ul>	
	The following modules can be diagnosed: <ul style="list-style-type: none"> <li>• CC-Link IE Field Network remote I/O modules (NZ2GF2B2-16A, NZ2GF2B2-16R, NZ2GF2B2-16S, NZ2GF2S2-16A, NZ2GF2S2-16R, NZ2GF2S2-16S)</li> <li>• CC-Link IE Field Network Basic remote I/O modules (NZ2MFB1-32D, NZ2MFB1-32T, NZ2MFB1-32TE1, NZ2MFB1-32DT, NZ2MFB1-32DTE1, NZ2MFB2-16A, NZ2MFB2-16R)</li> </ul>	
Tool interaction	The following tools can be started in GX Works3. <ul style="list-style-type: none"> <li>• CPU Module Logging Configuration Tool</li> <li>• GX LogViewer</li> </ul>	Page 730 Data Logging Function
Simulation	The following are supported by the simulation function. <ul style="list-style-type: none"> <li>• Project in which an RD77GF32 is used (SMM Simulator)</li> <li>• I/O control function of RCPUs</li> <li>• Project in which a MELSEC iQ-F series simple motion module is used (SMM Simulator2)</li> </ul>	Page 933 Using the Simulation Function
	<ul style="list-style-type: none"> <li>• The capacity of signal flow memory (for FB), which is used for simulating a project for an RnPCPU (R08PCPU, R16PCPU, R32PCPU, or R120PCPU), is expanded.</li> </ul>	
e-Manual Viewer interaction	<ul style="list-style-type: none"> <li>• Sample programs (ladder) on the manuals that can be browsed in e-Manual Viewer can be copied on ladder programs in GX Works3.</li> </ul>	Page 982 Using Sample Programs
Search/replacement	When "Move" is selected in the following option in the "Find and Replace" window, an undisplayed device comment is also moved when replacing the device. <ul style="list-style-type: none"> <li>• "Find/Replace Options" ⇒ "Replace" ⇒ "Device Comment"</li> </ul>	—
	<ul style="list-style-type: none"> <li>• When registering devices/labels within a selected range to a watch window or the "Device Batch Replace" screen, overlapped devices/labels are not registered.</li> </ul>	
Writing data to a programmable controller	<ul style="list-style-type: none"> <li>• Unused function blocks and functions can be written to a CPU module.</li> </ul>	
CC IE Field configuration window	The parameters of a device station can be saved in a project by selecting the checkbox of the following item in the "Options" screen. <ul style="list-style-type: none"> <li>• Save the parameter set by "Parameter Processing of Device Station" to project.</li> </ul>	
	<ul style="list-style-type: none"> <li>• Same parameters can be written to/read from device stations with the same model name by using the "The Parameter Processing of Same Device Station" screen.</li> </ul>	
CC-Link IEF Basic configuration window	The following iQ Sensor Solution functions are available.*5 <ul style="list-style-type: none"> <li>• Automatic detection of connected devices</li> <li>• Communication setting reflection of remote station</li> <li>• Parameter processing of remote station</li> </ul>	
Others	<ul style="list-style-type: none"> <li>• The safety communication setting can be configured before writing parameters of a safety remote I/O module to a CPU module.</li> <li>• The CPU module built-in database can be accessed from an external device.</li> </ul>	Page 767 Automatic restoration setting
	<ul style="list-style-type: none"> <li>• The automatic restoration setting is supported in a project for an RnSFCPU.</li> </ul>	
FX5CPU	The following options are added: <ul style="list-style-type: none"> <li>• "Convert" ⇒ "Basic Setting" ⇒ "Operational Setting" ⇒ "Collectively Allocate Temporary Area to Optimize the Number of Steps"</li> </ul>	Page 84 Option Settings for Each Function
	<ul style="list-style-type: none"> <li>• A CPU module can be accessed via a CC-Link IE Field Network module using the GOT transparent function.*4</li> </ul>	Page 569 Accessing via GOT (GOT Transparent Function)
	The following functions are available in a project for an FX5CPU: <ul style="list-style-type: none"> <li>• Memory dump</li> <li>• Change of TC setting value</li> <li>• Offline monitor</li> <li>• Parallel link</li> <li>• IP filter</li> <li>• File transfer function (FTP server)</li> <li>• Verification of extension adapters</li> <li>• Simulation of a simple motion module</li> <li>• Interaction with the FX5CPU simulation function</li> </ul>	—
	<ul style="list-style-type: none"> <li>• Devices used by the function of a CPU module are displayed in the "Device List" window.</li> </ul>	

## Parameters

Category	Module type	Module	Parameter <sup>*3*4</sup>	Description
Module parameter	RnCPU RnENCPU	Positioning modules (RD75D2, RD75D4, RD75P2, RD75P4)	"Basic setting" ⇔ "OPR basic parameter" ⇔ "OPR method"	"7: Limit switch combined method" can be selected.
Module extended parameter	RnPCPU RnSFCPU		"Axis n Positioning data" ⇔ "Offline Simulation"	Newly added
			"Axis n Positioning data" ⇔ "Auto Calc Command Speed"	Newly added
			"Axis n Positioning data" ⇔ "Auto Calc Auxiliary Arc"	Newly added

### Version 1.036N

Item	Description	Reference
Online program change	When writing data to a CPU module with either of the following functions, the behavior of each falling instruction right after the writing process is the same. <ul style="list-style-type: none"> <li>• Online program change</li> <li>• File batch online change</li> </ul>	Page 597 Writing Programs While a CPU Module is in the RUN State

### Version 1.038Q

Item	Description	Reference
Creating a ladder program Creating an ST Program Creating an FBD/LD program	Reserved area capacities of the following items can be set in the "Properties" screen of a function block. <ul style="list-style-type: none"> <li>• Label reserved area</li> <li>• Latch label reserved area</li> <li>• Signal flow reserved area</li> </ul>	Page 487 Setting reserved area capacities



## Version 1.040S

Item	Description	Reference
Process control function	<ul style="list-style-type: none"> <li>A process control system is supported in a project for an RnPSFCPU.</li> </ul>	Page 23 Process Control System
Navigation window	<ul style="list-style-type: none"> <li>The background color and font color can be changed.</li> <li>The tree can be filtered.</li> <li>A message will appear when moving data.</li> <li>Module parameters and module POU's (shortcut) can be hidden.</li> <li>A module tool can be opened.</li> </ul> <ul style="list-style-type: none"> <li>The default display of modules that only one "Module Parameter" was displayed is changed so as not to display "Module Parameter."</li> <li>The default display is changed so as not to display "Module POU (Shortcut)."</li> </ul>	Page 54 Navigation window
Ladder editor	<ul style="list-style-type: none"> <li>When a program including a specific instruction (INV, MEP, MEF, EGP, EGF) does not comply with the instruction specifications, a conversion error occurs.</li> <li>When a project is opened, a ladder program that was previously displayed is displayed.</li> <li>When the position of the mouse cursor is in a nested master control instruction at the start of monitoring ladder program, the ON/OFF status of the master control instruction and the nesting number is displayed in the window title of the ladder editor.</li> <li>A line statement name can be edited in the navigation window.</li> <li>The comment of a structure member is displayed in the "Input Device Comment" screen.</li> </ul> <ul style="list-style-type: none"> <li>A device assigned to a label can be entered as a label.</li> </ul> <p>When the number of displayed contacts are changed with the following option and input and output circuits of an FB/FUN is not displayed, the circuit is displayed highlighted.</p> <ul style="list-style-type: none"> <li>[Tool] ⇒ [Options] ⇒ "Program Editor" ⇒ "Ladder Editor" ⇒ "Ladder Diagram" ⇒ "Display Format" ⇒ "Display Connection of Ladder Diagram"</li> </ul>	Page 54 Navigation window Page 105 Opening a project
Creating an FBD/LD program	<ul style="list-style-type: none"> <li>The font color and the background color of comment elements can be changed in the "Color and Font" screen.</li> <li>The font color and the background color of comment elements can be changed individually.</li> </ul> <ul style="list-style-type: none"> <li>A page break can be displayed in an FBD/LD editor.</li> </ul> <ul style="list-style-type: none"> <li>When a jump label element of an FBD/LD is selected and the  key is pressed, a pointer type label is displayed in an edit box as an option.</li> </ul>	Page 81 Checking and Changing Colors and Fonts Page 319 Configuration of an FBD/LD editor Page 319 Configuration of an FBD/LD editor Page 325 Adding elements
Creating an SFC program	<ul style="list-style-type: none"> <li>The font color and the background color of comment elements can be changed in the "Color and Font" screen.</li> <li>The font color and the background color of comment elements can be changed individually.</li> </ul>	Page 81 Checking and Changing Colors and Fonts Page 343 Configuration of an SFC diagram editor
Options	<p>The following option is added:</p> <ul style="list-style-type: none"> <li>"Program Editor" ⇒ "SFC Diagram Editor" ⇒ "Action/Transition" ⇒ "Operational Setting" ⇒ "Include Device Comment in Copying"</li> </ul>	Page 84 Option Settings for Each Function
Printing	<ul style="list-style-type: none"> <li>Ladder programs can be printed by specifying the range (number of lines).</li> <li>Ladder programs can be printed by setting a page break for each ladder block.</li> <li>The page setting can be set for FBD/LD programs.</li> <li>Project data can be printed by changing the color and the font to the default setting.</li> <li>The contents of unset parameter items are no longer printed.</li> </ul>	Page 92 Printing Data
Q/L/FX series compatibility mode	<p>GX Works3 in the Q/L/FX series compatibility mode can be started in GX Works3. In GX Works3 in the Q/L/FX series compatibility mode, projects for a QCPU (Q mode), an LCPU, and an FXCPU can be used.</p> <p>The following operations can mainly be performed.</p> <ul style="list-style-type: none"> <li>Creating a new project</li> <li>Creating a new project with data read from a CPU module</li> <li>Opening a project</li> <li>Performing the system monitor function automatically</li> <li>Saving a project as a GX Works3 project or GX Works2 project</li> </ul>	Page 103 Creating a project Page 104 Creating a new project by reading data read from a programmable controller Page 105 Opening a project Page 126 Saving projects under the specified name
Opening a GX Works2 format project	<p>The following items can be imported in a project for an FX5CPU.</p> <ul style="list-style-type: none"> <li>Project used for an FXCPU (FX3G/FX3GC)</li> <li>CC-Link settings of network parameters</li> </ul> <ul style="list-style-type: none"> <li>The names of instructions used in ST programs are replaced automatically.</li> </ul>	Page 107 Opening a GX Works2 format project Page 907 Instructions in which the names need to be replaced

Item	Description	Reference
Opening a PX Developer format project	The following project parameters that are set in a PX Developer format project can be imported. <ul style="list-style-type: none"> <li>• Program execution setting</li> <li>• I/O control</li> <li>• Event notification</li> </ul>	Page 110 Opening a PX Developer format project Page 918 Correction of a PX Developer format project
	• The initial values of FB properties that are set in a PX Developer format project can be imported.	
Opening a GX IEC Developer format project	<ul style="list-style-type: none"> <li>• Data in an ASCII format file or SUL format file exported in GX IEC Developer can be imported into an open GX Works3 project.</li> <li>• Even when a GX Works3 project is not open, the module type of a GX IEC Developer format project can be changed.</li> <li>• An SUL format file (user library) exported in GX IEC Developer can be opened.</li> </ul>	Page 115 Opening a GX IEC Developer format project Page 509 Creating a GX Works3 format library from a GX IEC Developer format library
Module configuration diagram	• Module parameters of a module with multiple ports can be opened in the "Input the Configuration Detailed Information" window.	Page 193 Setting parameters on the module configuration diagram
Parameter	For a module in which the system parameter is set as follows, "Do not Synchronize" is automatically set to the "Setting" column in the "Select the Synchronous Target Module" screen. <ul style="list-style-type: none"> <li>• "I/O Assignment Setting" ⇒ "Module Status Setting" column: Empty</li> <li>• "Inter-module Synchronization Setting" ⇒ "Use Inter-module Synchronization Function in System": Use</li> </ul>	Page 202 Setting system parameters
iQ Sensor Solution function* <sup>5</sup>	In a project using AnyWireASLINK or CC-Link IE Field Network, the following functions are available. <ul style="list-style-type: none"> <li>• Data backup/restoration</li> </ul>	Page 210 iQ Sensor Solution functions
Module tool list	<ul style="list-style-type: none"> <li>• Analog input modules (FX5-4AD) are supported.</li> <li>• Analog output modules (FX5-4DA) are supported.</li> </ul>	Page 218 Displaying the module tool list
Importing/exporting ladder programs	A program including the elements below can be exported to a CSV file. Moreover, a program including the elements below can be imported from a CSV file. <ul style="list-style-type: none"> <li>• Label</li> <li>• Inline structured text box</li> <li>• Function block and function</li> </ul>	Page 297 Importing/exporting ladder programs
	• When exporting a text file, whether or not to output step numbers can be set.	
	<ul style="list-style-type: none"> <li>• A Zoom created in Ladder Diagram language can be exported in a CSV, HTML, or text file.</li> <li>• Listed instructions in a CSV file can be imported into a Zoom created in Ladder Diagram language.</li> </ul>	
	<ul style="list-style-type: none"> <li>• Ladder programs in functions or function blocks can be exported in a CSV, HTML, or text file.</li> <li>• Listed instructions in a CSV file can be imported into ladder programs in functions or function blocks.</li> </ul>	
Device comment editor	<ul style="list-style-type: none"> <li>• A screen can be split vertically.</li> <li>• When an unused device comment is deleted, the comments of bit-specified word devices are also deleted.</li> </ul>	Page 402 Configuration of a device comment editor
Memory size calculation	By selecting the version of an RnCPU, an RnENCPU, or an RnPCPU in the "Confirm Memory Size (Offline)" screen, the memory capacity can be calculated according to the selected version. <ul style="list-style-type: none"> <li>• RnCPU and RnENCPU: '30 and earlier versions' or '31 and later versions'</li> <li>• RnPCPU: '12 and earlier versions' or '13 and later versions'</li> </ul>	Page 432 Calculating Memory Size
Cross reference	• A device assigned to an alias source is displayed as a 'device' of the alias.	Page 457 Displaying cross reference information
Library management	• Elements of a library created in an ST program or an FBD/LD program can be updated in a batch.	Page 514 Updating library POU's
Simulation	<ul style="list-style-type: none"> <li>• Multiple systems that perform cyclic transmission can be simulated.</li> <li>• A simulation environment file can be saved.</li> <li>• A simulation environment file can be opened.</li> <li>• The label communication function from an external device can be set.</li> </ul>	Page 518 PROGRAM SIMULATION
Specifying a connection destination	• In a project for an RCPU, except for RnPSFCPU, the GOT transparent function is supported in the networks connecting a personal computer and a GOT or connecting a GOT and a connection station via Ethernet.* <sup>4</sup>	Page 569 Accessing via GOT (GOT Transparent Function)
Writing data to a programmable controller Online program change	• It is improved so that the status of edited function block or POU using a function will not be changed to unconverted when editing the program body of the subroutine type function block or function.	Page 487 Converting function blocks Page 505 Converting functions
	• Program files, FB files, and FUN files can be written without the program restoration information.* <sup>3</sup>	Page 580 Program restoration information Page 604 Program restoration information

Item	Description	Reference
Online program change	<ul style="list-style-type: none"> <li>When "Online Program Change" is performed after converting a program, whether or not to write the program can be selected in the "Online Data Operation" screen.</li> </ul>	Page 597 Writing Programs While a CPU Module is in the RUN State
	<ul style="list-style-type: none"> <li>The file batch online change can be performed when editing a global label, function block, or function in projects for an RnCPU, an RnENCPU, and an RnPCPU.*<sup>3</sup></li> </ul>	Page 605 Writing data for each file while a CPU module is running (file batch online change)
Device/buffer memory batch monitor	<ul style="list-style-type: none"> <li>Multiple word devices can be registered in a watch window in a batch.</li> </ul>	Page 635 Changing current values
Watch	<ul style="list-style-type: none"> <li>When data is changed by editing or converting a program, the change is not applied to a watch window automatically. It will be updated when clicking the [Update] button.</li> </ul>	Page 638 Updating the display
	<ul style="list-style-type: none"> <li>In a watch window, the display of the current values of bit devices can be changed from 'TRUE/FALSE' to 'ON/OFF.'</li> </ul>	Page 638 Other operations
	<ul style="list-style-type: none"> <li>The current values of bit devices can be changed by clicking the [ON]/[OFF]/[Switch ON/OFF] buttons on a watch window.</li> </ul>	—
Monitoring	<ul style="list-style-type: none"> <li>SQL statements that are buffered by the DB buffering function of a MES Interface module (RD81MES96) and stored procedure call information can be displayed in an intelligent function module monitor window.</li> </ul>	Page 658 Checking Current Values in an Intelligent Function Module
User authentication	<p>The following functions are supported in a project for an RnPSFCPU.</p> <ul style="list-style-type: none"> <li>Authentication destination setting in the online function</li> <li>Logging off from a CPU module</li> <li>Logging off all users from a CPU module</li> <li>Copying user information to the other system</li> </ul>	Page 686 Preventing Illegal Access to CPU Module (User Authentication)
Sensor/device monitor	<ul style="list-style-type: none"> <li>This function is available in a project using AnyWireASLINK.</li> </ul>	Page 705 Sensor/Device Status Check
Diagnostics	<p>The following modules can be diagnosed:</p> <ul style="list-style-type: none"> <li>CC-Link IE Field Network remote I/O modules (NZ2GFCE3N-32D, NZ2GFCE3N-32T, NZ2GFCE3N-32DT)</li> </ul>	Page 717 CC-Link IE TSN/CC-Link IE Field Network diagnostics
	<p>The following can be displayed in the CC-Link IE Field Network Basic diagnostics.</p> <ul style="list-style-type: none"> <li>Detailed error information of a remote station</li> </ul>	—
Safety programmable controller operation	<ul style="list-style-type: none"> <li>The safety module operation function is supported in a project for an RnPSFCPU.</li> </ul>	Page 764 Safety Programmable Controller Operations
Windows 10	<ul style="list-style-type: none"> <li>When a GX Works3 screen is not displayed properly, it can be fixed with high DPI scaling by using a Windows 10 function.</li> </ul>	Page 986 Troubleshooting
	<ul style="list-style-type: none"> <li>GX Developer can be installed with GX Works3.</li> </ul>	—
Conversion	<ul style="list-style-type: none"> <li>When changing the type of a function block, all the programs are converted (reassigned) in the next conversion.</li> </ul>	
Search/replacement	<ul style="list-style-type: none"> <li>Data is searched for or replaced in the display order in the navigation window.</li> </ul>	
Search/replacement Cross reference	<ul style="list-style-type: none"> <li>In an ST editor, FBD/LD editor, and SFC diagram editor, data can be searched for/replaced with the checkbox of "Multiple words" selected in "Find/Replace Options."</li> </ul>	
Device list	<ul style="list-style-type: none"> <li>When an instruction which uses multiple devices (example: BMOV (P)) exists in an ST, FBD/LD, or SFC program, all devices in the range used for the instruction are displayed in the device list.</li> <li>The number of times all devices for program indirection in programs have been used is displayed in the device list.</li> </ul>	
Interaction with iQ Works <sup>2</sup>	<p>The following operations can be performed in MELSOFT Navigator:</p> <ul style="list-style-type: none"> <li>Applying label information in an electrical CAD file that is imported in MELSOFT Navigator to global labels in GX Works3.</li> <li>Setting global labels in GX Works3 for label information in MELSOFT Navigator and exporting the label information as an electrical CAD file.</li> </ul>	
FX5CPU	<p>The following functions and settings are available in a project for FX5CPUs.*<sup>3</sup></p> <ul style="list-style-type: none"> <li>Extended file register (ER)</li> <li>Real-time monitor</li> <li>Web server setting</li> <li>MODBUS/TCP setting</li> <li>Time setting (SNTP client)</li> </ul>	
	<ul style="list-style-type: none"> <li>Logging data displayed in GX LogViewer can be monitored on a program editor by using the 'Offline monitor' function.</li> </ul>	Page 882 Checking logging data in version 1.063R or earlier



## Version 1.042U

Item	Description	Reference
Verification	When "Hide System Generated Items" is selected from the pull-down list in a Verify Result screen (detailed display), the following instruction codes are not displayed. <ul style="list-style-type: none"> <li>• NOP</li> <li>• LD TMP</li> <li>• OUT TMP</li> </ul>	Page 150 Detailed display (program)
Label editor	<ul style="list-style-type: none"> <li>• The selection status of "Access from External Device" can be pasted to other rows.</li> </ul>	Page 229 Editing a row
Ladder program	<ul style="list-style-type: none"> <li>• A label comment of a structure member can be edited in the "Input Device Comment" screen.</li> </ul>	Page 284 Entering/editing comments
FBD/LD editor SFC editor	<ul style="list-style-type: none"> <li>• A tool hint is displayed while options for labels are displayed.</li> </ul>	Page 319 Configuration of an FBD/LD editor Page 343 Configuration of an SFC diagram editor

## Version 1.044W

Item	Description	Reference
Opening another format file	In a ladder program, a program in which any of the following instructions is used and the argument is omitted can be read. <ul style="list-style-type: none"> <li>• D(P).DDRD, D(P).DDWR, JP.READ, JP.SREAD, JP.WRITE, JP.SWRITE, GP.READ, GP.SREAD, GP.WRITE, GP.SWRITE, J.ZNRD, J.ZNWR, JP.ZNWR, JP.ZNRD</li> </ul>	Page 107 Opening a GX Works2 format project Page 110 Opening a PX Developer format project

## Version 1.045X

Item	Description	Reference
Operating environment (operating system)	<ul style="list-style-type: none"> <li>Windows 10 IoT Enterprise 2016 LTSB is supported.</li> </ul>	—
Navigation window	<ul style="list-style-type: none"> <li>Unused data in a program is displayed in light blue.</li> </ul>	Page 54 Navigation window
Search/replacement	<p>After the cursor jumped from a search result to a program editor, label editor, or SFC block list, by using the following menu, the cursor jumps forward or backward from the current position to the positions where search or replacement was applied.</p> <ul style="list-style-type: none"> <li>[Find/Replace] ⇨ [Previous]/[Next]</li> </ul>	Page 61 Basic menus Page 448 Searching for/ Replacing Devices and Labels Page 450 Searching for/ Replacing Instructions Page 451 Searching for/ Replacing Character Strings Page 453 Changing Contacts between Open Contact and Close Contact Page 457 Displaying cross reference information
	<ul style="list-style-type: none"> <li>The ranges for search and replacement can be specified in a device comment editor.</li> </ul>	Page 446 Range specification in editors
	<ul style="list-style-type: none"> <li>An argument of a function block, argument of a function, and member of a structure can be searched for/replaced.</li> </ul>	Page 448 Searching for/ Replacing Devices and Labels
	<p>Options for labels can be displayed when entering a label name in the following functions.</p> <ul style="list-style-type: none"> <li>Device/label search</li> <li>Device/label replacement</li> <li>Open/close contact change</li> <li>Device batch replacement</li> </ul>	Page 448 Searching for/ Replacing Devices and Labels Page 453 Changing Contacts between Open Contact and Close Contact Page 454 Batch Replacing of Devices and Labels
Library	<p>The following menu is available even when the element selection window is not displayed:</p> <ul style="list-style-type: none"> <li>[Project] ⇨ [Library Operation] ⇨ [Register to Library List]</li> </ul>	Page 61 Basic menus
	<ul style="list-style-type: none"> <li>A library which is associated with a simple motion module can be used.</li> </ul>	Page 502 Using a library associated with a module
	<ul style="list-style-type: none"> <li>Password authentication for a read-protected POU can be disabled.</li> </ul>	Page 507 Creating a library file Page 512 Utilizing an element
	<ul style="list-style-type: none"> <li>An option to automatically check whether or not all the user libraries are updated is added.</li> </ul>	Page 514 Checking for library updates automatically
Options	<p>The following options are added:</p> <ul style="list-style-type: none"> <li>"Project" ⇨ "Navigation" ⇨ "Display Setting" ⇨ "Imported Library POU" ⇨ "Display Read-only POU"</li> <li>"Project" ⇨ "Navigation" ⇨ "Display Setting" ⇨ "Imported Library POU" ⇨ "Display Read-protected POU" ⇨ "Display Password Authentication Disabled POU"</li> <li>"Convert" ⇨ "Basic Setting" ⇨ "Operational Setting" ⇨ "Check the ladders in which certain instructions are used at inappropriate positions"</li> <li>"Other Editor" ⇨ "Label Editor Common" ⇨ "Fix the Number of Display Windows"</li> <li>"Program Editor" ⇨ "ST Editor" ⇨ "Editor Display Items" ⇨ "Highlight Matching Brackets"</li> <li>"Find/Replace" ⇨ "Cross Reference" ⇨ "Find Condition" ⇨ "Include Assigned Device in Finding Label Name"</li> </ul>	Page 84 Option Settings for Each Function
Printing	<ul style="list-style-type: none"> <li>In the "Print" screen, only the background color of a print result can be set to white.</li> <li>When printing a ladder program, the number of rows for device comments and the number of rows for wrapping a device/label name can be set in the "Print" screen.</li> </ul>	Page 92 Printing Data
Opening a GX Works2 format project	<ul style="list-style-type: none"> <li>The device/label automatic-assign setting can be utilized to the CPU parameter of GX Works3.</li> </ul>	Page 107 Opening a GX Works2 format project Page 900 Correcting parameters
	<p>The parameters of the following modules can be imported:</p> <ul style="list-style-type: none"> <li>Input modules (QX70, QX71, QX72)</li> <li>CC-Link IE Controller Network-equipped module (QJ71GP21S-SX)</li> </ul>	Page 107 Opening a GX Works2 format project
Verification	<ul style="list-style-type: none"> <li>Unconverted functions and function blocks are displayed in the "Verify Result" window.</li> <li>The "Caution" column is added in the [Result List] tab of the "Verify Result" window.</li> </ul>	Page 143 Verifying Projects Page 595 Verifying Programmable Controller Data

Item	Description	Reference
Module configuration diagram	<ul style="list-style-type: none"> <li>The station numbers of the modules controlled by a CPU module in another station are no longer displayed.</li> <li>The parameter information of a cut or copied module object are utilized to the parameter information of the paste destination.</li> </ul>	Page 188 Editor configuration when creating a module configuration diagram Page 194 Application of parameter information
CC-Link configuration window	The following iQ Sensor Solution functions are available in projects for an RnCPU and an RnENCPU: <sup>5</sup> <ul style="list-style-type: none"> <li>Automatic detection of connected devices</li> <li>Data backup/restoration</li> <li>Sensor/device monitor</li> </ul>	Page 210 iQ Sensor Solution functions
Ethernet configuration window	The following iQ Sensor Solution functions are available in projects for an RnCPU and an RnENCPU: <sup>5</sup> <ul style="list-style-type: none"> <li>Data backup/restoration</li> <li>Sensor/device monitor</li> </ul>	
iQ Sensor Solution function <sup>5</sup>	<ul style="list-style-type: none"> <li>This function is available in a project using a CC-Link-AnyWireASLINK bridge module.</li> </ul>	
Changing a module	A module name, module type, and station type of the following modules can be changed from the shortcut menu. <ul style="list-style-type: none"> <li>Another CPU module</li> <li>CC-Link IE built-in Ethernet module</li> <li>CPU extension module</li> </ul>	Page 222 Change Module
Ladder editor	<ul style="list-style-type: none"> <li>When entering an undefined label, a comment can be entered in the "Input Comment" screen.</li> <li>After pasting a ladder program including functions and function blocks to another project, if pasting the program again, the FB/FUN file is no longer pasted.</li> <li>Values in the "Increment Value" column of the "Continuous Paste" screen can be copied and pasted.</li> </ul>	Page 264 Creating a Ladder Program Page 290 Pasting Page 291 Pasting device numbers or label names consecutively
	The following uses are added to a simple search function. <ul style="list-style-type: none"> <li>Displaying instructions and labels by pressing the <b>[Ctrl]</b> + <b>[Space]</b> keys.</li> <li>Cross-searching a standard program and a safety program for a device</li> <li>Searching for a statement or note.</li> </ul>	Page 295 Simple search
	By using the following menu, the cursor jumps forward or backward from the current position to the positions where search was applied. <ul style="list-style-type: none"> <li>[Find/Replace] ⇨ [Previous]/[Next]</li> </ul>	
ST editor FBD/LD editor	<ul style="list-style-type: none"> <li>Device type specifiers can be added to devices index-modified devices.</li> </ul>	Page 309 Creating an ST Program Page 319 Creating an FBD/LD Program
FBD/LD editor	<ul style="list-style-type: none"> <li>A function to correct the layout in an FBD network block is added. (The 'Delete the Blank Column In FBD Network Block' function is integrated with this function.)</li> </ul>	Page 335 Layout correction
Memory size calculation	<ul style="list-style-type: none"> <li>By selecting the version ('12 and earlier versions' or '13 and later versions') of an RnSFCPU in the "Confirm Memory Size (Offline)" screen, the memory capacity can be calculated according to the selected version.</li> </ul>	Page 432 Calculating Memory Size
Cross reference	<ul style="list-style-type: none"> <li>When searching for a label that includes a label of "VAR_GLOBAL_CONSTANT" or "VAR_CONSTANT" class in the array element, a device which is assigned to the label to be searched is displayed.</li> </ul>	Page 457 Displaying cross reference information
Device list	<ul style="list-style-type: none"> <li>Display format can be set in a batch.</li> <li>When opening the device list without selecting a device, the mouse cursor is displayed in the text box of the toolbar in the list.</li> <li>When re-opening the device list, the mouse cursor is displayed at the same position as before the list was closed.</li> </ul>	Page 465 Displaying Device Usage
Simulation	Simulations in the following projects are supported. <ul style="list-style-type: none"> <li>Project for an R00CPU, an R01CPU, or an R02CPU</li> <li>Project for an RnPSFCPU</li> <li>When simulating a project for an RnSFCPU (R08SFCPU, R16SFCPU, R32SFCPU, or R120SFCPU), the capacity of signal memory to be used (for FB) increases.</li> </ul>	Page 518 PROGRAM SIMULATION
I/O system setting	The following instructions can be used for a condition of setting data. <ul style="list-style-type: none"> <li>INT_TO_REAL</li> <li>REAL_TO_INT</li> <li>DINT_TO_REAL</li> <li>REAL_TO_DINT</li> </ul>	Page 550 Creating setting data
Connection destination setting	<ul style="list-style-type: none"> <li>A CPU module can be accessed via a QCPU (Q mode).</li> </ul>	Page 570 Accessing via QCPU (Q mode)
Writing data to a programmable controller	<ul style="list-style-type: none"> <li>For RnCPUs, RnENCPUs, and RnSFCPUs, a file with no changes from the previous writing is not written to a CPU module.<sup>3</sup></li> </ul>	Page 581 Skip overwriting data

Item	Description	Reference
Writing data to a programmable controller Online program change	<ul style="list-style-type: none"> <li>For an RnSFCPU project, a standard program, standard FB, and standard FUN excluding the program restoration information can be written to a CPU module.*<sup>3</sup></li> </ul>	Page 580 Program restoration information Page 604 Program restoration information
Online program change	<ul style="list-style-type: none"> <li>For RnCPUs and RnENCPU, the online program change can be performed for an SFC active block.</li> <li>For an RnPCPU (redundant mode) project, the online program change can be performed for program files, FB files, and FUN files without including the program restoration information.*<sup>3</sup></li> <li>For an RnPCPU (redundant mode) project, program restoration information can be written in the background process.*<sup>3</sup></li> </ul>	Page 601 Online program change of SFC programs Page 603 Program transfer during the online program change Page 604 Program restoration information
Monitoring	<ul style="list-style-type: none"> <li>When monitoring a program in an FBD/LD editor or SFC editor, word devices with device type specifiers are displayed in the data types corresponding to the specifiers.</li> </ul>	Page 623 Word device
Device/buffer memory batch monitor	When using the following menu in a ladder editor, FBD/LD editor, or SFC diagram editor, the "Device/Buffer Memory Batch Monitor" window appears and a monitoring is started. <ul style="list-style-type: none"> <li>Right-click on the screen, and select [Online] from the shortcut menu ⇒ [Device/Buffer Memory Batch Monitor].</li> </ul>	Page 633 Checking Device/Buffer Memory in a Batch
Watch	<ul style="list-style-type: none"> <li>Label options can be displayed when entering a label name.</li> <li>Device type specifiers can be added to devices index-modified devices.</li> </ul>	Page 638 Registering to a watch window
Registering/canceling forced input/output* <sup>3</sup>	When connecting to a following CPU, input/output devices can forcibly be turned ON/OFF. <ul style="list-style-type: none"> <li>R00CPU, R01CPU, R02CPU</li> <li>RnPCPU (process mode/redundant mode)</li> </ul>	Page 644 Turning Input/Output Devices ON/OFF Forcibly
Pause FB/restart FB	<ul style="list-style-type: none"> <li>During a program execution, the execution of a process control function block can be paused or restarted.</li> <li>Process control function blocks whose operations are temporarily paused can be displayed and checked in a list.</li> </ul>	Page 650 Pausing/Restarting the Operation of Function Blocks
PX Developer Monitor Tool interaction	<ul style="list-style-type: none"> <li>Assignment information database files used for the GOT screen generator of PX Developer Monitor Tool can be exported.</li> </ul>	Page 665 PX Developer Monitor Tool interaction
User authentication	<ul style="list-style-type: none"> <li>"Assistant Developers" is added to the access level of user.*<sup>3</sup></li> </ul>	Page 683 Preventing Illegal Access to Project (User Authentication)
Offline monitor	<ul style="list-style-type: none"> <li>Label values displayed in GX LogViewer can be monitored on a program editor.</li> </ul>	Page 882 Checking logging data in version 1.063R or earlier
Diagnostic	The following information can be displayed in the CC-Link IE Field Network diagnostics. <ul style="list-style-type: none"> <li>Error history in a device station</li> </ul> The following modules can be diagnosed: <ul style="list-style-type: none"> <li>CC-Link IE Field Network Basic remote I/O modules (NZ2MF2S1-32D, NZ2MF2S1-32T, NZ2MF2S1-32TE1, NZ2MF2S1-32DT, NZ2MF2S1-32DTE1)</li> <li>CC-Link IE Field Network remote I/O modules (NZ2GF12A-60IOLH8, NZ2GFSS2-16DTE, NZ2GFSS2-8D, NZ2GFSS2-8TE, FCU8-EX564, FR-A8NCE)</li> <li>MELIPC (MI5122-VW)</li> <li>The 'simple CPU communication diagnostics' function is available.*<sup>3</sup></li> </ul>	Page 717 CC-Link IE TSN/CC-Link IE Field Network diagnostics Page 719 CC-Link IE Field Network Basic diagnostics Page 717 CC-Link IE TSN/CC-Link IE Field Network diagnostics Page 722 Simple CPU communication diagnostics
Safety operation mode switching	<ul style="list-style-type: none"> <li>The file size of a safety project does not increase when switching the safety operation mode of a CPU module without changing data in the project.</li> </ul>	Page 764 Safety operation mode switching



Item	Description	Reference
CC IE Field configuration window	<ul style="list-style-type: none"> <li>MELSOFT FieldDeviceConfigurator can be started by double-clicking a CC-Link IE Field Network waterproof remote IO-Link module (NZ2GF12A-60IOLH8) that is placed in this window.</li> <li>When MELSOFT FieldDeviceConfigurator is started, the following items set in GX Works3 are applied to the configurator: start I/O number and network number of the master station, station numbers of device stations, and connection destination setting information.</li> </ul> (To use this function, it is required that Version 1.02C or later of MELSOFT FieldDeviceConfigurator has been installed.)	FieldDeviceConfigurator Operating Manual
	<ul style="list-style-type: none"> <li>When setting module parameters of a safety remote I/O module in the "Parameter Processing of Device Station" screen, "Wiring selection of input" are set as follows: If "1: Double wiring (NC/NC)" is set in a wiring selection of input Xn (n: even number), the same setting is automatically applied to Xn+1 which makes a pair with Xn.</li> </ul>	—
	<ul style="list-style-type: none"> <li>Strings copied in another application such as Excel can be pasted to the station list in this window.</li> </ul>	—
Interaction with iQ Works (FX5CPU)*2	The following operations can be performed in MELSOFT Navigator: <ul style="list-style-type: none"> <li>Applying label information assigned in wirings (CHs) of analog inputs/outputs in an electrical CAD file which is imported in MELSOFT Navigator to global labels in GX Works3</li> <li>Setting global labels in GX Works3 for label information assigned in wirings (CHs) of analog inputs/outputs in MELSOFT Navigator, and exporting the label information as an electric CAD file</li> </ul>	
FX5CPU	<ul style="list-style-type: none"> <li>A power supply capacity and I/O points can be checked.</li> </ul>	Page 198 Checking the power supply capacity and I/O points
	<ul style="list-style-type: none"> <li>A simulation environment file can be saved.</li> <li>A simulation environment file can be opened.</li> </ul>	Page 545 Saving a simulation environment file Page 546 Opening a simulation environment file
	<ul style="list-style-type: none"> <li>The GOT transparent function, which connects a personal computer and a GOT, and the GOT and a CPU on Ethernet, is available.*4</li> </ul>	Page 569 Accessing via GOT (GOT Transparent Function)

## Parameters

Category	Module type	Module	Parameter*3*4	Description
CPU parameter	RnCPU RnENCPU		"Memory/Device Setting" ⇔ "Device/Label Memory Area Setting" ⇔ "Cassette Setting" ⇔ "Battery-less Option Cassette Setting"	Newly added
	RnSFCPU		Memory/Device Setting" ⇔ "Device/Label Memory Area Setting" ⇔ "Device/Label Memory Area Capacity Setting" ⇔ "Device/Label Memory Configuration Confirmation"	In a safety project, the configuration of the device/label memory area can be checked.
Module parameter	RnCPU RnENCPU		"Application Settings" ⇔ "Web Server Settings"	Newly added
			"Application Settings" ⇔ "Simple CPU Communication Setting"	Newly added
	RnCPU RnENCPU RnPCPU RnSFCPU	High speed data logger module (RD81DL96) MES interface module (RD81MES96)	"Basic Settings" ⇔ "Various Operations Settings" ⇔ "Mode Settings"	"Online(Asynchronous Mode)" can be selected.



## Version 1.047Z

Item	Description	Reference
Cross reference	<ul style="list-style-type: none"> <li>When searching for a label by entering the name of the device which was assigned to a label, only the label that the name of assigned device completely matches with the entered name is displayed in the search result.</li> </ul>	Page 457 Displaying cross reference information
Monitoring (FBD/LD editor, SFC diagram editor)	<p>The following contents are improved in the monitor value display area of variable elements.</p> <ul style="list-style-type: none"> <li>It is displayed at the front when overlapping.</li> <li>The font size is increased.</li> <li>The position can be changed.</li> <li>It can be enlarged.</li> </ul>	Page 624 Monitor value display area of variable elements
Device test with execution conditions	<p>While running a ladder program of a project for which any of the following CPU modules, a device or label value can be changed according to the conditions which were set in advance.*<sup>3</sup></p> <ul style="list-style-type: none"> <li>RnCPU</li> <li>RnENCPU</li> </ul>	Page 646 Changing Device/Label Value by Setting Conditions
Opening a GX Works2 format project	<ul style="list-style-type: none"> <li>Instructions that are automatically replaced in an ST or FBD/LD program are increased.</li> </ul>	Page 901 Automatic replacement of elements (GX Works3 Version 1.047Z or later)
PROFIBUS Configuration Tool	<p>In projects for an RnPCPU (redundant mode), an RnSFCPU, and an RnPSFCPU, the following functions of PROFIBUS Configuration Tool are available.</p> <ul style="list-style-type: none"> <li>Upload Configuration Image</li> <li>Download Configuration Image</li> </ul> <p>(To use this function, it is required that Version 1.01B or later of PROFIBUS Configuration Tool has been installed.)</p>	MELSEC iQ-R PROFIBUS-DP Module User's Manual (Application)
Writing data to a programmable controller	<ul style="list-style-type: none"> <li>Unused structures can be written to a CPU module.</li> <li>An error message is displayed when writing of device comments fails.</li> </ul>	—
Reading data from a programmable controller	<ul style="list-style-type: none"> <li>Unused structures are read as unconverted ones.</li> <li>When reading module parameters of a CC-Link IE Field Network module, a message indicating to check whether the parameters of a device station needs to be deleted is displayed.</li> </ul>	—
Watch	<ul style="list-style-type: none"> <li>By entering a value right after a device or label that is displayed in a program editor and whose data type is not the bit type is registered in a watch window, the current value can be changed to the entered value.</li> </ul>	—
FX5CPU	<ul style="list-style-type: none"> <li>When using the online program change function, a program and program restoration information can separately be written.*<sup>3</sup></li> </ul>	Page 604 Separate writing of a program and program restoration information (FX5CPU only)

## Parameters

Category	Module type	Module	Parameter* <sup>3*4</sup>	Description
CPU parameter	FX5CPU		"Program Setting" ⇔ "Program Capacity Setting"	Newly added

## Version 1.050C

Item	Description	Reference
Work window	<ul style="list-style-type: none"> <li>Floating work windows can be combined as one window.</li> </ul>	Page 53 Combining work windows in one window
Options	<p>The following option is added:</p> <ul style="list-style-type: none"> <li>"Program Editor" ⇔ "Ladder Editor" ⇔ "Ladder Diagram" ⇔ "Display Format" ⇔ "Autofit Text Size"</li> </ul>	Page 84 Option Settings for Each Function
Opening a GX Works2 format project	<ul style="list-style-type: none"> <li>The MELSOFT connection extended setting of high-speed universal model QCPUs can be applied to the module parameter of GX Works3.</li> </ul>	Page 107 Opening a GX Works2 format project
Opening a GX IEC Developer format project	<ul style="list-style-type: none"> <li>When opening a GX IEC Developer format project in GX Works3, the comments of an IL/MELSEC IL programs and FBD/LD programs can be imported with left-aligned.</li> </ul>	Page 115 Opening a GX IEC Developer format project
Property	<ul style="list-style-type: none"> <li>When saving a project, data can be compressed.</li> </ul>	Page 137 Compressing a project file
Verification	<p>The details of the verification results of the following programs are displayed in the detailed display (diagram/table format) screen.</p> <ul style="list-style-type: none"> <li>Ladder program</li> <li>FBD/LD program</li> <li>SFC program</li> </ul>	Page 145 Checking a verification result

Item	Description	Reference
Tag FB	<ul style="list-style-type: none"> <li>Up to 1000 tag FBs can be registered into a project.</li> </ul>	Page 249 Registering Tag FBs Page 665 Exporting an assignment information database file
Ladder editor	<p>When a ladder editor is split, the focus on the editor can be moved by using the following menu.</p> <ul style="list-style-type: none"> <li>[Window] ⇒ [Split Window Operation] ⇒ [Focus on Next Window]/[Focus on Previous Window]</li> </ul> <p>By using the following menu, the character size is automatically adjusted according to the display magnification of a ladder editor.</p> <ul style="list-style-type: none"> <li>[View] ⇒ [Text Size] ⇒ [Autofit]</li> </ul> <p>By using the following menu, the display magnification of a ladder editor is automatically adjusted according to the window width.</p> <ul style="list-style-type: none"> <li>[View] ⇒ [Zoom] ⇒ [Fit the editor width to the window width]</li> </ul> <ul style="list-style-type: none"> <li>Ladder editors displayed vertically can individually be scrolled.</li> </ul>	Page 264 Configuration of a ladder editor       Page 267 Splitting a ladder editor
ST editor Device comment editor Device memory editor	<p>When a ladder editor is split, the focus on the editor can be moved by using the following menu.</p> <ul style="list-style-type: none"> <li>[Window] ⇒ [Split Window Operation] ⇒ [Focus on Next Window]/[Focus on Previous Window]</li> </ul>	Page 309 Configuration of an ST editor Page 402 Configuration of a device comment editor Page 435 Configuration of a Device Memory Editor
FBD/LD editor SFC diagram editor	<p>By setting the following options, text layout of a newly added comment element can be set.</p> <ul style="list-style-type: none"> <li>"Program Editor" ⇒ "FBD/LD Editor" ⇒ "Enter Element" ⇒ "Operational Setting" ⇒ "Comment element text layout"</li> <li>"Program Editor" ⇒ "SFC Diagram Editor" ⇒ "Enter Element" ⇒ "Operational Setting" ⇒ "Comment element text layout"</li> </ul> <ul style="list-style-type: none"> <li>Text layout can be set for each comment element.</li> <li>Tab characters can be used for comment elements.</li> </ul>	Page 319 Creating an FBD/LD Program Page 342 Creating an SFC Program
Creating a program	<ul style="list-style-type: none"> <li>Sequential Function Chart language is supported in a project for an RnPCPU (redundant mode).<sup>3</sup></li> </ul>	Page 342 Creating an SFC Program
SFC diagram editor	<ul style="list-style-type: none"> <li>When creating a block or deleting all SFC elements in an SFC program, 'S0' is assigned to the initial step.</li> </ul>	
Reading sample comments	<p>Sample comments of the following intelligent function modules can be read.</p> <ul style="list-style-type: none"> <li>RD60P8-G</li> <li>RD60P8-G(Q)</li> <li>R60AD18-HA</li> <li>RE81WH</li> </ul>	Page 409 Reading sample comments
Program check	<ul style="list-style-type: none"> <li>Devices assigned to labels are included in the target of the duplicated coil check.</li> </ul>	Page 418 Target of duplicated coil check
Memory size calculation	<p>For the following CPU modules, by selecting the version of a CPU module in use in the "Confirm Memory Size (Offline)" screen, the memory capacity of global label assignment information can be calculated.</p> <ul style="list-style-type: none"> <li>RnCPU and RnENCPU: '40 and later versions'</li> <li>RnSFCPU: '16 and later versions'</li> </ul>	Page 432 Calculating Memory Size
Search/replacement	<ul style="list-style-type: none"> <li>The display status of "Find/Replace Options" in the "Find and Replace" window is retained even after exiting GX Works3.</li> </ul>	Page 448 Searching for/ Replacing Devices and Labels Page 450 Searching for/ Replacing Instructions Page 451 Searching for/ Replacing Character Strings Page 453 Changing Contacts between Open Contact and Close Contact Page 454 Batch Replacing of Devices and Labels

Item	Description	Reference
Cross reference	<ul style="list-style-type: none"> <li>When selecting a device or label in an editor, the row of the device or label in the search result of a cross reference window is also selected.</li> </ul>	Page 460 Device or label selected in an editor
	<ul style="list-style-type: none"> <li>By displaying a cross reference window while a local label is selected in a program editor, the names of both the program in which the label is used and the label are automatically entered in the input field in the window.</li> <li>By entering a label name, to which a character string such as a program file name is appended, in the input field, the type and range of the labels to search for can be specified.</li> </ul>	Page 459 Label type and range specification method Page 460 Local label selected in an editor
Simulation	<ul style="list-style-type: none"> <li>Functions that use an SD memory card can be simulated by creating a virtual SD memory card file.</li> </ul>	Page 542 SD memory card
	The following operations can be performed for GX Simulator3. <ul style="list-style-type: none"> <li>RnCPUs, RnENCPU, and RnSFPCUs: omission of writing files that are not changed</li> <li>RnPCPUs (redundant mode): background processing of program transfer (writing the program restoration information) during changing a program online</li> </ul>	Page 581 Skip overwriting data Page 603 Program transfer during the online program change
	A project including the following module can be simulated: <ul style="list-style-type: none"> <li>CC-Link IE Controller Network module (RJ71GP21S-SX)</li> </ul>	Page 933 Modules supported by GX Simulator3
	The following CPU module functions are available: <ul style="list-style-type: none"> <li>RnCPUs, RnENCPU, RnPCPUs, RnPSFPCUs, and RnSFPCUs: writing to an SD memory card/reading from an SD memory card</li> <li>RnCPUs and RnENCPU: real-time monitor, memory dump, web server, online change (SFC block), local device and label specification for target data/condition specification of the data logging function</li> <li>RnPCPUs: external input/output forced on/off</li> <li>RnSFPCUs: selection writing of program restoration information, LED control setting for program restoration information write status</li> </ul>	Page 942 Supported CPU module functions
	A virtual SD memory card is available when using the following CPU module functions. <ul style="list-style-type: none"> <li>RnCPUs, RnENCPU, RnPCPUs, RnSFPCUs, and RnPSFPCUs: device/file usage setting, label communication from GOT</li> <li>RnCPUs, RnENCPU, RnPCPUs: event history</li> </ul>	
	The following instructions are available: <ul style="list-style-type: none"> <li>Output instruction (DELTA(P))</li> <li>Reading/writing data instructions</li> </ul>	Page 952 Supported instructions
	"Memory Card" can be selected in the following CPU parameter items: <ul style="list-style-type: none"> <li>"File Setting" ⇔ "Initial Value Setting" ⇔ "Target Memory"</li> <li>"RAS Setting" ⇔ "Event History Setting" ⇔ "Save Destination"</li> </ul> This makes it possible to write the following files to a virtual SD memory card file. <ul style="list-style-type: none"> <li>Device initial value file</li> <li>Global label initial value file</li> <li>Local label initial value file</li> <li>Event history file</li> </ul>	Page 956 Supported parameters
	The following memory card parameter is available: <ul style="list-style-type: none"> <li>Setting of File/Data Use or Not in Memory Card</li> </ul> The following module parameter is available: <ul style="list-style-type: none"> <li>Web Server Settings</li> </ul>	
Specifying a connection destination	<ul style="list-style-type: none"> <li>GX Works3 can access an RnPSFCPU by using the GOT transparent function<sup>4</sup>.</li> </ul>	Page 569 Accessing via GOT (GOT Transparent Function)
Writing data to a programmable controller	<ul style="list-style-type: none"> <li>For an RnPCPU, a file with no changes from the previous writing is not written to a CPU module.<sup>3</sup></li> </ul>	Page 580 Writing data to a programmable controller
	<ul style="list-style-type: none"> <li>When writing a program to a CPU module after converting all programs, all the programs which are displayed in the "Online Data Operation" screen are automatically selected their checkboxes.</li> </ul>	Page 581 Skip overwriting data
File password	<ul style="list-style-type: none"> <li>A password can be registered for files in the SD memory card inserted in a personal computer.</li> </ul>	Page 610 File password function Page 692 Preventing Illegal Data Reading/Writing (File Password )
Monitoring	<ul style="list-style-type: none"> <li>Ladder editor: The monitor values of devices which are used as the arguments for input/output labels of a standard function or a standard function block are displayed in the data types of the input/output labels.</li> <li>ST editor: The monitor value of a device which is used as an argument of an instruction is displayed in the data type corresponding to that of the instruction.</li> </ul>	Page 620 Ladder Page 622 ST
	<ul style="list-style-type: none"> <li>While monitoring a program in an SFC diagram editor, activated steps can be displayed.<sup>3</sup></li> </ul>	Page 630 Monitoring SFC steps which were activated
Registering/canceling forced input/output	<ul style="list-style-type: none"> <li>When connecting to an RnSFPCPU, input/output devices can forcibly be turned ON/OFF.<sup>3</sup></li> </ul>	Page 644 Turning Input/Output Devices ON/OFF Forcibly



Item	Description	Reference
User authentication	<ul style="list-style-type: none"> <li>Users can log on to a project and a CPU module as a guest user. (It is required that the CPU module supports 'Assistant Developers.'<sup>*3</sup>)</li> </ul>	Page 684 Guest user
Diagnostics	<ul style="list-style-type: none"> <li>When connecting a personal computer to a sub-master station which operates as the master station in CC-Link IE Field network using a USB cable, the "Sensor/Device Monitor" screen appears.</li> </ul>	Page 705 Sensor/Device Status Check
	<ul style="list-style-type: none"> <li>The name of a program block in an FB file or a FUN file where a CPU error occurs is displayed in the module diagnostics screen.</li> </ul>	Page 708 Module Diagnostics
	The following modules can be diagnosed: <ul style="list-style-type: none"> <li>CC-Link IE Field Network block type remote IO-Link module (NZ2GF2S-60IOLD8)</li> </ul>	Page 717 CC-Link IE TSN/CC-Link IE Field Network diagnostics
	<ul style="list-style-type: none"> <li>Ethernet modules can be diagnosed in the simple CPU communication diagnostics.<sup>*4</sup></li> </ul>	—
AnyWireASLINK configuration window	<ul style="list-style-type: none"> <li>In a project using a CC-Link-AnyWireASLINK bridge module, up to 256 remote modules can be placed in this window.</li> </ul>	
AnyWireASLINK configuration window	Item names in this window are changed as follows: <ul style="list-style-type: none"> <li>"Transmission Points"→"Bit Data Points"</li> </ul>	
Sensor/device monitor	<ul style="list-style-type: none"> <li>"Occupied I/O Pts"→"Occupied Bit Pts" and "Occupied Word Pts"</li> </ul>	
CC-Link configuration window	Item names in this window are changed as follows: <ul style="list-style-type: none"> <li>"Intelligent Buffer Select (Word)"→"Intelligent Buffer Selection (decimal-word unit)"</li> </ul>	
CC IE Field configuration window	<ul style="list-style-type: none"> <li>When opening this window, "Assignment Method" which was previously selected is displayed.</li> </ul>	
	<ul style="list-style-type: none"> <li>When copying and pasting a device station in this window, its parameters are also copied and pasted.</li> </ul>	
	The "Device No. Reassignment" screen appears by selecting the following menu. In this screen, device numbers can sequentially be assigned to the link devices on a device station. <ul style="list-style-type: none"> <li>[CC IE Field Configuration] ⇨ [Device No. Reassignment]</li> </ul>	
	The following function is available when connecting a personal computer and the sub-master station that operates as a master station in CC-Link IE Field Network with a USB cable: <ul style="list-style-type: none"> <li>Automatic detection of connected devices</li> </ul>	
	Initial values or read values can be applied to write values by clicking the following buttons in the "Parameter Processing of Device Station" screen: <ul style="list-style-type: none"> <li>Copy "Initial Value" to "Write Value"</li> <li>Copy "Read Value" to "Write Value"</li> </ul>	
	<ul style="list-style-type: none"> <li>A safety module can be enabled when writing parameters to the module by selecting the checkbox of "Enable safety module when succeed to write parameter" in the "Parameter Processing of Device Station" screen.</li> </ul>	
	<ul style="list-style-type: none"> <li>The "Parameter Processing of Device Station" screen can be closed with discarding current changes by clicking the [Cancel] button in the screen.</li> </ul>	
FX5CPU	<ul style="list-style-type: none"> <li>The system monitor function is available.<sup>*3</sup></li> </ul>	Page 702 Module Status Check of a System
	<ul style="list-style-type: none"> <li>The sensor/device monitor function can be performed in a project using AnyWireASLINK.</li> </ul>	Page 705 Sensor/Device Status Check
	The following modules can be diagnosed: <ul style="list-style-type: none"> <li>FX5-20PG-P, FX5-20PG-D, FX5-ENET</li> </ul>	Page 708 Module Diagnostics
	<ul style="list-style-type: none"> <li>The 'simple CPU communication diagnostics' function is available.<sup>*3</sup></li> </ul>	—

## Parameters

Category	Module type	Module	Parameter*3*4	Description
CPU parameter	RnPCPU (redundant mode)		"Redundant System Settings" ⇒ "Redundant Behavior Setting" ⇒ "Setting to Wait Receiving Cyclic Data after Switching System"	Newly added
			"Redundant System Settings" ⇒ "Tracking Setting" ⇒ "Tracking Device/Label Setting" ⇒ "Device/Label Detailed Setting" ⇒ "<Detailed Setting>"	Step relays (S) can be set.
Module parameter	RnCPU RnENCPU		"Basic Settings" ⇒ "Own Node Settings" ⇒ "Communications by Network No./Station No."	Newly added
			"Application Settings" ⇒ "Network/Station No. <-> IP information setting"	Newly added
	RCPU	Ethernet interface modules (_RJ71EN71(E+IEC), _RJ71EN71(E+IEF), RJ71EN71(E+CCIEC), RJ71EN71(E+CCIEF), RJ71EN71(E+E))	"Application Settings" ⇒ "MODBUS/TCP Settings"	Newly added
			"Application Settings" ⇒ "Simple CPU Communication Setting"	Newly added

## Version 1.052E

Item	Description	Reference
Options (RCPU)	The following option is added: • "Convert" ⇒ "Basic Setting" ⇒ "Operational Setting" ⇒ "Optimization of Number of Steps" ⇒ "Optimize Level"	Page 85 Optimization of the number of steps
	The following option is changed. • Before change (version 1.015R to 1.050C) "Optimize the Number of Steps.": Yes • After change (version 1.052E) "Optimize the Number of Steps.": Yes "Optimize Level": Level 1	
FX5CPU (Verifying data with a programmable controller)	When verifying the device memory with the default settings, special relays (SM) and special registers (SD) are not verified.	Page 596 Device memory

## Version 1.055H

Item	Description	Reference
Process control function	<ul style="list-style-type: none"> <li>Initial values of FB properties saved in a project can be exported to a CSV file. The initial values of FB properties can be imported from the CSV file into the project.</li> </ul>	Page 23 List of functions supporting a process control system Page 397 FB property management (offline)
	<ul style="list-style-type: none"> <li>Execution intervals and phases of an FBD/LD program for process control can be set in the "Program File Setting" screen.</li> </ul>	Page 26 Process control extension toolbar Page 263 Execution interval and phase
Menu	The following menus are changed. <ul style="list-style-type: none"> <li>Before change (version 1.032J to 1.054G) [Online] ⇒ [FB Property] ⇒ [Update the Initial Value of FB Property]/[FB Property Management]</li> <li>After change (version 1.055H) [Online] ⇒ [FB Property Management (Online)]</li> </ul>	Page 61 Basic menus Page 666 FB Property Management (Online) screen
Multiple comments	<ul style="list-style-type: none"> <li>Comments of elements, which have been used in a project, such as common instructions or module FBs can be read.</li> </ul>	Page 83 Reading comments
	<ul style="list-style-type: none"> <li>Comments of the following elements are applied to the same read destination as sample comments: common instructions, standard functions, standard function blocks, module FBs, and module labels. Therefore, while displaying sample comments in an editor, the comments of the other elements such as common instructions or module FBs can be displayed.</li> </ul>	—
Opening a GX Works2 format project	<ul style="list-style-type: none"> <li>The parameters of a channel isolated pulse input module (QD60P8-G) can be imported.</li> </ul>	Page 108 Data to be changed
	<ul style="list-style-type: none"> <li>Elements that are automatically replaced in an ST or FBD/LD program are increased.</li> </ul>	Page 901 Automatic replacement of elements (GX Works3 Version 1.047Z or later)
Copying and pasting	<ul style="list-style-type: none"> <li>When copying and pasting a program block including a function or a function block to another project, whether to copy the FB file or the FUN file of the elements can be selected.</li> </ul>	Page 130 Copying and pasting data
	<ul style="list-style-type: none"> <li>A program block including a module FB can be copied and pasted to another project.</li> </ul>	
Verification	<ul style="list-style-type: none"> <li>A verification result of an ST program can be displayed in a list.</li> <li>Details of a verification result of an ST program are displayed in the detailed display (diagram/table format) screen.</li> <li>Only the mismatched data can be displayed in the detailed display (diagram/table format) screen.</li> </ul>	Page 150 Detailed display (program) Page 154 Detailed display (diagram/table format)
Reading sample comments	<ul style="list-style-type: none"> <li>When adding an intelligent function module to a project, sample comments for the module can be read.</li> </ul>	Page 207 Setting parameters Page 409 Reading sample comments
CC-Link IE TSN configuration window	<ul style="list-style-type: none"> <li>In projects for an RnCPU and an RnENCPU, a CC-Link IE TSN system can be configured using this window.</li> </ul>	Page 208 Setting network configuration and target devices MELSEC iQ-R CC-Link IE TSN User's Manual (Application)
	The following items can be set for a device station: <ul style="list-style-type: none"> <li>Motion Control Station</li> <li>PDO Mapping Setting</li> <li>Communication Period Setting</li> </ul>	
	The PDO mapping parameters of device stations can be set in a batch by using the following menu: <ul style="list-style-type: none"> <li>[CC-Link IE TSN Configuration] ⇒ [Batch Setting of PDO Mapping]</li> </ul>	
	The following functions are available for CC-Link IE TSN supported devices: <ul style="list-style-type: none"> <li>Connected/disconnected module detection</li> <li>Parameter of device station</li> <li>Command execution of device station</li> </ul>	
Device assignment confirmation	<ul style="list-style-type: none"> <li>Refresh devices which are assigned to a device station can be checked when using a CC-Link IE TSN module.</li> </ul>	Page 211 Checking refresh devices assigned to a module
	<ul style="list-style-type: none"> <li>Content in the "Explanation" column displayed in the link device list of the "Device Assignment Confirmation" screen can be applied to the device comment for each refresh device when using a CC-Link IE TSN module.</li> </ul>	Page 213 Applying explanations to device comments
Module tool list	The following modules are supported. (Predefined Protocol Support Tool For Positioning) <ul style="list-style-type: none"> <li>RJ71C24</li> <li>RJ71C24-R2</li> <li>RJ71C24-R4</li> </ul>	Page 218 Displaying the module tool list

Item	Description	Reference
Assigned device check	<ul style="list-style-type: none"> <li>Devices assigned to the global label can be checked if there is a same device assigned to another label.</li> </ul>	Page 241 Checking assigned devices
Structure definition	<ul style="list-style-type: none"> <li>Reserved area capacities of structure members can be set in the "Properties" screen of a structure definition.</li> <li>The online program change can be used after editing a structure definition by setting the reserved area capacities.</li> </ul>	Page 242 Setting reserved area capacities
Label editor	<ul style="list-style-type: none"> <li>Data including devices assigned to structure members can be exported to an XML file.</li> </ul>	Page 245 Exporting/importing a label Page 246 XML file
Creating a program Search/replacement Watch	<p>If "Yes" is selected for the following option, devices and labels for which a device comment has been set can be displayed as options by entering a device comment when searching for/replacing a device, inputting it in a program, or registering it in a watch window.</p> <ul style="list-style-type: none"> <li>"Edit" ⇒ "Instruction/Device/Label Candidacy Display" ⇒ "Candidate Display Setting" ⇒ "Display the Device to Which Device Comment Has Been Set"</li> </ul>	Page 269 Inserting contacts, coils, instructions, arguments Page 312 Inserting instructions, functions, and control syntax Page 325 Using the edit box Page 405 Device comment including @ Page 448 Searching for/ Replacing Devices and Labels Page 453 Changing Contacts between Open Contact and Close Contact Page 454 Batch Replacing of Devices and Labels Page 638 Registering to a watch window
Importing/exporting ladder programs (CSV file)	<ul style="list-style-type: none"> <li>When importing a program including a function block or function, the function block, function, and FB instance can be imported as undefined elements.</li> </ul>	Page 298 Importing from a CSV file
ST editor	<ul style="list-style-type: none"> <li>Change tracking of a program is displayed.</li> </ul>	Page 309 Configuration of an ST editor
FBD/LD editor	<ul style="list-style-type: none"> <li>By pressing the  +  /  /  /  keys, the cursor can be moved on an editor without selecting elements.</li> </ul>	Page 319 Configuration of an FBD/LD editor
	<ul style="list-style-type: none"> <li>The display format for Input/output labels of a function element and a function block element can be changed to their label comments.</li> </ul>	
	<ul style="list-style-type: none"> <li>The size of a comment element, function element, and function block element can be changed.</li> </ul>	Page 321 Elements Page 332 Changing the element size
SFC diagram editor	<ul style="list-style-type: none"> <li>By pressing the  +  /  /  /  keys, the cursor can be moved on an editor without selecting elements.</li> </ul>	Page 343 Configuration of an SFC diagram editor
	<ul style="list-style-type: none"> <li>By selecting [View] ⇒ [Open Zoom/Start Destination Block] on a step, the action (Zoom) assigned to the step can be opened.</li> </ul>	
Device comment	<ul style="list-style-type: none"> <li>By using '@' in device comments, options of devices can be refined when searching for/replacing a device, inputting it in a program, or registering it in a watch window.</li> </ul>	Page 405 Device comment including @
Device memory editor	<ul style="list-style-type: none"> <li>Only the values within the range specified in a device memory editor can be written to/read from a CPU module.</li> </ul>	Page 439 Writing/Reading Data to/from CPU Module
Highlighting display	<ul style="list-style-type: none"> <li>A row displayed in the following windows and screen can be highlighted: a cross reference window, the "Output" window, and the "Find Result" screen.</li> </ul>	Page 462 Highlighting display
Library	<ul style="list-style-type: none"> <li>A project including a module label or a module FB can be exported as a library file.</li> </ul>	—
	<ul style="list-style-type: none"> <li>If an element with the same name as one in a library file to be imported exists in a project, the element can be overwritten in importing the file.</li> </ul>	Page 512 Utilizing an element
	<ul style="list-style-type: none"> <li>Multiple elements can be utilized to a project in a batch.</li> </ul>	
	<ul style="list-style-type: none"> <li>Elements created in Ladder Diagram language or Sequential Function Chart language can be updated.</li> </ul>	Page 514 Updating library POU's
Connection destination setting	<ul style="list-style-type: none"> <li>An Ethernet board to communicate with an RCP module can be selected in GX Works3.</li> </ul>	Page 560 Specifying the Ethernet adapter on the personal computer side
	<ul style="list-style-type: none"> <li>A CPU module can be accessed via QJ71E71-100.</li> </ul>	Page 571 Accessing via QJ71E71-100
Parameter of a device station on CC-Link IE TSN <sup>3,4</sup>	<ul style="list-style-type: none"> <li>Parameters of a device station on CC-Link IE TSN can be written to, read from, or deleted from a CPU module or the SD memory card inserted in the CPU module.</li> <li>When writing parameters of a device station on CC-Link IE TSN to a CPU module or an SD memory card inserted in the CPU module, the parameters are automatically set to the device station.</li> </ul>	Page 583 Parameter Page 590 Parameters Page 605 Writing data for each file while a CPU module is running (file batch online change)

Item	Description	Reference
Writing data to a programmable controller <sup>*3</sup>	<ul style="list-style-type: none"> <li>In a project for an RnPCPU, only the program restoration information of a program file, FB file, and FUN file can be written to a CPU module.</li> </ul>	Page 580 Program restoration information
	<ul style="list-style-type: none"> <li>Writing of a memory card parameter which has not been changed can be skipped.</li> <li>Even when selecting an SD memory card as the writing destination, writing of data which has not been changed can be skipped.</li> </ul>	Page 581 Skip overwriting data
Online program change <sup>*3</sup>	<ul style="list-style-type: none"> <li>In a project for an RnPCPU, only the program restoration information of a program file, FB file, and FUN file can be written to a CPU module.</li> </ul>	Page 580 Program restoration information
	<ul style="list-style-type: none"> <li>Safety data can be written to an RnSFCPU in the test mode.</li> </ul>	Page 597 Writing Programs While a CPU Module is in the RUN State
	<ul style="list-style-type: none"> <li>The online change (SFC block) can be performed for an RnPCPU.</li> </ul>	Page 601 Online program change of SFC programs
Monitoring (ST editor)	<p>By using the following menu, the right half of the split window can be displayed or hidden.</p> <ul style="list-style-type: none"> <li>[Monitor] ⇒ [Switch ST Monitor Display (All)]/[Switch ST Monitor Display (Bit Type Only)]</li> </ul>	Page 622 ST
Watch	<ul style="list-style-type: none"> <li>The display format of a device or label can be changed.</li> <li>The data type of a device can be changed.</li> </ul>	Page 638 Operating a watch window
	<p>When comments have been set in the following device comments, those local devices are displayed as options by entering '/' at the end of a program file name.</p> <ul style="list-style-type: none"> <li>Common device comment</li> <li>Each program device comment with the same name as the program file name</li> </ul>	Page 638 Registering to a watch window
Device test with execution conditions <sup>*3</sup>	<ul style="list-style-type: none"> <li>In a project for an RnPCPU, a device or label value can be changed according to the conditions set in advance.</li> </ul>	Page 646 Changing Device/Label Value by Setting Conditions
PX Developer Monitor Tool interaction	<ul style="list-style-type: none"> <li>When exporting an assignment information database file, an "_" (underscore) at the end of a tag name can be deleted.</li> </ul>	Page 665 Exporting an assignment information database file
Sensor/device monitor	<p>The following display items are added:</p> <ul style="list-style-type: none"> <li>Transmission cycle time for bit and word data</li> <li>Input status of a word remote module</li> </ul>	Page 705 Sensor/Device Status Check
Diagnostics	<p>The following modules can be diagnosed in projects for an RnCPU and an RnENCPU:</p> <ul style="list-style-type: none"> <li>CC-Link IE TSN module (RJ71GN11-T2)</li> <li>DC safety I/O module (NZ2GFS12A2-14DT, NZ2GFS12A2-16DTE)</li> <li>DC input/transistor output combined modules (NZ2GN2B1-32DT, NZ2GN2B1-32DTE, NZ2GN2S1-32DT, NZ2GN2S1-32DTE)</li> <li>DC input modules (NZ2GN2B1-32D, NZ2GN2S1-32D)</li> <li>Transistor output modules (NZ2GN2B1-32T, NZ2GN2B1-32TE, NZ2GN2S1-32T, NZ2GN2S1-32TE)</li> <li>Analog input modules (NZ2GN2B-60AD4, NZ2GN2S-60AD4)</li> <li>Analog output modules (NZ2GN2B-60DA4, NZ2GN2S-60DA4)</li> <li>Inverters (FR-A800-GN, FR-F800-GN)</li> </ul>	Page 717 CC-Link IE TSN/CC-Link IE Field Network diagnostics
Options	<p>The default value for the following option is changed.</p> <ul style="list-style-type: none"> <li>Before change (version 1.052E to 1.054G) "Optimize Level": Level 2</li> <li>After change (version 1.055H) "Optimize Level": Level 1</li> </ul>	Page 876 Using a project, which was created in version 1.055H or later, in version 1.050C or earlier
	<p>The following options are added:</p> <ul style="list-style-type: none"> <li>"Project" ⇒ "Add New Module" ⇒ "Operation Setting" ⇒ "Read Sample Comment"</li> <li>"Program Editor" ⇒ "Common Item" ⇒ "Verify" ⇒ "Verify Setting" ⇒ "Minimize the Detailed Display (List Format)"</li> <li>"Program Editor" ⇒ "ST Editor" ⇒ "Verify" ⇒ "Verify Setting" ⇒ "Minimize the Detailed Display (List Format)"</li> <li>"Program Editor" ⇒ "ST Editor" ⇒ "Editor Display Items" ⇒ "Track Changes"</li> <li>"Program Editor" ⇒ "FBD/LD Editor" ⇒ "Comment" ⇒ "Display Item" ⇒ "Switch FB/FUN Argument to Comment"</li> <li>"Other Editor" ⇒ "Label Editor Common" ⇒ "Extended Display Setting" ⇒ "Item Name to Show in Hierarchy Display Area"</li> <li>"Edit" ⇒ "Instruction/Device/Label Candidacy Display" ⇒ "Candidate Display Setting" ⇒ "Display the Device to Which Device Comment Has Been Set"</li> <li>"Online" ⇒ "Write to PLC" ⇒ "Operational Setting" ⇒ "Show a completion message when the window is automatically closed in executing"/"Show a write completion message in completing writing to Safety PLC"</li> <li>"Convert" ⇒ "Basic Setting" ⇒ "Operational Setting" ⇒ "Structured Data Type" ⇒ "Enable to Set Reserved Area"</li> <li>"Convert" ⇒ "Basic Setting" ⇒ "Operational Setting" ⇒ "Check the Consistency of Global Label"</li> <li>"Convert" ⇒ "Process Control Extension Setting" ⇒ "Tag FB" ⇒ "PX Developer Monitor Tool Interaction" ⇒ "Remove Underscore at the End of Tag Name"</li> </ul>	—



Item	Description	Reference
Simulation	The following operation can be performed for GX Simulator3. • RnPCPU: omission of writing files that are not changed	Page 581 Skip overwriting data
	A project including any of the following modules can be simulated: • Main base unit (R33B) • Channel isolated pulse input modules (RD60P8-G, RD60P8-G(Q)) • HART communication analog input module (R60ADI8-HA) • Energy measuring module (RE81WH)	Page 933 Modules supported by GX Simulator3
	The following CPU module functions are available: • RnCPUs, RnENCPU, and RnPCPU: SFC-activated step monitor • RnCPUs, RnENCPU, and RnSFCPU: event history logging restriction • RnCPUs and RnENCPU: device test with execution conditions • RnPCPU (redundant mode): Program execution (SFC support), SFC program (diagram) monitor (SFC support) • RnSFCPU: external input/output forced on/off	Page 942 Supported CPU module functions
	The following instructions are available: • RnCPUs and RnENCPU: file operation instructions, data processing instructions (SORTTBL(_U), SORTTBL2(_U), DSORTTBL2(_U)) • R00CPU, R01CPU, and R02CPU: data shift instructions, clock instructions (DATE2SEC(P)_U, SEC2DATE(P)_U) • RnPCPU (redundant mode): SFC control instructions, SFC dedicated instruction • RnSFCPU: safety system instruction	Page 952 Supported instructions
	The following CPU parameter is available: • RnPCPU (redundant mode): SFC Setting	Page 956 Supported parameters
	• A multiple CPU system in which an RnSFCPU is set as the CPU No.1 can be simulated.	—
	• A monitoring interval can be specified for monitoring data of an RnCPU or an RnENCPU with the realtime monitor function.	—
Opening a PX Developer format project	If a specific condition is satisfied, the setting of the following option is changed to "Yes." • "Convert" ⇒ "Process Control Extension Setting" ⇒ "Tag FB" ⇒ "PX Developer Monitor Tool Interaction" ⇒ "Remove Underscore at the End of Tag Name"	Page 923 Tag names to which an underscore is added
	• Elements that are automatically replaced in an FBD/LD program are increased.	Page 921 Automatic replacement of instructions
e-Manual Viewer interaction	• Sample programs including a function block (ladder programs) can be used in GX Works3.	Page 982 Using Sample Programs



Item	Description	Reference
Printing	<ul style="list-style-type: none"> <li>When printing a ladder program or an FBD/LD program, label comments displayed in the program editor can be printed by selecting the checkbox of "Device/Label Comment" in the "Print" screen.</li> </ul>	—
	<ul style="list-style-type: none"> <li>When printing an FBD/LD program, by selecting the checkbox of "FB/FUN Argument Comment" in the "Print" screen, the program can be printed with the display format for the input/output labels of function and function block elements changed to their label comments.</li> </ul>	
	<ul style="list-style-type: none"> <li>The module information of AnyWireASLINK configuration can be printed.</li> </ul>	
AnyWireASLINK configuration window	<ul style="list-style-type: none"> <li>When "10: 0 points (0 input points/0 output points)" is set for "Transmission points setting" in the module parameter for RJ51AW12AL, "0 points (No Bit Data)" is displayed for "Bit Data Points" in this window.</li> <li>The content displayed for "TX Cycle Time (Approx.)" in this window switches depending on the value set for "To use or not to use word data setting" in the module parameters for RJ51AW12AL.</li> </ul>	
	<p>The following iQ Sensor Solution functions are available for word remote modules:<sup>*5</sup></p> <ul style="list-style-type: none"> <li>Automatic detection of connected devices</li> <li>Sensor parameter read/write</li> <li>Sensor/device monitor</li> <li>Data backup/restoration</li> </ul>	
CC IE Field configuration window	<ul style="list-style-type: none"> <li>Refresh devices are displayed.</li> </ul>	
	<p>Supplementary information of refresh devices can be displayed by selecting the following menu:</p> <ul style="list-style-type: none"> <li>[View] ⇒ [Docking Window] ⇒ [Supplementary Information]</li> </ul>	
	<p>Object names can be displayed or hidden by selecting the following menu:</p> <ul style="list-style-type: none"> <li>[View] ⇒ [Object Name Display]</li> </ul>	
	<p>The object name of a target module can be replaced with the module name selected as a replacement candidate by selecting the checkbox of the following item in the "Replace General CC IE Field Module" screen:</p> <ul style="list-style-type: none"> <li>Replace the object name of replacement target module to the module name selected in replacement candidate</li> </ul>	
Ladder editor	<ul style="list-style-type: none"> <li>By pressing <b>Ctrl</b> + <b>Alt</b> keys while directly entering a label comment or device comment on an editor, the entire character string of the comment can be selected.</li> </ul>	
Continuous paste screen (Ladder editor)	<ul style="list-style-type: none"> <li>The paste direction selected in this screen is applied to the next and subsequent continuous paste.</li> </ul>	
Conversion	<ul style="list-style-type: none"> <li>When a device with latch setting has been assigned to the 'VAR_GLOBAL' class or a device without latch setting to the 'VAR_GLOBAL_RETAIN' class in the global setting, a conversion error occurs.</li> </ul>	
Simple CPU communication diagnostics	<p>Up to 512 rows of the communication destination network statuses can be displayed in the "Simple CPU Communication Diagnostics" screen while diagnosing the following modules.</p> <ul style="list-style-type: none"> <li>_RJ71EN71 (E+IEC)</li> <li>_RJ71EN71 (E+IEF)</li> <li>RJ71EN71 (E+CCIEC)</li> <li>RJ71EN71 (E+CCIEF)</li> <li>RJ71EN71 (E+E)</li> </ul>	
Others	<ul style="list-style-type: none"> <li>The S.PHPL2 instruction can be used in a project for an RnPCPU.</li> </ul>	
	<ul style="list-style-type: none"> <li>The CPU module data backup/restoration function is available in a project for an RnPCPU.<sup>*3</sup></li> </ul>	
	<ul style="list-style-type: none"> <li>Saving an event history log is restricted in projects for an RnCPU and an RnENCPU.<sup>*3</sup></li> </ul>	
Options (FX5CPU)	<p>The following option is added:</p> <ul style="list-style-type: none"> <li>"Convert" ⇒ "Basic Setting" ⇒ "Operational Setting" ⇒ "Optimization of Number of Steps" ⇒ "Optimize Level"</li> </ul>	Page 85 Optimization of the number of steps
Memory size calculation (FX5CPU)	<ul style="list-style-type: none"> <li>Capacities of labels and latch labels can be displayed in a graph in the "Confirm Memory Size (Offline)" screen.</li> </ul>	Page 432 Calculating Memory Size
Simulation (FX5CPU)	<p>By selecting "Yes" for the following option, parameters, programs, and optional data are automatically written to GX Simulator3 when simulation is started:</p> <ul style="list-style-type: none"> <li>"Simulation" ⇒ "Start Simulation" ⇒ "Operational Setting" ⇒ "Automatically write programs and parameters when starting simulation."</li> </ul>	Page 522 Starting a simulation

Item	Description	Reference
Result of power supply capacity and I/O points check window (FX5CPU)	The following items are added in the window: <ul style="list-style-type: none"> <li>• Total Number of Points (Current/Maximum)</li> <li>• Number of I/O Points (Current/Maximum)</li> <li>• Number of Remote I/O Points (Current/Maximum)</li> <li>• Actual Number of Input Points for Control</li> <li>• Actual Number of Output Points for Control</li> </ul>	—
	24 VDC current consumption is divided into the following two kinds and displayed separately: <ul style="list-style-type: none"> <li>• Internal consumption current</li> <li>• External consumption current</li> </ul>	
	<ul style="list-style-type: none"> <li>• Display contents can be exported to a CSV file by clicking the [Output the CSV file] button.</li> </ul>	
	<ul style="list-style-type: none"> <li>• Column titles can be copied by selecting all the items and copying them.</li> </ul>	
CC-Link IEF Basic configuration window (FX5CPU)	The default value of the following item in the "Link Scan Setting" screen is changed to "500 ms." <ul style="list-style-type: none"> <li>• "Remote Station Disconnect Detected Setting" ⇒ "Time-out Period"</li> </ul>	

## Parameters

Category	Module type	Module	Parameter <sup>*3*4</sup>	Description
System parameter	RnSFCPU		"Multiple CPU Setting" ⇒ "Communication Setting between CPU" ⇒ "Fixed Scan Communication Area Setting"	Newly added
			"Inter-module Synchronization Setting" ⇒ "Select Inter-module Synchronization Target Module" ⇒ "<Detailed Setting>"	"Synchronize" can be selected in the "Setting" column for an RnSFCPU in the "Select the Synchronous Target Module" screen.
CPU parameter	RnCPU		"Memory/Device Setting" ⇒ "Link Direct Device Setting"	Newly added
	RnSFCPU		"RAS Setting" ⇒ "Error Detections Setting ⇒ "Synchronous Interrupt Program (I44,I45) Executing Time Excessive"	Newly added
			"RAS Setting" ⇒ "CPU Module Operation Setting at Error Detection" ⇒ "Synchronous Interrupt Execution Interval Error (CPU Module)"	Newly added
			"Refresh Setting between Multiple CPUs" ⇒ "Refresh Setting (At I45 Exe.)"	Newly added
			"Program Setting" ⇒ "<Detailed Setting>"	'I44' and 'I45' can be set in the "Event Execution Type Detailed Setting" screen.

Category	Module type	Module	Parameter <sup>*3*4</sup>	Description
Module parameter	RnCPU	Channel isolated digital-analog converter modules (R60DA8-G, R60DA8-G(Q), R60DA16-G)	"Application setting" ⇒ "Disconnection detection function"	Newly added
		CC-Link IE Controller Network modules (RJ71GP21-SX(R), RJ71GP21S-SX(R))	"Application Settings" ⇒ "Link points extended setting"	Newly added
		Ethernet interface modules (_RJ71EN71(E+IEC), _RJ71EN71(E+IEF), RJ71EN71(E+CCIEC), RJ71EN71(E+CCIEF), RJ71EN71(E+E))	"Application Settings" ⇒ "Simple CPU Communication Setting" ⇒ "<Detailed Setting>"	<ul style="list-style-type: none"> <li>Up to 512 rows can be set for "Setting No."</li> <li>"On Request" can be set for "Communication Setting."</li> <li>"MELSEC-A/AnS (Ethernet Module)" and "MELSEC-FX3 (Block/Adaptor)" can be selected for "Communication Destination."</li> <li>The communication destinations can be filtered.</li> </ul>
	RnCPU RnENCPU RnPCPU RnSFCPU	OPC UA server module (RD81OPC96)	"Basic Settings" ⇒ "Various Operations Settings" ⇒ "Mode Settings"	"Online(Asynchronous Mode)" can be selected.
	Flexible high-speed I/O control module (RD40PD01)	"Application setting" ⇒ "ADCValue logging function"	Newly added	
	Ethernet interface modules (_RJ71EN71(CCIEC), _RJ71EN71(E+IEC), RJ71EN71(CCIEC), RJ71EN71(E+CCIEC))	"Application Settings" ⇒ "Link points extended setting"	Newly added	
Memory card parameter	RnCPU RnENCPU	AnyWireASLINK master module (RJ51AW12AL)	"Basic setting" ⇒ "Easy replacement enable/disable setting for one slave module"	Newly added
		CC-Link IE TSN module (RJ71GN11-T2)	"Basic Settings" ⇒ "Refresh Setting" ⇒ "<Detailed Setting>"	Link side devices can be set in a batch. (Page 216 Setting link side devices in a batch (CC-Link IE TSN))
Memory card parameter	RnCPU RnENCPU		"Setting of File/Data Use or Not in Memory Card" ⇒ "Device Station Parameter"	Newly added

## Version 1.056J

Item	Description	Reference
Motion control setting function	<ul style="list-style-type: none"> <li>The motion control setting function is available.</li> </ul>	Page 219 Motion control setting function
Diagnostics	<p>The following module can be diagnosed in projects for an RnCPU and an RnENCPU:</p> <ul style="list-style-type: none"> <li>CC-Link IE TSN compatible motion modules (RD78G4, RD78G8, RD78G16, RD78G32, RD78G64)</li> <li>Servo amplifiers (MR-J5-G, MR-J5W2-G, MR-J5W3-G)</li> </ul>	Page 717 CC-Link IE TSN/CC-Link IE Field Network diagnostics

## Version 1.057K

Item	Description	Reference
Multiple comments	<ul style="list-style-type: none"> <li>Comments of libraries can be read.</li> </ul>	Page 83 Reading comments
Project version management	<ul style="list-style-type: none"> <li>A project update revision history can be managed for each data.</li> </ul>	Page 61 Basic menus Page 164 Project Version Management
Verification	By selecting "Yes" for the following option, the label memory can be verified. <ul style="list-style-type: none"> <li>"Other Editor" ⇒ "Label Editor Common" ⇒ "Verify" ⇒ "Include Label memory as Verify Target"</li> </ul>	Page 143 Verification
	<ul style="list-style-type: none"> <li>Details on the verification results of global labels, local labels, structures, and device comments are displayed in the detailed display (diagram/table format) screen.</li> </ul>	Page 154 Detailed display (diagram/table format)
Global label editor	<ul style="list-style-type: none"> <li>Devices assigned to structure members can be deleted in a batch.</li> </ul>	Page 238 When data type is structure
	The cursor can jump to the following option from the extension display area. <ul style="list-style-type: none"> <li>"Other Editor" ⇒ "Label Editor Common" ⇒ "Extended Display Setting" ⇒ "Item Name to Show in Hierarchy Display Area"</li> </ul>	
Memory size calculation	<ul style="list-style-type: none"> <li>The title of the "Size" column changes according to the unit selected for "Display Unit" in the "Confirm Memory Size (Offline)" screen. (Example: If "Byte" is selected, "Size (Byte)" is displayed as the title.)</li> </ul>	Page 432 Calculating Memory Size
Simulation	The following functions and instruction can be simulated. <ul style="list-style-type: none"> <li>Simple CPU communication setting function</li> <li>Database function</li> <li>Database access instruction</li> </ul>	Page 942 CPU module (RnCPU, RnENCPU, RnPCPU, LHCPU) Page 948 MELSEC iQ-R and MELSEC iQ-L series common functions Page 952 Application instruction Page 981 Database
Monitor	Monitoring for all the windows are stopped automatically when data is converted or all programs are converted during monitoring.	Page 613 Starting/stopping monitoring

Item	Description	Reference
Options	<p>The following option name is changed.</p> <ul style="list-style-type: none"> <li>• Before change (version 1.055H to 1.056J) Display the Device to Which Device Comment Has Been Set</li> <li>• After change (version 1.057K) Display the Corresponding Device in Entering Device Comment</li> </ul> <p>The following options are added:</p> <ul style="list-style-type: none"> <li>• "Program Editor" ⇒ "FBD/LD Editor" ⇒ "Element (Ladder Symbol)" ⇒ "Display Format" ⇒ "Number of Cells for Device/Label Name"</li> <li>• "Program Editor" ⇒ "FBD/LD Editor" ⇒ "FB/FUN" ⇒ "Display Format" ⇒ "Number of Wrapping Rows for Instance Name"</li> <li>• "Program Editor" ⇒ "FBD/LD Editor" ⇒ "FB/FUN" ⇒ "Display Format" ⇒ "Number of Cells for Instance Name"</li> <li>• "Program Editor" ⇒ "SFC Diagram Editor" ⇒ "FBD/LD Element" ⇒ "Display Format" ⇒ "Number of Cells for Device/Label Name"</li> <li>• "Other Editor" ⇒ "Label Editor Common" ⇒ "Verify" ⇒ "Include Label memory as Verify Target"</li> <li>• "Convert" ⇒ "Basic Setting" ⇒ "Operational Setting" ⇒ "Stop the Monitor in Executing Convert/Rebuild All"</li> </ul>	<p>Page 269 Inserting contacts, coils, instructions, arguments Page 312 Inserting instructions, functions, and control syntax Page 325 Using the edit box Page 405 Device comment including @ Page 448 Searching for/ Replacing Devices and Labels Page 453 Changing Contacts between Open Contact and Close Contact Page 454 Batch Replacing of Devices and Labels Page 638 Registering to a watch window</p>
Printing	<p>An FBD/LD program can be printed according to the settings in the following options.</p> <ul style="list-style-type: none"> <li>• "Program Editor" ⇒ "FBD/LD Editor" ⇒ "Element (Ladder Symbol)" ⇒ "Display Format" ⇒ "Number of Cells for Device/Label Name"</li> <li>• "Program Editor" ⇒ "FBD/LD Editor" ⇒ "FB/FUN" ⇒ "Display Format" ⇒ "Number of Wrapping Rows for Instance Name"</li> <li>• "Program Editor" ⇒ "FBD/LD Editor" ⇒ "FB/FUN" ⇒ "Display Format" ⇒ "Number of Cells for Instance Name"</li> </ul>	
FBD/LD editor SFC editor	<p>When a structure member the data type of which is any of the following is used as an LD element or FBD element, a comment set for the member can be displayed in a program editor.</p> <ul style="list-style-type: none"> <li>• Timer</li> <li>• Long timer</li> <li>• Retentive timer</li> <li>• Long retentive timer</li> <li>• Counter</li> <li>• Long counter</li> </ul>	

## Version 1.060N

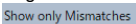
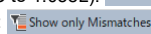
Item	Description	Reference
Navigation window	<ul style="list-style-type: none"> <li>Program files, program blocks, and worksheets can be sorted by execution order in a batch.</li> </ul>	Page 55 Sorting data
Opening a GX Works2 format project	<ul style="list-style-type: none"> <li>Projects for LCPUs are supported.</li> </ul>	Page 107 Opening a GX Works2 format project
Opening a GX Developer format project	<ul style="list-style-type: none"> <li>A project for a QSCPU which is created in GX Developer can be opened.</li> </ul>	Page 61 Basic menus Page 124 Opening a GX Developer format project
Verification	<p>Only the mismatched data can be displayed by using the following menu while the "Verify Result" window is displayed.</p> <ul style="list-style-type: none"> <li>[View] ⇒ [Show only Mismatches]</li> </ul>	Page 77 Available menus when displaying the verify result window Page 145 Checking a verification result
	<p>An icon on the toolbar in the detailed display (diagram/table format) screen is changed.</p> <ul style="list-style-type: none"> <li>Before change (version 1.050C to 1.058L): </li> <li>After change (version 1.060N): </li> </ul>	Page 155 Displaying mismatched data only
	<ul style="list-style-type: none"> <li>A verification result displayed in the detailed display (diagram/table format) screen can be exported to a file.</li> </ul>	Page 157 Exporting to a file
Overwriting a project Project revision history	<ul style="list-style-type: none"> <li>When a project revision can be registered when overwriting the project.</li> </ul>	Page 127 Registering a revision Page 161 Registering a revision when a project is overwritten
iQ Sensor Solution function* <sup>5</sup>	<ul style="list-style-type: none"> <li>This function is available in a project in which a CC-Link IE Field-AnyWireASLINK bridge module is used.</li> </ul>	Page 210 iQ Sensor Solution functions
Motion control setting function	<ul style="list-style-type: none"> <li>Public labels set with the motion control setting function can be registered as module labels in a global label editor of GX Works3.</li> </ul>	Page 248 Registering public labels set with the motion control setting function
Ladder editor	<ul style="list-style-type: none"> <li>When using the continuous pasting function, an increment target can be selected.</li> </ul>	Page 291 Pasting device numbers or label names consecutively
	<ul style="list-style-type: none"> <li>An FB instance name can be changed by double-clicking the name.</li> </ul>	Page 273 Changing an FB instance name
	<ul style="list-style-type: none"> <li>When a cell is cut in the "Insert mode," its lines are deleted from the editor.</li> </ul>	—
	<ul style="list-style-type: none"> <li>An inline structured text box remains when deleting a line that does not include the inline structured text box from a parallel circuit including the inline structured text box.</li> </ul>	—
	<ul style="list-style-type: none"> <li>When displaying only a ladder block for which a line statement is set, another line statement can be inserted in the ladder block.</li> </ul>	—
Ladder editor ST editor	<p>The following functions are available:</p> <ul style="list-style-type: none"> <li>FB property</li> <li>FB property management (offline)</li> <li>FB property management (online)</li> </ul>	Page 376 Displaying an FB property Page 397 FB Property Management (Offline) screen Page 666 FB Property Management (Online) screen
FBD/LD editor	<ul style="list-style-type: none"> <li>An FB instance name can be changed by double-clicking the name.</li> </ul>	Page 322 FBD element
FBD/LD editor SFC diagram editor	<p>The text layout of an comment element can be changed to the following three types:</p> <ul style="list-style-type: none"> <li>Align Top</li> <li>Align Middle</li> <li>Align Bottom</li> </ul>	Page 323 Common element
SFC diagram editor	<p>When a comment of transition No. overlaps with a jump symbol or connection line, the size of the transition can be changed by selecting the following menu.</p> <ul style="list-style-type: none"> <li>[Edit] ⇒ [Modify] ⇒ [Toggle Transition Size]</li> </ul>	Page 354 Entering comments of Transition No.
Reading sample comments	<p>Sample comments of the following intelligent function modules can be read.</p> <ul style="list-style-type: none"> <li>RD81MES96N</li> <li>R60MH112</li> <li>R60MH112NA</li> </ul>	Page 409 Reading sample comments

Item	Description	Reference
Memory size calculation	<ul style="list-style-type: none"> <li>• "Display Unit" displayed in the "Confirm Memory Size (Offline)" screen is changed to "Size Display Unit."</li> </ul>	Page 432 Calculating Memory Size
	The memory capacities of the following data can be displayed: <ul style="list-style-type: none"> <li>• Program</li> <li>• Label</li> <li>• Latch label</li> </ul>	
	The memory capacities of the following data can be displayed in projects for an RnCPU, an RnENCPU, and an RnPCPU: <ul style="list-style-type: none"> <li>• Label</li> <li>• Latch label</li> </ul>	
	The memory capacities of the following data can be displayed in projects for an RnSFCPU and an RnPSFCPU: <ul style="list-style-type: none"> <li>• Label</li> <li>• Latch label</li> <li>• Safety label</li> <li>• Standard/safety shared label</li> </ul>	
Device memory	• Device memory data can be exported to a CSV file.	Page 440 Exporting Device Memory Data
	• One point can be specified for "Word Multi-point Format" in the "Display Format" screen.	Page 435 Setting the display format
Cross reference window	• The cursor can remain in a cross reference window when jumping to each editor from the window.	Page 457 Displaying cross reference information
	• Device or label options can be displayed when entering a device or label name in the input field.	Page 459 Device/label options
Simulation	A project including the following module can be simulated: <ul style="list-style-type: none"> <li>• CC-Link IE TSN module</li> </ul>	Page 933 Supported modules Page 968 Network
	• The network functions and parameters of CC-Link IE TSN are available.	
	The following CPU module functions are available: <ul style="list-style-type: none"> <li>• RnCPUs and RnENCPU: link direct device setting, extension of points for CC-Link IE Controller Network</li> <li>• RnPCPU: device test with execution conditions, online change (SFC block)</li> <li>• RnPCPU (process mode): Writing of program restoration information</li> <li>• RnSFCPU: online change (ladder block) (safety program), file batch online change (safety program), multiple CPU synchronization interruption (I45), inter-module synchronous interrupt (I44), file batch online change of FB files and the global label setting file, file batch online change when the program memory does not have enough free space</li> </ul>	Page 942 Supported CPU module functions
	The following CPU parameter is available: <ul style="list-style-type: none"> <li>• Link Direct Device Setting</li> </ul>	Page 956 Supported parameters
Monitoring (Ladder editor)	<ul style="list-style-type: none"> <li>• If the current values of devices and labels are character strings, their monitor values are also displayed by the character strings.</li> <li>• The number of characters for monitor values (strings) displayed in the monitor screen can be changed.</li> </ul>	Page 620 Ladder
Device test with execution conditions <sup>*3</sup>	• This function is available in a project for an RnSFCPU.	Page 646 Changing Device/Label Value by Setting Conditions Page 687 Functions and operations that require user authentication
Process control function	• Up to four faceplates can be displayed at the same time.	Page 662 Checking tag data on the gauge window (faceplate)
Module diagnostics	• When diagnosing an RnCPU, an RnENCPU, or an RnPCPU, "Switch Display" is displayed in the [Error Information] tab of the module diagnostics screen. <sup>*3</sup>	Page 709 Error information
	• When diagnosing an RnCPU, an RnENCPU, or an RnPCPU, the FB hierarchy information of the function block with an error can be displayed in the module diagnostics screen. <sup>*3</sup>	Page 711 FB hierarchy information



Item	Description	Reference
Network diagnostics	The following modules can be diagnosed in projects for an RnCPU and an RnENCPU: <ul style="list-style-type: none"> <li>• CC-Link IE TSN compatible motion modules (RD78GHV, RD78GHW)</li> </ul>	Page 717 CC-Link IE TSN/CC-Link IE Field Network diagnostics
	The following modules (CC-Link IE Field Network communication mode) can be diagnosed: <sup>4</sup> <ul style="list-style-type: none"> <li>• DC input/transistor output combined modules (NZ2GN2B1-32DT, NZ2GN2B1-32DTE, NZ2GN2S1-32DT, NZ2GN2S1-32DTE)</li> <li>• DC input modules (NZ2GN2B1-32D, NZ2GN2S1-32D)</li> <li>• Transistor output modules (NZ2GN2B1-32T, NZ2GN2B1-32TE, NZ2GN2S1-32T, TNZ2GN2S1-32TE)</li> <li>• Analog input modules (NZ2GN2B-60AD4, NZ2GN2S-60AD4)</li> <li>• Analog output modules (NZ2GN2B-60DA4, NZ2GN2S-60DA4)</li> </ul>	
	The following modules can be diagnosed: <ul style="list-style-type: none"> <li>• MR-JET-G</li> <li>• MR-J5-G-RJ</li> <li>• FR-E800-E</li> <li>• Partner products</li> </ul>	
	<ul style="list-style-type: none"> <li>• An icon indicating that the parameter automatic setting of a device station failed is displayed in the CC-Link IE TSN/CC-Link IE Field Network diagnostics.</li> </ul>	
Firmware update	<ul style="list-style-type: none"> <li>• The firmware of modules can be updated using GX Works3.</li> </ul>	Page 61 Basic menus Page 776 Firmware Update
Printing	<ul style="list-style-type: none"> <li>• When printing a ladder program, inline structured text programs are printed on another sheet only if the checkbox of "Print Inline Structured Text Program on a Separate Sheet" is selected in the "Print" screen.</li> </ul>	—
AnyWireASLINK configuration window	<ul style="list-style-type: none"> <li>• In a project in which a CC-Link IE Field-AnyWireASLINK bridge module is used, up to 256 remote modules can be placed in this window.</li> </ul>	
CC-Link IE TSN configuration window	A mode set in the following parameter of a CC-Link IE TSN module is displayed: <ul style="list-style-type: none"> <li>• "Application Settings" ⇒ "Module Operation Mode"</li> <li>• "Application Settings" ⇒ "Communication Mode" ⇒ "Communication Mode"</li> </ul>	
	A device station can be replaced with a general CC-Link IE TSN module and vice versa by selecting the following menu: <ul style="list-style-type: none"> <li>• [CC-Link IE TSN Configuration] ⇒ [Change Module] ⇒ [Replace General CC-Link IE TSN module]/[Change to General CC-Link IE TSN module]</li> </ul>	
	The "Device No. Reassignment" screen appears by selecting the following menu. In this screen, device numbers can sequentially be assigned to the link devices on a device station. <ul style="list-style-type: none"> <li>• [CC-Link IE TSN Configuration] ⇒ [Device No. Reassignment]</li> </ul>	
	<ul style="list-style-type: none"> <li>• The "PDO Mapping Setting" screen appears by double-clicking "Detail Setting" in the "PDO Mapping Setting" column. In this screen, the PDO mapping parameters can be set.</li> </ul>	
CC IE Field configuration window	The following iQ Sensor Solution function is available in a project for an RnSFCPU: <sup>5</sup> <ul style="list-style-type: none"> <li>• Data backup/restoration</li> </ul>	



Item	Description	Reference
Label editor	<ul style="list-style-type: none"> <li>Check results are displayed in the "Output" window by clicking the [Check] button.</li> </ul>	—
ST editor	<ul style="list-style-type: none"> <li>When registering a label as an argument of a function or function block, the data type according to the argument is displayed in the "Undefined Label Registration" screen.</li> </ul>	
Reading data from a programmable controller	<ul style="list-style-type: none"> <li>Program blocks are displayed in execution order when reading a program from a CPU module. (If a project is not opened when its program is read, the program files are also displayed in execution order.)</li> </ul>	
	<ul style="list-style-type: none"> <li>When reading a project to which user information is registered from a CPU module while the project is not opened, the user can log on to the CPU module as a guest user.</li> </ul>	
Verifying data with a programmable controller	<p>By clicking any of the following buttons in the [Verify] tab of the "Online Data Operation" screen, checkboxes of data both on the project and the programmable controller sides can be selected:</p> <ul style="list-style-type: none"> <li>[Parameter + Program] button</li> <li>[Select Favorites] button</li> <li>[Select All] button</li> </ul>	
	<ul style="list-style-type: none"> <li>By clicking the [Open/Close All] button in the [Verify] tab of the "Online Data Operation" screen, the trees both on the project and programmable controller sides can be all expanded or collapsed.</li> </ul>	
	<ul style="list-style-type: none"> <li>By clicking the [Deselect All] button in the [Verify] tab of the "Online Data Operation" screen, the checkboxes of data both on the project and programmable controller sides can be unselected.</li> </ul>	
Others	<ul style="list-style-type: none"> <li>LHCPUs and MELSEC-L series modules are supported.*<sup>4</sup></li> </ul>	
	<ul style="list-style-type: none"> <li>Saving an event history log is restricted in a project for an RnPCPU.*<sup>3</sup></li> </ul>	
	<p>The following functions are available in a project for an RnSF CPU:*<sup>3</sup></p> <ul style="list-style-type: none"> <li>MELSEC-Q series MELSECNET/H network module</li> <li>CPU module data backup/restoration function</li> <li>Sequence scan synchronization sampling function</li> </ul>	
Options	<p>The following options are added:</p> <ul style="list-style-type: none"> <li>"Project" ⇒ "Revision" ⇒ "Operational Setting" ⇒ "Register to the Revision When Saving Project"</li> <li>"Project" ⇒ "Revision" ⇒ "Operational Setting" ⇒ "Automatically Set Revision Titles"</li> <li>"Project" ⇒ "Revision" ⇒ "Operational Setting" ⇒ "Display Confirmation Message Showing Whether to Register Revision"</li> <li>"Project" ⇒ "Revision" ⇒ "Operational Setting" ⇒ "Optimize Revision Information to Reduce File Size"</li> <li>"Program Editor" ⇒ "Ladder Editor" ⇒ "Ladder Diagram" ⇒ "Display Format" ⇒ "Number of Wrapping Rows for Device/Label Name"</li> <li>"Program Editor" ⇒ "Ladder Editor" ⇒ "Ladder Diagram" ⇒ "Edit Operation" ⇒ "Target Device No./Label Name to Increment"</li> <li>"Program Editor" ⇒ "FBD/LD Editor" ⇒ "Enter Element" ⇒ "Operational Setting" ⇒ "Horizontal alignment of text layout for comment element"</li> <li>"Program Editor" ⇒ "FBD/LD Editor" ⇒ "Enter Element" ⇒ "Operational Setting" ⇒ "Vertical alignment of text layout for comment element"</li> <li>"Program Editor" ⇒ "SFC Diagram Editor" ⇒ "Enter Element" ⇒ "Operational Setting" ⇒ "Horizontal alignment of text layout for comment element"</li> <li>"Program Editor" ⇒ "SFC Diagram Editor" ⇒ "Enter Element" ⇒ "Operational Setting" ⇒ "Vertical alignment of text layout for comment element"</li> <li>"Find/Replace" ⇒ "Cross Reference" ⇒ "Operational Setting" ⇒ "Jump with cursor in jumping"</li> <li>"Find/Replace" ⇒ "Cross Reference" ⇒ "Operational Setting" ⇒ "Auto-fill device/label name to display based on input history"</li> <li>"Monitor" ⇒ "Ladder Editor" ⇒ "Character String Monitoring Setting" ⇒ "Numbers of Characters to Display"</li> </ul>	

Item	Description	Reference
FX5CPU	<ul style="list-style-type: none"> <li>FX5JCPU are supported.</li> <li>Sample comments of a safety extension module (FX5-SF-MU4T5) can be read.</li> </ul>	—
	<p>The following option name is changed.</p> <ul style="list-style-type: none"> <li>Before change (version 1.032J to 1.058L): "Online" ⇨ "Connection Destination Specification" ⇨ "Operational Setting" ⇨ "Show the Select Connection Destination window before showing the Specify Connection Destination window."</li> <li>After change (version 1.060N): "Online" ⇨ "Specify Connection Destination" ⇨ "Operational Setting" ⇨ "Show the Connection Destination Simple Setting window"</li> </ul>	Page 557 Changing connection destination settings
	<p>The default value for the following option is changed.</p> <ul style="list-style-type: none"> <li>Before change (version 1.055H to 1.058L) "Optimize Level": Level 1</li> <li>After change (version 1.060N) "Optimize Level": Level 2</li> </ul>	Page 85 Optimization of the number of steps Page 877 Using a project, which was created in version 1.060N or later, in version 1.055H or earlier

## Parameters

Category	Module type	Module	Parameter <sup>*3*4</sup>	Description
CPU parameter	RnPSFCPU		"Redundant System Settings" ⇨ "Redundant Behavior Setting" ⇨ "Setting to Wait Receiving Cyclic Data after Switching System"	Newly added
	FX5CPU		"Memory/Device Setting" ⇨ "Internal Buffer Capacity Setting" ⇨ "Function to Use Internal Buffer"	Related functions are displayed in the explanation column.
Module parameter	RCPU		"Application Settings" ⇨ "Simple CPU Communication Setting" ⇨ "<Detailed Setting>"	Unset items can be displayed or hidden.
	LHCPU		"Application Settings" ⇨ "Simple CPU Communication Setting" ⇨ "<Detailed Setting>"	Unset items can be displayed or hidden.
	FX5CPU		"High Speed I/O" ⇨ "Input Function" ⇨ "High Speed Counter" ⇨ "<Detailed Setting>"	The [Simple Batch Setting] button is added in the "Setting Item" field. By clicking this button, the parameters of "High Speed Counter" can be set in the wizard format.
	FX5UCPU FX5UCCPU		"485 Serial Port" ⇨ "Basic Settings" ⇨ "Communication Protocol Type"	Related functions are displayed in the explanation column by selecting "Predefined Protocol Support Function."
	RCPU	Ethernet interface modules (_RJ71EN71(E+IEC), _RJ71EN71(E+IEF), RJ71EN71(E+CCIEC), RJ71EN71(E+CCIEF), RJ71EN71(E+E))	"Application Settings" ⇨ "Simple CPU Communication Setting" ⇨ "<Detailed Setting>"	<p>The following options can be selected for "Communication Destination":</p> <ul style="list-style-type: none"> <li>MELSEC iQ-L (built-in Ethernet)</li> <li>SIEMENS S7 series</li> <li>Fuji Electric MICREX-SX series</li> <li>JTEKT TOYOPUC series</li> </ul> <p>When setting the following devices for "Communication Destination," PLC No.5 to 8 can be selected for "Target PLC No":</p> <ul style="list-style-type: none"> <li>Fuji Electric MICREX-SX series</li> </ul> <p>Unset items can be displayed or hidden.</p>
	RnCPU RnENCPU RnPCPU RnSFCPU	RJ71C24	"MODBUS slave setting"	Newly added
	RnCPU RnENCPU	CC-Link IE TSN module (RJ71GN11-T2)	"Application Settings" ⇨ "Communication Speed"	Newly added
			"Application Settings" ⇨ "Communication Mode"	Newly added
	RnPCPU (redundant mode) RnPSFCPU	Ethernet interface module (RJ71EN71(E+E))	"Application Settings" ⇨ "Redundant System Settings" ⇨ "To Use or Not to Use Redundant System Settings" ⇨ "System Switching Request Issue at Communication Error" ⇨ "System Connection" ⇨ "Simple CPU Communication Port"	Newly added
FX5CPU	High speed pulse I/O modules (FX5-16ET/ES-H, FX5-16ET/ESS-H)	"High Speed I/O" ⇨ "Input Function" ⇨ "High Speed Counter" ⇨ "<Detailed Setting>"	The [Simple Batch Setting] button is added in the "Setting Item" field. By clicking this button, the parameters of "High Speed Counter" can be set in the wizard format.	



Category	Module type	Module	Parameter <sup>*3*4</sup>	Description
Remote password	FX5CPU		"Remote Password Setting" ⇒ "Module Conditions" ⇒ "Detail Setting"	"MELSOFT Transmission Port (UDP/IP)" is added in "System Connection Valid Setting" of the "Remote Password Detail Setting" screen.

## Version 1.061P

Item	Description	Reference
FX5CPU	The following module tool is available in projects for an FX5UCPU and an FX5UCCPU.*3 <ul style="list-style-type: none"> <li>Predefined Protocol Support Tool For Positioning</li> </ul>	—

## Version 1.063R

Item	Description	Reference
Opening a GX Works2 format project	<ul style="list-style-type: none"> <li>Settings for MELSECNET/H and MELSECNET/10 in network parameters can be imported.</li> </ul>	Page 107 Opening a GX Works2 format project
Network diagnostics	The following module can be diagnosed: <ul style="list-style-type: none"> <li>MELSECNET/H network modules (RJ71LP21-25, RJ71LP21-25(R))</li> </ul>	Page 720 MELSECNET diagnostics
Check program screen	<ul style="list-style-type: none"> <li>When opening this screen, "Check Content" that was previously set is displayed.</li> </ul>	—

## Version 1.065T

Item	Description	Reference
Printing	The following items can be set in the "Print" screen when printing an FBD/LD program: <ul style="list-style-type: none"> <li>• Fit to One Page</li> <li>• Magnification</li> </ul>	Page 95 Printing FBD/LD programs
	The following items can be set in the "Print" screen when printing an SFC program: <ul style="list-style-type: none"> <li>• Do not Print Direct Expressions of Transitions</li> <li>• Do not Print Actions</li> <li>• Fit to One Page</li> <li>• Magnification</li> </ul>	Page 96 Printing SFC programs
Opening another format project	The following functions are supported in a project for a redundant CPU: <ul style="list-style-type: none"> <li>• Opening a GX Works2 format project</li> <li>• Opening a PX Developer format project</li> </ul>	Page 107 Opening a GX Works2 format project Page 110 Opening a PX Developer format project
Opening a GX Developer format project	The following items can be imported: <ul style="list-style-type: none"> <li>• Options</li> <li>• Device memory</li> </ul>	Page 124 Opening a GX Developer format project
Project version management	Data to be registered can be verified with the latest data in a master project by performing any of the following operations in the "Register Data" screen: <ul style="list-style-type: none"> <li>• Double-click data to be registered.</li> <li>• Select and right-click data to be registered, then select [Verify with the Latest Revision] from the shortcut menu.</li> </ul>	Page 174 Data
	<ul style="list-style-type: none"> <li>• By selecting and right-clicking revision(s) in the revision list, then selecting [Verify with the Previous Revision]/[Verify Between Revisions] from the shortcut menu, project files or data associated with the selected revision(s) can be verified with each other.</li> </ul>	Page 178 Verifying a project file or data

Item	Description	Reference
CC-Link IE TSN configuration window	<ul style="list-style-type: none"> <li>In a project for an RnSFPCPU, a CC-Link IE TSN system can be configured using this window.</li> </ul>	Page 208 Setting network configuration and target devices
	<ul style="list-style-type: none"> <li>Parameters of a device station on CC-Link IE TSN can be written to, read from, or deleted from an RnSFPCPU or an SD memory card inserted in the CPU module.<sup>*3,*4</sup></li> <li>When writing parameters of a device station on CC-Link IE TSN to an RnSFPCPU or an SD memory card inserted in the CPU module, the parameters are automatically set to the device station.<sup>*3,*4</sup></li> </ul>	Page 579 Data to be written and writing destinations Page 584 Parameters of a remote I/O module (device station) on CC-Link IE TSN Page 590 Parameters of a remote I/O module (device station) on CC-Link IE TSN
	The following functions are available for CC-Link IE TSN supported devices in a project for an RnSFPCPU: <sup>*3,*4</sup> <ul style="list-style-type: none"> <li>Connected/disconnected module detection</li> <li>Parameter of device station</li> <li>Command execution of device station</li> </ul>	—
	A mode set in the following parameter of a CC-Link IE TSN compatible motion module is displayed: <ul style="list-style-type: none"> <li>"Application Settings" ⇒ "Module Operation Mode"</li> </ul>	
	For a CC-Link IE TSN module, the following display items are added: <ul style="list-style-type: none"> <li>Cyclic Transmission Time (Min.)</li> <li>Communication Period Interval (Min.)</li> </ul>	
	An IP address, subnet mask, and default gateway can be displayed in hexadecimal by selecting the following menu: <ul style="list-style-type: none"> <li>[Edit] ⇒ [IP Address Input Format] ⇒ [Hexadecimal]</li> </ul>	
	Network topology can be changed to a ring topology by selecting the following menu: <ul style="list-style-type: none"> <li>[CC-Link IE TSN Configuration] ⇒ [Change Transmission Path Method] ⇒ [Ring]</li> </ul>	
	<ul style="list-style-type: none"> <li>A station which got disconnected after a data link is detected as a disconnected device when performing 'connected/disconnected module detection.' "Reserved station" is displayed in "Reserved/Error Invalid Station" for the disconnected station.</li> </ul>	
	<ul style="list-style-type: none"> <li>Basic modules and extension modules can be placed in a batch by dragging and dropping a multiple-axis servo amplifier, such as MR-J5W2-G or MR-J5W3-G, onto the station list from the module list window.</li> </ul>	
	<ul style="list-style-type: none"> <li>PDO mapping parameters can be copied, cut, and pasted in the "PDO Mapping Setting" window.</li> </ul>	
	<ul style="list-style-type: none"> <li>"Motion Control Station" is displayed in the station list which is in a simple display mode when the own station is a CC-Link IE TSN compatible motion module.</li> </ul>	
	<ul style="list-style-type: none"> <li>If the number of link device points is deleted in the station list which is in a simple display mode, the start link device displayed in a detailed display mode is also deleted.</li> </ul>	
	<ul style="list-style-type: none"> <li>The [Error] and [Warning] buttons are added in the "Output" window; by clicking these buttons, error/warning messages can be displayed or hidden. The number of messages is displayed next to each button.</li> </ul>	
Object names can be displayed or hidden by selecting the following menu: <ul style="list-style-type: none"> <li>[View] ⇒ [Object Name Display]</li> </ul>		
Label editor	<ul style="list-style-type: none"> <li>A multiple-dimensional array can be set by entering the number of elements for multiple dimensions in the "Data Type Selection" screen.</li> </ul>	Page 236 Setting arrays for data type
	<ul style="list-style-type: none"> <li>A row can be deleted while the list is filtered.</li> </ul>	—
Ladder editor (excluding Zoom)	The colors of the following items can be changed in the "Color and Font" screen: <ul style="list-style-type: none"> <li>Line Statement (Shown in Navigation Window)</li> <li>Background of Line Statement (Shown in Navigation Window)</li> </ul>	

Item	Description	Reference
Ladder editor (including a Zoom)	"Insert mode" and "Overwrite mode" can be switched by selecting the following menu: • [Edit] ⇒ [Switch Overwrite/Insert mode]	Page 68 Available menus when editing a ladder program
	The ladder edit mode of all open ladder editors can be switched by selecting the following menu: • [Edit] ⇒ [Ladder Edit Mode] ⇒ [Read Mode (All Windows)]/[Write Mode (All Windows)]	Page 68 Available menus when editing a ladder program Page 268 Switching the ladder edit mode (read/write/monitor read/monitor write) Page 1000 Edit
	The ladder edit mode of all ladder editors that exist in a project can be switched by selecting the following menu: • [Edit] ⇒ [Ladder Edit Mode] ⇒ [Read Mode (All Ladder Programs Elements)]/[Write Mode (All Ladder Programs Elements)]	
	The following item is added in a screen which appears in switching to the monitor write mode: • Check the consistency between the editing target program file in GX Works3 and the one in PLC. By selecting this checkbox, whether a program in GX Works3 matches with one in a programmable controller can be checked before switching the mode.	Page 268 Monitor write mode
	• 100 or more ladder blocks can be copied. (Up to 300 ladder blocks) • The number of selected ladder blocks is displayed on the title bar.	—
Inline structured text	• Up to 20,000 characters can be entered in an inline structured text box.	Page 281 Inserting an inline structured text box
	The number of rows to display (height) of an inline structured text box can be changed by using the following menu: • [View] ⇒ [Height Setting of Inline Structured Text]	Page 282 Changing the number of rows to display
ST program	"Insert mode" and "Overwrite mode" can be switched by selecting the following menu: • [Edit] ⇒ [Switch Insert/Overwrite mode]	Page 71 Available menus when editing an ST program
	By selecting "Yes" for the following option, a syntax template is displayed with the arguments aligned vertically: • "Program Editor" ⇒ "ST Editor" ⇒ "Edit Operation" ⇒ "Vertically Align Arguments for Displaying Template"	Page 315 Displaying syntax templates
	• A constant label can be specified as an integer value of a CASE sentence.	—
FBD/LD program (including a Zoom)	Shortcut keys can be set for the following menus: • [Edit] ⇒ [Layout] ⇒ [Batch Correction of Layout in FBD Network Block] • [Edit] ⇒ [Layout] ⇒ [Delete the Blank Row Between FBD Network Blocks] • [Edit] ⇒ [Layout] ⇒ [Batch Alignment of All FBD Network Blocks to the Left]	
	• Elements can be connected to each other by the following procedure: Select a connection point or line, then move the cursor to a target connection point by pressing the <b>Ctrl</b> + <b>←</b> / <b>→</b> / <b>↑</b> / <b>↓</b> keys. • An element connected to another element can be connect to a different element by the following procedure: Select a connection point or line. Then, move the cursor to a target connection point by pressing the <b>Ctrl</b> + <b>Shift</b> + <b>←</b> / <b>→</b> / <b>↑</b> / <b>↓</b> keys.	Page 327 Common operations of elements
SFC program	By selecting the following menu, whether to automatically connect an SFC element and FBD/LD element with a connection line can be selected: • [Edit] ⇒ [Edit Mode] ⇒ [Element Auto-connect]	Page 73 Available menus when editing an SFC program (SFC diagram)
Data flow analysis	• The data flow analysis function is supported.	Page 467 Displaying a Range Affected by/Affecting a Device/Label



Item	Description	Reference
Simulation	<ul style="list-style-type: none"> <li>A project for an LHCPU can be simulated.</li> <li>The functions, instructions, and parameters of an LHCPU are available.</li> </ul>	Page 933 Modules supported by GX Simulator3 Page 939 Firmware versions of CPU modules Page 942 CPU module (RnCPU, RnENCPU, RnPCPU, LHCPU) Page 952 RCPUs and LHCPU Page 959 LHCPU Page 965 Module buffer memory Page 967 Link devices of network module Page 975 LHCPU Page 976 General module
	RnCPU and RnENCPU projects including the following module can be simulated: <ul style="list-style-type: none"> <li>CC-Link IE TSN compatible motion module</li> </ul>	Page 536 Simple motion module/motion module Page 933 Modules supported by GX Simulator3 Page 965 Module buffer memory Page 967 Link devices of network module
	An RnSFCPU project including any of the following modules can be simulated: <ul style="list-style-type: none"> <li>MELSECNET/H network modules (QJ71BR11, QJ71LP21(-25 S-25 G GE), QJ71NT11B)</li> </ul>	Page 933 Modules supported by GX Simulator3
	The following CPU module functions are available: <ul style="list-style-type: none"> <li>RnCPUs and RnENCPU: FB hierarchy information</li> <li>RnSFCPU: device test with execution conditions, real-time monitor, CC-Link IE Controller Network function of the RJ71EN71</li> </ul>	Page 942 CPU module (RnCPU, RnENCPU, RnPCPU, LHCPU) Page 945 CPU module (RnPSFCPU, RnSFCPU) MELSEC iQ-R CPU Module User's Manual (Application)
	The following instructions are available: <ul style="list-style-type: none"> <li>Module access instructions (RFS(P), COM(P), S(P).ZCOM)</li> <li>Process control instruction (S.PHPL2)</li> </ul>	Page 952 Supported instructions
	Projects for an RnCPU and an RnENCPU can be simulated while the following option is selected in "Communication Destination" of "Simple CPU Communication Setting": <ul style="list-style-type: none"> <li>MELSEC iQ-L (built-in Ethernet)</li> </ul>	Page 958 Module parameter
Recording monitor <sup>*3</sup>	<ul style="list-style-type: none"> <li>The recording status can be monitored.</li> </ul>	Page 707 Recording Status Check
Module diagnostics	<ul style="list-style-type: none"> <li>The display format of an error code can be switched between decimal and hexadecimal in the system monitor and the module diagnostics screen.</li> </ul>	Page 702 Module Status Check of a System Page 708 Module Diagnostics
CC-Link diagnostics	<ul style="list-style-type: none"> <li>The font color of the [Previous] and [Next] buttons is displayed in red when multiple screens exist.</li> </ul>	Page 721 CC-Link diagnostics
Firmware update	<ul style="list-style-type: none"> <li>The firmware of RnPCPUs can be updated using GX Works3.</li> </ul>	Page 776 Firmware Update
Recording <sup>*3</sup>	<ul style="list-style-type: none"> <li>This function is available in projects for RnCPUs (R04CPU, R08CPU, R16CPU, R32CPU, and R120CPU) and RnENCPU.</li> </ul>	Page 732 Recording Function



Item	Description	Reference	
Memory dump* <sup>4</sup>	<ul style="list-style-type: none"> <li>This function is available in a project for an RnSF CPU. (Only standard device values can be checked.)</li> </ul>	—	
Offline monitor* <sup>4</sup>	<ul style="list-style-type: none"> <li>Device data of an RnSF CPU which is collected with the memory dump function can be monitored on a program editor.</li> </ul>		
	<p>The following menus are changed.</p> <ul style="list-style-type: none"> <li>Before change (version 1.030G to 1.063R) [Debug] ⇒ [Offline Monitor] ⇒ [Offline Monitor (Memory Dump)] [Debug] ⇒ [Offline Monitor] ⇒ [Offline Monitor (Logging)] ⇒ [Connection Destination Setting] [Debug] ⇒ [Offline Monitor] ⇒ [Offline Monitor (Logging)] ⇒ [Disconnect Offline Monitor]</li> <li>After change (version 1.065T) [Recording] ⇒ [Start Offline Monitor] ⇒ [Memory Dump] [Recording] ⇒ [Start Offline Monitor] ⇒ [Logging File] [Recording] ⇒ [Stop Offline Monitor]</li> </ul>		
	<ul style="list-style-type: none"> <li>Data collected with the recording function can be monitored.</li> </ul>		Page 736 Checking Collected Data on Program Editor
	<p>The following functions are available:</p> <ul style="list-style-type: none"> <li>Seek bar</li> <li>Log marker</li> <li>Event history (offline monitor)</li> </ul>		Page 743 Operating the seek bar Page 747 Adding a log marker Page 749 Checking an event history (offline monitor)
	The GOT offline monitor can be started in GX Works3.	Page 755 Displaying the GOT offline monitor	
Safety system	<ul style="list-style-type: none"> <li>The safety communication function is available in an RnSF CPU project in which a CC-Link IE TSN module or CC-Link IE TSN compatible motion module is used.*<sup>4</sup></li> </ul>	—	
Module configuration diagram	<ul style="list-style-type: none"> <li>In the system configuration check, the check result type for a connector conversion module is changed from 'Warning' to 'Information.'</li> </ul>		
Device comment editor	<ul style="list-style-type: none"> <li>When zooming this screen in and out, the column width is automatically adjusted according to the display magnification.</li> </ul>		
Search/replacement	<ul style="list-style-type: none"> <li>In a ladder editor, even when some contacts of a function block are not displayed due to changes in the number of the contacts, the undisplayed contacts can be searched for.</li> </ul>		

Item	Description	Reference
Cross reference	<ul style="list-style-type: none"> <li>An LD element, FBD element, and ST editor for which a constant value is defined are supported.</li> </ul>	—
Writing data to a programmable controller	<p>When "Not use" is selected for the following system parameter, a multiple CPU system is regarded as the same configuration as a single CPU system; therefore, a project can be written to the CPU No.1 in the multiple CPU system.</p> <ul style="list-style-type: none"> <li>"Multiple CPU Setting" ⇒ "Communication Setting between CPU" ⇒ "Fixed Scan Communication Function"</li> </ul>	
Rebuild all (reassignment)	<ul style="list-style-type: none"> <li>When information on a structure member of a structure type label cannot be acquired properly, a conversion error (0x12121061) is displayed in the "Output" window and the conversion of all programs is canceled.</li> </ul>	
Monitoring (Ladder editor)	<ul style="list-style-type: none"> <li>Visibility of the ON/OFF status of a close contact, rising pulse, and falling pulse is enhanced.</li> </ul>	
Monitoring (Ladder editor, ST editor)	<ul style="list-style-type: none"> <li>While monitoring a program of a function, "---" is displayed as a monitor value of a local label with an indefinite value.</li> </ul>	
Event history	<ul style="list-style-type: none"> <li>Modify value events that are output from RnCPUs (R04CPU, R08CPU, R16CPU, R32CPU, and R120CPU) and RnENCPU can be checked in the "Event History" screen and the "Event History (Offline Monitor)" window.</li> </ul>	
CC-Link IE TSN/CC-Link IE Field Network diagnostics <sup>*4</sup>	<p>The following modules can be diagnosed in a project for an RnSFCPU:<sup>*3</sup></p> <ul style="list-style-type: none"> <li>CC-Link IE TSN module</li> <li>CC-Link IE TSN compatible motion modules</li> <li>Servo amplifiers (MR-J5-G, MR-J5W2-G, MR-J5W3-G, MR-J5-G-RJ)</li> </ul> <p>The following modules can be diagnosed in projects for an RnCPU, an RnENCPU, and an RnSFCPU:<sup>*3</sup></p> <ul style="list-style-type: none"> <li>DC safety input/transistor safety output combined module (NZ2GNSS2-16DTE)</li> <li>DC Safety input module (NZ2GNSS2-8D)</li> <li>Transistor safety output module (NZ2GNSS2-8TE)</li> </ul> <p>The following modules can be diagnosed:</p> <ul style="list-style-type: none"> <li>DC input/transistor output combined module (NZ2GNCE3-32DT)</li> <li>DC input modules (NZ2GNCE3-32D, NZ2GNCF1-32D)</li> <li>Transistor output module (NZ2GNCF1-32T)</li> <li>Inverter (FR-E800-SCE)</li> </ul> <p>The following statuses are displayed when diagnosing a CC-Link IE TSN module:</p> <ul style="list-style-type: none"> <li>Network synchronous communication status</li> <li>Connection order undefined status</li> </ul> <ul style="list-style-type: none"> <li>When diagnosing a CC-Link IE TSN module, information such as the model name of a device station, IP address, and firmware version can be checked in a list by clicking the [Station Information List] button.</li> </ul> <p>A CC-Link IE TSN module in which the following parameter is set can be diagnosed:</p> <ul style="list-style-type: none"> <li>"Basic Settings" ⇒ "Network Topology" ⇒ "Ring"</li> </ul> <p>A mode set in the following parameter is displayed when diagnosing a CC-Link IE TSN module or CC-Link IE TSN compatible motion module:</p> <ul style="list-style-type: none"> <li>"Application Settings" ⇒ "Communication Mode" ⇒ "Communication Mode"</li> </ul> <ul style="list-style-type: none"> <li>The error history of an extension module can be checked when diagnosing a CC-Link IE TSN module.</li> </ul>	
Options	<p>The following options are added:</p> <ul style="list-style-type: none"> <li>"Program Editor" ⇒ "ST Editor" ⇒ "Edit Operation" ⇒ "Vertically Align Arguments for Displaying Template"</li> <li>"Program Editor" ⇒ "SFC Diagram Editor" ⇒ "FBD/LD Element" ⇒ "Element Connection" ⇒ "Connect element automatically"</li> </ul>	
Operating environment (operating system)	<ul style="list-style-type: none"> <li>Windows XP<sup>®</sup> and Windows Vista<sup>®</sup> are no longer supported.</li> </ul>	
Others <sup>*4</sup>	<ul style="list-style-type: none"> <li>MELSOFT Update Manager is supported.</li> <li>If a data logging file is stored in the function memory, up to 10 settings of data logging can be performed at the same time by using the data logging function of an RnCPU and RnENCPU.</li> <li>The remote device test of a CC-Link IE TSN module is available.</li> </ul> <p>The following functions of a laser displacement sensor control module are available:</p> <ul style="list-style-type: none"> <li>Logging</li> <li>Median filter</li> </ul>	

Item	Description	Reference
CC-Link IE TSN configuration window (FX5UCPU, FX5UCCPU)	<ul style="list-style-type: none"> <li>A CC-Link IE TSN system can be configured using this window.</li> </ul>	Page 208 Setting network configuration and target devices
	<ul style="list-style-type: none"> <li>Parameters of a device station on CC-Link IE TSN can be written to, read from, or deleted from a CPU module or the SD memory card inserted in the CPU module.*<sup>3,4</sup></li> <li>When writing parameters of a device station on CC-Link IE TSN to a CPU module or an SD memory card inserted in the CPU module, the parameters are automatically set to the device station.*<sup>3,4</sup></li> </ul>	Page 579 Data to be written and writing destinations Page 584 Parameters of a remote I/O module (device station) on CC-Link IE TSN Page 590 Parameters of a remote I/O module (device station) on CC-Link IE TSN
	The following functions are available for CC-Link IE TSN supported devices: * <sup>3,4</sup> <ul style="list-style-type: none"> <li>Connected/disconnected module detection</li> <li>Parameter of device station</li> <li>Command execution of device station</li> </ul>	—
	A mode set in the following parameter of a CC-Link IE TSN module is displayed: <ul style="list-style-type: none"> <li>"Application Settings" ⇒ "Module Operation Mode"</li> <li>"Application Settings" ⇒ "Communication Mode" ⇒ "Communication Mode"</li> </ul>	
	A device station can be replaced with a general CC-Link IE TSN module and vice versa by selecting the following menu: <ul style="list-style-type: none"> <li>[CC-Link IE TSN Configuration] ⇒ [Change Module] ⇒ [Replace General CC-Link IE TSN module]/[Change to General CC-Link IE TSN module]</li> </ul> The "Device No. Reassignment" screen appears by selecting the following menu. In this screen, device numbers can sequentially be assigned to the link devices on a device station. <ul style="list-style-type: none"> <li>[CC-Link IE TSN Configuration] ⇒ [Device No. Reassignment]</li> </ul>	
Verification (FX5UCPU, FX5UCCPU)	<ul style="list-style-type: none"> <li>Module parameters of a CC-Link IE TSN module can be verified.</li> </ul>	Page 144 Module extended parameters
Opening a GX Works2 format project (FX5UJCPU)	<ul style="list-style-type: none"> <li>A project for an FXCPU (FX3U, FX3UC, FX3G, and FX3GC) can be replaced with a project for an FX5UJCPU.</li> </ul>	Page 107 Opening a GX Works2 format project
Simulation (FX5UCPU, FX5UCCPU)	A project including either of the following modules can be simulated. (The system simulation is not available.) <ul style="list-style-type: none"> <li>Safety extension modules (FX5-SF-8DI4, FX5-SF-MU4T5)</li> </ul>	Page 933 Modules supported by GX Simulator3 Page 950 CPU module (FX5CPU) Page 961 FX5CPU
Simulation (FX5UJCPU)	<ul style="list-style-type: none"> <li>A project for an FX5UJCPU can be simulated.</li> </ul>	
CC-Link IE TSN/CC-Link IE Field Network diagnostics * <sup>3,4</sup> (FX5UCPU, FX5UCCPU)	<ul style="list-style-type: none"> <li>A CC-Link IE TSN module can be diagnosed.</li> </ul>	Page 717 CC-Link IE TSN/CC-Link IE Field Network diagnostics

## Parameters

Category	Module type	Module	Parameter * <sup>3,4</sup>	Description
System parameter	RnCPU RnENCPU	CC-Link IE TSN module (RJ71GN11-T2)	"Inter-module Synchronization Setting" ⇒ "Select Inter-module Synchronization Target Module"	Newly added
			"Inter-module Synchronization Setting" ⇒ "Inter-module Synchronization Master Setting"	Newly added
CPU parameter	RnCPU RnENCPU		"Memory/Device Setting" ⇒ "Buffer Area Setting for Data Sampling"	Newly added
			RnSFPCU	"RAS Setting" ⇒ "LED Display Setting" ⇒ "FUNCTION LED" ⇒ "Function to use FUNCTION LED"
		"Memory/Device Setting" ⇒ "Link Direct Device Setting"	Newly added	
		"Memory/Device Setting" ⇒ "Internal Buffer Capacity Setting" ⇒ "Total Capacity" ⇒ "Memory Dump Function"	Newly added	
	RnPSFCPU	"Memory/Device Setting" ⇒ "Device/Label Memory Area Setting" ⇒ "Cassette Setting" ⇒ "Extended SRAM Cassette Setting"	"2MB" can be selected.	
	FX5UCPU FX5UCCPU	"Memory/Device Setting" ⇒ "Device/Label Memory Area Setting" ⇒ "<Detailed Setting>"	In the "Device/Label Memory Area Setting" screen, up to 63 K words can be set for the capacity of "Standard Area."	

Category	Module type	Module	Parameter <sup>*3*4</sup>	Description	
Module parameter	RnCPU RnENCPU		"Application Settings" ⇨ "Simple CPU Communication Setting" ⇨ "<Detailed Setting>"	The following options can be selected for "Communication Destination": <ul style="list-style-type: none"> <li>• MELSEC-Q (Ethernet module)</li> <li>• MELSEC-L (Ethernet module)</li> <li>• MELSEC-A/AnS (Ethernet Module)</li> <li>• MELSEC-FX3 (Ethernet Block/Adapter)</li> </ul>	
	FX5UCPU FX5UCCPU		"Application Settings" ⇨ "FTP Client Settings"	Newly added	
			"Application Settings" ⇨ "Simple CPU Communication Setting" ⇨ "<Detailed Setting>"	The following options can be selected for "Communication Destination": <ul style="list-style-type: none"> <li>• MELSEC iQ-R (built-in Ethernet)</li> <li>• MELSEC-Q (built-in Ethernet)</li> <li>• MELSEC-L (built-in Ethernet)</li> <li>• MELSEC iQ-L (built-in Ethernet)</li> <li>• MELSEC-FX3 (Ethernet Block/Adapter)</li> <li>• OMRON (CJ/CP series)</li> <li>• KEYENCE (KV series)</li> <li>• Panasonic (FP7 series)</li> <li>• MODBUS/TCP-compatible device</li> <li>• SIEMENS S7 series</li> <li>• Panasonic (FPOH series)</li> </ul>	
	All CPUs	Temperature input modules (R60RD8-G, Q64TDV-GH, L60RD8)	—		The following menu is available: <ul style="list-style-type: none"> <li>• [Edit] ⇨ [Channel Copy]</li> </ul>
		Temperature control modules (R60TCTRT2TT2, R60TCTRT2TT2BW, Q64TCTTBWN, L60TCTT4, FX5-4LC)			
	RCPU	Ethernet interface modules (_RJ71EN71(E+IEC), _RJ71EN71(E+IEF), RJ71EN71(E+CCIEC), RJ71EN71(E+CCIEF), RJ71EN71(E+E))	"Application Settings" ⇨ "Simple CPU Communication Setting" ⇨ "<Detailed Setting>"	"Options (Hexadecimal)" is added in the "Communication Destination Setting" screen.	
	RnCPU RnENCPU RnPCPU RnSFPCPU	Serial communication modules (RJ71C24, RJ71C24-R2, RJ71C24-R4)	"MODBUS slave setting" ⇨ "MODBUS device allocation parameter(common)" ⇨ "CC-Link IEF Remote Head Module" ⇨ "Access target"	Newly added	
		High speed data logger module (RD81DL96)	"Basic Settings" ⇨ "Various Operations Settings" ⇨ "Mode Settings"	"Firmware update" and "Module Initialization Setting" can be selected.	
		OPC UA server module (RD81OPC96)	"Basic Settings" ⇨ "Various Operations Settings" ⇨ "Mode Settings"	"Firmware update" and "Module Initialization Setting" can be selected.	
	RnCPU RnENCPU	CC-Link IE TSN module (RJ71GN11-T2)	"Basic Settings" ⇨ "Network Topology"	"Ring" can be selected.	
		CC-Link IE TSN compatible motion modules (RD78GHV, RD78GHW)	"Basic Settings" ⇨ "Network Topology"	"Ring" can be selected.	
			"Application Settings" ⇨ "Communication Speed"	Newly added	
	RnSFPCPU	CC-Link IE TSN compatible motion modules (RD78G41, RD78G8, RD78G16, RD78G32, RD78G64, RD78GHV, RD78GHW)	"Basic Settings" ⇨ "Safety Communication Setting" (for a safety project only)	Newly added	
		Ethernet interface modules (_RJ71EN71(CCIEC), _RJ71EN71(E+IEC), RJ71EN71(CCIEC), RJ71EN71(E+CCIEC), RJ71GP21-SX(R), RJ71GP21S-SX(R))	"Application Settings" ⇨ "Link points extended setting"	Newly added	
FX5UCPU FX5UCCPU	CC-Link system master/intelligent device module (FX5-CCL-MS)	"Required Settings" ⇨ "Parameter Setting Method" ⇨ "Setting Method of Basic/ Application Settings"	"Program" can be selected.		

Category	Module type	Module	Parameter <sup>*3*4</sup>	Description
Module extended parameter	RnCPU RnENCPU RnPCPU RnSFPCPU	Serial communication modules (RJ71C24, RJ71C24-R2, RJ71C24-R4)	"Simple CPU Communication Setting"	Newly added
Memory card parameter	RnSFPCPU		"Setting of File/Data Use or Not in Memory Card" ⇔ "Device Station Parameter"	Newly added





## Version 1.070Y

All CPUs: RCPU, LHCPU, and FX5CPU

Item	Module type	Description	Reference
Copying and pasting	All CPUs	<ul style="list-style-type: none"> <li>When copying and pasting a program block including a module FB to another project, the module FB is automatically added to the project.</li> </ul>	Page 131 Module FB
Opening a GX Works2 format project	RnCPU RnPCPU	<ul style="list-style-type: none"> <li>Module parameters of an analog module (Q66AD-DG) can be imported as that of a channel isolated analog-digital converter module (R60AD6-DG(Q)).</li> </ul>	—
	RnPCPU (redundant mode)	<ul style="list-style-type: none"> <li>A redundant type extension base unit (Q65WRB) can be replaced with a redundant extension base unit (R68WRB).</li> </ul>	
	RnCPU RnENCPU RnPCPU RnPSFCPU	<ul style="list-style-type: none"> <li>A power supply module (Q64RPN) can be replaced with a power supply module (R64RP).</li> </ul>	
	FX5UCPU FX5UCCPU	<ul style="list-style-type: none"> <li>An SFC program can be imported.</li> </ul>	Page 108 Data to be changed
Verification	All CPUs	<ul style="list-style-type: none"> <li>When the verification results of a ladder program and ST program are displayed, mismatched data can be merged into a verification source program.</li> </ul>	Page 156 Merging mismatched data into a verification source
		<ul style="list-style-type: none"> <li>Label comments for an array element and bit-specified label can be verified.</li> </ul>	Page 159 Label comment for an array element or bit-specified label
Redundant system configuration <sup>*4</sup>	RnPCPU (redundant mode)	<ul style="list-style-type: none"> <li>A redundant extension base unit (R68WRB) is available.</li> </ul>	Page 197 Display for a redundant extension base unit configuration Page 584 Writing of module extended parameters in a redundant system configuration
Adding a new module	All CPUs	<ul style="list-style-type: none"> <li>A module can be searched for in the "Add New Module" screen.</li> </ul>	Page 205 Adding a module
AnyWireASLINK configuration window	All CPUs	<p>The following iQ Sensor Solution function is available:</p> <ul style="list-style-type: none"> <li>Verification of connected devices and configurations</li> </ul>	Page 210 iQ Sensor Solution functions
		<ul style="list-style-type: none"> <li>Settings can be saved even if a remote module is not placed.</li> </ul>	—
Label editor	All CPUs	<p>The "Label Comment" window appears by either of the following operations:</p> <ul style="list-style-type: none"> <li>Right-click a cell and select [Open Label Comment Setting] from the shortcut menu.</li> <li>Press the <b>[Alt]</b> + <b>[Enter]</b> keys.</li> </ul>	Page 227 Configuration of a label editor
		<ul style="list-style-type: none"> <li>If a label comment is set for an array element or bit-specified label, a red square is displayed at the upper right of the cell.</li> </ul>	
		<ul style="list-style-type: none"> <li>Label comments for array elements and bit-specified labels can be exported to an XML file.</li> </ul>	Page 245 Exporting/importing a label
Structure definition	All CPUs	<ul style="list-style-type: none"> <li>Structure definitions can be exported to an XML file.</li> </ul>	Page 242 Exporting/importing structure definitions to/from a file
Label comment window	All CPUs	<p>A label comment can be set for the following data in this window:</p> <ul style="list-style-type: none"> <li>Label</li> <li>Array type label</li> <li>Bit-specified label</li> <li>Structure type label</li> <li>Structure member</li> </ul>	Page 61 Basic menus Page 76 Available menus when displaying a label editor Page 243 Setting a label comment Page 255 Registering labels in system label database

A

Item	Module type	Description	Reference
Tag FB setting editor	RnPCPU RnPSFCPU	<ul style="list-style-type: none"> <li>The versions of tag data and a process control function block used in a project can be checked whether they are supported in GX Works3 where the project is open.</li> </ul>	Page 249 Registering Tag FBs
Creating a program* <sup>3</sup> Creating a library Program check Conversion Search/replacement Cross reference	FX5UCPU FX5UCCPU	<ul style="list-style-type: none"> <li>Sequential Function Chart language is supported.</li> </ul>	Page 258 Programming Function Page 342 Creating an SFC Program Page 894 FX5CPUs
Creating a program	FX5UCPU FX5UCCPU	<ul style="list-style-type: none"> <li>Step relays (S) can be index-modified. (Excluding the ones used for a contact and coil)</li> </ul>	—
Ladder editor ST editor FBD/LD editor SFC diagram editor (transition/action)	All CPUs	<p>Label comments for a structure and its member can be displayed together by setting the following option to "In Order of Instance -&gt; Member" or "In Order of Member -&gt; Instance":</p> <ul style="list-style-type: none"> <li>"Other Editor" ⇔ "Label Editor Common" ⇔ "Display Setting" ⇔ "Hierarchy Display Setting for Structures Comment"</li> </ul> <p>Label comments of the following data are displayed in each editor. (In an ST editor, they are displayed on the tooltip when selecting a range of each data.)</p> <ul style="list-style-type: none"> <li>Array element of an array type label</li> <li>Bit-specified label</li> <li>Structure member</li> </ul>	Page 264 Configuration of a ladder editor Page 309 Configuration of an ST editor Page 322 FBD element

Item	Module type	Description	Reference
Ladder editor	All CPUs	A column width can be changed in the "Column Width" screen that appears by the following operation: <ul style="list-style-type: none"> <li>• Select and right-click a column, then select [Column Width] from the shortcut menu.</li> </ul>	Page 264 Configuration of a ladder editor
		By setting the following option to "Set to Optimized Width," a column width can be adjusted to the optimal width according to the elements within the range displayed in an editor when double-clicking the column header border: <ul style="list-style-type: none"> <li>• "Program Editor" ⇒ "Ladder Editor" ⇒ "Ladder Diagram" ⇒ "Edit Operation" ⇒ "Operation in adjusting column width by mouse"</li> </ul>	
		<ul style="list-style-type: none"> <li>• A function block can be inserted by entering its FB instance name in the element entry dialog.</li> </ul>	Page 272 Inserting a function block
		<ul style="list-style-type: none"> <li>• Options of FB instances are displayed by entering 'fb.' in the element entry dialog.</li> </ul>	Page 279 Inserting a function
		By selecting "Yes" for the following option, a column width is automatically adjusted so that the text of an input/output label (argument) does not get cut when inserting a function block and function: <ul style="list-style-type: none"> <li>• "Program Editor" ⇒ "Ladder Editor" ⇒ "FB/FUN" ⇒ "Operational Setting" ⇒ "Automatically adjust column width in creating"</li> </ul>	
		A label can be registered in the last row of a label editor by selecting the checkbox of the following item in the "Continuous Paste" screen: <ul style="list-style-type: none"> <li>• Register a label at the last row.</li> </ul>	Page 291 Pasting device numbers or label names consecutively
		<ul style="list-style-type: none"> <li>• The size of the "Line Statement List" screen can be changed.</li> </ul>	Page 286 Displaying a list
		The range selected in a ladder editor can be copied to the clipboard as an image by using the following menu: <ul style="list-style-type: none"> <li>• [Edit] ⇒ [Image Clip]</li> </ul>	Page 68 Available menus when editing a ladder program Page 296 Copying an image to the clipboard
		<ul style="list-style-type: none"> <li>• When changing a column width by dragging the mouse cursor, the width is displayed on the tooltip.</li> </ul>	—
		<ul style="list-style-type: none"> <li>• Options of FB instances are displayed when entering an FB instance name in the "FB Instance Name" screen or changing an FB instance name.</li> </ul>	
		An FB instance can be registered in the last row of a label editor by selecting the checkbox of the following item in the "FB Instance Name" screen: <ul style="list-style-type: none"> <li>• Register a FB instance at the last row.</li> </ul>	
		<ul style="list-style-type: none"> <li>• Label comments of the following data are displayed in the "Enter Ladder" screen with description and in the "Continuous Paste" screen: array element of an array type label, bit-specified label, and structure member.</li> </ul>	
		Label comments of the following data can be edited directly: <ul style="list-style-type: none"> <li>• Array element of an array type label</li> <li>• Bit-specified label</li> <li>• Structure member</li> </ul>	
		<ul style="list-style-type: none"> <li>• Visibility of vertical lines connected to an instruction (except for contact and coil), inline structured text box, and note is improved.</li> </ul>	
<ul style="list-style-type: none"> <li>• The cursor moves to the previous/next row by pressing the  +  /  keys from the edge of a grid toward the outside. In addition, the range from a point where the  key was first pressed to one where the cursor moved to is selected.</li> </ul>			
<ul style="list-style-type: none"> <li>• When a column is inserted or deleted in a ladder that is rectangularly selected (excluding a wrapped ladder), a column is added or deleted in each row.</li> </ul>			
<ul style="list-style-type: none"> <li>• The background color set in "Normal Background" of the "Color and Font" screen is applied to that of the outside of the grid; therefore, the background color of the inside and outside of the grid is unified.</li> </ul>			
Registering an undefined label	All CPUs	A label can be registered in the last row of a label editor by selecting the checkbox of the following item in the "Undefined Label Registration" screen: <ul style="list-style-type: none"> <li>• Register a label at the last row.</li> </ul>	



Item	Module type	Description	Reference
FBD/LD editor SFC diagram editor	All CPUs	<ul style="list-style-type: none"> <li>A connection line can be adjusted manually. (In an SFC diagram editor, only the connection line of an FBD/LD element can be adjusted.)</li> </ul>	Page 327 Common operations of elements
		<p>A device comment is displayed with the number of characters set in the following option:</p> <ul style="list-style-type: none"> <li>"Other Editor" ⇒ "Device Comment Editor" ⇒ "Number of Editing/Displaying Characters" ⇒ "Number of Device Comment Editing/Displaying Characters"</li> </ul>	—
SFC diagram editor	All CPUs	<p>Actions can be hidden by selecting the following menu:</p> <ul style="list-style-type: none"> <li>[View] ⇒ [Hide Actions]</li> </ul> <p>An SFC diagram editor becomes read-only when actions are hidden.</p>	Page 73 Available menus when editing an SFC program (SFC diagram) Page 343 Configuration of an SFC diagram editor
		<p>Actions can be hidden by selecting "Yes" for the following option:</p> <ul style="list-style-type: none"> <li>"Program Editor" ⇒ "SFC Diagram Editor" ⇒ "Action/Transition" ⇒ "Display Format" ⇒ "Hide Actions"</li> </ul> <p>An SFC diagram editor becomes read-only when actions are hidden.</p>	
		<ul style="list-style-type: none"> <li>The file size of a project can be reduced by changing the display format of a transition (Zoom) created in Ladder Diagram language.</li> </ul>	Page 348 Changing the display format (type) of a transition
		<ul style="list-style-type: none"> <li>"Enter Device/Label Comment Continuously" is added in the property screen for an action/transition in MELSAP-L (instruction format).</li> </ul>	Page 370 Creating Zooms (MELSAP-L (instruction format))
		<ul style="list-style-type: none"> <li>Comments of a device and label used in an action/transition in MELSAP-L (instruction format) can be edited in the "Edit Device/Label Comment" screen.</li> </ul>	Page 371 Editing a device comment and label comment
Conversion	All CPUs	<p>The following option name is changed.</p> <ul style="list-style-type: none"> <li>Before change (version 1.030G to 1.066U) Language Used by Instruction Conversion of String Operation</li> <li>After change (version 1.070Y) Language for Instruction Conversion of Character String Operation and Label Initial Value</li> </ul>	Page 430 Converting character codes
Search/replacement	All CPUs	<ul style="list-style-type: none"> <li>Label comments for an array element and bit-specified label can be searched for.</li> </ul>	Page 451 Searching for/ Replacing Character Strings
FB property page	RnPCPU RnPSFCPU	<ul style="list-style-type: none"> <li>Settings for FB properties are categorized in this screen; entered content can be checked, and settings for a function generator can be checked with a graph.</li> </ul>	Page 377 Displaying the FB property page
Data flow analysis	All CPUs	<ul style="list-style-type: none"> <li>An index-modified device is analyzed with the device value to which the index value is applied.</li> </ul>	Page 471 Analyzing an index-modified device
		<ul style="list-style-type: none"> <li>The monitor value of an analyzed device/label can be displayed in the "Dataflow Analysis" window.</li> </ul>	Page 475 Monitoring devices/labels
		<p>A comment specified in the following option is displayed in a device/label block or process block:</p> <ul style="list-style-type: none"> <li>"Other Editor" ⇒ "Label Editor Common" ⇒ "Display Setting" ⇒ "Hierarchy Display Setting for Structures Comment"</li> </ul>	Page 472 Displaying comments
Bookmark	All CPUs	<ul style="list-style-type: none"> <li>Position information of a program can be registered as a bookmark from a program editor and the "Dataflow Analysis" window.</li> </ul>	Page 479 Registering a Bookmark
Library	All CPUs	<ul style="list-style-type: none"> <li>A safety FB library is automatically registered in GX Works3 when installing GX Works3 for the first time.</li> </ul>	Page 515 Enhanced Use of Application Library/ MELSOFT Library



Item	Module type	Description	Reference
Simulation	All CPUs	By selecting "Yes" for the following option, parameters, programs, and optional data are automatically written to GX Simulator3 when simulation is started: <ul style="list-style-type: none"> <li>"Simulation" ⇒ "Start Simulation" ⇒ "Operational Setting" ⇒ "Automatically write programs and parameters when starting simulation."</li> </ul>	Page 522 Starting a simulation
	RnCPU (R04CPU, R08CPU, R16CPU, R32CPU, R120CPU) RnENCPU RnSFCPU	A project including any of the following modules can be simulated: <ul style="list-style-type: none"> <li>Recorder module (RD81RC96)</li> <li>MELSECNET/H network modules (RJ71LP21-25, RJ71LP21-25(R))</li> </ul>	Page 933 Modules supported by GX Simulator3 Page 965 Module buffer memory Page 967 Link devices of network module
	RnCPU RnENCPU	The following function is available: <ul style="list-style-type: none"> <li>Saving of device/label data write operation histories of the event history function</li> </ul>	MELSEC iQ-R CPU Module User's Manual (Application)
	RnPCPU	The following function is available: <ul style="list-style-type: none"> <li>FB hierarchy information</li> </ul>	
	RnSFCPU	The following functions are available: <ul style="list-style-type: none"> <li>Memory dump</li> <li>Extension of points for CC-Link IE Controller Network</li> </ul>	
	RnSFCPU	The following CPU parameters are available: <ul style="list-style-type: none"> <li>Link Direct Device Setting</li> <li>FUNCTION LED in LED Display Setting</li> </ul>	
	RnCPU (R04CPU, R08CPU, R16CPU, R32CPU, R120CPU) RnENCPU	<ul style="list-style-type: none"> <li>The function memory capacity that is used for simulating a project for any of the following CPU modules is increased: RnCPUs (R04CPU, R08CPU, R16CPU, R32CPU, and R120CPU) and RnENCUs. (Total capacity: 20480 KB, capacity for each file size: 8192 bytes)</li> </ul>	
	RnSFCPU	<ul style="list-style-type: none"> <li>An RnSFCPU project including a CC-Link IE TSN module or CC-Link IE TSN compatible motion module can be simulated.</li> </ul>	
	RnCPU RnENCPU	<ul style="list-style-type: none"> <li>If a data logging file is stored in the function memory, up to 10 settings of data logging can be performed at the same time by using the data logging function of an RnCPU and RnENCPU.</li> </ul>	—
	FX5UCPU FX5UCCPU		A project including either of the following modules can be simulated. (The system simulation is not available.) <ul style="list-style-type: none"> <li>CC-Link IE TSN module (FX5-CCLGN-MS)</li> <li>CC-Link system master/intelligent device module (FX5-CCL-MS)</li> </ul>
A project can be simulated while the following option is selected in "Communication Destination" in "Simple CPU Communication Setting" of the module parameters: <ul style="list-style-type: none"> <li>MELSEC iQ-R (built-in Ethernet)</li> <li>MELSEC iQ-L (built-in Ethernet)</li> </ul>			Page 950 CPU module (FX5CPU) Page 962 Module parameter (Ethernet port)
The following instructions are available: <ul style="list-style-type: none"> <li>Reading/writing data instructions (SP.FREAD, SP.FWRITE)</li> </ul>			Page 954 Application instruction
<ul style="list-style-type: none"> <li>When using the data logging function, data can be saved as a CSV file.</li> </ul>			MELSEC iQ-F FX5 User's Manual (Application)
		<ul style="list-style-type: none"> <li>In the "Device/Label Memory Area Setting" screen which appears by clicking "Detailed Setting" in "Device/Label Memory Area Setting" of CPU parameter, up to 63 K words can be set for the capacity of "Standard Area."</li> </ul>	—
Reading data from a programmable controller	All CPUs	<ul style="list-style-type: none"> <li>When reading only device memories with a device memory editor opened, the device memory editor remains open during and after the processing.</li> </ul>	
Writing data to a programmable controller Reading data from a programmable controller Deleting data in a programmable controller	FX5UCPU FX5UCCPU	The following data can be written, read, and deleted: <ul style="list-style-type: none"> <li>SFC program</li> <li>Content of "SFC Setting" in CPU parameters</li> </ul>	Page 585 Operations after writing SFC programs Page 586 Setting write target devices and their ranges
Device/buffer memory batch monitor	All CPUs	<ul style="list-style-type: none"> <li>The "Display Format" screen appears by clicking the [Open Display Format] button.</li> </ul>	Page 633 Checking Device/ Buffer Memory in a Batch
		<ul style="list-style-type: none"> <li>When zooming this screen in and out, the column width is automatically adjusted according to the text size.</li> </ul>	—

Item	Module type	Description	Reference
Watch	All CPUs	<ul style="list-style-type: none"> <li>When registering a label for which a value other than a fixed value is used as an array index, the index can be extracted and automatically registered as another watch item.</li> </ul>	Page 641 Registering an array index
		<ul style="list-style-type: none"> <li>When registering the arguments of an application instruction in a watch window, the arguments are registered according to their data types.</li> </ul>	—
	Label comments of the following data are displayed in a watch window: <ul style="list-style-type: none"> <li>Array element of an array type label</li> <li>Bit-specified label</li> <li>Structure member</li> </ul>		
	FX5UCPU FX5UCCPU	<ul style="list-style-type: none"> <li>The current value of a device/label used in an SFC program can be checked.</li> </ul>	
Intelligent function module monitor	All CPUs	<ul style="list-style-type: none"> <li>A device station can be monitored in a project in which a CC-Link IE TSN module (RJ71GN11-T2) is used.</li> </ul>	Page 659 Registration of a device station
System monitor	RnPCPU (redundant mode)	<ul style="list-style-type: none"> <li>This function is available in a redundant system configuration in which a redundant extension base unit (R68WRB) is used.</li> </ul>	Page 703 Redundant system configuration
	RnPCPU RnPSFCPU	<ul style="list-style-type: none"> <li>A trucking cable is no longer displayed in the base configuration when diagnosing an RnPCPU or RnPSFCPU.</li> </ul>	
Recording monitor <sup>*3</sup>	RnSFCPU	<ul style="list-style-type: none"> <li>The recording status can be monitored in a project for an RnSFCPU.</li> </ul>	Page 707 Recording Status Check
Recording <sup>*3</sup>	RnSFCPU	<ul style="list-style-type: none"> <li>This function is available in a project for an RnSFCPU.</li> </ul>	Page 732 Recording Function
	All CPUs	<ul style="list-style-type: none"> <li>A recording file can be saved in a file server.</li> <li>"Sampling Time(Approx.)" is displayed in the "Recording Setting" screen.</li> </ul>	
Event history (Offline monitor)	RnCPU (R04CPU, R08CPU, R16CPU, R32CPU, R120CPU) RnENCPU RnSFCPU	<ul style="list-style-type: none"> <li>Events in an event history can be refined.</li> </ul>	Page 749 Checking an event history (offline monitor)
Offline monitor <sup>*3*4</sup>	RnSFCPU	<ul style="list-style-type: none"> <li>Data collected from an RnSFCPU can be monitored by using the recording function of a recorder module.</li> </ul>	Page 740 Checking a recording file
	RnCPU (R04CPU, R08CPU, R16CPU, R32CPU, R120CPU) RnENCPU RnSFCPU	The following functions are available for a log marker: <ul style="list-style-type: none"> <li>Adding a comment</li> <li>Changing a marker color</li> </ul>	Page 747 Editing a comment/color
		<ul style="list-style-type: none"> <li>Log markers are automatically synchronized with GX LogViewer in which data is being displayed in a waveform.</li> </ul>	Page 748 Linking with GX LogViewer
		GX VideoViewer can be started by selecting the following menu: <ul style="list-style-type: none"> <li>[Tool] ⇄ [GX VideoViewer]</li> </ul>	Page 756 Playing a video
		<ul style="list-style-type: none"> <li>Index registers (Z) and long index registers (LZ) can be monitored regardless of the option setting in the "Recording File Reading" screen.</li> </ul>	—
Changing the module type/operation mode	FX5UCPU FX5UCCPU	The following data can be utilized when changing the module type from an FX5UCPU to an RCPU: <ul style="list-style-type: none"> <li>SFC program</li> <li>Number of step relay (S) points that is set in "Memory/Device Setting" of the CPU parameter</li> <li>Content of "SFC Setting" in CPU parameters</li> </ul>	Page 929 Data to be changed when changing the module type

Item	Module type	Description	Reference
Options	All CPUs	<p>The following options are added:</p> <ul style="list-style-type: none"> <li>• "Program Editor" ⇨ "Ladder Editor" ⇨ "Ladder Diagram" ⇨ "Edit Operation" ⇨ "Operation in adjusting column width by mouse"</li> <li>• "Program Editor" ⇨ "Ladder Editor" ⇨ "FB/FUN" ⇨ "Operational Setting" ⇨ "Automatically adjust column width in creating"</li> <li>• "Program Editor" ⇨ "SFC Diagram Editor" ⇨ "Action/Transition" ⇨ "Display Format" ⇨ "Hide Actions"</li> <li>• "Program Editor" ⇨ "SFC Diagram Editor" ⇨ "Action/Transition" ⇨ "Operational Setting" ⇨ "Enter label comment and device comment continuously"</li> <li>• "Other Editor" ⇨ "Label Editor Common" ⇨ "Display Setting" ⇨ "Hierarchy Display Setting for Structures Comment"</li> <li>• "Online" ⇨ "Write to PLC" ⇨ "Operational Setting" ⇨ "Intelligent Function Module takes priority to be selected for module extension parameter"</li> <li>• "Online" ⇨ "Write to PLC"/"Verify with PLC" ⇨ "Operational Setting" ⇨ "Show only the device memory start with the specified name"</li> <li>• "Online" ⇨ "Write to PLC"/"Verify with PLC" ⇨ "Operational Setting" ⇨ "Show only the file register start with the specified name"</li> <li>• "Simulation" ⇨ "Start Simulation" ⇨ "Operational Setting" ⇨ "Automatically write programs and parameters when starting simulation."</li> </ul>	—
	FX5UCPU FX5UCCPU	<p>The following options are added:</p> <ul style="list-style-type: none"> <li>• "Program Editor" ⇨ "SFC Diagram Editor"</li> <li>• "Monitor" ⇨ "SFC Diagram Editor"</li> </ul>	
Printing	FX5UCPU FX5UCCPU	<p>The following data can be printed:</p> <ul style="list-style-type: none"> <li>• SFC program</li> <li>• Content of "SFC Setting" in CPU parameters</li> </ul>	
FBD/LD editor	All CPUs	<ul style="list-style-type: none"> <li>• When the data type of a function block element is changed, the data type of its FB instance is changed as well as the data type of a function block element with the same FB instance.</li> <li>• When the data name of a function or function block is changed in the navigation window, the data type of a function element or function block element used in this editor is also changed.</li> </ul>	
Device comment editor	All CPUs	<ul style="list-style-type: none"> <li>• The cursor no longer moves to the "Device Name" column by pressing the  key while editing a device comment.</li> </ul>	
Cross reference	All CPUs	<ul style="list-style-type: none"> <li>• The "Label Comment" window appears by selecting and right-clicking a row in the search result then selecting [Comment Edit] from the shortcut menu.</li> </ul>	
Writing data to an SD memory card	All CPUs	<ul style="list-style-type: none"> <li>• Data written to an SD memory card can be transferred to a CPU module by using a boot operation function.</li> </ul>	
Monitoring	FX5UCPU FX5UCCPU	<p>The following monitor functions are available:</p> <ul style="list-style-type: none"> <li>• SFC diagram monitor</li> <li>• SFC auto-scroll</li> <li>• Zoom monitor</li> <li>• SFC block list monitor</li> <li>• SFC all blocks batch monitor</li> </ul>	
CC-Link IE Field Network Basic diagnostics	All CPUs	<p>The following modules can be diagnosed:</p> <ul style="list-style-type: none"> <li>• AC input module (NZ2MF2S2-16A)</li> <li>• Contact output module (NZ2MF2S2-16R)</li> </ul>	
Sensor/device monitor Ethernet diagnostics CC-Link IE Controller Network diagnostics CC-Link IE TSN/CC-Link IE Field Network diagnostics CC-Link diagnostics	RnPCPU (redundant mode)	<p>The following module and the modules mounted on it can be diagnosed:</p> <ul style="list-style-type: none"> <li>• Redundant extension base unit (R68WRB)</li> </ul>	
Diagnostics	FX5UCPU FX5UCCPU	<ul style="list-style-type: none"> <li>• The cursor can jump to the location in which an error has occurred in an SFC program.</li> </ul>	
Event history <sup>*3</sup>	RnSFCPU	<ul style="list-style-type: none"> <li>• A modify value event that is output from an RnSFCPU can be checked in the "Event History" screen and the "Event History (Offline Monitor)" window.</li> </ul>	

## Parameters

Category	Module type	Module	Parameter <sup>*3*4</sup>	Description
CPU parameter	RnPCPU (redundant mode)		"Redundant System Settings" ⇒ "Redundant system with extension base unit"	Newly added
	FX5UCPU FX5UCCPU		"SFC Setting"	Newly added
			"Memory/Device Setting" ⇒ "Device/Label Memory Area Setting" ⇒ "Device/Label Memory Area Detailed Setting" ⇒ "Device (high speed) Setting" ⇒ "<Detailed Setting>"	A device range is displayed in the "Latch (1)" or "Latch (2)" column.
			"Memory/Device Setting" ⇒ "Device/Label Memory Area Setting" ⇒ "Device/Label Memory Area Detailed Setting" ⇒ "Device (Standard) Setting" ⇒ "<Detailed Setting>"	
Module parameter	RnCPU RnENCPU		"Application Settings" ⇒ "Simple CPU Communication Setting" ⇒ "<Detailed Setting>"	The following item is added: • "Initial Communication Setting" ⇒ "Continue Communicating Until Receiving Response"
	All CPUs	Serial communication modules (RJ71C24, RJ71C24-R2, RJ71C24-R4, LJ71C24, LJ71C24-R4)	—	The following menu is available: • [Edit] ⇒ [Channel Copy]
		Multiple input modules (FX5-8AD, FX5-8AD(FX2N), L60MD4-G)		
		Energy measuring modules (QE82LG, QE83WH4W, QE84WH)		
Loop control module (Q62HLC)				
RnPCPU (redundant mode)	Ethernet interface modules (RJ71EN71(E+E), RJ71EN71(Q))	"Application Settings" ⇒ "Redundant System Settings" ⇒ "To Use or Not to Use Redundant System Settings"	Newly added	

## Version 1.072A

All CPUs: RCP, LHCPU, and FX5CPU

Item	Module type	Description	Reference
Redundant system configuration <sup>*4</sup>	RnPCPU (redundant mode)	<ul style="list-style-type: none"> <li>A redundant extension base unit (R66WRB-HT) is available.</li> </ul>	<p>Page 197 Display for a redundant extension base unit configuration</p> <p>Page 584 Writing of module extended parameters in a redundant system configuration</p>
System monitor	RnPCPU (redundant mode)	<ul style="list-style-type: none"> <li>This function is available in a redundant system configuration in which a redundant extension base unit (R66WRB-HT) is used.</li> </ul>	Page 703 Redundant system configuration
Sensor/device monitor Ethernet diagnostics CC-Link IE Controller Network diagnostics CC-Link IE TSN/CC-Link IE Field Network diagnostics CC-Link diagnostics	RnPCPU (redundant mode)	<p>The following module and the modules mounted on it can be diagnosed:</p> <ul style="list-style-type: none"> <li>Redundant extension base unit (R66WRB-HT)</li> </ul>	—
Recording monitor <sup>*3</sup>	RnCPU (R04CPU, R08CPU, R16CPU, R32CPU, R120CPU) RnENCPU RnSF CPU	<ul style="list-style-type: none"> <li>The recording status can be monitored in a project in which a camera recorder module is used.</li> </ul>	—
Recording <sup>*3</sup>	RnCPU (R04CPU, R08CPU, R16CPU, R32CPU, R120CPU) RnENCPU RnSF CPU	<ul style="list-style-type: none"> <li>This function is available in a project in which a camera recorder module is used.</li> <li>In a project in which a recorder module or camera recorder module is used, any device/label can be specified in "Device/Label Sampling Target Setting" of the "Recording Setting" screen.</li> </ul>	<p>Page 732 Recording Function</p> <p>—</p>
Offline monitor <sup>*3</sup>	RnCPU (R04CPU, R08CPU, R16CPU, R32CPU, R120CPU) RnENCPU RnSF CPU	<ul style="list-style-type: none"> <li>Data collected by the recording function of a camera recorder module can be monitored.</li> </ul>	Page 740 Checking a recording file
	All CPUs (excluding an R00CPU)	<ul style="list-style-type: none"> <li>A recording file and logging file can be played by clicking  (Play) in the "Seek Bar" window.</li> <li>A recording file and logging file that are saved on a network drive can be monitored.</li> </ul>	<p>Page 744 Seek bar</p> <p>—</p>
Label editor	All CPUs	<p>When a device assigned to a global label is deleted automatically due to specific operations (such as changing the data type of the label or adding/deleting/editing a structure member), that can be reported in the "Output" window by selecting "Yes" for the following option:</p> <ul style="list-style-type: none"> <li>"Other Editor" ⇨ "Label Editor Common" ⇨ "Operational Setting" ⇨ "Notify when assigned device is deleted"</li> </ul>	Page 237 Assignment (devices/labels)
Options	All CPUs	<p>The following option is added:</p> <ul style="list-style-type: none"> <li>"Other Editor" ⇨ "Label Editor Common" ⇨ "Operational Setting" ⇨ "Notify when assigned device is deleted"</li> </ul>	—
Parameter	RCP	<ul style="list-style-type: none"> <li>The operability of C intelligent function modules (RD55UP06-V and RD55UP12-V) and their parameter descriptions have been improved.</li> </ul>	—

A

## Version 1.075D

All CPUs: RCPU, LHCPU, and FX5CPU

Item	Module type	Description	Reference
Element selection window	All CPUs	<ul style="list-style-type: none"> <li>By selecting a category from the pull-down list of "Display Target" in the [Favorites], [Module], or [Library] tab, elements only in the category can be displayed.</li> </ul>	Page 57 Element selection window
		<ul style="list-style-type: none"> <li>An element can be searched for in the [Library] tab.</li> </ul>	Page 58 Searching for elements
		<ul style="list-style-type: none"> <li>Elements can be searched for in a batch in the [POU List] tab.</li> </ul>	
		<ul style="list-style-type: none"> <li>The definition of a module FB can be added to the navigation window by dragging and dropping the module FB from the [Module] tab onto "FB/FUN" in the navigation window.</li> </ul>	Page 503 Adding the definition of a module FB
Opening a GX Works2 format project	RCPU LHCPU	<ul style="list-style-type: none"> <li>Device comments of local devices can be imported.</li> </ul>	—
	RnCPU RnENCPU RnPCPU LHCPU	<ul style="list-style-type: none"> <li>Special relays/special registers that can be replaced are added.</li> </ul>	
	LHCPU	<p>The parameters of the following modules can be imported:</p> <ul style="list-style-type: none"> <li>Serial communication modules (LJ71C24, LJ71C24-R2)</li> <li>Multiple input module (L60MD4-G)</li> <li>Analog input modules (L60AD4, L60ADVL8, L60ADIL8, L60AD4-2GH)</li> <li>Analog output modules (L60DA4, L60DAVL8, L60DAIL8)</li> <li>Analog I/O module (L60AD2DA2)</li> <li>Temperature input module (L60RD8)</li> <li>Temperature control modules (L60TCTT4, L60TCTT4BW, L60TCRT4, L60TCRT4BW)</li> <li>Simple motion modules (LD77MS2, LD77MS4, LD77MS16)</li> <li>High-speed counter module (LD62, LD62D)</li> <li>LD75 type positioning modules (LD75P1, LD75P2, LD75P4, LD75D1, LD75D2, LD75D4)</li> <li>Flexible high-speed I/O control module (LD40PD01)</li> <li>Blank cover module (QG60)</li> </ul>	Page 108 Data to be changed
Opening a GX Developer format project	RnSFCPU	<p>The following items can be imported:</p> <ul style="list-style-type: none"> <li>User-defined FB</li> <li>Structure</li> <li>Global variable</li> <li>Local label</li> </ul>	Page 124 Opening a GX Developer format project
Help file	All CPUs	<ul style="list-style-type: none"> <li>e-Manual that is created in e-Manual Create can be displayed.</li> </ul>	Page 133 Associating data with an e-Manual Page 134 Opening a help file
iQ Sensor Solution function	RnCPU RnENCPU RnSFCPU	<ul style="list-style-type: none"> <li>This function is available in a project using a CC-Link IE TSN-AnyWireASLINK bridge module (NZZAW1GNAL).</li> </ul>	Page 210 iQ Sensor Solution functions
Simple device communication library	RnCPU RnENCPU RnPCPU (process mode) RnSFCPU	<p>A simple device communication library can be registered in GX Works3 by using the following menu:</p> <ul style="list-style-type: none"> <li>[Tool] ⇒ [Register Simple Device Communication Library]</li> </ul>	Page 217 Registering a simple device communication library
Assigned device check	RCPU LHCPU	<ul style="list-style-type: none"> <li>A global label to which a device is assigned can be checked if the initial value is set for the label.</li> </ul>	Page 241 Initial value check
Ladder editor	All CPUs	<ul style="list-style-type: none"> <li>The ON/OFF state of a function/function block is displayed during monitoring even if it is closed in an outline display.</li> </ul>	Page 621 ON/OFF state display
Ladder editor ST editor FBD/LD editor SFC diagram editor	All CPUs	<ul style="list-style-type: none"> <li>When jumping to an element in an editor, the element is displayed in the center of the editor.</li> </ul>	—

Item	Module type	Description	Reference
FBD/LD editor SFC diagram editor	All CPUs	<ul style="list-style-type: none"> <li>Multiple comment elements can be linked with a single element.</li> </ul>	Page 338 Linking a comment element with a single element
		<p>By selecting "Yes" for the following option, content in the "Remark" column that is set for a global label is displayed on its tooltip.</p> <ul style="list-style-type: none"> <li>"Program Editor" ⇒ "FBD/LD Editor" ⇒ "Tool Hint" ⇒ "Display Item in Tool Hint" ⇒ "Label Remark"</li> <li>"Program Editor" ⇒ "SFC Diagram Editor" ⇒ "Tool Hint" ⇒ "Display Item in Tool Hint" ⇒ "Label Remark"</li> </ul>	—
SFC diagram editor	All CPUs	<ul style="list-style-type: none"> <li>The display format of a transition (Zoom) that consists only of one close contact and TRAN can be changed.</li> </ul>	Page 348 Changing the display format (type) of a transition
		<ul style="list-style-type: none"> <li>Devices and labels of the close contact type are available when creating a transition to be displayed in the device/label format.</li> </ul>	Page 353 Creating a transition
		<p>A selection branch or simultaneous branch can be added by selecting the following menu after selecting an element that links with a comment element.</p> <ul style="list-style-type: none"> <li>[Edit] ⇒ [Insert] ⇒ [Selection Branch Leg]/[Simultaneous Branch Leg]</li> </ul>	—
Quick search	All CPUs	<ul style="list-style-type: none"> <li>The functions of navigation window can be searched for and displayed.</li> </ul>	Page 138 Searching the Navigation Window
Device/label search Device/label replacement Instruction search Instruction replacement	All CPUs	<ul style="list-style-type: none"> <li>By selecting "Include the input/output label of FB instance" under "Find Target," the input/output labels of FB instances in a ladder program and FBD/LD program are searched for or replaced.</li> </ul>	Page 448 Searching for/ Replacing Devices and Labels Page 450 Searching for/ Replacing Instructions
Cross reference* <sup>4</sup> Device list* <sup>4</sup>	RnCPU RnENCPU RnPCPU (process mode) RnSF CPU	<ul style="list-style-type: none"> <li>Devices used in "Simple Device Communication Setting" of the module parameter can be searched for.</li> </ul>	—
	FX5CPU	<p>Devices used in the following module parameter of Ethernet interface modules (FX5-ENET and FX5-ENET/IP) can be searched for.</p> <ul style="list-style-type: none"> <li>Simple CPU Communication Setting</li> </ul>	—
Cross Reference	All CPUs	<ul style="list-style-type: none"> <li>By adding a program file name, FB file name, or FUN file name to a label name, the range of the labels to search for can be specified.</li> </ul>	Page 459 Label type and range specification method
Cross Reference Data flow analysis	All CPUs	<ul style="list-style-type: none"> <li>By entering a label name as 'FB instance name.label name,' a local label of a function block can be searched for and analyzed.</li> </ul>	—
Data flow analysis* <sup>4</sup>	RnCPU RnENCPU RnPCPU (process mode) RnSF CPU	<ul style="list-style-type: none"> <li>"Simple Device Communication Setting" in the module parameters is added to the target range of data flow analysis.</li> </ul>	Page 467 Target range of data flow analysis
	All CPUs	<ul style="list-style-type: none"> <li>A device/label selected on a data flow diagram can be displayed in a waveform in GX LogViewer during offline monitoring.</li> </ul>	Page 754 Starting GX LogViewer
		<ul style="list-style-type: none"> <li>The monitor value of an FB instance is displayed.</li> </ul>	Page 476 Displaying the monitor value of an FB instance
		<ul style="list-style-type: none"> <li>Multiple elements can be selected on a data flow diagram.</li> </ul>	Page 473 Operations in a data flow diagram
		<p>Values in index registers of the following devices are considered.</p> <ul style="list-style-type: none"> <li>Link direct device</li> <li>Module access device</li> <li>CPU buffer memory access device</li> <li>Network number specified device</li> </ul>	—
Specifying a connection destination	FX5CPU	<ul style="list-style-type: none"> <li>A CPU module can be accessed via Ethernet interface modules (FX5-ENET and FX5-ENET/IP).</li> </ul>	Page 564 Accessing via Network (Single Network)
Reading/writing the label memory* <sup>3</sup>	RCPU	<ul style="list-style-type: none"> <li>The label memory can be read from/written to a CPU module in the "CPU Memory Operation" screen.</li> </ul>	Page 608 Reading/Writing the Label Memory Page 773 Reading/Writing the Label Memory
Firmware update* <sup>3,4</sup>	FX5UCPU FX5UCCPU	<ul style="list-style-type: none"> <li>The firmware of modules can be updated using GX Works3.</li> </ul>	Page 776 Firmware Update

Item	Module type	Description	Reference
Simulation	RnPCPU (redundant mode)	A project including the following module can be simulated: <ul style="list-style-type: none"> <li>Redundant extension base unit (R68WRB)</li> </ul>	Page 523 Simulation of an RnPCPU (redundant mode) Page 933 Modules supported by GX Simulator3
	RnCPU (R04CPU, R08CPU, R16CPU, R32CPU, R120CPU) RnENCPU	<ul style="list-style-type: none"> <li>A data logging setting where "Condition specification" is selected for the file switching timing can be used.</li> <li>A device value can be added to a saved file name for data logging.</li> <li>A data logging file can be saved in the CSV file format.</li> </ul>	IMELSEC iQ-R CPU Module User's Manual (Application)
	RnCPU RnENCPU	A project can be simulated while the following item in "Simple CPU Communication Setting" in the module parameters is set: <ul style="list-style-type: none"> <li>"Initial Communication Setting" ⇒ "Continue Communicating Until Receiving Response"</li> </ul>	—
	RnSFCPU	A project including the following module can be simulated: <ul style="list-style-type: none"> <li>Recorder module (RD81RC96)</li> </ul>	IMELSEC iQ-R CPU Module User's Manual (Application)
		The following function is available: <ul style="list-style-type: none"> <li>Saving of device/label data write operation histories of the event history function</li> </ul>	
	FX5UCPU FX5UCCPU	<ul style="list-style-type: none"> <li>The SFC function is available.</li> </ul>	Page 950 CPU module (FX5CPU) IMELSEC iQ-F FX5 User's Manual (Application)
	FX5UCPU FX5UCCPU	The following instructions are available: <ul style="list-style-type: none"> <li>SFC control instructions</li> <li>SFC dedicated instructions</li> </ul>	Page 954 Application instruction
FX5UCPU FX5UCCPU	<ul style="list-style-type: none"> <li>"SFC Setting" in CPU parameters is available.</li> </ul>	Page 961 CPU parameter	
Program list monitor <sup>*3</sup>	RnCPU RnENCPU RnPCPU	<ul style="list-style-type: none"> <li>A desired program can be started and stopped.</li> </ul>	Page 655 Checking the Processing Time of a Program Page 656 Starting a program Page 656 Stopping a program
Specified program monitor <sup>*3</sup>	RnCPU RnENCPU	<ul style="list-style-type: none"> <li>Devices/labels after executing a specified program can be monitored.</li> </ul>	Page 613 When monitoring devices/labels in a specified program
Sensor/device monitor	RnCPU RnENCPU RnSFCPU	This screen can be displayed by the following operation after selecting a CC-Link IE TSN-AnyWireASLINK bridge module (NZ2AW1GNAL) in the "CC-Link IE TSN/CC-Link IE Field Diagnostics" screen: <ul style="list-style-type: none"> <li>Right-click the module and select [AnyWireASLINK Sensor/Device Monitor] from the shortcut menu.</li> </ul>	Page 706 Checking the status of a sensor/device connected to a bridge module Page 718 Displaying the sensor/device monitor screen
PROFIBUS Configuration Tool	RCPU	The following function of PROFIBUS Configuration Tool is available. <ul style="list-style-type: none"> <li>Slave specific transfer</li> </ul> (To use this function, it is required that Version 1.04E or later of PROFIBUS Configuration Tool has been installed.)	IMELSEC iQ-R PROFIBUS-DP Module User's Manual (Application)



Item	Module type	Description	Reference
Ethernet configuration	FX5CPU	<ul style="list-style-type: none"> <li>MELSOFT connection modules and SLMP connection modules can be placed as ones connected to Ethernet interface modules (FX5-ENET and FX5-ENET/IP).</li> </ul>	—
CC-Link IE TSN configuration	RnCPU RnPCPU RnSFCPU	<ul style="list-style-type: none"> <li>The PDO mapping parameters can be set in a batch if there is any device station for which PDO mapping parameters are not set when checking the system configuration.</li> <li>If the own station is a CC-Link IE TSN compatible motion module, the checkbox in the "Motion Control Station" column of the station list is automatically selected by dragging and dropping a device station from the module list window onto the station list or network configuration.</li> </ul>	
Tag FB setting editor	RnPCPU RnPSFCPU	<p>Shortcut keys can be set for the following menus:</p> <ul style="list-style-type: none"> <li>[Edit] ⇨ [New Declaration (Before)]</li> <li>[Edit] ⇨ [Delete Row]</li> <li>[Edit] ⇨ [Export Assignment Information Database File]</li> <li>[Edit] ⇨ [FB Property Page]</li> </ul>	
Label editor	All CPUs	<p>Shortcut keys can be set for the following menus:</p> <ul style="list-style-type: none"> <li>[Edit] ⇨ [New Declaration (Before)]</li> <li>[Edit] ⇨ [Delete Row]</li> </ul>	
Ladder editor ST editor SFC diagram editor FBD/LD editor Label editor	FX5UCPU FX5UCCPU	<ul style="list-style-type: none"> <li>"String [Unicode]" can be set as the data type of a device/label.</li> </ul>	
FBD/LD program (including a Zoom)	All CPUs	<p>Shortcut keys can be set for the following menus:</p> <ul style="list-style-type: none"> <li>[Edit] ⇨ [Layout] ⇨ [Insert Row]</li> <li>[Edit] ⇨ [Layout] ⇨ [Delete Row]</li> <li>[Edit] ⇨ [Layout] ⇨ [Insert Column(in FBD Network Block)]</li> <li>[Edit] ⇨ [Layout] ⇨ [Delete Column(in FBD Network Block)]</li> <li>[Edit] ⇨ [Layout] ⇨ [Insert Multiple Rows]</li> <li>[Edit] ⇨ [Layout] ⇨ [Delete Multiple Rows]</li> </ul>	
Module start I/O No. related area ST editor Device memory editor Cross reference Data flow analysis Device/buffer memory batch monitor Watch Device test with execution conditions Interrupt program list monitor	All CPUs	<p>A device comment is displayed with the number of characters set in the following option:</p> <ul style="list-style-type: none"> <li>"Other Editor" ⇨ "Device Comment Editor" ⇨ "Number of Editing/ Displaying Characters" ⇨ "Number of Device Comment Editing/ Displaying Characters"</li> </ul>	
Search/replacement	All CPUs	<p>When using the following menu, the jump destination is displayed in the center of a work window.</p> <ul style="list-style-type: none"> <li>[Find/Replace] ⇨ [Previous]/[Next]</li> </ul>	
CC-Link IE TSN/CC-Link IE Field Network diagnostics <sup>*4</sup>	RnCPU FX5CPU	<p>The following modules can be diagnosed:</p> <ul style="list-style-type: none"> <li>Transistor output modules (NZ2GN12A2-16T, NZ2GN12A2-16TE, NZ2GN2B1-16T, NZ2GN2B1-16TE, NZ2GN2S1-16T, NZ2GN2S1-16TE)</li> <li>DC input modules (NZ2GN12A4-16D, NZ2GN12A4-16DE, NZ2GN2B1-16D, NZ2GN2S1-16D)</li> <li>DC input/transistor output combined modules (NZ2GN12A42-16DT, NZ2GN12A42-16DTE)</li> <li>CC-Link IE TSN-AnyWireASLINK bridge module (NZ2AW1GNAL)</li> <li>Servo amplifiers (MR-J5D1-G, MR-J5D2-G, MR-J5D3-G)</li> </ul>	
Simple CPU communication diagnostics <sup>*3*4</sup>	FX5CPU	<ul style="list-style-type: none"> <li>Ethernet interface modules (FX5-ENET and FX5-ENET/IP) can be diagnosed.</li> <li>A diagnostics target module can be specified.</li> </ul>	

Item	Module type	Description	Reference
Options	All CPUs	<p>The following option name is changed.</p> <ul style="list-style-type: none"> <li>• Before change (version 1.045X to 1.072A) "Project" ⇒ "User Library" ⇒ "Library Update Check"</li> <li>• After change (version 1.075D) "Project" ⇒ "Element Selection" ⇒ "Update Check"</li> </ul>	Page 514 Checking for library updates automatically
		<p>The following options are added:</p> <ul style="list-style-type: none"> <li>• "Project" ⇒ "Navigation" ⇒ "Operational Setting" ⇒ "Hide Docking Window When ESC Key is Pressed"</li> <li>• "Project" ⇒ "Element Selection" ⇒ "Update Check" ⇒ "Automatically check the version of module label, module FB, tag data structured data type, and process control FB."</li> <li>• "Program Editor" ⇒ "FBD/LD Editor" ⇒ "Tool Hint" ⇒ "Display Item in Tool Hint" ⇒ "Label Remark"</li> <li>• "Program Editor" ⇒ "SFC Diagram Editor" ⇒ "Tool Hint" ⇒ "Display Item in Tool Hint" ⇒ "Label Remark"</li> <li>• "Parameter" ⇒ "Common Item" ⇒ "Operational Setting" ⇒ "Operation on Double-clicking Pulldown List"</li> <li>• "Parameter" ⇒ "Network Configuration Settings" ⇒ "CC-Link IE TSN" ⇒ "Operational Setting" ⇒ "Check the station No. and IP address in closing the window to reflect the setting."</li> </ul>	—
	RnCPU RnENCPU	<p>The following option is added:</p> <ul style="list-style-type: none"> <li>• "Convert" ⇒ "Basic Setting" ⇒ "Operational Setting" ⇒ "Use Phase Processing Instructions"</li> </ul>	
Printing <sup>4</sup>	RnCPU RnENCPU RnPCPU (process mode) RnSFCEPU	<ul style="list-style-type: none"> <li>• Contents of "Simple Device Communication Setting" in the module parameters can be printed.</li> </ul>	
	FX5CPU	<p>Contents of the following parameters of Ethernet interface modules (FX5-ENET and FX5-ENET/IP) can be printed:</p> <ul style="list-style-type: none"> <li>• BACnet Function Setting</li> <li>• Simple CPU Communication Setting</li> </ul>	
Shortcut key	All CPUs	<ul style="list-style-type: none"> <li>• When updating GX Works3, shortcut keys that were set before the update are applied.</li> </ul>	
Reading/writing/deleting user data	All CPUs	<ul style="list-style-type: none"> <li>• A file with the '.QST' extension can be written, read, and deleted.</li> </ul>	
Offline monitor	RnCPU (R04CPU, R08CPU, R16CPU, R32CPU, R120CPU) RnENCPU RnSFCEPU	<ul style="list-style-type: none"> <li>• A recording file including up to 5,232,645 records can be monitored.</li> </ul>	
Others	All CPUs	<ul style="list-style-type: none"> <li>• When installing GX Works3, GX VideoViewer can be installed at the same time.</li> </ul>	 GX Works3 Installation Instructions
	FX5UJCPU	<p>The following modules can be used in a project:</p> <ul style="list-style-type: none"> <li>• Safety extension modules (FX5-SF-8DI4, FX5-SF-MU4T5)</li> </ul>	—

## Parameters

Category	Module type	Module	Parameter*3*4	Description
System parameter	RnCPU RnENCPU	CC-Link IE TSN compatible motion modules (RD78G41, RD78G8, RD78G16, RD78G32, RD78G64, RD78GHV, RD78GHW)	"Inter-module Synchronization Setting" ⇨ "Select Inter-module Synchronization Target Module"	Newly added
			"Inter-module Synchronization Setting" ⇨ "Inter-module Synchronization Master Setting"	Newly added
CPU parameter	RnPCPU		"Memory/Device Setting" ⇨ "Link Direct Device Setting"	Newly added
Module parameter	RnCPU RnENCPU RnPCPU (process mode) RnSFCPU	Ethernet interface modules (_RJ71EN71(E+IEC), _RJ71EN71(E+IEF), RJ71EN71(E+CCIEC), RJ71EN71(E+CCIEF), RJ71EN71(E+E))	"Application Settings" ⇨ "Simple Device Communication Setting"	Newly added
		EtherNet/IP module (RJ71EIP91)	"Basic Setting"	EtherNet/IP Configuration Tool for RJ71EIP91 can be started.
	RnSFCPU	CC-Link IE TSN module (RJ71GN11-T2)	"Basic Settings" ⇨ "Safety Communication Setting" ⇨ "<Detailed Setting>"	"CR800-R" can be selected for "Communication Destination."
	FX5CPU	Ethernet interface modules (FX5-ENET and FX5-ENET/IP)	"Basic Settings" ⇨ "BACnet Function Setting"	Newly added
			"Application Settings" ⇨ "Simple CPU Communication Setting"	Newly added
"Basic Settings" ⇨ "Own Node Settings" ⇨ "Communication Data Code"			Newly added	
		"Application Settings" ⇨ "Security" ⇨ "Disable Direct Connection with MELSOFT"	Newly added	
		"Application Settings" ⇨ "Security" ⇨ "Do Not Respond to CPU Module Search"	Newly added	

## Version 1.077F

All CPUs: RCPU, LHCPU, and FX5CPU

Item	Module type	Description	Reference
Start of GX Works3	All CPUs	<ul style="list-style-type: none"> <li>The display position and window size of GX Works3 at startup can be specified by specifying an option in a command line.</li> <li>Offline monitoring can be started when starting GX Works3 by specifying an option in a command line.</li> </ul>	Page 48 Starting GX Works3 by specifying the display position and window size
Creating a function block	All CPUs	<ul style="list-style-type: none"> <li>A function block can be created from a ladder block selected in a ladder editor.</li> </ul>	Page 484 Creating a Function Block
Reading a recording file	RnCPU (R04CPU, R08CPU, R16CPU, R32CPU, R120CPU), RnENCPU, RnSFCPU	<ul style="list-style-type: none"> <li>Project data saved in a recorder module can be read.</li> </ul>	Page 735 Reading a recording file
Offline monitor	RnCPU (R04CPU, R08CPU, R16CPU, R32CPU, R120CPU) RnENCPU RnSFCPU	<ul style="list-style-type: none"> <li>If project data is saved in a recorder module, camera recorder module, or file server, the following project data is automatically opened among the saved project data when starting offline monitoring: project data with the time information closest to the time at which a recording file to be played was saved.</li> </ul>	MESEK iQ-R System Recorder User's Manual (Application)
Options	All CPUs	<p>The following options are added:</p> <ul style="list-style-type: none"> <li>"Monitor" ⇨ "Common Item" ⇨ "Change Current Value" ⇨ "Show a confirmation message when modifying value in Watch."</li> <li>"Convert" ⇨ "Basic Setting" ⇨ "Operational Setting" ⇨ "Function Block" ⇨ "Check the Device Which is Connected to Argument"</li> </ul>	—



A

## Version 1.080J

All CPUs: RCPU, LHCPU, and FX5CPU

Item	Module type	Description	Reference
Printing	RCPU LHCPU	<ul style="list-style-type: none"> <li>Inline structured text programs used in an FBD/LD program can be printed.</li> </ul>	Page 95 Printing inline structured text programs used in FBD/LD programs
	All CPUs	<ul style="list-style-type: none"> <li>File names are displayed in the "Do Not Print" column of "Setting by Item" in the "Print" screen in the same order as the navigation window.</li> </ul>	—
Verification	RCPU LHCPU	<ul style="list-style-type: none"> <li>Inline structured text programs used in an FBD/LD program can be verified.</li> </ul>	Page 151 FBD/LD program Page 156 Merging mismatched data into a verification source Page 158 FBD/LD program
Quick search	All CPUs	<ul style="list-style-type: none"> <li>Menus can be searched for in the quick search.</li> </ul>	Page 78 Quick Search
Opening a GX Works2 format project	FX5CPU	<ul style="list-style-type: none"> <li>A project for an FXCPU (FX3S) can be replaced with a project for an FX5CPU.</li> </ul>	Page 107 Opening a GX Works2 format project
Opening a PX Developer format project	RCPU	<ul style="list-style-type: none"> <li>Inline ST parts used in a PX Developer project can be imported as an inline structured text program.</li> </ul>	Page 111 Data to be changed (PX Developer) Page 920 Inline ST part
Opening a GX IEC Developer format project	FX5UCPU FX5UCCPU	<ul style="list-style-type: none"> <li>POUs created in Sequential Function Chart language can be imported.</li> </ul>	Page 117 Data to be changed
AnyWireASLINK configuration window <sup>*5</sup>	RCPU	The following functions are available even when a specific error or alarm occurs in an AnyWireASLINK master module or CC-Link IE Field-AnyWireASLINK bridge module: <ul style="list-style-type: none"> <li>Automatic detection of connected devices</li> <li>Parameter processing of remote module</li> <li>Verification of connected devices and configurations</li> <li>Sensor/device monitor</li> </ul>	—
		The following function is available for a CC-Link-AnyWireASLINK bridge module and CC-Link IE Field-AnyWireASLINK bridge module: <ul style="list-style-type: none"> <li>Verification of connected devices and configurations</li> </ul>	
CC-Link IE TSN configuration window	RCPU	<ul style="list-style-type: none"> <li>The "CC-Link IE TSN Class" column is added.</li> </ul>	
		<ul style="list-style-type: none"> <li>The number of device stations that can be placed in this window is changed from 254 to 120 in a project using a CC-Link IE TSN compatible motion module.</li> </ul>	
Changing a module	RCPU	<ul style="list-style-type: none"> <li>The module names of CC-Link IE TSN compatible motion modules (RD78G4, RD78G8, RD78G16, RD78G32, RD78G64, RD78GHV, and RD78GHW only) can be changed.</li> </ul>	Page 222 Change Module
Navigation window	All CPUs	Program files, program blocks, and worksheets can be sorted by name or update date and time in a batch by either of the following operations: <ul style="list-style-type: none"> <li>Right-click "Project" and select [Sort] ⇒ [Name] from the shortcut menu.</li> <li>Right-click "Project" and select [Sort] ⇒ [Last Change] from the shortcut menu.</li> </ul>	Page 55 Sorting data
Label comment window	All CPUs	A label can be pasted by dragging and dropping its label name to any of the following screens: <ul style="list-style-type: none"> <li>Ladder editor</li> <li>ST editor</li> <li>FBD/LD editor</li> <li>SFC diagram editor</li> <li>Watch window</li> <li>[Favorites] tab in the element selection window</li> </ul>	Page 59 Adding from the "Label Comment" window Page 283 Pasting from each screen Page 640 Registering devices/labels from the "Label Comment" window
Creating a program <sup>*3</sup> (Standard program)	RnSFCPU	<ul style="list-style-type: none"> <li>Sequential Function Chart language is supported.</li> </ul>	—

Item	Module type	Description	Reference
Ladder editor	All CPUs	<ul style="list-style-type: none"> <li>A label comment or device comment can be directly edited by double-clicking it.</li> </ul>	Page 284 Entering/editing comments
		By selecting "Yes" for the following option, the "FB Instance Name" screen appears when pasting a function block: <ul style="list-style-type: none"> <li>"Program Editor" ⇒ "Ladder Editor" ⇒ "FB/FUN" ⇒ "Operational Setting" ⇒ "Show FB Instance Name Window in Pasting Ladder"</li> </ul>	—
		<ul style="list-style-type: none"> <li>The "Input Inline Structured Text Title" screen appears by double-clicking the title of an inline structured text.</li> </ul>	
		<ul style="list-style-type: none"> <li>Visibility of the vertical lines of parallel circuits is improved in the output circuits of function blocks and functions.</li> </ul>	
		<ul style="list-style-type: none"> <li>In a ladder block in which an FB instance or function is used, arguments which are not entered can be entered consecutively after entering an input, output, or input/output argument.</li> </ul>	
FBD/LD editor	All CPUs	An argument (input/output label) of a function element/function block element can be hidden by using smart tags or the following menus: <ul style="list-style-type: none"> <li>[Edit] ⇒ [I/O Argument] ⇒ [Mark as Hidden]</li> <li>[Edit] ⇒ [I/O Argument] ⇒ [Hide Argument]</li> </ul>	Page 71 Available menus when editing an FBD/LD program Page 158 FBD/LD program Page 331 Hiding arguments
		The height of a function element/function block element can be changed by using the following menus: <ul style="list-style-type: none"> <li>[Edit] ⇒ [Toggle FB/FUN Height] ⇒ [Adapt Width]</li> <li>[Edit] ⇒ [Toggle FB/FUN Height] ⇒ [Keep Width]</li> </ul>	Page 71 Available menus when editing an FBD/LD program Page 334 Changing the height of an element
	RCPU LHCPU	<ul style="list-style-type: none"> <li>An inline structured text element is available in an FBD/LD program.</li> </ul>	Page 71 Available menus when editing an FBD/LD program Page 319 Configuration of an FBD/LD editor Page 328 Inserting an inline structured text element Page 332 Changing the element size
		The colors of inline structured text elements can be changed in the following items in the "Color and Font" screen: <ul style="list-style-type: none"> <li>Data Name of Inline Structured Text Element</li> <li>Text of Inline Structured Text Element</li> <li>Background of Inline Structured Text Element</li> <li>Invalid Definition of FB/FUN/Inline Structured Text</li> </ul>	—
SFC diagram editor	All CPUs	The color of the following item can be changed in the "Color and Font" screen: <ul style="list-style-type: none"> <li>Background of Jump Symbol</li> </ul>	
		<ul style="list-style-type: none"> <li>A step with a jump symbol can be copied without selecting the jump source.</li> </ul>	
FBD/LD editor SFC diagram editor	All CPUs	<ul style="list-style-type: none"> <li>Visibility of elements and connection lines is improved.</li> </ul>	
Ladder editor ST editor FBD/LD editor	All CPUs	<ul style="list-style-type: none"> <li>If the definition name of the function block includes any of the following symbols, the symbol is replaced with an underscore ( _ ) in the "Label Name" column of the "Undefined Label Registration" or "FB Instance Name" screen: plus sign (+), minus sign (-), exclamation mark (!), left round bracket ( ( ), right round bracket ( ) ), or backquote ( ` ).</li> </ul>	Page 272 Inserting a function block Page 313 Inserting a function block Page 325 Inserting a function block
FB property page	RnPCPU RnPSFCPU	<ul style="list-style-type: none"> <li>This function is available for all loop tag FBs.</li> </ul>	Page 377 Displaying the FB property page
Device search/ replacement Instruction search/ replacement Character string search/ replacement Device batch replacement	RCPU LHCPU	<ul style="list-style-type: none"> <li>Data in an inline structured text program used in an FBD/LD program can be searched for/replaced.</li> </ul>	Page 448 Searching for/ Replacing Devices and Labels Page 450 Searching for/ Replacing Instructions Page 451 Searching for/ Replacing Character Strings Page 454 Batch Replacing of Devices and Labels
Character string search/ replacement	RCPU LHCPU	<ul style="list-style-type: none"> <li>The data name of an inline structured text box or inline structured text element can be searched for/replaced by entering "@STB" or "@IST."</li> </ul>	Page 451 Searching for/ Replacing Character Strings

Item	Module type	Description	Reference
Cross Reference	RCPU LHCPU	<ul style="list-style-type: none"> <li>Devices/labels in inline structured text programs used in an FBD/LD program can be searched for.</li> </ul>	—
Data flow analysis	RCPU LHCPU	<ul style="list-style-type: none"> <li>Devices/labels in inline structured text programs used in an FBD/LD program can be analyzed.</li> </ul>	
Bookmark	RCPU LHCPU	<ul style="list-style-type: none"> <li>Position information of an inline structured text program that is used in an FBD/LD editor can be registered as a bookmark.</li> </ul>	Page 479 Registering a Bookmark
Library	All CPUs	<ul style="list-style-type: none"> <li>A library using an each program device comment and/or a common device comment can be exported.</li> </ul>	Page 506 User library
Simulation	All CPUs	<p>A project including any of the following modules can be simulated:</p> <ul style="list-style-type: none"> <li>Temperature control modules (R60TCRT2TT2-TS, R60TCRT4-TS)</li> <li>High speed data communication module (RD81DC96)</li> <li>Camera recorder module (RD81RC96-CA)</li> <li>GP-IB interface module (RJ71GB91(M), RJ71GB91(S))</li> <li>CC-Link IE TSN compatible motion modules (RD78G4(S), RD78G8(S), RD78G16(S))</li> <li>CC-Link IE TSN compatible motion modules (FX5-40SSC-G(S), FX5-80SSC-G(S))</li> </ul>	<p>Page 933 Modules supported by GX Simulator3</p> <p>Page 937 Modules supported by GX Simulator3 (System simulation)</p> <p>Page 965 Module buffer memory</p> <p>Page 967 Link devices of network module</p>
	All CPUs	<p>A system including the following modules can be simulated:</p> <ul style="list-style-type: none"> <li>CC-Link IE TSN compatible motion modules (RD78G4(S), RD78G8(S), RD78G16(S), FX5-40SSC-G(S), FX5-80SSC-G(S))</li> <li>CC-Link IE TSN module (FX5-CCLGN-MS)</li> </ul>	<p>Page 536 Simple motion module/motion module</p> <p>Page 538 Network modules</p>
	All CPUs	<ul style="list-style-type: none"> <li>Multiple systems that perform transient transmission can be simulated.</li> </ul>	<p>Page 538 Network modules</p> <p>Page 968 Network functions</p> <p>Page 979 Simulation of network modules</p>
	All CPUs	<p>The following items are available when simulating network modules.</p> <ul style="list-style-type: none"> <li>Application settings in network parameters</li> <li>Dedicated instructions for network modules</li> </ul>	<p>Page 970 Network parameters</p> <p>Page 973 Dedicated instructions for network modules</p>
	All CPUs	<ul style="list-style-type: none"> <li>The current value of a timer, clock function, and system clock operate with the actual time.</li> </ul>	Page 977 Timer, clock function, and system clock
	All CPUs	<p>When writing a project to a simulator, the project is automatically saved by selecting "Yes" for the following option:</p> <ul style="list-style-type: none"> <li>"Project" ⇒ "Save" ⇒ "Auto-save Operational Setting" ⇒ "Automatically save in writing to Simulator as well"</li> </ul> <p>Note that this option can be set only when selecting "Yes" for any of the following options:</p> <ul style="list-style-type: none"> <li>"Project" ⇒ "Save" ⇒ "Auto-save Execution Setting" ⇒ "Save project after Write to PLC"</li> <li>"Project" ⇒ "Save" ⇒ "Auto-save Execution Setting" ⇒ "Save project after Online Program Change"</li> <li>"Project" ⇒ "Save" ⇒ "Auto-save Execution Setting" ⇒ "Save project after changing TC Setting Value and writing to PLC"</li> </ul>	—
	RnCPU RnENCPU	<p>The following functions are available:</p> <ul style="list-style-type: none"> <li>System monitoring information (SD2000 to SD2036)</li> <li>Specified program monitor</li> <li>CC-Link IE TSN motion module inter-module synchronization function</li> </ul> <p>The following instructions are available:</p> <ul style="list-style-type: none"> <li>Phase processing instructions</li> </ul>	<p> MELSEC iQ-R CPU Module User's Manual (Application)</p> <p>Page 952 RCPU and LHCPU</p>
RnCPU RnENCPU RnPCPU	<p>The following function is available:</p> <ul style="list-style-type: none"> <li>Program start/stop</li> <li>Label memory read/write</li> </ul>	 MELSEC iQ-R CPU Module User's Manual (Application)	
RnPCPU	<p>The following functions are available:</p> <ul style="list-style-type: none"> <li>Extension of points for CC-Link IE Controller Network</li> <li>Laser displacement sensor control module supporting the redundant system with redundant extension base unit</li> <li>Device/label access service processing constant wait function</li> </ul>		
FX5UCPU FX5UCCPU	<p>The following instructions are available:</p> <ul style="list-style-type: none"> <li>File operation instructions (SP.FREAD, SP.FWRITE, SP.FDELETE, SP.FCOPY, SP.FMOVE, SP.FRENAME, SP.FSTATUS)</li> <li>String processing instructions (\$MOV(P)_WS, SJIS2WS(P), SJIS2WSB(P), WS2SJIS(P))</li> </ul>	Page 954 FX5CPU	

Item	Module type	Description	Reference
Specifying a connection destination <sup>*3*4</sup>	RnCPU	• A CPU module can be accessed from a personal computer via a GOT and CC-Link IE TSN module.	Page 569 Accessing via a GOT and a module
	FX5CPU	• An FX5CPU to be accessed can be changed in the "Network Communication Route Detailed Setting of Ethernet" screen when connecting a personal computer to multiple FX5CPUs via a GOT and Ethernet.	
Monitor <sup>*3</sup>	RnCPU RnENCPU RnSFCPU	• The maximum and minimum values of scan time can be cleared from the monitor status bar during monitoring.	Page 614 Status monitoring
	RnCPU LHnCPU	• An inline structured text program used in an FBD/LD program can be monitored (only in an ST editor).	Page 623 FBD/LD
	RnCPU RnENCPU RnSFCPU	• Whether the IP address change function is used for a network number, station number, and IP address can be checked on the tooltip.	Page 704 Check of the specification method for a network No., station No., and IP address
Device/buffer memory batch monitor	All CPUs	• When changing the current value of a device that is not the bit type device, the device is registered in a watch window according to the displayed data type.	—
Watch	RnCPU LHnCPU	• Devices/labels in inline structured text programs used in an FBD/LD program can be registered (only from an ST editor).	Page 640 Registering devices/labels from program editor/label editor Page 641 Automatic registration to watch windows
Realtime monitor	RnCPU LHnCPU	A device/label selected in any of the following screens is automatically registered to the "Realtime Monitor Setting" screen of GX LogViewer: <ul style="list-style-type: none"> <li>• Ladder editor</li> <li>• ST editor</li> <li>• FBD/LD editor</li> <li>• Watch window</li> </ul>	Page 661 Procedure for using the realtime monitor
Intelligent function module monitor	RnCPU	• A CC-Link IE TSN compatible motion module can be registered in the intelligent function module monitor from the navigation window by using a shortcut menu.	Page 659 Registration of an intelligent function module
Offline monitor	All CPUs	• While monitoring a recording file or logging file, the values of devices/labels that match specified conditions and their indexes can be checked.	Page 751 Checking a device/label value
	All CPUs	The following shortcut menu name is changed. <ul style="list-style-type: none"> <li>• Before change (version 1.035M to 1.077F): Wave Display</li> <li>• After change (version 1.080J): Wave Display (Offline Monitor)</li> </ul>	Page 754 Starting GX LogViewer
Event history	All CPUs	• When an event code cannot be acquired, the cause is displayed.	—
User authentication <sup>*3</sup>	RnPSFCPU	• "Assistant Developers" is added to the access level of user.	Page 687 Functions and operations that require user authentication
Diagnostics	RnCPU LHnCPU	• The cursor can jump to an error location in an inline structured text program used in an FBD/LD program.	—
Firmware update	FX5SCPU	• The firmware of modules can be updated using GX Works3.	Page 776 Firmware Update

Item	Module type	Description	Reference
Options	All CPUs	The following option name is changed. <ul style="list-style-type: none"> <li>• Before change (version 1.035M to version 1.077F) "Project" ⇒ "Save" ⇒ "Operational Setting"</li> <li>• After change (version 1.080J) "Project" ⇒ "Save" ⇒ "Auto-save Execution Setting"</li> </ul>	Page 127 Overwriting projects
	All CPUs	The following options are added: <ul style="list-style-type: none"> <li>• "Project" ⇒ "Save" ⇒ "Auto-save Operational Setting" ⇒ "Automatically save in writing to Simulator as well"</li> <li>• "Program Editor" ⇒ "Ladder Editor" ⇒ "FB/FUN" ⇒ "Operational Setting" ⇒ "Show FB Instance Name Window in Pasting Ladder"</li> <li>• "Program Editor" ⇒ "FBD/LD Editor" ⇒ "Enter Element" ⇒ "Operational Setting" ⇒ "FB/FUN height"</li> <li>• "Program Editor" ⇒ "SFC Diagram Editor" ⇒ "Enter Element" ⇒ "Operational Setting" ⇒ "FB/FUN height"</li> <li>• "Online" ⇒ "Write to PLC" ⇒ "Operational Setting" ⇒ "Show a confirmation message in executing"</li> <li>• "Convert" ⇒ "Basic Setting" ⇒ "Operational Setting" ⇒ "SFC Diagram" ⇒ "Delete Unused Zoom"</li> </ul>	—
	RCP LHCPU FX5UCPU FX5UCCPU FX5UJCPU	The following option is added: <ul style="list-style-type: none"> <li>• "Intelligent Function Module" ⇒ "Simple Motion" ⇒ "Operational Setting" ⇒ "Select Simple Motion Module Setting as write target"</li> </ul>	
	FX5CPU	The following options are added: <ul style="list-style-type: none"> <li>• "Parameter" ⇒ "Device Setting" ⇒ "Display Setting" ⇒ "Display Device/Label Memory Area Setting as Simple Setting" ⇒ "Free Space for Label/Latch Label Memory Area to Allocate"</li> <li>• "Parameter" ⇒ "Device Setting" ⇒ "Display Setting" ⇒ "Display Device/Label Memory Area Setting as Simple Setting" ⇒ "Firmware Version of Target CPU"</li> <li>• "Convert" ⇒ "Basic Setting" ⇒ "Operational Setting" ⇒ "Check by the Threshold of Free Space for Label/Latch Label in Executing Convert/Rebuild All"</li> <li>• "Convert" ⇒ "Basic Setting" ⇒ "Operational Setting" ⇒ "Check by the Threshold of Free Space for Label/Latch Label in Executing Convert/Rebuild All" ⇒ "Threshold of Free Space for Label/Latch Label"</li> </ul>	



## Parameters

Category	Module type	Module	Parameter*3*4	Description
System parameter	RCPU	CC-Link IE TSN compatible motion modules (RD78G4(S), RD78G8(S), or RD78G16(S) only)	"Inter-module Synchronization Setting" ⇨ "Select Inter-module Synchronization Target Module"	Newly added
			"Inter-module Synchronization Setting" ⇨ "Inter-module Synchronization Master Setting"	Newly added
CPU parameter	FX5SCPU FX5UCPU		"Memory/Device Setting" ⇨ "Device/Label Memory Area Setting" ⇨ "<Detailed Setting>"	The device/label memory area is optimized according to the settings in "Batch Setting" by clicking the [Batch Setting] button in "Device/Label Memory Area Batch Setting" of the "Device/Label Memory Area Setting" screen.
	FX5SCPU FX5UCPU FX5UJCPU		"Memory/Device Setting" ⇨ "Device/Label Memory Area Setting" ⇨ "<Detailed Setting>"	The "Usage Status of Device/Label Memory Area" screen appears by clicking the [Usage Status] button in "Setting Area" of the "Device/Label Memory Area Setting" screen.
Module parameter*3*4	RCPU		"Application Settings" ⇨ "Simple Device Communication Setting" ⇨ "<Communication Destination Setting>" ⇨ "<Detailed Setting>"	The following operations can be performed for "Communication Destination Setting": <ul style="list-style-type: none"> <li>• Selecting "User Selection" for "Setting Method"</li> <li>• Importing/exporting the communication destination settings</li> </ul>
	FX5UJCPU		"Application Settings" ⇨ "Web Server Settings" ⇨ "Account Settings" ⇨ "<Detailed Setting>"	"User Web Page Only" and "Permit Both Displays" can be selected in the "Authority for Window Display" column of the "Web Server Account Settings" screen.
	All CPUs	CC-Link IE Field Network modules (RJ71GF11-T2(MR), RJ71GF11-T2(LR))	"Required Settings" ⇨ "Parameter Setting Method" ⇨ "Setting Method of Basic/Application Settings"	"Program" can be selected.
	RCPU	CC-Link IE TSN module (RJ71GN11-T2) CC-Link IE TSN compatible motion module	"Basic Settings" ⇨ "Connection Device Information" ⇨ "TSN HUB Setting"	Newly added
			"Basic Settings" ⇨ "Communication Period Setting" ⇨ "Multiple Period Setting" ⇨ "Low-Speed"	"x32," "x64," and "x128" can be selected.
	CC-Link IE TSN compatible motion modules (RD78G4, RD78G8, RD78G16, RD78G32, RD78G64, RD78GHV, and RD78GHW only)	"Refresh Setting"	Newly added	

## Version 1.082L

Item	Module type	Description	Reference
Opening a GX Works2 format project	LHCPU	The parameters of the following module can be imported: • AnyWireASLINK interface module (LJ51AW12AL)	Page 108 Data to be changed
Device assignment confirmation	RnCPU RnENCPU	• Refresh devices which are assigned to a device station can be checked when using a CC-Link IE TSN Plus master/local module.	Page 211 Checking refresh devices assigned to a module
		• Content in the "Explanation" column displayed in the link device list of the "Device Assignment Confirmation" screen can be applied to the device comment for each refresh device when using a CC-Link IE TSN Plus master/local module.	—
Module parameter	RnCPU RnENCPU	• Link side devices of a CC-Link IE TSN Plus master/local module can be set in a batch.	Page 216 Setting link side devices in a batch (CC-Link IE TSN)
Reading sample comments	RnCPU RnENCPU	• Sample comments of a CC-Link IE TSN Plus master/local module can be read.	—
Scan time measurement <sup>*3</sup>	RnCPU RnENCPU	• A scan time can be measured for any sections in a program.	Page 653 Measuring the Scan Time of a Program
Remote password <sup>*3*4</sup>	RnCPU RnENCPU	• This function is available when accessing a CPU module via a CC-Link IE TSN Plus master/local module.	Page 699 Remote password function
CC-Link IE TSN/CC-Link IE Field Network diagnostics <sup>*3*4</sup>	RnCPU RnENCPU	• A CC-Link IE TSN Plus master/local module can be diagnosed.	Page 717 CC-Link IE TSN/CC-Link IE Field Network diagnostics
Intelligent function module monitor <sup>*3*4</sup>	RnCPU RnENCPU	• A device station on CC-Link IE TSN can be monitored in a project in which a CC-Link IE TSN Plus master/local module is used.	—
Reading/writing the label memory	RnCPU	• This function is available even when a CPU module is in the RUN state.	—

## Parameters

Category	Module type	Module	Parameter <sup>*3*4</sup>	Description
System parameter	RnCPU RnENCPU	CC-Link IE TSN Plus master/local module (RJ71GN11-EIP(T+E))	"Inter-module Synchronization Setting" ⇔ "Select Inter-module Synchronization Target Module"	Newly added
			"Inter-module Synchronization Setting" ⇔ "Inter-module Synchronization Master Setting"	Newly added

## Version 1.085P

All CPUs: RnCPU, LHCPU, and FX5CPU

Item	Module type	Description	Reference
Operating environment (operating system)	All CPUs	• Windows 11 is supported.	—
Navigation window	RnCPU LHCPU	Module information can be sorted by module name or start I/O No. order in a batch by the following operations: • Right-click and select [Sort] ⇔ [Module Name] from the shortcut menu. • Right-click and select [Sort] ⇔ [Start I/O No.] from the shortcut menu.	Page 55 Sorting data
Element selection window	All CPUs	The following information of a program file of a user library is displayed in the [Library] tab: • Right-side of an element: title • Explanation column of an element: update date and time, comment	—
		• When utilizing a program file of a user library, the title and comment of the program file also can be utilized.	
Copying and pasting	All CPUs	• Data can be copied and pasted even if the module types of the copy source and copy destination are different.	Page 131 CPU module type combinations Page 131 When CPU module types are different
Verification	All CPUs	• Memory card parameters can be verified.	—
Guidance flow	FX5CPU	• The setting procedure of parameters can be checked in a flow.	Page 200 Guidance flow function

Item	Module type	Description	Reference
AnyWireASLINK configuration window Sensor/device monitor	RCPU	The following functions are available even if an ID (address) of a remote module connected to an AnyWireASLINK master module is duplicated: <ul style="list-style-type: none"> <li>• Automatic detection of connected devices</li> <li>• Parameter processing of remote module</li> <li>• Verification of connected devices and configurations</li> <li>• Sensor/device monitor</li> </ul>	—
CC-Link IE TSN configuration window <sup>4</sup>	RnCPU RnENCPU RnSFCPU	If the own station is a CC-Link IE TSN module, the following function is available even if data of the master station is not linked: <ul style="list-style-type: none"> <li>• Connected/disconnected module detection</li> </ul> <p>When "Multicast" is set for the following module parameter for CC-Link IE TSN compatible motion modules, "Online (Multicast Mode)" is displayed for "Mode Settings" in this window.</p> <ul style="list-style-type: none"> <li>• "Application Settings" ⇒ "Communication Mode" ⇒ "Communication Mode"</li> </ul> <ul style="list-style-type: none"> <li>• If the own station is a CC-Link IE TSN compatible motion module, the values in "LB Setting" and "LW Setting" of the own station can be set.</li> <li>• If the own station is a CC-Link IE TSN compatible motion module, the values in "RX setting," "RY setting," "RWw setting," and "RWr setting" can be set even when the checkbox in the "Motion Control Station" column of the station list is selected:</li> </ul> <p>"Synchronize" can be set for "Network Synchronous Communication" in this window even when the following module parameter of CC-Link IE TSN motion modules (only RD78GHV and RD78GHW) is set to "Ring":</p> <ul style="list-style-type: none"> <li>• "Basic Settings" ⇒ "Network Topology" ⇒ "Ring"</li> </ul>	
	FX5UCPU FX5UCCPU	When setting either of the following modules as the master station, "Authentication Class" can be set for a device station. <ul style="list-style-type: none"> <li>• CC-Link IE TSN module (FX5-CCLGN-MS)</li> <li>• CC-Link IE TSN compatible motion modules (FX5-40SSC-G(S), FX5-80SSCG(S))</li> </ul>	
	All CPUs	Parameters can be written to or read from multiple device stations in a batch by selecting the following menu: <ul style="list-style-type: none"> <li>• [CC IE Field Configuration] ⇒ [Online] ⇒ [The Parameter Processing of Multiple Device Stations]</li> </ul>	
Ladder editor ST editor FBD/LD editor Label editor	FX5UJCPU	<ul style="list-style-type: none"> <li>• "String [Unicode]" can be set as the data type of a device/label.</li> </ul>	
Label editor	All CPUs	<ul style="list-style-type: none"> <li>• When zooming this screen in and out, the column width is automatically adjusted according to the display magnification.</li> </ul>	
Ladder editor	All CPUs	<ul style="list-style-type: none"> <li>• The initial value set in the extension display area of a label editor in which an FB instance is registered is displayed preferentially as the initial value of label of 'VAR_PUBLIC' class or 'VAR_PUBLIC_RETAIN' class in the FB instance.</li> <li>• When editing a device/label comment directly, the comment can be fixed by clicking outside the editing range.</li> </ul>	
ST editor	All CPUs	<ul style="list-style-type: none"> <li>• The split can be restored by dragging the splitter bar to the bottom of an ST editor.</li> <li>• A row of the cursor position can be moved upward or downward by pressing the <b>Ctrl</b> + <b>Shift</b> + <b>↑</b> / <b>↓</b> keys.</li> <li>• A screen can be scrolled horizontally by scrolling the mouse wheel while pressing the <b>Shift</b> key.</li> <li>• Multiple rows can be selected and edited by pressing the <b>Shift</b> + <b>Alt</b> + <b>↑</b> / <b>↓</b> keys or dragging the mouse while pressing the <b>Alt</b> key.</li> <li>• A searched keyword can be highlighted with the incremental search function.</li> </ul>	Page 71 Available menus when editing an ST program Page 309 Configuration of an ST editor Page 312 Entering programs Page 316 Editing multiple rows simultaneously Page 317 Incremental search
FBD/LD editor	FX5CPU	<ul style="list-style-type: none"> <li>• An inline structured text element is available in an FBD/LD program.</li> </ul>	Page 328 Inserting an inline structured text element
FB property page	RnPCPU RnPSFCPU	This function is available for all the following tag FBs: <ul style="list-style-type: none"> <li>• Status tag</li> <li>• Alarm tag</li> <li>• Message tag</li> </ul>	Page 377 Displaying the FB property page

Item	Module type	Description	Reference
Simulation	RnCPU RnENCPU	The following function is available: • Scan time clear	IMELSEC iQ-R CPU Module User's Manual (Application)
	RnSF CPU	The following functions are available: • Program execution (SFC) • Scan time clear • SFC program (diagram) monitor • SFC-activated step monitor • Online change (SFC block) • Label memory read/write	IMELSEC iQ-R CPU Module User's Manual (Application)
		• SFC control instructions are available.	Page 952 Application instruction
		• "SFC Setting" in CPU parameters is available.	Page 956 CPU parameter
	RCPU FX5CPU	The following modules can be simulated together: • Simple motion module • Motion CPU • CC-Link IE TSN compatible motion module	Page 937 Modules supported by GX Simulator3 (System simulation)
	FX5UCPU FX5UCCPU	The following has been improved: • Processing time of the SP.FMOVE instruction (a file operation instruction) when 0 (File) is specified for the target type setting	IMELSEC iQ-F FX5 User's Manual (Application)
	FX5UJCPU	The following function is available: • User web page	
FX5SCPU	• A project for an FX5SCPU can be simulated.	Page 933 Modules supported by GX Simulator3	
Program configuration diagram	All CPUs	• The relation between program blocks, function blocks, and functions in a project can be displayed with a diagram by using this function.	Page 410 Checking/Editing the Relation between Programs
Library	RnPCPU RnPSFCPU	• A project including a user-defined tag FB can be exported as a library file.	—
Monitor <sup>*3</sup>	FX5UCPU FX5UJCPU	• The maximum and minimum values of scan time can be cleared from the monitor status bar during monitoring.	Page 614 Status monitoring
Watch	All CPUs	• Devices/labels used in a program can be registered in a batch from each editor.	Page 640 Registering devices/labels from program editor/label editor
		• The "Binary Watch" screen appears by selecting a row of a label in a watch window, then right-clicking and selecting [Add the Selected Label to Binary Watch Window] from the shortcut menu. The current value of the label can be displayed in a binary format in this screen.	Page 643 Monitoring in a binary format
CC-Link IE TSN diagnostics <sup>*3*4</sup>	All CPUs	The following modules can be diagnosed: • DC safety input/transistor safety output combined module (NZ2GNS12A2-16DTE and NZ2GNS12A2-14DT)	—
Firmware update <sup>*3</sup>	FX5UJCPU	• The firmware of modules can be updated using GX Works3.	Page 776 Firmware Update

Item	Module type	Description	Reference
Option	All CPUs	<p>The following options are added:</p> <ul style="list-style-type: none"> <li>• "Other Editor" ⇒ "Program Configuration Diagram" ⇒ "Auto-generation Target"</li> <li>• "Convert" ⇒ "Basic Setting" ⇒ "Operational Setting" ⇒ "Check the Generic Data Type of Label"</li> </ul> <p>The location of the following option is changed:</p> <ul style="list-style-type: none"> <li>• Before change (version 1.070Y to 1.082L): "Online" ⇒ "Write to PLC" ⇒ "Operational Setting" ⇒ "Intelligent Function Module takes priority to be selected for module extension parameter"</li> <li>• After change (version 1.085P): "Online" ⇒ "Common Item" ⇒ "Operational Setting" ⇒ "Intelligent Function Module takes priority to be selected for module extended parameter"</li> </ul> <p>By selecting "Yes" for this option, the module extended parameters for an intelligent function module are selected preferentially in the [Read] tab and [Verify] tab of the "Online Data Operation" screen.</p> <p>Selection items of the following option are changed:</p> <ul style="list-style-type: none"> <li>• "Program Editor" ⇒ "SFC Diagram Editor" ⇒ "Action/Transition" ⇒ "Display Format" ⇒ "Window Display Method"</li> </ul> <p>Before change (version 1.020W to 1.082L)</p> <ul style="list-style-type: none"> <li>• Open in One Window</li> <li>• Open a New Window</li> </ul> <p>After change (version 1.085P)</p> <ul style="list-style-type: none"> <li>• Open Single in Project</li> <li>• Open Single in Block</li> <li>• Open Single for Each Action/Transition</li> </ul>	—
	RCPU LHCPU FX5UCPU FX5UCCPU FX5UJCPU	<p>The following option name is changed.</p> <ul style="list-style-type: none"> <li>• Before change (version 1.080J to 1.082L): "Intelligent Function Module" ⇒ "Simple Motion" ⇒ "Operational Setting" ⇒ "Select Simple Motion Module Setting as write target"</li> <li>• After change (version 1.085P): "Intelligent Function Module" ⇒ "Simple Motion" ⇒ "Operational Setting" ⇒ "Select Simple Motion Module Setting as target"</li> </ul> <p>By selecting "Yes" for this option, the simple motion module setting is selected in the [Read] tab of the "Online Data Operation" screen.</p>	
Others <sup>*3</sup>	FX5UJCPU	<p>The following modules can be used in a project:</p> <ul style="list-style-type: none"> <li>• High speed pulse I/O modules (FX5-16ET/ES-H, FX5-16ET/ESS-H)</li> </ul>	



## ■Parameters

Category	Module type	Module	Parameter <sup>*3*4</sup>	Description
CPU parameter	RnCPU RnENCPU		"Memory/Device Setting" ⇔ "Device/Label Memory Area Setting" ⇔ "Device/Label Memory Area Detailed Setting" ⇔ "Device Setting" ⇔ "<Detailed Setting>"	"Write Protection Setting" is added.

Category	Module type	Module	Parameter <sup>*3*4</sup>	Description
Module parameter	FX5CPU		"Application Settings" ⇒ "Simple CPU Communication Setting" ⇒ "<Detailed Setting>"	The communication destinations can be filtered.
	FX5UCPU FX5UCCPU		"Application Settings" ⇒ "Simple CPU Communication Setting" ⇒ "<Detailed Setting>"	<ul style="list-style-type: none"> <li>"On Request" can be set for "Communication Setting."</li> <li>"MELSEC iQ-F(Ethernet module)" can be selected for "Communication Destination."</li> <li>"Options(Hexadecimal)" is added for "Communication Destination Setting."</li> </ul>
	FX5UJCPU		"Application Settings" ⇒ "Simple CPU Communication Setting" ⇒ "<Detailed Setting>"	<p>The following options can be selected for "Communication Destination":</p> <ul style="list-style-type: none"> <li>MELSEC iQ-R (built-in Ethernet)</li> <li>MELSEC-Q (built-in Ethernet)</li> <li>MELSEC-L (built-in Ethernet)</li> <li>MELSEC iQ-L (built-in Ethernet)</li> <li>MELSEC-FX3 (Ethernet Block/Adapter)</li> <li>OMRON (CJ/CP series)</li> <li>KEYENCE (KV series)</li> <li>Panasonic (FP7 series)</li> <li>MODBUS/TCP-compatible device</li> <li>SIEMENS S7 series</li> <li>Panasonic (FP0H series)</li> </ul>
			"Application Settings" ⇒ "FTP Client Settings"	Newly added
	RCPU	CC-Link IE TSN compatible motion modules (RD78G4, RD78G8, RD78G16, RD78G32, RD78G64, RD78GHV, RD78GHW, RD78G4(S), RD78G8(S), RD78G16(S))	"Application Settings" ⇒ "Communication Mode" ⇒ "Communication Mode"	Newly added
	RnCPU RnENCPU	Ethernet interface modules (_RJ71EN71(E+IEC), _RJ71EN71(E+IEF), RJ71EN71(E+CCIEC), RJ71EN71(E+CCIEF), RJ71EN71(E+E))	"Application Settings" ⇒ "Simple CPU Communication Setting" ⇒ "<Detailed Setting>"	<p>"SIEMENS S7 series(Extended)" can be selected for "Communication Destination."</p> <p>When setting any of the following devices for "Communication Destination," a bit device (F, TS, TC, STS, STC, CS, CC) and word device (TN, STN, CN) can be set:</p> <ul style="list-style-type: none"> <li>Own station</li> <li>MELSEC iQ-R (built-in Ethernet)</li> <li>MELSEC iQ-L (built-in Ethernet)</li> <li>MELSEC iQ-F (built-in Ethernet)</li> <li>MELSEC-Q (built-in Ethernet)</li> <li>MELSEC-L (built-in Ethernet)</li> <li>MELSEC iQ-R (Ethernet module)</li> <li>MELSEC-Q (Ethernet module)</li> <li>MELSEC-L (Ethernet module)</li> <li>SLMP supported device (QnA compatible 3E frame)</li> </ul> <p>When setting the following device for "Communication Destination," a bit device (F, TS, TC, CS, CC) and a word device (TN, CN) can be set:</p> <ul style="list-style-type: none"> <li>MELSEC-A/AnS (Ethernet Module)</li> </ul> <p>When setting the following device, a bit device (S, TS, CS) and a word device (TN, CN) can be set.</p> <ul style="list-style-type: none"> <li>MELSEC-FX3 (Ethernet Block/Adapter)</li> </ul>
	FX5CPU	Ethernet interface module (FX5-ENET/IP)	"Required Settings"	EtherNet/IP Configuration Tool can be started.
FX5UCPU FX5UCCPU	CC-Link IE TSN module (FX5-CCLGN-MS)	"Basic Settings" ⇒ "Connection Device Information" ⇒ "TSN HUB Setting"	Newly added	
		"Basic Settings" ⇒ "Communication Period Setting" ⇒ "Multiple Period Setting" ⇒ "Low-Speed"	"x32," "x64," and "x128" can be selected.	
		"Basic Settings" ⇒ "Communication Period Setting" ⇒ "Basic Period Setting" ⇒ "System Reservation Time"	"200.00us" can be selected.	



## Version 1.087R

All CPUs: RCPU, LHCPU, and FX5CPU

Item	Module type	Description	Reference
User authentication* <sup>3</sup>	RnSFCPU	<ul style="list-style-type: none"> <li>RnSFCPU in which vulnerability measures are enhanced can be set to communicate with only GX Works3 with enhanced vulnerability measures.</li> </ul>	Page 686 Preventing Illegal Access to CPU Module (User Authentication)
Others	All CPUs	<ul style="list-style-type: none"> <li>GX Developer and PX Developer cannot be installed together with GX Works3.</li> </ul>	☒ GX Works3 Installation Instructions

## Version 1.090U

All CPUs: RCPU, LHCPU, and FX5CPU

Item	Module type	Description	Reference
Operating environment (operating system)	All CPUs	<ul style="list-style-type: none"> <li>Windows 10 IoT Enterprise 2019 LTSC is supported.</li> </ul>	—
Print	FX5UJCPU	<p>The following contents of a CC-Link IE TSN module (FX5-CCLGN-MS) can be printed:</p> <ul style="list-style-type: none"> <li>Network Configuration Settings (CC-Link IE TSN configuration)</li> <li>Refresh Settings</li> <li>IP Filter Settings</li> </ul>	—
PROFIBUS Configuration Tool	RCPU	Parameters set in PROFIBUS Configuration Tool can be read. (To use this function, it is required that Version 1.06G or later of PROFIBUS Configuration Tool has been installed.)	☒ MELSEC iQ-R PROFIBUS-DP Module User's Manual (Application)
Guidance flow	FX5CPU	<ul style="list-style-type: none"> <li>An icon indicating that a flow of guidance is being displayed is added.</li> </ul>	Page 200 Guidance flow function
		<p>Guidance of the following functions is added:</p> <ul style="list-style-type: none"> <li>Latch function</li> <li>File transfer function</li> <li>Web server function</li> <li>Simple CPU communication function</li> </ul>	—
Verification	FX5UJCPU	<ul style="list-style-type: none"> <li>Module parameters of a CC-Link IE TSN module (FX5-CCLGN-MS) can be verified.</li> </ul>	—
AnyWireASLINK configuration window Sensor/device monitor	RCPU	<p>The following functions are available even if an ID (address) of a remote module connected to a CC-Link IE Field-AnyWireASLINK bridge module is duplicated:</p> <ul style="list-style-type: none"> <li>Automatic detection of connected devices</li> <li>Parameter processing of remote module</li> <li>Verification of connected devices and configurations</li> <li>Sensor/device monitor</li> </ul>	—
CC-Link IE TSN configuration window* <sup>4</sup>	LHCPU	<ul style="list-style-type: none"> <li>A CC-Link IE TSN system can be configured using this window.</li> </ul>	—
CC-Link IE TSN/CC-Link IE Field Network diagnostics	LHCPU	<ul style="list-style-type: none"> <li>CC-Link IE TSN compatible motion modules (LD78G4(S) and LD78G16(S)) can be diagnosed.</li> </ul>	—
	FX5UJCPU	<ul style="list-style-type: none"> <li>A CC-Link IE TSN module (FX5-CCLGN-MS) can be diagnosed.</li> </ul>	—
Changing a module	LHCPU	<ul style="list-style-type: none"> <li>MELSEC-L series simple motion modules (LD77MS2, LD77MS4, and LD77MS16) can be changed to MELSEC iQ-L series CC-Link IE TSN compatible motion modules (LD78G4(S) and LD78G16(S)).</li> </ul>	Page 222 Simple motion module/motion module (simple motion mode)
Ladder editor	All CPUs	<ul style="list-style-type: none"> <li>When the position of the mouse cursor is in a nested master control instruction, a device/label used in the master control instruction and its comment are displayed on the title bar.</li> </ul>	—
SFC diagram editor	All CPUs	<ul style="list-style-type: none"> <li>The display format of a transition (Zoom) without contacts can be changed.</li> </ul>	Page 348 Changing the display format (type) of a transition
FB property page	RnPCPU RnPSFCPU	<ul style="list-style-type: none"> <li>This function is available for user-defined tag FBs.</li> </ul>	Page 379 User-defined tag FB
Specifying a connection destination	LHCPU	<ul style="list-style-type: none"> <li>A CPU module can be accessed via CC-Link IE TSN compatible motion modules (LD78G4(S) and LD78G16(S)).</li> </ul>	—



Item	Module type	Description	Reference
Simulation	RCPU	A project including the following modules can be simulated: <ul style="list-style-type: none"> <li>• CC-Link IE TSN Plus master/local module (RJ71GN11-EIP(T+E))</li> <li>• MELSECWinCPU (R102WCPU-W)</li> </ul>	Page 933 Modules supported by GX Simulator3
		The following devices can be written to a CPU module during a simulation: <ul style="list-style-type: none"> <li>• Input (X)</li> <li>• Output (Y)</li> <li>• Safety input (SA\X)</li> <li>• Safety output (SA\Y)</li> </ul>	Page 586 Setting write target devices and their ranges Page 889 RCPUs
	RnCPU RnENCPU	The following functions are available: <ul style="list-style-type: none"> <li>• Write-protect for device data (from outside the CPU module)</li> <li>• Scan Time Measurement</li> </ul>	MELSEC iQ-R CPU Module User's Manual (Application)
		The following CPU parameter is available: <ul style="list-style-type: none"> <li>• Write Protection Setting</li> </ul>	Page 956 CPU parameter
	FX5UCPU FX5UCCPU FX5UJCPU	The following function is available: <ul style="list-style-type: none"> <li>• Scan time clear</li> </ul>	MELSEC iQ-F FX5 User's Manual (Application)
	FX5UCPU FX5UCCPU	<ul style="list-style-type: none"> <li>• A project can be simulated while "On Request" is set for "Communication Setting" of "Simple CPU Communication Setting."</li> </ul>	
FX5UJCPU	The following options can be selected in "Communication Destination" of "Simple CPU Communication Setting." <ul style="list-style-type: none"> <li>• MELSEC iQ-R (built-in Ethernet)</li> <li>• MELSEC iQ-L (built-in Ethernet)</li> </ul>		
		The following instructions are available: <ul style="list-style-type: none"> <li>• File operation instructions (SP.FREAD, SP.FWRITE, SP.FDELETE, SP.FCOPY, SP.FMOVE, SP.FRENAME, SP.FSTATUS)</li> <li>• String processing instructions (\$MOV(P)_WS, SJIS2WS(P), SJIS2WSB(P), WS2SJIS(P))</li> </ul>	Page 954 Application instruction
Intelligent function module monitor	RnCPU RnENCPU	<ul style="list-style-type: none"> <li>• Diagnostic information of EtherNet/IP for a CC-Link IE TSN Plus master/local module (RJ71GN11-EIP) can be monitored.</li> </ul>	—
Simple CPU communication diagnostics <sup>*3</sup>	RnPCPU	<ul style="list-style-type: none"> <li>• RnPCPUs can be monitored.</li> </ul>	
Recording <sup>*3*4</sup>	RnCPU RnENCPU	For RnCPUs and RnENCPUs, the co-recording function is available by combining with the following modules: <ul style="list-style-type: none"> <li>• Recorder module</li> <li>• Camera recorder module</li> <li>• CC-Link IE TSN compatible motion module</li> <li>• CC-Link IE TSN compatible motion module (simple motion mode)</li> <li>• Motion CPU</li> <li>• CC-Link IE TSN module</li> </ul>	MELSEC iQ-R System Recorder Co-recording Function Reference Manual
Offline monitor <sup>*3*4</sup>	RnCPU RnENCPU	Data collected by using the recording function can be monitored in the following screens: <ul style="list-style-type: none"> <li>• SFC diagram editor (including a Zoom)</li> <li>• SFC block list monitor</li> <li>• SFC all blocks batch monitor</li> </ul>	Page 740 Checking a recording file
Firmware update	FX5CPU	<ul style="list-style-type: none"> <li>• The check function before the update is enhanced.</li> </ul>	—
Option	All CPUs	The following options are added: <ul style="list-style-type: none"> <li>• "Program Editor" ⇒ "Common Item" ⇒ "Window" ⇒ "Message" ⇒ "Show a Message for Read-protected Data"</li> <li>• "Other Editor" ⇒ "Label Editor Common" ⇒ "Display Setting" ⇒ "Detailed Display Setting"</li> <li>• "Other Editor" ⇒ "Label Editor Common" ⇒ "Extended Display Setting" ⇒ "Extended Display Area"</li> <li>• "Other Editor" ⇒ "Label Editor Common" ⇒ "Extended Display Setting" ⇒ "System Label Setting Display Area"</li> </ul>	
	RnPCPU RnPSFCPU	The following option is added: <ul style="list-style-type: none"> <li>• "Project" ⇒ "Process Control Extension Setting" ⇒ "FB Property Page" ⇒ "Setting File Save Destination"</li> </ul>	
	FX5CPU	The following options are added: <ul style="list-style-type: none"> <li>• "Program Editor" ⇒ "Ladder Editor" ⇒ "Comment" ⇒ "Display Items" ⇒ "Device/Label Comment"</li> <li>• "Program Editor" ⇒ "Ladder Editor" ⇒ "Comment" ⇒ "Display Items" ⇒ "Statement"</li> <li>• "Program Editor" ⇒ "Ladder Editor" ⇒ "Comment" ⇒ "Display Items" ⇒ "Note"</li> </ul>	



## Parameters

Category	Module type	Module	Parameter <sup>*3*4</sup>	Description
CPU parameter	RnCPU RnENCPU		"Operation Related Setting" ⇨ "Co-recording Setting"	Newly added
	FX5UCPU FX5UCCPU		"PID Control Setting" is added.	Newly added
Module parameter	RnPCPU		"Application Settings" ⇨ "Simple CPU Communication Setting"	Newly added MELSEC iQ-R Ethernet User's Manual (Application)
	FX5JCPU		"Application Settings" ⇨ "Simple CPU Communication Setting" ⇨ "<Detailed Setting>"	<ul style="list-style-type: none"> <li>"On Request" can be set for "Communication Setting."</li> <li>"MELSEC iQ-F(Ethernet module)" can be selected for "Communication Destination."</li> <li>"Options(Hexadecimal)" is added for "Communication Destination Setting."</li> </ul>
	RCPU	CC-Link IE TSN module (RJ71GN11-T2)	"Application Settings" ⇨ "Co-recording Setting"	Newly added
	RnCPU RnENCPU	CC-Link IE TSN Plus master/local module (RJ71GN11-EIP(T+E))	Before change: "Basic Settings" ⇨ "External Device Configuration" After change: "Basic Settings" ⇨ "Ethernet Communication Setting"  Before change: "Basic Settings" ⇨ "Own Node Settings" ⇨ "Opening Method" After change: "Basic Settings" ⇨ "Ethernet Communication Setting" ⇨ "Opening Method"	The parameter name is changed.  The location of the parameter is changed.
Memory card parameter	FX5JCPU		"Setting of File/Data Use or Not in Memory Card" ⇨ "Device Station Parameter"	Newly added

## Version 1.095Z

All CPUs: RCP, LHCPU, and FX5CPU

Item	Module type	Description	Reference
Operating environment (operating system)	All CPUs	<ul style="list-style-type: none"> <li>Windows 7, Windows 8, Windows 8.1, and Windows 10 (version 1511 or earlier) are no longer supported.</li> </ul>	MELSEC iQ-R GX Works3 Installation Instructions
Printing <sup>*3</sup>	FX5CPU	The following data can be printed: <ul style="list-style-type: none"> <li>Attribute of a step: Operation hold step (SE or ST)</li> </ul>	—
	FX5JCPU FX5SCPU	The following data can be printed: <ul style="list-style-type: none"> <li>SFC program</li> <li>Content of "SFC Setting" in CPU parameters</li> </ul>	
Opening a GX Works2 format project <sup>*3*4</sup>	All CPUs	<ul style="list-style-type: none"> <li>A ladder program can be imported even if a label of 'VAR' class of an FB instance is included in the ladder program.</li> </ul>	—
	RnCPU RnENCPU RnSFCPU	<ul style="list-style-type: none"> <li>An MELSECNET/H network module (QJ71BR11) can be replaced with an MELSECNET/H network module (RJ71BR11).</li> </ul>	
	LHCPU	The parameters of the following modules can be imported: <ul style="list-style-type: none"> <li>Ethernet interface module (LJ71E71-100)</li> <li>CC-Link IE Field Network master/local module (LJ71GF11-T2)</li> </ul>	
	FX5JCPU FX5SCPU	<ul style="list-style-type: none"> <li>An SFC program can be imported.</li> </ul>	
Changing the module type/operation mode <sup>*3</sup>	FX5CPU	The following CPU parameter can be utilized when changing the module type from an FX5CPU to an RCP: <ul style="list-style-type: none"> <li>"SFC Setting" ⇨ "Output Mode Setting at Block Stop"</li> </ul>	—
	FX5CPU	The following data can be utilized when changing the module type from an FX5JCPU/FX5SCPU to an FX5UCPU/FX5UCCPU: <ul style="list-style-type: none"> <li>SFC program</li> <li>Number of step relay (S) points that is set in "Memory/Device Setting" of the CPU parameter</li> <li>Content of "SFC Setting" in CPU parameters</li> </ul>	
Module tool list	FX5UCPU FX5UCCPU FX5JCPU	<ul style="list-style-type: none"> <li>An information module (FX5-ENET) is supported. (Certificate Configuration Tool for FX5-ENET) (To use this function, it is required that Certificate Configuration Tool for FX5-ENET has been installed.)</li> </ul>	Page 218 Other Settings of Intelligent Function Modules MELSEC iQ-F FX5-ENET User's Manual

Item	Module type	Description	Reference
AnyWireASLINK configuration window <sup>*3</sup>	LHCPU	<ul style="list-style-type: none"> <li>In a project using a CC-Link IE Field Network master/local module (LJ71GF11-T2), an AnyWireASLINK system in which a CC-Link IE Field-AnyWireASLINK bridge module (NZ2AW1GFAL) is included can be configured using this window.</li> </ul>	—
CC-Link IE TSN configuration window <sup>*3</sup>	RCP RnENCPU RnSFCPU	<ul style="list-style-type: none"> <li>In a project using a CC-Link IE TSN module (RJ71GN11-SX), a CC-Link IE TSN system can be configured using this window.</li> </ul>	
		<p>When the following parameter of a CC-Link IE TSN module (RJ71GN11-SX) is set to "Extend," "Communication Period Setting (LB/LW)" of a master station can be selected.</p> <ul style="list-style-type: none"> <li>"Application Setting" ⇔ "LB/LW Points Extended Setting"</li> </ul>	
CC IE Field configuration window <sup>*3</sup>	RCP	<p>A character string edited in Excel can be pasted to the station list in this window by the following operation:</p> <ul style="list-style-type: none"> <li>Right-click and select [Paste from Clipboard (Module Information) to Station List] from the shortcut menu.</li> </ul> <p>The setting item in the station list in this window can be pasted to Excel by the following operation:</p> <ul style="list-style-type: none"> <li>Right-click and select [Copy to Clipboard of Station List (Header and Module Information)]</li> </ul>	
	LHCPU	<ul style="list-style-type: none"> <li>In a project using a CC-Link IE Field Network master/local module (LJ71GF11-T2), a CC-Link IE Field Network system can be configured using this window.</li> </ul>	
Ethernet configuration window <sup>*3</sup>	LHCPU	<ul style="list-style-type: none"> <li>In a project using an Ethernet interface module (LJ71E71-100), an Ethernet system can be configured using this window.</li> </ul>	
iQ Sensor Solution function <sup>*5</sup>	LHCPU	<p>This function is available in a project using the following modules:</p> <ul style="list-style-type: none"> <li>CC-Link IE Field Network master/local module (LJ71GF11-T2)</li> <li>CC-Link IE Field-AnyWireASLINK bridge module (NZ2AW1GFAL)</li> </ul>	
Creating a program Creating a library Program check Conversion Search/replacement Cross Reference	FX5UJCPU FX5SCPU	<ul style="list-style-type: none"> <li>Sequential Function Chart language is supported.</li> </ul>	<p>Page 258 Programming Function</p> <p>Page 342 Creating an SFC Program</p> <p>Page 894 FX5CPUs</p>
Ladder editor	All CPUs	<ul style="list-style-type: none"> <li>A label comment of an FB instance is displayed under the FB instance name.</li> </ul>	Page 273 Display of an FB instance
		<ul style="list-style-type: none"> <li>Listed instructions can be imported even if a label of 'VAR' class of an FB instance is included in a CSV file.</li> </ul>	Page 298 Importing from a CSV file
		<ul style="list-style-type: none"> <li>By setting an option, the height of an inline structured text box can be adjusted automatically.</li> </ul>	Page 282 Changing the number of rows to display
SFC program	RCP LHCPU	<ul style="list-style-type: none"> <li>A transition of TRUE or SM400 can be created automatically when the transition is created in MELSAP-L (instruction format).</li> </ul>	Page 370 Creating Zooms (MELSAP-L (instruction format))
	FX5CPU	<ul style="list-style-type: none"> <li>The ladder edit mode of a ladder editor (Zoom) can be switched to the monitor write mode.</li> </ul>	—
	FX5CPU	<ul style="list-style-type: none"> <li>An attribute of a step can be changed to an operation hold step (SE or ST).</li> </ul>	
Program configuration diagram	All CPUs	<ul style="list-style-type: none"> <li>A program configuration diagram can be edited.</li> </ul>	<p>Page 67 Available menus when displaying a program configuration diagram</p> <p>Page 414 Edit mode</p>
Device comment editor	All CPUs	<ul style="list-style-type: none"> <li>Linefeed comments can be displayed or hidden in a batch.</li> </ul>	Page 402 Configuration of a device comment editor
Device list	All CPUs	<ul style="list-style-type: none"> <li>A device comment can be edited directly.</li> </ul>	Page 465 Displaying Device Usage
Specifying a connection destination <sup>*3</sup>	RnCPU RnENCPU RnSFCPU	<p>When using CC-Link IE TSN modules (RJ71GN11-T2, RJ71GN11-EIP, RJ71GN11-SX), "Module" displayed in the "Specify Connection Destination" screen is changed as follow:</p> <ul style="list-style-type: none"> <li>Before change: RJ71GN11(-T2/-EIP)</li> <li>After change: RJ71GN11</li> </ul>	—
Writing data to a programmable controller <sup>*4</sup> Reading data from a programmable controller <sup>*4</sup>	RnCPU RnENCPU RnSFCPU	<ul style="list-style-type: none"> <li>Data of CC-Link IE TSN compatible motion modules (RD78G4, RD78G8, RD78G16, RD78G32, RD78G64, RD78GHV, RD78GHW) can be written to or read from the modules in the "Online Data Operation" screen.</li> </ul>	<p>Page 584 Data in a motion module</p> <p>Page 590 Data in a motion module</p>

Item	Module type	Description	Reference
Writing data to a programmable controller <sup>*3</sup> Reading data from a programmable controller <sup>*3</sup> Deleting data in a programmable controller <sup>*3</sup>	FX5UJCPU FX5SCPU	The following data can be written, read, and deleted: • SFC program • Content of "SFC Setting" in CPU parameters	—
Online program change <sup>*3</sup>	FX5CPU	The following data can be written to a CPU module using this function: • Single SFC block <sup>*3</sup> • SFC active block • SFC inactive block • Zoom	Page 601 Online program change of SFC programs
Monitor <sup>*3</sup>	FX5UCPU FX5UCCPU	The following monitor function is available: • SFC-activated step monitor	Page 630 Monitoring SFC steps which were activated
	FX5UJCPU FX5SCPU	The following monitor functions are available: • SFC diagram monitor • SFC auto-scroll • Zoom monitor • SFC block list monitor • SFC-activated step monitor • SFC all blocks batch monitor	
	FX5SCPU	• The maximum and minimum values of scan time can be cleared from the monitor status bar during monitoring.	Page 614 Status monitoring
Scan time measurement <sup>*3</sup>	RnSF CPU	• In a project for an RnSF CPU, a scan time can be measured for any sections in a standard program.	Page 653 Measuring the Scan Time of a Program
Sensor/device monitor <sup>*3</sup>	LH CPU	This function is available in a project using the following module: • CC-Link IE Field Network master/local module (LJ71GF11-T2)	—
Specified program monitor <sup>*3</sup>	RnSF CPU	• Devices/labels after executing a specified program can be monitored.	Page 613 When monitoring devices/labels in a specified program
Watch Intelligent function module monitor	All CPUs	• The [Start Watching] and [Stop Watching] buttons are added in a watch window and the "Intelligent Function Module Monitor" window.	Page 637 Checking Current Values by Registering Devices/Labels Page 658 Checking Current Values in an Intelligent Function Module
Watch <sup>*3</sup>	FX5UJCPU FX5SCPU	• The current value of a device/label used in an SFC program can be checked.	—
Offline monitor	All CPUs	• The value to move the index in "Previous Frame"/"Next Frame" can be set.	Page 744 Seek bar
Security key	All CPUs	• The secure mode can be set for a security key.	Page 675 Secure mode
Diagnostics <sup>*3</sup>	FX5UJCPU FX5SCPU	• The cursor can jump to the location in which an error has occurred in an SFC program.	—
Ethernet diagnostics	LH CPU	The following module can be diagnosed: • Ethernet interface module (LJ71E71-100)	—
CC-Link IE TSN diagnostics	All CPUs	The following modules can be diagnosed: • FPGA modules (NZ2GN2S-D41D01, NZ2GN2S-D41P01, NZ2GN2S-D41PD02) • Inverter (FR-A800-F/G)	Page 718 Displaying an error history
		The following shortcut menu name is changed: • Before change: [Error History] • After change: [Error/Event History]	
CC-Link IE Field Network diagnostics <sup>*3</sup>	RnCPU RnEN CPU	The following module can be diagnosed: • CC-Link IE TSN module (RJ71GN11-SX)	—
	All CPUs	The following modules can be diagnosed: • DC safety I/O modules (NZ2GFSS2-16DTE-S1, NZ2GFSS2-8D-S1, NZ2GFSS2-8TE-S1, NZ2GFSS2-32D-S1)	—
	LH CPU	The following module can be diagnosed: • CC-Link IE Field Network master/local module (LJ71GF11-T2)	—
MELSECNET diagnostics <sup>*3*4</sup>	RnCPU RnEN CPU RnSF CPU	The following module can be diagnosed: • MELSECNET/H network modules (RJ71BR11)	Page 720 MELSECNET diagnostics

Item	Module type	Description	Reference
Simple CPU communication diagnostics <sup>*3</sup>	RnSFCPU	<ul style="list-style-type: none"> <li>RnSFCPU can be diagnosed.</li> </ul>	—
Option	All CPUs	<p>The following options are added:</p> <ul style="list-style-type: none"> <li>"Program Editor" ⇒ "Ladder Editor" ⇒ "Ladder Diagram" ⇒ "Display Format" ⇒ "Display Setting of Label Name"</li> <li>"Program Editor" ⇒ "Ladder Editor" ⇒ "Inline Structured Text" ⇒ "Operational Setting" ⇒ Automatically Adjust Inline Structured Text Height"</li> <li>"Other Editor" ⇒ "Program Configuration Diagram" ⇒ "Update Configuration Diagram" ⇒ "Keep Element Arrangement"</li> <li>"Other Editor" ⇒ "Program Configuration Diagram" ⇒ "Message"</li> </ul>	
	RCPULHCPU	<p>The following option is added:</p> <ul style="list-style-type: none"> <li>"Program Editor" ⇒ "SFC Diagram Editor" ⇒ "Action/Transition" ⇒ "Operational Setting" ⇒ "Automatically Set Transition to TRUE/SM400"</li> </ul>	
	RnSFCPU	<p>The following option is added:</p> <ul style="list-style-type: none"> <li>"Monitor" ⇒ "Common Item" ⇒ "Timing to Execute Monitor Function and Modify Value Function" ⇒ "After the execution of specified program"</li> </ul>	
	FX5UJCPU FX5SCPU	<p>The following options are added:</p> <ul style="list-style-type: none"> <li>"Program Editor" ⇒ "SFC Diagram Editor"</li> <li>"Monitor" ⇒ "SFC Diagram Editor"</li> </ul>	
Others <sup>*3</sup>	RnSFCPU	<p>The following modules are available:</p> <ul style="list-style-type: none"> <li>MELSECNET/H network modules (RJ71LP21-25, RJ71LP21-25(R), RJ71BR11))</li> </ul>	
	All CPUs	<p>Terms are changed as follows:</p> <ul style="list-style-type: none"> <li>■Before change <ul style="list-style-type: none"> <li>Slave station, slave device, slave module</li> </ul> </li> <li>■After change <ul style="list-style-type: none"> <li>CC-Link, CC-Link IE Field, CC-Link IE TSN: Device station</li> <li>CC-Link IE Field Basic: Remote station</li> <li>AnyWireASLINK: Remote module</li> </ul> </li> </ul>	

## Parameters

Category	Module type	Module	Parameter <sup>*3*4</sup>	Description
CPU parameter	LHCPU		"Routing Setting"	Newly added
	FX5UCPU FX5UCCPU		"SFC Setting" ⇒ "Output Mode Setting Block Stop"	Newly added
	FX5UJCPU FX5SCPU		"SFC Setting"	Newly added
Module parameter	RnPCPU		"Application Settings" ⇒ "Web Server Settings"	Newly added
	RnSFCPU		"Simple CPU Communication Setting"	Newly added
	FX5SCPU		"Application Settings" ⇒ "Simple CPU Communication Setting"	<ul style="list-style-type: none"> <li>"On Request" can be set for "Communication Setting."</li> <li>"MELSEC iQ-F(Ethernet module)" can be selected for "Communication Destination."</li> <li>"Options(Hexadecimal)" is added for "Communication Destination Setting."</li> </ul>
	RnCPU RnENCPU RnSFCPU	CC-Link IE TSN module (RJ71GN11-SX)	"Basic Settings" ⇒ "Refresh Settings"	Link side devices can be set in a batch.
	RnSFCPU	CC-Link IE Field Network module (RJ71GF11-T2)	"Application Settings" ⇒ "Safety Communication Setting" ⇒ "Safety Protocol Version"	Newly added
	FX5UCPU FX5UCCPU FX5UJCPU	Information module (FX5-ENET)	"Application Settings" ⇒ "DNS Settings"	Newly added
			"Application Settings" ⇒ "Security" ⇒ "Certificate Configuration Tool Connection Setting"	Newly added
			"Application Settings" ⇒ "Mail Function Setting"	Newly added
"Application Settings" ⇒ "MQTT Communication Setting"			Newly added	

## Version 1.096A

All CPUs: RCPU, LHCPU, and FX5CPU

Item	Module type	Description	Reference
Project	All CPUs	A security version can be set in a project. By setting the security version to "2," the risk for the vulnerability can be reduced.	Page 697 Preventing Illegal Access to/Falsification of Data (Security Version)

## Version 1.100E

All CPUs: RCP, LHCPU, and FX5CPU

Item	Module type	Description	Reference
Print	All CPUs	<ul style="list-style-type: none"> <li>A data flow diagram can be printed.</li> </ul>	Page 96 Printing a data flow diagram
Opening a GX Works2 format project <sup>*3*4</sup>	RCP	<ul style="list-style-type: none"> <li>An AnyWireASLINK master module (QJ51AW12AL) can be replaced with an AnyWireASLINK master module (RJ51AW12AL).</li> </ul>	—
	RnCPU	<p>The following MELSECNET/H network modules (remote master station) can be replaced with a MELSECNET/H network module (RJ71GF11-T2):</p> <ul style="list-style-type: none"> <li>QJ71LP21-25</li> <li>QJ71LP21S-25</li> <li>QJ71LP21G</li> <li>QJ71BR11</li> </ul>	
Adding a new module	All CPUs	<ul style="list-style-type: none"> <li>A module can be searched for by entering a module type in the text box in the "Add New Module" screen.</li> </ul>	Page 206 Searching for a module
Ethernet configuration Sensor/device monitor	All CPUs	<p>An IP address, port number, subnet mask, and default gateway can be displayed in hexadecimal by selecting the following menu:</p> <ul style="list-style-type: none"> <li>[Edit] ⇒ [IP Address/Port No. Input Format] ⇒ [Hexadecimal]</li> </ul>	—
CC-Link IE TSN configuration window <sup>*3*4</sup>	All CPUs	<ul style="list-style-type: none"> <li>The display status of the station list (simple display/detailed display) can be retained even after closing this window.</li> </ul>	—
	All CPUs	<ul style="list-style-type: none"> <li>By using the following menu, the specified number of selected device stations can be copied, and can be pasted to the station list.</li> <li>Right-click and select [Module Continuous Arrangement] from the shortcut menu</li> </ul>	
	RnCPU RnENCPU RnSFCPU	<p>The CC-Link IE Field Configuration window can be displayed by selecting the following menu after selecting a CC-Link IE TSN-CC-Link IE Field Network bridge module (NZ2GN-GFB) of which "Master Station" is set for "Station-specific mode setting" in the module parameter:</p> <ul style="list-style-type: none"> <li>[CC-Link IE TSN Configuration] ⇒ [Open System Configuration] ⇒ [Open CC IE Field Configuration]</li> </ul>	
	RCP	<ul style="list-style-type: none"> <li>When displaying this window from the module parameter for a CC-Link IE TSN module (RJ71GN11-SX), the "CC-Link IE TSN Configuration Information" window can be displayed.</li> </ul>	
	RCP	<p>If the following parameter for a CC-Link IE TSN module (RJ71GN11-SX) is set to "Enable," "RX Setting," "RY Setting," "RWw Setting," and "RWr Setting" are blank when adding a device station in this window.</p> <ul style="list-style-type: none"> <li>"Application Settings" ⇒ "Master Station Shift Setting"</li> </ul>	
	RCP	<p>When the modules shown below are used, the following operations can be performed in the "IP Address Setting" screen: real machine information detection, setting an IP address, and starting/stopping the indicator display.</p> <ul style="list-style-type: none"> <li>CC-Link IE TSN module (RJ71GN11-T2)</li> <li>CC-Link IE TSN Plus master/local module (RJ71GN11-EIP(T+E))</li> <li>CC-Link IE TSN compatible motion module (RD78G4, RD78G8, RD78G16, RD78G32, RD78G64, RD78GHV, RD78GHW)</li> </ul>	
	LHCPU	<p>When using CC-Link IE TSN compatible motion modules (LD78G4(S) and LD78G16(S)), the following items can be displayed.</p> <ul style="list-style-type: none"> <li>Cyclic Transmission Time(Minimum value)</li> <li>Communication Period Interval(Minimum value)</li> </ul>	
CC IE Field configuration window <sup>*3</sup>	RnCPU RnENCPU RnSFCPU	<ul style="list-style-type: none"> <li>In a project using a CC-Link IE TSN-CC-Link IE Field Network bridge module (NZ2GN-GFB), a CC-Link IE Field Network system in which the network bridge module is included can be configured using this window.</li> </ul>	—
iQ Sensor Solution function <sup>*5</sup>	RnCPU RnENCPU RnSFCPU	<ul style="list-style-type: none"> <li>This function is available in a project using a CC-Link IE TSN-CC-Link IE Field Network bridge module (NZ2GN-GFB).</li> </ul>	Page 210 iQ Sensor Solution functions
Importing data	All CPUs	<p>The following data can be imported from an XML file output with Simulink PLC Coder:</p> <ul style="list-style-type: none"> <li>POUs (program block, function block, function)</li> <li>Global label</li> <li>Structure</li> </ul>	Page 132 Importing data

A





Item	Module type	Description	Reference
Global label editor	All CPUs	<ul style="list-style-type: none"> <li>A structure type global label can be duplicated including the setting of a device assigned to a global label.</li> </ul>	Page 76 Available menus when displaying a label editor Page 234 Duplicating a structure type global label
FB property management	RnPCPU RnSFPCPU	<ul style="list-style-type: none"> <li>The "FB Property Management (Online)" screen and the "FB Property Management (Offline)" screen can be displayed from an icon on the tool bar and the tag FB setting editor.</li> </ul>	Page 397 FB Property Management (Offline) screen Page 666 FB Property Management (Online) screen
Specifying a connection destination	RCPU	<ul style="list-style-type: none"> <li>Connection via a CC-Link IE TSN interface board is supported.</li> </ul>	Page 46 Connection through I/F boards
	LHCPU	<ul style="list-style-type: none"> <li>GX Works3 can access an LHCPU by using the GOT transparent function*4.</li> </ul>	Page 569 Accessing via GOT (GOT Transparent Function)
Registering/canceling forced input/output*3	FX5CPU	<ul style="list-style-type: none"> <li>Input/output devices can forcibly be turned ON/OFF.</li> </ul>	Page 644 Turning Input/Output Devices ON/OFF Forcibly
Verification	FX5CPU	<ul style="list-style-type: none"> <li>Module parameters of a high-speed counter module (FX5-2HC/ES) can be verified.</li> </ul>	—
CC-Link IE TSN diagnostics	RCPU	<ul style="list-style-type: none"> <li>In a project using a CC-Link IE TSN module (RJ71GN11-SX), the master station transition function is supported.</li> </ul>	Page 717 CC-Link IE TSN/CC-Link IE Field Network diagnostics
	All CPUs	The following modules can be diagnosed: <ul style="list-style-type: none"> <li>FCU8-EX569</li> </ul>	—
	All CPUs	<ul style="list-style-type: none"> <li>Contents displayed in the "Error/Event History" screen can be exported to a CSV file by clicking the [Save to CSV File] button in the "Error/Event History" screen.</li> </ul>	—
	RnCPU RnENCPU RnSFPCPU	The following modules can be diagnosed: <ul style="list-style-type: none"> <li>CC-Link IE TSN-CC-Link IE Field Network bridge module (N22GN-GFB)</li> </ul>	—
	RnCPU RnENCPU RnSFPCPU	The CC-Link IE Field Diagnostics screen can be displayed by the following operation after selecting a CC-Link IE TSN-CC-Link IE Field Network bridge module (N22GN-GFB). <ul style="list-style-type: none"> <li>Right-click data and select [CC-Link IE Field Diagnostics] from the shortcut menu.</li> </ul>	Page 718 Displaying the CC-Link IE Field Diagnostics screen
CC-Link IE Field Network diagnostics*3	RnCPU RnENCPU RnSFPCPU	The following modules can be diagnosed: <ul style="list-style-type: none"> <li>CC-Link IE TSN-CC-Link IE Field Network bridge module (N22GN-GFB)</li> </ul>	—
Offline monitor	All CPUs	<ul style="list-style-type: none"> <li>Search results displayed in the "Changed Point List" window can be sorted.</li> </ul>	Page 751 Search result sorting
Safety module operation*3*4	RnSFPCPU	<ul style="list-style-type: none"> <li>This function is available for a module used in a system using an RnSFPCPU.</li> </ul>	Page 768 Safety module operation
Option	All CPUs	The following option is added: <ul style="list-style-type: none"> <li>"Find/Replace" ⇒ "Cross Reference" ⇒ "Find Condition" ⇒ "Analyze and Find Constant in Find When Constant Label is Specified in Array Element"</li> </ul>	—
	RnCPU RnENCPU RnSFPCPU LHCPU	The following option is added: <ul style="list-style-type: none"> <li>"Parameter" ⇒ "User-defined Setting"</li> </ul>	—
Others	All CPUs	Terms are changed as follows: <ul style="list-style-type: none"> <li>■Before change               <ul style="list-style-type: none"> <li>Authentication Class</li> </ul> </li> <li>■After change               <ul style="list-style-type: none"> <li>CC-Link IE TSN Class</li> </ul> </li> </ul>	 Change of the Term Used in Software and Manuals Related to CC-Link IE TSN

## ■Parameters

Category	Module type	Module	Parameter*3*4	Description
CPU parameter	RnSFPCPU		"Memory/Device Setting" ⇒ "Device/Label Memory Area Setting" ⇒ "Device/Label Memory Area Detailed Setting" ⇒ "Device Setting" ⇒ "<Detailed Setting>"	"Write Protection Setting" is added.



Category	Module type	Module	Parameter <sup>*3*4</sup>	Description
Module parameter	RCPU	CC-Link IE TSN module (RJ71GN11-SX)	"Application Settings" ⇔ "Master Station Shift Setting"	Newly added
Module parameter (EtherNet/IP)	RCPU	CC-Link IE TSN Plus master/local module (RJ71GN11-EIP(T+E))	"Basic Settings" ⇔ "Refresh Settings"	The setting values of module extended parameters can be applied. To use this function, EtherNet/IP Configuration tool Version 1.04E or later is required to be installed. For details on EtherNet/IP Configuration tool, refer to the following:  MELSEC iQ-R CC-Link IE TSN Plus Master/Local Module User's Manual

- \*1 To use this function, it is required that MELSOFT Navigator supports the function. For information on the versions of supporting MELSOFT Navigator, refer to MELSOFT Navigator Help.
- \*2 To use this function, it is required that MELSOFT Navigator supports the function. For information on the versions of supporting MELSOFT Navigator, refer to following:  
 Let's start iQ Works Version 2
- \*3 To use this function, it is required that the firmware of a CPU module supports the function. For information on the firmware versions, refer to the following:  
 MELSEC iQ-R CPU Module User's Manual (Application)  
 MELSEC iQ-R Ethernet User's Manual (Application)  
 MELSEC iQ-F FX5 User's Manual (Application)
- \*4 To use this function, it is required that the firmware of a module supports the function. For information on the firmware versions, refer to the manual of the module.
- \*5 To use this function, it is required that the firmware of a module supports the function. For information on the firmware versions, refer to the following:  
 iQ Sensor Solution Reference Manual

# Modules

Supported version	Series	Module name	Model name	
Version 1.005F	MELSEC iQ-R	Ethernet interface module	RJ71EN71 (E+CCIEC), RJ71EN71 (CCIEC)	
Version 1.007H	MELSEC iQ-R	RCPU	R08PCPU, R16PCPU, R32PCPU, R120PCPU	
		Power supply module	R62P, R64P	
		C Controller	R12CCPU-V	
		Channel isolated RTD input module	R60RD8-G	
		Channel isolated thermocouple input module	R60TD8-G	
		Channel isolated analog input module	R60AD8-G, R60AD16-G	
		Channel isolated digital-analog converter modules	R60DA8-G, R60DA16-G	
	MELSEC iQ-F	FX5CPU	FX5UCPU, FX5UCCPU	
Version 1.010L	MELSEC-Q	MELSECNET/H network module	QJ71LP21 (-25 S-25 G GE), QJ71BR11, QJ71NT11B	
Version 1.015R	MELSEC iQ-R	RCPU	R04ENCPU, R08ENCPU, R16ENCPU, R32ENCPU, R120ENCPU R08SFCPU, R16SFCPU, R32SFCPU, R120SFCPU	
		Safety function module	R6SFM	
		CC-Link IE Field Network module	RJ71GF11-T2	
		MES interface module	RD81MES96	
		Temperature control module	R60TCTRT2TT2, R60TCTRT2TT2BW, R60TCRT4, R60RCRT4BW	
Version 1.019V	MELSEC iQ-F	FX5CPU	FX5UC-64MT/D, FX5UC-64MT/DSS, FX5UC-96MT/D, FX5UC-96MT/DSS	
		Input module	FX5-C16EX/D, FX5-C16EX/DS	
		Output module	FX5-C16EYT/D, FX5-C16EYT/DSS	
		Extension power supply module	FX5-C1PS-5V	
Version 1.020W	MELSEC iQ-R	Main base unit	R310B-HT	
		Extension base unit	R610B-HT	
		High speed data logger module	RD81DL96	
		Transistor high-speed output module	RY41NT2H, RY41PT2H	
		High-Speed analog input module	R60ADH4	
		Simple motion module	RD77GF4, RD77GF8, RD77GF16	
		Motion CPU	R64MTCPU	
C intelligent function module	RD55UP06-V			
Version 1.025B	MELSEC iQ-R	Redundant function module	R6RFM	
		Main base unit	R310RB, R38RB-HT	
		Extension base unit	R610RB, R68RB-HT	
		Power supply module	R64RP	
		CC-Link IE Controller Network module	RJ71GP21-SX (R)	
		CC-Link IE Field Network module	RJ71GF11-T2 (MR), RJ71GF11-T2 (SR), RJ71GF11-T2 (LR)	
		CC-Link IE Field Network remote head module	RJ72GF15-T2, RJ72GF15-T2 (SR), RJ72GF15-T2 (LR)	
		DC high-speed input module	RX41C6HS, RX61C6HS	
		Input module with diagnostic functions	RX40NC6B	
		Output module with diagnostic functions	RY40PT5B	
		AnyWireASLINK master module	RJ51AW12AL	
		NCCPU	R16NCCPU	
	Dual signal module	R173SXY		
		MELSEC iQ-F	FX5CPU	FX5U-32MR/DS, FX5U-32MT/DS, FX5U-32MT/DSS
			CC-Link IE Field Network module	FX5-CCLIEF
		I/O module	FX5-32ER/DS, FX5-32ET/DS, FX5-32ET/DSS	
		High speed pulse I/O module	FX5-16ET/ES-H, FX5-16ET/ESS-H	

Supported version	Series	Module name	Model name
Version 1.030G	MELSEC iQ-R	Power supply module	R63RP
		Triac output module	RY20S6
		Flexible high-speed I/O control module	RD40PD01
		Simple motion module	RD77GF32
	MELSEC iQ-F	FX5CPU	FX5U-64MR/DS, FX5U-64MT/DS, FX5U-64MT/DSS, FX5U-80MR/DS, FX5U-80MT/DS, FX5U-80MT/DSS
		I/O module	FX5-16ER/ES, FX5-16ET/ES, FX5-16ET/ESS
		RTD input adapter	FX5-4AD-PT-ADP
		Thermocouple input adapter	FX5-4AD-TC-ADP
		Simple motion module	FX5-80SSC-S
Version 1.032J	MELSEC iQ-R	AC input module	RX28
		Contact output module	RY18R2A
		High-speed analog output module	R60DAH4
		Extension cable	RC100B
Version 1.035M	MELSEC iQ-R	Robot CPU	R16RTCPU
		OPC UA server module	RD81OPC96
		BACnet interface module	RJ71BAC96
	MELSEC iQ-F	FX5CPU	FX5UC-32MT/DS-TS, FX5UC-32MT/DSS-TS
		Input module	FX5-C32EX/DS-TS
		Output module	FX5-C32EYT/D-TS, FX5-C32EYT/DSS-TS
		I/O module	FX5-C32ET/DS-TS, FX5-C32ET/DSS-TS
		Multiple input module	FX5-8AD
		Temperature control module	FX5-4LC
		Positioning module	FX5-20PG-P
		CC-Link system master/intelligent device module	FX5-CCL-MS
		AnyWireASLINK master module	FX5-ASL-M
Version 1.038Q	MELSEC iQ-R	CANopen module	RJ71CN91
Version 1.040S	MELSEC iQ-R	RCPU	R00CPU, R01CPU, R02CPU, R08PSFCPU, R16PSFCPU, R32PSFCPU, R120PSFCPU
		SIL2 function module	R6PSFM
		Input module with diagnostic functions	RX40NC6B (S2M), RX40NC6B (S2S)
		Output module with diagnostic functions	RY40PT5B (S2M), RY40PT5B (S2S)
	MELSEC-Q	MES interface module	QJ71MES96N
	MELSEC iQ-F	Analog input module	FX5-4AD
		Analog output module	FX5-4DA
	Version 1.045X	MELSEC iQ-R	PROFIBUS interface module
Input module			RX70C4, RX71C4, RX72C4, RX10-TS, RX40C7-TS, RX41C4-TS
Output module			RY40PT5B-AS, RY10R2-TS, RY40NT5P-TS, RY40PT5P-TS, RY41NT2P-TS, RY41PT1P-TS
CC-Link IE Controller Network module			RJ71GP21S-SX, RJ71GP21S-SX (R)
Channel isolated analog input module			R60AD8-G (S2M), R60AD8-G (S2S)
Channel isolated digital-analog converter modules			R60DA8-G (S2M)
MELSEC iQ-R MELSEC-Q		DeviceNet master/slave module	RJ71DN91, QJ71DN91



Supported version	Series	Module name	Model name	
Version 1.050C	MELSEC iQ-R	Main base unit	R33B	
		Channel isolated pulse input module	RD60P8-G, RD60P8-G (Q)	
		HART communication analog input module	R60ADI8-HA	
		Energy measuring module	RE81WH	
	MELSEC iQ-F	FX5CPU	FX5UC-32MR/DS-TS	
		Output module	FX5-C16EYR/D-TS	
		Positioning module	FX5-20PG-D	
		Ethernet interface module	FX5-ENET, FX5-ENET/IP	
		PROFIBUS interface module	FX5-DP-M	
Version 1.055H	MELSEC iQ-R	CC-Link IE TSN module	RJ71GN11-T2	
Version 1.056J	MELSEC iQ-R	CC-Link IE TSN compatible motion module	RD78G4, RD78G8, RD78G16, RD78G32, RD78G64	
Version 1.060N	MELSEC iQ-L	LHCPU	L04HCPU, L08HCPU, L16HCPU	
	MELSEC-L	CC-Link module	LJ61BT11	
		Input module	LX10, LX28, LX40C6, LX41C4, LX42C4	
		Output module	LY10R2, LY18R2A, LY20S6, LY28S1A, LY40NT5P, LY41NT1P, LY42NT1P, LY40PT5P, LY41PT1P, LY42PT1P	
		I/O module	LH42C4NT1P, LH42C4PT1P	
		Analog input module	L60AD4, L60ADVL8, L60ADIL8, L60AD4-2GH	
		Analog output module	L60DA4, L60DAVL8, L60DAIL8	
		Analog I/O module	L60AD2DA2	
		Temperature input module	L60RD8	
		Temperature control module	L60TCTT4, L60TCTT4BW, L60TCRT4, L60TCRT4BW	
		Multiple input module	L60MD4-G	
		High-speed counter module	LD62, LD62D	
		LD75 type positioning module	LD75P1, LD75P2, LD75P4, LD75D1, LD75D2, LD75D4	
		Flexible high-speed I/O control module	LD40PD01	
		Serial communication module	LJ71C24, LJ71C24-R2	
	Simple motion module	LD77MS2, LD77MS4, LD77MS16		
	MELSEC iQ-R	MES interface module	RD81MES96N	
		Laser displacement sensor control module	R60MH112, R60MH112NA	
		CC-Link IE TSN compatible motion module	RD78GHV, RD78GHW	
	MELSEC iQ-F	FX5CPU	FX5UJ-24MR/ES, FX5UJ-40MR/ES, FX5UJ-60MR/ES, FX5UJ-24MT/ES, FX5UJ-40MT/ES, FX5UJ-60MT/ES, FX5UJ-24MT/ESS, FX5UJ-40MT/ESS, FX5UJ-60MT/ESS	
		Safety extension module	FX5-SF-8DI4, FX5-SF-MU4T5	
	Version 1.063R	MELSEC iQ-R	MELSECNET/H network module	RJ71LP21-25, RJ71LP21-25(R)
	Version 1.065T	MELSEC iQ-R	Recorder module	RD81RC96
			Channel isolated analog-digital converter module	R60AD6-DG, R60AD6-DG(Q)
			EtherNet/IP module	RJ71EIP91
			C intelligent function module	RD55UP12-V
		MELSEC iQ-F	CC-Link IE TSN module	FX5-CCLGN-MS
Version 1.070Y	MELSEC iQ-R	Redundant extension base unit	R68WRB	
Version 1.072A	MELSEC iQ-R	Camera recorder module	RD81RC96-CA	
		GP-IB interface module	RJ71GB91(M), RJ71GB91(S)	
		Redundant extension base unit	R66WRB-HT	
	MELSEC iQ-F	CC-Link IE TSN compatible motion module (simple motion mode)	FX5-40SSC-G(S), FX5-80SSC-G(S)	
Version 1.075D	MELSEC iQ-R	High speed data communication module	RD81DC96	
		Temperature control module	R60TCRT2TT2-TS, R60TCRT4-TS	
		CC-Link IE TSN compatible motion module (simple motion mode)	RD78G4(S), RD78G8(S), RD78G16(S)	
	MELSEC iQ-F	Analog Input/output adaptor	FX5-4A-ADP	

Supported version	Series	Module name	Model name
Version 1.077F	MELSEC iQ-F	OPC UA module	FX5-OPC
Version 1.080J	MELSEC iQ-F	FX5CPU	FX5S-30MR/ES, FX5S-30MT/ES, FX5S-30MT/ESS, FX5S-40MR/ES, FX5S-40MT/ES, FX5S-40MT/ESS, FX5S-60MR/ES, FX5S-60MT/ES, FX5S-60MT/ESS, FX5S-80MR/ES, FX5S-80MT/ES, FX5S-80MT/ESS
Version 1.082L	MELSEC iQ-R	MELSECWinCPU	R102WCPU-W
		CC-Link IE TSN Plus master/local module	RJ71GN11-EIP(T+E)
	MELSEC-L	AnyWireASLINK master module	LJ51AW12AL
Version 1.090U	MELSEC iQ-L	LHCPU	L32HCPU
		CC-Link IE TSN compatible motion module (simple motion mode)	LD78G4(S), LD78G16(S)
Version 1.095Z	MELSEC iQ-R	MELSECNET/H network module	RJ71BR11
		CC-Link IE TSN module	RJ71GN11-SX
		Power supply module	R69P, R69RP
	MELSEC-L	CC-Link IE Field Network master/local module	LJ71GF11-T2
		Ethernet interface module	LJ71E71-100
	MELSEC iQ-F	FX5CPU	FX5UJ-24MR/DS, FX5UJ-24MT/DS, FX5UJ-24MT/DSS, FX5UJ-40MR/DS, FX5UJ-40MT/DS, FX5UJ-40MT/DSS, FX5UJ-60MR/DS, FX5UJ-60MT/DS, FX5UJ-60MT/DSS
Version 1.100E	MELSEC iQ-R	Input module with safety functions	RX40NC6S-TS
		Output module with safety functions	RY48PT20S-TS
	MELSEC iQ-F	High-speed counter module	FX5-2HC/ES

## Precautions

If a module profile is not registered in GX Works3, a project including the module cannot be opened, verified with another project, or read from a CPU module.

# Appendix 2 Using a Project in a Different Version

This section explains the considerations for using a project in a different version of GX Works3 from the one with which the project was created.

Note the following contents to use a project.

## Considerations common to all versions

### ■CPU module type

Function	Consideration
Opening a project Writing data to a programmable controller Reading data from a programmable controller Project verification Verifying data with a programmable controller	These functions cannot be used in GX Works3 which does not support the CPU module type in use.



### ■Parameters

Function	Consideration	Reference
Opening a project Reading data from a programmable controller	When a project which was created in a later version is opened in an earlier version or is read from a CPU module, the parameters which cannot be used in the earlier version will be deleted or return to the default.	—
Project verification	When a project for which parameter items added in the later version are set is verified with another project created in an earlier version, the parameters will not be verified.	
	When projects created in different versions are verified with each other, module parameters may not match.	Page 144 Unmatched module parameters
Verifying data with a programmable controller	When data is verified with that created in a different version, module parameters may not match.	Page 596 Unmatched module parameters

### ■Instructions

Function	Consideration
Reading data from a programmable controller Project verification Verifying data with a programmable controller	When an instruction, which is not supported in an earlier version, is used in a project in a later version, the project may not be verified or read from a CPU module in the earlier version.
Conversion	An error may occur when a program including an instruction supported by an earlier version is converted in a later version.

### ■Process control function blocks

Function	Consideration
Opening a project Reading data from a programmable controller	<p>A process control function block may be updated for addition/improvement in the function when the version of GX Works3 is upgraded.</p> <p>If a project is created in an earlier version of GX Works3, a function block in the project may also be created in the earlier version.</p> <p>When opening the project in a later version or reading it from a programmable controller, a message that recommends to update the version of process control function block may appear.</p> <p>In this case, check the considerations and update the version of process control function block. (  Page 249 Registering Tag FBs)</p> <p>Changing the process control program without update may cause an unintended operation.</p> <p>For additions and changes in a process control function block with a version upgrade, refer to 'Version Upgrade' in the following manual:</p> <p> MELSEC iQ-R Programming Manual (Process Control Function Blocks/Instructions)</p>
Opening a project Reading data from a programmable controller Project verification Verifying data with a programmable controller	When a function block, which is not supported in an earlier version, is used in a project in a later version, the project may not be opened, verified, or read from a CPU module in the earlier version.

## Using a project in a later version

### ■Using a project, which was created in version 1.010L, in version 1.015R or later

Function	Consideration
Library operation	<p>Even if libraries that contain global labels created in version 1.010L are registered in the library list in version 1.015R or later, the global labels are not displayed in the [Library] tab in the element selection window.</p> <p>A global label called by a utilized element will be changed to an undefined label without being utilized.</p>

### ■Using a project, which was created in version 1.011M or earlier, in version 1.015R or later

Function	Consideration
Option setting	<p>The following option will be set to "No" when a project, which was created in version 1.011M or earlier, is opened/read in version 1.015R or later.</p> <ul style="list-style-type: none"> <li>• [Tool] ⇒ [Options] ⇒ "Convert" ⇒ "Basic Setting" ⇒ "Operational Setting" ⇒ "Optimize the Number of Steps." (In version 1.015R to 1.050C)</li> <li>• [Tool] ⇒ [Options] ⇒ "Convert" ⇒ "Basic Setting" ⇒ "Operational Setting" ⇒ "Optimization of Number of Steps" ⇒ "Optimize the Number of Steps." (In version 1.052E or later)</li> </ul> <p>Therefore, the verification result is inconsistent due to the difference of the option setting.</p>
Verifying data with a programmable controller	<p>A verification result may mismatch when verifying a project, which was created in version 1.011M or earlier, against the global label setting in a CPU module. In this case, re-read/re-write the data from/to the CPU module, and then verify them again.</p>

### ■Using a project, which was created in version 1.027D or earlier, in version 1.030G or later

Function	Consideration
Option setting	<p>The following option will be set to "No" when a project, which was created in version 1.027D or earlier, is opened/read in version 1.030G or later.</p> <ul style="list-style-type: none"> <li>• [Tool] ⇒ [Options] ⇒ "Convert" ⇒ "Basic Setting" ⇒ "Operational Setting" ⇒ "Check the data type of instruction argument"</li> </ul>

### ■Using a project, which was created in version 1.027D or earlier, in version 1.050C or later

Function	Consideration
Option setting	<p>The following option will be set to "Do Not Check Only BMOV(P)/FMOV(P)" when a project, which was created in version 1.027D or earlier, is opened/read in version 1.050C or later.</p> <ul style="list-style-type: none"> <li>• [Tool] ⇒ [Options] ⇒ "Convert" ⇒ "Basic Setting" ⇒ "Operational Setting" ⇒ "Check the data type of instruction argument"</li> </ul>

### ■Using a project, which was created in version 1.033K or earlier, in version 1.035M or later

Function	Consideration
Option setting	<p>The following option will be set to "No" when a project, which was created in version 1.033K or earlier, is opened/read in version 1.035M or later.</p> <ul style="list-style-type: none"> <li>• [Tool] ⇒ [Options] ⇒ "Convert" ⇒ "Basic Setting" ⇒ "Operational Setting" ⇒ "Function Block" ⇒ "Enable to Use MC/MCR to Control EN"</li> </ul>
Option setting (FX5CPU)	<p>The following option will be set to "No" when a project, which was created in version 1.033K or earlier, is opened/read in version 1.035M or later.</p> <ul style="list-style-type: none"> <li>• [Tool] ⇒ [Options] ⇒ "Convert" ⇒ "Basic Setting" ⇒ "Operational Setting" ⇒ "Collectively Allocate Temporary Area to Optimize the Number of Steps" (version 1.035M to 1.050C)</li> <li>• [Tool] ⇒ [Options] ⇒ "Convert" ⇒ "Basic Setting" ⇒ "Operational Setting" ⇒ "Optimization of Number of Steps" ⇒ "Collectively Allocate Temporary Area to Optimize the Number of Steps" (version 1.052E or later)</li> </ul>

### ■Using a project, which was created in version 1.036N or earlier, in version 1.038Q or later

Function	Consideration
Option setting	<p>The following option will be set to "No" when a project, which was created in version 1.036N or earlier, is opened/read in version 1.038Q or later.</p> <ul style="list-style-type: none"> <li>• [Tool] ⇒ [Options] ⇒ "Convert" ⇒ "Basic Setting" ⇒ "Operational Setting" ⇒ "Function Block" ⇒ "Enable to Set Reserved Area"</li> </ul>

### ■Using a project, which was created in version 1.054G or earlier, in version 1.055H or later

Function	Consideration
Option setting	<p>The following option will be set to "No" when a project, which was created in version 1.054G or earlier, is opened/read in version 1.055H or later.</p> <ul style="list-style-type: none"> <li>• [Tool] ⇒ [Options] ⇒ "Convert" ⇒ "Basic Setting" ⇒ "Operational Setting" ⇒ "Structured Data Type" ⇒ "Enable to Set Reserved Area"</li> </ul>
Shortcut key	<p>A shortcut key assigned to the following menu will be assigned to [Online] ⇒ [FB Property Management (Online)] when the shortcut key settings, which was exported in version 1.054G or earlier, is imported in version 1.055H or later.</p> <ul style="list-style-type: none"> <li>• [Online] ⇒ [FB Property] ⇒ [FB Property Management]</li> </ul> <p>A shortcut key assigned to the following menu is discarded.</p> <ul style="list-style-type: none"> <li>• [Online] ⇒ [FB Property] ⇒ [Update the Initial Value of FB Property]</li> </ul>

## ■Using a project, which was created in version 1.072A or earlier, in version 1.075D or later

Function	Consideration
Opening a project	An error may occur when changing the module type/operation mode or when checking parameters if a project satisfying all the following conditions, which was created in version 1.072A or earlier, is opened in version 1.075D or later. <ul style="list-style-type: none"> <li>• A serial communication module (LJ71C24 or LJ71C24-R2) is placed.</li> <li>• "Interrupt Settings" in the module parameters for a serial communication module (LJ71C24 or LJ71C24-R2) are configured.</li> </ul> In this case, delete the serial communication module (LJ71C24 or LJ71C24-R2) after opening the project, then add the same module again. In addition, set the module parameters to be the same as the ones before deletion of the module.
Project verification Verifying data with a programmable controller	"Interrupt Settings" in the module parameters may not match when a project satisfying all the following conditions, which was created in version 1.072A or earlier, is verified with a project created in version 1.075D or later. <ul style="list-style-type: none"> <li>• A serial communication module (LJ71C24 or LJ71C24-R2) is placed.</li> <li>• "Interrupt Settings" in the module parameters for a serial communication module (LJ71C24 or LJ71C24-R2) are configured.</li> </ul> In this case, delete the serial communication module (LJ71C24 or LJ71C24-R2) after opening the project, then add the same module again. In addition, set the module parameters to be the same as the ones before deletion of the module. Then, verify the projects again.

## ■Using a project, which was created in version 1.082L or earlier, in version 1.085P or later

Function	Consideration
Writing data to a programmable controller	An error occurs when editing or checking parameters if a project satisfying all the following conditions, which was created in version 1.082L or earlier, is opened in version 1.085P or later. <ul style="list-style-type: none"> <li>• A CC-Link IE TSN compatible motion module is placed.</li> <li>• A value less than 14 us is set for "Transient Transmission Time" in the module parameters for a CC-Link IE TSN compatible motion module.</li> </ul>

## ■Using a project, which was created in version 1.090U or earlier, in version 1.095Z or later

Function	Consideration
Opening a project Reading data from a programmable controller	The following parameter will be set to "1" when a project for an RnSFCPU, which was created in version 1.090U or earlier, is opened or read from a CPU module in version 1.095Z or later: <ul style="list-style-type: none"> <li>• In "Safety Communication Setting" for a CC-Link IE Field Network module (RJ71GF11-T2), "Safety Protocol Version" of a row that has been set in version 1.090U or earlier.</li> </ul>
	An error occurs when any of the following projects, which were created in version 1.090U or earlier, is opened and the [Check] button or [Apply] button is clicked in the "Module Parameter" screen. <ul style="list-style-type: none"> <li>• A project in which "Maximum No. of Transient Transmissions" of the module parameter for a MELSECNET/H network module (QJLP21(-25 S-25 G GE), QJBR11, QJ71NT11B, RJ71LP21-25, or RJ71LP21-25(R)) is blank.</li> <li>• A project in which "Maximum No. of Transients in One Station" of the module parameter for a MELSECNET/H network modules (QJLP21(-25 S-25 G GE), QJBR11, QJ71NT11B, RJ71LP21-25, or RJ71LP21-25(R)) is not blank.</li> <li>• A project in which a value that exceeds "Maximum No. of Transient Transmissions" is set for "Maximum No. of Transients in One Station" of the module parameter for a MELSECNET/H network modules (QJLP21(-25 S-25 G GE), QJBR11, QJ71NT11B, RJ71LP21-25, or RJ71LP21-25(R)).</li> </ul>

## Using a project in an earlier version

### ■Using a project, which was created in version 1.005F or later, in version 1.002C or earlier

Function	Consideration
Reading data from a programmable controller	A project, which was created in version 1.005F or later, cannot be read in version 1.002C or earlier.

### ■Using a project, which was created in version 1.007H or later, in version 1.006G or earlier

Function	Consideration
Opening a project Reading data from a programmable controller	A project that contains an FBD/LD program cannot be opened/read in version 1.006G or earlier.

### ■Using a project, which was created in version 1.010L or later, in version 1.008J or earlier

Function	Consideration
Library operation	An edit-protected FBD/LD element is editable by opening it in version 1.008J. (Worksheet only)
	An element is not editable when an edit-protected ST program is opened and copied in version 1.008J or earlier. To make the element editable, open the project that contains the copied data in version 1.010L or later, and copy it again.
	When an edit-protected element is opened and copied in version 1.008J or earlier, then it is reopened in version 1.010L or later, the icon of the copied data (element) may indicate that the element is still edit-protected.



## ■Using a project, which was created in version 1.015R or later, in version 1.010L or earlier

Function	Consideration
Library operation	A read-protected element, which was utilized from a library, is identified as an element with a block password when it is opened in version 1.010L or earlier. Therefore, the element cannot be detected and the name cannot be changed.

## ■Using a project, which was created in version 1.015R or later, in version 1.011M or earlier

Function	Consideration
Opening a project Reading data from a programmable controller	A project that contains an SFC program cannot be opened/read in version 1.011M or earlier.
Option setting	A project that "Yes" has been selected for the following option cannot be opened/read in version 1.011M or earlier. In addition, a project that "Yes" has been selected for the following option cannot be verified with one created in version 1.011M or earlier. <ul style="list-style-type: none"> <li>• [Tool] ⇒ [Options] ⇒ "Convert" ⇒ "Basic Setting" ⇒ "Operational Setting" ⇒ "Optimize the Number of Steps." (In version 1.015R to 1.050C)</li> <li>• [Tool] ⇒ [Options] ⇒ "Convert" ⇒ "Basic Setting" ⇒ "Operational Setting" ⇒ "Optimization of Number of Steps" ⇒ "Optimize the Number of Steps." (In version 1.052E or later)</li> </ul>
Program file setting	When a project that the execution order has been set is opened and converted in version 1.011M or earlier, the order is changed to the program block name order.
Library operation	Even if libraries that contain global labels are registered in the library list in version 1.010L, the global labels are not displayed in the [Library] tab in the element selection window. In addition, global labels called by utilized elements will be changed to undefined labels without being utilized.  Libraries that contain a read-protected element can be registered in the library list in version 1.011M or earlier, but they cannot be used.

## ■Using a project, which was created in version 1.020W or later, in version 1.019V or earlier

Function	Consideration
Opening a project Reading data from a programmable controller	When a project, for which multiple connection destinations have been set, is opened in version 1.019V or earlier, the destinations except for one which was set first are deleted.
	A project, in which an extended temperature range base unit (R310B-HT, R610B-HT) has been placed, cannot be opened/read in version 1.019V or earlier.
	A project that contains an SFC program including multiple steps cannot be opened/read in version 1.019V or earlier.
	A project that contains an SFC program including a jump may not be opened/read in version 1.019V or earlier.
Project verification Verifying data with a programmable controller	CPU parameters of a project for an RnCPU or an RnENCPU cannot be verified with data in another project in version 1.019V or earlier.
	CPU parameters of a project, for which the daylight saving time setting is enabled, cannot be verified against data in a programmable controller in version 1.019V or earlier.
	A project, in which an extended temperature range base unit (R310B-HT, R610B-HT) has been placed, cannot be verified in version 1.019V or earlier.
	A project that contains an SFC program including multiple steps cannot be verified in version 1.019V or earlier.
	A project that contains an SFC program including a jump may not be verified in version 1.019V or earlier.
Library operation	A project that contains an SFC program including multiple steps cannot be read in version 1.019V or earlier.
	A project that contains an SFC program including a jump may not be read in version 1.019V or earlier.
	Libraries that contain an element, for which the edit password has individually been set, can be registered in the library list in version 1.019V or earlier, but they cannot be used.
	A help file, for which "Import" has been selected at exporting, retains as the unused data in a project or a library when it is opened by version 1.019V or earlier. When it is reopened in version 1.020W or later after being saved in version 1.019V or earlier, the help file of the unused data is deleted.
Reading from an SD memory card	A project that contains an SFC program including multiple steps cannot be read in version 1.019V or earlier.
	A project that contains an SFC program including a jump may not be read in version 1.019V or earlier.
Editing an SFC program	An SFC program, which was created in GX Works3 version 1.020W or later, may run unstably if it is used in version 1.019V or earlier. When editing an SFC program, use version 1.020W or later.

## ■Using a project, which was created in version 1.025B or later, in version 1.022Y or earlier

Function	Consideration
Opening a project Reading data from a programmable controller	When a project, which was created in version 1.025B or later and set an RnPCPU (redundant mode) as the CPU module type, is opened in version 1.022Y or earlier, the CPU module type is changed to an RnPCPU (process mode).
	A project used for a remote head module cannot be opened/read in version 1.022Y or earlier.
	A project, in which some worksheets are created in a POU, cannot be opened in version 1.025B or earlier.
	A project, in which an AnyWireASLINK master module (RJ51AW12AL) has been placed, cannot be opened/read in version 1.022Y or earlier.
Project verification Verifying data with a programmable controller	A project used for an RnPCPU (redundant mode) cannot be verified in version 1.022Y or earlier.
	A project used for a remote head module cannot be verified in version 1.022Y or earlier.
	Parameters of a project, in which a redundant power supply base unit (R310RB, R38RB-HT, R610RB, R68RB-HT) has been placed and for which a power supply 2 has been set, cannot be verified in version 1.022Y or earlier.
	A project, in which an AnyWireASLINK master module (RJ51AW12AL) has been placed, cannot be verified in version 1.022Y or earlier.
Connection destination specification	Connection destination settings return to the default when the "Specify Connection Destination" screen is opened if the settings meet any of the following conditions: <ul style="list-style-type: none"> <li>• "GOT" is selected for "PLC side I/F" and "CC IE Cont" is set in the "PLC side I/F Detailed Setting of GOT" screen.</li> <li>• "CC IE Control NET/10(H) Board" is set for "PC side I/F."</li> <li>• "CC-Link Board" is set for "PC side I/F."</li> <li>• "CC IE Field board" is set for "PC side I/F."</li> </ul>
Library operation	Libraries that contain a module label/ structure cannot be used in version 1.022Y or earlier.

## ■Using a project, which was created in version 1.030G or later, in version 1.027D or earlier

Function	Consideration
Opening a project Reading data from a programmable controller	A project, in which a flexible high-speed I/O control module (RD40PD01) or triac output module (RY20S6) has been placed, cannot be opened/read in version 1.027D or earlier to which profiles have not been registered.
	A project, for which an AnyWireASLINK configuration has been set, cannot be opened/read in version 1.027D or earlier.
	When a data type other than Word [Unsigned]/Bit String [16-bit]/Word [Signed] is used for an argument of BMOV(P) instruction, an error occurs at the conversion in version 1.027D or earlier.
	An SFC program in MELSAP-L (instruction format) is displayed in the detailed expression of a ladder when it is opened in version 1.027D or earlier.
	A project, in which a redundant power supply module (R63RP) has been placed, cannot be opened in version 1.026C or earlier.
	When a project, in which a redundant power supply module (R63RP) has been placed, is opened in version 1.026C or earlier, the name of the power supply module is blank.
	When writing a project, in which safety global labels or safety/standard shared global labels are created in version 1.030G or later, to a programmable controller, the project cannot be read in version 1.027D or earlier.
Project verification Verifying data with a programmable controller	A project, in which a flexible high-speed I/O control module (RD40PD01) or triac output module (RY20S6) has been placed, cannot be verified in version 1.027D or earlier in which a profile to which profiles have not been registered.
	A project, for which an AnyWireASLINK configuration has been set, cannot be verified in version 1.027D or earlier.
	A project, in which a redundant power supply module (R63RP) has been placed, cannot be verified in version 1.027D or earlier.
	A project that parameters for CC-Link IE Field Network Basic have been set cannot be verified in version 1.027D or earlier.
Connection destination specification	Connection destination settings return to the default if the settings meet either of the following conditions: <ul style="list-style-type: none"> <li>• "GOT" is selected for "PLC side I/F" and "CC IE Field" is set in the "PLC side I/F Detailed Setting of GOT" screen.</li> <li>• For a project which is used for an RnPCPU (redundant mode) and a remote head module, "GOT" is selected for "PLC side I/F" and "CC IE Cont" is set in the "PLC side I/F Detailed Setting of GOT" screen.</li> </ul>
Register/cancel forced input/output	The current value of devices in a CPU module, in which forced input/output has been registered in version 1.030G or later, cannot be changed in version 1.027D or earlier.

## ■Using a project, which was created in version 1.032J or later, in version 1.019V or earlier

Function	Consideration
Reading data from a programmable controller Verifying data with a programmable controller	A project, in which a following module has been placed, cannot be read/verified in version 1.019V or earlier. <ul style="list-style-type: none"> <li>• Analog output module (R60DA4, R60DA4(Q), R60DAI8, R60DAI8(Q), R60DAV8, R60DAV8(Q))</li> <li>• Channel isolated digital-analog converter module (R60DA8-G, R60DA8-G(Q), R60DA16-G)</li> <li>• High-Speed analog input module (Q64ADH)</li> </ul>

## ■Using a project, which was created in version 1.032J or later, in version 1.031H or earlier

Function	Consideration
Opening a project Reading data from a programmable controller	A project containing any of the following data cannot be used in version 1.031H or earlier. <ul style="list-style-type: none"> <li>• Program file in which "Yes" is selected for "Use the process control extension"</li> <li>• Function block in which "Yes" is selected for "Use as Tag FB"</li> <li>• Process control function block</li> <li>• Data registered in a tag FB setting</li> </ul>
	A project, in which an extension cable (RC100B) has been placed, cannot be opened/read in version 1.031H or earlier.
	A project, in which an analog output module (R60DAH4), an input module (RX28), and an output module (RY18R2A) have been placed, cannot be opened/read in version 1.031H or earlier to which profiles have not been registered.
Project verification Verifying data with a programmable controller	A project, in which an extension cable (RC100B) has been placed, cannot be verified in version 1.031H or earlier.
	A project, in which an analog output module (R60DAH4), an input module (RX28), and an output module (RY18R2A) has been placed, cannot be verified in version 1.031H or earlier to which profiles have not been registered.

## ■Using a project, which was created in version 1.035M or later, in version 1.019V or earlier

Function	Consideration
Reading data from a programmable controller	Module parameters of a project, in which a flexible high-speed I/O control module (RD40PD01) has been placed, cannot be read in version 1.019V or earlier.
Project verification Verifying data with a programmable controller	Module parameters of a project, in which a flexible high-speed I/O control module (RD40PD01) has been placed, cannot be verified in version 1.019V or earlier.

## ■Using a project, which was created in version 1.035M or later, in version 1.033K or earlier

Function	Consideration
Opening a project Reading data from a programmable controller	<p>A project, in which an OPC UA server module (RD81OPC96), BACnet module (RJ71BAC96), and a robot controller CPU (R16RTCPU) have been placed, cannot be opened/read in version 1.033K or earlier to which profiles have not been registered.</p> <p>When a project that saves the parameters of a device station is opened in version 1.033K or earlier, the parameters seem to be deleted even though the parameters are not deleted. By reopening the project in version 1.035M or later, the parameters of the device station can be used.</p> <p>Even if a project including unused function blocks and/or functions is read in version 1.033K or earlier, the function blocks and functions are not read.</p>
Option setting	<p>A project that "Yes" has been selected for the following option cannot be opened/read in version 1.033K or earlier.</p> <ul style="list-style-type: none"> <li>• [Tool] ⇒ [Options] ⇒ "Convert" ⇒ "Basic Setting" ⇒ "Operational Setting" ⇒ "Function Block" ⇒ "Enable to Use MC/MCR to Control EN"</li> </ul>
Project verification Verifying data with a programmable controller	<p>A project, in which an OPC UA server module (RD81OPC96), BACnet module (RJ71BAC96), and a robot controller CPU (R16RTCPU) have been placed, cannot be verified in version 1.033K or earlier to which profiles have not been registered.</p>
Configuration setting	<p>When a project that saves the parameters of a device station is opened in version 1.033K or earlier and the following operations are performed in the screen of CC-Link IE Field configuration setting, the saved parameter information will not be updated/deleted.</p> <ul style="list-style-type: none"> <li>• Editing the CC IE Field configuration</li> <li>• Parameter processing of a device station</li> <li>• Deleting the parameter information of a device station</li> </ul> <p>When the screen of the CC IE Field configuration setting is opened in version 1.035M or later after changing the station number of a device station in version 1.033K or earlier, the parameter information of the device station to which the station number was changed will be skipped and not read. By clicking the [Close with Reflecting the Setting] button in the state where the parameter information was skipped and not read, the information will be deleted.</p>
Conversion	<p>When a different data type is specified for the argument of an instruction by selecting "No" in the following option, an error occurs at the conversion in version 1.033K or earlier.</p> <ul style="list-style-type: none"> <li>• [Tool] ⇒ [Options] ⇒ "Convert" ⇒ "Basic Setting" ⇒ "Operational Setting" ⇒ "Check the data type of instruction argument"</li> </ul>

## ■Using a project, which was created in version 1.038Q or later, in version 1.036N or earlier

Function	Consideration
Opening a project Reading data from a programmable controller	<p>A project that "Yes" has been set for the following option cannot be opened/read from a CPU module in version 1.036N or earlier.</p> <ul style="list-style-type: none"> <li>• [Tool] ⇒ [Options] ⇒ "Convert" ⇒ "Basic Setting" ⇒ "Operational Setting" ⇒ "Function Block" ⇒ "Enable to Set Reserved Area"</li> </ul> <p>A project including an element with the security key registered cannot be opened in version 1.036N or earlier. By deleting the security key registered to the element, the project can be opened in version 1.036N or earlier.</p> <p>A project, in which a CANopen module (RJ71CN91) has been placed, cannot be opened/read in version 1.036N or earlier to which profiles have not been registered.</p>
Project verification Verifying data with a programmable controller	<p>A project, in which a CANopen module (RJ71CN91) has been placed, cannot be verified in version 1.036N or earlier to which profiles have not been registered.</p>
Library operation	<p>Libraries of a project that "Yes" has been selected for the following option can be registered in the library list in version 1.036N or earlier, but they cannot be used.</p> <ul style="list-style-type: none"> <li>• [Tool] ⇒ [Options] ⇒ "Convert" ⇒ "Basic Setting" ⇒ "Operational Setting" ⇒ "Function Block" ⇒ "Enable to Set Reserved Area"</li> </ul>

## ■Using a project, which was created in version 1.040S or later, in version 1.019V or earlier

Function	Consideration
Reading data from a programmable controller	<p>Module parameters of a project, in which a high-speed analog input module (R60ADH4) has been placed, cannot be read in version 1.019V or earlier.</p>
Project verification Verifying data with a programmable controller	<p>Module parameters of a project, in which a high-speed analog input module (R60ADH4) has been placed, cannot be verified in version 1.019V or earlier.</p>

## ■Using a project, which was created in version 1.040S or later, in version 1.038Q or earlier

Function	Consideration
Opening a project Reading data from a programmable controller	The setting of extended file registers (ER) in a project for an FX5CPU will be cleared when the project is opened in version 1.038Q or earlier. A message appears when opening the Device Memory editor. The Device Memory editor will not open by clicking the [OK] button on the message. Therefore, retry opening the device memory editor.
	A project, in which a SIL2 function module (R6PSFM) has been placed, cannot be opened/read in version 1.038Q or earlier.
	A project, in which an MES interface module (QJ71MES96N), an input module with diagnostic functions (RX40NC6B(S2M), RX40NC6B(S2S)), and an output module with diagnostic functions (RY40PT5B(S2M), RY40PT5B(S2S)) has been placed, cannot be opened/read in version 1.038Q or earlier to which profiles have not been registered.
	When printing FBD/LD programs, the paper size and the paper feed direction depend on the page setting.
	When a project for which the following items have been changed in the FBD/LD or SFC editor in opened in version 1.038Q or earlier, the changes will not be applied. <ul style="list-style-type: none"> <li>• Background color of an editor</li> <li>• Background color of a comment element</li> <li>• Font color of a comment element</li> </ul> Note that the font colors set for each comment element will remain in version 1.038Q or earlier.
Project verification Verifying data with a programmable controller	A project for an RnPCPU cannot be verified with another project in version 1.038Q or earlier.
	Module parameters of an RnPCPU to which a project that the FTP client has been set is written cannot be verified in version 1.038Q or earlier.
	A project, in which a SIL2 function module (R6PSFM) has been placed, cannot be verified in version 1.038Q or earlier.
Connection destination specification	A project, in which an MES interface module (QJ71MES96N), an input module with diagnostic functions (RX40NC6B(S2M), RX40NC6B(S2S)), and an output module with diagnostic functions (RY40PT5B(S2M), RY40PT5B(S2S)) has been placed, cannot be verified in version 1.038Q or earlier to which profiles have not been registered.
	Connection destination settings return to the default when the "Specify Connection Destination" screen is opened if the settings meet the following condition: <ul style="list-style-type: none"> <li>• "Ethernet board" is set for "PC side I/F," and "via GOT (Ethernet) transparent mode" is set in the "PLC side I/F Detailed Setting of GOT" screen.</li> </ul>

## ■Using a project, which was created in version 1.045X or later, in version 1.044W or earlier

Function	Consideration
Opening a project Reading data from a programmable controller	The following projects that are created in version 1.045X or later cannot be opened and read from a CPU module in version 1.044W or earlier. <ul style="list-style-type: none"> <li>• A project using a read-protected POU whose password authentication is disabled.</li> <li>• A project to which a user with the access level of "Assistant Developers" is registered.</li> </ul>
	The following projects that are created in version 1.045X or later cannot be verified with another project in version 1.044W or earlier. <ul style="list-style-type: none"> <li>• A project using a read-protected POU whose password authentication is disabled.</li> <li>• A project to which a user with the access level of "Assistant Developers" is registered.</li> </ul> When a project for an RnCPU or an RnENCPU, which was created in version 1.045X or later and in which any one of the following parameters has been set, is verified with another project in version 1.044W or earlier, the parameters of the CPU module will not be verified. <ul style="list-style-type: none"> <li>• Web Server Settings</li> <li>• Battery-less Option Cassette Setting</li> <li>• Simple CPU Communication Setting</li> </ul>
Opening a simulation environment file	A simulation environment file saved in version 1.045X or later cannot be opened in version 1.044W or earlier.
Connection destination specification	When a project, in which a connection destination routing a QCPU (Q mode) is specified, is opened in version 1.044W or earlier, only the setting of this connection destination returns to the default.
Library operation	When a password authentication for a read-protected POU is disabled in version 1.045X or later, a library including the POU cannot be used in version 1.044W or earlier.
User authentication	When reading user information whose access level is set as "Assistant Developers" in version 1.045X or later from a CPU module using version 1.044W or earlier, the access level is changed to "Users." (Page 689 Reading user information from a CPU module)

## ■Using a project, which was created in version 1.047Z or later, in version 1.045X or earlier

Function	Consideration
Reading data from a programmable controller	When reading a project including unused structures in version 1.045X or earlier, the structures cannot be read.
Verifying data with a programmable controller	A project including unused structures cannot be verified against data in a programmable controller in version 1.045X or earlier.
Conversion	When a program including an instruction to which "_M2" is added, an error occurs at the conversion in version 1.045X or earlier.

## ■Using a project, which was created in version 1.050C or later, in version 1.047Z or earlier

Function	Consideration
Opening a project Reading data from a programmable controller	A project, for which "Compression" is selected for "File Size" in the "Properties" screen cannot be opened in version 1.047Z or earlier.
	Regardless of the setting of the following option, a project in which data exists after 481th or later rows on the tag FB setting editor cannot be opened or read from a CPU module in version 1.047Z or earlier. <ul style="list-style-type: none"> <li>• [Tool] ⇒ [Options] ⇒ "Convert" ⇒ "Process Control Extension Setting" ⇒ "Tag FB" ⇒ "Maximum Number of Tags"</li> </ul>
	A project in which the value of the following option is set to 481 or higher cannot be opened or read from a CPU module in version 1.047Z or earlier. <ul style="list-style-type: none"> <li>• [Tool] ⇒ [Options] ⇒ "Convert" ⇒ "Process Control Extension Setting" ⇒ "Tag FB" ⇒ "Maximum Number of Tags"</li> </ul>
Reading data from a programmable controller	When a project, in which a main base unit (R33B) has been placed, is read from a CPU module in version 1.047Z or earlier, the model name of this base unit is displayed blank in the "System Parameter" screen.
Project verification	A project, for which "Compression" is selected for "File Size" in the "Properties" screen cannot be verified in version 1.047Z or earlier.
Verifying data with a programmable controller	When a project used for an RnPCPU (redundant mode) for which the following parameter is set is verified with another project which was created in version 1.047Z or earlier, the CPU parameters will not be verified. <ul style="list-style-type: none"> <li>• Setting to Wait Receiving Cyclic Data after Switching System</li> </ul>
	When a project for an RnCPU or an RnENCPU for which the following parameters are set is verified with another project which was created in version 1.047Z or earlier, the module parameters will not be verified. <ul style="list-style-type: none"> <li>• Communications by Network No./Station No.</li> <li>• Network/Station No. &lt;-&gt; IP information setting</li> </ul>
	When a project for an RnPCPU (redundant mode) for which a step relay (S) is set in the following parameter is verified with another project which was created in version 1.047Z or earlier, the module parameters will not be verified. <ul style="list-style-type: none"> <li>• Tracking Setting</li> </ul>
Conversion	When a ladder program including a function block or function whose definition is unclear is opened in version 1.047Z or earlier, the background color of the ladder block including the function block or function is displayed in yellow. In addition, an error occurs when this program is converted.
	When converting a project in version 1.047Z or earlier, an error will occur if "Do Not Check Only BMOV(P)/FMOV(P)" is selected for the following option and a data type different from the one defined to the argument of BMOV, BMOV, FMOV, or FMOV is specified. <ul style="list-style-type: none"> <li>• [Tool] ⇒ [Options] ⇒ "Convert" ⇒ "Basic Setting" ⇒ "Operational Setting" ⇒ "Check the data type of instruction argument"</li> </ul>
Reading from an SD memory card	An error occurs when a password is registered for a file in an SD memory card in version 1.050C or later and the file is read in version 1.047Z or earlier.

## ■Using a project, which was created in version 1.052E or later, in version 1.050C or earlier

Function	Consideration
Option setting	A project in which its options are set as follows cannot be opened, verified, or read from the CPU module in version 1.050C or earlier. <ul style="list-style-type: none"> <li>• [Tool] ⇒ [Options] ⇒ "Convert" ⇒ "Basic Setting" ⇒ "Operational Setting" ⇒ "Optimization of Number of Steps" ⇒ "Optimize the Number of Steps": Yes</li> <li>• [Tool] ⇒ [Options] ⇒ "Convert" ⇒ "Basic Setting" ⇒ "Operational Setting" ⇒ "Optimization of Number of Steps" ⇒ "Optimize Level": Level 2</li> </ul> Moreover, a project in the following conditions cannot be opened, verified, or read from a CPU module in version 1.011M or earlier: "Yes" is selected for "Optimize the Number of Steps." and also "Level 1" is selected for "Optimize Level" in the option shown below.

## ■Using a project, which was created in version 1.055H or later, in version 1.050C or earlier

Function	Consideration
Option setting	A project where "Level 2" has been set for the following option may not be opened, verified, or read from a CPU module in version 1.050C or earlier. (☞ Page 876 Using a project, which was created in version 1.052E or later, in version 1.050C or earlier) <ul style="list-style-type: none"> <li>• [Tool] ⇒ [Options] ⇒ "Convert" ⇒ "Basic Setting" ⇒ "Operational Setting" ⇒ "Optimization of Number of Steps" ⇒ "Optimize Level"</li> </ul> If both of the following conditions are satisfied, the default value for this option will be set to "Level 2" when creating a new project in version 1.055H or later. <ul style="list-style-type: none"> <li>• GX Works3 Version 1.052E to 1.054G which had been used or activated before has been updated to Version 1.055H or later.</li> <li>• The default value of "Optimization of Number of Steps" had never been changed in GX Works3 before its update.</li> </ul>

## ■Using a project, which was created in version 1.055H or later, in version 1.054G or earlier

Function	Consideration
Opening a project Reading data from a programmable controller	<p>A project that "Yes" has been selected for the following option cannot be opened/read from a CPU module in version 1.054G or earlier.</p> <ul style="list-style-type: none"> <li>• [Tool] ⇒ [Options] ⇒ "Convert" ⇒ "Basic Setting" ⇒ "Operational Setting" ⇒ "Structured Data Type" ⇒ "Enable to Set Reserved Area"</li> </ul> <p>A conversion error may occur when a project, where an element replaced automatically in opening another format project exists, is opened or read from a CPU module in version 1.054G or earlier.</p> <p>Input/output labels are displayed by their label names when a project that "Yes" has been selected for the following option is opened or read from a CPU module in version 1.054G or earlier.</p> <ul style="list-style-type: none"> <li>• "Program Editor" ⇒ "FBD/LD Editor" ⇒ "Comment" ⇒ "Display Item" ⇒ "Switch FB/FUN Argument to Comment"</li> </ul> <p>When a project where the width of an element in an FBD/LD program is set narrower than the default is opened in version 1.054G or earlier, its input/output label names may protrude from the element frame depending on the length. This can be fixed by re-pasting (cutting and pasting) the element.</p>
Reading data from a programmable controller	Parameters of a device station on CC-Link IE TSN which are written to a CPU module in version 1.055H or later cannot be read from the CPU module in version 1.054G or earlier.
Shortcut key	<p>A shortcut key assigned to the following menu will be assigned to [Online] ⇒ [FB Property] ⇒ [FB Property Management] when the shortcut key settings, which was exported in version 1.055H or later, is imported in version 1.054G or earlier.</p> <ul style="list-style-type: none"> <li>• [Online] ⇒ [FB Property Management (Online)]</li> </ul>
Project verification Verifying data with a programmable controller	When a project for which the size of an element has been changed in version 1.055H or later is verified with a project created in version 1.050C to 1.054G, the element is displayed as mismatched data in the "Verify Result" window; however, it is displayed as matched in the detailed display (diagram/table format) screen.
Verifying data with a programmable controller	When a program in which "Extended Mode (iQ-R Series Mode)" is selected for "Link Direct Device Setting" in the CPU parameters for an RnCPU or an RnENCPU, is verified with another project created in version 1.054G or earlier, the link direct device names of the verification destination will not be displayed properly in the detailed display tab. Therefore, "Mismatch" will be displayed in the verification result.
Connection destination specification	<p>When a project, in which a connection destination routing a QJ71E71-100 is specified, is opened in version 1.054G or earlier, only the setting of this connection destination returns to the default.</p> <p>Connection destination settings return to the default if a project, in which the settings meet either of the following conditions, is opened in version 1.054G or earlier:</p> <ul style="list-style-type: none"> <li>• "Ethernet board" is selected for "PC side I/F," and an Ethernet adapter is set in the "PC side I/F Detailed Setting of Ethernet Board" screen.</li> <li>• An Ethernet adapter is set in the "CPU Module Direct Coupled Setting" screen.</li> </ul>
Remote password	<p>Even if the settings of the following items in the remote password file of a CC-Link IE TSN module are changed in version 1.054G or earlier, the changed contents are discarded when the file is opened in version 1.055H or later.</p> <ul style="list-style-type: none"> <li>• SLMP Transmission Port (TCP/IP)</li> <li>• SLMP Transmission Port (UDP/IP)</li> </ul>
Library operation	<p>Libraries of a project that "Yes" has been selected for the following option can be registered in the library list in version 1.054G or earlier, but they cannot be used.</p> <ul style="list-style-type: none"> <li>• [Tool] ⇒ [Options] ⇒ "Convert" ⇒ "Basic Setting" ⇒ "Operational Setting" ⇒ "Structured Data Type" ⇒ "Enable to Set Reserved Area"</li> </ul> <p>Libraries that contain a module FB cannot be used in version 1.054G or earlier.</p>

## ■Using a project, which was created in version 1.060N or later, in version 1.055H or earlier

Function	Consideration
Option setting	<p>A project for an FX5CPU cannot be opened, verified, or read from the CPU module in version 1.055H or earlier if its options are set as follows.</p> <ul style="list-style-type: none"> <li>• [Tool] ⇒ [Options] ⇒ "Convert" ⇒ "Basic Setting" ⇒ "Operational Setting" ⇒ "Optimization of Number of Steps" ⇒ "Optimize the Number of Steps": Yes</li> <li>• [Tool] ⇒ [Options] ⇒ "Convert" ⇒ "Basic Setting" ⇒ "Operational Setting" ⇒ "Optimization of Number of Steps" ⇒ "Collectively Allocate Temporary Area to Optimize the Number of Steps": Yes</li> <li>• [Tool] ⇒ [Options] ⇒ "Convert" ⇒ "Basic Setting" ⇒ "Operational Setting" ⇒ "Optimization of Number of Steps" ⇒ "Optimize Level": Level 2</li> </ul> <p>If both of the following conditions are satisfied, the default value of "Optimize Level" will be set to "Level 1" when creating a new project for an FX5CPU in version 1.060N or later.</p> <ul style="list-style-type: none"> <li>• GX Works3 Version 1.055H to 1.058L which had been used or activated before is updated to Version 1.060N or later.</li> <li>• The default value of "Optimization of Number of Steps" had never been changed in the GX Works3 before its update.</li> </ul>

## ■Using a project, which was created in version 1.060N or later, in version 1.058L or earlier

Function	Consideration
Opening a project Reading data from a programmable controller	<p>When a project in which the display format (Word Multi-point Format) of device values in a device memory editor is set to "1 Point" is opened in version 1.058L or earlier, the display format will be changed as follows.</p> <ul style="list-style-type: none"> <li>• Bit and Word Format of Bit Device: 10 Points</li> <li>• Word Multi-point Format: 8 Points</li> </ul>

Function	Consideration
Project revision history	A project cannot be restored based on the revision registered with the following option set to "Yes" in version 1.058L or earlier. <ul style="list-style-type: none"> <li>• "Project" ⇒ "Revision" ⇒ "Operational Setting" ⇒ "Optimize Revision Information to Reduce File Size"</li> </ul>

### ■Using a project, which was created in version 1.065T or later, in version 1.063R or earlier

Function	Consideration
Opening a project	When a project, in which a number other than 10 is set for the number of rows to be displayed in an inline structured text box in version 1.065T or later, is opened in version 1.063R or earlier, the number of the rows is changed to 10.  When a project including an inline structured text program with 2049 characters or more, which is created in version 1.065T or later, is opened in version 1.063R or earlier, the program cannot be edited. (However, the program can be deleted and changed to the one with 2048 characters or less.) When copying and pasting an inline structured text box, an empty box will be pasted.
Opening a project Writing data to a programmable controller	When a project, in which a CC-Link IE TSN module is set to "Synchronize" in the "Select the Synchronous Target Module" screen, is opened in version 1.063R or earlier, the setting is displayed as "Do Not Synchronize." However, the CC-Link IE TSN module is actually set as a synchronous target. If this project is written to a CPU module, the CC-Link IE TSN module is written as a synchronous target.
Project version management (data acquisition)	A ladder program including an inline structured text program with 2049 characters or more, which is created in version 1.065T or later, cannot be acquired from a version management system in version 1.063R or earlier.
Reading data from a programmable controller	Parameters of a device station on CC-Link IE TSN which are written to an FX5UCPU or an FX5UCCPU in version 1.065T or later cannot be read from the CPU module in version 1.063R or earlier.
Reading from an SD memory card	In projects for an FX5UCPU and an FX5UCCPU, if parameters of a device station on CC-Link IE TSN are written to an SD memory card in version 1.065T or later, an error occurs when the parameters are read in version 1.063R or earlier.
Opening a simulation environment file	A simulation environment file saved in version 1.065T or later cannot be opened in version 1.063R or earlier.
Event history	If an event history is collected with the following parameter set to "Save," the history cannot be displayed in version 1.063R or earlier. <ul style="list-style-type: none"> <li>• "CPU Parameter" ⇒ "RAS Setting" ⇒ "Event History Setting" ⇒ "Save Device/Label Operations"</li> </ul>

### ■Using a project, which was created in version 1.070Y or later, in version 1.066U or earlier

Function	Consideration
Overwriting a project	If a project in which a label comment is set for an array element or bit-specified label is overwritten in version 1.066U or earlier, the label comment cannot be used.
Opening a project	When an RnSFCPU project in which a recorder module has been placed is opened in version 1.066U or earlier, a recording setting is displayed in the navigation window; however, safety devices are excluded from the collection targets of the recording function. If the recorder module is registered in the project again, the recording setting disappears from the navigation window.
Opening a project Reading data from a programmable controller	An error occurs at the program conversion when an FX5CPU project that contains a program with an index-modified step relay (S) is opened or read from a CPU module in version 1.066U or earlier.
Opening a project Reading data from a programmable controller Verification	Projects for an FX5UCPU and an FX5UCCPU that include an SFC program cannot be opened, read from the CPU module, or verified with another project in version 1.066U or earlier.
Library operation	Libraries that contain an SFC program used in projects for an FX5UCPU and an FX5UCCPU cannot be used in version 1.066U or earlier.
Intelligent function module monitor	When a project saved with all the following conditions satisfied is opened in version 1.066U or earlier, a registered device station is not displayed in an intelligent function module monitor: <ul style="list-style-type: none"> <li>• A device station on CC-Link IE TSN is registered in the intelligent function module monitor.</li> <li>• The intelligent function module monitor is open.</li> </ul>
Log marker	A log marker information file (*.lmcx) created in version 1.070Y or later cannot be read in version 1.066U or earlier.

### ■Using a project, which was created in version 1.072A or later, in version 1.070Y or earlier

Function	Consideration
Reading data from a programmable controller	When a project, in which a redundant extension base unit (R66WRB-HT) has been placed, is read from a CPU module in version 1.070Y or earlier, the model name of this base unit (R66WRB-HT) is displayed blank in the "System Parameter" screen.
Reading data from a programmable controller Opening a recording setting	If the following option is selected in a project in which a recorder module has been placed, a device/label specified as a collection target is deleted when reading the project from a CPU module or opening the "Recording Setting" screen in version 1.070Y or earlier. <ul style="list-style-type: none"> <li>• The "Recording Setting" screen ⇒ "Device/Label Sampling Setting" ⇒ "Device/Label Sampling Target Setting" ⇒ "Specify from the device/label used" ⇒ "Manual"</li> </ul>



## ■Using a project, which was created in version 1.075D or later, in version 1.072A or earlier

Function	Consideration
Opening a project Writing data to a programmable controller	When a project, in which a CC-Link IE TSN compatible motion module is set to "Synchronize" in the "Select the Synchronous Target Module" screen, is opened in version 1.072A or earlier, the setting is displayed as "Do Not Synchronize." However, the CC-Link IE TSN compatible motion module is actually set as a synchronous target. If this project is written to a CPU module, the CC-Link IE TSN compatible motion module is written as a synchronous target.
Opening a project Reading data from a programmable controller	An error occurs when converting a program if a project, where the display format of a transition (Zoom) including a close contact is changed, is opened or read from a CPU module in version 1.072A or earlier.
Verifying data with a programmable controller	When a program, in which "Extended Mode (iQ-R Series Mode)" is selected for "Link Direct Device Setting" in the CPU parameters for an RnPCPU, is verified with another project created in version 1.072A or earlier, the link direct device names of the verification destination will not be displayed properly in the detailed display tab. Therefore, "Mismatch" will be displayed in the verification result.
Simple CPU communication setting	If a project satisfies all the following conditions, the values in the simple CPU communication setting may become incorrect when opening the setting in version 1.072A or earlier. <ul style="list-style-type: none"> <li>• A serial communication module was placed in a project in version 1.072A or earlier.</li> <li>• The above project was opened in version 1.075D or later, and the simple CPU communication setting was configured.</li> </ul> In this case, upgrade the version to 1.075D or later, then open the simple CPU communication setting.

## ■Using a project, which was created in version 1.080J or later, in version 1.077F or earlier

Function	Consideration
Opening a project	Connection destination settings return to the default when the "Specify Connection Destination" screen is opened if a project, in which the settings meet the following condition, is opened in version 1.077F or earlier: <ul style="list-style-type: none"> <li>• "GOT" is selected for "PLC side I/F," and "CC IE TSN" is set in the "PLC side I/F Detailed Setting of GOT" screen.</li> </ul>
	Connection destination settings return to the default when the "Specify Connection Destination" screen is opened if a project for an FX5CPU, in which the settings meet the following condition, is opened in version 1.077F or earlier: <ul style="list-style-type: none"> <li>• "Ethernet Board" is selected for "PC side I/F," and "GOT" for "PLC side I/F," and "Ethernet Built-in CPU" is set for "via GOT (Ethernet) transparent mode" in the "PLC side I/F Detailed Setting of GOT" screen.</li> </ul> In addition, the settings in "Network Communication Route Detailed Setting of Ethernet" are discarded if a project, in which the connection destination settings meet the following condition, is opened in version 1.077F or earlier: <ul style="list-style-type: none"> <li>• "Ethernet Board" is selected for "PC side I/F," and "GOT" for "PLC side I/F," and "FX5-ENET(IP)" is set for "via GOT (Ethernet) transparent mode" in the "PLC side I/F Detailed Setting of GOT" screen.</li> </ul>
Opening a project Writing data to a programmable controller	When a project, in which a CC-Link IE TSN compatible motion module (RD78G4(S), RD78G8(S), or RD78G16(S) only) is set to "Synchronize" in the "Select the Synchronous Target Module" screen, is opened in version 1.077F or earlier, the setting is displayed as "Do Not Synchronize." However, the CC-Link IE TSN compatible motion module is actually set as a synchronous target. If this project is written to a CPU module, the CC-Link IE TSN compatible motion module is written as a synchronous target.
Opening a project Reading data from a programmable controller	A project, in which any arguments of function elements/function block elements are hidden, cannot be opened or read from a CPU module in version 1.077F or earlier. In this case, show the hidden arguments again, then open the project or read it from a CPU module in version 1.077F or earlier.
Reading data from a programmable controller	The following parameters return to the default when a project, in which "Use TSN HUB" is selected for "TSN HUB Setting" in the module parameters for a CC-Link IE TSN module (RJ71GN11-T2), is read from a CPU module in version 1.077F or earlier: <ul style="list-style-type: none"> <li>• Network Topology</li> <li>• Setting in units of 1us</li> <li>• Communication Period Interval Setting (Do not Set it in Units of 1us)</li> <li>• Communication Period Interval Setting (Set it in Units of 1us)</li> <li>• System Reservation Time</li> <li>• Cyclic Transmission Time</li> <li>• Transient Transmission Time</li> <li>• Authentication Class Setting</li> <li>• Disconnection Detection Setting</li> <li>• Station-based Block Data Assurance</li> </ul>
	An error occurs when changing the module parameters of a project after reading the project, in which "Refresh Setting" in the module parameters is set for a CC-Link IE TSN compatible motion module (RD78G4, RD78G8, RD78G16, RD78G32, RD78G64, RD78GHV, or RD78GHW only), from a CPU module in version 1.077F or earlier.
Opening a project Reading data from a programmable controller Project verification Verifying data with a programmable controller	A project using any of the following standard process FBs cannot be opened, verified, or read from a CPU module in version 1.077F or earlier: M+TP_HIGH, M+TP_LOW, M+TON_HIGH, M+TON_LOW, M+TOF_HIGH, and M+TOF_LOW. A project that contains an FBD/LD program using an inline structured text program cannot be opened, verified, or read from a CPU module in version 1.077F or earlier.
Library operation	Libraries that contain an inline structured text program used in an FBD/LD program can be registered in the library list in version 1.077F or earlier, but they cannot be used.

A

## ■Using a project, which was created in version 1.082L or later, in version 1.080J or earlier

Function	Consideration
Remote password	When a project, in which "CC-Link IE TSN Plus Master/Local Module" is set for "Product Name" in the "Remote Password Setting" screen, is opened in version 1.080J or earlier, "CC-Link IE TSN Plus Master/Local Module" is changed to "Unsupported Module."

## ■Using a project, which was created in version 1.085P or later, in version 1.082L or earlier

Function	Consideration
Library operation	Libraries that contain the following elements cannot be used in version 1.082L or earlier. <ul style="list-style-type: none"> <li>• System header POU (M+PHEADER)</li> <li>• System footer POU (M+PFOOTER)</li> <li>• Global label setting 'M+PTAG'</li> <li>• Process control function block</li> <li>• Tag data structure</li> </ul>
Reading data from a programmable controller	The following parameters return to the default when a project, in which "Use TSN HUB" is selected for "TSN HUB Setting" in the module parameters for a CC-Link IE TSN module (FX5-CCLGN-MS), is read from a CPU module in version 1.082L or earlier: <ul style="list-style-type: none"> <li>• Setting in units of 1us</li> <li>• Communication Period Interval Setting (Do not Set it in Units of 1us)</li> <li>• Communication Period Interval Setting (Set it in Units of 1us)</li> <li>• System Reservation Time</li> <li>• Cyclic Transmission Time</li> <li>• Transient Transmission Time</li> <li>• Authentication Class Setting</li> <li>• Disconnection Detection Setting</li> <li>• Station-based Block Data Assurance</li> </ul>

## ■Using a project, which was created in version 1.090U or later, in version 1.087R or earlier

Function	Consideration
Opening a project Reading data from a programmable controller	When opening either of the following projects for an LHCPU in version 1.087R or earlier, device comments/device memories/device initial values of Un\G65536 and later cannot be displayed or edited. <ul style="list-style-type: none"> <li>• A project in which device comments/device memories/device initial values of Un\G65536 and later are set.</li> <li>• A project that contains a program in which module access devices of Un\G65536 and later are not changed from the initial values.</li> </ul>
Verifying data with a programmable controller	When opening either of the following projects for an LHCPU in version 1.087R or earlier, device comments/device memories of Un\G65536 and later cannot be verified. <ul style="list-style-type: none"> <li>• A project in which device comments/device memories/device initial values of Un\G65536 and later are set.</li> <li>• A project that contains a program in which module access devices of Un\G65536 and later are not changed from the initial values.</li> </ul>
Conversion	In a project for an LHCPU that contains a program in which module access devices of Un\G65536 and later are used, an error occurs at the conversion in version 1.087R or earlier.
Remote password	When a project for an FX5UJCPU, in which "CC-Link IE TSN Module" is set for "Product Name" in the "Remote Password Setting" screen, is opened in version 1.087R or earlier, "CC-Link IE TSN Module" is changed to "Unsupported Module."

## ■Using a project, which was created in version 1.095Z or later, in version 1.090U or earlier

Function	Consideration
Reading data from a programmable controller	When a project, in which a power supply module (R69P, R69RP) has been placed, is read from a CPU module in version 1.090U or earlier, the model name of this power supply module (R69P, R69RP) is displayed blank in the "System Parameter" screen.
Opening a project Reading data from a programmable controller Verification	Projects for an FX5UJCPU and an FX5SCPU that include an SFC program cannot be opened, read from the CPU module, or verified with another project in version 1.090U or earlier.
Library operation	Libraries that contain an SFC program used in projects for an FX5UJCPU and an FX5SCPU cannot be used in version 1.090U or earlier.
Connection destination specification	Connection destination settings return to the default when a communication route is set to access a CPU module via either of the following modules: <ul style="list-style-type: none"> <li>• CC-Link IE Field Network master/local module (LJ71GF11-T2)</li> <li>• Ethernet interface module (LJ71E71-100)</li> </ul>

## ■Using a project, which was created in version 1.096A or later, in version 1.095Z or earlier

Function	Consideration
Project verification	If a security version of a project, which was created in version 1.096A or later, is '2,' the project cannot be verified with a project created in version 1.095Z or earlier.
Offline monitor	When a project that satisfies both of the following conditions is written to a programmable controller, and then a recording file is read from the programmable controller in version 1.095Z or earlier, the recording file cannot be monitored. <ul style="list-style-type: none"> <li>• A security version is set to "2."</li> <li>• A recorder module is placed.</li> </ul>

## ■Using a project, which was created in version 1.100E or later, in version 1.097B or earlier

Function	Consideration
Opening a project	Connection destination settings return to the default when the "Specify Connection Destination" screen is opened if a project for an LHCPU, in which the settings meet the following condition, is opened in version 1.097B or earlier: <ul style="list-style-type: none"> <li>• "Ethernet Board" is selected for "PC side I/F," and "GOT" for "PLC side I/F," and "Ethernet Built-in CPU" is set for "via GOT (Ethernet) transparent mode" in the "PLC side I/F Detailed Setting of GOT" screen.</li> </ul>
	Connection destination settings return to the default when the "Specify Connection Destination" screen is opened if a communication route is set to access a CPU module via a CC-Link IE TSN interface board.

A

# Appendix 3 Using a Previous Version of Function

## Checking logging data in version 1.063R or earlier

A value of logging data displayed in GX LogViewer can be displayed on the monitor screen of GX Works3. When moving the red cursor of GX LogViewer, a monitor value in GX Works3 is also changed accordingly. To use this function, GX LogViewer Version 1.64S or later is required to be installed.

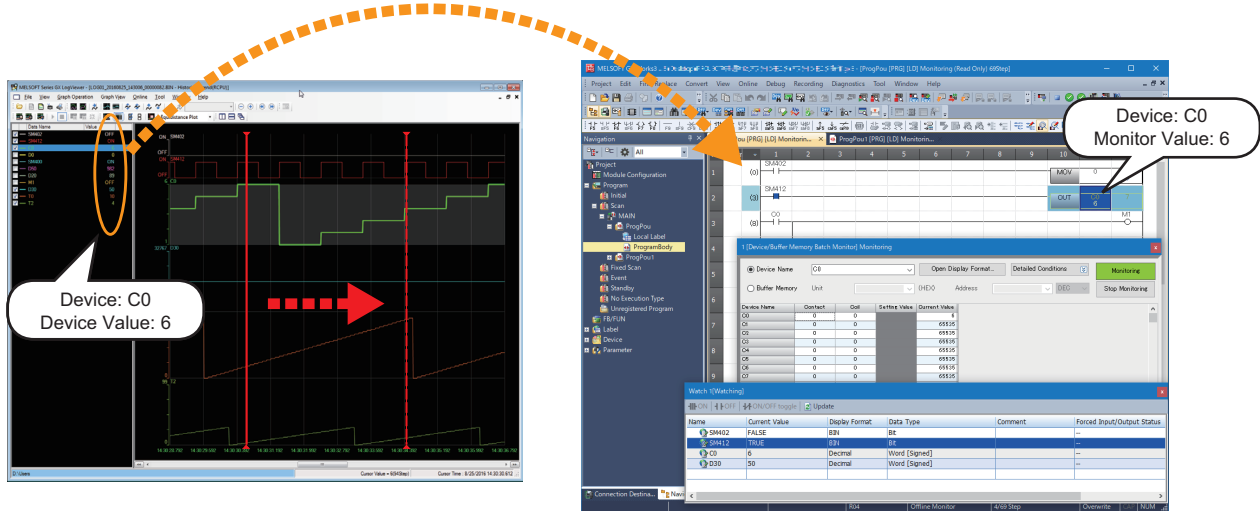

### Operating procedure

The following shows the operating procedure to check logging data.

#### Operating procedure

1. Open a logging file in GX LogViewer.
2. Set a logging file to be monitored in GX Works3. (☞ Page 883 Selecting a target monitor)
3. Start offline monitoring in GX Works3. (☞ Page 884 Starting offline monitoring)
4. Stop offline monitoring in GX Works3. (☞ Page 884 Stopping offline monitoring)

## Selecting a target monitor

Set a logging file to be monitored in the "Offline Monitor (Logging) Connection Destination Setting" screen.  
Only a logging file (\*.bin) output from an RCPU or an FX5CPU can be set.

### Window

Select [Debug] ⇒ [Offline Monitor] ⇒ [Offline Monitor (Logging)] ⇒ [Connection Destination Setting].

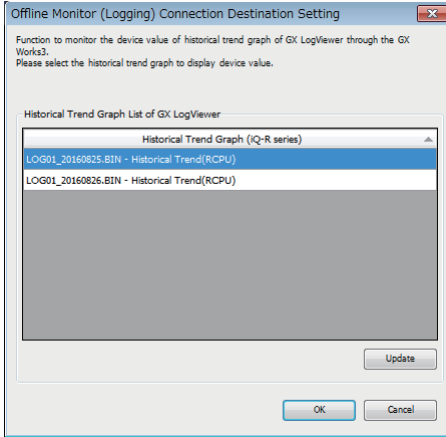

### Operating procedure

Select a logging file, and click the [OK] button.  
"Offline Monitor" is displayed on the status bar.

### Precautions

- A logging file is not displayed in the list when opening the "Offline Monitor (Logging) Connection Destination Setting" screen in GX Works3 before opening the logging file in GX LogViewer. Open a logging file in GX LogViewer, then click the [Update] button in the "Offline Monitor (Logging) Connection Destination Setting" screen.
- A logging file is not displayed in the list when performing any of the following functions in GX LogViewer.  
[Graph View] ⇒ [Change the Data to Draw Graphs]  
[Graph Operation] ⇒ [Show Previous Graph] or [Show Next Graph]

A

## Starting offline monitoring

### Operating procedure

1. Start monitoring in GX Works3. (☞ Page 613 Starting/stopping monitoring)
2. Move the red cursor in the "Historical Trend" window of GX LogViewer.

An updated device value in the graph legend area is displayed in the monitor screen of GX Works3.

### ■Online operation during offline monitoring

The following online functions are available during offline monitoring:

- Monitor on a program editor
- Device/buffer memory batch monitor
- Watch

## Stopping offline monitoring

### Operating procedure

Select [Debug] ⇒ [Offline Monitor] ⇒ [Offline Monitor (Logging)] ⇒ [Disconnect Offline Monitor].

Monitoring stops in all screens in GX Works3.

### ■Pausing and restarting offline monitoring

When stopping monitoring in GX Works3, offline monitoring pauses only in the stopped screen.

When restarting monitoring in GX Works3, offline monitoring also restarts.

## Considerations

### ■Duplicate devices

When multiple same devices exist in a logging file, the value of the device that is displayed at the lowermost row in the graph legend area of GX LogViewer is displayed in the monitor screen of GX Works3.

### ■Active status of blocks/steps in an SFC program

Active status is not displayed on an SFC diagram editor.

All blocks are displayed as "Uncreated Block" on all SFC blocks batch monitor.

### ■Conditions that monitored values are not displayed properly

When any of the following conditions is satisfied, a monitor value is not displayed properly.

Condition	Value
A device value to be monitored does not exist in a file opened in the "Historical Trend" window.	The following values are displayed. <ul style="list-style-type: none"><li>• Bit device, bit-specified word device: FALSE (0)</li><li>• Word device, double-word device, FLOAT [Double Precision]: -1</li></ul>
A device that exists either in the lower bit or the upper bit is monitored by specifying it in double-word format.	
An indirectly specified device is monitored.	
An index-modified device is monitored.	A device value excluding the index modification part is displayed. (Example: "D0" is displayed for "D0Z0.")
A project which was written to a CPU module when a logging file was output and a project to monitor do not match.	If label assignment status is inconsistent between in a logging file and in a project to be monitored, values that are different from the ones displayed in the "Historical Trend" window of GX LogViewer may be displayed.

### ■Conditions that labels can be monitored

Label values in a logging file can be monitored only when all of the following conditions are satisfied.

- GX Works3 Version 1.045X or later is used.
- GX LogViewer Version 1.82L or later is used.
- Monitoring is performed in the project which was written to a CPU module when a logging file was output.
- Label assignment status is consistent between in a logging file and in a project to be monitored.

# Appendix 4 Unusable Character Strings (Reserved Words)

Character strings used for application instruction names, common instruction names, special instruction names, instructions and so on are referred to as the reserved words.

Reserved words may not be used for names.

When the character strings defined as reserved words is used for names, an error occurs at the registration or conversion.

## Precautions

Characters are not case-sensitive.

### Unusable character strings for a name of a project/work space/library

Category		Character string
Invalid character	Symbol	Space, ", %, ', *, /, ., :, <, >, ?, \,  , environment dependent characters
	Surrogate pair	0xD800 to 0xDBFF, 0xDC00 to 0xDFFF
	Control code	U+0000 to U+001F, U+007F, U+0080 to U+009F, U+00A0 to U+00BF, U+FFFE, U+FFFF
Windows reserved word		COM1, COM2, COM3, COM4, COM5, COM6, COM7, COM8, COM9, LPT1, LPT2, LPT3, LPT4, LPT5, LPT6, LPT7, LPT8, LPT9, AUX, CON, PRN, NUL, CLOCK\$, END_MARK

### Unusable character strings for a data name

Category		Character string
Invalid character	Symbol <sup>*1</sup>	Space, !, ", #, \$, %, &, ', (, ), *, +, /, ., :, ;, <, =, >, ?, @, [ \ ], ^, ` , {,  , }, ~, environment dependent characters
	Surrogate pair	0xD800 to 0xDBFF, 0xDC00 to 0xDFFF
	Control code	U+0000 to U+001F, U+007F, U+0080 to U+009F, U+00A0 to U+00BF, U+FFFE, U+FFFF
	Others <sup>*1</sup>	COMMENT, GLBLINF, LOCALLABEL, SLIBFBFILE
Windows reserved word		COM1, COM2, COM3, COM4, COM5, COM6, COM7, COM8, COM9, LPT1, LPT2, LPT3, LPT4, LPT5, LPT6, LPT7, LPT8, LPT9, AUX, CON, PRN, NUL, CLOCK\$, END_MARK
Data type reserved words	Class <sup>*1</sup>	VAR, VAR_RETAIN, VAR_ACCESS, VAR_CONSTANT, VAR_INPUT, VAR_INPUT_RETAIN, VAR_OUTPUT, VAR_OUTPUT_RETAIN, VAR_IN_OUT, VAR_IN_EXT, VAR_EXTERNAL, VAR_EXTERNAL_CONSTANT, VAR_EXTERNAL_RETAIN, VAR_GLOBAL, VAR_GLOBAL_CONSTANT, VAR_GLOBAL_RETAIN, VAR_PUBLIC, VAR_PUBLIC_RETAIN
	Data type	BOOL, BYTE, INT, SINT, DINT, LINT, UINT, USINT, UDINT, ULINT, WORD, DWORD, LWORD, ARRAY, REAL, LREAL, TIME, STRING, WSTRING, TIMER, LTIMER, RETENTIVETIMER, LRETENTIVETIMER, COUNTER, LCOUNTER, POINTER ANY, ANY_NUM, ANY_BIT, ANY_REAL, ANY_INT, ANY_DATE, ANY_SIMPLE, ANY16, ANY32, DATE, DATE_AND_TIME, DT, TIME, TIME_OF_DAY, TOD, BODY_CCE, BODY_FBD, BODY_IL, BODY_LD, BODY_SFC, BODY_ST, END_BODY, END_PARAMETER_SECTION, PARAM_FILE_PATH, PARAMETER_SECTION, POW, LONGCOUNTER, LONGRETENTIVETIMER, LONGTIMER, UNKNOWN, ANY_BITADDR, ANY_WORDADDR, ANY_STRING, ANYSTRING_SINGLE, ANYSTRING_DOUBLE, ANY_ELEMENTARY, ANY_ELEMENTARY_IEC, ANY_MAGNITUDE, ANY_BOOL, ANY_SIGNED, ANY_UNSIGNED, ANYREAL_64, ANYREAL_32, ANY_DERIVED, ANY16_S, ANY16_U, ANY32_S, ANY32_U, ANY64, ANY64_S, ANY64_U, ANY_STRUCT, ANYWORD_ARRAY, ANY16_ARRAY, ANY16_S_ARRAY, ANY16_U_ARRAY, ANY32_ARRAY, ANY32_S_ARRAY, ANY32_U_ARRAY, ANY64_ARRAY, ANY64_S_ARRAY, ANY64_U_ARRAY, ANY_REAL_ARRAY, ANY_REAL_32_ARRAY, ANY_REAL_64_ARRAY, ANY_STRING_ARRAY, ANYSTRING_SINGLE_ARRAY, ANYSTRING_DOUBLE_ARRAY, ANYBIT_ARRAY, UINT_WORD, UDINT_DWORD, ULINT_LWORD, TIME2, KBIT64, KBIT32, KBIT16, WDEVICE, BDEVICE, DUMMYDEVICE, FB, FUN, STRUCT_MEMBER, BIT_ARRAY, STRUCT_ARRAY, STRING_ARRAY, WSTRING_ARRAY, LINT_ARRAY, ULINT_LWORD_ARRAY, DINT_ARRAY, UDINT_DWORD_ARRAY, INT_ARRAY, UINT_WORD_ARRAY, REAL_ARRAY, LREAL_ARRAY, TIME_ARRAY, NONE, ANY16_OR_STRING_SINGLE, ANY_DT, ANY_TM, ANY_BOOL_OR_POINTER



Category		Character string
IEC reserved word <sup>*1</sup>		ABS, ACOS, ACTION, ADD, AND, ANDN, ANY, ANY_BIT, ANY_INT, ANY_NUM, ANY_REAL, ARRAY, ASIN, AT, ATAN, BOOL, BY, BYTE, CAL, CALC, CASE, CONCAT, CONFIGURATION, CONSTANT, CONTINUE, COS, CTD, CTU, CTUD, D, DATE, DATE_AND_TIME, DELETE, DINT, DIV, DO, DT, DWORD, ELSE, ELSIF, END_ACTION, END_CASE, END_CONFIGURATION, END_FOR, END_FUNCTION, END_FUNCTION_BLOCK, END_IF, END_PROGRAM, END_REPEAT, END_RESOURCE, END_STEP, END_STRUCT, END_TRANSITION, END_TYPE, END_VAR, END_WHILE, EN, ENO, EQ, EXIT, EXP, EXPT, FALSE, F_EDGE, F_TRIG, FIND, FOR, FROM, FUNCTION, FUNCTION_BLOCK, GE, GT, IF, INITIAL_STEP, INSERT, INT, INTERVAL, JMP, JMPC, JMPCN, L, LD, LDN, LE, LEFT, LEN, LIMIT, LINT, LN, LOG, LREAL, LT, LWORD, MAX, MID, MIN, MOD, MOVE, MUL, MUX, N, NE, NEG, NOT, OF, ON, OR, ORN, P, PROGRAM, R, R1, R_TRIG, READ_ONLY, READ_WRITE, REAL, REPEAT, REPLACE, RESOURCE, RET, RETAIN, RETC, RETURN, RIGHT, ROL, ROR, RS, R_EDGE, S, S1, SD, SEL, SHL, SHR, SIN, SINGLE, SINT, SQRT, SR, ST, STEP, STN, STRING, STRUCT, SUB, TAN, TASK, THEN, TIME, TIME_OF_DAY, TO, TOD, TOF, TON, TP, TRANSITION, TRUE, TYPE, UDINT, UINT, ULINT, UNTIL, USINT, VAR, VAR_ACCESS, VAR_EXTERNAL, VAR_GLOBAL, VAR_INPUT, VAR_IN_OUT, VAR_OUTPUT, WHILE, WITH, WORD, XOR, XORN
Code conversion <sup>*1</sup>	Device	A, B, BL, C, CC, CN, CS, D, DX, DY, E, F, FD, FX, FY, G <sup>*2</sup> , GLP, H, HG <sup>*2</sup> , I, J, K, L, LC, LCC, LCN, LCS, LLP, LSC, LSN, LSS, LST, LSTC, LSTN, LSTS, LT, LTC, LTN, LTS, LZ, M, N, P, PH, R, RD, S, SB, SC, SD, SM, SN, SS, ST, STC, STN, STS, SW, SZ, T, TC, TN, TR, TS, U, V, VD, W, X, Y, Z, ZR, ZZ, RX <sup>*2</sup> , RY <sup>*2</sup> , RWr <sup>*2</sup> , RWW <sup>*2</sup>
	Others	Manufacturer-provided functions/function blocks, MELSEC instructions supported by a CPU module <sup>*3</sup>

\*1 Available for some names.

\*2 Regarded as a reserved word when the character string is used with a number.

\*3 Some instructions that are not supported by a CPU module may not be used. (Example: NOP and PHASERST)



## Unusable character strings for a label name

Category		Character string
Invalid character	Symbol	Space, !, ", #, \$, %, &, ', (, ), *, +, /, ,, -, ., : ;, <, =, >, ?, @, [, \, ], ^, ` , {,  , }, ~, environment dependent characters
	Surrogate pair	0xD800 to 0xDBFF, 0xDC00 to 0xDFFF
	Control code	U+0000 to U+001F, U+007F, U+0080 to U+009F, U+00A0 to U+00BF, U+FFFE, U+FFFF
Windows reserved word		CLOCK\$
Data type reserved words	Class	VAR, VAR_RETAIN, VAR_ACCESS, VAR_CONSTANT, VAR_INPUT, VAR_INPUT_RETAIN, VAR_OUTPUT, VAR_OUTPUT_RETAIN, VAR_IN_OUT, VAR_IN_EXT, VAR_EXTERNAL, VAR_EXTERNAL_CONSTANT, VAR_EXTERNAL_RETAIN, VAR_GLOBAL, VAR_GLOBAL_CONSTANT, VAR_GLOBAL_RETAIN, VAR_PUBLIC, VAR_PUBLIC_RETAIN
	Data type	BOOL, BYTE, INT, SINT, DINT, LINT, UINT, USINT, UDINT, ULINT, WORD, DWORD, LWORD, ARRAY, REAL, LREAL, TIME, STRING, WSTRING, TIMER, LTIMER, RETENTIVETIMER, LRETENTIVETIMER, COUNTER, LCOUNTER, POINTER ANY, ANY_NUM, ANY_BIT, ANY_REAL, ANY_INT, ANY_DATE, ANY_SIMPLE, ANY16, ANY32, DATE, DATE_AND_TIME, DT, TIME, TIME_OF_DAY, TOD, BODY_CCE, BODY_FBD, BODY_IL, BODY_LD, BODY_SFC, BODY_ST, END_BODY, END_PARAMETER_SECTION, PARAM_FILE_PATH, PARAMETER_SECTION, POW, LONGCOUNTER, LONGRETENTIVETIMER, LONGTIMER, UNKNOWN, ANY_BITADDR, ANY_WORDADDR, ANY_STRING, ANYSTRING_SINGLE, ANYSTRING_DOUBLE, ANY_ELEMENTARY, ANY_ELEMENTARY_IEC, ANY_MAGNITUDE, ANY_BOOL, ANY_SIGNED, ANY_UNSIGNED, ANYREAL_64, ANYREAL_32, ANY_DERIVED, ANY16_S, ANY16_U, ANY32_S, ANY32_U, ANY64, ANY64_S, ANY64_U, ANY_STRUCT, ANYWORD_ARRAY, ANY16_ARRAY, ANY16_S_ARRAY, ANY16_U_ARRAY, ANY32_ARRAY, ANY32_S_ARRAY, ANY32_U_ARRAY, ANY64_ARRAY, ANY64_S_ARRAY, ANY64_U_ARRAY, ANY_REAL_ARRAY, ANY_REAL_32_ARRAY, ANY_REAL_64_ARRAY, ANY_STRING_ARRAY, ANYSTRING_SINGLE_ARRAY, ANYSTRING_DOUBLE_ARRAY, ANYBIT_ARRAY, UINT_WORD, UDINT_DWORD, ULINT_LWORD, TIME2, KBIT64, KBIT32, KBIT16, WDEVICE, BDEVICE, DUMMYDEVICE, FB, FUN, STRUCT_MEMBER, BIT_ARRAY, STRUCT_ARRAY, STRING_ARRAY, WSTRING_ARRAY, LINT_ARRAY, ULINT_LWORD_ARRAY, UDINT_DWORD_ARRAY, INT_ARRAY, UINT_WORD_ARRAY, REAL_ARRAY, LREAL_ARRAY, TIME_ARRAY, NONE, ANY16_OR_STRING_SINGLE, ANY_DT, ANY_TM, ANY_BOOL_OR_POINTER
IEC reserved word		ABS, ACOS, ACTION, ADD, AND, ANDN, ANY, ANY_BIT, ANY_INT, ANY_NUM, ANY_REAL, ARRAY, ASIN, AT, ATAN, BOOL, BY, BYTE, CAL, CALC, CASE, CONCAT, CONFIGURATION, CONSTANT, CONTINUE, COS, CTD, CTU, CTUD, D, DATE, DATE_AND_TIME, DELETE, DINT, DIV, DO, DT, DWORD, ELSE, ELSIF, END_ACTION, END_CASE, END_CONFIGURATION, END_FOR, END_FUNCTION, END_FUNCTION_BLOCK, END_IF, END_PROGRAM, END_REPEAT, END_RESOURCE, END_STEP, END_STRUCT, END_TRANSITION, END_TYPE, END_VAR, END_WHILE, EN, ENO, EQ, EXIT, EXP, EXPT, FALSE, F_EDGE, F_TRIG, FIND, FOR, FROM, FUNCTION, FUNCTION_BLOCK, GE, GT, IF, INITIAL_STEP, INSERT, INT, INTERVAL, JMP, JMPC, JMPCN, L, LD, LDN, LE, LEFT, LEN, LIMIT, LINT, LN, LOG, LREAL, LT, LWORD, MAX, MID, MIN, MOD, MOVE, MUL, MUX, N, NE, NEG, NOT, OF, ON, OR, ORN, P, PROGRAM, R, R1, R_TRIG, READ_ONLY, READ_WRITE, REAL, REPEAT, REPLACE, RESOURCE, RET, RETAIN, RETC, RETURN, RIGHT, ROL, ROR, RS, R_EDGE, S, S1, SD, SEL, SHL, SHR, SIN, SINGLE, SINT, SQRT, SR, ST, STEP, STN, STRING, STRUCT, SUB, TAN, TASK, THEN, TIME, TIME_OF_DAY, TO, TOD, TOF, TON, TP, TRANSITION, TRUE, TYPE, UDINT, UINT, ULINT, UNTIL, USINT, VAR, VAR_ACCESS, VAR_EXTERNAL, VAR_GLOBAL, VAR_INPUT, VAR_IN_OUT, VAR_OUTPUT, WHILE, WITH, WORD, XOR, XORN
Code conversion	Device	A, B, BL, C, CC, CN, CS, D, DX, DY, E, F, FD, FX, FY, G <sup>*1</sup> , GLP <sup>*1</sup> , H, HG <sup>*1</sup> , I, J, K, L, LC, LCC, LCN, LCS, LLP <sup>*1</sup> , LSC <sup>*1</sup> , LSN <sup>*1</sup> , LSS <sup>*1</sup> , LST, LSTC, LSTN, LSTS, LT, LTC, LTN, LTS, LZ, M, N, P, PH, R, RD, S, SB, SC <sup>*1</sup> , SD, SM, SN <sup>*1</sup> , SS <sup>*1</sup> , ST, STC <sup>*1</sup> , STN <sup>*1</sup> , STS <sup>*1</sup> , SW, SZ <sup>*1</sup> , T, TC, TN, TR, TS, U, V, VD, W, X, Y, Z, ZR, ZZ, RX <sup>*1</sup> , RY <sup>*1</sup> , RWw <sup>*1</sup>
	Others	Manufacturer-provided functions/function blocks, MELSEC instructions supported by a CPU module <sup>*2</sup>

\*1 Regarded as a reserved word when the character string is used with a number.

\*2 Some instructions that are not supported by a CPU module may not be used. (Example: NOP and PHASERST)

## Unusable character strings for a path name

Category		Character string
Invalid character	Symbol	", *, /, ,, ;, <, >, ?,  , environment dependent characters <sup>*1</sup>
	Surrogate pair	0xD800 to 0xDBFF, 0xDC00 to 0xDFFF
	Control code	U+0000 to U+001F, U+007F, U+0080 to U+009F, U+00A0 to U+00BF, U+FFFE, U+FFFF
Windows reserved word		COM1, COM2, COM3, COM4, COM5, COM6, COM7, COM8, COM9, LPT1, LPT2, LPT3, LPT4, LPT5, LPT6, LPT7, LPT8, LPT9, AUX, CON, PRN, NUL, CLOCK\$, END_MARK

\*1 When an environment dependent character is included in a path name, a project can be opened by using the following menu:  
 [Project] ⇒ [Open]

# Appendix 5 Applicable Devices in GX Works3

## RCPUs

○: Applicable, △: Display only, ×: Not applicable —: Not available

Category	Device name	Symbol	Digit specification	Bit-specified word device	Device comment	Device memory	Initial device value
User device	Input	X	○	—	○	△	×
	Output	Y	○	—	○	△	×
	Internal relay	M	○	—	○	○	×
		#M	○	—	○	○	×
	Latch relay	L	○	—	○	○	×
	Link relay	B	○	—	○	○	×
	Annunciator	F	○	—	○	○	×
	Link special relay	SB	○	—	○	△	×
	Edge relay	V	○	—	○	○	×
		#V	○	—	○	○	×
	Step relay	S <sup>*1</sup>	○	—	×	△	×
	Timer	T	—	×	○	○	○
		#T	—	×	○	○	○
	Retentive timer	ST	—	×	○	○	○
		#ST	—	×	○	○	○
	Long timer	LT	—	×	○	○	○
		#LT	—	×	○	○	○
	Long retentive timer	LST	—	×	○	○	○
		#LST	—	×	○	○	○
	Counter	C	—	×	○	○	○
		#C	—	×	○	○	○
	Long counter	LC	—	×	○	○	○
		#LC	—	×	○	○	○
	Data register	D	—	○	○	○	○
		#D	—	○	○	○	○
	Link register	W	—	○	○	○	○
	Link special register	SW	—	○	○	○	○
	Direct access input	DX	—				
	Direct access output	DY	—				
	System device	Function input	FX	—			
Function output		FY	—				
Function register		FD	—				
Special relay		SM	○	—	○	△	×
Special register		SD	—	○	○	○	○
Link direct device	Link input	J□X	○	—	○	△ <sup>*2</sup>	×
	Link output	J□Y	○	—	○	△ <sup>*2</sup>	×
	Link relay	J□B	○	—	○	△ <sup>*2</sup>	×
	Link special relay	J□SB	○	—	○	△ <sup>*2</sup>	×
	Link register	J□W	—	○	○	○ <sup>*2</sup>	○
	Link special register	J□SW	—	○	○	○ <sup>*2</sup>	○
Module access device	Module access device	U□G	—	○	○	○ <sup>*2</sup>	○
CPU buffer memory access device	CPU buffer memory access device	U3E□G	—	○	○	○ <sup>*2</sup>	○
		U3E□HG	—	○	○	○ <sup>*2</sup>	○

Category	Device name	Symbol	Digit specification	Bit-specified word device	Device comment	Device memory	Initial device value
Index register	Index register	Z	—	×	×	○	×
		#Z	—	×	×	○	×
	Long index register	LZ	—	×	×	○	×
		#LZ	—	×	×	○	×
File register	File register	R	—	○	○	×	×
		ZR	—	○	○	○	○
Refresh data register	Refresh data register	RD	—	○	○	○	○
Nesting	Nesting	N	—	—	×	×	×
Pointer	Pointer	P	—	—	○	×	×
		#P	—	—	○	×	×
	Interrupt pointer	I	—	—	○	×	×
Other devices	SFC block device	BL	—	—	○	×	×
	SFC transition device	TR	—	—	×	×	×
	Step relay (with block specification)	BL□\S	—	—	○	×	×
	SFC transition device (with block specification)	BL□\TR	—	—	○	×	×
	Network number specified device	J	—	—	○	×	×
	I/O number specified device	U	—	—	○	×	×
Constant	Decimal constant	K	—	—	—	—	—
	Hexadecimal constant	H	—	—	—	—	—
	Real constant	E	—	—	—	—	—
	String constant	—	—	—	—	—	—

\*1 When editing it in other places except in a Zoom, specify a step relay with block specification (BL□\S).

\*2 Cannot be written to/read from the module in a device memory editor.

## How to input local devices

Prefix '#' to the device name (Example: #D10)

## Creating comments for module access devices

Device comments within the following range can be created in the buffer memory (3E00H to 3E30H) of a CPU module in a multiple CPU system.

Supported range	Unsupported range
U0 (IG0) to U1FF (IG268435455)	U200 (IG0) to U3DF (IG268435455)
U3E0 (IG0) to U3E3 (IG268435455)	

## Applicable devices in a safety project (safety devices)

○: Applicable, △: Display only, ×: Not applicable —: Not available

Category	Device name	Symbol	Digit specification	Bit-specified word device	Device comment	Device memory	Initial device value
Safety user device	Safety input	SAIX	○	—	○	△	×
	Safety output	SAIY	○	—	○	△	×
	Safety internal relay	SAIM	○	—	○	○	×
		SA#M	○	—	○	○	×
	Safety link relay	SAIB	○	—	○	○	×
	Safety timer	SAIT	—	×	○	○	×
		SA#T	—	×	○	○	×
	Safety retentive timer	SAIST	—	×	○	○	×
		SA#ST	—	×	○	○	×
	Safety counter	SAIC	—	×	○	○	×
		SA#C	—	×	○	○	×
	Safety data register	SAID	—	○	○	○	×
		SA#D	—	○	○	○	×
Safety link register	SAIW	—	○	○	○	×	
Safety system device	Safety special relay	SAISM	○	—	○	△	×
	Safety special register	SAISD	—	○	○	○	×

### ■How to input device

Global device: Prefix 'SA\'' to the device name. (Example: SA\D10)

Local device: Prefix 'SA\#' to the device name. (Example: SA#D10)

# LHCPUs

○: Applicable, △: Display only, ×: Not applicable —: Not available

Category	Device name	Symbol	Digit specification	Bit-specified word device	Device comment	Device memory	Initial device value	
User device	Input	X	○	—	○	△	×	
	Output	Y	○	—	○	△	×	
	Internal relay	M	○	—	○	○	×	
		#M	○	—	○	○	×	
	Latch relay	L	○	—	○	○	×	
	Link relay	B	○	—	○	○	×	
	Annunciator	F	○	—	○	○	×	
	Link special relay	SB	○	—	○	△	×	
	Edge relay	V	○	—	○	○	×	
		#V	○	—	○	○	×	
	Step relay	S <sup>1</sup>	○	—	×	△	×	
	Timer	T	—	×	○	○	○	
		#T	—	×	○	○	○	
	Retentive Timer	ST	—	×	○	○	○	
		#ST	—	×	○	○	○	
	Long Timer	LT	—	×	○	○	○	
		#LT	—	×	○	○	○	
	Long Retentive Timer	LST	—	×	○	○	○	
		#LST	—	×	○	○	○	
	Counter	C	—	×	○	○	○	
		#C	—	×	○	○	○	
	Long Counter	LC	—	×	○	○	○	
		#LC	—	×	○	○	○	
	Data register	D	—	○	○	○	○	
		#D	—	○	○	○	○	
	Link register	W	—	○	○	○	○	
	Link special register	SW	—	○	○	○	○	
	Direct access input	DX	—					
	Direct access output	DY	—					
	System device	Function input	FX	—				
		Function output	FY	—				
Function register		FD	—					
Special relay		SM	○	—	○	△	×	
Special register		SD	—	○	○	○	○	
Link direct device	Link input	J□X	○	—	○	△ <sup>*2</sup>	×	
	Link output	J□Y	○	—	○	△ <sup>*2</sup>	×	
	Link relay	J□B	○	—	○	△ <sup>*2</sup>	×	
	Link special relay	J□SB	○	—	○	△ <sup>*2</sup>	×	
	Link register	J□W	—	○	○	○ <sup>*2</sup>	○	
	Link special register	J□SW	—	○	○	○ <sup>*2</sup>	○	
Module access device	Module access device	U□G	—	○	○	○ <sup>*2</sup>	○	
CPU buffer memory access device	CPU buffer memory access device	U3E□G	—	○	○	○ <sup>*2</sup>	○	
		U3E□HG	—					
Index register	Index register	Z	—	×	×	○	×	
		#Z	—					
	Long index register	LZ	—	×	×	○	×	
		#LZ	—					

Category	Device name	Symbol	Digit specification	Bit-specified word device	Device comment	Device memory	Initial device value
File register	File register	R	—	○	○	×	×
		ZR	—	○	○	○	○
Refresh data register	Refresh data register	RD	—	○	○	○	○
Nesting	Nesting	N	—	—	×	×	×
Pointer	Pointer	P	—	—	○	×	×
		#P	—	—	○	×	×
	Interrupt pointer	I	—	—	○	×	×
Other devices	SFC block device	BL	—	—	○	×	×
	SFC transition device	TR	—	—	○	×	×
	Step relay (with block specification)	BL□\S	—	—	○	×	×
	SFC transition device (with block specification)	BL□\TR	—	—	○	×	×
	Network number specified device	J	—	—	○	×	×
	I/O number specified device	U	—	—	○	×	×
Constant	Decimal constant	K	—	—	○	×	×
	Hexadecimal constant	H	—	—	○	×	×
	Real constant	E	—	—	○	×	×
	String constant	—	—	—	○	×	×

\*1 When editing it in other places except in a Zoom, specify a step relay with block specification (BL□\S).

\*2 Cannot be written to/read from the module in a device memory editor.

## How to input local devices

Prefix '#' to the device name (Example: #D10)

## Creating comments for module access devices

Device comments within the following range can be created in the buffer memory (3E00H to 3E30H) of a CPU module.

Supported range	Unsupported range
U0 (IG0) to U1FF (IG268435455)	U200 (IG0) to U3DF (IG268435455)
U3E0 (IG0) to U3E3 (IG268435455)	

# FX5CPUs

○: Applicable, △: Display only, ×: Not applicable —: Not available

Category	Device name	Symbol	Digit specification	Bit-specified word device	Device comment	Device memory	Initial device value	Memory dump
User device	Input	X	○	—	○	△	×	○
	Output	Y	○	—	○	△	×	○
	Internal relay	M	○	—	○	○	×	○
		#M	—					
	Latch relay	L	○	—	○	○	×	○
	Link relay	B	○	—	○	○	×	○
	Annunciator	F	○	—	○	○	×	○
	Link special relay	SB	○	—	○	△	×	○
	Edge relay	V	—					
		#V	—					
	Step relay	S*1	○	—	○	○*2	×	○
	Timer	T	—	×	○	○	○	○
		#T	—					
	Retentive timer	ST	—	×	○	○	○	○
		#ST	—					
	Long Timer	LT	—					
		#LT	—					
	Long Retentive Timer	LST	—					
		#LST	—					
	Counter	C	—	×	○	○	○	○
		#C	—					
	Long counter	LC	—	×	○	○	○	○
		#LC	—					
	Data register	D	—	○	○	○	○	○
		#D	—					
	Link register	W	—	○	○	○	○	○
	Link special register	SW	—	○	○	○	○	○
	Direct access input	DX	—					
	Direct access output	DY	—					
	System device	Function input	FX	—				
Function output		FY	—					
Function register		FD	—					
Special relay		SM	○	—	○	△	×	○
Special register		SD	—	○	○	○	○	○
Link direct device	Link input	J□X	—					
	Link output	J□Y	—					
	Link relay	J□B	—					
	Link special relay	J□SB	—					
	Link register	J□W	—					
	Link special register	J□SW	—					
Module access device	Module access device	U□G*3	—	○	○	○*4	○	×
CPU buffer memory access device	CPU buffer memory access device	U3E□VG	—					
		U3E□H G	—					
Index register	Index register	Z	—	×	×	○	×	○
		#Z	—					
	Long index register	LZ	—	×	×	○	×	○
		#LZ	—					



Category	Device name	Symbol	Digit specification	Bit-specified word device	Device comment	Device memory	Initial device value	Memory dump
File register	File register	R	—	○	○	○	○	○
		ZR	—					
	Extended file register	ER	—	○	×	○	×	×
Refresh data register	Refresh data register	RD	—					
Nesting	Nesting	N	—	—	×	×	×	×
Pointer	Pointer	P	—	—	○	×	×	×
		#P	—					
	Interrupt pointer	I	—	—	○	×	×	×
Others	SFC block device	BL	—	—	○	×	×	×
	SFC transition device	TR	—	—	×	×	×	×
	Step relay (with block specification)	BL□\S	—	—	○	×	×	○
	SFC transition device (with block specification)	BL□\TR	—	—	○	×	×	×
	Network number specified device	J	—					
	I/O number specified device	U	—	—	○	×	×	×
Constant	Decimal constant	K	—					
	Hexadecimal constant	H	—					
	Real constant	E	—					
	String constant	—	—					

\*1 Specify a step relay with block specification (BL□\S) to edit the S device in other than a Zoom if "Use" is set in "To Use or Not to Use SFC" of the CPU parameter.

\*2 A step relay (S) is used as a step relay with block specification (BL□\S) to control an SFC program if "Use" is set in "To Use or Not to Use SFC" of the CPU parameter.

Therefore, the step relay (S) is treated as a read-only device.

\*3 FX5SCPU's do not support it.

\*4 Cannot be written to/read from the module in a device memory editor.

## Creating comments for module access devices

Device comments can be created within the range of U01 (\G0) to U10 (\G262143).

# Remote head modules

○: Applicable, △: Display only, ×: Not applicable —: Not available

Category	Device name	Symbol	Digit specification	Bit-specified word device	Device comment	Device memory
User device	Input	X	○	—	○	△
	Output	Y	○	—	○	△
	Internal relay	M	—			
		#M	—			
	Latch relay	L	—			
	Link relay	B	—			
	Annunciator	F	—			
	Link special relay	SB	○	—	○	△
	Edge relay	V	—			
		#V	—			
	Step relay	S	—			
	Timer	T	—			
		#T	—			
	Retentive timer	ST	—			
		#ST	—			
	Long timer	LT	—			
		#LT	—			
	Long retentive timer	LST	—			
		#LST	—			
	Counter	C	—			
		#C	—			
	Long counter	LC	—			
		#LC	—			
	Data register	D	—			
		#D	—			
	Link register	W	—	○	○	○
	Link special register	SW	—	○	○	○
	Direct access input	DX	○	—	×	×
	Direct access output	DY	○	—	×	×
	System device	Function input	FX	—		
Function output		FY	—			
Function register		FD	—			
Special relay		SM	○	—	○	△
Special register		SD	—	○	○	○
Link direct device	Link input	J□X	—			
	Link output	J□Y	—			
	Link relay	J□B	—			
	Link special relay	J□SB	—			
	Link register	J□W	—			
	Link special register	J□SW	—			
Module access device	Module access device	U□\G	—	○	○	○*1
CPU buffer memory access device	CPU buffer memory access device	U3E□\G	—	○	×	×
		U3E□\HG	—			
Index register	Index register	Z	—			
		#Z	—			
	Long index register	LZ	—			
		#LZ	—			

Category	Device name	Symbol	Digit specification	Bit-specified word device	Device comment	Device memory
File register	File register	R	—	○	×	×
		ZR	—	○	×	×
Refresh data register	Refresh data register	RD	—	○	○	○
Nesting	Nesting	N	—			
Pointer	Pointer	P	—			
		#P	—			
	Interrupt pointer	I	—			
Other devices	SFC block device	BL	—			
	SFC transition device	TR	—			
	Step relay (with block specification)	BL□S	—			
	SFC transition device (with block specification)	BL□TR	—			
	Network number specified device	J	—	—	×	×
	I/O number specified device	U	—	—	×	×
Constant	Decimal constant	K	—			
	Hexadecimal constant	H	—			
	Real constant	E	—			
	String constant	—	—			

\*1 Cannot be written to/read from the module in a device memory editor.

# Appendix 6 Label Memory Types

---

The label memory are used by a system for label assignment.

The following table shows the label memory types that are displayed in GX Works3.

Symbol	Description
GV:	The label memory assigned to a global label other than the pointer type.
UV:	The label memory assigned to a module label.
LV:	The label memory assigned to a local label other than the pointer type.
LLV:	The label memory assigned to a local latch label, which is a latch attribute local label of a function block.
LLP	The label memory assigned to a pointer type local label.
GLP	The label memory assigned to a pointer type global label.

## Precautions

In GX Works3, the address of label memory assigned to a label may be displayed; however, this address cannot be directly used by a user.

# MEMO

---

A

# Appendix 7 Replacement of Another Format Project

When using another format project in the GX Works3 format, some instructions, devices, and programs are required to be replaced. Check the contents in this section, and correct the project.

## Replacement of a GX Works2 format project

The following explains the methods for replacing data to use a GX Works2 format project in the GX Works3 format.

To use a GX Works2 format project for an FXCPU in the GX Works3 format, refer to the following:

 Transition from MELSEC FX3G, FX3U, FX3UC Series to MELSEC iQ-F Series Handbook

For details on the conversion processing for each data, refer to the following:

 Page 107 Opening a GX Works2 format project

### Correcting parameters

The device/label automatic-assign settings in a GX Works2 format project are applied to "Label Area Capacity," "Latch Label Area Capacity," and "Latch Type Setting of Latch Type Label" of "CPU Parameter" in a GX Works3 format project.

However, depending on a GX Works2 format project, the settings may not be applied.

In that case, check the changes in the "Output" window, and set "CPU Parameter" depending on the label capacity of the project.

The setting items for a GX Works3 format project corresponding to that for a GX Works2 format project are as follows.

GX Works2		GX Works3	
Project	Device/label automatic-assign setting	CPU parameter	Setting content
<ul style="list-style-type: none"> <li>Simple project with labels</li> <li>Structured project</li> </ul>	Total points (VAR)	Label area capacity	The settings are applied.
	Total points (VAR_RETAIN)	Latch label area capacity	
	Latch selection column (latch type)	Latch type setting of latch type label	<ul style="list-style-type: none"> <li>When all the latch types of each data type<sup>*1</sup> are the same, the settings are applied.</li> <li>When a latch type is different between these data types<sup>*1</sup>, "Latch(1)" is set.</li> </ul>
<ul style="list-style-type: none"> <li>Simple project with no labels</li> <li>A project in which the value of "Use Volume" exceeds that of "Total Capacity" in the "Device/Label Memory Configuration" screen in GX Works3.<sup>*2,*3</sup></li> <li>A project created in GX Works2 Version 1.570U or earlier</li> </ul>	Total points (VAR)	Label area capacity	"0 K word" is set.
	Total points (VAR_RETAIN)	Latch label area capacity	
	Latch selection column (latch type)	Latch type setting of latch type label	"Latch(1)" is set.

\*1 Word device, bit device, timer, retentive timer, and counter

\*2 For details on the device/label memory, refer to the following:

 MELSEC iQ-R CPU Module User's Manual (Application)

\*3 The "Device/Label Memory Configuration" screen appears when "Device/Label Memory Configuration Confirmation" is clicked in "CPU Parameter."

## Automatic replacement of elements (GX Works3 Version 1.047Z or later)

Many of the elements (instructions, standard functions, and standard function blocks) used in a GX Works2 format project are automatically replaced with ones available in GX Works3.

For some of these elements, however, the data type and the order of arguments are different between GX Works2 and GX Works3. Therefore, correcting the data type and the order of arguments is required to avoid an error at the program conversion. (Page 913 Replacement of instructions (GX Works3 Version 1.040S or later))

In addition, elements not supported by MELSEC iQ-R series or MELSEC iQ-L series modules cannot be replaced with ones available in GX Works3. (Page 906 Elements that are not supported by MELSEC iQ-R series or MELSEC iQ-L series modules)

### ■Elements to be replaced automatically (for compatibility use)

The following table shows the elements (instructions, standard functions, and standard function blocks) of ST and FBD/LD programs that are automatically replaced.

The elements to which "\_M2" is added to their names are the replacements for elements of a GX Works2 format project.

Do not use these elements to create a program in GX Works3.

Name before replacement → Name after replacement		
- → MINUS_M2	-P → MINUSP_M2	* → MULTI_M2
*P → MULTIP_M2	/ → DIVISION_M2	/P → DIVISIONP_M2
+ → PLUS_M2	+P → PLUSP_M2	ABRST1_M → Z_ABRST1_M2
ABRST2_M → Z_ABRST2_M2	ABRST3_M → Z_ABRST3_M2	ABRST4_M → Z_ABRST4_M2
ABS_E → ABS_E_M2	ACOS → ACOS_M2	ACOS_E → ACOS_E_M2
ACOS_E_MD → ACOS_M2	ACOS_MD → ACOS_M2	ACOSD → ACOSD_M2
ACOSD_E_MD → ACOSD_M2	ACOSD_MD → ACOSD_M2	ADD_E → ADD_E_M2
ADD_TIME_E → ADD_TIME_E_M2	AND_E → AND_E_M2	AND_EQ_M → AND_EQ_M2
AND_GE_M → AND_GE_M2	AND_GT_M → AND_GT_M2	AND_LE_M → AND_LE_M2
AND_LT_M → AND_LT_M2	AND_NE_M → AND_NE_M2	AND< → AND_LT_M2
AND<= → AND_LE_M2	AND<> → AND_NE_M2	AND= → AND_EQ_M2
AND> → AND_GT_M2	AND>= → AND_GE_M2	ANDD_EQ_M → ANDD_EQ_M2
ANDD_GE_M → ANDD_GE_M2	ANDD_GT_M → ANDD_GT_M2	ANDD_LE_M → ANDD_LE_M2
ANDD_LT_M → ANDD_LT_M2	ANDD_NE_M → ANDD_NE_M2	ANDD< → ANDD_LT_M2
ANDD<= → ANDD_LE_M2	ANDD<> → ANDD_NE_M2	ANDD= → ANDD_EQ_M2
ANDD> → ANDD_GT_M2	ANDD>= → ANDD_GE_M2	ASIN → ASIN_M2
ASIN_E → ASIN_E_M2	ASIN_E_MD → ASIN_M2	ASIN_MD → ASIN_M2
ASIND → ASIND_M2	ASIND_E_MD → ASIND_M2	ASIND_MD → ASIND_M2
ATAN → ATAN_M2	ATAN_E → ATAN_E_M2	ATAN_E_MD → ATAN_M2
ATAN_MD → ATAN_M2	ATAND → ATAND_M2	ATAND_E_MD → ATAND_M2
ATAND_MD → ATAND_M2	BAND → BAND_M2	BAND_MD → BAND_M2
BAND_P_MD → BANDP_M2	BANDP → BANDP_M2	BCD_TO_DINT_E → BCD_TO_DINT_E_M2
BCD_TO_INT_E → BCD_TO_INT_E_M2	BCD_TO_STR_E → BCD_TO_STR_E_M2	BDSQR → BDSQR_M2
BDSQRP → BDSQRP_M2	BIDIN_M → G_BIDIN_M2	BIDINP_M → GP_BIDIN_M2
BIDOUT_M → G_BIDOUT_M2	BIDOUTP_M → GP_BIDOUT_M2	BINDA → BINDA_M2
BINDA_K_MD → BINDA_M2	BINDA_K_P_MD → BINDAP_M2	BINDA_MD → BINDA_M2
BINDA_P_MD → BINDAP_M2	BINDA_P_S_MD → BINDAP_M2	BINDA_S_MD → BINDA_M2
BINDAP → BINDAP_M2	BITARR_TO_DINT_E → BITARR_TO_DINT_E_M2	BITARR_TO_INT_E → BITARR_TO_INT_E_M2
BK-P → BKMINUSP_M2	BKCMP_EQ_M → BKCMP_EQ_M2	BKCMP_EQP_M → BKCMP_EQP_M2
BK+ → BKPLUSP_M2	BK+P → BKPLUSP_M2	BK- → BKMINUS_M2
BKCMP_GE_M → BKCMP_GE_M2	BKCMP_GEP_M → BKCMP_GEP_M2	BKCMP_GT_M → BKCMP_GT_M2
BKCMP_GTP_M → BKCMP_GTP_M2	BKCMP_LE_M → BKCMP_LE_M2	BKCMP_LEP_M → BKCMP_LEP_M2
BKCMP_LT_M → BKCMP_LT_M2	BKCMP_LTP_M → BKCMP_LTP_M2	BKCMP_NE_M → BKCMP_NE_M2
BKCMP_NEP_M → BKCMP_NEP_M2	BKCMP< → BKCMP_LT_M2	BKCMP<P → BKCMP_LTP_M2
BKCMP<= → BKCMP_LE_M2	BKCMP<=P → BKCMP_LEP_M2	BKCMP<> → BKCMP_NE_M2
BKCMP<>P → BKCMP_NEP_M2	BKCMP= → BKCMP_EQ_M2	BKCMP=P → BKCMP_EQP_M2

Name before replacement → Name after replacement		
BKCOMP> → BKCOMP_GT_M2	BKCOMP>P → BKCOMP_GTP_M2	BKCOMP>= → BKCOMP_GE_M2
BKCOMP>=P → BKCOMP_GEP_M2	BKMINUS_M → BKMINUS_M2	BKMINUSP_M → BKMINUSP_M2
BKPLUS_M → BKPLUS_M2	BKPLUSP_M → BKPLUSP_M2	BKRST → BKRST_M2
BKRST_M → BKRST_M2	BKRSTP → BKRSTP_M2	BKRSTP_M → BKRSTP_M2
BOOL_TO_DINT_E → BOOL_TO_DINT_E_M2	BOOL_TO_DWORD_E → BOOL_TO_DWORD_E_M2	BOOL_TO_INT_E → BOOL_TO_INT_E_M2
BOOL_TO_STR_E → BOOL_TO_STR_E_M2	BOOL_TO_TIME_E → BOOL_TO_TIME_E_M2	BOOL_TO_WORD_E → BOOL_TO_WORD_E_M2
BSQR → BSQR_M2	BSQRP → BSQRP_M2	BUFRCV_M → ZP_BUFRCV_M2
BUFSND_M → ZP_BUFSND_M2	CLOSE_M → ZP_CLOSE_M2	COS → COS_M2
COS_E → COS_E_M2	CONCAT_E → CONCAT_E_M2	COS_E_MD → COS_M2
COS_MD → COS_M2	COSD → COSD_M2	COSD_E_MD → COSD_M2
COSD_MD → COSD_M2	CPY_BIT_OF_INT_E → CPY_BIT_OF_INT_E_M2	CPY_BITARR_E → CPY_BITARR_E_M2
CSET_M → ZP_CSET_M2	CSET_P_M → ZP_CSET_M2	CTD → CTD_M2 <sup>*1</sup>
CTD_E → CTD_E_M2 <sup>*1</sup>	CTU → CTU_M2 <sup>*1</sup>	CTU_E → CTU_E_M2 <sup>*1</sup>
CTUD → CTUD_M2 <sup>*1</sup>	CTUD_E → CTUD_E_M2 <sup>*1</sup>	D-P → DMINUSP_M2
DABIN_P_MD → DABINP_M2	DABIN_P_S_MD → DABINP_M2	D/ → DDIVISION_M2
D/P → DDIVISIONP_M2	DABIN → DABIN_M2	D+ → DPLUS_M2
D* → DMULTI_M2	D*P → DMULTIP_M2	DABIN_MD → DABIN_M2
D+P → DPLUSP_M2	D- → DMINUS_M2	DABIN_S_MD → DABIN_M2
DABINP → DABINP_M2	DB* → DBMULTI_M2	DB*P → DBMULTIP_M2
DBAND → DBAND_M2	DBAND_MD → DBAND_M2	DBAND_P_MD → DBANDP_M2
DBANDP → DBANDP_M2	DBINDA → DBINDA_M2	DBINDA_K_MD → DBINDA_M2
DBINDA_K_P_MD → DBINDAP_M2	DBINDA_MD → DBINDA_M2	DBINDA_P_MD → DBINDAP_M2
DBINDA_P_S_MD → DBINDAP_M2	DBINDA_S_MD → DBINDA_M2	DBINDAP → DBINDAP_M2
DBK-P → DBKMINUSP_M2	DBKCOMP_EQ_M → DBKCOMP_EQ_M2	DBK- → DBKMINUS_M2
DBKCOMP_GE_M → DBKCOMP_GE_M2	DBKCOMP_GEP_M → DBKCOMP_GEP_M2	DBKCOMP_EQP_M → DBKCOMP_EQP_M2
DBK+ → DBKPLUS_M2	DBK+P → DBKPLUSP_M2	DBKCOMP_GT_M → DBKCOMP_GT_M2
DBKCOMP_GTP_M → DBKCOMP_GTP_M2	DBKCOMP_LE_M → DBKCOMP_LE_M2	DBKCOMP_LEP_M → DBKCOMP_LEP_M2
DBKCOMP_LT_M → DBKCOMP_LT_M2	DBKCOMP_LTP_M → DBKCOMP_LTP_M2	DBKCOMP_NE_M → DBKCOMP_NE_M2
DBKCOMP_NEP_M → DBKCOMP_NEP_M2	DBKCOMP< → DBKCOMP_LT_M2	DBKCOMP<> → DBKCOMP_NE_M2
DBKCOMP<>P → DBKCOMP_NEP_M2	DBKCOMP= → DBKCOMP_EQ_M2	DBKCOMP<P → DBKCOMP_LTP_M2
DBKCOMP<= → DBKCOMP_LE_M2	DBKCOMP<=P → DBKCOMP_LEP_M2	DBKCOMP=P → DBKCOMP_EQP_M2
DBKCOMP> → DBKCOMP_GT_M2	DBKCOMP>P → DBKCOMP_GTP_M2	DBKCOMP>= → DBKCOMP_GE_M2
DBKCOMP>=P → DBKCOMP_GEP_M2	DBKMINUS_M → DBKMINUS_M2	DBKMINUSP_M → DBKMINUSP_M2
DBKPLUS_M → DBKPLUS_M2	DBKPLUSP_M → DBKPLUSP_M2	DBMULTI_M → DBMULTI_M2
DBMULTIP_M → DBMULTIP_M2	DDABIN → DDABIN_M2	DDABIN_MD → DDABIN_M2
DDABIN_P_MD → DDABINP_M2	DDABIN_P_S_MD → DDABINP_M2	DDABIN_S_MD → DDABIN_M2
DDABINP → DDABINP_M2	DDEC → DDEC_M2	DDEC_M → DDEC_M2
DDECP → DDECP_M2	DDECP_M → DDECP_M2	DDIVID_3_M → DDIVISION_M2
DDIVIDP_3_M → DDIVISIONP_M2	DEC → DEC_M2	DEC_M → DEC_M2
DECP → DECP_M2	DECP_M → DECP_M2	DELETE_E → DELETE_E_M2
DGBIN → DGBIN_M2	DGBIN_M → DGBIN_M2	DGBINP → DGBINP_M2
DGBINP_M → DGBINP_M2	DGRY → DGRY_M2	DGRY_M → DGRY_M2
DGRYP → DGRYP_M2	DGRYP_M → DGRYP_M2	DINC → DINC_M2
DINC_M → DINC_M2	DINCP → DINCP_M2	DINCP_M → DINCP_M2
DINT_TO_BITARR_E → DINT_TO_BITARR_E_M2	DIV_TIME_E → DIV_TIME_E_M2	DINT_TO_INT_E → DINT_TO_INT_E_M2
DINT_TO_LREAL_E → DINT_TO_LREAL_E_M2	DINT_TO_REAL_E → DINT_TO_REAL_E_M2	DINT_TO_STR_E → DINT_TO_STR_E_M2
DINT_TO_TIME_E → DINT_TO_TIME_E_M2	DINT_TO_WORD_E → DINT_TO_WORD_E_M2	DIV_E → DIV_E_M2
DINT_TO_BCD_E → DINT_TO_BCD_E_M2	DINT_TO_BOOL_E → DINT_TO_BOOL_E_M2	DINT_TO_DWORD_E → DINT_TO_DWORD_E_M2
DIVID_3_M → DIVISION_M2	DIVIDP_3_M → DIVISIONP_M2	DLIMIT → DLIMIT_M2
DLIMIT_MD → DLIMIT_M2	DLIMIT_P_MD → DLIMITP_M2	DLIMITP → DLIMITP_M2



Name before replacement → Name after replacement		
DMAX → DMAX_M2	DMAX_M → DMAX_M2	DMAXP → DMAXP_M2
DMAXP_M → DMAXP_M2	DMEAN → DMEAN_M2	DMEAN_M → DMEAN_M2
DMEANP → DMEANP_M2	DMEANP_M → DMEANP_M2	DMIN → DMIN_M2
DMIN_M → DMIN_M2	DMINP → DMINP_M2	DMINP_M → DMINP_M2
DMINUS_3_M → DMINUS_M2	DMINUS_M → DMINUS_2_M2	DMINUSP_3_M → DMINUSP_M2
DMINUSP_M → DMINUSP_2_M2	DMULTI_3_M → DMULTI_M2	DMULTIP_3_M → DMULTIP_M2
DPLUS_3_M → DPLUS_M2	DPLUS_M → DPLUS_2_M2	DPLUSP_3_M → DPLUSP_M2
DPLUSP_M → DPLUSP_2_M2	DROL → DROL_M2	DROL_M → DROL_M2
DROR → DROR_M2	DROR_M → DROR_M2	DSCL → DSCL_M2
DSCL2 → DSCL2_M2	DSCL2P → DSCL2P_M2	DSCLP → DSCLP_M2
DSORT → DSORT_M2	DSORT_M → DSORT_M2	DSTR → DSTR_M2
DSTR_K_MD → DSTR_M2	DSTR_K_P_MD → DSTRP_M2	DSTR_MD → DSTR_M2
DSTR_P_MD → DSTRP_M2	DSTR_P_S_MD → DSTRP_M2	DSTR_S_MD → DSTR_M2
DSTRP → DSTRP_M2	DTO → DTO_M2	DTO_M → DTO_M2
DTOP → DTOP_M2	DTOP_M → DTOP_M2	DVAL → DVAL_M2
DVAL_MD → DVAL_M2	DVAL_P_MD → DVALP_M2	DVAL_P_S_MD → DVALP_M2
DVAL_S_MD → DVAL_M2	DVALP → DVALP_M2	DWORD_TO_BOOL_E → DWORD_TO_BOOL_E_M2
DWORD_TO_DINT_E → DWORD_TO_DINT_E_M2	DWORD_TO_INT_E → DWORD_TO_INT_E_M2	DWORD_TO_STR_E → DWORD_TO_STR_E_M2
DWORD_TO_TIME_E → DWORD_TO_TIME_E_M2	DWORD_TO_WORD_E → DWORD_TO_WORD_E_M2	DWSUM → DWSUM_M2
DWSUM_M → DWSUM_M2	DWSUMP → DWSUMP_M2	DWSUMP_M → DWSUMP_M2
DZONE → DZONE_M2	DZONE_MD → DZONE_M2	DZONE_P_MD → DZONEP_M2
DZONEP → DZONEP_M2	EQ_E → EQ_E_M2	EREXP → EREXP_M2
EREXP_M → EREXP_M2	EREXPP → EREXP_M2	EREXPP_M → EREXP_M2
ERRCLR_M → ZP_ERRCLR_M2	ERRRD_M → ZP_ERRRD_M2	EXP → EXP_M2
EXP_E → EXP_E_M2	EXP_E_MD → EXP_M2	EXP_MD → EXP_M2
EXPD → EXPD_M2	EXPD_E_MD → EXPD_M2	EXPD_MD → EXPD_M2
EXPT_E → EXPT_E_M2	F_TRIG → F_TRIG_M2*1	F_TRIG_E → F_TRIG_E_M2*1
FIND_E → FIND_E_M2	G_BIDIN → G_BIDIN_M2	G_BIDOUT → G_BIDOUT_M2
G_CCASET → G_CCASET_M2	G_CPRTCL → G_CPRTCL_M2	G_GETE → G_GETE_M2
G_INPUT → G_INPUT_M2	G_OGLOAD → G_OGLOAD_M2	G_OGSTOR → G_OGSTOR_M2
G_ONDEMAND → G_ONDEMAND_M2	G_OUTPUT → G_OUTPUT_M2	G_PRR → G_PRR_M2
G_PUTE → G_PUTE_M2	G_RDMSG → G_RDMSG_M2	G_REQ → G_REQ_M2
G_RIRCV → G_RIRCV_M2	G_RIRD → G_RIRD_M2	G_RISEND → G_RISEND_M2
G_RITO → G_RITO_M2	G_RIWT → G_RIWT_M2	G_RLPASET → G_RLPASET_M2
G_SPBUSY → G_SPBUSY_M2	GBIN → GBIN_M2	GBIN_M → GBIN_M2
GBINP → GBINP_M2	GBINP_M → GBINP_M2	GE_E → GE_E_M2
GET_BIT_OF_INT_E → GET_BIT_OF_INT_E_M2	GETE_M → G_GETE_M2	GETEP_M → GP_GETE_M2
GP_BIDIN → GP_BIDIN_M2	GP_BIDOUT → GP_BIDOUT_M2	GP_CCASET → GP_CCASET_M2
GP_CPRTCL → GP_CPRTCL_M2	GP_ECPRTCL → GP_ECPRTCL_M2	GP_GETE → GP_GETE_M2
GP_OGLOAD → GP_OGLOAD_M2	GP_OGSTOR → GP_OGSTOR_M2	GP_ONDEMAND → GP_ONDEMAND_M2
GP_OUTPUT → GP_OUTPUT_M2	GP_PRR → GP_PRR_M2	GP_PUTE → GP_PUTE_M2
GP_RDMSG → GP_RDMSG_M2	GP_RECV → GP_RECV_M2	GP_REQ → GP_REQ_M2
GP_RIRCV → GP_RIRCV_M2	GP_RIRD → GP_RIRD_M2	GP_RISEND → GP_RISEND_M2
GP_RITO → GP_RITO_M2	GP_RIWT → GP_RIWT_M2	GP_RLPASET → GP_RLPASET_M2
GP_SEND → GP_SEND_M2	GP_SPBUSY → GP_SPBUSY_M2	GRY → GRY_M2
GRY_M → GRY_M2	GRYP → GRYP_M2	GRYP_M → GRYP_M2
GT_E → GT_E_M2	INC → INC_M2	INC_M → INC_M2
INCP → INCP_M2	INCP_M → INCP_M2	INPUT_M → G_INPUT_M2
INSERT_E → INSERT_E_M2	INT_TO_BCD_E → INT_TO_BCD_E_M2	INT_TO_BITARR_E → INT_TO_BITARR_E_M2
INT_TO_BOOL_E → INT_TO_BOOL_E_M2	INT_TO_DINT_E → INT_TO_DINT_E_M2	INT_TO_DWORD_E → INT_TO_DWORD_E_M2
INT_TO_LREAL_E → INT_TO_LREAL_E_M2	INT_TO_REAL_E → INT_TO_REAL_E_M2	INT_TO_STR_E → INT_TO_STR_E_M2

Name before replacement → Name after replacement		
INT_TO_TIME_E → INT_TO_TIME_E_M2	INT_TO_WORD_E → INT_TO_WORD_E_M2	LD_EQ_M → LD_EQ_M2
LD_GE_M → LD_GE_M2	LD_GT_M → LD_GT_M2	LD_LE_M → LD_LE_M2
LD_LT_M → LD_LT_M2	LD_NE_M → LD_NE_M2	LD< → LD_LT_M2
LD<= → LD_LE_M2	LD<> → LD_NE_M2	LD= → LD_EQ_M2
LD> → LD_GT_M2	LD>= → LD_GE_M2	LDD_EQ_M → LDD_EQ_M2
LDD_GE_M → LDD_GE_M2	LDD_GT_M → LDD_GT_M2	LDD_LE_M → LDD_LE_M2
LDD_LT_M → LDD_LT_M2	LDD_NE_M → LDD_NE_M2	LDD< → LDD_LT_M2
LDD<= → LDD_LE_M2	LDD<> → LDD_NE_M2	LDD= → LDD_EQ_M2
LDD> → LDD_GT_M2	LDD>= → LDD_GE_M2	LE_E → LE_E_M2
LEFT → LEFT_M2	LEFT_E → LEFT_E_M2	LEFT_M → LEFT_M2
LEN → LEN_M2	LEN_E → LEN_E_M2	LEN_MD → LEN_M2
LEN_S → LEN_M2	LEN_S_MD → LEN_M2	LIMIT → LIMIT_M2
LIMIT_MD → LIMIT_M2	LIMIT_E → LIMITATION_E_M2	LIMIT_P_MD → LIMITP_M2
LIMITATION_E → LIMITATION_E_M2	LIMITP → LIMITP_M2	LN_E → LN_E_M2
LOG → LOG_M2	LOG_E → LOG_E_M2	LOG_E_MD → LOG_M2
LOG_MD → LOG_M2	LOGD → LOGD_M2	LOGD_E_MD → LOGD_M2
LOGD_MD → LOGD_M2	LREAL_TO_DINT_E → LREAL_TO_DINT_E_M2	LREAL_TO_INT_E → LREAL_TO_INT_E_M2
LREAL_TO_REAL_E → LREAL_TO_REAL_E_M2	LT_E → LT_E_M2	MAX_E → MAXIMUM_E_M2
MAX_M → MAX_M2	M_REAL_TO_REAL_E → M_REAL_TO_REAL_E_M2	MAX → MAX_M2
MAXP_M → MAXP_M2	MAXIMUM_E → MAXIMUM_E_M2	MAXP → MAXP_M2
MEANP → MEANP_M2	MEAN → MEAN_M2	MEAN_M → MEAN_M2
MIN → MIN_M2	MEANP_M → MEANP_M2	MID_E → MID_E_M2
MINP → MINP_M2	MIN_M → MIN_M2	MINIMUM_E → MINIMUM_E_M2
MINUS_M → MINUS_2_M2	MINP_M → MINP_M2	MINUS_3_M → MINUS_M2
MOD_E → MOD_E_M2	MINUSP_3_M → MINUSP_M2	MINUSP_M → MINUSP_2_M2
MUL_TIME_E → MUL_TIME_E_M2	MOVE_E → MOVE_E_M2	MUL_E → MUL_E_M2
MUX_E → MUX_E_M2	MULTI_3_M → MULTI_M2	MULTIP_3_M → MULTIP_M2
OGLOAD_U_M → G_OGLOAD_M2	NE_E → NE_E_M2	NOT_E → NOT_E_M2
OGSTOR_UP_M → GP_OGSTOR_M2	OGLOAD_UP_M → GP_OGLOAD_M2	OGSTOR_U_M → G_OGSTOR_M2
OPEN_M → ZP_OPEN_M2	ONDEMAND_M → G_ONDEMAND_M2	ONDEMANDP_M → GP_ONDEMAND_M2
OR_E → OR_E_M2	OR_EQ_M → OR_EQ_M2	OR_GE_M → OR_GE_M2
OR_GT_M → OR_GT_M2	OR_LE_M → OR_LE_M2	OR_LT_M → OR_LT_M2
OR_NE_M → OR_NE_M2	OR< → OR_LT_M2	OR<> → OR_NE_M2
OR<= → OR_LE_M2	OR= → OR_EQ_M2	OR> → OR_GT_M2
OR>= → OR_GE_M2	ORD_EQ_M → ORD_EQ_M2	ORD_GE_M → ORD_GE_M2
ORD_GT_M → ORD_GT_M2	ORD_GE → ORD_GE_M2	ORD_LE_M → ORD_LE_M2
ORD_LT_M → ORD_LT_M2	ORD_NE_M → ORD_NE_M2	ORD< → ORD_LT_M2
ORD<= → ORD_LE_M2	ORD<> → ORD_NE_M2	ORD= → ORD_EQ_M2
ORD> → ORD_GT_M2	ORD>= → ORD_GE_M2	OUTPUT_M → G_OUTPUT_M2
OUTPUTP_M → GP_OUTPUT_M2	PFWRP_P_M → ZP_PFWRP_M2	PINIT_M → ZP_PINIT_M2
PINIT_P_M → ZP_PINIT_M2	PLUS_3_M → PLUS_M2	PLUS_M → PLUS_2_M2
PLUSP_3_M → PLUSP_M2	PLUSP_M → PLUSP_2_M2	PRR_M → G_PRR_M2
PRRP_M → GP_PRR_M2	PSTRT1_P_M → ZP_PSTRT1_M2	PSTRT2_P_M → ZP_PSTRT2_M2
PSTRT3_P_M → ZP_PSTRT3_M2	PSTRT4_P_M → ZP_PSTRT4_M2	PUTE_M → G_PUTE_M2
PUTEP_M → GP_PUTE_M2	R_TRIG → R_TRIG_M2 <sup>*1</sup>	R_TRIG_E → R_TRIG_E_M2 <sup>*1</sup>
RDMSG_MD → G_RDMSG_M2	RDMSG_P_MD → GP_RDMSG_M2	REAL_TO_DINT_E → REAL_TO_DINT_E_M2
REAL_TO_INT_E → REAL_TO_INT_E_M2	REAL_TO_LREAL_E → REAL_TO_LREAL_E_M2	REAL_TO_M_REAL_E → REAL_TO_M_REAL_E_M2
REAL_TO_STR_E → REAL_TO_STR_E_M2	RECV_UP_M → GP_RECV_M2	RECV_P_M → GP_RECV_M2
RECVS_U_M → Z_RECVS_M2	REMTO_P_MD → ZP_REMTO_M2	REPLACE_E → REPLACE_E_M2
REQ_M → G_REQ_M2	REQ_U_M → G_REQ_M2	REQ_UP_M → GP_REQ_M2
REQP_M → GP_REQ_M2	RIGHT → RIGHT_M2	RIGHT_E → RIGHT_E_M2

Name before replacement → Name after replacement		
RIGHT_M → RIGHT_M2	RIRCV_MD → G_RIRCV_M2	RIRCV_P_MD → GP_RIRCV_M2
RIRD_MD → G_RIRD_M2	RIRD_P_MD → GP_RIRD_M2	RISEND_MD → G_RISEND_M2
RISEND_P_MD → GP_RISEND_M2	RITO_MD → G_RITO_M2	RITO_P_MD → GP_RITO_M2
RIWT_MD → G_RIWT_M2	RIWT_P_MD → GP_RIWT_M2	RLPASET_MD → G_RLPASET_M2
RLPASET_P_MD → GP_RLPASET_M2	ROL → ROL_M2	ROL_E → ROL_E_M2
ROL_M → ROL_M2	ROR → ROR_M2	ROR_E → ROR_E_M2
ROR_M → ROR_M2	RS → RS_M2*1	RS_E → RS_E_M2*1
SCL → SCL_M2	SCL2 → SCL2_M2	SCL2P → SCL2P_M2
SCLP → SCLP_M2	SEL_E → SEL_E_M2	SEND_4_P_M → GP_SEND_M2
SEND_UP_M → GP_SEND_M2	SET_BIT_OF_INT_E → SET_BIT_OF_INT_E_M2	SHL_E → SHL_E_M2
SHR_E → SHR_E_M2	SIN → SIN_M2	SIN_E → SIN_E_M2
SIN_E_MD → SIN_M2	SIN_MD → SIN_M2	SIND → SIND_M2
SIND_E_MD → SIND_M2	SIND_MD → SIND_M2	SORT → SORT_M2
SORT_M → SORT_M2	SPBUSY_MD → G_SPBUSY_M2	SPBUSY_P_MD → GP_SPBUSY_M2
SQRT_E → SQRT_E_M2	SR → SR_M2*1	SR_E → SR_E_M2*1
STR → STR_M2	STR_K_MD → STR_M2	STR_K_P_MD → STRP_M2
STR_MD → STR_M2	STR_P_MD → STRP_M2	STR_P_S_MD → STRP_M2
STR_S_MD → STR_M2	STR_TO_BCD_E → STR_TO_BCD_E_M2	STR_TO_BOOL_E → STR_TO_BOOL_E_M2
STR_TO_DINT_E → STR_TO_DINT_E_M2	STR_TO_DWORD_E → STR_TO_DWORD_E_M2	STR_TO_INT_E → STR_TO_INT_E_M2
STR_TO_REAL_E → STR_TO_REAL_E_M2	STR_TO_TIME_E → STR_TO_TIME_E_M2	STR_TO_WORD_E → STR_TO_WORD_E_M2
STRP → STRP_M2	SUB_E → SUB_E_M2	SUB_TIME_E → SUB_TIME_E_M2
SWAP → SWAP_M2	SWAP_MD → SWAP_M2	SWAP_P_MD → SWAPP_M2
SWAPP → SWAPP_M2	TAN → TAN_M2	TAN_E → TAN_E_M2
TAN_E_MD → TAN_M2	TAN_MD → TAN_M2	TAND → TAND_M2
TAND_E_MD → TAND_M2	TAND_MD → TAND_M2	TEACH1_P_M → ZP_TEACH1_M2
TEACH2_P_M → ZP_TEACH2_M2	TEACH3_P_M → ZP_TEACH3_M2	TEACH4_P_M → ZP_TEACH4_M2
TIME_TO_BOOL_E → TIME_TO_BOOL_E_M2	TIME_TO_DINT_E → TIME_TO_DINT_E_M2	TIME_TO_DWORD_E → TIME_TO_DWORD_E_M2
TIME_TO_INT_E → TIME_TO_INT_E_M2	TIME_TO_STR_E → TIME_TO_STR_E_M2	TIME_TO_WORD_E → TIME_TO_WORD_E_M2
TO → TO_M2	TO_M → TO_M2	TOF_HIGH → TOF_HIGH_M2*1
TOF_HIGH_E → TOF_HIGH_E_M2*1	TON_HIGH → TON_HIGH_M2*1	TON_HIGH_E → TON_HIGH_E_M2*1
TOP → TOP_M2	TOP_M → TOP_M2	TP_HIGH → TP_HIGH_M2*1
TP_HIGH_E → TP_HIGH_E_M2*1	UINI_M → ZP_UINI_M2	UINI_U_M → Z_UINI_M2
UINI_UP_M → ZP_UINI_M2	VAL → VAL_M2	VAL_MD → VAL_M2
VAL_P_MD → VALP_M2	VAL_P_S_MD → VALP_M2	VAL_S_MD → VAL_M2
VALP → VALP_M2	WORD_TO_BOOL_E → WORD_TO_BOOL_E_M2	WORD_TO_DINT_E → WORD_TO_DINT_E_M2
WORD_TO_DWORD_E → WORD_TO_DWORD_E_M2	WORD_TO_INT_E → WORD_TO_INT_E_M2	WORD_TO_STR_E → WORD_TO_STR_E_M2
WORD_TO_TIME_E → WORD_TO_TIME_E_M2	WSUM → WSUM_M2	WSUM_M → WSUM_M2
WSUMP → WSUMP_M2	WSUMP_M → WSUMP_M2	XOR_E → XOR_E_M2
Z_ABRST1 → Z_ABRST1_M2	Z_ABRST2 → Z_ABRST2_M2	Z_ABRST3 → Z_ABRST3_M2
Z_ABRST4 → Z_ABRST4_M2	Z_RECVS → Z_RECVS_M2	Z_UINI → Z_UINI_M2
ZONE → ZONE_M2	ZONE_MD → ZONE_M2	ZONE_P_MD → ZONEP_M2
ZONEP → ZONEP_M2	ZP_BUFRCV → ZP_BUFRCV_M2	ZP_BUFSEND → ZP_BUFSEND_M2
ZP_CLOSE → ZP_CLOSE_M2	ZP_CSET → ZP_CSET_M2	ZP_ERRCLR → ZP_ERRCLR_M2
ZP_ERRRD → ZP_ERRRD_M2	ZP_OPEN → ZP_OPEN_M2	ZP_PFWRT → ZP_PFWRT_M2
ZP_PINIT → ZP_PINIT_M2	ZP_PSTR1 → ZP_PSTR1_M2	ZP_PSTR2 → ZP_PSTR2_M2
ZP_PSTR3 → ZP_PSTR3_M2	ZP_PSTR4 → ZP_PSTR4_M2	ZP_REMTO → ZP_REMTO_M2
ZP_TEACH1 → ZP_TEACH1_M2	ZP_TEACH2 → ZP_TEACH2_M2	ZP_TEACH3 → ZP_TEACH3_M2
ZP_TEACH4 → ZP_TEACH4_M2	ZP_UINI → ZP_UINI_M2	—

\*1 Automatically replaced only when opening a GX Works2 format project in GX Works3 Version 1.055H or later.



### ■Elements that are not supported by MELSEC iQ-R series or MELSEC iQ-L series modules

If an instruction which is not supported by MELSEC iQ-R series or MELSEC iQ-L series modules is included in a program of a GX Works2 format project, the instruction will be replaced with one using SM4095/SD4095.

In addition, functions and function blocks that are unavailable in an ST program and an FBD/LD program of GX Works3 will be replaced with undefined ones.

Correct the program in GX Works3 by changing these elements to ones which are supported by these modules and have the equivalent functions. (MELSEC iQ-R series only)

 MELSEC iQ-R Programming Manual (CPU Module Instructions, Standard Functions/Function Blocks)

## Correcting element names and arguments (GX Works3 Version 1.046Y or earlier)

For some elements (instructions, functions, and function blocks), the data type of arguments differs between a GX Works2 format project and a GX Works3 format project.

If these elements are used in a GX Works2 format project, a conversion error may occur in GX Works3 Version 1.046Y or earlier. In that case, replace their element names and arguments.

When opening a GX Works2 format project in GX Works3 Version 1.047Z or later, the replacements shown in this section is not required.

For details, refer to the following:

☞ Page 901 Automatic replacement of elements (GX Works3 Version 1.047Z or later)

In addition, instructions which are not supported by MELSEC iQ-R series or MELSEC iQ-L series modules cannot be replaced with ones available in GX Works3. Refer to the following and correct the instructions.

☞ Page 906 Elements that are not supported by MELSEC iQ-R series or MELSEC iQ-L series modules

The following table, that indicates the replacement method, is not applied to a ladder program.

### ■ Instructions in which the names need to be replaced

Names that need to be replaced → names after replacement			
BAND → BAND_U	BANDP → BANDP_U	BINDA → BINDA_U	BINDAP → BINDAP_U
DABIN → DABIN_U	DABINP → DABINP_U	DBAND → DBAND_U	DBANDP → DBANDP_U
DBINDA → DBINDA_U	DBINDAP → DBINDAP_U	DDABIN → DDABIN_U	DDABINP → DDABINP_U
DDEC → DDEC_U	DDECP → DDECP_U	DEC → DEC_U	DECP → DECP_U
DGBIN → DGBIN_U	DGBINP → DGBINP_U	DGRY → DGRY_U	DGRYP → DGRYP_U
DINC → DINC_U	DINCP → DINCP_U	DLIMITP → DLIMITP_U	DMAXP → DMAXP_U
DMEAN → DMEAN_U	DMEANP → DMEANP_U	DMINP → DMINP_U	DSCL → DSCL_U
DSCL2 → DSCL2_U	DSCL2P → DSCL2P_U	DSCLP → DSCLP_U	DSTR → DSTR_U
DSTRP → DSTRP_U	DVAL → DVAL_U	DVALP → DVALP_U	DWSUM → DWSUM_U
DWSUMP → DWSUMP_U	DZONE → DZONE_U	DZONEP → DZONEP_U	GBIN → GBIN_U
GBINP → GBINP_U	GRY → GRY_U	GRYP → GRYP_U	INC → INC_U
INCP → INCP_U	LIMITP → LIMITP_U	MAXP → MAXP_U	MEAN → MEAN_U
MEANP → MEANP_U	MINP → MINP_U	SCL → SCL_U	SCL2 → SCL2_U
SCL2P → SCL2P_U	SCLP → SCLP_U	STR → STR_U	STRP → STRP_U
VAL → VAL_U	VALP → VALP_U	WSUM → WSUM_U	WSUMP → WSUMP_U
ZONE → ZONE_U	ZONEP → ZONEP_U	-	-

## ■ Standard functions/function blocks of which names and arguments need to be replaced

Names that need to be replaced → names after replacement		
BCD_TO_STR → BCD_TO_STRING	BCD_TO_STR_E → BCD_TO_STRING_E <sup>*1</sup>	BOOL_TO_STR → BOOL_TO_STRING
BOOL_TO_STR_E → BOOL_TO_STRING_E <sup>*1</sup>	DINT_TO_STR → DINT_TO_STRING	DINT_TO_STR_E → DINT_TO_STRING_E <sup>*1</sup>
DWORD_TO_STR → DWORD_TO_STRING	DWORD_TO_STR_E → DWORD_TO_STRING_E <sup>*1</sup>	INT_TO_STR → INT_TO_STRING
INT_TO_STR_E → INT_TO_STRING_E <sup>*1</sup>	LIMITATION → LIMIT	LIMITATION_E → LIMIT_E <sup>*3</sup>
MAXIMUM → MAX	MAXIMUM_E → MAX_E <sup>*2</sup>	MINIMUM → MIN
MINIMUM_E → MIN_E <sup>*2</sup>	REAL_TO_STR → REAL_TO_STRING	REAL_TO_STR_E → REAL_TO_STRING_E <sup>*1</sup>
STR_TO_BCD → STRING_TO_BCD	STR_TO_BCD_E → STRING_TO_BCD_E <sup>*1</sup>	STR_TO_BOOL → STRING_TO_BOOL
STR_TO_BOOL_E → STRING_TO_BOOL_E <sup>*1</sup>	STR_TO_DINT → STRING_TO_DINT	STR_TO_DINT_E → STRING_TO_DINT_E <sup>*1</sup>
STR_TO_DWORD → STRING_TO_DWORD	STR_TO_DWORD_E → STRING_TO_DWORD_E <sup>*1</sup>	STR_TO_INT → STRING_TO_INT
STR_TO_INT_E → STRING_TO_INT_E <sup>*1</sup>	STR_TO_REAL → STRING_TO_REAL	STR_TO_REAL_E → STRING_TO_REAL_E <sup>*1</sup>
STR_TO_TIME → STRING_TO_TIME	STR_TO_TIME_E → STRING_TO_TIME_E <sup>*1</sup>	STR_TO_WORD → STRING_TO_WORD
STR_TO_WORD_E → STRING_TO_WORD_E <sup>*1</sup>	TIME_TO_STR → TIME_TO_STRING	TIME_TO_STR_E → TIME_TO_STRING_E <sup>*1</sup>
WORD_TO_STR → WORD_TO_STRING	WORD_TO_STR_E → WORD_TO_STRING_E <sup>*1</sup>	-

\*1 The following replacement is required.

The second argument → the third argument, the third argument → the left side of the assignment statement, the left side of the assignment statement → the second argument

Example: M0 := BCD\_TO\_STR\_E( SM400, I\_word, I\_string ); → I\_string := BCD\_TO\_STRING\_E( SM400, M0, I\_word );

\*2 The following replacement is required.

The second argument → the third argument, the third argument → the fourth argument, the fourth argument → the left side of the assignment statement, the left side of the assignment statement → the second argument

Example: M0 := MAXIMUM\_E( SM400, D1, D2, D3 ); → D3 := MAX\_E( SM400, M0, D1, D2 );

\*3 The following replacement is required.

The second argument → the third argument, the third argument → the fourth argument, the fourth argument → the fifth argument, the fifth argument → the left side of the assignment statement, the left side of the assignment statement → the second argument

Example: M0 := LIMITATION\_E( SM400, D1, D2, D3, D4 ); → D4 := LIMIT\_E( SM400, M0, D1, D2, D3 );

## ■ Instructions in which the names and arguments need to be replaced

Names that need to be replaced → names after replacement		
ACOSD_E_MD → ACOSD	ACOSD_MD → ACOSD <sup>*1</sup>	AND_DT_EQ_M → ANDDT_EQ <sup>*7</sup>
AND_DT_GE_M → ANDDT_GE <sup>*7</sup>	AND_DT_GT_M → ANDDT_GT <sup>*7</sup>	AND_DT_LE_M → ANDDT_LE <sup>*7</sup>
AND_DT_LT_M → ANDDT_LT <sup>*7</sup>	AND_DT_NE_M → ANDDT_NE <sup>*7</sup>	AND_EDEQ_M → ANDED_EQ
AND_EDGE_M → ANDED_GE	AND_EDGT_M → ANDED_GT	AND_EDLE_M → ANDED_LE
AND_EDLT_M → ANDED_LT	AND_EDNE_M → ANDED_NE	AND_EEQ_M → ANDE_EQ
AND_EGE_M → ANDE_GE	AND_EGT_M → ANDE_GT	AND_ELE_M → ANDE_LE
AND_ELT_M → ANDE_LT	AND_ENE_M → ANDE_NE	AND_EQ_M → AND_EQ
AND_GE_M → AND_GE	AND_GT_M → AND_GT	AND_LE_M → AND_LE
AND_LT_M → AND_LT	AND_NE_M → AND_NE	AND_STRING_EQ_M → ANDSTRING_EQ
AND_STRING_GE_M → ANDSTRING_GE	AND_STRING_GT_M → ANDSTRING_GT	AND_STRING_LE_M → ANDSTRING_LE
AND_STRING_LT_M → ANDSTRING_LT	AND_STRING_NE_M → ANDSTRING_NE	AND_TM_EQ_M → ANDTM_EQ <sup>*8</sup>
AND_TM_GE_M → ANDTM_GE <sup>*8</sup>	AND_TM_GT_M → ANDTM_GT <sup>*8</sup>	AND_TM_LE_M → ANDTM_LE <sup>*8</sup>
AND_TM_LT_M → ANDTM_LT <sup>*8</sup>	AND_TM_NE_M → ANDTM_NE <sup>*8</sup>	ANDD_EQ_M → ANDD_EQ
ANDD_GE_M → ANDD_GE	ANDD_GT_M → ANDD_GT	ANDD_LE_M → ANDD_LE
ANDD_LT_M → ANDD_LT	ANDD_NE_M → ANDD_NE	ASIND_E_MD → ASIND
ASIND_MD → ASIND <sup>*1</sup>	ATAND_E_MD → ATAND	ATAND_MD → ATAND <sup>*1</sup>
BKCMP_EQ_M → BKCMP_EQ <sup>*9</sup>	BKCMP_EQP_M → BKCMP_EQP <sup>*9</sup>	BKCMP_GE_M → BKCMP_GE <sup>*9</sup>
BKCMP_GEP_M → BKCMP_GEP <sup>*9</sup>	BKCMP_GT_M → BKCMP_GT <sup>*9</sup>	BKCMP_GTP_M → BKCMP_GTP <sup>*9</sup>
BKCMP_LE_M → BKCMP_LE <sup>*9</sup>	BKCMP_LEP_M → BKCMP_LEP <sup>*9</sup>	BKCMP_LT_M → BKCMP_LT <sup>*9</sup>
BKCMP_LTP_M → BKCMP_LTP <sup>*9</sup>	BKCMP_NE_M → BKCMP_NE <sup>*9</sup>	BKCMP_NEP_M → BKCMP_NEP <sup>*9</sup>
BKMINUS_M → BKMINUS	BKMINUSP_M → BKMINUSP	BKPLUS_M → BKPLUS
BKPLUSP_M → BKPLUSP	BMINUS_3_M → BMINUS	BMINUSP_3_M → BMINUSP
BPLUS_3_M → BPLUS	BPLUSP_3_M → BPLUSP	BREAK_MD → BREAK <sup>*6</sup>
BREAK_P_MD → BREAKP <sup>*6</sup>	CALL_M → CALL_1 <sup>*6</sup>	CALLP_M → CALLP_1 <sup>*6</sup>

**Names that need to be replaced → names after replacement**

CHGT_D_M → D_CHGT <sup>3</sup>	CHGT_DP_M → DP_CHGT <sup>3</sup>	CJ_M → CJ <sup>6</sup>
CMP_M → CMP <sup>9</sup>	CMPP_M → CMPP <sup>9</sup>	COSD_E_MD → COSD
COSD_MD → COSD <sup>1</sup>	DATEMINUS_M → DATEMINUS	DATEMINUS_S_M → S_DATEMINUS
DATEMINUS_SP_M → SP_DATEMINUS	DATEMINUSP_M → DATEMINUSP	DATEPLUS_M → DATEPLUS
DATEPLUS_S_M → S_DATEPLUS	DATEPLUS_SP_M → SP_DATEPLUS	DATEPLUSP_M → DATEPLUSP
DBKCMP_EQ_M → DBKCMP_EQ <sup>11</sup>	DBKCMP_EQP_M → DBKCMP_EQP <sup>11</sup>	DBKCMP_GE_M → DBKCMP_GE <sup>11</sup>
DBKCMP_GEP_M → DBKCMP_GEP <sup>11</sup>	DBKCMP_GT_M → DBKCMP_GT <sup>11</sup>	DBKCMP_GTP_M → DBKCMP_GTP <sup>11</sup>
DBKCMP_LE_M → DBKCMP_LE <sup>11</sup>	DBKCMP_LEP_M → DBKCMP_LEP <sup>11</sup>	DBKCMP_LT_M → DBKCMP_LT <sup>11</sup>
DBKCMP_LTP_M → DBKCMP_LTP <sup>11</sup>	DBKCMP_NE_M → DBKCMP_NE <sup>11</sup>	DBKCMP_NEP_M → DBKCMP_NEP <sup>11</sup>
DBKMINUS_M → DBKMINUS <sup>12</sup>	DBKMINUSP_M → DBKMINUSP <sup>12</sup>	DBKPLUS_M → DBKPLUS <sup>12</sup>
DBKPLUSP_M → DBKPLUSP <sup>12</sup>	DBMINUS_3_M → DBMINUS	DBMINUSP_3_M → DBMINUSP
DBPLUS_3_M → DBPLUS	DBPLUSP_3_M → DBPLUSP	DCMP_M → DCMP <sup>11</sup>
DCMPP_M → DCMPP <sup>11</sup>	DDIVID_3_M → DDIVISION	DDIVIDP_3_M → DDIVISIONP
DIV_MD → EDIVISION <sup>5</sup>	DIV_P_MD → EDIVISIONP <sup>5</sup>	DIVID_3_M → DIVISION
DIVIDP_3_M → DIVISIONP	DLIMIT_MD → DLIMIT	DMAX_M → DMAX <sup>10</sup>
DMIN_M → DMIN <sup>10</sup>	DMINUS_3_M → DMINUS	DMINUSP_3_M → DMINUSP
DMULTI_3_M → DMULTI	DMULTIP_3_M → DMULTIP	DPLUS_3_M → DPLUS
DPLUSP_3_M → DPLUSP	DROL_2_M → DROL	DROL_M → DROL
DROR_2_M → DROR	DROR_M → DROR	DZCP_M → DZCP <sup>13</sup>
DZCPP_M → DZCPP <sup>13</sup>	EDDIV_M → EDDIVISION	EDDIVP_M → EDDIVISIONP
EDIV_M → EDIVISION	EDIVP_M → EDIVISIONP	EDMINUS_3_M → EDMINUS_3
EDMINUSP_3_M → EDMINUSP_3	EDPLUS_3_M → EDPLUS_3	EDPLUSP_3_M → EDPLUSP_3
EMINUS_3_M → EMINUS_3	EMINUSP_3_M → EMINUSP_3	EPLUS_3_M → EPLUS_3
EPLUSP_3_M → EPLUSP_3	EXPD_MD → EXPD <sup>1</sup>	IRET_M → IRET
JMP_M → JMP <sup>6</sup>	LD_DT_EQ_M → LDDT_EQ <sup>7</sup>	LD_DT_GE_M → LDDT_GE <sup>7</sup>
LD_DT_GT_M → LDDT_GT <sup>7</sup>	LD_DT_LE_M → LDDT_LE <sup>7</sup>	LD_DT_LT_M → LDDT_LT <sup>7</sup>
LD_DT_NE_M → LDDT_NE <sup>7</sup>	LD_EDEQ_M → LDED_EQ	LD_EDGE_M → LDED_GE
LD_EDGT_M → LDED_GT	LD_EDLE_M → LDED_LE	LD_EDLT_M → LDED_LT
LD_EDNE_M → LDED_NE	LD_EEQ_M → LDE_EQ	LD_EGE_M → LDE_GE
LD_EGT_M → LDE_GT	LD_ELE_M → LDE_LE	LD_ELT_M → LDE_LT
LD_ENE_M → LDE_NE	LD_EQ_M → LD_EQ	LD_GE_M → LD_GE
LD_GT_M → LD_GT	LD_LE_M → LD_LE	LD_LT_M → LD_LT
LD_NE_M → LD_NE	LD_STRING_EQ_M → LDSTRING_EQ	LD_STRING_GE_M → LDSTRING_GE
LD_STRING_GT_M → LDSTRING_GT	LD_STRING_LE_M → LDSTRING_LE	LD_STRING_LT_M → LDSTRING_LT
LD_STRING_NE_M → LDSTRING_NE	LD_TM_EQ_M → LDTM_EQ <sup>8</sup>	LD_TM_GE_M → LDTM_GE <sup>8</sup>
LD_TM_LE_M → LDTM_GT <sup>8</sup>	LD_TM_LE_M → LDTM_LE <sup>8</sup>	LD_TM_LT_M → LDTM_LT <sup>8</sup>
LD_TM_NE_M → LDTM_NE <sup>8</sup>	LDD_EQ_M → LDD_EQ	LDD_GE_M → LDD_GE
LDD_GT_M → LDD_GT	LDD_LE_M → LDD_LE	LDD_LT_M → LDD_LT
LDD_NE_M → LDD_NE	LOGD_MD → LOGD <sup>11</sup>	MINUS_3_M → MINUS
MINUSP_3_M → MINUSP	MULTI_3_M → MULTI	MULTIP_3_M → MULTIP
NEXT_M → NEXT	OR_DT_EQ_M → ORDT_EQ <sup>7</sup>	OR_DT_GE_M → ORDT_GE <sup>7</sup>
OR_DT_GT_M → ORDT_GT <sup>7</sup>	OR_DT_LE_M → ORDT_LE <sup>7</sup>	OR_DT_LT_M → ORDT_LT <sup>7</sup>
OR_DT_NE_M → ORDT_NE <sup>7</sup>	OR_EDEQ_M → ORED_EQ	OR_EDGE_M → ORED_GE
OR_EDGT_M → ORED_GT	OR_EDLE_M → ORED_LE	OR_EDLT_M → ORED_LT
OR_EDNE_M → ORED_NE	OR_EEQ_M → ORE_EQ	OR_EGE_M → ORE_GE
OR_EGT_M → ORE_GT	OR_ELE_M → ORE_LE	OR_ELT_M → ORE_LT
OR_ENE_M → ORE_NE	OR_EQ_M → OR_EQ	OR_GE_M → OR_GE
OR_GT_M → OR_GT	OR_LE_M → OR_LE	OR_LT_M → OR_LT
OR_NE_M → OR_NE	OR_STRING_EQ_M → ORSTRING_EQ	OR_STRING_GE_M → ORSTRING_GE
OR_STRING_GT_M → ORSTRING_GT	OR_STRING_LE_M → ORSTRING_LE	OR_STRING_LT_M → ORSTRING_LT
OR_STRING_NE_M → ORSTRING_NE	OR_TM_EQ_M → ORTM_EQ <sup>8</sup>	OR_TM_GE_M → ORTM_GE <sup>8</sup>
OR_TM_GT_M → ORTM_GT <sup>8</sup>	OR_TM_LE_M → ORTM_LE <sup>8</sup>	OR_TM_LT_M → ORTM_LT <sup>8</sup>
OR_TM_NE_M → ORTM_NE <sup>8</sup>	ORD_EQ_M → ORD_EQ	ORD_GE_M → ORD_GE

## Names that need to be replaced → names after replacement

ORD_GT_M → ORD_GT	ORD_LE_M → ORD_LE	ORD_LT_M → ORD_LT
ORD_NE_M → ORD_NE	PLUS_3_M → PLUS	PLUSP_3_M → PLUSP
SCJ_M → SCJ <sup>*6</sup>	SIND_E_MD → SIND	SIND_MD → SIND <sup>*1</sup>
SMOV_M → SMOV <sup>*4</sup>	SMOV_MD → MOV	SMOV_P_MD → MOV_P
SMOV_P_S_MD → STRINGMOV_P	SMOV_S_MD → STRINGMOV	STRING_MOV_M → STRINGMOV
STRING_MOVP_M → STRINGMOV_P	STRING_PLUS_3_M → STRINGPLUS	STRING_PLUSP_3_M → STRINGPLUSP
TAND_E_MD → TAND	TAND_MD → TAND <sup>*1</sup>	ZCP_M → ZCP <sup>*2</sup>
ZCPP_M → ZCPP <sup>*2</sup>	-	-

\*1 The following replacement is required.

The types of second and third arguments → FLOAT (Double Precision) (ANYREAL\_64) type

Example: `I_eno := EXPD_MD(I_en, I_word_array_1, I_word_array_2);` → `I_eno := EXPD(I_en, I_real_1, I_real_2);`

\*2 The following replacement is required.

The types of second, third, and fourth arguments → the unsigned BIN 16 bit (ANY16\_U) type

Example: `I_eno := ZCP_M(I_en, I_any16_1, I_any16_2, I_any16_3, I_bit_array);` → `I_eno := ZCP(I_en, I_word_1, I_word_2, I_word_3, I_bit_array);`

\*3 The following replacement is required.

Add the signed BIN 16 bit (ANY16\_S) type to the fifth argument. Then, the fifth argument → the sixth argument, the sixth argument → the seventh argument

Example: `I_eno := CHGT_D_M(I_en, I_int_1, I_string, I_int_2, I_bit_array, I_int);` → `I_eno := D_CHGT(I_en, I_int_1, I_string, I_int_2, I_int_3, I_bit_array, I_int);`

\*4 The following replacement is required.

The types of third, fourth, and fifth arguments → the unsigned BIN 16 bit (ANY16\_U) type

Example: `I_eno := SMOV_M(I_en, I_int_1, I_any16_1, I_any16_2, I_any16_3, I_int_2);` → `I_eno := SMOV(I_en, I_int_1, I_word_1, I_word_2, I_word_3, I_int_2);`

\*5 The following replacement is required.

The types of second, third, and fourth arguments → FLOAT (Single Precision) (ANYREAL\_32) type

Example: `I_eno := DIV_MD(I_en, I_any32_1, I_any32_2, I_any32_3);` → `I_eno := EDIVISION(I_en, I_real_1, I_real_2, I_real_3);`

\*6 The following replacement is required.

The type of second argument → the device name (POINTER) type

Example: `I_eno := BREAK_MD(I_en, I_int_1, I_int_2);` → `I_eno := BREAK(I_en, I_pointer, I_int_2);`

\*7 The following replacement is required.

The types of second and third arguments → the signed BIN 16 bit (ANY\_DT) type

Example: `I_eno := LD_DT_EQ_M(I_en, I_any16_array_1, I_any16_array_2, I_int_3);` → `I_eno := LDDT_EQ(I_en, I_int_1, I_int_2, I_int_3);`

\*8 The following replacement is required.

The types of second and third arguments → the signed BIN 16 bit (ANY\_TM) type

Example: `I_eno := LD_TM_EQ_M(I_en, I_any16_array_1, I_any16_array_2, I_int_3);` → `I_eno := LDTM_EQ(I_en, I_int_1, I_int_2, I_int_3);`

\*9 The following replacement is required.

The types of second and third arguments → the signed BIN 16 bit (ANY16\_S) type

Example: `I_eno := CMP_M(I_en, I_word_1, I_word_2, I_bit_array);` → `I_eno := CMP(I_en, I_int_1, I_int_2, I_bit_array);`

\*10 The following replacement is required.

The type of second argument → the signed BIN 32 bit (ANY32\_S) type, the type of fourth argument → the signed BIN 32 bit (ANY32\_S\_ARRAY, number of elements: 4) type

Example: `I_eno := DMAX_M(I_en, I_any32_1, I_word, I_any32_2);` → `I_eno := DMAX(I_en, I_dint, I_word, I_dint_array);`

\*11 The following replacement is required.

The types of second and third arguments → the signed BIN 32 bit (ANY32\_S) type

Example: `I_eno := DBKCMP_EQ_M(I_en, I_any32_1, I_any32_2, I_word, I_bool);` → `I_eno := DBKCMP_EQ(I_en, I_dint_1, I_dint_2, I_word, I_bool);`

\*12 The following replacement is required.

The types of second, third, and fifth arguments → the signed BIN 32 bit (ANY32\_S) type, the type of fourth argument → the unsigned BIN 16 bit (ANY16) type

Example: `I_eno := DBKMINUS_M(I_en, I_any32_1, I_any32_2, I_any32_3, I_any32_4);` → `I_eno := DBKMINUS(I_en, I_dint_1, I_dint_2, I_word, I_dint_3);`

\*13 The following replacement is required.

The types of second, third, and fourth arguments → the signed BIN 32 bit (ANY32\_S) type

Example: `I_eno := DZCP_M(I_en, I_any32_1, I_any32_2, I_any32_3, I_bit_array);` → `I_eno := DZCP(I_en, I_dint_1, I_dint_2, I_dint_3, I_bit_array);`



## ■ Standard functions of which arguments need to be replaced

Name					
ABS_E <sup>*1</sup>	ACOS <sup>*3</sup>	ACOS_E <sup>*1</sup>	ADD_E <sup>*2</sup>	ADD_TIME_E <sup>*2</sup>	AND_E <sup>*2</sup>
ASIN <sup>*3</sup>	ASIN_E <sup>*1</sup>	ATAN <sup>*3</sup>	ATAN_E <sup>*1</sup>	BCD_TO_DINT_E <sup>*1</sup>	BCD_TO_INT_E <sup>*1</sup>
BITARR_TO_DINT_E <sup>*2</sup>	BITARR_TO_INT_E <sup>*1</sup>	BOOL_TO_DINT_E <sup>*1</sup>	BOOL_TO_DWORD_E <sup>*1</sup>	BOOL_TO_INT_E <sup>*1</sup>	BOOL_TO_TIME_E <sup>*1</sup>
BOOL_TO_WORD_E <sup>*1</sup>	CONCAT_E <sup>*2</sup>	COS <sup>*3</sup>	COS_E <sup>*1</sup>	CPY_BIT_OF_INT_E <sup>*2</sup>	CPY_BITARR_E <sup>*2</sup>
DELETE_E <sup>*2</sup>	DINT_TO_BCD_E <sup>*1</sup>	DINT_TO_BITARR_E <sup>*2</sup>	DINT_TO_BOOL_E <sup>*1</sup>	DINT_TO_DWORD_E <sup>*1</sup>	DINT_TO_INT_E <sup>*1</sup>
DINT_TO_LREAL <sup>*1</sup>	DINT_TO_LREAL_E <sup>*1</sup>	DINT_TO_REAL_E <sup>*1</sup>	DINT_TO_TIME_E <sup>*1</sup>	DINT_TO_WORD_E <sup>*1</sup>	DIV_E <sup>*2</sup>
DIV_TIME_E <sup>*2</sup>	DWORD_TO_BOOL_E <sup>*1</sup>	DWORD_TO_DINT_E <sup>*1</sup>	DWORD_TO_INT_E <sup>*1</sup>	DWORD_TO_TIME_E <sup>*1</sup>	DWORD_TO_WORD_E <sup>*1</sup>
EQ_E <sup>*2</sup>	EXP <sup>*3</sup>	EXP_E <sup>*1</sup>	EXPT_E <sup>*2</sup>	FIND_E <sup>*2</sup>	GE_E <sup>*2</sup>
GET_BIT_OF_INT_E <sup>*2</sup>	GT_E <sup>*2</sup>	INSERT_E <sup>*4</sup>	INT_TO_BCD_E <sup>*1</sup>	INT_TO_BITARR_E <sup>*2</sup>	INT_TO_BOOL_E <sup>*1</sup>
INT_TO_DINT_E <sup>*1</sup>	INT_TO_DWORD_E <sup>*1</sup>	INT_TO_LREAL_E <sup>*1</sup>	INT_TO_REAL_E <sup>*1</sup>	INT_TO_TIME_E <sup>*1</sup>	INT_TO_WORD_E <sup>*1</sup>
LE_E <sup>*2</sup>	LEFT <sup>*6</sup>	LEFT_E <sup>*2</sup>	LEN <sup>*3</sup>	LEN_E <sup>*1</sup>	LN_E <sup>*1</sup>
LREAL_TO_DINT_E <sup>*1</sup>	LREAL_TO_INT_E <sup>*1</sup>	LREAL_TO_REAL_E <sup>*1</sup>	LT_E <sup>*2</sup>	MID_E <sup>*4</sup>	MOD_E <sup>*2</sup>
MOVE_E <sup>*1</sup>	MUL_E <sup>*1</sup>	MUL_TIME_E <sup>*1</sup>	MUX_E <sup>*1</sup>	NE_E <sup>*1</sup>	NOT_E <sup>*1</sup>
OR_E <sup>*1</sup>	REAL_TO_DINT_E <sup>*1</sup>	REAL_TO_INT_E <sup>*1</sup>	REAL_TO_LREAL_E <sup>*1</sup>	REPLACE_E <sup>*7</sup>	RIGHT <sup>*6</sup>
RIGHT_E <sup>*2</sup>	ROL <sup>*5</sup>	ROL_E <sup>*2</sup>	ROR <sup>*5</sup>	ROR_E <sup>*2</sup>	SEL_E <sup>*1</sup>
SET_BIT_OF_INT_E <sup>*2</sup>	SHL_E <sup>*1</sup>	SHR_E <sup>*1</sup>	SIN <sup>*3</sup>	SIN_E <sup>*1</sup>	SQRT_E <sup>*1</sup>
SUB_E <sup>*1</sup>	SUB_TIME_E <sup>*2</sup>	TAN <sup>*3</sup>	TAN_E <sup>*1</sup>	TIME_TO_BOOL_E <sup>*1</sup>	TIME_TO_DINT_E <sup>*1</sup>
TIME_TO_DWORD_E <sup>*1</sup>	TIME_TO_INT_E <sup>*1</sup>	TIME_TO_WORD_E <sup>*1</sup>	WORD_TO_BOOL_E <sup>*1</sup>	WORD_TO_DINT_E <sup>*1</sup>	WORD_TO_DWORD_E <sup>*1</sup>
WORD_TO_INT_E <sup>*1</sup>	WORD_TO_TIME_E <sup>*1</sup>	XOR_E <sup>*2</sup>	-	-	-

\*1 The following replacement is required.

The second argument → the third argument, the third argument → the left side of the assignment statement, the left side of the assignment statement → the second argument

Example: M0 := ABS\_E( SM400, I\_num\_in, I\_num\_d ); → I\_num\_d := ABS\_E( SM400, M0, I\_num\_in );

\*2 The following replacement is required.

The second argument → the third argument, the third argument → the fourth argument, the fourth argument → the left side of the assignment statement, the left side of the assignment statement → the second argument

Example: M0 := ADD\_E( SM400, I\_num1, I\_num2, I\_num\_d ); → I\_num\_d := ADD\_E( SM400, M0, I\_num1, I\_num2 );

\*3 The following replacement is required.

The third argument → the left side of the assignment statement. Delete the first argument.

Example: ACOS( SM400, I\_real\_s, I\_real\_d ); → I\_real\_d := ACOS( I\_real\_s );

\*4 The following replacement is required.

The second argument → the third argument, the third argument → the fourth argument, the fourth argument → the fifth argument, the fifth argument → the left side of the assignment statement, the left side of the assignment statement → the second argument

Example: M0 := INSERT\_E( SM400, I\_string1, I\_string2, I\_num\_in, I\_string\_d ); → I\_string\_d := INSERT\_E( SM400, M0, I\_string1, I\_string2, I\_num\_in );

\*5 The following replacement is required.

Delete the first argument. The third argument → the left side of the assignment statement. Add the input value (WORD type) to the second argument.

Example: ROL( SM400, I\_any16\_in, I\_any16\_d ); → I\_any16\_d := ROL( I\_any16\_in, I\_any16\_n );

\*6 The following replacement is required.

The fourth argument → the left side of the assignment statement. Delete the first argument.

Example: LEFT( SM400, I\_string1, I\_num\_in, I\_string\_d ); → I\_string\_d := LEFT( I\_string1, I\_num\_in );

\*7 The following replacement is required.

The second argument → the third argument, the third argument → the fourth argument, the fourth argument → the fifth argument, the fifth argument → the sixth argument, the sixth argument → the left side of the assignment statement, the left side of the assignment statement → the second argument

Example: M0 := REPLACE\_E( SM400, I\_string1, I\_string2, I\_num1, I\_num2, I\_string\_d ); → I\_string\_d := REPLACE\_E( SM400, M0, I\_string1, I\_string2, I\_num1, I\_num2 );

## ■ Standard function blocks of which arguments need to be replaced

Name					
CTD <sup>*1</sup>	CTD_E <sup>*1</sup>	CTU <sup>*2</sup>	CTU_E <sup>*2</sup>	CTUD <sup>*1,*2</sup>	CTUD_E <sup>*1,*2</sup>
F_TRIG <sup>*3</sup>	F_TRIG_E <sup>*3,*4</sup>	R_TRIG <sup>*3</sup>	R_TRIG_E <sup>*3,*4</sup>	RS <sup>*7</sup>	RS_E <sup>*7,*4</sup>
SR <sup>*2</sup>	SR_E <sup>*7,*5</sup>	TOF_E <sup>*5</sup>	TON_E <sup>*6</sup>	TP_E <sup>*6</sup>	-

\*1 The following replacement is required.

LOAD → LD

Example: CTD\_1( CD := I\_bool, LOAD := I\_bool, PV := I\_int, Q := I\_bool\_d, CV := I\_int\_d ); → CTD\_1( CD := I\_bool, LD := I\_bool, PV := I\_int, Q := I\_bool\_d, CV := I\_int\_d );

\*2 The following replacement is required.

RESET → R

Example: CTU\_1( CU := I\_bool, RESET := I\_bool, PV := I\_int, Q := I\_bool\_d, CV := I\_int\_d ); → CTU\_1( CU := I\_bool, R := I\_bool, PV := I\_int, Q := I\_bool\_d, CV := I\_int\_d );

\*3 The following replacement is required.

\_CLK → CLK

Example: R\_TRIG\_1( \_CLK := I\_bool, Q := I\_bool\_d ); → R\_TRIG\_1( CLK := I\_bool, Q := I\_bool\_d );

\*4 The following replacement is required.

The fourth argument → the second argument, the second argument → the third argument, the third argument → the fourth argument

Example: R\_TRIG\_E\_1( EN := SM400, \_CLK := I\_bool, Q := I\_bool\_d, ENO := M0 ); → R\_TRIG\_E\_1( EN := SM400, ENO := M0, CLK := I\_bool, Q := I\_bool\_d );

\*5 The following replacement is required.

The fifth argument → the second argument, the second argument → the third argument, the third argument → the fourth argument, the fourth argument → the fifth argument

Example: inst\_TOF\_E( EN := I\_bool1, IN := I\_bool2, PT := I\_time, Q := I\_bool3, ET := I\_time2, ENO := I\_bool4 ); → inst\_TOF\_E( EN := I\_bool1, ENO := I\_bool4, IN := I\_bool2, PT := I\_time1, Q := I\_bool3, ET := I\_time2 );

\*6 The following replacement is required.

The sixth argument → the second argument, the second argument → the third argument, the third argument → the fourth argument, the fourth argument → the fifth argument, the fifth argument → the sixth argument

Example: inst\_TON\_E( EN := I\_bool1, IN := I\_bool2, PT := I\_time1, Q := I\_bool3, ET := I\_time2, ENO := I\_bool4 ); → inst\_TON\_E( EN := I\_bool1, ENO := I\_bool4, IN := I\_bool2, PT := I\_time1, Q := I\_bool3, ET := I\_time2 );

\*7 The following replacement is required.

\_S → S, \_R → R

Example: RS\_1( \_S := I\_bool, \_R1 := I\_bool, Q1 := I\_bool\_d ); → RS\_1( S := I\_bool, R1 := I\_bool, Q1 := I\_bool\_d );

## ■ LIMIT instruction

Names that need to be replaced → names after replacement	
LIMIT <sup>*1</sup>	DLIMIT → LIMIT <sup>*2</sup>

\*1 The following replacement is required.

Delete the first argument. The second argument → the first argument, the third argument → the second argument, the fourth argument → the third argument, the fifth argument → the left side of the assignment statement

Example: LIMIT( SM400, D1, D2, D3, D4 ); → D4 := LIMIT( D1, D2, D3 );

\*2 The following replacement is required.

Delete the first argument. The second argument → the first argument:D, the third argument → the second argument:D, the fourth argument → the third argument:D, the fifth argument → the left side of the assignment statement:D ('D' indicates a suffix.)

Example: DLIMIT(SM400, D0, D2, D4, D6); → D6:D := LIMIT(D0:D, D2:D, D4:D);

## Replacement of instructions (GX Works3 Version 1.040S or later)

The following table shows the instructions in which the data types of arguments differ between a GX Works2 format project and a GX Works3 format project.

When a label is specified to an argument, it can be used in GX Works3 without replacing its data type by selecting "No" or "Do Not Check Only BMOV(P)/FMOV(P)" in the following option.

- [Tool] ⇒ [Options] ⇒ "Convert" ⇒ "Basic Setting" ⇒ "Operational Setting" ⇒ "Check the data type of instruction argument"

Name					
BDSQR	BDSQRP	BMOV	BMOV_P	BMOV_E	BSQR
BSQRP	D_DDRD	DP_DDRD	D_DDWR	DP_DDWR	DB*
DB*P	DHOURM	DSORT	DVAL	DVALP	DWSUM
DWSUMP	FMOV	FMOV_P	G_BIDIN	GP_BIDIN	G_BIDOUT
GP_BIDOUT	G_CCPASET	GP_CCPASET	G_CCREQ	GP_CCREQ	G_CPRTCL
GP_CPRTCL	G_GETE	GP_GETE	G_INPUT	G_OGLOAD	GP_OGLOAD
G_OGSTOR	GP_OGSTOR	G_ONDEMAND	GP_ONDEMAND	G_OUTPUT	GP_OUTPUT
G_PRR	GP_PRR	G_PUTTE	GP_PUTTE	G_RDMSG	GP_RDMSG
G_READ	GP_READ	G_REQ	GP_REQ	G_RIRCV	GP_RIRCV
G_RIRD	GP_RIRD	G_RISEND	GP_RISEND	G_RIWT	GP_RIWT
G_RLPASET	GP_RLPASET	G_SPBUSY	GP_SPBUSY	G_WRITE	GP_WRITE
GP_ECPRTCL	J_CCREQ	JP_CCREQ	J_REQ	JP_REQ	J_RIRD
JP_RIRD	J_RIWT	JP_RIWT	J_ZNRD	JP_ZNRD	J_ZNWR
JP_ZNWR	S_2PID	S_ABS	S_ADD	S_AMR	S_AT1
S_AVE	S_BC	S_BPI	S_BUMP	S_D	S_DBND
S_DED	S_DIV	S_DUTY	S_ENG	S_EQ	S_FG
S_FLT	S_GE	S_GT	S_HS	S_I	S_IENG
S_IFG	S_IN	S_IPD	S_LE	S_LIMT	S_LLAG
S_LS	S_LT	S_MID	S_MOUT	S_MUL	S_ONF2
S_ONF3	S_OUT1	S_OUT2	S_PGS	S_PHPL	S_PID
S_PIDP	S_PSUM	S_R	S_SEL	S_SPI	S_SQR
S_SUB	S_SUM	S_TPC	S_VLMT1	S_VLMT2	SECOND
SECONDP	SORT	SP_ECPRTCL	STR	STRP	VAL
VALP	Z_ABRST1	Z_ABRST2	Z_ABRST3	Z_ABRST4	Z_MBREQ
ZP_MBREQ	Z_MBRW	ZP_MBRW	Z_RECVS	Z_UINI	ZP_UINI
ZP_BUFRCV	ZP_BUFSDND	ZP_CLOSE	ZP_CSET	ZP_ERRRD	ZP_OPEN
ZP_PFWRT	ZP_PINIT	ZP_PSTRT1	ZP_PSTRT2	ZP_PSTRT3	ZP_PSTRT4
ZP_TEACH1	ZP_TEACH2	ZP_TEACH3	ZP_TEACH4	-	-

A

## Precautions

If "No" or "Do Not Check Only BMOV(P)/FMOV(P)" is selected for the following option when the data type of an argument of an instruction is changed, it is not checked whether the data type is appropriate for the instruction.

- [Tool] ⇒ [Options] ⇒ "Convert" ⇒ "Basic Setting" ⇒ "Operational Setting" ⇒ "Check the data type of instruction argument"

In this case, the area in the memory which is actually used may not match the one which is used for the label specified as an argument.

Refer to the following manual and check that the data type of the label is appropriate.

 MELSEC iQ-R Programming Manual (CPU Module Instructions, Standard Functions/Function Blocks)

 MELSEC iQ-R Programming Manual (Process Control Function Blocks/Instructions)

 MELSEC iQ-R Programming Manual (Module Dedicated Instructions)

## Correcting devices

### ■Devices that are not supported by MELSEC iQ-R series or MELSEC iQ-L series modules

- When a device which is not supported by MELSEC iQ-R series or MELSEC iQ-L series modules is included in a program of a GX Works2 format project, it is replaced with SM4095/SD4095. In addition, if the program is a ladder program, the device used as an argument of an instruction may be replaced with a character string (SM4095 or SD4095). To search for this character string, refer to the following:

 Page 451 Searching for/Replacing Character Strings

- Step relays (S) and file registers (R) will be deleted when they are set as the device memory data or the initial device value data in a GX Works2 format project.

### ■Number of device points and start/end device

An available range for the number of device points may differ depending on the module series.

If a value, which cannot be set for MELSEC iQ-R series or MELSEC iQ-L series modules, has been set in parameters of a GX Works2 format project, it is corrected when the project is opened in GX Works3.

### ■Increase in the number of device points due to differences in local device setting units

The number of device points assigned to each local device differs depending on the module series. When the module type is changed, CPU parameters are automatically modified, which results in increase in the number of device points.

The following table shows the setting units for each series.

Series	Setting units
MELSEC-Q	Bit device: 1-point units Word device: 1-point units
MELSEC-L	
MELSEC iQ-R	Bit device: 64-point units Word device (D): 4-point units Word device (T/ST/C): 32-point units Word device (LT/LST): 1-point units
MELSEC iQ-L	

### ■Device name and label name display

- For a device that was set as a local device in GX Works2, prefix the device name with '#.'
- When a label used in GX Works2 has a name starting with "M+" or "P+," the "+" of the label name is replaced with "\_".

### ■Step relays (S) and SFC block devices (BL)

Step relays (S) and SFC block devices (BL) may not be available in an ST editor and FBD/LD editor.

Correct the program to provide the equivalent operation to the ST program and Structured Ladder/FBD program of GX Works2.

For details, refer to the following:

 MELSEC iQ-R Programming Manual (Program Design)

### ■Correcting devices in address representation

Correct each device in address representation by replacing the character string.

GX Works3 does not support address representation of devices (such as '%MW0.0').

When address representation is used in a project created in GX Works2, it is read as is.

## Correcting programs

### ■ Structured Ladder/FBD program

- The execution order is handled differently between Structured Ladder/Function Block Diagram language in GX Works2 and Function Block Diagram/Ladder Diagram language in GX Works3. Display the execution order and check it.
- A way of counting FBD network blocks differ between a program written in Structured Ladder/Function Block Diagram language in GX Works2 and a program written in Function Block Diagram/Ladder Diagram language in GX Works3. For a program written in Structured Ladder/Function Block Diagram language in GX Works2, a single function block is counted as a single FBD network block. For a program written in Function Block Diagram/Ladder Diagram language in GX Works3, all connected elements are counted as a single FBD network block. Therefore, a GX Works2 program may exceed the maximum number of creatable FBD network blocks (4096) when it is opened in GX Works3. In this case, divide the program and reduce the number of FBD network blocks.
- A performance of an return element differ between a program written in Structured Ladder/Function Block Diagram language in GX Works2 and a program written in Function Block Diagram/Ladder Diagram language in GX Works3. For details on return elements in GX Works3, refer to the following:  
(☞ Page 323 Common element)
- The number and the order of input/output arguments in some function elements and function block elements differ between a program written in Structured Ladder/Function Block Diagram language in GX Works2 and a program written in Function Block Diagram/Ladder Diagram language in GX Works3. Those elements are displayed as undefined FUNs and FBs. Select [Edit] ⇒ [Update FB/FUN] to update the definition information, and correct the program.
- When a program in which members of standard FB are referenced is created in Structured Ladder/Function Block Diagram of GX Works2, a conversion error may occur after opening the program with GX Works3. In this case, check the member name and class of the standard FB, and correct the program.
- Inverting the contact is available for input/output arguments of function elements/function block elements in Function Block Diagram/Ladder Diagram language of GX Works3. (☞ Page 326 Switching methods for contacts/instructions)  
Connection lines of those elements are deleted when the elements other than above are inverted in a Structured Ladder/FBD program of GX Works2. Correct the program to provide equivalent operations to the Structured Ladder/FBD program in GX Works2.
- Function Block Diagram/Ladder Diagram language in GX Works3 does not support wired OR of FBD elements. Correct the program to provide the equivalent operation to the Structured Ladder/FBD program of GX Works2 since a conversion error is caused.
- When a pointer branch instruction (CJ, SCJ, JMP), a jump, or a subroutine program is used, a conversion error may occur.\*1
- The program layout may be changed due to the differences between a Structured Ladder/FBD editor of GX Works2 and an FBD/LD editor of GX Works3. In that case, correct the layout properly.  
Additionally, the layout can be corrected by the layout correction function. For details on the layout correction function, refer to the following:  
(☞ Page 335 Layout correction)
- Ladder block label used in the Structured Ladder/FBD of GX Works2 is defined as the pointer type in a local label.

\*1 For details, refer to the following:

☞ MELSEC iQ-R Programming Manual (Program Design)

## ■SFC program

- Program restoration information included in an SFC program in GX Works3 is replaced with the source information in GX Works2. Note the data size of the program because it increases after replacement. The size can be checked in the "Size (Byte)" column on the [Write] tab on the "Online Data Operation" screen.
- A POU which is not included in the program setting of a structured project in GX Works2 cannot be read. Move the POU to the program setting before reading.
- When a label name such as "Step0" is included on an SFC diagram in GX Works2, the label name may duplicate with a step name and a label name in an SFC block after reading the SFC program. Change the step name/label name to avoid duplication.
- When an SFC program in the MELSAP-L (start condition format) format is read, it is converted into a program equivalent to one in MELSAP3 format.
- The settings to show an output only and not show a contact in a Zoom, cannot be set in GX Works3. Therefore, 'LD SM400' is added to a ladder block in which there is no contact when the ladder block is displayed in MELSAP3 format.
- A program is read in the detailed expression when some display formats (MELSAP3 and MELSAP-L) are used to display an SFC program in GX Works2.
- An SFC program such as shown below cannot be read with version 1.019V or earlier. It is because the connection point is not connected to the same line on which the starting point is connected on the branch. Adjust the positions for the starting point and the connection point of the branch so that they are connected to the same line before reading the program.

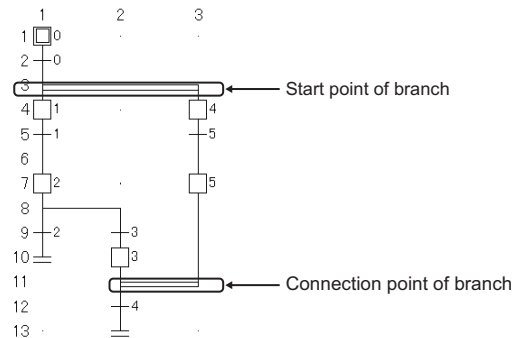
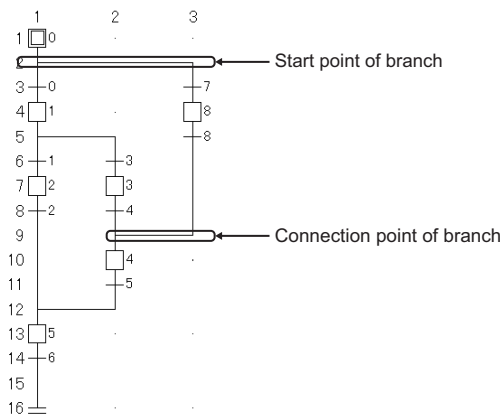

- An SFC program, such as shown below, cannot be read. It is because the connection point is not connected to the same line on which the starting point is connected on the branch. Switch the position of the jump or end step, and adjust the positions for the starting point and the connection point of the branch so that they are connected to the same line before reading the program.

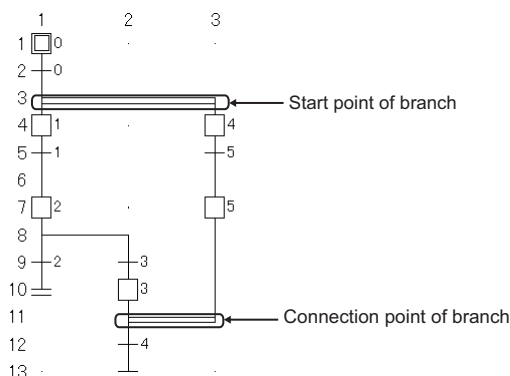
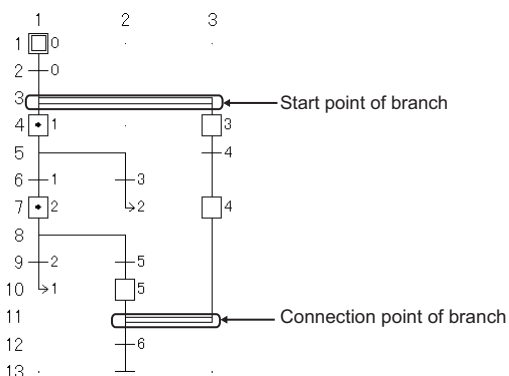

- When an independent SFC diagram exists between the SFC diagrams in which multiple initial steps are connected each other as shown below, the program is read by moving the independent program to the rightmost.

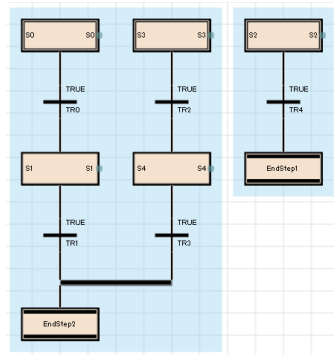
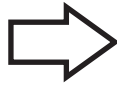
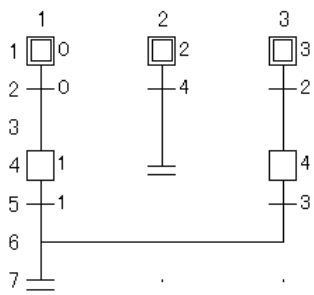

# Replacement of a PX Developer format project

Some units of PX Developer format project data are not supported by GX Works3.

A project needs to be corrected according to a GX Works3 format project after opening it.







Check the contents in this section, then correct a PX Developer project and a GX Works2 project.

For details on the conversion processing for each data, refer to the following:

 Page 110 Opening a PX Developer format project

## Correction of a PX Developer format project

### ■ Setting items

Setting item in PX Developer		Operation in opening	Correction method												
Module FB declaration		Deleting the data	In an FBD/LD editor of GX Works3, create a program equivalent to a module FB in a PX Developer project by using an input (X), output (Y), or a module access device (U□\G). Delete a module FB (that is used in a PX Developer project) read to an FBD/LD program in GX Works3.												
Initial value of an FB property	Tag FB declaration	Returning to the default if the initial values of FB properties were not read.	Set the initial value of an FB property of a tag FB which has been set for a PX Developer project as that of the initial value of an FB property of a tag FB in a GX Works3 format project. (  Page 375 Display/setting an FB property)												
	FB		Set the initial value of an FB property of an FB which has been set for a PX Developer project as that of the initial value of an FB property of an FB in a GX Works3 format project. (  Page 375 Display/setting an FB property)												
GX Works2 label assignment		Converting the data <sup>*1</sup>	<p>After opening a project, correct the global label "GXW2LabelAssignment_PX" as mentioned below to use a label name used in a PX Developer project in a GX Works3 format project. After the correction, delete the global label.</p> <table border="1" data-bbox="686 985 1348 1064"> <thead> <tr> <th></th> <th>Label Name</th> <th></th> <th>Remark</th> </tr> </thead> <tbody> <tr> <td>1</td> <td>myVar01</td> <td>...</td> <td>myVar02</td> </tr> <tr> <td>2</td> <td></td> <td>...</td> <td></td> </tr> </tbody> </table> <p> <b>①</b> After opening a project, search for a character string in the "Label Name" column (label name used in a GX Works2 project) of "GXW2LabelAssignment_PX" in a GX Works3 format project. ( Page 445 SEARCHING FOR DATA)  <b>②</b> After checking that replacement is available, then replace the character string in the "Label Name" column with a character string (label name used in a PX Developer project) in the "Remark" column<sup>2</sup>.  <b>③</b> Delete the replaced label setting from "GXW2LabelAssignment_PX."                      When same names are shown in the "Label Name" column and the "Remark" column, delete the label setting from GXW2LabelAssignment_PX." (The procedure <b>①</b> and <b>②</b> is not required.)                 </p> <p><b>Point</b> </p> <p>A label name can easily be changed using the 'Automatic synchronization' function. ( Page 233 Automatic synchronization)</p> <p><b>①</b> Select "Yes" in the following option.</p> <ul style="list-style-type: none"> <li>• [Tool] ⇒ [Options] ⇒ "Other Editor" ⇒ "Label Editor Common" ⇒ "Track label name automatically in program editor"</li> </ul> <p><b>②</b> Convert all the programs. ( Page 420 Converting any or all programs)</p> <p>A conversion error may occur; however, go on to step <b>③</b>.</p> <p><b>③</b> Open the global label "GXW2LabelAssignment_PX" in a label editor.</p> <p><b>④</b> Copy a cell of the "Remarks" column<sup>2</sup>, and paste it to the "Label Name" column. The label name in the program is replaced.</p> <p><b>⑤</b> Check that the label name is replaced, delete the global label "GXW2LabelAssignment_PX."</p>		Label Name		Remark	1	myVar01	...	myVar02	2		...	
	Label Name		Remark												
1	myVar01	...	myVar02												
2		...													

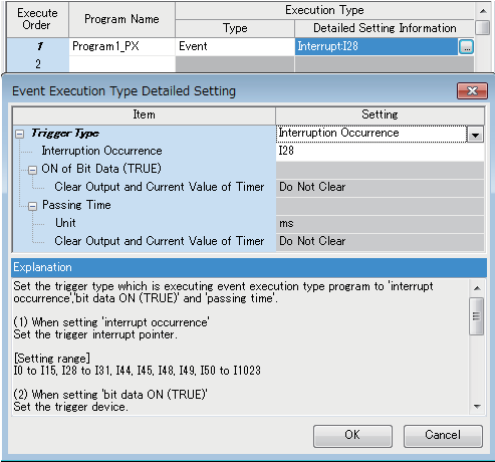
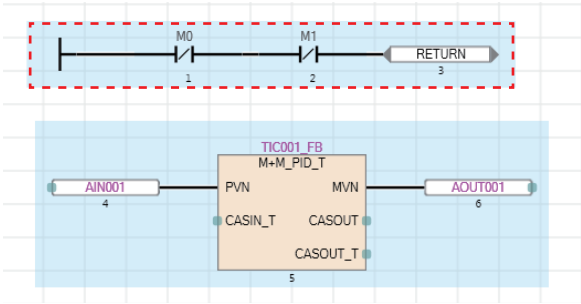
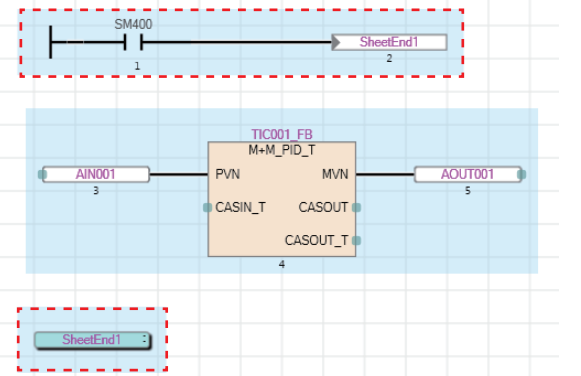

Setting item in PX Developer	Operation in opening	Correction method
Interrupt pointer execution	Changing to "No Execution Type"	<p>Set the following for the target program.</p> <ol style="list-style-type: none"> <li>1 Select "CPU Parameter" ⇒ "Program Setting," then set a program name of a program to execute the interrupt pointer in the "Program Name" column. Select "Event" in the "Type" column of "Execution Type."</li> <li>2 Click the [...] button in the "Detailed Setting Information" column, and select "Interruption Occurrence" for "Trigger Type" on the "Event Execution Type Detailed Setting" screen. Set an interrupt pointer for "Interruption Occurrence."</li> </ol> 
Execution condition settings of a program and an FBD sheet	Converting as a comment element	<p>Create a program to control the execution by combining a contact with jump/return on an FBD/LD editor in GX Works3 according to the execution condition settings of a program and an FBD sheet which have been set for a PX Developer project.</p> <p>The following shows the examples of processing to control the execution of a program.</p> <p>Example 1) Execute a program when 'M0' or 'M1' is true. (It is not executed when 'M0' and 'M1' are false.)</p>  <p>Example 2) Not execute a program of a worksheet always</p> 
I/O simulation setting	Deleting the data	<p>Register the contents of the I/O simulation setting which is set for a PX Developer project to the I/O system setting of the simulation function in GX Works3.</p> <p>For details on the I/O system setting, refer to the following:</p> <p>☞ Page 547 Simulation of External Device Operations</p>



- \*1 Converted as a global label "GXW2LabelAssignment\_PX" of GX Works3.  
 Each data is converted as follows: (☞ Page 227 Configuration of a label editor)  
 Global label of GX Works2: "Label Name" column  
 Global variable name in PX Developer: "Remark" column  
 Comment: "Comment" column
- \*2 The "Remarks" column is displayed by clicking the [Detail Display] button in a label editor.

## ■Program layout

The program layout may be changed due to the differences between an FBD editor of PX Developer and an FBD/LD editor of GX Works3. In that case, correct the layout properly.

Additionally, the layout can be corrected by the layout correction function. For details on the layout correction function, refer to the following:

☞ Page 335 Layout correction

## ■Inline ST part

When opening a PX Developer format project created in PX Developer Version 1.55H or later in GX Works3 Version 1.080J or later, input/output variables of an inline ST part in the PX Developer format project are converted into local labels.

Check if a label name is duplicated or a data type of the PX Developer format project is different from the one before the project is opened in GX Works3.

In addition, the execution order of the program may be different between before and after opening the PX Developer format project because the input/output variables are replaced with local labels. Check the execution order.

**Ex.**

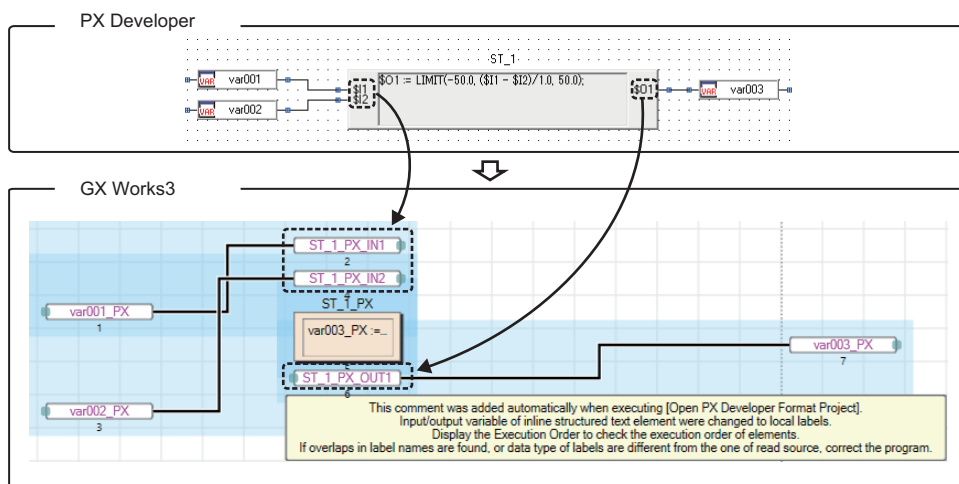

## Correction of a GX Works2 project

Some settings for a GX Works2 project that are used in a PX Developer format project are not applied to a GX Works3 format project.

The following shows the settings that are not applied to a GX Works3 format project.

### ■Execution order of programs

The execution order of programs is changed as follow.

- Programs in a GX Works2 project → Programs in a PX Developer project

Correct the execution order in "Program Setting" of "CPU Parameter" in a GX Works3 format project as necessary.

### ■Others

For details on the replacement of other data, refer to the following:

☞ Page 900 Replacement of a GX Works2 format project

## Automatic replacement of instructions

When using GX Works3 and PX Developer with either of the following version combinations, elements used in a PX Developer format project are automatically replaced with ones available in GX Works3 (for compatibility use).

- GX Works3: Version 1.055H or later, PX Developer: Version 1.52E or later
- GX Works3: Version 1.080J or later, PX Developer: Version 1.55H or later

This section explains the replacement of elements being used in a PX Developer project.

For details on the replacement of elements being used in a GX Works2 format project, refer to the following:

 Page 901 Automatic replacement of elements (GX Works3 Version 1.047Z or later)

### ■Elements to be replaced automatically (for compatibility use)

The following table shows the elements that are automatically replaced.

The elements to which "\_PX" is added to their names are the replacements for elements of a PX Developer project. Do not use these elements to create a program in GX Works3.

- GX Works3: Version 1.055H or later, PX Developer: Version 1.52E or later

Name before replacement → Name after replacement		
EDGE_CHECK → EDGE_CHECK_PX	LATCH_BOOL → LATCH_BOOL_PX	LATCH_DWORD → LATCH_DWORD_PX
LATCH_REAL → LATCH_REAL_PX	LATCH_WORD → LATCH_WORD_PX	TOF_HIGH → TOF_HIGH_PX
TOF_LOW → TOF_LOW_PX	TON_HIGH → TON_HIGH_PX	TON_LOW → TON_LOW_PX
TP_HIGH → TP_HIGH_PX	TP_LOW → TP_LOW_PX	—

- GX Works3: Version 1.080J or later, PX Developer: Version 1.55H or later

Name before replacement → Name after replacement		
CTD → M+CTD	CTU → M+CTU	CTUD → M+CTUD
EDGE_CHECK → M+EDGE_CHECK	F_TRIG → M+F_TRIG	LATCH_BOOL → M+LATCH_BOOL
LATCH_DWORD → M+LATCH_DWORD	LATCH_REAL → M+LATCH_REAL	LATCH_WORD → M+LATCH_WORD
R_TRIG → M+R_TRIG	RS → M+RS	SR → M+SR
TOF_HIGH → M+TOF_HIGH	TOF_LOW → M+TOF_LOW	TON_HIGH → M+TON_HIGH
TON_LOW → M+TON_LOW	TP_HIGH → M+TP_HIGH	TP_LOW → M+TP_LOW

A

### Point

When using GX Works3 and PX Developer with either of the following version combinations, elements are replaced with ones that are not supported by that version of GX Works3; therefore, an error occurs when converting a project.

Upgrade GX Works3 and PX Developer to their latest versions.

- GX Works3: Version 1.054G or earlier, PX Developer: Version 1.52E or later
- GX Works3: Version 1.077F or earlier, PX Developer: Version 1.55H or later

## Considerations

The following shows the considerations when opening a PX Developer format project in GX Works3.

### ■Tag names that cannot be set in GX Works3

Some tag names set in a PX Developer format project may include characters that cannot be used for label names in GX Works3. (Page 887 Unusable character strings for a label name)

In that case, the tag FB settings are not applied to GX Works3, and the initial FB property values are changed to their default. To apply the initial FB property values, change the tag names in a PX Developer project in advance.

Examples of tag names that cannot be set in GX Works3 and their correction method are as follows.

Unavailable tag name		Correction method																																																																																
<p>■Tag names before opening a project.</p> <ul style="list-style-type: none"> <li>"Tag FB declaration" window in a PX Developer project</li> </ul> <table border="1"> <thead> <tr> <th>No.</th> <th>Tag FB Variable Name</th> <th>Tag FB Type</th> <th>Tag Type</th> <th>Assigned Device</th> </tr> </thead> <tbody> <tr> <td></td> <td>1 TIC001</td> <td>M_PID</td> <td>PID</td> <td>ZR3000</td> </tr> <tr> <td>(A)</td> <td>LC001</td> <td>M_PID</td> <td>PID</td> <td>ZR3130</td> </tr> <tr> <td>(B)</td> <td>SINGLE</td> <td>M_PID</td> <td>PID</td> <td>ZR3260</td> </tr> </tbody> </table> <p>(A) LC001: A reserved word (device) for GX Works3 and number are used together.</p> <p>(B) SINGLE: A reserved word (IEC reserved word) for GX Works3 is used.</p> <p>■When opening a project, the status will be changed as follows because tag names that cannot be used in GX Works3 have been used.</p> <p>The following two warning messages appear in the "Output" window.</p> <table border="1"> <thead> <tr> <th>No.</th> <th>Result</th> <th>Data Name</th> <th>Category</th> <th>Content</th> </tr> </thead> <tbody> <tr> <td>15</td> <td>Warning</td> <td>-</td> <td>Tag FB Setting</td> <td>An unsettable character or an unsupported tag FB by GX Works3 has been used in tag name.</td> </tr> <tr> <td>16</td> <td>Warning</td> <td>-</td> <td>FB Property</td> <td>Default value was set as the initial value for FB property because Tag FB Setting has not been</td> </tr> </tbody> </table> <ul style="list-style-type: none"> <li>Category: Tag FB Setting Content: An unsettable character or an unsupported tag FB by GX Works3 has been used in tag name. Please check it through Tag FB Setting.</li> <li>Category: FB Property Content: Default value was set as the initial value for FB property because Tag FB Setting has not been applied or the setting that does not reflect the initial value of FB property has been selected.</li> </ul> <p>When [Apply] button is clicked in the tag FB setting editor, an error occurs.</p> <table border="1"> <thead> <tr> <th>No.</th> <th>Tag Name</th> <th>Tag FB Type</th> <th>Tag Type</th> <th>Structured Data Type</th> <th>FB Instance Name</th> </tr> </thead> <tbody> <tr> <td>1</td> <td>TIC001</td> <td>M+M_PID</td> <td>PID</td> <td>M+TM_PID</td> <td>TIC001_FB</td> </tr> <tr> <td>2</td> <td>LC001</td> <td>M+M_PID</td> <td>PID</td> <td>M+TM_PID</td> <td>LC001_FB</td> </tr> <tr> <td>3</td> <td>SINGLE</td> <td>M+M_PID</td> <td>PID</td> <td>M+TM_PID</td> <td>SINGLE_FB</td> </tr> </tbody> </table> <p>The initial values of FB properties are changed to their default.</p>		No.	Tag FB Variable Name	Tag FB Type	Tag Type	Assigned Device		1 TIC001	M_PID	PID	ZR3000	(A)	LC001	M_PID	PID	ZR3130	(B)	SINGLE	M_PID	PID	ZR3260	No.	Result	Data Name	Category	Content	15	Warning	-	Tag FB Setting	An unsettable character or an unsupported tag FB by GX Works3 has been used in tag name.	16	Warning	-	FB Property	Default value was set as the initial value for FB property because Tag FB Setting has not been	No.	Tag Name	Tag FB Type	Tag Type	Structured Data Type	FB Instance Name	1	TIC001	M+M_PID	PID	M+TM_PID	TIC001_FB	2	LC001	M+M_PID	PID	M+TM_PID	LC001_FB	3	SINGLE	M+M_PID	PID	M+TM_PID	SINGLE_FB	<p>■Correct the tag names as follows.</p> <p>Correct the tag names that cannot be set in GX Works3 in the "Tag FB declaration" windows of a PX Developer project.</p> <p>In a program where the tag FB is used, correct the variable names of the tag FB. *1</p> <p>A correction example of tag names is as follows.</p> <ul style="list-style-type: none"> <li>"Tag FB declaration" window in a PX Developer project</li> </ul> <table border="1"> <thead> <tr> <th>No.</th> <th>Tag FB Variable Name</th> <th>Tag FB Type</th> <th>Tag Type</th> <th>Assigned Device</th> </tr> </thead> <tbody> <tr> <td></td> <td>1 TIC001</td> <td>M_PID</td> <td>PID</td> <td>ZR3000</td> </tr> <tr> <td>(A)</td> <td>LC_001</td> <td>M_PID</td> <td>PID</td> <td>ZR3130</td> </tr> <tr> <td>(B)</td> <td>SINGLE_1</td> <td>M_PID</td> <td>PID</td> <td>ZR3260</td> </tr> </tbody> </table> <p>(A) LC_001: Add any text between the reserved word (device) for GX Works3 and the number.</p> <p>(B) SINGLE_01: Add any text to the reserved word (IEC reserved word) for GX Works3.</p> <p>■When opening a project, the tag FB settings are applied and the initial FB property values are utilized.</p>		No.	Tag FB Variable Name	Tag FB Type	Tag Type	Assigned Device		1 TIC001	M_PID	PID	ZR3000	(A)	LC_001	M_PID	PID	ZR3130	(B)	SINGLE_1	M_PID	PID	ZR3260
No.	Tag FB Variable Name	Tag FB Type	Tag Type	Assigned Device																																																																														
	1 TIC001	M_PID	PID	ZR3000																																																																														
(A)	LC001	M_PID	PID	ZR3130																																																																														
(B)	SINGLE	M_PID	PID	ZR3260																																																																														
No.	Result	Data Name	Category	Content																																																																														
15	Warning	-	Tag FB Setting	An unsettable character or an unsupported tag FB by GX Works3 has been used in tag name.																																																																														
16	Warning	-	FB Property	Default value was set as the initial value for FB property because Tag FB Setting has not been																																																																														
No.	Tag Name	Tag FB Type	Tag Type	Structured Data Type	FB Instance Name																																																																													
1	TIC001	M+M_PID	PID	M+TM_PID	TIC001_FB																																																																													
2	LC001	M+M_PID	PID	M+TM_PID	LC001_FB																																																																													
3	SINGLE	M+M_PID	PID	M+TM_PID	SINGLE_FB																																																																													
No.	Tag FB Variable Name	Tag FB Type	Tag Type	Assigned Device																																																																														
	1 TIC001	M_PID	PID	ZR3000																																																																														
(A)	LC_001	M_PID	PID	ZR3130																																																																														
(B)	SINGLE_1	M_PID	PID	ZR3260																																																																														

\*1 The variable name of a tag FB used in a program can be changed by editing the assignment information on a local variable sheet. For details, refer to the following:

📖PX Developer Version 1 Operating Manual (Programming Tool)

## ■Tag names to which an underscore is added

When opening a PX Developer format project, some tag names which cannot be set in GX Works3 are suffixed with an "\_" (underscore).

To monitor or control data using these changed tag names in PX Developer Monitor Tool, change the settings of the tag names in PX Developer Monitor Tool.

By selecting "Yes" for the following option in GX Works3 before exporting an assignment information database file, however, changing the settings of the tag names in PX Developer is not necessary.

- [Tool] ⇒ [Options] ⇒ "Convert" ⇒ "Process Control Extension Setting" ⇒ "Tag FB" ⇒ "PX Developer Monitor Tool Interaction" ⇒ "Remove Underscore at the End of Tag Name"

This option is automatically set to "Yes" if there is a tag name that is suffixed with an "\_" (underscore) when opening a PX Developer format project.

## ■Data name duplication

When opening a PX Developer format project, data names of a PX Developer project are changed as follows:

- A data name is suffixed with "\_PX."
- An invalid character used for a data name is changed to an "\_" (underscore).

Therefore, the data name may be duplicated and the project data change may be canceled.

Correct the data name of PX Developer format project, and open the project again.

The following shows the example of duplication and the correction method.

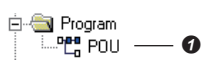
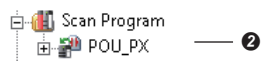
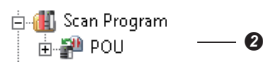
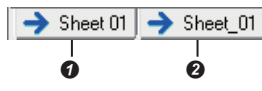
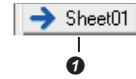
Duplication example	Correction method
<p>Open a PX Developer format project including the following ❶ and ❷ in GX Works3.</p> <p>❶ Program POU of a PX Developer project (data name: POU)</p>  <p>❷ Program body of a GX Works2 project (data name: POU_PX)</p>  <p>When opening the project, the data name ❶ is suffixed with "_PX." (The data name ❷ is not changed.)</p> <p>❶: POU → POU_PX ❷: POU_PX</p> <p>Since the data names ❶ and ❷ are duplicated, the data change is canceled.</p>	<p>Open the project again after deleting "_PX" in the data name ❷ as follows:</p> <ul style="list-style-type: none"> <li>• ❷: POU_PX → POU</li> </ul>  <p>When opening the project, the data name ❶ is suffixed with "_PX." (The data name ❷ is not changed.)</p> <p>❶: POU → POU_PX ❷: POU</p> <p>The data change continues since the data names ❶ and ❷ are not duplicated.</p>
<p>Open a PX Developer format project including the following ❶ and ❷ in GX Works3.</p> <p>❶ FBD sheet of a PX Developer project (data name: Sheet 01)</p> <p>❷ FBD sheet of a PX Developer project (data name: Sheet_01)</p>  <p>When opening the project, an invalid character (space) in the data name ❶ is changed to an "_". Moreover, both data names ❶ and ❷ are suffixed with "_PX."</p> <p>❶: Sheet 01 → Sheet_01_PX ❷: Sheet_01 → Sheet_01_PX</p> <p>Since the data names ❶ and ❷ are duplicated, the data change is canceled.</p>	<p>Open the project again after deleting the invalid character (space) in the data name ❶ as follows:</p> <ul style="list-style-type: none"> <li>• ❶: Sheet 01 → Sheet01</li> </ul>  <p>When opening the project, both data names ❶ and ❷ are suffixed with "_PX."</p> <p>❶: sheet 01 → sheet01_PX ❷: sheet_01 → sheet_01_PX</p> <p>The data change continues since the data names ❶ and ❷ are not duplicated.</p>

## ■Label area capacity

When a PX Developer format project is opened in GX Works3, if the value of "Use Volume" exceeds that of "Total Capacity" in the "Device/Label Memory Configuration" screen of a GX Works3 format project, "0 K Word" is set for "Label Area Capacity" and "Latch Label Area Capacity." (Page 114 Label area capacity)

In that case, check the changes in the "Output" window, and correct "CPU Parameter" in the GX Works3 format project according to the label capacity on the project.

## Replacement of a GX Developer format project

---



The following explains the methods for replacing data to use a GX Developer format project in the GX Works3 format.

Only the projects for QSCPU's can be used in the GX Works3 format.

For details on the conversion processing for each data, refer to the following:

 Page 124 Opening a GX Developer format project

For details on a MELSEC iQ-R series safety project, refer to the following:







-  Page 30 Safety system
-  MELSEC iQ-R Safety Application Guide

### Programs

---

Programs in a GX Developer format project are replaced with standard programs.

The following shows the procedure to correct a standard program to a safety program.

- 1.** Create safety program data in GX Works3. ( Page 129 Creating data)
- 2.** Cut a ladder to be used in a safety program and paste it to the safety program according to the execution order.  
Example: a ladder including a safety device
- 3.** Change any devices to safety ones which can be edited in a GX Works3 format project. ( Page 925 Devices)
- 4.** Change the standard devices/labels used in both standard and safety programs to standard/safety shared labels.  
( Page 926 Standard/safety shared labels)
- 5.** Change the labels to be used in a safety program to the safety labels. ( Page 927 Safety labels)
- 6.** Redefine the function blocks. ( Page 927 Safety FBs, Page 928 User-defined FBs)
- 7.** Convert (reassign) all the programs. ( Page 420 Converting Programs)

#### Point

---

Ladders to be used in a safety program can be checked in GX Developer. For details, refer to the following:  
 GX Developer Version 8 Operating Manual (Safety Programmable Controller)

---

## Devices

The following devices need to be changed to safety devices which can be edited in a GX Works3 format project. (  Page 891 Applicable devices in a safety project (safety devices))

- Safety device used in a GX Developer format project
- Standard device used only in a safety program of a GX Works3 format project

Check the corresponding devices in GX Developer, then change them to safety devices by following the procedure below.

### Operating procedure

Prefix the corresponding device names with "SA\." (  Page 448 Searching for/Replacing Devices and Labels)

**Ex.**

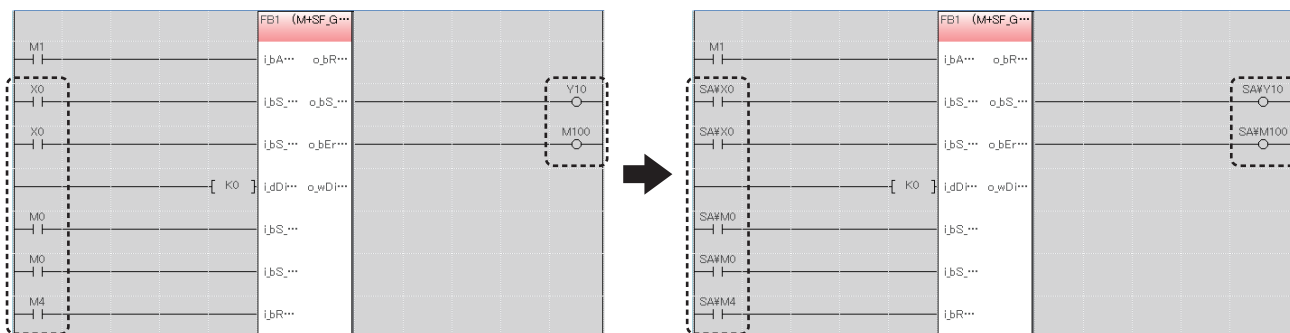

M1 is the device used for passing data between a standard program and a safety program. This device needs to be changed to a standard/safety shared label. (  Page 926 Standard/safety shared labels)

#### ■Devices that are not supported by MELSEC iQ-R series modules

Devices which are not supported by MELSEC iQ-R series modules are replaced with SM4095/SD4095. Among these devices, the ones used as instruction arguments may be replaced with a character string (SM4095 or SD4095). To search for these character strings, refer to the following:

 Page 451 Searching for/Replacing Character Strings

#### ■When device values are set in the device memory

When replacing a device to a safety device, set the value of the device set in the device memory again as the value of the safety device.



A

## Standard/safety shared labels

If a standard device/label is used to pass data between standard and safety programs, the device/label needs to be changed to a standard/safety shared label. Correct the standard device/label and the program by following the procedure below.

### Operating procedure

#### ■Standard devices

1. Create a new standard/safety shared label. \*1 (  Page 129 Creating data)
2. Register a label in the global editor for standard/safety shared labels. (  Page 227 Registering Labels)
3. Change the standard device used in a safety program to the registered label.
4. Add a ladder to pass data between the standard and safety programs in the standard program.

For the method to pass data between standard and safety programs, refer to the following:

 MELSEC iQ-R Safety Application Guide

\*1 Select "Standard/Safety Shared" for "Category" in the "New Data" screen.

#### ■Labels

1. Create a new standard/safety shared label. \*1 (  Page 129 Creating data)
2. Cut the label in the label editor and paste it to the global label editor for standard/safety shared labels. \*2
3. Define the global label that became undefined on the program editor. \*3
4. Add a ladder to pass data between the standard and safety programs in the standard program.

For the method to pass data between standard and safety programs, refer to the following:

 MELSEC iQ-R Safety Application Guide

\*1 Select "Standard/Safety Shared" for "Category" in the "New Data" screen.

\*2 To change a local label to a standard/safety shared label, its class needs to be corrected. For details on the classes that can be set for standard/safety shared labels, refer to the following:

 MELSEC iQ-R CPU Module User's Manual (Application)

\*3 Labels are automatically defined if the following option is set to "Synchronize":

·[Tool] ⇒ [Options] ⇒ "Program Editor" ⇒ "Ladder Editor" ⇒ "Label Synchronization" ⇒ "Operational Setting" ⇒ "Operation on Editing Label Editor"

#### Ex.

When changing a standard device (M1) used in a standard program (1) and a safety program (2) to a standard/safety shared label (\_M1)

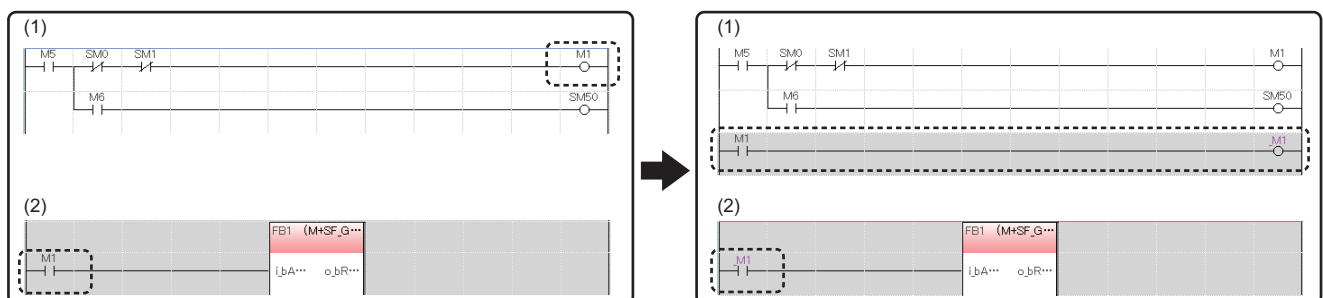



## Safety labels

Labels to be used in a safety program needs to be changed to safety labels.  
Change global labels and local labels to safety labels by the following procedure.

### Operating procedure

#### ■Global labels

1. Create a new safety global label.\*<sup>1</sup> (☞ Page 129 Creating data)
2. Cut the label in the global label editor and paste it to the label editor for safety global labels. (☞ Page 227 Registering Labels)
3. Change the device assigned to the label to a safety device.
4. Define the global label that became undefined on the program editor.\*<sup>2</sup>

\*<sup>1</sup> Select "Safety" for "Category" in the "New Data" screen.

\*<sup>2</sup> Labels are automatically defined if the following option is set to "Synchronize":

[Tool] ⇒ [Options] ⇒ "Program Editor" ⇒ "Ladder Editor" ⇒ "Label Synchronization" ⇒ "Operational Setting" ⇒ "Operation on Editing Label Editor"

#### ■Local labels

Cut a label in the local label editor of a standard program, and paste it to the local label editor of a safety program.

## Safety FBs

Safety FBs are changed to undefined function blocks. In addition, their function block names are changed to function block names in a safety FB library of the MELSEC iQ-R series.

Redefine undefined function blocks by following the procedure below.

### Operating procedure

1. Register a safety FB library for MELSEC iQ-R series in GX Works3. (☞ Page 515 Enhanced Use of Application Library/MELSOFT Library)
2. Drag and drop the registered safety FB library onto "FB/FUN" in the navigation window.
3. Select and right-click the undefined function block in a program editor, and then select [Edit] ⇒ [Update FB/FUN] from the shortcut menu.
4. Read the displayed message, and click the [OK] button.
5. Select and right-click its FB instance name. Select [Edit] ⇒ [Edit FB Instance] from the shortcut menu, then change the name. (☞ Page 273 Changing an FB instance name)

The function block is defined.



#### Point

- To obtain the safety FB library, please contact your local Mitsubishi Electric sales office or representative.

## User-defined FBs

To use user-defined FBs that are used in a standard program in a safety program, replace data by following the procedure below.

### Operating procedure

- 1.** Cut a user-defined FB to be used in a safety program, and paste it to the safety program according to the execution order.
- 2.** Cut the FB instance of the user-defined FB in the local label editor of the standard program, and paste it to the local label editor of the safety program.
- 3.** Create a safety FB.\*1 (  Page 129 Creating data)
- 4.** Cut the program and all local labels of the user-defined FB and past them to the safety FB respectively.
- 5.** Change the devices used in the program of the user-defined FB to safety devices. (  Page 925 Devices)
- 6.** Set the safety FB created in step 3 for the data type of the FB instance label in the local label editor of the safety program.

\*1 Select "Safety" for "Category" in the "New Data" screen.

### Precautions

To change a part of a program in a user-defined FB to a safety FB, create a safety FB, then divide the processing to the user-defined FB (standard FB) and to the safety FB.

# Appendix 8 Considerations for Changing from FX5CPUs to RCPUs

This section explains the considerations when changing the module type from an FX5CPU to an RCPU.

## Considerations before changing the module type

### ■Checking the security set to a project

When an element to which a block password and security key are set is included, the module type cannot be changed to an RCPU.

Delete the setting of a block password and a security key before changing the module type. (Block password: [☞ Page 672](#)  
Deleting a block password, security key: [☞ Page 676](#) Deleting a security key)

### ■Checking the security version set in a project

For a project whose security version is '2,' the module type cannot be changed to an RCPU. Change the security version to '1' before changing the module type. ([☞ Page 698](#) When changing a security version from "2" to "1")

### ■Checking the representation recognized as an input (X) or output (Y) after changing the module type.

An element such as 'X08' or 'Y0F,' which is not recognized as a device in an FX5CPU, is not converted when changing the module type.

These elements are recognized as devices in an RCPU after the change. Correct them before changing the module type.

## Procedure to change the module type

1. Check the project data before changing the module type. ([☞ Page 929](#) Considerations before changing the module type)
2. Change the project for an FX5CPU to one used for an RCPU by changing the module type and operation mode.
3. Set the module configuration for the project after changing the module type and operation mode.
4. Set the parameter.
5. Correct the program. ([☞ Page 931](#) Correction after changing the module type)  
Replace inputs (X), outputs (Y), module specification numbers, and instructions.  
Review the program according to the system configuration after changing the module type and operation mode.
6. Check the operation on the programmable controller.

## Data to be changed when changing the module type

Project data for an FX5CPU		Description
Program	Ladder*1	Inputs (X) and outputs (Y) are converted to hexadecimal from octal. File registers (R) are replaced with file registers (ZR).
Function	ST	
Function block	FBD/LD	
	SFC	
Program file management	Program file	
	FBFILE	
	FUNFILE	
Module Configuration Diagram		Returns to the default.
System Parameter	I/O Assignment Setting	Returns to the default.

Project data for an FX5CPU		Description
CPU Parameter	Name Setting	Applied.
	Operation Related Setting	When it cannot be applied as it is, it will be changed according to the settings of the new module type.
	Interrupt Settings	
	Service Processing Setting	
	File Setting	
	RAS Setting	
	Program Setting	
	SFC Setting	
	Memory/Device Setting	When "Use" is set in the following CPU parameter, the number of step relay (S) points is applied. If "Not to Use" is set, the number of step relay (S) points will be changed to '0.' • "To Use or Not to Use SFC"
Module Parameter	Ethernet Port	Applied. If a module that cannot be set in a project for an RCPU is specified as a communication destination, the module type cannot be changed. For numbers set for "Port No." in "Web Server Settings," the ones which cannot be set in a project for an RCPU will be returned to the default.
	485 Serial Port	Deleted.
	High Speed I/O	
	Input Response Time	
	Analog Input	
	Analog Output	
	Expansion Board	
Memory Card Parameter	Boot Setting	Applied.
	Setting of File/Data Use or Not in Memory Card	When it cannot be applied as it is, it will be changed according to the settings of the new module type.
Module Information		Deleted.
Remote Password		Returns to the default.
Structured Data Types		The definitions of the module labels are deleted.
Label	Global Label	Inputs (X) and outputs (Y) are converted to hexadecimal from octal. File registers (R) are replaced with file registers (ZR). M+Global and all the data in M+Global are deleted.
	Local Label	Applied.
Device Memory		Step relays (S) are deleted.
Device Comment		Inputs (X) and outputs (Y) are converted to hexadecimal from octal. File registers (R) are replaced with file registers (ZR). Extended file registers (ER) are deleted. The data of SM4096 or later are deleted. The data of SD4096 or later are deleted.
Device Initial Value		A device which cannot be used for a module after changing the module type is deleted. File registers (R) are replaced with file registers (ZR). The data of SD4096 or later are deleted.
Connection Destination Setting		Returns to the default.
Options		The setting value for file registers (R) is replaced with that for file registers (ZR) in [Tool] ⇒ [Options] ⇒ "Project" ⇒ "Device Comment Reference/Reflection Target."
Print Setting		Returns to the default.
Properties for a project		If "Compression" is selected for "File Size," it is changed to "Standard."

\*1 An instruction of which the argument specification is different exists in the module types before and after the change. When correcting a program, note that a device used for such an instruction is not converted at the module type change.

## Correction after changing the module type

### ■ Replacing devices

Inputs (X) and outputs (Y) are used sequentially from the start in FX5CPUs.

In RCPUs, inputs (X) and outputs (Y) are used in order from the number set to the start XY, and the numbers never duplicate between inputs (X) and outputs (Y).

Therefore, devices need to be replaced so that the device numbers of inputs (X) and outputs (Y) will not duplicate.

**Ex.**

When the system configuration before and after changing the module type is the following:

- System configuration for FX5CPUs

Model name	Module type	Input	Output
FX5U-32MR/ES	CPU	16 points	16 points
FX5-16EX/ES	Input	16 points	—
FX5-16EYR/ES	Output	—	16 points
FX5-40SSC-S	Simple motion	—	—

- System configuration for RCPUs

Model name	Module type	Input	Output	Start XY
R04	CPU	—	—	3E00
RX10	Input	16 points	—	0000
RX10	Input	16 points	—	0010
RY10R2	Output	—	16 points	0020
RY10R2	Output	—	16 points	0030
RD77MS4	Simple motion	32 points	32 points	0040

A

Correct a device number as shown below:

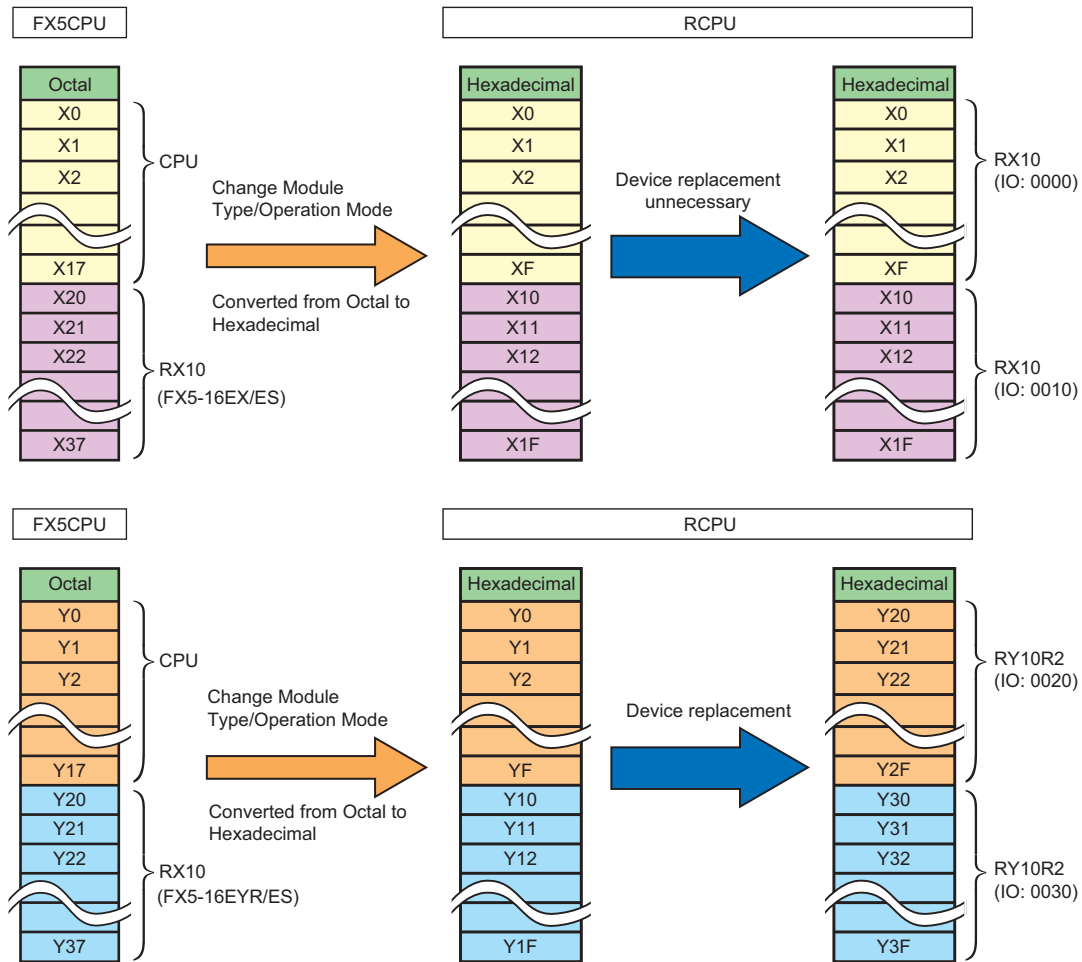

### ■ Replacing module specification numbers

A module specification number can be replaced by using the Replace Device/Label function.  
(Example: "U1" → "U4")

### ■ Replacing instructions

An instruction which cannot be used for RCPUs is replaced with the one that can be used.  
An instruction which cannot be used can be checked by an error occurring at conversion.

### ■ Correcting FBD/LD programs

The number and the order of input/output arguments differ in some function elements between programs written for an FX5CPU and an RCPU in Function Block Diagram/Ladder Diagram language.

Those elements are displayed as undefined FUNs. Select [Edit] ⇨ [Update FB/FUN] to update the definition information, and correct the programs.

# Appendix 9 Using the Simulation Function

## Supported modules

The following shows the modules supported by the simulation function.

### Modules supported by GX Simulator3

Even if any of following modules is in the system configuration of a project, the simulation can be performed without any errors.

Series	Module type	Module name	
MELSEC iQ-R	Main base	R35B, R38B, R312B, R310B-HT, R33B, R310RB, R38RB-HT	
	Extension base	R65B, R68B, R612B, R610B-HT, R610RB, R68RB-HT, R68WRB, R66WRB-HT	
	RQ extension base	RQ65B, RQ68B, RQ612B	
	PLC CPU	R00CPU, R01CPU, R02CPU, R04CPU, R08CPU, R16CPU, R32CPU, R120CPU, R04ENCPU, R08ENCPU, R16ENCPU, R32ENCPU, R120ENCPU	
	Process CPU	R08PCPU, R16PCPU, R32PCPU, R120PCPU	
	SIL2 process CPU	R08PSFCPU, R16PSFCPU, R32PSFCPU, R120PSFCPU	
	Safety CPU	R08SFCPU, R16SFCPU, R32SFCPU, R120SFCPU	
	C controller	R12CCPU-V	
	Motion CPU	R16MTCPU, R32MTCPU, R64MTCPU	
	MELSECWinCPU	R102WCPU-W	
	NCCPU	R16NCCPU	
	Robot CPU	R16RTCPU	
	Power supply	R61P, R62P, R63P, R64P, R63RP, R64RP	
	CPU extension	SIL2 function module	R6PSFM
		Redundant function module	R6RFM
		Safety function module	R6SFM
		Ethernet interface module	_RJ71EN71(CCIEC), _RJ71EN71(CCIEF), _RJ71EN71(E+IEC), _RJ71EN71(E+IEF)
	Input	RX10, RX28, RX40C7, RX40NC6H, RX40PC6H, RX41C4, RX41C6HS, RX42C4, RX61C6HS, RX70C4, RX71C4, RX72C4, RX40NC6B	
	Output	RY10R2, RY20S6, RY18R2A, RY40NT5P, RY40PT5P, RY41NT2P, RY41NT2H, RY41PT1P, RY41PT2H, RY42NT2P, RY42PT1P, RY40PT5B, RY40PT5B-AS	
	I/O	RH42C4NT2P	
	NC dedicated module	R173SXY	
	Sensor control	R60MH112, R60MH112-NA	
	Analog input	R60AD4, R60ADV8, R60ADI8, R60AD8-G, R60AD16-G, R60ADH4, R60ADI8-HA	
Analog output	R60DA4, R60DAV8, R60DAI8, R60DA8-G, R60DA16-G, R60DAH4		
Temperature input	R60RD8-G, R60TD8-G		
Temperature control module	R60TCTRT2TT2, R60TCTRT2TT2BW, R60TCRT4, R60TCRT4BW, R60TCTRT2TT2-TS, R60TCRT4-TS		
CC-Link IE TSN compatible motion module	RD78G4, RD78G8, RD78G16, RD78G32, RD78G64, RD78GHV, RD78GHW, RD78G4(S), RD78G8(S), RD78G16(S)		
Simple motion	RD77MS2, RD77MS4, RD77MS8, RD77MS16, RD77GF4, RD77GF8, RD77GF16, RD77GF32		
Pulse I/O, Positioning	RD62P2, RD62P2E, RD62D2, RD60P8-G, RD75P2, RD75P4, RD75D2, RD75D4, RD40PD01		
Energy measuring module	RE81WH		

Series	Module type	Module name	
MELSEC iQ-R	Information module	C intelligent function module	RD55UP06-V
		High speed data communication module	RD81DC96
		High speed data logger module	RD81DL96
		MES interface module	RD81MES96, RD81MES96N
		OPC UA server module	RD81OPC96
		Recorder module	RD81RC96
		Camera recorder module	RD81RC96-CA
		Serial communication module	RJ71C24, RJ71C24-R2, RJ71C24-R4
		Ethernet interface module	RJ71EN71(CCIEC), RJ71EN71(CCIEF), RJ71EN71(E+E), RJ71EN71(E+CCIEC), RJ71EN71(E+CCIEF), RJ71EN71(Q)
	GP-IB interface module	RJ71GB91(M), RJ71GB91(S)	
	Network module	AnyWireASLINK master module	RJ51AW12AL
		CC-Link system master/local module	RJ61BT11
		BACnet interface module	RJ71BAC96
		CANopen module	RJ71CN91
		DeviceNet master/slave module	RJ71DN91
		EtherNet/IP module	RJ71EIP91
		CC-Link IE Field Network module	RJ71GF11-T2, RJ71GF11-T2(MR), RJ71GF11-T2(SR), RJ71GF11-T2(LR)
		CC-Link IE TSN module	RJ71GN11-T2
		CC-Link IE TSN Plus master/local module	RJ71GN11-EIP(T+E)
		CC-Link IE Controller Network module	RJ71GP21-SX, RJ71GP21-SX(R), RJ71GP21S-SX, RJ71GP21S-SX(R)
		MELSECNET/H network module	RJ71LP21-25, RJ71LP21-25(R)
PROFIBUS interface module	RJ71PB91V(S)		
Blank cover module	RG60		
MELSEC iQ-L	PLC PCU	L04HCPU, L08HCPU, L16HCPU	
	CPU extension	_IO	



Series	Module type	Module name	
MELSEC iQ-F	PLC CPU	FX5U-32MR/DS, FX5U-32MR/ES, FX5U-32MT/DS, FX5U-32MT/DSS, FX5U-32MT/ES, FX5U-32MT/ESS, FX5U-64MR/DS, FX5U-64MR/ES, FX5U-64MT/DS, FX5U-64MT/DSS, FX5U-64MT/ES, FX5U-64MT/ESS, FX5U-80MR/DS, FX5U-80MR/ES, FX5U-80MT/DS, FX5U-80MT/DSS, FX5U-80MT/ES, FX5U-80MT/ESS, FX5UC-32MR/DS-TS, FX5UC-32MT/D, FX5UC-32MT/DS-TS, FX5UC-32MT/DSS, FX5UC-32MT/DSS-TS, FX5UC-64MT/D, FX5UC-64MT/DSS, FX5UC-96MT/D, FX5UC-96MT/DSS, FX5UJ-24MR/ES, FX5UJ-24MT/ES, FX5UJ-24MT/ESS, FX5UJ-40MR/ES, FX5UJ-40MT/ES, FX5UJ-40MT/ESS, FX5UJ-60MR/ES, FX5UJ-60MT/ES, FX5UJ-60MT/ESS, FX5SCPU FX5S-30MR/ES, FX5S-30MT/ES, FX5S-30MT/ESS, FX5S-40MR/ES, FX5S-40MT/ES, FX5S-40MT/ESS, FX5S-60MR/ES, FX5S-60MT/ES, FX5S-60MT/ESS, FX5S-80MR/ES, FX5S-80MT/ES, FX5S-80MT/ESS	
	Input	Terminal type	FX5-8EX/ES, FX5-16EX/ES
		Connector type	FX5-C16EX/D, FX5-C16EX/DS, FX5-C32EX/D, FX5-C32EX/DS
		Spring clamp terminal type	FX5-C32EX/DS-TS
	Output	Terminal type	FX5-8EYR/ES, FX5-8EYT/ES, FX5-8EYT/ESS, FX5-16EYR/ES, FX5-16EYT/ES, FX5-16EYT/ESS
		Connector type	FX5-C16EYT/D, FX5-C16EYT/DSS, FX5-C32EYT/D, FX5-C32EYT/DSS
		Spring clamp terminal type	FX5-C16EYR/D-TS, FX5-C32EYT/D-TS, FX5-C32EYT/DSS-TS
	I/O	Terminal type	FX5-16ER/ES, FX5-16ET/ES, FX5-16ET/ESS, FX5-32ER/ES, FX5-32ET/ES, FX5-32ET/ESS, FX5-32ER/DS, FX5-32ET/DS, FX5-32ET/DSS, FX5-16ET/ES-H, FX5-16ET/ESS-H
		Connector type	FX5-C32ET/D, FX5-C32ET/DSS
		Spring clamp terminal type	FX5-C32ET/DS-TS, FX5-C32ET/DSS-TS
	Analog input	FX5-4AD	
	Analog output	FX5-4DA	
	Multiple input	FX5-8AD	
	Temperature control module	FX5-4LC	
	Pulse I/O, Positioning	FX5-20PG-D, FX5-20PG-P	
	CC-Link IE TSN compatible motion module	FX5-40SSC-G(S), FX5-80SSC-G(S)	
	Simple motion	FX5-40SSC-S, FX5-80SSC-S	
	Information module	FX5-ENET, FX5-ENET/IP	
	Network module	FX5-CCLGN-MS, FX5-CCLIEF, FX5-CCL-MS, FX5-ASL-M, FX5-DP-M	
	Safety extension module	FX5-SF-MU4T5, FX5-SF-8DI4	
	Extension power supply module	Terminal type	FX5-1PSU-5V
		Connector type	FX5-C1PS-5V
	Connector conversion module	FX5-CNV-IF	
	FX5/FX bus conversion module	FX5-CNV-BUS, FX5-CNV-BUSC	

Series	Module type		Module name
MELSEC-Q	Input		QX28, QX10(-TS), QX40(-TS), QX80(-TS), QX70, QX50, QX41(-S2), QX81(-S2), QX71, QX42, QX72, QX82, QX40-S1, QX40H(NoiseF_OFF), QX40H(NoiseF_ON), QX70H(NoiseF_OFF), QX70H(NoiseF_ON), QX80H(NoiseF_OFF), QX80H(NoiseF_ON), QX90H(NoiseF_OFF), QX90H(NoiseF_ON), QX41-S1, QX11L(QX21L), QX42-S1, QX82-S1
	Output		QY10(-TS), QY40P(-TS), QY50, QY80(-TS), QY18A, QY22, QY68A, QY70, QY11AL, QY41P, QY81P, QY71, QY13L, QY23L, QY51PL, QY41H, QY42P, QY82P
	I/O		QX48Y57, QH42P, QX41Y41P
	Interrupt input		QI60
	Analog input		Q64AD, Q68ADV, Q68ADI, Q64AD-GH, Q62AD-DGH, Q68AD-G, Q66AD-DG, Q64ADH, Q61LD, Q68CT
	Analog output		Q62DA, Q62DAN, Q64DA, Q64DAN, Q68DAV, Q68DAVN, Q68DAI, Q68DAIN, Q62DA-FG, Q66DA-G, Q64DAH
	Analog I/O		Q64AD2DA
	Temperature input		Q64RD, Q64RD-G, Q68RD3-G, Q64TD, Q64TDV-GH, Q68TD-G-H01, Q68TD-G-H02
	Temperature control module		Q64TCTT, Q64TCTTN, Q64TCTTBW, Q64TCTTBWN, Q64TCRT, Q64TCRTN, Q64TCRTBW, Q64TCRTBWN
	Loop control		Q62HLC
	Pulse I/O, Positioning		QD70D4, QD70D8, QD72P3C3, QD73A1, QD63P6, QD64D2, QD65PD2, QD60P8-G
	Energy measuring module		QE81WH, QE81WH4W, QE82LG, QE83WH4W, QE84WH
	Information module	Intelligent communications module	QD51, QD51-R24
		MES interface module	QJ71MES96, QJ71MES96N
		Web server module	QJ71WS96
	Network module	AnyWireASLINK master module	QJ51AW12AL
		CC-Link/LT master module	QJ61CL12
		AS-i master module	QJ71AS92
		MELSECNET/H network module	QJ71BR11, QJ71LP21(-25 S-25 G GE), QJ71NT11B
		DeviceNet master/slave module	QJ71DN91
		FL-net (OPCN-2) interface module	QJ71FL71(-T -B5)(-F01), QJ71FL71-B2(-F01)
	MODBUS(R) interface module		QJ71MT91, QJ71MB91
	Blank cover module		QG60
Partner products		—	
MELSEC-L	Input		LX28, LX10, LX40C6, LX41C4, LX42C4
	Output		LY18R2A, LY28S1A, LY10R2, LY20S6, LY40NT5P, LY40PT5P, LY41NT1P, LY41PT1P, LY42NT1P, LY42PT1P
	I/O		LH42C4NT1P, LH42C4PT1P
	Analog input		L60AD4, L60AD4-2GH, L60ADVL8, L60ADIL8
	Analog output		L60DA4, L60DAVL8, L60DAIL8
	Analog I/O		L60AD2DA2
	Temperature input		L60RD8
	Temperature control module		L60TCTT4, L60TCTT4BW, L60TCRT4, L60TCRT4BW
	Multiple input		L60MD4-G
	Pulse I/O, Positioning		LD75D1, LD75D2, LD75D4, LD75P1, LD75P2, LD75P4, LD62, LD62D, LD40PD01
	Information module	Serial communication module	LJ71C24, LJ71C24-R2
	Network module	AnyWireASLINK master module	LJ51AW12AL
		CC-Link system master/local module	LJ61BT11

## Modules supported by GX Simulator3 (System simulation)

The following table shows modules that can be simulated interacting with other modules and the maximum number of the modules.

Series	Module type	Module name	Maximum number of modules (in all systems)	
MELSEC iQ-R	PLC CPU	R00CPU, R01CPU, R02CPU, R04CPU, R08CPU, R16CPU, R32CPU, R120CPU, R04ENCPU, R08ENCPU, R16ENCPU, R32ENCPU, R120ENCPU	4 <sup>*1</sup>	
	Process CPU	R08PCPU, R16PCPU, R32PCPU, R120PCPU		
	SIL2 process CPU	R08PSFCPU, R16PSFCPU, R32PSFCPU, R120PSFCPU		
	Safety CPU	R08SFCPU, R16SFCPU, R32SFCPU, R120SFCPU		
	Simple motion		RD77MS2, RD77MS4, RD77MS8, RD77MS16	6 <sup>*2</sup>
			RD77GF4, RD77GF8, RD77GF16, RD77GF32	2 <sup>*3</sup>
	Motion CPU	R16MTCPU, R32MTCPU, R64MTCPU		
	CC-Link IE TSN compatible motion module		RD78G4, RD78G8, RD78G16, RD78G32, RD78G64, RD78GHV, RD78GHW	
			RD78G4(S), RD78G8(S), RD78G16(S)	
	CPU extension	Ethernet interface module	_RJ71EN71(CCIEC), _RJ71EN71(CCIEF), _RJ71EN71(E+IEC), _RJ71EN71(E+IEF)	4 <sup>*4</sup>
Information module	Ethernet interface module	RJ71EN71(CCIEC), RJ71EN71(CCIEF), RJ71EN71(E+CCIEC), RJ71EN71(E+CCIEF)	4 <sup>*4</sup> (2 per system)	
Network module	CC-Link IE Field Network module	RJ71GF11-T2, RJ71GF11-T2(MR), RJ71GF11-T2(SR), RJ71GF11-T2(LR)		
	CC-Link IE TSN module	RJ71GN11-T2		
	CC-Link IE Controller Network module	RJ71GP21-SX, RJ71GP21-SX(R), RJ71GP21S-SX, RJ71GP21S-SX(R)		
MELSEC iQ-L	PLC CPU	L04HCPU, L08HCPU, L16HCPU	4 <sup>*1</sup>	
MELSEC iQ-F	PLC CPU	FX5U-32MR/DS, FX5U-32MR/ES, FX5U-32MT/DS, FX5U-32MT/DSS, FX5U-32MT/ES, FX5U-32MT/ESS, FX5U-64MR/DS, FX5U-64MR/ES, FX5U-64MT/DS, FX5U-64MT/DSS, FX5U-64MT/ES, FX5U-64MT/ESS, FX5U-80MR/DS, FX5U-80MR/ES, FX5U-80MT/DS, FX5U-80MT/DSS, FX5U-80MT/ES, FX5U-80MT/ESS, FX5UC-32MR/DS-TS, FX5UC-32MT/D, FX5UC-32MT/DS-TS, FX5UC-32MT/DSS, FX5UC-32MT/DSS-TS, FX5UC-64MT/D, FX5UC-64MT/DSS, FX5UC-96MT/D, FX5UC-96MT/DSS, FX5UJ-24MR/ES, FX5UJ-24MT/ES, FX5UJ-24MT/ESS, FX5UJ-40MR/ES, FX5UJ-40MT/ES, FX5UJ-40MT/ESS, FX5UJ-60MR/ES, FX5UJ-60MT/ES, FX5UJ-60MT/ESS		
	Simple motion	FX5-40SSC-S, FX5-80SSC-S	6 <sup>*2</sup>	
	CC-Link IE TSN compatible motion module	FX5-40SSC-G(S), FX5-80SSC-G(S)	2 <sup>*3</sup>	
	Network module	FX5-CCLGN-MS, FX5-CCLIEF	4 <sup>*4</sup> (2 per system)	

\*1 The sum of all CPU modules

\*2 The sum of all simple motion modules

· Simple motion modules (RD77MS2, RD77MS4, RD77MS8, RD77MS16, FX5-40SSC-S, and FX5-80SSC-S)

\*3 The sum of all the following modules:

· Simple motion modules (RD77GF4, RD77GF8, RD77GF16, and RD77GF32)

· Motion CPU

· CC-Link IE TSN compatible motion module

\*4 The sum of all Ethernet interface modules and network modules

A

### ■Modules supported by SMM Simulator

Series	Module type	Model name
MELSEC iQ-R	Simple motion	RD77MS2
		RD77MS4
		RD77MS8
		RD77MS16
		RD77GF4
		RD77GF8
		RD77GF16
		RD77GF32
MELSEC iQ-F	Simple motion	FX5-40SSC-S
		FX5-80SSC-S

### ■Modules supported by MU Simulator

Series	Module Type	Model Name
MELSEC iQ-R	CC-Link IE TSN compatible motion module	RD78G4
		RD78G8
		RD78G16
		RD78G32
		RD78G64
		RD78GHV
		RD78GHW
		RD78G4(S)
		RD78G8(S)
		RD78G16(S)
MELSEC iQ-F	CC-Link IE TSN compatible motion module	FX5-40SSC-G(S)
		FX5-80SSC-G(S)

### ■Modules supported by MT Simulator2

Series	Module type	Model name
MELSEC iQ-R	Motion CPU	R16MTCPU
		R32MTCPU
		R64MTCPU

## Firmware versions of CPU modules

GX Simulator3 runs based on the following firmware versions. When the firmware version of a CPU module is not matched with the following one, operation of the actual module and GX Simulator3 may differ.

Module type	Supported version of GX Works3	Firmware version	
RnCPU (R00CPU, R01CPU, R02CPU)	Version 1.045X or later	01	
	Version 1.050C or later	05	
	Version 1.055H or later	08	
	Version 1.060N or later	12	
	Version 1.065T or later	15	
	Version 1.070Y or later	18	
	Version 1.075D or later	21	
	Version 1.080J or later	24	
	Version 1.085P or later	26	
	Version 1.090U or later	30	
RnCPU (R04CPU, R08CPU, R16CPU, R32CPU, R120CPU)	Version 1.007H or later	03	
	Version 1.020W or later	13	
	Version 1.025B or later	17	
	Version 1.030G or later	22	
	Version 1.035M or later	26	
	Version 1.040S or later	28	
	Version 1.045X or later	31	
	Version 1.050C or later	35	
	Version 1.055H or later	40	
	Version 1.060N or later	44	
	Version 1.065T or later	47	
	Version 1.070Y or later	50	
	Version 1.075D or later	53	
	Version 1.080J or later	57	
	Version 1.085P or later	59	
	Version 1.090U or later	63	
	RnENCPU	Version 1.020W or later	13
		Version 1.025B or later	17
Version 1.030G or later		22	
Version 1.035M or later		26	
Version 1.040S or later		28	
Version 1.045X or later		31	
Version 1.050C or later		35	
Version 1.055H or later		40	
Version 1.060N or later		44	
Version 1.065T or later		47	
Version 1.070Y or later		50	
Version 1.075D or later		53	
Version 1.080J or later		57	
Version 1.085P or later		59	
Version 1.090U or later		63	

Module type	Supported version of GX Works3	Firmware version
RnPCPU	Version 1.010L or later	01
	Version 1.020W or later	02
	Version 1.025B or later	03
	Version 1.030G or later	05
	Version 1.035M or later	08
	Version 1.040S or later	10
	Version 1.045X or later	13
	Version 1.050C or later	16
	Version 1.055H or later	18
	Version 1.060N or later	20
	Version 1.065T or later	22
	Version 1.070Y or later	24
	Version 1.075D or later	25
	Version 1.080J or later	27
	Version 1.085P or later	29
	Version 1.090U or later	33
RnSFCPU	Version 1.020W or later	03
	Version 1.030G or later	06
	Version 1.035M or later	07
	Version 1.040S or later	08
	Version 1.045X or later	10
	Version 1.050C or later	13
	Version 1.055H or later	16
	Version 1.060N or later	17
	Version 1.065T or later	19
	Version 1.070Y or later	21
	Version 1.075D or later	23
	Version 1.080J or later	24
	Version 1.085P or later	26
RnPSFCPU	Version 1.045X or later	01
	Version 1.060N or later	03
	Version 1.065T or later	04
	Version 1.085P or later	08
	Version 1.090U or later	09
LHCPU	Version 1.065T or later	01
	Version 1.080J or later	02
	Version 1.085P or later	04
FX5UCPU, FX5UCCPU	Version 1.025B or later	1.015
	Version 1.030G or later	1.031
	Version 1.035M or later	1.040
	Version 1.040S or later	1.050
	Version 1.045X or later	1.060
	Version 1.050C or later	1.065
	Version 1.055H or later	1.110
	Version 1.065T or later	1.201
	Version 1.070Y or later	1.210
	Version 1.075D or later	1.220
	Version 1.080J or later	1.240
	Version 1.085P or later	1.260
Version 1.090U or later	1.270	

Module type	Supported version of GX Works3	Firmware version
FX5UJCPU	Version 1.065T or later	1.000
	Version 1.080J or later	1.010
	Version 1.085P or later	1.020
	Version 1.090U or later	1.030
FX5SCPU	Version 1.085P or later	1.000

## Firmware versions of network modules

GX Simulator3 operates based on the firmware with the following version.

Network module	Supported version of GX Works3	Firmware version
RnENCPU (network part)	Version 1.040S or later	18
	Version 1.060N or later	39
	Version 1.080J or later	54
RJ71EN71	Version 1.040S or later	18
	Version 1.060N or later	39
	Version 1.080J or later	54
RJ71GP21-SX	Version 1.040S or later	18
	Version 1.060N or later	39
	Version 1.080J or later	54
RJ71GP21S-SX	Version 1.050C or later	18
	Version 1.060N or later	39
	Version 1.080J or later	54
RJ71GF11-T2	Version 1.040S or later	18
	Version 1.060N or later	39
	Version 1.080J or later	54
RJ71GN11-T2	Version 1.060N or later	01
	Version 1.080J or later	12
FX5-CCLIEF	Version 1.040S or later	1.004
	Version 1.080J or later	1.005
FX5-CCLGN-MS	Version 1.080J or later	1.001

## Supported CPU module functions

The simulation function of GX Works3 does not support some functions of a CPU module.

The following shows the functions which are supported by the simulation function.

For details on each function, refer to the following:

📖 MELSEC iQ-R CPU Module User's Manual (Application)

📖 MELSEC iQ-F FX5 User's Manual (Application)

### CPU module (RnCPU, RnENCPU, RnPCPU, LHCPU)

Function name			Remarks	
Basic	Program	Program execution (ladder, ST, and FBD/LD)		Page 974 Program execution time
		Program execution (SFC)		
		Scan time monitoring time (WDT) setting		
	Clock	Clock	Clock	The clock data is written to the internal time of a simulator. It differs from the time of a personal computer.
			Time zone setting	The clock of a personal computer is copied to the internal time and used.
			Daylight saving time <sup>*1</sup>	—
		System clock		
	LED display			
	Writing to PLC/reading from PLC	Writing data to a programmable controller (including data writing while a CPU module is in RUN)		
		Reading from a programmable controller (including data reading while a CPU module is in RUN)		
	Diagnostics	Self-diagnostics	Error detection	Page 978 Errors for the self-diagnostics function
			Module diagnostics	This function is available only for the host station.
	Monitor and test	Basic monitor	Monitoring a program (circuit monitor)	
		Test	Testing device and label data (changing values)	Testing device and label data (changing values)
				Testing local device and local label data
Debug	Online program change	Online change (ladder block)		
	Program restoration information write selection <sup>*2</sup>			
System operation setting	LED control setting for program restoration information write status <sup>*2*3</sup>			
	File batch online change operation setting <sup>*3*4</sup>			



Function name				Remarks
Operation	Program	Program execution setting	Program execution type setting	—
			Device/file usage setting	A virtual SD memory card file can be used.
		Interrupt	Fixed scan interval setting	Page 974 Program execution time
			File register block number saving/recovering setting	—
			Interrupt priority setting from module <sup>*4</sup>	
			Interrupt enable setting in executing instruction <sup>*4</sup>	
		PID control		
		Process control <sup>*5</sup>		
		Constant scan	Page 974 Program execution time	
		Database <sup>*1*3</sup>		
	Operation	Remote operation	Operation change	—
			Latch clear	
			RUN-PAUSE contact setting	
	Device/data	Device/label memory area setting	Device/label memory area setting	
			Local device setting	
		Link direct device setting		
		Refresh memory setting <sup>*1</sup>		
		Internal buffer capacity setting <sup>*6</sup>		
		Index register setting		
		Initial device/label value setting		
Label initial value reflection setting <sup>*5</sup>				
Label initialization function after converting all programs and writing to a programmable controller <sup>*5</sup>				
Device comment				
File register setting				
Timer device limit setting				
STOP→RUN operation setting of output (Y)				
Label access setting from external devices <sup>*3</sup>				
Write-protect for device data (from outside the CPU module) <sup>*7</sup>				
System clock (SM400 to SM403) every end update setting <sup>*7</sup>				
SD memory card <sup>*6</sup>	Writing to an SD memory card/reading from an SD memory card			
	SD memory card forcibly disabled			
Latch			This function is not available while GX Simulator3 is stopped.	
Communication setting	Device/label access service processing setting		—	
	Device/label access service processing constant wait <sup>*5</sup>			
RAS	Diagnostics	Error clear		
		FB hierarchy information <sup>*4</sup>		
	System monitoring information (SD2000 to SD2036) <sup>*7</sup>			The MAC address and firmware hash value cannot be used.
History	Event history (Error history/module error history collecting)	—	This function is available only for the host station. A virtual SD memory card file can be used. <sup>*6</sup>	
		Event history logging restriction <sup>*4</sup>		



Function name				Remarks	
Maintenance	Monitor	(Interrupt) program list monitor	Program start/stop <sup>*4</sup>	Page 974 Program execution time	
		Scan time monitor			
		Scan time measurement <sup>*7</sup>			
		Scan time clear <sup>*7</sup>			—
		SFC program (diagram) monitor	SFC-activated step monitor <sup>*1</sup>		
		(Local) device/label batch/registration monitor			
		Buffer memory monitor			
		Real-time monitor <sup>*1</sup>			Page 974 Program execution time
		Specified program monitor <sup>*7</sup>			—
	Test	Device test with execution conditions			
		External input/output forced on/off			
		Clearing device, label and file register			
		Clearing a latch device and label			
	Debug	Change of TC setting value <sup>*4</sup>			
		Online change (SFC block)	Inactive block		
			Active block		
		Memory dump <sup>*1,*6</sup>			
	Web server <sup>*7</sup>	Detailed module information			
		Device batch monitor			
		Device test			
Watch					
CPU diagnostics					
Event history					
Access log					
User web page <sup>*6</sup>					
Display refreshing cycle					
Language switching					
Multiple CPU system <sup>*2*4</sup>		Operation setting	Other PLC control module setting	Control CPU setting	These functions are available only for CPUs that are simulated in the system simulation.
	Importing I/O from outside group				
	Operation mode setting		Clock data synchronization		
			Operation setting at stop error		
	CPU data communication	Communication	Fixed scan communication setting		
			CPU number-based data assurance		
			Communication by refresh		
			Communication by direct access		
Interrupt	Multiple CPU synchronization interruption (I45)				
Redundant system <sup>*8</sup>	 Page 523 Simulation of an RnPCPU (redundant mode)				

\*1 RnPCPUs do not support it.

\*2 RnPCPUs (redundant mode) do not support it.

\*3 An R00CPU, R01CPU, and R02CPU do not support it.

\*4 LHCPUs do not support it.

\*5 Only RnPCPUs support it.

\*6 R00CPU do not support it.

\*7 RnCPUs and RnENCPUs support it.

\*8 Only RnPCPUs (redundant mode) support it.

## CPU module (RnPSFCPU, RnSFCPU)

Function name				Remarks	
Basic	Program	Program execution (ladder, ST, and FBD/LD)		Standard program	Page 974 Program execution time
				Safety program	
		Program execution (SFC) <sup>*1</sup>		Standard program	
		Scan time monitoring time (WDT) setting		Standard program	
	Safety program				
	Clock	Clock	Clock		The clock data is written to the internal time of a simulator. It differs from the time of a personal computer.
			Time zone		The clock of a personal computer is copied to the internal time and used.
		System clock	System clock		—
			Safety special relay/safety special register		
	Writing to PLC/reading from PLC	Writing to a programmable controller (including data writing while a CPU module is in RUN)		Standard program	
Safety program					
Reading from a programmable controller (including data reading while a CPU module is in RUN)		Standard program			
		Safety program			
Diagnostics	Self-diagnostics	Error detection		This function is available only for the host station.	
		Module diagnostics			
Monitor and test	Monitoring a program (circuit monitor)		Standard program	—	
			Safety program		
	Testing device and label data (changing values)	Testing device and label data (changing values)	Standard device/standard label		
			Safety device/safety label		
			Standard/safety shared label		
		Testing local device and local label data	Standard device/standard label		
			Safety device/safety label		
			Standard/safety shared label		
Debug	Online program change	Online change (ladder block)	Standard program		
			Safety program <sup>*1</sup>		
	Program restoration information write selection <sup>*1</sup>				
System operation setting <sup>*1</sup>	LED control setting for program restoration information write status				
	File batch online change operation setting				

A

Function name				Remarks		
Operation	Program	Program execution setting	Program execution type setting	Standard program	—	
				Safety program		
			Device/file usage setting	Standard program		
				Safety program		
		Interrupt	Fixed scan interval setting	Standard program		Page 974 Program execution time
			File register block number saving/recovering setting	Standard program		—
			Interrupt priority setting from module	Standard program		
			Interrupt enable setting in executing instruction	Standard program		
		PID control		Standard program		
		Process control <sup>*2</sup>		Standard program		
	Constant scan			Page 974 Program execution time		
	Operation	Remote operation	Operation change		—	
			Latch clear	Standard device/ standard label		
			RUN-PAUSE contact setting			
	Device/data	Device/label memory area setting	Device/label memory area setting	Standard device/ standard label	—	
Safety device/ safety label						
Standard/safety shared label						
Local device setting			Standard program (Standard device/ standard label)			
		Safety program (Safety device/ safety label)				
Link direct device setting <sup>*1</sup>						
Refresh memory setting						
Internal buffer capacity setting						
Index register setting		Standard program				
Initial device/label value setting		Standard device/ standard label				
Label initial value reflection setting <sup>*2</sup>		Standard label				
Label initialization after converting all programs (reassignment) <sup>*2</sup>		Standard label				
Device comment		Standard device				
		Safety device				
File register setting		Standard program				
Timer device limit setting		Standard program				
		Safety program				
STOP→RUN operation setting of output (Y)						
Label access setting from external devices		Standard label				
Latch	Latch	Standard device/ standard label	This function is not available while GX Simulator3 is stopped.			
SD memory card	Writing to an SD memory card/reading from an SD memory card		—			
	SD memory card forcibly disabled					
Communication setting	Device/label access service processing setting					
Diagnostics and history	Diagnostics	Error clear				
	History	Event history (error history/module error history collecting)	—	This function is available only for the host station. A virtual SD memory card file can be used.		
Event history logging restriction <sup>*1</sup>						

Function name				Remarks
Maintenance	Monitor	(Interrupt) program list monitor		Page 974 Program execution time
		Scan time monitor		
		Scan time clear <sup>*1</sup>		
		SFC program (diagram) monitor <sup>*1</sup>	SFC-activated step monitor	
		(Local) device batch/registration monitor		
		Buffer memory monitor		
	Test	Device test with execution condition <sup>*1</sup>		Standard device/ standard label
		External input/output forced on/off <sup>*1</sup>		
		Clearing device, label and file register		Standard device/ standard label
				Safety device/ safety label
				Standard/safety shared label
		Clearing a latch device and label		
	Debug	Change TC setting <sup>*1</sup>		
		Online change (SFC block) <sup>*1</sup>		Inactive block Active block
Memory dump <sup>*1</sup>		Standard device		
Multiple CPU system <sup>*1</sup>	Operation setting	Other PLC control module setting	Control CPU setting	These functions are available only for CPUs that are simulated in the system simulation.
			Importing I/O from outside group	
		Operation mode setting	Clock data synchronization	
			Operation setting at stop error	
	Multiple CPU synchronous startup setting			
	CPU data communication	Communication	Fixed scan communication setting	
			CPU number-based data assurance	
			Communication by refresh	
			Communication by direct access	
	Interrupt	Multiple CPU synchronization interruption (I45)		
Safety (RnSFCPU + R6SFM) (RnPSFCPU + R6PSFM)	Safety communication	CC-Link IE Field Network (safety communication function)	Safety refresh monitoring time	
			Safety data transfer device setting	
	Safety communication	CC-Link IE TSN (safety communication function) <sup>*1</sup>	Safety refresh monitoring time	
			Safety data transfer device setting	
Safety condition control	Safety/test mode			Only the test mode can be used.
Redundant system <sup>*2</sup>	Page 523 Simulation of an RnPSFCPU			

\*1 Only RnSFCPUs support it.

\*2 Only RnPSFCPUs support it.



## MELSEC iQ-R and MELSEC iQ-L series common functions

Function name			Remarks	
System configuration	System configuration setting	I/O assignment setting	—	
		MELSEC iQ-R series 2-slots module		
Program	Operation setting	MELSEC iQ-R series module setting (all modules)	Network parameter (CC-Link, CC-Link IE Control, CC-Link IE Field, CC-Link IE TSN, Ethernet)	
		Data communication		Refresh (I/O, network, buffer memory (intelligent function module))
			Direct access (U□\G, J□\X, J□\Y, J□\B, J□\SB, J□\W, J□\SW)	Access with module FB (dedicated instruction) and module label is available. This function is not available in a safety program.
			Program	Interrupt from module* <sup>1</sup>
	Program creation support		Module label and module FB (device comment) auto-creation	Page 954 Module dedicated instruction Page 973 Dedicated instructions for network modules
			Sample program display (template display)* <sup>1</sup>	
			Parameter auto-creation (initial setting and refresh setting)	
	Label communication	Access from an external device	Label communication from GOT* <sup>2</sup>	A virtual SD memory card file can be used.
	Inter-module synchronization	Inter-module synchronization	Fixed cycle synchronous control* <sup>3</sup>	—
		Interrupt	Inter-module synchronous interrupt (I44)	
Security	File reading/writing restriction	File password* <sup>4</sup>	When a virtual SD memory card file to which a file with a password is copied is set in GX Simulator3, the copied file can be read from the virtual SD memory card file. (Password authentication is required.)	
RAS	History	Event history	A virtual SD memory card file can be used.* <sup>4</sup> Among events that occur on a network, only the events for modules that are simulated in the system simulation can be checked.	
		Diagnostics	Module diagnostics	This function is available only for the host station.
			CC-Link IE Controller Network diagnostics	These functions are available only for modules that are simulated in the system simulation. The operation test cannot be used.
			CC-Link IE TSN diagnostics* <sup>5</sup>	
Ethernet	Simple CPU communication* <sup>6</sup>		This function is available only when any of the following options is selected for "Communication Destination" in "Simple CPU Communication Setting" of the module parameter: <ul style="list-style-type: none"> <li>• MELSEC iQ-R (built-in Ethernet)</li> <li>• MELSEC iQ-L (built-in Ethernet)</li> <li>• MELSEC iQ-F (built-in Ethernet)</li> </ul>	

- \*1 LHCPU do not support it.
- \*2 An R00CPU, R01CPU, and R02CPU do not support it.
- \*3 Not available for a CC-Link IE TSN module.
- \*4 An R00CPU does not support it.
- \*5 RnPSFCPU do not support it.
- \*6 RnCPU and RnENCPU support it.

## CPU module (FX5CPU)

Function name	Remarks
Scan time monitoring time (WDT) setting	Page 976 Watchdog timer Page 974 Program execution time
Clock	The clock data is written to the internal time of a simulator. It differs from the time of a personal computer.
Online program change	Online change (ladder block)
Interrupt	Multiple interrupt
PID control	
Constant scan	
Remote operation	Remote RUN/STOP
	Remote PAUSE
	Remote RESET
Device/label memory area setting	
Program capacity setting	
Internal buffer capacity setting	
Initial device value setting	
Latch	This function is not available while GX Simulator3 is stopped.
SD memory card	SD memory card forced stop
Device/label access service processing setting	
Memory dump	
Real-time monitor	
RAS	Self-diagnostics
	Error clear
	Event history
SFC	This function is available only for the host station.
Scan time clear	
MELSOFT connection	
Web server	Detailed module information
	Device batch monitor
	Device test
	Watch
	CPU diagnostics
	Event history
	Access log
	User web page
	Display refreshing cycle
	Language switching
Simple CPU communication	Diagnostics functions are not available. For FX5UCPUs, FX5UCCPUs, and FX5UJCPUs, this function is available only when any of the following options is selected for "Communication Destination" in "Simple CPU Communication Setting" of the module parameter: <ul style="list-style-type: none"> <li>• MELSEC iQ-R (built-in Ethernet)</li> <li>• MELSEC iQ-L (built-in Ethernet)</li> <li>• MELSEC iQ-F (built-in Ethernet)*1</li> </ul> For FX5SCPUs, this function is available only when "MELSEC iQ-F (built-in Ethernet)"*1 is selected for "Communication Destination" in "Simple CPU Communication Setting" of the module parameter.

\*1 Only the modules supported by the simulation function are available.



## Supported devices

---

The simulation function supports devices of CPU modules.

In addition, special relays and special registers that functions supported by the simulation function use are also supported.

For details on the devices, refer to the following:

 MELSEC iQ-R CPU Module User's Manual (Application)

 MELSEC iQ-F FX5 User's Manual (Application)

# Supported instructions

The instructions supported by the Simulation function are shown below:

For details on each instruction, refer to the following:

📖 MELSEC iQ-R Programming Manual (CPU Module Instructions, Standard Functions/Function Blocks)

📖 MELSEC iQ-R Programming Manual (Process Control Function Blocks/Instructions)

📖 MELSEC iQ-F FX5 Programming Manual (Instructions, Standard Functions/Function Blocks)

Note that no processing is performed for unsupported instructions (NOP processing).

## RCPU and LHCPU

### ■ Sequence instruction

Classification	Symbol
Contact instruction	AND, ANDF, ANDFI, ANDP, ANDPI, ANI, LD, LDF, LDFI, LDI, LDP, LDPI, OR, ORF, ORFI, ORI, ORP, ORPI
Association instruction	ANB, EGF, EGP, INV, MEF, MEP, MPP, MPS, MRD, ORB
Output instruction	DELTA(P) <sup>*1</sup> , FF, OUT, OUT C, OUT F, OUT LC, OUT LT/LST, OUT T/ST, OUTH T/ST, PLF, PLS, RST, RST F, SET, SET F
Shift instruction	SFT(P)
Master control instruction	MC, MCR
Phase processing instruction	PHASE, PHASECHG, PHASEEND
Termination instruction	END, FEND
Stop instruction	STOP
No operation instruction	NOP

\*1 Intelligent function modules supporting GX Simulator3 (system simulation) support it.

### ■ Basic instruction

Classification	Symbol <sup>*1</sup>
Comparison operation instruction	AND□(U), ANDD□(U), BKCOMP□(P)(U), CMP(P)(U) <sup>*2</sup> , DBKCOMP□(P)(U), DCMP(P)(U) <sup>*2</sup> , DZCP(P)(U) <sup>*2</sup> , LD□(U), LDD□(U), OR□(U), ORD□(U), ZCP(P)(U) <sup>*2</sup>
Arithmetic operation instruction	*(P)(U), +(P)(U), -(P)(U), /(P)(U), B*(P), B+(P), B-(P), B/(P), BK+(P)(U), BK-(P)(U), D*(P)(U), D+(P)(U), D-(P)(U), D/(P)(U), DB*(P), DB+(P), DB-(P), DB/(P), DBK+(P)(U), DBK-(P)(U), DDEC(P)(U), DEC(P)(U), DINC(P)(U), INC(P)(U)
Logical operation instruction	BKAND(P), BKOR(P), BKXNR(P), BKXOR(P), DAND(P), DOR(P), DXNR(P), DXOR(P), WAND(P), WOR(P), WXNR(P), WXOR(P)
Bit processing instruction	BKRST(P), BRST(P), BSET(P), DTEST(P), TEST(P)
Data conversion instruction	ASC2INT(P), BCD(P), BIN(P), BKBCD(P), BKBIN(P), BTOW(P), DABCD(P), DABIN(P)(U), DBCD(P), DBIN(P), DBL2DINT(P), DBL2INT(P), DBL2UDINT(P), DBL2UINT(P), DDABCD(P), DDABIN(P)(U), DECO(P), DGBIN(P)(U), DGRY(P)(U), DHABIN(P), DINT2INT(P), DINT2UDINT(P), DINT2UINT(P), DIS(P), DNEG(P), DVAL(P)(U), EMOD(P), ENCO(P), FLT2DINT(P), FLT2INT(P), FLT2UDINT(P), FLT2UINT(P), GBIN(P)(U), GRY(P)(U), HABIN(P), INT2DINT(P), INT2UDINT(P), INT2UINT(P), NDIS(P), NEG(P), NUNI(P), SEG(P), UDINT2DINT(P), UDINT2INT(P), UDINT2UINT(P), UINT2DINT(P), UINT2INT(P), UINT2UDINT(P), UNI(P), VAL(P)(U), WTOB(P)
Data shift instruction	BSFL(P), BSFR(P), EDSFTL(P) <sup>*2</sup> , EDSFTR(P) <sup>*2</sup> , ESFTL(P) <sup>*2</sup> , ESFTR(P) <sup>*2</sup> , DDSFR(P) <sup>*2</sup> , DDSFL(P) <sup>*2</sup> , DSFL(P), DSFR(P), DWSFTL(P) <sup>*2</sup> , DWSFTR(P) <sup>*2</sup> , ESFR(P) <sup>*2</sup> , ESFL(P) <sup>*2</sup> , EDSFR(P) <sup>*2</sup> , EDSFL(P) <sup>*2</sup> , SFL(P), SFR(P), SFTER(P) <sup>*2</sup> , SFTDWL(P) <sup>*2</sup> , SFTBL(P), SFTBR(P), SFTEDL(P) <sup>*2</sup> , SFTEDR(P) <sup>*2</sup> , SFTTEL(P) <sup>*2</sup> , SFTDWR(P) <sup>*2</sup> , SFTL(P) <sup>*2</sup> , SFTR(P) <sup>*2</sup> , SFTWL(P), SFTWR(P), WSFL(P) <sup>*2</sup> , WSFR(P) <sup>*2</sup>
Data transfer instruction	BLKMOVB(P), BMOV(P), BMOVL(P), BXCH(P), CML(P), CMLB(P), DCML(P), DFMOV(P), DFMOVL(P), DMOV(P), DSWAP(P) <sup>*2</sup> , DXCH(P), FMOV(P), FMOVL(P), MOV(P), MOVB(P), SMOV(P) <sup>*2</sup> , SWAP(P), XCH(P)

\*1 □ indicates an operator.

\*2 RnCPUs, RnENCUs, and LHCPUs support it.

### ■ Application instruction

Classification	Symbol <sup>*1</sup>
Program branch instruction	CJ, GOEND, JMP, SCJ
Program execution control instruction	DI, EI, IMASK, IRET, SIMASK, WDT(P)
Structure creation instruction	BREAK(P), CALL(P), ECALL(P), EFCALL(P), FCALL(P), FOR, NEXT, RET, XCALL
Program control instruction	POFF(P), PSCAN(P), PSTOP(P)
Rotation instruction	DRCL(P), DRCR(P), DROL(P), DROR(P), RCL(P), RCR(P), ROL(P), ROR(P)
Data table operation instruction	FDEL(P), FIFR(P), FIFW(P), FINS(P), FPOP(P)

Classification	Symbol*1
Reading/writing data instruction	S(P).DEVLD, SP.DEVST, SP.FREAD, SP.FWRITE
File operation instruction*2	SP.FDELETE, SP.FCOPY, SP.FMOVE, SP.FRENAME, SP.FSTATUS
Data control instruction	BAND(P)(U), DBAND(P)(U), DLIMIT(P)(U), DSCL(P)(U), DSCL2(P)(U), DZONE(P)(U), LIMIT(P)(U), SCL(P)(U), SCL2(P)(U), ZONE(P)(U)
Data processing instruction	BON(P)*2, CRC(P)*2, DBON(P)*2, DMAX(P)(U), DMEAN(P)(U), DMIN(P)(U), DSERDATA(P), DSERMM(P)*2, DSORTD(U), DSORTTBL2(U)*2, DSQRT(P)*2, DSUM(P), DWSUM(P)(U), MAX(P)(U), MEAN(P)(U), MIN(P)(U), SERDATA(P), SERMM(P)*2, SORTD(U), SORTTBL(U)*2, SORTTBL2(U)*2, SQRT(P)*2, SUM(P), WSUM(P)(U)
Check code instruction	CCD(P)
Debugging and failure diagnostic instruction	LEDR, PALERT(P)*3, PABORT*3
String processing instruction	\$+(P), \$MOV(P), \$MOV(P)_WS, AND\$□, BCDDA(P), BINDA(P)(U), BINHA(P), DBCDDA(P), DBINDA(P)(U), DBINHA(P), DSTR(P)(U), ESTR(P), INSTR(P), INT2ASC(P), LD\$□, LEFT(P), LEN(P), MIDR(P), MIDW(P), OR\$□, RIGHT(P), SJIS2WS(P), SJIS2WSB(P), STR(P)(U), STRDEL(P), STRINS(P), WS2SJIS(P)
Real number instruction	ACOS(P), ACOSD(P), ANDE□, ANDED□, ASIN(P), ASIND(P), ATAN(P), ATAND(P), BACOS(P), BASIN(P), BATAN(P), BCOS(P), BDSQRT(P), BSIN(P), BSQRT(P), BTAN(P), COS(P), COSD(P), DBL2FLT(P), DEG(P), DEGD(P), DINT2DBL(P), DINT2FLT(P), E*(P), E+(P), E-(P), E/(P), ECOMP(P)*2, ED*(P), ED+(P), ED-(P), ED/(P), EDCMP(P)*2, EDMAX(P), EDMIN(P), EDMOV(P), EDNEG(P), EDSQRT(P), EDZCP(P)*2, EMAX(P), EMIN(P), EMOV(P), ENEG(P), EREXP(P), ESQRT(P), EVAL(P), EXP(P), EXPD(P), EZCP(P)*2, FLT2DBL(P), INT2DBL(P), INT2FLT(P), LDE□, LDED□, LOG(P), LOG10(P), LOG10D(P), LOGD(P), ORE□, ORED□, POW(P), POWD(P), RAD(P), RADD(P), SIN(P), SIND(P), TAN(P), TAND(P), UDINT2DBL(P), UDINT2FLT(P), UINT2DBL(P), UINT2FLT(P)
Random number instruction	RND(P), SRND(P)
Index register instruction	ZPOP(P), ZPUSH(P)
File register operation instruction	QDRSET(P), RSET(P)
Read/write instruction for each 1 byte of a file register.	ZRRDB(P), ZRWRB(P)
Indirect address read instruction	ADRSET(P)
Special counter instruction	UDCNT1, UDCNT2
Special timer instruction	STMR, TTMR
Pulse related instruction	PLSY, PWM, SPD
Shortcut control instruction	ROTC
Ramp signal instruction	RAMPQ
Matrix input instruction	MTR
Database access instruction	DBOPEN(P)*2, DBCLOSE(P)*2, DBINSERT(P)*2,4, DBUPDATE(P)*2,4, DBSELECT(P)*2,4, DBDELETE(P)*2,4, DBIMPORT(P)*2,4, DBEXPORT(P)*2, DBTRANS(P)*2, DBCOMMIT(P)*2, DBROLBAK(P)*2
Clock instruction	ANDDT□, ANDTM□, DATE+(P), DATE-(P), DATERD(P), DATEWR(P), DATE2SEC(P)(U), LDDT□, LDTM□, ORDT□, ORTM□, SEC2DATE(P)(U), S(P).DATE+, S(P).DATE-, S(P).DATERD, SEC2TIME(P), TCOMP(P)*2, TIME2SEC(P), TZCP(P)*2
Timing check instruction	DHOURM*2, DUTY, HOURM*2, TIMCHK
Module access instruction	DFROM(P), DFROMD(P), DTO(P), DTOD(P), FROM(P), FROMD(P), TO(P), TOD(P), RFS(P), COM(P), S(P).ZCOM
Logging instruction	LOGTRG(R)
PID operation	PID*2
PID control instruction	PIDCONT(P), PIDINIT(P), PIDPRMW(P), PIDRUN(P), PIDSTOP(P), S(P).PIDCONT, S(P).PIDINIT, S(P).PIDPRMW, S(P).PIDRUN, S(P).PIDSTOP
Process control instruction*3	S.2PID, S.□, S.ABS, S.ADD, S.AMR, S.AT1, S.AVE, S.BC, S.BPI, S.BUMP, S.D, S.DBND, S.DED, S.DIV, S.DUTY, S.ENG, S.FG, S.FLT, S.HS, S.I, S.IENG, S.IFG, S.IN, S.IPD, S.LIMIT, S.LLAG, S.LS, S.MID, S.MOUT, S.MUL, S.ONF2, S.ONF3, S.OUT1, S.OUT2, S.PGS, S.PHPL, S.PHPL2, S.PID, S.PIDP, S.PSUM, S.R, S.SEL, S.SPI, S.SQR, S.SUB, S.SUM, S.TPC, S.VLMT1, S.VLMT2
Multiple CPU dedicated instruction*5,6	D(P).DDR, D(P).DDWR, M(P).DDR, M(P).DDWR
SFC control instruction	AND, ANI, BMOV(P), BRSET, DMOV(P), LD, LDI, MOV(P), OR, ORI, PAUSE, RST, RSTART, SET
SFC dedicated instruction	TRAN
Safety system instruction*7	SP.SIDRD

\*1 □ indicates an operator.  
 \*2 RnCPUs, RnENCPU, and LHCPUs support it.  
 \*3 Only RnPCPU support it.  
 \*4 The field name and index are not case-sensitive.  
 \*5 Executes during interaction with the system simulation.  
 \*6 LHCPUs do not support it.  
 \*7 Only RnSFCPU support it.

## ■Module dedicated instruction

When simulating a system including any of the following modules, the dedicated instructions for the module are available. For details on the module dedicated instructions, refer to the manual for each module.

Module type		Module name
CPU extension	Ethernet interface module	_RJ71EN71(CCIIEC), _RJ71EN71(CCIIEF), _RJ71EN71(E+IEC), _RJ71EN71(E+IEF)
CC-Link IE TSN compatible motion module		RD78G4, RD78G8, RD78G16, RD78G32, RD78G64, RD78GHV, RD78GHW, RD78G4(S), RD78G8(S), RD78G16(S)
Network module	CC-Link IE Field Network module	RJ71GF11-T2, RJ71GF11-T2(MR), RJ71GF11-T2(SR), RJ71GF11-T2(LR)
	CC-Link IE TSN module	RJ71GN11-T2
	CC-Link IE Controller Network module	RJ71GP21-SX, RJ71GP21-SX(R), RJ71GP21S-SX, RJ71GP21S-SX(R)

## FX5CPU

### ■Sequence instruction

Classification	Symbol
Contact instruction	AND, ANDF, ANDFI, ANDP, ANDPI, ANI, LD, LDF, LDFI, LDI, LDP, LDPI, OR, ORF, ORFI, ORI, ORP, ORPI
Output instruction	FF, ALT, ALTP, ANR, ANRP, ANS, OUT, OUT C, OUT F, OUT LC, OUT T/ST, OUTH T/ST, OUTHS T/ST, PLF, PLS, RST, RST F, SET, SET F
Master control instruction	MC, MCR
Shift instruction	SFT(P)
Association instruction	ANB, INV, MEF, MEP, MPP, MPS, MRD, ORB
Termination instruction	END, FEND
Stop instruction	STOP

### ■Basic instruction

Classification	Symbol*1
Comparison operation instruction	AND□(_U), ANDD□(_U), BKCMP□(P)(_U), CMP(P)(_U), DBKCMP□(P)(_U), DCOMP(P)(_U), DZCP(P)(_U), LD□(_U), LDD□(_U), OR□(_U), ORD□(_U), ZCP(P)(_U)
Arithmetic operation instruction	*(P)(_U), +(P)(_U), -(P)(_U), /(P)(_U), ADD(P)(_U), B*(P), B+(P), B-(P), B/(P), BK+(P)(_U), BK-(P)(_U), D*(P)(_U), D+(P)(_U), D-(P)(_U), D/(P)(_U), DADD(P)(_U), DB*(P), DB+(P), DB-(P), DB/(P), DBK+(P)(_U), DBK-(P)(_U), DDEC(P)(_U), DDIV(P)(_U), DEC(P)(_U), DINC(P)(_U), DIV(P)(_U), DMUL(P)(_U), DSUB(P)(_U), INC(P)(_U), MUL(P)(_U), SUB(P)(_U)
Logical operation instruction	BKAND(P), BKOR(P), BKXNR(P), BKXOR(P), DAND(P), DOR(P), DXNR(P), DXOR(P), WAND(P), WOR(P), WXNR(P), WXOR(P)
Bit processing instruction	BKRST(P), BRST(P), BSET(P), DTEST(P), TEST(P)
Data conversion instruction	BCD(P), BIN(P), BTOW(P), DABIN(P)(_U), DBCD(P), DBIN(P), DDABIN(P)(_U), DECO(P), DGBIN(P)(_U), DGRY(P)(_U), DINT2INT(P), DINT2UDINT(P), DINT2UINT(P), DIS(P), DNEG(P), DVAL(P)(_U), ENCO(P), FLT2DINT(P), FLT2INT(P), FLT2UDINT(P), FLT2UINT(P), GBIN(P)(_U), GRY(P)(_U), HEXA(P), INT2DINT(P), INT2UDINT(P), INT2UINT(P), NDIS(P), NEG(P), NUNI(P), UDINT2DINT(P), UDINT2INT(P), UDINT2UINT(P), UINT2DINT(P), UINT2INT(P), UINT2UDINT(P), UNI(P), VAL(P)(_U), WTOB(P)
Data shift instruction	BSFL(P), BSFR(P), DSFL(P), DSFR(P), SFL(P), SFR(P), SFTL(P), SFTR(P), WSFL(P), WSFR(P)
External device I/O instruction	DSW, SEGD, SEGDP, SEGL
Data transfer instruction	BLKMOVB(P), BMOV(P), CML(P), CMLB(P), DCML(P), DFMOV(P), DMOV(P), DPRUN(P), DSWAP(P), DXCH(P), FMOV(P), MOV(P), MOVB(P), PRUN(P), SMOV(P), SWAP(P), XCH(P)

\*1 □ indicates an operator.

### ■Application instruction

Classification	Symbol*1
Rotation instruction	DRCL(P), DRCR(P), DROL(P), DROR(P), RCL(P), RCR(P), ROL(P), ROR(P)
Program branch instruction	CJ, GOEND
Program execution control instruction	DI, EI, IMASK, IRET, SIMASK, WDT(P)
Structure creation instruction	BREAK(P), CALL(P), FOR, NEXT, RET, SRET, XCALL
Data table operation instruction	FDEL(P), FINS(P), POP(P), SFRD(P), SFWR(P)
File operation instruction	SP.FREAD, SP.FWRITE, SP.FDELETE, SP.FCOPY, SP.FMOVE, SP.FRENAME, SP.FSTATUS

Classification	Symbol*1
Extended file register operation instruction	ERREAD, ERWRITE, ERINIT
String processing instruction	\$+(P), \$MOV(P), \$MOV(P)_WS, AND\$□, ASCII(P), BINDA(P)(_U), DBINDA(P)(_U), DEST(R)(P), DST(R)(P)(_U), ESTR(P), INSTR(P), LD\$□, LEFT(P), LEN(P), MIDR(P), MIDW(P), OR\$□, RIGHT(P), SJIS2WS(P), SJIS2WSB(P), STR(P)(_U), STRDEL(P), STRINS(P), WS2SJIS(P)
Random number instruction	RND(P)
Index register instruction	ZPOP(P), ZPUSH(P)
Data control instruction	BAND(P)(_U), DBAND(P)(_U), DLIMIT(P)(_U), DSCL(P)(_U), DSCL2(P)(_U), DZONE(P)(_U), LIMIT(P)(_U), SCL(P)(_U), SCL2(P)(_U), ZONE(P)(_U)
Special timer instruction	STMR, TTMR
Shortcut control instruction	ROTC
Ramp signal instruction	RAMPF
Matrix input instruction	MTR
Handy instruction	ABSD, DABSD, INCD, IST
Check code	CCD(P)
Data processing instruction	BON(P), CRC(P), DBON(P), DMAX(P)(_U), DMEAN(P)(_U), DMIN(P)(_U), DSERDATA(P), DSERMM(P), DSORTTBL2(_U), DSQRT(P), DSUM(P), DWSUM(P)(_U), MAX(P)(_U), MEAN(P)(_U), MIN(P)(_U), SERMM(P), SORTTBL(_U), SORTTBL2(_U), SQRT(P), SUM(P), WSUM(P)(_U)
Indirect address read instruction	ADRSET(P)
Clock instruction	ANDDT□, ANDTM□, DHTOS(P), DSTOH(P), HTOS(P), LDDT□, LDTM□, ORDT□, ORTM□, STOHP), TADD(P), TCMP(P), TRD(P), TSUB(P), TWR(P), TZCP(P)
Timing check instruction	DHOURM, DUTY, HOURM
Module access instruction	DFROM(P), DFROMD(P), DTO(P), DTOD(P), FROM(P), FROMD(P), TO(P), TOD(P)
Real-time Monitor Function Instruction	RTM
Step ladder instruction	STL, RETSTL
PID operation	PID
Real number instruction	ACOS(P), ANDE□, ASIN(P), ATAN(P), COS(P), DACOS(P), DASIN(P), DATAN(P), DCOS(P), DDEG(P), DEADD(P), DEBCD(P), DEBIN(P), DEDIV(P), DEG(P), DEMOV(P), DEMUL(P), DENEG(P), DESQR(P), DESUB(P), DEVAL(P), DEXP(P), DEZCP(P), DINT2FLT(P), DLOGE(P), DLOG10(P), DRAD(P), DSIN(P), DTAN(P), E*(P), E+(P), E-(P), E/(P), ECMP(P), EMAX(P), EMIN(P), EMOV(P), ENEG(P), ESQRT(P), EVAL(P), EXP(P), INT2FLT(P), LDE□, LOG(P), LOG10(P), ORE□, POW(P), RAD(P), SIN(P), TAN(P), UDINT2FLT(P), UINT2FLT(P)
SFC control instruction	AND, ANI, BMOV(P), DMOV(P), LD, LDI, MOV(P), OR, ORI, OUT, RST, SET, ZRST(P)
SFC dedicated instruction	TRAN

\*1 □ indicates an operator.

## ■ Module dedicated instruction

When simulating a system including any of the following modules, the dedicated instructions for the module are available.

For details on the module dedicated instructions, refer to the manual for each module.

Module type	Module name
CC-Link IE TSN compatible motion module	FX5-40SSC-G(S), FX5-80SSC-G(S)
Network module	CC-Link IE Field Network module
	CC-Link IE TSN module
	FX5-CCLIEF
	FX5-CCLGN-MS

# Supported parameters

The simulation function does not support some parameter setting items.

The following shows the parameter setting items which are supported by the simulation function.

## RCPU

### ■System parameter

Item		
I/O Assignment Setting	Base/Power/Extension Cable Setting	Slots
		Base/Power Supply Module/Extension Cable
	I/O Assignment Setting	Module Name
		Module Status Setting
		Module/Points/Start XY
		Control PLC Setting
CPU Module Operation Setting at Error Detection		
Setting of Points Occupied by Empty Slot		
Multiple CPU Setting	Setting for number of CPU modules	
	Communication Setting between CPU	Refresh setting
		CPU Buffer Memory Setting
		PLC Unit Data
		Fixed Scan Communication Function
	Fixed Scan Communication Setting	Fixed Scan Communication Area Setting
Fixed Scan Interval Setting of Fixed Scan Communication		
Operation Mode Setting	Fixed Scan Communication Function and Inter-module Synchronization Function	
	Stop Setting	
Other PLC Control Module Setting	Synchronous Startup Setting	
	I/O Setting Outside Group	
Inter-module Synchronization Setting	Use Inter-module Synchronization Function in System	
	Select Inter-module Synchronization Target Module	
	Fixed Scan Interval Setting of Inter-module Synchronization	
	Inter-module Synchronization Master Setting	

### ■CPU parameter

Item	
Operation Related Setting	Timer Limit Setting
	RUN-PAUSE Contact Setting
	Remote Reset Setting (same operation as for "Enable")
	Output Mode Setting at STOP to RUN
	Module Synchronous Setting
	Clock Related Setting
Interrupt Settings	Fixed Scan Interval Setting
	Fixed Scan Execution Mode Setting
	Interrupt Enable Setting in Executing Instruction
	Block No. Save/Recovery Setting
	Interrupt Priority Setting from Module
Service Processing Setting	Device/Label Access Service Processing Setting
File Setting	File Register Setting
	Initial Value Setting <sup>*1</sup>
	Label Initial Value Reflection Setting <sup>*2</sup>
	File Setting for Device Data Storage

Item			
Memory/Device Setting	Device/Label Memory Area Setting	Extended SRAM Cassette Setting	
		Device/Label Memory Area Capacity Setting	
		Device/Label Memory Area Detailed Setting	Points
			Safety device points <sup>*3</sup>
			Local Device
			Safety local device <sup>*3</sup>
	Latch Range Setting		
	Write Protection Setting <sup>*4</sup>		
	Latch Type Setting of Latch Type Label		
	Index Register Setting		
	Refresh Memory Setting		
Device Latch Interval Setting			
Pointer Setting			
Internal Buffer Capacity Setting			
Link Direct Device Setting			
RAS Setting	Scan Time Monitoring Time (WDT) Setting		
	Constant Scan Setting		
	Error Detections Setting	Battery Error	
		Module Verification Error	
		Fuse Blown	
		Redundant Power Supply System Error (same operation as for "Not Detected")	
	CPU Module Operation Setting at Error Detected		
	LED Display Setting		
Event History Setting <sup>*5</sup>	—		
	Save Device/Label Operations		
Program Setting	Program Setting	Program Setting	
		Execute Order	
		Program Name	
		Execution Type	
		Detailed Setting Information (Fixed Scan)	
		Detailed Setting Information (Event)	
	Device/File Use or not		
Both Systems Program Executions Setting (same operation as for "Control System Execution") <sup>*6</sup>			
FB/FUN File Setting			
SFC Setting	SFC Program Start Mode Setting		
	Start Conditions Setting		
	Output Mode Setting at Block Stop		
Refresh Setting between Multiple CPUs	Refresh Setting (At the END)		
	Refresh Setting (At I45 Exe.)		
Redundant System Settings <sup>*8</sup>	Redundant Behavior Setting	Watching Standby System Setting (same operation as for "Disable")	
Safety Function Setting	Safety Function Setting	Safety Cycle Time <sup>*3</sup>	
		Safety I/O Hold Time <sup>*7</sup>	

\*1 "Memory Card" can be specified for "Target Memory."

\*2 RnPCPUs and RnPSFCPUs support it.

\*3 RnSFCPUs and RnPSFCPUs support it.

\*4 RnCPUs and RnENCPU support it.

\*5 "Memory Card" can be specified for "Save Destination."

\*6 RnPCPUs (redundant mode) and RnPSFCPUs support it.

\*7 Only RnPSFCPUs support it.

\*8 Only RnPCPUs (redundant mode) support it.



## ■Module parameter

Item		
Required Settings*1	Station Type	
Basic Settings*1	Own Node Settings	IP Address*2,*3
	Refresh Settings	
Application Settings	Web Server Settings*2,*4	
	Simple CPU Communication Setting*5	
Refresh Setting*6		

\*1 Only network modules support it.

\*2 RnCPUs and RnENCPU support it.

\*3 The IP address set in this parameter is available only in a simulation of simple CPU communication.

\*4 The value in the account setting cannot be changed. (  Page 981 Account)

\*5 Any of the following options can be selected for "Communication Destination":

- MELSEC iQ-R (built-in Ethernet)
- MELSEC iQ-L (built-in Ethernet)
- MELSEC iQ-F (built-in Ethernet)

\*6 Modules except for network modules support it.

## ■Memory card parameter

Item
Setting of File/Data Use or Not in Memory Card*1

\*1 Cannot be set for parameters of a device station.



# LHCPU

## ■System parameter

Item		
I/O Assignment Setting	I/O Assignment Setting	Module Name
		Module Status Setting
		Module/Points/Start XY

## ■CPU parameter

Item			
Operation Related Setting	Timer Limit Setting		
	RUN-PAUSE Contact Setting		
	Remote Reset Setting (same operation as for "Enable")		
	Output Mode Setting at STOP to RUN		
	Clock Related Setting		
Interrupt Settings	Fixed Scan Interval Setting		
	Fixed Scan Execution Mode Setting		
	Block No. Save/Recovery Setting		
Service Processing Setting	Device/Label Access Service Processing Setting		
File Setting	File Register Setting		
	Initial Value Setting <sup>*1</sup>		
	Label Initial Value Reflection Setting		
	File Setting for Device Data Storage		
Memory/Device Setting	Device/Label Memory Area Setting	Device/Label Memory Area Capacity Setting	
		Device/Label Memory Area Detailed Setting	Points
			Local Device
			Latch Range Setting
	Latch Type Setting of Latch Type Label		
	Index Register Setting		
	Refresh Memory Setting		
	Device Latch Interval Setting		
	Pointer Setting		
	Internal Buffer Capacity Setting		
	RAS Setting	Scan Time Monitoring Time (WDT) Setting	
Constant Scan Setting			
Error Detections Setting		Battery Error	
		Fuse Blown	
CPU Module Operation Setting at Error Detected			
LED Display Setting			
Event History Setting <sup>*2</sup>			
Program Setting	Program Setting	Program Setting	Program Name
			Execution Type
			Detailed Setting Information (Fixed Scan)
			Detailed Setting Information (Event)
			Device/File Use or not
FB/FUN File Setting			
SFC Setting	SFC Program Start Mode Setting		
	Start Conditions Setting		
	Output Mode Setting at Block Stop		

\*1 "Memory Card" can be specified for "Target Memory."

\*2 "Memory Card" can be specified for "Save Destination."

A

## ■Module parameter

Item	
Application Settings	Simple CPU Communication Setting <sup>*1</sup>

\*1 Any of the following options can be selected for "Communication Destination":

- MELSEC iQ-R (built-in Ethernet)
- MELSEC iQ-L (built-in Ethernet)
- MELSEC iQ-F (built-in Ethernet)

## ■Memory card parameter

Item	
Setting of File/Data Use or Not in Memory Card	

## FX5CPU

### ■System parameter

Item	
I/O Assignment Setting	Model Name
	Intelligent Module No.
	Serial Communication ch
	Number of Input Points
	Number of Output Points
	CPU Module Operation Setting at Error Detected

### ■CPU parameter

Item		
Name Setting	Title Setting	
	Comment Setting	
Operation Related Setting	RUN Contact Setting	
	Remote Reset Setting	
	Clock Related Setting	Time Zone
Interrupt Settings	Fixed Scan Interval Setting	
	Fixed Scan Execution Mode Setting	
	Interrupt Priority Setting from Module	
Service Processing Setting	Device/Label Access Service Processing Setting	
File Setting	Initial Value Setting	
Memory/Device Setting	Device/Label Memory Area Setting	Option Battery Setting
		Device/Label Memory Area Capacity Setting
		Device/Label Memory Area Detailed Setting
	Index Register Setting	
	Pointer Setting	
	Internal Buffer Capacity Setting	
RAS Setting	Scan Time Monitoring Time (WDT) Setting	
	Constant Scan Setting	
	Error Detections Setting	
	CPU Module Operation Setting at Error Detected	
	LED Display Setting	
	Event History Setting	
Program Setting	Program Setting	
	FB/FUN File Setting	
	Program Capacity Setting	
SFC Setting	SFC Program Setting	
	SFC Program Start Mode Setting	
	Start Conditions Setting	
	FX3 Compatible Transition Operation Mode Setting	

A

## ■Module parameter (Ethernet port)

Item		
Basic Settings	Own Node Settings	IP Address
Application Settings	Web Server Settings* <sup>1</sup>	
	Simple CPU Communication Setting* <sup>2</sup>	

\*1 The value in the account setting cannot be changed. (  Page 981 Account)

\*2 Any of the following options can be selected for "Communication Destination":

- MELSEC iQ-R (built-in Ethernet)
- MELSEC iQ-L (built-in Ethernet)
- MELSEC iQ-F (built-in Ethernet)

## ■Module parameter (expansion board)

Item	
Basic Settings	Expansion Board

## ■Module parameter (network module)

Item		
Required Settings	Network No.	Network No.
	Station No.	Setting Method
		Station No.
	Parameter Setting Method	Setting Method of Basic/Application Settings
Basic Settings	Refresh Settings	
Application Settings	Module Operation Mode	

# Process response operation

The following shows the specifications when using a process response operation in the 'I/O System Setting' function. For details on the conversion processing, refer to the following:

📖 MELSEC iQ-R Programming Manual (Process Control Function Blocks/Instructions)

## DIRECT

Convert an input value to an output value by using a specified upper and lower limit.

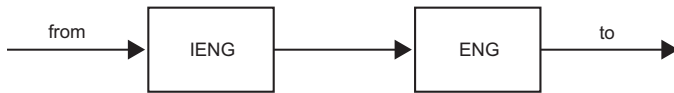

- IENG: Engineering value inverse conversion
- ENG: Engineering value conversion

### ■Instruction format

to := DIRECT(to\_min, to\_max, from\_min, from\_max, from)

### ■Argument

Argument name	Data type	Description	Range
to_min	REAL (Constant)	Lower limit of an output value	-999999.0<=to_min<to_max
to_max	REAL (Constant)	Upper limit of an output value	to_min<to_max<=999999.0
from_min	REAL (Constant)	Lower limit of an input value	-999999.0<=from_min<from_max
from_max	REAL (Constant)	Upper limit of an input value	from_min<from_max<=999999.0
from	REAL	Input value	—

### ■Return value

Output value: REAL

## REVERSE

Convert an input value to an output value by using a specified upper and lower limit.



- IENG: Engineering value inverse conversion
- REV: Inversion
- ENG: Engineering value conversion

### ■Instruction format

to := REVERSE(to\_min, to\_max, from\_min, from\_max, from)

### ■Argument

Argument name	Data type	Description	Range
to_min	REAL (Constant)	Lower limit of an output value	-999999.0<=to_min<to_max
to_max	REAL (Constant)	Upper limit of an output value	to_min<to_max<=999999.0
from_min	REAL (Constant)	Lower limit of an input value	-999999.0<=from_min<from_max
from_max	REAL (Constant)	Upper limit of an input value	from_min<from_max<=999999.0
from	REAL	Input value	—

### ■Return value

Output value: REAL

## LAG\_DED

Convert an input value to an output value by using a specified upper and lower limit.

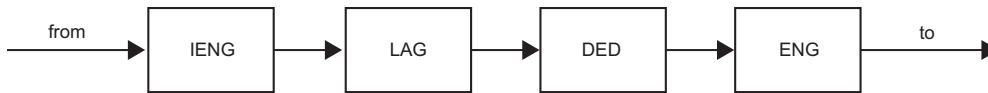

- IENG: Engineering value inverse conversion
- LAG: Primary delay
- DED: Dead time
- ENG: Engineering value conversion

### ■Instruction format

to := LAG\_DED(to\_min, to\_max, from\_min, from\_max, lag, ded, from)

### ■Argument

Argument name	Data type	Description	Range
to_min	REAL (Constant)	Lower limit of an output value	-999999.0<=to_min<to_max
to_max	REAL (Constant)	Upper limit of an output value	to_min<to_max<=999999.0
from_min	REAL (Constant)	Lower limit of an input value	-999999.0<=from_min<from_max
from_max	REAL (Constant)	Upper limit of an input value	from_min<from_max<=999999.0
lag	REAL (Constant)	Lag time constant (second)	0.0<=lag<=999999.0
ded	INT (Constant)	Dead time (second)	0<=ded<=999
from	REAL	Input value	—

### ■Return value

Output value: REAL

## LAG\_DED\_REV

Convert an input value to an output value by using a specified upper and lower limit.



- IENG: Engineering value inverse conversion
- LAG: Primary delay
- DED: Dead time
- REV: Inversion
- ENG: Engineering value conversion

### ■Instruction format

to := LAG\_DED\_REV(to\_min, to\_max, from\_min, from\_max, lag, ded, from)

### ■Argument

Argument name	Data type	Description	Range
to_min	REAL (Constant)	Lower limit of an output value	-999999.0<=to_min<to_max
to_max	REAL (Constant)	Upper limit of an output value	to_min<to_max<=999999.0
from_min	REAL (Constant)	Lower limit of an input value	-999999.0<=from_min<from_max
from_max	REAL (Constant)	Upper limit of an input value	from_min<from_max<=999999.0
lag	REAL (Constant)	Lag time constant (second)	0.0<=lag<=999999.0
ded	INT (Constant)	Dead time (second)	0<=ded<=999
from	REAL	Input value	—

### ■Return value

Output value: REAL

## Module buffer memory

The following shows the number of points of buffer memory (U□\G) for a module supported by the simulation function. When simulating the following systems, the number of points supported by MT Simulator2 or SMM Simulator can be used. The number may differ from the one shown in this section.

- Page 529 Multiple CPU system
- Page 532 Programmable controller CPU and motion CPU
- Page 536 Simple motion module/motion module
- Page 538 Network modules

Series	Module type		Points		
MELSEC iQ-R	PLC CPU		8388608		
	MELSECWinCPU				
	Motion CPU				
	Redundant module		2097152		
	Safety CPU		2048		
	SIL2 function module				
	Input		131072		
	Output				
	I/O				
	NC dedicated module				
	Analog input				
	Analog output				
	Temperature input				
	Temperature control module				
	Simple motion	RD77MS		12582912	
		RD77GF			
	CC-Link IE TSN compatible motion module			16777216	
	Pulse I/O, Positioning <sup>*1</sup>			131072	
	Energy measuring module				
	Information module	Serial communication module			
		Ethernet interface module		12582912	
		High speed data logger module		131072	
		MES interface module			
		OPC UA Server module			
		Recorder module		8388608	
		C intelligent function module			
		High speed data communication module		131072	
		Camera recorder module		8388608	
		GP-IB interface module		131072	
	Network Module	CC-Link system master/local module		131072	
		CC-Link IE Field Network module		12582912	
		CC-Link IE Controller Network module			
		AnyWireASLINK master module		131072	
BACnet interface module					
CANopen module					
EtherNet/IP module		8388608			
DeviceNet master/slave module		131072			
PROFIBUS interface module					
CC-Link IE TSN module		16777216			
CC-Link IE TSN Plus master/local module					
MELSECNET/H network module		12582912			

Series	Module type	Points		
MELSEC iQ-L	PLC CPU	2048		
	Network module	CC-Link module	32768	
	Intelligent function module		61440	
MELSEC iQ-F	Simple motion	98304		
MELSEC-Q	Analog input		131072	
	Analog output			
	Analog I/O			
	Temperature input			
	Temperature control module			
	Loop control			
	Pulse I/O, Positioning			
	Energy measuring module			
	Information module	Intelligent communications module		
		MES interface module		
		Web server module		
	Network Module	AnyWireASLINK master module		
		CC-Link/LT master module		
		AS-i master module		
		MELSECNET/H network module		
		FL-net (OPCN-2) interface module		
		MODBUS(R) interface module		
DeviceNet master/slave module				
Partner products				

\*1 For a counter module, the actual number of buffer memory points that can be used is up to 1024.



# Link devices of network module

The following shows the link devices and the number of points for network module supported by the simulation function.

Series	Module type		Device type	Points	
MELSEC iQ-R	Network module	Ethernet (When using CC-Link IE Controller Network)	J□\SB	512	
			J□\SW		
			J□\X	8192	
			J□\Y		
			J□\B	65538	
			J□\W	262144	
			Ethernet (When using CC-Link IE Field Network)	J□\SB	512
				J□\SW	
				J□\X	16384
				J□\Y	
		J□\W			
		CC-Link IE Controller Network	J□\SB	512	
			J□\SW		
			J□\X	8192	
			J□\Y		
			J□\B	65538	
			J□\W	262144	
		CC-Link IE Field Network	J□\SB	512	
			J□\SW		
			J□\X	16384	
			J□\Y		
			J□\W		
		CC-Link IE TSN	J□\SB	4096	
			J□\SW		
			J□\X	16384	
			J□\Y		
			J□\B	32768	
J□\W					
MELSECNET/H network module	J□\SB	512			
	J□\SW				
	J□\X	8192			
	J□\Y				
	J□\B	16384			
	J□\W				
Simple motion module	RD77GF	J□\SB	512		
		J□\SW			
		J□\X	16384		
		J□\Y			
		J□\W			
		CC-Link IE TSN compatible motion module	RD78G(H) RD78G(S)	J□\SB	4096
				J□\SW	
		Network module	MELSECNET/H network	J□\SB	512
				J□\SW	
				J□\X	8192
J□\Y					
J□\B	16384				
J□\W					
Network module	MELSECNET/H network	J□\SB	512		
		J□\SW			
		J□\X	8192		
		J□\Y			
		J□\B	16384		
		J□\W			



# Network

The following shows the network types, network modules, network functions, network parameters, and network module dedicated instructions that are supported by the simulation function (simulation of network modules).

For details on each item, refer to the manual for each network module.

## Network types

Series	Network type
MELSEC iQ-R	CC-Link IE Controller Network
	CC-Link IE Field Network
	CC-Link IE TSN
MELSEC iQ-F	CC-Link IE Field Network
	CC-Link IE TSN

## Network modules

Series	Network module
MELSEC iQ-R	RnENCPU (network part)
	RJ71EN71
	RJ71GP21-SX
	RJ71GF11-T2
	RJ71GN11-T2
MELSEC iQ-F	FX5-CCLIEF
	FX5-CCLGN-MS

## Network functions

### ■CC-Link IE Controller Network

Function		Remarks	
Cyclic transmission	Communication with another station	—	
	Link refresh		
	Direct access for link devices		
	Cyclic data integrity assurance		Data is sent for each station regardless of the parameter setting contents.
	Interlink transmission		—
	Cyclic transmission punctuality assurance		
	Group cyclic transmission		
	Cyclic transmission stop and restart		
Transient transmission	Dedicated instruction	—	
	Group transient transmission		
RAS	External power supply	Same operation as for OFF.	
Others	Interrupt request to CPU module	—	

## ■CC-Link IE Field Network

Function		Remarks		
Cyclic transmission	Communications using RX, RY, RWr, and RWw	—		
	Link refresh			
	Direct access for link devices			
	Cyclic data integrity assurance		Data is sent for each station regardless of the parameter setting contents.	
	Interlink transmission		—	
	Sequence scan synchronization specification			
	Cyclic transmission punctuality assurance			
	I/O maintenance settings			Output hold/clear setting during CPU STOP
				Data link faulty station setting
Cyclic transmission stop and restart				
Transient transmission	Communications within the same network			
RAS	Self-diagnostics function	Page 979 Duplicate station number		
Others	CC-Link IE Field Network synchronous communication	This function is available only for network modules (local stations or intelligent device stations) that are simulated in the system simulation.		
	Reserved station	—		
	Error invalid station			
	Interrupt request to CPU module			
	Safety communication			

## ■CC-Link IE TSN

Function		Remarks		
Cyclic transmission	Communications using RX, RY, RWr, and RWw	—		
	Communications using LB and LW			
	Link refresh			
	Direct access to link devices			
	Cyclic data assurance		Data is sent for each station regardless of the parameter setting contents.	
	Communication cycle coexistence		—	
	Interlink transmission			
	I/O maintenance settings			Output hold/clear setting during CPU STOP
				Data link faulty station setting
Transient transmission	Communications using a dedicated instruction			
Security	IP filter	This function is not available for communicating with an external device.		
RAS	Master station duplication detection	Page 979 Duplicate station number		
	IP address duplication detection			
	Time synchronization	—		
Synchronization	CC-Link IE TSN network synchronous communication	This function is available only for network modules (local stations or intelligent device stations) that are simulated in the system simulation.		
Safety communications		—		
Troubleshooting	CC-Link IE TSN diagnostics			
Others	Reserved station			
	Error invalid station setting			

A

## Network parameters

### ■CC-Link IE Controller Network

Parameter		Remarks	
Required Settings	Station Type	Station Type	—
	Network No.	Network No.	
	Station No.	Setting Method	
		Station No.	
	Network Range Assignment	Total No. of Stations	
		LB/LW Setting (1)	
		LB/LW Setting (2)	
		LX/LY Setting (1)	
		LX/LY Setting (2)	
		I/O Master Station	
		Reserved Station	
Pairing	Since system switching is not supported by simulator, cyclic transmission is performed only from a control system.		
Shared Group Setting	—		
Basic Settings	Refresh Settings		
Application Settings	Supplementary Cyclic Settings	Data Link Monitoring Time	
		Constant Link Scan Time	
		Transient Setting	Punctuality Assurance
		Maximum No. of Transients in One Station	
	Link points extended setting		
	Interrupt Settings		
	Transient Transmission Group No.		
	Parameter Name		
	Event Reception from Other Stations		
	Module Operation Mode		
Interlink Transmission Settings			

## ■CC-Link IE Field Network

Parameter			Remarks	
Required Settings	Station Type	Station Type	A submaster station always operates as a local station.	
	Network No.	Network No.		
	Station No.	Station No. Setting Method		
	Parameter Setting Method	Setting Method of Basic/Application Settings		
Basic Settings	Network Configuration Settings	Total Linked Stations		
		Station No.		
		Model Name		
		Station Type		
		RX/RX		
		RWr/RWw		
		Reserved/Error Invalid Station/System Switching Monitoring Target Station		Only "Reserved Station" and "Error Invalid Station" can be set.
		Pairing		Since system switching is not supported by simulator, cyclic transmission is performed only from a control system.
		Network Synchronous Communication		This parameter is available only for network modules (local stations) that are simulated in the system simulation support this parameter.
		Alias		—
Comment				
Refresh Setting	Refresh Setting (SB/SW)			
Application Settings	Supplementary Cyclic Settings	Link Scan Mode		
		I/O Maintenance Settings		Output Hold/Clear Setting during CPU STOP
				Data Link Error Station Setting
				Output Mode upon CPU Error
	Interrupt Settings			
	Communication Mode			
	Parameter Name			
	Event Reception from Other Stations			
	Module Operation Mode			
	Interlink Transmission Settings			
	Safety Communication Setting	To Use or Not to Use the Safety Communication Setting		
		Safety Communication Setting		

A

■CC-Link IE TSN

Parameter			Remarks	
Required Settings	Station Type	Station Type	—	
	Network No.	Network No.		
	Station No./IP Address Setting	Station No./IP Address Setting Method		
		Station No.		
		IP Address	IP Address	These parameters are not available for communicating with an external device.
		Subnet Mask		
	Default Gateway			
Parameter Setting Method	Setting Method of Basic/Application Settings		—	
Basic Settings	Network Configuration Settings	Station Type	These parameters are not available for communicating with an external device.	
		RX/RX		
		RWr/RWw		
		LB/LW		
		IP Address		
		Subnet Mask		
		Default Gateway		
		Reserved/Error Invalid Station		—
	Network Synchronous Communication		This parameter is available only for local stations.	
	Communication Period Setting	Multiple Period Setting (Normal-Speed/Low-Speed)		
	Station Information	Alias	—	
		Comment		
	Refresh Settings			These parameters are available only for local stations.
	Communication Period Setting	Basic Period Setting	Transient Transmission Time	
Multiple Period Setting		Normal-Speed		
		Low-Speed		
Safety Communication Setting	To Use or Not to Use the Safety Communication Setting		—	
	Safety Communication Setting			
Application Settings	Communication Speed			
	Supplementary Cyclic Settings	Station-based Block Data Assurance		
		I/O Maintenance Settings	Output Hold/Clear Setting during CPU STOP	
			Data Link Error Station Setting	
	Output Mode upon CPU Error			
	Transient Transmission Group No.			
	Communication Mode			
	Parameter Name			
	Event Reception from Other Stations			
	Module Operation Mode			
	Security	IP Filter Settings	IP Filter	
IP Filter Settings			Access from IP address below (Deny/Allow)	
			Range Setting	
			IP Address	
	IP Address Excluded from Range			
Interlink Transmission Settings			—	

## Dedicated instructions for network modules

### ■CC-Link IE Controller Network

Classification	Symbol
Link dedicated instruction	READ, SREAD, WRITE, SWRITE, SEND, RECV, RECVS, REQ, RRUN, RSTOP, RTMRD, RTMWR
Others	UINI

### ■CC-Link IE Field Network

Classification	Symbol
Link dedicated instruction	READ, SREAD, WRITE, SWRITE, SEND, RECV, RECVS, REQ
Others	CCPASET, UINI

### ■CC-Link IE TSN

Classification	Symbol
Link dedicated instruction	READ, SREAD, WRITE, SWRITE, SEND, RECV, REQ
Others	CCPASET, CCPASETX, UINI

## Precautions

Note that no processing is performed for unsupported instructions (NOP processing).

# Considerations

The following describes the considerations on debugging programs using the simulation function.

## Program execution time

Since the instruction processing speed differs between the simulation function and CPU module, the simulator operates as follows.

- A simulation time is calculated by adding a value of instruction processing time every execution of an instruction in a CPU module.

The simulator operates behind the actual time when the simulation time takes longer than the actual time due to the performance of a personal computer.

The simulation time gains in accordance with the actual time when the actual time takes longer than the simulation time.

- When the actual scan time is longer than a value set in the following CPU parameter, a constant scan time error does not occur even after a constant scan time is exceeded; therefore, instructions continue.

· [CPU Parameter] ⇒ [RAS Setting] ⇒ [Constant Scan Setting]

For instruction processing time, refer to the following:

📖 MELSEC iQ-R Programming Manual (CPU Module Instructions, Standard Functions/Function Blocks)

## Periodic execution type program

A program is executed in accordance with the simulation time.

If the load on GX Simulator3 is high due to the number of periodic execution type programs and their cycles, the response from GX Simulator3 is delayed and a communication error may occur.

## Handling of floating point

A rounding error may occur in the operation result of an instruction using floating point. The result will not be the same as that of a CPU module.

## Multiple CPU system function

The multiple CPU system function can be used for only CPU modules that are simulated in the system simulation.

Simulation for a single CPU module or CPU modules that are not simulated are not supported.

No errors are detected in CPU modules that are not simulated and modules controlled by the CPUs.

## RnSF CPU

### ■ Safety operation mode

The simulation function can be used in the test mode only.

### ■ Safety support functions

The following menus cannot be performed during a simulation.

- [Online] ⇒ [Safety PLC Operation] ⇒ [Check Safety Data Identity]
- [Online] ⇒ [Safety PLC Operation] ⇒ [Switch Safety Operation Mode]
- [Online] ⇒ [User Authentication]

### ■ Identification check for safety data

When the target for writing is a simulator, the writing is not treated as one to a programmable controller.

Therefore, the file ID and the writing date and time are not updated.



## LHCPU

The following explains the display content in the GX Simulator3 (system simulation) screen when simulating a project for an LHCPU.

- A system is always displayed with all the blocks in the table below configured.

The following table shows the maximum number of modules which can be attached in each block.

Block	Number of modules (maximum)	Remarks
Main block	9 <sup>*1</sup>	Power supply modules, branch modules, extension modules, and END covers are not displayed in the GX Simulator3 (system simulation) screen.
Extension block 1	10	
Extension block 2	10	
Extension block 3	11	

\*1 Excluding the CPU and built-in I/O parts of a CPU module.

- Modules are placed from the head of the main block. If one block is not enough for placing all the modules, the rest is placed in the next block.
- A module which occupies the size for two modules is counted as two modules. If a block does not have size for two more modules, the module is placed at the head of the next block.
- If a blank row exists between modules in the I/O assignment setting of the system parameter, "(Empty)" is displayed in the GX Simulator3 (system simulation) screen.
- If the number of placed modules exceeds the maximum number of attachable modules, GX Simulator3 operates as follows:
  - Simulation of a CPU module: The simulation regards modules in excess of the maximum number as not placed.
  - System simulation: An error indicating a module configuration error occurs when adding the system in the GX Simulator3 (system simulation) screen.

## General module

When a general module is set in the I/O assignment setting of the system parameter, the inputs (X), outputs (Y), and buffer memory of the general module can be accessed.

The following table shows the range of accessible inputs (X), outputs (Y), and buffer memory.

Series	Module name	Type	Input (X)/output (Y)	Buffer memory
MELSEC iQ-R	General CPU module	—	—	Equivalent to a CPU module of a simulator
	General I/O module	Input	Follows the number of occupied points of a slot set in the I/O assignment setting of the system parameter.	Equivalent to an input module.
		Output		Equivalent to an output module.
		High-speed input		Equivalent to an input module.
		Interrupt		Equivalent to an analog input module.
		I/O mixed (Mixed)		Equivalent to an I/O module.
	I/O mixed (Both sides)	Equivalent to an I/O module.		
General intelligent module	—	—	Equivalent to an analog input module.	
MELSEC iQ-L	General I/O module	Input	Follows the I/O points of the system parameter.	Equivalent to an input module.
		Output		Equivalent to an output module.
		I/O mixed (Both sides)		Equivalent to an I/O module.
	General intelligent module	—	—	Equivalent to an analog input module.
MELSEC-Q	General I/O module	Input	Follows the I/O points of the system parameter.	Equivalent to an input module.
		Output		Equivalent to an output module.
		High-speed input		Equivalent to an input module.
		Interrupt		Equivalent to an analog input module.
		I/O mixed (Mixed)		Equivalent to an I/O module.
	I/O mixed (Both sides)	Equivalent to an I/O module.		
	General intelligent module	—		—
MELSEC iQ-F	General I/O module	—	Follows the I/O points of the system parameter.	—
	General intelligent module	—	—	Equivalent to an intelligent module.

## Other modules

### ■I/O module

Simulation of the operation does not support I/O module.

### ■Intelligent function module

The buffer memory for an intelligent function module is reserved by the information set in "I/O Assignment Setting" of "System Parameter."

The buffer memory (U□\G) cannot be accessed when the I/O assignment setting is not configured.

By setting an intelligent function module as the module type in the I/O assignment setting, the buffer memory corresponding to the set module is created.

If the module type is not specified, it becomes an empty slot.

If the module type is specified without specifying the number of points, the number of points for the set module will be one specified in "Setting of Points Occupied by Empty Slot" of "System Parameter."

## Watchdog timer

If the watchdog timer has been set in a project, the processing time for one instruction will be the fastest one among the ones described in the following:

- Project for an RCP: MELSEC iQ-R Programming Manual (CPU Module Instructions, Standard Functions/Function Blocks)
- Project for an FX5CPU: MELSEC iQ-F FX5 Programming Manual (Instructions, Standard Functions/Function Blocks)

## Attachment of extended SRAM cassette

The simulator operates as if an extended SRAM cassette (8 MB or 16 MB<sup>\*1</sup>) was attached.

A parameter error will occur when specifying the capacity more than 8 MB or 16 MB in "Extended SRAM Cassette Setting" of "CPU Parameter."

- \*1 The capacity of an extended SRAM cassette differs depending on the types.
- 8MB: RnPCPUs, RnSFPCUs, and RnPSFCPUs
  - 16MB: RnCPUs and RnENCPUs

## SD memory card

When GX Simulator3 (system simulation) is in RUN, the setting of a virtual SD memory card file cannot be changed.

For details of a virtual SD memory card file, refer to the following:

 Page 542 SD memory card

### ■File operation instructions

The operation of an SD memory card can be simulated with file operation instructions (SP.FREAD, SP.FWRITE, SP.FDELETE, SP.FCOPY, SP.FMOVE, SP.FRENAME, and SP.FSTATUS) only when a virtual SD memory card file is set in the GX Simulator3 (system simulation) screen.

When a virtual SD memory card file is not set or when a single CPU module is simulated, the operation of an SD memory card cannot be simulated even with file operation instructions.

If an error with code '8000H' occurs when using a file operation instruction, set a virtual SD memory card file in the GX Simulator3 (system simulation) screen.

## Drive usage

The data in the ROM drive of a CPU module (program memory/data memory) is stored in a temporary folder in the hard disk of a personal computer.

The ROM drive usage per data depends on the hard disk of a personal computer.

## Enabling the remote RESET

In the simulation function, the simulator operates on the assumption that "Enable" is selected in "Remote Reset Setting" of "Operation Related Setting" of "CPU Parameter."

In the multiple CPU system, the CPU, in which the RESET button in the system simulation is enabled, operates as if "Enable" is being set. The CPU, in which the RESET button is disabled, operates as if "Disable" is being set.

## Writing parameters to an intelligent function module

When writing parameters on the "Online Data Operation" screen, the availability differs according to the interaction with an intelligent function module.

○: Writable, ×: Not writable, —: Not supported

Parameter	With interaction	Without interaction
Simple motion module setting	○	×
Others	—	×

## Timer, clock function, and system clock

The current value of a timer, clock function, and system clock operate with the actual time.

However, GX Simulator3 operates based on the simulation time when selecting the following menu in the GX Simulator3 (system simulation) screen.

- [Tool] ⇨ [Synchronize Timer with Simulation Time]

The clock on a personal computer is applied to the time of the clock function every time simulation is started or reset.

## When the base setting is not set

The following table shows the operations of GX Simulator3 when the model name of a base unit and the number of slots are not set.

Base setting		Operation of GX Simulator3
Base Module Name	Slots	
Not set	Not set	When the number of slots is not set, the system on the simulation operates as if the eight base units in MELSEC iQ-R series, which have eight slots for each, were being set. (R38B × 1 unit, R68B × 7 units)
Not set	Set	The system on the simulation operates as if a base unit in MELSEC iQ-R series (R312B or R612B), which has more slots than the set number, were being set for the base unit for which the number of slots is set.*1

\*1 The slots which exceeds the set number of slots are treated as empty ones.

To use a MELSEC-Q series base unit, set the model name of a base unit and the number of slots.

## When the model name of a power supply module is not set

When the model name of a power supply module is not set, the power supply module operates as if R61P was being used on a MELSEC iQ-R series base unit, or Q61P was being used on a MELSEC-Q series base unit.

## Errors for the self-diagnostics function

The following self-diagnostics errors are not detected:

- 1900H: Constant scan time error
- 1A00H: Safety cycle time exceeded
- 1A01H: Safety cycle processing error

## Error information on module diagnostics

Within errors detected by the simulator, error information which is different from the one that will occur in an actual CPU module may be displayed in the module diagnostics screen.

## Remote operation screen

Under the following conditions, the operating status (such as a stand-by station) related to a redundant system is not displayed even if the "Remote Operation" screen is opened after a simulation of an RnPSFCPU is started.

- Parameters are not written to GX Simulator3.
- GX Simulator3 is not reset.

## Simulation of network modules

### ■ Connection among network modules using cables

The network modules on the network with the same network number operates as all network modules are connected.

### ■ Online operations for another station

Online operations for GX Simulator3 (system simulation) can be performed for the own station only.

### ■ Duplicate station number

If a duplicate station number is detected before data transmission is ready, a duplication error occurs in both stations.

If it is detected when data transmission is ready, a duplication error occurs in the station where the setting is configured later.

### ■ Troubleshooting on network modules

For details on troubleshooting, refer to the following:

📖 MELSEC iQ-R CC-Link IE Controller Network User's Manual (Application)

📖 MELSEC iQ-R CC-Link IE Field Network User's Manual (Application)

📖 MELSEC iQ-R CC-Link IE TSN User's Manual (Application)

📖 MELSEC iQ-F FX5 User's Manual (CC-Link IE)

In a simulation of network modules, some steps in the procedure for troubleshooting that is effective for the actual network modules are not supported.

The following table shows the procedure for troubleshooting and whether each step is supported in a simulation of network modules.

○: Supported, ×: Not supported

Procedure for troubleshooting	Support status
1. Check the LED status.	○
2. Check the network status by performing the CC-Link IE TSN/CC-Link IE Field Network diagnostics or CC-Link IE Controller Network diagnostics.	○
3. Check the error information by performing module diagnostics for a network module.	×
4. Check the event history by performing module diagnostics for a CPU module.*1	○
5. Check the system monitor and the detailed module information.	×
6. Monitor link special relays (SB) and/or link special registers (SW).	○

\*1 Can be checked by performing the following operation.

Select [Diagnostics] ⇒ [Module Diagnostics (CPU Diagnostics)], and click the [Event History] button in the module diagnostics screen.

## Web server

The following shows the considerations when using the web server function during a simulation.

For details on this function, refer to the following:

📖 MELSEC iQ-R/MELSEC iQ-F Web Server Function Guide Book

### ■ Access to a web server

To access a web server, enter the following address in the address bar of the web browser.

`http://localhost:(own station port number)/`

In 'own station port number,' enter the port number displayed in GX Simulator3 (system simulation) screen regardless of the setting of the own station port number of the parameter.

**Ex.**

When '20111' is displayed in the GX Simulator3 (system simulation) screen, enter 'http://localhost:20111/'

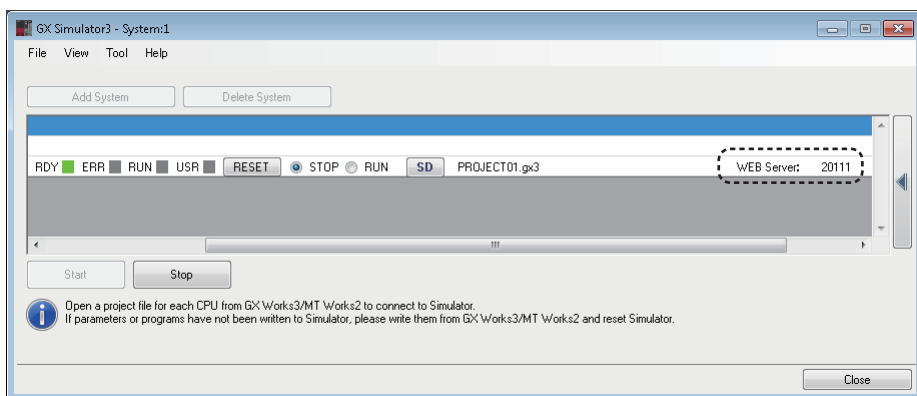

### ■ When the port number cannot be used

When the port number cannot be used because it is duplicated with that of another application or other reasons, the web server cannot be accessed.

### ■ Web browser

The following web browsers can be used.

Browser	Browser version	
	MELSEC iQ-R series	MELSEC iQ-F series
Internet Explorer	11	11
Microsoft Edge	41	41
Google Chrome	62.0	55.0

## Precautions

When the LAN setting of Google Chrome is set to use a proxy server, the web server cannot be accessed.

Check the LAN setting and change it so as not to use a proxy server.

## Account

The following table shows the values in the account setting during a simulation.

Item	Value	
	RnCPU	FX5CPU
User name	User	User
Write Device	Enable	Enable
Authority for Window Display	Permit Both Displays	Permit Both Displays
Update System Web Page	Disable	Not supported
Initial Display Window	System Web Page	System Web Page

## Precautions

GX Simulator3 (system simulation) always runs in the state where a user is logging on to the web server. Therefore, a user cannot log off from the server during a simulation.

## System web page version

The following table shows the system web page version during a simulation.

Module type	GX Works3 version	System web page version
RnCPU	Version 1.050C or later	1.00
RnENCPU	Version 1.055H or later	1.01
	Version 1.060N or later	1.02
	Version 1.065T or later	1.03
	Version 1.070Y or later	1.04
	Version 1.075D or later	1.05
	Version 1.080J or later	1.07
	Version 1.085P or later	1.08
	Version 1.090U or later	1.09

## Database

A database created in an actual SD memory card and one created in a virtual SD memory card are not compatible with each other. (Even if they are created based on same data, the size of each created database differs.)

To use a database during a simulation, create the database in a virtual SD memory card with GX Simulator3.

For the method for creating a database, refer to the following:

 MELSEC iQ-R CPU Module User's Manual (Application)

Operations when an error occurs while these databases are used may differ between a CPU module and GX Simulator3.

# Appendix 10 Using Sample Programs

This section shows the method for using sample programs (ladder programs), described in e-Manual, in GX Works3. For the operation method of e-Manual Viewer, refer to e-Manual Viewer Help.

## Supported version

To use this function, GX Works3 and e-Manual Viewer of the following versions are required to be installed according to a sample program to be used in GX Works3.

### ■Ladder program without a function block

- GX Works3: Version 1.035M or later
- e-Manual Viewer: Version 1.13P or later

### ■Ladder program with a function block

- GX Works3: Version 1.055H or later
- e-Manual Viewer: Version 1.18U or later

## Operating procedure

The following shows the operating procedure to use a sample program (ladder program) in GX Works3.

### Operating procedure

#### ■Ladder program without a function block

1. Create module labels in a GX Works3 project and set parameters by following the descriptions in e-Manual.
2. Click "Copy a label (for GX Works3)" in e-Manual to copy the global labels or local labels.
3. Set the orders of the following items to be the same:
  - Column items for the labels copied in step 2 (label name, data type, class, assignment (device/label))
  - Column items in a label editor of GX Works3
4. Paste the labels into a global label editor or local label editor in GX Works3.
5. Click "Copy Ladder Program (for GX Works3)" in e-Manual to copy the ladder program.
6. Paste the program into a ladder editor in GX Works3.
7. Convert the program.

#### ■Ladder program with a function block

1. Create module labels in a GX Works3 project and set parameters by following the descriptions in e-Manual.
2. Click "Copy a label (for GX Works3)" in e-Manual to copy the global labels or local labels.
3. Set the orders of the following items to be the same:
  - Column items for the labels copied in step 2 (label name, data type, class, assignment (device/label))
  - Column items in a label editor of GX Works3
4. Paste the labels into a global label editor or local label editor in GX Works3.
5. Click "Copy Ladder Program (for GX Works3)" in e-Manual to copy the ladder program.
6. Paste the program into a ladder editor in GX Works3.

Function blocks in the sample program are changed to undefined function blocks.

Redefine the function block by the following operations.

7. Drag and drop the corresponding function block from the element selection window onto the undefined function block on the ladder editor.
8. Set each item in the "FB Instance Name" screen and click the [OK] button.
9. Convert the program.



## Considerations

### ■When a label name is duplicated

An error occurs at the program conversion when a label name in a sample program and one in a project where the program is pasted are duplicated.

Copy and paste the sample program again by the following operations.

#### Operating procedure

1. Delete the ladder program pasted into an editor.
2. Change the label name duplicated in a label editor.
3. Paste the sample program into a ladder editor in GX Works3.
4. Change the label name used in the ladder program to the one set in the step 2.

### ■When an undefined label exists

In the following cases, the module labels in sample programs are pasted as undefined labels.

Check that the latest GX Works3 is installed.

- The versions of module labels differ between the sample program and GX Works3.
- GX Works3 does not support the module labels of the sample program.

### ■When an incorrect function block is redefined

Check if a redefined function block is the same as the one in a sample program before the program conversion.

If a different function block is redefined by mistake, copy and paste the sample program again by the following operations.

#### Operating procedure

1. Delete the following data from a project.
  - Ladder program pasted into an editor
  - Redefined function block (including its FB instance)
2. Paste a sample program into a ladder editor in GX Works3.
3. Drag and drop the same function block as the one in the sample program from the element selection window onto the ladder editor.
4. Convert the program.

### ■When an FB instance name differs from the one in a sample program

When the FB instance name of a redefined function block differs from the one in a sample program, a conversion error may occur.

In that case, change the FB instance name where an error has occurred to the one of the redefined function block.

# Appendix 11 USB Driver Installation Procedure

---

To communicate with a CPU module via USB, installing a USB driver is required.

## Operating procedure

1. Connect a personal computer and a CPU module with a USB cable, and turn the power of the programmable controller ON.
2. Right-click "Unknown Device" and click "Update driver" in Windows Device Manager.
3. Select "Browse my computer for drivers" on the "Update Drivers" screen, and specify 'Easysocket\USBDrivers' in the folder where GX Works3 is installed on the next screen.

When an installation folder is not changed at the installation, the installation folder is as follows:

- 64-bit version operating system: C:\Program Files (x86)\MELSOFT\Easysocket\USBDrivers
- 32-bit version operating system: C:\Program Files\MELSOFT\Easysocket\USBDrivers

If multiple MELSOFT products are already installed, specify 'Easysocket\USBDrivers' which is in the folder of the first product installed.

If 'Easysocket\USBDrivers' does not exist, search for 'USBDrivers' in the Windows explorer.

# MEMO

---

A

# Appendix 12 Troubleshooting

This section shows the errors which may occur when using GX Works3 and their corrective actions.

Symptom	Check point	Corrective action
Contents in the screen are not displayed properly. (For example, overlapping of icons, text overflowing from the frame of a button, etc.)	Is the size of the text and other items in the screen set to a value other than 100% (96 DPI, 9 pt etc.) in Windows settings?	<ul style="list-style-type: none"> <li>• Set the value to 100% (96 DPI, 9 pt etc.).</li> <li>• For Windows 10 (version 1703 or later) or later<sup>*1</sup>, the display of GX Works3 can be displayed with high DPI scaling by using a function of the operating system.<sup>*2</sup></li> </ul> <ol style="list-style-type: none"> <li>① Select and right-click 'GXW3.exe'<sup>*3</sup>, then select [Properties] from the shortcut menu.</li> <li>② Click the [Change high DPI settings] button in the [Compatibility] tab.</li> <li>③ Select the checkbox of "Override high DPI scaling behavior. Scaling performed by:", then select "System" from the pull-down list.</li> <li>④ Click the [OK] button.</li> </ol>
Timeout occurs while GX Works3 is accessing to a built-in Ethernet CPU in Ethernet.	Is communication with GX Works3 allowed when Windows Firewall is enabled?	<p>For details, refer to the following:</p> <p> Page 561 When communication with GX Works3 is not allowed by the Windows firewall</p>

\*1 The Windows version can be checked by the following procedure.

- ① Enter "winver" in the search box of Windows, and select it from the menu.
- ② Check the version in the displayed screen.

\*2 The display of GX Works3 will be blurred by enlarging.

The following lists the setting values for "Change the size of text, apps, and other items" and the recommended display resolution for each setting value in Windows 10 or later.

- Setting value: 100%, display resolution: 1024 × 768 dots or more
- Setting value: 125%, display resolution: 1900 × 1200 dots or more
- Setting value: 150%, display resolution: 1900 × 1200 dots or more
- Setting value: 175%, display resolution: 2880 × 1620 dots or more
- Setting value: 200%, display resolution: 2880 × 1620 dots or more
- Setting value: 225%, display resolution: 3840 × 2160 dots or more
- Setting value: 250%, display resolution: 3840 × 2160 dots or more

\*3 'GXW3.exe' is stored in the folder where GX Works3 has been installed.

The following is an example of a storage location.

- 64-bit version operating system: C:\Program Files (x86)\MELSOFT\GPPW3\GXW3.exe
- 32-bit version operating system: C:\Program Files\MELSOFT\GPPW3\GXW3.exe

# MEMO

---

A

# Appendix 13 Differences from Existing MELSOFT Applications

This section shows the differences between GX Works3 version 1.100E and GX Works2 version 1.621X.

For details on the functions and option settings of GX Works2, refer to the following:

- 📖 GX Works2 Version 1 Operating Manual (Common)
- 📖 GX Works2 Version 1 Operating Manual (Simple Project)
- 📖 GX Works2 Version 1 Operating Manual (Structured Project)

For the differences with PX Developer, refer to the following:

- 📖 Differences of PX Developer and GX Works3 process control functions(FA-A-0236)

For details on the functions and option settings of PX Developer, refer to the following:

- 📖 PX Developer Version 1 Operating Manual (Programming Tool)
- 📖 PX Developer Version 1 Operating Manual (Monitor Tool)

## Differences of functions

This section explains the differences of functions from ones of GX Works2.

### List of GX Works2 functions

Function	Reference
Common function	Page 989 Common function
Label	Page 996 Label
Device comment	Page 997 Device comment
Device memory	Page 998 Device memory
Verification result	Page 999 Verification result
Sampling trace	Page 999 Sampling trace
Ladder editor	Page 1000 Ladder editor
SFC diagram	Page 1004 SFC diagram
SFC block list	Page 1005 SFC block list
ST editor	Page 1006 ST editor
Structured Ladder/FBD editor	Page 1007 Structured Ladder/FBD editor
CC IE Field configuration window	Page 1009 CC IE Field configuration window
CC-Link configuration window	Page 1010 CC-Link configuration window
AnyWireASLINK configuration window	Page 1011 AnyWireASLINK configuration window
Ethernet configuration window	Page 1012 Ethernet configuration window
CC-Link IEF Basic configuration window	Page 1013 CC-Link IEF Basic configuration window
Sensor/device monitor screen	Page 1014 Sensor/device monitor screen
GX Simulator2 screen	Page 1015 GX Simulator2 screen
Predefined protocol support	Page 1016 Predefined protocol support

## Common function

These functions can always be used regardless of the editing or setting target.

### ■Project

○: Similar function supported, ×: Similar function not supported

GX Works2		GX Works3			
		Supported or not	Reference/similar function		
New		○	Page 103 Creating a project		
Open		○	Page 105 Opening a project		
Close		○	• [Project] ⇨ [Close]		
Save		○	Page 127 Overwriting projects		
Save As		○	Page 126 Saving projects under the specified name		
Compress/Unpack	Compress	○	Page 137 Compressing a project file		
	Unpack	×			
Delete		○	Page 127 Deleting a project		
Verify		○	Page 143 Verifying Projects		
Project Revision	Revision Entry	○	Page 160 Registering a revision		
	Revision List	○	Page 162 Revision list screen		
Change PLC Type		○	Page 139 Changing the Module Type and Operation Mode of Projects		
Change Project Type		×			
Object	New	○	Page 129 Creating data		
	Rename	○	Page 130 Changing a data name		
	Delete	○	Page 132 Deleting data		
	Copy	○	Page 130 Copying and pasting data		
	Paste	○			
	Set as Default Connection	○	Page 558 Switching connection destinations		
	Property	○	Page 135 Properties		
Intelligent Function Module	New Module		○	Page 205 Setting parameters of modules	
	Delete Module		○	Page 132 Deleting data	
	Property		○	Page 135 Properties	
	Save the Positioning Module Data		×		
	Read from the Positioning Module Data		×		
	Save GX Configurator-QP Data		×		
	Import GX Configurator-QP Data		×		
	Intelligent Function Module Parameter List		○	Page 214 Checking/changing the number of intelligent function module parameters	
	Save/Read FX Special Module Data	Read new FX Special Module Data		×	
		Save FX Special Module Data		×	
Read from FX Special Module Data		×			
Open Other Data	Open Other Project		○	Page 107 Opening a GX Works2 format project Page 110 Opening a PX Developer format project Page 124 Opening a GX Developer format project	
			○	Page 115 Opening a GX IEC Developer format project	
			×		
Export to GX Developer Format File		×			

GX Works2		GX Works3	
		Supported or not	Reference/similar function
Library	Create	○	Page 507 Creating a library file
	Install	○	Page 511 Registering user libraries in the library list
	Export FB to Library (Project)	×*1	
	Deinstall	○	Page 511 Deleting libraries/updating display information
	Reload	○	
	Rename	×*2	
	Open	○	Page 507 Creating a library file
	Close	○	
	Change Password	○	
	Save As	○	
	Save	○	
	Help	○	
Security	Change Password	○	Page 684 Changing a password of the logon user It is available only in projects for an RnSFPCPU and an RnPSFCPU.
	User Management	○	Page 685 User management It is available only in projects for an RnSFPCPU and an RnPSFCPU.
	Data Security Setting	×	
	Soft Security Key Management	○	Page 675 Creating/deleting a security key
Print	○	Page 92 Printing Data	
Print Preview	○	Page 92 Printing Data	
Print Window	×		
Print Window Preview	×		
Printer Setup	○	Page 92 Printing Data	
(Recently used files 1 to 4)	○	• [Project] ⇔ [Recent Projects] ⇔ [(project path used recently 1 to 10)]	
Start GX Developer	○	• [Project] ⇔ [Start GX Works2]	
Exit	○	Page 49 End	

\*1 In GX Works3, function blocks cannot be exported directly to a project.  
To import FB elements, which were exported to a library file, in a project, refer to the following:

 Page 510 Enhanced use of libraries

\*2 An arbitrary name can be set to a library file to be exported.  
However, the file name of an imported library file cannot be changed.

## ■Edit

○: Similar function supported, ×: Similar function not supported

GX Works2		GX Works3	
		Supported or not	Similar function
Undo	○	• [Edit] ⇔ [Undo]	
Redo	○	• [Edit] ⇔ [Redo]	
Cut	○	• [Edit] ⇔ [Cut]	
Copy	○	• [Edit] ⇔ [Copy]	
Paste	○	• [Edit] ⇔ [Paste]	



## ■Find/Replace

○: Similar function supported, ×: Similar function not supported

GX Works2	GX Works3	
	Supported or not	Reference/similar function
Cross Reference	○	Page 457 Displaying cross reference information
Device List	○	Page 465 Displaying Device Usage
Find Device	○	Page 448 Searching for/Replacing Devices and Labels
Find Instruction	○	Page 450 Searching for/Replacing Instructions
Find Contact or Coil	○	
Find String	○	Page 451 Searching for/Replacing Character Strings
Replace Device	○	Page 448 Searching for/Replacing Devices and Labels
Replace Instruction	○	Page 450 Searching for/Replacing Instructions
Replace String	○	Page 451 Searching for/Replacing Character Strings
Change Open/Close Contact	○	Page 453 Changing Contacts between Open Contact and Close Contact
Device Batch Replace	○	Page 454 Batch Replacing of Devices and Labels
Register to Device Batch Replace	○	• [Find/Replace] ⇔ [Register to Device Batch Replace]

## ■Convert/Compile

○: Similar function supported, ×: Similar function not supported

GX Works2	GX Works3	
	Supported or not	Reference/similar function
Build	○	Page 420 Converting any or all programs
Online Program Change	○	Page 600 Writing data after changing programs partially while a CPU module is running (Online program change)
Rebuild All	○	Page 420 Converting any or all programs

A

## ■View

○: Similar function supported, ×: Similar function not supported

GX Works2		GX Works3		
		Supported or not	Reference/similar function	
Toolbar	Toolbar name	○	Page 51 Main frame	
	Display All	×		
Statusbar		○	Page 51 Main frame	
Color and Font		○	Page 81 Checking and Changing Colors and Fonts	
Docking Window	Navigation	○	Page 54 Navigation window	
	Element Selection	○	Page 57 Element selection window	
	Output	○	• [View] ⇨ [Docking Window] ⇨ [Output]	
	Cross Reference	○	Page 457 Displaying cross reference information	
	Device List	○	Page 465 Displaying Device Usage	
	Device Reference (CC-Link)	○	Page 211 Checking refresh devices assigned to a module	
	Device Reference (AnyWireASLINK)	×		
	Watch 1 to 4	○	Page 637 Checking Current Values by Registering Devices/Labels	
	Intelligent Function Module Monitor	Module 1 to 10	○	Page 658 Checking Current Values in an Intelligent Function Module
	Intelligent Function Module Guidance		×	
	Find/Replace		○	• [View] ⇨ [Docking Window] ⇨ [Find/Replace]
	Debug	Break Point	×	
		Break Device	×	
Skip Range		×		
Reset the Window Position to its Default		○	Page 51 Displaying docked windows	

## ■Online

○: Similar function supported, ×: Similar function not supported

GX Works2		GX Works3	
		Supported or not	Reference/similar function
Read from PLC		○	Page 577 Writing/Reading Programmable Controller Data
Write to PLC		○	
Verify with PLC		○	Page 595 Verifying Programmable Controller Data
Remote Operation		○	Page 759 Remote Operation
Redundant Operation		○	Page 761 Redundant Programmable Controller Operations
Password/Keyword	New	○	Page 695 Setting a file password
	Delete	○	
	Disable	○	
Soft Security Key Management		○	Page 678 Registering a security key in a program file
PLC Memory Operation	Format PLC Memory	○	Page 769 Checking Memory Usage
	Clear PLC Memory	○	
	Arrange PLC Memory	×	
Delete PLC Data		○	Page 577 Writing/Reading Programmable Controller Data
PLC User Data	Read	○	Page 607 Reading/Writing/Deleting User Data
	Write	○	
	Delete	○	
Export to ROM Format		×	
Program Memory Batch Download		×	
Latch Data Backup	Backup	× <sup>*1</sup>	
	Delete Backup Data	× <sup>*1</sup>	

GX Works2		GX Works3		
		Supported or not	Reference/similar function	
PLC Module Change	Create Backup Data	×*2		
	Restore	×*2		
Set Clock		○	Page 758 Clock Setting in a CPU Module	
Register/Cancel Display Module Menu		×		
Monitor	Monitor Mode	○	Page 268 Switching the ladder edit mode (read/write/monitor read/monitor write)	
	Monitor (Write Mode)	○		
	Start Monitoring (All Windows)	○	Page 613 Starting/stopping monitoring	
	Stop Monitoring (All Windows)	○		
	Start Monitoring	○		
	Stop Monitoring	○		
	Change Value Format (Decimal)	○	Page 613 Changing display format of word devices	
	Change Value Format (Hexadecimal)	○		
	Device/Buffer Memory Batch	○	Page 633 Checking Device/Buffer Memory in a Batch	
	Program List	○	Page 655 Checking the Processing Time of a Program	
	Interrupt Program List	○	Page 657 Checking Execution Counts of Interrupt Programs	
	Change Instance (Function Block)	×		
	SFC All Block Batch Monitoring	○	Page 632 Monitoring all SFC blocks in batch/active steps	
SFC Auto Scroll	○	Page 629 Monitoring with the SFC auto-scroll		
Watch	Start Watching	○	Page 637 Checking Current Values by Registering Devices/Labels	
	Stop Watching	○		
	Insert Next Object	×		
	Display Format of Bit Device	Number Display	×	
		ON/OFF Display	×	
		Symbol Display	×	
Register to Watch	○	Page 637 Checking Current Values by Registering Devices/Labels		
Local Device Batch Read + Save CSV		×		

\*1 A function of RnCPUs.

For details, refer to the following:

 MELSEC iQ-R CPU Module User's Manual (Application)

\*2 A function of RnPCPUs.

For details, refer to the following:

 MELSEC iQ-R CPU Module User's Manual (Application)

## ■ Debug

○: Similar function supported, ×: Similar function not supported

GX Works2		GX Works3	
		Supported or not	Reference/similar function
Start/Stop Simulation		○	Page 522 Simulation
Instructions Unsupported by Simulation		×	
Modify Value		○	Page 612 Changing current values
Forced Input Output Registration/Cancellation		○	Page 644 Turning Input/Output Devices ON/OFF Forcibly
Device Test with Execution Condition	Register	○	Page 646 Changing Device/Label Value by Setting Conditions
	Registration Check/Disable	○	
	Batch Disable	○	
Sampling trace	Open Sampling Trace	× <sup>*1</sup>	
Scan Time Measurement		○	Page 653 Measuring the Scan Time of a Program
Step Execution	Stop	×	
	Cancel	×	
	Break Execution	×	
	Step Execution	×	
	Execution Option	×	
Break Setting	Set/Cancel Break Point	×	
	Enable/Disable Break Point	×	
	Cancel All Break Points	×	
	Break Point Window	×	
	Cancel All Break Devices	×	
	Break Device Window	×	
Skip Setting	Set/Cancel Skip Range	×	
	Enable/Disable Skip Range	×	
	Cancel All Skip Ranges	×	
	Skip Range Window	×	

\*1 GX Works3 does not have a similar function. Use the following functions instead.  
 Data logging function (CPU Module Logging Configuration Tool)  
 Realtime monitor function (GX LogViewer)

## ■ Diagnostics

○: Similar function supported, ×: Similar function not supported

GX Works2		GX Works3	
		Supported or not	Reference/similar function
PLC Diagnostics		○	Page 708 Module Diagnostics
Ethernet Diagnostics		○	Page 714 Ethernet diagnostics
CC IE Control Diagnostics		○	Page 715 CC-Link IE Controller Network diagnostics
CC IE Field Diagnostics		○	Page 717 CC-Link IE TSN/CC-Link IE Field Network diagnostics
CC-Link IEF Basic Diagnostics		○	Page 719 CC-Link IE Field Network Basic diagnostics
MELSECNET Diagnostics		○	Page 720 MELSECNET diagnostics
CC-Link Diagnostics		○	Page 721 CC-Link diagnostics
Sensor/Device Monitor		○	Page 705 Sensor/Device Status Check
System Monitor		○	Page 702 Module Status Check of a System
Online Module Change		×	

## ■ Tool

○: Similar function supported, ×: Similar function not supported

GX Works2		GX Works3	
		Supported or not	Reference/similar function
IC Memory Card	Read IC Memory Card	○	Page 610 Writing to/Reading from a memory card
	Write IC Memory Card	○	
	Read from IC Memory Card (Edit and Data Copy)	×	
	Write to IC Memory Card (Edit and Data Copy)	×	
Check Program		○	Page 417 Program check
Check Parameter		○	Page 201 Checking parameters
Clear All Parameters		×	
Check Device Duplication of Global Label		○	Page 241 Checking assigned devices
Device/Label Automatic-Assign Setting		×	
Block Password		○	Page 671 Setting block password
Confirm Memory Size		○	Page 432 Calculating Memory Size
Delete Unused Device Comment		○	Page 406 Deleting unused device comments
Merge Data		×	
Set TEL Data/Connect via Modem	Line Connection	×	
	Line Disconnection	×	
	AT Command Registration	×	
	Phone Book	×	
	Options	×	
Logging Configuration Tool		○	Page 730 Data Logging Function
Real-time Monitor Function		○	Page 661 Checking Current Logging Data
Ethernet Adapter Module Configuration Tool		×	
Built-in I/O Module Tool	Positioning Monitor	×	
	High-Speed Counter Monitor	×	
	I/O Monitor	×	
Check Intelligent Function Module Parameter	Check Auto Refresh Duplication	○	Page 201 Checking parameters
Intelligent Function Module Tool		○	Page 218 Displaying the module tool list
Predefined Protocol Support Function		○	Page 220 Predefined Protocol Support Function
Language Selection		× <sup>*1</sup>	
Profile Management	Register	○	Page 186 Managing Profiles
	Delete	○	
Key Customize		○	Page 80 Checking and Changing Shortcut Keys
Options		○	Page 84 Option Settings for Each Function

\*1 GX Works3 supports multiple languages, and therefore the display language such as one on the menu can be switched on a personal computer.

For details, refer to the section.

☞ Page 50 Display Language Switching



## ■Window

○: Similar function supported, ×: Similar function not supported

GX Works2	GX Works3	
	Supported or not	Reference/similar function
Cascade	○	• [Window] ⇔ [Cascade]
Tile Vertically	○	• [Window] ⇔ [Tile Vertically]
Tile Horizontally	○	• [Window] ⇔ [Tile Horizontally]
Arrange Icons	○	• [Window] ⇔ [Arrange Icons]
Close All	○	• [Window] ⇔ [Close All Windows]
(Switch to other window)	○	• [Window] ⇔ [(Window information being displayed)]
Other Window	○	Page 52 Arranging work windows

## ■Help

○: Similar function supported, ×: Similar function not supported

GX Works2	GX Works3	
	Supported or not	Reference/similar function
GX Works2 Help	○	Page 42 Displaying Help
Connection to MITSUBISHI ELECTRIC FA Global Website	○	Page 43 Connecting to MITSUBISHI ELECTRIC FA Global Website
About	○	Page 43 Checking the version of GX Works3

## Label

The following table shows the functions available for setting and editing labels.

○: Similar function supported, ×: Similar function not supported

GX Works2	GX Works3		
	Supported or not	Reference/similar function	
Delete	○	—	
Select All	○		
New Declaration (Before)	○	Page 229 Editing a row	
New Declaration (After)	○		
Delete Row	○		
Read from CSV File	○	Page 245 Exporting/importing a label	
Write to CSV File	○		
System Label	Reservation to Register System Label	○	Page 255 Registering labels in system label database
	Reservation to Release System Label	○	Page 255 Releasing system labels
	Import System Label	○	Page 255 Importing system labels in system label database to GX Works3
	Reflect to System Label Database	○	Page 255 Registering labels in system label database
	Check the changes of the System Label Database	○	Page 256 Importing the changes of system label database
	Execute Verification Synchronous with System Label	○	Page 256 Verifying system label information
Sort	○	Page 229 Sorting labels	
Unused label list	○	Page 463 Displaying a list of unused labels	

## Device comment

The following table shows the functions available for editing device comments.

### ■Edit

○: Similar function supported, ×: Similar function not supported

GX Works2	GX Works3	
	Supported or not	Reference/similar function
Delete	○	—
Select All	○	
Import from Sample Comment	○	Page 409 Reading sample comments
Clear All (All Devices)	○	Page 406 Clearing all device comments
Clear All (All Displayed Devices)	○	
Read from CSV File	○	Page 407 Importing/exporting device comments
Write to CSV File	○	
Hide Bit Specification Information	○	• [Edit] ⇨ [Hide All Bit Specification Information]
Show Bit Specification Information	○	• [Edit] ⇨ [Show All Bit Specification Information]
Cut The Range including Hidden Bit Specification Information	○	Page 404 Creating device comments
Copy The Range including Hidden Bit Specification Information	○	
Paste The Range including Hidden Bit Specification Information	○	

### ■View

○: Similar function supported, ×: Similar function not supported

GX Works2	GX Works3		
	Supported or not	Reference/similar function	
Text Size	Bigger	○	• [View] ⇨ [Zoom] ⇨ [Zoom In]
	Smaller	○	• [View] ⇨ [Zoom] ⇨ [Zoom Out]

## Device memory

The following table shows the functions available for setting the device memory.

### ■Edit

○: Similar function supported, ×: Similar function not supported

GX Works2	GX Works3	
	Supported or not	Reference/similar function
Delete	○	—
Insert Row	×	
Input Device	×	
Paste Text	○	Page 438 Setting character strings
FILL	○	Page 437 Setting values in batch

### ■Find/Replace

○: Similar function supported, ×: Similar function not supported

GX Works2	GX Works3	
	Supported or not	
Find Device Cell	×	

### ■View

○: Similar function supported, ×: Similar function not supported

GX Works2	GX Works3	
	Supported or not	Reference/similar function
Display Mode	○	• [View] ⇒ [Display Format Detailed Setting]
Register	○	• [View] ⇒ [Display Format Detailed Setting]
Setup	×	

### ■Tool

○: Similar function supported, ×: Similar function not supported

GX Works2	GX Works3	
	Supported or not	Reference/similar function
Read Device Memory from PLC	○	Page 439 Writing/Reading Data to/from CPU Module
Write Device Memory to PLC	○	
Read from Excel File	×	
Write to Excel File	○	Page 440 Exporting Device Memory Data



## Verification result

The following table shows the functions available while a verification result is displayed.

### ■Edit

○: Similar function supported, ×: Similar function not supported

GX Works2	GX Works3	
	Supported or not	Reference/similar function
Write to CSV File	○	Page 145 Checking a verification result

### ■Find/Replace

○: Similar function supported, ×: Similar function not supported

GX Works2	GX Works3	
	Supported or not	Reference/similar function
Next Unmatch	○	Page 145 Checking a verification result
Previous Unmatch	○	



### ■View

○: Similar function supported, ×: Similar function not supported

GX Works2	GX Works3	
	Supported or not	Reference/similar function
Return to Result List	○	• [View] ⇒ [Return to Result List]
Close Detail Result	○	• [View] ⇒ [Close Detailed Result]
Close All Detail Result	○	• [View] ⇒ [Close All Detailed Result]

## Sampling trace

GX Works3 does not have a similar function. Use the following functions instead.

Function	Reference
Data logging	 MELSEC iQ-R CPU Module User's Manual (Application)
Realtime monitor	 GX LogViewer Version 1 Operating Manual

## Ladder editor







The following table shows the functions available for editing data in a ladder editor.

### ■Edit

○: Similar function supported, ×: Similar function not supported

GX Works2		GX Works3		
		Supported or not	Reference/similar function	
Continuous Paste		○	Page 291 Pasting device numbers or label names consecutively	
Delete		○	—	
Restore After Ladder Conversion		○	Page 292 Returning ladder diagrams to the condition before editing	
Insert Row		○	• [Edit] ⇔ [Insert Row]/[Delete Row]/[Insert Column]/[Delete Column]	
Delete Row		○		
Insert Column		○		
Delete Column		○		
NOP Batch Insert		○	Page 289 Inserting/deleting NOP instruction	
NOP Batch Delete		○		
Edit Line		× <sup>*1</sup>		
Delete Line		× <sup>*1</sup>		
Change TC Setting		○	Page 289 Changing TC setting values	
Ladder Edit Mode	Read Mode	○	Page 268 Switching the ladder edit mode (read/write/monitor read/monitor write)	
	Write Mode	○		
	Read Mode (All Windows)	○		
	Write Mode (All Windows)	○		
Ladder Symbol	Open Contact	○	Page 269 Entering ladders	
	Close Contact	○		
	Open Branch	○		
	Close Branch	○		
	Coil	○		
	Application Instruction	○		
	Vertical Line	○		
	Horizontal Line	○		
	Delete Vertical Line	○		
	Delete Horizontal Line	○		
	Pulse Contact Symbol	Rising Pulse		○
		Falling Pulse		○
		Rising Pulse Branch		○
		Falling Pulse Branch		○
		Rising Pulse Close		○
		Falling Pulse Close		○
Rising Pulse Close Branch		○		
Falling Pulse Close Branch		○		
Invert Operation Results	○	• [Edit] ⇔ [Ladder Symbol] ⇔ [Invert Operation Results]/[Operation Result Rising Pulse]/[Operation Result Falling Pulse]		
Operation Result Rising Pulse	○			
Operation Result Falling Pulse	○			
Inline Structured Text	Insert Inline Structured Text Box	○	Page 281 Inserting an inline structured text box	
	Display Template	○	Page 315 Displaying syntax templates	
	Mark Template (Left)	○		
	Mark Template (Right)	○		
Edit FB Instance		○	Page 273 Changing an FB instance name	

GX Works2		GX Works3	
		Supported or not	Reference/similar function
Documentation	Device Comment	○	Page 284 Entering/editing comments
	Statement	○	Page 285 Entering/editing statements
	Note	○	Page 288 Entering/editing notes
	Statement/Note Batch Edit	○	Page 285 Entering/editing statements Page 288 Entering/editing notes
Easy Edit	Connect Line to Right-Side Symbol	○	• [Edit] ⇔ [Easy Edit] ⇔ [Connect Horizontal Line to Right-Side Ladder Symbol]
	Connect Line to Left-Side Symbol	○	• [Edit] ⇔ [Easy Edit] ⇔ [Connect Horizontal Line to Left-Side Ladder Symbol]
	Enter/Delete HLine Rightward	○	• [Edit] ⇔ [Easy Edit] ⇔ [Enter/Delete Horizontal Line to Rightward]
	Enter/Delete HLine Leftward	○	• [Edit] ⇔ [Easy Edit] ⇔ [Enter/Delete Horizontal Line to Leftward]
	Enter/Delete VLine Downward	○	• [Edit] ⇔ [Easy Edit] ⇔ [Enter/Delete Vertical Line to Downward]
	Enter/Delete VLine Upward	○	• [Edit] ⇔ [Easy Edit] ⇔ [Enter/Delete Vertical Line to Upward]
	Switch Open/Close Contact	○	Page 270 Switching methods for contacts/instructions
	Switch Statement/Note Type	○	• [Edit] ⇔ [Easy Edit] ⇔ [Switch Statement/Note Type]
	Instruction Partial Edit	○	• [Edit] ⇔ [Easy Edit] ⇔ [Instruction Partial Edit]
	Edit List for Ladder Block	×	
Read from CSV File		○	Page 298 Importing from a CSV file
Write to CSV File		○	Page 301 Exporting to a CSV file

\*1 In GX Works3, a line can be drawn with the shortcut keys ( +  /  /  / ) ( Page 271 Drawing a line)

## ■Find/Replace

○: Similar function supported, ×: Similar function not supported

GX Works2	GX Works3	
	Supported or not	Reference/similar function
Change Module I/O No.	×	
Switch Statement/Note Type	×	
Line Statement List	○	Page 286 Displaying a list
Jump	○	Page 296 Jump
Jump to Next Ladder Block Start	○	• [Find/Replace] ⇔ [Jump to Next Ladder Block Start]
Jump to Previous Ladder Block Start	○	• [Find/Replace] ⇔ [Jump to Previous Ladder Block Start]
Next Device	×	
Next Contact	×	
Next Coil	×	
Back	○	• [Find/Replace] ⇔ [Previous]/[Next]

## ■View

○: Similar function supported, ×: Similar function not supported

GX Works2		GX Works3	
		Supported or not	Reference/similar function
Comment		○	Page 284 Entering/editing comments
Statement		○	Page 285 Entering/editing statements
Note		○	Page 288 Entering/editing notes
Display Lines of Monitored Current Value		○	• [View] ⇒ [Display Lines of Monitored Current Value]
Display Format for Device Comment		○	• [View] ⇒ [Display Format for Device Comment]
Display Ladder Block	Hide Ladder Block	× <sup>*1</sup>	
	Display Ladder Block	× <sup>*1</sup>	
	Hide All Ladder Block	× <sup>*1</sup>	
	Display All Ladder Block	× <sup>*1</sup>	
Device Display	Device Display	×	
	Batch Device Display	○	Page 264 Configuration of a ladder editor
	Cancel All Device Display	○	
Display Compile Result		×	
Zoom		○	• [View] ⇒ [Zoom] ⇒ [Set Zoom Factor]/[Zoom In]/[Zoom Out]/[Fit the editor width to the window width]
Text Size	Bigger	○	Page 81 Checking and Changing Colors and Fonts The character size can be changed for each editor by using the following menu. • [View] ⇒ [Text Size] ⇒ [Bigger]/[Smaller]
	Smaller	○	
Open Other Window	Open Reference Window	× <sup>*2</sup>	
	Update Reference Window	× <sup>*2</sup>	
	Open Reference Source Window	× <sup>*2</sup>	
	Tile FB Horizontally	○	• [View] ⇒ [Open Program Body of Selected Element] ⇒ [Tile Horizontally]
	Open Label Setting	○	• [View] ⇒ [Open Label Setting] ⇒ [Open in Front]
	Open Zoom SFC Block	○	Page 369 Creating/displaying Zooms (action/transition)
Move SFC Cursor	Up	×	
	Down	×	
	Left	×	
	Right	×	
Open Instruction Help		○	Page 296 Displaying instruction help
ST Monochrome Display		×	

\*1 The display status of ladder blocks in a ladder editor can be changed by using the following menu.  
[View] ⇒ [Outline] ⇒ [Expand/Collapse of Outlines]/[Expand/Collapse of All Outlines]/[Show/Hide of Outlines]

\*2 By splitting a ladder editor vertically, ladder blocks which are described in different parts can be edited and monitored at once.  
For details, refer to the following:  
 Page 267 Splitting a ladder editor

## ■Online

○: Similar function supported, ×: Similar function not supported

GX Works2		GX Works3	
		Supported or not	
Monitor	Monitor Condition Setting	×	
	Monitor Stop Condition Setting	×	
	Entry Ladder Monitor	×	
	Delete All Entry Ladder	×	

## SFC diagram

The following table shows the functions available for editing SFC diagrams.

By comparing with GX Works2, the functions are enhanced and their operability have been improved.

For the editing method, refer to the following:

 Page 342 Creating an SFC Program

### ■Edit

○: Similar function supported, ×: Similar function not supported

GX Works2		GX Works3	
		Supported or not	Reference/similar function
Delete		○	—
Arrange SFC		×	
Change TC Setting		○	Page 289 Changing TC setting values
Ladder Edit Mode	Read Mode	×	
	Write Mode	×	
	Read Mode (All Windows)	×	
	Write Mode (All Windows)	×	
SFC Step Attribute	No Attribute	○	Page 351 Changing a step name/step No./step attribute/step attribute target
	Stored Coil	○	
	Stored Operation (without Transition Check)	○	
	Stored Operation (with Transition Check)	○	
	Reset	○	
Sort SFC Step No.		×	
Documentation	SFC Step/Transition Comment	×	

### ■Find/Replace

○: Similar function supported, ×: Similar function not supported

GX Works2		GX Works3	
		Supported or not	
Jump		×	
Find Jump Step		×	
Change SFC Step No.		×	

### ■Convert/Compile

○: Similar function supported, ×: Similar function not supported

GX Works2		GX Works3	
		Supported or not	Reference/similar function
Convert Block		○	Page 368 Converting a block

### ■View

○: Similar function supported, ×: Similar function not supported

GX Works2		GX Works3	
		Supported or not	Reference/similar function
Program Display		×	
SFC Step/Transition Comment		○	Page 343 Configuration of an SFC diagram editor
Zoom		○	• [View] ⇨ [Zoom] ⇨ [Set Zoom Factor]/[Zoom In]/[Zoom Out]
Text Size	Bigger	×	
	Smaller	×	
SFC Column Setting		×	

GX Works2	GX Works3	
	Supported or not	Reference/similar function
Open SFC Blocklist	○	Page 372 Displaying an SFC block list
MELSAP3 Display	○	Page 347 Display format of action/transition
MELSAP-L (Instruction Format) Display	○	
MELSAP-L (Start Conditions Format) Display	×	
Open Zoom/Start Destination Block	○	Page 343 Configuration of an SFC diagram editor
Back to Start SFC Block	○	Page 352 Creating a step that makes another block activated
Open Header	○	Page 373 Displaying local label editor
Reset the Window Position to its Default	×	

### ■Online

○: Similar function supported, ×: Similar function not supported

GX Works2	GX Works3	
	Supported or not	
Monitor	Monitor Condition Setting	×
	Monitor Stop Condition Setting	×

## SFC block list

The following table shows the functions available for editing the SFC block list.

### ■Find/Replace

○: Similar function supported, ×: Similar function not supported

GX Works2	GX Works3	
	Supported or not	Reference/similar function
Jump	○	Page 373 Jump
Find Block No.	×	
Block Information Find Device	○	Page 373 Searching for block information

### ■View

○: Similar function supported, ×: Similar function not supported

GX Works2	GX Works3	
	Supported or not	Reference/similar function
SFC Block List Comment	○	Page 372 Displaying an SFC block list
Device Display	○	
Open SFC Body	○	Page 372 Displaying SFC diagrams
Open Header	○	Page 373 Displaying local label editor

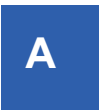

## ST editor

The following table shows the functions available for editing data in an ST editor.

### ■Edit

○: Similar function supported, ×: Similar function not supported

GX Works2	GX Works3	
	Supported or not	Reference/similar function
Delete	○	—
List Operands	×	
Display Template	○	Page 315 Displaying syntax templates
Mark Template (Left)	○	
Mark Template (Right)	○	

### ■Find/Replace

○: Similar function supported, ×: Similar function not supported

GX Works2	GX Works3		
	Supported or not	Reference/similar function	
Jump	○	Page 317 Jump	
Bookmark	Toggle Bookmark	○	Page 479 Registering a Bookmark
	Bookmark List	○	
	Next Bookmark	○	
	Previous Bookmark	○	
	Delete All Bookmarks	○	

### ■View

○: Similar function supported, ×: Similar function not supported

GX Works2	GX Works3		
	Supported or not	Reference/similar function	
Display Compile Result	×		
Zoom	Set Zoom Factor	○	• [View] ⇨ [Zoom] ⇨ [Set Zoom Factor]
	Increase Zoom	○	• [View] ⇨ [Zoom] ⇨ [Zoom In]
	Decrease Zoom	○	• [View] ⇨ [Zoom] ⇨ [Zoom Out]
Zoom Header/Body	Header	○	• [View] ⇨ [Open Label Setting of Selected Element] ⇨ [Open in Front]
	Body	○	• [View] ⇨ [Open Program of Selected Element] ⇨ [Open in Front]
Open Header	○	• [View] ⇨ [Open Label Setting] ⇨ [Open in Front]	
ST Monochrome Display	×		

### ■Online

○: Similar function supported, ×: Similar function not supported

GX Works2	GX Works3		
	Supported or not	Reference/similar function	
Monitor	Start Monitoring	○	Page 622 Monitor
	Start Monitor (bit type only)	○	



## Structured Ladder/FBD editor

The following table shows the functions available for editing data in a Structured Ladder/FBD editor.

### ■Edit

○: Similar function supported, ×: Similar function not supported

GX Works2		GX Works3	
		Supported or not	Reference/similar function
Delete		○	—
Select Mode		○	Contacts/coils can always be placed when the editor is in the 'Write' mode.
Interconnect Mode		○	Lines can always be drawn when the editor is in the 'Write' mode.
Guided Mode	Guided Editing	×	
	Overwrite Mode	×	
	Insert Mode	×	
	Line Mode	×	
	Auto Comment	×	
Auto Connect		○	• [Edit] ⇨ [Edit Mode] ⇨ [Element Auto-connect]
Recalculate Line		○	Lines are always be arranged automatically when the editor is in the 'Write' mode. Page 335 Correcting layout in an FBD network block Page 335 Correcting layout in an FBD network block in a batch
Insert Row		○	Page 335 Layout correction
Insert Column		○	
New Ladder Block List	Top	×	
	Before	×	
	After	×	
	Bottom	×	
Input Instruction		○	In GX Works2, enter an instruction in "Input Instruction" screen. In GX Works3, instructions can be entered directly in the editor.
Ladder Symbol	Open Contact	○	Page 325 Inserting from the menu or on the toolbar
	Close Contact	○	
	Coil	○	
	Jump	○	
	Return	○	
	Open Branch	○	
	Close Branch	○	
	Input Label	○	
	Output Label	○	
	Horizontal Line Segment	×	
	Vertical Line Segment	×	
	Rising Pulse	○	Page 325 Inserting from the menu or on the toolbar
	Falling Pulse	○	
	Rising Pulse Close	○	
	Falling Pulse Close	○	
	Comment	○	
Ladder Block Label	○		
Left Power Rail	○		
List Operands		○	• [Edit] ⇨ [Change Name]
Number of Pins	Increment	○	Page 330 Adding/deleting arguments
	Delete	○	

GX Works2		GX Works3	
		Supported or not	Reference/similar function
Ladder Block List		○	Page 340 Displaying FBD network blocks in a list
Signal Configuration	Configure	○	Page 326 Switching methods for contacts/instructions
	Toggle	○	

## ■Find/Replace

○: Similar function supported, ×: Similar function not supported

GX Works2		GX Works3	
		Supported or not	Reference/similar function
Jump		○	Page 340 Displaying FBD network blocks in a list

## ■View

○: Similar function supported, ×: Similar function not supported

GX Works2		GX Works3	
		Supported or not	Reference/similar function
View Mode	Label	○	Labels used in programs are always displayed with their label names.
	Device	×	
	Address	×	
	Comment	×	
	Change Label-Device-Address Mode	×	
	Change Label-Comment Mode	×	
	Change I/O Label-Comment Mode	○	
Add Label Display Items	Device	○	
	Address	×	
	Label Comment	○	Page 319 Configuration of an FBD/LD editor
	Device Comment	○	
All Device Display		×	
Cancel All Device Display		×	
Grid		○	Page 319 Configuration of an FBD/LD editor
Print Wrap Position		○	• [View] ⇨ [Display Page Break]
Display Compile Result		×	
Zoom	Set Zoom Factor	○	• [View] ⇨ [Zoom] ⇨ [Set Zoom Factor]
	Increase Zoom	○	• [View] ⇨ [Zoom] ⇨ [Zoom In]
	Decrease Zoom	○	• [View] ⇨ [Zoom] ⇨ [Zoom Out]
Zoom Header/Body	Header	○	• [View] ⇨ [Open Label Setting of Selected Element]
	Body	○	• [View] ⇨ [Open Program Body of Selected Element]
Open Header		○	• [View] ⇨ [Open Label Setting] ⇨ [Open in Front]

## CC IE Field configuration window

The following table shows the functions available while the "CC IE Field Configuration" window is displayed.

### ■CC IE Field configuration

○: Similar function supported, ×: Similar function not supported

GX Works2		GX Works3		
		Supported or not	Reference/similar function	
Change Module	Replace General CC IE Field Module	○	Page 208 Setting network configuration and target devices	
	Change to General CC IE Field Module	○		
Change Transmission Path Method	Line/Star	○		
	Ring	○		
Supplementary Setting		○		Navigation window <ul style="list-style-type: none"> <li>• "Module Parameter" ⇒ "Basic Settings" ⇒ "Network Topology"</li> <li>• "Module Parameter" ⇒ "Basic Settings" ⇒ "Operation of Master Station after Reconnection"</li> <li>• "Module Parameter" ⇒ "Application Settings" ⇒ "Supplementary Cyclic Settings"</li> </ul>
Equal Assignment		○		Page 208 Setting network configuration and target devices
Identical Point Assignment		○		
Device No. Reassignment		○		
Open System Configuration	Open AnyWireASLINK Configuration	○		
Check	System Configuration	○		
Online	Detect Now	○		
	Verification of the Configuration with the Connected Module	×		
	Parameter Processing of Device Station	○		
	Command Execution of Device Station	○		
	Backup Device Station	○		
	Restore Device Station	○		
Close with Discarding the Setting		○		
Close with Reflecting the Setting		○		

### ■Edit

○: Similar function supported, ×: Similar function not supported

GX Works2		GX Works3	
		Supported or not	Reference/similar function
Copy		○	—
Paste		○	
Select All		○	
Delete		○	

### ■View

○: Similar function supported, ×: Similar function not supported

GX Works2		GX Works3	
		Supported or not	Reference/similar function
Docking Window	Module List	○	—
	Output	○	
	Supplementary Information	○	
Object Name Display		○	



## CC-Link configuration window

The following table shows the functions available while the "CC-Link Configuration" window is displayed.

### ■CC-Link Configuration

○: Similar function supported, ×: Similar function not supported

GX Works2		GX Works3		
		Supported or not	Reference/similar function	
Change Module	Replace General CC-Link Module	○	Page 208 Setting network configuration and target devices	
	Change to General CC-Link Module	○		
Open System Configuration	Open AnyWireASLINK Configuration	○		
Check	System Configuration	○		
Online	Detect Now	○		
	Verification of the Configuration with the Connected Module	×		
	Parameter Processing of Device Station	○		Page 208 Setting network configuration and target devices
	Command Execution of Device Station	○		
	Backup Device Station	○		
Restore Device Station	○			
Close with Discarding the Setting	○			
Close with Reflecting the Setting	○			

### ■Edit

○: Similar function supported, ×: Similar function not supported

GX Works2		GX Works3	
		Supported or not	Reference/similar function
Copy		○	—
Paste		○	
Select All		○	
Delete		○	

### ■View

○: Similar function supported, ×: Similar function not supported

GX Works2		GX Works3	
		Supported or not	Reference/similar function
Docking Window	Module List	○	—
	Output	○	
	Verify Result	×	

## AnyWireASLINK configuration window

The following table shows the functions available while the "AnyWireASLINK Configuration" window is displayed.

### ■AnyWireASLINK Configuration

○: Similar function supported, ×: Similar function not supported

GX Works2		GX Works3	
		Supported or not	Reference/similar function
Change Module	Replace General AnyWireASLINK Module	○	Page 208 Setting network configuration and target devices
	Change to General AnyWireASLINK Module	○	
Address Auto-Input		○	
Check	System Configuration	○	
Online	Detect Now	○	
	Verification of the Configuration with the Connected Module	○	
	Parameter Processing of Remote Module	○	
	Backup Remote Module	○	
	Restore Remote Module	○	
Close with Discarding the Setting		○	
Close with Saving the Setting		○	

### ■Edit

○: Similar function supported, ×: Similar function not supported

GX Works2		GX Works3	
		Supported or not	Reference/similar function
Copy		○	—
Paste		○	
Select All		○	
Delete		○	

### ■View

○: Similar function supported, ×: Similar function not supported

GX Works2		GX Works3	
		Supported or not	Reference/similar function
Docking Window	Module List	○	—
	Output	○	
	Verify Result	○	

A

## Ethernet configuration window

The following table shows the functions available while the "Ethernet Configuration" window is displayed.

The settings of a network configuration and a target device in GX Works3 is set in the configuration setting screen. (☞ Page 208 Setting network configuration and target devices)

For details on the settings, refer to each user's manual.

### ■Ethernet Configuration

○: Similar function supported, ×: Similar function not supported

GX Works2		GX Works3		
		Supported or not	Reference/similar function	
Change Module	Replace General SLMP Module	○	Page 208 Setting network configuration and target devices	
	Change to General SLMP Module	○		
Check	System Configuration	○		
Online	Detect Now	○		
	Communication Setting Reflection of Ethernet Device	○		
	Parameter Processing of Ethernet Device	○		
	Backup Ethernet Device	○		—
	Restore Ethernet Device	○		
Close with Discarding the Setting		○		
Close with Reflecting the Setting		○		

### ■Edit

○: Similar function supported, ×: Similar function not supported

GX Works2		GX Works3	
		Supported or not	Reference/similar function
Copy		○	—
Paste		○	
Select All		○	
Delete		○	

### ■View

○: Similar function supported, ×: Similar function not supported

GX Works2		GX Works3	
		Supported or not	Reference/similar function
Docking Window	Module List	○	—
	Output	○	

## CC-Link IEF Basic configuration window

The following table shows the functions available while the "CC-Link IEF Basic Configuration" window is displayed.

### ■CC-Link IEF Basic Configuration

○: Similar function supported, ×: Similar function not supported

GX Works2		GX Works3	
		Supported or not	Reference/similar function
Change Module	Replace CC-Link IEF Basic Connected Module	○	Page 208 Setting network configuration and target devices
	Change to CC-Link IEF Basic Connected Module	○	
Link Scan Setting		○	
Check	System Configuration	○	
Online	Detect Now	○	
	Communication Setting Reflection of Remote Station	○	
	Parameter Processing of Remote Station	○	
Close with Discarding the Setting		○	
Close with Reflecting the Setting		○	

### ■Edit

○: Similar function supported, ×: Similar function not supported

GX Works2		GX Works3	
		Supported or not	Reference/similar function
Copy		○	—
Paste		○	
Select All		○	
Delete		○	

### ■View

○: Similar function supported, ×: Similar function not supported

GX Works2		GX Works3	
		Supported or not	Reference/similar function
Docking Window	Module List	○	—
	Output	○	

A

## Sensor/device monitor screen

The following table shows the functions available while the sensor/device monitor screen is displayed.

### ■Sensor/Device Monitor

○: Similar function supported, ×: Similar function not supported

GX Works2		GX Works3	
		Supported or not	Reference/similar function
Open System Configuration	Open AnyWireASLINK Configuration	○	Page 705 Sensor/Device Status Check

### ■View

○: Similar function supported, ×: Similar function not supported

GX Works2		GX Works3	
		Supported or not	Reference/similar function
Docking Window	Monitoring Information	○	Page 705 Sensor/Device Status Check

### ■Online (CC-Link IE Field Network)

○: Similar function supported, ×: Similar function not supported

GX Works2		GX Works3	
		Supported or not	Reference/similar function
Parameter Processing of Device Station		○	Page 705 Sensor/Device Status Check
Command Execution of Device Station		○	
Start Monitoring		○	
Stop Monitoring		○	

### ■Online (CC-Link)

○: Similar function supported, ×: Similar function not supported

GX Works2		GX Works3	
		Supported or not	Reference/Similar function
Parameter Processing of Device Station		○	Page 705 Sensor/Device Status Check
Command Execution of Device Station		○	
Backup Device Station		○	
Restore Device Station		○	
Start Monitoring		○	
Stop Monitoring		○	

### ■Online (AnyWireASLINK)

○: Similar function supported, ×: Similar function not supported

GX Works2		GX Works3	
		Supported or not	Reference/similar function
Parameter Processing of Remote Module		○	Page 705 Sensor/Device Status Check
Backup Remote Module		○	
Restore Remote Module		○	
Start Monitoring		○	
Stop Monitoring		○	



## ■Online (Ethernet)

○: Similar function supported, ×: Similar function not supported

GX Works2	GX Works3	
	Supported or not	Reference/Similar function
Parameter Processing of Ethernet Device	○	Page 705 Sensor/Device Status Check
Backup Ethernet Device	○	
Restore Ethernet Device	○	
Start Monitoring	○	
Stop Monitoring	○	

## GX Simulator2 screen

The following table shows the functions available while "GX Simulator2" screen is displayed.

### ■Tool

○: Similar function supported, ×: Similar function not supported

GX Simulator2		GX Simulator3	
		Supported or not	Reference/similar function
Backup Device Memory in Simulation	Save	○	The device memory of GX Simulator3 can be read and written by using the following menu in GX Works3. • [Online] ⇒ [Read from PLC] • [Online] ⇒ [Write to PLC]
	Read	○	
I/O System Setting		○	Page 547 Simulation of External Device Operations

### ■Options

○: Similar function supported, ×: Similar function not supported

GX Simulator2		GX Simulator3	
		Supported or not	
Start in minimized status		×	
Save device memory at stop		×	

A

## Predefined protocol support

The following tables show the functions available while the predefined protocol support function is used.

### ■File

○: Similar function supported, ×: Similar function not supported

GX Works2		GX Works3	
		Supported or not	Reference/similar function
New		○	Page 220 Predefined Protocol Support Function
Open		○	
Close		○	
Save		○	
Save As		○	
Open Other Data	Serial Communication Module Format	×	
	Ethernet Module Format	×	
	Built-in/Adapter Serial Format	×	
	Built-in Ethernet Format	×	
Print		○	—
Exit		○	

### ■Edit

○: Similar function supported, ×: Similar function not supported

GX Works2		GX Works3	
		Supported or not	Reference/similar function
Add Protocol		○	Page 220 Predefined Protocol Support Function
Change to Editable Protocol		○	
Protocol Detailed Setting		○	
Add Receive Packet		○	
Delete		○	
Copy		○	
Paste		○	
Delete Multiple Protocols		○	
Copy Multiple Protocols		○	
Paste Multiple Protocols		○	
Device Batch Setting		○	
Save User Protocol Library		○	

### ■Module Read/Write

○: Similar function supported, ×: Similar function not supported

GX Works2		GX Works3	
		Supported or not	Reference/similar function
Read from Module		○	—
Write to Module		○	
Module Verification		○	

## ■Tool

○: Similar function supported, ×: Similar function not supported

GX Works2	GX Works3	
	Supported or not	Reference/similar function
Setting Device List	○	—
Register Predefined Protocol Library	○	

## ■Debug

○: Similar function supported, ×: Similar function not supported

GX Works2	GX Works3	
	Supported or not	Reference/similar function
Module Selection	○	—
Protocol Execution Log	○	
State Monitor	×	

## ■Window

○: Similar function supported, ×: Similar function not supported

GX Works2	GX Works3	
	Supported or not	Reference/similar function
Cascade	○	—
Tile Horizontally	○	
(Switch to other window)	○	

## Differences of option settings

This section explains the differences of option settings from ones of GX Works2.

Note that the option settings of GX Works3 can be set in the "Options" screen ([Tool] ] ⇒ [Options]).

For details, refer to the following:

☞ Page 84 Option Settings for Each Function

### List of GX Works2 option settings

Item		Reference
Project	Common Setting	Page 1019 Common Setting
	Automatic Save	Page 1019 Automatic Save
	Change history	Page 1019 Change history
Program Editor	All Editors	Page 1020 All Editors
	Structured Ladder/FBD/ST	Page 1020 Structured Ladder/FBD/ST
	Structured Ladder/FBD	Page 1021 Structured Ladder/FBD
	ST	Page 1022 ST
	Ladder/SFC	Page 1023 Ladder/SFC
	Ladder	Page 1024 Ladder
	SFC	Page 1025 SFC
Device Comment Editor		Page 1026 Device Comment Editor
Device Memory Editor		Page 1026 Device Memory Editor
Label Setting Editor		Page 1026 Label Setting Editor
Parameter		Page 1027 Parameter
Monitor	Common	Page 1027 Common
	Structured Ladder/FBD/ST	Page 1027 Structured Ladder/FBD/ST
	Ladder/SFC	Page 1028 Ladder/SFC
	Ladder	Page 1028 Ladder
	SFC	Page 1028 SFC
PLC Read/Write		Page 1029 PLC Read/Write
Online Change		Page 1029 Online Change
Symbolic Information		Page 1029 Symbolic Information
Save Destination of Device Comment		Page 1030 Save Destination of Device Comment
Compile	Basic Setting	Page 1030 Basic Setting
	Output Result	Page 1030 Output Result
	Ladder/SFC	Page 1030 Ladder/SFC
	Structured Ladder/FBD/ST	Page 1031 Structured Ladder/FBD/ST
Intelligent Function Module	QD75/LD75 type positioning	Page 1032 QD75/LD75 Type Positioning
	Guidance	Page 1032 Guidance
iQ Works Interaction		Page 1032 iQ Works Interaction
System Label Setting		Page 1032 System Label Setting
Sampling Trace		Page 1032 Sampling trace

## Project

### ■Common Setting

○: Similar setting supported, ×: Similar setting not supported

GX Works2	GX Works3	
	Supported or not	Similar setting
Automatically change language according to system	○	• "Edit" ⇨ "Language" ⇨ "Automatically change language according to system"
Use Dedicated Instruction for GX Developer, GX IEC Developer	×	
Connect directly to PLC on creating a new project	×	
Enable the security check for the project	×	

### ■Automatic Save

○: Similar setting supported, ×: Similar setting not supported

GX Works2	GX Works3	
	Supported or not	Similar setting
Save project after compiling	○	• "Project" ⇨ "Save" ⇨ "Save project after conversion"
Save project after writing to PLC	○	• "Project" ⇨ "Save" ⇨ "Save project after Write to PLC"
Save project after online change	○	• "Project" ⇨ "Save" ⇨ "Save project after Online Program Change"
Save project after changes in TC setting values are written to PLC	○	• "Project" ⇨ "Save" ⇨ "Save project after changing TC Setting Value and writing to PLC"

### ■Change history

○: Similar setting supported, ×: Similar setting not supported

GX Works2	GX Works3	
	Supported or not	Similar setting
Revision is not Registered when Save Project	○	• "Project" ⇨ "Revision" ⇨ "Operational Setting" ⇨ "Register to the Revision When Saving Project"
Revision is Registered when Save Project	○	
Display confirmation message showing whether to register history	○	• "Project" ⇨ "Revision" ⇨ "Operational Setting" ⇨ "Display Confirmation Message Showing Whether to Register Revision"
Automatically set revision titles	○	• "Project" ⇨ "Revision" ⇨ "Operational Setting" ⇨ "Automatically Set Revision Titles"

A

## Program Editor

### ■All Editors

○: Similar setting supported, ×: Similar setting not supported

GX Works2		GX Works3	
		Supported or not	Similar setting
Device Comment	Program/Program File Name	○	• "Project" ⇔ "Device Comment Reference/Reflection Target" ⇔ "(program/program file name)"
	Specify the Reference/Reflection Target	○	• "Project" ⇔ "Device Comment Reference/Reflection Target"
	Reference/Reflect the other, when device comment is not set	○	• "Project" ⇔ "Device Comment Reference/Reflection Target" ⇔ "Reference/Reflection Target for Device Comment" ⇔ "Reference/Reflect the Other Device Comment When Setting Device Comment"
	[Apply to all programs] button	×	
	[Global] button	○	• "Project" ⇔ "Device Comment Reference/Reflection Target" ⇔ "(program/program file name)" Select 'Common' for the application and reference destinations of device comments for each device.
	[Local] button	○	• "Project" ⇔ "Device Comment Reference/Reflection Target" ⇔ "(program/program file name)" Select 'Each Program' or the application and reference destinations of device comments for each device.
	[PLC Parameter Setting] button	×	

### ■Structured Ladder/FBD/ST

○: Similar setting supported, ×: Similar setting not supported

GX Works2		GX Works3	
		Supported or not	Similar setting
Tool Hint	Monitored Value	×	• "Program Editor" ⇔ "FBD/LD Editor" ⇔ "Tool Hint" ⇔ "Display Item in Tool Hint"
	Class	○	
	Device	○	
	Address	×	
	Device Comment	○	
	Data Type	○	
	Constant Value	○	
	Label Comment	○	
	Remark	×	
Tool Hint Display Format	×		

## ■ Structured Ladder/FBD

○: Similar setting supported, ×: Similar setting not supported

GX Works2		GX Works3	
		Supported or not	Similar setting
Label	Display label name/comment of contact or coil in multiline	○	<ul style="list-style-type: none"> <li>• Comment: "Program Editor" ⇒ "FBD/LD Editor" ⇒ "Comment" ⇒ "Display Format" ⇒ "Number of Rows"</li> <li>• Label name: "Program Editor" ⇒ "FBD/LD Editor" ⇒ "Element (Ladder Symbol)" ⇒ "Display Format" ⇒ "Numbers of Wrapping Rows for Device/Label Name"</li> <li>• Label name: "Program Editor" ⇒ "FBD/LD Editor" ⇒ "Element (Ladder Symbol)" ⇒ "Display Format" ⇒ "Number of Cells for Device/Label Name"</li> </ul>
	Device	○	<ul style="list-style-type: none"> <li>• "Program Editor" ⇒ "FBD/LD Editor" ⇒ "Element (Ladder Symbol)" ⇒ "Display Format" ⇒ "Display Labels and Devices"</li> </ul>
	Address	×	
	Label Comment	○	<ul style="list-style-type: none"> <li>• "Program Editor" ⇒ "FBD/LD Editor" ⇒ "Comment" ⇒ "Display Item" ⇒ "Display Label/Device Comment"</li> </ul>
	Device Comment	○	
	Declare new label name	○	<ul style="list-style-type: none"> <li>• "Program Editor" ⇒ "FBD/LD Editor" ⇒ "Enter Element" ⇒ "Operational Setting" ⇒ "Open undefined label registration window at element entry"</li> </ul>
FB/FUN	Wrap instance name for function block	○	<ul style="list-style-type: none"> <li>• "Program Editor" ⇒ "FBD/LD Editor" ⇒ "FB/FUN" ⇒ "Display Format" ⇒ "Number of Wrapping Rows for Instance Name"</li> </ul>
	Specify the number of enable characters for label name/comment	×	
	Automatic input/output labels	×	
	Automatic ENO labels	×	
	Automatically Add Output Variable to VAR_IN_OUT	×	
	Pin overwrites	×	
	Double clicking opens header	○	<ul style="list-style-type: none"> <li>• "Program Editor" ⇒ "FBD/LD Editor" ⇒ "FB/FUN" ⇒ "Operational Setting" ⇒ "Operation on Double-clicking"</li> </ul>
	Double clicking opens body	○	
Guided	Ladder Wrapping	×	
	Return Contacts	×	
	Open Structured Ladder/FBD Editor in guided mode	×	
	Allow hotkey repeater	×	
	Enter label names after contacts and coils	×	
	Auto Comment Block Width	×	

## ■ST

○: Similar setting supported, ×: Similar setting not supported

GX Works2	GX Works3	
	Supported or not	Similar setting
Auto Indention	○	<ul style="list-style-type: none"> <li>• "Program Editor" ⇨ "ST Editor" ⇨ "Edit Operation" ⇨ "Automatic Indention"</li> </ul>
Instruction/label name prediction	○	<ul style="list-style-type: none"> <li>• "Edit" ⇨ "Instruction/Device/Label Candidacy Display" ⇨ "Operational Setting" ⇨ "Instruction/Device/Label name Prediction"</li> </ul> The setting is applied to all program editors.
Tabulator Length	○	<ul style="list-style-type: none"> <li>• "Program Editor" ⇨ "ST Editor" ⇨ "Edit Operation" ⇨ "Tabulator Length"</li> </ul>



## ■Ladder/SFC

○: Similar setting supported, ×: Similar setting not supported

GX Works2		GX Works3	
		Supported or not	Similar setting
Enter ladder	Check duplicated coil	○	• "Program Editor" ⇒ "Ladder Editor" ⇒ "Enter ladder" ⇒ "Operational Setting" ⇒ "Check Duplicated Coil"
	Enter label comment and device comment	○	• "Program Editor" ⇒ "Ladder Editor" ⇒ "Enter ladder" ⇒ "Operational Setting" ⇒ "Enter label comment and device comment"
	Do not leave the Device/Label Comment field editing status	×	
	Do not display note in ladder input window when edit coil instructions	○	• "Program Editor" ⇒ "Ladder Editor" ⇒ "Enter ladder" ⇒ "Operational Setting" ⇒ "Display Note in Ladder Input Window When Editing Coil Instructions"
	Check special relay/special register compatible with A-PLC	×	
	Display available instruction tool hints in entering instruction	○	• "Program Editor" ⇒ "Ladder Editor" ⇒ "Enter ladder" ⇒ "Display Setting" ⇒ "Display tool hint of instruction when entering instruction"
	Display available instructions in entering instruction	○	• "Edit" ⇒ "Instruction/Device/Label Candidacy Display" ⇒ "Operational Setting" ⇒ "Instruction/Device/Label name Prediction"
	Display available labels in entering instruction	○	• "Edit" ⇒ "Instruction/Device/Label Candidacy Display" ⇒ "Operational Setting" ⇒ "Instruction/Device/Label name Prediction" • "Edit" ⇒ "Instruction/Device/Label Candidacy Display" ⇒ "Candidate Display Setting" ⇒ "Display Local Labels" • "Edit" ⇒ "Instruction/Device/Label Candidacy Display" ⇒ "Candidate Display Setting" ⇒ "Display Global Labels"
Tool Hint	Monitored Value	○	• "Program Editor" ⇒ "Ladder Editor" ⇒ "Tool Hint" ⇒ "Display Item in Tool Hint"
	Class	○	
	Device	○	
	Device Comment	○	
	Data Type	○	
	Constant Value	○	
	Label Comment	○	
	Remark	×	
	Tool Hint Display Format	○	• "Program Editor" ⇒ "Ladder Editor" ⇒ "Tool Hint" ⇒ "Display in Multiline"

## ■Ladder

○: Similar setting supported, ×: Similar setting not supported

GX Works2		GX Works3	
		Supported or not	Similar setting
Comment	Device Comment	○	• "Program Editor" ⇨ "Ladder Editor" ⇨ "Comment" ⇨ "Display Items"
	Statement	○	
	Note	○	
	Device Comment Display Format	○	• "Program Editor" ⇨ "Ladder Editor" ⇨ "Comment" ⇨ "Display Format"
	Copy device comment in copying ladder	○	• "Program Editor" ⇨ "Ladder Editor" ⇨ "Comment" ⇨ "Operational Setting" ⇨ "Copy Device Comment in Copying Ladder"
Ladder Diagram	Display Connection of Ladder Diagram	○	• "Program Editor" ⇨ "Ladder Editor" ⇨ "Ladder Diagram" ⇨ "Display Format" ⇨ "Display Connection of Ladder Diagram"
	Use the Switching Ladder Edit Mode (Read, Write, Monitor, Monitor (Write))	○	• "Program Editor" ⇨ "Ladder Editor" ⇨ "Ladder Diagram" ⇨ "Edit Operation" ⇨ "Use the Switching Ladder Edit Mode (Read, Write, Monitor, Monitor (Write))"
	Display labels and devices	○	• "Program Editor" ⇨ "Ladder Editor" ⇨ "Ladder Diagram" ⇨ "Display Format" ⇨ "Display labels and devices"
	Display STL instruction in contact format.	×	
	Display Instruction Help at symbol error occurrence	○	• "Program Editor" ⇨ "Ladder Editor" ⇨ "Enter Ladder" ⇨ "Operational Setting" ⇨ "Display Help ladder input window when symbol errors occur"
	Open Undefined Label Registration dialog at ladder entry	○	• "Program Editor" ⇨ "Ladder Editor" ⇨ "Enter Ladder" ⇨ "Operational Setting" ⇨ "Open Undefined Label Registration Window at Ladder Entry"
	Set initial value to '1' for Enter HLine/Delete HLine dialog	○	• "Program Editor" ⇨ "Ladder Editor" ⇨ "Ladder Diagram" ⇨ "Edit Operation" ⇨ "Set initial value to '1' for Enter HLine/Delete HLine dialog"
Stop at the connection points (Instruction/Vertical Line) when enter or delete horizontal line	○	• "Program Editor" ⇨ "Ladder Editor" ⇨ "Ladder Diagram" ⇨ "Edit Operation" ⇨ "Stop at the connection points (Instruction/Vertical Line) when enter or delete horizontal line"	

## ■SFC

○: Similar setting supported, ×: Similar setting not supported

GX Works2		GX Works3	
		Supported or not	Similar setting
Comment	Block List	○	• "Program Editor" ⇔ "SFC Diagram Editor" ⇔ "Blocklist" ⇔ "Comment Display Items" ⇔ "Display Label/Device Comment"
	Step/Transition	○	• "Program Editor" ⇔ "SFC Diagram Editor" ⇔ "Comment" ⇔ "Display Item" ⇔ "Display Label/Device Comment"
SFC 1	SFC Edit Area	×	
	Tile SFC and Zoom vertically	Arrange	×
		SFC Display Window Ratio	×
	MELSAP-L Label/Device Display Format	×	
Jump to start destination block	×		
SFC 2	Leave comment or step No. selected	×	
Zoom	Open Zoom with New Window	○	• "Program Editor" ⇔ "SFC Diagram Editor" ⇔ "Action/Transition" ⇔ "Display Format" ⇔ "Window Display Method"
	Number of Action/Transition Contacts	○	• "Program Editor" ⇔ "Ladder Editor" ⇔ "Ladder Diagram" ⇔ "Display Format" ⇔ "Display Connection of Ladder Diagram"

## Device Comment Editor

○: Similar setting supported, ×: Similar setting not supported

GX Works2	GX Works3	
	Supported or not	Similar setting
Number of Device Comment Edit/Display Characters	○	<ul style="list-style-type: none"> <li>"Other Editor" ⇒ "Device Comment Editor" ⇒ "Number of Editing/Displaying Characters" ⇒ "Number of Device Comment Editing/Displaying Characters"</li> </ul>
Extended setting	×	
Execute the operation including the hidden bit specification information	×	

## Device Memory Editor

○: Similar setting supported, ×: Similar setting not supported

GX Works2	GX Works3	
	Supported or not	
Always Confirm	×	
Auto	×	
Specify the number of column	×	

## Label Setting Editor

○: Similar setting supported, ×: Similar setting not supported

GX Works2	GX Works3	
	Supported or not	Similar setting
Automatic copy and increment when inserting a row	○	<ul style="list-style-type: none"> <li>"Other Editor" ⇒ "Label Editor Common" ⇒ "Editor Setting" ⇒ "Automatic Copy and Increment in Inserting a Row"</li> </ul>
Copy data type/comment items	○	<ul style="list-style-type: none"> <li>"Other Editor" ⇒ "Label Editor Common" ⇒ "Editor Setting" ⇒ "Automatic Copy and Increment in Inserting a Row" ⇒ "Copy Data Type/Comment Items"</li> </ul>
Default Length of String Data Type	○	<ul style="list-style-type: none"> <li>"Other Editor" ⇒ "Label Editor Common" ⇒ "Data Type Setting" ⇒ "Data Length of Character String Data Type"</li> </ul>
Display last blank row	○	<ul style="list-style-type: none"> <li>"Other Editor" ⇒ "Label Editor Common" ⇒ "Display Setting" ⇒ "Display Last Blank Row"</li> </ul>

## Parameter



○: Similar setting supported, ×: Similar setting not supported

GX Works2	GX Works3	
	Supported or not	
Use user defined parameter	○	
Display number of columns for CC-Link list setting	×	
Display number of rows for CC-Link station information	×	

## Monitor

### ■Common

○: Similar setting supported, ×: Similar setting not supported

GX Works2	GX Works3	
	Supported or not	
Disable Current Value Changing by Pressing the  +  keys	×	
Start monitoring if converted or compiled program is opened during monitoring	×	

### ■Structured Ladder/FBD/ST

○: Similar setting supported, ×: Similar setting not supported

GX Works2	GX Works3	
	Supported or not	Similar setting
Display Format of Monitoring Value	○	<ul style="list-style-type: none"> <li>"Monitor" ⇒ "ST Editor" ⇒ "Display Setting" ⇒ "Display Format of Monitoring Value"</li> <li>"Monitor" ⇒ "FBD/LD Editor" ⇒ "Display Setting" ⇒ "Display Format of Monitoring Value"</li> </ul>
Monitor buffer memory and link direct device	○	<ul style="list-style-type: none"> <li>"Monitor" ⇒ "ST Editor" ⇒ "Operational Setting" ⇒ "Monitor Buffer Memory and Link Memory"</li> <li>"Monitor" ⇒ "FBD/LD Editor" ⇒ "Operational Setting" ⇒ "Monitor Buffer Memory and Link Memory"</li> </ul>
Significant Characters	○	<ul style="list-style-type: none"> <li>"Monitor" ⇒ "ST Editor" ⇒ "Character String Monitoring Setting" ⇒ "Numbers of Characters to Display"</li> <li>"Monitor" ⇒ "FBD/LD Editor" ⇒ "Character String Monitoring Setting" ⇒ "Numbers of Characters to Display"</li> <li>"Monitor" ⇒ "SFC Diagram Editor" ⇒ "Character String Monitoring Setting" ⇒ "Numbers of Characters to Display"</li> </ul>
Verify with PLC setting before starting monitoring	×	

A

## ■Ladder/SFC

○: Similar setting supported, ×: Similar setting not supported

GX Works2	GX Works3	
	Supported or not	Similar setting
Set automatic registration destination	○	<ul style="list-style-type: none"> <li>• "Monitor" ⇒ "Ladder Editor" ⇒ "Setting for Automatic Registration to Watch Window" ⇒ "Set Automatic Registration Destination"</li> <li>• "Monitor" ⇒ "SFC Diagram Editor" ⇒ "Setting for Automatic Registration to Watch Window" ⇒ "Set Automatic Registration Destination"</li> </ul>

## ■Ladder

○: Similar setting supported, ×: Similar setting not supported

GX Works2	GX Works3	
	Supported or not	Similar setting
Display Format of Monitoring Value	○	• "Monitor" ⇒ "Ladder Editor" ⇒ "Display Setting" ⇒ "Display Format of Monitoring Value"
Monitor buffer memory and link direct device	○	• "Monitor" ⇒ "Ladder Editor" ⇒ "Operational Setting" ⇒ "Monitor Buffer Memory and Link Memory"
FXGP format Ladder monitor	×	
Display monitored value by device/label name of contact/coil instruction	○	• "Monitor" ⇒ "Ladder Editor" ⇒ "Operational Setting" ⇒ "Display Monitored Value by Device/Label Name of Contact/Coil Instruction"
Display Lines for Monitoring Current Value	○	• "Monitor" ⇒ "Ladder Editor" ⇒ "Display Setting" ⇒ "Display Lines for Monitoring Current Value"

## ■SFC

○: Similar setting supported, ×: Similar setting not supported

GX Works2	GX Works3	
	Supported or not	Similar setting
Watch Step Not Transferring within Watching Time	×	
Program/Program File Name	×	
Target All Blocks	×	
Specify the Block	×	Detail Setting
Stop Transition Watch Monitor when Detected	×	
Monitor block start with new window	○	• "Monitor" ⇒ "SFC Diagram Editor" ⇒ "Auto-scroll Monitor Setting" ⇒ "Monitor the Block Start in a New Window"

## PLC Read/Write

○: Similar setting supported, ×: Similar setting not supported

GX Works2	GX Works3	
	Supported or not	Similar setting
Keep last file selection for PLC read/write dialog	○	• "Online" ⇒ "Write to PLC" ⇒ "Operational Setting" ⇒ "Store file selection status in writing to PLC."
Turn PLC to STOP at time of PLC write after executing Rebuild All and do not execute remote RUN	×	
Clear the device ranges set in the Device/Label Automatic-Assign setting to 0 at time of PLC write after a Rebuild All operation	×	
Check the password in reading/writing/verifying/deleting PLC	×	
Check program cache memory when writing to PLC	×	
Merge device comment with the project data at time of PLC read	×	
Show a completion message if the PLC read/write window is automatically closed	○	• "Online" ⇒ "Write to PLC" ⇒ "Operational Setting" ⇒ "Show a completion message when the window is automatically closed in executing"
Show the confirmation message in executing Write to PLC	○	• "Online" ⇒ "Write to PLC" ⇒ "Operational Setting" ⇒ "Show a confirmation message in executing"

## Online Change

○: Similar setting supported, ×: Similar setting not supported

GX Works2	GX Works3	
	Supported or not	Similar setting
Execute fall instruction	×	
Transfer program cache memory to program memory	×	
Execute online change based on relative step No.	×	
Execute online change by Compile	○	• "Convert" ⇒ "Online Program Change" ⇒ "Operational Setting" ⇒ "Execute Online Program Change in Converting"
Under booting, reflect changes to boot source during online program change	×	• When performing the online program change during the boot operation, select the checkbox of "Reflect Changes to Boot Source."

## Symbolic Information

○: Similar setting supported, ×: Similar setting not supported

GX Works2	GX Works3	
	Supported or not	Similar setting
Setting for Writing Symbolic Information to PLC	×	
Write symbolic information when Online Program Change is executed	×	
In the Write to PLC window, keep the symbolic information selected status as a write target	○	• "Online" ⇒ "Program Restore Information" ⇒ "Operational Setting" ⇒ "Enable the setting to write/not to write program restore information"
Setting for Save Destination of Symbolic Information to PLC	×	

A

## Save Destination of Device Comment

○: Similar setting supported, ×: Similar setting not supported

GX Works2	GX Works3	
	Supported or not	
Set save destination of device comment to the target memory of PLC data	×	
Save Destination of Device Comment	×	

## Compile

### ■Basic Setting

○: Similar setting supported, ×: Similar setting not supported

GX Works2	GX Works3	
	Supported or not	Similar setting
Enable calling function block and using inline ST	×	
Do not execute duplicated coil check, ladder check and consistency (pair) check after Build or Online Program Change	○	• "Convert" ⇨ "Basic Setting" ⇨ "Program Check" ⇨ "Execute Program Check after Build or Online Program Change"
Do not target the SET instruction for duplicated coil check	○	• "Convert" ⇨ "Basic Setting" ⇨ "Program Check" ⇨ "Target the SET instruction for duplicated coil check"
Use the same label name in global label and local label	○	• "Convert" ⇨ "Basic Setting" ⇨ "Operational Setting" ⇨ "Use the Same Label Name in Global Label and Local Label"
Create cross reference information after completion compile.	×	

### ■Output Result

○: Similar setting supported, ×: Similar setting not supported

GX Works2	GX Works3	
	Supported or not	Similar setting
Stop Build by	○	• "Convert" ⇨ "Output Result" ⇨ "Cancel Conversion" ⇨ "Number of Conversions to Cancel"
Disable Warning and Notification Message	×	Display the Use Status Notification of Automatic-Assign Device in Output Result

### ■Ladder/SFC

○: Similar setting supported, ×: Similar setting not supported

GX Works2	GX Works3	
	Supported or not	
Compile Condition	×	
	Make sure that the instruction is not used beyond the device range assigned by the label	



## ■ Structured Ladder/FBD/ST

○: Similar setting supported, ×: Similar setting not supported

GX Works2		GX Works3
		Supported or not
Compile Condition 1	Use lower-case device names as labels	×
	Function Output Setting	×
	Allow VAR_OUTPUT at FB call (ST)	×
	Add temporary variables as arguments to use macrocode	×
Compile Condition 2	(D)INT_TO_BOOL_E,(D)WORD_TO_BOOL_E, TIME_TO_BOOL_E(I)	×
	NOT_E	×
	LIMITATION_E,MAXIMUM_E,MINIMUM_E	×
	EQ_E,NE_E,GT_E,GE_E,LT_E,LE_E	×
	AND_E,OR_E, XOR_E	×
	User Defined Function with EN/ENO	×
	User Defined Function Block with EN/ENO	×
Compile Condition 3	Automatically assign each system device to output of functions that use EN/ENO	×

## Intelligent Function Module

### ■QD75/LD75 Type Positioning

○: Similar setting supported, ×: Similar setting not supported

GX Works2	GX Works3	
	Supported or not	
Display Specification of Positioning Data	×	
Confirm PLC operation status when writing a Data	×	
Display a confirmation message when writing to flash ROM	×	

### ■Guidance

○: Similar setting supported, ×: Similar setting not supported

GX Works2	GX Works3	
	Supported or not	
Display intelligent function module guidance	×	

## iQ Works Interaction

○: Similar setting supported, ×: Similar setting not supported

GX Works2	GX Works3	
	Supported or not	
Enable an editing of parameters set in MELSOFT Navigator	×	

## System Label Setting

○: Similar setting supported, ×: Similar setting not supported

GX Works2	GX Works3	
	Supported or not	Similar setting
Use MELSOFT Navigator Option Information	○	• "iQ Works Interaction" ⇔ "System Label Setting" ⇔ "System Label Setting" ⇔ "Use MELSOFT Navigator Option Information"
System Label Name Setting	○	• "iQ Works Interaction" ⇔ "System Label Setting" ⇔ "System Label Setting" ⇔ "Use MELSOFT Navigator Option Information" ⇔ "System Label Name Setting"

## Sampling trace

○: Similar setting supported, ×: Similar setting not supported

GX Works2	GX Works3	
	Supported or not	
Display a message to confirm operation contents at the start of trace	×	
Display a message to confirm discard of the trace result at the start of trace	×	
Display a caution message in saving data as GX LogViewer format CSV file	×	

# MEMO

---

A

# INDEX

---

## B

---

Block password . . . . . 671

## C

---

Calculating memory size . . . . . 432  
Clock . . . . . 758  
Color . . . . . 81  
Comment . . . . . 284  
Common device comment . . . . . 400  
Current value . . . . . 637

## D

---

Data . . . . . 100  
Data Logging . . . . . 730  
Device comment for each program . . . . . 400  
Device memory . . . . . 434

## E

---

Event history . . . . . 723  
Execution count of interrupt program . . . . . 657

## F

---

FB type . . . . . 485  
File password . . . . . 692  
Font . . . . . 81  
Function . . . . . 279,314,504  
Function block . . . . . 272,313,484

## G

---

Global device . . . . . 259

## I

---

I/O assignment setting . . . . . 202  
Initial device value . . . . . 441  
Initialization . . . . . 771  
Inline structured text . . . . . 281,328

## L

---

Latch clear . . . . . 772  
Local device . . . . . 259

## M

---

MC . . . . . 283  
Memory dump . . . . . 726  
Module FB . . . . . 500  
Module label . . . . . 248  
Monitoring . . . . . 613  
Multiple CPU setting . . . . . 202

## N

---

Network configuration . . . . . 208  
NOP . . . . . 289

Note . . . . . 288

## O

---

Offline monitor . . . . . 736

## P

---

Processing time of program . . . . . 655  
Profile . . . . . 186

## R

---

Refresh device . . . . . 211  
Remote operation . . . . . 760  
Remote password . . . . . 699  
RUN/STOP switch . . . . . 760

## S

---

Sample comment . . . . . 409  
Security key authentication . . . . . 673,680  
Shortcut key . . . . . 80  
Simulation environment file . . . . . 545  
Single file format . . . . . 99  
Statement . . . . . 285  
Synchronous setting . . . . . 202  
System monitor . . . . . 702

## T

---

Title . . . . . 136

## U

---

USB driver . . . . . 984  
User authentication . . . . . 683  
User data . . . . . 607

## W

---

Watch . . . . . 637  
Workspace format . . . . . 98

## Z

---

Zero clear . . . . . 771

# MEMO

---

# REVISIONS

\*The manual number is given on the bottom left of the back cover.

Revision date	*Manual number	Description
June 2014	SH(NA)-081215ENG-A	First edition
July 2014	SH(NA)-081215ENG-B	Partial correction
October 2014	SH(NA)-081215ENG-C	<p>■Added or modified parts</p> <p>Section 1.2, Section 2.4, Section 2.8, Section 2.9, Section 3.1, Section 3.2, Section 4.2, Section 4.3, Section 4.4, Section 5.1, Section 5.2, Section 5.4, Section 6.1, Section 6.5, Section 12.3, Chapter 13, Section 13.2, Section 13.4, Section 13.8, Section 15.2, Section 15.3, Section 15.4, Section 16.1, Section 17.3, Appendix 1</p>
January 2015	SH(NA)-081215ENG-D	<p>■Added or modified parts</p> <p>TERMS, Chapter 1, Section 1.1, Section 1.2, Section 1.3, Section 1.4, Section 2.3, Section 2.4, Section 2.9, Section 3.1, Section 3.2, Section 3.3, Section 3.4, Section 3.5, Chapter 4, Section 4.1, Section 4.2, Section 4.3, Section 4.4, Section 5.1, Section 5.2, Section 5.3, Section 5.4, Section 6.3, Section 6.2, Section 6.3, Section 6.4, Section 6.5, Section 6.6, Section 7.1, Section 8.1, Chapter 9, Section 9.1, Section 9.2, Section 9.3, Section 9.4, Section 9.5, Section 9.6, Section 9.7, Chapter 10, Section 10.1, Section 10.2, Chapter 11, Section 11.1, Section 11.2, Section 12.1, Section 12.2, Section 12.3, Section 12.4, Section 12.5, Section 12.6, Section 12.7, Section 13.1, Section 13.3, Section 13.4, Chapter 14, Section 14.1, Section 14.2, Section 14.5, Section 14.6, Section 14.7, Section 14.8, Section 15.3, Section 15.4, Section 15.5, Chapter 16, Section 16.1, Section 16.2, Section 16.3, Section 16.4, Section 18.1, Section 18.2, Section 18.4, Appendix 1, Appendix 3, Appendix 4</p>
April 2015	SH(NA)-081215ENG-E	<p>■Added or modified parts</p> <p>TERMS, Section 2.3, Section 2.4, Section 2.9, Section 3.2, Section 3.3, Section 3.4, Section 3.5, Section 3.6, Section 4.2, Section 4.3, Section 4.4, Section 6.1, Section 6.2, Section 6.3, Section 6.7, Chapter 10, Section 10.1, Section 10.3, Section 10.4, Section 13.2, Section 15.4, Chapter 16, Section 16.2, Section 16.3, Appendix 1, Appendix 4</p>
July 2015	SH(NA)-081215ENG-F	<p>■Added or modified parts</p> <p>TERMS, Section 1.2, Section 1.3, Section 1.4, Section 2.1, Section 2.3, Section 2.4, Section 2.7, Section 2.9, Section 3.1, Section 3.2, Section 3.3, Section 3.4, Section 3.5, Section 3.6, Section 3.7, Section 4.1, Section 4.2, Section 4.3, Section 5.1, Section 5.2, Section 5.4, Section 6.1, Section 6.2, Section 6.3, Section 6.5, Section 6.6, Section 6.8, Section 6.9, Section 6.10, Chapter 9, Section 9.1, Section 9.2, Section 9.3, Section 9.4, Section 9.5, Section 9.6, Section 9.7, Chapter 10, Section 10.1, Section 10.3, Section 10.4, Chapter 11, Section 11.3, Section 12.3, Section 13.1, Section 13.3, Section 13.6, Chapter 14, Section 14.1, Section 14.2, Section 14.3, Section 14.4, Section 14.9, Chapter 15, Section 15.3, Section 15.4, Section 15.5, Section 15.6, Section 15.7, Section 16.2, Section 16.4, Chapter 18, Section 18.3, Section 18.5, Appendix 1, Appendix 2, Appendix 3, Appendix 4, Appendix 5</p>
January 2016	SH(NA)-081215ENG-G	<p>■Added or modified parts</p> <p>TERMS, Section 2.2, Section 2.3, Section 2.4, Section 2.9, Section 3.2, Section 3.3, Section 3.5, Section 4.1, Section 4.2, Section 4.3, Section 4.5, Section 5.2, Section 6.1, Section 6.3, Section 6.4, Section 6.5, Section 6.6, Section 6.7, Section 6.8, Section 6.9, Section 6.10, Chapter 9, Section 9.5, Section 10.1, Section 10.2, Section 10.3, Section 10.4, Section 11.1, Section 11.2, Section 11.3, Section 11.4, Section 12.1, Section 12.2, Section 13.1, Section 13.3, Section 13.6, Section 14.2, Section 14.3, Section 14.9, Section 18.1, Appendix 1, Appendix 2, Appendix 4, Appendix 5, Appendix 6, Appendix 7</p>
February 2016	SH(NA)-081215ENG-H	<p>■Added or modified parts</p> <p>Section 2.3, Section 2.4, Section 3.2, Section 3.5, Section 6.5, Section 6.8, Section 6.9, Section 13.1, Section 13.3, Section 15.5, Appendix 1, Appendix 7</p>
May 2016	SH(NA)-081215ENG-I	<p>■Added or modified parts</p> <p>TERMS, Section 1.2, Section 1.3, Section 1.4, Section 1.5, Section 1.6, Section 1.8, Section 2.1, Section 2.2, Section 2.3, Section 2.4, Section 2.6, Section 3.1, Section 3.2, Section 3.3, Section 3.4, Section 3.5, Section 3.6, Section 4.1, Section 4.2, Section 4.4, Section 5.1, Section 5.2, Section 5.3, Chapter 6, Section 6.2, Section 6.3, Section 6.7, Section 6.8, Section 6.9, Section 6.10, Section 7.3, Section 8.1, Chapter 9, Section 9.1, Section 9.5, Section 9.6, Section 9.7, Chapter 10, Section 10.1, Section 10.3, Section 10.4, Section 11.3, Section 11.4, Section 12.1, Section 12.2, Section 12.3, Section 12.6, Section 12.7, Section 12.8, Section 13.1, Section 13.2, Section 13.3, Section 13.4, Section 13.6, Section 14.1, Section 14.2, Section 14.3, Section 14.4, Section 14.5, Section 14.6, Section 14.8, Section 14.9, Chapter 15, Section 15.3, Section 15.5, Section 16.1, Section 16.2, Section 16.3, Chapter 18, Section 18.1, Section 18.2, Section 18.3, Section 18.4, Section 18.6, Appendix 1, Appendix 3, Appendix 4, Appendix 5, Appendix 7, Appendix 8</p>

Revision date	*Manual number	Description
October 2016	SH(NA)-081215ENG-J	<p>■Added or modified parts</p> <p>TERMS, Section 2.4, Section 2.5, Section 2.8, Section 2.9, Section 3.1, Section 3.2, Section 3.5, Section 4.1, Section 4.2, Section 5.2, Section 6.3, Section 6.5, Section 6.6, Section 6.7, Section 6.9, Section 6.10, Section 7.2, Section 7.3, Chapter 9, Section 9.1, Section 9.3, Section 9.6, Section 11.1, Section 11.2, Section 11.3, Section 11.4, Section 12.1, Section 12.2, Section 12.6, Section 13.1, Section 13.2, Section 13.3, Section 13.6, Section 14.1, Section 14.2, Section 14.4, Section 14.5, Section 14.8, Section 14.10, Section 15.6, Section 16.1, Section 16.3, Section 16.4, Chapter 17, Section 17.1, Appendix 1, Appendix 2, Appendix 4, Appendix 5, Appendix 7, Appendix 8</p>
January 2017	SH(NA)-081215ENG-K	<p>■Added or modified parts</p> <p>TERMS, Section 1.2, Section 1.7, Section 1.8, Section 2.4, Section 2.8, Section 2.9, Section 3.1, Section 3.2, Section 3.4, Section 3.5, Section 5.4, Section 6.1, Section 6.2, Section 6.3, Section 6.5, Section 6.6, Section 6.7, Section 6.8, Section 6.9, Section 7.1, Chapter 10, Section 10.1, Section 13.1, Section 13.3, Chapter 14, Section 14.1, Section 14.2, Section 14.11, Section 16.2, Section 16.4, Section 18.4, Appendix 1, Appendix 4, Appendix 5, Appendix 7</p>
February 2017	SH(NA)-081215ENG-L	<p>■Added or modified parts</p> <p>Section 3.6, Section 5.4</p>
April 2017	SH(NA)-081215ENG-M	<p>■Added or modified parts</p> <p>Section 1.2, Section 2.4, Section 2.7, Section 2.8, Section 2.9, Section 3.2, Section 3.4, Section 3.5, Section 4.1, Section 4.2, Section 5.2, Section 6.3, Section 6.5, Section 6.7, Section 6.9, Section 9.1, Section 10.1, Section 11.3, Section 12.1, Section 12.2, Section 12.9, Section 13.1, Section 13.2, Section 13.3, Section 13.6, Chapter 14, Section 14.2, Section 14.9, Section 14.10, Section 16.4, Chapter 17, Section 17.1, Section 17.2, Section 17.3, Section 18.4, Appendix 1, Appendix 4, Appendix 5, Appendix 7, Appendix 9</p>
July 2017	SH(NA)-081215ENG-N	<p>■Added or modified parts</p> <p>Section 1.2, Section 3.3, Section 3.5, Section 6.9, Section 10.1, Section 13.2, Appendix 1, Appendix 4</p>
October 2017	SH(NA)-081215ENG-O	<p>■Added or modified parts</p> <p>TERMS, Section 1.2, Section 1.3, Section 1.4, Section 1.7, Section 1.8, Section 2.3, Section 2.4, Section 2.7, Section 2.8, Section 2.9, Section 3.1, Section 3.2, Section 3.4, Section 3.5, Section 3.6, Chapter 4, Section 4.1, Section 4.2, Section 4.3, Section 4.4, Section 5.1, Section 5.2, Section 5.3, Section 5.4, Section 5.5, Section 6.2, Section 6.3, Section 6.4, Section 6.5, Section 6.6, Section 6.7, Section 6.8, Section 6.9, Section 6.10, Section 7.2, Section 7.3, Section 8.2, Section 8.3, Chapter 9, Section 9.1, Section 9.6, Section 9.7, Chapter 10, Section 10.1, Section 10.2, Section 10.3, Section 10.4, Section 11.1, Section 11.3, Section 12.1, Section 12.8, Section 13.1, Section 13.2, Section 13.3, Section 13.4, Section 13.6, Chapter 14, Section 14.1, Section 14.2, Section 14.3, Section 14.4, Section 14.5, Section 14.6, Section 14.8, Section 14.10, Chapter 15, Section 15.1, Section 15.2, Section 15.3, Section 15.4, Section 15.5, Section 15.6, Section 15.7, Section 16.1, Section 16.2, Section 16.3, Section 16.4, Section 16.5, Section 17.1, Section 17.2, Section 17.3, Chapter 18, Section 18.1, Section 18.2, Section 18.3, Section 18.4, Section 18.6, Appendix 1, Appendix 2, Appendix 3, Appendix 4, Appendix 5, Appendix 7, Appendix 10, Appendix 11</p>
April 2018	SH(NA)-081215ENG-P	<p>■Added or modified parts</p> <p>Section 1.2, Section 1.7, Section 2.3, Section 2.4, Section 2.8, Section 3.2, Section 3.5, Section 3.7, Chapter 4, Section 4.1, Section 4.2, Section 4.6, Section 5.1, Section 5.2, Section 6.3, Section 6.4, Section 6.5, Section 6.9, Section 6.10, Section 7.2, Chapter 9, Section 9.1, Section 9.3, Section 9.4, Section 9.5, Section 9.6, Section 9.7, Section 10.1, Section 10.3, Section 11.2, Section 11.3, Section 11.4, Section 12.1, Section 12.7, Section 12.10, Section 13.1, Section 13.2, Section 13.3, Chapter 14, Section 14.2, Section 14.3, Section 14.4, Section 14.5, Section 14.6, Section 14.9, Section 14.11, Section 15.3, Section 15.4, Section 15.5, Chapter 16, Section 16.1, Section 16.2, Section 16.4, Section 17.3, Appendix 1, Appendix 2, Appendix 4, Appendix 5, Appendix 7, Appendix 11</p>
July 2018	SH(NA)-081215ENG-Q	<p>■Added or modified parts</p> <p>Section 2.4, Section 5.2, Section 6.3, Section 6.7, Section 6.9, Section 7.2, Section 9.1, Section 9.2, Section 9.3, Section 9.4, Section 9.6, Section 10.1, Section 11.1, Section 11.3, Section 13.3, Chapter 14, Section 14.1, Section 14.2, Section 14.4, Section 14.6, Appendix 1, Appendix 4, Appendix 5, Appendix 7, Appendix 11</p>
October 2018	SH(NA)-081215ENG-R	<p>■Added or modified parts</p> <p>Section 1.3, Section 2.3, Section 2.4, Section 2.8, Section 2.9, Section 3.2, Section 3.3, Section 3.5, Section 4.2, Section 4.6, Section 5.4, Section 6.3, Section 6.4, Section 6.5, Section 6.6, Section 6.7, Section 6.10, Section 9.6, Section 10.3, Section 11.3, Section 12.6, Section 13.1, Section 13.6, Section 14.2, Section 14.5, Section 14.12, Chapter 15, Section 15.4, Section 15.5, Section 15.6, Section 16.4, Appendix 1, Appendix 4, Appendix 5, Appendix 11</p>
December 2018	SH(NA)-081215ENG-S	<p>■Added or modified parts</p> <p>Section 1.2, Section 2.8, Section 3.5, Section 13.2, Section 16.4, Appendix 1, Appendix 4</p>

Revision date	*Manual number	Description
April 2019	SH(NA)-081215ENG-T	<p>■Added or modified parts</p> <p>Section 1.2, Section 1.7, Section 2.2, Section 2.4, Section 2.7, Section 2.8, Section 3.2, Section 3.3, Section 3.4, Section 3.5, Section 4.2, Section 4.3, Section 4.6, Section 5.2, Section 6.2, Section 6.3, Section 6.4, Section 6.5, Section 6.6, Section 6.7, Section 6.9, Section 6.10, Section 7.4, Chapter 9, Section 9.1, Section 9.4, Section 9.5, Section 9.6, Section 10.3, Section 12.1, Section 12.2, Section 12.3, Section 12.4, Section 12.7, Section 12.8, Section 13.1, Section 13.2, Section 13.3, Section 14, Section 14.2, Section 14.4, Section 14.6, Section 14.12, Section 15.7, Section 16.2, Section 16.4, Appendix 1, Appendix 3, Appendix 4, Appendix 5, Appendix 7, Appendix 8, Appendix 9, Appendix 11</p>
June 2019	SH(NA)-081215ENG-U	<p>■Added or modified parts</p> <p>Section 2.4, Section 4.3, Appendix 1</p>
July 2019	SH(NA)-081215ENG-V	<p>■Added or modified parts</p> <p>Section 2.4, Section 2.7, Section 3.5, Section 3.7, Section 5.2, Section 6.3, Section 6.4, Section 6.5, Section 6.6, Section 6.7, Section 6.8, Section 6.9, Section 6.10, Section 9.1, Section 9.4, Section 9.5, Section 10.3, Section 14.1, Section 14.4, Section 16.3, Section 17.3, Appendix 1, Appendix 5, Appendix 11</p>
October 2019	SH(NA)-081215ENG-W	<p>■Added or modified parts</p> <p>TERMS, Chapter 1, Section 1.2, Section 1.9, Section 2.3, Section 2.4, Section 2.9, Section 3.1, Section 3.2, Section 3.3, Section 3.4, Section 3.5, Section 3.6, Chapter 4, Section 4.1, Section 4.2, Section 4.3, Section 5.3, Section 5.5, Section 6.3, Section 6.4, Section 6.5, Section 6.6, Section 6.7, Section 6.10, Section 6.11, Section 7.5, Section 9.6, Section 11.1, Section 11.3, Section 12.1, Section 12.2, Section 12.3, Section 12.4, Section 12.5, Section 12.6, Section 12.7, Section 12.8, Section 12.9, Section 12.10, Section 13.1, Section 13.3, Section 13.4, Section 13.6, Chapter 14, Section 14.2, Section 14.4, Section 14.5, Section 14.6, Section 14.12, Section 14.13, Section 15.3, Section 15.5, Section 16.1, Section 16.3, Section 16.4, Section 16.5, Section 17.1, Section 17.2, Chapter 18, Section 18.7, Appendix 1, Appendix 3, Appendix 4, Appendix 5, Appendix 7, Appendix 11</p>
November 2019	SH(NA)-081215ENG-X	Partial correction
December 2019	SH(NA)-081215ENG-Y	<p>■Added or modified part</p> <p>Appendix 1</p>
February 2020	SH(NA)-081215ENG-Z	<p>■Added or modified parts</p> <p>Section 3.2, Section 12.1, Section 12.7, Section 12.8, Section 14.1, Section 16.4, Appendix 1</p>
June 2020	SH(NA)-081215ENG-AA	<p>■Added or modified parts</p> <p>SAFETY PRECAUTIONS, TERMS, Section 1.2, Section 2.1, Section 2.4, Section 2.9, Section 3.1, Section 3.2, Section 3.3, Section 3.5, Section 3.7, Section 4.2, Section 4.6, Section 5.2, Section 6.3, Section 6.4, Section 6.5, Chapter 9, Section 9.5, Section 9.6, Section 9.8, Section 11.1, Section 11.3, Section 11.4, Section 12.2, Section 13.1, Section 14.2, Section 14.4, Section 16.1, Section 16.3, Section 16.4, Section 16.5, Section 16.6, Chapter 17, Section 17.3, Section 17.4, Section 18.4, Appendix 1, Appendix 2, Appendix 3, Appendix 4, Appendix 5, Appendix 6, Appendix 8, Appendix 9, Appendix 10, Appendix 11, Appendix 12, Appendix 13</p>
October 2020	SH(NA)-081215ENG-AB	<p>■Added or modified parts</p> <p>SAFETY PRECAUTIONS, CONDITIONS OF USE FOR THE PRODUCT, Section 1.2, Section 2.1, Section 2.4, Section 3.3, Section 3.5, Section 3.7, Section 4.1, Section 4.2, Section 5.2, Section 5.4, Section 5.5, Section 6.3, Section 6.4, Section 6.5, Section 6.6, Section 6.7, Chapter 9, Section 9.3, Section 9.8, Section 9.9, Section 10.4, Section 11.2, Section 12.10, Section 13.1, Section 14.2, Section 14.4, Section 14.10, Section 16.1, Section 16.3, Section 17.3, Section 17.4, Section 18.7, Appendix 1, Appendix 2, Appendix 5, Appendix 8, Appendix 9, Appendix 13</p>
January 2021	SH(NA)-081215ENG-AC	<p>■Added or modified parts</p> <p>TERMS, GENERIC TERMS AND ABBREVIATIONS, Section 2.5, Section 2.8, Section 3.5, Section 3.7, Section 4.2, Section 4.3, Section 4.6, Section 5.2, Section 13.1, Section 13.2, Section 16.4, Section 16.5, Chapter 17, Section 17.3, Section 17.4, Section 18.4, Appendix 1, Appendix 2</p>
April 2021	SH(NA)-081215ENG-AD	<p>■Added or modified parts</p> <p>GENERIC TERMS AND ABBREVIATIONS, Section 1.8, Section 2.3, Section 2.4, Section 3.2, Section 3.3, Section 3.4, Section 3.6, Section 4.2, Section 4.3, Section 4.6, Section 5.2, Section 6.3, Section 6.4, Section 6.5, Section 6.6, Section 9.1, Section 9.2, Section 9.6, Section 9.8, Section 10.1, Section 10.3, Section 11.2, Section 11.4, Section 12.2, Section 12.3, Section 13.2, Section 13.3, Section 13.6, Chapter 14, Section 14.1, Section 14.2, Section 14.3, Section 14.4, Section 14.8, Section 16.2, Section 16.5, Section 17.4, Chapter 18, Section 18.4, Section 18.7, Section 18.8, Appendix 1, Appendix 2, Appendix 7, Appendix 9, Appendix 13</p>
July 2021	SH(NA)-081215ENG-AE	<p>■Added or modified parts</p> <p>Section 2.1, Section 10.1, Appendix 1</p>



Revision date	*Manual number	Description
October 2021	SH(NA)-081215ENG-AF	<p>■Added or modified parts</p> <p>GENERIC TERMS AND ABBREVIATIONS, Section 2.3, Section 2.4, Section 2.5, Section 2.10, Section 3.2, Section 3.4, Section 3.6, Section 4.6, Section 5.2, Section 6.1, Section 6.3, Section 6.4, Section 6.5, Section 6.6, Section 6.7, Section 9.1, Section 9.3, Section 9.4, Section 9.5, Section 9.6, Section 9.7, Section 9.8, Section 9.9, Section 10.1, Section 10.3, Section 11.1, Section 11.3, Section 12.6, Section 13.4, Section 14.1, Section 14.2, Section 14.4, Section 14.11, Section 15.2, Section 16.1, Section 16.4, Section 17.4, Appendix 1, Appendix 2, Appendix 4, Appendix 5, Appendix 7, Appendix 9, Appendix 13</p>
January 2022	SH(NA)-081215ENG-AG	<p>■Added or modified parts</p> <p>Section 2.4, Section 3.2, Section 4.2, Section 13.1, Chapter 14, Section 14.1, Section 14.8, Section 15.5, Section 15.7, Section 16.5, Appendix 1, Appendix 2, Appendix 13</p>
April 2022	SH(NA)-081215ENG-AH	<p>■Added or modified parts</p> <p>GENERIC TERMS AND ABBREVIATIONS, Section 2.3, Section 2.4, Section 3.3, Section 4.2, Section 6.3, Section 6.4, Section 6.7, Section 6.9, Section 10.1, Section 14.1, Section 14.4, Appendix 1, Appendix 2, Appendix 9, Appendix 13</p>
July 2022	SH(NA)-081215ENG-AI	<p>■Added or modified parts</p> <p>Section 15.5, Appendix 1</p>
October 2022	SH(NA)-081215ENG-AJ	<p>■Added or modified parts</p> <p>GENERIC TERMS AND ABBREVIATIONS, Section 2.4, Section 3.2, Section 3.3, Section 4.2, Section 4.6, Section 5.2, Section 6.3, Section 6.5, Section 6.6, Section 6.7, Section 6.10, Section 11.4, Section 13.1, Section 14.2, Section 14.3, Section 14.4, Section 16.5, Section 16.6, Section 17.4, Section 18.7, Appendix 1, Appendix 2, Appendix 5, Appendix 9, Appendix 13</p>
April 2023	SH(NA)-081215ENG-AK	<p>■Added or modified parts</p> <p>GENERIC TERMS AND ABBREVIATIONS, Section 2.4, Section 3.2, Section 3.3, Section 3.5, Section 3.7, Section 3.8, Section 4.2, Section 5.2, Section 6.1, Section 6.3, Section 6.6, Section 6.8, Section 6.9, Section 6.10, Section 6.11, Section 9.3, Section 9.7, Section 10.3, Section 11.3, Section 12.2, Section 12.3, Section 13.1, Section 13.3, Section 13.4, Chapter 14, Section 14.1, Section 14.2, Section 14.3, Section 14.4, Section 14.8, Section 14.11, Chapter 15, Section 15.2, Section 15.5, Section 15.8, Section 16.1, Section 16.2, Section 16.5, Section 17.4, Section 18.4, Appendix 1, Appendix 2, Appendix 4, Appendix 5, Appendix 8, Appendix 9, Appendix 13</p>
June 2023	SH(NA)-081215ENG-AL	<p>■Added or modified parts</p> <p>Section 3.3, Section 3.5, Section 3.7, Section 3.8, Section 6.11, Section 10.3, Section 13.1, Chapter 15, Section 15.1, Section 15.2, Section 15.8, Appendix 1, Appendix 2, Appendix 8</p>
October 2023	SH(NA)-081215ENG-AM	<p>■Added or modified parts</p> <p>Section 1.9, Section 2.4, Section 2.10, Section 3.3, Section 4.2, Section 5.2, Section 6.7, Section 6.10, Section 8.3, Section 9.6, Section 9.7, Section 12.6, Section 13.1, Section 13.7, Section 14.4, Section 14.5, Section 14.13, Section 14.14, Chapter 15, Section 16.5, Section 16.6, Section 17.4, Section 18.4, Appendix 1, Appendix 2, Appendix 4, Appendix 13</p>

Japanese manual number: SH-081214-AL

This manual confers no industrial property rights or any rights of any other kind, nor does it confer any patent licenses. Mitsubishi Electric Corporation cannot be held responsible for any problems involving industrial property rights which may occur as a result of using the contents noted in this manual.

© 2014 MITSUBISHI ELECTRIC CORPORATION

# INFORMATION AND SERVICES

---

For further information and services, please contact your local Mitsubishi Electric sales office or representative.  
Visit our website to find our locations worldwide.

MITSUBISHI ELECTRIC Factory Automation Global Website  
Locations Worldwide  
[www.MitsubishiElectric.com/fa/about-us/overseas/](http://www.MitsubishiElectric.com/fa/about-us/overseas/)

## TRADEMARKS

---

Microsoft, Excel, Internet Explorer, Microsoft Edge, Windows, Windows XP, and Windows Vista are trademarks of the Microsoft group of companies.

Android and Google Chrome are either registered trademarks or trademarks of Google LLC.

Safari is a trademark of Apple Inc.

IOS (iOS) is either a registered trademark or a trademark of Cisco Systems, Inc. and/or its affiliates in the United States and certain other countries, and iOS is used under license by Apple Inc.

Subversion is either a registered trademark or a trademark of the Apache Software Foundation in the United States and/or other countries.

TOYOPUC is either a registered trademark or a trademark of JTEKT Corporation.

Simulink is a registered trademark of The MathWorks, Inc.

The company names, system names and product names mentioned in this manual are either registered trademarks or trademarks of their respective companies.

In some cases, trademark symbols such as <sup>™</sup> or <sup>®</sup> are not specified in this manual.

## COPYRIGHTS

---

The screens (screenshots) are used in accordance with the Microsoft Corporation guideline.

FlexGrid for Windows Forms

Copyright © 2002-2010 ComponentOne LLC.

SharpSvn 1.8

Copyright © 2007-2012 The SharpSvn Project

For details, refer to "MELSOFT\GPPW3\Licenses\SharpSvn-License.txt" in the folder in which this product has been installed.

FluentFTP

Copyright © 2015 Robin Rodricks and FluentFTP Contributors

RapidJSON v1.1.0

Copyright © 2015 THL A29 Limited, a Tencent company, and Milo Yip.

For details, refer to "MELSOFT\GPPW3\Licenses\RapidJSON-License.txt" in the folder in which this product has been installed.



SH(NA)-081215ENG-AM(2310)

MODEL:GXW3-O-E

## **mitsubishi electric corporation**

HEAD OFFICE: TOKYO BLDG., 2-7-3, MARUNOUCHI, CHIYODA-KU, TOKYO 100-8310, JAPAN  
NAGOYA WORKS: 1-14, YADA-MINAMI 5-CHOME, HIGASHI-KU, NAGOYA 461-8670, JAPAN

When exported from Japan, this manual does not require application to the  
Ministry of Economy, Trade and Industry for service transaction permission.

Specifications subject to change without notice.