



Programmable Controller

MELSEC iQ-R
series

MELSEC iQ-R File Operation Function Block Reference



SAFETY PRECAUTIONS

(Read these precautions before using this product.)

Before using this product, please read this manual and the relevant manuals carefully and pay full attention to safety to handle the product correctly.

The precautions given in this manual are concerned with this product only. For the safety precautions of the programmable controller system, refer to the MELSEC iQ-R Module Configuration Manual.

In this manual, the safety precautions are classified into two levels: "⚠ WARNING" and "⚠ CAUTION".

 WARNING	Indicates that incorrect handling may cause hazardous conditions, resulting in death or severe injury.
 CAUTION	Indicates that incorrect handling may cause hazardous conditions, resulting in minor or moderate injury or property damage.

Under some circumstances, failure to observe the precautions given under "⚠ CAUTION" may lead to serious consequences.

Observe the precautions of both levels because they are important for personal and system safety.

Make sure that the end users read this manual and then keep the manual in a safe place for future reference.

CONDITIONS OF USE FOR THE PRODUCT

- (1) MELSEC programmable controller ("the PRODUCT") shall be used in conditions;
- i) where any problem, fault or failure occurring in the PRODUCT, if any, shall not lead to any major or serious accident; and
 - ii) where the backup and fail-safe function are systematically or automatically provided outside of the PRODUCT for the case of any problem, fault or failure occurring in the PRODUCT.
- (2) The PRODUCT has been designed and manufactured for the purpose of being used in general industries. MITSUBISHI ELECTRIC SHALL HAVE NO RESPONSIBILITY OR LIABILITY (INCLUDING, BUT NOT LIMITED TO ANY AND ALL RESPONSIBILITY OR LIABILITY BASED ON CONTRACT, WARRANTY, TORT, PRODUCT LIABILITY) FOR ANY INJURY OR DEATH TO PERSONS OR LOSS OR DAMAGE TO PROPERTY CAUSED BY the PRODUCT THAT ARE OPERATED OR USED IN APPLICATION NOT INTENDED OR EXCLUDED BY INSTRUCTIONS, PRECAUTIONS, OR WARNING CONTAINED IN MITSUBISHI ELECTRIC USER'S, INSTRUCTION AND/OR SAFETY MANUALS, TECHNICAL BULLETINS AND GUIDELINES FOR the PRODUCT.
- ("Prohibited Application")
- Prohibited Applications include, but not limited to, the use of the PRODUCT in;
- Nuclear Power Plants and any other power plants operated by Power companies, and/or any other cases in which the public could be affected if any problem or fault occurs in the PRODUCT.
 - Railway companies or Public service purposes, and/or any other cases in which establishment of a special quality assurance system is required by the Purchaser or End User.
 - Aircraft or Aerospace, Medical applications, Train equipment, transport equipment such as Elevator and Escalator, Incineration and Fuel devices, Vehicles, Manned transportation, Equipment for Recreation and Amusement, and Safety devices, handling of Nuclear or Hazardous Materials or Chemicals, Mining and Drilling, and/or other applications where there is a significant risk of injury to the public or property.
- Notwithstanding the above restrictions, Mitsubishi Electric may in its sole discretion, authorize use of the PRODUCT in one or more of the Prohibited Applications, provided that the usage of the PRODUCT is limited only for the specific applications agreed to by Mitsubishi Electric and provided further that no special quality assurance or fail-safe, redundant or other safety features which exceed the general specifications of the PRODUCTS are required. For details, please contact the Mitsubishi Electric representative in your region.
- (3) Mitsubishi Electric shall have no responsibility or liability for any problems involving programmable controller trouble and system trouble caused by DoS attacks, unauthorized access, computer viruses, and other cyberattacks.

INTRODUCTION

Thank you for purchasing the Mitsubishi Electric MELSEC iQ-R series programmable controllers.

Before using the products, please read this manual and the relevant manuals carefully and develop familiarity with the functions and performance of the MELSEC iQ-R series programmable controller to handle the products correctly.

Please make sure that the end users read this manual.

CONTENTS

SAFETY PRECAUTIONS	1
CONDITIONS OF USE FOR THE PRODUCT	2
INTRODUCTION	2
RELEVANT MANUALS	4
TERMS	5
GENERIC TERMS AND ABBREVIATIONS	5
CHAPTER 1 OVERVIEW	6
1.1 FB List	6
1.2 How to Obtain the FB Library	6
1.3 System Configuration	6
CHAPTER 2 DETAILS	8
2.1 M+FileOperation_SaveLoggingCSV_W_R	8
Overview	8
Labels to use	8
FB details	9
Performance value	14
Error code	15
2.2 M+FileOperation_SendLoggingFile_R	16
Overview	16
Labels to use	16
FB details	18
Performance value	22
Error code	24
CHAPTER 3 APPLICATION EXAMPLES	25
3.1 M+FileOperation_SaveLoggingCSV_W_R	25
3.2 M+FileOperation_SendLoggingFile_R	30
APPENDIX	37
Appendix 1 CSV File Output Format	37
INSTRUCTION INDEX	40
REVISIONS	42
WARRANTY	43
TRADEMARKS	44

RELEVANT MANUALS

Manual name [manual number]	Description	Available form
MELSEC iQ-R File Operation Function Block Reference [BCN-P5999-1368] (this manual)	Specifications, functions, input/output labels, and programming of the file operation FBs	e-manual PDF
MELSEC iQ-R Module Configuration Manual [SH-081262ENG]	Common information on the hardware configuration of all modules, overview of each system configuration, and specifications of the power supply module, base unit, SD memory card, and battery.	Print book e-manual PDF
MELSEC iQ-R CPU Module User's Manual (Startup) [SH-081263ENG]	Specifications, procedures before operation, and troubleshooting of the CPU module	Print book e-manual PDF
MELSEC iQ-R CPU Module User's Manual (Application) [SH-081264ENG]	Memory, functions, devices, and parameters of the CPU module	Print book e-manual PDF
MELSEC iQ-R Ethernet User's Manual (Application) [SH-081257ENG]	Functions, parameter settings, programming, troubleshooting, I/O signals, and buffer memory of Ethernet	Print book e-manual PDF
MELSEC iQ-R Programming Manual (CPU Module Instructions, Standard Functions/Function Blocks) [SH-081266ENG]	Instructions for the CPU module and standard functions/function blocks	e-manual PDF
GX Works3 Operating Manual [SH-081215ENG]	System configuration, parameter settings, and online operations of GX Works3	e-manual PDF



e-Manual refers to the Mitsubishi Electric FA electronic book manuals that can be browsed using a dedicated tool.

e-Manual has the following features:

- Required information can be cross-searched in multiple manuals.
- Other manuals can be accessed from the links in the manual.
- The hardware specifications of each part can be found from the product figures.
- Pages that users often browse can be bookmarked.
- Sample programs can be copied to an engineering tool.

TERMS

Unless otherwise specified, this manual uses the following terms.

Term	Description
Buffer memory	Memory in an intelligent function module to store data such as setting values and monitor values. For CPU modules, it refers to memory to store data such as setting values and monitor values of the Ethernet function, or data used for data communication of the multiple CPU system function.
Engineering tool	A tool used for setting up programmable controllers, programming, debugging, and maintenance
Global label	A label that is valid for all the program data when multiple program data are created in the project. There are two types of global label: a module specific label (module label), which is generated automatically by GX Works3, and an optional label, which can be created for any specified device.
Module label	A label that represents one of memory areas (I/O signals and buffer memory areas) specific to each module in a given character string. For the module used, GX Works3 automatically generates this label, which can be used as a global label.

GENERIC TERMS AND ABBREVIATIONS

Unless otherwise specified, this manual uses the following generic terms and abbreviations.

Generic term/abbreviation	Description
FB	Function Block. An FB is used in a sequence program. It consists of individual circuit blocks which are used repeatedly in a sequence program. Using FBs helps to develop programs more efficiently, reduce mistakes, and improve quality of programs.

1 OVERVIEW

FB described in this reference manual indicates the FB library for file operation.

1.1 FB List

The following table lists the FB library in this reference manual.

Name*1	Description
M+FileOperation_SaveLoggingCSV_W_R	Reads the signed word logging data stored in the file register (ZR), such as the analog data of multiple channels, and stores the data in CSV format in an SD memory card.
M+FileOperation_SendLoggingFile_R	Transfers the logging data file to the FTP server by using the file transfer function (FTP client) of the CPU module.

*1 An FB name ends in the FB version information such as "_00A"; however, this reference manual leaves it out.

1.2 How to Obtain the FB Library

For the FB library, please consult your local Mitsubishi representative.

For how to register the FB library, refer to the GX Works3 Operating Manual.

1.3 System Configuration

The following figure shows a system configuration example to use the FB library in this reference manual.

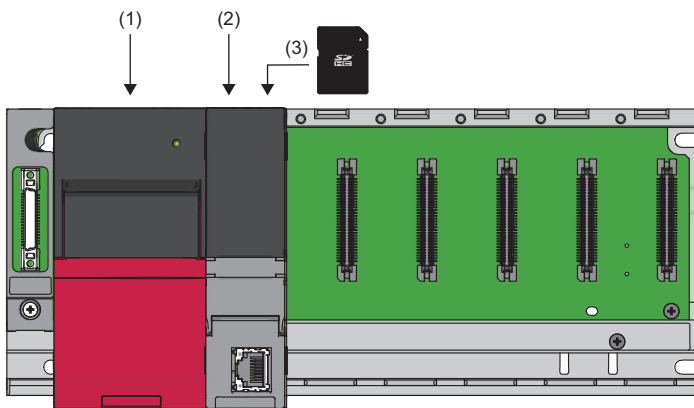

- (1) Power supply module
- (2) CPU module
- (3) SD memory card

For the specifications of the modules, refer to the user's manual for the module used.

2 DETAILS

2.1 M+FileOperation_SaveLoggingCSV_W_R

Overview

This FB reads signed word logging data stored in a file register (ZR), such as analog data of multiple channels, and stores the data in CSV format in an SD memory card.

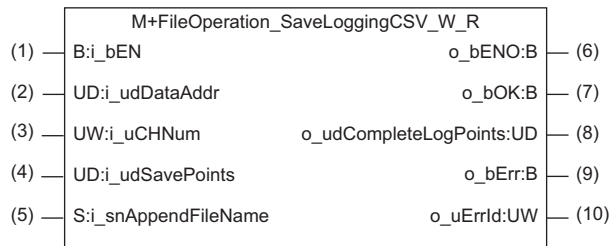

Labels to use

Input label

No.	Variable name	Name	Data type	Scope	Description
(1)	i_bEN	Execution command	Bit	On or off	On: The FB is activated. Off: The FB is not activated.
(2)	i_udDataAddr	Start address of the storage location of logging data	Double word [unsigned]	Valid device range.	Specify the start address of the file register (ZR) where logging data is stored. Store the logging data in signed word format.
(3)	i_uCHNum	Number of channels	Word [unsigned]	1 to 4	Specify the number of channels of the logging data to be stored.
(4)	i_udSavePoints	Number of save points	Double word [unsigned]	1 to 10000000	Specify the number of points of the logging data to be stored.
(5)	i_snAppendFileName	CSV file name	String	1 to 28 characters	Specify a CSV file name. The file extension (.CSV) is automatically added by this FB.

Output label

No.	Variable name	Name	Data type	Initial data	Description
(6)	o_bENO	Execution status	Bit	OFF	On: The execution command is on. Off: The execution command is off.
(7)	o_bOK	Normal completion	Bit	OFF	The on state indicates that the storage of the logging data in an SD memory card is completed.
(8)	o_udCompleteLogPoints	Number of storage completed logging data points	Double word [unsigned]	0	Returns the number of points of the logging data stored in an SD memory card.
(9)	o_bErr	Error completion	Bit	OFF	The on state indicates that an error has occurred in the FB.
(10)	o_uErrId	Error code	Word [unsigned]	0	The error code of an error occurred in the FB is stored.

FB details

Relevant devices

■CPU module

MELSEC iQ-R series programmable controller CPU of firmware version "31" or later

Point

For the CPU modules classified in the programmable controller CPU, refer to the following.



 MELSEC iQ-R Module Configuration Manual

- The R00CPU does not support this FB.
- The R01CPU and R02CPU of firmware version "06" or later support this FB.

■Engineering tool

GX Works3 of version 1.045X or later (When the R01CPU or R02CPU is used: version 1.047Z or later)

Basic specifications

Item	Description
Language to use	ST
Number of steps	1662 The number of steps of the FB embedded in a program depends on the CPU module used, the input/output definitions, and the option settings of GX Works3. For the options setting of GX Works3, refer to the following.  GX Works3 Operating Manual
Label usage	<ul style="list-style-type: none">• Label: 5268 points (word)• Latch label: 0 points (word) The usage of labels embedded in a program depends on the CPU module used, the devices specified as an argument, and the options setting of GX Works3. For the options setting of GX Works3, refer to the following.  GX Works3 Operating Manual
Number of index register used	<ul style="list-style-type: none">• Index register: 0 points• Long index register: 1 point (device number used: LZ0) When using interrupt programs, do not use the corresponding index register in the interrupt programs.
Number of file registers used	Logging data must be stored in the file register. Refer to the following calculation formula and set the file register capacity. File register (ZR) capacity = $i_udDataAddr$ (start address of the storage location of logging data) + (i_uCHNum (number of channels) × $i_udSavePoints$ (number of save points)) For the setting method, refer to the following.  MELSEC iQ-R CPU Module User's Manual (Application)
FB compilation method	Macro type
FB dependence	No dependence
FB operation	Pulse execution type (multiple scan execution type)

Functional description

- When i_bEN (execution command) is turned on, this FB stores the logging data stored in the file register in CSV format in the SD memory card attached to the CPU module sequentially from the specified address of the file register (ZR) specified in i_udDataAddr (start address of the storage location of logging data).

Ex.

The following shows an example of file register and CSV file content.

- i_udDataAddr (start address of the storage location of logging data): K10000
- i_uCHNum (number of channels): K2
- i_udSavePoints (number of save points): K10000

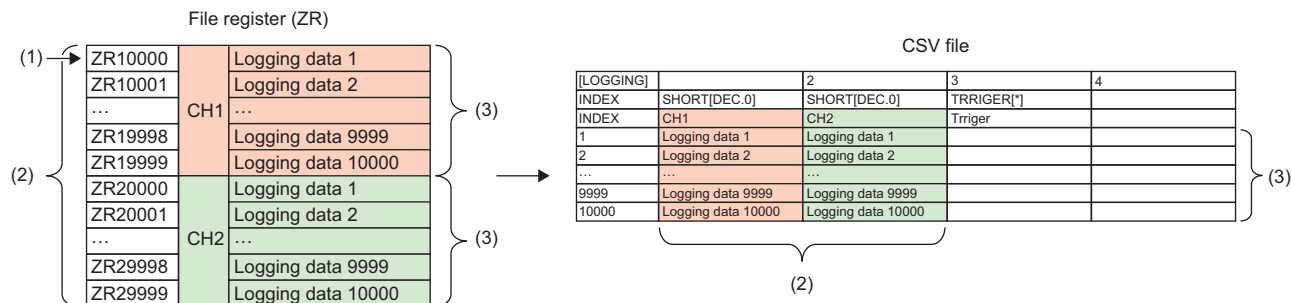

- Logging data is stored in increments of 500 points. When K1300 is specified for i_udSavePoints (number of save points), logging data of 500 points is stored in an SD memory card first. Sequentially, data from 501 points to 1000 points is stored and data from 1001 points to 1300 points is stored.
- Store logging data of each channel sequentially into the file register. Store signed word logging data into the file register.
- For the format of CSV files that this FB creates, refer to CSV File Output Format. (Page 37 CSV File Output Format)

- Logging data can be stored into the file register using M+R60ADH_ReadContinuousLogging of the R60ADH4 and other FBs. When using M+R60ADH_ReadContinuousLogging, set the value as follows. For details on M+R60ADH_ReadContinuousLogging, refer to the following.

📖 MELSEC iQ-R Analog-Digital Converter Module/Digital-Analog Converter Module Function Block Reference

Ex.

The following shows an example when the logging data of two channels is stored in an SD memory card.

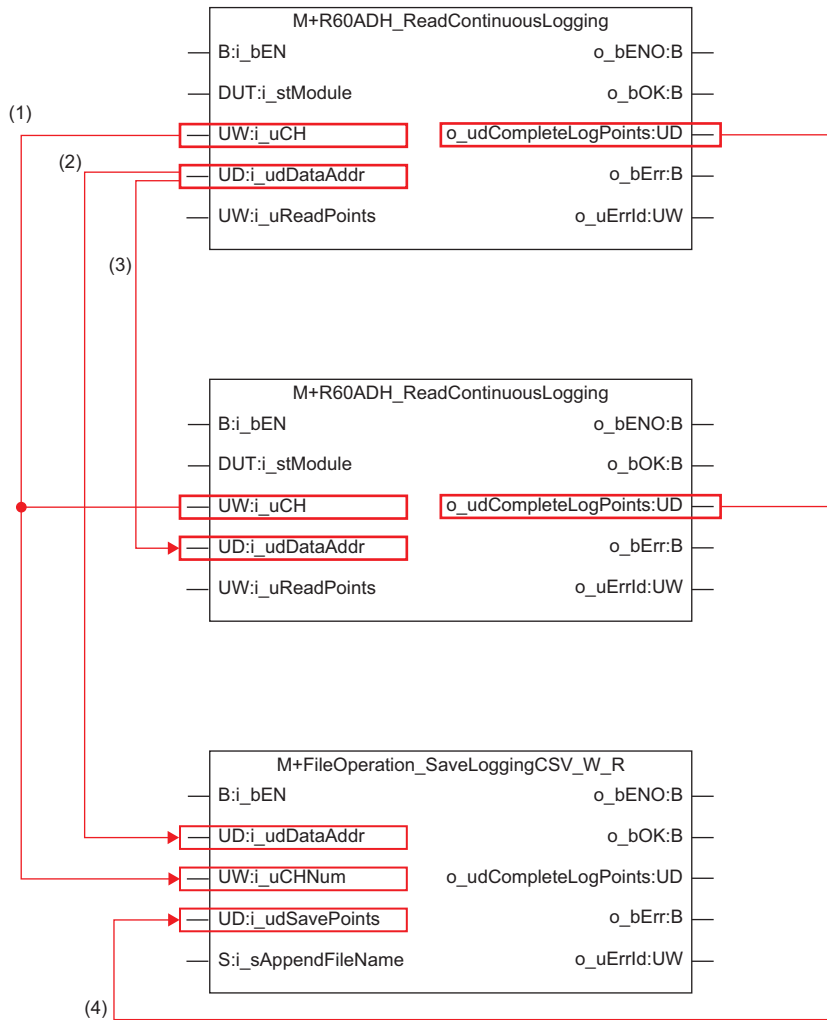

- Specify CH1 for the first FB and CH2 for the second FB as target channels in M+R60ADH_ReadContinuousLogging. Specify 2 for the number of channels in M+FileOperation_SaveLoggingCSV_W_R.
- Specify the start address of the file register (ZR) where the CH1 logging data is stored for the start address of the storage location of logging data in M+FileOperation_SaveLoggingCSV_W_R.
- Specify the consecutive start addresses of the file register for CH1 and CH2 in M+R60ADH_ReadContinuousLogging.
- Specify the number of points of logging data that is read using M+R60ADH_ReadContinuousLogging for the number of save points in M+FileOperation_SaveLoggingCSV_W_R. In this case, check that the number of logging data that has been read from CH1 and CH2 is larger than the specified number of save points.

- When this FB creates a CSV file in an SD memory card, a file of the same name, if already exists in the SD memory card, is replaced with the newly created file.
- If the set value of `i_uCHNum` (number of channels) is out of range, `o_bErr` (error completion) turns on and the processing of the FB is interrupted. In addition, 0100H is stored in `o_uErrId` (error code). (📖 Page 15 Error code)
- If the set value of `i_udSavePoints` (number of save points) is out of range, `o_bErr` (error completion) turns on and the processing of the FB is interrupted. In addition, 0101H is stored in `o_uErrId` (error code). (📖 Page 15 Error code)
- If the character length of the set value of `i_snAppendFileName` (CSV file name) is out of range, `o_bErr` (error completion) turns on and the processing of the FB is interrupted. In addition, 0102H is stored in `o_uErrId` (error code). (📖 Page 15 Error code)
- If the number of points of logging data that is read from the file register exceeds the capacity of the file register (ZR), the processing of the FB is interrupted. In addition, 0200H is stored in `o_uErrId` (error code). (📖 Page 15 Error code)
- If SM606 (SD memory card forced disable instruction) is on when the logging data is stored in a CSV file, the SP.FWRITE instruction is not processed, resulting in the logging data not being stored. In such a case, `o_bErr` (error completion) turns on and the processing of the FB is interrupted. In addition, 0201H is stored in `o_uErrId` (error code). (📖 Page 15 Error code)
- In the event of a CPU error, if the CPU module is in a stop error state, `o_bErr` (error completion) and `o_uErrId` (error code) are not updated. In the event of a CPU error, if the CPU module is in a continuation error state, `o_bErr` (error completion) turns on and the error code is stored in `o_uErrId` (error code). (📖 Page 15 Error code)
- If `i_bEN` (execution command) is turned off while `o_bOK` (normal completion) or `o_bErr` (error completion) is off, `o_bErr` (error completion) turns on in one scan. In addition, 0206H is stored in `o_uErrId` (error code) in one scan. (📖 Page 15 Error code)
- The SP.FWRITE instruction (type 1) is used in this FB. If an error occurs in the SP.FWRITE instruction, `o_bErr` (error completion) turns on and the processing of the FB is interrupted. In addition, the error code for the SP.FWRITE instruction is stored in `o_uErrId` (error code). (📖 Page 15 Error code)
- The SP.FWRITE instruction is used in this FB. If a value that cannot be used by the SP.FWRITE instruction is set for `i_snAppendFileName` (CSV file name), an operation error (3405H) may occur at execution of the FB. For details on the SP.FWRITE instruction, refer to the following.

📖 MELSEC iQ-R Programming Manual (CPU Module Instructions, Standard Functions/Function Blocks)

■ Error completion due to the SD memory card

- A CPU error occurs if this FB is executed when no SD memory card is installed in the CPU module or when the installed SD memory card does not have enough free space. For the capacity of the SD memory card, check the performance specifications of the SD memory card. (📖 MELSEC iQ-R Module Configuration Manual)
- If the number of CSV files exceeds the number of storable files of the SD memory card due to execution of this FB, a CPU error occurs. Check the number of storable files. (📖 MELSEC iQ-R CPU Module User's Manual (Startup))
- The operating status (continue or stop) of the CPU module at the time of the failure of access to the SD memory card can be set with the parameter.

Timing chart of I/O signals

■ When the operation is completed successfully

When 20000 is set to the number of read points

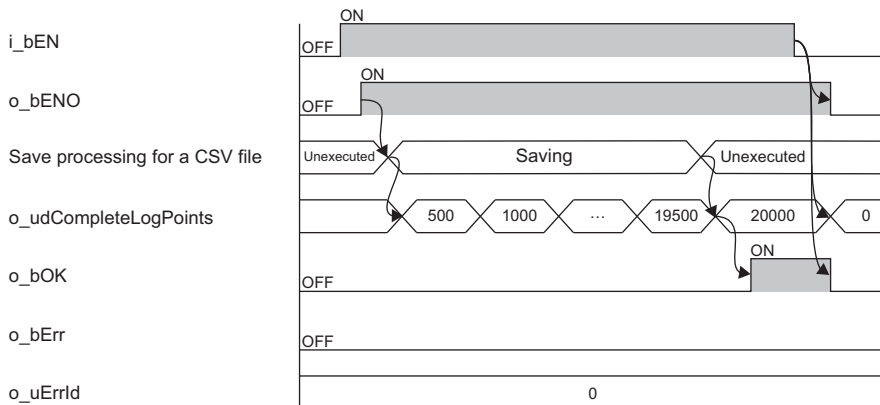

■ When the operation is completed with an error

When an error is detected before a CSV file is stored

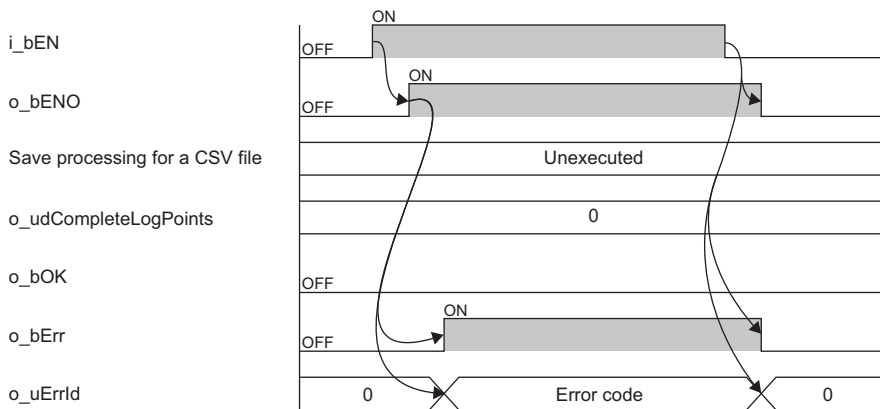

Restrictions and precautions

- This FB does not include the error recovery processing. Prepare the error recovery processing separately to suit the user's system and the expected operation.
- The FB cannot be used in an interrupt program.
- Using the FB in a program that is to be executed only once, such as a program that uses subroutines or the FOR-NEXT instruction, has a problem that i_bEN (execution command) can no longer be turned off and normal operation is not possible; Always use the FB in a program that is capable of turning off i_bEN (execution command).
- The FB requires the configuration of the ladder for every input label.
- To use more than one of this FB, create an interlock to avoid simultaneous execution.
- Change the settings of "Memory/Device Setting" of "CPU Parameter" so that the memory capacity required to use this FB is secured. Otherwise, an error may occur in GX Works3.
- Specify a string (ASCII code or Shift JIS code) for i_snAppendFileName (CSV file name). If anything other than string is specified for i_snAppendFileName (CSV file name), a file may not be written.

Performance value

The following table lists the performance values of this FB under the following conditions.

- CPU module: R120CPU
- SD memory card: NZ1MEM-4GBSD
- File register storage location: Extended SRAM cassette
- FB compilation method: Macro type

The values in the table (time from processing start to processing end, maximum scan time, and number of scans required for processing) are a reference since the values vary depending on the time required for processing programs other than this FB.

Input label		Time from processing start to processing end	Maximum scan time	Number of scans required for processing
Number of channels	Number of save points			
1	1	307ms	0.323ms	2171 scans
	10000	4090ms	4.070ms	28435 scans
	100000	38800ms	4.070ms	270103 scans
	1000000	396000ms	4.070ms	2771811 scans
	10000000	3930000ms	4.070ms	27063525 scans
2	1	338ms	0.343ms	2308 scans
	10000	6120ms	5.110ms	42817 scans
	100000	55200ms	5.110ms	385939 scans
	1000000	589000ms	5.110ms	4063547 scans
3	1	352ms	0.366ms	2358 scans
	10000	7570ms	6.160ms	52829 scans
	100000	74700ms	6.190ms	521317 scans
	1000000	769000ms	6.250ms	5297023 scans
4	1	337ms	0.404ms	2413 scans
	10000	9440ms	7.260ms	65646 scans
	100000	93600ms	7.260ms	650558 scans
	1000000	970000ms	7.400ms	6628888 scans

Error code

Error code	Description	Action
0100H	An out-of-range value is set in <code>i_uCHNum</code> (number of channels). The number of channels is set out of the range of 1 to 4.	Review and correct the settings and then execute the FB again.
0101H	An out-of-range value is set in <code>i_udSavePoints</code> (number of save points). The number of save points is set out of the range of 1 to 10000000.	Review and correct the settings and then execute the FB again.
0102H	A character string with an out-of-range character length is set in <code>i_snAppendFileName</code> (CSV file name).	Set a string with character length of 1 to 28.
0200H	The file register address exceeds the capacity of the file register (ZR).	Review and correct the settings according to the following relational expression, and then execute the FB again. $(i_udDataAddr \text{ (start address of the storage location of logging data)} + (i_uCHNum \text{ (number of channels)} \times i_udSavePoints \text{ (number of save points)}) - 1) \leq \text{Maximum assignment address of the file register (ZR)}$
0201H	An access to the SD memory card has failed because SM606 (SD memory card forced disable instruction) is on. While logging data is being saved, turning on SM606 results in the partially created CSV file being saved in the SD memory card.	Turn off SM606 and check that SM607 (SD memory card forced stop status flag) is turned off, then execute the FB again.
0202H	Execution of this FB has been attempted without inserting an SD memory card into the CPU module.	Insert an SD memory card for saving the target CSV files into the CPU module, and then execute the FB again.
0203H	An access to the SD memory card has failed because SM600 (Memory card available flag) is off.	Make the SD memory card an available state, and then execute the FB again.
0204H	The SD memory card is frequently accessed from programs in addition to this FB, and a timeout has occurred.	Reduce the frequency of the access to the SD memory card.
0205H	Because SM601 (Memory card protect flag) is on, data cannot be written to the SD memory card.	Turn off the protect switch on the SD memory card, check that SM601 is off, and execute the FB again.
0206H	<code>i_bEN</code> (execution command) has been turned off during the processing.	Do not turn off <code>i_bEN</code> (execution command) until <code>o_bOK</code> (normal completion) or <code>o_bErr</code> (error completion) turns on.
Other than above	Error codes related to the SP.FWRITE instruction executed when logging data is written to an SD memory card.	For details on the error code that has occurred, refer to the following description of the SP.FWRITE instruction.  MELSEC iQ-R Programming Manual (CPU Module Instructions, Standard Functions/Function Blocks)

2.2 M+FileOperation_SendLoggingFile_R

Overview

This FB transfers logging data files to the FTP server by using the file transfer function (FTP client) of the CPU module.

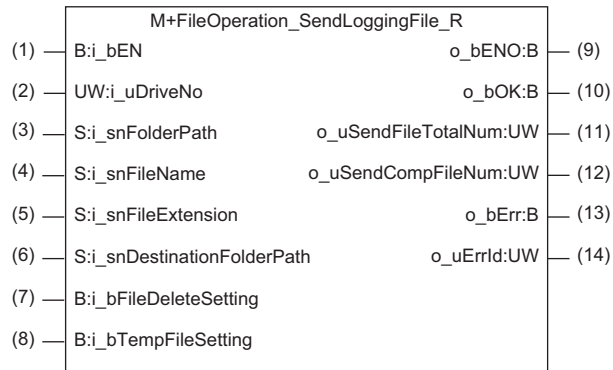

Labels to use

Input label

No.	Label name	Name (comment)	Data type	Scope	Description
(1)	i_bEN	Execution command	Bit	On or off	On: The FB is activated. Off: The FB is not activated.
(2)	i_uDriveNo	Transfer source drive number	Word [unsigned]	2 to 4	Specify the number for the drive where the file to be transferred is stored. (Page 19 Specifying the transfer source file path) 2: SD memory card 3: Device/label memory 4: User memory
(3)	i_snFolderPath	Transfer source folder path	String	0 to 245 (A two-byte character is equivalent to two characters.)	Specify the path of the folder where the file to be transferred is stored. (Page 19 Specifying the transfer source file path) When the string is not specified, files in the root directory of the transfer source drive will be transferred.
(4)	i_snFileName	Transfer source file name	String	1 to 255 (A two-byte character is equivalent to two characters.)	Specify the name of the file to be transferred. (Page 19 Specifying the transfer source file path)
(5)	i_snFileExtension	Transfer source file extension	String	0 to 255 (A two-byte character is equivalent to two characters.)	Specify the extension (not including the period) of the file to be transferred. (Page 19 Specifying the transfer source file path) When the string is not specified, files without extension will be transferred.
(6)	i_snDestinationFolderPath	Transfer destination folder path	String	0 to 255 (A two-byte character is equivalent to two characters.)	Specify the path of the folder to store the transferred files.
(7)	i_bFileDeleteSetting	Transferred file delete setting	Bit	On or off	Specify whether to delete the files in the transfer source after file transfer is completed successfully. On: Deleted Off: Not deleted
(8)	i_bTempFileSetting	Temporary file create setting for file transfer	Bit	On or off	Specify whether to create a temporary file to prevent file corruption when an error occurs during transfer. On: Not created Off: Created

Output label

No.	Label name	Name (comment)	Data type	Initial data	Description
(9)	o_bENO	Execution status	Bit	OFF	On: The execution command is on. Off: The execution command is off.
(10)	o_bOK	Normal completion	Bit	OFF	The on state indicates that file transfer is completed successfully.
(11)	o_uSendFileTotalNum	Total number of files to be processed	Word [unsigned]	0	Indicates the number of files to be transferred.
(12)	o_uSendCompFileNum	Number of processed files	Word [unsigned]	0	Indicates the number of files that have been transferred.
(13)	o_bErr	Error completion	Bit	OFF	The on state indicates that an error has occurred in the FB.
(14)	o_uErrId	Error code	Word [unsigned]	0	The error code of an error occurred in the FB is stored.

FB details

Relevant devices

■CPU module

MELSEC iQ-R series programmable controller CPU of firmware version "31" or later



For the CPU modules classified in the programmable controller CPU, refer to the following.

MELSEC iQ-R Module Configuration Manual

- The R00CPU, R01CPU, and R02CPU of firmware version "06" or later support this FB.

■Engineering tool

GX Works3 of version 1.045X or later (When the R00CPU, R01CPU, or R02CPU is used: version 1.047Z or later)

Basic specifications

Item	Description
Language to use	ST
Number of steps	1546 The number of steps of the FB embedded in a program depends on the CPU module used, the input/output definitions, and the option settings of GX Works3. For the options setting of GX Works3, refer to the following. GX Works3 Operating Manual
Label usage	<ul style="list-style-type: none">• Label: 1204 points (word)• Latch label: 0 points (word) The usage of labels embedded in a program depends on the CPU module used, the devices specified as an argument, and the options setting of GX Works3. For the options setting of GX Works3, refer to the following. GX Works3 Operating Manual
Number of index register used	<ul style="list-style-type: none">• Index register: 0 points• Long index register: 0 points
FB compilation method	Macro type
FB dependence	No dependence
FB operation	Pulse execution type (multiple scan execution type)

Functional description

- Before using this FB, set values in the following; Navigation window of GX Works3 ⇒ [Parameter] ⇒ CPU module model name ⇒ [Basic Settings] of [Module Parameter] ⇒ [Own Node Settings] and [Application Settings] ⇒ [FTP Client Settings] (MELSEC iQ-R Ethernet User's Manual (Application))
- When i_bEN (execution command) is turned on, the CPU module file (up to 4G bytes) specified by the input label is transferred to the FTP server folder specified by i_snDestinationFolderPath (transfer destination folder path). An error immediately interrupts the transfer.
- When i_bFileDeleteSetting (transferred file delete setting) is set to on, the transferred file is deleted after the transfer.
- When i_bTempFileSetting (temporary file create setting for file transfer) is set to off, a temporary file (FTPCLI_I.TMP) will be created during file transfer to prevent file corruption in the transfer destination when an error such as cable disconnection and power-off occurs.
- After all of the specified files are transferred, o_bOK (normal completion) turns on and the number of transferred files is stored in o_uSendFileTotalNum (number of processed files) and o_uSendCompFileNum (number of processed files).

Specifying the transfer source file path

Specify a path of up to 255 characters for the transfer source file as follows.

Ex.

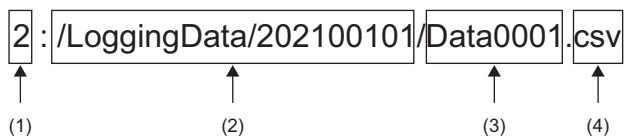

- (1) i_uDriveNo (transfer source drive number): Specify the number for the drive where the file to be transferred is stored.
 2: SD memory card (Not supported by the R00CPU.)
 3: Device/label memory
 4: User memory
- (2) i_snFolderPath (transfer source folder path): Specify a path (up to 245 characters) of the folder where the file to be transferred is stored.
 Use "\" or "/" as a delimiter for the folder path.
 When the string is not specified, files under the specified drive will be transferred.
- (3) i_snFileName (transfer source file name): Specify the name of the file to be transferred. (Wildcards can be used.)
 If the string is not specified, an error occurs.
- (4) i_snFileExtension (transfer source file extension): Specify the extension (not including the period) of the file to be transferred. (Wildcards can be used.)
 When the string is not specified, files without extension will be transferred.

Wildcards that can be used to specify the transfer source file path

To specify i_snFileName (transfer source file name) or i_snFileExtension (transfer source file extension), the following symbols can be used as wildcard.

Symbol	Conditions
*	All files whose name has any given character string (including an empty string) after "*" will be transferred.
?	All files whose name has any given character string (not including an empty string) in "?" position will be transferred. (The symbol can be placed in multiple positions in the file name.)

However, the following wildcards must not be used. If used, o_bErr (error completion) turns on, the processing of the FB is interrupted, and 0105H or 0106H is stored in o_uErrId (error code). (Page 24 Error code)

- "*" is placed in multiple positions in i_snFileName (transfer source file name) or i_snFileExtension (transfer source file extension). (Example: *abc*.csv, abc.*s*)
- Both "*" and "?" are placed in i_snFileName (transfer source file name) or i_snFileExtension (transfer source file extension). (Example: *ab?.csv)

Files are not transferred when the total number of characters of the transfer source file path exceeds 255 even if i_snFileName (transfer source file name) and i_snFileExtension (transfer source file extension) satisfy the wildcard conditions.

■Error completion due to the transfer source file path

When the transfer source file path meets any of the following conditions, o_bErr (error completion) turns on and the processing of the FB is interrupted, then the error code is stored in o_uErrId (error code). (📖 Page 24 Error code)

Item	Conditions	Error code
Total number of characters of the transfer source file path	255 is exceeded.	0207H
i_uDriveNo (transfer source drive number)	A numeric character other than 2, 3, and 4 is specified.	0103H
i_snFolderPath (transfer source folder path)	<ul style="list-style-type: none"> The total number of characters exceeds 245. Wildcards are used to specify the path. 	0104H
i_snFileName (transfer source file name)	<ul style="list-style-type: none"> The string is not specified. The specified name does not satisfy the wildcard conditions. 	0105H
i_snFileExtension (transfer source file extension)	The specified name does not satisfy the wildcard conditions.	0106H

■Specifying the transfer destination file path

Specify a path of up to 255 characters for the transfer destination file as follows.

Ex.

/LoggingData/202100101/Data0001.csv

↑
↑
(1)
(2)

(1) i_snDestinationFolderPath (transfer destination folder path): Specify the path of the transfer destination folder of the FTP server.

Use "\" or "/" as a delimiter for the folder path.

If the string is not specified, the file is transferred to the root directory.

When the specified folder does not exist, a folder is created automatically.

(2) File name: The transfer source file name specified by i_snFileName (transfer source file name) and i_snFileExtension (transfer source file extension).

If a file with the same name already exists in the transfer destination folder, the existing file will be replaced with the newly created file.

■Error completion due to the transfer destination file path

When the transfer destination file path meets any of the following conditions, o_bErr (error completion) turns on and the processing of the FB is interrupted, then the error code is stored in o_uErrId (error code). (📖 Page 24 Error code)

Item	Conditions	Error code
Total number of characters of the transfer destination file path	255 is exceeded.	0208H
i_snDestinationFolderPath (transfer destination folder path)	<ul style="list-style-type: none"> The total number of characters exceeds 255. Wildcards are used to specify the path. 	0107H

■Other events that result in error completion

- If i_bEN (execution command) is turned off while o_bOK (normal completion) or o_bErr (error completion) is off, o_bErr (error completion) turns on in one scan or remains on until file transfer is completed if the file is being transferred. In addition, 0206H is stored in o_uErrId (error code) in one scan. (📖 Page 24 Error code)
- If the FB is executed while SM753 (File being accessed) is on, the transfer processing starts after SM753 (File being accessed) turns off. If SM753 (File being accessed) does not turn off even after 90 seconds have passed since the execution of the FB, o_bErr (error completion) turns on, the processing of the FB is interrupted, and 0209H is stored in o_uErrId (error code). (📖 Page 24 Error code)
- If the FB is executed while SM1525 (Initial processing error completion state) is on, o_bErr (error completion) turns on, the processing of the FB is interrupted, and 020AH is stored in o_uErrId (error code). (📖 Page 24 Error code)
- This FB uses the SP.FTPPUT instruction. If an error occurs under the SP.FTPPUT instruction, o_bErr (error completion) turns on and the processing of the FB is interrupted. In addition, the error code from the SP.FTPPUT instruction is stored in o_uErrId (error code). (📖 Page 24 Error code) For details on the SP.FTPPUT instruction, refer to the following.

📖 MELSEC iQ-R Programming Manual (CPU Module Instructions, Standard Functions/Function Blocks)

Timing chart of I/O signals

■ When the operation is completed successfully

Ex.

When 10 files are to be transferred

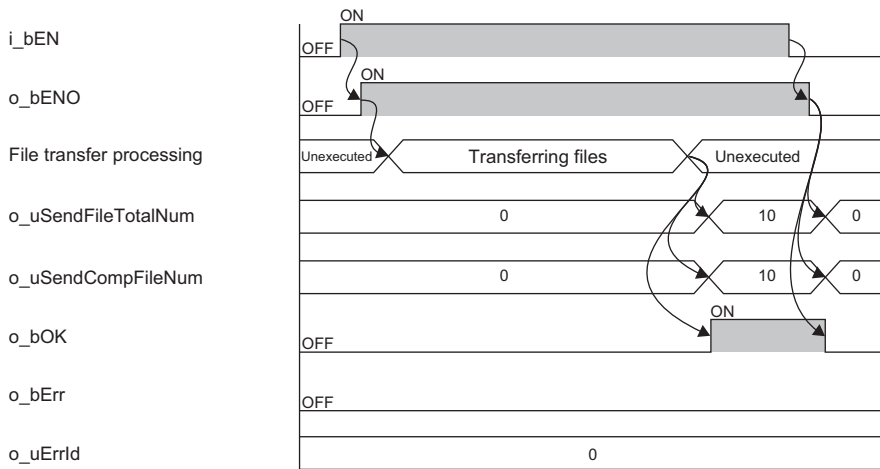

■ When the operation is completed with an error

Ex.

When an error is detected before the file transfer processing

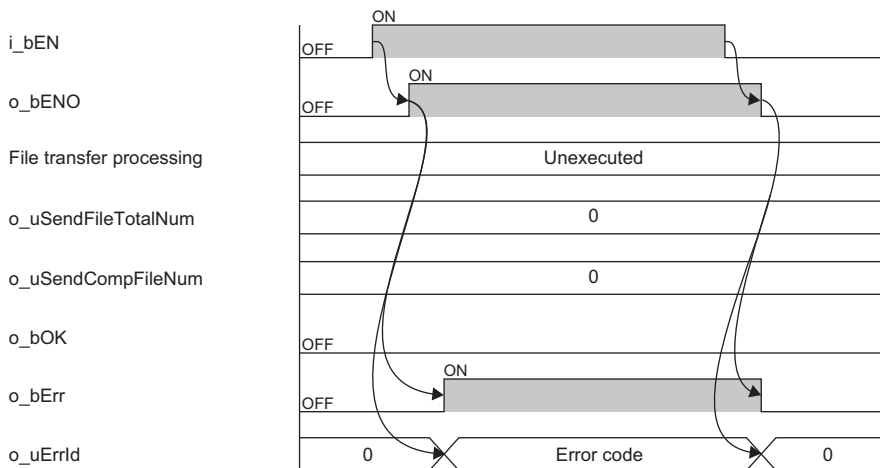

Restrictions and precautions

- This FB does not include the error recovery processing. Prepare the error recovery processing separately to suit the user's system and the expected operation.
- The FB cannot be used in an interrupt program.
- Using the FB in a program that is to be executed only once, such as a program that uses subroutines or the FOR-NEXT instruction, has a problem that i_bEN (execution command) can no longer be turned off and normal operation is not possible; Always use the FB in a program that is capable of turning off i_bEN (execution command).
- The FB requires the configuration of the ladder for every input label.
- To use more than one of this FB, create an interlock to avoid simultaneous execution.
- Change the settings of "Memory/Device Setting" of "CPU Parameter" so that the memory capacity required to use this FB is secured. Otherwise, an error may occur in GX Works3.
- The string type input labels support one-byte alphanumeric characters, symbols, kana characters, and two-byte characters (Shift JIS code). Characters that are not supported are treated as "_".
- If the CPU module state is changed from RUN to STOP during file transfer, the file transfer processing continues until file transfer is completed.

Performance value

The following table lists the performance values of this FB under the following conditions.

- CPU module: R120CPU
- SD memory card: NZ1MEM-2GBSD
- File register storage location: Extended SRAM cassette
- FB compilation method: Macro type
- FTP server (personal computer): Windows 10 Enterprise (64-bit) [CPU: Intel Core i5-8500 3.0 GHz, memory: 8 GB, communication interface: Ethernet port (data transfer speed: 1 Gbps or more)]

The values in the table (time from processing start to processing end, maximum scan time, and number of scans required for processing) are a reference since the values vary depending on the time required for processing programs other than this FB.

Input label*1		Transfer source file*2		Time from processing start to processing end	Maximum scan time	Number of scans required for processing
Transferred file delete setting	Temporary file create setting for file transfer	Number of channels	Number of save points			
Off (Not deleted)	Off (Created)	1	1	359ms	0.540ms	2177 scans
			10000	736ms	0.535ms	4426 scans
			100000	4350ms	0.532ms	26215 scans
			1000000	42700ms	0.536ms	259364 scans
			10000000	450000ms	0.528ms	2753758 scans
		2	1	364ms	0.540ms	2186 scans
			10000	965ms	0.529ms	5691 scans
			100000	6320ms	0.532ms	38344 scans
			1000000	62300ms	0.533ms	380352 scans
		3	1	361ms	0.538ms	2176 scans
			10000	1170ms	0.535ms	7025 scans
			100000	8300ms	0.542ms	50487 scans
			1000000	82000ms	0.537ms	530051 scans
		4	1	348ms	0.531ms	2048 scans
			10000	1360ms	0.525ms	8208 scans
			100000	10300ms	0.530ms	62602 scans
			1000000	102000ms	0.527ms	622008 scans

Input label*1		Transfer source file*2		Time from processing start to processing end	Maximum scan time	Number of scans required for processing		
Transferred file delete setting	Temporary file create setting for file transfer	Number of channels	Number of save points					
Off (Not deleted)	On (Not created)	1	1	281ms	0.544ms	1681 scans		
			10000	693ms	0.527ms	4092 scans		
			100000	4270ms	0.535ms	25886 scans		
			1000000	42500ms	0.543ms	258740 scans		
			10000000	450000ms	0.534ms	2748344 scans		
		2	1	297ms	0.526ms	1663 scans		
			10000	886ms	0.526ms	5379 scans		
			100000	6280ms	0.540ms	38111 scans		
			1000000	62300ms	0.532ms	380669 scans		
		3	1	307ms	0.531ms	1761 scans		
			10000	1130ms	0.538ms	6792 scans		
			100000	8250ms	0.537ms	50226 scans		
		4	1	292ms	0.531ms	1731 scans		
			10000	1300ms	0.531ms	7768 scans		
			100000	10300ms	0.533ms	62212 scans		
		On (Deleted)	Off (Created)	1	1	371ms	0.535ms	2104 scans
					10000	759ms	0.533ms	4471 scans
					100000	4360ms	0.540ms	26329 scans
					1000000	42600ms	0.531ms	259601 scans
					10000000	451000ms	0.529ms	2751388 scans
2	1			358ms	0.526ms	2113 scans		
	10000			1020ms	0.523ms	6032 scans		
	100000			6390ms	0.538ms	38436 scans		
	1000000			63300ms	0.525ms	386982 scans		
3	1			358ms	0.524ms	2107 scans		
	10000			1210ms	0.530ms	7234 scans		
	100000			8320ms	0.528ms	50836 scans		
4	1			388ms	0.526ms	2304 scans		
	10000			1420ms	0.561ms	8499 scans		
	100000			10400ms	0.539ms	62701 scans		
1000000	103000ms			0.533ms	621818 scans			

*1 The following input labels are excluded from the performance value conditions since these parameters do not significantly affect the processing time.

- i_uDriveNo (transfer source drive number)
- i_snFolderPath (transfer source folder path)
- i_snFileName (transfer source file name)
- i_snFileExtension (transfer source file extension)
- i_snDestinationFolderPath (transfer destination folder path)

*2 The transfer source file is the CSV file saved by M+FileOperation_SaveLoggingCSV_W_R.

Error code

Error code	Description	Action
0103H	The value set for i_uDriveNo (transfer source drive number) is out of range.	Specify i_uDriveNo (transfer source drive number) with a value of 2 to 4. Review and correct the specification and execute the FB again.
0104H	i_snFolderPath (transfer source folder path) is not specified correctly.	Specify i_snFolderPath (transfer source folder path) with a string of 0 to 245 characters. Do not use wildcards. Review and correct the specification and execute the FB again.
0105H	i_snFileName (transfer source file name) is not specified correctly.	Specify i_snFileName (transfer source file name) with a string of 1 to 255 characters. When wildcards are used, review and correct the wildcards. Review and correct the specification and execute the FB again.
0106H	i_snFileExtension (transfer source file extension) is not specified correctly.	Specify i_snFileExtension (transfer source file extension) with a string of 0 to 255 characters. When wildcards are used, review and correct the wildcards. Review and correct the specification and execute the FB again.
0107H	i_snDestinationFolderPath (transfer destination folder path) is not specified correctly.	Specify i_snDestinationFolderPath (transfer destination folder path) with a string of 0 to 255 characters. Do not use wildcards. Review and correct the specification and execute the FB again.
0206H	i_bEN (execution command) has been turned off during the processing.	Do not turn off i_bEN (execution command) until o_bOK (normal completion) or o_bErr (error completion) turns on.
0207H	The number of characters of the transfer source file path exceeds 255.	Review and correct the following so that the total number of characters of the transfer source file path is 255 or less. <ul style="list-style-type: none"> • i_snFolderPath (transfer source folder path) • i_snFileName (transfer source file name) • i_snFileExtension (transfer source file extension) Review and correct the specification and execute the FB again.
0208H	The number of characters of the transfer destination file path exceeds 255.	Review and correct the following so that the total number of characters of the transfer destination file path is 255 or less. <ul style="list-style-type: none"> • i_snDestinationFolderPath (transfer destination folder path) • i_snFileName (transfer source file name) • i_snFileExtension (transfer source file extension) Review and correct the specification and execute the FB again.
0209H	File transfer failed because the file access processing is being executed.	Reduce the frequency of the file access processing which turns on SM753.
020AH	File transfer failed because the initial processing of the Ethernet function is not completed successfully.	Review and correct the settings for the CPU module parameters. Review and correct the settings and then execute the FB again.
Other than above	Error codes related to the SP.FTPPUT instruction executed at the file transfer.	For details on the error code that has occurred, refer to the list of error codes in the following. <ul style="list-style-type: none"> 📖 MELSEC iQ-R CPU Module User's Manual (Application) 📖 MELSEC iQ-R Ethernet User's Manual (Application)

3 APPLICATION EXAMPLES

This chapter shows application examples for each FB library.

3.1 M+FileOperation_SaveLoggingCSV_W_R

1. M+R60ADH_ReadContinuousLogging records the CH1 and CH2 logging data that are collected by the continuous logging function of the high speed analog-digital converter module (R60ADH4) into a file register area for 100,000 points (ZR0 to ZR99999).
2. M+FileOperation_SaveLoggingCSV_W_R saves the logging data stored in the file register area into an SD memory card.

System configuration

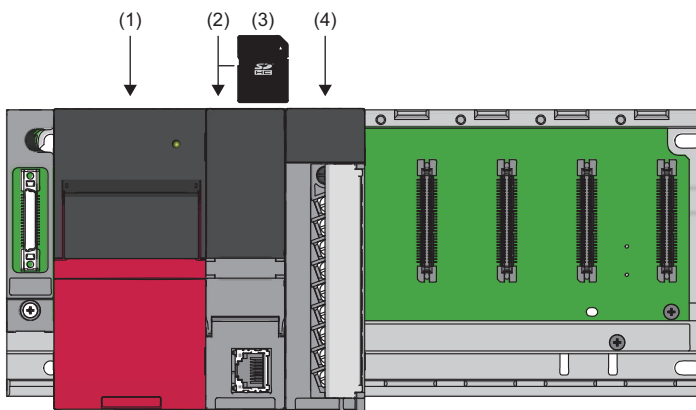

No.	Product	Model	Remarks
(1)	Power supply module	R61P	—
(2)	CPU module	R04CPU	If the file register capacity is not enough, install an extended SRAM cassette as required.
(3)	SD memory card	NZ1MEM-2GBSD	—
(4)	High speed analog-digital converter module	R60ADH4	—

Precautions

The configuration of the ladder is required for every input label. Failure to do so makes the set values undefined values.

Parameter setting

■CPU parameter

Set the CPU parameters for the R04CPU as follows. For the other CPU parameters, use the default values.

[Navigation window] ⇒ [Parameter] ⇒ [R04CPU] ⇒ [CPU Parameter] ⇒ [File Setting]

Item	Setting
File Register Setting	
Use Or Not Setting	Use Common File Register in All Programs
Capacity	128 K Word
File Name	MAIN
Initial Value Setting	
Target Memory	Data Memory
Setting of Device Initial Value Use Or Not	Not Use
Global Device Initial Value File Name	
File Setting for Device Data Storage	
Use Or Not Setting	Not Use
Capacity	1 K Word
File Name	DEVSTORE

Explanation
Set the capacity of file register.
[Setting range]

Buttons: Check, Restore the Default Settings, Apply

■Module parameters of high speed analog-digital converter module

Set the module parameters for the R60ADH4 as follows. For the other module parameters, use the default values.

[Navigation window] ⇒ [Parameter] ⇒ [Module Information] ⇒ [R60ADH4] ⇒ [Basic Settings]

Item	CH1	CH2	CH3
Range switching function	The input range of the analog input can be set for each channel and the		
Operation mode setting function	Set the operation mode.		
Operation mode setting	Simultaneous conversion mode(5us/4CH)		
A/D conversion enable/disable setting function	Set whether to enable or disable the output of the A/D conversion value.		
A/D conversion enable/disable setting	A/D conversion enable	A/D conversion enable	A/D conversion disable
A/D conversion method	Set the A/D conversion control method.		

Explanation
Set whether to enable or disable the output of the A/D conversion value.

Buttons: Check, Restore the Default Settings

Program examples

Label setting

Classification	Label name	Description	Device																																																																																																									
Module label	RCPU.stSM.bAfter_RUN1_Scan_ON	Turning on for one scan after RUN	SM402																																																																																																									
	R60ADH_1.uContinuousLoggingStartStopRequest_D	Continuous logging start/stop request	U0\G100																																																																																																									
	R60ADH_1.uContinuousLoggingCycleSettingValue_D	Continuous logging cycle setting value	U0\G280																																																																																																									
Labels to be defined	Define the global labels as follows.																																																																																																											
	<table border="1"> <thead> <tr> <th></th> <th>Label Name</th> <th>Data Type</th> <th>Class</th> <th>Assign (Device/Label)</th> </tr> </thead> <tbody> <tr><td>1</td><td>G_bLOG_EN</td><td>Bit</td><td>VAR_GLOBAL</td><td>M0</td></tr> <tr><td>2</td><td>G_uLOG_ReadPoints</td><td>Word [Unsigned]/Bit String [16-bit]</td><td>VAR_GLOBAL</td><td>D0</td></tr> <tr><td>3</td><td>G_bLOG1_ENO</td><td>Bit</td><td>VAR_GLOBAL</td><td>M1</td></tr> <tr><td>4</td><td>G_bLOG1_OK</td><td>Bit</td><td>VAR_GLOBAL</td><td>M2</td></tr> <tr><td>5</td><td>G_uLOG1_CompleteLogPoints</td><td>Double Word [Unsigned]/Bit String [32-bit]</td><td>VAR_GLOBAL</td><td>D2</td></tr> <tr><td>6</td><td>G_bLOG1_Err</td><td>Bit</td><td>VAR_GLOBAL</td><td>F0</td></tr> <tr><td>7</td><td>G_uLOG1_ErrId</td><td>Word [Unsigned]/Bit String [16-bit]</td><td>VAR_GLOBAL</td><td>D4</td></tr> <tr><td>8</td><td>G_uLOG2_DataAddr</td><td>Double Word [Unsigned]/Bit String [32-bit]</td><td>VAR_GLOBAL</td><td>D6</td></tr> <tr><td>9</td><td>G_bLOG2_ENO</td><td>Bit</td><td>VAR_GLOBAL</td><td>M3</td></tr> <tr><td>10</td><td>G_bLOG2_OK</td><td>Bit</td><td>VAR_GLOBAL</td><td>M4</td></tr> <tr><td>11</td><td>G_uLOG2_CompleteLogPoints</td><td>Double Word [Unsigned]/Bit String [32-bit]</td><td>VAR_GLOBAL</td><td>D8</td></tr> <tr><td>12</td><td>G_bLOG2_Err</td><td>Bit</td><td>VAR_GLOBAL</td><td>F1</td></tr> <tr><td>13</td><td>G_uLOG2_ErrId</td><td>Word [Unsigned]/Bit String [16-bit]</td><td>VAR_GLOBAL</td><td>D10</td></tr> <tr><td>14</td><td>G_bOSV_EN</td><td>Bit</td><td>VAR_GLOBAL</td><td>M5</td></tr> <tr><td>15</td><td>G_snCSV_AppendFileName</td><td>String(32)</td><td>VAR_GLOBAL</td><td>D20</td></tr> <tr><td>16</td><td>G_bOSV_ENO</td><td>Bit</td><td>VAR_GLOBAL</td><td>M6</td></tr> <tr><td>17</td><td>G_bOSV_OK</td><td>Bit</td><td>VAR_GLOBAL</td><td>M7</td></tr> <tr><td>18</td><td>G_uCSV_CompleteLogPoints</td><td>Double Word [Unsigned]/Bit String [32-bit]</td><td>VAR_GLOBAL</td><td>D12</td></tr> <tr><td>19</td><td>G_bOSV_Err</td><td>Bit</td><td>VAR_GLOBAL</td><td>F2</td></tr> <tr><td>20</td><td>G_uCSV_ErrId</td><td>Word [Unsigned]/Bit String [16-bit]</td><td>VAR_GLOBAL</td><td>D14</td></tr> </tbody> </table>		Label Name	Data Type	Class	Assign (Device/Label)	1	G_bLOG_EN	Bit	VAR_GLOBAL	M0	2	G_uLOG_ReadPoints	Word [Unsigned]/Bit String [16-bit]	VAR_GLOBAL	D0	3	G_bLOG1_ENO	Bit	VAR_GLOBAL	M1	4	G_bLOG1_OK	Bit	VAR_GLOBAL	M2	5	G_uLOG1_CompleteLogPoints	Double Word [Unsigned]/Bit String [32-bit]	VAR_GLOBAL	D2	6	G_bLOG1_Err	Bit	VAR_GLOBAL	F0	7	G_uLOG1_ErrId	Word [Unsigned]/Bit String [16-bit]	VAR_GLOBAL	D4	8	G_uLOG2_DataAddr	Double Word [Unsigned]/Bit String [32-bit]	VAR_GLOBAL	D6	9	G_bLOG2_ENO	Bit	VAR_GLOBAL	M3	10	G_bLOG2_OK	Bit	VAR_GLOBAL	M4	11	G_uLOG2_CompleteLogPoints	Double Word [Unsigned]/Bit String [32-bit]	VAR_GLOBAL	D8	12	G_bLOG2_Err	Bit	VAR_GLOBAL	F1	13	G_uLOG2_ErrId	Word [Unsigned]/Bit String [16-bit]	VAR_GLOBAL	D10	14	G_bOSV_EN	Bit	VAR_GLOBAL	M5	15	G_snCSV_AppendFileName	String(32)	VAR_GLOBAL	D20	16	G_bOSV_ENO	Bit	VAR_GLOBAL	M6	17	G_bOSV_OK	Bit	VAR_GLOBAL	M7	18	G_uCSV_CompleteLogPoints	Double Word [Unsigned]/Bit String [32-bit]	VAR_GLOBAL	D12	19	G_bOSV_Err	Bit	VAR_GLOBAL	F2	20	G_uCSV_ErrId	Word [Unsigned]/Bit String [16-bit]	VAR_GLOBAL	D14		
	Label Name	Data Type	Class	Assign (Device/Label)																																																																																																								
1	G_bLOG_EN	Bit	VAR_GLOBAL	M0																																																																																																								
2	G_uLOG_ReadPoints	Word [Unsigned]/Bit String [16-bit]	VAR_GLOBAL	D0																																																																																																								
3	G_bLOG1_ENO	Bit	VAR_GLOBAL	M1																																																																																																								
4	G_bLOG1_OK	Bit	VAR_GLOBAL	M2																																																																																																								
5	G_uLOG1_CompleteLogPoints	Double Word [Unsigned]/Bit String [32-bit]	VAR_GLOBAL	D2																																																																																																								
6	G_bLOG1_Err	Bit	VAR_GLOBAL	F0																																																																																																								
7	G_uLOG1_ErrId	Word [Unsigned]/Bit String [16-bit]	VAR_GLOBAL	D4																																																																																																								
8	G_uLOG2_DataAddr	Double Word [Unsigned]/Bit String [32-bit]	VAR_GLOBAL	D6																																																																																																								
9	G_bLOG2_ENO	Bit	VAR_GLOBAL	M3																																																																																																								
10	G_bLOG2_OK	Bit	VAR_GLOBAL	M4																																																																																																								
11	G_uLOG2_CompleteLogPoints	Double Word [Unsigned]/Bit String [32-bit]	VAR_GLOBAL	D8																																																																																																								
12	G_bLOG2_Err	Bit	VAR_GLOBAL	F1																																																																																																								
13	G_uLOG2_ErrId	Word [Unsigned]/Bit String [16-bit]	VAR_GLOBAL	D10																																																																																																								
14	G_bOSV_EN	Bit	VAR_GLOBAL	M5																																																																																																								
15	G_snCSV_AppendFileName	String(32)	VAR_GLOBAL	D20																																																																																																								
16	G_bOSV_ENO	Bit	VAR_GLOBAL	M6																																																																																																								
17	G_bOSV_OK	Bit	VAR_GLOBAL	M7																																																																																																								
18	G_uCSV_CompleteLogPoints	Double Word [Unsigned]/Bit String [32-bit]	VAR_GLOBAL	D12																																																																																																								
19	G_bOSV_Err	Bit	VAR_GLOBAL	F2																																																																																																								
20	G_uCSV_ErrId	Word [Unsigned]/Bit String [16-bit]	VAR_GLOBAL	D14																																																																																																								

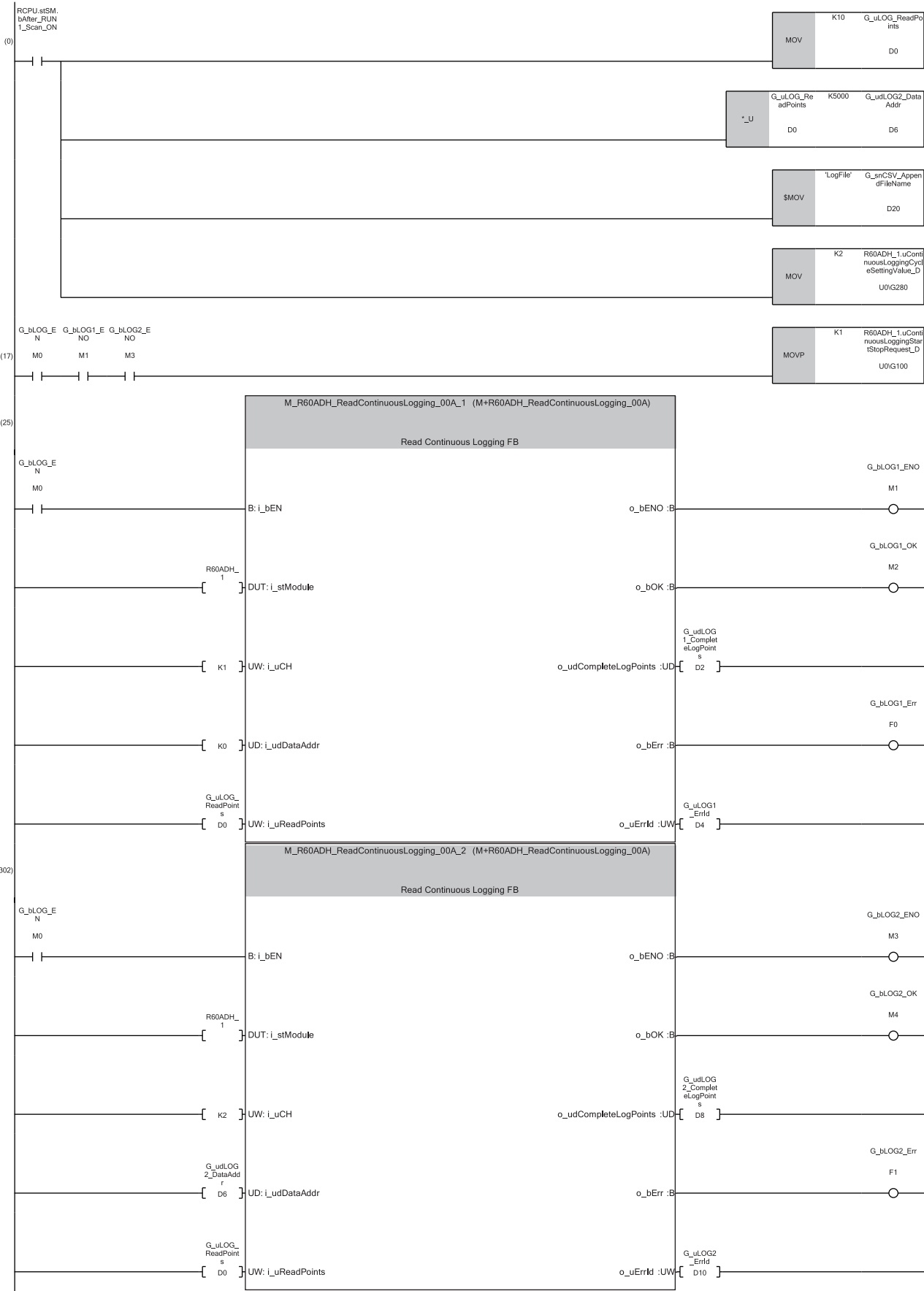

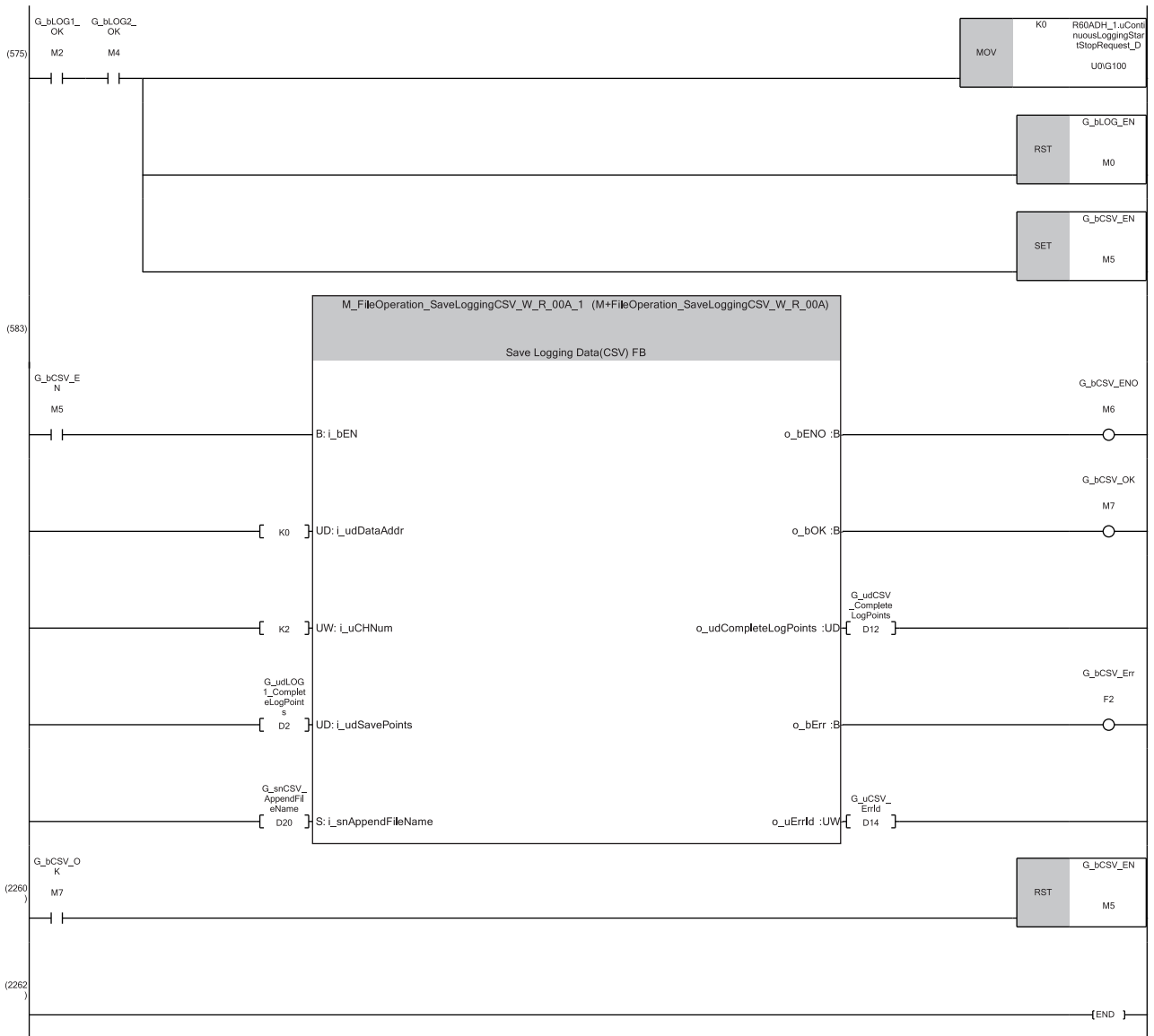

(0) The initial value is set.

(17)The logging data is recorded in the file register area.

(583)The logging data in the file register area is stored in the SD memory card in the CSV format.

3.2 M+FileOperation_SendLoggingFile_R

1. M+R60ADH_ReadContinuousLogging records the CH1 and CH2 logging data that are collected by using the continuous logging function of the high speed analog-digital converter module (R60ADH4) into a file register area for 100,000 points (ZR0 to ZR99999).
2. M+FileOperation_SaveLoggingCSV_W_R saves the logging data stored in the file register area into an SD memory card.
3. M+FileOperation_SendLoggingFile_R transfers the logging data in the SD memory card to the FTP server.

System configuration

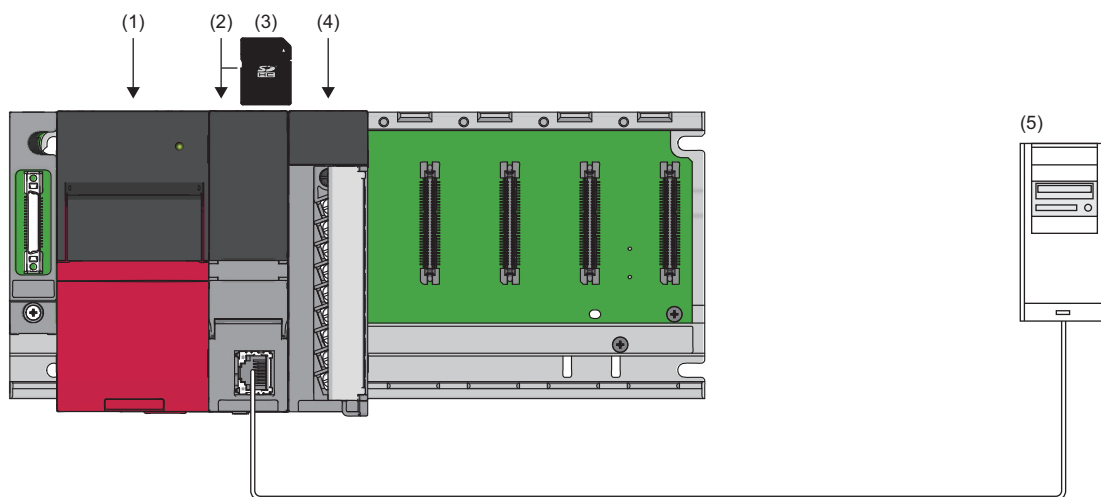

No.	Product	Model	Remarks
(1)	Power supply module	R61P	—
(2)	CPU module	R04CPU	If the file register capacity is not enough, install an extended SRAM cassette as required.
(3)	SD memory card	NZ1MEM-2GBSD	—
(4)	High speed analog-digital converter module	R60ADH4	—
(5)	FTP server	—	—

Precautions

The configuration of the ladder is required for every input label. Failure to do so makes the set values undefined values.

Parameter setting

■CPU parameter

Set the CPU parameters for the R04CPU as follows. For the other CPU parameters, use the default values.

[Navigation window] ⇒ [Parameter] ⇒ [R04CPU] ⇒ [CPU Parameter] ⇒ [File Setting]

Item	Setting
File Register Setting	
Use Or Not Setting	Use Common File Register in All Programs
Capacity	128 K Word
File Name	MAIN
Initial Value Setting	
Target Memory	Data Memory
Setting of Device Initial Value Use Or Not	Not Use
Global Device Initial Value File Name	
File Setting for Device Data Storage	
Use Or Not Setting	Not Use
Capacity	1 K Word
File Name	DEVSTORE

Explanation
Set the capacity of file register.
[Setting range]

■CPU module parameters

Set the module parameters for the R04CPU as follows. For the other CPU parameters, use the default values.

[Navigation window] ⇒ [Parameter] ⇒ [R04CPU] ⇒ [Module Parameter] ⇒ [Basic Settings]

Item	Setting
Own Node Settings	
Parameter Setting Method	Parameter Editor
IP Address	192.168.0.1
Subnet Mask	255.255.255.0
Default Gateway	
Communications by Network No./Station No.	Disable
Enable/Disable Online Change	Disable All (SLMP)
Communication Data Code	Binary
Opening Method	Do Not Open by Program
CC-Link IEF Basic Settings	
External Device Configuration	
Transmission Port Settings	

Explanation
Set the IP address of the own node.
Ensure that the own node and the external device to be communicated with have the same class and subnet address.
If IP address is not set, the module operates with following IP address.
RJ71EN71 PORT1: 192.168.3.40
RJ71EN71 PORT2: 192.168.4.40
CPU1 built-in Ethernet port: 192.168.3.39

[Navigation window] ⇒ [Parameter] ⇒ [R04CPU] ⇒ [Module Parameter] ⇒ [Application Settings]

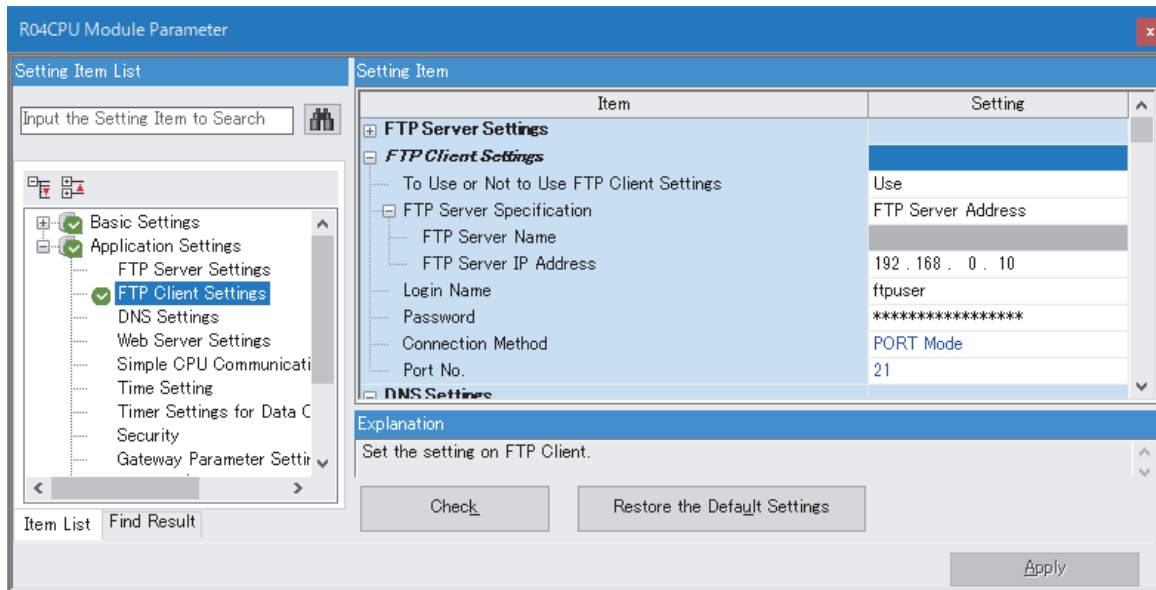

■ Module parameters of high speed analog-digital converter module

Set the module parameters for the R60ADH4 as follows. For the other module parameters, use the default values.

[Navigation window] ⇒ [Parameter] ⇒ [Module Information] ⇒ [R60ADH4] ⇒ [Basic Settings]

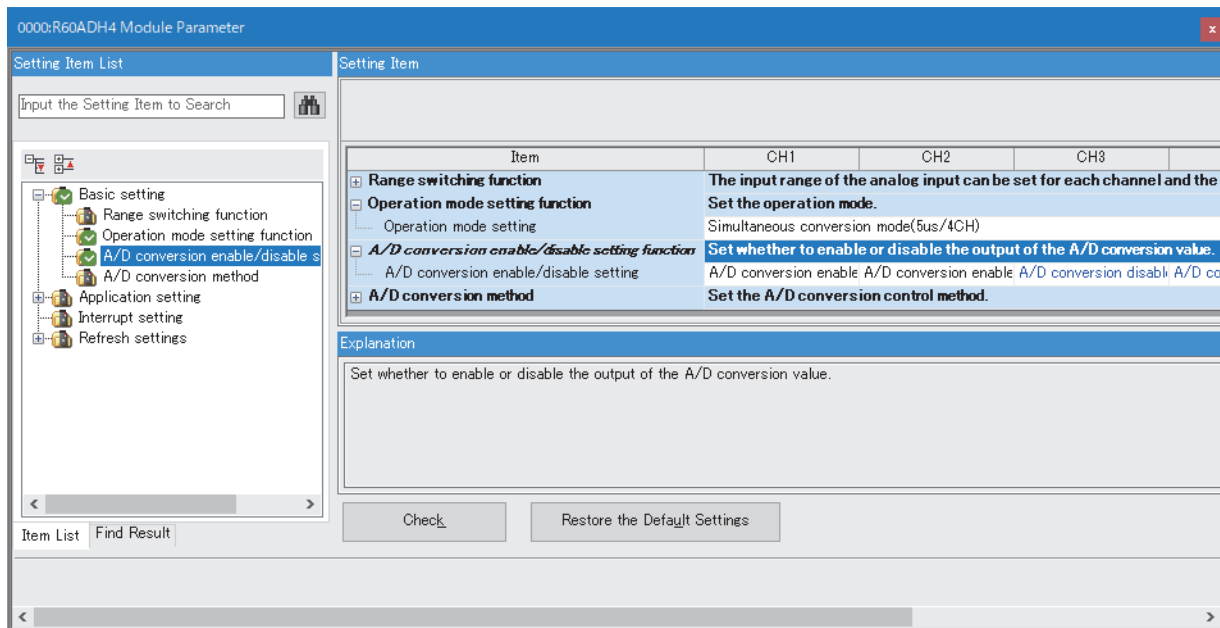

Program examples

Label setting

Classification	Label name	Description	Device																																																																																																																																																											
Module label	RCPU.stSM.bAfter_RUN1_Scan_ON	Turning on for one scan after RUN	SM402																																																																																																																																																											
	R60ADH_1.uContinuousLoggingStartStopRequest_D	Continuous logging start/stop request	U0\G100																																																																																																																																																											
	R60ADH_1.uContinuousLoggingCycleSettingValue_D	Continuous logging cycle setting value	U0\G280																																																																																																																																																											
Labels to be defined	Define the global labels as follows.																																																																																																																																																													
	<table border="1"> <thead> <tr> <th></th> <th>Label Name</th> <th>Data Type</th> <th>Class</th> <th>Assign (Device/Label)</th> </tr> </thead> <tbody> <tr><td>1</td><td>G_bLOG_EN</td><td>Bit</td><td>VAR_GLOBAL</td><td>M0</td></tr> <tr><td>2</td><td>G_uLOG_ReadPoints</td><td>Word [Unsigned]/Bit String [16-bit]</td><td>VAR_GLOBAL</td><td>D0</td></tr> <tr><td>3</td><td>G_bLOG1_ENO</td><td>Bit</td><td>VAR_GLOBAL</td><td>M1</td></tr> <tr><td>4</td><td>G_bLOG1_OK</td><td>Bit</td><td>VAR_GLOBAL</td><td>M2</td></tr> <tr><td>5</td><td>G_udLOG1_CompleteLogPoints</td><td>Double Word [Unsigned]/Bit String [32-bit]</td><td>VAR_GLOBAL</td><td>D2</td></tr> <tr><td>6</td><td>G_bLOG1_Err</td><td>Bit</td><td>VAR_GLOBAL</td><td>F0</td></tr> <tr><td>7</td><td>G_uLOG1_ErrId</td><td>Word [Unsigned]/Bit String [16-bit]</td><td>VAR_GLOBAL</td><td>D4</td></tr> <tr><td>8</td><td>G_udLOG2_DataAddr</td><td>Double Word [Unsigned]/Bit String [32-bit]</td><td>VAR_GLOBAL</td><td>D6</td></tr> <tr><td>9</td><td>G_bLOG2_ENO</td><td>Bit</td><td>VAR_GLOBAL</td><td>M3</td></tr> <tr><td>10</td><td>G_bLOG2_OK</td><td>Bit</td><td>VAR_GLOBAL</td><td>M4</td></tr> <tr><td>11</td><td>G_udLOG2_CompleteLogPoints</td><td>Double Word [Unsigned]/Bit String [32-bit]</td><td>VAR_GLOBAL</td><td>D8</td></tr> <tr><td>12</td><td>G_bLOG2_Err</td><td>Bit</td><td>VAR_GLOBAL</td><td>F1</td></tr> <tr><td>13</td><td>G_uLOG2_ErrId</td><td>Word [Unsigned]/Bit String [16-bit]</td><td>VAR_GLOBAL</td><td>D10</td></tr> <tr><td>14</td><td>G_bCSV_EN</td><td>Bit</td><td>VAR_GLOBAL</td><td>M5</td></tr> <tr><td>15</td><td>G_snCSV_AppendFileName</td><td>String(32)</td><td>VAR_GLOBAL</td><td>D20</td></tr> <tr><td>16</td><td>G_bCSV_ENO</td><td>Bit</td><td>VAR_GLOBAL</td><td>M6</td></tr> <tr><td>17</td><td>G_bCSV_OK</td><td>Bit</td><td>VAR_GLOBAL</td><td>M7</td></tr> <tr><td>18</td><td>G_udCSV_CompleteLogPoints</td><td>Double Word [Unsigned]/Bit String [32-bit]</td><td>VAR_GLOBAL</td><td>D12</td></tr> <tr><td>19</td><td>G_bCSV_Err</td><td>Bit</td><td>VAR_GLOBAL</td><td>F2</td></tr> <tr><td>20</td><td>G_uCSV_ErrId</td><td>Word [Unsigned]/Bit String [16-bit]</td><td>VAR_GLOBAL</td><td>D14</td></tr> <tr><td>21</td><td>G_bFTP_EN</td><td>Bit</td><td>VAR_GLOBAL</td><td>M8</td></tr> <tr><td>22</td><td>G_snFTP_DestinationFolderPath</td><td>String(255)</td><td>VAR_GLOBAL</td><td>D60</td></tr> <tr><td>23</td><td>G_bFTP_FileDeleteSetting</td><td>Bit</td><td>VAR_GLOBAL</td><td>M9</td></tr> <tr><td>24</td><td>G_bFTP_TempFileSetting</td><td>Bit</td><td>VAR_GLOBAL</td><td>M10</td></tr> <tr><td>25</td><td>G_bFTP_ENO</td><td>Bit</td><td>VAR_GLOBAL</td><td>M11</td></tr> <tr><td>26</td><td>G_bFTP_OK</td><td>Bit</td><td>VAR_GLOBAL</td><td>M12</td></tr> <tr><td>27</td><td>G_uFTP_SendFileTotalNum</td><td>Word [Unsigned]/Bit String [16-bit]</td><td>VAR_GLOBAL</td><td>D15</td></tr> <tr><td>28</td><td>G_uFTP_SendCompFileNum</td><td>Word [Unsigned]/Bit String [16-bit]</td><td>VAR_GLOBAL</td><td>D16</td></tr> <tr><td>29</td><td>G_bFTP_Err</td><td>Bit</td><td>VAR_GLOBAL</td><td>F3</td></tr> <tr><td>30</td><td>G_uFTP_ErrId</td><td>Word [Unsigned]/Bit String [16-bit]</td><td>VAR_GLOBAL</td><td>D17</td></tr> </tbody> </table>		Label Name	Data Type	Class	Assign (Device/Label)	1	G_bLOG_EN	Bit	VAR_GLOBAL	M0	2	G_uLOG_ReadPoints	Word [Unsigned]/Bit String [16-bit]	VAR_GLOBAL	D0	3	G_bLOG1_ENO	Bit	VAR_GLOBAL	M1	4	G_bLOG1_OK	Bit	VAR_GLOBAL	M2	5	G_udLOG1_CompleteLogPoints	Double Word [Unsigned]/Bit String [32-bit]	VAR_GLOBAL	D2	6	G_bLOG1_Err	Bit	VAR_GLOBAL	F0	7	G_uLOG1_ErrId	Word [Unsigned]/Bit String [16-bit]	VAR_GLOBAL	D4	8	G_udLOG2_DataAddr	Double Word [Unsigned]/Bit String [32-bit]	VAR_GLOBAL	D6	9	G_bLOG2_ENO	Bit	VAR_GLOBAL	M3	10	G_bLOG2_OK	Bit	VAR_GLOBAL	M4	11	G_udLOG2_CompleteLogPoints	Double Word [Unsigned]/Bit String [32-bit]	VAR_GLOBAL	D8	12	G_bLOG2_Err	Bit	VAR_GLOBAL	F1	13	G_uLOG2_ErrId	Word [Unsigned]/Bit String [16-bit]	VAR_GLOBAL	D10	14	G_bCSV_EN	Bit	VAR_GLOBAL	M5	15	G_snCSV_AppendFileName	String(32)	VAR_GLOBAL	D20	16	G_bCSV_ENO	Bit	VAR_GLOBAL	M6	17	G_bCSV_OK	Bit	VAR_GLOBAL	M7	18	G_udCSV_CompleteLogPoints	Double Word [Unsigned]/Bit String [32-bit]	VAR_GLOBAL	D12	19	G_bCSV_Err	Bit	VAR_GLOBAL	F2	20	G_uCSV_ErrId	Word [Unsigned]/Bit String [16-bit]	VAR_GLOBAL	D14	21	G_bFTP_EN	Bit	VAR_GLOBAL	M8	22	G_snFTP_DestinationFolderPath	String(255)	VAR_GLOBAL	D60	23	G_bFTP_FileDeleteSetting	Bit	VAR_GLOBAL	M9	24	G_bFTP_TempFileSetting	Bit	VAR_GLOBAL	M10	25	G_bFTP_ENO	Bit	VAR_GLOBAL	M11	26	G_bFTP_OK	Bit	VAR_GLOBAL	M12	27	G_uFTP_SendFileTotalNum	Word [Unsigned]/Bit String [16-bit]	VAR_GLOBAL	D15	28	G_uFTP_SendCompFileNum	Word [Unsigned]/Bit String [16-bit]	VAR_GLOBAL	D16	29	G_bFTP_Err	Bit	VAR_GLOBAL	F3	30	G_uFTP_ErrId	Word [Unsigned]/Bit String [16-bit]	VAR_GLOBAL	D17		
	Label Name	Data Type	Class	Assign (Device/Label)																																																																																																																																																										
1	G_bLOG_EN	Bit	VAR_GLOBAL	M0																																																																																																																																																										
2	G_uLOG_ReadPoints	Word [Unsigned]/Bit String [16-bit]	VAR_GLOBAL	D0																																																																																																																																																										
3	G_bLOG1_ENO	Bit	VAR_GLOBAL	M1																																																																																																																																																										
4	G_bLOG1_OK	Bit	VAR_GLOBAL	M2																																																																																																																																																										
5	G_udLOG1_CompleteLogPoints	Double Word [Unsigned]/Bit String [32-bit]	VAR_GLOBAL	D2																																																																																																																																																										
6	G_bLOG1_Err	Bit	VAR_GLOBAL	F0																																																																																																																																																										
7	G_uLOG1_ErrId	Word [Unsigned]/Bit String [16-bit]	VAR_GLOBAL	D4																																																																																																																																																										
8	G_udLOG2_DataAddr	Double Word [Unsigned]/Bit String [32-bit]	VAR_GLOBAL	D6																																																																																																																																																										
9	G_bLOG2_ENO	Bit	VAR_GLOBAL	M3																																																																																																																																																										
10	G_bLOG2_OK	Bit	VAR_GLOBAL	M4																																																																																																																																																										
11	G_udLOG2_CompleteLogPoints	Double Word [Unsigned]/Bit String [32-bit]	VAR_GLOBAL	D8																																																																																																																																																										
12	G_bLOG2_Err	Bit	VAR_GLOBAL	F1																																																																																																																																																										
13	G_uLOG2_ErrId	Word [Unsigned]/Bit String [16-bit]	VAR_GLOBAL	D10																																																																																																																																																										
14	G_bCSV_EN	Bit	VAR_GLOBAL	M5																																																																																																																																																										
15	G_snCSV_AppendFileName	String(32)	VAR_GLOBAL	D20																																																																																																																																																										
16	G_bCSV_ENO	Bit	VAR_GLOBAL	M6																																																																																																																																																										
17	G_bCSV_OK	Bit	VAR_GLOBAL	M7																																																																																																																																																										
18	G_udCSV_CompleteLogPoints	Double Word [Unsigned]/Bit String [32-bit]	VAR_GLOBAL	D12																																																																																																																																																										
19	G_bCSV_Err	Bit	VAR_GLOBAL	F2																																																																																																																																																										
20	G_uCSV_ErrId	Word [Unsigned]/Bit String [16-bit]	VAR_GLOBAL	D14																																																																																																																																																										
21	G_bFTP_EN	Bit	VAR_GLOBAL	M8																																																																																																																																																										
22	G_snFTP_DestinationFolderPath	String(255)	VAR_GLOBAL	D60																																																																																																																																																										
23	G_bFTP_FileDeleteSetting	Bit	VAR_GLOBAL	M9																																																																																																																																																										
24	G_bFTP_TempFileSetting	Bit	VAR_GLOBAL	M10																																																																																																																																																										
25	G_bFTP_ENO	Bit	VAR_GLOBAL	M11																																																																																																																																																										
26	G_bFTP_OK	Bit	VAR_GLOBAL	M12																																																																																																																																																										
27	G_uFTP_SendFileTotalNum	Word [Unsigned]/Bit String [16-bit]	VAR_GLOBAL	D15																																																																																																																																																										
28	G_uFTP_SendCompFileNum	Word [Unsigned]/Bit String [16-bit]	VAR_GLOBAL	D16																																																																																																																																																										
29	G_bFTP_Err	Bit	VAR_GLOBAL	F3																																																																																																																																																										
30	G_uFTP_ErrId	Word [Unsigned]/Bit String [16-bit]	VAR_GLOBAL	D17																																																																																																																																																										

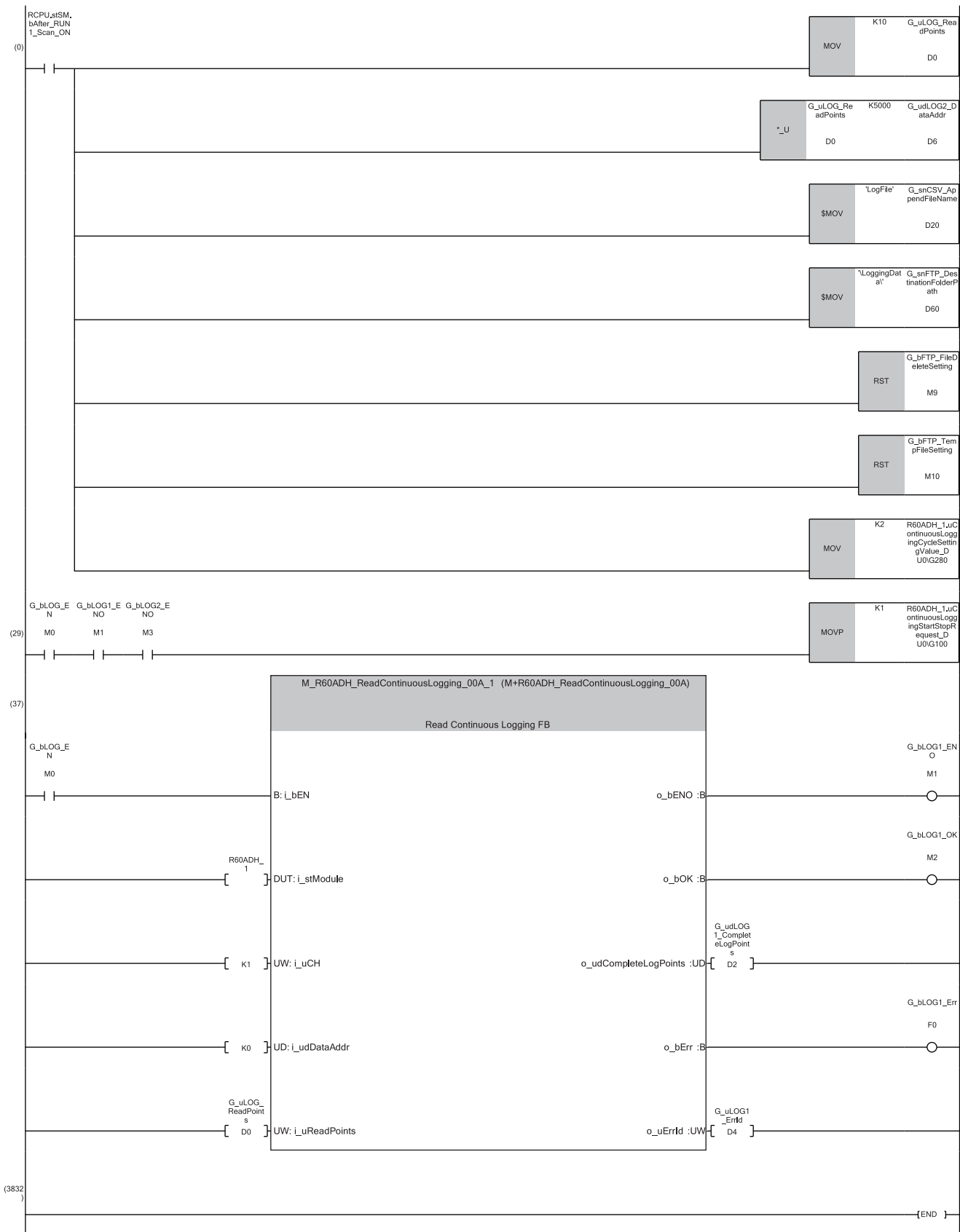

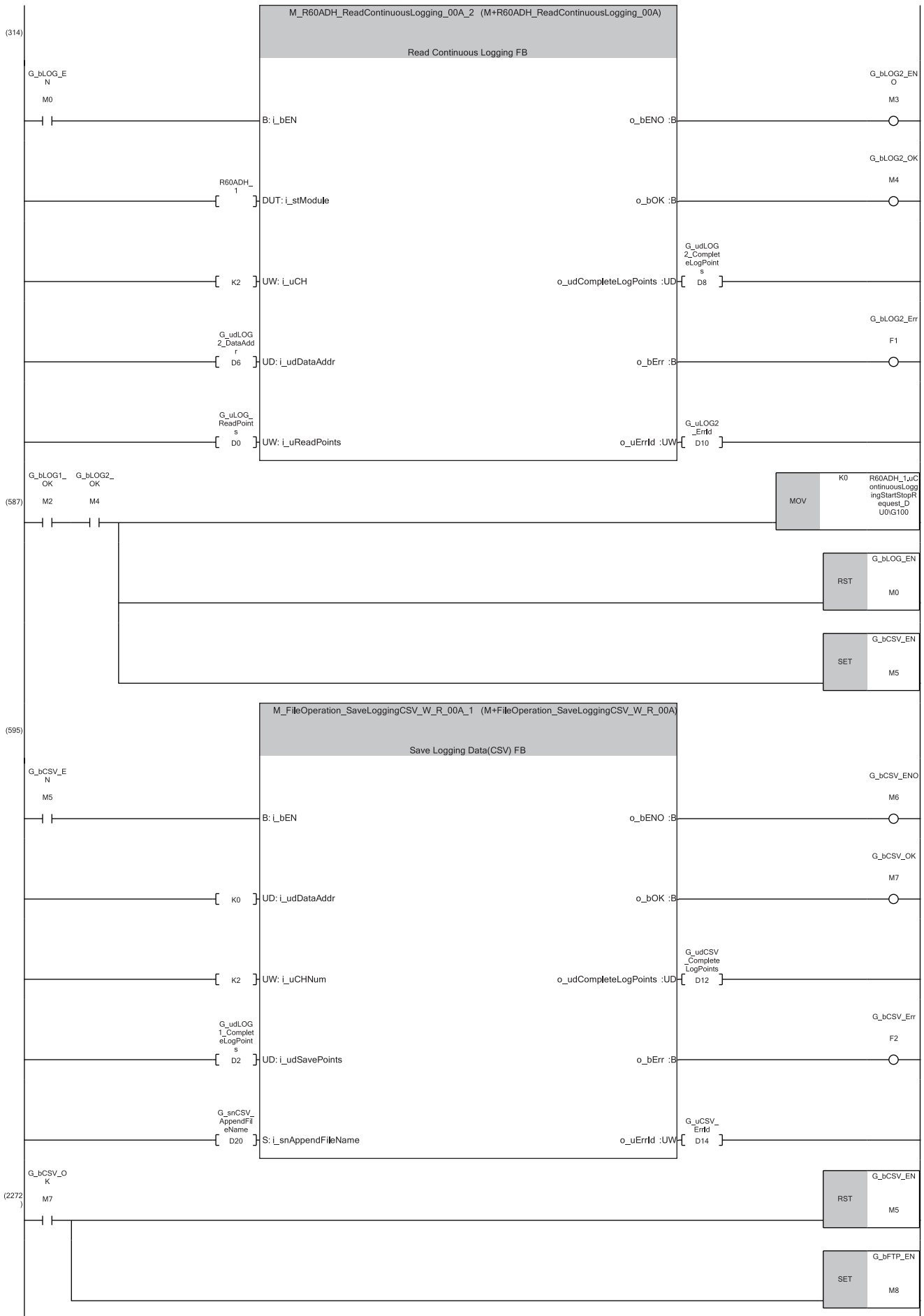

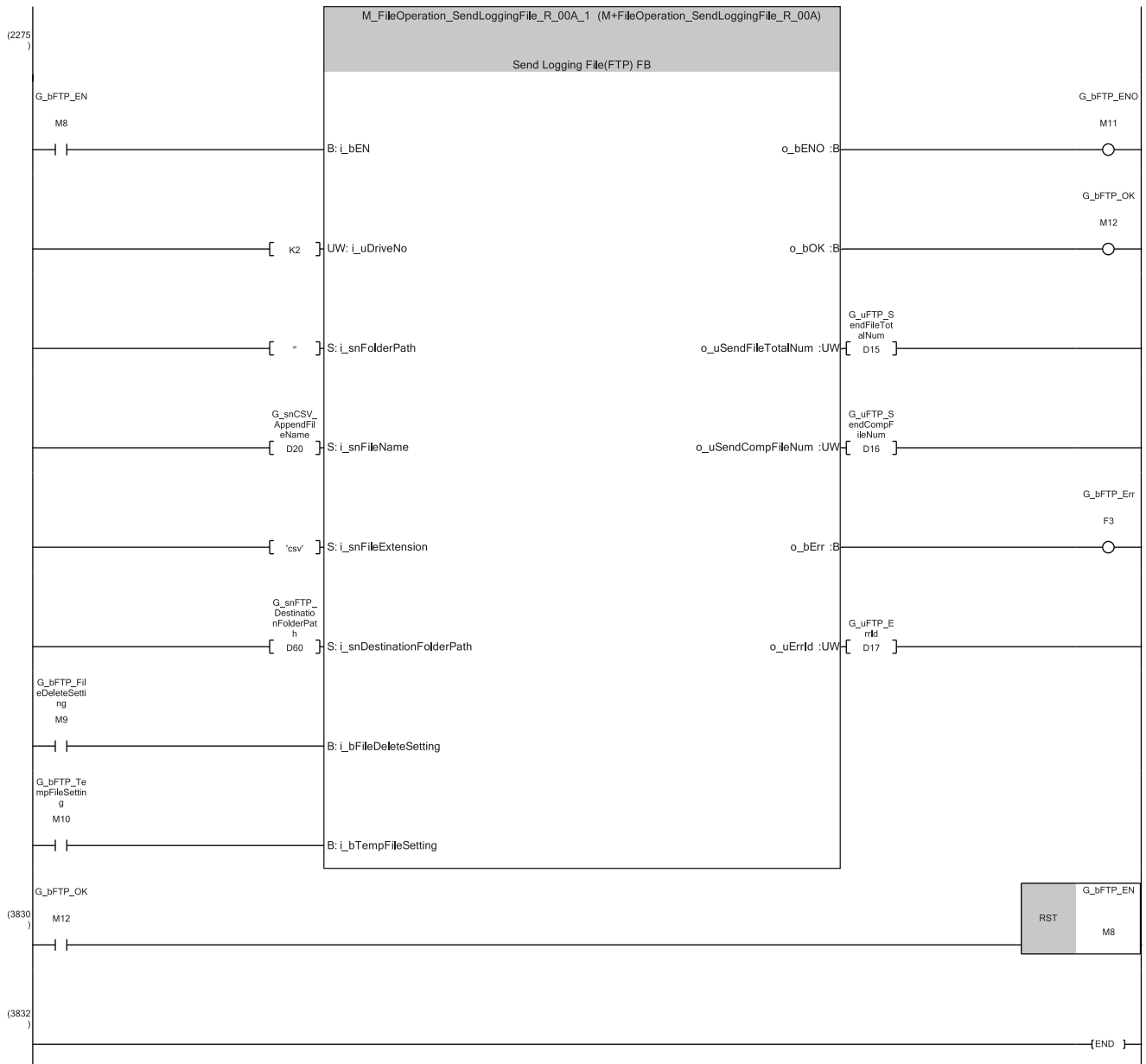

(0) The initial value is set.

(29)The logging data is recorded in the file register area.

(595)The logging data in the file register area is stored in the SD memory card in the CSV format.

(2375)The CSV files in the SD memory card are transferred to the FTP server.

APPENDIX

Appendix 1 CSV File Output Format

The following table shows the format specifications of CSV files stored using M+FileOperation_SaveLoggingCSV_W_R.

Item	Description
Delimiter	Comma (,)
Line feed code	CRLF (0DH, 0AH)
Character code	ASCII
File size	158888967 bytes at maximum*1

*1 The file size is maximum when i_uCHNum (number of channels) is 1, i_udSavePoints (number of save points) is 10000000, and logging data is a negative 5-digit value.

The following figure is an example of how output contents are arranged in the rows and columns after a write to a CSV file.

[LOGGING]		2	3	4	
INDEX	SHORT[DEC.0]	SHORT[DEC.0]	SHORT[DEC.0]	SHORT[DEC.0]	TRIGGER[*]
INDEX	CH1	CH2	CH3	CH4	Trigger
1	-5000	-10000	10000	20000	
2	-4998	-9996	9996	19992	
3	-4996	-9992	9992	19984	
4	-4994	-9988	9988	19976	
5	-4992	-9984	9984	19968	
...	
4996	4990	9980	-9980	-19960	
4997	4992	9984	-9984	-19968	
4998	4994	9988	-9988	-19976	
4999	4996	9992	-9982	-19984	
5000	4998	9996	-9996	-19992	

(3) (4) (5)

- (1) Header row
- (2) Data row
- (3) Index column
- (4) Data column
- (5) Trigger generation information column



Header row

■File information row

Information related to the CSV file is described.

Column No.	Item	Output content	Size (byte)
Column 1	File type	[LOGGING]	9
Column 2	(Blank)	—	0
Column 3	Data type information row number	2 (row number of the data type information row from the beginning of the file)	1
Column 4	Data name row number	3 (row number of the data name row from the beginning of the file)	1
Column 5	Data start row number	4 (row number of the data start row from the beginning of the file)	1

■Data information row

Data type of each column is described. The data type of each column is output in the format of "Data type"[Added information].

Column No.	Item	Output content of "Data type"	Size (byte)	Output content of "[Added information]"	Size (byte)
Column 1	Index column	INDEX	5	—	0
Column 2	Data column ^{*1}	SHORT (signed 16-bit integer specification)	5	[DEC.0] (decimal format specification)	7
Column 3					
Column 4					
Column 5					
Column 6	Trigger generation information column	TRIGGER	7	[*] (specification of the use of "*" as a generated character)	3

*1 The number of data columns differs depending on the number of channels.

■Data name row

Data name of each column is described. The data name of each column is output in the format of "Data name".

Column No.	Item	Output content	Size (byte)
Column 1	Index column	INDEX	5
Column 2	Data column ^{*1}	CHn (A value of 1 to 4 is stored in n.)	3
Column 3			
Column 4			
Column 5			
Column 6	Trigger generation information column	Trigger	7

*1 The number of data columns differs depending on the number of channels.

Data row

Data of each column is described. The data of each column is output in the format of "Data".

Item	Description	Size (byte) ^{*1}
Index column	After 1 is output, the increment values are output in order.	1 to 8
Data column	Logging data is output.	1 to 6
Trigger generation information column	—	0

*1 The size differs depending on the number of digits of data. One digit requires one byte.

MEMO

A

INSTRUCTION INDEX

M

M+FileOperation_SaveLoggingCSV_W_R.....	8
M+FileOperation_SendLoggingFile_R.....	16

MEMO

REVISIONS

*The manual number is given on the bottom left of the back cover.

Revision date	*Manual number	Description
October 2020	BCN-P5999-1368-A	First edition
February 2023	BCN-P5999-1368-B	■Added FB M+FileOperation_SendLoggingFile_R ■Added or modified parts Section 1.1, Chapter 2, Chapter 3

Japanese manual number: BCN-P5999-1367-B

This manual confers no industrial property rights or any rights of any other kind, nor does it confer any patent licenses. Mitsubishi Electric Corporation cannot be held responsible for any problems involving industrial property rights which may occur as a result of using the contents noted in this manual.

© 2020 MITSUBISHI ELECTRIC CORPORATION

WARRANTY

Please confirm the following product warranty details before using this product.

1. Gratis Warranty Term and Gratis Warranty Range

If any faults or defects (hereinafter "Failure") found to be the responsibility of Mitsubishi occurs during use of the product within the gratis warranty term, the product shall be repaired at no cost via the sales representative or Mitsubishi Service Company.

However, if repairs are required onsite at domestic or overseas location, expenses to send an engineer will be solely at the customer's discretion. Mitsubishi shall not be held responsible for any re-commissioning, maintenance, or testing on-site that involves replacement of the failed module.

[Gratis Warranty Term]

The gratis warranty term of the product shall be for one year after the date of purchase or delivery to a designated place. Note that after manufacture and shipment from Mitsubishi, the maximum distribution period shall be six (6) months, and the longest gratis warranty term after manufacturing shall be eighteen (18) months. The gratis warranty term of repair parts shall not exceed the gratis warranty term before repairs.

[Gratis Warranty Range]

- (1) The range shall be limited to normal use within the usage state, usage methods and usage environment, etc., which follow the conditions and precautions, etc., given in the instruction manual, user's manual and caution labels on the product.
- (2) Even within the gratis warranty term, repairs shall be charged for in the following cases.
 1. Failure occurring from inappropriate storage or handling, carelessness or negligence by the user. Failure caused by the user's hardware or software design.
 2. Failure caused by unapproved modifications, etc., to the product by the user.
 3. When the Mitsubishi product is assembled into a user's device, Failure that could have been avoided if functions or structures, judged as necessary in the legal safety measures the user's device is subject to or as necessary by industry standards, had been provided.
 4. Failure that could have been avoided if consumable parts (battery, backlight, fuse, etc.) designated in the instruction manual had been correctly serviced or replaced.
 5. Failure caused by external irresistible forces such as fires or abnormal voltages, and Failure caused by force majeure such as earthquakes, lightning, wind and water damage.
 6. Failure caused by reasons unpredictable by scientific technology standards at time of shipment from Mitsubishi.
 7. Any other failure found not to be the responsibility of Mitsubishi or that admitted not to be so by the user.

2. Onerous repair term after discontinuation of production

- (1) Mitsubishi shall accept onerous product repairs for seven (7) years after production of the product is discontinued. Discontinuation of production shall be notified with Mitsubishi Technical Bulletins, etc.
- (2) Product supply (including repair parts) is not available after production is discontinued.

3. Overseas service

Overseas, repairs shall be accepted by Mitsubishi's local overseas FA Center. Note that the repair conditions at each FA Center may differ.

4. Exclusion of loss in opportunity and secondary loss from warranty liability

Regardless of the gratis warranty term, Mitsubishi shall not be liable for compensation to:

- (1) Damages caused by any cause found not to be the responsibility of Mitsubishi.
- (2) Loss in opportunity, lost profits incurred to the user by Failures of Mitsubishi products.
- (3) Special damages and secondary damages whether foreseeable or not, compensation for accidents, and compensation for damages to products other than Mitsubishi products.
- (4) Replacement by the user, maintenance of on-site equipment, start-up test run and other tasks.

5. Changes in product specifications

The specifications given in the catalogs, manuals or technical documents are subject to change without prior notice.

TRADEMARKS

Microsoft and Windows are either registered trademarks or trademarks of Microsoft Corporation in the United States and/or other countries.

Unicode is either a registered trademark or a trademark of Unicode, Inc. in the United States and other countries.

The company names, system names and product names mentioned in this manual are either registered trademarks or trademarks of their respective companies.

In some cases, trademark symbols such as [™] or [®] are not specified in this manual.

BCN-P5999-1368-B(2302)

mitsubishi electric corporation

HEAD OFFICE: TOKYO BLDG., 2-7-3, MARUNOUCHI, CHIYODA-KU, TOKYO 100-8310, JAPAN
NAGOYA WORKS: 1-14, YADA-MINAMI 5-CHOME, HIGASHI-KU, NAGOYA 461-8670, JAPAN

When exported from Japan, this manual does not require application to the
Ministry of Economy, Trade and Industry for service transaction permission.

Specifications subject to change without notice.