

Programmable Controller

MELSEC iQ-R
series

MELSEC iQ-R Ethernet, CC-Link IE, and
MELSECNET/H Function Block Reference



SAFETY PRECAUTIONS

(Read these precautions before using Mitsubishi Electric programmable controllers.)

Before using the products described under "Relevant products", please read this manual and the relevant manuals carefully and pay full attention to safety to handle the products correctly.

The precautions given in this manual are concerned with the products only. For the safety precautions of the programmable controller system, refer to the MELSEC iQ-R Module Configuration Manual.

In this manual, the safety precautions are classified into two levels: "⚠ WARNING" and "⚠ CAUTION".

 WARNING	Indicates that incorrect handling may cause hazardous conditions, resulting in death or severe injury.
 CAUTION	Indicates that incorrect handling may cause hazardous conditions, resulting in minor or moderate injury or property damage.

Under some circumstances, failure to observe the precautions given under "⚠ CAUTION" may lead to serious consequences.

Observe the precautions of both levels because they are important for personal and system safety.

Make sure that the end users read this manual and then keep the manual in a safe place for future reference.

CONDITIONS OF USE FOR THE PRODUCT

- (1) MELSEC programmable controller ("the PRODUCT") shall be used in conditions;
- i) where any problem, fault or failure occurring in the PRODUCT, if any, shall not lead to any major or serious accident; and
 - ii) where the backup and fail-safe function are systematically or automatically provided outside of the PRODUCT for the case of any problem, fault or failure occurring in the PRODUCT.
- (2) The PRODUCT has been designed and manufactured for the purpose of being used in general industries. MITSUBISHI ELECTRIC SHALL HAVE NO RESPONSIBILITY OR LIABILITY (INCLUDING, BUT NOT LIMITED TO ANY AND ALL RESPONSIBILITY OR LIABILITY BASED ON CONTRACT, WARRANTY, TORT, PRODUCT LIABILITY) FOR ANY INJURY OR DEATH TO PERSONS OR LOSS OR DAMAGE TO PROPERTY CAUSED BY the PRODUCT THAT ARE OPERATED OR USED IN APPLICATION NOT INTENDED OR EXCLUDED BY INSTRUCTIONS, PRECAUTIONS, OR WARNING CONTAINED IN MITSUBISHI ELECTRIC USER'S, INSTRUCTION AND/OR SAFETY MANUALS, TECHNICAL BULLETINS AND GUIDELINES FOR the PRODUCT.
- ("Prohibited Application")
- Prohibited Applications include, but not limited to, the use of the PRODUCT in;
- Nuclear Power Plants and any other power plants operated by Power companies, and/or any other cases in which the public could be affected if any problem or fault occurs in the PRODUCT.
 - Railway companies or Public service purposes, and/or any other cases in which establishment of a special quality assurance system is required by the Purchaser or End User.
 - Aircraft or Aerospace, Medical applications, Train equipment, transport equipment such as Elevator and Escalator, Incineration and Fuel devices, Vehicles, Manned transportation, Equipment for Recreation and Amusement, and Safety devices, handling of Nuclear or Hazardous Materials or Chemicals, Mining and Drilling, and/or other applications where there is a significant risk of injury to the public or property.
- Notwithstanding the above restrictions, Mitsubishi Electric may in its sole discretion, authorize use of the PRODUCT in one or more of the Prohibited Applications, provided that the usage of the PRODUCT is limited only for the specific applications agreed to by Mitsubishi Electric and provided further that no special quality assurance or fail-safe, redundant or other safety features which exceed the general specifications of the PRODUCTS are required. For details, please contact the Mitsubishi Electric representative in your region.
- (3) Mitsubishi Electric shall have no responsibility or liability for any problems involving programmable controller trouble and system trouble caused by DoS attacks, unauthorized access, computer viruses, and other cyberattacks.

INTRODUCTION

Thank you for purchasing the Mitsubishi Electric MELSEC iQ-R series programmable controllers.

This manual describes the module function blocks for the relevant products listed below.

Before using the products, please read this manual and the relevant manuals carefully and develop familiarity with the functions and performance of the MELSEC iQ-R series programmable controller to handle the products correctly.

When applying the program examples provided in this manual to an actual system, ensure the applicability and confirm that it will not cause system control problems.

Please make sure that the end users read this manual.

Relevant products

Item	Model
Ethernet-equipped module	RJ71EN71, R04ENCPU, R08ENCPU, R16ENCPU, R32ENCPU, R120ENCPU
CC-Link IE TSN master/local module	RJ71GN11-T2, RJ71GN11-SX
CC-Link IE TSN Plus master/local module	RJ71GN11-EIP
CC-Link IE Controller Network module	RJ71GP21-SX, RJ71GP21S-SX
CC-Link IE Field Network master/local module	RJ71GF11-T2
MELSECNET/H network module	RJ71LP21-25, RJ71BR11

CONTENTS

SAFETY PRECAUTIONS	1
CONDITIONS OF USE FOR THE PRODUCT	2
INTRODUCTION	2
RELEVANT MANUALS	6
TERMS	7
GENERIC TERMS AND ABBREVIATIONS	8
CHAPTER 1 OVERVIEW	9
1.1 Function Block (FB) List	9
1.2 How to Obtain	10
1.3 System Configuration	11
CHAPTER 2 Ethernet-EQUIPPED MODULE FB	15
2.1 M+model_DeviceRead	15
2.2 M+model_DeviceWrite	20
2.3 M+model_Send	26
2.4 M+model_Recv	32
2.5 M+model_RemoteStopRun	37
2.6 M+model_ReadTime	42
2.7 M+model_WriteTime	46
2.8 M+model_ConnectionOpen	51
2.9 M+model_ConnectionClose	56
2.10 M+model_Recv_Socket	59
2.11 M+model_Send_Socket	62
2.12 M+model_Refresh_Data	65
2.13 M+model_SLMP_DeviceRead_IP	67
2.14 M+model_SLMP_DeviceWrite_IP	73
CHAPTER 3 CC-Link IE TSN MASTER/LOCAL MODULE FB	79
3.1 M+model_DeviceRead	79
3.2 M+model_DeviceWrite	84
3.3 M+model_Send	91
3.4 M+model_Recv	97
3.5 M+model_RemoteStopRun	102
3.6 M+model_SLMP_DeviceRead_IP	108
3.7 M+model_SLMP_DeviceWrite_IP	115
3.8 M+model_SetAddress	122
3.9 M+model_SetParameterX	125
3.10 M+model_RemoteRead	132
3.11 M+model_RemoteWrite	137
3.12 M+model_RemoteReset_IP	142
3.13 M+model_RemoteReset2_IP	147
CHAPTER 4 CC-Link IE TSN Plus MASTER/LOCAL MODULE FB	151
4.1 M+model_DeviceRead	151
4.2 M+model_DeviceWrite	152
4.3 M+model_Send	153
4.4 M+model_Recv	154

4.5	M+model_RemoteStopRun.....	155
4.6	M+model_SLMP_DeviceRead_IP.....	156
4.7	M+model_SLMP_DeviceWrite_IP.....	157
4.8	M+model_RemoteRead.....	158
4.9	M+model_RemoteWrite.....	159
4.10	M+model_RemoteReset_IP.....	160
4.11	M+model_RemoteReset2_IP.....	161
4.12	M+model_ConnectionOpen.....	162
4.13	M+model_ConnectionClose.....	165
4.14	M+model_Recv_Socket.....	167
4.15	M+model_Send_Socket.....	170
4.16	M+model_Refresh_Data.....	172

CHAPTER 5 CC-Link IE Controller Network-EQUIPPED MODULE FB 174

5.1	M+model_DeviceRead.....	174
5.2	M+model_DeviceWrite.....	175
5.3	M+model_Send.....	176
5.4	M+model_Recv.....	177
5.5	M+model_RemoteStopRun.....	178
5.6	M+model_ReadTime.....	179
5.7	M+model_WriteTime.....	180
5.8	M+model_StationNoSet.....	181
5.9	M+model_RedundantSystem_GetAddress.....	184

CHAPTER 6 CC-Link IE Field Network-EQUIPPED MASTER/LOCAL MODULE FB 188

6.1	M+model_DeviceRead.....	188
6.2	M+model_DeviceWrite.....	189
6.3	M+model_Send.....	190
6.4	M+model_Recv.....	191
6.5	M+model_RemoteStopRun.....	192
6.6	M+model_ReadTime.....	193
6.7	M+model_WriteTime.....	194
6.8	M+model_SetParameter.....	195
6.9	M+model_SetParameterRedundant.....	201
6.10	M+model_StationNoSet.....	207
6.11	M+model_RedundantSystem_GetAddress.....	208
6.12	M+model_ReadSystemTypeInfoInformation.....	209
6.13	M+model_ReadSystemStatusInformation.....	213
6.14	M+model_RemoteReset.....	217

CHAPTER 7 MELSECNET/H NETWORK MODULE FB 220

7.1	M+model_DeviceRead.....	220
7.2	M+model_DeviceWrite.....	221
7.3	M+model_Send.....	222
7.4	M+model_Recv.....	223
7.5	M+model_RemoteStopRun.....	224
7.6	M+model_ReadTime.....	225
7.7	M+model_WriteTime.....	226
7.8	M+model_RedundantSystem_GetAddress.....	227

INSTRUCTION INDEX

229

REVISIONS231
TRADEMARKS232

RELEVANT MANUALS

Manual name [manual number]	Description	Available form
MELSEC iQ-R Ethernet, CC-Link IE, and MELSECNET/H Function Block Reference [BCN-P5999-0381] (this manual)	Specifications of the module FBs of the following: <ul style="list-style-type: none"> • MELSEC iQ-R Ethernet-equipped module • CC-Link IE TSN master/local module • CC-Link IE TSN Plus master/local module • CC-Link IE Controller Network module • CC-Link IE Field Network master/local module • MELSECNET/H network module 	e-Manual PDF
MELSEC iQ-R Programming Manual (Module Dedicated Instructions) [SH-081976ENG]	Dedicated instructions for the intelligent function modules	e-Manual PDF
MELSEC iQ-R CPU Module User's Manual (Application) [SH-081264ENG]	Memory, functions, devices, and parameters of the CPU module	Print book e-Manual PDF
MELSEC iQ-R Ethernet User's Manual (Application) [SH-081257ENG]	Functions, parameter settings, programming, troubleshooting, I/O signals, and buffer memory of Ethernet	Print book e-Manual PDF
MELSEC iQ-R CC-Link IE TSN User's Manual (Application) [SH-082129ENG]	Functions, parameter settings, troubleshooting, I/O signals, and buffer memory of CC-Link IE TSN	Print book e-Manual PDF
MELSEC iQ-R CC-Link IE TSN Plus Master/Local Module User's Manual [SH-082472ENG]	Specifications, procedures before operation, system configuration, wiring, functions, parameter settings, programming, troubleshooting, I/O signals, and buffer memory of the CC-Link IE TSN Plus master/local module	Print book e-Manual PDF
MELSEC iQ-R CC-Link IE Controller Network User's Manual (Application) [SH-081258ENG]	Functions, parameter settings, troubleshooting, and buffer memory of CC-Link IE Controller Network	Print book e-Manual PDF
MELSEC iQ-R CC-Link IE Field Network User's Manual (Application) [SH-081259ENG]	Functions, parameter settings, programming, troubleshooting, I/O signals, and buffer memory of CC-Link IE Field Network	Print book e-Manual PDF
MELSEC iQ-R MELSECNET/H Network Module User's Manual (Application) [SH-082204ENG]	Functions, parameter settings, programming, troubleshooting, and buffer memory of MELSEC iQ-R MELSECNET/H network module	Print book e-Manual PDF

Point

e-Manual refers to the Mitsubishi Electric FA electronic book manuals that can be browsed using a dedicated tool.

e-Manual has the following features:

- Required information can be cross-searched in multiple manuals.
- Other manuals can be accessed from the links in the manual.
- The hardware specifications of each part can be found from the product figures.
- Pages that users often browse can be bookmarked.
- Sample programs can be copied to an engineering tool.

TERMS

Unless otherwise specified, this manual uses the following terms.

Term	Description
Engineering tool	A tool used for setting up programmable controllers, programming, debugging, and maintenance
Module label	A label that represents one of memory areas (I/O signals and buffer memory areas) specific to each module in a given character string. For the module used, GX Works3 automatically generates this label, which can be used as a global label.

GENERIC TERMS AND ABBREVIATIONS

Unless otherwise specified, this manual uses the following generic terms and abbreviations.

Generic term/abbreviation	Description
CC-Link IE Controller Network-equipped module	An RJ71GP21-SX CC-Link IE Controller Network module, an RJ71GP21S-SX CC-Link IE Controller Network module, and the following modules when the CC-Link IE Controller Network function is used: <ul style="list-style-type: none">• RJ71EN71• RnENCPU (network part)
CC-Link IE Field Network-equipped master/local module	An RJ71GF11-T2 CC-Link IE Field Network master/local module and the following modules when the CC-Link IE Field Network function is used: <ul style="list-style-type: none">• RJ71EN71• RnENCPU (network part)
Ethernet-equipped module	A generic term for the following modules when the Ethernet function is used: <ul style="list-style-type: none">• RJ71EN71• RnENCPU (network part)
MELSECNET/H	An abbreviation for the MELSECNET/H network system
RnENCPU (network part)	A module on the right-hand side of the RnENCPU (📖 MELSEC iQ-R Ethernet/CC-Link IE User's Manual (Startup))

1 OVERVIEW

The FBs described in this reference are module FBs (for GX Works3) to be used in the MELSEC iQ-R series network modules and the Ethernet function of the CPU module.

1.1 Function Block (FB) List

This section lists the module FBs described in this reference. An FB name ends in the FB version information such as "_00A"; however, this reference manual leaves out it.

The following symbols represent network modules.

- Ethernet: Ethernet-equipped module
- CCIETSN: CC-Link IE TSN master/local module (T2: RJ71GN11-T2, SX: RJ71GN11-SX)
- CCIETSN Plus: CC-Link IE TSN Plus master/local module
- CCIEC: CC-Link IE Controller Network-equipped module
- CCIEF: CC-Link IE Field Network-equipped master/local module
- NET/H: MELSECNET/H network module

○: Available, —: Not available

Name	Description	Ethernet	CCIETSN	CCIETSN Plus	CCIEC	CCIEF	NET/H
M+model_DeviceRead	Reads data by specifying a device in the programmable controller of another station.	○	○	○	○	○	○
M+model_DeviceWrite	Writes data by specifying a device in the programmable controller of another station.	○	○	○	○	○	○
M+model_Send	Sends data to the programmable controller of another station.	○	○	○	○	○	○
M+model_Recv	Reads the data received from the programmable controller of another station.	○	○	○	○	○	○
M+model_RemoteStopRun	Sends a remote STOP/RUN request to the programmable controller of another station.	○	○	○	○	○	○
M+model_ReadTime	Reads clock data from the programmable controller of another station to adjust the time of the programmable controller CPU of own station.	○	—	—	○	○	○
M+model_WriteTime	Writes the clock data of the programmable controller of own station to another station to adjust the time of the programmable controller CPU of another station.	○	—	—	○	○	○
M+model_ConnectionOpen	Opens (establishes) a connection.	○	—	○	—	—	—
M+model_ConnectionClose	Closes (disconnects) the connection.	○	—	○	—	—	—
M+model_Recv_Socket	Reads the data received from the external device through socket communication or fixed buffer communication.	○	—	○	—	—	—
M+model_Send_Socket	Sends data to the external device through socket communication or fixed buffer communication.	○	—	○	—	—	—
M+model_Refresh_Data	Transfers module label data.	○	—	○	—	—	—
M+model_SLMP_DeviceRead_IP	Reads data from the SLMP-compatible device specified by an IP address.	○	○	○	—	—	—
M+model_SLMP_DeviceWrite_IP	Writes data to the SLMP-compatible device specified by an IP address.	○	○	○	—	—	—
M+model_SetAddress	Sets the station number or IP address for the own station.	—	○	—	—	—	—
M+model_SetParameterX	Sets parameters for a module.	—	T2: ○ SX: ×	—	—	—	—
M+model_RemoteRead	Reads data from the buffer memory of the remote station in units of words.	—	T2: ○ SX: ×	○	—	—	—
M+model_RemoteWrite	Writes data to the buffer memory of the remote station in units of words.	—	T2: ○ SX: ×	○	—	—	—

Name	Description	Ethernet	CCIETSN	CCIETSN Plus	CCIEC	CCIEF	NET/H
M+model_RemoteReset_IP	Sends the remote STOP of an SLMP request to the target station specified by an IP address and then sends the remote RESET.	—	○	○	—	—	—
M+model_RemoteReset2_IP	Sends the remote RESET of an SLMP request to the target station specified by an IP address.	—	○	○	—	—	—
M+model_SetParameter	Sets the parameters in the master, submaster, and local stations.	—	—	—	—	○	—
M+model_SetParameterRedundant	Sets the parameters in the master station in the redundant system.	—	—	—	—	○	—
M+model_StationNoSet	Sets the station number of the own station.	—	—	—	○	○	—
M+model_RedundantSystem_GetAddress	Identifies the control system or standby system in the target (another station) redundant system and acquires the address of the control system or standby system in the redundant system.	—	—	—	○	○	○ ^{*1}
M+model_ReadSystemTypeInformation	Reads the model information of the system configuration module of the intelligent device station (remote head module).	—	—	—	—	○	—
M+model_ReadSystemStatusInformation	Reads the status information of the system configuration module of the intelligent device station (remote head module).	—	—	—	—	○	—
M+model_RemoteReset	Sends a remote STOP request to the target station and then sends a remote RESET request.	—	—	—	—	○	—

*1 This FB cannot be used for the RJ71BR11.

1.2 How to Obtain

Module FBs are installed at the same time as installing GX Works3; however, the module FBs in this reference may not be installed with some versions of GX Works3. It is recommended to install the latest version of GX Works3.

1.3 System Configuration

The following shows the system configuration for using the module FBs in this reference. For the specifications of modules to be used, refer to the user's manual for each module.

Ethernet-equipped module

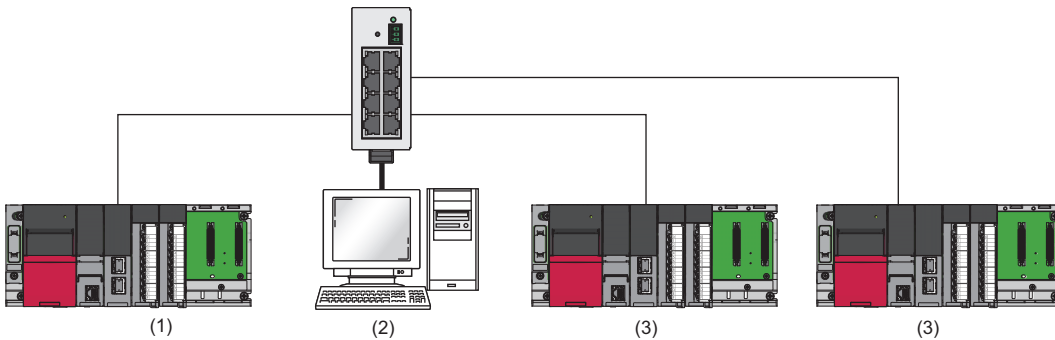

- (1) Own station
- (2) External device
- (3) Other stations

CC-Link IE TSN master/local module

■RJ71GN11-T2

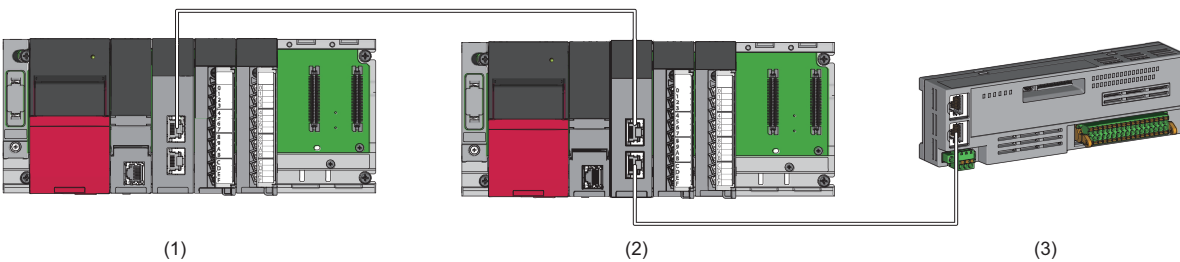

- (1) Own station
- (2) Another station
- (3) Remote I/O module or other devices

■RJ71GN11-SX

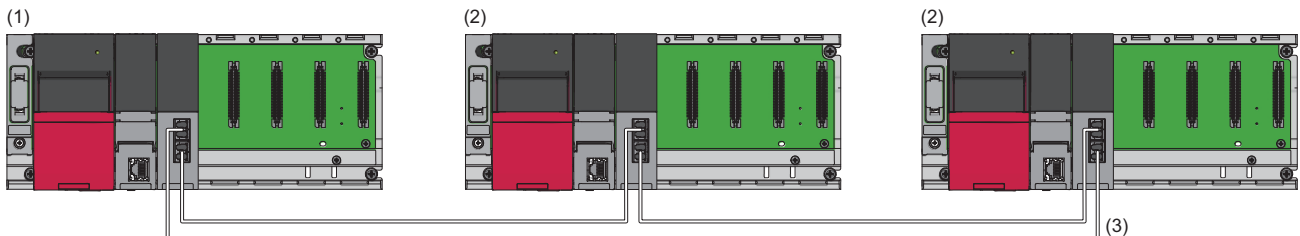

- (1) Master station
- (2) Local station
- (3) Network No.1

CC-Link IE TSN Plus master/local module

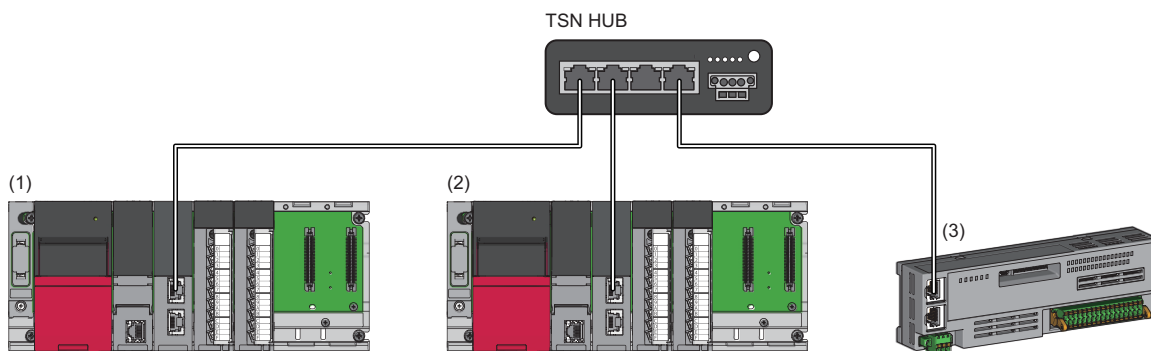

- (1) Own station
- (2) Another station
- (3) Remote I/O module or other devices

CC-Link IE Controller Network module

■When performing communications between the control station and normal station

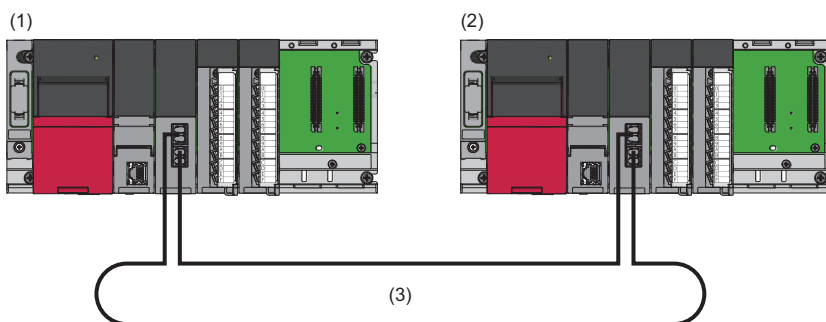

- (1) Control station
- (2) Normal station
- (3) Network No.1

■When performing communications between the control station and normal station in a redundant system

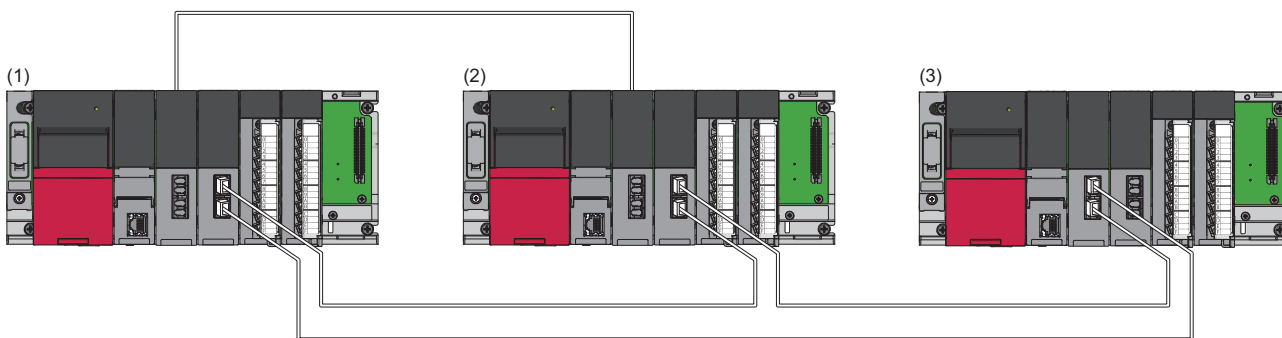

- (1) Control station (station No.1) in the control system (system A)
- (2) Normal station (station No.2) in the standby system (system B)
- (3) Normal station (station No.3)

CC-Link IE Field Network master/local module

■When performing communications between the master station and local station

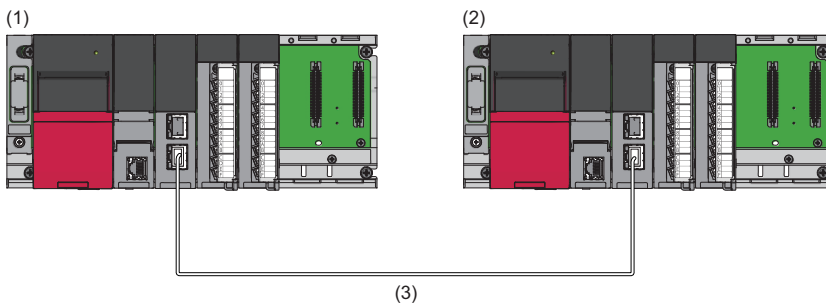

- (1) Master station
- (2) Local station
- (3) Network No.1

■When performing communications between the master station and intelligent device station (remote head module)

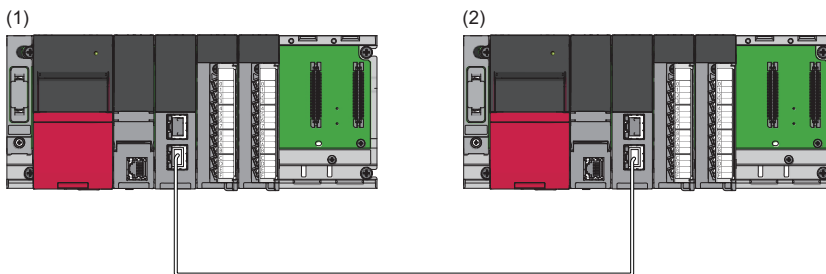

- (1) Master station
- (2) Intelligent device station

■When using the modules in the redundant master station configuration

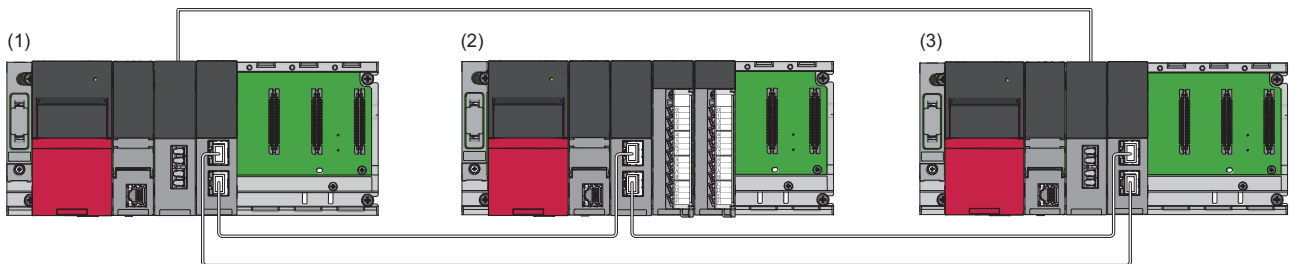

- (1) Master station (control system)
- (2) Slave station
- (3) Submaster station (standby system)

MELSECNET/H network module

■When performing communications between the control station and normal station

- Optical loop system

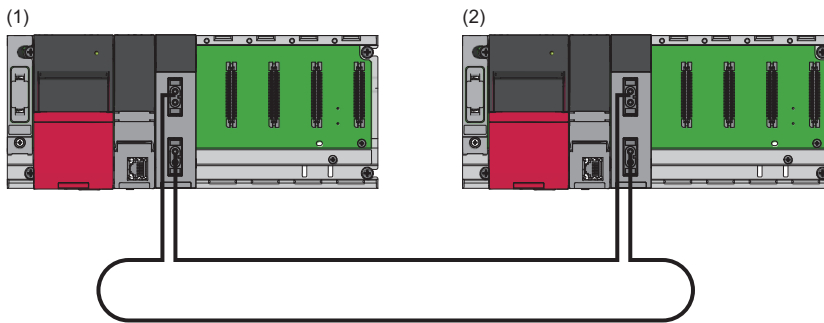

(1) Control station (station No.1)

(2) Normal station (station No.2)

- Coaxial bus system

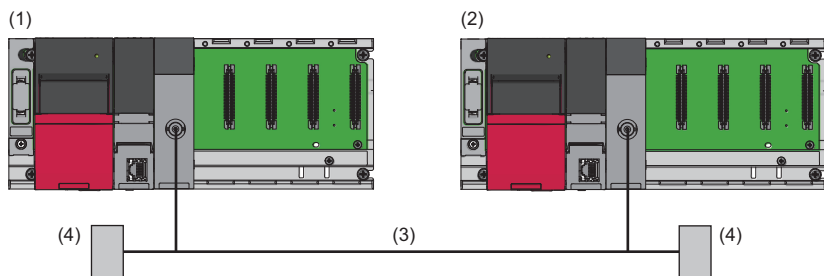

(1) Control station (station No.1)

(2) Normal station (station No.2)

(3) Coaxial bus system

(4) Terminating resistor

■When performing communications between the control station and normal station in a redundant system

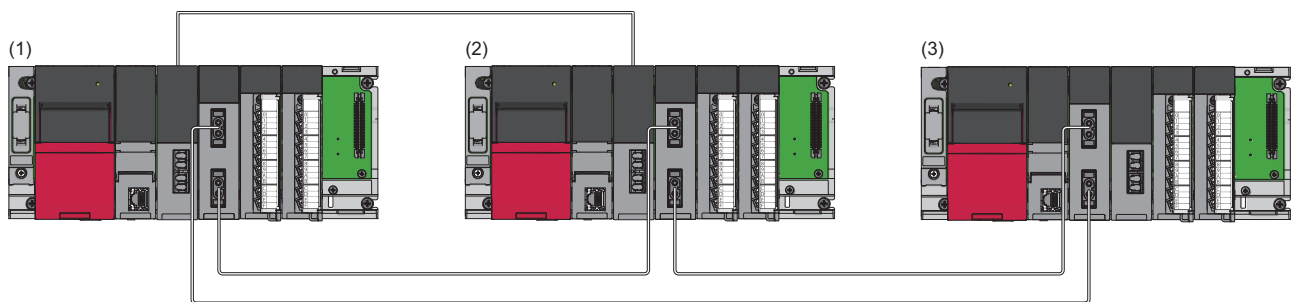

(1) Control station (station No.1) in the control system (system A)

(2) Normal station (station No.2) in the standby system (system B)

(3) Normal station (station No.3)

2 Ethernet-EQUIPPED MODULE FB

2.1 M+model_DeviceRead

Name

■RJ71EN71, RnENCPU (network part)

This FB is displayed as follows on the engineering tool depending on the settings.

Name	Module model name	
	RJ71EN71	RnENCPU (network part)
M+RJ71EN71_EE_DeviceRead	RJ71EN71(E+E)	—
M+RJ71EN71_C_DeviceRead	RJ71EN71(CCIEC)	_RJ71EN71(CCIEC)
M+RJ71EN71_EC_DeviceRead	RJ71EN71(E+CCIEC)	_RJ71EN71(E+IEC)
M+RJ71EN71_F_DeviceRead	RJ71EN71(CCIEF)	_RJ71EN71(CCIEF)
M+RJ71EN71_EF_DeviceRead	RJ71EN71(E+CCIEF)	_RJ71EN71(E+IEF)

■RJ71GP21(S)-SX

M+RJ71GP21_DeviceRead

■RJ71GF11-T2

M+RJ71GF11_DeviceRead

■RJ71LP21-25

M+RJ71LP21_DeviceRead

■RJ71BR11

M+RJ71BR11_DeviceRead

Overview

Item	Description																																																																																										
Overview	Reads data by specifying a device in the programmable controller of another station.																																																																																										
Symbol	<div style="border: 1px solid black; padding: 10px; margin: 10px 0;"> <p style="text-align: center;">M+RJ71GF11_DeviceRead</p> <table style="width: 100%; border-collapse: collapse;"> <tr> <td style="width: 5%; text-align: right;">(1) —</td> <td style="width: 40%;">B: i_bEN</td> <td style="width: 10%;"></td> <td style="width: 10%; text-align: left;">o_bENO: B</td> <td style="width: 5%;"></td> <td style="width: 20%; text-align: right;">(7)</td> </tr> <tr> <td style="text-align: right;">(2) —</td> <td>DUT: i_stModule</td> <td></td> <td style="text-align: left;">o_bOK: B</td> <td></td> <td style="text-align: right;">(8)</td> </tr> <tr> <td style="text-align: right;">(3) —</td> <td>UW: i_u2TargetAddress</td> <td></td> <td style="text-align: left;">o_bErr: B</td> <td></td> <td style="text-align: right;">(9)</td> </tr> <tr> <td style="text-align: right;">(4) —</td> <td>UW: i_uDataLength</td> <td></td> <td style="text-align: left;">o_uErrId: UW</td> <td></td> <td style="text-align: right;">(10)</td> </tr> <tr> <td style="text-align: right;">(5) —</td> <td>S: i_s32TargetDevice</td> <td></td> <td style="text-align: left;">o_uReadData: UW</td> <td></td> <td style="text-align: right;">(11)</td> </tr> <tr> <td style="text-align: right;">(6) —</td> <td>UW: i_uChannel</td> <td></td> <td></td> <td></td> <td></td> </tr> <tr> <td></td> <td style="padding-left: 20px;">pbi_uCPU_Type</td> <td style="text-align: right;">(12)</td> <td></td> <td></td> <td></td> </tr> <tr> <td></td> <td style="padding-left: 20px;">pbi_uResendCountMax</td> <td style="text-align: right;">(13)</td> <td></td> <td></td> <td></td> </tr> <tr> <td></td> <td style="padding-left: 20px;">pbi_uTimeUnit</td> <td style="text-align: right;">(14)</td> <td></td> <td></td> <td></td> </tr> <tr> <td></td> <td style="padding-left: 20px;">pbi_uMonitorTime</td> <td style="text-align: right;">(15)</td> <td></td> <td></td> <td></td> </tr> <tr> <td></td> <td style="padding-left: 20px;">pbi_bStationSpecific</td> <td style="text-align: right;">(16)</td> <td></td> <td></td> <td></td> </tr> <tr> <td></td> <td style="padding-left: 20px;">pbo_uResendCount</td> <td style="text-align: right;">(17)</td> <td></td> <td></td> <td></td> </tr> <tr> <td></td> <td style="padding-left: 20px;">pbo_u4ErrTime</td> <td style="text-align: right;">(18)</td> <td></td> <td></td> <td></td> </tr> <tr> <td></td> <td style="padding-left: 20px;">pbo_uErrNetworkNo</td> <td style="text-align: right;">(19)</td> <td></td> <td></td> <td></td> </tr> <tr> <td></td> <td style="padding-left: 20px;">pbo_uErrStationNo</td> <td style="text-align: right;">(20)</td> <td></td> <td></td> <td></td> </tr> </table> </div> <p>The above FB is an example for the RJ71GF11-T2.</p>	(1) —	B: i_bEN		o_bENO: B		(7)	(2) —	DUT: i_stModule		o_bOK: B		(8)	(3) —	UW: i_u2TargetAddress		o_bErr: B		(9)	(4) —	UW: i_uDataLength		o_uErrId: UW		(10)	(5) —	S: i_s32TargetDevice		o_uReadData: UW		(11)	(6) —	UW: i_uChannel						pbi_uCPU_Type	(12)					pbi_uResendCountMax	(13)					pbi_uTimeUnit	(14)					pbi_uMonitorTime	(15)					pbi_bStationSpecific	(16)					pbo_uResendCount	(17)					pbo_u4ErrTime	(18)					pbo_uErrNetworkNo	(19)					pbo_uErrStationNo	(20)			
(1) —	B: i_bEN		o_bENO: B		(7)																																																																																						
(2) —	DUT: i_stModule		o_bOK: B		(8)																																																																																						
(3) —	UW: i_u2TargetAddress		o_bErr: B		(9)																																																																																						
(4) —	UW: i_uDataLength		o_uErrId: UW		(10)																																																																																						
(5) —	S: i_s32TargetDevice		o_uReadData: UW		(11)																																																																																						
(6) —	UW: i_uChannel																																																																																										
	pbi_uCPU_Type	(12)																																																																																									
	pbi_uResendCountMax	(13)																																																																																									
	pbi_uTimeUnit	(14)																																																																																									
	pbi_uMonitorTime	(15)																																																																																									
	pbi_bStationSpecific	(16)																																																																																									
	pbo_uResendCount	(17)																																																																																									
	pbo_u4ErrTime	(18)																																																																																									
	pbo_uErrNetworkNo	(19)																																																																																									
	pbo_uErrStationNo	(20)																																																																																									

Labels

Input arguments

No.	Variable name	Name	Data type	Range	Description															
(1)	i_bEN	Execution command	Bit	—	On: Start FB. Off: Do not start FB.															
(2)	i_stModule	Module label	Structure	—	Specify the module for which the FB is to be executed. Specify the module label of the modules. (Example: EN71_EE_1, EN71_EF_1, EN71_F_1, GF11_1, GP21_1, LP21_1, BR11_1)															
(3)	i_u2TargetAddress	Target station address	Word [Unsigned]/ Bit String [16-bit] (0..1)	—	<p>Specify the network number and station number of the target station when "Target station address specification method" is off. When specifying the address using a label, use an array as the data type.</p> <ul style="list-style-type: none"> • 1st word: Network number (1 to 239) • 2nd word: Station number <p>Station number of Ethernet or CC-Link IE Controller Network</p> <ul style="list-style-type: none"> • 1 to 120 <p>Station number of CC-Link IE Field Network</p> <ul style="list-style-type: none"> • 125: Master station • 126: Master operating station • 1 to 120: Local station, remote device station, intelligent device station, submaster station <p>Station number of MELSECNET/H</p> <ul style="list-style-type: none"> • 1 to 64 <p>Specify the IP address of the target station when "Target station address specification method" is on (Ethernet only). Specify the third and fourth octets to the 1st word, and first and second octets to the 2nd word. When specifying the address using a label, use an array as the data type.</p> <ul style="list-style-type: none"> • 0000001H to FFFFFFFEH <p>Note that the fourth octet cannot be set to 0 or 255 (FFH).</p> <table border="1" style="margin-left: 40px;"> <tr> <td></td> <td style="text-align: center;">b15</td> <td style="text-align: center;">b8</td> <td style="text-align: center;">b7</td> <td style="text-align: center;">b0</td> </tr> <tr> <td>+0</td> <td style="text-align: center;">3</td> <td style="text-align: center;">4</td> <td colspan="2"></td> </tr> <tr> <td>+1</td> <td style="text-align: center;">1</td> <td style="text-align: center;">2</td> <td colspan="2"></td> </tr> </table> <p>1 to 4: IP address octet</p>		b15	b8	b7	b0	+0	3	4			+1	1	2		
	b15	b8	b7	b0																
+0	3	4																		
+1	1	2																		
(4)	i_uDataLength	Read data length	Word [Unsigned]/ Bit String [16-bit]	—	<p>Specify the number of words to be read.</p> <ul style="list-style-type: none"> • When reading data from RCP, QCPU, or LCP: 1 to 8192 words • When reading data from QnACP: 1 to 480 words <p>When specifying 961 words or more, specify 9 or 10 in "Own station channel".</p>															
(5)	i_s32TargetDevice	Target station read device	Character string (32)	—	<p>Specify the start address of the target station from which data is to be read. The following cannot be specified as an argument. Specifying any of the following may cause a CPU error (2820H: Device/label/buffer memory specification incorrect).</p> <ul style="list-style-type: none"> • Dynamically specified array elements (Example: wLabel[D0]) • Digit-specified labels (Example: K4bLabel) • Indirectly specified devices (Example: @W0) • Local devices (Example: #D0) 															
(6)	i_uChannel	Own station channel	Word [Unsigned]/ Bit String [16-bit]	—	<p>Specify the channel to be used by the own station.</p> <p> MELSEC iQ-R Programming Manual (Module Dedicated Instructions)</p>															

Output arguments

No.	Variable name	Name	Data type	Description	Default value
(7)	o_bENO	Execution status	Bit	On: The execution command is turned on. Off: The execution command is turned off.	Off
(8)	o_bOK	Normal completion	Bit	The FB has been processed normally when this argument is on.	Off
(9)	o_bErr	Error completion	Bit	The FB has been processed abnormally when this argument is on.	Off
(10)	o_uErrId	Error code	Word [Unsigned]/ Bit String [16-bit]	An error code is stored at error completion.	0
(11)	o_uReadData	Read data storage device	Word [Unsigned]/ Bit String [16-bit]	Specify the start number of the device for storing the read data The following cannot be specified as an argument. Specifying any of the following may cause a CPU error (2820H: Device/label/buffer memory specification incorrect). <ul style="list-style-type: none"> • Dynamically specified array elements (Example: wLabel[D0]) • Digit-specified labels (Example: K4bLabel) • Indirectly specified devices (Example: @W0) • Local devices (Example: #D0) 	0

Operation parameters

No.	Variable name	Name	Data type	Range	Description	Default value
(12)	pbi_uCPU_Type	Target station CPU type	Word [Unsigned]/Bit String [16-bit]	0000H, 03D0H to 03D3H, 03E0H to 03E3H, 03FFH	Specify the CPU type of the target station. <ul style="list-style-type: none"> • 0000H: To CPU of target station (control CPU) • 03D0H: To control system CPU • 03D1H: To standby system CPU • 03D2H: To system A CPU • 03D3H: To system B CPU • 03E0H: To multiple CPU No.1 • 03E1H: To multiple CPU No.2 • 03E2H: To multiple CPU No.3 • 03E3H: To multiple CPU No.4 • 03FFH: To CPU of target station (control CPU) 	0
(13)	pbi_uResendCountMax	Maximum number of resends	Word [Unsigned]/Bit String [16-bit]	0 to 15	Specify the number of resends to be performed if the data transfer is not completed within the monitoring time specified by "Arrival monitoring time". <ul style="list-style-type: none"> • 0 to 15 	5
(14)	pbi_uTimeUnit	Arrival monitoring time unit	Word [Unsigned]/Bit String [16-bit]	0, 1	Specify the unit of the "Arrival monitoring time". <ul style="list-style-type: none"> • 0: 1s • 1: 100ms 	0
(15)	pbi_uMonitorTime	Arrival monitoring time (Ethernet)	Word [Unsigned]/Bit String [16-bit]	—	Specify the monitoring time until completion of processing. If "Arrival monitoring time unit" is set to 1s, specify the TCP resend timer value or a greater value for the monitoring time until completion of processing. If the processing is not completed within the monitoring time, data is resent until the value specified in "Maximum number of resends" is reached. <ul style="list-style-type: none"> • 0 to TCP resend timer value: Time represented by "TCP resend timer value" • Effective range ("TCP resend timer value" + 1) to 16383: ("TCP resend timer value" + 1) seconds to 16383s When "Arrival monitoring time unit" is set to 100ms <ul style="list-style-type: none"> • Effective range 1 to 65535: 1 to 65535 × 100ms 	0
		Arrival monitoring time (CC-Link IE Controller Network, CC-Link IE Field Network, MELSECNET/H)		—	Specify the monitoring time until completion of processing. If the processing is not completed within the monitoring time, data is resent until the value specified in "Maximum number of resends" is reached. When "Arrival monitoring time unit" is set to 1s <ul style="list-style-type: none"> • Effective range 1 to 32767: 1s to 32767s When "Arrival monitoring time unit" is set to 100ms <ul style="list-style-type: none"> • Effective range 1 to 65535: 1 to 65535 × 100ms 	0: 10s

No.	Variable name	Name	Data type	Range	Description	Default value
(16)	pbi_bStationSpecific	Target station address specification method	Bit	On or off	Specify the specification method of a target station. <ul style="list-style-type: none"> • Off: Use the network number and station number. • On: Use the IP address (IPv4). (Ethernet only). 	Off

Public variables

No.	Variable name	Name	Data type	Description	Default value
(17)	pbo_uResendCount	Number of resends	Word [Unsigned]/Bit String [16-bit]	The number of resends performed (result) is stored.	0
(18)	pbo_u4ErrTime	Error occurrence time	Word [Unsigned]/Bit String [16-bit] (0..3)	Clock data at the time of error occurrence is stored. 1st word <ul style="list-style-type: none"> • Upper 8 bits: Month (01H to 12H) • Lower 8 bits: Lower 2 digits of year (00H to 99H) 2nd word <ul style="list-style-type: none"> • Upper 8 bits: Hour (00H to 23H) • Lower 8 bits: Day (01H to 31H) 3rd word <ul style="list-style-type: none"> • Upper 8 bits: Second (00H to 59H) • Lower 8 bits: Minute (00H to 59H) 4th word <ul style="list-style-type: none"> • Upper 8 bits: Upper 2 digits of year (00H to 99H) • Lower 8 bits: Day of week (00H (Sunday) to 06H (Saturday)) 	0
(19)	pbo_uErrNetworkNo	Error detection network number	Word [Unsigned]/Bit String [16-bit]	The network number of the station in which an error was detected is stored.	0
(20)	pbo_uErrStationNo	Error-detected station number	Word [Unsigned]/Bit String [16-bit]	The station number of the station in which an error was detected is stored. Station number of Ethernet or CC-Link IE Controller Network <ul style="list-style-type: none"> • 1 to 120 Station number of CC-Link IE Field Network <ul style="list-style-type: none"> • 125: Master station • 1 to 120: Local station, remote device station, intelligent device station, submaster station Station number of MELSECNET/H <ul style="list-style-type: none"> • 1 to 64 	0

FB details

Item	Description
Available device	Target module <ul style="list-style-type: none"> • RJ71GF11-T2 • RJ71GP21(S)-SX • RJ71EN71 • RnENCPU (network part) • RJ71LP21-25 • RJ71BR11
	CPU module RCPU
	Engineering tool GX Works3
Language	Ladder diagram
Number of basic steps	85 steps The number of steps of the FB embedded in a program depends on the CPU module used, the input/output definitions, and the option settings of GX Works3. For the option settings of GX Works3, refer to GX Works3 Operating Manual.
Processing	When i_bEN (execution command) is turned on, this function reads device data from another station.
FB compilation method	Macro type
FB operation	Pulse type (multiple-scan execution type)
Input condition for FB_EN	None

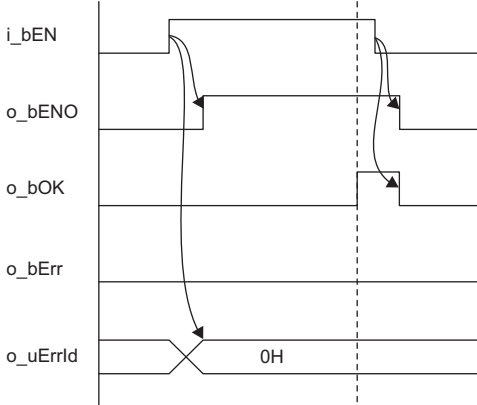
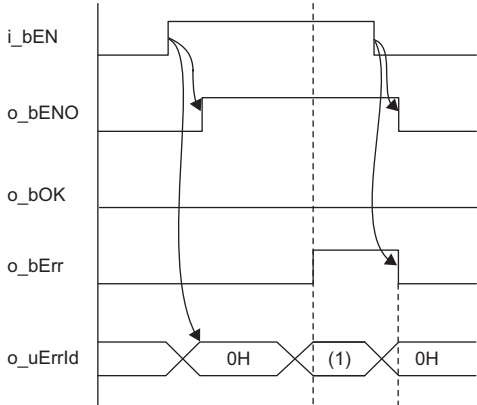
Item	Description
Timing chart of I/O signals	<ul style="list-style-type: none"> For normal completion  <ul style="list-style-type: none"> For error completion (same as in the case of a module error)  <p>(1) Error code</p>
Precautions	<ul style="list-style-type: none"> This FB does not include error recovery processing. Please create error recovery processing separately according to the system and required operations. This FB uses the GP.READ instruction. Turn off i_bEN (execution command) after o_bOK (normal completion) or o_bErr (error completion) is turned on. By turning off i_bEN (execution command), o_bOK (normal completion) or o_bErr (error completion) is turned off and o_uErrld (error code) is cleared to 0. This FB uses the label initial value by each program. When the program file using this FB is specified to boot file setting for the boot operation in the CPU module, specify the initial label value file by each program to the boot file setting as well. (MELSEC iQ-R CPU Module User's Manual (Application)) If an error code that is not described in Page 19 Error codes appears, the initial label value files by each program may not be set to the boot file setting. In this case, specify the initial label value files by each program to the boot file setting. When this FB is executed, an operation error may occur in the programmable controller CPU. In this case, check the detailed information of the operation error in event history and correct the input argument of the module FB.

Error codes

Error code	Reference
4000H to 4FFFH	MELSEC iQ-R CPU Module User's Manual (Application)
6F00H to 6FFFH	
C000H to CFFFH	MELSEC iQ-R Ethernet User's Manual (Application)
D000H to DFFFH	MELSEC iQ-R CC-Link IE Field Network User's Manual (Application)
E000H to EFFFH	MELSEC iQ-R CC-Link IE Controller Network User's Manual (Application)
F000H to FFFFH	MELSEC iQ-R MELSECNET/H Network Module User's Manual (Application)

2.2 M+model_DeviceWrite

Name

■RJ71EN71, RnENCPU (network part)

This FB is displayed as follows on the engineering tool depending on the settings.

Name	Module model name	
	RJ71EN71	RnENCPU (network part)
M+RJ71EN71_EE_DeviceWrite	RJ71EN71(E+E)	—
M+RJ71EN71_C_DeviceWrite	RJ71EN71(CCIEC)	_RJ71EN71(CCIEC)
M+RJ71EN71_EC_DeviceWrite	RJ71EN71(E+CCIEC)	_RJ71EN71(E+IEC)
M+RJ71EN71_F_DeviceWrite	RJ71EN71(CCIEF)	_RJ71EN71(CCIEF)
M+RJ71EN71_EF_DeviceWrite	RJ71EN71(E+CCIEF)	_RJ71EN71(E+IEF)

■RJ71GP21(S)-SX

M+RJ71GP21_DeviceWrite

■RJ71GF11-T2

M+RJ71GF11_DeviceWrite

■RJ71LP21-25

M+RJ71LP21_DeviceWrite

■RJ71BR11

M+RJ71BR11_DeviceWrite

Overview

Item	Description																																				
Overview	Writes data by specifying a device in the programmable controller of another station.																																				
Symbol	<div style="border: 1px solid black; padding: 10px; margin: 10px 0;"> <p style="text-align: center;">M+RJ71GF11_DeviceWrite</p> <table style="width: 100%; border-collapse: collapse;"> <tr> <td style="width: 50%;">(1) — B: i_bEN</td> <td style="width: 50%;">o_bENO: B — (8)</td> </tr> <tr> <td>(2) — DUT: i_stModule</td> <td>o_bOK: B — (9)</td> </tr> <tr> <td>(3) — UW: i_u2TargetAddress</td> <td>o_bErr: B — (10)</td> </tr> <tr> <td>(4) — UW: i_uDataLength</td> <td>o_uErrId: UW — (11)</td> </tr> <tr> <td>(5) — UW: i_uWriteData</td> <td></td> </tr> <tr> <td>(6) — S: i_s32TargetDevice</td> <td></td> </tr> <tr> <td>(7) — UW: i_uChannel</td> <td></td> </tr> </table> <table style="width: 100%; border-collapse: collapse;"> <tr><td style="width: 50%;">pbi_uCPU_Type</td><td>(12)</td></tr> <tr><td>pbi_uTargetStation</td><td>(13)</td></tr> <tr><td>pbi_bArrivalConfirm</td><td>(14)</td></tr> <tr><td>pbi_uResendCountMax</td><td>(15)</td></tr> <tr><td>pbi_uTimeUnit</td><td>(16)</td></tr> <tr><td>pbi_uMonitorTime</td><td>(17)</td></tr> <tr><td>pbi_bStationSpecific</td><td>(18)</td></tr> <tr><td>pbo_uResendCount</td><td>(19)</td></tr> <tr><td>pbo_u4ErrTime</td><td>(20)</td></tr> <tr><td>pbo_uErrNetworkNo</td><td>(21)</td></tr> <tr><td>pbo_uErrStationNo</td><td>(22)</td></tr> </table> </div> <p>The above FB is an example for the RJ71GF11-T2.</p>	(1) — B: i_bEN	o_bENO: B — (8)	(2) — DUT: i_stModule	o_bOK: B — (9)	(3) — UW: i_u2TargetAddress	o_bErr: B — (10)	(4) — UW: i_uDataLength	o_uErrId: UW — (11)	(5) — UW: i_uWriteData		(6) — S: i_s32TargetDevice		(7) — UW: i_uChannel		pbi_uCPU_Type	(12)	pbi_uTargetStation	(13)	pbi_bArrivalConfirm	(14)	pbi_uResendCountMax	(15)	pbi_uTimeUnit	(16)	pbi_uMonitorTime	(17)	pbi_bStationSpecific	(18)	pbo_uResendCount	(19)	pbo_u4ErrTime	(20)	pbo_uErrNetworkNo	(21)	pbo_uErrStationNo	(22)
(1) — B: i_bEN	o_bENO: B — (8)																																				
(2) — DUT: i_stModule	o_bOK: B — (9)																																				
(3) — UW: i_u2TargetAddress	o_bErr: B — (10)																																				
(4) — UW: i_uDataLength	o_uErrId: UW — (11)																																				
(5) — UW: i_uWriteData																																					
(6) — S: i_s32TargetDevice																																					
(7) — UW: i_uChannel																																					
pbi_uCPU_Type	(12)																																				
pbi_uTargetStation	(13)																																				
pbi_bArrivalConfirm	(14)																																				
pbi_uResendCountMax	(15)																																				
pbi_uTimeUnit	(16)																																				
pbi_uMonitorTime	(17)																																				
pbi_bStationSpecific	(18)																																				
pbo_uResendCount	(19)																																				
pbo_u4ErrTime	(20)																																				
pbo_uErrNetworkNo	(21)																																				
pbo_uErrStationNo	(22)																																				

Labels

Input arguments

No.	Variable name	Name	Data type	Range	Description															
(1)	i_bEN	Execution command	Bit	—	On: Start FB. Off: Do not start FB.															
(2)	i_stModule	Module label	Structure	—	Specify the module for which the FB is to be executed. Specify the module label of the modules. (Example: EN71_EE_1, EN71_EF_1, EN71_F_1, GF11_1, GP21_1, LP21_1, BR11_1)															
(3)	i_u2TargetAddress	Target station address	Word [Unsigned]/ Bit String [16-bit] (0..1)	—	<p>Specify the network number and station number of the target station when "Target station address specification method" is off. When specifying the numbers using a label, use an array as the data type.</p> <p>■When "Target station specification method" is set to 0 to specify a station number</p> <ul style="list-style-type: none"> • 1st word: Network number (1 to 239) • 2nd word: Station number <p>Station number of Ethernet or CC-Link IE Controller Network</p> <ul style="list-style-type: none"> • 1 to 120 <p>Station number of CC-Link IE Field Network</p> <ul style="list-style-type: none"> • 125: Master station • 126: Master operating station • 1 to 120: Local station, remote device station, intelligent device station, submaster station <p>Station number of MELSECNET/H</p> <ul style="list-style-type: none"> • 1 to 64 <p>■When "Target station specification method" is set to 1 to specify a group</p> <ul style="list-style-type: none"> • 1st word: Network number (1 to 239) • 2nd word: Transient transmission group number (1 to 32) <p>■When "Target station specification method" is set to 2 to specify all stations</p> <ul style="list-style-type: none"> • 1st word: Network number (1 to 239) • 2nd word: 0 (The setting is ignored.) <p>Specify the IP address of the target station when "Target station address specification method" is on (Ethernet only). Specify the third and fourth octets to the 1st word, and first and second octets to the 2nd word. When specifying the address using a label, use an array as the data type.</p> <ul style="list-style-type: none"> • 00000001H to FFFFFFFEH <p>Note that the fourth octet cannot be set to 0 or 255 (FFH).</p> <table border="1" style="margin-left: auto; margin-right: auto;"> <tr> <td></td> <td style="text-align: center;">b15</td> <td style="text-align: center;">b8</td> <td style="text-align: center;">b7</td> <td style="text-align: center;">b0</td> </tr> <tr> <td>+0</td> <td style="text-align: center;">3</td> <td style="text-align: center;">4</td> <td colspan="2"></td> </tr> <tr> <td>+1</td> <td style="text-align: center;">1</td> <td colspan="2" style="text-align: center;">2</td> <td></td> </tr> </table> <p>1 to 4: IP address octet</p>		b15	b8	b7	b0	+0	3	4			+1	1	2		
	b15	b8	b7	b0																
+0	3	4																		
+1	1	2																		
(4)	i_uDataLength	Write data length	Word [Unsigned]/ Bit String [16-bit]	—	<p>Specify the number of words to be written.</p> <ul style="list-style-type: none"> • When writing to RCP, QCP, or LCP: 1 to 8192 words • When writing to QnACP: 1 to 480 words <p>When specifying 961 words or more, specify 9 or 10 in "Own station channel".</p>															
(5)	i_uWriteData	Write data storage device	Word [Unsigned]/ Bit String [16-bit]	—	<p>Specify the start device of own station containing the write data. The following cannot be specified as an argument. Specifying any of the following may cause a CPU error (2820H: Device/label/buffer memory specification incorrect).</p> <ul style="list-style-type: none"> • Dynamically specified array elements (Example: wLabel[D0]) • Digit-specified labels (Example: K4bLabel) • Indirectly specified devices (Example: @W0) • Local devices (Example: #D0) 															
(6)	i_s32TargetDevice	Target station write device	Character string (32)	—	<p>Specify the start device of the target station to which data is to be written. The following cannot be specified as an argument. Specifying any of the following may cause a CPU error (2820H: Device/label/buffer memory specification incorrect).</p> <ul style="list-style-type: none"> • Dynamically specified array elements (Example: wLabel[D0]) • Digit-specified labels (Example: K4bLabel) • Indirectly specified devices (Example: @W0) • Local devices (Example: #D0) 															

No.	Variable name	Name	Data type	Range	Description
(7)	i_uChannel	Own station channel	Word [Unsigned]/ Bit String [16-bit]	—	Specify the channel to be used by the own station. [] MELSEC iQ-R Programming Manual (Module Dedicated Instructions)

■Output arguments

No.	Variable name	Name	Data type	Description	Default value
(8)	o_bENO	Execution status	Bit	On: The execution command is turned on. Off: The execution command is turned off.	Off
(9)	o_bOK	Normal completion	Bit	The FB has been processed normally when this argument is on.	Off
(10)	o_bErr	Error completion	Bit	The FB has been processed abnormally when this argument is on.	Off
(11)	o_uErrId	Error code	Word [Unsigned]/ Bit String [16-bit]	An error code is stored at error completion.	0

■Operation parameters

No.	Variable name	Name	Data type	Range	Description	Default value
(12)	pbi_uCPU_Type	Target station CPU type	Word [Unsigned]/ Bit String [16-bit]	0000H, 03D0H to 03D3H, 03E0H to 03E3H, 03FFH	Specify the CPU type of the target station. <ul style="list-style-type: none"> • 0000H: To CPU of target station (control CPU) • 03D0H: To control system CPU • 03D1H: To standby system CPU • 03D2H: To system A CPU • 03D3H: To system B CPU • 03E0H: To multiple CPU No.1 • 03E1H: To multiple CPU No.2 • 03E2H: To multiple CPU No.3 • 03E3H: To multiple CPU No.4 • 03FFH: To CPU of target station (control CPU) 	0
(13)	pbi_uTargetStation	Target station specification method	Word [Unsigned]/ Bit String [16-bit]	0 to 2	Specify the specification method of a target station. <ul style="list-style-type: none"> • 0: Station number specification → Station with the station number specified in "Target station address" • 1: Group specification (only when "OFF (No)" is specified in "Arrival acknowledgment") → All stations of the transient transmission group number specified in "Arrival station address" (For the CC-Link IE Field Network, the value 1 cannot be specified.) • 2: All stations (only when "OFF (No)" is specified in "Arrival acknowledgment") → All stations of the network number specified in "Arrival station address" (broadcast excluding own station) 	0

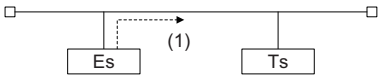
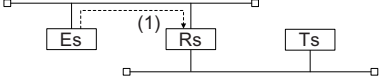
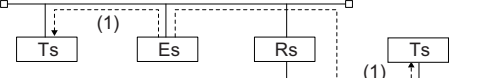
No.	Variable name	Name	Data type	Range	Description	Default value
(14)	pbi_bArrivalConfirm	Arrival acknowledgment	Bit	On or off	<p>Specify whether to use arrival acknowledgment.</p> <p>■Off: No check</p> <ul style="list-style-type: none"> When the target station is within the own network, sending data from the own station completes the sending.  <p>(1) Completion Es: Execution source Ts: Target station</p> <ul style="list-style-type: none"> When the target station is within another network, data arrival to the relay station within the own network completes the sending.  <p>(1) Completion Es: Execution source Rs: Relay station Ts: Target station</p> <p>■On: Check Sending data is completed when the data is written to the target station.</p>  <p>(1) Completion Es: Execution source Rs: Relay station Ts: Target station</p>	Off
(15)	pbi_uResendCountMax	Maximum number of resends	Word [Unsigned]/ Bit String [16-bit]	0 to 15	<p>Specify the number of resends to be performed if the data transfer is not completed within the monitoring time specified by "Arrival monitoring time".</p> <ul style="list-style-type: none"> 0 to 15 	5
(16)	pbi_uTimeUnit	Arrival monitoring time unit	Word [Unsigned]/ Bit String [16-bit]	0, 1	<p>Specify the unit of the "Arrival monitoring time".</p> <ul style="list-style-type: none"> 0: 1s 1: 100ms 	0
(17)	pbi_uMonitorTime	Arrival monitoring time (Ethernet)	Word [Unsigned]/ Bit String [16-bit]	—	<p>Specify the monitoring time until completion of processing. If "Arrival monitoring time unit" is set to 1s, specify the TCP resend timer value or a greater value for the monitoring time until completion of processing. If the processing is not completed within the monitoring time, data is resent until the value specified in "Maximum number of resends" is reached.</p> <ul style="list-style-type: none"> 0 to TCP resend timer value: Time represented by "TCP resend timer value" Effective range ("TCP resend timer value" + 1) to 16383: ("TCP resend timer value" + 1) seconds to 16383s <p>When "Arrival monitoring time unit" is set to 100ms</p> <ul style="list-style-type: none"> Effective range 1 to 65535: 1 to 65535 × 100ms 	0
		Arrival monitoring time (CC-Link IE Controller Network, CC-Link IE Field Network, MELSECNET/H)		—	<p>Specify the monitoring time until completion of processing. If the processing is not completed within the monitoring time, data is resent until the value specified in "Maximum number of resends" is reached.</p> <p>When "Arrival monitoring time unit" is set to 1s</p> <ul style="list-style-type: none"> Effective range 1 to 32767: 1s to 32767s <p>When "Arrival monitoring time unit" is set to 100ms</p> <ul style="list-style-type: none"> Effective range 1 to 65535: 1 to 65535 × 100ms 	0: 10s
(18)	pbi_bStationSpecific	Target station address specification method	Bit	On or off	<p>Specify the specification method of a target station.</p> <ul style="list-style-type: none"> Off: Use the network number and station number. On: Use the IP address (IPv4). (Ethernet only). 	Off

Public variables

No.	Variable name	Name	Data type	Description	Default value
(19)	pbo_uResendCount	Number of resends	Word [Unsigned]/Bit String [16-bit]	The number of resends performed (result) is stored.	0
(20)	pbo_u4ErrTime	Error occurrence time	Word [Unsigned]/Bit String [16-bit] (0..3)	Clock data at the time of error occurrence is stored. 1st word • Upper 8 bits: Month (01H to 12H) • Lower 8 bits: Lower 2 digits of year (00H to 99H) 2nd word • Upper 8 bits: Hour (00H to 23H) • Lower 8 bits: Day (01H to 31H) 3rd word • Upper 8 bits: Second (00H to 59H) • Lower 8 bits: Minute (00H to 59H) 4th word • Upper 8 bits: Upper 2 digits of year (00H to 99H) • Lower 8 bits: Day of week (00H (Sunday) to 06H (Saturday))	0
(21)	pbo_uErrNetworkNo	Error detection network number	Word [Unsigned]/Bit String [16-bit]	The network number of the station in which an error was detected is stored.	0
(22)	pbo_uErrStationNo	Error-detected station number	Word [Unsigned]/Bit String [16-bit]	The station number of the station in which an error was detected is stored. Station number of Ethernet or CC-Link IE Controller Network • 1 to 120 Station number of CC-Link IE Field Network • 125: Master station • 1 to 120: Local station, remote device station, intelligent device station, submaster station Station number of MELSECNET/H • 1 to 64	0

FB details

Item	Description
Available device	Target module <ul style="list-style-type: none"> • RJ71GF11-T2 • RJ71GP21(S)-SX • RJ71EN71 • RnENCPU (network part) • RJ71LP21-25 • RJ71BR11
	CPU module RCPU
	Engineering tool GX Works3
Language	Ladder diagram
Number of basic steps	90 steps The number of steps of the FB embedded in a program depends on the CPU module used, the input/output definitions, and the option settings of GX Works3. For the option settings of GX Works3, refer to GX Works3 Operating Manual.
Processing	When i_bEN (execution instruction) is turned on, this function writes device data to another station.
FB compilation method	Macro type
FB operation	Pulse type (multiple-scan execution type)
Input condition for FB_EN	None

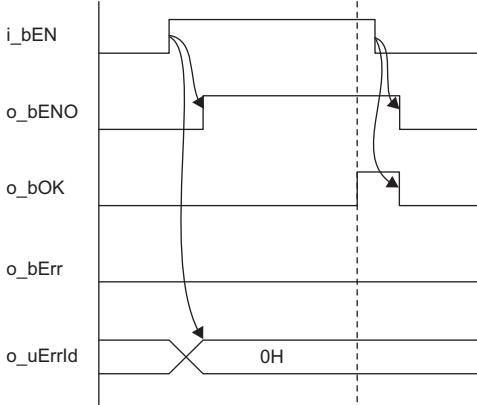
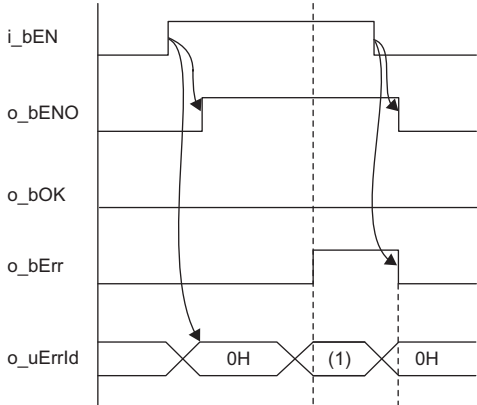
Item	Description
Timing chart of I/O signals	<ul style="list-style-type: none"> For normal completion  <ul style="list-style-type: none"> For error completion (same as in the case of a module error)  <p>(1) Error code</p>
Precautions	<ul style="list-style-type: none"> This FB does not include error recovery processing. Please create error recovery processing separately according to the system and required operations. This FB uses the GP.WRITE instruction. Turn off i_bEN (execution command) after o_bOK (normal completion) or o_bErr (error completion) is turned on. By turning off i_bEN (execution command), o_bOK (normal completion) or o_bErr (error completion) is turned off and o_uErrld (error code) is cleared to 0. This FB uses the label initial value by each program. When the program file using this FB is specified to boot file setting for the boot operation in the CPU module, specify the initial label value file by each program to the boot file setting as well. (MELSEC iQ-R CPU Module User's Manual (Application)) If an error code that is not described in Page 25 Error codes appears, the initial label value files by each program may not be set to the boot file setting. In this case, specify the initial label value files by each program to the boot file setting. When this FB is executed, an operation error may occur in the programmable controller CPU. In this case, check the detailed information of the operation error in event history and correct the input argument of the module FB.

Error codes

Error code	Reference
4000H to 4FFFH	MELSEC iQ-R CPU Module User's Manual (Application)
6F00H to 6FFFH	
C000H to CFFFH	MELSEC iQ-R Ethernet User's Manual (Application)
D000H to DFFFH	MELSEC iQ-R CC-Link IE Field Network User's Manual (Application)
E000H to EFFFH	MELSEC iQ-R CC-Link IE Controller Network User's Manual (Application)
F000H to FFFFH	MELSEC iQ-R MELSECNET/H Network Module User's Manual (Application)

2.3 M+model_Send

Name

■RJ71EN71, RnENCPU (network part)

This FB is displayed as follows on the engineering tool depending on the settings.

Name	Module model name	
	RJ71EN71	RnENCPU (network part)
M+RJ71EN71_EE_Send	RJ71EN71(E+E)	—
M+RJ71EN71_C_Send	RJ71EN71(CCIEC)	_RJ71EN71(CCIEC)
M+RJ71EN71_EC_Send	RJ71EN71(E+CCIEC)	_RJ71EN71(E+IEC)
M+RJ71EN71_F_Send	RJ71EN71(CCIEF)	_RJ71EN71(CCIEF)
M+RJ71EN71_EF_Send	RJ71EN71(E+CCIEF)	_RJ71EN71(E+IEF)

■RJ71GP21(S)-SX

M+RJ71GP21_Send

■RJ71GF11-T2

M+RJ71GF11_Send

■RJ71LP21-25

M+RJ71LP21_Send

■RJ71BR11

M+RJ71BR11_Send

Overview

Item	Description
Overview	Sends data to the programmable controller of another station.
Symbol	<p>The diagram shows a function block named M+RJ71GF11_Send. It has eight inputs on the left, numbered 1 to 8, and eight outputs on the right, numbered 9 to 12. The inputs are: (1) B: i_bEN, (2) DUT: i_stModule, (3) UW: i_uTargetNetworkNo, (4) UW: i_uTargetStationNo, (5) UW: i_uChannel, (6) UW: i_uTargetChannel, (7) UW: i_uDataLength, and (8) UW: i_uSendData. The outputs are: (9) o_bENO: B, (10) o_bOK: B, (11) o_bErr: B, and (12) o_uErrId: UW. Below the main diagram, there is a list of internal variables: pbi_uTargetStation (13), pbi_bArrivalConfirm (14), pbi_uResendCountMax (15), pbi_uMonitorTime (16), pbo_uResendCount (17), pbo_u4ErrTime (18), pbo_uErrNetworkNo (19), and pbo_uErrStationNo (20).</p> <p>The above FB is an example for the RJ71GF11-T2.</p>

Labels

Input arguments

No.	Variable name	Name	Data type	Range	Description
(1)	i_bEN	Execution command	Bit	—	On: Start FB. Off: Do not start FB.
(2)	i_stModule	Module label	Structure	—	Specify the module for which the FB is to be executed. Specify the module label of the modules. (Example: EN71_EE_1, EN71_EF_1, EN71_F_1, GF11_1, GP21_1, LP21_1, BR11_1)
(3)	i_uTargetNetworkNo	Target network number	Word [Unsigned]/ Bit String [16-bit]	1 to 239	Specify the network number of the target station.
(4)	i_uTargetStationNo	Target station number	Word [Unsigned]/ Bit String [16-bit]	—	Specify the station number of the target station or the transient transmission group number. <ul style="list-style-type: none"> ■When "Target station specification method" is set to 0 to specify a station number Station number of Ethernet or CC-Link IE Controller Network <ul style="list-style-type: none"> • 1 to 120 Station number of CC-Link IE Field Network <ul style="list-style-type: none"> • 125: Master station • 126: Master operating station • 1 to 120: Local station, remote device station, intelligent device station, submaster station Station number of MELSECNET/H <ul style="list-style-type: none"> • 1 to 64 ■When "Target station specification method" is set to 1 to specify a group Specify the transient transmission group number. <ul style="list-style-type: none"> • 1 to 32 ■When "Target station specification method" is set to 2 to specify all stations The setting is ignored.
(5)	i_uChannel	Own station channel	Word [Unsigned]/ Bit String [16-bit]	—	Specify the channel to be used by the own station. <ul style="list-style-type: none"> □ MELSEC iQ-R Programming Manual (Module Dedicated Instructions)
(6)	i_uTargetChannel	Target station data storage channel	Word [Unsigned]/ Bit String [16-bit]	1 to 8	Specify the channel of the target station for storing data. When the target station is a CC-Link IE Field Network master/local module, specify 1 or 2.
(7)	i_uDataLength	Send data length	Word [Unsigned]/ Bit String [16-bit]	—	Specify the number of words to be sent. <ul style="list-style-type: none"> • When the target station is RCP, QCPU, or LCP: 1 to 960 words • When the target station is QnACPU: 1 to 480 words
(8)	i_uSendData	Send data storage device	Word [Unsigned]/ Bit String [16-bit]	—	Specify the start device of own station containing the send data. The following cannot be specified as an argument. Specifying any of the following may cause a CPU error (2820H: Device/label/buffer memory specification incorrect). <ul style="list-style-type: none"> • Dynamically specified array elements (Example: wLabel[D0]) • Digit-specified labels (Example: K4bLabel) • Indirectly specified devices (Example: @W0) • Local devices (Example: #D0)

Output arguments

No.	Variable name	Name	Data type	Description	Default value
(9)	o_bENO	Execution status	Bit	On: The execution command is turned on. Off: The execution command is turned off.	Off
(10)	o_bOK	Normal completion	Bit	The FB has been processed normally when this argument is on.	Off
(11)	o_bErr	Error completion	Bit	The FB has been processed abnormally when this argument is on.	Off
(12)	o_uErrId	Error code	Word [Unsigned]/Bit String [16-bit]	An error code is stored at error completion.	0

■ Operation parameters

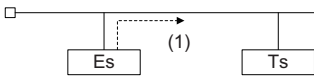
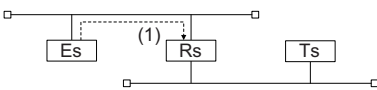
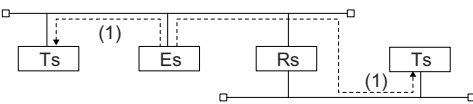
No.	Variable name	Name	Data type	Range	Description	Default value
(13)	pbi_uTargetStation	Target station specification method	Word [Unsigned]/ Bit String [16-bit]	0 to 2	Specify the specification method of a target station. <ul style="list-style-type: none"> • 0: Station number specification → Station with the station number specified in "Target station number" • 1: Group specification (only when "OFF (No)" is specified in "Arrival acknowledgment") → All stations of the transient transmission group number specified in "Target station number" (For the CC-Link IE Field Network, the value 1 cannot be specified.) • 2: All stations (only when "OFF (No)" is specified in "Arrival acknowledgment") → All stations of the network number specified in "Target network number" (broadcast excluding own station) 	0
(14)	pbi_bArrivalConfirm	Arrival acknowledgment	Bit	On or off	Specify whether to use arrival acknowledgment. <p>■Off: No check</p> <ul style="list-style-type: none"> • When the target station is within the own network, sending data from the own station completes the sending.  <p>(1) Completion Es: Execution source Ts: Target station</p> <ul style="list-style-type: none"> • When the target station is within another network, data arrival to the relay station within the own network completes the sending.  <p>(1) Completion Es: Execution source Rs: Relay station Ts: Target station</p> <p>■On: Check Sending data is completed when the data is written to the target station.</p>  <p>(1) Completion Es: Execution source Rs: Relay station Ts: Target station</p>	Off
(15)	pbi_uResendCountMax	Maximum number of resends	Word [Unsigned]/ Bit String [16-bit]	0 to 15	Specify the number of resends to be performed if the data transfer is not completed within the monitoring time specified by "Arrival monitoring time". <ul style="list-style-type: none"> • 0 to 15 	5
(16)	pbi_uMonitorTime	Arrival monitoring time (Ethernet)	Word [Unsigned]/ Bit String [16-bit]	0 to 16383	Specify the TCP resend timer value or a greater value for the monitoring time until completion of processing. If the processing is not completed within the monitoring time, data is resent until the value specified in "Maximum number of resends" is reached. <ul style="list-style-type: none"> • 0 to TCP resend timer value: Time represented by "TCP resend timer value" • ("TCP resend timer value" + 1) to 16383: ("TCP resend timer value" + 1) seconds to 16383s 	0
		Arrival monitoring time (CC-Link IE Controller Network, CC-Link IE Field Network, MELSECNET/H)		0, 1 to 32767	Specify the monitoring time until completion of processing. If the processing is not completed within the monitoring time, data is resent until the value specified in "Maximum number of resends" is reached. <ul style="list-style-type: none"> • 0: 10s • 1 to 32767: 1 to 32767s 	0

Public variables

No.	Variable name	Name	Data type	Description	Default value
(17)	pbo_uResendCount	Number of resends	Word [Unsigned]/Bit String [16-bit]	The number of resends performed (result) is stored.	0
(18)	pbo_u4ErrTime	Error occurrence time	Word [Unsigned]/Bit String [16-bit] (0..3)	<p>Clock data at the time of error occurrence is stored.</p> <p>1st word</p> <ul style="list-style-type: none"> • Upper 8 bits: Month (01H to 12H) • Lower 8 bits: Lower 2 digits of year (00H to 99H) <p>2nd word</p> <ul style="list-style-type: none"> • Upper 8 bits: Hour (00H to 23H) • Lower 8 bits: Day (01H to 31H) <p>3rd word</p> <ul style="list-style-type: none"> • Upper 8 bits: Second (00H to 59H) • Lower 8 bits: Minute (00H to 59H) <p>4th word</p> <ul style="list-style-type: none"> • Upper 8 bits: Upper 2 digits of year (00H to 99H) • Lower 8 bits: Day of week (00H (Sunday) to 06H (Saturday)) 	0
(19)	pbo_uErrNetworkNo	Error detection network number	Word [Unsigned]/Bit String [16-bit]	The network number of the station in which an error was detected is stored.	0
(20)	pbo_uErrStationNo	Error-detected station number	Word [Unsigned]/Bit String [16-bit]	<p>The station number of the station in which an error was detected is stored.</p> <p>Station number of Ethernet or CC-Link IE Controller Network</p> <ul style="list-style-type: none"> • 1 to 120 <p>Station number of CC-Link IE Field Network</p> <ul style="list-style-type: none"> • 125: Master station • 1 to 120: Local station, remote device station, intelligent device station, submaster station <p>Station number of MELSECNET/H</p> <ul style="list-style-type: none"> • 1 to 64 	0

FB details

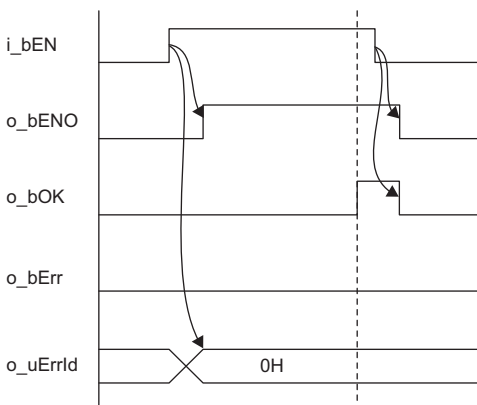
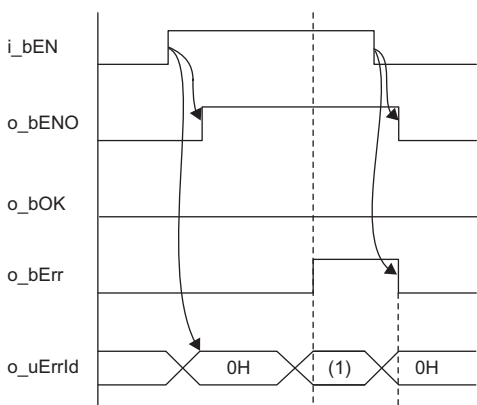
Item	Description	
Available device	Target module	<ul style="list-style-type: none"> • RJ71GF11-T2 • RJ71GP21(S)-SX • RJ71EN71 • RnENCPU (network part) • RJ71LP21-25 • RJ71BR11
	CPU module	RCPU
	Engineering tool	GX Works3
Language	Ladder diagram	
Number of basic steps	75 steps The number of steps of the FB embedded in a program depends on the CPU module used, the input/output definitions, and the option settings of GX Works3. For the option settings of GX Works3, refer to GX Works3 Operating Manual.	
Processing	When i_bEN (execution instruction) is turned on, this function sends a message to another station.	
FB compilation method	Macro type	
FB operation	Pulse type (multiple-scan execution type)	
Input condition for FB_EN	None	
Timing chart of I/O signals	<p>• For normal completion</p>  <p>• For error completion (same as in the case of a module error)</p>  <p>(1) Error code</p>	

Item	Description
Precautions	<ul style="list-style-type: none"> • This FB does not include error recovery processing. Please create error recovery processing separately according to the system and required operations. • This FB uses the GP.SEND instruction. • Turn off i_bEN (execution command) after o_bOK (normal completion) or o_bErr (error completion) is turned on. By turning off i_bEN (execution command), o_bOK (normal completion) or o_bErr (error completion) is turned off and o_uErrId (error code) is cleared to 0. • This FB uses the label initial value by each program. When the program file using this FB is specified to boot file setting for the boot operation in the CPU module, specify the initial label value file by each program to the boot file setting as well. (MELSEC iQ-R CPU Module User's Manual (Application)) If an error code that is not described in Page 31 Error codes appears, the initial label value files by each program may not be set to the boot file setting. In this case, specify the initial label value files by each program to the boot file setting. • When this FB is executed, an operation error may occur in the programmable controller CPU. In this case, check the detailed information of the operation error in event history and correct the input argument of the module FB.

Error codes

Error code	Reference
4000H to 4FFFH	MELSEC iQ-R CPU Module User's Manual (Application)
6F00H to 6FFFH	
C000H to CFFFH	MELSEC iQ-R Ethernet User's Manual (Application)
D000H to DFFFH	MELSEC iQ-R CC-Link IE Field Network User's Manual (Application)
E000H to EFFFH	MELSEC iQ-R CC-Link IE Controller Network User's Manual (Application)
F000H to FFFFH	MELSEC iQ-R MELSECNET/H Network Module User's Manual (Application)

2.4 M+model_Recv

Name

■RJ71EN71, RnENCPU (network part)

This FB is displayed as follows on the engineering tool depending on the settings.

Name	Module model name	
	RJ71EN71	RnENCPU (network part)
M+RJ71EN71_EE_Recv	RJ71EN71(E+E)	—
M+RJ71EN71_C_Recv	RJ71EN71(CCIEC)	_RJ71EN71(CCIEC)
M+RJ71EN71_EC_Recv	RJ71EN71(E+CCIEC)	_RJ71EN71(E+IEC)
M+RJ71EN71_F_Recv	RJ71EN71(CCIEF)	_RJ71EN71(CCIEF)
M+RJ71EN71_EF_Recv	RJ71EN71(E+CCIEF)	_RJ71EN71(E+IEF)

■RJ71GP21(S)-SX

M+RJ71GP21_Recv

■RJ71GF11-T2

M+RJ71GF11_Recv

■RJ71LP21-25

M+RJ71LP21_Recv

■RJ71BR11

M+RJ71BR11_Recv

Overview

Item	Description
Overview	Reads the data received from the programmable controller of another station.
Symbol	<p>The diagram shows a function block named M+RJ71GF11_Recv. It has three main inputs on the left: (1) B: i_bEN, (2) DUT: i_stModule, and (3) UW: i_uRecvChannel. It has six main outputs on the right: (4) o_bENO: B, (5) o_bOK: B, (6) o_bErr: B, (7) o_uErrId: UW, (8) o_uRecvDataLength: UW, and (9) o_uRecvData: UW. Below these are 18 internal parameters: pbi_bReadTiming (10), pbi_uMonitorTime (11), pbo_uResendCount (12), pbo_u4ErrTime (13), pbo_uErrNetworkNo (14), pbo_uErrStationNo (15), pbo_uSendNetworkNo (16), pbo_uSendStationNo (17), and pbo_uSendChannel (18).</p>
	The above FB is an example for the RJ71GF11-T2.

Labels

Input arguments

No.	Variable name	Name	Data type	Range	Description
(1)	i_bEN	Execution command	Bit	—	On: Start FB. Off: Do not start FB.
(2)	i_stModule	Module label	Structure	—	Specify the module for which the FB is to be executed. Specify the module label of the modules. (Example: EN71_EE_1, EN71_EF_1, EN71_F_1, GF11_1, GP21_1, LP21_1, BR11_1)
(3)	i_uRecvChannel	Receive data storage channel	Word [Unsigned]/Bit String [16-bit]	—	Specify the channel containing the data to be read.  MELSEC iQ-R Programming Manual (Module Dedicated Instructions)

Output arguments

No.	Variable name	Name	Data type	Description	Default value
(4)	o_bENO	Execution status	Bit	On: The execution command is turned on. Off: The execution command is turned off.	Off
(5)	o_bOK	Normal completion	Bit	The FB has been processed normally when this argument is on.	Off
(6)	o_bErr	Error completion	Bit	The FB has been processed abnormally when this argument is on.	Off
(7)	o_uErrId	Error code	Word [Unsigned]/Bit String [16-bit]	An error code is stored at error completion.	0
(8)	o_uRecvDataLength	Receive data length	Word [Unsigned]/Bit String [16-bit]	The number of received data is stored. • 1 to 960 words	0
(9)	o_uRecvData	Receive data storage device	Word [Unsigned]/Bit String [16-bit]	Specify the start number of the device for storing received data. The following cannot be specified as an argument. Specifying any of the following may cause a CPU error (2820H: Device/label/buffer memory specification incorrect). • Dynamically specified array elements (Example: wLabel[D0]) • Digit-specified labels (Example: K4bLabel) • Indirectly specified devices (Example: @W0) • Local devices (Example: #D0)	0

Operation parameters

No.	Variable name	Name	Data type	Range	Description	Default value
(10)	pbi_bReadTiming	Read timing	Bit	On	Specify the timing of executing data read processing. • On: Start reading in the first END processing after the module FB starts.	On
(11)	pbi_uMonitorTime	Arrival monitoring time (Ethernet)	Word [Unsigned]/Bit String [16-bit]	0 to 16383	Specify the TCP resend timer value or a greater value for the monitoring time until completion of processing (the setting is valid only when "Read timing" is on). When the processing is not completed normally within the monitoring time, the processing is completed with an error. • 0 to TCP resend timer value: Time represented by "TCP resend timer value" • ("TCP resend timer value" + 1) to 16383: ("TCP resend timer value" + 1) seconds to 16383s	0
		Arrival monitoring time (CC-Link IE Controller Network, CC-Link IE Field Network, MELSECNET/H)		0, 1 to 32767	Specify the monitoring time until completion of processing (the setting is valid only when "Read timing" is on). When the processing is not completed normally within the monitoring time, the processing is completed with an error. • 0: 10s • 1 to 32767: 1 to 32767s	0

■Public variables

No.	Variable name	Name	Data type	Description	Default value
(12)	pbo_uResendCount	Number of resends	Word [Unsigned]/ Bit String [16-bit]	The number of resends performed (result) is stored.	0
(13)	pbo_u4ErrTime	Error occurrence time	Word [Unsigned]/ Bit String [16-bit] (0..3)	Clock data at the time of error occurrence is stored. 1st word <ul style="list-style-type: none"> • Upper 8 bits: Month (01H to 12H) • Lower 8 bits: Lower 2 digits of year (00H to 99H) 2nd word <ul style="list-style-type: none"> • Upper 8 bits: Hour (00H to 23H) • Lower 8 bits: Day (01H to 31H) 3rd word <ul style="list-style-type: none"> • Upper 8 bits: Second (00H to 59H) • Lower 8 bits: Minute (00H to 59H) 4th word <ul style="list-style-type: none"> • Upper 8 bits: Upper 2 digits of year (00H to 99H) • Lower 8 bits: Day of week (00H (Sunday) to 06H (Saturday)) 	0
(14)	pbo_uErrNetworkNo	Error detection network number	Word [Unsigned]/ Bit String [16-bit]	The network number of the station in which an error was detected is stored.	0
(15)	pbo_uErrStationNo	Error-detected station number	Word [Unsigned]/ Bit String [16-bit]	The station number of the station in which an error was detected is stored. Station number of Ethernet or CC-Link IE Controller Network <ul style="list-style-type: none"> • 1 to 120 Station number of CC-Link IE Field Network <ul style="list-style-type: none"> • 125: Master station <ul style="list-style-type: none"> • 1 to 120: Local station, remote device station, intelligent device station, submaster station Station number of MELSECNET/H <ul style="list-style-type: none"> • 1 to 64 	0
(16)	pbo_uSendNetworkNo	Send station network number	Word [Unsigned]/ Bit String [16-bit]	The network number of the send station is stored.	0
(17)	pbo_uSendStationNo	Send station number	Word [Unsigned]/ Bit String [16-bit]	The station number of the send station is stored. Station number of Ethernet or CC-Link IE Controller Network <ul style="list-style-type: none"> • 1 to 120 Station number of CC-Link IE Field Network <ul style="list-style-type: none"> • 125: Master station <ul style="list-style-type: none"> • 1 to 120: Local station, remote device station, intelligent device station, submaster station Station number of MELSECNET/H <ul style="list-style-type: none"> • 1 to 64 	0
(18)	pbo_uSendChannel	Channel used by send station	Word [Unsigned]/ Bit String [16-bit]	The channel number used by the send station is stored. 1 to 8	0

FB details

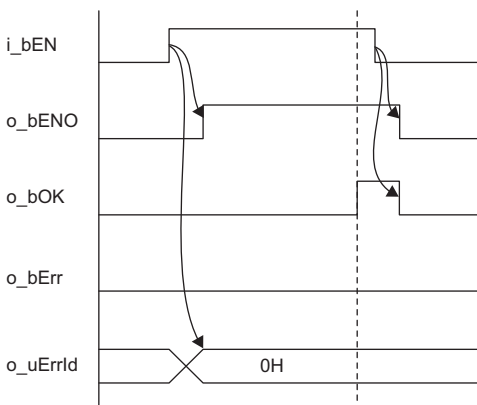
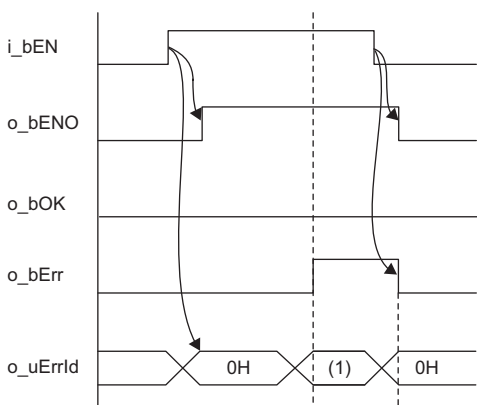
Item	Description	
Available device	Target module	<ul style="list-style-type: none"> • RJ71GF11-T2 • RJ71GP21(S)-SX • RJ71EN71 • RnENCPU (network part) • RJ71LP21-25 • RJ71BR11
	CPU module	RCPU
	Engineering tool	GX Works3
Language	Ladder diagram	
Number of basic steps	94 steps The number of steps of the FB embedded in a program depends on the CPU module used, the input/output definitions, and the option settings of GX Works3. For the option settings of GX Works3, refer to GX Works3 Operating Manual.	
Processing	When i_bEN (execution instruction) is turned on, this function receives a message from another station.	
FB compilation method	Macro type	
FB operation	Pulse type (multiple-scan execution type)	
Input condition for FB_EN	None	
Timing chart of I/O signals	<p>• For normal completion</p>  <p>• For error completion (same as in the case of a module error)</p>  <p>(1) Error code</p>	

Item	Description
Precautions	<ul style="list-style-type: none"> • This FB does not include error recovery processing. Please create error recovery processing separately according to the system and required operations. • This FB uses the GP.RECV instruction. • Turn off i_bEN (execution command) after o_bOK (normal completion) or o_bErr (error completion) is turned on. By turning off i_bEN (execution command), o_bOK (normal completion) or o_bErr (error completion) is turned off and o_uErrId (error code) is cleared to 0. • This FB uses the label initial value by each program. When the program file using this FB is specified to boot file setting for the boot operation in the CPU module, specify the initial label value file by each program to the boot file setting as well. (MELSEC iQ-R CPU Module User's Manual (Application)) If an error code that is not described in Page 36 Error codes appears, the initial label value files by each program may not be set to the boot file setting. In this case, specify the initial label value files by each program to the boot file setting. • When this FB is executed, an operation error may occur in the programmable controller CPU. In this case, check the detailed information of the operation error in event history and correct the input argument of the module FB.

Error codes

Error code	Reference
C000H to CFFFH	MELSEC iQ-R Ethernet User's Manual (Application)
D000H to DFFFH	MELSEC iQ-R CC-Link IE Field Network User's Manual (Application)
E000H to EFFFH	MELSEC iQ-R CC-Link IE Controller Network User's Manual (Application)
F000H to FFFFH	MELSEC iQ-R MELSECNET/H Network Module User's Manual (Application)

2.5 M+model_RemoteStopRun

Name

■RJ71EN71, RnENCPU (network part)

This FB is displayed as follows on the engineering tool depending on the settings.

Name	Module model name	
	RJ71EN71	RnENCPU (network part)
M+RJ71EN71_EE_RemoteStopRun	RJ71EN71(E+E)	—
M+RJ71EN71_C_RemoteStopRun	RJ71EN71(CCIEC)	_RJ71EN71(CCIEC)
M+RJ71EN71_EC_RemoteStopRun	RJ71EN71(E+CCIEC)	_RJ71EN71(E+IEC)
M+RJ71EN71_F_RemoteStopRun	RJ71EN71(CCIEF)	_RJ71EN71(CCIEF)
M+RJ71EN71_EF_RemoteStopRun	RJ71EN71(E+CCIEF)	_RJ71EN71(E+IEF)

■RJ71GP21(S)-SX

M+RJ71GP21_RemoteStopRun

■RJ71GF11-T2

M+RJ71GF11_RemoteStopRun

■RJ71LP21-25

M+RJ71LP21_RemoteStopRun

■RJ71BR11

M+RJ71BR11_RemoteStopRun

Overview

Item	Description
Overview	Sends a remote STOP/RUN request to the programmable controller of another station.

Symbol

M+RJ71GF11_RemoteStopRun

(1) B: i_bEN	o_bENO: B (7)
(2) DUT: i_stModule	o_bOK: B (8)
(3) UW: i_uTargetNetworkNo	o_bErr: B (9)
(4) UW: i_uTargetStationNo	o_uErrId: UW (10)
(5) UW: i_uChannel	
(6) UW: i_uRemoteType	

pbi_uCPU_Type (11)
pbi_uTargetStation (12)
pbi_uForciblyRun (13)
pbi_uDeviceClear (14)
pbi_uResendCountMax (15)
pbi_uMonitorTime (16)
pbo_uResendCount (17)
pbo_u4ErrTime (18)
pbo_uErrNetworkNo (19)
pbo_uErrStationNo (20)

The above FB is an example for the RJ71GF11-T2.

Labels

Input arguments

No.	Variable name	Name	Data type	Range	Description
(1)	i_bEN	Execution command	Bit	—	On: Start FB. Off: Do not start FB.
(2)	i_stModule	Module label	Structure	—	Specify the module for which the FB is to be executed. Specify the module label of the modules. (Example: EN71_EE_1, EN71_EF_1, EN71_F_1, GF11_1, GP21_1, LP21_1, BR11_1)
(3)	i_uTargetNetworkNo	Target network number	Word [Unsigned]/ Bit String [16-bit]	1 to 239	Specify the network number of the target station.
(4)	i_uTargetStationNo	Target station number	Word [Unsigned]/ Bit String [16-bit]	—	Specify the station number of the target station or the transient transmission group number. <ul style="list-style-type: none"> ■When "Target station specification method" is set to 0 to specify a station number Station number of Ethernet or CC-Link IE Controller Network <ul style="list-style-type: none"> • 1 to 120 Station number of CC-Link IE Field Network <ul style="list-style-type: none"> • 125: Master station • 126: Master operating station • 1 to 120: Local station, remote device station, intelligent device station, submaster station Station number of MELSECNET/H <ul style="list-style-type: none"> • 1 to 64 ■When "Target station specification method" is set to 1 to specify a group Specify the transient transmission group number. <ul style="list-style-type: none"> • 1 to 32 ■When "Target station specification method" is set to 2 to specify all stations The setting is ignored.
(5)	i_uChannel	Own station channel	Word [Unsigned]/ Bit String [16-bit]	—	Specify the channel to be used by the own station. <ul style="list-style-type: none"> □□ MELSEC iQ-R Programming Manual (Module Dedicated Instructions)
(6)	i_uRemoteType	Remote operation	Word [Unsigned]/ Bit String [16-bit]	1, 2	Specify remote RUN or STOP. <ul style="list-style-type: none"> • 1: Remote RUN • 2: Remote STOP

Output arguments

No.	Variable name	Name	Data type	Description	Default value
(7)	o_bENO	Execution status	Bit	On: The execution command is turned on. Off: The execution command is turned off.	Off
(8)	o_bOK	Normal completion	Bit	The FB has been processed normally when this argument is on.	Off
(9)	o_bErr	Error completion	Bit	The FB has been processed abnormally when this argument is on.	Off
(10)	o_uErrId	Error code	Word [Unsigned]/ Bit String [16-bit]	An error code is stored at error completion.	0

■ Operation parameters

No.	Variable name	Name	Data type	Range	Description	Default value
(11)	pbi_uCPU_Type	Target station CPU type	Word [Unsigned]/Bit String [16-bit]	0000H, 03D0H to 03D3H, 03E0H to 03E3H, 03FFH	Specify the CPU type of the target station. <ul style="list-style-type: none"> • 0000H: To CPU of target station (control CPU) • 03D0H: To control system CPU • 03D1H: To standby system CPU • 03D2H: To system A CPU • 03D3H: To system B CPU • 03E0H: To multiple CPU No.1 • 03E1H: To multiple CPU No.2 • 03E2H: To multiple CPU No.3 • 03E3H: To multiple CPU No.4 • 03FFH: To CPU of target station (control CPU) 	0
(12)	pbi_uTargetStation	Target station specification method	Word [Unsigned]/Bit String [16-bit]	0 to 2	Specify the specification method of a target station. <ul style="list-style-type: none"> • 0: Station number specification → Station with the station number specified in "Target station number" • 1: Group specification → All stations of the transient transmission group number specified in "Target station number" (For the CC-Link IE Field Network, the value 1 cannot be specified.) • 2: All stations → All stations of the network number specified in "Target network number" (simultaneous broadcast except own station) 	0
(13)	pbi_uForciblyRun	Specification of forced remote RUN	Word [Unsigned]/Bit String [16-bit]	1, 2	<p>■"Remote operation": 1 (remote RUN) Specify whether to forcibly execute remote RUN. The forcible execution function enables forcible execution of remote RUN from another station when a station which executed remote STOP can no longer execute remote RUN.</p> <ul style="list-style-type: none"> • 1: Not forcibly executed • 2: Forcibly executed <p>■"Remote operation": 2 (remote STOP) Any setting here is ignored and the following setting is always used.</p> <ul style="list-style-type: none"> • 2: Forcibly executed 	1
(14)	pbi_uDeviceClear	Specification of device clear at remote RUN	Word [Unsigned]/Bit String [16-bit]	0 to 2	<p>■"Remote operation": 1 (remote RUN) Specify how to handle the CPU module device memory after remote RUN is executed.</p> <ul style="list-style-type: none"> • 0: Do not clear. • 1: Clear (except the latch range). • 2: Clear (including the latch range). <p>■"Remote operation": 2 (remote STOP) Any setting here is ignored.</p>	0
(15)	pbi_uResendCountMax	Maximum number of resends	Word [Unsigned]/Bit String [16-bit]	0 to 15	Specify the number of resends to be performed if the data transfer is not completed within the monitoring time specified by "Arrival monitoring time".	5
(16)	pbi_uMonitorTime	Arrival monitoring time (Ethernet)	Word [Unsigned]/Bit String [16-bit]	0 to 16383	Specify the TCP resend timer value or a greater value for the monitoring time until completion of processing. If the processing is not completed within the monitoring time, data is resent until the value specified in "Maximum number of resends" is reached. <ul style="list-style-type: none"> • 0 to TCP resend timer value: Time represented by "TCP resend timer value" • ("TCP resend timer value" + 1) to 16383: ("TCP resend timer value" + 1) seconds to 16383s 	0
		Arrival monitoring time (CC-Link IE Controller Network, CC-Link IE Field Network, MELSECNET/H)		0, 1 to 32767	Specify the monitoring time until completion of processing. If the processing is not completed within the monitoring time, data is resent until the value specified in "Maximum number of resends" is reached. <ul style="list-style-type: none"> • 0: 10s • 1 to 32767: 1 to 32767s 	0

Public variables

No.	Variable name	Name	Data type	Description	Default value
(17)	pbo_uResendCount	Number of resends	Word [Unsigned]/Bit String [16-bit]	The number of resends performed (result) is stored.	0
(18)	pbo_u4ErrTime	Error occurrence time	Word [Unsigned]/Bit String [16-bit] (0..3)	Clock data at the time of error occurrence is stored. 1st word • Upper 8 bits: Month (01H to 12H) • Lower 8 bits: Lower 2 digits of year (00H to 99H) 2nd word • Upper 8 bits: Hour (00H to 23H) • Lower 8 bits: Day (01H to 31H) 3rd word • Upper 8 bits: Second (00H to 59H) • Lower 8 bits: Minute (00H to 59H) 4th word • Upper 8 bits: Upper 2 digits of year (00H to 99H) • Lower 8 bits: Day of week (00H (Sunday) to 06H (Saturday))	0
(19)	pbo_uErrNetworkNo	Error detection network number	Word [Unsigned]/Bit String [16-bit]	The network number of the station in which an error was detected is stored.	0
(20)	pbo_uErrStationNo	Error-detected station number	Word [Unsigned]/Bit String [16-bit]	The station number of the station in which an error was detected is stored. Station number of Ethernet or CC-Link IE Controller Network • 1 to 120 Station number of CC-Link IE Field Network • 125: Master station • 1 to 120: Local station, remote device station, intelligent device station, submaster station Station number of MELSECNET/H • 1 to 64	0

FB details

Item	Description
Available device	Target module • RJ71GF11-T2 • RJ71GP21(S)-SX • RJ71EN71 • RnENCPU (network part) • RJ71LP21-25 • RJ71BR11
	CPU module RCPU
	Engineering tool GX Works3
Language	Ladder diagram
Number of basic steps	122 steps The number of steps of the FB embedded in a program depends on the CPU module used, the input/output definitions, and the option settings of GX Works3. For the option settings of GX Works3, refer to GX Works3 Operating Manual.
Processing	When i_bEN (execution command) is turned on, this function performs remote STOP/RUN for other stations.
FB compilation method	Macro type
FB operation	Pulse type (multiple-scan execution type)
Input condition for FB_EN	None

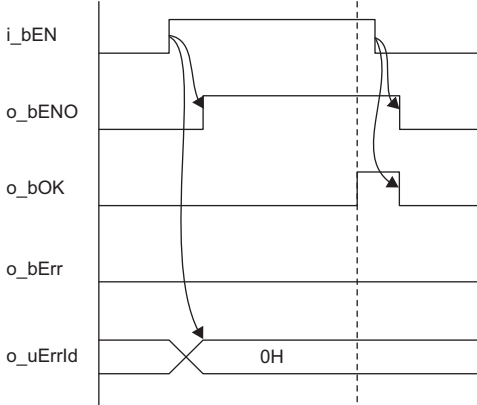
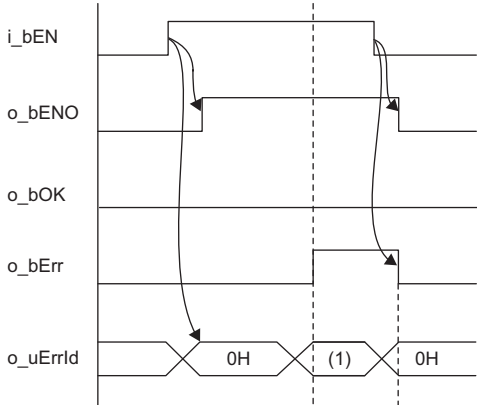
Item	Description
Timing chart of I/O signals	<ul style="list-style-type: none"> For normal completion  <ul style="list-style-type: none"> For error completion (same as in the case of a module error)  <p>(1) Error code</p>
Precautions	<ul style="list-style-type: none"> This FB does not include error recovery processing. Please create error recovery processing separately according to the system and required operations. This FB uses the GP.REQ instruction. Turn off i_bEN (execution command) after o_bOK (normal completion) or o_bErr (error completion) is turned on. By turning off i_bEN (execution command), o_bOK (normal completion) or o_bErr (error completion) is turned off and o_uErrld (error code) is cleared to 0. This FB uses the label initial value by each program. When the program file using this FB is specified to boot file setting for the boot operation in the CPU module, specify the initial label value file by each program to the boot file setting as well. (MELSEC iQ-R CPU Module User's Manual (Application)) If an error code that is not described in Page 41 Error codes appears, the initial label value files by each program may not be set to the boot file setting. In this case, specify the initial label value files by each program to the boot file setting. When this FB is executed, an operation error may occur in the programmable controller CPU. In this case, check the detailed information of the operation error in event history and correct the input argument of the module FB.

Error codes

Error code	Reference
4000H to 4FFFH	MELSEC iQ-R CPU Module User's Manual (Application)
6F00H to 6FFFH	
C000H to CFFFH	MELSEC iQ-R Ethernet User's Manual (Application)
D000H to DFFFH	MELSEC iQ-R CC-Link IE Field Network User's Manual (Application)
E000H to EFFFH	MELSEC iQ-R CC-Link IE Controller Network User's Manual (Application)
F000H to FFFFH	MELSEC iQ-R MELSECNET/H Network Module User's Manual (Application)

2.6 M+model_ReadTime

Name

■RJ71EN71, RnENCPU (network part)

This FB is displayed as follows on the engineering tool depending on the settings.

Name	Module model name	
	RJ71EN71	RnENCPU (network part)
M+RJ71EN71_EE_ReadTime	RJ71EN71(E+E)	—
M+RJ71EN71_C_ReadTime	RJ71EN71(CCIEC)	_RJ71EN71(CCIEC)
M+RJ71EN71_EC_ReadTime	RJ71EN71(E+CCIEC)	_RJ71EN71(E+IEC)
M+RJ71EN71_F_ReadTime	RJ71EN71(CCIEF)	_RJ71EN71(CCIEF)
M+RJ71EN71_EF_ReadTime	RJ71EN71(E+CCIEF)	_RJ71EN71(E+IEF)

■RJ71GP21(S)-SX

M+RJ71GP21_ReadTime

■RJ71GF11-T2

M+RJ71GF11_ReadTime

■RJ71LP21-25

M+RJ71LP21_ReadTime

■RJ71BR11

M+RJ71BR11_ReadTime

Overview

Item	Description																																																
Overview	Reads clock data from the programmable controller of another station to adjust the time of the programmable controller CPU of own station.																																																
Symbol	<div style="border: 1px solid black; padding: 10px; width: fit-content; margin: 0 auto;"> <p style="text-align: center;">M+RJ71GF11_ReadTime</p> <table style="width: 100%; border-collapse: collapse;"> <tr> <td style="width: 10%;">(1) —</td> <td style="width: 40%;">B: i_bEN</td> <td style="width: 10%;"></td> <td style="width: 20%;">o_bENO: B</td> <td style="width: 10%;"></td> <td style="width: 10%;">(6)</td> </tr> <tr> <td>(2) —</td> <td>DUT: i_stModule</td> <td></td> <td>o_bOK: B</td> <td></td> <td>(7)</td> </tr> <tr> <td>(3) —</td> <td>UW: i_uTargetNetworkNo</td> <td></td> <td>o_bErr: B</td> <td></td> <td>(8)</td> </tr> <tr> <td>(4) —</td> <td>UW: i_uTargetStationNo</td> <td></td> <td>o_uErrId: UW</td> <td></td> <td>(9)</td> </tr> <tr> <td>(5) —</td> <td>UW: i_uChannel</td> <td></td> <td></td> <td></td> <td></td> </tr> <tr> <td></td> <td></td> <td></td> <td>pbi_uCPU_Type</td> <td>(10)</td> <td></td> </tr> <tr> <td></td> <td></td> <td></td> <td>pbi_uResendCountMax</td> <td>(11)</td> <td></td> </tr> <tr> <td></td> <td></td> <td></td> <td>pbi_uMonitorTime</td> <td>(12)</td> <td></td> </tr> </table> </div> <p>The above FB is an example for the RJ71GF11-T2.</p>	(1) —	B: i_bEN		o_bENO: B		(6)	(2) —	DUT: i_stModule		o_bOK: B		(7)	(3) —	UW: i_uTargetNetworkNo		o_bErr: B		(8)	(4) —	UW: i_uTargetStationNo		o_uErrId: UW		(9)	(5) —	UW: i_uChannel								pbi_uCPU_Type	(10)					pbi_uResendCountMax	(11)					pbi_uMonitorTime	(12)	
(1) —	B: i_bEN		o_bENO: B		(6)																																												
(2) —	DUT: i_stModule		o_bOK: B		(7)																																												
(3) —	UW: i_uTargetNetworkNo		o_bErr: B		(8)																																												
(4) —	UW: i_uTargetStationNo		o_uErrId: UW		(9)																																												
(5) —	UW: i_uChannel																																																
			pbi_uCPU_Type	(10)																																													
			pbi_uResendCountMax	(11)																																													
			pbi_uMonitorTime	(12)																																													

Labels

Input arguments

No.	Variable name	Name	Data type	Range	Description
(1)	i_bEN	Execution command	Bit	—	On: Start FB. Off: Do not start FB.
(2)	i_stModule	Module label	Structure	—	Specify the module for which the FB is to be executed. Specify the module label of the modules. (Example: EN71_EE_1, EN71_EF_1, EN71_F_1, GF11_1, GP21_1, LP21_1, BR11_1)
(3)	i_uTargetNetworkNo	Target network number	Word [Unsigned]/ Bit String [16-bit]	1 to 239	Specify the network number of the target station.
(4)	i_uTargetStationNo	Target station number	Word [Unsigned]/ Bit String [16-bit]	—	Specifies the station number of the target station. Station number of Ethernet or CC-Link IE Controller Network • 1 to 120 Station number of CC-Link IE Field Network • 125: Master station • 126: Master operating station • 1 to 120: Local station, remote device station, intelligent device station, submaster station Station number of MELSECNET/H • 1 to 64
(5)	i_uChannel	Own station channel	Word [Unsigned]/ Bit String [16-bit]	—	Specify the channel to be used by the own station.  MELSEC iQ-R Programming Manual (Module Dedicated Instructions)

Output arguments

No.	Variable name	Name	Data type	Description	Default value
(6)	o_bENO	Execution status	Bit	On: The execution command is turned on. Off: The execution command is turned off.	Off
(7)	o_bOK	Normal completion	Bit	The FB has been processed normally when this argument is on.	Off
(8)	o_bErr	Error completion	Bit	The FB has been processed abnormally when this argument is on.	Off
(9)	o_uErrId	Error code	Word [Unsigned]/ Bit String [16-bit]	An error code is stored at error completion.	0

■ Operation parameters

No.	Variable name	Name	Data type	Range	Description	Default value
(10)	pbi_uCPU_Type	Target station CPU type	Word [Unsigned]/Bit String [16-bit]	0000H, 03D0H to 03D3H, 03E0H to 03E3H, 03FFH	Specify the CPU type of the target station. <ul style="list-style-type: none"> • 0000H: To CPU of target station (control CPU) • 03D0H: To control system CPU • 03D1H: To standby system CPU • 03D2H: To system A CPU • 03D3H: To system B CPU • 03E0H: To multiple CPU No.1 • 03E1H: To multiple CPU No.2 • 03E2H: To multiple CPU No.3 • 03E3H: To multiple CPU No.4 • 03FFH: To CPU of target station (control CPU) 	0
(11)	pbi_uResendCountMax	Maximum number of resends	Word [Unsigned]/Bit String [16-bit]	0 to 15	Specify the number of resends to be performed if the data transfer is not completed within the monitoring time specified by "Arrival monitoring time".	5
(12)	pbi_uMonitorTime	Arrival monitoring time (Ethernet)	Word [Unsigned]/Bit String [16-bit]	0 to 16383	Specify the TCP resend timer value or a greater value for the monitoring time until completion of processing. If the processing is not completed within the monitoring time, data is resent until the value specified in "Maximum number of resends" is reached. <ul style="list-style-type: none"> • 0 to TCP resend timer value: Time represented by "TCP resend timer value" • ("TCP resend timer value" + 1) to 16383: ("TCP resend timer value" + 1) seconds to 16383s 	0
		Arrival monitoring time (CC-Link IE Controller Network, CC-Link IE Field Network, MELSECNET/H)		0, 1 to 32767	Specify the monitoring time until completion of processing. If the processing is not completed within the monitoring time, data is resent until the value specified in "Maximum number of resends" is reached. <ul style="list-style-type: none"> • 0: 10s • 1 to 32767: 1 to 32767s 	0

FB details

Item	Description	
Available device	Target module <ul style="list-style-type: none"> • RJ71GF11-T2 • RJ71GP21(S)-SX • RJ71EN71 • RnENCPU (network part) • RJ71LP21-25 • RJ71BR11 	
	CPU module	RCPU
	Engineering tool	GX Works3
Language	Ladder diagram	
Number of basic steps	133 steps The number of steps of the FB embedded in a program depends on the CPU module used, the input/output definitions, and the option settings of GX Works3. For the option settings of GX Works3, refer to GX Works3 Operating Manual.	
Processing	When i_bEN (execution instruction) is turned on, this function reads clock data from another station to adjust the time of the programmable controller CPU of own station.	
FB compilation method	Macro type	
FB operation	Pulse type (multiple-scan execution type)	
Input condition for FB_EN	None	

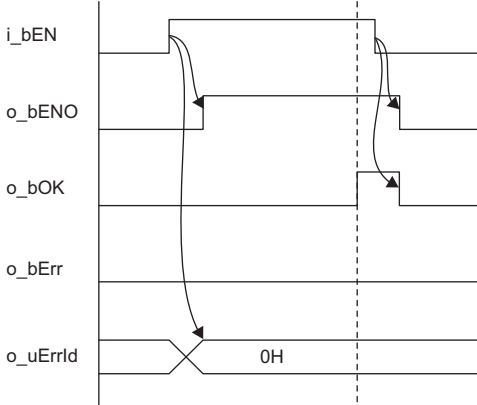
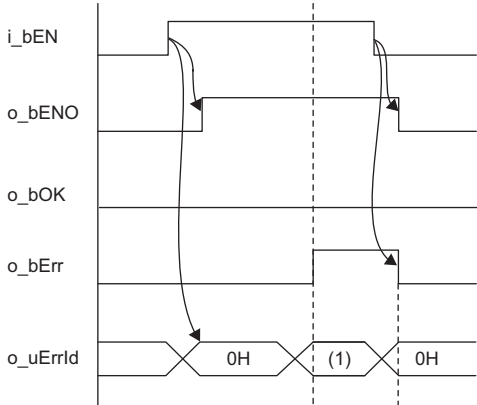
Item	Description
Timing chart of I/O signals	<ul style="list-style-type: none"> For normal completion  <ul style="list-style-type: none"> For error completion (same as in the case of a module error)  <p>(1) Error code</p>
Precautions	<ul style="list-style-type: none"> This FB does not include error recovery processing. Please create error recovery processing separately according to the system and required operations. This FB uses the GP.REQ instruction. Turn off i_bEN (execution command) after o_bOK (normal completion) or o_bErr (error completion) is turned on. By turning off i_bEN (execution command), o_bOK (normal completion) or o_bErr (error completion) is turned off and o_uErrld (error code) is cleared to 0. This FB uses the label initial value by each program. When the program file using this FB is specified to boot file setting for the boot operation in the CPU module, specify the initial label value file by each program to the boot file setting as well. (MELSEC iQ-R CPU Module User's Manual (Application)) If an error code that is not described in Page 45 Error codes appears, the initial label value files by each program may not be set to the boot file setting. In this case, specify the initial label value files by each program to the boot file setting. When this FB is executed, an operation error may occur in the programmable controller CPU. In this case, check the detailed information of the operation error in event history and correct the input argument of the module FB.

Error codes

Error code	Reference
4000H to 4FFFH	MELSEC iQ-R CPU Module User's Manual (Application)
6F00H to 6FFFH	
C000H to CFFFH	MELSEC iQ-R Ethernet User's Manual (Application)
D000H to DFFFH	MELSEC iQ-R CC-Link IE Field Network User's Manual (Application)
E000H to EFFFH	MELSEC iQ-R CC-Link IE Controller Network User's Manual (Application)
F000H to FFFFH	MELSEC iQ-R MELSECNET/H Network Module User's Manual (Application)

2.7 M+model_WriteTime

Name

■RJ71EN71, RnENCPU (network part)

This FB is displayed as follows on the engineering tool depending on the settings.

Name	Module model name	
	RJ71EN71	RnENCPU (network part)
M+RJ71EN71_EE_WriteTime	RJ71EN71(E+E)	—
M+RJ71EN71_C_WriteTime	RJ71EN71(CCIEC)	_RJ71EN71(CCIEC)
M+RJ71EN71_EC_WriteTime	RJ71EN71(E+CCIEC)	_RJ71EN71(E+IEC)
M+RJ71EN71_F_WriteTime	RJ71EN71(CCIEF)	_RJ71EN71(CCIEF)
M+RJ71EN71_EF_WriteTime	RJ71EN71(E+CCIEF)	_RJ71EN71(E+IEF)

■RJ71GP21(S)-SX

M+RJ71GP21_WriteTime

■RJ71GF11-T2

M+RJ71GF11_WriteTime

■RJ71LP21-25

M+RJ71LP21_WriteTime

■RJ71BR11

M+RJ71BR11_WriteTime

Overview

Item	Description												
Overview	Writes the clock data of the programmable controller of own station to another station to adjust the time of the programmable controller CPU of another station.												
Symbol	<div style="border: 1px solid black; padding: 10px; width: fit-content; margin: 0 auto;"> <p style="text-align: center;">M+RJ71GF11_WriteTime</p> <table style="width: 100%; border-collapse: collapse;"> <tr> <td style="width: 50%;">(1) — B: i_bEN</td> <td style="width: 50%; text-align: right;">o_bENO: B — (6)</td> </tr> <tr> <td>(2) — DUT: i_stModule</td> <td style="text-align: right;">o_bOK: B — (7)</td> </tr> <tr> <td>(3) — UW: i_uTargetNetworkNo</td> <td style="text-align: right;">o_bErr: B — (8)</td> </tr> <tr> <td>(4) — UW: i_uTargetStationNo</td> <td style="text-align: right;">o_uErrId: UW — (9)</td> </tr> <tr> <td>(5) — UW: i_uChannel</td> <td></td> </tr> <tr> <td colspan="2" style="text-align: center; padding-top: 10px;"> pbi_uCPU_Type (10) pbi_uTargetStation (11) pbi_uResendCountMax (12) pbi_uMonitorTime (13) </td> </tr> </table> </div> <p>The above FB is an example for the RJ71GF11-T2.</p>	(1) — B: i_bEN	o_bENO: B — (6)	(2) — DUT: i_stModule	o_bOK: B — (7)	(3) — UW: i_uTargetNetworkNo	o_bErr: B — (8)	(4) — UW: i_uTargetStationNo	o_uErrId: UW — (9)	(5) — UW: i_uChannel		pbi_uCPU_Type (10) pbi_uTargetStation (11) pbi_uResendCountMax (12) pbi_uMonitorTime (13)	
(1) — B: i_bEN	o_bENO: B — (6)												
(2) — DUT: i_stModule	o_bOK: B — (7)												
(3) — UW: i_uTargetNetworkNo	o_bErr: B — (8)												
(4) — UW: i_uTargetStationNo	o_uErrId: UW — (9)												
(5) — UW: i_uChannel													
pbi_uCPU_Type (10) pbi_uTargetStation (11) pbi_uResendCountMax (12) pbi_uMonitorTime (13)													

Labels

Input arguments

No.	Variable name	Name	Data type	Range	Description
(1)	i_bEN	Execution command	Bit	—	On: Start FB. Off: Do not start FB.
(2)	i_stModule	Module label	Structure	—	Specify the module for which the FB is to be executed. Specify the module label of the modules. (Example: EN71_EE_1, EN71_EF_1, EN71_F_1, GF11_1, GP21_1, LP21_1, BR11_1)
(3)	i_uTargetNetworkNo	Target network number	Word [Unsigned]/ Bit String [16-bit]	1 to 239	Specify the network number of the target station.
(4)	i_uTargetStationNo	Target station number	Word [Unsigned]/ Bit String [16-bit]	—	Specify the station number of the target station or the transient transmission group number. <ul style="list-style-type: none"> ■When "Target station specification method" is set to 0 to specify a station number <ul style="list-style-type: none"> Station number of Ethernet or CC-Link IE Controller Network <ul style="list-style-type: none"> • 1 to 120 Station number of CC-Link IE Field Network <ul style="list-style-type: none"> • 125: Master station • 126: Master operating station • 1 to 120: Local station, remote device station, intelligent device station, submaster station Station number of MELSECNET/H <ul style="list-style-type: none"> • 1 to 64 ■When "Target station specification method" is set to 1 to specify a group <ul style="list-style-type: none"> Specify the transient transmission group number. <ul style="list-style-type: none"> • 1 to 32 ■When "Target station specification method" is set to 2 to specify all stations <ul style="list-style-type: none"> The setting is ignored.
(5)	i_uChannel	Own station channel	Word [Unsigned]/ Bit String [16-bit]	—	Specify the channel to be used by the own station. <ul style="list-style-type: none"> □□ MELSEC iQ-R Programming Manual (Module Dedicated Instructions)

Output arguments

No.	Variable name	Name	Data type	Description	Default value
(6)	o_bENO	Execution status	Bit	On: The execution command is turned on. Off: The execution command is turned off.	Off
(7)	o_bOK	Normal completion	Bit	The FB has been processed normally when this argument is on.	Off
(8)	o_bErr	Error completion	Bit	The FB has been processed abnormally when this argument is on.	Off
(9)	o_uErrId	Error code	Word [Unsigned]/Bit String [16-bit]	An error code is stored at error completion.	0

■Operation parameters

No.	Variable name	Name	Data type	Range	Description	Default value
(10)	pbi_uCPU_Type	Target station CPU type	Word [Unsigned]/Bit String [16-bit]	0000H, 03D0H to 03D3H, 03E0H to 03E3H, 03FFH	Specify the CPU type of the target station. <ul style="list-style-type: none"> • 0000H: To CPU of target station (control CPU) • 03D0H: To control system CPU • 03D1H: To standby system CPU • 03D2H: To system A CPU • 03D3H: To system B CPU • 03E0H: To multiple CPU No.1 • 03E1H: To multiple CPU No.2 • 03E2H: To multiple CPU No.3 • 03E3H: To multiple CPU No.4 • 03FFH: To CPU of target station (control CPU) 	0
(11)	pbi_uTargetStation	Target station specification method	Word [Unsigned]/Bit String [16-bit]	0 to 2	Specify the specification method of a target station. <ul style="list-style-type: none"> • 0: Station number specification → Station with the station number specified in "Target station number" • 1: Group specification → All stations of the transient transmission group number specified in "Target station number" (For the CC-Link IE Field Network, the value 1 cannot be specified.) • 2: All stations → All stations of the network number specified in "Target network number" (simultaneous broadcast except own station) 	0
(12)	pbi_uResendCountMax	Maximum number of resends	Word [Unsigned]/Bit String [16-bit]	0 to 15	Specify the number of resends to be performed if the data transfer is not completed within the monitoring time specified by "Arrival monitoring time".	5
(13)	pbi_uMonitorTime	Arrival monitoring time (Ethernet)	Word [Unsigned]/Bit String [16-bit]	0 to 16383	Specify the TCP resend timer value or a greater value for the monitoring time until completion of processing. If the processing is not completed within the monitoring time, data is resent until the value specified in "Maximum number of resends" is reached. <ul style="list-style-type: none"> • 0 to TCP resend timer value: Time represented by "TCP resend timer value" • ("TCP resend timer value" + 1) to 16383: ("TCP resend timer value" + 1) seconds to 16383s 	0
		Arrival monitoring time (CC-Link IE Controller Network, CC-Link IE Field Network, MELSECNET/H)		0, 1 to 32767	Specify the monitoring time until completion of processing. If the processing is not completed within the monitoring time, data is resent until the value specified in "Maximum number of resends" is reached. <ul style="list-style-type: none"> • 0: 10s • 1 to 32767: 1 to 32767s 	0

FB details

Item	Description	
Available device	Target module	<ul style="list-style-type: none"> • RJ71GF11-T2 • RJ71GP21(S)-SX • RJ71EN71 • RnENCPU (network part) • RJ71LP21-25 • RJ71BR11
	CPU module	RCPUCPU
	Engineering tool	GX Works3
Language	Ladder diagram	
Number of basic steps	133 steps The number of steps of the FB embedded in a program depends on the CPU module used, the input/output definitions, and the option settings of GX Works3. For the option settings of GX Works3, refer to GX Works3 Operating Manual.	
Processing	When i_bEN (execution instruction) is turned on, this function writes clock data to another station to adjust the time of the programmable controller CPU of the station.	
FB compilation method	Macro type	
FB operation	Pulse type (multiple-scan execution type)	
Input condition for FB_EN	None	
Timing chart of I/O signals	<p>• For normal completion</p> <p>• For error completion (same as in the case of a module error)</p> <p>(1) Error code</p>	

Item	Description
Precautions	<ul style="list-style-type: none"> • This FB does not include error recovery processing. Please create error recovery processing separately according to the system and required operations. • This FB uses the GP.REQ instruction. • Turn off i_bEN (execution command) after o_bOK (normal completion) or o_bErr (error completion) is turned on. By turning off i_bEN (execution command), o_bOK (normal completion) or o_bErr (error completion) is turned off and o_uErrId (error code) is cleared to 0. • This FB uses the label initial value by each program. When the program file using this FB is specified to boot file setting for the boot operation in the CPU module, specify the initial label value file by each program to the boot file setting as well. (MELSEC iQ-R CPU Module User's Manual (Application)) If an error code that is not described in Page 50 Error codes appears, the initial label value files by each program may not be set to the boot file setting. In this case, specify the initial label value files by each program to the boot file setting. • When this FB is executed, an operation error may occur in the programmable controller CPU. In this case, check the detailed information of the operation error in event history and correct the input argument of the module FB.

Error codes

Error code	Reference
4000H to 4FFFH	MELSEC iQ-R CPU Module User's Manual (Application)
6F00H to 6FFFH	
C000H to CFFFH	MELSEC iQ-R Ethernet User's Manual (Application)
D000H to DFFFH	MELSEC iQ-R CC-Link IE Field Network User's Manual (Application)
E000H to EFFFH	MELSEC iQ-R CC-Link IE Controller Network User's Manual (Application)
F000H to FFFFH	MELSEC iQ-R MELSECNET/H Network Module User's Manual (Application)

2.8 M+model_ConnectionOpen

Name

■RJ71EN71, RnENCPU (network part)

This FB is displayed as follows on the engineering tool depending on the settings.

Name	Module model name	
	RJ71EN71	RnENCPU (network part)
M+RJ71EN71_EE_ConnectionOpen	RJ71EN71(E+E)	—
M+RJ71EN71_EC_ConnectionOpen	RJ71EN71(E+CCIEC)	_RJ71EN71(E+IEC)
M+RJ71EN71_EF_ConnectionOpen	RJ71EN71(E+CCIEF)	_RJ71EN71(E+IEF)

■RCPU, RnENCPU (CPU part)

M+RCPU_ConnectionOpen

Overview

Item	Description
Overview	Opens (establishes) a connection.

Item	Description																																																																																										
Symbol	<div style="border: 1px solid black; padding: 10px; margin: 10px 0;"> <p style="text-align: center;">M+RCPU_ConnectionOpen</p> <table style="width: 100%; border-collapse: collapse;"> <tr> <td style="width: 15%;">(1) —</td> <td style="width: 45%;">B: i_bEN</td> <td style="width: 15%;"></td> <td style="width: 25%;">o_bENO: B</td> <td style="width: 5%;"></td> <td style="width: 10%;">(4)</td> </tr> <tr> <td>(2) —</td> <td>DUT: i_stModule</td> <td></td> <td>o_bOK: B</td> <td></td> <td>(5)</td> </tr> <tr> <td>(3) —</td> <td>UW: i_uConnectionNo</td> <td></td> <td>o_bErr: B</td> <td></td> <td>(6)</td> </tr> <tr> <td></td> <td></td> <td></td> <td>o_uErrId: UW</td> <td></td> <td>(7)</td> </tr> </table> <table style="width: 100%; border-collapse: collapse;"> <tr> <td style="width: 15%;"></td> <td style="width: 45%;">pbi_bUseParameters 0</td> <td style="width: 15%;"></td> <td style="width: 25%;"></td> <td style="width: 5%;"></td> <td style="width: 10%;">(8)</td> </tr> <tr> <td></td> <td>pbi_uProtocol 0</td> <td></td> <td></td> <td></td> <td>(9)</td> </tr> <tr> <td></td> <td>pbi_uOpen_System 0</td> <td></td> <td></td> <td></td> <td>(10)</td> </tr> <tr> <td></td> <td>pbi_uConnUsage 0</td> <td></td> <td></td> <td></td> <td>(11)</td> </tr> <tr> <td></td> <td>pbi_bProcedure 0</td> <td></td> <td></td> <td></td> <td>(12)</td> </tr> <tr> <td></td> <td>pbi_uExist_Confirm 0</td> <td></td> <td></td> <td></td> <td>(13)</td> </tr> <tr> <td></td> <td>pbi_uLocal_Port_No 4096</td> <td></td> <td></td> <td></td> <td>(14)</td> </tr> <tr> <td></td> <td>pbi_uTarget_Port_No 4096</td> <td></td> <td></td> <td></td> <td>(15)</td> </tr> <tr> <td></td> <td>pbi_u2IP_Address 0</td> <td></td> <td></td> <td></td> <td>(16)</td> </tr> <tr> <td></td> <td>pbi_bEnable_Online_Change 0</td> <td></td> <td></td> <td></td> <td>(17)</td> </tr> <tr> <td></td> <td>pbi_bData_Code 0</td> <td></td> <td></td> <td></td> <td>(18)</td> </tr> </table> </div> <p>The above FB is an example for the CPU module.</p>	(1) —	B: i_bEN		o_bENO: B		(4)	(2) —	DUT: i_stModule		o_bOK: B		(5)	(3) —	UW: i_uConnectionNo		o_bErr: B		(6)				o_uErrId: UW		(7)		pbi_bUseParameters 0				(8)		pbi_uProtocol 0				(9)		pbi_uOpen_System 0				(10)		pbi_uConnUsage 0				(11)		pbi_bProcedure 0				(12)		pbi_uExist_Confirm 0				(13)		pbi_uLocal_Port_No 4096				(14)		pbi_uTarget_Port_No 4096				(15)		pbi_u2IP_Address 0				(16)		pbi_bEnable_Online_Change 0				(17)		pbi_bData_Code 0				(18)
(1) —	B: i_bEN		o_bENO: B		(4)																																																																																						
(2) —	DUT: i_stModule		o_bOK: B		(5)																																																																																						
(3) —	UW: i_uConnectionNo		o_bErr: B		(6)																																																																																						
			o_uErrId: UW		(7)																																																																																						
	pbi_bUseParameters 0				(8)																																																																																						
	pbi_uProtocol 0				(9)																																																																																						
	pbi_uOpen_System 0				(10)																																																																																						
	pbi_uConnUsage 0				(11)																																																																																						
	pbi_bProcedure 0				(12)																																																																																						
	pbi_uExist_Confirm 0				(13)																																																																																						
	pbi_uLocal_Port_No 4096				(14)																																																																																						
	pbi_uTarget_Port_No 4096				(15)																																																																																						
	pbi_u2IP_Address 0				(16)																																																																																						
	pbi_bEnable_Online_Change 0				(17)																																																																																						
	pbi_bData_Code 0				(18)																																																																																						

Labels

■Input arguments

No.	Variable name	Name	Data type	Range	Description
(1)	i_bEN	Execution command	Bit	—	On: Start FB. Off: Do not start FB.
(2)	i_stModule	Module label	Structure	—	Specify the module for which the FB is to be executed. Specify the module label of the modules. (Example: EN71_EE_1, EN71_EF_1, RCPU)
(3)	i_uConnectionNo	Connection No.	Word [Unsigned]/ Bit String [16-bit]	<ul style="list-style-type: none"> • RCPU (CPU part for the RnENCPU): 1 to 16 • RJ71EN71: 1 to 128 • RnENCPU (network part): 1 to 64 	Specify the number of the connection to be opened.

■Output arguments

No.	Variable name	Name	Data type	Description	Default value
(4)	o_bENO	Execution status	Bit	On: The execution command is turned on. Off: The execution command is turned off.	Off
(5)	o_bOK	Normal completion	Bit	The FB has been processed normally when this argument is on.	Off
(6)	o_bErr	Error completion	Bit	The FB has been processed abnormally when this argument is on.	Off
(7)	o_uErrId	Error code	Word [Unsigned]/Bit String [16-bit]	An error code is stored at error completion.	0

■ Operation parameters

No.	Variable name	Name	Data type	Range	Description	Default value
(8)	pbi_bUseParameters	Parameter used	Bit	On or off	Specify whether to use the parameter values set by the engineering tool or the following operation parameter values when processing for opening a connection. <ul style="list-style-type: none"> • Off: Performs open processing according to the external device configuration setting made by the engineering tool. (The following operation parameters need not be set. Any settings are ignored if made.) • On: Performs open processing according to the following operation parameters. 	Off
(9)	pbi_uProtocol	Protocol	Word [Unsigned]/ Bit String [16-bit]	0, 1	Select the protocol to be used for the connection to be opened. <ul style="list-style-type: none"> • 0: TCP/IP • 1: UDP/IP 	0
(10)	pbi_uOpen_System	Open method	Word [Unsigned]/ Bit String [16-bit]	0 to 2	Select the connection open method. <ul style="list-style-type: none"> • 0: Active open or UDP/IP • 1: Unpassive open • 2: Fullpassive open 	0
(11)	pbi_uConnUsage	Connection use application	Word [Unsigned]/ Bit String [16-bit]	0 to 2	Specify the purpose of the connection: sending, receiving, or pairing open with regard to the external device. <ul style="list-style-type: none"> • 0: Send • 1: Receive • 2: Pairing open (The value 2 can be set for the connection No.1 to No.7 and No.9 to No.15.) Valid only when connection No.1 to 16 is used with the RJ71EN71 or the RnENCPU (network part). For the RCPU (CPU part for the RnENCPU), the setting is ignored because it does not support communications using a fixed buffer.	0
(12)	pbi_bProcedure	Communication procedure	Bit	On or off	Specify whether to use a communication procedure. <ul style="list-style-type: none"> • Off: Procedure not used • On: Procedure used Valid only when connection No.1 to 16 is used with the RJ71EN71 or the RnENCPU (network part). For the RCPU (CPU part for the RnENCPU), the setting is ignored because it does not support communications using a fixed buffer.	Off
(13)	pbi_uExist_Confirm	Alive check	Word [Unsigned]/ Bit String [16-bit]	0 to 2	Specify whether to enable the arrive check function (with the use mode). <ul style="list-style-type: none"> • 0: Disable the alive check. • 1: Enable KeepAlive (in TCP/IP mode only). • 2: Enable the alive check with UDP (in UDP/IP mode only) Valid only when connection No.1 to 16 is used with the RJ71EN71 or the RnENCPU (network part). For the RCPU (CPU part for the RnENCPU), the setting is ignored because it does not support communications using a fixed buffer.	0
(14)	pbi_uLocal_Port_No	Own node port number	Word [Unsigned]/ Bit String [16-bit]	1 to 4999, 5010 to 65534	Specify the port number of the own node. Port numbers 1 to 1023 are generally reserved port numbers (WELL KNOWN PORT NUMBERS), and therefore port numbers 1024 to 4999 and 5010 to 65534 should be used.	4096
(15)	pbi_uTarget_Port_No	Destination port number	Word [Unsigned]/ Bit String [16-bit]	1 to 65534, 65535	Specify the destination port number. With the connection that is assigned port No.65535 (only when the UDP/IP protocol is selected), data is received through all port numbers. Data cannot be sent with the connection which is assigned port No.65535 and therefore a port number from 1 to 65534 should be specified to send data.	4096

No.	Variable name	Name	Data type	Range	Description	Default value															
(16)	pbi_u2IP_Address	IP address of external device	Word [Unsigned] Bit String [16-bit] (0..1)	0.0.0.1 to 255.255.2 55.255 (00000001 H to FFFFFFFH H)	Specify the IP address of an external device. Specify the third and fourth octets to the 1st word, and first and second octets to the 2nd word. Specify 255.255.255.255 (FFFFFFFH) when performing simultaneous broadcast. <table border="1" style="margin-left: auto; margin-right: auto;"> <tr> <td></td> <td style="text-align: center;">b15</td> <td style="text-align: center;">b8</td> <td style="text-align: center;">b7</td> <td style="text-align: center;">b0</td> </tr> <tr> <td>+0</td> <td style="text-align: center;">(3)</td> <td></td> <td></td> <td style="text-align: center;">(4)</td> </tr> <tr> <td>+1</td> <td style="text-align: center;">(1)</td> <td></td> <td></td> <td style="text-align: center;">(2)</td> </tr> </table> (1) to (4): IP address octet		b15	b8	b7	b0	+0	(3)			(4)	+1	(1)			(2)	192.168.1. 1 (C0A8010 1H)
	b15	b8	b7	b0																	
+0	(3)			(4)																	
+1	(1)			(2)																	
(17)	pbi_bEnable_Online_Change	Online program change	Bit	On or off	Specify whether to enable or disable the online program change. <ul style="list-style-type: none"> Off: Disable On: Enable Valid only for the RJ71EN71 or the RnENCPU (network part). For the RCP (CPU part for the RnENCPU), the setting is ignored. Set this item in the module parameters of the CPU module.	Off															
(18)	pbi_bData_Code	Communication data code	Bit	On or off	Set the communication code used. <ul style="list-style-type: none"> Off: Binary code On: ASCII code Valid only for the RJ71EN71 or the RnENCPU (network part). For the RCP (CPU part for the RnENCPU), the setting is ignored. Set this item in the module parameters of the CPU module.	Off															

FB details

Item	Description	
Available device	Target module <ul style="list-style-type: none"> RCP (CPU part for the RnENCPU) RJ71EN71 RnENCPU (network part) 	
	CPU module	RCP
	Engineering tool	GX Works3
Language	Ladder diagram	
Number of basic steps	171 steps The number of steps of the FB embedded in a program depends on the CPU module used, the input/output definitions, and the option settings of GX Works3. For the option settings of GX Works3, refer to GX Works3 Operating Manual.	
Processing	When i_bEN (execution command) is turned on, this function opens (establishes) a connection for data communication with an external device.	
FB compilation method	Macro type	
FB operation	Pulse type (multiple-scan execution type)	

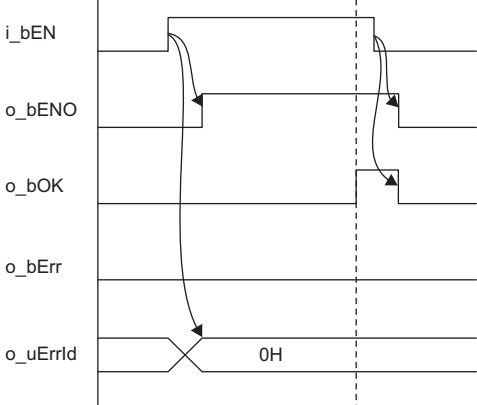
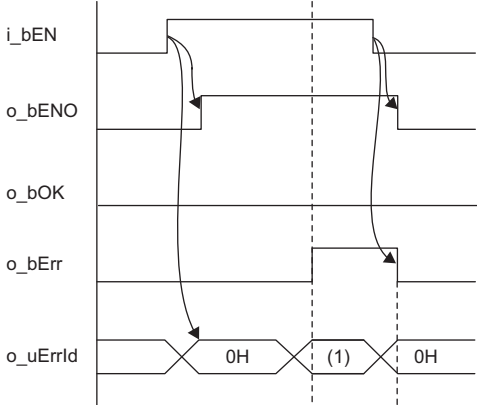
Item	Description
Timing chart of I/O signals	<ul style="list-style-type: none"> For normal completion  <ul style="list-style-type: none"> For error completion (same as in the case of a module error)  <p>(1) Error code</p>
Precautions	<ul style="list-style-type: none"> Specifications of the FBs <ul style="list-style-type: none"> This module FB cannot be executed for the connection that is being used by another module FB or a dedicated instruction. An error occurs if this module FB is executed for the connection in use. When open processing is performed according to the content of the operation parameter with pbi_bUseParameters set to ON, the available communication means are the fixed-buffer communications and socket communications only. If this FB is executed for the connection for which parameters are already set by "External Device Connection Configuration Setting", make settings so that the parameters specified by this FB are overwritten. This FB uses the label initial value by each program. When the program file using this FB is specified to boot file setting for the boot operation in the CPU module, specify the initial label value file by each program to the boot file setting as well. (MELSEC iQ-R CPU Module User's Manual (Application)) If an error code that is not described in Page 55 Error codes appears, the initial label value files by each program may not be set to the boot file setting. In this case, specify the initial label value files by each program to the boot file setting. When this FB is executed, an operation error may occur in the programmable controller CPU. In this case, check the detailed information of the operation error in event history and correct the input argument of the module FB. Operations of the FBs <ul style="list-style-type: none"> Turn off i_bEN (execution command) after o_bOK (normal completion) or o_bErr (error completion) is turned on. By turning off i_bEN (execution command), o_bOK (normal completion) or o_bErr (error completion) is turned off and o_uErrld (error code) is cleared to 0.

Error codes

Error code	Reference
C000H to CFFFH	MELSEC iQ-R Ethernet User's Manual (Application)

2.9 M+model_ConnectionClose

Name

■RJ71EN71, RnENCPU (network part)

This FB is displayed as follows on the engineering tool depending on the settings.

Name	Module model name	
	RJ71EN71	RnENCPU (network part)
M+RJ71EN71_EE_ConnectionClose	RJ71EN71(E+E)	—
M+RJ71EN71_EC_ConnectionClose	RJ71EN71(E+CCIEC)	_RJ71EN71(E+IEC)
M+RJ71EN71_EF_ConnectionClose	RJ71EN71(E+CCIEF)	_RJ71EN71(E+IEF)

■RCPU, RnENCPU (CPU part)

M+RCPU_ConnectionClose

Overview

Item	Description
Overview	Closes (disconnects) the connection.
Symbol	<p>The above FB is an example for the CPU module.</p>

Labels

■Input arguments

No.	Variable name	Name	Data type	Range	Description
(1)	i_bEN	Execution command	Bit	—	On: Start FB. Off: Do not start FB.
(2)	i_stModule	Module label	Structure	—	Specify the module for which the FB is to be executed. Specify the module label of the modules. (Example: EN71_EE_1, EN71_EF_1, RCPU)
(3)	i_uConnectionNo	Connection No.	Word [Unsigned]/ Bit String [16-bit]	<ul style="list-style-type: none"> • RCPU (CPU part for the RnENCPU): 1 to 16 • RJ71EN71: 1 to 128 • RnENCPU (network part): 1 to 64 	Specify the number of the connection to be closed. This function closes all connections if 65535 (FFFFH) is specified.

■Output arguments

No.	Variable name	Name	Data type	Description	Default value
(4)	o_bENO	Execution status	Bit	On: The execution command is turned on. Off: The execution command is turned off.	Off
(5)	o_bOK	Normal completion	Bit	The FB has been processed normally when this argument is on.	Off
(6)	o_bErr	Error completion	Bit	The FB has been processed abnormally when this argument is on.	Off
(7)	o_uErrId	Error code	Word [Unsigned]/ Bit String [16-bit]	An error code is stored at error completion.	0

Public variables

No.	Variable name	Name	Data type	Description	Default value
(8)	pbo_uErrConn_No	Error connection No.	Word [Unsigned]/ Bit String [16-bit]	The number of the connection for which close processing was completed with an error is stored. If 65535 (FFFFH) is specified in "Connection No." (i_uConnectionNo), the number of the connection for which close processing was first completed with an error is stored.	0

FB details

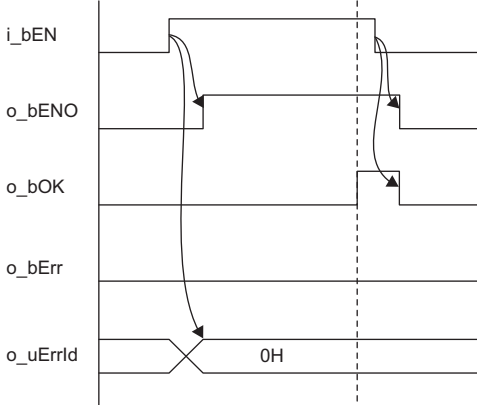
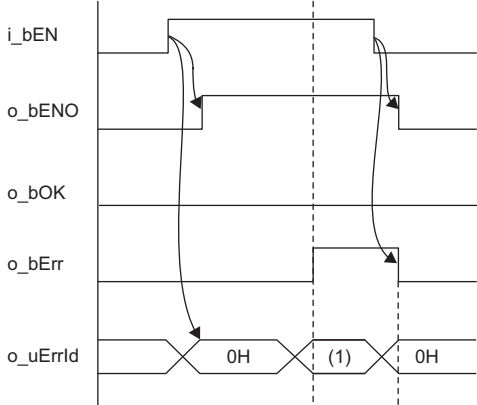
Item	Description	
Available device	Target module <ul style="list-style-type: none"> • RCP (CPU part for the RnENCPU) • RJ71EN71 • RnENCPU (network part) 	
	CPU module	RCP
	Engineering tool	GX Works3
Language	Ladder diagram	
Number of basic steps	86 steps The number of steps of the FB embedded in a program depends on the CPU module used, the input/output definitions, and the option settings of GX Works3. For the option settings of GX Works3, refer to GX Works3 Operating Manual.	
Processing	<ul style="list-style-type: none"> • When i_bEN (execution command) is turned on, this function closes a connection for data communication with an external device. • The function closes all connections if 65535 (FFFFH) is specified for "Connection No." (i_uConnectionNo) in the input argument. • If the function fails to close even one connection among those specified to be closed, it is completed with an error. 	
FB compilation method	Macro type	
FB operation	Pulse type (multiple-scan execution type)	
Timing chart of I/O signals	<ul style="list-style-type: none"> • For normal completion 	
	<ul style="list-style-type: none"> • For error completion (same as in the case of a module error)  <p>(1) Error code</p>	

Item	Description
Precautions	<ul style="list-style-type: none"> • This module FB cannot be executed for the connection that is being used by another module FB or a dedicated instruction. An error occurs if this module FB is executed for the connection in use. • Turn off i_bEN (execution command) after o_bOK (normal completion) or o_bErr (error completion) is turned on. By turning off i_bEN (execution command), o_bOK (normal completion) or o_bErr (error completion) is turned off and o_uErrId (error code) is cleared to 0. • When this FB is executed, an operation error may occur in the programmable controller CPU. In this case, check the detailed information of the operation error in event history and correct the input argument of the module FB.

Error codes

Error code	Reference
C000H to CFFFH	 MELSEC iQ-R Ethernet User's Manual (Application)

2.10 M+model_Recv_Socket

Name

■RJ71EN71, RnENCPU (network part)

This FB is displayed as follows on the engineering tool depending on the settings.

Name	Module model name	
	RJ71EN71	RnENCPU (network part)
M+RJ71EN71_EE_Recv_Socket	RJ71EN71(E+E)	—
M+RJ71EN71_EC_Recv_Socket	RJ71EN71(E+CCIEC)	_RJ71EN71(E+IEC)
M+RJ71EN71_EF_Recv_Socket	RJ71EN71(E+CCIEF)	_RJ71EN71(E+IEF)

■RCPU, RnENCPU (CPU part)

M+RCPU_Recv_Socket

Overview

Item	Description
Overview	Reads the data received from the external device through socket communications or fixed buffer communications.
Symbol	<p>The above FB is an example for the CPU module.</p>

Labels

■Input arguments

No.	Variable name	Name	Data type	Range	Description
(1)	i_bEN	Execution command	Bit	—	On: Start FB. Off: Do not start FB.
(2)	i_stModule	Module label	Structure	—	Specify the module for which the FB is to be executed. Specify the module label of the modules. (Example: EN71_EE_1, EN71_EF_1, RCPU)
(3)	i_uConnectionNo	Connection No.	Word [Unsigned]/ Bit String [16-bit]	<ul style="list-style-type: none"> RCPU (CPU part for the RnENCPU): 1 to 16 RJ71EN71: 1 to 128 RnENCPU (network part): 1 to 64 	Specify the number of the connection to be received.

■Output arguments

No.	Variable name	Name	Data type	Description	Default value								
(4)	o_bENO	Execution status	Bit	On: The execution command is turned on. Off: The execution command is turned off.	Off								
(5)	o_bOK	Normal completion	Bit	The FB has been processed normally when this argument is on.	Off								
(6)	o_bErr	Error completion	Bit	The FB has been processed abnormally when this argument is on.	Off								
(7)	o_uErrId	Error code	Word [Unsigned]/Bit String [16-bit]	An error code is stored at error completion.	0								
(8)	o_uRecvData	Receive data storage destination	Word [Unsigned]/Bit String [16-bit]	<p>Specify the receive data length and the start number of the device for storing received data. The data that has been read is stored sequentially in ascending order of addresses as shown below.</p> <ul style="list-style-type: none"> When the data unit is word 1st word: Receive data length (unit: word) 2nd to nth word: Receive data 1 to m When the data unit is byte 1st word: Receive data length (unit: byte) 2nd to nth word: <table border="1" style="margin-left: auto; margin-right: auto;"> <tr> <td style="text-align: center;">b15···b8</td> <td style="text-align: center;">b7···b0</td> </tr> <tr> <td style="text-align: center;">(2)</td> <td style="text-align: center;">(1)</td> </tr> <tr> <td style="text-align: center;">⋮</td> <td style="text-align: center;">⋮</td> </tr> <tr> <td style="text-align: center;">(4)</td> <td style="text-align: center;">(3)</td> </tr> </table> <p>(1) Receive data 1 (2) Receive data 2 (3) Receive data m-1 (4) Receive data m</p> <p>The data format, unit, and data length range of receive data vary depending on the module type and connection number. Receive data is stored in the word area in order from the first half (b0 to b7) to the second half (b8 to b15). The following cannot be specified as an argument. Specifying any of the following may cause a CPU error (2820H: Device/label/buffer memory specification incorrect).</p> <ul style="list-style-type: none"> Dynamically specified array elements (Example: wLabel[D0]) Digit-specified labels (Example: K4bLabel) Indirectly specified devices (Example: @W0) Local devices (Example: #D0) 	b15···b8	b7···b0	(2)	(1)	⋮	⋮	(4)	(3)	0
b15···b8	b7···b0												
(2)	(1)												
⋮	⋮												
(4)	(3)												

■Operation parameters

No.	Variable name	Name	Data type	Range	Description	Default value
(9)	pbi_bReadTiming	Read timing	Bit	On or off	<p>Specify the timing of executing data read processing.</p> <ul style="list-style-type: none"> Off: Start reading soon after the module FB starts. On: Start reading in the first END processing after the module FB starts. 	<ul style="list-style-type: none"> RCPU (CPU part for the RnENCPU): Off RJ71EN71, RnENCPU (network part): On

FB details

Item	Description
Available device	Target module <ul style="list-style-type: none"> RCPU (CPU part for the RnENCPU) RJ71EN71 RnENCPU (network part)
	CPU module <ul style="list-style-type: none"> RCPU
	Engineering tool <ul style="list-style-type: none"> GX Works3
Language	Ladder diagram
Number of basic steps	<p>109 steps</p> <p>The number of steps of the FB embedded in a program depends on the CPU module used, the input/output definitions, and the option settings of GX Works3. For the option settings of GX Works3, refer to GX Works3 Operating Manual.</p>
Processing	When i_bEN (execution instruction) is turned on, this function reads the data received to the connection specified by the input argument.

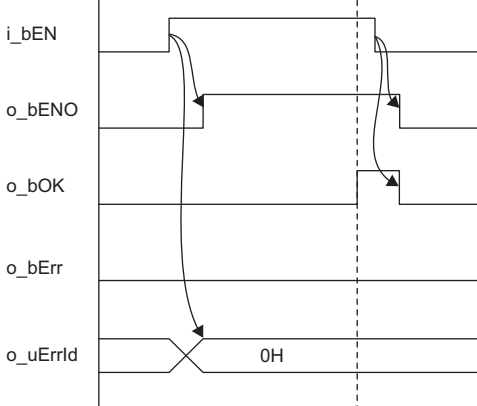
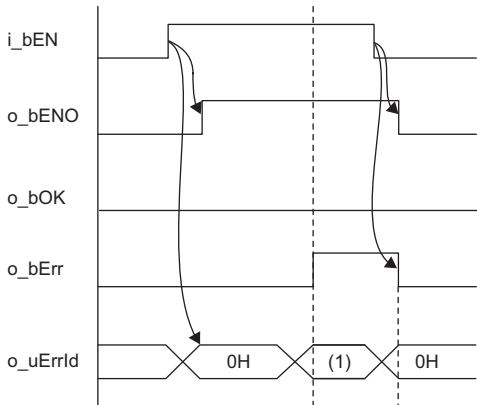
Item	Description
FB compilation method	Macro type
FB operation	Pulse type (multiple-scan execution type)
Timing chart of I/O signals	<ul style="list-style-type: none"> • For normal completion  <ul style="list-style-type: none"> • For error completion (same as in the case of a module error)  <p>(1) Error code</p>
Precautions	<ul style="list-style-type: none"> • This module FB cannot be executed for the connection that is being used by another module FB or a dedicated instruction. An error occurs if this module FB is executed for the connection in use. • Turn off i_bEN (execution command) after o_bOK (normal completion) or o_bErr (error completion) is turned on. By turning off i_bEN (execution command), o_bOK (normal completion) or o_bErr (error completion) is turned off and o_uErrld (error code) is cleared to 0. • When this FB is executed, an operation error may occur in the programmable controller CPU. In this case, check the detailed information of the operation error in event history and correct the input argument of the module FB. <p>■For the RCP (CPU part for the RnENCPU)</p> <ul style="list-style-type: none"> • The execution command of this FB can be executed at any timing. However, when executing it after receiving data, SD1506 (Socket communications reception status signal) or corresponding module label must be added to conditions of the execution. • When the module FB is executed by specifying ON (start reading in the first END processing after the FB starts) in operation parameter "Read timing", the module FB extends the scan time to complete data read processing within one END processing. <p>■For the RJ71EN71 or the RnENCPU (network part)</p> <ul style="list-style-type: none"> • The execution command of this FB can be executed at any timing. However, when executing it after receiving data, 'Socket/fixed buffer reception status signal' (UnG1900016 to UnG1900023) must be added to conditions of the execution. • When the module FB is executed by specifying OFF (Start reading soon after the module FB starts) in operation parameter "Read timing", processing completes in a single scan. • This FB uses the label initial value by each program. When the program file using this FB is specified to boot file setting for the boot operation in the CPU module, specify the initial label value file by each program to the boot file setting as well. (MELSEC iQ-R CPU Module User's Manual (Application)) If an error code that is not described in Page 61 Error codes appears, the initial label value files by each program may not be set to the boot file setting. In this case, specify the initial label value files by each program to the boot file setting.

Error codes

Error code	Reference
C000H to CFFFH	MELSEC iQ-R Ethernet User's Manual (Application)

2.11 M+model_Send_Socket

Name

■RJ71EN71, RnENCPU (network part)

This FB is displayed as follows on the engineering tool depending on the settings.

Name	Module model name	
	RJ71EN71	RnENCPU (network part)
M+RJ71EN71_EE_Send_Socket	RJ71EN71(E+E)	—
M+RJ71EN71_EC_Send_Socket	RJ71EN71(E+CCIEC)	_RJ71EN71(E+IEC)
M+RJ71EN71_EF_Send_Socket	RJ71EN71(E+CCIEF)	_RJ71EN71(E+IEF)

■RCPU, RnENCPU (CPU part)

M+RCPU_Send_Socket

Overview

Item	Description
Overview	Sends data to the external device through socket communications or fixed buffer communications.
Symbol	<p>The above FB is an example for the CPU module.</p>

Labels

■Input arguments

No.	Variable name	Name	Data type	Range	Description
(1)	i_bEN	Execution command	Bit	—	On: Start FB. Off: Do not start FB.
(2)	i_stModule	Module label	Structure	—	Specify the module for which the FB is to be executed. Specify the module label of the modules. (Example: EN71_EE_1, EN71_EF_1, RCPU)
(3)	i_uConnectionNo	Connection No.	Word [Unsigned]/ Bit String [16-bit]	<ul style="list-style-type: none"> • RCPU (CPU part for the RnENCPU): 1 to 16 • RJ71EN71: 1 to 128 • RnENCPU (network part): 1 to 64 	Specify the number of the connection to be sent.

No.	Variable name	Name	Data type	Range	Description								
(4)	i_uSendData	Send data storage destination	Word [Unsigned]/ Bit String [16-bit]	—	<p>Specify the send data length and the start number of the device containing the send data.*1</p> <ul style="list-style-type: none"> When the data unit is word 1st word: Send data length (unit: word) 2nd to nth word: Send data 1 to send data m When the data unit is byte 1st word: Send data length (unit: byte) 2nd to nth word: <table border="1" style="margin-left: auto; margin-right: auto;"> <tr> <td style="text-align: center;">b15···b8</td> <td style="text-align: center;">b7···b0</td> </tr> <tr> <td style="text-align: center;">(2)</td> <td style="text-align: center;">(1)</td> </tr> <tr> <td style="text-align: center;">⋮</td> <td style="text-align: center;">⋮</td> </tr> <tr> <td style="text-align: center;">(4)</td> <td style="text-align: center;">(3)</td> </tr> </table> <p>(1) Send data 1 (2) Send data 2 (3) Send data m-1 (4) Send data m</p> <p>The data format and data length range of send data vary depending on the module type and the setting of the connection used.</p> <p>Data is sent in the word area in order from the first half (b0 to b7) to the second half (b8 to b15).</p> <p>The following cannot be specified as an argument. Specifying any of the following may cause a CPU error (2820H: Device/label/buffer memory specification incorrect).</p> <ul style="list-style-type: none"> Dynamically specified array elements (Example: wLabel[D0]) Digit-specified labels (Example: K4bLabel) Indirectly specified devices (Example: @W0) Local devices (Example: #D0) 	b15···b8	b7···b0	(2)	(1)	⋮	⋮	(4)	(3)
b15···b8	b7···b0												
(2)	(1)												
⋮	⋮												
(4)	(3)												

*1 The data unit and the range of send data length differ depending on the communication method of parameters and communication data code setting as follows.

Parameter setting		Data unit	Send data length
Communication method	Communication data code		
Communications using a fixed buffer (procedure used)	Binary	Word	1 to 5113
	ASCII	Word	1 to 2556
Communications using a fixed buffer (procedure not used)	Binary/ASCII	Byte	1 to 10238
Socket communications	Binary/ASCII	Byte	1 to 10238

■Output arguments

No.	Variable name	Name	Data type	Description	Default value
(5)	o_bENO	Execution status	Bit	On: The execution command is turned on. Off: The execution command is turned off.	Off
(6)	o_bOK	Normal completion	Bit	The FB has been processed normally when this argument is on.	Off
(7)	o_bErr	Error completion	Bit	The FB has been processed abnormally when this argument is on.	Off
(8)	o_uErrId	Error code	Word [Unsigned]/ Bit String [16-bit]	An error code is stored at error completion.	0

FB details

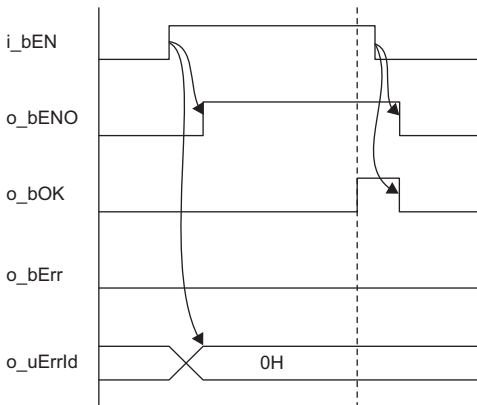
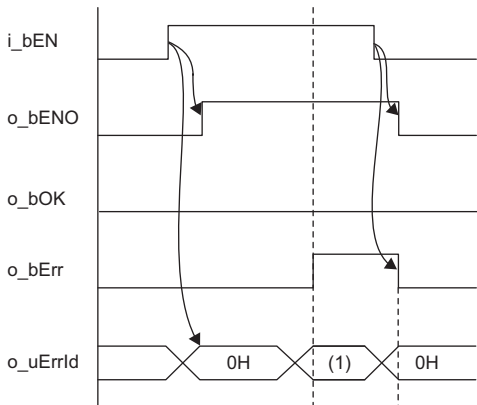
Item	Description	
Available device	Target module	<ul style="list-style-type: none"> • RCPU (CPU part for the RnENCPU) • RJ71EN71 • RnENCPU (network part)
	CPU module	RCPU
	Engineering tool	GX Works3
Language	Ladder diagram	
Number of basic steps	60 steps The number of steps of the FB embedded in a program depends on the CPU module used, the input/output definitions, and the option settings of GX Works3. For the option settings of GX Works3, refer to GX Works3 Operating Manual.	
Processing	When i_bEN (execution instruction) is turned on, this function sends the data to the external device of the connection specified by the input argument.	
FB compilation method	Macro type	
FB operation	Pulse type (multiple-scan execution type)	
Timing chart of I/O signals	<ul style="list-style-type: none"> • For normal completion  <ul style="list-style-type: none"> • For error completion (same as in the case of a module error)  <p>(1) Error code</p>	
Precautions	<ul style="list-style-type: none"> • This module FB cannot be executed for the connection that is being used by another module FB or a dedicated instruction. An error occurs if this module FB is executed for the connection in use. • Turn off i_bEN (execution command) after o_bOK (normal completion) or o_bErr (error completion) is turned on. By turning off i_bEN (execution command), o_bOK (normal completion) or o_bErr (error completion) is turned off and o_uErrld (error code) is cleared to 0. • When this FB is executed, an operation error may occur in the programmable controller CPU. In this case, check the detailed information of the operation error in event history and correct the input argument of the module FB. 	

Error codes

Error code	Reference
C000H to CFFFH	 MELSEC iQ-R Ethernet User's Manual (Application)

2.12 M+model_Refresh_Data

Name

This FB is displayed as follows on the engineering tool depending on the settings.

Name	Module model name	
	RJ71EN71	RnENCPU (network part)
M+RJ71EN71_EE_Refresh_Data	RJ71EN71(E+E)	—
M+RJ71EN71_EC_Refresh_Data	RJ71EN71(E+CCIEC)	_RJ71EN71(E+IEC)
M+RJ71EN71_EF_Refresh_Data	RJ71EN71(E+CCIEF)	_RJ71EN71(E+IEF)

Overview

Item	Description
Overview	Transfers module label data.
Symbol	<p>The above FB is an example for the CPU module.</p>

Labels

■Input arguments

No.	Variable name	Name	Data type	Range	Description
(1)	i_bEN	Execution command	Bit	—	On: Start FB. Off: Do not start FB.
(2)	i_stModule	Module label	Structure	—	Specify the module for which the FB is to be executed. Specify the module label of the modules. (Example: EN71_EE_1, EN71_EF_1, RCPNU)

■Output arguments

No.	Variable name	Name	Data type	Description	Default value
(3)	o_bENO	Execution status	Bit	On: The execution command is turned on. Off: The execution command is turned off.	Off

FB details

Item	Description	
Available device	Target module	<ul style="list-style-type: none"> • RJ71EN71 • RnENCPU (network part)
	CPU module	RCPU
	Engineering tool	GX Works3
Language	Ladder diagram	
Number of basic steps	33 steps The number of steps of the FB embedded in a program depends on the CPU module used, the input/output definitions, and the option settings of GX Works3. For the option settings of GX Works3, refer to GX Works3 Operating Manual.	
Processing	When i_bEN (execution instruction) is turned on, this function transfers the following buffer memory data of the RJ71EN71 or the RnENCPU (network part) to the module label. <ul style="list-style-type: none"> • Open completion signal (addresses 1900000 to 1900007) • Open request signal (addresses 1900008 to 1900015) • Socket/fixed buffer reception status signal (addresses 1900016 to 1900023) 	
FB compilation method	Macro type	
FB operation	ON-time execution type	
Timing chart of I/O signals	<p>The timing chart shows two signals: i_bEN (input) and o_bENO (output). i_bEN is a rectangular pulse. o_bENO is a rectangular pulse that starts at the rising edge of i_bEN and ends at the falling edge of i_bEN, indicating a direct but slightly delayed response.</p>	
Precautions	When another FB is used, write the program so that scan is executed every time at the beginning of the program. <ul style="list-style-type: none"> • When this FB is executed, an operation error may occur in the programmable controller CPU. In this case, check the detailed information of the operation error in event history and correct the input argument of the module FB. 	

Error code

This FB has no error code.

2.13 M+model_SLMP_DeviceRead_IP

Name

M+RCPU_SLMP_DeviceRead_IP

Overview

Item	Description																																				
Overview	Reads data from the SLMP-compatible device specified by an IP address. The external device must support SLMP command (Device Read).																																				
Symbol	<div style="border: 1px solid black; padding: 10px; width: fit-content; margin: 0 auto;"> <p style="text-align: center;">M+RCPU_SLMP_DeviceRead_IP</p> <table style="width: 100%; border-collapse: collapse;"> <tr> <td style="width: 10%;">(1)</td> <td style="width: 40%;">B: i_bEN</td> <td style="width: 40%;">o_bENO: B</td> <td style="width: 10%; text-align: right;">(10)</td> </tr> <tr> <td>(2)</td> <td>DUT: i_stModule</td> <td>o_bOK: B</td> <td style="text-align: right;">(11)</td> </tr> <tr> <td>(3)</td> <td>UW: i_u2IP_Address</td> <td>o_bErr: B</td> <td style="text-align: right;">(12)</td> </tr> <tr> <td>(4)</td> <td>UW: i_uSubCommand</td> <td>o_uErrId: UW</td> <td style="text-align: right;">(13)</td> </tr> <tr> <td>(5)</td> <td>UW: i_uDeviceCode</td> <td>o_uReadData: UW</td> <td style="text-align: right;">(14)</td> </tr> <tr> <td>(6)</td> <td>UW: i_u2DeviceNo</td> <td></td> <td></td> </tr> <tr> <td>(7)</td> <td>UW: i_uDevicePoints</td> <td></td> <td></td> </tr> <tr> <td>(8)</td> <td>UW: i_uChannel</td> <td></td> <td></td> </tr> <tr> <td>(9)</td> <td>UW: i_uTarget_Port_No</td> <td></td> <td></td> </tr> </table> <p style="margin-left: 20px;"> pbi_uRequestModuleIO (15) pbi_uResendCountMax (16) pbi_uMonitorTime (17) pbo_uResendCount (18) pbo_u4ErrTime (19) pbo_u2ErrIP_Address (20) </p> </div>	(1)	B: i_bEN	o_bENO: B	(10)	(2)	DUT: i_stModule	o_bOK: B	(11)	(3)	UW: i_u2IP_Address	o_bErr: B	(12)	(4)	UW: i_uSubCommand	o_uErrId: UW	(13)	(5)	UW: i_uDeviceCode	o_uReadData: UW	(14)	(6)	UW: i_u2DeviceNo			(7)	UW: i_uDevicePoints			(8)	UW: i_uChannel			(9)	UW: i_uTarget_Port_No		
(1)	B: i_bEN	o_bENO: B	(10)																																		
(2)	DUT: i_stModule	o_bOK: B	(11)																																		
(3)	UW: i_u2IP_Address	o_bErr: B	(12)																																		
(4)	UW: i_uSubCommand	o_uErrId: UW	(13)																																		
(5)	UW: i_uDeviceCode	o_uReadData: UW	(14)																																		
(6)	UW: i_u2DeviceNo																																				
(7)	UW: i_uDevicePoints																																				
(8)	UW: i_uChannel																																				
(9)	UW: i_uTarget_Port_No																																				

Labels

Input arguments

No.	Variable name	Name	Data type	Range	Description															
(1)	i_bEN	Execution command	Bit	—	On: Start FB. Off: Do not start FB.															
(2)	i_stModule	Module label	Structure	—	Specify the module for which the FB is to be executed. Specify the module label of the modules.															
(3)	i_u2IP_Address	IP address of external device	Word [Unsigned]/Bit String [16-bit] (0..1)	0.0.0.1 to 255.255.255.254 (00000001H to FFFFFFFEH)	Specify the IP address of an external device. Specify the third and fourth octets to the 1st word, and first and second octets to the 2nd word. Note that the fourth octet cannot be set to 0 or 255 (FFH). <div style="margin-top: 10px;"> <table style="margin-left: auto; margin-right: auto; border-collapse: collapse;"> <tr> <td></td> <td style="text-align: center;">b15</td> <td style="text-align: center;">b8</td> <td style="text-align: center;">b7</td> <td style="text-align: center;">b0</td> </tr> <tr> <td style="text-align: right;">+0</td> <td style="border: 1px solid black; padding: 2px 10px;">(3)</td> <td style="border: 1px solid black; padding: 2px 10px;">(4)</td> <td></td> <td></td> </tr> <tr> <td style="text-align: right;">+1</td> <td style="border: 1px solid black; padding: 2px 10px;">(1)</td> <td style="border: 1px solid black; padding: 2px 10px;">(2)</td> <td></td> <td></td> </tr> </table> <p>(1) to (4): IP address octet</p> </div>		b15	b8	b7	b0	+0	(3)	(4)			+1	(1)	(2)		
	b15	b8	b7	b0																
+0	(3)	(4)																		
+1	(1)	(2)																		
(4)	i_uSubCommand	Sub command	Word [Unsigned]/Bit String [16-bit]	—	Specify the read unit and specification method of a device. <ul style="list-style-type: none"> ■0th bit: Read unit 0: In units of words 1: In units of bits ■1st bit: Specification method of the device is read 0: Specify the device code in 2 digits and the start device number in 6 digits (for MELSEC-Q/L series). 1: Specify the device code in 4 digits and the start device number in 8 digits (for MELSEC iQ-R series). 															

No.	Variable name	Name	Data type	Range	Description
(5)	i_uDeviceCode	Device code ^{*1}	Word [Unsigned]/Bit String [16-bit]	—	Specify the device code of the device to be read in binary code. <ul style="list-style-type: none"> • When the 1st bit of the subcommand is 0: 2 digits • When the 1st bit of the subcommand is 1: 4 digits
(6)	i_u2DeviceNo	Head device No.	Word [Unsigned]/Bit String [16-bit] (0..1)	—	Specify the start device number of the device to be read in binary code. <ul style="list-style-type: none"> • When the 1st bit of the subcommand is 0: 6 digits • When the 1st bit of the subcommand is 1: 8 digits
(7)	i_uDevicePoints	Number of device points	Word [Unsigned]/Bit String [16-bit]	—	Specify the number of device points of the device to be read in binary code. <ul style="list-style-type: none"> • When the 0th bit of the subcommand is 0: 1 to 960 • When the 0th bit of the subcommand is 1: 1 to 3972
(8)	i_uChannel	Own station channel	Word [Unsigned]/Bit String [16-bit]	1 to 9	Specify the channel to be used by the own station. Since whether or not a serial number ^{*2} is given to the request message depends on the channel, specify the channel as follows according to the application. <ul style="list-style-type: none"> • 1: No serial number is given • 2 to 9: Serial number is given
(9)	i_uTarget_Port_No	Destination port number	Word [Unsigned]/Bit String [16-bit]	1 to 65534	Specify the UDP port number of an external device.

*1 For details on each device code, refer to the following.

 SLMP Reference Manual

*2 Give the serial numbers when sending several request messages to the same SLMP-compatible device. Serial numbers to be given are automatically numbered by the system. For the serial number, refer to the following.

 SLMP Reference Manual

■Output arguments

No.	Variable name	Name	Data type	Description	Default value																																																																																																												
(10)	o_bENO	Execution status	Bit	On: The execution command is turned on. Off: The execution command is turned off.	Off																																																																																																												
(11)	o_bOK	Normal completion	Bit	The FB has been processed normally when this argument is on.	Off																																																																																																												
(12)	o_bErr	Error completion	Bit	The FB has been processed abnormally when this argument is on.	Off																																																																																																												
(13)	o_uErrId	Error code	Word [Unsigned]/Bit String [16-bit]	An error code is stored at error completion.	0																																																																																																												
(14)	o_uReadData	Read data storage destination	Word [Unsigned]/Bit String [16-bit]	<p>Specify the start device number of the device for storing the read data. The read data is stored in binary code.</p> <p>■When the 0th bit of the subcommand is 0 The device data is read in units of words. Example: When reading the bit device M100 to M115 (one word) in units of words 1st word:</p> <table style="margin-left: 40px;"> <tr> <td style="text-align: center;">b15</td> <td style="text-align: center;">b8</td> <td style="text-align: center;">b7</td> <td style="text-align: center;">b0</td> </tr> <tr> <td style="text-align: center;">1</td> <td style="text-align: center;">2</td> <td style="text-align: center;">3</td> <td style="text-align: center;">4</td> </tr> <tr> <td style="text-align: center;">⋮</td> <td style="text-align: center;">⋮</td> <td style="text-align: center;">⋮</td> <td style="text-align: center;">⋮</td> </tr> <tr> <td style="text-align: center;">0</td> <td style="text-align: center;">0</td> <td style="text-align: center;">1</td> <td style="text-align: center;">0</td> </tr> <tr> <td style="text-align: center;">0</td> <td style="text-align: center;">1</td> <td style="text-align: center;">0</td> <td style="text-align: center;">0</td> </tr> <tr> <td style="text-align: center;">0</td> <td style="text-align: center;">0</td> <td style="text-align: center;">1</td> <td style="text-align: center;">1</td> </tr> <tr> <td style="text-align: center;">0</td> <td style="text-align: center;">1</td> <td style="text-align: center;">0</td> <td style="text-align: center;">1</td> </tr> <tr> <td style="text-align: center;">0</td> <td style="text-align: center;">0</td> <td style="text-align: center;">1</td> <td style="text-align: center;">0</td> </tr> <tr> <td style="text-align: center;">0</td> <td style="text-align: center;">0</td> <td style="text-align: center;">1</td> <td style="text-align: center;">0</td> </tr> </table> <p style="margin-left: 40px;">M115 ⋯ M100</p> <p>Example: When reading the word device D0 to D2 in units of words 1st word:</p> <table style="margin-left: 40px;"> <tr> <td style="text-align: center;">b15</td> <td style="text-align: center;">b8</td> <td style="text-align: center;">b7</td> <td style="text-align: center;">b0</td> </tr> <tr> <td style="text-align: center;">1</td> <td style="text-align: center;">2</td> <td style="text-align: center;">3</td> <td style="text-align: center;">4</td> </tr> <tr> <td colspan="4" style="text-align: center;">⏟</td> </tr> <tr> <td colspan="4" style="text-align: center;">D0</td> </tr> </table> <p>2nd word:</p> <table style="margin-left: 40px;"> <tr> <td style="text-align: center;">b15</td> <td style="text-align: center;">b8</td> <td style="text-align: center;">b7</td> <td style="text-align: center;">b0</td> </tr> <tr> <td style="text-align: center;">0</td> <td style="text-align: center;">0</td> <td style="text-align: center;">0</td> <td style="text-align: center;">2</td> </tr> <tr> <td colspan="4" style="text-align: center;">⏟</td> </tr> <tr> <td colspan="4" style="text-align: center;">D1</td> </tr> </table> <p>3rd word:</p> <table style="margin-left: 40px;"> <tr> <td style="text-align: center;">b15</td> <td style="text-align: center;">b8</td> <td style="text-align: center;">b7</td> <td style="text-align: center;">b0</td> </tr> <tr> <td style="text-align: center;">1</td> <td style="text-align: center;">D</td> <td style="text-align: center;">E</td> <td style="text-align: center;">F</td> </tr> <tr> <td colspan="4" style="text-align: center;">⏟</td> </tr> <tr> <td colspan="4" style="text-align: center;">D2</td> </tr> </table> <p>■When the 0th bit of the subcommand is 1 The device data is read in units of bits. Example: When reading the bit device M100 to M107 in units of bits 1st word:</p> <table style="margin-left: 40px;"> <tr> <td style="text-align: center;">b15</td> <td style="text-align: center;">b8</td> <td style="text-align: center;">b7</td> <td style="text-align: center;">b0</td> </tr> <tr> <td style="text-align: center;">0</td> <td style="text-align: center;">1</td> <td style="text-align: center;">0</td> <td style="text-align: center;">0</td> </tr> <tr> <td style="text-align: center;">M102</td> <td style="text-align: center;">M103</td> <td style="text-align: center;">M100</td> <td style="text-align: center;">M101</td> </tr> </table> <p>2nd word:</p> <table style="margin-left: 40px;"> <tr> <td style="text-align: center;">b15</td> <td style="text-align: center;">b8</td> <td style="text-align: center;">b7</td> <td style="text-align: center;">b0</td> </tr> <tr> <td style="text-align: center;">1</td> <td style="text-align: center;">1</td> <td style="text-align: center;">0</td> <td style="text-align: center;">0</td> </tr> <tr> <td style="text-align: center;">M106</td> <td style="text-align: center;">M107</td> <td style="text-align: center;">M104</td> <td style="text-align: center;">M105</td> </tr> </table>	b15	b8	b7	b0	1	2	3	4	⋮	⋮	⋮	⋮	0	0	1	0	0	1	0	0	0	0	1	1	0	1	0	1	0	0	1	0	0	0	1	0	b15	b8	b7	b0	1	2	3	4	⏟				D0				b15	b8	b7	b0	0	0	0	2	⏟				D1				b15	b8	b7	b0	1	D	E	F	⏟				D2				b15	b8	b7	b0	0	1	0	0	M102	M103	M100	M101	b15	b8	b7	b0	1	1	0	0	M106	M107	M104	M105	0
b15	b8	b7	b0																																																																																																														
1	2	3	4																																																																																																														
⋮	⋮	⋮	⋮																																																																																																														
0	0	1	0																																																																																																														
0	1	0	0																																																																																																														
0	0	1	1																																																																																																														
0	1	0	1																																																																																																														
0	0	1	0																																																																																																														
0	0	1	0																																																																																																														
b15	b8	b7	b0																																																																																																														
1	2	3	4																																																																																																														
⏟																																																																																																																	
D0																																																																																																																	
b15	b8	b7	b0																																																																																																														
0	0	0	2																																																																																																														
⏟																																																																																																																	
D1																																																																																																																	
b15	b8	b7	b0																																																																																																														
1	D	E	F																																																																																																														
⏟																																																																																																																	
D2																																																																																																																	
b15	b8	b7	b0																																																																																																														
0	1	0	0																																																																																																														
M102	M103	M100	M101																																																																																																														
b15	b8	b7	b0																																																																																																														
1	1	0	0																																																																																																														
M106	M107	M104	M105																																																																																																														

■ Operation parameters

No.	Variable name	Name	Data type	Range	Description	Default value
(15)	pbi_uRequestModuleIO	Requested module I/O No.	Word [Unsigned]/Bit String [16-bit]	03D0H to 03D3H, 03E0H to 03E3H, 03FFH	Specify the module of the access destination. <ul style="list-style-type: none"> • 03D0H: Control system CPU • 03D1H: Standby system CPU • 03D2H: System A CPU • 03D3H: System B CPU • 03FFH: Own station, control CPU • 03E0H: Multiple CPU No.1 • 03E1H: Multiple CPU No.2 • 03E2H: Multiple CPU No.3 • 03E3H: Multiple CPU No.4 	03FFH
(16)	pbi_uResendCountMax	Maximum number of resends	Word [Unsigned]/Bit String [16-bit]	0 to 15	Specify the number of resends to be performed if the data transfer is not completed within the monitoring time specified by pbi_uMonitorTime (Arrival monitoring time). <ul style="list-style-type: none"> • 0 to 15 	5
(17)	pbi_uMonitorTime	Arrival monitoring time	Word [Unsigned]/Bit String [16-bit]	0, 1 to 32767	Specify the monitoring time until completion of processing. If the processing is not completed within the monitoring time, data is resent until the value specified in pbi_uResendCountMax (Maximum number of resends) is reached. <ul style="list-style-type: none"> • 0: 10s • 1 to 32767: 1 to 32767s 	0

■ Public variables

No.	Variable name	Name	Data type	Description	Default value															
(18)	pbo_uResendCount	Number of resends	Word [Unsigned]/Bit String [16-bit]	The number of resends performed (result) is stored.	0															
(19)	pbo_u4ErrTime	Error occurrence time	Word [Unsigned]/Bit String [16-bit] (0..3)	Clock data at the time of error occurrence is stored. 1st word <ul style="list-style-type: none"> • Upper 8 bits: Month (01H to 12H) • Lower 8 bits: Lower 2 digits of year (00H to 99H) 2nd word <ul style="list-style-type: none"> • Upper 8 bits: Hour (00H to 23H) • Lower 8 bits: Day (01H to 31H) 3rd word <ul style="list-style-type: none"> • Upper 8 bits: Second (00H to 59H) • Lower 8 bits: Minute (00H to 59H) 4th word <ul style="list-style-type: none"> • Upper 8 bits: Upper 2 digits of year (00H to 99H) • Lower 8 bits: Day of week (00H (Sunday) to 06H (Saturday)) 	0															
(20)	pbo_u2ErrIP_Address	Error-detected station IP address	Word [Unsigned]/Bit String [16-bit] (0..1)	The IP address of the station in which an error was detected is stored. The third and fourth octets are stored in the 1st word, and first and second octets are stored in the 2nd word. <table style="margin-left: auto; margin-right: auto; border-collapse: collapse;"> <tr> <td></td> <td style="text-align: center;">b15</td> <td style="text-align: center;">b8</td> <td style="text-align: center;">b7</td> <td style="text-align: center;">b0</td> </tr> <tr> <td style="text-align: right;">+0</td> <td style="border: 1px solid black; text-align: center;">(3)</td> <td style="border: 1px solid black; text-align: center;">(4)</td> <td colspan="2"></td> </tr> <tr> <td style="text-align: right;">+1</td> <td style="border: 1px solid black; text-align: center;">(1)</td> <td style="border: 1px solid black; text-align: center;">(2)</td> <td colspan="2"></td> </tr> </table> (1) to (4): IP address octet		b15	b8	b7	b0	+0	(3)	(4)			+1	(1)	(2)			0
	b15	b8	b7	b0																
+0	(3)	(4)																		
+1	(1)	(2)																		

FB details

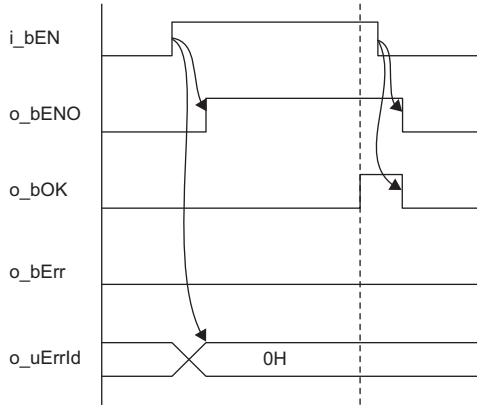
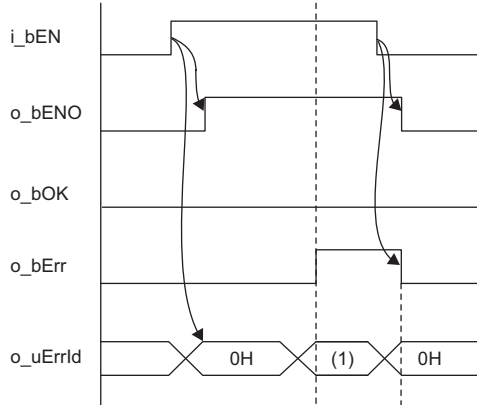
Item	Description	
Available device	Target module	<ul style="list-style-type: none"> • RnCPU*¹ • RnENCPU (CPU part)*¹
	CPU module	<ul style="list-style-type: none"> • RnCPU*¹ • RnENCPU*¹
	Engineering tool	GX Works3* ²
Language	Ladder diagram	
Number of basic steps	190 steps The number of steps of the FB embedded in a program depends on the CPU module used, the input/output definitions, and the option settings of GX Works3. For the option settings of GX Works3, refer to GX Works3 Operating Manual.	
Processing	<ul style="list-style-type: none"> • When i_bEN (execution command) is turned on, this function reads device data from the SLMP-compatible device. • Execute this FB while the IP address for an external device is specified. • This FB uses Read command (command: 0401) of the SLMP. The message of the SLMP command is a binary code. (📖 SLMP Reference Manual) 	
FB compilation method	Macro type	
FB operation	ON-time execution type	
Timing chart of I/O signals	<ul style="list-style-type: none"> • For normal completion  <ul style="list-style-type: none"> • For error completion (same as in the case of a module error)  <p>(1) Error code</p>	

Item	Description
Precautions	<ul style="list-style-type: none"> • This FB does not include error recovery processing. Please create error recovery processing separately according to the system and required operations. • This FB uses the SLMPSND instruction. • Turn off i_bEN (execution command) after o_bOK (normal completion) or o_bErr (error completion) is turned on. By turning off i_bEN (execution command), o_bOK (normal completion) or o_bErr (error completion) is turned off and o_uErrId (error code) is cleared to 0. • In this FB, access devices (such as link direct device) that are accessed by the extension specification of the SLMP cannot be read. • In this FB, stations in other network cannot be set as the target station. • When this FB is executed for the port of an external device where the remote password is set, execute this FB after performing the unlock processing of the remote password. When this FB is executed for the port of an external device where the remote password is set, an error will occur. • The target station must support "Read (command: 0401)" of the SLMP command. • This FB is for communications in binary code only. (Communications using ASCII code cannot be performed.) • This FB uses UDP communications. Set the protocol setting of the external device to UDP. • This FB uses the label initial value by each program. When the program file using this FB is specified to boot file setting for the boot operation in the CPU module, specify the initial label value file by each program to the boot file setting as well. (MELSEC iQ-R CPU Module User's Manual (Application)) If an error code that is not described in Page 72 Error codes appears, the initial label value files by each program may not be set to the boot file setting. In this case, specify the initial label value files by each program to the boot file setting. • When this FB is executed, an operation error may occur in the programmable controller CPU. In this case, check the detailed information of the operation error in event history and correct the input argument of the module FB.

*1 The supported firmware version is "17" or later.

*2 The supported version is "1.020W" or later.

Error codes

Error code	Description	Action
100H	A value out of the range is set in the number of device points (i_uDevicePoints) of the argument.	Set the value within the setting range in the number of device points (i_uDevicePoints).
C000H to CFFFH	MELSEC iQ-R Ethernet User's Manual (Application)	

2.14 M+model_SLMP_DeviceWrite_IP

Name

M+RCPU_SLMP_DeviceWrite_IP

Overview

Item	Description																																																																
Overview	Writes data to the SLMP-compatible device specified by an IP address. The external device must support SLMP command (Device Write).																																																																
Symbol	<div style="border: 1px solid black; padding: 10px; margin: 10px 0;"> <p style="text-align: center;">M+RCPU_SLMP_DeviceWrite_IP</p> <table style="width: 100%; border-collapse: collapse;"> <tr> <td style="width: 5%; text-align: right;">(1)</td> <td style="width: 35%;">B: i_bEN</td> <td style="width: 35%; text-align: left;">o_bENO: B</td> <td style="width: 5%; text-align: right;">(11)</td> </tr> <tr> <td style="text-align: right;">(2)</td> <td>DUT: i_stModule</td> <td style="text-align: left;">o_bOK: B</td> <td style="text-align: right;">(12)</td> </tr> <tr> <td style="text-align: right;">(3)</td> <td>UW: i_u2IP_Address</td> <td style="text-align: left;">o_bErr: B</td> <td style="text-align: right;">(13)</td> </tr> <tr> <td style="text-align: right;">(4)</td> <td>UW: i_uSubCommand</td> <td style="text-align: left;">o_uErrId: UW</td> <td style="text-align: right;">(14)</td> </tr> <tr> <td style="text-align: right;">(5)</td> <td>UW: i_uDeviceCode</td> <td></td> <td></td> </tr> <tr> <td style="text-align: right;">(6)</td> <td>UW: i_u2DeviceNo</td> <td></td> <td></td> </tr> <tr> <td style="text-align: right;">(7)</td> <td>UW: i_uDevicePoints</td> <td></td> <td></td> </tr> <tr> <td style="text-align: right;">(8)</td> <td>UW: i_uWriteData</td> <td></td> <td></td> </tr> <tr> <td style="text-align: right;">(9)</td> <td>UW: i_uChannel</td> <td></td> <td></td> </tr> <tr> <td style="text-align: right;">(10)</td> <td>UW: i_uTarget_Port_No</td> <td></td> <td></td> </tr> <tr> <td></td> <td style="padding-left: 20px;">pbi_uRequestModuleIO (15)</td> <td></td> <td></td> </tr> <tr> <td></td> <td style="padding-left: 20px;">pbi_uResendCountMax (16)</td> <td></td> <td></td> </tr> <tr> <td></td> <td style="padding-left: 20px;">pbi_uMonitorTime (17)</td> <td></td> <td></td> </tr> <tr> <td></td> <td style="padding-left: 20px;">pbo_uResendCount (18)</td> <td></td> <td></td> </tr> <tr> <td></td> <td style="padding-left: 20px;">pbo_u4ErrTime (19)</td> <td></td> <td></td> </tr> <tr> <td></td> <td style="padding-left: 20px;">pbo_u2ErrIP_Address (20)</td> <td></td> <td></td> </tr> </table> </div>	(1)	B: i_bEN	o_bENO: B	(11)	(2)	DUT: i_stModule	o_bOK: B	(12)	(3)	UW: i_u2IP_Address	o_bErr: B	(13)	(4)	UW: i_uSubCommand	o_uErrId: UW	(14)	(5)	UW: i_uDeviceCode			(6)	UW: i_u2DeviceNo			(7)	UW: i_uDevicePoints			(8)	UW: i_uWriteData			(9)	UW: i_uChannel			(10)	UW: i_uTarget_Port_No				pbi_uRequestModuleIO (15)				pbi_uResendCountMax (16)				pbi_uMonitorTime (17)				pbo_uResendCount (18)				pbo_u4ErrTime (19)				pbo_u2ErrIP_Address (20)		
(1)	B: i_bEN	o_bENO: B	(11)																																																														
(2)	DUT: i_stModule	o_bOK: B	(12)																																																														
(3)	UW: i_u2IP_Address	o_bErr: B	(13)																																																														
(4)	UW: i_uSubCommand	o_uErrId: UW	(14)																																																														
(5)	UW: i_uDeviceCode																																																																
(6)	UW: i_u2DeviceNo																																																																
(7)	UW: i_uDevicePoints																																																																
(8)	UW: i_uWriteData																																																																
(9)	UW: i_uChannel																																																																
(10)	UW: i_uTarget_Port_No																																																																
	pbi_uRequestModuleIO (15)																																																																
	pbi_uResendCountMax (16)																																																																
	pbi_uMonitorTime (17)																																																																
	pbo_uResendCount (18)																																																																
	pbo_u4ErrTime (19)																																																																
	pbo_u2ErrIP_Address (20)																																																																

Labels

Input arguments

No.	Variable name	Name	Data type	Range	Description															
(1)	i_bEN	Execution command	Bit	—	On: Start FB. Off: Do not start FB.															
(2)	i_stModule	Module label	Structure	—	Specify the module for which the FB is to be executed. Specify the module label of the modules.															
(3)	i_u2IP_Address	IP address of external device	Word [Unsigned]/Bit String [16-bit] (0..1)	0.0.0.1 to 255.255.255.254 (1H to FFFFFFFEH)	Specify the IP address of the target station. Specify the third and fourth octets to the 1st word, and first and second octets to the 2nd word. Note that the fourth octet cannot be set to 0 or 255 (FFH). <table style="margin-left: auto; margin-right: auto;"> <tr> <td></td> <td style="text-align: center;">b15</td> <td style="text-align: center;">b8</td> <td style="text-align: center;">b7</td> <td style="text-align: center;">b0</td> </tr> <tr> <td>+0</td> <td style="border: 1px solid black; text-align: center;">(3)</td> <td style="border: 1px solid black; text-align: center;">(4)</td> <td colspan="2"></td> </tr> <tr> <td>+1</td> <td style="border: 1px solid black; text-align: center;">(1)</td> <td style="border: 1px solid black; text-align: center;">(2)</td> <td colspan="2"></td> </tr> </table> (1) to (4): IP address octet		b15	b8	b7	b0	+0	(3)	(4)			+1	(1)	(2)		
	b15	b8	b7	b0																
+0	(3)	(4)																		
+1	(1)	(2)																		
(4)	i_uSubCommand	Sub command	Word [Unsigned]/Bit String [16-bit]	—	Specify the write unit and specification method of a device. 0th bit: Write unit 0: In units of words 1: In units of bits Specification method of the device is written 0: Specify the device code in 2 digits and the start device number in 6 digits (for MELSEC-Q/L series). 1: Specify the device code in 4 digits and the start device number in 8 digits (for MELSEC iQ-R series).															
(5)	i_uDeviceCode	Device code ^{*1}	Word [Unsigned]/Bit String [16-bit]	—	Specify the device code of the device to be written in binary code. <ul style="list-style-type: none"> • When the 1st bit of the subcommand is 0: 2 digits • When the 1st bit of the subcommand is 1: 4 digits 															
(6)	i_u2DeviceNo	Head device No.	Word [Unsigned]/Bit String [16-bit] (0..1)	—	Specify the start device number of the device to be written in binary code. <ul style="list-style-type: none"> • When the 1st bit of the subcommand is 0: 6 digits • When the 1st bit of the subcommand is 1: 8 digits 															
(7)	i_uDevicePoints	Number of device points	Word [Unsigned]/Bit String [16-bit]	—	Specify the number of device points of the device to be written in binary code. <ul style="list-style-type: none"> • When the 0th bit of the subcommand is 0: 1 to 960 • When the 0th bit of the subcommand is 1: 1 to 3972 															

No.	Variable name	Name	Data type	Range	Description																																																																																																
(8)	i_uWriteData	Write data storage destination	Word [Unsigned]/Bit String [16-bit]	—	<p>Specify the start device number of the device for storing the write data.</p> <p>■When the 0th bit of the subcommand is 0 The device data is written in units of words. Example: When writing the bit device M100 to M115 (one word) in units of words 1st word:</p> <table border="1" style="margin-left: 20px;"> <tr> <td style="text-align: center;">b15</td> <td style="text-align: center;">b8</td> <td style="text-align: center;">b7</td> <td style="text-align: center;">b0</td> </tr> <tr> <td style="text-align: center;">1</td> <td style="text-align: center;">2</td> <td style="text-align: center;">3</td> <td style="text-align: center;">4</td> </tr> <tr> <td style="text-align: center;">⋮</td> <td style="text-align: center;">⋮</td> <td style="text-align: center;">⋮</td> <td style="text-align: center;">⋮</td> </tr> <tr> <td style="text-align: center;">0</td> <td style="text-align: center;">0</td> <td style="text-align: center;">0</td> <td style="text-align: center;">1</td> </tr> <tr> <td style="text-align: center;">0</td> <td style="text-align: center;">0</td> <td style="text-align: center;">1</td> <td style="text-align: center;">0</td> </tr> <tr> <td style="text-align: center;">0</td> <td style="text-align: center;">0</td> <td style="text-align: center;">1</td> <td style="text-align: center;">1</td> </tr> <tr> <td style="text-align: center;">0</td> <td style="text-align: center;">1</td> <td style="text-align: center;">0</td> <td style="text-align: center;">0</td> </tr> <tr> <td style="text-align: center;">0</td> <td style="text-align: center;">0</td> <td style="text-align: center;">0</td> <td style="text-align: center;">0</td> </tr> <tr> <td style="text-align: center;">M115</td> <td style="text-align: center;">⋯</td> <td style="text-align: center;">M100</td> <td></td> </tr> </table> <p>Example: When writing the word device D0 to D2 in units of words 1st word:</p> <table border="1" style="margin-left: 20px;"> <tr> <td style="text-align: center;">b15</td> <td style="text-align: center;">b8</td> <td style="text-align: center;">b7</td> <td style="text-align: center;">b0</td> </tr> <tr> <td style="text-align: center;">1</td> <td style="text-align: center;">2</td> <td style="text-align: center;">3</td> <td style="text-align: center;">4</td> </tr> <tr> <td colspan="4" style="text-align: center;">D0</td> </tr> </table> <p>2nd word:</p> <table border="1" style="margin-left: 20px;"> <tr> <td style="text-align: center;">b15</td> <td style="text-align: center;">b8</td> <td style="text-align: center;">b7</td> <td style="text-align: center;">b0</td> </tr> <tr> <td style="text-align: center;">0</td> <td style="text-align: center;">0</td> <td style="text-align: center;">0</td> <td style="text-align: center;">2</td> </tr> <tr> <td colspan="4" style="text-align: center;">D1</td> </tr> </table> <p>3rd word:</p> <table border="1" style="margin-left: 20px;"> <tr> <td style="text-align: center;">b15</td> <td style="text-align: center;">b8</td> <td style="text-align: center;">b7</td> <td style="text-align: center;">b0</td> </tr> <tr> <td style="text-align: center;">1</td> <td style="text-align: center;">D</td> <td style="text-align: center;">E</td> <td style="text-align: center;">F</td> </tr> <tr> <td colspan="4" style="text-align: center;">D2</td> </tr> </table> <p>■When the 0th bit of the subcommand is 1 The device data is written in units of bits. Example: When writing the bit device M100 to M107 in units of bits 1st word:</p> <table border="1" style="margin-left: 20px;"> <tr> <td style="text-align: center;">b15</td> <td style="text-align: center;">b8</td> <td style="text-align: center;">b7</td> <td style="text-align: center;">b0</td> </tr> <tr> <td style="text-align: center;">0</td> <td style="text-align: center;">1</td> <td style="text-align: center;">0</td> <td style="text-align: center;">0</td> </tr> <tr> <td style="text-align: center;">M102</td> <td style="text-align: center;">M103</td> <td style="text-align: center;">M100</td> <td style="text-align: center;">M101</td> </tr> </table> <p>2nd word:</p> <table border="1" style="margin-left: 20px;"> <tr> <td style="text-align: center;">b15</td> <td style="text-align: center;">b8</td> <td style="text-align: center;">b7</td> <td style="text-align: center;">b0</td> </tr> <tr> <td style="text-align: center;">1</td> <td style="text-align: center;">1</td> <td style="text-align: center;">0</td> <td style="text-align: center;">0</td> </tr> <tr> <td style="text-align: center;">M106</td> <td style="text-align: center;">M107</td> <td style="text-align: center;">M104</td> <td style="text-align: center;">M105</td> </tr> </table>	b15	b8	b7	b0	1	2	3	4	⋮	⋮	⋮	⋮	0	0	0	1	0	0	1	0	0	0	1	1	0	1	0	0	0	0	0	0	M115	⋯	M100		b15	b8	b7	b0	1	2	3	4	D0				b15	b8	b7	b0	0	0	0	2	D1				b15	b8	b7	b0	1	D	E	F	D2				b15	b8	b7	b0	0	1	0	0	M102	M103	M100	M101	b15	b8	b7	b0	1	1	0	0	M106	M107	M104	M105
b15	b8	b7	b0																																																																																																		
1	2	3	4																																																																																																		
⋮	⋮	⋮	⋮																																																																																																		
0	0	0	1																																																																																																		
0	0	1	0																																																																																																		
0	0	1	1																																																																																																		
0	1	0	0																																																																																																		
0	0	0	0																																																																																																		
M115	⋯	M100																																																																																																			
b15	b8	b7	b0																																																																																																		
1	2	3	4																																																																																																		
D0																																																																																																					
b15	b8	b7	b0																																																																																																		
0	0	0	2																																																																																																		
D1																																																																																																					
b15	b8	b7	b0																																																																																																		
1	D	E	F																																																																																																		
D2																																																																																																					
b15	b8	b7	b0																																																																																																		
0	1	0	0																																																																																																		
M102	M103	M100	M101																																																																																																		
b15	b8	b7	b0																																																																																																		
1	1	0	0																																																																																																		
M106	M107	M104	M105																																																																																																		
(9)	i_uChannel	Own station channel	Word [Unsigned]/Bit String [16-bit]	1 to 9	<p>Specify the channel to be used by the own station. Since whether or not a serial number^{*2} is given to the request message depends on the channel, specify the channel as follows according to the application.</p> <ul style="list-style-type: none"> • 1: No serial number is given • 2 to 9: Serial number is given 																																																																																																
(10)	i_uTarget_Port_No	Destination port number	Word [Unsigned]/Bit String [16-bit]	1 to 65534	Specify the UDP port number of an external device.																																																																																																

*1 For details on each device code, refer to the following.

📖 SLMP Reference Manual

*2 Give the serial numbers when sending several request messages to the same SLMP-compatible device. Serial numbers to be given are automatically numbered by the system. For the serial number, refer to the following.

📖 SLMP Reference Manual

■Output arguments

No.	Variable name	Name	Data type	Description	Default value
(11)	o_bENO	Execution status	Bit	On: The execution command is turned on. Off: The execution command is turned off.	Off
(12)	o_bOK	Normal completion	Bit	The FB has been processed normally when this argument is on.	Off
(13)	o_bErr	Error completion	Bit	The FB has been processed abnormally when this argument is on.	Off
(14)	o_uErrId	Error code	Word [Unsigned]/Bit String [16-bit]	An error code is stored at error completion.	0

■Operation parameters

No.	Variable name	Name	Data type	Range	Description	Default value
(15)	pbi_uRequestModuleIO	Requested module I/O No.	Word [Unsigned]/Bit String [16-bit]	03D0H to 03D3H, 03E0H to 03E3H, 03FFH	Specify the module of the access destination. <ul style="list-style-type: none"> • 03D0H: Control system CPU • 03D1H: Standby system CPU • 03D2H: System A CPU • 03D3H: System B CPU • 03FFH: Own station, control CPU • 03E0H: Multiple CPU No.1 • 03E1H: Multiple CPU No.2 • 03E2H: Multiple CPU No.3 • 03E3H: Multiple CPU No.4 	03FFH
(16)	pbi_uResendCountMax	Maximum number of resends	Word [Unsigned]/Bit String [16-bit]	0 to 15	Specify the number of resends to be performed if the data transfer is not completed within the monitoring time specified by pbi_uMonitorTime (Arrival monitoring time). <ul style="list-style-type: none"> • 0 to 15 	5
(17)	pbi_uMonitorTime	Arrival monitoring time	Word [Unsigned]/Bit String [16-bit]	0, 1 to 32767	Specify the monitoring time until completion of processing. If the processing is not completed within the monitoring time, data is resent until the value specified in pbi_uResendCountMax (Maximum number of resends) is reached. <ul style="list-style-type: none"> • 0: 10s • 1 to 32767: 1 to 32767s 	0

Public variables

No.	Variable name	Name	Data type	Description	Default value															
(18)	pbo_uResendCount	Number of resends	Word [Unsigned]/Bit String [16-bit]	The number of resends performed (result) is stored.	0															
(19)	pbo_u4ErrTime	Error occurrence time	Word [Unsigned]/Bit String [16-bit] (0..3)	Clock data at the time of error occurrence is stored. 1st word • Upper 8 bits: Month (01H to 12H) • Lower 8 bits: Lower 2 digits of year (00H to 99H) 2nd word • Upper 8 bits: Hour (00H to 23H) • Lower 8 bits: Day (01H to 31H) 3rd word • Upper 8 bits: Second (00H to 59H) • Lower 8 bits: Minute (00H to 59H) 4th word • Upper 8 bits: Upper 2 digits of year (00H to 99H) • Lower 8 bits: Day of week (00H (Sunday) to 06H (Saturday))	0															
(20)	pbo_u2ErrIP_Address	Error-detected station IP address	Word [Unsigned]/Bit String [16-bit] (0..1)	The IP address of the station in which an error was detected is stored. The third and fourth octets are stored in the 1st word, and first and second octets are stored in the 2nd word. <table style="margin-left: auto; margin-right: auto; border-collapse: collapse;"> <tr> <td></td> <td style="text-align: center;">b15</td> <td style="text-align: center;">b8</td> <td style="text-align: center;">b7</td> <td style="text-align: center;">b0</td> </tr> <tr> <td style="text-align: right;">+0</td> <td style="border: 1px solid black; text-align: center;">(3)</td> <td style="border: 1px solid black; text-align: center;">(4)</td> <td colspan="2"></td> </tr> <tr> <td style="text-align: right;">+1</td> <td style="border: 1px solid black; text-align: center;">(1)</td> <td style="border: 1px solid black; text-align: center;">(2)</td> <td colspan="2"></td> </tr> </table> (1) to (4): IP address octet		b15	b8	b7	b0	+0	(3)	(4)			+1	(1)	(2)			0
	b15	b8	b7	b0																
+0	(3)	(4)																		
+1	(1)	(2)																		

FB details

Item	Description
Available device	Target module <ul style="list-style-type: none"> • RnCPU^{*1} • RnENCPU (CPU part)^{*1}
	CPU module <ul style="list-style-type: none"> • RnCPU^{*1} • RnENCPU^{*1}
	Engineering tool <ul style="list-style-type: none"> • GX Works3^{*2}
Language	Ladder diagram
Number of basic steps	210 steps The number of steps of the FB embedded in a program depends on the CPU module used, the input/output definitions, and the option settings of GX Works3. For the option settings of GX Works3, refer to GX Works3 Operating Manual.
Processing	<ul style="list-style-type: none"> • When i_bEN (execution command) is turned on, this function writes device data of the SLMP-compatible device. • Execute this FB while the IP address for an external device is specified. • This FB uses Write command (command: 1401) of the SLMP. The message of the SLMP command is a binary code. (📖 SLMP Reference Manual)
FB compilation method	Macro type
FB operation	ON-time execution type

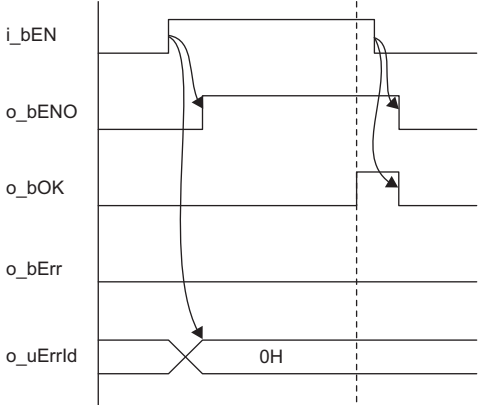
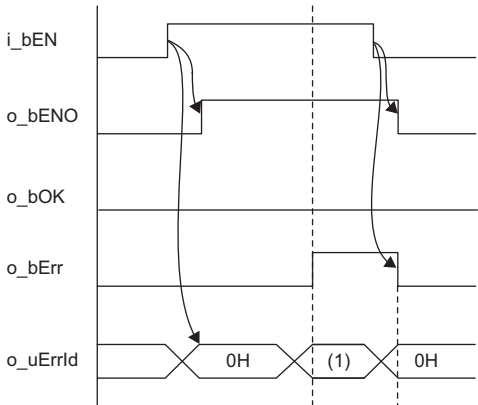
Item	Description
Timing chart of I/O signals	<ul style="list-style-type: none"> For normal completion  <ul style="list-style-type: none"> For error completion (same as in the case of a module error)  <p>(1) Error code</p>

Precautions	<ul style="list-style-type: none"> This FB does not include error recovery processing. Please create error recovery processing separately according to the system and required operations. This FB uses the SLMPSEND instruction. Turn off i_bEN (execution command) after o_bOK (normal completion) or o_bErr (error completion) is turned on. By turning off i_bEN (execution command), o_bOK (normal completion) or o_bErr (error completion) is turned off and o_uErrId (error code) is cleared to 0. In this FB, access devices (such as link direct device) that are accessed by the extension specification of the SLMP cannot be written. In this FB, stations in other network cannot be set as the target station. When this FB is executed for the port of an external device where the remote password is set, execute this FB after performing the unlock processing of the remote password. When this FB is executed for the port of an external device where the remote password is set, an error will occur. The target station must support "Write (command: 1401)" of the SLMP command. This FB is for communications in binary code only. (Communications using ASCII code cannot be performed.) This FB uses UDP communications. Set the protocol setting of the external device to UDP. This FB uses the label initial value by each program. When the program file using this FB is specified to boot file setting for the boot operation in the CPU module, specify the initial label value file by each program to the boot file setting as well. (MELSEC iQ-R CPU Module User's Manual (Application)) If an error code that is not described in Page 78 Error codes appears, the initial label value files by each program may not be set to the boot file setting. In this case, specify the initial label value files by each program to the boot file setting. When this FB is executed, an operation error may occur in the programmable controller CPU. In this case, check the detailed information of the operation error in event history and correct the input argument of the module FB.
-------------	--

*1 The supported firmware version is "17" or later.

*2 The supported version is "1.020W" or later.

Error codes		
Error code	Description	Action
100H	A value out of the range is set in the number of device points (i_uDevicePoints) of the argument.	Set the value within the setting range in the number of device points (i_uDevicePoints).
C000H to CFFFH	MELSEC iQ-R Ethernet User's Manual (Application)	

3 CC-Link IE TSN MASTER/LOCAL MODULE FB

3.1 M+model_DeviceRead

Name

■RJ71GN11-T2
M+RJ71GN11_DeviceRead

■RJ71GN11-SX
M+RJ71GN11_SX_DeviceRead

■RJ71GN11-EIP
M+RJ71GN11_SE_DeviceRead

Overview

Item	Description																																																																																										
Overview	Reads data by specifying a device in the programmable controller of another station.																																																																																										
Symbol	<div style="border: 1px solid black; padding: 10px; margin: 10px 0;"> <p style="text-align: center;">M+RJ71GN11_DeviceRead</p> <table style="width: 100%; border-collapse: collapse;"> <tr> <td style="width: 10%;">(1)</td> <td style="width: 40%;">B: i_bEN</td> <td style="width: 10%;"></td> <td style="width: 20%;">o_bENO: B</td> <td style="width: 10%;"></td> <td style="width: 10%;">(7)</td> </tr> <tr> <td>(2)</td> <td>DUT: i_stModule</td> <td></td> <td>o_bOK: B</td> <td></td> <td>(8)</td> </tr> <tr> <td>(3)</td> <td>UW: i_u2TargetAddress</td> <td></td> <td>o_bErr: B</td> <td></td> <td>(9)</td> </tr> <tr> <td>(4)</td> <td>UW: i_uDataLength</td> <td></td> <td>o_uErrId: UW</td> <td></td> <td>(10)</td> </tr> <tr> <td>(5)</td> <td>S: i_s32TargetDevice</td> <td></td> <td>o_uReadData: UW</td> <td></td> <td>(11)</td> </tr> <tr> <td>(6)</td> <td>UW: i_uChannel</td> <td></td> <td></td> <td></td> <td></td> </tr> <tr> <td></td> <td style="padding-left: 40px;">pbi_uCPU_Type</td> <td></td> <td></td> <td></td> <td>(12)</td> </tr> <tr> <td></td> <td style="padding-left: 40px;">pbi_uResendCountMax</td> <td></td> <td></td> <td></td> <td>(13)</td> </tr> <tr> <td></td> <td style="padding-left: 40px;">pbi_uTimeUnit</td> <td></td> <td></td> <td></td> <td>(14)</td> </tr> <tr> <td></td> <td style="padding-left: 40px;">pbi_uMonitorTime</td> <td></td> <td></td> <td></td> <td>(15)</td> </tr> <tr> <td></td> <td style="padding-left: 40px;">pbi_bStationSpecific</td> <td></td> <td></td> <td></td> <td>(16)</td> </tr> <tr> <td></td> <td style="padding-left: 40px;">pbo_uResendCount</td> <td></td> <td></td> <td></td> <td>(17)</td> </tr> <tr> <td></td> <td style="padding-left: 40px;">pbo_u4ErrTime</td> <td></td> <td></td> <td></td> <td>(18)</td> </tr> <tr> <td></td> <td style="padding-left: 40px;">pbo_uErrStationAddress1</td> <td></td> <td></td> <td></td> <td>(19)</td> </tr> <tr> <td></td> <td style="padding-left: 40px;">pbo_uErrStationAddress2</td> <td></td> <td></td> <td></td> <td>(20)</td> </tr> </table> </div> <p>The above FB is an example for the RJ71GN11-T2.</p>	(1)	B: i_bEN		o_bENO: B		(7)	(2)	DUT: i_stModule		o_bOK: B		(8)	(3)	UW: i_u2TargetAddress		o_bErr: B		(9)	(4)	UW: i_uDataLength		o_uErrId: UW		(10)	(5)	S: i_s32TargetDevice		o_uReadData: UW		(11)	(6)	UW: i_uChannel						pbi_uCPU_Type				(12)		pbi_uResendCountMax				(13)		pbi_uTimeUnit				(14)		pbi_uMonitorTime				(15)		pbi_bStationSpecific				(16)		pbo_uResendCount				(17)		pbo_u4ErrTime				(18)		pbo_uErrStationAddress1				(19)		pbo_uErrStationAddress2				(20)
(1)	B: i_bEN		o_bENO: B		(7)																																																																																						
(2)	DUT: i_stModule		o_bOK: B		(8)																																																																																						
(3)	UW: i_u2TargetAddress		o_bErr: B		(9)																																																																																						
(4)	UW: i_uDataLength		o_uErrId: UW		(10)																																																																																						
(5)	S: i_s32TargetDevice		o_uReadData: UW		(11)																																																																																						
(6)	UW: i_uChannel																																																																																										
	pbi_uCPU_Type				(12)																																																																																						
	pbi_uResendCountMax				(13)																																																																																						
	pbi_uTimeUnit				(14)																																																																																						
	pbi_uMonitorTime				(15)																																																																																						
	pbi_bStationSpecific				(16)																																																																																						
	pbo_uResendCount				(17)																																																																																						
	pbo_u4ErrTime				(18)																																																																																						
	pbo_uErrStationAddress1				(19)																																																																																						
	pbo_uErrStationAddress2				(20)																																																																																						

Labels

Input arguments

No.	Variable name	Name	Data type	Range	Description															
(1)	i_bEN	Execution command	Bit	—	On: Start FB. Off: Do not start FB.															
(2)	i_stModule	Module label	Structure	—	Specify the module for which the FB is to be executed. Specify the module label of the modules. (Example: GN11_1, GN11_SX_1, GN11_SE_1)															
(3)	i_u2TargetAddress	Target station address	Word [Unsigned]/ Bit String [16-bit] (0..1)	—	Specify the network number and station number of the target station when "Target station address specification method" is off. When specifying the address using a label, use an array as the data type. <ul style="list-style-type: none"> 1st word: Network number (1 to 239) 2nd word: Station number Station number of Ethernet or CC-Link IE Controller Network <ul style="list-style-type: none"> 1 to 120 Station number of CC-Link IE Field Network <ul style="list-style-type: none"> 125: Master station 126: Master operating station Station number of CC-Link IE TSN <ul style="list-style-type: none"> 125: Master station 1 to 120: Local station Specify the IP address of the target station when "Target station address specification method" is on. Specify the third and fourth octets to the 1st word, and first and second octets to the 2nd word. When specifying the address using a label, use an array as the data type. <ul style="list-style-type: none"> Ethernet, CC-Link IE TSN 00000001H to FFFFFFFEH Specify a value within the range of 1 to 254 (FEH) for the fourth octet. <table style="margin-left: 40px;"> <tr> <td></td> <td style="text-align: center;">b15</td> <td style="text-align: center;">b8</td> <td style="text-align: center;">b7</td> <td style="text-align: center;">b0</td> </tr> <tr> <td style="text-align: right;">+0</td> <td style="border: 1px solid black; width: 40px; height: 20px; text-align: center;">3</td> <td style="border: 1px solid black; width: 40px; height: 20px;"></td> <td style="border: 1px solid black; width: 40px; height: 20px; text-align: center;">4</td> <td style="border: 1px solid black; width: 40px; height: 20px;"></td> </tr> <tr> <td style="text-align: right;">+1</td> <td style="border: 1px solid black; width: 40px; height: 20px; text-align: center;">1</td> <td style="border: 1px solid black; width: 40px; height: 20px;"></td> <td style="border: 1px solid black; width: 40px; height: 20px; text-align: center;">2</td> <td style="border: 1px solid black; width: 40px; height: 20px;"></td> </tr> </table> 1 to 4: IP address octet		b15	b8	b7	b0	+0	3		4		+1	1		2	
	b15	b8	b7	b0																
+0	3		4																	
+1	1		2																	
(4)	i_uDataLength	Read data length	Word [Unsigned]/ Bit String [16-bit]	—	Specify the number of words to be read. <ul style="list-style-type: none"> When reading data from the RCP, QCPU, or LCP <ul style="list-style-type: none"> For channel 1 to channel 8: 1 to 960 words For channel 9 and channel 10: 1 to 8192 words When reading data from the QnACPU <ul style="list-style-type: none"> 1 to 480 words 															
(5)	i_s32TargetDevice	Target station read device	Character string (32)	—	Specify the start address of the target station from which data is to be read.															
(6)	i_uChannel	Own station channel	Word [Unsigned]/ Bit String [16-bit]	—	Specify the channel to be used by the own station. MELSEC iQ-R Programming Manual (Module Dedicated Instructions)															

Output arguments

No.	Variable name	Name	Data type	Description	Default value
(7)	o_bENO	Execution status	Bit	On: The execution command is turned on. Off: The execution command is turned off.	Off
(8)	o_bOK	Normal completion	Bit	The FB has been processed normally when this argument is on.	Off
(9)	o_bErr	Error completion	Bit	The FB has been processed abnormally when this argument is on.	Off
(10)	o_uErrId	Error code	Word [Unsigned]/ Bit String [16-bit]	An error code is stored at error completion.	0
(11)	o_uReadData	Read data storage device	Word [Unsigned]/ Bit String [16-bit]	Specify the start number of the device for storing the read data	0

■ Operation parameters

No.	Variable name	Name	Data type	Range	Description	Default value
(12)	pbi_uCPU_Type	Target station CPU type	Word [Unsigned]/Bit String [16-bit]	0000H, 03D0H to 03D3H, 03E0H to 03E3H, 03FFH	Specify the CPU type of the target station. <ul style="list-style-type: none"> • 0000H: To CPU of target station (control CPU) • 03D0H: To control system CPU • 03D1H: To standby system CPU • 03D2H: To system A CPU • 03D3H: To system B CPU • 03E0H: To multiple CPU No.1 • 03E1H: To multiple CPU No.2 • 03E2H: To multiple CPU No.3 • 03E3H: To multiple CPU No.4 • 03FFH: To CPU of target station (control CPU) 	0
(13)	pbi_uResendCountMax	Maximum number of resends	Word [Unsigned]/Bit String [16-bit]	0 to 15	Specify the number of resends to be performed if the data transfer is not completed within the monitoring time specified by "Arrival monitoring time". <ul style="list-style-type: none"> • 0 to 15 	5
(14)	pbi_uTimeUnit	Arrival monitoring time unit	Word [Unsigned]/Bit String [16-bit]	0, 1	Specify the unit of the "Arrival monitoring time".*1 <ul style="list-style-type: none"> • 0: 1s • 1: 100ms 	0
(15)	pbi_uMonitorTime	Arrival monitoring time	Word [Unsigned]/Bit String [16-bit]	0 to 65535	Specify the monitoring time until completion of processing. If the processing is not completed within the monitoring time, data is resent until the value specified in "Maximum number of resends" is reached. <p>When "Arrival monitoring time unit" is set to 1s</p> <ul style="list-style-type: none"> • Effective range 1 to 32767: 1s to 32767s <p>When "Arrival monitoring time unit" is set to 100ms</p> <ul style="list-style-type: none"> • Effective range 1 to 65535: 1 to 65535 × 100ms 	0: 10s
(16)	pbi_bStationSpecific	Target station address specification method	Bit	On or off	Specify the specification method of a target station. <ul style="list-style-type: none"> • Off: Use the network number and station number. • On: Use the IP address (IPv4). (Ethernet and CC-Link IE TSN only). 	Off

*1 Set the lower 2 bits (bit 0 and 1) of the set value to bit 8 and 9 of the control data (error completion type) of the READ instruction. For the dedicated instruction, the error (D24AH) occurs if the lower 2 bits exceed the effective range.

Public variables

No.	Variable name	Name	Data type	Description	Default value
(17)	pbo_uResendCount	Number of resends	Word [Unsigned]/Bit String [16-bit]	The number of resends performed (result) is stored. If an error was detected, the number of resends performed (result) between error detection and resend stop is stored.	0
(18)	pbo_u4ErrTime	Error occurrence time	Word [Unsigned]/Bit String [16-bit] (0..3)	Clock data at the time of error occurrence is stored. 1st word <ul style="list-style-type: none"> Upper 8 bits: Month (01H to 12H) Lower 8 bits: Lower 2 digits of year (00H to 99H) 2nd word <ul style="list-style-type: none"> Upper 8 bits: Hour (00H to 23H) Lower 8 bits: Day (01H to 31H) 3rd word <ul style="list-style-type: none"> Upper 8 bits: Second (00H to 59H) Lower 8 bits: Minute (00H to 59H) 4th word <ul style="list-style-type: none"> Upper 8 bits: Upper 2 digits of year (00H to 99H) Lower 8 bits: Day of week (00H (Sunday) to 06H (Saturday)) 	0
(19)	pbo_uErrStationAddress1	Error-detected station address 1	Word [Unsigned]/Bit String [16-bit]	<ul style="list-style-type: none"> When "Target station address specification method" is off The network number of the station in which an error was detected is stored. When "Target station address specification method" is on The IP addresses (the third and fourth octets) of the station in which an error was detected are stored. (Ethernet and CC-Link IE TSN only) Example: When the IP address is 192.168.1.2 0102h 	0
(20)	pbo_uErrStationAddress2	Error-detected station address 2	Word [Unsigned]/Bit String [16-bit]	<ul style="list-style-type: none"> When "Target station address specification method" is off The station number of the station in which an error was detected is stored. <ul style="list-style-type: none"> Ethernet or CC-Link IE Controller Network 0001H to 0078H (1 to 120) CC-Link IE Field Network 007DH (125): Master station 0001H to 0078H (1 to 120): Local station, remote device station, intelligent device station, submaster station CC-Link IE TSN 007DH: Master station 0001H to 0078H (1 to 120): Slave station When "Target station address specification method" is on The IP addresses (the first and second octets) of the station in which an error was detected are stored. (Ethernet and CC-Link IE TSN only) Example: When the IP address is 192.168.1.2 C0A8h 	0

FB details

Item	Description
Available device	Target module <ul style="list-style-type: none"> RJ71GN11-T2 RJ71GN11-SX RJ71GN11-EIP
	CPU module RCPU
	Engineering tool GX Works3
Language	Ladder diagram
Number of basic steps	82 steps The number of steps of the FB embedded in a program depends on the CPU module used, the input/output definitions, and the option settings of GX Works3. For the option settings of GX Works3, refer to GX Works3 Operating Manual.
Processing	When i_bEN (execution command) is turned on, this function reads device data from another station.
FB compilation method	Macro type
FB operation	Pulse type (multiple-scan execution type)
Input condition for FB_EN	None

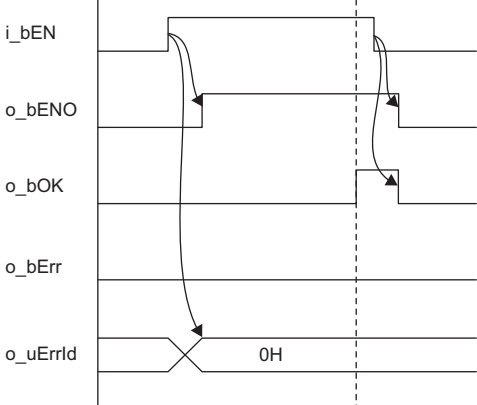
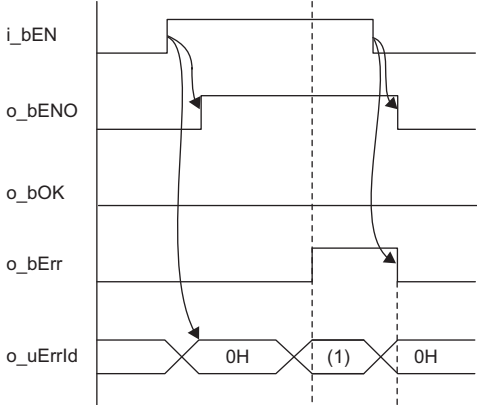
Item	Description
Timing chart of I/O signals	<ul style="list-style-type: none"> • For normal completion  <ul style="list-style-type: none"> • For error completion (same as in the case of a module error)  <p>(1) Error code</p>
Precautions	<ul style="list-style-type: none"> • This FB does not include error recovery processing. Please create error recovery processing separately according to the system and required operations. • This FB uses the GP.READ instruction. • Turn off i_bEN (execution command) after o_bOK (normal completion) or o_bErr (error completion) is turned on. By turning off i_bEN (execution command), o_bOK (normal completion) or o_bErr (error completion) is turned off and o_uErrld (error code) is cleared to 0. • This FB uses the label initial value by each program. When the program file using this FB is specified to boot file setting for the boot operation in the CPU module, specify the initial label value file by each program to the boot file setting as well. (MELSEC iQ-R CPU Module User's Manual (Application)) If an error code that is not described in Page 83 Error codes appears, the initial label value files by each program may not be set to the boot file setting. In this case, specify the initial label value files by each program to the boot file setting. • When this FB is executed, an operation error may occur in the programmable controller CPU. In this case, check the detailed information of the operation error in event history and correct the input argument of the module FB.

Error codes

Error code	Reference
C000H to CFFFH D000H to DFFFH	<ul style="list-style-type: none"> MELSEC iQ-R CC-Link IE TSN User's Manual (Application) MELSEC iQ-R CC-Link IE TSN Plus Master/Local Module User's Manual

3.2 M+model_DeviceWrite

Name

■RJ71GN11-T2

M+RJ71GN11_DeviceWrite

■RJ71GN11-SX

M+RJ71GN11_SX_DeviceWrite

■RJ71GN11-EIP

M+RJ71GN11_SE_DeviceWrite

Overview

Item	Description																																																																																																												
Overview	Writes data by specifying a device in the programmable controller of another station.																																																																																																												
Symbol	<div style="border: 1px solid black; padding: 10px; margin: 10px 0;"> <p style="text-align: center;">M+RJ71GN11_DeviceWrite</p> <table style="width: 100%; border-collapse: collapse;"> <tr> <td style="width: 10%;">(1) —</td> <td style="width: 40%;">B: i_bEN</td> <td style="width: 10%;"></td> <td style="width: 10%;">o_bENO: B</td> <td style="width: 10%;"></td> <td style="width: 10%;">(8)</td> </tr> <tr> <td>(2) —</td> <td>DUT: i_stModule</td> <td></td> <td>o_bOK: B</td> <td></td> <td>(9)</td> </tr> <tr> <td>(3) —</td> <td>UW: i_u2TargetAddress</td> <td></td> <td>o_bErr: B</td> <td></td> <td>(10)</td> </tr> <tr> <td>(4) —</td> <td>UW: i_uDataLength</td> <td></td> <td>o_uErrId: UW</td> <td></td> <td>(11)</td> </tr> <tr> <td>(5) —</td> <td>UW: i_uWriteData</td> <td></td> <td></td> <td></td> <td></td> </tr> <tr> <td>(6) —</td> <td>S: i_s32TargetDevice</td> <td></td> <td></td> <td></td> <td></td> </tr> <tr> <td>(7) —</td> <td>UW: i_uChannel</td> <td></td> <td></td> <td></td> <td></td> </tr> <tr> <td></td> <td style="padding-left: 40px;">pbi_uCPU_Type</td> <td>(12)</td> <td></td> <td></td> <td></td> </tr> <tr> <td></td> <td style="padding-left: 40px;">pbi_bArrivalConfirm</td> <td>(13)</td> <td></td> <td></td> <td></td> </tr> <tr> <td></td> <td style="padding-left: 40px;">pbi_uResendCountMax</td> <td>(14)</td> <td></td> <td></td> <td></td> </tr> <tr> <td></td> <td style="padding-left: 60px;">pbi_uTimeUnit</td> <td>(15)</td> <td></td> <td></td> <td></td> </tr> <tr> <td></td> <td style="padding-left: 60px;">pbi_uMonitorTime</td> <td>(16)</td> <td></td> <td></td> <td></td> </tr> <tr> <td></td> <td style="padding-left: 60px;">pbi_bStationSpecific</td> <td>(17)</td> <td></td> <td></td> <td></td> </tr> <tr> <td></td> <td style="padding-left: 60px;">pbi_uTargetStation</td> <td>(18)</td> <td></td> <td></td> <td></td> </tr> <tr> <td></td> <td style="padding-left: 60px;">pbo_uResendCount</td> <td>(19)</td> <td></td> <td></td> <td></td> </tr> <tr> <td></td> <td style="padding-left: 60px;">pbo_u4ErrTime</td> <td>(20)</td> <td></td> <td></td> <td></td> </tr> <tr> <td></td> <td style="padding-left: 60px;">pbo_uErrStationAddress1</td> <td>(21)</td> <td></td> <td></td> <td></td> </tr> <tr> <td></td> <td style="padding-left: 60px;">pbo_uErrStationAddress2</td> <td>(22)</td> <td></td> <td></td> <td></td> </tr> </table> </div> <p>The above FB is an example for the RJ71GN11-T2.</p>	(1) —	B: i_bEN		o_bENO: B		(8)	(2) —	DUT: i_stModule		o_bOK: B		(9)	(3) —	UW: i_u2TargetAddress		o_bErr: B		(10)	(4) —	UW: i_uDataLength		o_uErrId: UW		(11)	(5) —	UW: i_uWriteData					(6) —	S: i_s32TargetDevice					(7) —	UW: i_uChannel						pbi_uCPU_Type	(12)					pbi_bArrivalConfirm	(13)					pbi_uResendCountMax	(14)					pbi_uTimeUnit	(15)					pbi_uMonitorTime	(16)					pbi_bStationSpecific	(17)					pbi_uTargetStation	(18)					pbo_uResendCount	(19)					pbo_u4ErrTime	(20)					pbo_uErrStationAddress1	(21)					pbo_uErrStationAddress2	(22)			
(1) —	B: i_bEN		o_bENO: B		(8)																																																																																																								
(2) —	DUT: i_stModule		o_bOK: B		(9)																																																																																																								
(3) —	UW: i_u2TargetAddress		o_bErr: B		(10)																																																																																																								
(4) —	UW: i_uDataLength		o_uErrId: UW		(11)																																																																																																								
(5) —	UW: i_uWriteData																																																																																																												
(6) —	S: i_s32TargetDevice																																																																																																												
(7) —	UW: i_uChannel																																																																																																												
	pbi_uCPU_Type	(12)																																																																																																											
	pbi_bArrivalConfirm	(13)																																																																																																											
	pbi_uResendCountMax	(14)																																																																																																											
	pbi_uTimeUnit	(15)																																																																																																											
	pbi_uMonitorTime	(16)																																																																																																											
	pbi_bStationSpecific	(17)																																																																																																											
	pbi_uTargetStation	(18)																																																																																																											
	pbo_uResendCount	(19)																																																																																																											
	pbo_u4ErrTime	(20)																																																																																																											
	pbo_uErrStationAddress1	(21)																																																																																																											
	pbo_uErrStationAddress2	(22)																																																																																																											

Labels

Input arguments

No.	Variable name	Name	Data type	Range	Description															
(1)	i_bEN	Execution command	Bit	—	On: Start FB. Off: Do not start FB.															
(2)	i_stModule	Module label	Structure	—	Specify the module for which the FB is to be executed. Specify the module label of the modules. (Example: GN11_1, GN11_SX_1, GN11_SE_1)															
(3)	i_u2TargetAddress	Target station address	Word [Unsigned]/ Bit String [16-bit] (0..1)	—	<p>Specify the network number and station number of the target station when "Target station address specification method" is off. When specifying the address using a label, use an array as the data type.</p> <p>■When "Target station specification method" is set to 0 to specify a station number</p> <ul style="list-style-type: none"> • 1st word: Network number (1 to 239) • 2nd word: Station number <p>Station number of Ethernet or CC-Link IE Controller Network</p> <ul style="list-style-type: none"> • 1 to 120 <p>Station number of CC-Link IE Field Network</p> <ul style="list-style-type: none"> • 125: Master station • 126: Master operating station • 1 to 120: Local station, remote device station, intelligent device station, submaster station <p>CC-Link IE TSN</p> <ul style="list-style-type: none"> • 125: Master station • 1 to 120: Local station <p>■When "Target station specification method" is set to 1 to specify a group (CC-Link IE Field Network is not supported.)</p> <ul style="list-style-type: none"> • 1st word: Network number (1 to 239) • 2nd word: Transient transmission group number (1 to 32) <p>■When "Target station specification method" is set to 2 to specify all stations</p> <ul style="list-style-type: none"> • 1st word: Network number (1 to 239) • 2nd word: 0 (The setting is ignored.) <p>Specify the IP address of the target station when "Target station address specification method" is on. Specify the third and fourth octets to the 1st word, and first and second octets to the 2nd word. When specifying the address using a label, use an array as the data type.</p> <ul style="list-style-type: none"> • Ethernet, CC-Link IE TSN <p>00000001H to FFFFFFFEH Specify a value within the range of 1 to 254 (FEH) for the fourth octet.</p> <table border="1" style="margin-left: 40px;"> <tr> <td></td> <td style="text-align: center;">b15</td> <td style="text-align: center;">b8</td> <td style="text-align: center;">b7</td> <td style="text-align: center;">b0</td> </tr> <tr> <td>+0</td> <td style="text-align: center;">3</td> <td colspan="2"></td> <td style="text-align: center;">4</td> </tr> <tr> <td>+1</td> <td colspan="2" style="text-align: center;">1</td> <td colspan="2" style="text-align: center;">2</td> </tr> </table> <p>1 to 4: IP address octet</p>		b15	b8	b7	b0	+0	3			4	+1	1		2	
	b15	b8	b7	b0																
+0	3			4																
+1	1		2																	
(4)	i_uDataLength	Write data length	Word [Unsigned]/ Bit String [16-bit]	—	<p>Specify the number of words to be written.</p> <p>■When writing data to the RCP, QCPU, or LCP</p> <ul style="list-style-type: none"> • For channel 1 to channel 8: 1 to 960 words • For channel 9 and channel 10: 1 to 8192 words <p>■When writing data to the QnACP</p> <ul style="list-style-type: none"> • 1 to 480 words 															
(5)	i_uWriteData	Write data storage device	Word [Unsigned]/ Bit String [16-bit]	—	Specify the start device of own station containing the write data.															
(6)	i_s32TargetDevice	Target station write device	Character string (32)	—	Specify the start device of the target station to which data is to be written.															
(7)	i_uChannel	Own station channel	Word [Unsigned]/ Bit String [16-bit]	—	Specify the channel to be used by the own station. MELSEC iQ-R Programming Manual (Module Dedicated Instructions)															

■Output arguments

No.	Variable name	Name	Data type	Description	Default value
(8)	o_bENO	Execution status	Bit	On: The execution command is turned on. Off: The execution command is turned off.	Off
(9)	o_bOK	Normal completion	Bit	The FB has been processed normally when this argument is on.	Off
(10)	o_bErr	Error completion	Bit	The FB has been processed abnormally when this argument is on.	Off
(11)	o_uErrId	Error code	Word [Unsigned]/ Bit String [16-bit]	An error code is stored at error completion.	0

■Operation parameters

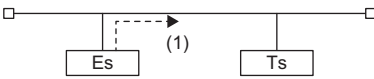
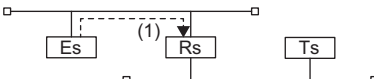
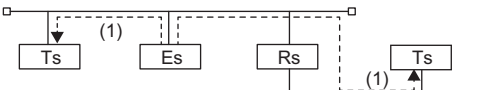
No.	Variable name	Name	Data type	Range	Description	Default value
(12)	pbi_uCPU_Type	Target station CPU type	Word [Unsigned]/ Bit String [16-bit]	0000H, 03D0H to 03D3H, 03E0H to 03E3H, 03FFH	Specify the CPU type of the target station. <ul style="list-style-type: none"> • 0000H: To CPU of target station (control CPU) • 03D0H: To control system CPU • 03D1H: To standby system CPU • 03D2H: To system A CPU • 03D3H: To system B CPU • 03E0H: To multiple CPU No.1 • 03E1H: To multiple CPU No.2 • 03E2H: To multiple CPU No.3 • 03E3H: To multiple CPU No.4 • 03FFH: To CPU of target station (control CPU) 	0
(13)	pbi_bArrivalConfirm	Arrival acknowledgment	Bit	On or off	Specify whether to use arrival acknowledgment. <p>■Off: No check</p> <ul style="list-style-type: none"> • When the target station is within the own network, sending data from the own station completes the sending.  <p>(1) Completion Es: Execution source Ts: Target station</p> <ul style="list-style-type: none"> • When the target station is within another network, data arrival to the relay station within the own network completes the sending.  <p>(1) Completion Es: Execution source Rs: Relay station Ts: Target station</p> <p>■On: Check Sending data is completed when the data is written to the target station.</p>  <p>(1) Completion Es: Execution source Rs: Relay station Ts: Target station</p>	Off
(14)	pbi_uResendCountMax	Maximum number of resends	Word [Unsigned]/ Bit String [16-bit]	0 to 15	Specify the number of resends to be performed if the data transfer is not completed within the monitoring time specified by "Arrival monitoring time". <ul style="list-style-type: none"> • 0 to 15 	5
(15)	pbi_uTimeUnit	Arrival monitoring time unit	Word [Unsigned]/ Bit String [16-bit]	0, 1	Specify the unit of the "Arrival monitoring time". ¹ <ul style="list-style-type: none"> • 0: 1s • 1: 100ms 	0

No.	Variable name	Name	Data type	Range	Description	Default value
(16)	pbi_uMonitorTime	Arrival monitoring time	Word [Unsigned]/ Bit String [16-bit]	0 to 65535	Specify the monitoring time until completion of processing. If the processing is not completed within the monitoring time, data is resent until the value specified in "Maximum number of resends" is reached. When the "Arrival monitoring time unit" is set to 0 <ul style="list-style-type: none"> • 0: 10s • Effective range 1 to 32767: 1s to 32767s When the "Arrival monitoring time unit" is set to 1 <ul style="list-style-type: none"> • 0: 10s • Effective range 1 to 65535: 1 to 65535 × 100ms 	0: 10s
(17)	pbi_bStationSpecific	Target station address specification method	Bit	On or off	Specify the specification method of a target station. <ul style="list-style-type: none"> • Off: Use the network number and station number. • On: Use the IP address (IPv4). (Ethernet and CC-Link IE TSN only). 	Off
(18)	pbi_uTargetStation	Target station specification method	Word [Unsigned]/ Bit String [16-bit]	0 to 2	Specify the specification method of a target station. <ul style="list-style-type: none"> • 0: Station number specification → Station with the station number specified in "Target station address" • 1: Group specification (only when "OFF (No)" is specified in "Arrival acknowledgment") → All stations of the transient transmission group number specified in "Arrival station address" (For the CC-Link IE Field Network, the value 1 cannot be specified.) • 2: All stations (only when "OFF (No)" is specified in "Arrival acknowledgment") → All stations of the network number specified in "Arrival station address" (broadcast excluding own station) 	0

*1 Set the lower 2 bits (bit 0 and 1) of the set value to bit 8 and 9 of the control data (execution/error completion type) of the WRITE instruction.

For the dedicated instruction, the error (D24AH) occurs if the lower 2 bits exceed the effective range.



Public variables

No.	Variable name	Name	Data type	Description	Default value
(19)	pbo_uResendCount	Number of resends	Word [Unsigned]/Bit String [16-bit]	The number of resends performed (result) is stored. If an error was detected, the number of resends performed (result) between error detection and resend stop is stored.	0
(20)	pbo_u4ErrTime	Error occurrence time	Word [Unsigned]/Bit String [16-bit] (0..3)	Clock data at the time of error occurrence is stored. 1st word <ul style="list-style-type: none"> Upper 8 bits: Month (01H to 12H) Lower 8 bits: Lower 2 digits of year (00H to 99H) 2nd word <ul style="list-style-type: none"> Upper 8 bits: Hour (00H to 23H) Lower 8 bits: Day (01H to 31H) 3rd word <ul style="list-style-type: none"> Upper 8 bits: Second (00H to 59H) Lower 8 bits: Minute (00H to 59H) 4th word <ul style="list-style-type: none"> Upper 8 bits: Upper 2 digits of year (00H to 99H) Lower 8 bits: Day of week (00H (Sunday) to 06H (Saturday)) 	0
(21)	pbo_uErrStationAddress 1	Error-detected station address 1	Word [Unsigned]/Bit String [16-bit]	<ul style="list-style-type: none"> When "Target station address specification method" is off The network number of the station in which an error was detected is stored. When "Target station address specification method" is on The IP addresses (the third and fourth octets) of the station in which an error was detected are stored. (Ethernet and CC-Link IE TSN only) Example: When the IP address is 192.168.1.2 0102h 	0
(22)	pbo_uErrStationAddress 2	Error-detected station address 2	Word [Unsigned]/Bit String [16-bit]	<ul style="list-style-type: none"> When "Target station address specification method" is off The station number of the station in which an error was detected is stored. <ul style="list-style-type: none"> Ethernet or CC-Link IE Controller Network 0001H to 0078H (1 to 120) CC-Link IE Field Network 007DH (125): Master station 0001H to 0078H (1 to 120): Local station, remote device station, intelligent device station, submaster station CC-Link IE TSN 007DH: Master station 0001H to 0078H (1 to 120): Slave station When "Target station address specification method" is on The IP addresses (the first and second octets) of the station in which an error was detected are stored. (Ethernet and CC-Link IE TSN only) Example: When the IP address is 192.168.1.2 C0A8h 	0

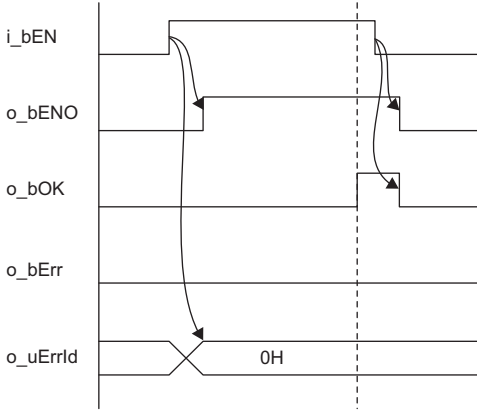
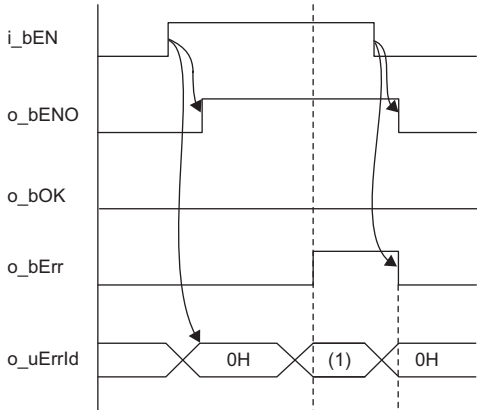
FB details

Item	Description	
Available device	Target module <ul style="list-style-type: none"> • RJ71GN11-T2 • RJ71GN11-SX • RJ71GN11-EIP 	
	CPU module	RCPU
	Engineering tool	GX Works3
Language	Ladder diagram	
Number of basic steps	102 steps The number of steps of the FB embedded in a program depends on the CPU module used, the input/output definitions, and the option settings of GX Works3. For the option settings of GX Works3, refer to GX Works3 Operating Manual.	
Processing	When i_bEN (execution instruction) is turned on, this function writes device data to another station.	
FB compilation method	Macro type	
FB operation	Pulse type (multiple-scan execution type)	
Input condition for FB_EN	None	
Timing chart of I/O signals	<ul style="list-style-type: none"> • For normal completion  <ul style="list-style-type: none"> • For error completion (same as in the case of a module error)  <p>(1) Error code</p>	
Precautions	<ul style="list-style-type: none"> • This FB does not include error recovery processing. Please create error recovery processing separately according to the system and required operations. • This FB uses the GP.WRITE instruction. • Turn off i_bEN (execution command) after o_bOK (normal completion) or o_bErr (error completion) is turned on. By turning off i_bEN (execution command), o_bOK (normal completion) or o_bErr (error completion) is turned off and o_uErrld (error code) is cleared to 0. • This FB uses the label initial value by each program. When the program file using this FB is specified to boot file setting for the boot operation in the CPU module, specify the initial label value file by each program to the boot file setting as well. (MELSEC iQ-R CPU Module User's Manual (Application)) If an error code that is not described in Page 90 Error codes appears, the initial label value files by each program may not be set to the boot file setting. In this case, specify the initial label value files by each program to the boot file setting. • When this FB is executed, an operation error may occur in the programmable controller CPU. In this case, check the detailed information of the operation error in event history and correct the input argument of the module FB. 	

Error codes

Error code	Reference
C000H to CFFFH	 MELSEC iQ-R CC-Link IE TSN User's Manual (Application)
D000H to DFFFH	 MELSEC iQ-R CC-Link IE TSN Plus Master/Local Module User's Manual

3.3 M+model_Send

Name

■ **RJ71GN11-T2**

M+RJ71GN11_Send

■ **RJ71GN11-SX**

M+RJ71GN11_SX_Send

■ **RJ71GN11-EIP**

M+RJ71GN11_SE_Send

Overview

Item	Description
Overview	Sends data to the programmable controller of another station.

Item	Description																																																																																
Symbol	<div style="border: 1px solid black; padding: 10px; margin: 10px 0;"> <p style="text-align: center;">M+RJ71GN11_Send</p> <table style="width: 100%; border-collapse: collapse;"> <tr> <td style="width: 5%; text-align: right;">(1)</td> <td style="width: 45%;">B: i_bEN</td> <td style="width: 10%;"></td> <td style="width: 15%; text-align: right;">o_bENO: B</td> <td style="width: 25%; text-align: right;">(8)</td> </tr> <tr> <td style="text-align: right;">(2)</td> <td>DUT: i_stModule</td> <td></td> <td style="text-align: right;">o_bOK: B</td> <td style="text-align: right;">(9)</td> </tr> <tr> <td style="text-align: right;">(3)</td> <td>UW: i_u2TargetAddress</td> <td></td> <td style="text-align: right;">o_bErr: B</td> <td style="text-align: right;">(10)</td> </tr> <tr> <td style="text-align: right;">(4)</td> <td>UW: i_uChannel</td> <td></td> <td style="text-align: right;">o_uErrId: UW</td> <td style="text-align: right;">(11)</td> </tr> <tr> <td style="text-align: right;">(5)</td> <td>UW: i_uTargetChannel</td> <td></td> <td></td> <td></td> </tr> <tr> <td style="text-align: right;">(6)</td> <td>UW: i_uDataLength</td> <td></td> <td></td> <td></td> </tr> <tr> <td style="text-align: right;">(7)</td> <td>UW: i_uSendData</td> <td></td> <td></td> <td></td> </tr> <tr> <td></td> <td style="padding-left: 20px;">pbi_bArrivalConfirm</td> <td style="text-align: right;">(12)</td> <td></td> <td></td> </tr> <tr> <td></td> <td style="padding-left: 20px;">pbi_uResendCountMax</td> <td style="text-align: right;">(13)</td> <td></td> <td></td> </tr> <tr> <td></td> <td style="padding-left: 20px;">pbi_uMonitorTime</td> <td style="text-align: right;">(14)</td> <td></td> <td></td> </tr> <tr> <td></td> <td style="padding-left: 20px;">pbi_bStationSpecific</td> <td style="text-align: right;">(15)</td> <td></td> <td></td> </tr> <tr> <td></td> <td style="padding-left: 20px;">pbi_uTargetStation</td> <td style="text-align: right;">(16)</td> <td></td> <td></td> </tr> <tr> <td></td> <td style="padding-left: 20px;">pbo_uResendCount</td> <td style="text-align: right;">(17)</td> <td></td> <td></td> </tr> <tr> <td></td> <td style="padding-left: 20px;">pbo_u4ErrTime</td> <td style="text-align: right;">(18)</td> <td></td> <td></td> </tr> <tr> <td></td> <td style="padding-left: 20px;">pbo_uErrStationAddress1</td> <td style="text-align: right;">(19)</td> <td></td> <td></td> </tr> <tr> <td></td> <td style="padding-left: 20px;">pbo_uErrStationAddress2</td> <td style="text-align: right;">(20)</td> <td></td> <td></td> </tr> </table> </div> <p>The above FB is an example for the RJ71GN11-T2.</p>	(1)	B: i_bEN		o_bENO: B	(8)	(2)	DUT: i_stModule		o_bOK: B	(9)	(3)	UW: i_u2TargetAddress		o_bErr: B	(10)	(4)	UW: i_uChannel		o_uErrId: UW	(11)	(5)	UW: i_uTargetChannel				(6)	UW: i_uDataLength				(7)	UW: i_uSendData					pbi_bArrivalConfirm	(12)				pbi_uResendCountMax	(13)				pbi_uMonitorTime	(14)				pbi_bStationSpecific	(15)				pbi_uTargetStation	(16)				pbo_uResendCount	(17)				pbo_u4ErrTime	(18)				pbo_uErrStationAddress1	(19)				pbo_uErrStationAddress2	(20)		
(1)	B: i_bEN		o_bENO: B	(8)																																																																													
(2)	DUT: i_stModule		o_bOK: B	(9)																																																																													
(3)	UW: i_u2TargetAddress		o_bErr: B	(10)																																																																													
(4)	UW: i_uChannel		o_uErrId: UW	(11)																																																																													
(5)	UW: i_uTargetChannel																																																																																
(6)	UW: i_uDataLength																																																																																
(7)	UW: i_uSendData																																																																																
	pbi_bArrivalConfirm	(12)																																																																															
	pbi_uResendCountMax	(13)																																																																															
	pbi_uMonitorTime	(14)																																																																															
	pbi_bStationSpecific	(15)																																																																															
	pbi_uTargetStation	(16)																																																																															
	pbo_uResendCount	(17)																																																																															
	pbo_u4ErrTime	(18)																																																																															
	pbo_uErrStationAddress1	(19)																																																																															
	pbo_uErrStationAddress2	(20)																																																																															

Labels

Input arguments

No.	Variable name	Name	Data type	Range	Description															
(1)	i_bEN	Execution command	Bit	—	On: Start FB. Off: Do not start FB.															
(2)	i_stModule	Module label	Structure	—	Specify the module for which the FB is to be executed. Specify the module label of the modules. (Example: GN11_1, GN11_SX_1, GN11_SE_1)															
(3)	i_u2TargetAddress	Target station address	Word [Unsigned]/ Bit String [16-bit] (0..1)	—	<p>Specify the network number and station number of the target station when "Target station address specification method" is off. When specifying the address using a label, use an array as the data type.</p> <p>■When "Target station specification method" is set to 0 to specify a station number</p> <ul style="list-style-type: none"> • 1st word: Network number (1 to 239) • 2nd word: Station number <p>Station number of Ethernet or CC-Link IE Controller Network</p> <ul style="list-style-type: none"> • 1 to 120 <p>Station number of CC-Link IE Field Network</p> <ul style="list-style-type: none"> • 125: Master station • 126: Master operating station • 1 to 120: Local station, remote device station, intelligent device station, submaster station <p>CC-Link IE TSN</p> <ul style="list-style-type: none"> • 125: Master station • 1 to 120: Local station <p>■When "Target station specification method" is set to 1 to specify a group (CC-Link IE Field Network is not supported.)</p> <ul style="list-style-type: none"> • 1st word: Network number (1 to 239) • 2nd word: Transient transmission group number (1 to 32) <p>■When "Target station specification method" is set to 2 to specify all stations</p> <ul style="list-style-type: none"> • 1st word: Network number (1 to 239) • 2nd word: 0 (The setting is ignored.) <p>Specify the IP address of the target station when "Target station address specification method" is on. Specify the third and fourth octets to the 1st word, and first and second octets to the 2nd word. When specifying the address using a label, use an array as the data type.</p> <ul style="list-style-type: none"> • CC-Link IE TSN 0000001H to FFFFFFFEH <p>Specify a value within the range of 1 to 254 (FEH) for the fourth octet.</p> <table border="1" style="margin-left: 40px;"> <tr> <td></td> <td style="text-align: center;">b15</td> <td style="text-align: center;">b8</td> <td style="text-align: center;">b7</td> <td style="text-align: center;">b0</td> </tr> <tr> <td style="text-align: right;">+0</td> <td style="text-align: center;">3</td> <td style="text-align: center;">4</td> <td colspan="2"></td> </tr> <tr> <td style="text-align: right;">+1</td> <td style="text-align: center;">1</td> <td style="text-align: center;">2</td> <td colspan="2"></td> </tr> </table> <p>1 to 4: IP address octet</p>		b15	b8	b7	b0	+0	3	4			+1	1	2		
	b15	b8	b7	b0																
+0	3	4																		
+1	1	2																		
(4)	i_uChannel	Own station channel	Word [Unsigned]/ Bit String [16-bit]	—	Specify the channel number to be used for data transmission by own station.  MELSEC iQ-R Programming Manual (Module Dedicated Instructions)															
(5)	i_uTargetChannel	Target station data storage channel	Word [Unsigned]/ Bit String [16-bit]	1 to 8	Specify the channel of the target station for storing data. When the target station is a CC-Link IE Field Network master/local module, specify 1 or 2.															
(6)	i_uDataLength	Send data length	Word [Unsigned]/ Bit String [16-bit]	—	Specify the number of words to be sent. • When the target station is RCP, QCPU, or LCP: 1 to 960 words • When the target station is QnACPU: 1 to 480 words															
(7)	i_uSendData	Send data storage device	Word [Unsigned]/ Bit String [16-bit]	—	Specify the start device of own station containing the send data.															

■Output arguments

No.	Variable name	Name	Data type	Description	Default value
(8)	o_bENO	Execution status	Bit	On: The execution command is turned on. Off: The execution command is turned off.	Off
(9)	o_bOK	Normal completion	Bit	The FB has been processed normally when this argument is on.	Off
(10)	o_bErr	Error completion	Bit	The FB has been processed abnormally when this argument is on.	Off
(11)	o_uErrId	Error code	Word [Unsigned]/Bit String [16-bit]	An error code is stored at error completion.	0

■Operation parameters

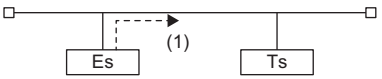
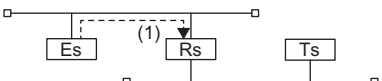
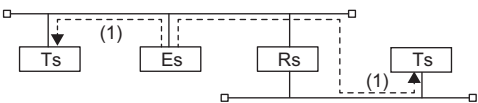
No.	Variable name	Name	Data type	Range	Description	Default value
(12)	pbi_bArrivalConfirm	Arrival acknowledgment	Bit	On or off	<p>Specify whether to use arrival acknowledgment.</p> <p>■Off: No check</p> <ul style="list-style-type: none"> When the target station is within the own network, sending data from the own station completes the sending.  <p>(1) Completion Es: Execution source Ts: Target station</p> <ul style="list-style-type: none"> When the target station is within another network, data arrival to the relay station within the own network completes the sending.  <p>(1) Completion Es: Execution source Rs: Relay station Ts: Target station</p> <p>■On: Check Sending data is completed when the data is written to the target station.</p>  <p>(1) Completion Es: Execution source Rs: Relay station Ts: Target station</p>	Off
(13)	pbi_uResendCountMax	Maximum number of resends	Word [Unsigned]/Bit String [16-bit]	0 to 15	<p>Specify the number of resends to be performed if the data transfer is not completed within the monitoring time specified by "Arrival monitoring time".</p> <ul style="list-style-type: none"> 0 to 15 	5
(14)	pbi_uMonitorTime	Arrival monitoring time	Word [Unsigned]/Bit String [16-bit]	0, 1 to 32767	<p>Specify the monitoring time until completion of processing.</p> <p>If the processing is not completed within the monitoring time, data is resent until the value specified in "Maximum number of resends" is reached.</p> <ul style="list-style-type: none"> 0: 10s Effective range 1 to 32767: 1s to 32767s 	0
(15)	pbi_bStationSpecific	Target station address specification method	Bit	On or off	<p>Specify the specification method of a target station.</p> <ul style="list-style-type: none"> Off: Use the network number and station number. On: Use the IP address (IPv4). (CC-Link IE TSN only). 	Off

No.	Variable name	Name	Data type	Range	Description	Default value
(16)	pbi_uTargetStation	Target station specification method	Word [Unsigned]/Bit String [16-bit]	0 to 2	Specify the specification method of a target station. <ul style="list-style-type: none"> • 0: Station number specification → Station with the station number specified in "Target station address" • 1: Group specification → All stations of the transient transmission group number specified in "Target station address" (For the CC-Link IE Field Network, the value 1 cannot be specified.) • 2: All stations → All stations of the network number specified in "Target station address" (simultaneous broadcast except own station) 	0



Public variables

No.	Variable name	Name	Data type	Description	Default value
(17)	pbo_uResendCount	Number of resends	Word [Unsigned]/Bit String [16-bit]	The number of resends performed (result) is stored. If an error was detected, the number of resends performed (result) between error detection and resend stop is stored.	0
(18)	pbo_u4ErrTime	Error occurrence time	Word [Unsigned]/Bit String [16-bit] (0..3)	Clock data at the time of error occurrence is stored. 1st word <ul style="list-style-type: none"> • Upper 8 bits: Month (01H to 12H) • Lower 8 bits: Lower 2 digits of year (00H to 99H) 2nd word <ul style="list-style-type: none"> • Upper 8 bits: Hour (00H to 23H) • Lower 8 bits: Day (01H to 31H) 3rd word <ul style="list-style-type: none"> • Upper 8 bits: Second (00H to 59H) • Lower 8 bits: Minute (00H to 59H) 4th word <ul style="list-style-type: none"> • Upper 8 bits: Upper 2 digits of year (00H to 99H) • Lower 8 bits: Day of week (00H (Sunday) to 06H (Saturday)) 	0
(19)	pbo_uErrStationAddress1	Error-detected station address 1	Word [Unsigned]/Bit String [16-bit]	<ul style="list-style-type: none"> ■When "Target station address specification method" is off The network number of the station in which an error was detected is stored. ■When "Target station address specification method" is on The IP addresses (the third and fourth octets) of the station in which an error was detected are stored. (CC-Link IE TSN only) Example: When the IP address is 192.168.1.2 0102h 	0
(20)	pbo_uErrStationAddress2	Error-detected station address 2	Word [Unsigned]/Bit String [16-bit]	<ul style="list-style-type: none"> ■When "Target station address specification method" is off The station number of the station in which an error was detected is stored. <ul style="list-style-type: none"> • Ethernet or CC-Link IE Controller Network 0001H to 0078H (1 to 120) • CC-Link IE Field Network 007DH (125): Master station 0001H to 0078H (1 to 120): Local station, remote device station, intelligent device station, submaster station • CC-Link IE TSN 007DH: Master station 0001H to 0078H (1 to 120): Slave station ■When "Target station address specification method" is on The IP addresses (the first and second octets) of the station in which an error was detected are stored. (CC-Link IE TSN only) Example: When the IP address is 192.168.1.2 C0A8h 	0

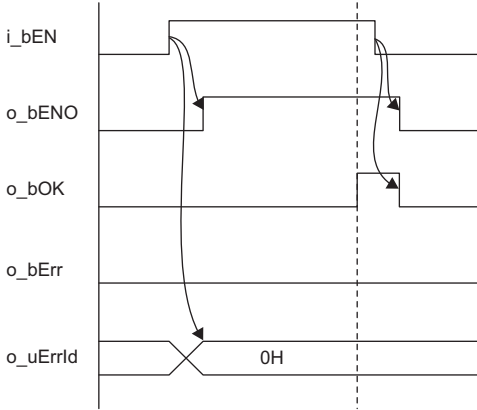
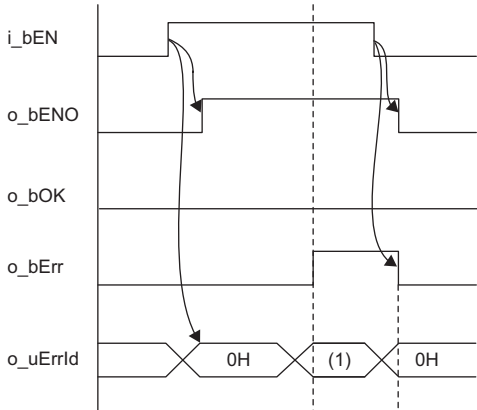
FB details

Item	Description	
Available device	Target module <ul style="list-style-type: none"> • RJ71GN11-T2 • RJ71GN11-SX • RJ71GN11-EIP 	
	CPU module	RCPU
	Engineering tool	GX Works3
Language	Ladder diagram	
Number of basic steps	93 steps The number of steps of the FB embedded in a program depends on the CPU module used, the input/output definitions, and the option settings of GX Works3. For the option settings of GX Works3, refer to GX Works3 Operating Manual.	
Processing	When i_bEN (execution instruction) is turned on, this function sends a message to another station.	
FB compilation method	Macro type	
FB operation	Pulse type (multiple-scan execution type)	
Input condition for FB_EN	None	
Timing chart of I/O signals	<ul style="list-style-type: none"> • For normal completion  <ul style="list-style-type: none"> • For error completion (same as in the case of a module error)  <p>(1) Error code</p>	
Precautions	<ul style="list-style-type: none"> • This FB does not include error recovery processing. Please create error recovery processing separately according to the system and required operations. • This FB uses the GP.SEND instruction. • Turn off i_bEN (execution command) after o_bOK (normal completion) or o_bErr (error completion) is turned on. By turning off i_bEN (execution command), o_bOK (normal completion) or o_bErr (error completion) is turned off and o_uErrld (error code) is cleared to 0. • This FB uses the label initial value by each program. When the program file using this FB is specified to boot file setting for the boot operation in the CPU module, specify the initial label value file by each program to the boot file setting as well. (MELSEC iQ-R CPU Module User's Manual (Application)) If an error code that is not described in Page 96 Error codes appears, the initial label value files by each program may not be set to the boot file setting. In this case, specify the initial label value files by each program to the boot file setting. • When this FB is executed, an operation error may occur in the programmable controller CPU. In this case, check the detailed information of the operation error in event history and correct the input argument of the module FB. 	

Error codes

Error code	Reference
C000H to CFFFH	 MELSEC iQ-R CC-Link IE TSN User's Manual (Application)
D000H to DFFFH	 MELSEC iQ-R CC-Link IE TSN Plus Master/Local Module User's Manual

3.4 M+model_Recv

Name

■RJ71GN11-T2
M+RJ71GN11_Recv

■RJ71GN11-SX
M+RJ71GN11_SX_Recv

■RJ71GN11-EIP
M+RJ71GN11_SE_Recv

Overview

Item	Description																																																																																																
Overview	Reads the data received from the programmable controller of another station.																																																																																																
Symbol	<div style="border: 1px solid black; padding: 10px; margin: 10px 0;"> <p style="text-align: center;">M+RJ71GN11_Recv</p> <table style="width: 100%; border-collapse: collapse;"> <tr> <td style="width: 10%; vertical-align: top;">(1) —</td> <td style="width: 40%;">B: i_bEN</td> <td style="width: 10%;"></td> <td style="width: 10%;"></td> <td style="width: 10%;"></td> <td style="width: 10%; text-align: right;">o_bENO: B (4)</td> </tr> <tr> <td style="vertical-align: top;">(2) —</td> <td>DUT: i_stModule</td> <td></td> <td></td> <td></td> <td style="text-align: right;">o_bOK: B (5)</td> </tr> <tr> <td style="vertical-align: top;">(3) —</td> <td>UW: i_uRecvChannel</td> <td></td> <td></td> <td></td> <td style="text-align: right;">o_bErr: B (6)</td> </tr> <tr> <td></td> <td></td> <td></td> <td></td> <td style="text-align: right;">o_uErrId: UW (7)</td> <td></td> </tr> <tr> <td></td> <td></td> <td></td> <td style="text-align: right;">o_uRecvDataLength: UW (8)</td> <td></td> <td></td> </tr> <tr> <td></td> <td></td> <td></td> <td style="text-align: right;">o_uRecvData: UW (9)</td> <td></td> <td></td> </tr> <tr> <td></td> <td style="padding-left: 20px;">pbi_bReadTiming (10)</td> <td></td> <td></td> <td></td> <td></td> </tr> <tr> <td></td> <td style="padding-left: 20px;">pbi_uMonitorTime (11)</td> <td></td> <td></td> <td></td> <td></td> </tr> <tr> <td></td> <td style="padding-left: 20px;">pbi_bStationSpecific (12)</td> <td></td> <td></td> <td></td> <td></td> </tr> <tr> <td></td> <td style="padding-left: 20px;">pbo_uResendCount (13)</td> <td></td> <td></td> <td></td> <td></td> </tr> <tr> <td></td> <td style="padding-left: 20px;">pbo_u4ErrTime (14)</td> <td></td> <td></td> <td></td> <td></td> </tr> <tr> <td></td> <td style="padding-left: 20px;">pbo_uErrStationAddress1 (15)</td> <td></td> <td></td> <td></td> <td></td> </tr> <tr> <td></td> <td style="padding-left: 20px;">pbo_uErrStationAddress2 (16)</td> <td></td> <td></td> <td></td> <td></td> </tr> <tr> <td></td> <td style="padding-left: 20px;">pbo_uSendStationAddress1 (17)</td> <td></td> <td></td> <td></td> <td></td> </tr> <tr> <td></td> <td style="padding-left: 20px;">pbo_uSendStationAddress2 (18)</td> <td></td> <td></td> <td></td> <td></td> </tr> <tr> <td></td> <td style="padding-left: 20px;">pbo_uSendChannel (19)</td> <td></td> <td></td> <td></td> <td></td> </tr> </table> </div> <p>The above FB is an example for the RJ71GN11-T2.</p>	(1) —	B: i_bEN				o_bENO: B (4)	(2) —	DUT: i_stModule				o_bOK: B (5)	(3) —	UW: i_uRecvChannel				o_bErr: B (6)					o_uErrId: UW (7)					o_uRecvDataLength: UW (8)						o_uRecvData: UW (9)				pbi_bReadTiming (10)						pbi_uMonitorTime (11)						pbi_bStationSpecific (12)						pbo_uResendCount (13)						pbo_u4ErrTime (14)						pbo_uErrStationAddress1 (15)						pbo_uErrStationAddress2 (16)						pbo_uSendStationAddress1 (17)						pbo_uSendStationAddress2 (18)						pbo_uSendChannel (19)				
(1) —	B: i_bEN				o_bENO: B (4)																																																																																												
(2) —	DUT: i_stModule				o_bOK: B (5)																																																																																												
(3) —	UW: i_uRecvChannel				o_bErr: B (6)																																																																																												
				o_uErrId: UW (7)																																																																																													
			o_uRecvDataLength: UW (8)																																																																																														
			o_uRecvData: UW (9)																																																																																														
	pbi_bReadTiming (10)																																																																																																
	pbi_uMonitorTime (11)																																																																																																
	pbi_bStationSpecific (12)																																																																																																
	pbo_uResendCount (13)																																																																																																
	pbo_u4ErrTime (14)																																																																																																
	pbo_uErrStationAddress1 (15)																																																																																																
	pbo_uErrStationAddress2 (16)																																																																																																
	pbo_uSendStationAddress1 (17)																																																																																																
	pbo_uSendStationAddress2 (18)																																																																																																
	pbo_uSendChannel (19)																																																																																																

Labels

Input arguments

No.	Variable name	Name	Data type	Range	Description
(1)	i_bEN	Execution command	Bit	—	On: Start FB. Off: Do not start FB.
(2)	i_stModule	Module label	Structure	—	Specify the module for which the FB is to be executed. Specify the module label of the modules. (Example: GN11_1, GN11_SE_1)
(3)	i_uRecvChannel	Receive data storage channel	Word [Unsigned]/ Bit String [16-bit]	—	Specify the channel containing the data to be read. ☞ MELSEC iQ-R Programming Manual (Module Dedicated Instructions)

■Output arguments

No.	Variable name	Name	Data type	Description	Default value
(4)	o_bENO	Execution status	Bit	On: The execution command is turned on. Off: The execution command is turned off.	Off
(5)	o_bOK	Normal completion	Bit	The FB has been processed normally when this argument is on.	Off
(6)	o_bErr	Error completion	Bit	The FB has been processed abnormally when this argument is on.	Off
(7)	o_uErrId	Error code	Word [Unsigned]/Bit String [16-bit]	An error code is stored at error completion.	0
(8)	o_uRecvDataLength	Receive data length	Word [Unsigned]/Bit String [16-bit]	The number of received data is stored. 1 to 960 words	0
(9)	o_uRecvData	Receive data storage device	Word [Unsigned]/Bit String [16-bit]	Specify the start number of the device for storing received data.	0

■Operation parameters

No.	Variable name	Name	Data type	Range	Description	Default value
(10)	pbi_bReadTiming	Read timing	Bit	On	Specify the timing of executing data read processing. • On: Start reading in the first END processing after the module FB starts.	On
(11)	pbi_uMonitorTime	Arrival monitoring time	Word [Unsigned]/ Bit String [16-bit]	0, 1 to 32767	Specify the monitoring time until completion of processing (the setting is valid only when "Read timing" is on). When the processing is not completed normally within the monitoring time, the processing is completed with an error. • 0: 10s • Effective range 1 to 32767: 1s to 32767s	0
(12)	pbi_bStationSpecific	Sending station address display method	Bit	On or off	Specify the sending station address display method • Off: Use the network number and station number. • On: Use the IP address (IPv4). (CC-Link IE TSN only).	Off

■Public variables



No.	Variable name	Name	Data type	Description	Default value
(13)	pbo_uResendCount	Number of resends	Word [Unsigned]/ Bit String [16-bit]	0 is stored in this area.	0
(14)	pbo_u4ErrTime	Error occurrence time	Word [Unsigned]/ Bit String [16-bit] (0..3)	Clock data at the time of error occurrence is stored. 1st word • Upper 8 bits: Month (01H to 12H) • Lower 8 bits: Lower 2 digits of year (00H to 99H) 2nd word • Upper 8 bits: Hour (00H to 23H) • Lower 8 bits: Day (01H to 31H) 3rd word • Upper 8 bits: Second (00H to 59H) • Lower 8 bits: Minute (00H to 59H) 4th word • Upper 8 bits: Upper 2 digits of year (00H to 99H) • Lower 8 bits: Day of week (00H (Sunday) to 06H (Saturday))	0
(15)	pbo_uErrStationAddress1	Error-detected station address 1	Word [Unsigned]/ Bit String [16-bit]	■When "Sending station address display method" is off The network number of the station in which an error was detected is stored. ■When "Sending station address display method" is on The IP addresses (the third and fourth octets) of the station in which an error was detected are stored. (CC-Link IE TSN only) Example: When the IP address is 192.168.1.2 0102h	0

No.	Variable name	Name	Data type	Description	Default value
(16)	pbo_uErrStationAddress2	Error-detected station address 2	Word [Unsigned]/ Bit String [16-bit]	<p>■When "Sending station address display method" is off The station number of the station in which an error was detected is stored.</p> <ul style="list-style-type: none"> Ethernet or CC-Link IE Controller Network 0001H to 0078H (1 to 120) CC-Link IE Field Network 007DH (125): Master station 0001H to 0078H (1 to 120): Local station, remote device station, intelligent device station, submaster station CC-Link IE TSN 007DH: Master station 0001H to 0078H (1 to 120): Slave station <p>■When "Sending station address display method" is on The IP addresses (the first and second octets) of the station in which an error was detected are stored. (CC-Link IE TSN only) Example: When the IP address is 192.168.1.2 C0A8h</p>	0
(17)	pbo_uSendStationAddress1	Sending station address 1	Word [Unsigned]/ Bit String [16-bit]	<p>■When "Sending station address display method" is off The network number and station number of the sending station are stored.</p> <p>■When "Sending station address display method" is on The IP addresses (the third and fourth octets) of the sending station are stored. (CC-Link IE TSN only) Example: When the IP address is 192.168.1.2 0102h</p>	0
(18)	pbo_uSendStationAddress2	Sending station address 2	Word [Unsigned]/ Bit String [16-bit]	<p>■When "Sending station address display method" is off The station number of the sending station is stored.</p> <ul style="list-style-type: none"> Ethernet or CC-Link IE Controller Network 0001H to 0078H (1 to 120) CC-Link IE Field Network 007DH (125): Master station 0001H to 0078H (1 to 120): Local station, remote device station, intelligent device station, submaster station CC-Link IE TSN 007DH: Master station 0001H to 0078H (1 to 120): Slave station <p>■When "Sending station address display method" is on The IP addresses (the first and second octets) of the sending station are stored. (CC-Link IE TSN only) Example: When the IP address is 192.168.1.2 C0A8h</p>	0
(19)	pbo_uSendChannel	Channel used by sending station	Word [Unsigned]/ Bit String [16-bit]	The channel number used by the send station is stored. 1 to 8	0

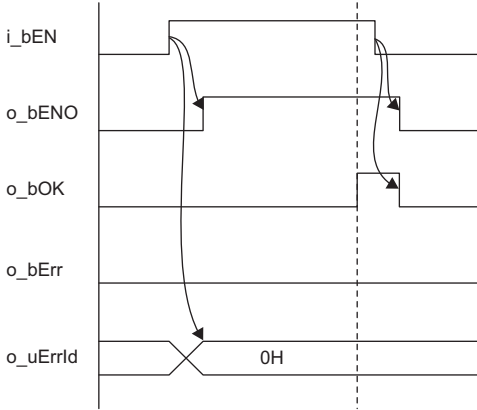
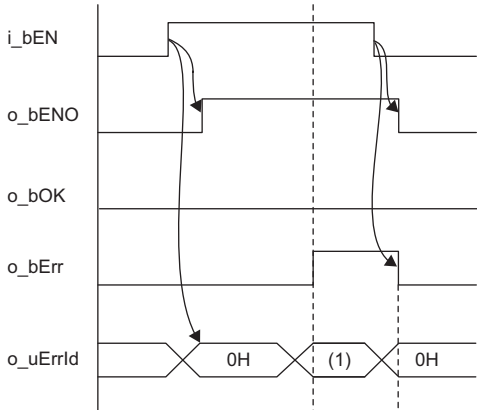
FB details

Item	Description	
Available device	Target module <ul style="list-style-type: none"> • RJ71GN11-T2 • RJ71GN11-SX • RJ71GN11-EIP 	
	CPU module	RCPU
	Engineering tool	GX Works3
Language	Ladder diagram	
Number of basic steps	76 steps The number of steps of the FB embedded in a program depends on the CPU module used, the input/output definitions, and the option settings of GX Works3. For the option settings of GX Works3, refer to GX Works3 Operating Manual.	
Processing	When i_bEN (execution instruction) is turned on, this function receives a message from another station.	
FB compilation method	Macro type	
FB operation	Pulse type (multiple-scan execution type)	
Input condition for FB_EN	None	
Timing chart of I/O signals	<ul style="list-style-type: none"> • For normal completion  <ul style="list-style-type: none"> • For error completion (same as in the case of a module error)  <p>(1) Error code</p>	
Precautions	<ul style="list-style-type: none"> • This FB does not include error recovery processing. Please create error recovery processing separately according to the system and required operations. • This FB uses the GP.RECV instruction. • Turn off i_bEN (execution command) after o_bOK (normal completion) or o_bErr (error completion) is turned on. By turning off i_bEN (execution command), o_bOK (normal completion) or o_bErr (error completion) is turned off and o_uErrld (error code) is cleared to 0. • This FB uses the label initial value by each program. When the program file using this FB is specified to boot file setting for the boot operation in the CPU module, specify the initial label value file by each program to the boot file setting as well. (MELSEC iQ-R CPU Module User's Manual (Application)) If an error code that is not described in Page 101 Error codes appears, the initial label value files by each program may not be set to the boot file setting. In this case, specify the initial label value files by each program to the boot file setting. • When this FB is executed, an operation error may occur in the programmable controller CPU. In this case, check the detailed information of the operation error in event history and correct the input argument of the module FB. 	

Error codes

Error code	Reference
C000H to CFFFH	 MELSEC iQ-R CC-Link IE TSN User's Manual (Application)
D000H to DFFFH	 MELSEC iQ-R CC-Link IE TSN Plus Master/Local Module User's Manual

3.5 M+model_RemoteStopRun

Name

■RJ71GN11-T2

M+RJ71GN11_RemoteStopRun

■RJ71GN11-SX

M+RJ71GN11_SX_RemoteStopRun

■RJ71GN11-EIP

M+RJ71GN11_SE_RemoteStopRun

Overview

Item	Description																																																																																																
Overview	Sends a remote STOP/RUN request to the programmable controller of another station.																																																																																																
Symbol	<div style="border: 1px solid black; padding: 10px; margin: 10px 0;"> <p style="text-align: center;">M+RJ71GN11_RemoteStopRun</p> <table style="width: 100%; border-collapse: collapse;"> <tr> <td style="width: 10%; vertical-align: top;">(1) —</td> <td style="width: 40%;">B: i_bEN</td> <td style="width: 10%;"></td> <td style="width: 20%;">o_bENO: B</td> <td style="width: 10%;"></td> <td style="width: 10%; text-align: right;">(6)</td> </tr> <tr> <td style="vertical-align: top;">(2) —</td> <td>DUT: i_stModule</td> <td></td> <td>o_bOK: B</td> <td></td> <td style="text-align: right;">(7)</td> </tr> <tr> <td style="vertical-align: top;">(3) —</td> <td>UW: i_u2TargetAddress</td> <td></td> <td>o_bErr: B</td> <td></td> <td style="text-align: right;">(8)</td> </tr> <tr> <td style="vertical-align: top;">(4) —</td> <td>UW: i_uChannel</td> <td></td> <td>o_uErrId: UW</td> <td></td> <td style="text-align: right;">(9)</td> </tr> <tr> <td style="vertical-align: top;">(5) —</td> <td>UW: i_uRemoteType</td> <td></td> <td></td> <td></td> <td></td> </tr> <tr> <td></td> <td style="padding-left: 20px;">pbi_uCPU_Type</td> <td></td> <td></td> <td></td> <td style="text-align: right;">(10)</td> </tr> <tr> <td></td> <td style="padding-left: 20px;">pbi_uResendCountMax</td> <td></td> <td></td> <td></td> <td style="text-align: right;">(11)</td> </tr> <tr> <td></td> <td style="padding-left: 20px;">pbi_uMonitorTime</td> <td></td> <td></td> <td></td> <td style="text-align: right;">(12)</td> </tr> <tr> <td></td> <td style="padding-left: 20px;">pbi_bStationSpecific</td> <td></td> <td></td> <td></td> <td style="text-align: right;">(13)</td> </tr> <tr> <td></td> <td style="padding-left: 20px;">pbi_uTargetStation</td> <td></td> <td></td> <td></td> <td style="text-align: right;">(14)</td> </tr> <tr> <td></td> <td style="padding-left: 20px;">pbi_uForciblyRun</td> <td></td> <td></td> <td></td> <td style="text-align: right;">(15)</td> </tr> <tr> <td></td> <td style="padding-left: 20px;">pbi_uDeviceClear</td> <td></td> <td></td> <td></td> <td style="text-align: right;">(16)</td> </tr> <tr> <td></td> <td style="padding-left: 20px;">pbo_uResendCount</td> <td></td> <td></td> <td></td> <td style="text-align: right;">(17)</td> </tr> <tr> <td></td> <td style="padding-left: 20px;">pbo_u4ErrTime</td> <td></td> <td></td> <td></td> <td style="text-align: right;">(18)</td> </tr> <tr> <td></td> <td style="padding-left: 20px;">pbo_uErrStationAddress1</td> <td></td> <td></td> <td></td> <td style="text-align: right;">(19)</td> </tr> <tr> <td></td> <td style="padding-left: 20px;">pbo_uErrStationAddress2</td> <td></td> <td></td> <td></td> <td style="text-align: right;">(20)</td> </tr> </table> <p>The above FB is an example for the RJ71GN11-T2.</p> </div>	(1) —	B: i_bEN		o_bENO: B		(6)	(2) —	DUT: i_stModule		o_bOK: B		(7)	(3) —	UW: i_u2TargetAddress		o_bErr: B		(8)	(4) —	UW: i_uChannel		o_uErrId: UW		(9)	(5) —	UW: i_uRemoteType						pbi_uCPU_Type				(10)		pbi_uResendCountMax				(11)		pbi_uMonitorTime				(12)		pbi_bStationSpecific				(13)		pbi_uTargetStation				(14)		pbi_uForciblyRun				(15)		pbi_uDeviceClear				(16)		pbo_uResendCount				(17)		pbo_u4ErrTime				(18)		pbo_uErrStationAddress1				(19)		pbo_uErrStationAddress2				(20)
(1) —	B: i_bEN		o_bENO: B		(6)																																																																																												
(2) —	DUT: i_stModule		o_bOK: B		(7)																																																																																												
(3) —	UW: i_u2TargetAddress		o_bErr: B		(8)																																																																																												
(4) —	UW: i_uChannel		o_uErrId: UW		(9)																																																																																												
(5) —	UW: i_uRemoteType																																																																																																
	pbi_uCPU_Type				(10)																																																																																												
	pbi_uResendCountMax				(11)																																																																																												
	pbi_uMonitorTime				(12)																																																																																												
	pbi_bStationSpecific				(13)																																																																																												
	pbi_uTargetStation				(14)																																																																																												
	pbi_uForciblyRun				(15)																																																																																												
	pbi_uDeviceClear				(16)																																																																																												
	pbo_uResendCount				(17)																																																																																												
	pbo_u4ErrTime				(18)																																																																																												
	pbo_uErrStationAddress1				(19)																																																																																												
	pbo_uErrStationAddress2				(20)																																																																																												

Labels

Input arguments

No.	Variable name	Name	Data type	Range	Description															
(1)	i_bEN	Execution command	Bit	—	On: Start FB. Off: Do not start FB.															
(2)	i_stModule	Module label	Structure	—	Specify the module for which the FB is to be executed. Specify the module label of the modules. (Example: GN11_1, GN11_SX_1, GN11_SE_1)															
(3)	i_u2TargetAddress	Target station address	Word [Unsigned]/ Bit String [16-bit] (0..1)	—	<p>Specify the network number and station number of the target station when "Target station address specification method" is off. When specifying the address using a label, use an array as the data type.</p> <p>■When "Target station specification method" is set to 0 to specify a station number</p> <ul style="list-style-type: none"> • 1st word: Network number (1 to 239) • 2nd word: Station number <p>Station number of Ethernet or CC-Link IE Controller Network</p> <ul style="list-style-type: none"> • 1 to 120 <p>Station number of CC-Link IE Field Network</p> <ul style="list-style-type: none"> • 125: Master station • 126: Master operating station • 1 to 120: Local station, remote device station, intelligent device station, submaster station <p>CC-Link IE TSN</p> <ul style="list-style-type: none"> • 125: Master station • 1 to 120: Local station <p>■When "Target station specification method" is set to 1 to specify a group (CC-Link IE Field Network is not supported.)</p> <ul style="list-style-type: none"> • 1st word: Network number (1 to 239) • 2nd word: Transient transmission group number (1 to 32) <p>■When "Target station specification method" is set to 2 to specify all stations</p> <ul style="list-style-type: none"> • 1st word: Network number (1 to 239) • 2nd word: 0 (The setting is ignored.) <p>Specify the IP address of the target station when "Target station address specification method" is on. Specify the third and fourth octets to the 1st word, and first and second octets to the 2nd word. When specifying the address using a label, use an array as the data type.</p> <ul style="list-style-type: none"> • CC-Link IE TSN 00000001H to FFFFFFFEH <p>Specify a value within the range of 1 to 254 (FEH) for the fourth octet.</p> <table border="1" style="margin-left: 40px;"> <tr> <td></td> <td style="text-align: center;">b15</td> <td style="text-align: center;">b8</td> <td style="text-align: center;">b7</td> <td style="text-align: center;">b0</td> </tr> <tr> <td>+0</td> <td style="text-align: center;">3</td> <td style="text-align: center;">4</td> <td colspan="2"></td> </tr> <tr> <td>+1</td> <td style="text-align: center;">1</td> <td style="text-align: center;">2</td> <td colspan="2"></td> </tr> </table> <p>1 to 4: IP address octet</p>		b15	b8	b7	b0	+0	3	4			+1	1	2		
	b15	b8	b7	b0																
+0	3	4																		
+1	1	2																		
(4)	i_uChannel	Own station channel	Word [Unsigned]/ Bit String [16-bit]	—	Specify the channel to be used by the own station. ☞ MELSEC iQ-R Programming Manual (Module Dedicated Instructions)															
(5)	i_uRemoteType	Remote operation	Word [Unsigned]/ Bit String [16-bit]	1, 2	Specify remote RUN or STOP. • 1: Remote RUN • 2: Remote STOP															

■Output arguments

No.	Variable name	Name	Data type	Description	Default value
(6)	o_bENO	Execution status	Bit	On: The execution command is turned on. Off: The execution command is turned off.	Off
(7)	o_bOK	Normal completion	Bit	The FB has been processed normally when this argument is on.	Off
(8)	o_bErr	Error completion	Bit	The FB has been processed abnormally when this argument is on.	Off
(9)	o_uErrId	Error code	Word [Unsigned]/Bit String [16-bit]	An error code is stored at error completion.	0

■Operation parameters

No.	Variable name	Name	Data type	Range	Description	Default value
(10)	pbi_uCPU_Type	Target station CPU type	Word [Unsigned]/Bit String [16-bit]	0000H, 03D0H to 03D3H, 03E0H to 03E3H, 03FFH	Specify the CPU type of the target station. <ul style="list-style-type: none"> • 0000H: To CPU of target station (control CPU) • 03D0H: To control system CPU • 03D1H: To standby system CPU • 03D2H: To system A CPU • 03D3H: To system B CPU • 03E0H: To multiple CPU No.1 • 03E1H: To multiple CPU No.2 • 03E2H: To multiple CPU No.3 • 03E3H: To multiple CPU No.4 • 03FFH: To CPU of target station (control CPU) 	0
(11)	pbi_uResendCountMax	Maximum number of resends	Word [Unsigned]/Bit String [16-bit]	0 to 15	Specify the number of resends to be performed if the data transfer is not completed within the monitoring time specified by "Arrival monitoring time".	5
(12)	pbi_uMonitorTime	Arrival monitoring time	Word [Unsigned]/Bit String [16-bit]	0, 1 to 32767	Specify the monitoring time until completion of processing. If the processing is not completed within the monitoring time, data is resent until the value specified in "Maximum number of resends" is reached. <ul style="list-style-type: none"> • 0: 10s • Effective range 1 to 32767: 1s to 32767s 	0
(13)	pbi_bStationSpecific	Target station address specification method	Bit	On or off	Specify the specification method of a target station. <ul style="list-style-type: none"> • Off: Use the network number and station number. • On: Use the IP address (IPv4). (CC-Link IE TSN only). 	Off
(14)	pbi_uTargetStation	Target station specification method	Word [Unsigned]/Bit String [16-bit]	0 to 2	Specify the specification method of a target station. <ul style="list-style-type: none"> • 0: Station number specification → Station with the station number specified in "Target station address" • 1: Group specification → All stations of the transient transmission group number specified in "Target station address" (For the CC-Link IE Field Network, the value 1 cannot be specified.) • 2: All stations → All stations of the network number specified in "Target station address" (simultaneous broadcast except own station) 	0
(15)	pbi_uForciblyRun	Specification of forced remote RUN	Word [Unsigned]/Bit String [16-bit]	1, 2	<ul style="list-style-type: none"> ■"Remote operation": 1 (remote RUN) Specify whether to forcibly execute remote RUN. The forcible execution function enables forcible execution of remote RUN from another station when a station which executed remote STOP can no longer execute remote RUN. <ul style="list-style-type: none"> • 1: Not forcibly executed • 2: Forcibly executed ■"Remote operation": 2 (remote STOP) Any setting here is ignored and the following setting is always used. <ul style="list-style-type: none"> • 2: Forcibly executed 	1

No.	Variable name	Name	Data type	Range	Description	Default value
(16)	pbi_uDeviceClear	Specification of device clear at remote RUN	Word [Unsigned]/Bit String [16-bit]	0 to 2	<ul style="list-style-type: none"> ■"Remote operation": 1 (remote RUN) Specify how to handle the CPU module device memory after remote RUN is executed. • 0: Do not clear. • 1: Clear (except the latch range). • 2: Clear (including the latch range). ■"Remote operation": 2 (remote STOP) Any setting here is ignored. 	0



■Public variables

No.	Variable name	Name	Data type	Description	Default value
(17)	pbo_uResendCount	Number of resends	Word [Unsigned]/Bit String [16-bit]	The number of resends performed (result) is stored. If an error was detected, the number of resends performed (result) between error detection and resend stop is stored.	0
(18)	pbo_u4ErrTime	Error occurrence time	Word [Unsigned]/Bit String [16-bit] (0..3)	Clock data at the time of error occurrence is stored. 1st word <ul style="list-style-type: none"> • Upper 8 bits: Month (01H to 12H) • Lower 8 bits: Lower 2 digits of year (00H to 99H) 2nd word <ul style="list-style-type: none"> • Upper 8 bits: Hour (00H to 23H) • Lower 8 bits: Day (01H to 31H) 3rd word <ul style="list-style-type: none"> • Upper 8 bits: Second (00H to 59H) • Lower 8 bits: Minute (00H to 59H) 4th word <ul style="list-style-type: none"> • Upper 8 bits: Upper 2 digits of year (00H to 99H) • Lower 8 bits: Day of week (00H (Sunday) to 06H (Saturday)) 	0
(19)	pbo_uErrStationAddress 1	Error-detected station address 1	Word [Unsigned]/Bit String [16-bit]	<ul style="list-style-type: none"> ■When "Target station address specification method" is off The network number of the station in which an error was detected is stored. ■When "Target station address specification method" is on The IP addresses (the third and fourth octets) of the station in which an error was detected are stored. (Ethernet and CC-Link IE TSN only) Example: When the IP address is 192.168.1.2 0102h 	0
(20)	pbo_uErrStationAddress 2	Error-detected station address 2	Word [Unsigned]/Bit String [16-bit]	<ul style="list-style-type: none"> ■When "Target station address specification method" is off The station number of the station in which an error was detected is stored. • Ethernet or CC-Link IE Controller Network 0001H to 0078H (1 to 120) • CC-Link IE Field Network 007DH (125): Master station 0001H to 0078H (1 to 120): Local station, remote device station, intelligent device station, submaster station • CC-Link IE TSN 007DH: Master station 0001H to 0078H (1 to 120): Slave station ■When "Target station address specification method" is on The IP addresses (the first and second octets) of the station in which an error was detected are stored. (Ethernet and CC-Link IE TSN only) Example: When the IP address is 192.168.1.2 C0A8h 	0

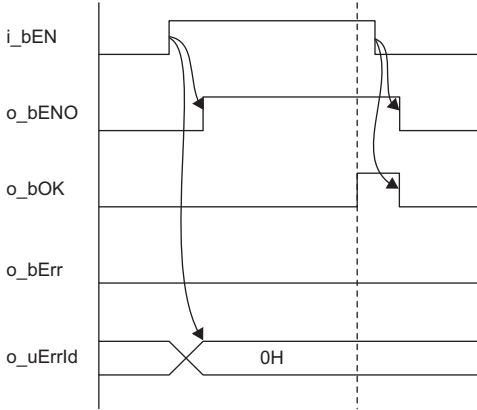
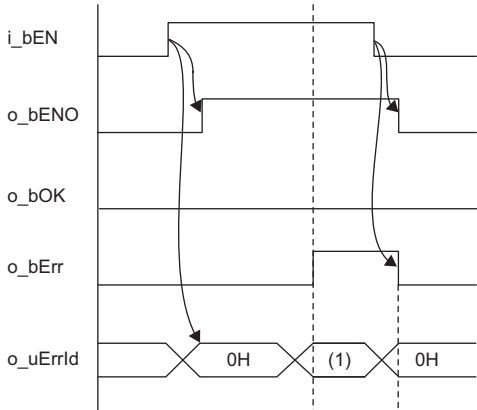
FB details

Item	Description	
Available device	Target module <ul style="list-style-type: none"> • RJ71GN11-T2 • RJ71GN11-SX • RJ71GN11-EIP 	
	CPU module	RCPU
	Engineering tool	GX Works3
Language	Ladder diagram	
Number of basic steps	204 steps The number of steps of the FB embedded in a program depends on the CPU module used, the input/output definitions, and the option settings of GX Works3. For the option settings of GX Works3, refer to GX Works3 Operating Manual.	
Processing	When i_bEN (execution instruction) is turned on, this function performs remote STOP/RUN for other stations.	
FB compilation method	Macro type	
FB operation	Pulse type (multiple-scan execution type)	
Input condition for FB_EN	None	
Timing chart of I/O signals	<ul style="list-style-type: none"> • For normal completion  <ul style="list-style-type: none"> • For error completion (same as in the case of a module error)  <p>(1) Error code</p>	
Precautions	<ul style="list-style-type: none"> • This FB does not include error recovery processing. Please create error recovery processing separately according to the system and required operations. • This FB uses the GP.REQ instruction. • Turn off i_bEN (execution command) after o_bOK (normal completion) or o_bErr (error completion) is turned on. By turning off i_bEN (execution command), o_bOK (normal completion) or o_bErr (error completion) is turned off and o_uErrld (error code) is cleared to 0. • This FB uses the label initial value by each program. When the program file using this FB is specified to boot file setting for the boot operation in the CPU module, specify the initial label value file by each program to the boot file setting as well. (MELSEC iQ-R CPU Module User's Manual (Application)) If an error code that is not described in Page 107 Error codes appears, the initial label value files by each program may not be set to the boot file setting. In this case, specify the initial label value files by each program to the boot file setting. • When this FB is executed, an operation error may occur in the programmable controller CPU. In this case, check the detailed information of the operation error in event history and correct the input argument of the module FB. 	

Error codes

Error code	Reference
C000H to CFFFH	 MELSEC iQ-R CC-Link IE TSN User's Manual (Application)
D000H to DFFFH	 MELSEC iQ-R CC-Link IE TSN Plus Master/Local Module User's Manual

3.6 M+model_SLMP_DeviceRead_IP

Name

■RJ71GN11-T2

M+RJ71GN11_SLMP_DeviceRead_IP

■RJ71GN11-SX

M+RJ71GN11_SX_SLMP_DeviceRead_IP

■RJ71GN11-EIP

M+RJ71GN11_SE_SLMP_DeviceRead_IP

Overview

Item	Description																																																																																																
Overview	Reads data from the SLMP-compatible device by specifying IP address.																																																																																																
Symbol	<div style="border: 1px solid black; padding: 10px; margin: 10px 0;"> <p style="text-align: center;">M+RJ71GN11_SLMP_DeviceRead_IP</p> <table style="width: 100%; border-collapse: collapse;"> <tr> <td style="width: 10%;">(1) —</td> <td style="width: 40%;">B: i_bEN</td> <td style="width: 10%;"></td> <td style="width: 10%;">o_bENO: B</td> <td style="width: 10%;"></td> <td style="width: 10%;">(10)</td> </tr> <tr> <td>(2) —</td> <td>DUT: i_stModule</td> <td></td> <td>o_bOK: B</td> <td></td> <td>(11)</td> </tr> <tr> <td>(3) —</td> <td>UW: i_u2IP_Address</td> <td></td> <td>o_bErr: B</td> <td></td> <td>(12)</td> </tr> <tr> <td>(4) —</td> <td>UW: i_uSubCommand</td> <td></td> <td>o_uErrId: UW</td> <td></td> <td>(13)</td> </tr> <tr> <td>(5) —</td> <td>UW: i_uDeviceCode</td> <td></td> <td>o_uReadData: UW</td> <td></td> <td>(14)</td> </tr> <tr> <td>(6) —</td> <td>UW: i_u2DeviceNo</td> <td></td> <td></td> <td></td> <td></td> </tr> <tr> <td>(7) —</td> <td>UW: i_uDevicePoints</td> <td></td> <td></td> <td></td> <td></td> </tr> <tr> <td>(8) —</td> <td>UW: i_uChannel</td> <td></td> <td></td> <td></td> <td></td> </tr> <tr> <td>(9) —</td> <td>UW: i_uTarget_Port_No</td> <td></td> <td></td> <td></td> <td></td> </tr> <tr> <td></td> <td style="padding-left: 40px;">pbi_uRequestModuleIO</td> <td></td> <td></td> <td></td> <td>(15)</td> </tr> <tr> <td></td> <td style="padding-left: 40px;">pbi_uResendCountMax</td> <td></td> <td></td> <td></td> <td>(16)</td> </tr> <tr> <td></td> <td style="padding-left: 40px;">pbi_uMonitorTime</td> <td></td> <td></td> <td></td> <td>(17)</td> </tr> <tr> <td></td> <td style="padding-left: 40px;">pbo_uResendCount</td> <td></td> <td></td> <td></td> <td>(18)</td> </tr> <tr> <td></td> <td style="padding-left: 40px;">pbo_u4ErrTime</td> <td></td> <td></td> <td></td> <td>(19)</td> </tr> <tr> <td></td> <td style="padding-left: 40px;">pbo_uErrIP_Address_3rd_4th</td> <td></td> <td></td> <td></td> <td>(20)</td> </tr> <tr> <td></td> <td style="padding-left: 40px;">pbo_uErrIP_Address_1st_2nd</td> <td></td> <td></td> <td></td> <td>(21)</td> </tr> </table> </div> <p>The above FB is an example for the RJ71GN11-T2.</p>	(1) —	B: i_bEN		o_bENO: B		(10)	(2) —	DUT: i_stModule		o_bOK: B		(11)	(3) —	UW: i_u2IP_Address		o_bErr: B		(12)	(4) —	UW: i_uSubCommand		o_uErrId: UW		(13)	(5) —	UW: i_uDeviceCode		o_uReadData: UW		(14)	(6) —	UW: i_u2DeviceNo					(7) —	UW: i_uDevicePoints					(8) —	UW: i_uChannel					(9) —	UW: i_uTarget_Port_No						pbi_uRequestModuleIO				(15)		pbi_uResendCountMax				(16)		pbi_uMonitorTime				(17)		pbo_uResendCount				(18)		pbo_u4ErrTime				(19)		pbo_uErrIP_Address_3rd_4th				(20)		pbo_uErrIP_Address_1st_2nd				(21)
(1) —	B: i_bEN		o_bENO: B		(10)																																																																																												
(2) —	DUT: i_stModule		o_bOK: B		(11)																																																																																												
(3) —	UW: i_u2IP_Address		o_bErr: B		(12)																																																																																												
(4) —	UW: i_uSubCommand		o_uErrId: UW		(13)																																																																																												
(5) —	UW: i_uDeviceCode		o_uReadData: UW		(14)																																																																																												
(6) —	UW: i_u2DeviceNo																																																																																																
(7) —	UW: i_uDevicePoints																																																																																																
(8) —	UW: i_uChannel																																																																																																
(9) —	UW: i_uTarget_Port_No																																																																																																
	pbi_uRequestModuleIO				(15)																																																																																												
	pbi_uResendCountMax				(16)																																																																																												
	pbi_uMonitorTime				(17)																																																																																												
	pbo_uResendCount				(18)																																																																																												
	pbo_u4ErrTime				(19)																																																																																												
	pbo_uErrIP_Address_3rd_4th				(20)																																																																																												
	pbo_uErrIP_Address_1st_2nd				(21)																																																																																												

Labels

■Input arguments

No.	Variable name	Name	Data type	Range	Description															
(1)	i_bEN	Execution command	Bit	—	On: Start FB. Off: Do not start FB.															
(2)	i_stModule	Module label	Structure	—	Specify the module for which the FB is to be executed. Specify the module label of the modules. (Example: GN11_1, GN11_SX_1, GN11_SE_1)															
(3)	i_u2IP_Address	IP address of external device	Word [Unsigned]/Bit String [16-bit] (0..1)	00000001H to DFFFFFFEH	Specify the IP address of an external device. Specify the third and fourth octets to the 1st word, and first and second octets to the 2nd word. Specify a value within the range of 1 to 254 (FEH) for the fourth octet. <div style="margin-top: 10px;"> <table style="margin-left: auto; margin-right: auto; border-collapse: collapse;"> <tr> <td></td> <td style="text-align: center;">b15</td> <td style="text-align: center;">b8</td> <td style="text-align: center;">b7</td> <td style="text-align: center;">b0</td> </tr> <tr> <td style="text-align: right;">+0</td> <td style="border: 1px solid black; padding: 2px;">3: 1~255</td> <td style="border: 1px solid black; padding: 2px;"></td> <td style="border: 1px solid black; padding: 2px;">4: 1~254</td> <td style="border: 1px solid black; padding: 2px;"></td> </tr> <tr> <td style="text-align: right;">+1</td> <td style="border: 1px solid black; padding: 2px;">1: 1~223</td> <td style="border: 1px solid black; padding: 2px;"></td> <td style="border: 1px solid black; padding: 2px;">2: 1~255</td> <td style="border: 1px solid black; padding: 2px;"></td> </tr> </table> </div>		b15	b8	b7	b0	+0	3: 1~255		4: 1~254		+1	1: 1~223		2: 1~255	
	b15	b8	b7	b0																
+0	3: 1~255		4: 1~254																	
+1	1: 1~223		2: 1~255																	

1 to 4: IP address octet

No.	Variable name	Name	Data type	Range	Description
(4)	i_uSubCommand	Sub command	Word [Unsigned]/Bit String [16-bit]	—	Specify the read unit and specification method of a device. <ul style="list-style-type: none"> 0th bit: Specify whether the device is read in units of words or in units of bits. 0: In units of words 1: In units of bits <ul style="list-style-type: none"> 1st bit: Specify the combination of the number of digits of the device code and start device number of the device to be read. 0: Specify the device code in 2 digits and the start device number in 6 digits (for MELSEC-Q/L series). 1: Specify the device code in 4 digits and the start device number in 8 digits (for MELSEC iQ-R series).
(5)	i_uDeviceCode	Device code	Word [Unsigned]/Bit String [16-bit]	—	Specify the device code of the device to be read in binary code. <ul style="list-style-type: none"> When the 1st bit of the subcommand is 0: 2 digits When the 1st bit of the subcommand is 1: 4 digits
(6)	i_u2DeviceNo	Head device No.	Word [Unsigned]/Bit String [16-bit] (0..1)	—	Specify the start device number of the device to be read in binary code. <ul style="list-style-type: none"> When the 1st bit of the subcommand is 0: 6 digits When the 1st bit of the subcommand is 1: 8 digits
(7)	i_uDevicePoints	Number of device points	Word [Unsigned]/Bit String [16-bit]	—	Specify the number of device points of the device to be read in binary code. <ul style="list-style-type: none"> When the 0th bit of the subcommand is 0: 1 to 960 When the 0th bit of the subcommand is 1: 1 to 3972
(8)	i_uChannel	Own station channel	Word [Unsigned]/Bit String [16-bit]	1 to 17	Specify the channel to be used by the own station.*1  MELSEC iQ-R Programming Manual (Module Dedicated Instructions)
(9)	i_uTarget_Port_No	Destination port number	Word [Unsigned]/Bit String [16-bit]	1 to 65534	Specify the UDP port number of an external device. For the port number to specify, check the manual for the external device.

*1 Set 1 when not adding a serial No. Set 2 to 9 when adding a serial No. Set 10 to 17 when communicating using the station number extension frame.

■Output arguments

No.	Variable name	Name	Data type	Description	Default value																																																																																																												
(10)	o_bENO	Execution status	Bit	On: The execution command is turned on. Off: The execution command is turned off.	Off																																																																																																												
(11)	o_bOK	Normal completion	Bit	The FB has been processed normally when this argument is on.	Off																																																																																																												
(12)	o_bErr	Error completion	Bit	The FB has been processed abnormally when this argument is on.	Off																																																																																																												
(13)	o_uErrId	Error code	Word [Unsigned]/Bit String [16-bit]	An error code is stored at error completion.	0																																																																																																												
(14)	o_uReadData	Read data storage destination	Word [Unsigned]/Bit String [16-bit]	<p>Specify the start device number of the device for storing the read data.</p> <ul style="list-style-type: none"> When the 0th bit of the subcommand is 0, the device data is read in units of words. <p>Example: When reading the bit device M100 to M115 (one word) in units of words 1st word:</p> <table style="margin-left: 20px;"> <tr> <td style="text-align: center;">b15</td> <td style="text-align: center;">b8</td> <td style="text-align: center;">b7</td> <td style="text-align: center;">b0</td> </tr> <tr> <td style="text-align: center;">1</td> <td style="text-align: center;">2</td> <td style="text-align: center;">3</td> <td style="text-align: center;">4</td> </tr> <tr> <td colspan="4" style="text-align: center;">⋮</td> </tr> <tr> <td style="text-align: center;">0</td> <td style="text-align: center;">0</td> <td style="text-align: center;">1</td> <td style="text-align: center;">0</td> </tr> <tr> <td style="text-align: center;">0</td> <td style="text-align: center;">1</td> <td style="text-align: center;">0</td> <td style="text-align: center;">0</td> </tr> <tr> <td style="text-align: center;">1</td> <td style="text-align: center;">1</td> <td style="text-align: center;">0</td> <td style="text-align: center;">1</td> </tr> <tr> <td style="text-align: center;">0</td> <td style="text-align: center;">1</td> <td style="text-align: center;">0</td> <td style="text-align: center;">0</td> </tr> <tr> <td style="text-align: center;">0</td> <td style="text-align: center;">1</td> <td style="text-align: center;">0</td> <td style="text-align: center;">0</td> </tr> <tr> <td style="text-align: center;">M115</td> <td style="text-align: center;">...</td> <td style="text-align: center;">M100</td> <td></td> </tr> </table> <p>Example: When reading the word device D0 to D2 in units of words 1st word:</p> <table style="margin-left: 20px;"> <tr> <td style="text-align: center;">b15</td> <td style="text-align: center;">b8</td> <td style="text-align: center;">b7</td> <td style="text-align: center;">b0</td> </tr> <tr> <td style="text-align: center;">1</td> <td style="text-align: center;">2</td> <td style="text-align: center;">3</td> <td style="text-align: center;">4</td> </tr> <tr> <td colspan="4" style="text-align: center;">⏟</td> </tr> <tr> <td colspan="4" style="text-align: center;">D0</td> </tr> </table> <p>2nd word:</p> <table style="margin-left: 20px;"> <tr> <td style="text-align: center;">b15</td> <td style="text-align: center;">b8</td> <td style="text-align: center;">b7</td> <td style="text-align: center;">b0</td> </tr> <tr> <td style="text-align: center;">0</td> <td style="text-align: center;">0</td> <td style="text-align: center;">0</td> <td style="text-align: center;">2</td> </tr> <tr> <td colspan="4" style="text-align: center;">⏟</td> </tr> <tr> <td colspan="4" style="text-align: center;">D1</td> </tr> </table> <p>3rd word:</p> <table style="margin-left: 20px;"> <tr> <td style="text-align: center;">b15</td> <td style="text-align: center;">b8</td> <td style="text-align: center;">b7</td> <td style="text-align: center;">b0</td> </tr> <tr> <td style="text-align: center;">1</td> <td style="text-align: center;">D</td> <td style="text-align: center;">E</td> <td style="text-align: center;">F</td> </tr> <tr> <td colspan="4" style="text-align: center;">⏟</td> </tr> <tr> <td colspan="4" style="text-align: center;">D2</td> </tr> </table> <ul style="list-style-type: none"> When the 0th bit of the subcommand is 1, read the device data in units of bits. <p>Example: When reading the bit device M100 to M107 in units of bits 1st word:</p> <table style="margin-left: 20px;"> <tr> <td style="text-align: center;">b15</td> <td style="text-align: center;">b8</td> <td style="text-align: center;">b7</td> <td style="text-align: center;">b0</td> </tr> <tr> <td style="text-align: center;">0</td> <td style="text-align: center;">1</td> <td style="text-align: center;">0</td> <td style="text-align: center;">0</td> </tr> <tr> <td style="text-align: center;">M102</td> <td style="text-align: center;">M103</td> <td style="text-align: center;">M100</td> <td style="text-align: center;">M101</td> </tr> </table> <p>2nd word:</p> <table style="margin-left: 20px;"> <tr> <td style="text-align: center;">b15</td> <td style="text-align: center;">b8</td> <td style="text-align: center;">b7</td> <td style="text-align: center;">b0</td> </tr> <tr> <td style="text-align: center;">1</td> <td style="text-align: center;">1</td> <td style="text-align: center;">0</td> <td style="text-align: center;">0</td> </tr> <tr> <td style="text-align: center;">M106</td> <td style="text-align: center;">M107</td> <td style="text-align: center;">M104</td> <td style="text-align: center;">M105</td> </tr> </table>	b15	b8	b7	b0	1	2	3	4	⋮				0	0	1	0	0	1	0	0	1	1	0	1	0	1	0	0	0	1	0	0	M115	...	M100		b15	b8	b7	b0	1	2	3	4	⏟				D0				b15	b8	b7	b0	0	0	0	2	⏟				D1				b15	b8	b7	b0	1	D	E	F	⏟				D2				b15	b8	b7	b0	0	1	0	0	M102	M103	M100	M101	b15	b8	b7	b0	1	1	0	0	M106	M107	M104	M105	0
b15	b8	b7	b0																																																																																																														
1	2	3	4																																																																																																														
⋮																																																																																																																	
0	0	1	0																																																																																																														
0	1	0	0																																																																																																														
1	1	0	1																																																																																																														
0	1	0	0																																																																																																														
0	1	0	0																																																																																																														
M115	...	M100																																																																																																															
b15	b8	b7	b0																																																																																																														
1	2	3	4																																																																																																														
⏟																																																																																																																	
D0																																																																																																																	
b15	b8	b7	b0																																																																																																														
0	0	0	2																																																																																																														
⏟																																																																																																																	
D1																																																																																																																	
b15	b8	b7	b0																																																																																																														
1	D	E	F																																																																																																														
⏟																																																																																																																	
D2																																																																																																																	
b15	b8	b7	b0																																																																																																														
0	1	0	0																																																																																																														
M102	M103	M100	M101																																																																																																														
b15	b8	b7	b0																																																																																																														
1	1	0	0																																																																																																														
M106	M107	M104	M105																																																																																																														

■Operation parameters

No.	Variable name	Name	Data type	Range	Description	Default value
(15)	pbi_uRequestModuleIO	Requested module I/O No.	Word [Unsigned]/Bit String [16-bit]	03E0H to 03E3H, 03FFH	Specify the module of the access destination. <ul style="list-style-type: none"> • 03E0H: Multiple CPU No.1 • 03E1H: Multiple CPU No.2 • 03E2H: Multiple CPU No.3 • 03E3H: Multiple CPU No.4 • 03FFH: Own station, control CPU 	03FFH
(16)	pbi_uResendCountMax	Maximum number of resends	Word [Unsigned]/Bit String [16-bit]	0 to 15	Specify the number of resends to be performed if the data transfer is not completed within the monitoring time specified by "Arrival monitoring time". <ul style="list-style-type: none"> • 0 to 15 	5
(17)	pbi_uMonitorTime	Arrival monitoring time	Word [Unsigned]/Bit String [16-bit]	0, 1 to 32767	Specify the monitoring time until completion of processing. If the processing is not completed within the monitoring time, data is resent until the value specified in "Maximum number of resends" is reached. <ul style="list-style-type: none"> • 0: 10s • Effective range 1 to 32767: 1s to 32767s 	0

■Public variables

No.	Variable name	Name	Data type	Description	Default value
(18)	pbo_uResendCount	Number of resends	Word [Unsigned]/Bit String [16-bit]	The number of resends performed (result) is stored. If an error was detected, the number of resends performed (result) between error detection and resend stop is stored.	0
(19)	pbo_u4ErrTime	Error occurrence time	Word [Unsigned]/Bit String [16-bit] (0..3)	Clock data at the time of error occurrence is stored.*1 1st word <ul style="list-style-type: none"> • Upper 8 bits: Month (01H to 12H) • Lower 8 bits: Lower 2 digits of year (00H to 99H) 2nd word <ul style="list-style-type: none"> • Upper 8 bits: Hour (00H to 23H) • Lower 8 bits: Day (01H to 31H) 3rd word <ul style="list-style-type: none"> • Upper 8 bits: Second (00H to 59H) • Lower 8 bits: Minute (00H to 59H) 4th word <ul style="list-style-type: none"> • Upper 8 bits: Upper 2 digits of year (00H to 99H) • Lower 8 bits: Day of week (00H (Sunday) to 06H (Saturday)) 	0
(20)	pbo_uErrIP_Address_3rd_4th	Error-detected device IP addresses (the third and fourth octets)	Word [Unsigned]/Bit String [16-bit]	The IP addresses (the third and fourth octets) of the device in which an error was detected are stored.*1 Example: When the IP address is 192.168.1.2 0102h	0
(21)	pbo_uErrIP_Address_1st_2nd	Error-detected device IP addresses (the first and second octets)	Word [Unsigned]/Bit String [16-bit]	The IP addresses (the first and second octets) of the device in which an error was detected are stored.*1 Example: When the IP address is 192.168.1.2 C0A8h	0

*1 The value is stored only when the dedicated instruction was completed with an error.

The value set to the external device IP address of the input argument is stored in the error-detected device IP addresses (the third and fourth octets) and the error-detected device IP addresses (the first and second octets).

FB details

Item	Description	
Available device	Target module <ul style="list-style-type: none"> • RJ71GN11-T2 • RJ71GN11-SX • RJ71GN11-EIP 	
	CPU module	RCPU
	Engineering tool	GX Works3
Language	Ladder diagram	
Number of basic steps	248 steps The number of steps of the FB embedded in a program depends on the CPU module used, the input/output definitions, and the option settings of GX Works3. For the option settings of GX Works3, refer to GX Works3 Operating Manual.	
Processing	<ul style="list-style-type: none"> • When i_bEN (execution command) is turned on, this function reads device data from the SLMP-compatible device. • This FB is executed specifying the IP address of an external device. • This FB uses Device Read (command: 0401) of the SLMP for the Read command. The message of the SLMP command is a binary code. (📖 SLMP Reference Manual) 	
FB compilation method	Macro type	
FB operation	Pulse type (multiple-scan execution type)	

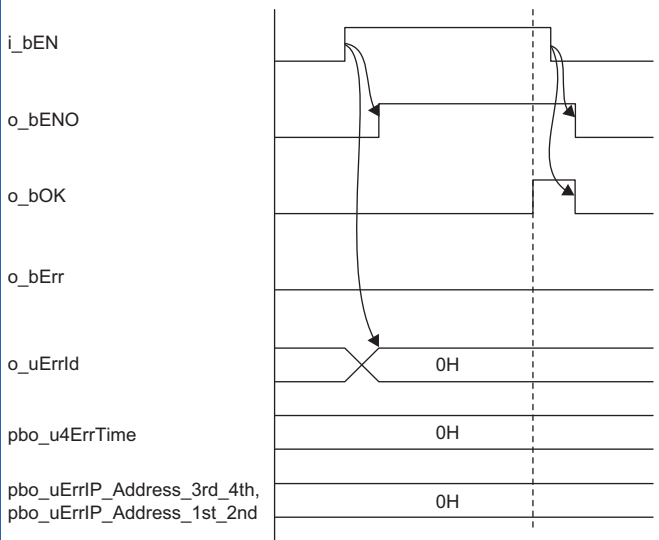
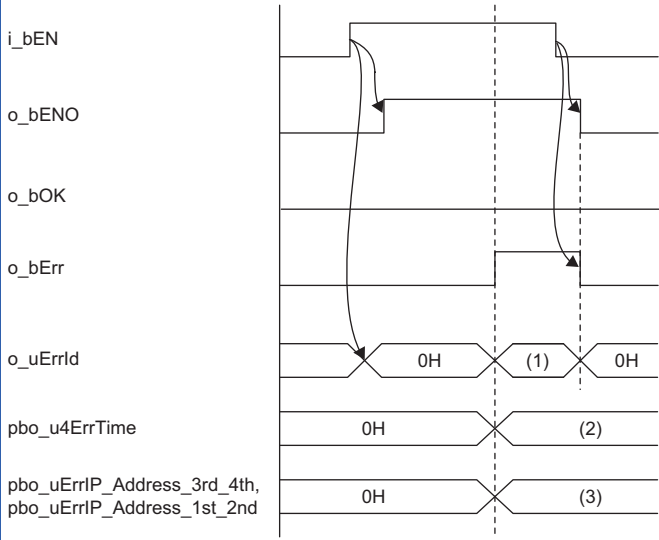
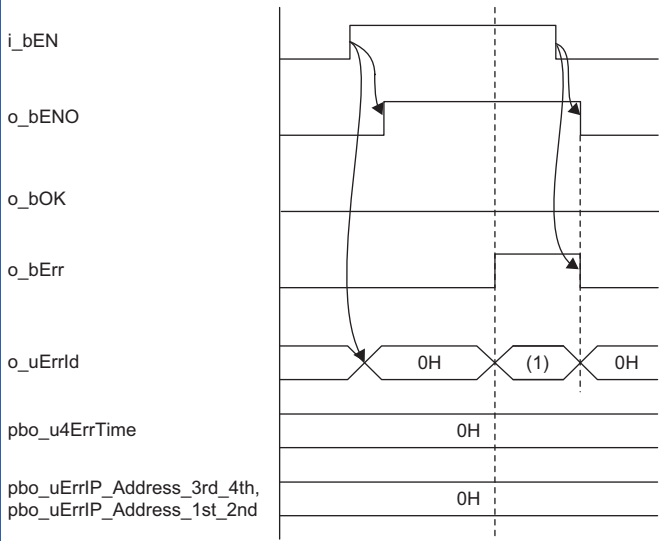
Item	Description
Timing chart of I/O signals	<ul style="list-style-type: none"> For normal completion 
	<ul style="list-style-type: none"> For error completion (When the dedicated instruction was completed with an error)  <p>(1) Error code (2) Error occurrence time (3) Error-detected device IP address</p>
	<ul style="list-style-type: none"> For error completion (When the dedicated instruction was completed successfully but the end code indicates an error)  <p>(1) Error code</p>

Item	Description
Precautions	<ul style="list-style-type: none"> This FB does not include error recovery processing. Please create error recovery processing separately according to the system and required operations. This FB uses the GP.SLMPSND instruction. Even if the target device has sent an abnormal response, the GP.SLMPSND instruction is completed successfully. In this FB, the instruction is determined to be completed successfully or completed with an error by the end code of the response frame. When the instruction was determined to be completed with an error by the end code, the end code is stored to the error code of the output argument. When the GP.SLMPSND instruction is completed successfully, the values are not stored to the error occurrence time of the public variable, the error-detected device IP addresses (the third and fourth octets), and the error-detected device IP addresses (the first and second octets).^{*1} Turn off i_bEN (execution command) after o_bOK (normal completion) or o_bErr (error completion) is turned on. By turning off i_bEN (execution command), o_bOK (normal completion) or o_bErr (error completion) is turned off and o_uErrId (error code) is cleared to 0. In this FB, access devices (such as link direct device) that are accessed by the extension specification of the SLMP cannot be read. In this FB, stations in other network cannot be set as the target station. For the port of an external device where the remote password is set, execute this FB after performing the unlock processing of the remote password. When this FB is executed for the port of an external device where the remote password is set, an error will occur. The target station must support "Device Read (command: 0401H)" of the SLMP command. This FB is for communications in binary code only. (Communications using ASCII code cannot be performed.) This FB uses UDP/IP communications. This FB uses the label initial value by each program. When the program file using this FB is specified to boot file setting for the boot operation in the CPU module, specify the initial label value file by each program to the boot file setting as well. (MELSEC iQ-R CPU Module User's Manual (Application)) If an error code that is not described in Page 114 Error codes appears, the initial label value files by each program may not be set to the boot file setting. In this case, specify the initial label value files by each program to the boot file setting. When this FB is executed, an operation error may occur in the programmable controller CPU. In this case, check the detailed information of the operation error in event history and correct the input argument of the module FB.

*1 If 0 (initial value) is stored in the error occurrence time, the error-detected device IP addresses (the third and fourth octets), and the error-detected device IP addresses (the first and second octets), check and take actions using the manuals for the SLMP-compatible device used.

Error codes

Error code	Reference
0100H	When the read unit is set to 0 (in units of words), a number other than 1 to 960 is specified. When the read unit is set to 1 (in units of bits), a number other than 1 to 3972 is specified.
1000H to 3FFFH	<ul style="list-style-type: none"> MELSEC iQ-R CC-Link IE TSN User's Manual (Application) MELSEC iQ-R CC-Link IE TSN Plus Master/Local Module User's Manual
4000H to 4FFFH	MELSEC iQ-R CPU Module User's Manual (Application)
D000H to DFFFH	<ul style="list-style-type: none"> MELSEC iQ-R CC-Link IE TSN User's Manual (Application) MELSEC iQ-R CC-Link IE TSN Plus Master/Local Module User's Manual

Labels

Input arguments

No.	Variable name	Name	Data type	Range	Description															
(1)	i_bEN	Execution command	Bit	—	On: Start FB. Off: Do not start FB.															
(2)	i_stModule	Module label	Structure	—	Specify the module for which the FB is to be executed. Specify the module label of the modules. (Example: GN11_1, GN11_SX_1, GN11_SE_1)															
(3)	i_u2IP_Address	IP address of external device	Word [Unsigned]/Bit String [16-bit] (0..1)	00000001H to DFFFFFFEH	Specify the IP address of the target station. Specify the third and fourth octets to the 1st word, and first and second octets to the 2nd word. Specify a value within the range of 1 to 254 (FEH) for the fourth octet. <table border="1" style="margin-left: auto; margin-right: auto;"> <tr> <td></td> <td style="text-align: center;">b15</td> <td style="text-align: center;">b8</td> <td style="text-align: center;">b7</td> <td style="text-align: center;">b0</td> </tr> <tr> <td>+0</td> <td style="text-align: center;">3: 1~255</td> <td style="text-align: center;">4: 1~254</td> <td></td> <td></td> </tr> <tr> <td>+1</td> <td style="text-align: center;">1: 1~223</td> <td style="text-align: center;">2: 1~255</td> <td></td> <td></td> </tr> </table> 1 to 4: IP address octet		b15	b8	b7	b0	+0	3: 1~255	4: 1~254			+1	1: 1~223	2: 1~255		
	b15	b8	b7	b0																
+0	3: 1~255	4: 1~254																		
+1	1: 1~223	2: 1~255																		
(4)	i_uSubCommand	Sub command	Word [Unsigned]/Bit String [16-bit]	—	Specify the write unit and specification method of a device. <ul style="list-style-type: none"> 0th bit: Specify whether the device is written in units of words or in units of bits. 0: In units of words 1: In units of bits <ul style="list-style-type: none"> 1st bit: Specify the combination of the number of digits of the device code and start device number of the device to be written. 0: Specify the device code in 2 digits and the start device number in 6 digits (for MELSEC-Q/L series). 1: Specify the device code in 4 digits and the start device number in 8 digits (for MELSEC iQ-R series).															
(5)	i_uDeviceCode	Device code	Word [Unsigned]/Bit String [16-bit]	—	Specify the device code of the device to be written in binary code. <ul style="list-style-type: none"> When the 1st bit of the subcommand is 0: 2 digits When the 1st bit of the subcommand is 1: 4 digits 															
(6)	i_u2DeviceNo	Head device No.	Word [Unsigned]/Bit String [16-bit] (0..1)	—	Specify the start device number of the device to be written in binary code. <ul style="list-style-type: none"> When the 1st bit of the subcommand is 0: 6 digits When the 1st bit of the subcommand is 1: 8 digits 															
(7)	i_uDevicePoints	Number of device points	Word [Unsigned]/Bit String [16-bit]	—	Specify the number of device points of the device to be written in binary code. <ul style="list-style-type: none"> When the 0th bit of the subcommand is 0 1 to 960 When the 0th bit of the subcommand is 1 Own station channel is 1 to 9: 1 to 3972 Own station channel is 10 to 17: 1 to 3960 															

■Output arguments

No.	Variable name	Name	Data type	Description	Default value
(11)	o_bENO	Execution status	Bit	On: The execution command is turned on. Off: The execution command is turned off.	Off
(12)	o_bOK	Normal completion	Bit	The FB has been processed normally when this argument is on.	Off
(13)	o_bErr	Error completion	Bit	The FB has been processed abnormally when this argument is on.	Off
(14)	o_uErrId	Error code	Word [Unsigned]/Bit String [16-bit]	An error code is stored at error completion.	0

■Operation parameters

No.	Variable name	Name	Data type	Range	Description	Default value
(15)	pbi_uRequestModuleIO	Requested module I/O No.	Word [Unsigned]/Bit String [16-bit]	03E0H to 03E3H, 03FFH	Specify the module of the access destination. <ul style="list-style-type: none"> • 03E0H: Multiple CPU No.1 • 03E1H: Multiple CPU No.2 • 03E2H: Multiple CPU No.3 • 03E3H: Multiple CPU No.4 • 03FFH: Own station, control CPU 	03FFH
(16)	pbi_uResendCountMax	Maximum number of resends	Word [Unsigned]/Bit String [16-bit]	0 to 15	Specify the number of resends to be performed if the data transfer is not completed within the monitoring time specified by "Arrival monitoring time". <ul style="list-style-type: none"> • 0 to 15 	5
(17)	pbi_uMonitorTime	Arrival monitoring time	Word [Unsigned]/Bit String [16-bit]	0, 1 to 32767	Specify the monitoring time until completion of processing. If the processing is not completed within the monitoring time, data is resent until the value specified in "Maximum number of resends" is reached. <ul style="list-style-type: none"> • 0: 10s • Effective range 1 to 32767: 1s to 32767s 	0

Public variables

No.	Variable name	Name	Data type	Description	Default value
(18)	pbo_uResendCount	Number of resends	Word [Unsigned]/Bit String [16-bit]	The number of resends performed (result) is stored. If an error was detected, the number of resends performed (result) between error detection and resend stop is stored.	0
(19)	pbo_u4ErrTime	Error occurrence time	Word [Unsigned]/Bit String [16-bit] (0..3)	Clock data at the time of error occurrence is stored.*1 1st word • Upper 8 bits: Month (01H to 12H) • Lower 8 bits: Lower 2 digits of year (00H to 99H) 2nd word • Upper 8 bits: Hour (00H to 23H) • Lower 8 bits: Day (01H to 31H) 3rd word • Upper 8 bits: Second (00H to 59H) • Lower 8 bits: Minute (00H to 59H) 4th word • Upper 8 bits: Upper 2 digits of year (00H to 99H) • Lower 8 bits: Day of week (00H (Sunday) to 06H (Saturday))	0
(20)	pbo_uErrIP_Address_3rd_4th	Error-detected device IP addresses (the third and fourth octets)	Word [Unsigned]/Bit String [16-bit]	The IP addresses (the third and fourth octets) of the device in which an error was detected are stored.*1 Example: When the IP address is 192.168.1.2 0102h	0
(21)	pbo_uErrIP_Address_1st_2nd	Error-detected device IP addresses (the first and second octets)	Word [Unsigned]/Bit String [16-bit]	The IP addresses (the first and second octets) of the device in which an error was detected are stored.*1 Example: When the IP address is 192.168.1.2 C0A8h	0

*1 The value is stored only when the dedicated instruction was completed with an error.

The value set to the external device IP address of the input argument is stored in the error-detected device IP addresses (the third and fourth octets) and the error-detected device IP addresses (the first and second octets).

FB details

Item	Description
Available device	Target module <ul style="list-style-type: none"> • RJ71GN11-T2 • RJ71GN11-SX • RJ71GN11-EIP
	CPU module <ul style="list-style-type: none"> • RCPUR
	Engineering tool <ul style="list-style-type: none"> • GX Works3
Language	Ladder diagram
Number of basic steps	268 steps The number of steps of the FB embedded in a program depends on the CPU module used, the input/output definitions, and the option settings of GX Works3. For the option settings of GX Works3, refer to GX Works3 Operating Manual.
Processing	<ul style="list-style-type: none"> • When i_bEN (execution command) is turned on, this function writes device data of the SLMP-compatible device. • This FB is executed specifying the IP address of an external device. • This FB uses Device Write (command: 1401) of the SLMP for the Write command. The message of the SLMP command is a binary code. (SLMP Reference Manual)
FB compilation method	Macro type
FB operation	Pulse type (multiple-scan execution type)

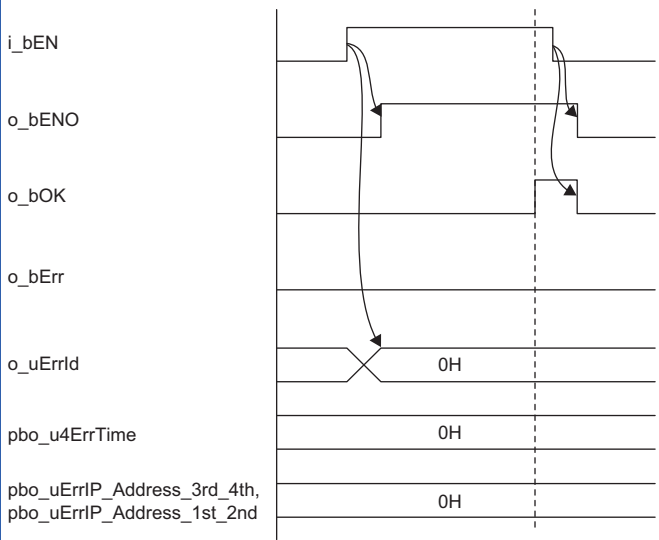
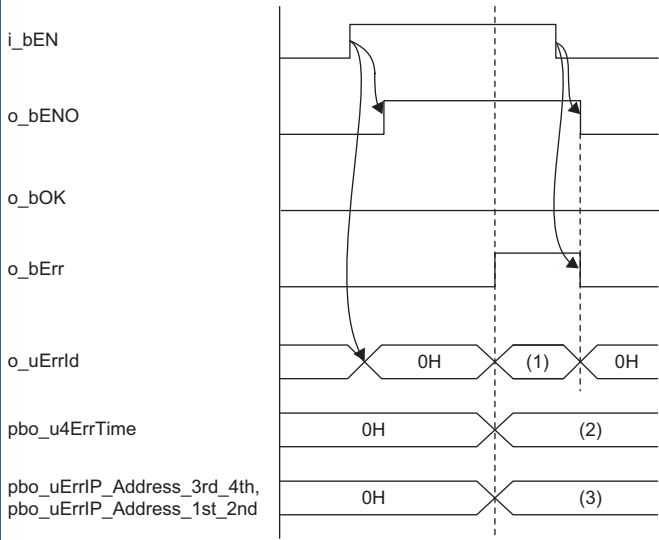
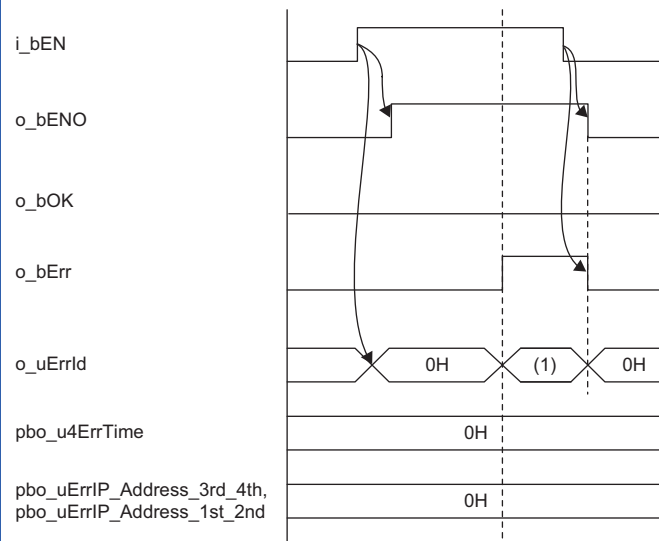
Item	Description
Timing chart of I/O signals	<p>• For normal completion</p>  <p>• For error completion (When the dedicated instruction was completed with an error)</p>  <p>(1) Error code (2) Error occurrence time (3) Error-detected device IP address</p> <p>• For error completion (When the dedicated instruction was completed successfully but the end code indicates an error)</p>  <p>(1) Error code</p>

Item	Description
Precautions	<ul style="list-style-type: none"> This FB does not include error recovery processing. Please create error recovery processing separately according to the system and required operations. This FB uses the GP.SLMPSND instruction. Even if the target device has sent an abnormal response, the GP.SLMPSND instruction is completed successfully. In this FB, the instruction is determined to be completed successfully or completed with an error by the end code of the response frame. When the instruction was determined to be completed with an error by the end code, the end code is stored to the error code of the output argument. When the GP.SLMPSND instruction is completed successfully, the values are not stored to the error occurrence time of the public variable, the error-detected device IP addresses (the third and fourth octets), and the error-detected device IP addresses (the first and second octets).^{*1} Turn off i_bEN (execution command) after o_bOK (normal completion) or o_bErr (error completion) is turned on. By turning off i_bEN (execution command), o_bOK (normal completion) or o_bErr (error completion) is turned off and o_uErrId (error code) is cleared to 0. In this FB, access devices (such as link direct device) that are accessed by the extension specification of the SLMP cannot be written. In this FB, stations in other network cannot be set as the target station. For the port of an external device where the remote password is set, execute this FB after performing the unlock processing of the remote password. When this FB is executed for the port of an external device where the remote password is set, an error will occur. The target station must support "Device Write (command: 1401H)" of the SLMP command. This FB is for communications in binary code only. (Communications using ASCII code cannot be performed.) This FB uses UDP/IP communications. This FB uses the label initial value by each program. When the program file using this FB is specified to boot file setting for the boot operation in the CPU module, specify the initial label value file by each program to the boot file setting as well. (MELSEC iQ-R CPU Module User's Manual (Application)) If an error code that is not described in Page 121 Error codes appears, the initial label value files by each program may not be set to the boot file setting. In this case, specify the initial label value files by each program to the boot file setting. When this FB is executed, an operation error may occur in the programmable controller CPU. In this case, check the detailed information of the operation error in event history and correct the input argument of the module FB.

*1 If 0 (initial value) is stored in the error occurrence time, the error-detected device IP addresses (the third and fourth octets), and the error-detected device IP addresses (the first and second octets), check and take actions using the manuals for the SLMP-compatible device used.

Error codes

Error code	Reference
0100H	<p>When the read unit is set to 0 (in units of words), a number other than 1 to 960 is specified.</p> <p>When the read unit is set to 1 (in units of bits) and the own station channel is 1 to 9: A number other than 1 to 3972 is specified.</p> <p>When the read unit is set to 1 (in units of bits) and the own station channel is 10 to 17: A number other than 1 to 3960 is specified.</p>
1000H to 3FFFH	<p>MELSEC iQ-R CC-Link IE TSN User's Manual (Application)</p> <p>MELSEC iQ-R CC-Link IE TSN Plus Master/Local Module User's Manual</p>
4000H to 4FFFH	<p>MELSEC iQ-R CPU Module User's Manual (Application)</p>
D000H to DFFFH	<p>MELSEC iQ-R CC-Link IE TSN User's Manual (Application)</p> <p>MELSEC iQ-R CC-Link IE TSN Plus Master/Local Module User's Manual</p>

3.8 M+model_SetAddress

Name

■RJ71GN11-T2

M+RJ71GN11_SetAddress

■RJ71GN11-SX

M+RJ71GN11_SX_SetAddress

Overview

Item	Description																				
Overview	Sets the station number/IP address for the own station.																				
Symbol	<div style="border: 1px solid black; padding: 5px; width: fit-content; margin: 0 auto;"> <p style="text-align: center;">M+RJ71GN11_SetAddress</p> <table style="width: 100%; border-collapse: collapse;"> <tr> <td style="width: 15%; text-align: right;">(1) —</td> <td style="width: 35%;">B: i_bEN</td> <td style="width: 15%;"></td> <td style="width: 15%; text-align: left;">o_bENO: B</td> <td style="width: 20%; text-align: right;">(5)</td> </tr> <tr> <td style="text-align: right;">(2) —</td> <td>DUT: i_stModule</td> <td></td> <td style="text-align: left;">o_bOK: B</td> <td style="text-align: right;">(6)</td> </tr> <tr> <td style="text-align: right;">(3) —</td> <td>UW: i_uStationNo</td> <td></td> <td style="text-align: left;">o_bErr: B</td> <td style="text-align: right;">(7)</td> </tr> <tr> <td style="text-align: right;">(4) —</td> <td>UW: i_u2IPAddress</td> <td></td> <td style="text-align: left;">o_uErrId: UW</td> <td style="text-align: right;">(8)</td> </tr> </table> </div>	(1) —	B: i_bEN		o_bENO: B	(5)	(2) —	DUT: i_stModule		o_bOK: B	(6)	(3) —	UW: i_uStationNo		o_bErr: B	(7)	(4) —	UW: i_u2IPAddress		o_uErrId: UW	(8)
(1) —	B: i_bEN		o_bENO: B	(5)																	
(2) —	DUT: i_stModule		o_bOK: B	(6)																	
(3) —	UW: i_uStationNo		o_bErr: B	(7)																	
(4) —	UW: i_u2IPAddress		o_uErrId: UW	(8)																	

Labels

■Input arguments

No.	Variable name	Name	Data type	Range	Description															
(1)	i_bEN	Execution command	Bit	—	On: Start FB. Off: Do not start FB.															
(2)	i_stModule	Module label	Structure	—	Specify the module for which the FB is to be executed. Specify the module label of the modules. (Example: GN11_1, GN11_SX_1)															
(3)	i_uStationNo	Station number of the own station	Word [Unsigned]/ Bit String [16-bit]	0 to 120	Specify the station number to be set. Master station: 0 Local station: 1 to 120															
(4)	i_u2IPAddress	IP address	Word [Unsigned]/ Bit String [16-bit] (0..1)	0000001H to DFFFFFFEH	Specify the IP address to be set. When specifying the numbers using a label, use an array as the data type. <table style="margin-left: 20px; border-collapse: collapse;"> <tr> <td></td> <td style="text-align: center;">b15</td> <td style="text-align: center;">b8</td> <td style="text-align: center;">b7</td> <td style="text-align: center;">b0</td> </tr> <tr> <td style="text-align: right;">+0</td> <td style="border: 1px solid black; text-align: center; width: 30px;">3</td> <td style="border: 1px solid black; text-align: center; width: 30px;">4</td> <td></td> <td></td> </tr> <tr> <td style="text-align: right;">+1</td> <td style="border: 1px solid black; text-align: center;">1</td> <td style="border: 1px solid black; text-align: center;">2</td> <td></td> <td></td> </tr> </table> 1 to 4: IP address octet		b15	b8	b7	b0	+0	3	4			+1	1	2		
	b15	b8	b7	b0																
+0	3	4																		
+1	1	2																		

Output arguments

No.	Variable name	Name	Data type	Description	Default value
(5)	o_bENO	Execution status	Bit	On: The execution command is turned on. Off: The execution command is turned off.	Off
(6)	o_bOK	Normal completion	Bit	The FB has been processed normally when this argument is on.	Off
(7)	o_bErr	Error completion	Bit	The FB has been processed abnormally when this argument is on.	Off
(8)	o_uErrId	Error code	Word [Unsigned]/ Bit String [16-bit]	An error code is stored at error completion.	0

FB details

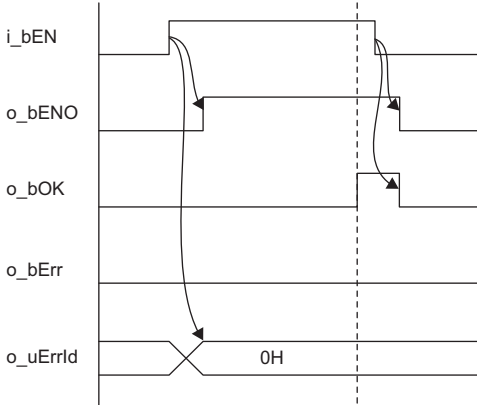
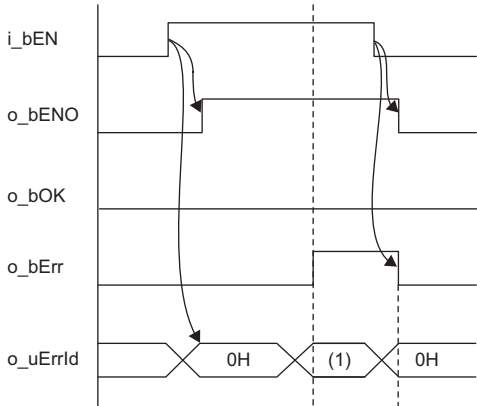
Item	Description
Available device	Target module <ul style="list-style-type: none"> • RJ71GN11-T2 • RJ71GN11-SX
	CPU module <ul style="list-style-type: none"> • RCPUCPU
	Engineering tool <ul style="list-style-type: none"> • GX Works3
Language	Ladder diagram
Number of basic steps	50 steps The number of steps of the FB embedded in a program depends on the CPU module used, the input/output definitions, and the option settings of GX Works3. For the option settings of GX Works3, refer to GX Works3 Operating Manual.
Processing	Set the station number/IP address when i_bEN (execution instruction) is turned on.
FB compilation method	Macro type
FB operation	Pulse type (multiple-scan execution type)
Input condition for FB_EN	None
Timing chart of I/O signals	<ul style="list-style-type: none"> • For normal completion  <ul style="list-style-type: none"> • For error completion (same as in the case of a module error)  <p>(1) Error code</p>

Item	Description
Precautions	<ul style="list-style-type: none"> • This FB does not include error recovery processing. Please create error recovery processing separately according to the system and required operations. • This FB uses the GP.UINI instruction. • Turn off i_bEN (execution command) after o_bOK (normal completion) or o_bErr (error completion) is turned on. By turning off i_bEN (execution command), o_bOK (normal completion) or o_bErr (error completion) is turned off and o_uErrId (error code) is cleared to 0. • When the broadcast address or the reserved address is set to the IP address, the data may not link. Do not set the broadcast address and the reserved address to the IP address. • When this FB is executed, an operation error may occur in the programmable controller CPU. In this case, check the detailed information of the operation error in event history and correct the input argument of the module FB.

Error codes

Error code	Reference
C000H to CFFFH D000H to DFFFH	 MELSEC iQ-R CC-Link IE TSN User's Manual (Application)

3.9 M+model_SetParameterX

Name

M+RJ71GN11_SetParameterX

Overview

Item	Description																																																																								
Overview	Sets parameters for a module.																																																																								
Symbol	<div style="border: 1px solid black; padding: 10px; margin: 10px 0;"> <p style="text-align: center;">M+RJ71GN11_SetParameterX</p> <table style="width: 100%; border-collapse: collapse;"> <tr> <td style="width: 5%; text-align: right;">(1)</td> <td style="width: 45%;">B: i_bEN</td> <td style="width: 45%; text-align: left;">o_bENO: B</td> <td style="width: 5%; text-align: right;">(8)</td> </tr> <tr> <td style="text-align: right;">(2)</td> <td>DUT: i_stModule</td> <td style="text-align: left;">o_bOK: B</td> <td style="text-align: right;">(9)</td> </tr> <tr> <td style="text-align: right;">(3)</td> <td>UW: i_uTotalStations</td> <td style="text-align: left;">o_bErr: B</td> <td style="text-align: right;">(10)</td> </tr> <tr> <td style="text-align: right;">(4)</td> <td>UW: i_u2175NetworkConfigurationSet</td> <td style="text-align: left;">o_uErrId: UW</td> <td style="text-align: right;">(11)</td> </tr> <tr> <td style="text-align: right;">(5)</td> <td>UW: i_u16ReservedStationSet</td> <td></td> <td></td> </tr> <tr> <td style="text-align: right;">(6)</td> <td>UW: i_u16ErrInvalidStationSet</td> <td></td> <td></td> </tr> <tr> <td style="text-align: right;">(7)</td> <td>UW: i_u11CommunicationCycleSet</td> <td></td> <td></td> </tr> <tr> <td></td> <td style="padding-left: 40px;">pbi_uTopologySet</td> <td></td> <td style="text-align: right;">(12)</td> </tr> <tr> <td></td> <td style="padding-left: 40px;">pbi_bNetworkConfigurationSetFlg</td> <td></td> <td style="text-align: right;">(13)</td> </tr> <tr> <td></td> <td style="padding-left: 40px;">pbi_bReservedStationSetFlg</td> <td></td> <td style="text-align: right;">(14)</td> </tr> <tr> <td></td> <td style="padding-left: 40px;">pbi_bErrInvalidStationSetFlg</td> <td></td> <td style="text-align: right;">(15)</td> </tr> <tr> <td></td> <td style="padding-left: 40px;">pbi_bDatalinkFaultyStationSet</td> <td></td> <td style="text-align: right;">(16)</td> </tr> <tr> <td></td> <td style="padding-left: 40px;">pbi_bCPU_StopOutputSet</td> <td></td> <td style="text-align: right;">(17)</td> </tr> <tr> <td></td> <td style="padding-left: 40px;">pbi_bCPU_StopErrOutputSet</td> <td></td> <td style="text-align: right;">(18)</td> </tr> <tr> <td></td> <td style="padding-left: 40px;">pbi_bClassSet</td> <td></td> <td style="text-align: right;">(19)</td> </tr> <tr> <td></td> <td style="padding-left: 40px;">pbi_uDisconnectionDetectionSet</td> <td></td> <td style="text-align: right;">(20)</td> </tr> <tr> <td></td> <td style="padding-left: 40px;">pbi_uCommModeSet</td> <td></td> <td style="text-align: right;">(21)</td> </tr> <tr> <td></td> <td style="padding-left: 40px;">pbi_bCommSpeedSet</td> <td></td> <td style="text-align: right;">(22)</td> </tr> </table> </div>	(1)	B: i_bEN	o_bENO: B	(8)	(2)	DUT: i_stModule	o_bOK: B	(9)	(3)	UW: i_uTotalStations	o_bErr: B	(10)	(4)	UW: i_u2175NetworkConfigurationSet	o_uErrId: UW	(11)	(5)	UW: i_u16ReservedStationSet			(6)	UW: i_u16ErrInvalidStationSet			(7)	UW: i_u11CommunicationCycleSet				pbi_uTopologySet		(12)		pbi_bNetworkConfigurationSetFlg		(13)		pbi_bReservedStationSetFlg		(14)		pbi_bErrInvalidStationSetFlg		(15)		pbi_bDatalinkFaultyStationSet		(16)		pbi_bCPU_StopOutputSet		(17)		pbi_bCPU_StopErrOutputSet		(18)		pbi_bClassSet		(19)		pbi_uDisconnectionDetectionSet		(20)		pbi_uCommModeSet		(21)		pbi_bCommSpeedSet		(22)
(1)	B: i_bEN	o_bENO: B	(8)																																																																						
(2)	DUT: i_stModule	o_bOK: B	(9)																																																																						
(3)	UW: i_uTotalStations	o_bErr: B	(10)																																																																						
(4)	UW: i_u2175NetworkConfigurationSet	o_uErrId: UW	(11)																																																																						
(5)	UW: i_u16ReservedStationSet																																																																								
(6)	UW: i_u16ErrInvalidStationSet																																																																								
(7)	UW: i_u11CommunicationCycleSet																																																																								
	pbi_uTopologySet		(12)																																																																						
	pbi_bNetworkConfigurationSetFlg		(13)																																																																						
	pbi_bReservedStationSetFlg		(14)																																																																						
	pbi_bErrInvalidStationSetFlg		(15)																																																																						
	pbi_bDatalinkFaultyStationSet		(16)																																																																						
	pbi_bCPU_StopOutputSet		(17)																																																																						
	pbi_bCPU_StopErrOutputSet		(18)																																																																						
	pbi_bClassSet		(19)																																																																						
	pbi_uDisconnectionDetectionSet		(20)																																																																						
	pbi_uCommModeSet		(21)																																																																						
	pbi_bCommSpeedSet		(22)																																																																						

Labels

Input arguments

No.	Variable name	Name	Data type	Range	Description
(1)	i_bEN	Execution command	Bit	—	On: Start FB. Off: Do not start FB.
(2)	i_stModule	Module label	Structure	—	Specify the module for which the FB is to be executed. Specify the instance of the module label as an argument. (Example: GN11_1)
(3)	i_uTotalStations	Total number of stations	Word [Unsigned]/ Bit String [16-bit]	2 to 121	Specify the total number of stations of network module connected.
(4)	i_u2175NetworkConfigurationSet	Network configuration setting data	Word [Unsigned]/ Bit String [16-bit] (0..2174)	—	Specify the start address of the storage location of network configuration setting data. Set data for the number of stations specified in "Total number of stations". (Page 127 Network configuration setting data)

No.	Variable name	Name	Data type	Range	Description																																																																																																																																																																																																																																																																																																		
(5)	i_u16ReservedStationSet	Reserved station setting data	Word [Unsigned]/ Bit String [16-bit] (0..15)	—	<p>Specify the start address of the storage location of the reserved-station setting data.</p> <p>Setting: Specify a reserved station.</p> <ul style="list-style-type: none"> • 0: Not specified (default) • 1: Specified <table border="1"> <thead> <tr> <th></th> <th>b15</th><th>b14</th><th>b13</th><th>b12</th><th>b11</th><th>b10</th><th>b9</th><th>b8</th><th>b7</th><th>b6</th><th>b5</th><th>b4</th><th>b3</th><th>b2</th><th>b1</th><th>b0</th> </tr> </thead> <tbody> <tr><td>+0</td><td>16</td><td>15</td><td>14</td><td>13</td><td>12</td><td>11</td><td>10</td><td>9</td><td>8</td><td>7</td><td>6</td><td>5</td><td>4</td><td>3</td><td>2</td><td>1</td></tr> <tr><td>+1</td><td>32</td><td>31</td><td>30</td><td>29</td><td>28</td><td>27</td><td>26</td><td>25</td><td>24</td><td>23</td><td>22</td><td>21</td><td>20</td><td>19</td><td>18</td><td>17</td></tr> <tr><td>+2</td><td>48</td><td>47</td><td>46</td><td>45</td><td>44</td><td>43</td><td>42</td><td>41</td><td>40</td><td>39</td><td>38</td><td>37</td><td>36</td><td>35</td><td>34</td><td>33</td></tr> <tr><td>+3</td><td>64</td><td>63</td><td>62</td><td>61</td><td>60</td><td>59</td><td>58</td><td>57</td><td>56</td><td>55</td><td>54</td><td>53</td><td>52</td><td>51</td><td>50</td><td>49</td></tr> <tr><td>+4</td><td>80</td><td>79</td><td>78</td><td>77</td><td>76</td><td>75</td><td>74</td><td>73</td><td>72</td><td>71</td><td>70</td><td>69</td><td>68</td><td>67</td><td>66</td><td>65</td></tr> <tr><td>+5</td><td>96</td><td>95</td><td>94</td><td>93</td><td>92</td><td>91</td><td>90</td><td>89</td><td>88</td><td>87</td><td>86</td><td>85</td><td>84</td><td>83</td><td>82</td><td>81</td></tr> <tr><td>+6</td><td>112</td><td>111</td><td>110</td><td>109</td><td>108</td><td>107</td><td>106</td><td>105</td><td>104</td><td>103</td><td>102</td><td>101</td><td>100</td><td>99</td><td>98</td><td>97</td></tr> <tr><td>+7</td><td colspan="7">-</td><td>120</td><td>119</td><td>118</td><td>117</td><td>116</td><td>115</td><td>114</td><td>113</td><td colspan="2"></td></tr> <tr><td>+8</td><td colspan="16">-</td></tr> <tr><td>+9</td><td colspan="16">-</td></tr> <tr><td>+10</td><td colspan="16">-</td></tr> <tr><td>+11</td><td colspan="16">-</td></tr> <tr><td>+12</td><td colspan="16">-</td></tr> <tr><td>+13</td><td colspan="16">-</td></tr> <tr><td>+14</td><td colspan="16">-</td></tr> <tr><td>+15</td><td colspan="16">-</td></tr> </tbody> </table> <p>Numbers 1 to 120 in the table indicate station numbers. The master station cannot be specified as a reserved station.</p>		b15	b14	b13	b12	b11	b10	b9	b8	b7	b6	b5	b4	b3	b2	b1	b0	+0	16	15	14	13	12	11	10	9	8	7	6	5	4	3	2	1	+1	32	31	30	29	28	27	26	25	24	23	22	21	20	19	18	17	+2	48	47	46	45	44	43	42	41	40	39	38	37	36	35	34	33	+3	64	63	62	61	60	59	58	57	56	55	54	53	52	51	50	49	+4	80	79	78	77	76	75	74	73	72	71	70	69	68	67	66	65	+5	96	95	94	93	92	91	90	89	88	87	86	85	84	83	82	81	+6	112	111	110	109	108	107	106	105	104	103	102	101	100	99	98	97	+7	-							120	119	118	117	116	115	114	113			+8	-																+9	-																+10	-																+11	-																+12	-																+13	-																+14	-																+15	-															
	b15	b14	b13	b12	b11	b10	b9	b8	b7	b6	b5	b4	b3	b2	b1	b0																																																																																																																																																																																																																																																																																							
+0	16	15	14	13	12	11	10	9	8	7	6	5	4	3	2	1																																																																																																																																																																																																																																																																																							
+1	32	31	30	29	28	27	26	25	24	23	22	21	20	19	18	17																																																																																																																																																																																																																																																																																							
+2	48	47	46	45	44	43	42	41	40	39	38	37	36	35	34	33																																																																																																																																																																																																																																																																																							
+3	64	63	62	61	60	59	58	57	56	55	54	53	52	51	50	49																																																																																																																																																																																																																																																																																							
+4	80	79	78	77	76	75	74	73	72	71	70	69	68	67	66	65																																																																																																																																																																																																																																																																																							
+5	96	95	94	93	92	91	90	89	88	87	86	85	84	83	82	81																																																																																																																																																																																																																																																																																							
+6	112	111	110	109	108	107	106	105	104	103	102	101	100	99	98	97																																																																																																																																																																																																																																																																																							
+7	-							120	119	118	117	116	115	114	113																																																																																																																																																																																																																																																																																								
+8	-																																																																																																																																																																																																																																																																																																						
+9	-																																																																																																																																																																																																																																																																																																						
+10	-																																																																																																																																																																																																																																																																																																						
+11	-																																																																																																																																																																																																																																																																																																						
+12	-																																																																																																																																																																																																																																																																																																						
+13	-																																																																																																																																																																																																																																																																																																						
+14	-																																																																																																																																																																																																																																																																																																						
+15	-																																																																																																																																																																																																																																																																																																						
(6)	i_u16ErrInvalidStationSet	Error invalid station setting data	Word [Unsigned]/ Bit String [16-bit] (0..15)	—	<p>Specify the start address of the storage location of the error invalid station setting.</p> <p>Setting: Specify an error invalid station.</p> <ul style="list-style-type: none"> • 0: Not specified (default) • 1: Specified <table border="1"> <thead> <tr> <th></th> <th>b15</th><th>b14</th><th>b13</th><th>b12</th><th>b11</th><th>b10</th><th>b9</th><th>b8</th><th>b7</th><th>b6</th><th>b5</th><th>b4</th><th>b3</th><th>b2</th><th>b1</th><th>b0</th> </tr> </thead> <tbody> <tr><td>+0</td><td>16</td><td>15</td><td>14</td><td>13</td><td>12</td><td>11</td><td>10</td><td>9</td><td>8</td><td>7</td><td>6</td><td>5</td><td>4</td><td>3</td><td>2</td><td>1</td></tr> <tr><td>+1</td><td>32</td><td>31</td><td>30</td><td>29</td><td>28</td><td>27</td><td>26</td><td>25</td><td>24</td><td>23</td><td>22</td><td>21</td><td>20</td><td>19</td><td>18</td><td>17</td></tr> <tr><td>+2</td><td>48</td><td>47</td><td>46</td><td>45</td><td>44</td><td>43</td><td>42</td><td>41</td><td>40</td><td>39</td><td>38</td><td>37</td><td>36</td><td>35</td><td>34</td><td>33</td></tr> <tr><td>+3</td><td>64</td><td>63</td><td>62</td><td>61</td><td>60</td><td>59</td><td>58</td><td>57</td><td>56</td><td>55</td><td>54</td><td>53</td><td>52</td><td>51</td><td>50</td><td>49</td></tr> <tr><td>+4</td><td>80</td><td>79</td><td>78</td><td>77</td><td>76</td><td>75</td><td>74</td><td>73</td><td>72</td><td>71</td><td>70</td><td>69</td><td>68</td><td>67</td><td>66</td><td>65</td></tr> <tr><td>+5</td><td>96</td><td>95</td><td>94</td><td>93</td><td>92</td><td>91</td><td>90</td><td>89</td><td>88</td><td>87</td><td>86</td><td>85</td><td>84</td><td>83</td><td>82</td><td>81</td></tr> <tr><td>+6</td><td>112</td><td>111</td><td>110</td><td>109</td><td>108</td><td>107</td><td>106</td><td>105</td><td>104</td><td>103</td><td>102</td><td>101</td><td>100</td><td>99</td><td>98</td><td>97</td></tr> <tr><td>+7</td><td colspan="7">-</td><td>120</td><td>119</td><td>118</td><td>117</td><td>116</td><td>115</td><td>114</td><td>113</td><td colspan="2"></td></tr> <tr><td>+8</td><td colspan="16">-</td></tr> <tr><td>+9</td><td colspan="16">-</td></tr> <tr><td>+10</td><td colspan="16">-</td></tr> <tr><td>+11</td><td colspan="16">-</td></tr> <tr><td>+12</td><td colspan="16">-</td></tr> <tr><td>+13</td><td colspan="16">-</td></tr> <tr><td>+14</td><td colspan="16">-</td></tr> <tr><td>+15</td><td colspan="16">-</td></tr> </tbody> </table> <p>Numbers 1 to 120 in the table indicate station numbers. The master station cannot be specified as a reserved station.</p>		b15	b14	b13	b12	b11	b10	b9	b8	b7	b6	b5	b4	b3	b2	b1	b0	+0	16	15	14	13	12	11	10	9	8	7	6	5	4	3	2	1	+1	32	31	30	29	28	27	26	25	24	23	22	21	20	19	18	17	+2	48	47	46	45	44	43	42	41	40	39	38	37	36	35	34	33	+3	64	63	62	61	60	59	58	57	56	55	54	53	52	51	50	49	+4	80	79	78	77	76	75	74	73	72	71	70	69	68	67	66	65	+5	96	95	94	93	92	91	90	89	88	87	86	85	84	83	82	81	+6	112	111	110	109	108	107	106	105	104	103	102	101	100	99	98	97	+7	-							120	119	118	117	116	115	114	113			+8	-																+9	-																+10	-																+11	-																+12	-																+13	-																+14	-																+15	-															
	b15	b14	b13	b12	b11	b10	b9	b8	b7	b6	b5	b4	b3	b2	b1	b0																																																																																																																																																																																																																																																																																							
+0	16	15	14	13	12	11	10	9	8	7	6	5	4	3	2	1																																																																																																																																																																																																																																																																																							
+1	32	31	30	29	28	27	26	25	24	23	22	21	20	19	18	17																																																																																																																																																																																																																																																																																							
+2	48	47	46	45	44	43	42	41	40	39	38	37	36	35	34	33																																																																																																																																																																																																																																																																																							
+3	64	63	62	61	60	59	58	57	56	55	54	53	52	51	50	49																																																																																																																																																																																																																																																																																							
+4	80	79	78	77	76	75	74	73	72	71	70	69	68	67	66	65																																																																																																																																																																																																																																																																																							
+5	96	95	94	93	92	91	90	89	88	87	86	85	84	83	82	81																																																																																																																																																																																																																																																																																							
+6	112	111	110	109	108	107	106	105	104	103	102	101	100	99	98	97																																																																																																																																																																																																																																																																																							
+7	-							120	119	118	117	116	115	114	113																																																																																																																																																																																																																																																																																								
+8	-																																																																																																																																																																																																																																																																																																						
+9	-																																																																																																																																																																																																																																																																																																						
+10	-																																																																																																																																																																																																																																																																																																						
+11	-																																																																																																																																																																																																																																																																																																						
+12	-																																																																																																																																																																																																																																																																																																						
+13	-																																																																																																																																																																																																																																																																																																						
+14	-																																																																																																																																																																																																																																																																																																						
+15	-																																																																																																																																																																																																																																																																																																						
(7)	i_u11CommunicationCycleSet	Communication cycle setting data	Word [Unsigned]/ Bit String [16-bit] (0..10)	—	<p>Specify the communication cycle. (☞ Page 128 Communication cycle setting data)</p>																																																																																																																																																																																																																																																																																																		

Network configuration setting data

Element number	Item name	Range	Description					
0	For 1st module (master station)	Station setting information	— Set the station type, number of occupied stations, and station number. b15 b12 b11 b8 b7 b0 <table border="1" style="width: 100%; text-align: center;"><tr><td style="width: 33%;">(3)</td><td style="width: 33%;">(2)</td><td style="width: 33%;">(1)</td></tr></table> (1) Station number 0 (fixed) (2) Number of occupied stations 1 (fixed) (3) Station type 15: Master station (fixed)	(3)	(2)	(1)		
(3)		(2)	(1)					
1 to 6		Not used	—	—				
7 to 8		LB offset	0 to 32752	Set the offset value from the head of LB in increments of 16 points.				
9 to 10		Number of LB points	0 to 32768	Set the number of LB points in increments of 16 points.				
11 to 12		LW offset	0 to 16383	Set the offset value from the head of LW.				
13 to 14	Number of LW points	0 to 16384	Set the number of LW points.					
15	For 2nd module (slave station)	Station setting information	— Set the station type, number of occupied stations, and station number. b15 b12 b11 b8 b7 b0 <table border="1" style="width: 100%; text-align: center;"><tr><td style="width: 33%;">(3)</td><td style="width: 33%;">(2)</td><td style="width: 33%;">(1)</td></tr></table> (1) Station number 1 to 120 (2) Number of occupied stations 1 (fixed) (3) Station type 0: Remote station 1: Local station	(3)	(2)	(1)		
(3)		(2)	(1)					
16 to 17		RX/Ry offset	0 to 16368	Set the offset value from the head of RX/Ry in increments of 16 points.				
18		Number of RX/Ry points	0 to 16384	Set the number of RX/Ry points in increments of 16 points.				
19 to 20		RWr/RWw offset	0 to 8188	Set the offset value from the head of RWr/RWw in increments of 4 points.				
21		Number of RWr/RWw points	0 to 8192	Set the number of RWr/RWw points in increments of 4 points.				
22 to 23		LB offset	0 to 32752	Set the offset value from the head of LB in increments of 16 points.				
24 to 25		Number of LB points	0 to 32768	Set the number of LB points in increments of 16 points.				
26 to 27		LW offset	0 to 16383	Set the offset value from the head of LW.				
28 to 29		Number of LW points	0 to 16384	Set the number of LW points.				
30 to 31		IP address	0000001H to DFFFFFFEH (1 to 3758096382)	Set the IP address. • 30: Set the IP address (the third and fourth octets) of the target station. b15 b8 b7 b0 <table border="1" style="width: 100%; text-align: center;"><tr><td style="width: 33%;">3</td><td style="width: 33%;">4</td></tr></table> • 31: Set the IP address (the first and second octets). b15 b8 b7 b0 <table border="1" style="width: 100%; text-align: center;"><tr><td style="width: 33%;">1</td><td style="width: 33%;">2</td></tr></table> Only for the slave station, set the IP address. For the master station, the IP address setting is not required.	3	4	1	2
3		4						
1		2						
32		Communication cycle setting	0 to 2	0: Standard cycle 1: Medium speed 2: Low speed				
33 to 2174	For 3rd to 121st module (slave station) For setting details, refer to the 2nd module (15 to 32).							

- Set for all the stations.

If the specified total number of stations does not match the individual station setting data, the total number of individual stations specified in the total number of stations takes precedence. Any individual station information exceeding the total number of stations is ignored.

Example) When the station information of ten stations is set even if the total number of stations is two.

→ The 1st and 2nd information is enabled and parameters which are set the 3rd to 10th station information are ignored.

■Communication cycle setting data

Element number	Item	Description	Setting range
0	Setting in increments of 1μs	Specify whether to set the communication cycle interval in increments of 1μs. • 0: Not set • 1: Set	0, 1
1 2	Communication cycle interval setting	Set the communication cycle interval setting. ■When the "Setting in increments of 1μs" is set to "0" [Specification method] Set one of the following value to the element number 1. (The values set to the element number 2 are ignored.) • 2: 125.00μs • 3: 250.00μs • 4: 500.00μs • 5: 1000.00μs • 6: 2000.00μs • 7: 4000.00μs • 8: 8000.00μs* ¹ [Setting range] 2 to 8 [Example] For 250.00μs: element number 1 → 3, element number 2 → 0 ■When the "Setting in increments of 1μs" is set to "1" [Specification method] • Element number 1: Set the value in units of ms. • Element number 2: Set the value in units of μs. [Setting range] 125.00μs to 10000.00μs* ² [Example] For 162.00μs: element number 1 → 0, element number 2 → 162	Left
3	Not used	—	—
4	System reservation time	Set the system reservation time. • 0: 20.00μs • 1: 200.00μs	0, 1
5 6	Cyclic transmission time	Set the cyclic transmission time of the CC-Link IE TSN. ■Specification method • Element number 5: Set the value in units of ms. • Element number 6: Set the value in units of μs. ■Setting range 5μs to 9966.00μs* ³ ■When the value is 38μs (0ms, 38μs) • Element number 5: 0 • Element number 6: 38	Left
7 8	Not used	—	—
9	Medium speed	Specify the medium speed cycle for the communication cycle interval set in "Communication cycle interval setting". (Unit: double)	4 (fixed)
10	Low speed	Specify the low speed cycle for the communication cycle interval set in "Communication cycle interval setting". (Unit: double)	16 (fixed)

*1 The supported firmware version is "04" or later.

*2 The setting range for the firmware version with "03" or earlier is 125.00μs to 4000.00μs.

*3 The setting range for the firmware version with "03" or earlier is 5μs to 3966.00μs.

Output arguments

No.	Variable name	Name	Data type	Description	Default value
(8)	o_bENO	Execution status	Bit	On: The execution command is turned on. Off: The execution command is turned off.	Off
(9)	o_bOK	Normal completion	Bit	The FB has been processed normally when this argument is on.	Off
(10)	o_bErr	Error completion	Bit	The FB has been processed abnormally when this argument is on.	Off
(11)	o_uErrId	Error code	Word [Unsigned]/Bit String [16-bit]	An error code is stored at error completion.	0

Operation parameters

○: Can be set, ×: Cannot be set

No.	Variable name	Name	Data type	Range	Description	Default value	Master station	Local station
(12)	pbi_uTopologySet	Network topology setting	Word [Unsigned]/Bit String [16-bit]	0, 1	Specify the network topology. • 0: Line topology, star topology, or coexistence of star and line topologies • 1: Ring topology* ²	0	○	×
(13)	pbi_bNetworkConfigurationSetFlg	Presence of network configuration setting data	Bit	Off, on	Specify whether to enable/disable the network configuration setting data. • Off: Disable • On: Enable	Off	○	×
(14)	pbi_bReservedStationSetFlg	Presence of reserved station setting data	Bit	Off, on	Specify whether to enable/disable the reserved station setting data. • Off: Disable • On: Enable	Off	○	×
(15)	pbi_bErrInvalidStationSetFlg	Presence of error invalid station setting data	Bit	Off, on	Specify whether to enable/disable the error invalid station setting data. • Off: Disable • On: Enable	Off	○	×
(16)	pbi_bDataLinkFaultyStationSet	Data link faulty station setting	Bit	Off, on	Specify whether to hold or clear the input data from a data link faulty station. • Off: Clear • On: Hold	Off	○	○
(17)	pbi_bCPU_StopOutputSet	Output setting for CPU STOP	Bit	Off, on	Specify whether to hold or clear the output data when the operating status of a CPU module is STOP. • Off: Hold • On: Clear	Off	○	○
(18)	pbi_bCPU_StopErrOutputSet	Output setting for CPU stop error	Bit	Off, on	Specify whether to hold or clear the output data when the a CPU module caused a stop error. • Off: Clear • On: Hold	Off	○	○
(19)	pbi_bClassSet	CC-Link IE TSN Class setting	Bit	Off, on	Set the CC-Link IE TSN Class of the slave station to be connected. • Off: Coexistence of CC-Link IE TSN Class B and A or CC-Link IE TSN Class A • On: CC-Link IE TSN Class B	ON	○	×
(20)	pbi_uDisconnectionDetectionSet	Disconnection detection setting	Word [Unsigned]/Bit String [16-bit]	1 to 3	Set the continuous communications failure count before the slave station is detected to be disconnected. • 1: 2 times • 2: 4 times • 3: 8 times	2 (4 times)	○	×
(21)	pbi_uCommModeSet	Communication mode setting	Word [Unsigned]/Bit String [16-bit]	0, 1	Set communication mode. • 0: Unicast • 1: Multicast* ¹	0	○	×
(22)	pbi_bCommSpeedSet	Communication speed setting	Bit	Off, on	Set the communication speed. • Off: 1Gbps • On: 100Mbps* ¹	Off	○	○

*1 The supported firmware version is "04" or later.

*2 The supported firmware version is "10" or later.

FB details

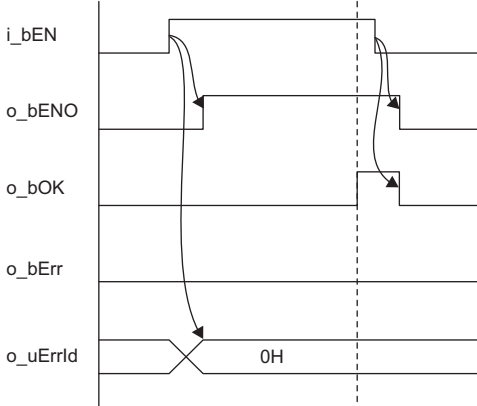
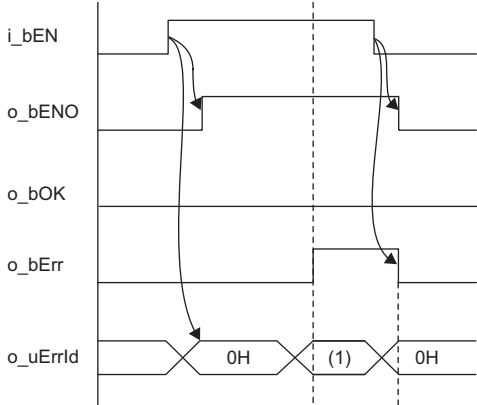
Item	Description	
Available device	Target module	RJ71GN11-T2
	CPU module	RCPU
	Engineering tool	GX Works3
Language	Ladder diagram	
Number of basic steps	93 steps The number of steps of the FB embedded in a program depends on the CPU module used, the input/output definitions, and the option settings of GX Works3. For the option settings of GX Works3, refer to GX Works3 Operating Manual.	
Processing	When i_bEN (execution command) is turned on, this function sets parameters for a module.	
FB compilation method	Macro type	
FB operation	Pulse type (multiple-scan execution type)	
Input condition for FB_EN	None	
Timing chart of I/O signals	<ul style="list-style-type: none"> For normal completion  <ul style="list-style-type: none"> For error completion (same as in the case of a module error)  <p>(1) Error code</p>	
Precautions	<ul style="list-style-type: none"> This FB does not include error recovery processing. Please create error recovery processing separately according to the system and required operations. This FB uses the GP.CCPASET instruction. Turn off i_bEN (execution command) after o_bOK (normal completion) or o_bErr (error completion) is turned on. By turning off i_bEN (execution command), o_bOK (normal completion) or o_bErr (error completion) is turned off and o_uErrld (error code) is cleared to 0. Before executing the FB, execute the M+model_SetAddress of the module FB or the UINI instruction of the dedicated instruction, and set the station number and IP address (regardless of the "Station number/IP address setting" set from the module parameter of the engineering tool). This FB uses the label initial value by each program. When the program file using this FB is specified to boot file setting for the boot operation in the CPU module, specify the initial label value file by each program to the boot file setting as well. (MELSEC iQ-R CPU Module User's Manual (Application)) If an error code that is not described in Page 131 Error codes appears, the initial label value files by each program may not be set to the boot file setting. In this case, specify the initial label value files by each program to the boot file setting. When this FB is executed, an operation error may occur in the programmable controller CPU. In this case, check the detailed information of the operation error in event history and correct the input argument of the module FB. 	

Error codes

Error code	Reference
0101H	The value out of the effective range is specified to the network topology setting.
C000H to CFFFH D000H to DFFFH	 MELSEC iQ-R CC-Link IE TSN User's Manual (Application)

3.10 M+model_RemoteRead

Name

■RJ71GN11-T2

M+RJ71GN11_RemoteRead

■RJ71GN11-EIP

M+RJ71GN11_SE_RemoteRead

Overview

Item	Description																																																																		
Overview	Reads data from the buffer memory area of the remote station in units of words.																																																																		
Symbol	<div style="border: 1px solid black; padding: 10px; margin: 10px 0;"> <p style="text-align: center;">M+RJ71GN11_RemoteRead</p> <table style="width: 100%; border-collapse: collapse;"> <tr> <td style="width: 5%; text-align: right;">(1)</td> <td style="width: 40%;">B: i_bEN</td> <td style="width: 15%;"></td> <td style="width: 20%;"></td> <td style="width: 20%;"></td> <td style="width: 10%; text-align: right;">(7)</td> </tr> <tr> <td style="text-align: right;">(2)</td> <td>DUT: i_stModule</td> <td></td> <td>o_bOK: B</td> <td></td> <td style="text-align: right;">(8)</td> </tr> <tr> <td style="text-align: right;">(3)</td> <td>UW: i_u2TargetAddress</td> <td></td> <td>o_bErr: B</td> <td></td> <td style="text-align: right;">(9)</td> </tr> <tr> <td style="text-align: right;">(4)</td> <td>UD: i_udTargetBuffer</td> <td></td> <td>o_uErrId: UW</td> <td></td> <td style="text-align: right;">(10)</td> </tr> <tr> <td style="text-align: right;">(5)</td> <td>UW: i_uDataLength</td> <td></td> <td>o_uReadData: UW</td> <td></td> <td style="text-align: right;">(11)</td> </tr> <tr> <td style="text-align: right;">(6)</td> <td>UW: i_uChannel</td> <td></td> <td></td> <td></td> <td></td> </tr> <tr> <td></td> <td style="padding-left: 20px;">pbi_uTargetStartIO</td> <td style="text-align: right;">(12)</td> <td></td> <td></td> <td></td> </tr> <tr> <td></td> <td style="padding-left: 20px;">pbi_uResendCountMax</td> <td style="text-align: right;">(13)</td> <td></td> <td></td> <td></td> </tr> <tr> <td></td> <td style="padding-left: 20px;">pbi_uMonitorTime</td> <td style="text-align: right;">(14)</td> <td></td> <td></td> <td></td> </tr> <tr> <td></td> <td style="padding-left: 20px;">pbi_bStationSpecific</td> <td style="text-align: right;">(15)</td> <td></td> <td></td> <td></td> </tr> <tr> <td></td> <td style="padding-left: 20px;">pbo_uResendCount</td> <td style="text-align: right;">(16)</td> <td></td> <td></td> <td></td> </tr> </table> </div> <p>The above FB is an example for the RJ71GN11-T2.</p>	(1)	B: i_bEN				(7)	(2)	DUT: i_stModule		o_bOK: B		(8)	(3)	UW: i_u2TargetAddress		o_bErr: B		(9)	(4)	UD: i_udTargetBuffer		o_uErrId: UW		(10)	(5)	UW: i_uDataLength		o_uReadData: UW		(11)	(6)	UW: i_uChannel						pbi_uTargetStartIO	(12)					pbi_uResendCountMax	(13)					pbi_uMonitorTime	(14)					pbi_bStationSpecific	(15)					pbo_uResendCount	(16)			
(1)	B: i_bEN				(7)																																																														
(2)	DUT: i_stModule		o_bOK: B		(8)																																																														
(3)	UW: i_u2TargetAddress		o_bErr: B		(9)																																																														
(4)	UD: i_udTargetBuffer		o_uErrId: UW		(10)																																																														
(5)	UW: i_uDataLength		o_uReadData: UW		(11)																																																														
(6)	UW: i_uChannel																																																																		
	pbi_uTargetStartIO	(12)																																																																	
	pbi_uResendCountMax	(13)																																																																	
	pbi_uMonitorTime	(14)																																																																	
	pbi_bStationSpecific	(15)																																																																	
	pbo_uResendCount	(16)																																																																	

Labels

Input arguments

No.	Variable name	Name	Data type	Range	Description															
(1)	i_bEN	Execution command	Bit	—	On: Start FB. Off: Do not start FB.															
(2)	i_stModule	Module label	Structure	—	Specify the module for which the FB is to be executed. Specify the module label of the modules. (Example: GN11_1, GN11_SE_1)															
(3)	i_u2TargetAddress	Target station address	Word [Unsigned]/ Bit String [16-bit] (0..1)	—	Specify the network number and station number of the target station when "Target station address specification method" is off. When specifying the numbers using a label, use an array as the data type. 1st word: Network number (1 to 239) 2nd word: Station number • Station number of CC-Link IE TSN 1 to 120: Remote station Specify the IP address of the target station when "Target station address specification method" is on. When specifying the numbers using a label, use an array as the data type. • CC-Link IE TSN 00000001H to DFFFFFFEH Specify a value within the range of 1 to 254 (FEH) for the fourth octet. <table style="margin-left: auto; margin-right: auto; border-collapse: collapse;"> <tr> <td></td> <td style="text-align: center;">b15</td> <td style="text-align: center;">b8</td> <td style="text-align: center;">b7</td> <td style="text-align: center;">b0</td> </tr> <tr> <td style="text-align: right;">+0</td> <td style="border: 1px solid black; width: 30px; height: 20px; text-align: center;">3</td> <td style="border: 1px solid black; width: 30px; height: 20px;"></td> <td style="border: 1px solid black; width: 30px; height: 20px; text-align: center;">4</td> <td style="border: 1px solid black; width: 30px; height: 20px;"></td> </tr> <tr> <td style="text-align: right;">+1</td> <td style="border: 1px solid black; width: 30px; height: 20px; text-align: center;">1</td> <td style="border: 1px solid black; width: 30px; height: 20px;"></td> <td style="border: 1px solid black; width: 30px; height: 20px; text-align: center;">2</td> <td style="border: 1px solid black; width: 30px; height: 20px;"></td> </tr> </table> 1 to 4: IP address octet		b15	b8	b7	b0	+0	3		4		+1	1		2	
	b15	b8	b7	b0																
+0	3		4																	
+1	1		2																	
(4)	i_udTargetBuffer	Read buffer memory of the target station	Double word [Unsigned]/ Bit String [32-bit]	00000000H to FFFFFFFFH	Specify the start buffer memory address of the target station containing the read data.															
(5)	i_uDataLength	Read data length	Word [Unsigned]/ Bit String [16-bit]	1 to 240	Specify the number of read data points (in units of words).															
(6)	i_uChannel	Own station channel	Word [Unsigned]/ Bit String [16-bit]	1 to 32	Specify the channel to be used by the own station. MELSEC iQ-R Programming Manual (Module Dedicated Instructions)															

Output arguments

No.	Variable name	Name	Data type	Description	Default value
(7)	o_bENO	Execution status	Bit	On: The execution command is turned on. Off: The execution command is turned off.	Off
(8)	o_bOK	Normal completion	Bit	The FB has been processed normally when this argument is on.	Off
(9)	o_bErr	Error completion	Bit	The FB has been processed abnormally when this argument is on.	Off
(10)	o_uErrId	Error code	Word [Unsigned]/ Bit String [16-bit]	An error code is stored at error completion.	0
(11)	o_uReadData	Read data storage device	Word [Unsigned]/ Bit String [16-bit]	Specify the start number of the device for storing the read data	0

■ Operation parameters

No.	Variable name	Name	Data type	Range	Description	Default value
(12)	pbi_uTargetStartIO	Start input/output number of the target station	Word [Unsigned]/Bit String [16-bit]	0000H	Specify the start input/output number of the target station.	0000H
(13)	pbi_uResendCountMax	Maximum number of resends	Word [Unsigned]/Bit String [16-bit]	0 to 15	Specify the number of resends to be performed if the data transfer is not completed within the monitoring time specified by "Arrival monitoring time". 0 to 15	5
(14)	pbi_uMonitorTime	Arrival monitoring time	Word [Unsigned]/Bit String [16-bit]	0 to 32767	Specify the monitoring time until completion of processing. If the processing is not completed within the monitoring time, data is resent until the value specified in the "Maximum number of resends" is reached. • 0: 10s • Effective range 1 to 32767: 1s to 32767s	0: 10s
(15)	pbi_bStationSpecific	Target station address specification method	Bit	Off, on	Specify the specification method of a target station. • Off: Use the network number and station number. • On: Use the IP address (IPv4). (CC-Link IE TSN only).	Off



■ Public variables

No.	Variable name	Name	Data type	Description	Default value
(16)	pbo_uResendCount	Number of resends	Word [Unsigned]/Bit String [16-bit]	The number of resends performed (result) is stored. If an error was detected, the number of resends performed (result) between error detection and resend stop is stored.	0

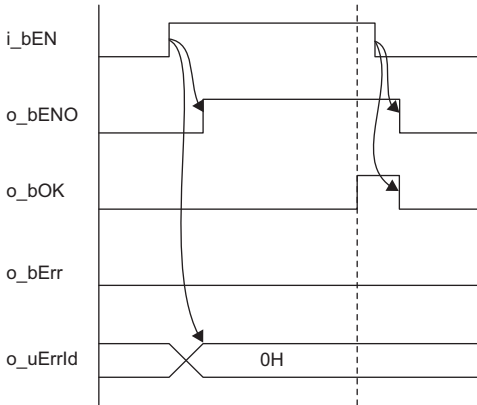
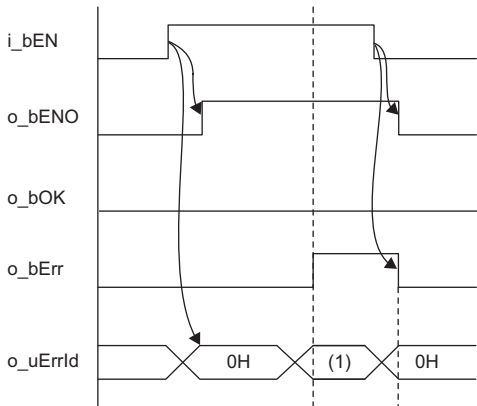
FB details

Item	Description	
Available device	Target module	<ul style="list-style-type: none"> • RJ71GN11-T2 • RJ71GN11-EIP
	CPU module	RCPU
	Engineering tool	GX Works3
Language	Ladder diagram	
Number of basic steps	97 steps The number of steps of the FB embedded in a program depends on the CPU module used, the input/output definitions, and the option settings of GX Works3. For the option settings of GX Works3, refer to GX Works3 Operating Manual.	
Processing	When i_bEN (execution instruction) is turned on, this function writes device data to the programmable controller of another station.	
FB compilation method	Macro type	
FB operation	Pulse type (multiple-scan execution type)	
Input condition for FB_EN	None	
Timing chart of I/O signals	<ul style="list-style-type: none"> • For normal completion  <ul style="list-style-type: none"> • For error completion (same as in the case of a module error)  <p>(1) Error code</p>	
Precautions	<ul style="list-style-type: none"> • This FB does not include error recovery processing. Please create error recovery processing separately according to the system and required operations. • This FB uses the GP.REMFRDIP instruction. • Turn off i_bEN (execution command) after o_bOK (normal completion) or o_bErr (error completion) is turned on. By turning off i_bEN (execution command), o_bOK (normal completion) or o_bErr (error completion) is turned off and o_uErrld (error code) is cleared to 0. • This FB uses the label initial value by each program. When the program file using this FB is specified to boot file setting for the boot operation in the CPU module, specify the initial label value file by each program to the boot file setting as well. (MELSEC iQ-R CPU Module User's Manual (Application)) If an error code that is not described in Page 136 Error codes appears, the initial label value files by each program may not be set to the boot file setting. In this case, specify the initial label value files by each program to the boot file setting. • When this FB is executed, an operation error may occur in the programmable controller CPU. In this case, check the detailed information of the operation error in event history and correct the input argument of the module FB. 	

Error codes

Error code	Reference
4000H to 4FFFH	 Manual for the target station used
C000H to CFFFH	 MELSEC iQ-R CC-Link IE TSN User's Manual (Application)
D000H to DFFFH	 MELSEC iQ-R CC-Link IE TSN Plus Master/Local Module User's Manual

3.11 M+model_RemoteWrite

Name

■RJ71GN11-T2

M+RJ71GN11_RemoteWrite

■RJ71GN11-EIP

M+RJ71GN11_SE_RemoteWrite

Overview

Item	Description																																																																								
Overview	Writes data to the buffer memory area of the remote station in units of words.																																																																								
Symbol	<div style="border: 1px solid black; padding: 10px; margin: 10px 0;"> <p style="text-align: center;">M+RJ71GN11_RemoteWrite</p> <table style="width: 100%; border-collapse: collapse;"> <tr> <td style="width: 10%;">(1)</td> <td style="width: 40%;">B: i_bEN</td> <td style="width: 10%;"></td> <td style="width: 20%;">o_bENO: B</td> <td style="width: 10%;"></td> <td style="width: 10%;">(8)</td> </tr> <tr> <td>(2)</td> <td>DUT: i_stModule</td> <td></td> <td>o_bOK: B</td> <td></td> <td>(9)</td> </tr> <tr> <td>(3)</td> <td>UW: i_u2TargetAddress</td> <td></td> <td>o_bErr: B</td> <td></td> <td>(10)</td> </tr> <tr> <td>(4)</td> <td>UD: i_udTargetBuffer</td> <td></td> <td>o_uErrId: UW</td> <td></td> <td>(11)</td> </tr> <tr> <td>(5)</td> <td>UW: i_uWriteData</td> <td></td> <td></td> <td></td> <td></td> </tr> <tr> <td>(6)</td> <td>UW: i_uDataLength</td> <td></td> <td></td> <td></td> <td></td> </tr> <tr> <td>(7)</td> <td>UW: i_uChannel</td> <td></td> <td></td> <td></td> <td></td> </tr> <tr> <td></td> <td></td> <td></td> <td>pbi_uTargetStartIO</td> <td></td> <td>(12)</td> </tr> <tr> <td></td> <td></td> <td></td> <td>pbi_uResendCountMax</td> <td></td> <td>(13)</td> </tr> <tr> <td></td> <td></td> <td></td> <td>pbi_uMonitorTime</td> <td></td> <td>(14)</td> </tr> <tr> <td></td> <td></td> <td></td> <td>pbi_bStationSpecific</td> <td></td> <td>(15)</td> </tr> <tr> <td></td> <td></td> <td></td> <td>pbo_uResendCount</td> <td></td> <td>(16)</td> </tr> </table> </div> <p>The above FB is an example for the RJ71GN11-T2.</p>	(1)	B: i_bEN		o_bENO: B		(8)	(2)	DUT: i_stModule		o_bOK: B		(9)	(3)	UW: i_u2TargetAddress		o_bErr: B		(10)	(4)	UD: i_udTargetBuffer		o_uErrId: UW		(11)	(5)	UW: i_uWriteData					(6)	UW: i_uDataLength					(7)	UW: i_uChannel								pbi_uTargetStartIO		(12)				pbi_uResendCountMax		(13)				pbi_uMonitorTime		(14)				pbi_bStationSpecific		(15)				pbo_uResendCount		(16)
(1)	B: i_bEN		o_bENO: B		(8)																																																																				
(2)	DUT: i_stModule		o_bOK: B		(9)																																																																				
(3)	UW: i_u2TargetAddress		o_bErr: B		(10)																																																																				
(4)	UD: i_udTargetBuffer		o_uErrId: UW		(11)																																																																				
(5)	UW: i_uWriteData																																																																								
(6)	UW: i_uDataLength																																																																								
(7)	UW: i_uChannel																																																																								
			pbi_uTargetStartIO		(12)																																																																				
			pbi_uResendCountMax		(13)																																																																				
			pbi_uMonitorTime		(14)																																																																				
			pbi_bStationSpecific		(15)																																																																				
			pbo_uResendCount		(16)																																																																				

Labels

Input arguments

No.	Variable name	Name	Data type	Range	Description															
(1)	i_bEN	Execution command	Bit	—	On: Start FB. Off: Do not start FB.															
(2)	i_stModule	Module label	Structure	—	Specify the module for which the FB is to be executed. Specify the module label of the modules. (Example: GN11_1, GN11_SE_1)															
(3)	i_u2TargetAddress	Target station address	Word [Unsigned]/ Bit String [16-bit] (0..1)	—	Specify the network number and station number of the target station when "Target station address specification method" is off. When specifying the numbers using a label, use an array as the data type. 1st word: Network number (1 to 239) 2nd word: Station number • Station number of CC-Link IE TSN 1 to 120: Remote station Specify the IP address of the target station when "Target station address specification method" is on. When specifying the numbers using a label, use an array as the data type. • CC-Link IE TSN 00000001H to DFFFFFFEH Specify a value within the range of 1 to 254 (FEH) for the fourth octet. <table style="margin-left: auto; margin-right: auto;"> <tr> <td></td> <td style="text-align: center;">b15</td> <td style="text-align: center;">b8</td> <td style="text-align: center;">b7</td> <td style="text-align: center;">b0</td> </tr> <tr> <td style="text-align: right;">+0</td> <td style="border: 1px solid black; text-align: center;">3</td> <td style="border: 1px solid black; text-align: center;">4</td> <td></td> <td></td> </tr> <tr> <td style="text-align: right;">+1</td> <td style="border: 1px solid black; text-align: center;">1</td> <td style="border: 1px solid black; text-align: center;">2</td> <td></td> <td></td> </tr> </table> 1 to 4: IP address octet		b15	b8	b7	b0	+0	3	4			+1	1	2		
	b15	b8	b7	b0																
+0	3	4																		
+1	1	2																		
(4)	i_udTargetBuffer	Target station write buffer	Double word [Unsigned]/ Bit String [32-bit]	00000000 H to FFFFFFFH H	Specify the start buffer memory address of the target station to which the data is written.															
(5)	i_uWriteData	Write data storage device	Word [Unsigned]/ Bit String [16-bit]	—	Specify the start device of own station containing the write data.															
(6)	i_uDataLength	Write data length	Word [Unsigned]/ Bit String [16-bit]	1 to 240	Specify the number of write data points (in units of words).															
(7)	i_uChannel	Own station channel	Word [Unsigned]/ Bit String [16-bit]	1 to 32	Specify the channel to be used by the own station. MELSEC iQ-R Programming Manual (Module Dedicated Instructions)															

Output arguments

No.	Variable name	Name	Data type	Description	Default value
(8)	o_bENO	Execution status	Bit	On: The execution command is turned on. Off: The execution command is turned off.	Off
(9)	o_bOK	Normal completion	Bit	The FB has been processed normally when this argument is on.	Off
(10)	o_bErr	Error completion	Bit	The FB has been processed abnormally when this argument is on.	Off
(11)	o_uErrId	Error code	Word [Unsigned]/ Bit String [16-bit]	An error code is stored at error completion.	0

■ Operation parameters

No.	Variable name	Name	Data type	Range	Description	Default value
(12)	pbi_uTargetStartIO	Start input/output number of the target station	Word [Unsigned]/Bit String [16-bit]	0000H	Specify the start input/output number of the target station.	0000H
(13)	pbi_uResendCountMax	Maximum number of resends	Word [Unsigned]/Bit String [16-bit]	0 to 15	Specify the number of resends to be performed if the data transfer is not completed within the monitoring time specified by "Arrival monitoring time". 0 to 15	5
(14)	pbi_uMonitorTime	Arrival monitoring time	Word [Unsigned]/Bit String [16-bit]	0 to 32767	Specify the monitoring time until completion of processing. If the processing is not completed within the monitoring time, data is resent until the value specified in the "Maximum number of resends" is reached. • 0: 10s • Effective range 1 to 32767: 1s to 32767s	0: 10s
(15)	pbi_bStationSpecific	Target station address specification method	Bit	Off, on	Specify the specification method of a target station. • Off: Use the network number and station number. • On: Use the IP address (IPv4). (CC-Link IE TSN only).	Off



■ Public variables

No.	Variable name	Name	Data type	Description	Default value
(16)	pbo_uResendCount	Number of resends	Word [Unsigned]/Bit String [16-bit]	The number of resends performed (result) is stored. If an error was detected, the number of resends performed (result) between error detection and resend stop is stored.	0

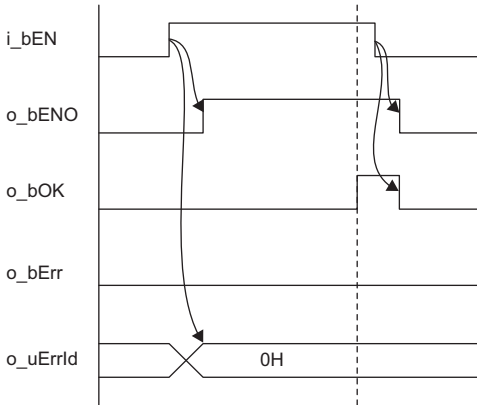
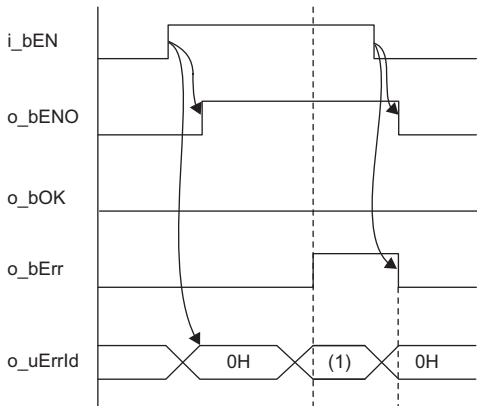
FB details

Item	Description	
Available device	Target module <ul style="list-style-type: none"> • RJ71GN11-T2 • RJ71GN11-EIP 	
	CPU module	RCPU
	Engineering tool	GX Works3
Language	Ladder diagram	
Number of basic steps	97 steps The number of steps of the FB embedded in a program depends on the CPU module used, the input/output definitions, and the option settings of GX Works3. For the option settings of GX Works3, refer to GX Works3 Operating Manual.	
Processing	When i_bEN (execution instruction) is turned on, this function writes device data to another station.	
FB compilation method	Macro type	
FB operation	Pulse type (multiple-scan execution type)	
Input condition for FB_EN	None	
Timing chart of I/O signals	<ul style="list-style-type: none"> • For normal completion  <ul style="list-style-type: none"> • For error completion (same as in the case of a module error)  <p>(1) Error code</p>	
Precautions	<ul style="list-style-type: none"> • This FB does not include error recovery processing. Please create error recovery processing separately according to the system and required operations. • This FB uses the GP.REMTODIP instruction. • Turn off i_bEN (execution command) after o_bOK (normal completion) or o_bErr (error completion) is turned on. By turning off i_bEN (execution command), o_bOK (normal completion) or o_bErr (error completion) is turned off and o_uErrld (error code) is cleared to 0. • This FB uses the label initial value by each program. When the program file using this FB is specified to boot file setting for the boot operation in the CPU module, specify the initial label value file by each program to the boot file setting as well. (MELSEC iQ-R CPU Module User's Manual (Application)) If an error code that is not described in Page 141 Error codes appears, the initial label value files by each program may not be set to the boot file setting. In this case, specify the initial label value files by each program to the boot file setting. • When this FB is executed, an operation error may occur in the programmable controller CPU. In this case, check the detailed information of the operation error in event history and correct the input argument of the module FB. 	

Error codes

Error code	Reference
4000H to 4FFFH	 Manual for the target station used
C000H to CFFFH	 MELSEC iQ-R CC-Link IE TSN User's Manual (Application)
D000H to DFFFH	 MELSEC iQ-R CC-Link IE TSN Plus Master/Local Module User's Manual

3.12 M+model_RemoteReset_IP

Name

■RJ71GN11-T2

M+RJ71GN11_RemoteReset_IP

■RJ71GN11-SX

M+RJ71GN11_SX_RemoteReset_IP

■RJ71GN11-EIP

M+RJ71GN11_SE_RemoteReset_IP

Overview

Item	Description																																																
Overview	Sends the remote STOP of an SLMP request to the target station specified by an IP address and then sends the remote RESET.																																																
Symbol	<div style="border: 1px solid black; padding: 10px; width: fit-content; margin: 10px auto;"> <p style="text-align: center;">M+RJ71GN11_RemoteReset_IP</p> <table style="width: 100%; border-collapse: collapse;"> <tr> <td style="width: 15%;">(1) —</td> <td style="width: 45%;">B: i_bEN</td> <td style="width: 20%;"></td> <td style="width: 20%;">o_bENO: B</td> <td style="width: 10%;"></td> <td style="width: 10%;">(6)</td> </tr> <tr> <td>(2) —</td> <td>DUT: i_stModule</td> <td></td> <td>o_bOK: B</td> <td></td> <td>(7)</td> </tr> <tr> <td>(3) —</td> <td>UW: i_u2TargetAddress</td> <td></td> <td>o_bErr: B</td> <td></td> <td>(8)</td> </tr> <tr> <td>(4) —</td> <td>UW: i_uTarget_Port_No</td> <td></td> <td>o_uErrId: UW</td> <td></td> <td>(9)</td> </tr> <tr> <td>(5) —</td> <td>UW: i_uChannel</td> <td></td> <td></td> <td></td> <td></td> </tr> <tr> <td></td> <td></td> <td></td> <td>pbo_u4ErrTime</td> <td>(10)</td> <td></td> </tr> <tr> <td></td> <td></td> <td></td> <td>pbo_uErrIP_Address_3rd_4th</td> <td>(11)</td> <td></td> </tr> <tr> <td></td> <td></td> <td></td> <td>pbo_uErrIP_Address_1st_2nd</td> <td>(12)</td> <td></td> </tr> </table> </div> <p>The above FB is an example for the RJ71GN11-T2.</p>	(1) —	B: i_bEN		o_bENO: B		(6)	(2) —	DUT: i_stModule		o_bOK: B		(7)	(3) —	UW: i_u2TargetAddress		o_bErr: B		(8)	(4) —	UW: i_uTarget_Port_No		o_uErrId: UW		(9)	(5) —	UW: i_uChannel								pbo_u4ErrTime	(10)					pbo_uErrIP_Address_3rd_4th	(11)					pbo_uErrIP_Address_1st_2nd	(12)	
(1) —	B: i_bEN		o_bENO: B		(6)																																												
(2) —	DUT: i_stModule		o_bOK: B		(7)																																												
(3) —	UW: i_u2TargetAddress		o_bErr: B		(8)																																												
(4) —	UW: i_uTarget_Port_No		o_uErrId: UW		(9)																																												
(5) —	UW: i_uChannel																																																
			pbo_u4ErrTime	(10)																																													
			pbo_uErrIP_Address_3rd_4th	(11)																																													
			pbo_uErrIP_Address_1st_2nd	(12)																																													

Labels

Input arguments

No.	Variable name	Name	Data type	Range	Description															
(1)	i_bEN	Execution command	Bit	—	On: Start FB. Off: Do not start FB.															
(2)	i_stModule	Module label	Structure	—	Specify the module for which the FB is to be executed. Specify the module label of the modules. (Example: GN11_1, GN11_SX_1, GN11_SE_1)															
(3)	i_u2TargetAddress	IP address of external device	Word [Unsigned]/ Bit String [16-bit] (0..1)	Right	Specify the IP address of an external device. When specifying the address using a label, use an array as the data type. • 00000001H to DFFFFFFEH Specify a value within the range of 1 to 254 (FEH) for the fourth octet. <table style="margin-left: auto; margin-right: auto;"> <tr> <td></td> <td style="text-align: center;">b15</td> <td style="text-align: center;">b8</td> <td style="text-align: center;">b7</td> <td style="text-align: center;">b0</td> </tr> <tr> <td>+0</td> <td style="border: 1px solid black; text-align: center;">3</td> <td style="border: 1px solid black; text-align: center;">4</td> <td></td> <td></td> </tr> <tr> <td>+1</td> <td style="border: 1px solid black; text-align: center;">1</td> <td style="border: 1px solid black; text-align: center;">2</td> <td></td> <td></td> </tr> </table> 1 to 4: IP address octet		b15	b8	b7	b0	+0	3	4			+1	1	2		
	b15	b8	b7	b0																
+0	3	4																		
+1	1	2																		
(4)	i_uTarget_Port_No	Destination port number	Word [Unsigned]/ Bit String [16-bit]	1 to 65534	Specify the UDP port number of an external device. For the port number to specify, check the manual for the external device.															
(5)	i_uChannel	Own station channel	Word [Unsigned]/ Bit String [16-bit]	1 to 17	Specify the channel to be used by the own station.*1															

*1 To perform communications using the frame without the serial number on this FB, specify 1 to the own station channel. When a number of 2 to 9 is specified, this FB communicates using the frame with the serial number. When a number of 10 to 17 is specified, this FB communicates using the station number extension frame.

Output arguments

No.	Variable name	Name	Data type	Description	Default value
(6)	o_bENO	Execution status	Bit	On: The execution command is turned on. Off: The execution command is turned off.	Off
(7)	o_bOK	Normal completion	Bit	The FB has been processed normally when this argument is on.	Off
(8)	o_bErr	Error completion	Bit	The FB has been processed abnormally when this argument is on.	Off
(9)	o_uErrId	Error code	Word [Unsigned]/ Bit String [16-bit]	An error code is stored at error completion.	0

Public variables

No.	Variable name	Name	Data type	Description	Default value
(10)	pbo_u4ErrTime	Error occurrence time	Word [Unsigned]/Bit String [16-bit] (0..3)	Clock data at the time of error occurrence is stored. ^{*1} 1st word • Upper 8 bits: Month (01H to 12H) • Lower 8 bits: Lower 2 digits of year (00H to 99H) 2nd word • Upper 8 bits: Hour (00H to 23H) • Lower 8 bits: Day (01H to 31H) 3rd word • Upper 8 bits: Second (00H to 59H) • Lower 8 bits: Minute (00H to 59H) 4th word • Upper 8 bits: Upper 2 digits of year (00H to 99H) • Lower 8 bits: Day of week (00H (Sunday) to 06H (Saturday))	0
(11)	pbo_uErrIP_Address_3rd_4th	Error-detected device IP addresses (the third and fourth octets)	Word [Unsigned]/Bit String [16-bit]	The IP addresses (the third and fourth octets) of the station in which an error was detected are stored. ^{*1} Example: When the IP address is 192.168.1.2 0102h	0
(12)	pbo_uErrIP_Address_1st_2nd	Error-detected device IP addresses (the first and second octets)	Word [Unsigned]/Bit String [16-bit]	The IP addresses (the first and second octets) of the station in which an error was detected are stored. ^{*1} Example: When the IP address is 192.168.1.2 C0A8h	0

*1 The value is stored only when the dedicated instruction was completed with an error.

The value set to the target station address of the input argument is stored in the error-detected device IP addresses (the third and fourth octets) and the error-detected device IP addresses (the first and second octets).

FB details

Item	Description
Available device	Target module
	CPU module
	Engineering tool
Language	Ladder diagram
Number of basic steps	362 steps The number of steps of the FB embedded in a program depends on the CPU module used, the input/output definitions, and the option settings of GX Works3. For the option settings of GX Works3, refer to GX Works3 Operating Manual.
Processing	When i_bEN (execution command) is turned on, this function sends the remote STOP of an SLMP request to the target station and then sends the remote RESET.
FB compilation method	Macro type
FB operation	Pulse type (multiple-scan execution type)
Input condition for FB_EN	None

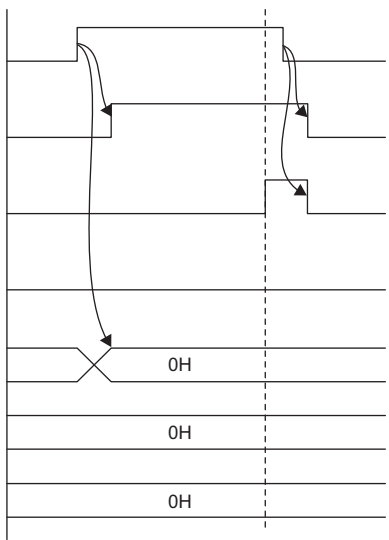
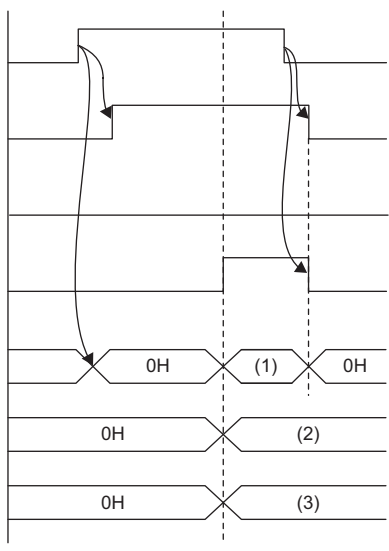
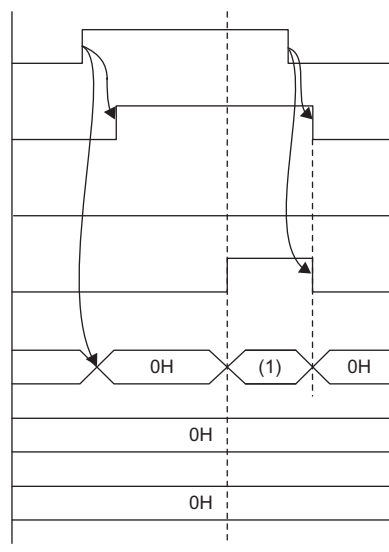
Item	Description
Timing chart of I/O signals	<ul style="list-style-type: none"> For normal completion  <p> i_bEN o_bENO o_bOK o_bErr o_uErrId pbo_u4ErrTime pbo_uErrIP_Address_3rd_4th, pbo_uErrIP_Address_1st_2nd </p>
	<ul style="list-style-type: none"> For error completion (When the dedicated instruction was completed with an error)  <p> i_bEN o_bENO o_bOK o_bErr o_uErrId pbo_u4ErrTime pbo_uErrIP_Address_3rd_4th, pbo_uErrIP_Address_1st_2nd </p> <p> (1) Error code (2) Error occurrence time (3) Error-detected station address </p>
	<ul style="list-style-type: none"> For error completion (When the dedicated instruction was completed successfully but the end code indicates an error)  <p> i_bEN o_bENO o_bOK o_bErr o_uErrId pbo_u4ErrTime pbo_uErrIP_Address_3rd_4th, pbo_uErrIP_Address_1st_2nd </p> <p>(1) Error code</p>

Item	Description
Precautions	<ul style="list-style-type: none"> This FB does not include error recovery processing. Please create error recovery processing separately according to the system and required operations. This FB uses the GP.SLMPSND instruction. Even if the target device has sent an abnormal response, the GP.SLMPSND instruction is completed successfully. In this FB, the instruction is determined to be completed successfully or completed with an error by the end code of the response frame. When the instruction was determined to be completed with an error by the end code, the end code is stored to the error code of the output argument. When the GP.SLMPSND instruction is completed successfully, the values are not stored to the error occurrence time of the public variable, the error-detected device IP addresses (the third and fourth octets), and the error-detected device IP addresses (the first and second octets).^{*1} Turn off i_bEN (execution command) after o_bOK (normal completion) or o_bErr (error completion) is turned on. By turning off i_bEN (execution command), o_bOK (normal completion) or o_bErr (error completion) is turned off and o_uErrId (error code) is cleared to 0. When the remote RESET request is sent and completed successfully, o_bOK (normal completion) is turned on. Whether the target station is actually reset remotely or not depends on the target station status. In this FB, stations in other network cannot be set as the target station. The target station must support "Remote STOP (command: 1002H)" and "Remote Reset (command: 1006H)" of the SLMP command. This FB uses UDP/IP communications. When this FB is executed, an operation error may occur in the programmable controller CPU. In this case, check the detailed information of the operation error in event history and correct the input argument of the module FB.

*1 If 0 (initial value) is stored in the error occurrence time, the error-detected device IP addresses (the third and fourth octets), and the error-detected device IP addresses (the first and second octets), check and take actions using the manuals for the SLMP-compatible device used.

Error codes

Error code	Reference
1000H to 3FFFH	<ul style="list-style-type: none"> MELSEC iQ-R CC-Link IE TSN User's Manual (Application) MELSEC iQ-R CC-Link IE TSN Plus Master/Local Module User's Manual
4000H to 4FFFH	<ul style="list-style-type: none"> MELSEC iQ-R CPU Module User's Manual (Application)
D000H to DFFFH	<ul style="list-style-type: none"> MELSEC iQ-R CC-Link IE TSN User's Manual (Application) MELSEC iQ-R CC-Link IE TSN Plus Master/Local Module User's Manual

3.13 M+model_RemoteReset2_IP

Name

■ **RJ71GN11-T2**
M+RJ71GN11_RemoteReset2_IP

■ **RJ71GN11-SX**
M+RJ71GN11_SX_RemoteReset2_IP

■ **RJ71GN11-EIP**
M+RJ71GN11_SE_RemoteReset2_IP

Overview

Item	Description																																								
Overview	Sends the remote RESET of an SLMP request to the target station specified by an IP address.																																								
Symbol	<div style="border: 1px solid black; padding: 10px; width: fit-content; margin: 10px auto;"> <p style="text-align: center;">M+RJ71GN11_RemoteReset2_IP</p> <table style="width: 100%; border-collapse: collapse;"> <tr> <td style="width: 15%;">(1) —</td> <td style="width: 35%;">B: i_bEN</td> <td style="width: 15%;"></td> <td style="width: 15%;">o_bENO: B</td> <td style="width: 20%;">(6)</td> </tr> <tr> <td>(2) —</td> <td>DUT: i_stModule</td> <td></td> <td>o_bOK: B</td> <td>(7)</td> </tr> <tr> <td>(3) —</td> <td>UW: i_u2TargetAddress</td> <td></td> <td>o_bErr: B</td> <td>(8)</td> </tr> <tr> <td>(4) —</td> <td>UW: i_uTarget_Port_No</td> <td></td> <td>o_uErrId: UW</td> <td>(9)</td> </tr> <tr> <td>(5) —</td> <td>UW: i_uChannel</td> <td></td> <td></td> <td></td> </tr> <tr> <td></td> <td></td> <td></td> <td>pbo_u4ErrTime</td> <td>(10)</td> </tr> <tr> <td></td> <td></td> <td></td> <td>pbo_uErrIP_Address_3rd_4th</td> <td>(11)</td> </tr> <tr> <td></td> <td></td> <td></td> <td>pbo_uErrIP_Address_1st_2nd</td> <td>(12)</td> </tr> </table> </div> <p>The above FB is an example for the RJ71GN11-T2.</p>	(1) —	B: i_bEN		o_bENO: B	(6)	(2) —	DUT: i_stModule		o_bOK: B	(7)	(3) —	UW: i_u2TargetAddress		o_bErr: B	(8)	(4) —	UW: i_uTarget_Port_No		o_uErrId: UW	(9)	(5) —	UW: i_uChannel							pbo_u4ErrTime	(10)				pbo_uErrIP_Address_3rd_4th	(11)				pbo_uErrIP_Address_1st_2nd	(12)
(1) —	B: i_bEN		o_bENO: B	(6)																																					
(2) —	DUT: i_stModule		o_bOK: B	(7)																																					
(3) —	UW: i_u2TargetAddress		o_bErr: B	(8)																																					
(4) —	UW: i_uTarget_Port_No		o_uErrId: UW	(9)																																					
(5) —	UW: i_uChannel																																								
			pbo_u4ErrTime	(10)																																					
			pbo_uErrIP_Address_3rd_4th	(11)																																					
			pbo_uErrIP_Address_1st_2nd	(12)																																					

Labels

Input arguments

No.	Variable name	Name	Data type	Range	Description															
(1)	i_bEN	Execution command	Bit	—	On: Start FB. Off: Do not start FB.															
(2)	i_stModule	Module label	Structure	—	Specify the module for which the FB is to be executed. Specify the module label of the modules. (Example: GN11_1, GN11_SX_1, GN11_SE_1)															
(3)	i_u2TargetAddress	IP address of external device	Word [Unsigned] /Bit String [16-bit] (0..1)	Right	Specify the IP address of an external device. When specifying the address using a label, use an array as the data type. • 00000001H to DFFFFFFEH Specify a value within the range of 1 to 254 (FEH) for the fourth octet. <table style="margin-left: 40px; border-collapse: collapse;"> <tr> <td></td> <td style="text-align: center;">b15</td> <td style="text-align: center;">b8</td> <td style="text-align: center;">b7</td> <td style="text-align: center;">b0</td> </tr> <tr> <td style="text-align: right;">+0</td> <td style="border: 1px solid black; width: 40px; text-align: center;">3</td> <td style="border: 1px solid black; width: 40px;"></td> <td style="border: 1px solid black; width: 40px; text-align: center;">4</td> <td style="border: 1px solid black; width: 40px;"></td> </tr> <tr> <td style="text-align: right;">+1</td> <td style="border: 1px solid black; text-align: center;">1</td> <td style="border: 1px solid black;"></td> <td style="border: 1px solid black; text-align: center;">2</td> <td style="border: 1px solid black;"></td> </tr> </table> 1 to 4: IP address octet		b15	b8	b7	b0	+0	3		4		+1	1		2	
	b15	b8	b7	b0																
+0	3		4																	
+1	1		2																	
(4)	i_uTarget_Port_No	Destination port number	Word [Unsigned] /Bit String [16-bit]	1 to 65534	Specify the UDP port number of an external device. For the port number to specify, check the manual for the external device.															
(5)	i_uChannel	Own station channel	Word [Unsigned] /Bit String [16-bit]	1 to 17	Specify the channel to be used by the own station.*1															

*1 To perform communications using the frame without the serial number on this FB, specify 1 to the own station channel. When a number of 2 to 9 is specified, this FB communicates using the frame with the serial number. When a number of 10 to 17 is specified, this FB communicates using the station number extension frame.

Output arguments

No.	Variable name	Name	Data type	Description	Default value
(6)	o_bENO	Execution status	Bit	On: The execution command is turned on. Off: The execution command is turned off.	Off
(7)	o_bOK	Normal completion	Bit	The FB has been processed normally when this argument is on.	Off
(8)	o_bErr	Error completion	Bit	The FB has been processed abnormally when this argument is on.	Off
(9)	o_uErrId	Error code	Word [Unsigned] /Bit String [16-bit]	An error code is stored at error completion.	0

Public variables

No.	Variable name	Name	Data type	Description	Default value
(10)	pbo_u4ErrTime	Error occurrence time	Word [Unsigned]/Bit String [16-bit] (0..3)	Clock data at the time of error occurrence is stored. ^{*1} 1st word • Upper 8 bits: Month (01H to 12H) • Lower 8 bits: Lower 2 digits of year (00H to 99H) 2nd word • Upper 8 bits: Hour (00H to 23H) • Lower 8 bits: Day (01H to 31H) 3rd word • Upper 8 bits: Second (00H to 59H) • Lower 8 bits: Minute (00H to 59H) 4th word • Upper 8 bits: Upper 2 digits of year (00H to 99H) • Lower 8 bits: Day of week (00H (Sunday) to 06H (Saturday))	0
(11)	pbo_uErrIP_Address_3rd_4th	Error-detected device IP addresses (the third and fourth octets)	Word [Unsigned]/Bit String [16-bit]	The IP addresses (the third and fourth octets) of the station in which an error was detected are stored. ^{*1} Example: When the IP address is 192.168.1.2 0102h	0
(12)	pbo_uErrIP_Address_1st_2nd	Error-detected device IP addresses (the first and second octets)	Word [Unsigned]/Bit String [16-bit]	The IP addresses (the first and second octets) of the station in which an error was detected are stored. ^{*1} Example: When the IP address is 192.168.1.2 C0A8h	0

*1 The value is stored only when the dedicated instruction was completed with an error.

The value set to the target station address of the input argument is stored in the error-detected device IP addresses (the third and fourth octets) and the error-detected device IP addresses (the first and second octets).

FB details

Item	Description
Available device	Target module
	CPU module
	Engineering tool
Language	Ladder diagram
Number of basic steps	171 steps The number of steps of the FB embedded in a program depends on the CPU module used, the input/output definitions, and the option settings of GX Works3. For the option settings of GX Works3, refer to GX Works3 Operating Manual.
Processing	When i_bEN (execution command) is turned on, this function sends the remote RESET of an SLMP request to the target station.
FB compilation method	Macro type
FB operation	Pulse type (multiple-scan execution type)
Input condition for FB_EN	None

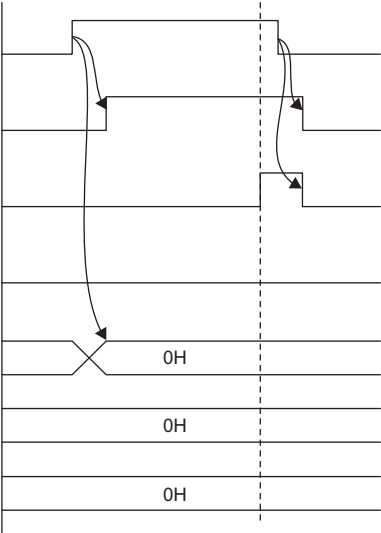
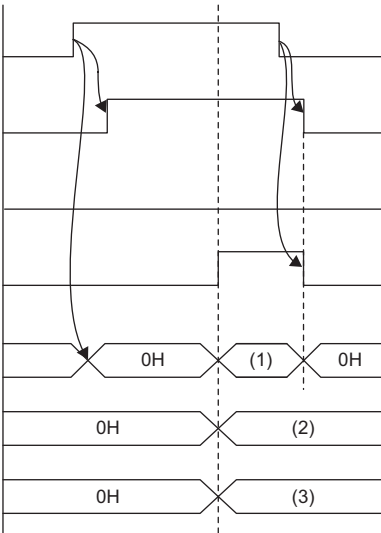
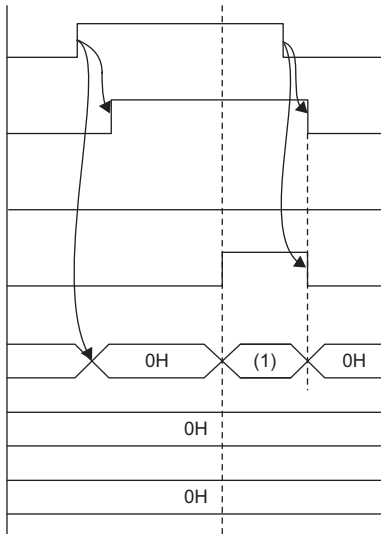
Item	Description
Timing chart of I/O signals	<ul style="list-style-type: none"> For normal completion 
	<ul style="list-style-type: none"> For error completion (When the dedicated instruction was completed with an error) 
	<ul style="list-style-type: none"> For error completion (When the dedicated instruction was completed successfully but the end code indicates an error)  <p>(1) Error code</p>

Item	Description
Precautions	<ul style="list-style-type: none"> • This FB does not include error recovery processing. Please create error recovery processing separately according to the system and required operations. • This FB uses the GP.SLMPSND instruction. Even if the target device has sent an abnormal response, the GP.SLMPSND instruction is completed successfully. In this FB, the instruction is determined to be completed successfully or completed with an error by the end code of the response frame. When the instruction was determined to be completed with an error by the end code, the end code is stored to the error code of the output argument. • When the GP.SLMPSND instruction is completed successfully, the values are not stored to the error occurrence time of the public variable, the error-detected device IP addresses (the third and fourth octets), and the error-detected device IP addresses (the first and second octets).^{*1} • Turn off i_bEN (execution command) after o_bOK (normal completion) or o_bErr (error completion) is turned on. By turning off i_bEN (execution command), o_bOK (normal completion) or o_bErr (error completion) is turned off and o_uErrId (error code) is cleared to 0. • When the remote RESET request is sent and completed successfully, o_bOK (normal completion) is turned on. Whether the target station is actually reset remotely or not depends on the target station status. • In this FB, stations in other network cannot be set as the target station. • The external device must support SLMP command (Remote Reset (1006H)). • This FB uses UDP/IP communications.

*1 If 0 (initial value) is stored in the error occurrence time, the error-detected device IP addresses (the third and fourth octets), and the error-detected device IP addresses (the first and second octets), check and take actions using the manuals for the SLMP-compatible device used.

Error codes

Error code	Reference
1000H to 3FFFH	<ul style="list-style-type: none"> 📖 MELSEC iQ-R CC-Link IE TSN User's Manual (Application) 📖 MELSEC iQ-R CC-Link IE TSN Plus Master/Local Module User's Manual
4000H to 4FFFH	<ul style="list-style-type: none"> 📖 MELSEC iQ-R CPU Module User's Manual (Application)
D000H to DFFFH	<ul style="list-style-type: none"> 📖 MELSEC iQ-R CC-Link IE TSN User's Manual (Application) 📖 MELSEC iQ-R CC-Link IE TSN Plus Master/Local Module User's Manual

4 CC-Link IE TSN Plus MASTER/LOCAL MODULE FB

4.1 M+model_DeviceRead

The FB is the same as M+model_DeviceRead of the CC-Link IE TSN master/local module FB. ( Page 79
M+model_DeviceRead)

4.2 M+model_DeviceWrite

The FB is the same as M+model_DeviceWrite of the CC-Link IE TSN master/local module FB. ( Page 84 M+model_DeviceWrite)

4.3 M+model_Send

The FB is the same as M+model_Send of the CC-Link IE TSN master/local module FB. (☞ Page 91 M+model_Send)

4.4 M+model_Recv

The FB is the same as M+model_Recv of the CC-Link IE TSN master/local module FB. (☞ Page 97 M+model_Recv)

4.5 M+model_RemoteStopRun

The FB is the same as M+model_RemoteStopRun of the CC-Link IE TSN master/local module FB. (☞ Page 102 M+model_RemoteStopRun)

4.6 M+model_SLMP_DeviceRead_IP

The FB is the same as M+model_SLMP_DeviceRead_IP of the CC-Link IE TSN master/local module FB. (☞ Page 108 M+model_SLMP_DeviceRead_IP)

4.7 M+model_SLMP_DeviceWrite_IP

The FB is the same as M+model_SLMP_DeviceWrite_IP of the CC-Link IE TSN master/local module FB. (☞ Page 115 M+model_SLMP_DeviceWrite_IP)

4.8 M+model_RemoteRead

The FB is the same as M+model_RemoteRead of the CC-Link IE TSN master/local module FB. ( Page 132 M+model_RemoteRead)

4.9 M+model_RemoteWrite

The FB is the same as M+model_RemoteWrite of the CC-Link IE TSN master/local module FB. (☞ Page 137 M+model_RemoteWrite)

4.10 M+model_RemoteReset_IP

The FB is the same as M+model_RemoteReset_IP of the CC-Link IE TSN master/local module FB. (☞ Page 142 M+model_RemoteReset_IP)

4.11 M+model_RemoteReset2_IP

The FB is the same as M+model_RemoteReset2_IP of the CC-Link IE TSN master/local module FB. (☞ Page 147 M+model_RemoteReset2_IP)

4.12 M+model_ConnectionOpen

Name

M+RJ71GN11_SE_ConnectionOpen

Overview

Item	Description
Overview	Opens (establishes) a connection for data communication with an external device.
Symbol	<p>The diagram shows a box labeled 'M+RJ71GN11_SE_ConnectionOpen'. On the left side, there are three input variables: (1) B:i_bEN, (2) DUT:i_stModule, and (3) UW:i_uConnectionNo. On the right side, there are three output variables: (4) o_bENO:B, (5) o_bOK:B, and (6) o_bErr:B. Below the box, there are seven additional output variables: (7) o_uErrId:UW, (8) pbi_bUseParameters, (9) pbi_uProtocol, (10) pbi_uOpen_System, (11) pbi_uLocal_Port_No, (12) pbi_uTarget_Port_No, and (13) pbi_u2IP_Address.</p>

Labels

Input arguments

No.	Variable name	Name	Data type	Range	Description
(1)	i_bEN	Execution command	Bit	—	On: Start FB. Off: Do not start FB.
(2)	i_stModule	Module label	Structure	—	Specify the module for which the FB is to be executed. Specify the module label of the modules. (Example: GN11_SE_1)
(3)	i_uConnectionNo	Connection No.	Word [Unsigned]/ Bit String [16-bit]	1 to 16	Specify the number of the connection to be opened. • 1 to 8: Port 1, socket communications • 9 to 16: Port 2, socket communications

Output arguments

No.	Variable name	Name	Data type	Description	Default value
(4)	o_bENO	Execution status	Bit	On: The execution command is turned on. Off: The execution command is turned off.	Off
(5)	o_bOK	Normal completion	Bit	The FB has been processed normally when this argument is on.	Off
(6)	o_bErr	Error completion	Bit	The FB has been processed abnormally when this argument is on.	Off
(7)	o_uErrId	Error code	Word [Unsigned]/Bit String [16-bit]	An error code is stored at error completion.	0

■ Operation parameters

No.	Variable name	Name	Data type	Range	Description	Default value															
(8)	pbi_bUseParameters	Parameter used	Bit	On or off	Specify whether to use the parameter values set by the engineering tool or the following operation parameter values when processing for opening a connection. <ul style="list-style-type: none"> • Off: Performs open processing according to the external device connection configuration setting made by the engineering tool. (The following operation parameters need not be set. Any settings are ignored if made.) • On: Performs open processing according to the following operation parameters. 	Off															
(9)	pbi_uProtocol	Protocol	Word [Unsigned]/ Bit String [16-bit]	0, 1	Select the protocol to be used for the connection to be opened. <ul style="list-style-type: none"> • 0: TCP/IP • 1: UDP/IP 	0															
(10)	pbi_uOpen_System	Open method	Word [Unsigned]/ Bit String [16-bit]	0 to 2	Select the connection open method. <ul style="list-style-type: none"> • 0: Active open or UDP/IP • 1: Unpassive open • 2: Fullpassive open 	0															
(11)	pbi_uLocal_Port_No	Own node port number	Word [Unsigned]/ Bit String [16-bit]	1024 to 65534 ^{*1}	Specify the port number of the own node.	4096															
(12)	pbi_uTarget_Port_No	Destination port number	Word [Unsigned]/ Bit String [16-bit]	1024 to 65535	Specify the destination port number. With the connection that is assigned to port No.65535 (only when the UDP/IP protocol is selected), data is received through all port number.	4096															
(13)	pbi_u2IP_Address	IP address of external device	Word [Unsigned]/ Bit String [16-bit]	0.0.0.1 to 255.255.255.255 (00000001H to FFFFFFFFH) ^{*2}	Specify the IP address of an external device. Specify the third and fourth octets to the 1st word, and first and second octets to the 2nd word. Specify 255.255.255.255 (FFFFFFFH) when performing simultaneous broadcast. <div style="text-align: center; margin-top: 10px;"> <table border="1" style="border-collapse: collapse; width: 100%;"> <tr> <td style="padding: 2px 10px;"></td> <td style="text-align: center; padding: 2px 10px;">b15</td> <td style="text-align: center; padding: 2px 10px;">b8</td> <td style="text-align: center; padding: 2px 10px;">b7</td> <td style="text-align: center; padding: 2px 10px;">b0</td> </tr> <tr> <td style="padding: 2px 10px;">+0</td> <td style="text-align: center; padding: 2px 10px;">(3)</td> <td style="text-align: center; padding: 2px 10px;">(4)</td> <td colspan="2"></td> </tr> <tr> <td style="padding: 2px 10px;">+1</td> <td style="text-align: center; padding: 2px 10px;">(1)</td> <td style="text-align: center; padding: 2px 10px;">(2)</td> <td colspan="2"></td> </tr> </table> </div>		b15	b8	b7	b0	+0	(3)	(4)			+1	(1)	(2)			192.168.1.1 (COA80101H)
	b15	b8	b7	b0																	
+0	(3)	(4)																			
+1	(1)	(2)																			

*1 The following port numbers cannot be used.

20, 21, 161, 162, 5000 to 5011, 45237 to 45239, 61440 to 61442, 61448, 61460 to 61464, 61500, 61501, 62000 to 65534

*2 When 0.0.0.0 is specified, the device operates with the default value.

FB details

Item	Description	
Available device	Target module	RJ71GN11-EIP
	CPU module	RCPU
	Engineering tool	GX Works3
Language	Ladder diagram	
Number of basic steps	102 steps The number of steps of the FB embedded in a program depends on the CPU module used, the input/output definitions, and the option settings of GX Works3. For the option settings of GX Works3, refer to the GX Works3 Operating Manual.	
Processing	When i_bEN (execution command) is turned on, this function opens (establishes) a connection for data communication with an external device.	
FB compilation method	Macro type	
FB operation	Pulse type (multiple-scan execution type)	

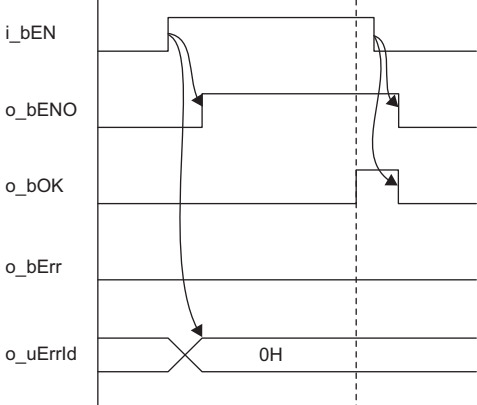
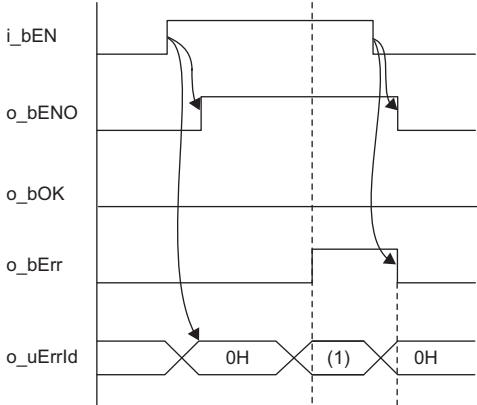
Item	Description
Timing chart of I/O signals	<ul style="list-style-type: none"> For normal completion  <ul style="list-style-type: none"> For error completion (same as in the case of a module error)  <p>(1) Error code</p>
Precautions	<ul style="list-style-type: none"> This FB cannot be executed for the connection that is being used by another FB or a dedicated instruction. An error occurs if this FB is executed for the connection in use. Turn off i_bEN (execution command) after o_bOK (normal completion) or o_bErr (error completion) is turned on. By turning off i_bEN (execution command), o_bOK (normal completion) or o_bErr (error completion) is turned off and o_uErrld (error code) is cleared to 0. If this FB is executed for the connection for which parameters are already set by "External Device Connection Configuration Setting", make settings so that the parameters specified by this FB are overwritten. When open processing is performed according to the content of the operation parameter with pbi_bUseParameters (parameter used) set to ON, the available communication means is the socket communications only. This FB uses the label initial value by each program. When the program file using this FB is specified to boot file setting for the boot operation in the CPU module, specify the initial label value file by each program to the boot file setting as well. (MELSEC iQ-R CPU Module User's Manual (Application))

Error codes

Error code	Reference
C000H to CFFFH	 MELSEC iQ-R CC-Link IE TSN Plus Master/Local Module User's Manual

4.13 M+model_ConnectionClose

Name

M+RJ71GN11_SE_ConnectionClose

Overview

Item	Description
Overview	Closes (disconnects) a connection for data communication with an external device.
Symbol	<pre> graph LR subgraph Symbol direction TB B["(1) B:i_bEN"] DUT["(2) DUT:i_stModule"] UW["(3) UW:i_uConnectionNo"] ENO["(4) o_bENO:B"] OK["(5) o_bOK:B"] Err["(6) o_bErr:B"] ErrId["(7) o_uErrId:UW"] ConnNo["(8) pbo_uErrConn_No"] end </pre>

4

Labels

Input arguments

No.	Variable name	Name	Data type	Range	Description
(1)	i_bEN	Execution command	Bit	—	On: Start FB. Off: Do not start FB.
(2)	i_stModule	Module label	Structure	—	Specify the module for which the FB is to be executed. Specify the module label of the modules. (Example: GN11_SE_1)
(3)	i_uConnectionNo	Connection No.	Word [Unsigned]/ Bit String [16-bit]	1 to 16	Specify the number of the connection to be closed. • 1 to 8: Port 1, socket communications • 9 to 16: Port 2, socket communications

Output arguments

No.	Variable name	Name	Data type	Description	Default value
(4)	o_bENO	Execution status	Bit	On: The execution command is turned on. Off: The execution command is turned off.	Off
(5)	o_bOK	Normal completion	Bit	The FB has been processed normally when this argument is on.	Off
(6)	o_bErr	Error completion	Bit	The FB has been processed abnormally when this argument is on.	Off
(7)	o_uErrId	Error code	Word [Unsigned]/ Bit String [16-bit]	An error code is stored at error completion.	0

Public variables

No.	Variable name	Name	Data type	Description	Default value
(8)	pbo_uErrConn_No	Error connection No.	Word [Unsigned]/ Bit String [16-bit]	The number of the connection for which close processing was completed with an error is stored. If 65535 (FFFFH) is specified in i_uConnectionNo (connection No.), the number of the connection for which close processing was first completed with an error is stored.	0

FB details

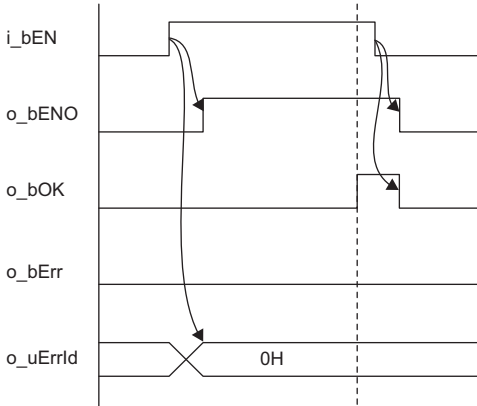
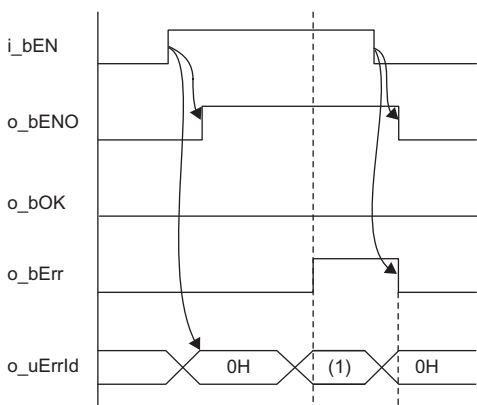
Item	Description	
Available device	Target module	RJ71GN11-EIP
	CPU module	RCPU
	Engineering tool	GX Works3
Language	Ladder diagram	
Number of basic steps	84 steps The number of steps of the FB embedded in a program depends on the CPU module used, the input/output definitions, and the option settings of GX Works3. For the option settings of GX Works3, refer to the GX Works3 Operating Manual.	
Processing	<ul style="list-style-type: none"> When i_bEN (execution command) is turned on, this function closes a connection for data communication with an external device. The function closes all connections if 65535 (FFFFH) is specified for i_uConnectionNo (connection No.) in the input argument. If the function fails to close even one connection among those specified to be closed, it is completed with an error. 	
FB compilation method	Macro type	
FB operation	Pulse type (multiple-scan execution type)	
Timing chart of I/O signals	<ul style="list-style-type: none"> For normal completion  <ul style="list-style-type: none"> For error completion (same as in the case of a module error)  <p>(1) Error code</p>	
Precautions	<ul style="list-style-type: none"> This FB cannot be executed for the connection that is being used by another FB or a dedicated instruction. An error occurs if this FB is executed for the connection in use. Turn off i_bEN (execution command) after o_bOK (normal completion) or o_bErr (error completion) is turned on. By turning off i_bEN (execution command), o_bOK (normal completion) or o_bErr (error completion) is turned off and o_uErrld (error code) is cleared to 0. 	

Error codes

Error code	Reference
C000H to CFFFH	MELSEC iQ-R CC-Link IE TSN Plus Master/Local Module User's Manual

4.14 M+model_Recv_Socket

Name

M+RJ71GN11_SE_Recv_Socket

Overview

Item	Description
Overview	Reads the data received through socket communications.
Symbol	<p>The diagram shows a box labeled 'M+RJ71GN11_SE_Recv_Socket'. On the left side, there are three input variables: (1) B:i_bEN, (2) DUT:i_stModule, and (3) UW:i_uConnectionNo. On the right side, there are four output variables: (4) o_bENO:B, (5) o_bOK:B, (6) o_bErr:B, and (7) o_uErrId:UW. At the bottom of the box, there is one more output variable: (8) o_uRecvData:UW. Below the box, there is a variable (9) pbo_uReadTiming.</p>

4

Labels

Input arguments

No.	Variable name	Name	Data type	Range	Description
(1)	i_bEN	Execution command	Bit	—	On: Start FB. Off: Do not start FB.
(2)	i_stModule	Module label	Structure	—	Specify the module for which the FB is to be executed. Specify the module label of the modules. (Example: GN11_SE_1)
(3)	i_uConnectionNo	Connection No.	Word [Unsigned]/ Bit String [16-bit]	1 to 16	Specify the number of the connection to which received data is to be read out. • 1 to 8: Port 1, socket communications • 9 to 16: Port 2, socket communications

Output arguments

No.	Variable name	Name	Data type	Description	Default value
(4)	o_bENO	Execution status	Bit	On: The execution command is turned on. Off: The execution command is turned off.	Off
(5)	o_bOK	Normal completion	Bit	The FB has been processed normally when this argument is on.	Off
(6)	o_bErr	Error completion	Bit	The FB has been processed abnormally when this argument is on.	Off
(7)	o_uErrId	Error code	Word [Unsigned]/Bit String [16-bit]	An error code is stored at error completion.	0

No.	Variable name	Name	Data type	Description	Default value
(8)	o_uRecvData	Receive data storage destination	Word [Unsigned]/Bit String [16-bit]	<p>Specify the start number of the device for storing the receive data length and received data. The data that has been read is stored sequentially in ascending order of addresses as shown below.</p> <ul style="list-style-type: none"> • 1st word: Receive data length (unit: byte) • 2nd word (upper 8 bits): Receive data 1 • 2nd word (lower 8 bits): Receive data 2 • 3rd word (upper 8 bits): Receive data 3 • 3rd word (lower 8 bits): Receive data 4 • : • n(th) word (upper 8 bits): Receive data (n-1)×2-1 • n(th) word (lower 8 bits): Receive data (n-1)×2 <p>The range of receive data length varies depending on the connection No.</p> <ul style="list-style-type: none"> • Connection No.1 to No.8: 1 to 2046 • Connection No.9 to No.16: 1 to 10238 <p>Receive data is stored in the word area in order from the first half (b0 to b7) to the second half (b8 to b15).</p>	0

■Operation parameters

No.	Variable name	Name	Data type	Range	Description	Default value
(9)	pbi_bReadTiming	Read timing	Bit	On or off	<p>Specify the timing of executing data read processing.</p> <ul style="list-style-type: none"> • Off: Start reading soon after the FB starts. • On: Start reading in the first END processing after the FB starts. 	On

FB details

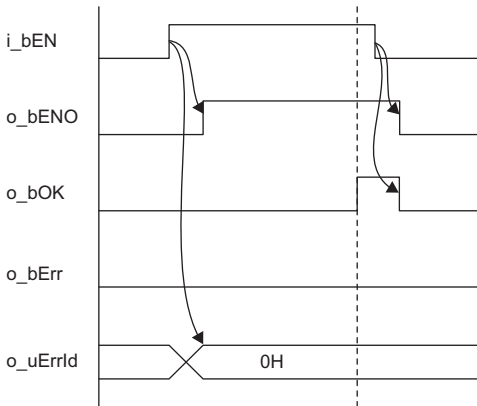
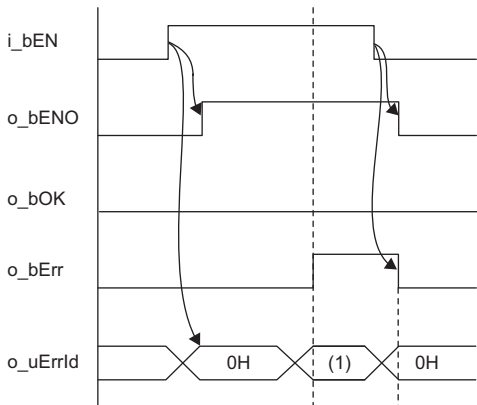
Item	Description	
Available device	Target module	RJ71GN11-EIP
	CPU module	RCPU
	Engineering tool	GX Works3
Language	Ladder diagram	
Number of basic steps	58 steps The number of steps of the FB embedded in a program depends on the CPU module used, the input/output definitions, and the option settings of GX Works3. For the option settings of GX Works3, refer to the GX Works3 Operating Manual.	
Processing	When i_bEN (execution command) is turned on, this function reads the received data to the connection specified by the input argument.	
FB compilation method	Macro type	
FB operation	Pulse type (multiple-scan execution type)	
Timing chart of I/O signals	<p>• For normal completion</p>  <p>• For error completion (same as in the case of a module error)</p>  <p>(1) Error code</p>	
Precautions	<ul style="list-style-type: none"> The execution command of this FB can be executed at any timing. However, when executing it after receiving data, 'Socket reception status signal' (Un\G6291472) must be added to conditions of the execution. This FB cannot be executed for the connection that is being used by another FB or a dedicated instruction. An error occurs if this FB is executed for the connection in use. When the FB is executed while OFF (Start reading soon after the FB starts) is specified in operation parameter "Read timing", processing completes in a single scan. Turn off i_bEN (execution command) after o_bOK (normal completion) or o_bErr (error completion) is turned on. By turning off i_bEN (execution command), o_bOK (normal completion) or o_bErr (error completion) is turned off and o_uErrld (error code) is cleared to 0. 	

Error codes

Error code	Reference
C000H to CFFFH	 MELSEC iQ-R CC-Link IE TSN Plus Master/Local Module User's Manual

4.15 M+model_Send_Socket

Name

M+RJ71GN11_SE_Send_Socket

Overview

Item	Description
Overview	Sends the data to the external device of the specified connection.
Symbol	<p>The diagram shows a rectangular box labeled 'M+RJ71GN11_SE_Send_Socket'. On the left side, there are four input variables: (1) B:i_bEN, (2) DUT:i_stModule, (3) UW:i_uConnectionNo, and (4) UW:i_uSendData. On the right side, there are four output variables: (5) o_bENO:B, (6) o_bOK:B, (7) o_bErr:B, and (8) o_uErrId:UW.</p>

Labels

Input arguments

No.	Variable name	Name	Data type	Range	Description
(1)	i_bEN	Execution command	Bit	—	On: Start FB. Off: Do not start FB.
(2)	i_stModule	Module label	Structure	—	Specify the module for which the FB is to be executed. Specify the module label of the modules. (Example: GN11_SE_1)
(3)	i_uConnectionNo	Connection No.	Word [Unsigned]/ Bit String [16-bit]	1 to 16	Specify the number of the connection of an external device to which the data is to be sent. • 1 to 8: Port 1, socket communications • 9 to 16: Port 2, socket communications
(4)	i_uSendData	Send data storage destination	Word [Unsigned]/ Bit String [16-bit]	—	Specify the start number of the device containing the send data length and data to be sent. • 1st word: Send data length (unit: byte) • 2nd word (upper 8 bits): Send data 1 • 2nd word (lower 8 bits): Send data 2 • 3rd word (upper 8 bits): Send data 3 • 3rd word (lower 8 bits): Send data 4 : • n(th) word (upper 8 bits): Send data (n-1)×2-1 • n(th) word (lower 8 bits): Send data (n-1)×2 The range of send data length varies depending on the connection No. • Connection No.1 to No.8: 1 to 2046 Connection No.9 to No.16: 1 to 10238

Output arguments

No.	Variable name	Name	Data type	Description	Default value
(5)	o_bENO	Execution status	Bit	On: The execution command is turned on. Off: The execution command is turned off.	Off
(6)	o_bOK	Normal completion	Bit	The FB has been processed normally when this argument is on.	Off
(7)	o_bErr	Error completion	Bit	The FB has been processed abnormally when this argument is on.	Off
(8)	o_uErrId	Error code	Word [Unsigned]/Bit String [16-bit]	An error code is stored at error completion.	0

FB details

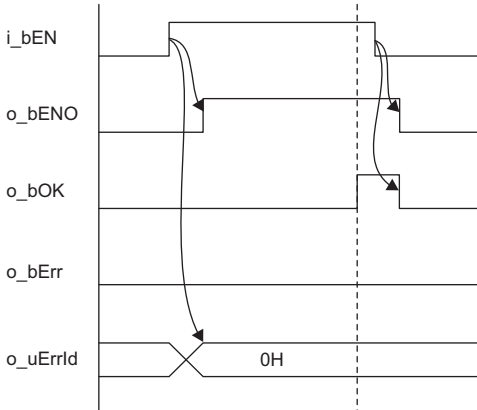
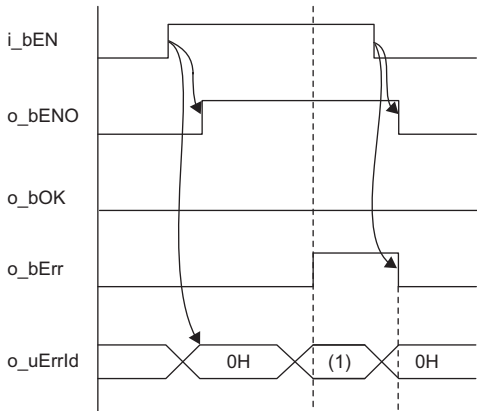
Item	Description	
Available device	Target module	RJ71GN11-EIP
	CPU module	RCPU
	Engineering tool	GX Works3
Language	Ladder diagram	
Number of basic steps	41 steps The number of steps of the FB embedded in a program depends on the CPU module used, the input/output definitions, and the option settings of GX Works3. For the option settings of GX Works3, refer to the GX Works3 Operating Manual.	
Processing	When i_bEN (execution command) is turned on, this function sends the data to the external device of the connection specified by the input argument.	
FB compilation method	Macro type	
FB operation	Pulse type (multiple-scan execution type)	
Timing chart of I/O signals	<ul style="list-style-type: none"> For normal completion  <ul style="list-style-type: none"> For error completion (same as in the case of a module error)  <p>(1) Error code</p>	
Precautions	<ul style="list-style-type: none"> This FB cannot be executed for the connection that is being used by another FB or a dedicated instruction. An error occurs if this FB is executed for the connection in use. Turn off i_bEN (execution command) after o_bOK (normal completion) or o_bErr (error completion) is turned on. By turning off i_bEN (execution command), o_bOK (normal completion) or o_bErr (error completion) is turned off and o_uErrld (error code) is cleared to 0. 	

Error codes

Error code	Reference
C000H to CFFFH	 MELSEC iQ-R CC-Link IE TSN Plus Master/Local Module User's Manual

4.16 M+model_Refresh_Data

Name

M+RJ71GN11_SE_Refresh_Data

Overview

Item	Description
Overview	Transfers the data from the buffer memory in the target module to the module label.
Symbol	

Labels

Input arguments

No.	Variable name	Name	Data type	Range	Description
(1)	i_bEN	Execution command	Bit	—	On: Start FB. Off: Do not start FB.
(2)	i_stModule	Module label	Structure	—	Specify the module for which the FB is to be executed. Specify the module label of the modules. (Example: GN11_SE_1)

Output arguments

No.	Variable name	Name	Data type	Description	Default value
(3)	o_bENO	Execution status	Bit	On: The execution command is turned on. Off: The execution command is turned off.	Off

FB details

Item	Description
Available device	Target module RJ71GN11-EIP
	CPU module RCPU
	Engineering tool GX Works3
Language	Ladder diagram
Number of basic steps	44 steps The number of steps of the FB embedded in a program depends on the CPU module used, the input/output definitions, and the option settings of GX Works3. For the option settings of GX Works3, refer to the GX Works3 Operating Manual.
Processing	When i_bEN (execution command) is turned on, this function transfers the following buffer memory data of the target module to the module label. <ul style="list-style-type: none"> 'Open completion signal' (Un\G6291456) 'Open request signal' (Un\G6291464) 'Socket reception status signal' (Un\G6291472)
FB compilation method	Macro type
FB operation	ON-time execution type
Timing chart of I/O signals	<p>The timing chart shows two signals: i_bEN (input) and o_bENO (output). i_bEN is a pulse that starts at a certain point and ends at a later point. o_bENO is a signal that becomes active (high) immediately after i_bEN starts and remains active until i_bEN ends. This indicates that o_bENO is active for the entire duration of i_bEN.</p>
Precautions	When another FB is used, write the program so that this FB is executed every scan, at the beginning of the program.

Error codes

This FB has no error code.

5 CC-Link IE Controller Network-EQUIPPED MODULE FB

5.1 M+model_DeviceRead

The FB is the same as M+model_DeviceRead of the Ethernet-equipped module FB. (☞ Page 15 M+model_DeviceRead)

5.2 M+model_DeviceWrite

The FB is the same as M+model_DeviceWrite of the Ethernet-equipped module FB. (☞ Page 20 M+model_DeviceWrite)

5.3 M+model_Send

The FB is the same as M+model_Send of the Ethernet-equipped module FB. (☞ Page 26 M+model_Send)

5.4 M+model_Recv

The FB is the same as M+model_Recv of the Ethernet-equipped module FB. (☞ Page 32 M+model_Recv)

5.5 M+model_RemoteStopRun

The FB is the same as M+model_RemoteStopRun of the Ethernet-equipped module FB. (☞ Page 37 M+model_RemoteStopRun)

5.6 M+model_ReadTime

The FB is the same as M+model_ReadTime of the Ethernet-equipped module FB. (☞ Page 42 M+model_ReadTime)

5.7 M+model_WriteTime

The FB is the same as M+model_WriteTime of the Ethernet-equipped module FB. ( Page 46 M+model_WriteTime)

5.8 M+model_StationNoSet

Name

■RJ71EN71, RnENCPU (network part)

This FB is displayed as follows on the engineering tool depending on the settings.

Name	Module model name	
	RJ71EN71	RnENCPU (network part)
M+RJ71EN71_C_StationNoSet	RJ71EN71(CCIEC)	_RJ71EN71(CCIEC)
M+RJ71EN71_EC_StationNoSet	RJ71EN71(E+CCIEC)	_RJ71EN71(E+IEC)
M+RJ71EN71_F_StationNoSet	RJ71EN71(CCIEF)	_RJ71EN71(CCIEF)
M+RJ71EN71_EF_StationNoSet	RJ71EN71(E+CCIEF)	_RJ71EN71(E+IEF)

■RJ71GP21(S)-SX

M+RJ71GP21_StationNoSet

■RJ71GF11-T2

M+RJ71GF11_StationNoSet

5

Overview

Item	Description
Overview	Sets the station number of the own station.
Symbol	<p>The above FB is an example for the RJ71GP21-SX.</p>

Labels

■Input arguments

No.	Variable name	Name	Data type	Range	Description
(1)	i_bEN	Execution command	Bit	—	On: Start FB. Off: Do not start FB.
(2)	i_stModule	Module label	Structures	—	Specify the module for which the FB is to be executed. Specify the module label of the modules. (Example: EN71_EE_1, EN71_EF_1, EN71_F_1, GF11_1, GP21_1)
(3)	i_uSetStationNo	Setting station number	Word [Unsigned]/ Bit String [16-bit]	1 to 120	Specifies the station number to be set.

■ Output arguments



No.	Variable name	Name	Data type	Description	Default value
(4)	o_bENO	Execution status	Bit	On: The execution command is turned on. Off: The execution command is turned off.	Off
(5)	o_bOK	Normal completion	Bit	The FB has been processed normally when this argument is on.	Off
(6)	o_bErr	Error completion	Bit	The FB has been processed abnormally when this argument is on.	Off
(7)	o_uErrId	Error code	Word [Unsigned]/ Bit String [16-bit]	An error code is stored at error completion.	0

FB details

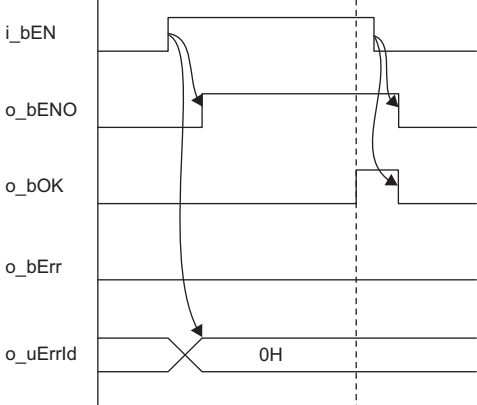
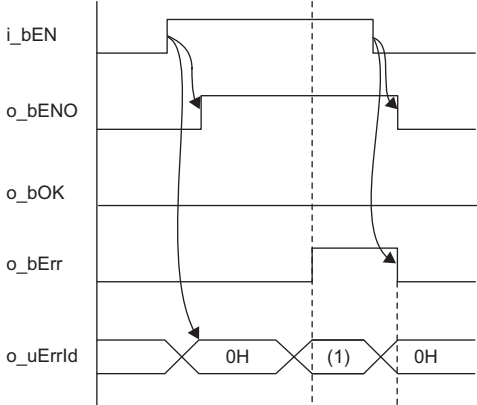
Item	Description
Available device	Target module
	CPU module
	Engineering tool
Language	Ladder diagram
Number of basic steps	44 steps The number of steps of the FB embedded in a program depends on the CPU module used, the input/output definitions, and the option settings of GX Works3. For the option settings of GX Works3, refer to GX Works3 Operating Manual.
Processing	When i_bEN (execution instruction) is turned on, this function sets the station number of the own station.
FB compilation method	Macro type
FB operation	Pulse type (multiple-scan execution type)
Input condition for FB_EN	None

Item	Description
Timing chart of I/O signals	<ul style="list-style-type: none"> For normal completion  <ul style="list-style-type: none"> For error completion (same as in the case of a module error)  <p>(1) Error code</p>
Precautions	<ul style="list-style-type: none"> This FB does not include error recovery processing. Please create error recovery processing separately according to the system and required operations. This FB uses the GP.UINI instruction. Turn off i_bEN (execution command) after o_bOK (normal completion) or o_bErr (error completion) is turned on. By turning off i_bEN (execution command), o_bOK (normal completion) or o_bErr (error completion) is turned off and o_uErrld (error code) is cleared to 0. When this FB is executed, an operation error may occur in the programmable controller CPU. In this case, check the detailed information of the operation error in event history and correct the input argument of the module FB.

Error codes

Error code	Reference
D000H to DFFFH	 MELSEC iQ-R CC-Link IE Field Network User's Manual (Application)
E000H to EFFFH	 MELSEC iQ-R CC-Link IE Controller Network User's Manual (Application)

5.9 M+model_RedundantSystem_GetAddress

Name

■RJ71GP21(S)-SX

M+RJ71GP21_RedundantSystem_GetAddress

■RJ71GF11-T2

M+RJ71GF11_RedundantSystem_GetAddress

■RJ71LP21-25

M+RJ71LP21_RedundantSystem_GetAddress

Overview

Item	Description																																										
Overview	Identifies the control system or standby system in the target (another station) redundant system and acquires the address of the control system or standby system in the redundant system.																																										
Symbol	<div style="border: 1px solid black; padding: 10px; margin: 10px 0;"> <p style="text-align: center;">M+RJ71GP21_RedundantSystem_GetAddress</p> <table style="width: 100%; border-collapse: collapse;"> <tr> <td style="width: 10%; vertical-align: top;">(1) —</td> <td style="width: 40%;">B: i_bEN</td> <td style="width: 10%;"></td> <td style="width: 20%;"></td> <td style="width: 10%;"></td> <td style="width: 10%; text-align: right;">(5)</td> </tr> <tr> <td style="vertical-align: top;">(2) —</td> <td>DUT: i_stModule</td> <td></td> <td>o_bENO: B</td> <td></td> <td style="text-align: right;">(6)</td> </tr> <tr> <td style="vertical-align: top;">(3) —</td> <td>UW: i_u2SystemA_TargetAddress</td> <td></td> <td>o_bOK: B</td> <td></td> <td style="text-align: right;">(7)</td> </tr> <tr> <td style="vertical-align: top;">(4) —</td> <td>UW: i_u2SystemB_TargetAddress</td> <td></td> <td>o_bErr: B</td> <td></td> <td style="text-align: right;">(8)</td> </tr> <tr> <td></td> <td></td> <td></td> <td>o_uErrId: UW</td> <td></td> <td style="text-align: right;">(9)</td> </tr> <tr> <td></td> <td></td> <td></td> <td>o_u2TargetAddress: UW</td> <td></td> <td style="text-align: right;">(9)</td> </tr> <tr> <td></td> <td style="text-align: center;">pbi_uTargetSystem_Type (10)</td> <td></td> <td></td> <td></td> <td></td> </tr> </table> </div> <p>The above FB is an example for the RJ71GP21-SX.</p>	(1) —	B: i_bEN				(5)	(2) —	DUT: i_stModule		o_bENO: B		(6)	(3) —	UW: i_u2SystemA_TargetAddress		o_bOK: B		(7)	(4) —	UW: i_u2SystemB_TargetAddress		o_bErr: B		(8)				o_uErrId: UW		(9)				o_u2TargetAddress: UW		(9)		pbi_uTargetSystem_Type (10)				
(1) —	B: i_bEN				(5)																																						
(2) —	DUT: i_stModule		o_bENO: B		(6)																																						
(3) —	UW: i_u2SystemA_TargetAddress		o_bOK: B		(7)																																						
(4) —	UW: i_u2SystemB_TargetAddress		o_bErr: B		(8)																																						
			o_uErrId: UW		(9)																																						
			o_u2TargetAddress: UW		(9)																																						
	pbi_uTargetSystem_Type (10)																																										

Labels

■Input arguments

No.	Variable name	Name	Data type	Range	Description
(1)	i_bEN	Execution command	Bit	—	On: Start FB. Off: Do not start FB.
(2)	i_stModule	Module label	Structures	—	Specify the module for which the FB is to be executed. Specify the module label of the modules.
(3)	i_u2SystemA_Target Address	System A target station address	Word [Unsigned]/ Bit String [16-bit] (0..1)	—	Specify the network number and station number of the system A target station. <ul style="list-style-type: none"> 1st word: Network number (1 to 239) 2nd word: Station number Network number <ul style="list-style-type: none"> Set the network number same as that of the FB executing station. Station number of CC-Link IE Controller Network <ul style="list-style-type: none"> 1 to 120 Station number of CC-Link IE Field Network <ul style="list-style-type: none"> 125: Master station 1 to 120: Local station, submaster station Station number of MELSECNET/H <ul style="list-style-type: none"> 1 to 64
(4)	i_u2SystemB_Target Address	System B target station address	Word [Unsigned]/ Bit String [16-bit] (0..1)	—	Specify the network number and station number of the system B target station. <ul style="list-style-type: none"> 1st word: Network number (1 to 239) 2nd word: Station number Network number <ul style="list-style-type: none"> Set the network number same as that of the FB executing station. Station number of CC-Link IE Controller Network <ul style="list-style-type: none"> 1 to 120 Station number of CC-Link IE Field Network <ul style="list-style-type: none"> 125: Master station 1 to 120: Local station, submaster station Station number of MELSECNET/H <ul style="list-style-type: none"> 1 to 64

Output arguments

No.	Variable name	Name	Data type	Description	Default value
(5)	o_bENO	Execution status	Bit	On: The execution command is turned on. Off: The execution command is turned off.	Off
(6)	o_bOK	Normal completion	Bit	The FB has been processed normally when this argument is on.	Off
(7)	o_bErr	Error completion	Bit	The FB has been processed abnormally when this argument is on.	Off
(8)	o_uErrId	Error code	Word [Unsigned]/ Bit String [16-bit]	An error code is stored at error completion.	0
(9)	o_u2TargetAddress	Target station address	Word [Unsigned]/ Bit String [16-bit] (0..1)	The target station address of the current control system or standby system in the target redundant system is stored. <ul style="list-style-type: none"> 1st word: Network number (1 to 239) 2nd word: Station number Network number <ul style="list-style-type: none"> The network number same as that of the FB executing station is stored. Station number of CC-Link IE Controller Network <ul style="list-style-type: none"> 1 to 120 Station number of CC-Link IE Field Network <ul style="list-style-type: none"> 125: Master station 1 to 120: Local station, submaster station Station number of MELSECNET/H <ul style="list-style-type: none"> 1 to 64 	0

Operation parameters

No.	Variable name	Name	Data type	Range	Description	Default value
(10)	pbi_uTargetSystem_Type	Target system type	Word [Unsigned]/ Bit String [16-bit]	0 to 1	Specify the type of the target system. <ul style="list-style-type: none"> 0: Control system 1: Standby system 	0

FB details

Item	Description
Available device	Target module <ul style="list-style-type: none"> RJ71GF11-T2^{*1} RJ71GP21(S)-SX RJ71LP21-25 CPU module RCPU Engineering tool GX Works3
Language	Ladder diagram
Number of basic steps	<ul style="list-style-type: none"> RJ71GF11-T2: 425 steps RJ71GP21(S)-SX: 237 steps RJ71LP21-25: 237 steps The number of steps of the FB embedded in a program depends on the CPU module used, the input/output definitions, and the option settings of GX Works3. For the option settings of GX Works3, refer to GX Works3 Operating Manual.
Processing	When i_bEN (execution instruction) is turned on, this function identifies the control system or standby system in the target (another station) redundant system and acquires the address of the control system or standby system in the redundant system. This FB is used in combination with the following FBs. <ul style="list-style-type: none"> DeviceRead DeviceWrite Send RemoteStopRun ReadTime WriteTime The procedure when this FB is used with DeviceRead is shown below. To execute DeviceRead to the control system in the redundant system, execute DeviceRead to the target station address of the control system which is acquired by this FB. <ol style="list-style-type: none"> Specify the system A and system B target station addresses and execute this FB. (Specify the control system.) The target station address of the control system is output. Set the target station address of the control system to i_u2TargetAddress of DeviceRead and execute DeviceRead. DeviceRead is executed to the control system.
FB compilation method	Macro type
FB operation	ON-time execution type

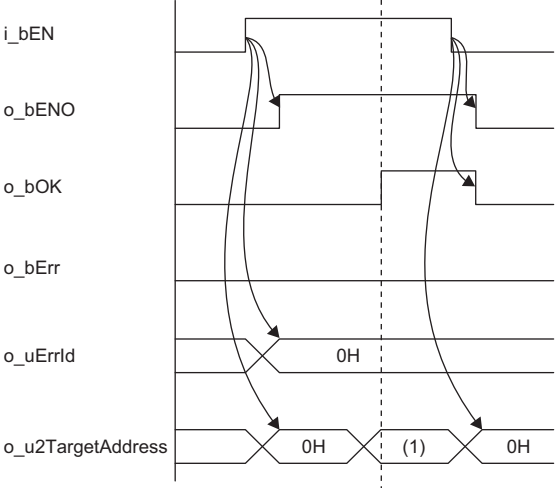
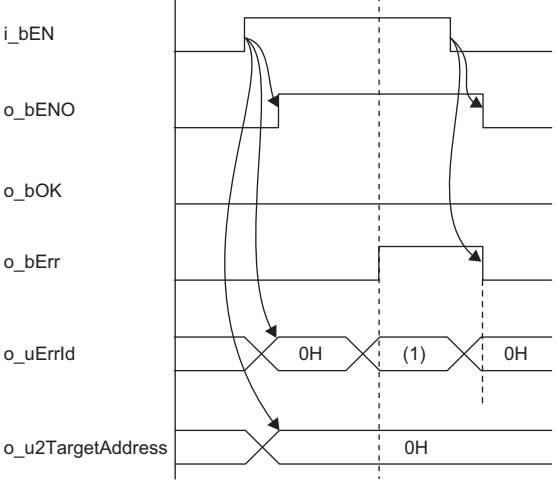
Item	Description
Input condition for FB_EN	None
Timing chart of I/O signals	<p>• For normal completion</p>  <p>(1) Target station address</p> <p>• For error completion (same as in the case of a module error)</p>  <p>(1) Error code</p>
Precautions	<ul style="list-style-type: none"> • When using this FB, set "Module Label" for the refresh target device of SB and SW in "Refresh Setting" of "Basic Settings". • This FB does not include error recovery processing. Please create error recovery processing separately according to the system and required operations. • Turn off i_bEN (execution command) after o_bOK (normal completion) or o_bErr (error completion) is turned on. By turning off i_bEN (execution command), o_bOK (normal completion) or o_bErr (error completion) is turned off and o_uErrId (error code) is cleared to 0. • This FB can be executed only for the redundant system of the same network number. • This FB cannot be executed for redundant line configuration on CC-Link IE Field Network. • This FB is enabled when 'Baton pass status of own station' (SB0047) is on. • When the target station is the master station or submaster station, this FB cannot detect whether it is in a redundant system. • Even when the station number which does not exist in the network configuration setting is specified, it may completed successfully. • For "System A target station address" and "System B target station address", specify the addresses of the pairing-set stations. In CC-Link IE Field Network, specify the addresses of the pairing-set stations or the combination of the master station and submaster station. • When this FB is executed, an operation error may occur in the programmable controller CPU. In this case, check the detailed information of the operation error in event history and correct the input argument of the module FB.

*1 The supported firmware version is "12" or later.

Error codes

Error code	Description	Action
100H	A value out of the range is set in a target station address of the argument.	Correct the range of the target station address.
101H	The network number of the target station differs from that of the FB executing station.	Set the network number same as that of the FB executing station.
102H	The same value is set in the system A and system B target station addresses of the argument.	Set the different value in the system A and system B target station addresses.
200H	The target station (station of control system or standby system) does not exist in a network.	Correct the network connection of the target station.
201H	The target station is not in a redundant system.	Execute this FB to a redundant system.
202H	"Module Label" is not selected for the refresh target device in "Refresh Setting" of "Basic Settings".	Set "Module Label" for the refresh target device in "Refresh setting" of "Basic Settings".

6 CC-Link IE Field Network-EQUIPPED MASTER/ LOCAL MODULE FB

6.1 M+model_DeviceRead

The FB is the same as M+model_DeviceRead of the Ethernet-equipped module FB. (☞ Page 15 M+model_DeviceRead)

6.2 M+model_DeviceWrite

The FB is the same as M+model_DeviceWrite of the Ethernet-equipped module FB. (☞ Page 20 M+model_DeviceWrite)

6.3 M+model_Send

The FB is the same as M+model_Send of the Ethernet-equipped module FB. (☞ Page 26 M+model_Send)

6.4 M+model_Recv

The FB is the same as M+model_Recv of the Ethernet-equipped module FB. (☞ Page 32 M+model_Recv)

6.5 M+model_RemoteStopRun

The FB is the same as M+model_RemoteStopRun of the Ethernet-equipped module FB. (☞ Page 37 M+model_RemoteStopRun)

6.6 M+model_ReadTime

The FB is the same as M+model_ReadTime of the Ethernet-equipped module FB. (☞ Page 42 M+model_ReadTime)

6.7 M+model_WriteTime

The FB is the same as M+model_WriteTime of the Ethernet-equipped module FB. (🔗 Page 46 M+model_WriteTime)

6.8 M+model_SetParameter

Name

■RJ71EN71, RnENCPU (network part)

This FB is displayed as follows on the engineering tool depending on the settings.

Name	Module model name	
	RJ71EN71	RnENCPU (network part)
M+RJ71EN71_F_SetParameter	RJ71EN71(CCIEF)	_RJ71EN71(CCIEF)
M+RJ71EN71_EF_SetParameter	RJ71EN71(E+CCIEF)	_RJ71EN71(E+IEF)

■RJ71GF11-T2

M+RJ71GF11_SetParameter

Overview

Item	Description
Overview	Sets the parameters in the master, submaster, and local stations.

Item	Description				
Symbol	<div style="border: 1px solid black; padding: 10px; margin: 10px 0;"> <p style="text-align: center;">M_RJ71GF11_SetParameter</p> <table style="width: 100%; border-collapse: collapse;"> <tr> <td style="width: 50%; vertical-align: top;"> <p>(1) — B: i_bEN</p> <p>(2) — DUT: i_stModule</p> <p>(3) — UW: i_uTotalStations</p> <p>(4) — UW: i_u605NetworkConfigurationSet</p> <p>(5) — UW: i_u8ReservedStationSet</p> <p>(6) — UW: i_u8ErrInvalidStationSet</p> </td> <td style="width: 50%; vertical-align: top;"> <p>o_bENO: B (7)</p> <p>o_bOK: B (8)</p> <p>o_bErr: B (9)</p> <p>o_uErrId: UW (10)</p> </td> </tr> </table> <table style="width: 100%; border-collapse: collapse;"> <tr> <td style="width: 50%; vertical-align: top;"> <p style="padding-left: 40px;">pbi_uConstantLinkScanTime (11)</p> <p style="padding-left: 40px;">pbi_ulpAddress (12)</p> <p style="padding-left: 20px;">pbi_bNetworkConfigurationSetFlg (13)</p> <p style="padding-left: 20px;">pbi_bReservedStationSetFlg (14)</p> <p style="padding-left: 20px;">pbi_bErrInvalidStationSetFlg (15)</p> <p style="padding-left: 40px;">pbi_bSubMasterSet (16)</p> <p style="padding-left: 40px;">pbi_bIP_PacketTransferFlg (17)</p> <p style="padding-left: 20px;">pbi_bDatalinkFaultyStationSet (18)</p> <p style="padding-left: 20px;">pbi_bCPU_StopOutputSet (19)</p> <p style="padding-left: 20px;">pbi_bCPU_StopErrOutputSet (20)</p> <p style="padding-left: 40px;">pbi_bLinkScanModeSet (21)</p> <p style="padding-left: 40px;">pbi_bTopologySet (22)</p> <p style="padding-left: 40px;">pbi_bMasterReturnSet (23)</p> <p style="padding-left: 20px;">pbi_bSubMasterOperateParam (24)</p> </td> <td style="width: 50%;"></td> </tr> </table> </div> <p>The above FB is an example for the RJ71GF11-T2.</p>	<p>(1) — B: i_bEN</p> <p>(2) — DUT: i_stModule</p> <p>(3) — UW: i_uTotalStations</p> <p>(4) — UW: i_u605NetworkConfigurationSet</p> <p>(5) — UW: i_u8ReservedStationSet</p> <p>(6) — UW: i_u8ErrInvalidStationSet</p>	<p>o_bENO: B (7)</p> <p>o_bOK: B (8)</p> <p>o_bErr: B (9)</p> <p>o_uErrId: UW (10)</p>	<p style="padding-left: 40px;">pbi_uConstantLinkScanTime (11)</p> <p style="padding-left: 40px;">pbi_ulpAddress (12)</p> <p style="padding-left: 20px;">pbi_bNetworkConfigurationSetFlg (13)</p> <p style="padding-left: 20px;">pbi_bReservedStationSetFlg (14)</p> <p style="padding-left: 20px;">pbi_bErrInvalidStationSetFlg (15)</p> <p style="padding-left: 40px;">pbi_bSubMasterSet (16)</p> <p style="padding-left: 40px;">pbi_bIP_PacketTransferFlg (17)</p> <p style="padding-left: 20px;">pbi_bDatalinkFaultyStationSet (18)</p> <p style="padding-left: 20px;">pbi_bCPU_StopOutputSet (19)</p> <p style="padding-left: 20px;">pbi_bCPU_StopErrOutputSet (20)</p> <p style="padding-left: 40px;">pbi_bLinkScanModeSet (21)</p> <p style="padding-left: 40px;">pbi_bTopologySet (22)</p> <p style="padding-left: 40px;">pbi_bMasterReturnSet (23)</p> <p style="padding-left: 20px;">pbi_bSubMasterOperateParam (24)</p>	
<p>(1) — B: i_bEN</p> <p>(2) — DUT: i_stModule</p> <p>(3) — UW: i_uTotalStations</p> <p>(4) — UW: i_u605NetworkConfigurationSet</p> <p>(5) — UW: i_u8ReservedStationSet</p> <p>(6) — UW: i_u8ErrInvalidStationSet</p>	<p>o_bENO: B (7)</p> <p>o_bOK: B (8)</p> <p>o_bErr: B (9)</p> <p>o_uErrId: UW (10)</p>				
<p style="padding-left: 40px;">pbi_uConstantLinkScanTime (11)</p> <p style="padding-left: 40px;">pbi_ulpAddress (12)</p> <p style="padding-left: 20px;">pbi_bNetworkConfigurationSetFlg (13)</p> <p style="padding-left: 20px;">pbi_bReservedStationSetFlg (14)</p> <p style="padding-left: 20px;">pbi_bErrInvalidStationSetFlg (15)</p> <p style="padding-left: 40px;">pbi_bSubMasterSet (16)</p> <p style="padding-left: 40px;">pbi_bIP_PacketTransferFlg (17)</p> <p style="padding-left: 20px;">pbi_bDatalinkFaultyStationSet (18)</p> <p style="padding-left: 20px;">pbi_bCPU_StopOutputSet (19)</p> <p style="padding-left: 20px;">pbi_bCPU_StopErrOutputSet (20)</p> <p style="padding-left: 40px;">pbi_bLinkScanModeSet (21)</p> <p style="padding-left: 40px;">pbi_bTopologySet (22)</p> <p style="padding-left: 40px;">pbi_bMasterReturnSet (23)</p> <p style="padding-left: 20px;">pbi_bSubMasterOperateParam (24)</p>					

Labels

Input arguments

No.	Variable name	Name	Data type	Range	Description																																																																																																																																																											
(1)	i_bEN	Execution command	Bit	—	On: Start FB. Off: Do not start FB.																																																																																																																																																											
(2)	i_stModule	Module label	Structures	—	Specify the module for which the FB is to be executed. Specify the module label of the modules.																																																																																																																																																											
(3)	i_uTotalStations	Total number of slave stations	Word [Unsigned]/ Bit String [16-bit]	1 to 120, 121	Specify the total number of the slave stations connected. • 1 to 120: Applicable when "Presence of submaster function" is off (disabled) • 1 to 121: Applicable when "Presence of submaster function" is on (enabled)																																																																																																																																																											
(4)	i_u605NetworkConfigurationSet	Network configuration setting data	Word [Unsigned]/ Bit String [16-bit] (0..604)	—	Specify the start address of the storage location of network configuration setting data. When specifying the address using a label, use an array as the data type. Set data for the number of stations specified in "Total number of slave stations". ( Page 197 Network configuration setting data)																																																																																																																																																											
(5)	i_u8ReservedStationSet	Reserved station setting data	Word [Unsigned]/ Bit String [16-bit] (0..7)	—	Specify the start address of the storage location of the reserved-station setting data. When specifying the address using a label, use an array as the data type. Setting: Specify an error invalid station. (No default value) • 0: Not specified • 1: Specified <table border="1" style="margin-left: 40px;"> <thead> <tr> <th></th> <th>b15</th><th>b14</th><th>b13</th><th>b12</th><th>b11</th><th>b10</th><th>b9</th><th>b8</th><th>b7</th><th>b6</th><th>b5</th><th>b4</th><th>b3</th><th>b2</th><th>b1</th><th>b0</th> </tr> </thead> <tbody> <tr><td>+0</td><td>16</td><td>15</td><td>14</td><td>13</td><td>12</td><td>11</td><td>10</td><td>9</td><td>8</td><td>7</td><td>6</td><td>5</td><td>4</td><td>3</td><td>2</td><td>1</td></tr> <tr><td>+1</td><td>32</td><td>31</td><td>30</td><td>29</td><td>28</td><td>27</td><td>26</td><td>25</td><td>24</td><td>23</td><td>22</td><td>21</td><td>20</td><td>19</td><td>18</td><td>17</td></tr> <tr><td>+2</td><td>48</td><td>47</td><td>46</td><td>45</td><td>44</td><td>43</td><td>42</td><td>41</td><td>40</td><td>39</td><td>38</td><td>37</td><td>36</td><td>35</td><td>34</td><td>33</td></tr> <tr><td>+3</td><td>64</td><td>63</td><td>62</td><td>61</td><td>60</td><td>59</td><td>58</td><td>57</td><td>56</td><td>55</td><td>54</td><td>53</td><td>52</td><td>51</td><td>50</td><td>49</td></tr> <tr><td>+4</td><td>80</td><td>79</td><td>78</td><td>77</td><td>76</td><td>75</td><td>74</td><td>73</td><td>72</td><td>71</td><td>70</td><td>69</td><td>68</td><td>67</td><td>66</td><td>65</td></tr> <tr><td>+5</td><td>96</td><td>95</td><td>94</td><td>93</td><td>92</td><td>91</td><td>90</td><td>89</td><td>88</td><td>87</td><td>86</td><td>85</td><td>84</td><td>83</td><td>82</td><td>81</td></tr> <tr><td>+6</td><td>112</td><td>111</td><td>110</td><td>109</td><td>108</td><td>107</td><td>106</td><td>105</td><td>104</td><td>103</td><td>102</td><td>101</td><td>100</td><td>99</td><td>98</td><td>97</td></tr> <tr><td>+7</td><td colspan="8" style="text-align: center;">-</td><td>120</td><td>119</td><td>118</td><td>117</td><td>116</td><td>115</td><td>114</td><td>113</td><td colspan="2"></td></tr> </tbody> </table> Numbers 1 to 120 in the table indicate station numbers.		b15	b14	b13	b12	b11	b10	b9	b8	b7	b6	b5	b4	b3	b2	b1	b0	+0	16	15	14	13	12	11	10	9	8	7	6	5	4	3	2	1	+1	32	31	30	29	28	27	26	25	24	23	22	21	20	19	18	17	+2	48	47	46	45	44	43	42	41	40	39	38	37	36	35	34	33	+3	64	63	62	61	60	59	58	57	56	55	54	53	52	51	50	49	+4	80	79	78	77	76	75	74	73	72	71	70	69	68	67	66	65	+5	96	95	94	93	92	91	90	89	88	87	86	85	84	83	82	81	+6	112	111	110	109	108	107	106	105	104	103	102	101	100	99	98	97	+7	-								120	119	118	117	116	115	114	113		
	b15	b14	b13	b12	b11	b10	b9	b8	b7	b6	b5	b4	b3	b2	b1	b0																																																																																																																																																
+0	16	15	14	13	12	11	10	9	8	7	6	5	4	3	2	1																																																																																																																																																
+1	32	31	30	29	28	27	26	25	24	23	22	21	20	19	18	17																																																																																																																																																
+2	48	47	46	45	44	43	42	41	40	39	38	37	36	35	34	33																																																																																																																																																
+3	64	63	62	61	60	59	58	57	56	55	54	53	52	51	50	49																																																																																																																																																
+4	80	79	78	77	76	75	74	73	72	71	70	69	68	67	66	65																																																																																																																																																
+5	96	95	94	93	92	91	90	89	88	87	86	85	84	83	82	81																																																																																																																																																
+6	112	111	110	109	108	107	106	105	104	103	102	101	100	99	98	97																																																																																																																																																
+7	-								120	119	118	117	116	115	114	113																																																																																																																																																
(6)	i_u8ErrInvalidStationSet	Error invalid station setting data	Word [Unsigned]/ Bit String [16-bit] (0..7)	—	Specify the start address of the storage location of the error invalid station setting. When specifying the address using a label, use an array as the data type. Setting: Specify a reserved station. • 0: Not specified • 1: Specified If both an error invalid station and a reserved station are specified for the same station, the reserved station will take priority. <table border="1" style="margin-left: 40px;"> <thead> <tr> <th></th> <th>b15</th><th>b14</th><th>b13</th><th>b12</th><th>b11</th><th>b10</th><th>b9</th><th>b8</th><th>b7</th><th>b6</th><th>b5</th><th>b4</th><th>b3</th><th>b2</th><th>b1</th><th>b0</th> </tr> </thead> <tbody> <tr><td>+0</td><td>16</td><td>15</td><td>14</td><td>13</td><td>12</td><td>11</td><td>10</td><td>9</td><td>8</td><td>7</td><td>6</td><td>5</td><td>4</td><td>3</td><td>2</td><td>1</td></tr> <tr><td>+1</td><td>32</td><td>31</td><td>30</td><td>29</td><td>28</td><td>27</td><td>26</td><td>25</td><td>24</td><td>23</td><td>22</td><td>21</td><td>20</td><td>19</td><td>18</td><td>17</td></tr> <tr><td>+2</td><td>48</td><td>47</td><td>46</td><td>45</td><td>44</td><td>43</td><td>42</td><td>41</td><td>40</td><td>39</td><td>38</td><td>37</td><td>36</td><td>35</td><td>34</td><td>33</td></tr> <tr><td>+3</td><td>64</td><td>63</td><td>62</td><td>61</td><td>60</td><td>59</td><td>58</td><td>57</td><td>56</td><td>55</td><td>54</td><td>53</td><td>52</td><td>51</td><td>50</td><td>49</td></tr> <tr><td>+4</td><td>80</td><td>79</td><td>78</td><td>77</td><td>76</td><td>75</td><td>74</td><td>73</td><td>72</td><td>71</td><td>70</td><td>69</td><td>68</td><td>67</td><td>66</td><td>65</td></tr> <tr><td>+5</td><td>96</td><td>95</td><td>94</td><td>93</td><td>92</td><td>91</td><td>90</td><td>89</td><td>88</td><td>87</td><td>86</td><td>85</td><td>84</td><td>83</td><td>82</td><td>81</td></tr> <tr><td>+6</td><td>112</td><td>111</td><td>110</td><td>109</td><td>108</td><td>107</td><td>106</td><td>105</td><td>104</td><td>103</td><td>102</td><td>101</td><td>100</td><td>99</td><td>98</td><td>97</td></tr> <tr><td>+7</td><td colspan="8" style="text-align: center;">-</td><td>120</td><td>119</td><td>118</td><td>117</td><td>116</td><td>115</td><td>114</td><td>113</td><td colspan="2"></td></tr> </tbody> </table> Numbers 1 to 120 in the table indicate station numbers.		b15	b14	b13	b12	b11	b10	b9	b8	b7	b6	b5	b4	b3	b2	b1	b0	+0	16	15	14	13	12	11	10	9	8	7	6	5	4	3	2	1	+1	32	31	30	29	28	27	26	25	24	23	22	21	20	19	18	17	+2	48	47	46	45	44	43	42	41	40	39	38	37	36	35	34	33	+3	64	63	62	61	60	59	58	57	56	55	54	53	52	51	50	49	+4	80	79	78	77	76	75	74	73	72	71	70	69	68	67	66	65	+5	96	95	94	93	92	91	90	89	88	87	86	85	84	83	82	81	+6	112	111	110	109	108	107	106	105	104	103	102	101	100	99	98	97	+7	-								120	119	118	117	116	115	114	113		
	b15	b14	b13	b12	b11	b10	b9	b8	b7	b6	b5	b4	b3	b2	b1	b0																																																																																																																																																
+0	16	15	14	13	12	11	10	9	8	7	6	5	4	3	2	1																																																																																																																																																
+1	32	31	30	29	28	27	26	25	24	23	22	21	20	19	18	17																																																																																																																																																
+2	48	47	46	45	44	43	42	41	40	39	38	37	36	35	34	33																																																																																																																																																
+3	64	63	62	61	60	59	58	57	56	55	54	53	52	51	50	49																																																																																																																																																
+4	80	79	78	77	76	75	74	73	72	71	70	69	68	67	66	65																																																																																																																																																
+5	96	95	94	93	92	91	90	89	88	87	86	85	84	83	82	81																																																																																																																																																
+6	112	111	110	109	108	107	106	105	104	103	102	101	100	99	98	97																																																																																																																																																
+7	-								120	119	118	117	116	115	114	113																																																																																																																																																

Network configuration setting data

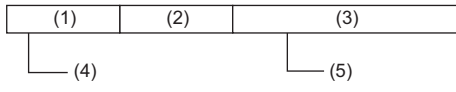
Element number	Item name		Range	Description
0	For 1st module	Slave station setting information	—	Specify the station type and number. b15 ... b12 b11 ... b8 b7 ... b0  (1) Station type (2) Fixed to 1 (3) Station number (4) 0: Remote I/O station, 1: Remote device station, 2: Intelligent device station, 3: Local station (master-slave system), 4: Submaster station, F: Master station (5) 0: Master station, 1 to 120: Station number
1		RX/Ry offset	0 to 16368	Specify the offset value from the head of RX/Ry in increments of 16 points.
2		Number of RX/Ry points	—	Specify the number of RX/Ry points in increments of 16 points. • Master station, local station: 0 to 2048 • Intelligent device station: 0 to 2048 • Remote I/O station: 0 to 64 • Remote device station: 0 to 128
3		RWr/RWw offset	0 to 8188	Specify the offset value from the head of RWr/RWw/LW in increments of 4 points.
4		Number of RWr/RWw points	—	Specify the number of RWr/RWw points in increments of 16 points. • Master station, local station: 0 to 1024 • Intelligent device station: 0 to 1024 • Remote device station: 0 to 64
5 to 599	Setting for the 2nd to 120th module			
600	For 121st module	Slave station setting information	Same as for the 1st module	
601		RX/Ry offset		
602		Number of RX/Ry points		
603		RWr/RWw offset		
604		Number of RWr/RWw points		

If the specified total number of slave stations does not match the individual station setting data, the total number of individual stations specified in the total number of slave stations take precedence and any individual station information exceeding the total number of slave stations is ignored. Note that 1 is added to the total number of slave stations when "Presence of submaster function" is on (enabled).

Example) When the station information of 10 stations is set even if the total number of slave stations is 2.

→ The 1st and 2nd information is enabled and parameters which are set the 3rd to 10th station information are ignored.

Output arguments

No.	Variable name	Name	Data type	Description	Default value
(7)	o_bENO	Execution status	Bit	On: The execution command is turned on. Off: The execution command is turned off.	Off
(8)	o_bOK	Normal completion	Bit	The FB has been processed normally when this argument is on.	Off
(9)	o_bErr	Error completion	Bit	The FB has been processed abnormally when this argument is on.	Off
(10)	o_uErrId	Error code	Word [unsigned]	An error code is stored at error completion.	0

■ Operation parameters

○: Can be set, ×: Cannot be set

No.	Variable name	Name	Data type	Range	Description	Default value	Master station	Submaster station	Local station
(11)	pbi_uConstantLinkScanTime	Constant link scan time	Word [Unsigned]/ Bit String [16-bit]	0, 1 to 200	Specify the constant link scan time. • 0: Not set (default value) • 1 to 200: 1ms to 200ms	0	○	○ ^{*1}	×
(12)	pbi_ulpAddresses	Upper 2 digits of IP address	Word [Unsigned]/ Bit String [16-bit]	—	Set the IP address when the IP packet transfer function is used. Only the upper two digits (1st and 2nd octets) of a 4-digit IP address can be set. The 3rd and 4th digits are each determined automatically from the network number and station number (master station is 125).	0	○	○ ^{*1}	×
(13)	pbi_bNetworkConfigurationSetFlg	Presence of network configuration setting data	Bit	Off, on	Specify whether to enable/disable the network configuration setting data. • Off: Disable • On: Enable	Off	○	○ ^{*1}	×
(14)	pbi_bReservedStationSetFlg	Presence of reserved station specification data	Bit	Off, on	Specify whether to enable/disable the reserved station specification data. • Off: Disable • On: Enable	Off	○	○ ^{*1}	×
(15)	pbi_bErrInvalidStationSetFlg	Presence of error invalid station setting data	Bit	Off, on	Specify whether to enable/disable the error invalid station setting data. • Off: Disable • On: Enable	Off	○	○ ^{*1}	×
(16)	pbi_bSubMasterSet	Presence of submaster function	Bit	Off, on	Specify whether to use the submaster function • Off: Do not use. • On: Use.	Off	○	×	×
(17)	pbi_bIP_PacketTransferFlg	Presence of IP packet transfer function	Bit	Off, on	Specify whether to enable/disable the IP address. (Specify whether to enable/disable the IP packet transfer function.) • Off: Disable • On: Enable	Off	○	○ ^{*1}	×
(18)	pbi_bDataLinkFaultyStationSet	Data link faulty station setting	Bit	Off, on	Specify whether to hold or clear the input data from a data link faulty station. • Off: Clear • On: Hold	Off	○	○	○
(19)	pbi_bCPU_StopOutputSet	Output setting for CPU STOP	Bit	Off, on	Specify whether to hold or clear the output data when the operating status of a CPU module is STOP. • Off: Hold • On: Clear	Off	○	○	○
(20)	pbi_bCPU_StopErrOutputSet	Output setting for CPU stop error	Bit	Off, on	Specify whether to hold or clear the output data when the a CPU module caused a stop error. • Off: Clear • On: Hold	Off	○	○	○
(21)	pbi_bLinkScanModeSet	Link scan mode setting	Bit	Off, on	Specify whether to perform a link scan and sequence scan synchronously or asynchronously. (Valid when "Constant link scan time" is 0 (no setting)) • Off: Asynchronous • On: Synchronous	Off	○	○	×
(22)	pbi_bTopologySet	Network topology setting	Bit	Off, on	Specify the network topology. • Off: Line topology, star topology, or coexistence of star and line topologies • On: Ring topology	Off	○	○ ^{*1}	×

No.	Variable name	Name	Data type	Range	Description	Default value	Master station	Submaster station	Local station
(23)	pbi_bMasterReturnSet	Master station return time operation setting	Bit	Off, on	Specify the operation mode applicable when the master station returns. <ul style="list-style-type: none"> • Off: The master station returns as the master operating station. • On: The master station returns as the submaster operating station. 	Off	○	×	×
(24)	pbi_bSubMasterOperateParam	Submaster station parameter operation setting	Bit	Off, on	Specify which station parameters (master or own station) should be used for the submaster station to work. <ul style="list-style-type: none"> • Off: The submaster station operates with the parameters of the master station. • On: The submaster station operates with the parameters of the own (submaster) station. 	Off	×	○	×

*1 Valid only when "Submaster station parameter operation setting" is ON (Operating with the parameters of the own (submaster) station)

FB details

Item	Description
Available device	Target module <ul style="list-style-type: none"> • RJ71EN71 • RJ71GF11-T2 • RnENCPU (network part)
	CPU module <ul style="list-style-type: none"> • RCPUCPU
	Engineering tool <ul style="list-style-type: none"> • GX Works3
Language	Ladder diagram
Number of basic steps	79 steps The number of steps of the FB embedded in a program depends on the CPU module used, the input/output definitions, and the option settings of GX Works3. For the option settings of GX Works3, refer to GX Works3 Operating Manual.
Processing	When i_bEN (execution command) is turned on, this function sets parameters for a module.
FB compilation method	Macro type
FB operation	Pulse type (multiple-scan execution type)
Input condition for FB_EN	None

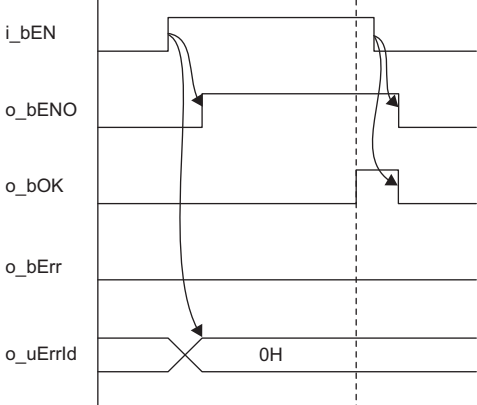
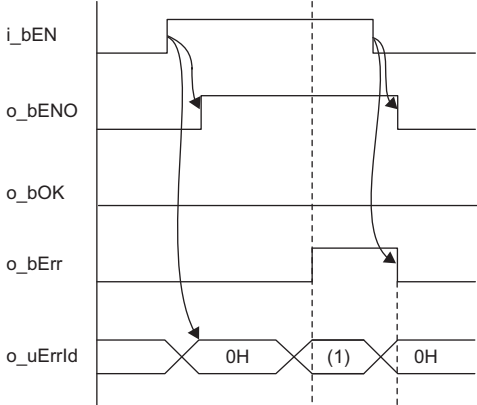
Item	Description
Timing chart of I/O signals	<ul style="list-style-type: none"> • For normal completion  <ul style="list-style-type: none"> • For error completion (same as in the case of a module error)  <p>(1) Error code</p>
Precautions	<ul style="list-style-type: none"> • This FB does not include error recovery processing. Please create error recovery processing separately according to the system and required operations. • This FB uses the GP.CCPASET instruction. • Turn off i_bEN (execution command) after o_bOK (normal completion) or o_bErr (error completion) is turned on. By turning off i_bEN (execution command), o_bOK (normal completion) or o_bErr (error completion) is turned off and o_uErrld (error code) is cleared to 0. • When this FB is executed, an operation error may occur in the programmable controller CPU. In this case, check the detailed information of the operation error in event history and correct the input argument of the module FB.

Error codes

Error code	Reference
D000H to DFFFH	 MELSEC iQ-R CC-Link IE Field Network User's Manual (Application)

6.9 M+model_SetParameterRedundant

Name

M+RJ71GF11_SetParameterRedundant

Overview

Item	Description																
Overview	Sets the parameters in the master station in the redundant system.																
Symbol	<div style="border: 1px solid black; padding: 10px;"> <p style="text-align: center;">M+RJ71GF11_SetParameterRedundant</p> <table style="width: 100%; border-collapse: collapse;"> <tr> <td style="width: 50%;">(1) — B: i_bEN</td> <td style="width: 50%;">o_bENO: B — (8)</td> </tr> <tr> <td>(2) — DUT: i_stModule</td> <td>o_bOK: B — (9)</td> </tr> <tr> <td>(3) — UW: i_uTotalStations</td> <td>o_bErr: B — (10)</td> </tr> <tr> <td>(4) — UW: i_u605NetworkConfigurationSet</td> <td>o_uErrId: UW — (11)</td> </tr> <tr> <td>(5) — UW: i_u8ReservedStationSet</td> <td></td> </tr> <tr> <td>(6) — UW: i_u8ErrInvalidStationSet</td> <td></td> </tr> <tr> <td>(7) — UW: i_u16RedundantSystemSet</td> <td></td> </tr> <tr> <td colspan="2" style="text-align: center;"> pbi_uConstantLinkScanTime (12) pbi_ulpAddress (13) pbi_uMonitoringTime (14) pbi_bNetworkConfigurationSetFlg (15) pbi_bReservedStationSetFlg (16) pbi_bErrInvalidStationSetFlg (17) pbi_bRedundantSystemFlg (18) pbi_bSubMasterSet (19) pbi_bIP_PacketTransferFlg (20) pbi_bMonitoringTimeFlg (21) pbi_bDatalinkFautlyStationSet (22) pbi_bCPU_StopOutputSet (23) pbi_bCPU_StopErrOutputSet (24) pbi_bLinkScanModeSet (25) pbi_bTopologySet (26) pbi_bMasterReturnSet (27) pbi_bSubMasterOperateParam (28) </td> </tr> </table> </div>	(1) — B: i_bEN	o_bENO: B — (8)	(2) — DUT: i_stModule	o_bOK: B — (9)	(3) — UW: i_uTotalStations	o_bErr: B — (10)	(4) — UW: i_u605NetworkConfigurationSet	o_uErrId: UW — (11)	(5) — UW: i_u8ReservedStationSet		(6) — UW: i_u8ErrInvalidStationSet		(7) — UW: i_u16RedundantSystemSet		pbi_uConstantLinkScanTime (12) pbi_ulpAddress (13) pbi_uMonitoringTime (14) pbi_bNetworkConfigurationSetFlg (15) pbi_bReservedStationSetFlg (16) pbi_bErrInvalidStationSetFlg (17) pbi_bRedundantSystemFlg (18) pbi_bSubMasterSet (19) pbi_bIP_PacketTransferFlg (20) pbi_bMonitoringTimeFlg (21) pbi_bDatalinkFautlyStationSet (22) pbi_bCPU_StopOutputSet (23) pbi_bCPU_StopErrOutputSet (24) pbi_bLinkScanModeSet (25) pbi_bTopologySet (26) pbi_bMasterReturnSet (27) pbi_bSubMasterOperateParam (28)	
(1) — B: i_bEN	o_bENO: B — (8)																
(2) — DUT: i_stModule	o_bOK: B — (9)																
(3) — UW: i_uTotalStations	o_bErr: B — (10)																
(4) — UW: i_u605NetworkConfigurationSet	o_uErrId: UW — (11)																
(5) — UW: i_u8ReservedStationSet																	
(6) — UW: i_u8ErrInvalidStationSet																	
(7) — UW: i_u16RedundantSystemSet																	
pbi_uConstantLinkScanTime (12) pbi_ulpAddress (13) pbi_uMonitoringTime (14) pbi_bNetworkConfigurationSetFlg (15) pbi_bReservedStationSetFlg (16) pbi_bErrInvalidStationSetFlg (17) pbi_bRedundantSystemFlg (18) pbi_bSubMasterSet (19) pbi_bIP_PacketTransferFlg (20) pbi_bMonitoringTimeFlg (21) pbi_bDatalinkFautlyStationSet (22) pbi_bCPU_StopOutputSet (23) pbi_bCPU_StopErrOutputSet (24) pbi_bLinkScanModeSet (25) pbi_bTopologySet (26) pbi_bMasterReturnSet (27) pbi_bSubMasterOperateParam (28)																	

6

Labels

Input arguments

No.	Variable name	Name	Data type	Range	Description
(1)	i_bEN	Execution command	Bit	—	On: Start FB. Off: Do not start FB.
(2)	i_stModule	Module label	Structures	—	Specify the module for which the FB is to be executed. Specify the module label of the modules.
(3)	i_uTotalStations	Total number of slave stations	Word [Unsigned]/ Bit String [16-bit]	1 to 120, 121	Specify the total number of the slave stations connected. 1 to 120: Applicable when "Presence of submaster function" is off (disabled) 1 to 121: Applicable when "Presence of submaster function" is on (enabled)
(4)	i_u605NetworkC onfigurationSet	Network configuration setting data	Word [Unsigned]/ Bit String [16-bit] (0..604)	—	Specify the start address of the storage location of network configuration setting data. When specifying the address using a label, use an array as the data type. Set data for the number of stations specified in "Total number of slave stations". (Page 203 Network configuration setting data)

No.	Variable name	Name	Data type	Range	Description																																																																																																																																																									
(5)	i_u8ReservedStationSet	Reserved station setting data	Word [Unsigned]/ Bit String [16-bit] (0..7)	—	<p>Specify the start address of the storage location of the reserved-station setting data.</p> <p>Setting: Specify a reserved station.</p> <ul style="list-style-type: none"> • 0: Not specified • 1: Specified <table border="1"> <thead> <tr> <th></th> <th>b15</th><th>b14</th><th>b13</th><th>b12</th><th>b11</th><th>b10</th><th>b9</th><th>b8</th><th>b7</th><th>b6</th><th>b5</th><th>b4</th><th>b3</th><th>b2</th><th>b1</th><th>b0</th> </tr> </thead> <tbody> <tr><td>+0</td><td>16</td><td>15</td><td>14</td><td>13</td><td>12</td><td>11</td><td>10</td><td>9</td><td>8</td><td>7</td><td>6</td><td>5</td><td>4</td><td>3</td><td>2</td><td>1</td></tr> <tr><td>+1</td><td>32</td><td>31</td><td>30</td><td>29</td><td>28</td><td>27</td><td>26</td><td>25</td><td>24</td><td>23</td><td>22</td><td>21</td><td>20</td><td>19</td><td>18</td><td>17</td></tr> <tr><td>+2</td><td>48</td><td>47</td><td>46</td><td>45</td><td>44</td><td>43</td><td>42</td><td>41</td><td>40</td><td>39</td><td>38</td><td>37</td><td>36</td><td>35</td><td>34</td><td>33</td></tr> <tr><td>+3</td><td>64</td><td>63</td><td>62</td><td>61</td><td>60</td><td>59</td><td>58</td><td>57</td><td>56</td><td>55</td><td>54</td><td>53</td><td>52</td><td>51</td><td>50</td><td>49</td></tr> <tr><td>+4</td><td>80</td><td>79</td><td>78</td><td>77</td><td>76</td><td>75</td><td>74</td><td>73</td><td>72</td><td>71</td><td>70</td><td>69</td><td>68</td><td>67</td><td>66</td><td>65</td></tr> <tr><td>+5</td><td>96</td><td>95</td><td>94</td><td>93</td><td>92</td><td>91</td><td>90</td><td>89</td><td>88</td><td>87</td><td>86</td><td>85</td><td>84</td><td>83</td><td>82</td><td>81</td></tr> <tr><td>+6</td><td>112</td><td>111</td><td>110</td><td>109</td><td>108</td><td>107</td><td>106</td><td>105</td><td>104</td><td>103</td><td>102</td><td>101</td><td>100</td><td>99</td><td>98</td><td>97</td></tr> <tr><td>+7</td><td colspan="8">-</td><td>120</td><td>119</td><td>118</td><td>117</td><td>116</td><td>115</td><td>114</td><td>113</td></tr> </tbody> </table> <p>Numbers 1 to 120 in the table indicate station numbers.</p>		b15	b14	b13	b12	b11	b10	b9	b8	b7	b6	b5	b4	b3	b2	b1	b0	+0	16	15	14	13	12	11	10	9	8	7	6	5	4	3	2	1	+1	32	31	30	29	28	27	26	25	24	23	22	21	20	19	18	17	+2	48	47	46	45	44	43	42	41	40	39	38	37	36	35	34	33	+3	64	63	62	61	60	59	58	57	56	55	54	53	52	51	50	49	+4	80	79	78	77	76	75	74	73	72	71	70	69	68	67	66	65	+5	96	95	94	93	92	91	90	89	88	87	86	85	84	83	82	81	+6	112	111	110	109	108	107	106	105	104	103	102	101	100	99	98	97	+7	-								120	119	118	117	116	115	114	113
	b15	b14	b13	b12	b11	b10	b9	b8	b7	b6	b5	b4	b3	b2	b1	b0																																																																																																																																														
+0	16	15	14	13	12	11	10	9	8	7	6	5	4	3	2	1																																																																																																																																														
+1	32	31	30	29	28	27	26	25	24	23	22	21	20	19	18	17																																																																																																																																														
+2	48	47	46	45	44	43	42	41	40	39	38	37	36	35	34	33																																																																																																																																														
+3	64	63	62	61	60	59	58	57	56	55	54	53	52	51	50	49																																																																																																																																														
+4	80	79	78	77	76	75	74	73	72	71	70	69	68	67	66	65																																																																																																																																														
+5	96	95	94	93	92	91	90	89	88	87	86	85	84	83	82	81																																																																																																																																														
+6	112	111	110	109	108	107	106	105	104	103	102	101	100	99	98	97																																																																																																																																														
+7	-								120	119	118	117	116	115	114	113																																																																																																																																														
(6)	i_u8ErrInvalidStationSet	Error invalid station setting data	Word [Unsigned]/ Bit String [16-bit] (0..7)	—	<p>Specify the start address of the storage location of the error invalid station setting.</p> <p>Setting: Specify an error invalid station.</p> <ul style="list-style-type: none"> • 0: Not specified • 1: Specified <p>If both an error invalid station and a reserved station are specified for the same station, the reserved station will take priority.</p> <table border="1"> <thead> <tr> <th></th> <th>b15</th><th>b14</th><th>b13</th><th>b12</th><th>b11</th><th>b10</th><th>b9</th><th>b8</th><th>b7</th><th>b6</th><th>b5</th><th>b4</th><th>b3</th><th>b2</th><th>b1</th><th>b0</th> </tr> </thead> <tbody> <tr><td>+0</td><td>16</td><td>15</td><td>14</td><td>13</td><td>12</td><td>11</td><td>10</td><td>9</td><td>8</td><td>7</td><td>6</td><td>5</td><td>4</td><td>3</td><td>2</td><td>1</td></tr> <tr><td>+1</td><td>32</td><td>31</td><td>30</td><td>29</td><td>28</td><td>27</td><td>26</td><td>25</td><td>24</td><td>23</td><td>22</td><td>21</td><td>20</td><td>19</td><td>18</td><td>17</td></tr> <tr><td>+2</td><td>48</td><td>47</td><td>46</td><td>45</td><td>44</td><td>43</td><td>42</td><td>41</td><td>40</td><td>39</td><td>38</td><td>37</td><td>36</td><td>35</td><td>34</td><td>33</td></tr> <tr><td>+3</td><td>64</td><td>63</td><td>62</td><td>61</td><td>60</td><td>59</td><td>58</td><td>57</td><td>56</td><td>55</td><td>54</td><td>53</td><td>52</td><td>51</td><td>50</td><td>49</td></tr> <tr><td>+4</td><td>80</td><td>79</td><td>78</td><td>77</td><td>76</td><td>75</td><td>74</td><td>73</td><td>72</td><td>71</td><td>70</td><td>69</td><td>68</td><td>67</td><td>66</td><td>65</td></tr> <tr><td>+5</td><td>96</td><td>95</td><td>94</td><td>93</td><td>92</td><td>91</td><td>90</td><td>89</td><td>88</td><td>87</td><td>86</td><td>85</td><td>84</td><td>83</td><td>82</td><td>81</td></tr> <tr><td>+6</td><td>112</td><td>111</td><td>110</td><td>109</td><td>108</td><td>107</td><td>106</td><td>105</td><td>104</td><td>103</td><td>102</td><td>101</td><td>100</td><td>99</td><td>98</td><td>97</td></tr> <tr><td>+7</td><td colspan="8">-</td><td>120</td><td>119</td><td>118</td><td>117</td><td>116</td><td>115</td><td>114</td><td>113</td></tr> </tbody> </table> <p>Numbers 1 to 120 in the table indicate station numbers.</p>		b15	b14	b13	b12	b11	b10	b9	b8	b7	b6	b5	b4	b3	b2	b1	b0	+0	16	15	14	13	12	11	10	9	8	7	6	5	4	3	2	1	+1	32	31	30	29	28	27	26	25	24	23	22	21	20	19	18	17	+2	48	47	46	45	44	43	42	41	40	39	38	37	36	35	34	33	+3	64	63	62	61	60	59	58	57	56	55	54	53	52	51	50	49	+4	80	79	78	77	76	75	74	73	72	71	70	69	68	67	66	65	+5	96	95	94	93	92	91	90	89	88	87	86	85	84	83	82	81	+6	112	111	110	109	108	107	106	105	104	103	102	101	100	99	98	97	+7	-								120	119	118	117	116	115	114	113
	b15	b14	b13	b12	b11	b10	b9	b8	b7	b6	b5	b4	b3	b2	b1	b0																																																																																																																																														
+0	16	15	14	13	12	11	10	9	8	7	6	5	4	3	2	1																																																																																																																																														
+1	32	31	30	29	28	27	26	25	24	23	22	21	20	19	18	17																																																																																																																																														
+2	48	47	46	45	44	43	42	41	40	39	38	37	36	35	34	33																																																																																																																																														
+3	64	63	62	61	60	59	58	57	56	55	54	53	52	51	50	49																																																																																																																																														
+4	80	79	78	77	76	75	74	73	72	71	70	69	68	67	66	65																																																																																																																																														
+5	96	95	94	93	92	91	90	89	88	87	86	85	84	83	82	81																																																																																																																																														
+6	112	111	110	109	108	107	106	105	104	103	102	101	100	99	98	97																																																																																																																																														
+7	-								120	119	118	117	116	115	114	113																																																																																																																																														
(7)	i_u16RedundantSystemSet	Redundant system setting data	Word [Unsigned]/ Bit String [16-bit] (0..15)	—	<p>■Element number 0 to 7</p> <p>Specify the system switching monitoring target station.</p> <ul style="list-style-type: none"> • 0: Not specified • 1: Specified <p>If a system switching monitoring target station, an error invalid station, and a reserved station are specified for the same station, the reserved station will take priority.</p> <p>If a system switching monitoring target station and an error invalid station are specified for the same station, the error invalid station will take priority.</p> <table border="1"> <thead> <tr> <th></th> <th>b15</th><th>b14</th><th>b13</th><th>b12</th><th>b11</th><th>b10</th><th>b9</th><th>b8</th><th>b7</th><th>b6</th><th>b5</th><th>b4</th><th>b3</th><th>b2</th><th>b1</th><th>b0</th> </tr> </thead> <tbody> <tr><td>+0</td><td>16</td><td>15</td><td>14</td><td>13</td><td>12</td><td>11</td><td>10</td><td>9</td><td>8</td><td>7</td><td>6</td><td>5</td><td>4</td><td>3</td><td>2</td><td>1</td></tr> <tr><td>+1</td><td>32</td><td>31</td><td>30</td><td>29</td><td>28</td><td>27</td><td>26</td><td>25</td><td>24</td><td>23</td><td>22</td><td>21</td><td>20</td><td>19</td><td>18</td><td>17</td></tr> <tr><td>+2</td><td>48</td><td>47</td><td>46</td><td>45</td><td>44</td><td>43</td><td>42</td><td>41</td><td>40</td><td>39</td><td>38</td><td>37</td><td>36</td><td>35</td><td>34</td><td>33</td></tr> <tr><td>+3</td><td>64</td><td>63</td><td>62</td><td>61</td><td>60</td><td>59</td><td>58</td><td>57</td><td>56</td><td>55</td><td>54</td><td>53</td><td>52</td><td>51</td><td>50</td><td>49</td></tr> <tr><td>+4</td><td>80</td><td>79</td><td>78</td><td>77</td><td>76</td><td>75</td><td>74</td><td>73</td><td>72</td><td>71</td><td>70</td><td>69</td><td>68</td><td>67</td><td>66</td><td>65</td></tr> <tr><td>+5</td><td>96</td><td>95</td><td>94</td><td>93</td><td>92</td><td>91</td><td>90</td><td>89</td><td>88</td><td>87</td><td>86</td><td>85</td><td>84</td><td>83</td><td>82</td><td>81</td></tr> <tr><td>+6</td><td>112</td><td>111</td><td>110</td><td>109</td><td>108</td><td>107</td><td>106</td><td>105</td><td>104</td><td>103</td><td>102</td><td>101</td><td>100</td><td>99</td><td>98</td><td>97</td></tr> <tr><td>+7</td><td colspan="8">-</td><td>120</td><td>119</td><td>118</td><td>117</td><td>116</td><td>115</td><td>114</td><td>113</td></tr> </tbody> </table> <p>Numbers 1 to 120 in the table indicate station numbers.</p> <p>■Element number 8 to 15</p> <p>Fixed to 0</p>		b15	b14	b13	b12	b11	b10	b9	b8	b7	b6	b5	b4	b3	b2	b1	b0	+0	16	15	14	13	12	11	10	9	8	7	6	5	4	3	2	1	+1	32	31	30	29	28	27	26	25	24	23	22	21	20	19	18	17	+2	48	47	46	45	44	43	42	41	40	39	38	37	36	35	34	33	+3	64	63	62	61	60	59	58	57	56	55	54	53	52	51	50	49	+4	80	79	78	77	76	75	74	73	72	71	70	69	68	67	66	65	+5	96	95	94	93	92	91	90	89	88	87	86	85	84	83	82	81	+6	112	111	110	109	108	107	106	105	104	103	102	101	100	99	98	97	+7	-								120	119	118	117	116	115	114	113
	b15	b14	b13	b12	b11	b10	b9	b8	b7	b6	b5	b4	b3	b2	b1	b0																																																																																																																																														
+0	16	15	14	13	12	11	10	9	8	7	6	5	4	3	2	1																																																																																																																																														
+1	32	31	30	29	28	27	26	25	24	23	22	21	20	19	18	17																																																																																																																																														
+2	48	47	46	45	44	43	42	41	40	39	38	37	36	35	34	33																																																																																																																																														
+3	64	63	62	61	60	59	58	57	56	55	54	53	52	51	50	49																																																																																																																																														
+4	80	79	78	77	76	75	74	73	72	71	70	69	68	67	66	65																																																																																																																																														
+5	96	95	94	93	92	91	90	89	88	87	86	85	84	83	82	81																																																																																																																																														
+6	112	111	110	109	108	107	106	105	104	103	102	101	100	99	98	97																																																																																																																																														
+7	-								120	119	118	117	116	115	114	113																																																																																																																																														

■ Network configuration setting data

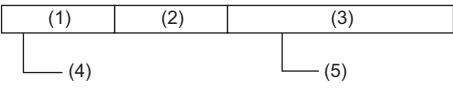
Element number	Item name		Range	Description
0	For 1st module	Slave station setting information	—	Specify the station type and number. b15 ... b12 b11 ... b8 b7 ... b0  (1) Station type (2) Fixed to 1 (3) Station number (4) 0: Remote I/O station, 1: Remote device station, 2: Intelligent device station, 3: Local station (master-slave system), 4: Submaster station, 5: Intelligent device station (redundant line), F: Master station (5) 0: Master station, 1 to 120: Station number
1		RX/Ry offset	0 to 16368	Specify the offset value from the head of RX/Ry in increments of 16 points.
2		Number of RX/Ry points	0 to 2048, 0 to 64, 0 to 128	Specify the number of RX/Ry points in increments of 16 points. • Master station, local station: 0 to 2048 • Intelligent device station: 0 to 2048 • Remote I/O station: 0 to 64 • Remote device station: 0 to 128
3		RWr/RWw offset	0 to 8188	Specify the offset value from the head of RWr/RWw/LW in increments of 4 points.
4		Number of RWr/RWw points	0 to 1024, 0 to 64	Specify the number of RWr/RWw points in increments of 4 points. • Master station, local station: 0 to 1024 • Intelligent device station: 0 to 1024 • Remote device station: 0 to 64
5 to 599	Setting for the 2nd to 120th module			
600	For 121st module	Slave station setting information	Same as for the 1st module	
601		RX/Ry offset		
602		Number of RX/Ry points		
603		RWr/RWw offset		
604		Number of RWr/RWw points		

If the specified total number of slave stations does not match the individual station setting data, the total number of individual stations specified in the total number of slave stations take precedence and any individual station information exceeding the total number of slave stations is ignored. Note that 1 is added to the total number of slave stations when "Presence of submaster function" is on (enabled).

Ex.

When the station information of 10 stations is set even if the total number of slave stations is 2

The 1st and 2nd information is enabled and parameters which are set to the 3rd to 10th station information are ignored.

■Output arguments

No.	Variable name	Name	Data type	Description	Default value
(8)	o_bENO	Execution status	Bit	On: The execution command is turned on. Off: The execution command is turned off.	Off
(9)	o_bOK	Normal completion	Bit	The on state indicates that the module FB processing has been completed successfully.	Off
(10)	o_bErr	Error completion	Bit	The on state indicates that the module FB processing has been completed with an error.	Off
(11)	o_uErrId	Error code	Word [Unsigned]/Bit String [16-bit]	An error code is stored at error completion.	0

■Operation parameters

○: Can be set, ×: Cannot be set (for master station, submaster station, local station, redundant slave station)

No.	Variable name	Name	Data type	Range	Description	Default value	Redundant master station		Redundant line	
							System A	System B	System A	System B
(12)	pbi_uConstantLinkScanTime	Constant link scan time	Word [Unsigned]/Bit String [16-bit]	0, 1 to 200	Specify the constant link scan time. • 0: Not set (default value) • 1 to 200: 1ms to 200ms	0	○	×	○	○
(13)	pbi_ulpAddress	Upper 2 digits of IP address	Word [Unsigned]/Bit String [16-bit]	—	Set the IP address when the IP packet transfer function is used. Only the upper two digits (1st and 2nd octets) of a 4-digit IP address can be set. The 3rd and 4th digits are each determined automatically from the network number and station number (master station is 125).	0	○	×	○	○
(14)	pbi_uMonitoringTime	System switching monitoring time	Word [Unsigned]/Bit String [16-bit]	5 to 5000	Set the system switching monitoring time. This parameter is enabled when the system switching monitoring time setting is on (Enable).	2000	○	×	○	○
(15)	pbi_bNetworkConfigurationSetFlg	Presence of network configuration setting data	Bit	Off, on	Specify whether to enable/disable the network configuration setting data. • Off: Disable • On: Enable	Off	○	×	○	○
(16)	pbi_bReservedStationSetFlg	Presence of reserved station specification data	Bit	Off, on	Specify whether to enable/disable the reserved station specification data. • Off: Disable • On: Enable	Off	○	×	○	○
(17)	pbi_bErrInvalidStationSetFlg	Presence of error invalid station setting data	Bit	Off, on	Specify whether to enable/disable the error invalid station setting data. • Off: Disable • On: Enable	Off	○	×	○	○
(18)	Pbi_bRedundantSystemFlg	Presence of redundant system setting data	Bit	Off, on	Specify whether to enable/disable the redundant system setting data. • Off: Disable • On: Enable	Off	○	×	○	○
(19)	pbi_bSubMasterSet	Presence of submaster function	Bit	Off, on	Specify whether to use the submaster function. • Off: Do not use. • On: Use.	Off	× ^{*1}	×	× ^{*1}	× ^{*1}
(20)	pbi_bIPPacketTransferFlg	Presence of IP packet transfer function	Bit	Off, on	Specify whether to enable/disable the IP packet transfer function. • Off: Disable • On: Enable	Off	○	×	○	○

No.	Variable name	Name	Data type	Range	Description	Default value	Redundant master station		Redundant line	
							System A	System B	System A	System B
(21)	pbi_bMonitoringTimeFlg	System switching monitoring time setting	Bit	Off, on	Specify whether to use the system switching monitoring time setting. • Off: Disable • On: Enable	Off	○	×	○	○
(22)	pbi_bDataLinkFaultyStationSet	Data link faulty station setting	Bit	Off, on	Specify whether to hold or clear the input data from a data link faulty station. • Off: Clear • On: Hold	Off	○	○	○	○
(23)	pbi_bCPU_StopOutputSet	Output setting for CPU STOP	Bit	Off, on	Specify whether to hold or clear the output data when the operating status of a CPU module is STOP. • Off: Hold • On: Clear	Off	○	○	○	○
(24)	pbi_bCPU_StopErrOutputSet	Output setting for CPU stop error	Bit	Off, on	Specify whether to hold or clear the output data when the a CPU module caused a stop error. • Off: Clear • On: Hold	Off	○	○	○	○
(25)	pbi_bLinkScanModeSet	Link scan mode setting	Bit	Off, on	Specify whether to perform a link scan and sequence scan synchronously or asynchronously. (Valid when "Constant link scan time" is 0 (no setting)) • Off: Asynchronous • On: Synchronous	Off	○	×	○	○
(26)	pbi_bTopologySet	Network topology setting	Bit	Off, on	Specify the network topology. • Off: Line topology, star topology, or coexistence of star and line topologies • On: Ring topology	Off	○	×	○	○
(27)	pbi_bMasterReturnSet	Master station return time operation setting	Bit	Off, on	Specify the operation mode applicable when the master station returns. • Off: The master station returns as the master operating station. • On: The master station returns as the submaster operating station.	Off	× ^{*2}	×	× ^{*2}	× ^{*2}
(28)	pbi_bSubMasterOperateParam	Submaster station parameter operation setting	Bit	Off, on	Specify which station parameters (master or own station) should be used for the submaster station to work. • Off: The submaster station operates with the parameters of the master station. • On: The submaster station operates with the parameters of the own (submaster) station.	Off	× ^{*3}	×	× ^{*3}	× ^{*3}

*1 For the redundant master station, the parameter is fixed to on (use). For the redundant line, the parameter is fixed to off (not use).

*2 For the redundant master station, the parameter is fixed to on (returning as the submaster operating station). For the redundant line, the parameter is fixed to off (returning as the master operating station).

*3 These parameters are fixed to on (operating with the parameters of the own (submaster) station).

FB details

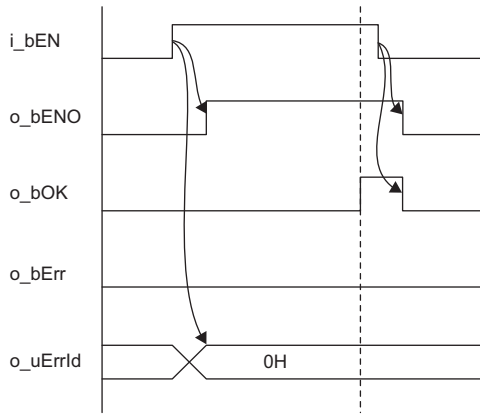
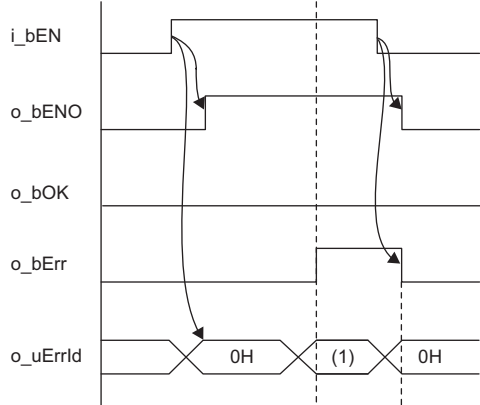
Item	Description	
Available device	Target module	RJ71GF11-T2* ¹
	CPU module	RCPU
	Engineering tool	GX Works3
Language	Ladder diagram	
Number of basic steps	84 steps The number of steps of the FB embedded in a program depends on the CPU module used, the input/output definitions, and the option settings of GX Works3. For the option settings of GX Works3, refer to GX Works3 Operating Manual.	
Processing	When i_bEN (execution command) is turned on, this function sets parameters for a module.	
FB compilation method	Macro type	
FB operation	Pulse type (multiple-scan execution type)	
Input condition for FB_EN	None	
Timing chart of I/O signals	<ul style="list-style-type: none"> For normal completion  <ul style="list-style-type: none"> For error completion (same as in the case of a module error)  <p>(1) Error code</p>	
Precautions	<ul style="list-style-type: none"> This FB does not include error recovery processing. Please create error recovery processing separately according to the system and required operations. This FB uses the GP.CCPASETTR instruction. Turn off i_bEN (execution command) after o_bOK (normal completion) or o_bErr (error completion) is turned on. By turning off i_bEN (execution command), o_bOK (normal completion) or o_bErr (error completion) is turned off and o_uErrld (error code) is cleared to 0. 	

*1 The supported firmware version is "59" or later.

Error codes

Error code	Reference
D000H to DFFFH	 MELSEC iQ-R CC-Link IE Field Network User's Manual (Application)

6.10 M+model_StationNoSet

The FB is the same as M+model_StationNoSet of the CC-Link IE Controller Network-equipped module FB. (☞ Page 181 M+model_StationNoSet)

6.11 M+model_RedundantSystem_GetAddress

The FB is the same as M+model_RedundantSystem_GetAddress of the CC-Link IE Controller Network-equipped module FB.
( Page 184 M+model_RedundantSystem_GetAddress)

6.12 M+model_ReadSystemTypeInfoInformation

Name

■RJ71EN71, RnENCPU (network part)

This FB is displayed as follows on the engineering tool depending on the settings.

Name	Module model name	
	RJ71EN71	RnENCPU (network part)
M+RJ71EN71_F_ReadSystemTypeInfoInformation	RJ71EN71(CCIEF)	_RJ71EN71(CCIEF)
M+RJ71EN71_EF_ReadSystemTypeInfoInformation	RJ71EN71(E+CCIEF)	_RJ71EN71(E+IEF)

■RJ71GF11-T2

M+RJ71GF11_ReadSystemTypeInfoInformation

Overview

Item	Description																																												
Overview	Reads the system configuration model information of the intelligent device station (remote head module).																																												
Symbol	<div style="border: 1px solid black; padding: 10px; width: fit-content; margin: 10px auto;"> <p style="text-align: center;">M+RJ71GF11_ReadSystemTypeInfoInformation</p> <table style="width: 100%; border-collapse: collapse;"> <tr> <td style="width: 15%;">(1) B: i_bEN</td> <td style="width: 40%;"></td> <td style="width: 15%;">o_bENO: B</td> <td style="width: 10%;"></td> <td style="width: 10%;">(5)</td> </tr> <tr> <td>(2) DUT: i_stModule</td> <td></td> <td>o_bOK: B</td> <td></td> <td>(6)</td> </tr> <tr> <td>(3) UW: i_u2TargetAddress</td> <td></td> <td>o_bErr: B</td> <td></td> <td>(7)</td> </tr> <tr> <td>(4) UW: i_uChannel</td> <td></td> <td>o_uErrId: UW</td> <td></td> <td>(8)</td> </tr> <tr> <td></td> <td></td> <td>o_uUnitTypeData: UW</td> <td></td> <td>(9)</td> </tr> <tr> <td colspan="5" style="padding-top: 10px;"> <table style="width: 100%; border-collapse: collapse;"> <tr><td style="width: 15%;">pbi_uResendCountMax</td><td style="width: 85%;">(10)</td></tr> <tr><td>pbi_uTimeUnit</td><td>(11)</td></tr> <tr><td>pbi_uMonitorTime</td><td>(12)</td></tr> <tr><td>pbo_uResendCount</td><td>(13)</td></tr> <tr><td>pbo_u4ErrTime</td><td>(14)</td></tr> <tr><td>pbo_uErrNetworkNo</td><td>(15)</td></tr> <tr><td>pbo_uErrStationNo</td><td>(16)</td></tr> </table> </td> </tr> </table> <p>The above FB is an example for the RJ71GF11-T2.</p> </div>	(1) B: i_bEN		o_bENO: B		(5)	(2) DUT: i_stModule		o_bOK: B		(6)	(3) UW: i_u2TargetAddress		o_bErr: B		(7)	(4) UW: i_uChannel		o_uErrId: UW		(8)			o_uUnitTypeData: UW		(9)	<table style="width: 100%; border-collapse: collapse;"> <tr><td style="width: 15%;">pbi_uResendCountMax</td><td style="width: 85%;">(10)</td></tr> <tr><td>pbi_uTimeUnit</td><td>(11)</td></tr> <tr><td>pbi_uMonitorTime</td><td>(12)</td></tr> <tr><td>pbo_uResendCount</td><td>(13)</td></tr> <tr><td>pbo_u4ErrTime</td><td>(14)</td></tr> <tr><td>pbo_uErrNetworkNo</td><td>(15)</td></tr> <tr><td>pbo_uErrStationNo</td><td>(16)</td></tr> </table>					pbi_uResendCountMax	(10)	pbi_uTimeUnit	(11)	pbi_uMonitorTime	(12)	pbo_uResendCount	(13)	pbo_u4ErrTime	(14)	pbo_uErrNetworkNo	(15)	pbo_uErrStationNo	(16)
(1) B: i_bEN		o_bENO: B		(5)																																									
(2) DUT: i_stModule		o_bOK: B		(6)																																									
(3) UW: i_u2TargetAddress		o_bErr: B		(7)																																									
(4) UW: i_uChannel		o_uErrId: UW		(8)																																									
		o_uUnitTypeData: UW		(9)																																									
<table style="width: 100%; border-collapse: collapse;"> <tr><td style="width: 15%;">pbi_uResendCountMax</td><td style="width: 85%;">(10)</td></tr> <tr><td>pbi_uTimeUnit</td><td>(11)</td></tr> <tr><td>pbi_uMonitorTime</td><td>(12)</td></tr> <tr><td>pbo_uResendCount</td><td>(13)</td></tr> <tr><td>pbo_u4ErrTime</td><td>(14)</td></tr> <tr><td>pbo_uErrNetworkNo</td><td>(15)</td></tr> <tr><td>pbo_uErrStationNo</td><td>(16)</td></tr> </table>					pbi_uResendCountMax	(10)	pbi_uTimeUnit	(11)	pbi_uMonitorTime	(12)	pbo_uResendCount	(13)	pbo_u4ErrTime	(14)	pbo_uErrNetworkNo	(15)	pbo_uErrStationNo	(16)																											
pbi_uResendCountMax	(10)																																												
pbi_uTimeUnit	(11)																																												
pbi_uMonitorTime	(12)																																												
pbo_uResendCount	(13)																																												
pbo_u4ErrTime	(14)																																												
pbo_uErrNetworkNo	(15)																																												
pbo_uErrStationNo	(16)																																												

Labels

■Input arguments

No.	Variable name	Name	Data type	Range	Description
(1)	i_bEN	Execution command	Bit	—	On: Start FB. Off: Do not start FB.
(2)	i_stModule	Module label	Structures	—	Specify the module for which the FB is to be executed. Specify the module label of the modules.
(3)	i_u2TargetAddress	Target station address	Word [Unsigned]/ Bit String [16-bit] (0..1)	—	Specifies the station number of the target station. • 1st word: Network number • 2nd word: Station number (1) 0 (The setting is ignored.) (2) Station number • 1 to 120: Intelligent device station (remote head module)
(4)	i_uChannel	Own station channel	Word [Unsigned]/ Bit String [16-bit]	—	Specify the channel to be used by the own station. MELSEC iQ-R Programming Manual (Module Dedicated Instructions)

■Output arguments

No.	Variable name	Name	Data type	Description	Default value
(5)	o_bENO	Execution status	Bit	On: The execution command is turned on. Off: The execution command is turned off.	Off
(6)	o_bOK	Normal completion	Bit	The FB has been processed normally when this argument is on.	Off
(7)	o_bErr	Error completion	Bit	The FB has been processed abnormally when this argument is on.	Off
(8)	o_uErrId	Error code	Word [Unsigned]/ Bit String [16-bit]	An error code is stored at error completion.	0
(9)	o_uUnitTypeData	Model data storage device	Word [Unsigned]/ Bit String [16-bit]	The start number of the device for storing model data is stored. The following cannot be specified as an argument. Specifying any of the following may cause a CPU error (2820H: Device/label/buffer memory specification incorrect). <ul style="list-style-type: none"> • Dynamically specified array elements (Example: wLabel[D0]) • Digit-specified labels (Example: K4bLabel) • Indirectly specified devices (Example: @W0) • Local devices (Example: #D0) 	0

■Operation parameters

No.	Variable name	Name	Data type	Range	Description	Default value
(10)	pbi_uResendCountMax	Maximum number of resends	Word [Unsigned]/ Bit String [16-bit]	0 to 15	Specify the number of resends to be performed if the data transfer is not completed within the monitoring time specified by "Arrival monitoring time". <ul style="list-style-type: none"> • 0 to 15 	5
(11)	pbi_uTimeUnit	Arrival monitoring time unit	Word [Unsigned]/ Bit String [16-bit]	0, 1	Specify the unit of the "Arrival monitoring time". <ul style="list-style-type: none"> • 0: 1s • 1: 100ms 	0
(12)	pbi_uMonitorTime	Arrival monitoring time	Word [Unsigned]/ Bit String [16-bit]	—	Specify the monitoring time until completion of processing. If the processing is not completed within the monitoring time, data is resent until the value specified in "Maximum number of resends" is reached. When "Arrival monitoring time unit" is set to 1s <ul style="list-style-type: none"> • Effective range 1 to 32767: 1s to 32767s When "Arrival monitoring time unit" is set to 100ms <ul style="list-style-type: none"> • Effective range 1 to 65535: 1 to 65535 × 100ms 	0: 10s

■Public variables

No.	Variable name	Name	Data type	Description	Default value
(13)	pbo_uResendCount	Number of resends	Word [Unsigned]/Bit String [16-bit]	The number of resends performed (result) is stored.	0
(14)	pbo_u4ErrTime	Error occurrence time	Word [Unsigned]/Bit String [16-bit] (0..3)	Clock data at the time of error occurrence is stored. 1st word <ul style="list-style-type: none"> • Upper 8 bits: Month (01H to 12H) • Lower 8 bits: Lower 2 digits of year (00H to 99H) 2nd word <ul style="list-style-type: none"> • Upper 8 bits: Hour (00H to 23H) • Lower 8 bits: Day (01H to 31H) 3rd word <ul style="list-style-type: none"> • Upper 8 bits: Second (00H to 59H) • Lower 8 bits: Minute (00H to 59H) 4th word <ul style="list-style-type: none"> • Upper 8 bits: Upper 2 digits of year (00H to 99H) • Lower 8 bits: Day of week (00H (Sunday) to 06H (Saturday)) 	0
(15)	pbo_uErrNetworkNo	Error detection network number	Word [Unsigned]/Bit String [16-bit]	The network number of the station in which an error was detected is stored.	0
(16)	pbo_uErrStationNo	Error-detected station number	Word [Unsigned]/Bit String [16-bit]	The station number of the station in which an error was detected is stored. <ul style="list-style-type: none"> • 125: Master station • 1 to 120: Local station, intelligent device station, submaster station 	0

FB details

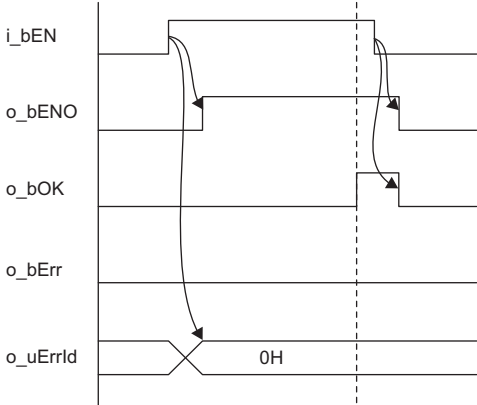
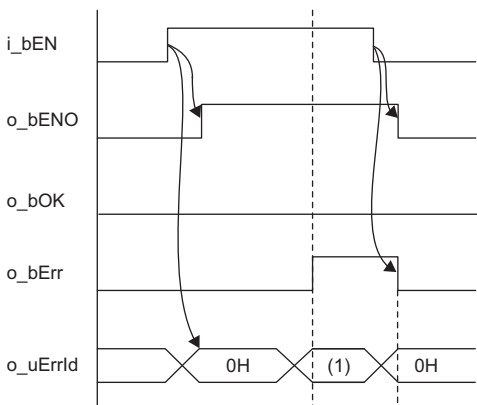
Item	Description	
Available device	Target module	<ul style="list-style-type: none"> • RJ71EN71^{*1} • RJ71GF11-T2^{*1} • RnENCPU (network part)^{*1}
	CPU module	RCPU
	Engineering tool	GX Works3
Language	Ladder diagram	
Number of basic steps	79 steps The number of steps of the FB embedded in a program depends on the CPU module used, the input/output definitions, and the option settings of GX Works3. For the option settings of GX Works3, refer to GX Works3 Operating Manual.	
Processing	When i_bEN (execution instruction) is turned on, this function reads the model information of the system configuration module of the intelligent device station (remote head module).	
FB compilation method	Macro type	
FB operation	Pulse type (multiple-scan execution type)	
Input condition for FB_EN	None	
Timing chart of I/O signals	<p>• For normal completion</p>  <p>• For error completion (same as in the case of a module error)</p>  <p>(1) Error code</p>	
Precautions	<ul style="list-style-type: none"> • This FB does not include error recovery processing. Please create error recovery processing separately according to the system and required operations. • This FB uses the GP.SINFTYRD instruction. • Turn off i_bEN (execution command) after o_bOK (normal completion) or o_bErr (error completion) is turned on. By turning off i_bEN (execution command), o_bOK (normal completion) or o_bErr (error completion) is turned off and o_uErrld (error code) is cleared to 0. • This FB uses the label initial value by each program. When the program file using this FB is specified to boot file setting for the boot operation in the CPU module, specify the initial label value file by each program to the boot file setting as well. (MELSEC iQ-R CPU Module User's Manual (Application)) If an error code that is not described in Page 212 Error codes appears, the initial label value files by each program may not be set to the boot file setting. In this case, specify the initial label value files by each program to the boot file setting. • When this FB is executed, an operation error may occur in the programmable controller CPU. In this case, check the detailed information of the operation error in event history and correct the input argument of the module FB. 	

*1 The supported firmware version is "12" or later.

Error codes

Error code	Reference
D000H to DFFFH	 MELSEC iQ-R CC-Link IE Field Network User's Manual (Application)

6.13 M+model_ReadSystemStatusInformation

Name

■RJ71EN71, RnENCPU (network part)

This FB is displayed as follows on the engineering tool depending on the settings.

Name	Module model name	
	RJ71EN71	RnENCPU (network part)
M+RJ71EN71_F_ReadSystemStatusInformation	RJ71EN71(CCIEF)	_RJ71EN71(CCIEF)
M+RJ71EN71_EF_ReadSystemStatusInformation	RJ71EN71(E+CCIEF)	_RJ71EN71(E+IEF)

■RJ71GF11-T2

M+RJ71GF11_ReadSystemStatusInformation

Overview

Item	Description																								
Overview	Reads the system configuration model status of the intelligent device station (remote head module).																								
Symbol	<div style="border: 1px solid black; padding: 10px; width: fit-content; margin: 10px auto;"> <p style="text-align: center;">M+RJ71GF11_ReadSystemStatusInformation</p> <table style="width: 100%; border-collapse: collapse;"> <tr> <td style="width: 15%;">(1) B: i_bEN</td> <td style="width: 35%;"></td> <td style="width: 15%;">o_bENO: B</td> <td style="width: 35%;">(5)</td> </tr> <tr> <td>(2) DUT: i_stModule</td> <td></td> <td>o_bOK: B</td> <td>(6)</td> </tr> <tr> <td>(3) UW: i_u2TargetAddress</td> <td></td> <td>o_bErr: B</td> <td>(7)</td> </tr> <tr> <td>(4) UW: i_uChannel</td> <td></td> <td>o_uErrId: UW</td> <td>(8)</td> </tr> <tr> <td></td> <td></td> <td>o_uUnitStatusData: UW</td> <td>(9)</td> </tr> <tr> <td colspan="4" style="padding-top: 10px;"> pbi_uResendCountMax (10) pbi_uTimeUnit (11) pbi_uMonitorTime (12) pbo_uResendCount (13) pbo_u4ErrTime (14) pbo_uErrNetworkNo (15) pbo_uErrStationNo (16) </td> </tr> </table> <p style="text-align: center; margin-top: 10px;">The above FB is an example for the RJ71GF11-T2.</p> </div>	(1) B: i_bEN		o_bENO: B	(5)	(2) DUT: i_stModule		o_bOK: B	(6)	(3) UW: i_u2TargetAddress		o_bErr: B	(7)	(4) UW: i_uChannel		o_uErrId: UW	(8)			o_uUnitStatusData: UW	(9)	pbi_uResendCountMax (10) pbi_uTimeUnit (11) pbi_uMonitorTime (12) pbo_uResendCount (13) pbo_u4ErrTime (14) pbo_uErrNetworkNo (15) pbo_uErrStationNo (16)			
(1) B: i_bEN		o_bENO: B	(5)																						
(2) DUT: i_stModule		o_bOK: B	(6)																						
(3) UW: i_u2TargetAddress		o_bErr: B	(7)																						
(4) UW: i_uChannel		o_uErrId: UW	(8)																						
		o_uUnitStatusData: UW	(9)																						
pbi_uResendCountMax (10) pbi_uTimeUnit (11) pbi_uMonitorTime (12) pbo_uResendCount (13) pbo_u4ErrTime (14) pbo_uErrNetworkNo (15) pbo_uErrStationNo (16)																									

Labels

■Input arguments

No.	Variable name	Name	Data type	Range	Description
(1)	i_bEN	Execution command	Bit	—	On: Start FB. Off: Do not start FB.
(2)	i_stModule	Module label	Structures	—	Specify the module for which the FB is to be executed. Specify the module label of the modules.
(3)	i_u2TargetAddress	Target station address	Word [Unsigned]/ Bit String [16-bit] (0..1)	—	Specifies the station number of the target station. • 1st word: Network number • 2nd word: Station number (1) 0 (The setting is ignored.) (2) Station number • 1 to 120: Intelligent device station (remote head module)
(4)	i_uChannel	Own station channel	Word [Unsigned]/ Bit String [16-bit]	—	Specify the channel to be used by the own station. MELSEC iQ-R Programming Manual (Module Dedicated Instructions)

■Output arguments

No.	Variable name	Name	Data type	Description	Default value
(5)	o_bENO	Execution status	Bit	On: The execution command is turned on. Off: The execution command is turned off.	Off
(6)	o_bOK	Normal completion	Bit	The FB has been processed normally when this argument is on.	Off
(7)	o_bErr	Error completion	Bit	The FB has been processed abnormally when this argument is on.	Off
(8)	o_uErrId	Error code	Word [Unsigned]/ Bit String [16-bit]	An error code is stored at error completion.	0
(9)	o_uUnitStatusData	Module status data storage device	Word [Unsigned]/ Bit String [16-bit]	The start number of the device for storing module status data is stored. The following cannot be specified as an argument. Specifying any of the following may cause a CPU error (2820H: Device/label/buffer memory specification incorrect). <ul style="list-style-type: none"> • Dynamically specified array elements (Example: wLabel[D0]) • Digit-specified labels (Example: K4bLabel) • Indirectly specified devices (Example: @W0) • Local devices (Example: #D0) 	0

■Operation parameters

No.	Variable name	Name	Data type	Range	Description	Default value
(10)	pbi_uResendCountMax	Maximum number of resends	Word [Unsigned]/ Bit String [16-bit]	0 to 15	Specify the number of resends to be performed if the data transfer is not completed within the monitoring time specified by "Arrival monitoring time". <ul style="list-style-type: none"> • 0 to 15 	5
(11)	pbi_uTimeUnit	Arrival monitoring time unit	Word [Unsigned]/ Bit String [16-bit]	0, 1	Specify the unit of the "Arrival monitoring time". <ul style="list-style-type: none"> • 0: 1s • 1: 100ms 	0
(12)	pbi_uMonitorTime	Arrival monitoring time	Word [Unsigned]/ Bit String [16-bit]	—	Specify the monitoring time until completion of processing. If the processing is not completed within the monitoring time, data is resent until the value specified in "Maximum number of resends" is reached. When "Arrival monitoring time unit" is set to 1s <ul style="list-style-type: none"> • Effective range 1 to 32767: 1s to 32767s When "Arrival monitoring time unit" is set to 100ms <ul style="list-style-type: none"> • Effective range 1 to 65535: 1 to 65535 × 100ms 	0: 10s

■Public variables

No.	Variable name	Name	Data type	Description	Default value
(13)	pbo_uResendCount	Number of resends	Word [Unsigned]/Bit String [16-bit]	The number of resends performed (result) is stored.	0
(14)	pbo_u4ErrTime	Error occurrence time	Word [Unsigned]/Bit String [16-bit] (0..3)	Clock data at the time of error occurrence is stored. 1st word <ul style="list-style-type: none"> • Upper 8 bits: Month (01H to 12H) • Lower 8 bits: Lower 2 digits of year (00H to 99H) 2nd word <ul style="list-style-type: none"> • Upper 8 bits: Hour (00H to 23H) • Lower 8 bits: Day (01H to 31H) 3rd word <ul style="list-style-type: none"> • Upper 8 bits: Second (00H to 59H) • Lower 8 bits: Minute (00H to 59H) 4th word <ul style="list-style-type: none"> • Upper 8 bits: Upper 2 digits of year (00H to 99H) • Lower 8 bits: Day of week (00H (Sunday) to 06H (Saturday)) 	0
(15)	pbo_uErrNetworkNo	Error detection network number	Word [Unsigned]/Bit String [16-bit]	The network number of the station in which an error was detected is stored.	0
(16)	pbo_uErrStationNo	Error-detected station number	Word [Unsigned]/Bit String [16-bit]	The station number of the station in which an error was detected is stored. <ul style="list-style-type: none"> • 125: Master station • 1 to 120: Local station, intelligent device station, submaster station 	0

FB details

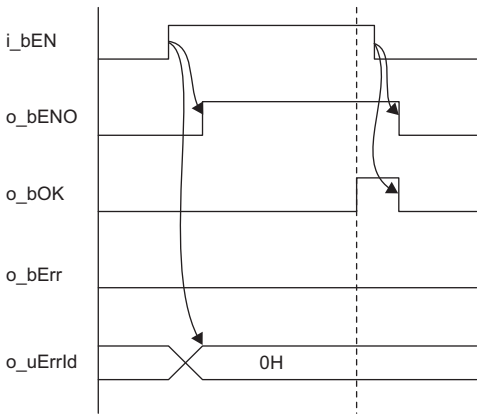
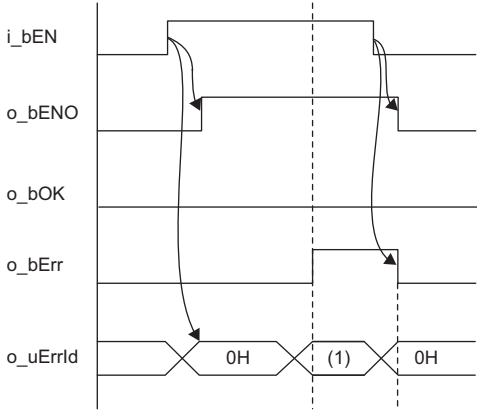
Item	Description	
Available device	Target module	<ul style="list-style-type: none"> • RJ71EN71*¹ • RJ71GF11-T2*¹ • RnENCPU (network part)*¹
	CPU module	RCPU
	Engineering tool	GX Works3
Language	Ladder diagram	
Number of basic steps	79 steps The number of steps of the FB embedded in a program depends on the CPU module used, the input/output definitions, and the option settings of GX Works3. For the option settings of GX Works3, refer to GX Works3 Operating Manual.	
Processing	When i_bEN (execution instruction) is turned on, this function reads the status information of the system configuration module of the intelligent device station (remote head module).	
FB compilation method	Macro type	
FB operation	Pulse type (multiple-scan execution type)	
Input condition for FB_EN	None	
Timing chart of I/O signals	<ul style="list-style-type: none"> • For normal completion  <ul style="list-style-type: none"> • For error completion (same as in the case of a module error)  <p>(1) Error code</p>	
Precautions	<ul style="list-style-type: none"> • This FB does not include error recovery processing. Please create error recovery processing separately according to the system and required operations. • This FB uses the GP.SINFSTRD instruction. • Turn off i_bEN (execution command) after o_bOK (normal completion) or o_bErr (error completion) is turned on. By turning off i_bEN (execution command), o_bOK (normal completion) or o_bErr (error completion) is turned off and o_uErrld (error code) is cleared to 0. • This FB uses the label initial value by each program. When the program file using this FB is specified to boot file setting for the boot operation in the CPU module, specify the initial label value file by each program to the boot file setting as well. (MELSEC iQ-R CPU Module User's Manual (Application)) If an error code that is not described in Page 216 Error codes appears, the initial label value files by each program may not be set to the boot file setting. In this case, specify the initial label value files by each program to the boot file setting. • When this FB is executed, an operation error may occur in the programmable controller CPU. In this case, check the detailed information of the operation error in event history and correct the input argument of the module FB. 	

*1 The supported firmware version is "12" or later.

Error codes

Error code	Reference
D000H to DFFFH	 MELSEC iQ-R CC-Link IE Field Network User's Manual (Application)

Public variables

No.	Variable name	Name	Data type	Description	Default value
(9)	pbo_u4ErrTime	Error occurrence time	Word [Unsigned]/ Bit String [16-bit] (0..3)	Clock data at the time of error occurrence is stored. 1st word • Upper 8 bits: Month (01H to 12H) • Lower 8 bits: Lower 2 digits of year (00H to 99H) 2nd word • Upper 8 bits: Hour (00H to 23H) • Lower 8 bits: Day (01H to 31H) 3rd word • Upper 8 bits: Second (00H to 59H) • Lower 8 bits: Minute (00H to 59H) 4th word • Upper 8 bits: Upper 2 digits of year (00H to 99H) • Lower 8 bits: Day of week (00H (Sunday) to 06H (Saturday))	0
(10)	pbo_uErrNetworkNo	Error detection network number	Word [Unsigned]/ Bit String [16-bit]	The network number of the station in which an error was detected is stored.	0
(11)	pbo_uErrStationNo	Error-detected station number	Word [Unsigned]/ Bit String [16-bit]	The station number of the station in which an error was detected is stored. • 125: Master station • 126: Master operating station • 1 to 120: Local station, intelligent device station, remote device station, submaster station	0

FB details

Item	Description
Available device	Target module • RJ71EN71 ^{*1} • RJ71GF11-T2 ^{*1} • RnENCPU (network part) ^{*1}
	CPU module RCPU
	Engineering tool GX Works3 ^{*2}
Language	Ladder diagram
Number of basic steps	150 steps The number of steps of the FB embedded in a program depends on the CPU module used, the input/output definitions, and the option settings of GX Works3. For the option settings of GX Works3, refer to GX Works3 Operating Manual.
Processing	When i_bEN (execution instruction) is turned on, this function sends a remote STOP request to the target station and then sends a remote RESET request.
FB compilation method	Macro type
FB operation	Pulse type (multiple-scan execution type)
Input condition for FB_EN	None

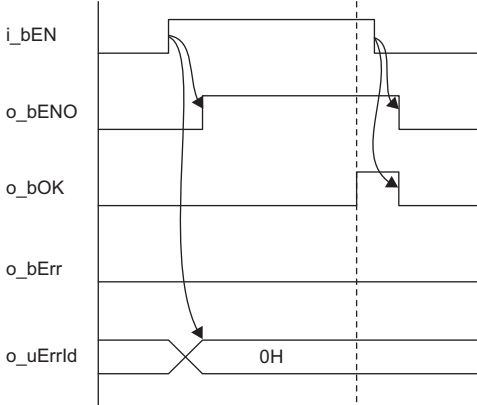
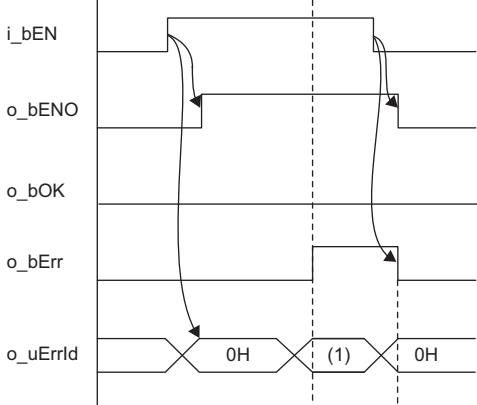
Item	Description
Timing chart of I/O signals	<ul style="list-style-type: none"> For normal completion  <ul style="list-style-type: none"> For error completion (same as in the case of a module error)  <p>(1) Error code</p>
Precautions	<ul style="list-style-type: none"> This FB does not include error recovery processing. Please create error recovery processing separately according to the system and required operations. This FB uses the GP.SLMPREQ instruction. Turn off i_bEN (execution command) after o_bOK (normal completion) or o_bErr (error completion) is turned on. By turning off i_bEN (execution command), o_bOK (normal completion) or o_bErr (error completion) is turned off and o_uErrId (error code) is cleared to 0. When the remote RESET request is sent and completed successfully, o_bOK (normal completion) is turned on. Whether the target station is actually reset remotely or not depends on the target station status. In this FB, stations in other network cannot be set as the target station. When this FB is executed, an operation error may occur in the programmable controller CPU. In this case, check the detailed information of the operation error in event history and correct the input argument of the module FB.

*1 The supported firmware version is "18" or later.

*2 The supported version is "1.035M" or later.

Error codes

Error code	Reference
D000H to DFFFH	 MELSEC iQ-R CC-Link IE Field Network User's Manual (Application)

7 MELSECNET/H NETWORK MODULE FB

7.1 M+model_DeviceRead

The FB is the same as M+model_DeviceRead of the Ethernet-equipped module FB. (☞ Page 15 M+model_DeviceRead)

7.2 M+model_DeviceWrite

The FB is the same as M+model_DeviceWrite of the Ethernet-equipped module FB. (☞ Page 20 M+model_DeviceWrite)

7.3 M+model_Send

The FB is the same as M+model_Send of the Ethernet-equipped module FB. (☞ Page 26 M+model_Send)

7.4 M+model_Recv

The FB is the same as M+model_Recv of the Ethernet-equipped module FB. (☞ Page 32 M+model_Recv)

7.5 M+model_RemoteStopRun

The FB is the same as M+model_RemoteStopRun of the Ethernet-equipped module FB. ( Page 37
M+model_RemoteStopRun)

7.6 M+model_ReadTime

The FB is the same as M+model_ReadTime of the Ethernet-equipped module FB. ( Page 42 M+model_ReadTime)

7.7 M+model_WriteTime

The FB is the same as M+model_WriteTime of the Ethernet-equipped module FB. ( Page 46 M+model_WriteTime)

7.8 M+model_RedundantSystem_GetAddress

The FB is the same as M+model_RedundantSystem_GetAddress of the CC-Link IE Controller Network-equipped module FB.
( Page 184 M+model_RedundantSystem_GetAddress)

INSTRUCTION INDEX

M

M+RCPU_ConnectionClose	56	M+RJ71EN71_EF_Send_Socket	62
M+RCPU_ConnectionOpen	51	M+RJ71EN71_EF_SetParameter	195
M+RCPU_Recv_Socket	59	M+RJ71EN71_EF_StationNoSet	181
M+RCPU_Send_Socket	62	M+RJ71EN71_EF_WriteTime	46
M+RCPU_SLMP_DeviceRead_IP	67	M+RJ71EN71_F_DeviceRead	15
M+RCPU_SLMP_DeviceWrite_IP	73	M+RJ71EN71_F_DeviceWrite	20
M+RJ71BR11_DeviceRead	15	M+RJ71EN71_F_ReadSystemStatusInformation	213
M+RJ71BR11_DeviceWrite	20	M+RJ71EN71_F_ReadSystemTypeInformation	209
M+RJ71BR11_ReadTime	42	M+RJ71EN71_F_ReadTime	42
M+RJ71BR11_Recv	32	M+RJ71EN71_F_Recv	32
M+RJ71BR11_RemoteStopRun	37	M+RJ71EN71_F_RemoteStopRun	37
M+RJ71BR11_Send	26	M+RJ71EN71_F_Send	26
M+RJ71BR11_WriteTime	46	M+RJ71EN71_F_SetParameter	195
M+RJ71EN71_C_DeviceRead	15	M+RJ71EN71_F_StationNoSet	181
M+RJ71EN71_C_DeviceWrite	20	M+RJ71EN71_F_WriteTime	46
M+RJ71EN71_C_ReadTime	42	M+RJ71EN71_RemoteReset	217
M+RJ71EN71_C_Recv	32	M+RJ71GF11_DeviceRead	15
M+RJ71EN71_C_RemoteStopRun	37	M+RJ71GF11_DeviceWrite	20
M+RJ71EN71_C_Send	26	M+RJ71GF11_ReadSystemStatusInformation	213
M+RJ71EN71_C_StationNoSet	181	M+RJ71GF11_ReadSystemTypeInformation	209
M+RJ71EN71_C_WriteTime	46	M+RJ71GF11_ReadTime	42
M+RJ71EN71_EC_ConnectionClose	56	M+RJ71GF11_Recv	32
M+RJ71EN71_EC_ConnectionOpen	51	M+RJ71GF11_RedundantSystem_GetAddress	184
M+RJ71EN71_EC_DeviceRead	15	M+RJ71GF11_RemoteReset	217
M+RJ71EN71_EC_DeviceWrite	20	M+RJ71GF11_RemoteStopRun	37
M+RJ71EN71_EC_ReadTime	42	M+RJ71GF11_Send	26
M+RJ71EN71_EC_Recv	32	M+RJ71GF11_SetParameter	195
M+RJ71EN71_EC_Recv_Socket	59	M+RJ71GF11_SetParameterRedundant	201
M+RJ71EN71_EC_Refresh_Data	65	M+RJ71GF11_StationNoSet	181
M+RJ71EN71_EC_RemoteStopRun	37	M+RJ71GF11_WriteTime	46
M+RJ71EN71_EC_Send	26	M+RJ71GN11_DeviceRead	79
M+RJ71EN71_EC_Send_Socket	62	M+RJ71GN11_DeviceWrite	84
M+RJ71EN71_EC_StationNoSet	181	M+RJ71GN11_Recv	97
M+RJ71EN71_EC_WriteTime	46	M+RJ71GN11_RemoteRead	132
M+RJ71EN71_EE_ConnectionClose	56	M+RJ71GN11_RemoteReset2_IP	147
M+RJ71EN71_EE_ConnectionOpen	51	M+RJ71GN11_RemoteReset_IP	142
M+RJ71EN71_EE_DeviceRead	15	M+RJ71GN11_RemoteStopRun	102
M+RJ71EN71_EE_DeviceWrite	20	M+RJ71GN11_RemoteWrite	137
M+RJ71EN71_EE_ReadTime	42	M+RJ71GN11_SE_ConnectionClose	165
M+RJ71EN71_EE_Recv	32	M+RJ71GN11_SE_ConnectionOpen	162
M+RJ71EN71_EE_Recv_Socket	59	M+RJ71GN11_SE_DeviceRead	79
M+RJ71EN71_EE_Refresh_Data	65	M+RJ71GN11_SE_DeviceWrite	84
M+RJ71EN71_EE_RemoteStopRun	37	M+RJ71GN11_SE_Send	91
M+RJ71EN71_EE_Send	26	M+RJ71GN11_SE_Recv	97
M+RJ71EN71_EE_Send_Socket	62	M+RJ71GN11_SE_Recv_Socket	167
M+RJ71EN71_EE_WriteTime	46	M+RJ71GN11_SE_Refresh_Data	172
M+RJ71EN71_EF_ConnectionClose	56	M+RJ71GN11_SE_RemoteRead	132
M+RJ71EN71_EF_ConnectionOpen	51	M+RJ71GN11_SE_RemoteReset2_IP	147
M+RJ71EN71_EF_DeviceRead	15	M+RJ71GN11_SE_RemoteReset_IP	142
M+RJ71EN71_EF_DeviceWrite	20	M+RJ71GN11_SE_RemoteStopRun	102
M+RJ71EN71_EF_ReadSystemStatusInformation	213	M+RJ71GN11_SE_RemoteWrite	137
M+RJ71EN71_EF_ReadSystemTypeInformation	209	M+RJ71GN11_SE_Send	91
M+RJ71EN71_EF_ReadTime	42	M+RJ71GN11_SE_Send_Socket	170
M+RJ71EN71_EF_Recv	32	M+RJ71GN11_SE_SLMP_DeviceRead_IP	108
M+RJ71EN71_EF_Recv_Socket	59	M+RJ71GN11_SE_SLMP_DeviceWrite_IP	115
M+RJ71EN71_EF_Refresh_Data	65	M+RJ71GN11_SetAddress	122
M+RJ71EN71_EF_RemoteStopRun	37	M+RJ71GN11_SetParameterX	125
M+RJ71EN71_EF_Send	26	M+RJ71GN11_SLMP_DeviceRead_IP	108
		M+RJ71GN11_SLMP_DeviceWrite_IP	115
		M+RJ71GN11_SX_DeviceRead	79
		M+RJ71GN11_SX_DeviceWrite	84

M+RJ71GN11_SX_Recv	97
M+RJ71GN11_SX_RemoteReset2_IP	147
M+RJ71GN11_SX_RemoteReset_IP	142
M+RJ71GN11_SX_RemoteStopRun	102
M+RJ71GN11_SX_Send	91
M+RJ71GN11_SX_SetAddress	122
M+RJ71GN11_SX_SLMP_DeviceRead_IP	108
M+RJ71GN11_SX_SLMP_DeviceWrite_IP	115
M+RJ71GP21_DeviceRead	15
M+RJ71GP21_DeviceWrite	20
M+RJ71GP21_ReadTime	42
M+RJ71GP21_Recv	32
M+RJ71GP21_RedundantSystem_GetAddress	184
M+RJ71GP21_RemoteStopRun	37
M+RJ71GP21_Send	26
M+RJ71GP21_StationNoSet	181
M+RJ71GP21_WriteTime	46
M+RJ71LP21_DeviceRead	15
M+RJ71LP21_DeviceWrite	20
M+RJ71LP21_ReadTime	42
M+RJ71LP21_Recv	32
M+RJ71LP21_RedundantSystem_GetAddress	184
M+RJ71LP21_RemoteStopRun	37
M+RJ71LP21_Send	26
M+RJ71LP21_WriteTime	46

REVISIONS

*The manual number is given on the bottom left of the back cover.

Revision date	*Manual number	Description
June 2014	BCN-P5999-0381-A	First edition
July 2014	BCN-P5999-0381-B	Partial correction
November 2014	BCN-P5999-0381-C	<ul style="list-style-type: none"> ■Added function CC-Link IE Controller Network function of the RJ71EN71 ■Added or modified parts Section 2.1, 2.2, 3.3, 4.1, 5.1
July 2015	BCN-P5999-0381-D	<ul style="list-style-type: none"> ■Added or modified parts Section 2.1, 2.2, 2.3, 2.4, 2.5, 2.6, 2.7, 3.1, 3.2, 3.3, 3.4, 3.5, 4.1, 5.1
January 2016	BCN-P5999-0381-E	<ul style="list-style-type: none"> ■Added or modified parts Chapter 1, Section 2.1, 2.2, 2.3, 2.4, 2.5, 2.6, 2.7, 3.1, 3.2, 3.3, 3.4, 3.5, 3.6, 3.7, 4.1, 5.1
May 2016	BCN-P5999-0381-F	<ul style="list-style-type: none"> ■Added or modified parts Chapter 1, Section 4.2, 5.3, 5.4, 5.5
April 2017	BCN-P5999-0381-G	<ul style="list-style-type: none"> ■Added or modified parts Section 3.6, 3.7, 5.6
April 2018	BCN-P5999-0381-H	<ul style="list-style-type: none"> ■Added or modified parts Section 2.1, 2.2, 2.3, 2.4, 2.5, 2.6, 2.7, 3.1, 3.2, 3.3, 3.4, 3.5, 3.6, 3.7, 4.1, 4.2, 5.1, 5.4, 5.5, 5.6
May 2019	BCN-P5999-0381-I	<ul style="list-style-type: none"> ■Added model RJ71GN11-T2 ■Added or modified parts Chapter 1, 2, 3, 4, 5, TRADEMARK
May 2019	BCN-P5999-0381-J	<ul style="list-style-type: none"> ■Added or modified part Chapter 3
October 2019	BCN-P5999-0381-K	<ul style="list-style-type: none"> ■Added or modified part Section 3.9
November 2019	BCN-P5999-0381-L	<ul style="list-style-type: none"> ■Added or modified parts Section 3.1, 3.2, 3.3, 3.4, 3.5, 3.6, 3.7, 3.9, 3.10, 3.11
February 2020	BCN-P5999-0381-M	<ul style="list-style-type: none"> ■Added model RJ71LP21-25 ■Added or modified parts Chapter 1, Section 2.1, 2.2, 2.3, 2.4, 2.5, 2.6, 2.7, 2.8, 2.10, 2.13, 2.14, 3.1, 3.2, 3.3, 3.4, 3.5, 3.6, 3.7, 3.9, 3.10, 3.11, 4.9, 5.11, 5.12, Chapter 6
March 2020	BCN-P5999-0381-N	<ul style="list-style-type: none"> ■Added or modified part RELEVANT MANUALS
April 2021	BCN-P5999-0381-O	<ul style="list-style-type: none"> ■Added or modified parts Section 2.1, 2.2, 2.3, 2.4, 2.10, 2.11
August 2021	BCN-P5999-0381-P	<ul style="list-style-type: none"> ■Added or modified parts Chapter 1, Section 2.1, 2.2, 2.3, 2.4, 2.5, 2.6, 2.7, 2.8, 2.9, 2.10, 2.11, 2.12, 2.13, 2.14, 3.1, 3.2, 3.3, 3.4, 3.5, 3.6, 3.7, 3.8, 3.9, 3.10, 3.11, 3.12, 4.8, 4.9, 5.8, 5.11, 5.12, 5.13
October 2021	BCN-P5999-0381-Q	<ul style="list-style-type: none"> ■Added or modified parts Section 1.1, 5.9
January 2022	BCN-P5999-0381-R	<ul style="list-style-type: none"> ■Added model RJ71GN11-EIP ■Added or modified parts INTRODUCTION, RELEVANT MANUALS, Section 1.1, 1.3, 3.1, 3.2, 3.3, 3.4, 3.5, 3.6, 3.7, 3.8, 3.10, 3.11, 3.12, Chapter 4 ■Chapter number change Chapter 4 to 6 → Chapter 5 to 7
April 2022	BCN-P5999-0381-S	<ul style="list-style-type: none"> ■Added or modified parts Section 1.1, 3.5, 3.6, 3.7, 3.9, 3.12, 3.13, 4.11
April 2023	BCN-P5999-0381-T	<ul style="list-style-type: none"> ■Added models RJ71GN11-SX, RJ71BR11 ■Added or modified parts INTRODUCTION, Section 1.1, 1.3, 2.1, 2.2, 2.3, 2.4, 2.5, 2.6, 2.7, 3.1, 3.2, 3.3, 3.4, 3.5, 3.6, 3.8, 3.9, 3.12, 3.13

Japanese manual number: BCN-P5999-0372-T

This manual confers no industrial property rights or any rights of any other kind, nor does it confer any patent licenses. Mitsubishi Electric Corporation cannot be held responsible for any problems involving industrial property rights which may occur as a result of using the contents noted in this manual.

TRADEMARKS

The company names, system names and product names mentioned in this manual are either registered trademarks or trademarks of their respective companies.

In some cases, trademark symbols such as [™] or [®] are not specified in this manual.

BCN-P5999-0381-T(2304)

MITSUBISHI ELECTRIC CORPORATION

HEAD OFFICE: TOKYO BLDG., 2-7-3, MARUNOUCHI, CHIYODA-KU, TOKYO 100-8310, JAPAN
NAGOYA WORKS: 1-14, YADA-MINAMI 5-CHOME, HIGASHI-KU, NAGOYA 461-8670, JAPAN

When exported from Japan, this manual does not require application to the
Ministry of Economy, Trade and Industry for service transaction permission.

Specifications subject to change without notice.