

Programmable Controller

MELSEC iQ-R
series

MELSEC iQ-R System Recorder
User's Manual (Startup)



SAFETY PRECAUTIONS

(Read these precautions before using this product.)

Before using this product, please read this manual and the relevant manuals carefully and pay full attention to safety to handle the product correctly. If products are used in a different way from that specified by manufacturers, the protection function of the products may not work properly.

The precautions given in this manual are concerned with this product only. For the safety precautions of the programmable controller system, refer to the MELSEC iQ-R Module Configuration Manual.

In this manual, the safety precautions are classified into two levels: "⚠ WARNING" and "⚠ CAUTION".

 WARNING	Indicates that incorrect handling may cause hazardous conditions, resulting in death or severe injury.
 CAUTION	Indicates that incorrect handling may cause hazardous conditions, resulting in minor or moderate injury or property damage.

Under some circumstances, failure to observe the precautions given under "⚠ CAUTION" may lead to serious consequences.

Observe the precautions of both levels because they are important for personal and system safety.

Make sure that the end users read this manual and then keep the manual in a safe place for future reference.

[Design Precautions]

WARNING

- Configure safety circuits external to the programmable controller to ensure that the entire system operates safely even when a fault occurs in the external power supply or the programmable controller. Failure to do so may result in an accident due to an incorrect output or malfunction.
 - (1) Emergency stop circuits, protection circuits, and protective interlock circuits for conflicting operations (such as forward/reverse rotations or upper/lower limit positioning) must be configured external to the programmable controller.
 - (2) When the programmable controller detects an abnormal condition, it stops the operation and all outputs are:
 - Turned off if the overcurrent or overvoltage protection of the power supply module is activated.
 - Held or turned off according to the parameter setting if the self-diagnostic function of the CPU module detects an error such as a watchdog timer error.
 - (3) All outputs may be turned on if an error occurs in a part, such as an I/O control part, where the CPU module cannot detect any error. To ensure safety operation in such a case, provide a safety mechanism or a fail-safe circuit external to the programmable controller. For a fail-safe circuit example, refer to the MELSEC iQ-R Module Configuration Manual.
 - (4) Outputs may remain on or off due to a failure of a component such as a relay and transistor in an output circuit. Configure an external circuit for monitoring output signals that could cause a serious accident.
 - In an output circuit, when a load current exceeding the rated current or an overcurrent caused by a load short-circuit flows for a long time, it may cause smoke and fire. To prevent this, configure an external safety circuit, such as a fuse.
 - Configure a circuit so that the programmable controller is turned on first and then the external power supply. If the external power supply is turned on first, an accident may occur due to an incorrect output or malfunction.
 - For the operating status of each station after a communication failure, refer to manuals for the network used. For the manuals, please consult your local Mitsubishi representative. Incorrect output or malfunction due to a communication failure may result in an accident.
 - When connecting an external device with a CPU module or intelligent function module to modify data of a running programmable controller, configure an interlock circuit in the program to ensure that the entire system will always operate safely. For other forms of control (such as program modification, parameter change, forced output, or operating status change) of a running programmable controller, read the relevant manuals carefully and ensure that the operation is safe before proceeding. Improper operation may damage machines or cause accidents. When a Safety CPU is used, data cannot be modified while the Safety CPU is in SAFETY MODE.
 - Especially, when a remote programmable controller is controlled by an external device, immediate action cannot be taken if a problem occurs in the programmable controller due to a communication failure. To prevent this, configure an interlock circuit in the program, and determine corrective actions to be taken between the external device and CPU module in case of a communication failure.
-

[Design Precautions]

WARNING

- Do not write any data to the "system area" and "write-protect area" of the buffer memory in the module. Also, do not use any "use prohibited" signals as an output signal from the CPU module to each module. Doing so may cause malfunction of the programmable controller system. For the "system area", "write-protect area", and the "use prohibited" signals, refer to the user's manual for the module used. For areas used for safety communications, they are protected from being written by users, and thus safety communications failure caused by data writing does not occur.
 - If a communication cable is disconnected, the network may be unstable, resulting in a communication failure of multiple stations. Configure an interlock circuit in the program to ensure that the entire system will always operate safely even if communications fail. Incorrect output or malfunction due to a communication failure may result in an accident. When safety communications are used, an interlock by the safety station interlock function protects the system from an incorrect output or malfunction.
-

[Design Precautions]

CAUTION

- Do not install the control lines or communication cables together with the main circuit lines or power cables. Doing so may result in malfunction due to electromagnetic interference. Keep a distance of 100mm or more between those cables.
 - During control of an inductive load such as a lamp, heater, or solenoid valve, a large current (approximately ten times greater than normal) may flow when the output is turned from off to on. Therefore, use a module that has a sufficient current rating.
 - After the CPU module is powered on or is reset, the time taken to enter the RUN status varies depending on the system configuration, parameter settings, and/or program size. Design circuits so that the entire system will always operate safely, regardless of the time.
 - Do not power off the programmable controller or reset the CPU module while the settings are being written. Doing so will make the data in the flash ROM and SD memory card undefined. The values need to be set in the buffer memory and written to the flash ROM and SD memory card again. Doing so also may cause malfunction or failure of the module.
 - When changing the operating status of the CPU module from external devices (such as the remote RUN/STOP functions), select "Do Not Open by Program" for "Opening Method" of "Module Parameter". If "Open by Program" is selected, an execution of the remote STOP function causes the communication line to close. Consequently, the CPU module cannot reopen the line, and external devices cannot execute the remote RUN function.
-

[Security Precautions]

WARNING

- To maintain the security (confidentiality, integrity, and availability) of the programmable controller and the system against unauthorized access, denial-of-service (DoS) attacks, computer viruses, and other cyberattacks from external devices via the network, take appropriate measures such as firewalls, virtual private networks (VPNs), and antivirus solutions.
-

[Installation Precautions]

WARNING

- Shut off the external power supply (all phases) used in the system before mounting or removing the module. Failure to do so may result in electric shock or cause the module to fail or malfunction.
-

[Installation Precautions]

CAUTION

- Use the programmable controller in an environment that meets the general specifications in the MELSEC iQ-R Module Configuration Manual. Failure to do so may result in electric shock, fire, malfunction, or damage to or deterioration of the product.
 - To mount a module, place the concave part(s) located at the bottom onto the guide(s) of the base unit, and push in the module until the hook(s) located at the top snaps into place. Incorrect interconnection may cause malfunction, failure, or drop of the module.
 - To mount a module with no module fixing hook, place the concave part(s) located at the bottom onto the guide(s) of the base unit, push in the module, and fix it with screw(s). Incorrect interconnection may cause malfunction, failure, or drop of the module.
 - When using the programmable controller in an environment of frequent vibrations, fix the module with a screw.
 - Tighten the screws within the specified torque range. Undertightening can cause drop of the component or wire, short circuit, or malfunction. Overtightening can damage the screw and/or module, resulting in drop, short circuit, or malfunction. For the specified torque range, refer to the MELSEC iQ-R Module Configuration Manual.
 - When using an extension cable, connect it to the extension cable connector of the base unit securely. Check the connection for looseness. Poor contact may cause malfunction.
 - When using an SD memory card, fully insert it into the SD memory card slot. Check that it is inserted completely. Poor contact may cause malfunction.
 - Securely insert an extended SRAM cassette or a battery-less option cassette into the cassette connector of the CPU module. After insertion, close the cassette cover and check that the cassette is inserted completely. Poor contact may cause malfunction.
 - Do not directly touch any conductive parts and electronic components of the module, SD memory card, extended SRAM cassette, battery-less option cassette, or connector. Doing so can cause malfunction or failure of the module.
-

[Wiring Precautions]

WARNING

- Shut off the external power supply (all phases) used in the system before installation and wiring. Failure to do so may result in electric shock or cause the module to fail or malfunction.
- After installation and wiring, attach a blank cover module (RG60) to each empty slot before powering on the system for operation. Also, attach an extension connector protective cover ^{*1} to each unused extension cable connector as necessary. Directly touching any conductive parts of the connectors while power is on may result in electric shock.

*1 For details, please consult your local Mitsubishi Electric representative.

[Wiring Precautions]

CAUTION

- Individually ground the FG and LG terminals of the programmable controller with a ground resistance of 100 ohms or less. Failure to do so may result in electric shock or malfunction.
 - Use applicable solderless terminals and tighten them within the specified torque range. If any spade solderless terminal is used, it may be disconnected when the terminal screw comes loose, resulting in failure.
 - Check the rated voltage and signal layout before wiring to the module, and connect the cables correctly. Connecting a power supply with a different voltage rating or incorrect wiring may cause fire or failure.
 - Connectors for external devices must be crimped or pressed with the tool specified by the manufacturer, or must be correctly soldered. Incomplete connections may cause short circuit, fire, or malfunction.
 - Securely connect the connector to the module. Poor contact may cause malfunction.
 - Do not install the control lines or communication cables together with the main circuit lines or power cables. Doing so may result in malfunction due to noise. Keep a distance of 100mm or more between those cables.
 - Place the cables in a duct or clamp them. If not, dangling cables may swing or inadvertently be pulled, resulting in malfunction or damage to modules or cables.
In addition, the weight of the cables may put stress on modules in an environment of strong vibrations and shocks. Do not clamp the extension cables with the jacket stripped. Doing so may change the characteristics of the cables, resulting in malfunction.
 - Check the interface type and correctly connect the cable. Incorrect wiring (connecting the cable to an incorrect interface) may cause failure of the module and external device.
 - Tighten the terminal screws or connector screws within the specified torque range. Undertightening can cause drop of the screw, short circuit, fire, or malfunction. Overtightening can damage the screw and/or module, resulting in drop, short circuit, fire, or malfunction.
 - When disconnecting the cable from the module, do not pull the cable by the cable part. For the cable with connector, hold the connector part of the cable. For the cable connected to the terminal block, loosen the terminal screw. Pulling the cable connected to the module may result in malfunction or damage to the module or cable.
 - Prevent foreign matter such as dust or wire chips from entering the module. Such foreign matter can cause a fire, failure, or malfunction.
 - A protective film is attached to the top of the module to prevent foreign matter, such as wire chips, from entering the module during wiring. Do not remove the film during wiring. Remove it for heat dissipation before system operation.
 - Programmable controllers must be installed in control panels. Connect the main power supply to the power supply module in the control panel through a relay terminal block. Wiring and replacement of a power supply module must be performed by qualified maintenance personnel with knowledge of protection against electric shock. For wiring, refer to the MELSEC iQ-R Module Configuration Manual.
 - For Ethernet cables to be used in the system, select the ones that meet the specifications in the user's manual for the module used. If not, normal data transmission is not guaranteed.
-

[Startup and Maintenance Precautions]

WARNING

- Do not touch any terminal while power is on. Doing so will cause electric shock or malfunction.
 - Correctly connect the battery connector. Do not charge, disassemble, heat, short-circuit, solder, or throw the battery into the fire. Also, do not expose it to liquid or strong shock. Doing so will cause the battery to produce heat, explode, ignite, or leak, resulting in injury and fire.
 - Shut off the external power supply (all phases) used in the system before cleaning the module or retightening the terminal screws, connector screws, or module fixing screws. Failure to do so may result in electric shock.
-

[Startup and Maintenance Precautions]

CAUTION

- When connecting an external device with a CPU module or intelligent function module to modify data of a running programmable controller, configure an interlock circuit in the program to ensure that the entire system will always operate safely. For other forms of control (such as program modification, parameter change, forced output, or operating status change) of a running programmable controller, read the relevant manuals carefully and ensure that the operation is safe before proceeding. Improper operation may damage machines or cause accidents.
 - Especially, when a remote programmable controller is controlled by an external device, immediate action cannot be taken if a problem occurs in the programmable controller due to a communication failure. To prevent this, configure an interlock circuit in the program, and determine corrective actions to be taken between the external device and CPU module in case of a communication failure.
 - Do not disassemble or modify the modules. Doing so may cause failure, malfunction, injury, or a fire.
 - Use any radio communication device such as a cellular phone or PHS (Personal Handy-phone System) more than 25cm away in all directions from the programmable controller. Failure to do so may cause malfunction.
 - Shut off the external power supply (all phases) used in the system before mounting or removing the module. Failure to do so may cause the module to fail or malfunction.
 - Tighten the screws within the specified torque range. Undertightening can cause drop of the component or wire, short circuit, or malfunction. Overtightening can damage the screw and/or module, resulting in drop, short circuit, or malfunction.
 - After the first use of the product, do not perform each of the following operations more than 50 times (IEC 61131-2/JIS B 3502 compliant). Exceeding the limit may cause malfunction.
 - Mounting/removing the module to/from the base unit
 - Inserting/removing the extended SRAM cassette or battery-less option cassette to/from the CPU module
 - Mounting/removing the terminal block to/from the module
 - Connecting/disconnecting the extension cable to/from the base unit
 - After the first use of the product, do not insert/remove the SD memory card to/from the CPU module more than 500 times. Exceeding the limit may cause malfunction.
 - Do not touch the metal terminals on the back side of the SD memory card. Doing so may cause malfunction or failure of the module.
 - Do not touch the integrated circuits on the circuit board of an extended SRAM cassette or a battery-less option cassette. Doing so may cause malfunction or failure of the module.
 - Do not drop or apply shock to the battery to be installed in the module. Doing so may damage the battery, causing the battery fluid to leak inside the battery. If the battery is dropped or any shock is applied to it, dispose of it without using.
 - Startup and maintenance of a control panel must be performed by qualified maintenance personnel with knowledge of protection against electric shock. Lock the control panel so that only qualified maintenance personnel can operate it.
 - Before handling the module, touch a conducting object such as a grounded metal to discharge the static electricity from the human body. Wearing a grounded antistatic wrist strap is recommended. Failure to discharge the static electricity may cause the module to fail or malfunction.
-

[Operating Precautions]

CAUTION

- When changing data and operating status, and modifying program of the running programmable controller from an external device such as a personal computer connected to an intelligent function module, read relevant manuals carefully and ensure the safety before operation. Incorrect change or modification may cause system malfunction, damage to the machines, or accidents.
 - Do not power off the programmable controller or reset the CPU module while the setting values in the buffer memory are being written to the flash ROM in the module. Doing so will make the data in the flash ROM and SD memory card undefined. The values need to be set in the buffer memory and written to the flash ROM and SD memory card again. Doing so can cause malfunction or failure of the module.
-

[Disposal Precautions]

CAUTION

- When disposing of this product, treat it as industrial waste.
 - When disposing of batteries, separate them from other wastes according to the local regulations. For details on battery regulations in EU member states, refer to the MELSEC iQ-R Module Configuration Manual.
-

[Transportation Precautions]

CAUTION

- When transporting lithium batteries, follow the transportation regulations. For details on the regulated models, refer to the MELSEC iQ-R Module Configuration Manual.
 - The halogens (such as fluorine, chlorine, bromine, and iodine), which are contained in a fumigant used for disinfection and pest control of wood packaging materials, may cause failure of the product. Prevent the entry of fumigant residues into the product or consider other methods (such as heat treatment) instead of fumigation. The disinfection and pest control measures must be applied to unprocessed raw wood.
-

CONDITIONS OF USE FOR THE PRODUCT

- (1) MELSEC programmable controller ("the PRODUCT") shall be used in conditions;
- i) where any problem, fault or failure occurring in the PRODUCT, if any, shall not lead to any major or serious accident; and
 - ii) where the backup and fail-safe function are systematically or automatically provided outside of the PRODUCT for the case of any problem, fault or failure occurring in the PRODUCT.
- (2) The PRODUCT has been designed and manufactured for the purpose of being used in general industries. MITSUBISHI ELECTRIC SHALL HAVE NO RESPONSIBILITY OR LIABILITY (INCLUDING, BUT NOT LIMITED TO ANY AND ALL RESPONSIBILITY OR LIABILITY BASED ON CONTRACT, WARRANTY, TORT, PRODUCT LIABILITY) FOR ANY INJURY OR DEATH TO PERSONS OR LOSS OR DAMAGE TO PROPERTY CAUSED BY the PRODUCT THAT ARE OPERATED OR USED IN APPLICATION NOT INTENDED OR EXCLUDED BY INSTRUCTIONS, PRECAUTIONS, OR WARNING CONTAINED IN MITSUBISHI ELECTRIC USER'S, INSTRUCTION AND/OR SAFETY MANUALS, TECHNICAL BULLETINS AND GUIDELINES FOR the PRODUCT.
- ("Prohibited Application")
- Prohibited Applications include, but not limited to, the use of the PRODUCT in;
- Nuclear Power Plants and any other power plants operated by Power companies, and/or any other cases in which the public could be affected if any problem or fault occurs in the PRODUCT.
 - Railway companies or Public service purposes, and/or any other cases in which establishment of a special quality assurance system is required by the Purchaser or End User.
 - Aircraft or Aerospace, Medical applications, Train equipment, transport equipment such as Elevator and Escalator, Incineration and Fuel devices, Vehicles, Manned transportation, Equipment for Recreation and Amusement, and Safety devices, handling of Nuclear or Hazardous Materials or Chemicals, Mining and Drilling, and/or other applications where there is a significant risk of injury to the public or property.
- Notwithstanding the above restrictions, Mitsubishi Electric may in its sole discretion, authorize use of the PRODUCT in one or more of the Prohibited Applications, provided that the usage of the PRODUCT is limited only for the specific applications agreed to by Mitsubishi Electric and provided further that no special quality assurance or fail-safe, redundant or other safety features which exceed the general specifications of the PRODUCTS are required. For details, please contact the Mitsubishi Electric representative in your region.
- (3) Mitsubishi Electric shall have no responsibility or liability for any problems involving programmable controller trouble and system trouble caused by DoS attacks, unauthorized access, computer viruses, and other cyberattacks.

INTRODUCTION

Thank you for purchasing the Mitsubishi Electric MELSEC iQ-R series programmable controllers.

This manual describes the performance specifications and procedures for operation to use System Recorder.

Before using this product, please read this manual and the relevant manuals carefully and develop familiarity with the functions and performance of the MELSEC iQ-R series programmable controller to handle the product correctly.

When applying the program examples provided in this manual to an actual system, ensure the applicability and confirm that it will not cause system control problems.

Note that the menu names and operating procedures may differ depending on an operating system in use and its version.



When reading this manual, replace the names and procedures with the applicable ones as necessary.

Please make sure that the end users read this manual.

COMPLIANCE WITH EMC AND LOW VOLTAGE DIRECTIVES

Method of ensuring compliance



To ensure that Mitsubishi Electric programmable controllers maintain the EMC and Low Voltage Directives or other regulations when incorporated into other machinery or equipment, certain measures may be necessary. Please refer to one of the following manuals.

-  MELSEC iQ-R Module Configuration Manual (SH-081262ENG)
-  Safety Guidelines (IB-0800525)

Certification marks on the side of the programmable controller indicate compliance with the relevant regulations.

Additional measures

To ensure that this product maintains the EMC and Low Voltage Directives or other regulations, please refer to the following.

-  MELSEC iQ-R Module Configuration Manual (SH-081262ENG)
-  Safety Guidelines (IB-0800525)

CONTENTS

SAFETY PRECAUTIONS	1
CONDITIONS OF USE FOR THE PRODUCT	9
INTRODUCTION	10
COMPLIANCE WITH EMC AND LOW VOLTAGE DIRECTIVES	10
RELEVANT MANUALS	13
TERMS	14
CHAPTER 1 System Recorder	15
CHAPTER 2 PERFORMANCE SPECIFICATIONS	17
2.1 Recording Function	17
CHAPTER 3 FUNCTION LIST	19
3.1 Recording Function	19
3.2 Offline Monitor Function	22
3.3 Camera Recording Function	22
3.4 Data Flow Analysis Function	22
3.5 Co-recording Function	22
CHAPTER 4 PROCEDURES FOR OPERATION	23
4.1 Recording Function	23
Parameter setting	29
Recording setting	34
4.2 Offline Monitor Function	35
4.3 Camera Recording Function	37
4.4 Data Flow Analysis Function	37
4.5 Co-recording Function	37
CHAPTER 5 SYSTEM CONFIGURATION	38
5.1 Overall System Configuration	38
When using a recorder module and Camera Recording Package	38
When using a camera recorder module	39
5.2 System Components and Engineering Tools	40
System components	40
Engineering tools	42
Configuring multiple modules	43
5.3 Recorder Module	45
Part names	45
Hardware specifications	47
Function list	48
SD memory card	49
Ethernet cable	53
External dimensions	55
5.4 Camera Recorder Module	56
Part names	56
Hardware specifications	58
Function list	59
SD memory card	60

Ethernet cable60
Network camera60
External dimensions60

INDEX **62**

REVISIONS64
WARRANTY65
TRADEMARKS66

RELEVANT MANUALS

Manual name [manual number]	Description	Available form
MELSEC iQ-R System Recorder User's Manual (Startup) [SH-082279ENG] (this manual)	Specifications, procedures for operation, and system configuration of System Recorder, and specifications of a recorder module/camera recorder module	Print book e-Manual PDF
MELSEC iQ-R System Recorder User's Manual (Application) [SH-082281ENG]	Functions, parameter settings, recording settings, and troubleshooting of System Recorder, and detailed specifications of a recorder module/camera recorder module	Print book e-Manual PDF
MELSEC iQ-R System Recorder Co-recording Function Reference Manual [SH-082553ENG]	Function, system configuration, parameter settings, and troubleshooting for co-recording	e-Manual PDF
MELSEC iQ-R CPU Module User's Manual (Startup) [SH-081263ENG]	Specifications, procedures before operation, and troubleshooting of a CPU module	Print book e-Manual PDF
MELSEC iQ-R CPU Module User's Manual (Application) [SH-081264ENG]	Memory, functions, devices, and parameters of a CPU module	Print book e-Manual PDF
GX Works3 Operating Manual [SH-081215ENG]	System configurations, parameter settings, and operation methods for the online function in GX Works3	e-Manual PDF
MELSEC iQ-R Module Configuration Manual [SH-081262ENG]	The combination of the MELSEC iQ-R series modules, common information on the installation/wiring in the system, and specifications of the power supply module, base unit, SD memory card, and battery	Print book e-Manual PDF
Camera Recording Package User's Manual [BCN-P5999-1324]	Network camera settings, programmable controller settings, and function blocks for the camera recording function	e-Manual PDF
Video Verification Tool Operating Manual [BCN-P5999-1327]	Basic operations and method for playing a video file in Video Verification Tool	e-Manual PDF
GX VideoViewer Version 1 Operating Manual [SH-082370ENG]	Basic operations and method for playing a video file in GX VideoViewer	e-Manual PDF

This manual does not include detailed information on the following:

- General specifications
- Applicable combinations of CPU modules and the other modules, and the number of mountable modules
- Applicable combinations of remote head modules and the other modules, and the number of mountable modules
- Installation

For details, refer to the following:

 MELSEC iQ-R Module Configuration Manual

Point

e-Manual refers to the Mitsubishi Electric FA electronic book manuals that can be browsed using a dedicated tool.

e-Manual has the following features:

- Required information can be cross-searched in multiple manuals.
- Other manuals can be accessed from the links in the manual.
- Hardware specifications of each part can be found from the product figures.
- Pages that users often browse can be bookmarked.
- Sample programs can be copied to an engineering tool.

TERMS

Unless otherwise specified, this manual uses the following terms.

Term	Description
Buffer area for data sampling	A memory area in a CPU module to pass sampled devices and labels to a recorder module/camera recorder module
ONVIF Profile S	Simple profiles that focus on functions to deliver and display videos compliant with ONVIF standards
ONVIF supported network camera	A network camera that supports ONVIF Profile S
ONVIF®	ONVIF (Open Network Video Interface Forum) is a forum for developing common standard interfaces between network camera products.
Recording file	A file that consists of folders to which information such as a date and time or character strings can be added and files saved in the folders
Recording setting	A setting for the recording function such as a sampling target, sampling interval, and saving period

1 System Recorder

System Recorder is a solution that integrates the following three steps performed in the breakdown maintenance phase.

Step	Description	Supported function		Module or tool to be used
Recording	Labels, servo axes, and camera videos are sampled and recorded with time stamps in addition to all devices of a programmable controller CPU.	Recording function	Devices and labels only	<ul style="list-style-type: none"> • CPU module • Recorder module^{*1} • GX Works3
			Video data in addition to devices and labels	<ul style="list-style-type: none"> • CPU module • Camera recorder module^{*2} • GX Works3
		Camera recording function		<ul style="list-style-type: none"> • CPU module • Camera Recording Package • GX VideoViewer^{*3*4}
		Servo system recorder function ^{*5}		<ul style="list-style-type: none"> • Motion module • Motion controller
		Co-recording function		<ul style="list-style-type: none"> • CPU module • Recorder module^{*1} • CC-Link IE TSN master/local module^{*6} • GX Works3
Reproduction	Recorded data is linked and reproduced. A timing when an error occurs can easily be identified.	Offline monitor function	Devices and labels only	<ul style="list-style-type: none"> • CPU module • Recorder module^{*1} • GX Works3
			Video data in addition to devices and labels	<ul style="list-style-type: none"> • CPU module • Camera recorder module^{*2} • GX Works3 • GX VideoViewer^{*3*4}
Analysis	A sequence program is traced. It can easily be traced and the time to identify the cause of an error can be shortened.	Data flow analysis function		<ul style="list-style-type: none"> • GX Works3

*1 A camera recorder module can also be used.

*2 By using a recorder module together, target data can be sampled for each module as follows:

Device and label: Recorder module

Video data: Camera recorder module

*3 GX VideoViewer Pro can also be used.

*4 An updated tool of Video Verification Tool. Only a video file with the extension *.mkv can be checked in Video Verification Tool.

*5 By using a motion module or motion controller, data such as a position command, speed command, motor speed, and torque for each axis can be sampled and displayed in GX LogViewer with a time stamp.

For the servo system recorder function, refer to the following:

 MELSEC iQ-R Motion Module User's Manual (Application)

 MELSEC iQ-R Motion Controller Programming Manual (Common)

*6 The co-recording function can be used via a network.

MEMO

2 PERFORMANCE SPECIFICATIONS

This chapter shows the performance specifications of System Recorder.

2.1 Recording Function

This section shows the performance specifications of the recording function.

Recorder module		
Item	Specification	
Number of recording settings	Up to 4	
Maximum number of device and label data points that can be sampled/accumulated	Maximum number of points that can be sampled (CPU module)	6 MB (total of all settings) ^{*1}
	Maximum number of points that can be accumulated (Recorder module)	800 MB (total of all settings) ^{*2}
Save destination memory capacity	SD memory card	SD memory card capacity (SD/SDHC memory card: Up to 16 GB)
	File server	File server capacity

*1 Can be set in the buffer area setting for data sampling in the CPU parameter.

For details, refer to the following:

MELSEC iQ-R System Recorder User's Manual (Application)

*2 Can be set in the recording buffer setting in the module parameter.

For details, refer to the following:

MELSEC iQ-R System Recorder User's Manual (Application)

Point

For the specifications of a recorder module, refer to the following:

Page 45 Recorder Module

Camera recorder module			
Item		Specification	
		Main ^{*1}	Sub ^{*1}
Number of recording settings	Up to 4		
Maximum number of device and label data points that can be sampled/accumulated	Maximum number of points that can be sampled (CPU module)	6 MB (total of all settings) ^{*2}	—
	Maximum number of points that can be accumulated (Camera recorder module)	800 MB (total of all settings) ^{*3,4}	—
Maximum capacity for accumulating video data			800 MB (total of all settings) ^{*3}
Save destination memory capacity	SD memory card	SD memory card capacity (SD/SDHC memory card: Up to 16 GB)	
	File server	File server capacity	

*1 For details, refer to the following:

Page 43 Configuring multiple modules

*2 Can be set in the buffer area setting for data sampling in the CPU parameter.

For details, refer to the following:

MELSEC iQ-R System Recorder User's Manual (Application)

*3 Can be set in the recording buffer setting in the module parameter.

For details, refer to the following:

MELSEC iQ-R System Recorder User's Manual (Application)

*4 Total of the maximum number of device and label data points that can be accumulated and the maximum capacity for accumulating video data when setting a camera recorder module as the main module



For the specifications of a camera recorder module, refer to the following:

☞ Page 56 Camera Recorder Module

3 FUNCTION LIST

This chapter shows the function list of System Recorder.

For details on the functions, refer to the following:

📖 MELSEC iQ-R System Recorder User's Manual (Application)

3.1 Recording Function

The recording function can be used to output data in a CPU module and video data captured by a network camera to a recording file and save them to a save destination specified in the recording setting when a file saving trigger is satisfied.

Item ^{*1}		Specification	
General	Recording operation setting	<ul style="list-style-type: none"> Main^{*2} Sub^{*2} 	
Recording target data		<ul style="list-style-type: none"> Devices and labels of a CPU module Event histories saved in a CPU module Video data delivered from a network camera (ONVIF supported network camera)^{*3} 	
Recording method		<ul style="list-style-type: none"> File saving trigger only Recording startup trigger + file saving trigger 	
Saving period	File saving trigger only	Saving period before trigger ^{*4*5}	<ul style="list-style-type: none"> 0 to 86400 s 0 to 1440 m 0 to 24 h
		Saving period after trigger ^{*4*5}	0 to 60 s
	Recording startup trigger + file saving trigger ^{*4}	<ul style="list-style-type: none"> 1 to 86400 s 1 to 1440 m 1 to 24 h 	
Recording startup trigger ^{*6}	Number of settings	1 per recording setting	
	Establishment condition	<ul style="list-style-type: none"> Rise Fall 	
File saving trigger ^{*6} (Lapse of a specified time after the completion of data accumulation)	Number of settings	1 per recording setting	
	Specification	<ul style="list-style-type: none"> Specify Not specify 	
	Elapsed time after completion of data accumulation ^{*4}	<ul style="list-style-type: none"> 0 to 86400 s 0 to 1440 m 0 to 24 h 	
File saving trigger (Rise, fall, or timeout of a device of a CPU module)	Number of settings	Up to 16 per recording setting	
	Establishment condition	<ul style="list-style-type: none"> Rise Fall Timeout 	
	Timeout time ^{*7}	<ul style="list-style-type: none"> 1 to 86400 s 1 to 1440 m 1 to 24 h 	
	Trigger comment	Number of available characters: Up to 64 characters Available characters: Unicode Basic Multilingual Plane Character code: UTF-16LE	
File saving trigger (CPU stop error)	Number of settings	1 per recording setting	
	Specification	<ul style="list-style-type: none"> Specify Not specify 	
File saving trigger ^{*8} (Camera event)	Number of settings	Up to 16 per recording setting (4 sub modules × 4 network cameras) ^{*9}	
	Specification	<ul style="list-style-type: none"> Specify Not specify 	
	Establishment condition	When a camera event is received from a network camera	

Item*1	Specification	
Device and label	Sampling method	<ul style="list-style-type: none"> • Each scan • Time specification*10 • Trigger instruction (instruction name: DATATRIG) • Safety cycle time*11
	Time interval*12	<ul style="list-style-type: none"> • 1 to 60000 ms • 1 to 86400 s • 1 to 1440 m • 1 to 24 h
Video data*3	Simple setting mode	<ul style="list-style-type: none"> • Disable • Enable
	Video data receiving target setting	Up to 4 per recording setting
	Reception and accumulation methods	According to the frame rate of video data
	Video delivery method	RTP/UDP
	Video codec	<ul style="list-style-type: none"> • H.264 • Motion JPEG
	Resolution	<ul style="list-style-type: none"> • FHD (1920 × 1080) • SXVGA (1280 × 960) • HD (1280 × 720) • VGA (640 × 480)
	Frame rate (fps)	<ul style="list-style-type: none"> • 10 • 30 • 120 • 180
	Video rotation angle	<ul style="list-style-type: none"> • 0° • 180°
	Video quality	<ul style="list-style-type: none"> • High • Middle • Low
	Video file saving format (extension)	<ul style="list-style-type: none"> • When selecting H.264 codec: MP4 container format (.mp4) • When selecting Motion JPEG codec: MOV container format (.mov)
Save destination setting	Save destination	<ul style="list-style-type: none"> • SD memory card • File server*13
File server setting	Host name	<ul style="list-style-type: none"> • Number of available characters: Up to 64 characters • Available characters: (IMEI)MELSEC iQ-R System Recorder User's Manual (Application) • Character code: ASCII
	User name	<ul style="list-style-type: none"> • Number of available characters: Up to 20 characters • Available characters: (IMEI)MELSEC iQ-R System Recorder User's Manual (Application) • Character code: ASCII
	Password	<ul style="list-style-type: none"> • Number of available characters: Up to 127 characters • Available characters: (IMEI)MELSEC iQ-R System Recorder User's Manual (Application) • Character code: ASCII
	Path	<ul style="list-style-type: none"> • Number of available characters: Up to 256 characters (up to 64 for the host name part) • Available characters: Unicode Basic Multilingual Plane • Character code: UTF-16LE

Item*1		Specification	
Save folder name	Folder name	Up to 64 characters	
	Format	[Additional information]_[Fixed information]	
	Additional information	Number of available characters	Up to 54 characters
		Additional information	<ul style="list-style-type: none"> • Date and time (when a file saving trigger is satisfied or a recording file is saved)*14 • Trigger comment (character code: ASCII) • Value in numerical value data (up to 2) • Value in string data (character code: ASCII) (up to 2) • Any character strings
	Fixed information	Format	[Recording setting number][Saving cause]_[Folder number]
		Recording setting number	Setting No.1: 1 Setting No.2: 2 Setting No.3: 3 Setting No.4: 4
Saving cause		<ul style="list-style-type: none"> • File saving in the "Recording Monitor" screen: MS • Lapse of a set time after the completion of data accumulation: AS • Device of a CPU module: TS + condition number (2 digits) • CPU stop error: ES • Camera event: CE • Co-recording: CO 	
Folder number		001 to 999	
	Number of recording files that can be saved	1 to 999	
Saving a file when there is no free folder number		<ul style="list-style-type: none"> • Overwrite • Not save 	
Project data saving	Automatic saving at the start of recording	<ul style="list-style-type: none"> • Not save • Save 	
Recording file/project data reading (Reading from an SD memory card inserted in a recorder module/camera recorder module)	Port number/protocol used	21/TCP, 49152 to 65535/TCP	

*1 Some settings are restricted depending on the version of a CPU module, recorder module/camera recorder module, or GX Works3. For details, refer to 'Added and Changed Functions' in the following:

📖 MELSEC iQ-R System Recorder User's Manual (Application)

*2 For details, refer to the following:

📄 Page 43 Configuring multiple modules

*3 When specifying it as recording target data, use a camera recorder module.

*4 The recording function runs based on the time in a recorder module/camera recorder module.

*5 Set the total of the saving periods before and after trigger to a value between 1 and 86400 seconds.

*6 Can be set only when selecting "Recording Startup Trigger + File Saving Trigger" for "Recording Method."

*7 Can be set only when specifying a timeout as a condition for satisfying a trigger.

*8 Can be set only when using a camera recorder module.

*9 One camera event can be set per network camera.

*10 The recording function runs based on the time in a CPU module.

*11 Can be set when using a safety CPU.

*12 Can be set only when selecting "Time Specification" for "Sampling Method."

*13 The operations of the following operating systems have been confirmed:

Windows® 10 (Home, Pro, Enterprise, Education)

Windows Server® 2016 (Standard)

Windows Server 2019 (Standard)

*14 A date and time acquired from a CPU module is added.

3.2 Offline Monitor Function

The offline monitor function can be used to reproduce the status of a program and operations (videos) of a device when a trouble occurs by using a recording file.

3.3 Camera Recording Function

The camera recording function can be used to record camera videos linked with a CPU module by using Camera Recording Package and a network camera connected to the built-in Ethernet of the CPU module.

Recorded video files can be played in GX VideoViewer.

3.4 Data Flow Analysis Function

The data flow analysis function can be used to search for devices, labels, and parameters in a program and the event history of the current value change that cause selected devices and labels to be changed, and display their related items in a flow diagram.

3.5 Co-recording Function

The co-recording function can be used to perform recording synchronously on target devices by sending and receiving a co-recording trigger.

Item		Specification
Co-recording setting	Co-recording setting	<ul style="list-style-type: none">• Not use• Use

4 PROCEDURES FOR OPERATION

4.1 Recording Function

This section shows the procedures for performing the recording function.

Devices and labels only

The following shows the procedure for accumulating devices and labels by using a recorder module*1.

*1 A camera recorder module can also be used.

1. Mount a CPU module and recorder module on a base unit, and wire them.

Do not use an electric screwdriver to attach and remove module fixing screws.



To use an SD memory card for saving an event history file, insert the SD memory card in the CPU module.

2. Prepare an SD memory card or a file server to save a recording file.

To save a recording file to an SD memory card, insert the SD memory card in the recorder module.

 Page 51 Insertion/removal method of an SD memory card

To save a recording file to a file server, connect the recorder module and the file server. In this case, an SD memory card is not required to be inserted in the recorder module.

For the operating systems of a file server the operations of which have been confirmed, refer to the following:

 Page 19 Recording Function

3. Check the following items, then turn the power of the system ON.

- The power supply is wired correctly.
- The power supply voltage is within the specification.
- The CPU module is in the STOP state.

In addition, when saving a recording file to a file server, start the file server.

4. Connect a personal computer on which GX Works3 is installed to the CPU module.

5. Initialize the CPU module.

If an SD memory card is inserted in the CPU module, initialize it.

For the method for initializing the CPU module and SD memory card, refer to the following:

 GX Works3 Operating Manual

6. Set the recorder module in the system parameter in GX Works3.

System parameters can be set by reading an actual system configuration to a module configuration diagram in GX Works3.



After setting the recorder module, "Save" is automatically set for "Save Device/Label Operations" in the event history setting in the CPU parameter; therefore, writing data to devices and labels from an engineering tool, external device, a programmable controller on another station, or another CPU module is registered as an event history.

7. Set parameters of the recorder module.

 Page 29 Parameter setting

In addition, set parameters of the CPU module as necessary.



To save a recording file to a file server, the recorder module and the file server must be connected via Ethernet; therefore, set the IP address in the module parameter of the recorder module.

When specifying a file server by using its host name, the DNS setting must be configured in the module parameter of the recorder module.

8. Create a sequence program in GX Works3.
9. Configure the recording setting for the recorder module.

 Page 34 Recording setting

Point 

Access to the file server can be checked by performing the file saving test in the file server setting. If the own node setting is changed in the module parameter of the recorder module, write the module parameters, turn the power OFF and ON or reset the CPU module, and then perform the file saving test.

10. Write data such as the parameters and program, and the recording setting to the CPU module at the same time.

For details on writing to the CPU module, refer to the following:

 GX Works3 Operating Manual

Point 

The boot operation cannot be performed for a recording setting. To perform it for a program or parameter, the recording setting must be written to the data memory.

11. Reset the CPU module or turn the power OFF and ON to apply the settings.

12. To save a recording file to an SD memory card, format the SD memory card inserted in the recorder module.

For the method for formatting an SD memory card, refer to the following:

 MELSEC iQ-R System Recorder User's Manual (Application)

13. Check the connection between the recorder module and the personal computer.

Connect the CPU module and personal computer to check the IP address setting status of the recorder module in the system monitor of GX Works3.

Point 

The procedure for checking the connection between the recorder module and the personal computer is as follows:

- ❶ Make sure that the personal computer and the recorder module are connected with an Ethernet cable.
 - ❷ Enter 'ping (IP address set for the recorder module)' in the Windows command prompt. ( Page 29 Module parameter)
 - ❸ Check the response from the recorder module with its IP address set in the command prompt.
-

14. Check the READY LED and ERROR LED of the CPU module and the ERR LED of the recorder module.

If an error occurs, use the diagnostics function of GX Works3 to check the error description and clear the error.

15. Switch the CPU module to RUN.

The P RUN LED of the CPU module turns ON.

The program runs and recording starts.

16. Make sure that the recording function is running properly.

Whether the recording function is running properly can be checked in 'In recording operation' (Un\G1501, Un\G1701, Un\G1901, Un\G2101), the recording monitor, or with the statuses of the LEDs (RUN LED and OPR LED) of the recorder module.

For details on the buffer memory and recording monitor, refer to the following:

 MELSEC iQ-R System Recorder User's Manual (Application)

17. Satisfy a file saving trigger.

When the trigger is satisfied, the recording file is saved to the save destination specified in the recording setting.

Point 

Information saved in a CPU module, such as errors occurred in each module or on networks, is also saved at the same time as the recording file is saved.

Video data in addition to devices and labels

The following shows the procedure for accumulating devices and labels, and receiving and accumulating video data by using a camera recorder module.

1. Use a dedicated configuration tool for each camera manufacturer to configure the following initial settings for a network camera.

- IP address
- User account

For the setting procedure, refer to the manual for a network camera used.

Point

- Some ONVIF supported network cameras require an account for ONVIF communication. For the method for creating an account, visit the ONVIF website.
- For some network cameras, other initial settings may be required in addition to the IP address and user account. For the setting procedure for a network camera, refer to the following:
 Applicable Network Cameras for Camera Recorder Module(FA-A-0326)

2. Set the network camera to detect the following camera event when using a camera event as a file saving trigger.

- Motion detection

For the setting procedure, refer to the manual for a network camera used.

Restriction

Only camera event types supported by a camera recorder module are received.

3. Mount a CPU module and camera recorder module on a base unit, and wire them.

Do not use an electric screwdriver to attach and remove module fixing screws.

Point

When setting a device and label to be sampled and using an SD memory card to save an event history file, insert the SD memory card to the CPU module.

4. Prepare an SD memory card or a file server to save a recording file.

To save a recording file to an SD memory card, insert the SD memory card in the camera recorder module.

 Page 51 Insertion/removal method of an SD memory card

To save a recording file to a file server, connect the camera recorder module and the file server. In this case, an SD memory card is not required to be inserted in the camera recorder module.

For the operating systems of a file server the operations of which have been confirmed, refer to the following:

 Page 19 Recording Function

Point

A network camera that does not require PoE power supply and camera recorder module can also be connected directly via Ethernet. In this case, specify an SD memory card as a save destination for a recording file. In addition, for reading a recording file, the camera recorder module and a personal computer must be connected via Ethernet.

5. Check the following items, then turn the power of the system ON.

- The power supply is wired correctly.
- The power supply voltage is within the specification.
- The CPU module is in the STOP state.

In addition, when saving a recording file to a file server, start the file server.

6. Connect a personal computer on which GX Works3 is installed to the CPU module.

7. Initialize the CPU module.

If an SD memory card is inserted in the CPU module, initialize it.

For the method for initializing the CPU module and SD memory card, refer to the following:

 GX Works3 Operating Manual

8. Set the camera recorder module in the system parameter in GX Works3.

System parameters can be set by reading an actual system configuration to a module configuration diagram in GX Works3.

Point 

After setting the camera recorder module, "Save" is automatically set for "Save Device/Label Operations" in the event history setting in the CPU parameter; therefore, writing data to devices and labels from an engineering tool, external device, a programmable controller on another station, or another CPU module is registered as an event history.

9. Set module parameters of the camera recorder module.

 Page 29 Module parameter

In addition, set parameters of the CPU module as necessary.

Point 

-
- To save a recording file to a file server, the camera recorder module and file server must be connected via Ethernet; therefore, set the IP address in the module parameter of the camera recorder module.
When specifying a file server by using its host name, the DNS setting must be configured in the module parameter of the camera recorder module.
 - The recording operation setting is set to "Main" by default.
When using multiple camera recorder modules or both a recorder module and camera recorder module in a configuration, the recording operation setting may be required to be changed.
For the configuration when configuring multiple modules, refer to the following:
 Page 43 Configuring multiple modules
 - Set the same segment value as a connected network camera for the IP address.
-

10. Set module extended parameters of the camera recorder module.

 Page 30 Module extended parameter

Note that when opening the module extended parameter screen, the I/O assignment is required for a target camera recorder module in advance.

11. Create a sequence program in GX Works3.

12. Configure the recording setting for the camera recorder module.

 Page 34 Recording setting

Point 

-
- Access to the file server can be checked by performing the file saving test in the file server setting. If the own node setting is changed in the module parameter of the camera recorder module, write the module parameters, turn the power OFF and ON or reset the CPU module, and then perform the file saving test.
 - When using a camera event as a file saving trigger, enable the camera event trigger setting.
-

13. Write data such as the parameters and program, and the recording setting to the CPU module at the same time.

For details on writing to the CPU module, refer to the following:

 GX Works3 Operating Manual

Point 

- The boot operation cannot be performed for a recording setting. To perform it for a program or parameter, the recording setting must be written to the data memory.
- The setting contents of the module extended parameter are related to those of some module parameters (recording operation setting or recording buffer setting). It is recommended to write module parameters and module extended parameters at the same time.

14. Reset the CPU module or turn the power OFF and ON to apply the settings.

Point 

When restarting the system, start the network camera in advance.

15. To save a recording file to an SD memory card, format the SD memory card inserted in the camera recorder module.

For the method for formatting an SD memory card, refer to the following:

 MELSEC iQ-R System Recorder User's Manual (Application)

16. Check the connection between the camera recorder module and the personal computer.

Connect the CPU module and personal computer to check the IP address setting status of the camera recorder module in the system monitor of GX Works3.

Point 

The procedure for checking the connection between the camera recorder module and the personal computer is as follows:

- ❶ Make sure that the personal computer and the camera recorder module are connected with an Ethernet cable.
- ❷ Enter 'ping (IP address set for the camera recorder module)' in the Windows command prompt. ( Page 29 Module parameter)
- ❸ Check the response from the camera recorder module with its IP address set in the command prompt.

17. Check the READY LED and ERROR LED of the CPU module and the ERR LED of the camera recorder module.

If an error occurs, use the diagnostics function of GX Works3 to check the error description and clear the error.

18. Check the connection status between the camera recorder module and the target network camera in 'Network camera connection status' (Un\G34300, Un\G34800, Un\G35300, Un\G35800).

The network camera communication function of the camera recorder module can be used while 'connected' is stored in 'Network camera connection status.'

For details on the buffer memory and the network camera communication function, refer to the following:

 MELSEC iQ-R System Recorder User's Manual (Application)

19. Switch the CPU module to RUN.

The P RUN LED of the CPU module turns ON.

The program runs and recording starts.

20. Make sure that the recording function is running properly.

If 'Module READY' (X0) and 'Recording function operation status' (X3) are ON, and 'operating' is stored in 'Camera recording status' (Un\G1650 to 1653, Un\G1850 to 1853, Un\G2050 to 2053, Un\G2250 to 2253), the recording function is running properly.

The operating status of the recording function can be checked in 'In recording operation' (Un\G1501, Un\G1701, Un\G1901, Un\G2101), the recording monitor, or with the statuses of the LEDs (RUN LED and OPR LED) of the camera recorder module.

The operating status for video data can be checked in 'Camera recording status' (Un\G1650 to 1653, Un\G1850 to 1853, Un\G2050 to 2053, Un\G2250 to 2253), 'Network camera connection status' (Un\G34300, Un\G34800, Un\G35300, Un\G35800), or the camera monitor of the camera recorder module.

For details on the buffer memory, recording monitor, and camera monitor, refer to the following:

 MELSEC iQ-R System Recorder User's Manual (Application)

21. Satisfy a file saving trigger.

When the trigger is satisfied, the recording file is saved to the save destination specified in the recording setting.

Point 

Information saved in a CPU module, such as errors occurred in each module or on networks, is also saved at the same time as the recording file is saved.

Parameter setting

Parameters of a recorder module/camera recorder module can be set in GX Works3.

For details on the parameter setting, refer to the following:

MELSEC iQ-R System Recorder User's Manual (Application)

Module parameter

Operating procedure

1. Set module parameters of a recorder module/camera recorder module.

Recorder module: [Navigation window] ⇒ [Parameter] ⇒ [Module Information] ⇒ [(target module)]

Camera recorder module: [Navigation window] ⇒ [Parameter] ⇒ [Module Information] ⇒ [(target module)] ⇒ [Module Parameter]

4

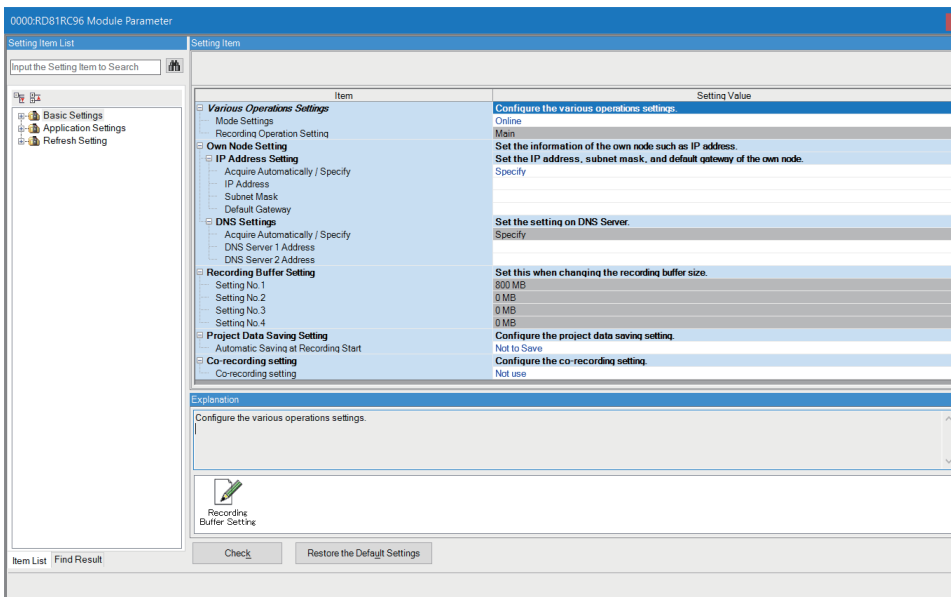

Point

When using an RnCPU or RnENCPU as a CPU module, project data can be saved to a save destination for a recording file and used when playing the recording file. Set "Automatic Saving at Recording Start" to "Save" under "Project Data Saving Setting."

For details on the project data saving function, refer to the following:

MELSEC iQ-R System Recorder User's Manual (Application)

Precautions

To read a recording file saved to an SD memory card, the recorder module/camera recorder module and a personal computer must be connected via Ethernet.

Set the IP address and subnet mask of the recorder module/camera recorder module in advance.

The IP address setting status of the recorder module/camera recorder module can be checked in the system monitor.

For details on the system monitor, refer to the following:

GX Works3 Operating Manual

Module extended parameter

The following shows the procedure for setting module extended parameters when using a camera recorder module.

Operating procedure

1. Open the module extended parameter screen.

 [Navigation window] ⇒ [Parameter] ⇒ [Module Information] ⇒ [(target module)] ⇒ [Module Extended Parameter]

2. Set each item for a network camera in the "Camera Individual Settings" screen displayed by clicking the [...] button in the "IP Address" or "Camera Comment" column in the module extended parameter screen.

3. Click the [Common Settings] button in the module extended parameter screen to set each item for the GOT linkage as necessary.

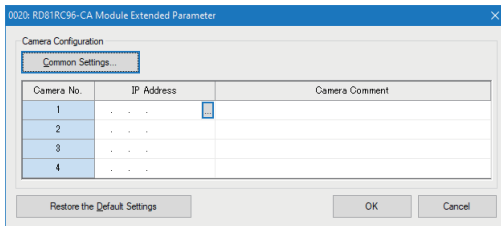

Point

- When using multiple camera recorder modules on a network, set the IP address of a network camera in the module extended parameter so that it does not overlap with another camera recorder module. In addition, only one camera recorder module can be connected to one network camera.

- When using a camera event as a file saving trigger, configure the camera event setting.

For details, refer to the following:

 MELSEC iQ-R System Recorder User's Manual (Application)

- A network camera can also be set by actually connecting to the network camera and acquiring information from the connected one.

This setting method is recommended because the setting range differs for each network camera.

For this method, refer to the following:

 Page 31 Setting method by acquiring information from a network camera

■ Setting method by acquiring information from a network camera

The following shows the method for setting a network camera by actually connecting to the network camera and acquiring information from the connected one.

This method can reduce man-hours required to set a network camera.

Operating procedure

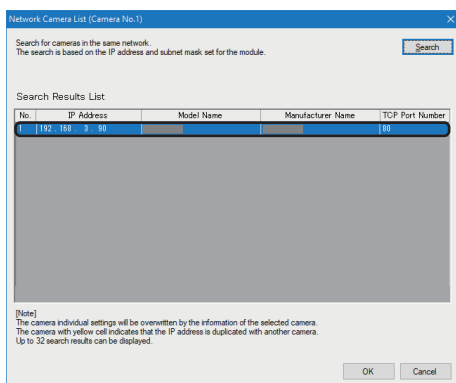
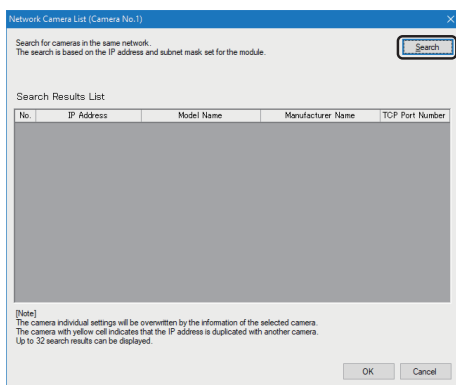
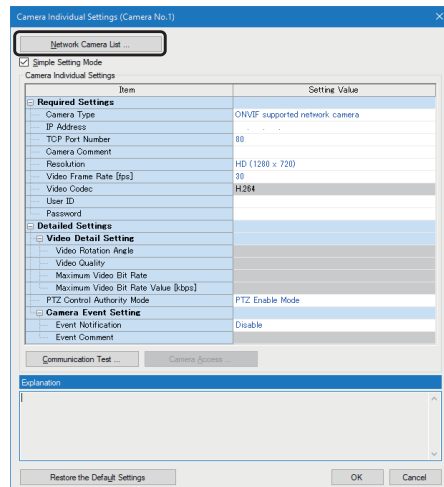
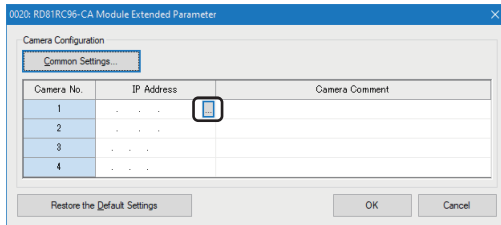

1. Open the "Camera Individual Settings" screen.

[Navigation window] ⇒ [Parameter] ⇒ [Module Information] ⇒ [(target module)] ⇒ [Module Extended Parameter] ⇒ click the [...] button in the "IP Address" or "Camera Comment" column

2. When using an ONVIF supported network camera, click the [Network Camera List] button in the "Camera Individual Settings" screen.

3. Click the [Search] button to search for a network camera in the same network configuration as a camera recorder module.

4. Select a network camera in the search result, and click the [OK] button.

The IP address and TCP port number are applied to the "Camera Individual Settings" screen.

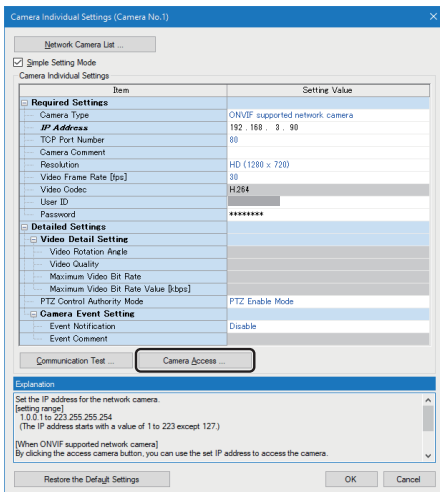

5. When using an ONVIF supported network camera, click the [Camera Access] button in the "Camera Individual Settings" screen.

The network camera can be connected by using a web browser.

6. Adjust the settings in the "Camera Individual Settings" screen in the web browser.

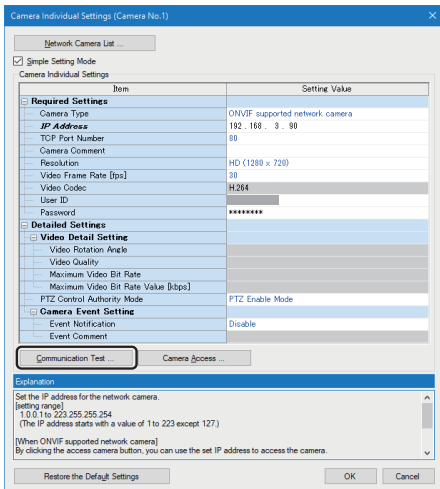

7. Click the [Communication Test] button in the "Camera Individual Settings" screen.

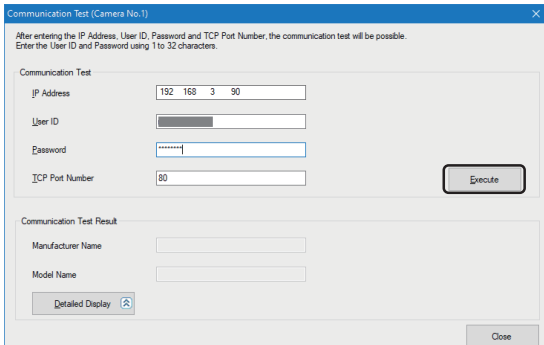

8. Click the [Execute] button in the "Communication Test" screen.

By performing the communication test, whether a user ID and password are correct can be checked before writing module extended parameters to the camera recorder module.

When the test is successful, information on the network camera can be checked.

-
- A network camera can be searched for when all of the following conditions are satisfied:
 - A camera recorder module and GX Works3 are online.
 - The camera recorder module and network camera are connected via Ethernet.
 - The network camera is started.
 - If the IP address setting is not written to a camera recorder module when searching for a network camera, a network camera in the same network configuration as the default IP address of the camera recorder module is searched for. For some network configurations, set the IP address of the camera recorder module, write module parameters, and turn the power OFF and ON or reset a CPU module before searching for a network camera.
 - The time required for the communication test differs for each network camera model.
 - If a network camera is not set to detect camera events, a camera event cannot be selected for "Event Notification" in the communication test result for some network camera models. In this case, set the network camera to detect camera events.
-

Recording setting

The recording setting for a recorder module/camera recorder module can be configured by using GX Works3.

For details on the recording setting, refer to the following:

📖 MELSEC iQ-R System Recorder User's Manual (Application)

Operating procedure

1. Display the "Recording Setting" screen.

🖱️ [Navigation window] ⇒ [Parameter] ⇒ [Recording Setting] ⇒ right-click ⇒ [New]

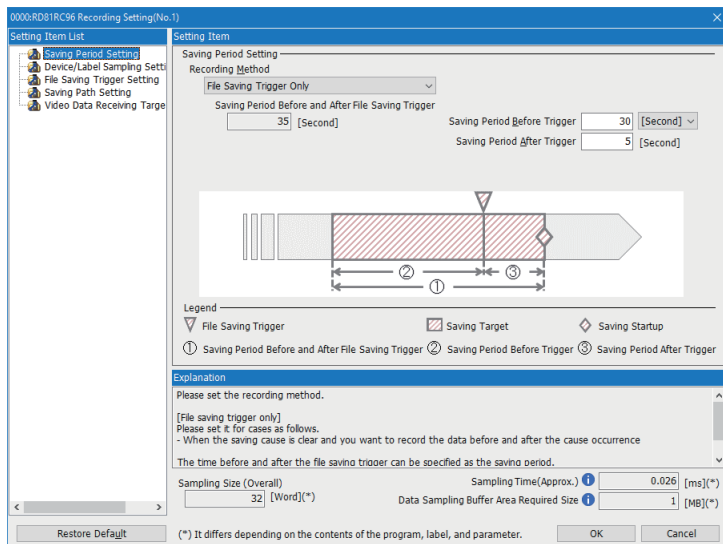

4.2 Offline Monitor Function

This section shows the procedures for performing the offline monitor function.

Devices and labels only

1. Prepare a recording file.

Storage location	Operation
SD memory card	Select [Recording] ⇒ [Read Recording File] in GX Works3 to read a recording file.*1*2
File server	Connect a file server to a personal computer on which the offline monitor function is performed.

*1 For details on reading recording files, refer to the following:

 GX Works3 Operating Manual

*2 Project data can also be read at the same time.

When using the project data saving function, project data saved to an SD memory card inserted in a recorder module is read.

When not using the project data saving function, project data is read from a CPU module.

For details on the project data saving function, refer to the following:

 MELSEC iQ-R System Recorder User's Manual (Application)

2. Select [Recording] ⇒ [Start Offline Monitor] ⇒ [Recording File] in GX Works3 to open the recording file.

When using the project data saving function to save project data to a file server where the recording file is saved, the project data in the file server is automatically opened.

For details on the project data saving function, refer to the following:

 MELSEC iQ-R System Recorder User's Manual (Application)

Point

- To play the recording file, the project used when writing the recording setting to the CPU module is required.
- If a file server is specified as a save destination and project data applied when writing the recording setting to a CPU module is not saved, or if the project data saving function is not used, prepare project data separately by performing an operation such as reading from the CPU module.

3. Operate the seek bar to check the recording result.

For details on the offline monitor, refer to the following:

 GX Works3 Operating Manual

Video data in addition to devices and labels

1. Prepare a recording file.

Storage location	Operation
SD memory card	Select [Recording] ⇒ [Read Recording File] in GX Works3 to read a recording file.*1*2
File server	Connect a file server to a personal computer on which the offline monitor function is performed.

*1 For details on reading recording files, refer to the following:

 GX Works3 Operating Manual

*2 Project data can also be read at the same time.

When using the project data saving function, project data saved to an SD memory card inserted in a camera recorder module is read.

When not using the project data saving function, project data is read from a CPU module.

For details on the project data saving function, refer to the following:

 MELSEC iQ-R System Recorder User's Manual (Application)

2. Select [Recording] ⇒ [Start Offline Monitor] ⇒ [Recording File] in GX Works3 to open the recording file.

When using the project data saving function to save project data to a file server where the recording file is saved, the project data in the file server is automatically opened.

For details on the project data saving function, refer to the following:

 MELSEC iQ-R System Recorder User's Manual (Application)

Point

- When playing video files only, this procedure is not required.
- To play the recording file, the project used when writing the recording setting to the CPU module is required.
- If a file server is specified as a save destination and project data applied when writing the recording setting to a CPU module is not saved, or if the project data saving function is not used, prepare project data separately by performing an operation such as reading from the CPU module.

3. Open a video file in GX VideoViewer.

For the operation methods of GX VideoViewer, refer to the following:

 GX VideoViewer Version 1 Operating Manual

4. Operate the seek bar in GX Works3 or GX VideoViewer to check the recording result.

4.3 Camera Recording Function

This section shows the procedure for performing the camera recording function.

1. Use FBs included in Camera Recording Package to record a camera video.

For details, refer to the following:

 Camera Recording Package User's Manual

2. Use GX VideoViewer to play the recorded video file.

For details, refer to the following:

 GX VideoViewer Version 1 Operating Manual

4.4 Data Flow Analysis Function

This section shows the procedure for performing the data flow analysis function.

1. Perform data flow analysis in GX Works3.

For details, refer to the following:

 GX Works3 Operating Manual

4.5 Co-recording Function

For the procedure for performing the co-recording function, refer to the following:

 MELSEC iQ-R System Recorder Co-recording Function Reference Manual

5 SYSTEM CONFIGURATION

This chapter shows the system configuration of System Recorder.

5.1 Overall System Configuration

This section shows the overall system configuration of System Recorder.

For the system configuration when using the co-recording function, refer to the following:

📖 MELSEC iQ-R System Recorder Co-recording Function Reference Manual

When using a recorder module and Camera Recording Package

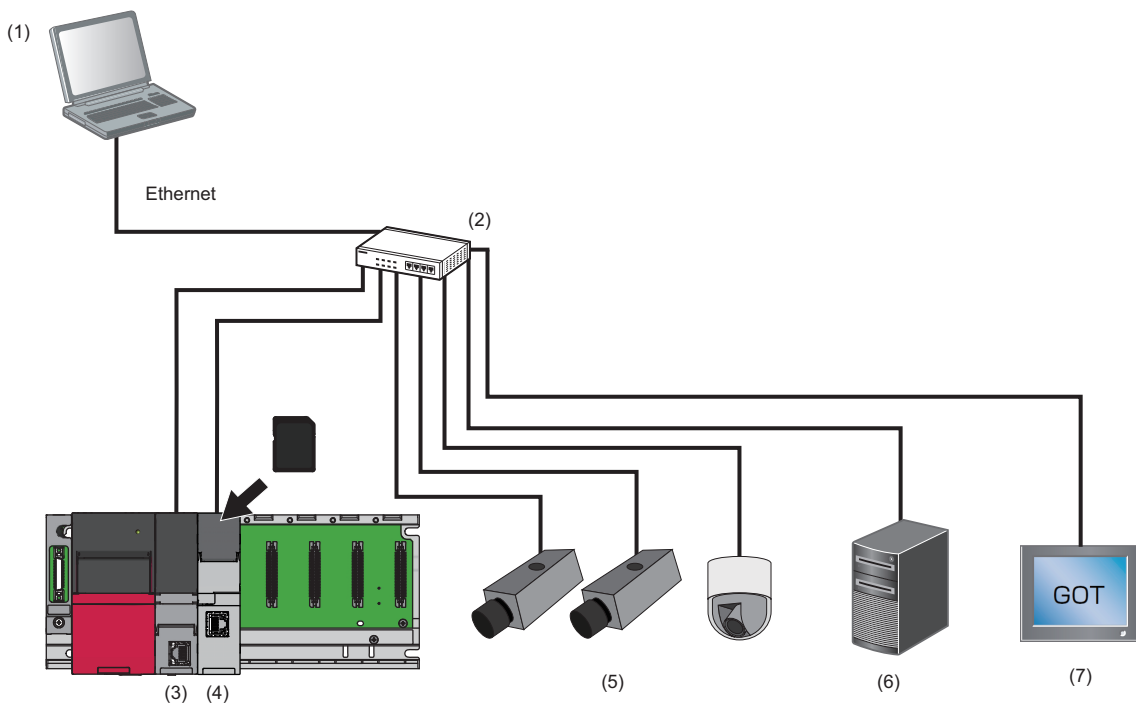

Type		
(1)	Engineering tool	GX Works3 GX LogViewer GT Designer3 ^{*1} GX VideoViewer ^{*2}
(2)	PoE switching hub	
(3)	CPU module	
(4)	Recorder module	
(5)	Network camera ^{*2}	
(6)	File server	
(7)	GOT ^{*1}	

*1 Required only when using the GOT offline monitor.

*2 Required only when using Camera Recording Package.

When using a camera recorder module

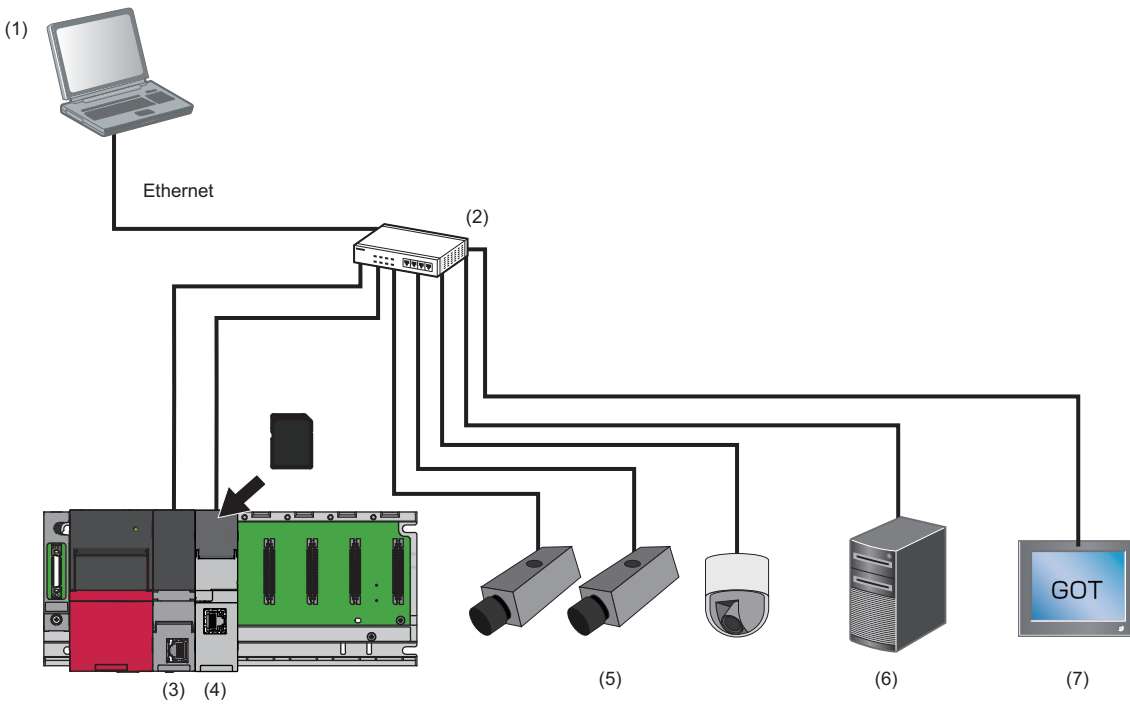

Type		
(1)	Engineering tool	GX Works3 GX LogViewer GT Designer3 ^{*1} GX VideoViewer
(2)	PoE switching hub	
(3)	CPU module	
(4)	Camera recorder module	
(5)	Network camera	
(6)	File server	
(7)	GOT ^{*1}	

*1 Required only when using the GOT offline monitor or the GOT linkage function of a camera recorder module.

5.2 System Components and Engineering Tools



This section shows the system components and engineering tools for System Recorder.

When using the co-recording function, refer to the following:

 MELSEC iQ-R System Recorder Co-recording Function Reference Manual

System components

Programmable controllers

Module		Model name	First 3 or 4 digits of product information*1	Firmware version*1	Reference
CPU module	RnCPU	R04CPU	'19' or later	'50' or later*2*3	 MELSEC iQ-R CPU Module User's Manual (Startup)  MELSEC iQ-R CPU Module User's Manual (Application)
		R08CPU	'20' or later		
		R16CPU	'20' or later		
		R32CPU	'17' or later		
		R120CPU	'17' or later		
	RnENCPU	R04ENCPU	'32' or later		
		R08ENCPU	'30' or later		
		R16ENCPU	'27' or later		
		R32ENCPU	'30' or later		
		R120ENCPU	'22' or later		
	RnSF CPU	R08SF CPU	'05' or later	'23' or later*2*3	
		R16SF CPU			
		R32SF CPU			
R120SF CPU					
Recorder module*4		RD81RC96	No restrictions	'01' or later*3*5	Page 45 Recorder Module
Camera recorder module*6		RD81RC96-CA	No restrictions	'01' or later*3	Page 56 Camera Recorder Module

*1 For the method for checking the product information and firmware version, refer to the following:

 MELSEC iQ-R Module Configuration Manual

*2 When using a camera recorder module or configuring a recorder module and multiple camera recorder modules for video data, use a CPU module with any of the following firmware versions: ( Page 43 Configuring multiple modules)

RnCPU or RnENCPU: '55' or later
RnSF CPU: '24' or later

*3 The versions are limited depending on the contents of a recording setting. Refer to 'Added and Changed Functions' in the following:
 MELSEC iQ-R System Recorder User's Manual (Application)

*4 Only one recorder module can be used per CPU module.

In a multiple CPU system, up to four recorder modules can be used when configuring four CPU modules.

*5 When using both a recorder module and camera recorder module, use a recorder module with the firmware version '04' or later.
( Page 43 Configuring multiple modules)

*6 One camera recorder module with "Main" selected for the recording operation setting can be used per CPU module. Up to four modules can be used, including the main module and sub modules.

In a multiple CPU system, up to four modules, including a module with "Main" selected and ones with "Sub" selected for the recording operation setting, can be used per CPU module; therefore, up to 16 main and sub modules can be used when configuring four CPU modules.

For the main and sub modules, refer to the following:

 Page 43 Configuring multiple modules

Other devices

■ Network camera

The following shows the connectable network cameras.

- When using Camera Recording Package

Refer to the following:

 Network cameras supporting the Camera recording package (FA-A-0306)

Point

Use a MELIPC MI1000 or general-purpose NAS as an external storage.

- When using a camera recorder module

Network camera type	Model name	Connection interface	Video delivery method	Resolution	Video codec	Frame rate (fps)
ONVIF supported network camera ^{*1}	—	Ethernet	RTP/UDP	<ul style="list-style-type: none">• FHD (1920 × 1080)• SXVGA (1280 × 960)• HD (1280 × 720)• VGA (640 × 480)	H.264	<ul style="list-style-type: none">• 10• 30• 120• 180

*1 For connectable products for ONVIF supported network cameras, refer to the following:

 Applicable Network Cameras for Camera Recorder Module (FA-A-0326)





■ PoE switching hub

Use a product according to the maximum power consumption of a network camera used.

■ GOT

GOT2000 series (GT27/GT25 model) and GT SoftGOT2000 can be connected.

Engineering tools

Engineering tool	Model name	Version	Reference
GX Works3	SW1DND-GXW3-E	1.065T or later*1	 GX Works3 Operating Manual
GX LogViewer	SW1DNN-VIEWER-M	1.106K or later	 GX LogViewer Version 1 Operating Manual
GT Designer3	SW1DND-GTWK3-E	1.236W or later*2	 GT Designer3 (GOT2000) Screen Design Manual
GX VideoViewer	SW1DNN-REPROA-M	1.006G or later	 GX VideoViewer Version 1 Operating Manual

*1 The versions are limited depending on the contents of a recording setting. Refer to 'Added and Changed Functions' in the following:
 MELSEC iQ-R System Recorder User's Manual (Application)

*2 Use 1.245F or later when using the GOT linkage function of a camera recorder module.

Configuring multiple modules

The number of network cameras that can be connected to a camera recorder module differs depending on the settings such as the frame rate.

Therefore, a system in which multiple camera recorder modules are used must be configured according to the number and settings of required network cameras.

In addition, the number of network cameras connected to a system can be increased by using a recorder module to accumulate devices and labels, and a camera recorder module to receive and accumulate video data.

When configuring a system in which multiple camera recorder modules are used or both a recorder module and camera recorder module are used, configure a main module that controls all recording for the recorder module/camera recorder module and a sub module that operates in synchronization with the main module.

One main module must be set.

For details on the main and sub modules, refer to the following:

 MELSEC iQ-R System Recorder User's Manual (Application)

Point

"Main" or "Sub" can be set in the recording operation setting in the module parameter.

The recording operation setting of a camera recorder module is set to "Main" by default. When adding a camera recorder module to a configuration in which the main module is already set, select "Sub" for the camera recorder module in the module parameter.

For details on the module parameter, refer to the following:

 MELSEC iQ-R System Recorder User's Manual (Application)

Maximum number of connectable network cameras

The maximum number of network cameras that can be connected to one camera recorder module is determined by the following settings:

- Whether to set a camera recorder module as the main module
- Settings of a connected network camera (resolution, frame rate, and type of the network camera)

When connecting multiple network cameras with different resolution or frame rate settings to a camera recorder module, the smallest number of connectable network cameras is always applied as the maximum number.

The following tables show the maximum numbers of network cameras that can be connected to one camera recorder module.

■When setting a camera recorder module as the main module

—: Cannot be set

Frame rate	Resolution			
	VGA (640 × 480)	HD (1280 × 720)	SXVGA (1280 × 960)	FHD (1920 × 1080)
10/30	2	2	2	2
120	2	1	—	—
180	1	1	—	—

■ When setting a camera recorder module as a sub module

—: Cannot be set

Frame rate	Resolution			
	VGA (640 × 480)	HD (1280 × 720)	SXVGA (1280 × 960)	FHD (1920 × 1080)
10/30	4	4	4	4
120	2	1	—	—
180	1	1	—	—

Module configuration examples

The following tables show recommended module configuration examples for each number and setting of a network camera.

- When receiving and accumulating video data of two network cameras (30 fps/HD/H.264 codec)

Module configuration		Remarks
Camera recorder module	Recorder module	
1	0	Devices and labels are accumulated and video data is received and accumulated in the camera recorder module. Connect two network cameras to the camera recorder module.

- When receiving and accumulating video data of two network cameras (120 fps/HD/H.264 codec)

Module configuration		Remarks
Camera recorder module	Recorder module	
2	0	Devices and labels are accumulated in the main camera recorder module. Up to one network camera can be connected to the main and sub camera recorder module each. Connect it to each of them.

- When receiving and accumulating video data of four network cameras (30 fps/HD/H.264 codec)

Module configuration		Remarks
Camera recorder module	Recorder module	
1	1	Devices and labels are accumulated in the main recorder module. Connect four network cameras to the sub camera recorder module.

5.3 Recorder Module

This section explains a recorder module.

For details on the functions, module labels, input/output signals, and buffer memory of a recorder module, refer to the following:

📖 MELSEC iQ-R System Recorder User's Manual (Application)

Part names

The following shows the part names of a recorder module.

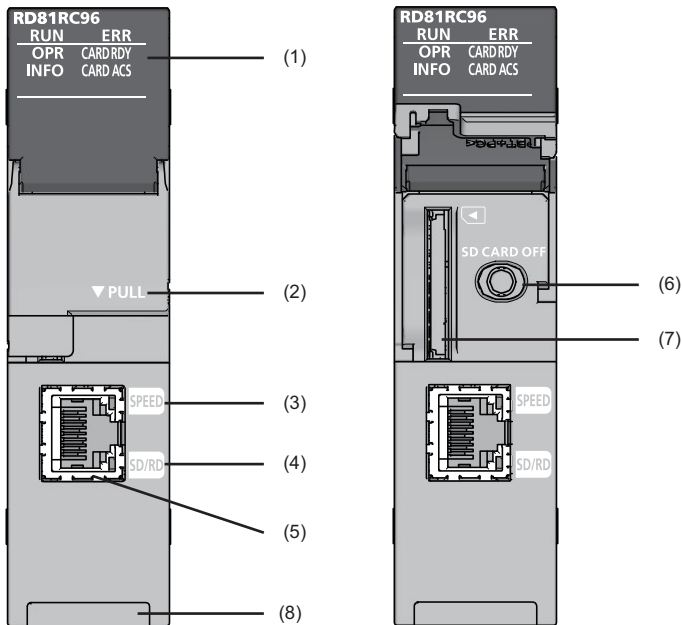

No.	Name	Description
(1)	RUN LED	Indicates the operating status. • ON: In operation • OFF: Hardware error
	ERR LED	Indicates the error status. • ON: Minor error or hardware error • Flashing: Moderate error or major error • OFF: In normal status
	OPR LED	Indicates the status of a module. • ON: In operation • OFF: Stopped
	INFO LED	Indicates the warning occurrence status. • ON: Warning • OFF: In normal status
	CARD RDY LED	Indicates the accessibility of an SD memory card. • ON: Accessible (mounted) • Flashing: Being mounted/unmounted • OFF: Inaccessible (not inserted/unmounted/write-protected)
	CARD ACS LED	Indicates the access status of an SD memory card. • ON: Being accessed • OFF: Not accessed
(2)	Slot cover	A cover of the SD memory card slot and the SD memory card lock switch. Open this cover to insert/remove an SD memory card or to operate the switch. Close the cover unless inserting/removing an SD memory card or operating the switch to prevent foreign material intrusion such as dust.
(3)	SPEED LED	Indicates the communication speed and the link status for Ethernet. • ON (orange): Linking-up (1 Gbps) • ON (green): Linking-up (100 Mbps) • OFF: Linking-down or linking-up (10 Mbps)

No.	Name	Description
(4)	SD/RD LED	Indicates the data sending/receiving status in Ethernet. <ul style="list-style-type: none"> • ON: Being sent/received • OFF: Not being sent/received
(5)	Ethernet port	A port for connecting a recorder module to 10BASE-T/100BASE-TX/1000BASE-T. (A recorder module distinguishes among 10BASE-T, 100BASE-TX, and 1000BASE-T depending on an external device.)
(6)	SD memory card lock switch (SD CARD OFF button)	A switch for disabling access to an SD memory card to remove it. Removing an SD memory card is prohibited while the CARD RDY LED is ON or flashing. For the procedures for inserting and removing an SD memory card, refer to the following:  Page 49 SD memory card
(7)	SD memory card slot	A slot for inserting an SD memory card. (SD, SDHC standards-compliant: 2 GB (SD) to 16 GB (SDHC))
(8)	Product information marking	Displays the product information (16 digits) of a module.

Point 

An INFO LED lighting factor can be checked in the INFO LED information in the "Module Diagnostics" screen or the buffer memory. Check the factor and take corrective action. ( MELSEC iQ-R System Recorder User's Manual (Application))

Hardware specifications

The following table shows the hardware specifications of a recorder module.

Item		Specification		
Ethernet port	Interface	1000BASE-T	100BASE-TX	10BASE-T
	Data transmission speed	1 Gbps	100 Mbps	10 Mbps
	Number of cascade connections (When using a repeater hub)	Consult the manufacturer of the repeater hub used.	2 levels maximum	4 levels maximum
	Transmission method	Base band		
	Maximum segment length	100 m (length between a hub and a node)		
	Supported function	Auto-negotiation (automatic recognition of the communication speed/communication method) Auto-MDI/MDI-X (automatic recognition of a straight/crossover cable)		
	IP version	IPv4 supported		
SD memory card slot	Power supply voltage	3.3 VDC		
	Power supply capacity	Up to 200 mA		
	Card size	SD memory card/SDHC memory card		
	Number of insertable cards	1		
Number of occupied I/O points		32 points/slot (I/O assignment: Intelligent function module 32 points)		
Clock		<ul style="list-style-type: none"> Acquired from a CPU module (CPU No.1 in a multiple CPU system). Time accuracy after obtaining the time, daily error of ± 9.504 seconds 		
5 VDC internal current consumption		1.0 A		
External dimensions	Height	106 mm		
	Width	27.8 mm		
	Depth	110 mm		
Weight		0.23 kg		

Precautions

The operation of a recorder module with the following connection methods is not guaranteed. Check the operation before use.

- Connection using Internet (general public line) (Internet-access service offered by an Internet service provider or a telecommunications carrier)
- Connection using a firewall device
- Connection using a broadband router
- Connection using a wireless LAN

Function list

The following table shows the function list of a recorder module.

For details on the functions, refer to the following:

 MELSEC iQ-R System Recorder User's Manual (Application)

Function	Description
Recording function	To accumulate devices and labels sampled in a CPU module, and output them and an event history of the CPU module to a recording file and save the file to a save destination specified in the recording setting when a file saving trigger is satisfied.
SD memory card format function	To format an SD memory card inserted in a recorder module.
Self-diagnostics function	To diagnose whether a recorder module operates normally.
Firmware update function	To update the firmware of a recorder module. For details, refer to the following:  MELSEC iQ-R Module Configuration Manual
Co-recording function	To perform recording synchronously on target devices by sending and receiving a co-recording trigger.

SD memory card

The following shows an SD memory card used for a recorder module.

Supported SD memory cards (sold separately)

The following table shows the supported SD memory cards.

When using an SD memory card, make sure to refer to the following: (📖 Page 52 Considerations for using an SD memory card)

Model name	Description
NZ1MEM-2GBSD	2 GB SD memory card
NZ1MEM-4GBSD	4 GB SD memory card
NZ1MEM-8GBSD	8 GB SD memory card
NZ1MEM-16GBSD	16 GB SD memory card

Operation for inserting an SD memory card

The following shows the flowchart for inserting an SD memory card.

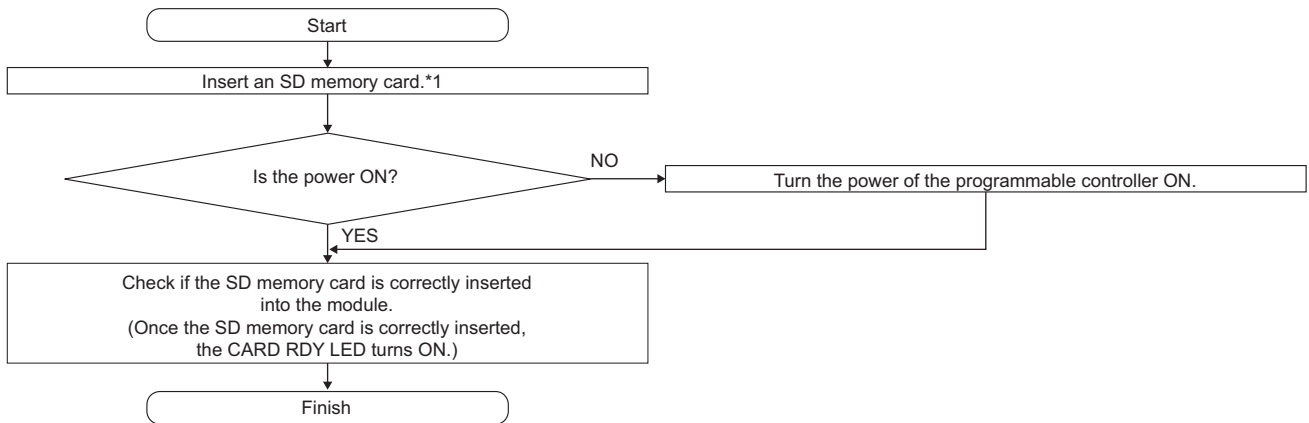

*1 📖 Page 51 Insertion procedure

Operation for removing an SD memory card

The following shows the flowchart for removing an SD memory card.

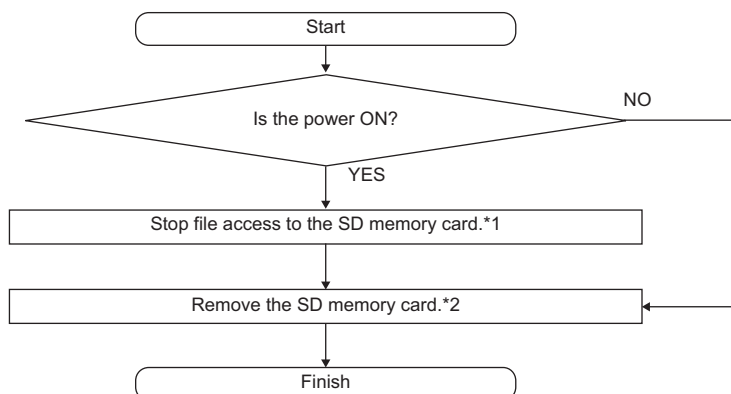

*1 📖 Page 50 Methods for stopping file access

*2 📖 Page 51 Removal procedure

Methods for stopping file access

The following are the methods for stopping file access.

Whether an SD memory card is being accessed such as when a recording file is being saved can be checked with the CARD ACS LED.

- Switch operation on the front of a module
- Input/output signal operation

■Switch operation on the front of a module

1. Press the SD memory card lock switch for one second or more.
2. Check that the CARD RDY LED is turned OFF.

■Input/output signal operation

1. Turn 'File access stop request' (Y0) from OFF to ON.
2. Check that 'File access status' (X2) turns from OFF to ON, or the CARD RDY LED turns OFF.

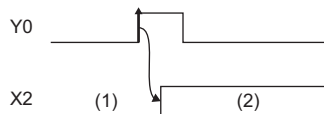

- (1) Accessible
(2) Access stopped

If 'File access stop request' is unintentionally turned ON, turn 'Clear file access stop request' ON.

An output signal is not turned from ON to OFF by a system. To turn the signal ON again, turn it from ON to OFF, then back to ON.

Methods for clearing file access stop

The following are the methods for clearing file access stop.

- Mounting of an SD memory card
- Input/output signal operation

■Mounting of an SD memory card

1. Remove an SD memory card if it is inserted.
2. Insert the SD memory card again.
3. Check that the CARD RDY LED turns ON.

■Input/output signal operation

File access can be restarted by turning 'Clear file access stop request' ON without replacing an SD memory card after turning 'File access stop request' ON.

1. Turn 'Clear file access stop request' (Y1) from OFF to ON.
2. Check that 'File access status' (X2) turns from ON to OFF.
3. Check that the CARD RDY LED turns ON.

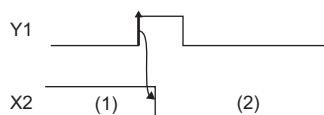

- (1) Access stopped
(2) Accessible

Insertion/removal method of an SD memory card

Make sure to stop file access when removing or replacing an SD memory card.

If the power is turned OFF or a module is reset while a file is being accessed, the file may be corrupted.

■ Insertion procedure

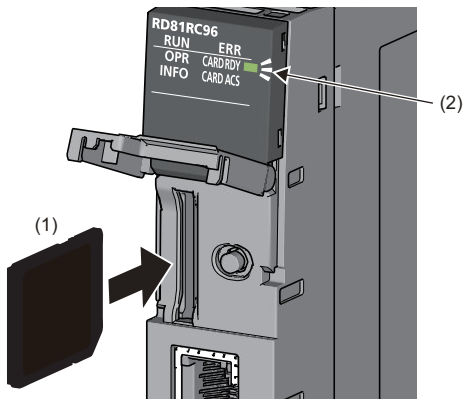

- 1.** Insert an SD memory card (1) straight into the SD memory card slot with its cutout pointed down.
Make sure it is not uplifted after inserting it.
If it is inserted insufficiently, it may cause malfunction due to poor contact.
- 2.** The CARD RDY LED (2) keeps flashing until the SD memory card is ready to be used. Once the CARD RDY LED (2) turns ON, the SD memory card can be used.

■ Removal procedure

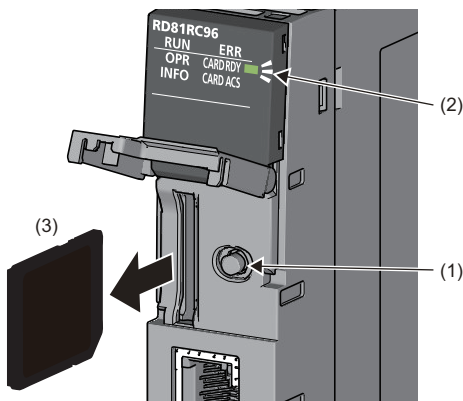

- 1.** Press the SD memory card lock switch (1) for one second or longer to stop the SD memory card access.
- 2.** The CARD RDY LED (2) is flashing while stopping the file access, and it turns OFF once the processing is completed.
- 3.** Push the SD memory card (3) in once, and pull it out straight.

Considerations for using an SD memory card

The following shows the considerations for using an SD memory card.

■Creating files/folders on an SD memory card

Do not insert an SD memory card used for the recording function in a device such as a personal computer to directly edit or create files and folders.

Otherwise, the function may not run properly.

■SD memory card to be used

Use a supported SD memory card. (☞ Page 49 Supported SD memory cards (sold separately))

If an unsupported SD memory card is used, data in the SD memory card may be corrupted while the system is running or the system may stop (a module major error (2450H) occurs in a CPU module).

■Turning the power OFF or resetting a CPU module

When turning the power OFF or resetting a CPU module while data is being written to an SD memory card, the writing may not be completed and the file may be corrupted.

Turn the power OFF or reset a CPU module after stopping file access. For the important data, create backups periodically.

If an SD memory card is damaged due to turning the power OFF or resetting a CPU module during writing, format the SD memory card.

■Removing or replacing an SD memory card

Make sure to stop file access before removing or replacing an SD memory card.

Otherwise, the data in the SD memory card being accessed may be corrupted or a file system failure may occur.

In addition, the status of the SD memory card may be falsely recognized by a module.

If an error occurs in the SD memory card, refer to the following:

☞ MELSEC iQ-R System Recorder User's Manual (Application)

■Formatting an SD memory card

For formatting an SD memory card, use the SD memory card format function of a module. (☞ MELSEC iQ-R System Recorder User's Manual (Application))

Do not reset a CPU module or turn the power OFF while an SD memory card is being formatted.

■SD memory card life

An SD memory card has a life (a limit on the number of times for writing data). For details, refer to the specification of an SD memory card to use.

■Write protect switch

When the write protect switch of an SD memory card is locked (write protected), no file can be written.

Make sure that the write protect switch is unlocked (write allowed).

Ethernet cable

The following shows the Ethernet cables that can be connected to a recorder module.

Connectable Ethernet (twisted pair) cables (sold separately)

The Ethernet cables compliant with IEEE802.3 1000BASE-T/100BASE-TX/10BASE-T standards can be used.

Type	Unshielded twisted pair cable (UTP cable) Shielded twisted pair cable (STP cable)	
	Straight cable	Crossover cable
1 Gbps	Category 5e or higher	Category 5e
100 Mbps	Category 5 or higher	Category 5 or 5e
10 Mbps	Category 3 or higher	Category 3 to 5e

Wiring of an Ethernet cable

The following shows the procedures for connecting and disconnecting an Ethernet cable.

■ Connection procedure

1. Check the insertion direction, and insert an Ethernet cable into the Ethernet port of a module until it clicks.
2. Lightly pull the cable to check that it is securely connected.
3. Check the SPEED LED lighting status of the Ethernet port connected with the Ethernet cable. (📖 Page 45 Part names)

Point

- The time required from when an Ethernet cable is connected to when the SPEED LED turns ON may vary. Normally, it turns ON in a few seconds. However, it may take longer because the linking-up processing is repeated due to the device condition on the line.
- When the SPEED LED does not turn ON, check if the connected Ethernet cable has any failure.
- The SPEED LED turns OFF when connecting with an Ethernet device on the network the data transmission speed of which is 10 Mbps. Check the communication status by performing the PING test, etc.

■ Disconnection procedure

1. Pull out the Ethernet cable while pinching a clip on the connector.

■ Considerations for 1000BASE-T/100BASE-TX connection

A communication error may occur due to the high frequency noise generated from a device other than a programmable controller depending on the installation environment.

The following shows the measures to be taken on the module side to prevent the influence of high frequency noise.

- Do not bundle a cable with the main circuit or power cable, or do not place it near those lines.
- Place cables in a duct.
- In the environment where a cable is susceptible to noise, use the STP cable.
- Change a target device connected with a module to one which communicates at 10 Mbps, and decrease the data transmission speed.

Wiring precautions

- To establish a reliable system and fully use the functions of a module, a wiring that does not easily receive the effects of noise is required.
- Sufficient safety measures must be taken when constructing the IEEE802.3 1000BASE-T/100BASE-TX/10BASE-T networks.
Consult a specialist when handling the terminal processing of connection cable, installing trunk cables, etc.
- Use a cable compliant with IEEE802.3 1000BASE-T/100BASE-TX/10BASE-T standards. (☞ Page 53 Connectable Ethernet (twisted pair) cables (sold separately))
- For the connection on the target device side, check the specifications of the target device in advance.
- Place an Ethernet cable in a duct or clamp it.
Otherwise, the dangling cable may swing or inadvertently be pulled. It may cause a module or the cable to damage or malfunction due to poor contact.
- Protect the core wire in the connector of a cable or the port of a module to prevent touching by hand and sticking dirt or dust.
If any oil from your hand, dirt or dust sticks the core wire, it may increase the transmission loss and fail a data link.
- Check if an Ethernet cable used is disconnected, a short-circuit is generated, and the connector is properly connected.
- Do not use an Ethernet cable with a broken clip.
Doing so may cause the unplugged cable or malfunction.
- Hold the connector of an Ethernet cable when connecting or disconnecting it.
If the cable is pulled while being connected to a module, it may cause the module or Ethernet cable to damage or malfunction due to poor contact.
- Attach the provided connector cover to protect an unused Ethernet port from dirt and dust.
- The maximum segment length of an Ethernet cable is 100 m. However, the length may be shorter depending on the use environment of the cable. For details, contact the manufacturer of the cable used.
- The bend radius of an Ethernet cable is limited. For details, check the specifications of the Ethernet cable used.

External dimensions

The following figures show the external dimensions of a recorder module.

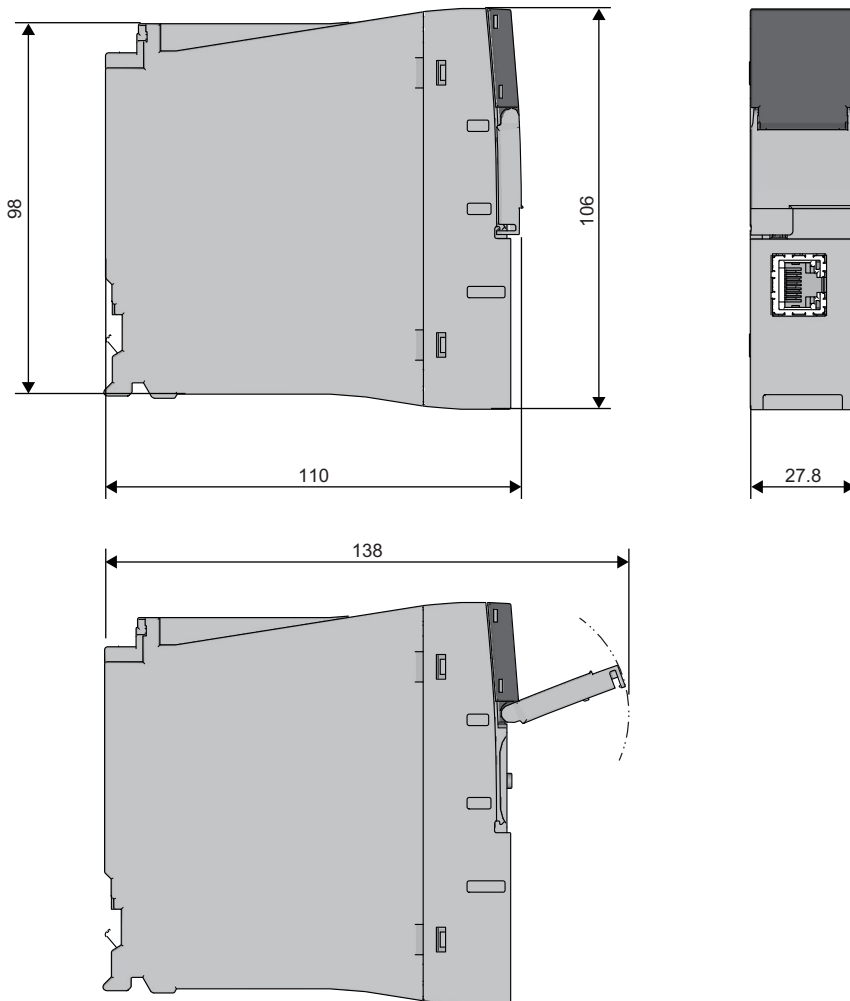

(Unit: mm)

5.4 Camera Recorder Module

This section explains a camera recorder module.

For details on the functions, module labels, input/output signals, and buffer memory of a camera recorder module, refer to the following:

📖 MELSEC iQ-R System Recorder User's Manual (Application)

Part names

The following shows the part names of a camera recorder module.

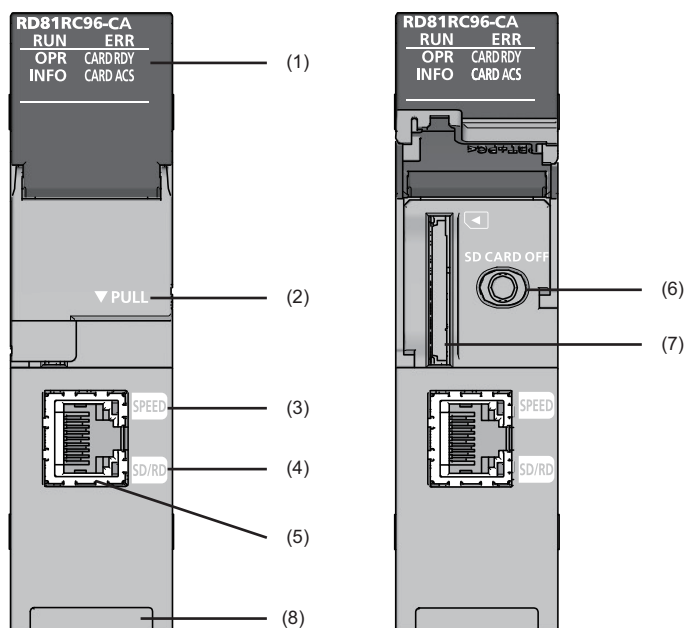

No.	Name	Description
(1)	RUN LED	Indicates the operating status. • ON: In operation • OFF: Hardware error
	ERR LED	Indicates the error status. • ON: Minor error or hardware error • Flashing: Moderate error or major error • OFF: In normal status
	OPR LED	Indicates the status of a module. • ON: In operation • OFF: Stopped
	INFO LED	Indicates the warning occurrence status. • ON: Warning • OFF: In normal status
	CARD RDY LED	Indicates the accessibility of an SD memory card. • ON: Accessible (mounted) • Flashing: Being mounted/unmounted • OFF: Inaccessible (not inserted/unmounted/write-protected)
	CARD ACS LED	Indicates the access status of an SD memory card. • ON: Being accessed • OFF: Not accessed
(2)	Slot cover	A cover of the SD memory card slot and the SD memory card lock switch. Open this cover to insert/remove an SD memory card or to operate the switch. Close the cover unless inserting/removing an SD memory card or operating the switch to prevent foreign material intrusion such as dust.
(3)	SPEED LED	Indicates the communication speed and the link status for Ethernet. • ON (orange): Linking-up (1 Gbps) • ON (green): Linking-up (100 Mbps) • OFF: Linking-down or linking-up (10 Mbps)

No.	Name	Description
(4)	SD/RD LED	Indicates the data sending/receiving status in Ethernet. <ul style="list-style-type: none"> • ON: Being sent/received • OFF: Not being sent/received
(5)	Ethernet port	A port for connecting a camera recorder module to 10BASE-T/100BASE-TX/1000BASE-T. (A camera recorder module distinguishes among 10BASE-T, 100BASE-TX, and 1000BASE-T depending on an external device.)
(6)	SD memory card lock switch (SD CARD OFF button)	A switch for disabling access to an SD memory card to remove it. Removing an SD memory card is prohibited while the CARD RDY LED is ON or flashing. For the procedures for inserting and removing an SD memory card, refer to the following:  Page 49 SD memory card
(7)	SD memory card slot	A slot for inserting an SD memory card. (SD, SDHC standards-compliant: 2 GB (SD) to 16 GB (SDHC))
(8)	Product information marking	Displays the product information (16 digits) of a module.

Point 

An INFO LED lighting factor can be checked in the INFO LED information in the "Module Diagnostics" screen or the buffer memory. Check the factor and take corrective action. ( MELSEC iQ-R System Recorder User's Manual (Application))

Hardware specifications

The following table shows the hardware specifications of a camera recorder module.

Item		Specification		
Ethernet port	Interface	1000BASE-T	100BASE-TX	10BASE-T
	Data transmission speed	1 Gbps	100 Mbps	10 Mbps
	Number of cascade connections (When using a repeater hub)	Consult the manufacturer of the repeater hub used.	2 levels maximum	4 levels maximum
	Transmission method	Base band		
	Maximum segment length	100 m (length between a hub and a node)		
	Supported function	Auto-negotiation (automatic recognition of the communication speed/communication method) Auto-MDI/MDI-X (automatic recognition of a straight/crossover cable)		
	IP version	IPv4 supported		
SD memory card slot	Power supply voltage	3.3 VDC		
	Power supply capacity	Up to 200 mA		
	Card size	SD memory card/SDHC memory card		
	Number of insertable cards	1		
Number of occupied I/O points		32 points/slot (I/O assignment: Intelligent function module 32 points)		
Clock		<ul style="list-style-type: none"> Acquired from a CPU module (CPU No.1 in a multiple CPU system). Time accuracy after obtaining the time, daily error of ± 9.504 seconds 		
5 VDC internal current consumption		1.0 A		
External dimensions	Height	106 mm		
	Width	27.8 mm		
	Depth	110 mm		
Weight		0.23 kg		
Number of preset registrations		Up to 100,000 ^{*1}		

*1 If it is exceeded, a preset position registration count upper limit reach error (error code: 1CA0H) occurs.

Precautions

The operation of a camera recorder module with the following connection methods is not guaranteed. Check the operation before use.

- Connection using Internet (general public line) (Internet-access service offered by an Internet service provider or a telecommunications carrier)
- Connection using a firewall device
- Connection using a broadband router
- Connection using a wireless LAN

The number of available cascade connections differs depending on the interface specifications of a network camera used. For details, refer to the manual for the network camera.

Function list

The following table shows the function list of a camera recorder module.

For details on the functions, refer to the following:

📖 MELSEC iQ-R System Recorder User's Manual (Application)

Function	Description
Recording function	To accumulate data (devices and labels) sampled in a CPU module and video data delivered from a network camera, and save them and an event history of the CPU module as a recording file when a file saving trigger is satisfied.
Network camera communication function	To communicate with a network camera via a network.
Camera time synchronization function	To synchronize the time between a camera recorder module and a network camera.
Camera event function	To notify the recording function of a camera event such as motion detection received from a network camera as a trigger.
Camera adjustment function (PTZ)	To control pan/tilt/zoom (PTZ) for a network camera and register adjusted ranges of captured data as preset positions.
GOT linkage function	To check a live video of a network camera and adjust its PTZ in a GOT connected to a CPU module on the same network as the network camera.
SD memory card format function	To format an SD memory card inserted in a camera recorder module.
Self-diagnostics function	To diagnose whether a camera recorder module operates normally.
Firmware update function	To update the firmware of a camera recorder module. For details, refer to the following: 📖 MELSEC iQ-R Module Configuration Manual
Co-recording function	To perform recording synchronously on target devices by sending and receiving a co-recording trigger.

SD memory card

An SD memory card used for a camera recorder module is the same as a recorder module.

☞ Page 49 SD memory card

Ethernet cable

An Ethernet cable connected to a camera recorder module is the same as a recorder module.

☞ Page 53 Ethernet cable

Network camera

The following shows a network camera connected to a camera recorder module.

Connectable network cameras

Refer to the following:

☞ When using a camera recorder module

Connection method

Connect a network camera to a camera recorder module via a switching hub.

In addition, a network camera supporting PoE power supply must be connected to a PoE switching hub.

For details on the connection method, refer to the manual for a network camera used.

External dimensions

The external dimensions of a camera recorder module are the same as a recorder module.

☞ Page 55 External dimensions

INDEX

C

Camera recorder module 56

E

Ethernet cable 53,60

External dimension 55

F

Function list of a camera recorder module 59

Function list of a recorder module 48

Function list of System Recorder 19

H

Hardware specification 47,58

P

Performance specifications of System Recorder . . 17

Procedure for operation 23

R

Recorder module 45

Recording setting 34

S

SD memory card 49,60

System configuration 38

System Recorder 15

MEMO

REVISIONS

*The manual number is given on the bottom left of the back cover.

Revision date	*Manual number	Description
June 2020	SH(NA)-082279ENG-A	First edition
June 2020	SH(NA)-082279ENG-B	Partial correction
October 2020	SH(NA)-082279ENG-C	■Added or modified parts Section 2.1, Section 3.1, Section 4.1, Section 4.2, Section 5.1, Section 5.2, Section 5.3
February 2021	SH(NA)-082279ENG-D	■Added or modified parts TERMS, Chapter 1, Section 2.1, Section 3.1, Section 4.1, Section 4.2, Section 5.1, Section 5.2, Section 5.4
July 2021	SH(NA)-082279ENG-E	■Added or modified parts Section 3.1, Section 4.1, Section 4.2, Section 5.2
April 2022	SH(NA)-082279ENG-F	■Added or modified parts Section 3.1, Section 4.1, Section 5.4
October 2022	SH(NA)-082279ENG-G	■Added or modified parts Chapter 1, Section 3.1, Section 3.5, Section 4.5, Section 5.1, Section 5.2, Section 5.3, Section 5.4

Japanese manual number: SH-082278-F

This manual confers no industrial property rights or any rights of any other kind, nor does it confer any patent licenses. Mitsubishi Electric Corporation cannot be held responsible for any problems involving industrial property rights which may occur as a result of using the contents noted in this manual.

© 2020 MITSUBISHI ELECTRIC CORPORATION

WARRANTY

Please confirm the following product warranty details before using this product.

1. Gratis Warranty Term and Gratis Warranty Range

If any faults or defects (hereinafter "Failure") found to be the responsibility of Mitsubishi occurs during use of the product within the gratis warranty term, the product shall be repaired at no cost via the sales representative or Mitsubishi Service Company.

However, if repairs are required onsite at domestic or overseas location, expenses to send an engineer will be solely at the customer's discretion. Mitsubishi shall not be held responsible for any re-commissioning, maintenance, or testing on-site that involves replacement of the failed module.

[Gratis Warranty Term]

The gratis warranty term of the product shall be for one year after the date of purchase or delivery to a designated place. Note that after manufacture and shipment from Mitsubishi, the maximum distribution period shall be six (6) months, and the longest gratis warranty term after manufacturing shall be eighteen (18) months. The gratis warranty term of repair parts shall not exceed the gratis warranty term before repairs.

[Gratis Warranty Range]

- (1) The range shall be limited to normal use within the usage state, usage methods and usage environment, etc., which follow the conditions and precautions, etc., given in the instruction manual, user's manual and caution labels on the product.
- (2) Even within the gratis warranty term, repairs shall be charged for in the following cases.
 1. Failure occurring from inappropriate storage or handling, carelessness or negligence by the user. Failure caused by the user's hardware or software design.
 2. Failure caused by unapproved modifications, etc., to the product by the user.
 3. When the Mitsubishi product is assembled into a user's device, Failure that could have been avoided if functions or structures, judged as necessary in the legal safety measures the user's device is subject to or as necessary by industry standards, had been provided.
 4. Failure that could have been avoided if consumable parts (battery, backlight, fuse, etc.) designated in the instruction manual had been correctly serviced or replaced.
 5. Failure caused by external irresistible forces such as fires or abnormal voltages, and Failure caused by force majeure such as earthquakes, lightning, wind and water damage.
 6. Failure caused by reasons unpredictable by scientific technology standards at time of shipment from Mitsubishi.
 7. Any other failure found not to be the responsibility of Mitsubishi or that admitted not to be so by the user.

2. Onerous repair term after discontinuation of production

- (1) Mitsubishi shall accept onerous product repairs for seven (7) years after production of the product is discontinued. Discontinuation of production shall be notified with Mitsubishi Technical Bulletins, etc.
- (2) Product supply (including repair parts) is not available after production is discontinued.

3. Overseas service

Overseas, repairs shall be accepted by Mitsubishi's local overseas FA Center. Note that the repair conditions at each FA Center may differ.

4. Exclusion of loss in opportunity and secondary loss from warranty liability

Regardless of the gratis warranty term, Mitsubishi shall not be liable for compensation to:

- (1) Damages caused by any cause found not to be the responsibility of Mitsubishi.
- (2) Loss in opportunity, lost profits incurred to the user by Failures of Mitsubishi products.
- (3) Special damages and secondary damages whether foreseeable or not, compensation for accidents, and compensation for damages to products other than Mitsubishi products.
- (4) Replacement by the user, maintenance of on-site equipment, start-up test run and other tasks.

5. Changes in product specifications

The specifications given in the catalogs, manuals or technical documents are subject to change without prior notice.

TRADEMARKS

ONVIF is a trademark of Onvif, Inc.

Windows is trademark of the Microsoft group of companies.

The company names, system names and product names mentioned in this manual are either registered trademarks or trademarks of their respective companies.

In some cases, trademark symbols such as [™] or [®] are not specified in this manual.

SH(NA)-082279ENG-G(2210)KWIX

MODEL: SYSRECORDER-U-IN-E

MODEL CODE: 13JX3A

mitsubishi electric corporation

HEAD OFFICE : TOKYO BUILDING, 2-7-3 MARUNOUCHI, CHIYODA-KU, TOKYO 100-8310, JAPAN
NAGOYA WORKS : 1-14, YADA-MINAMI 5-CHOME, HIGASHI-KU, NAGOYA, JAPAN

When exported from Japan, this manual does not require application to the
Ministry of Economy, Trade and Industry for service transaction permission.

Specifications subject to change without notice.