

Programmable Controller

MELSEC iQ-R
series

MELSEC iQ-R High Speed Data Logger Module User's Manual (Startup)

-RD81DL96
-SW1DNN-RDLUTL (High Speed Data Logger Module Tool)



SAFETY PRECAUTIONS

(Read these precautions before using this product.)

Before using this product, please read this manual and the relevant manuals carefully and pay full attention to safety to handle the product correctly. If products are used in a different way from that specified by manufacturers, the protection function of the products may not work properly.

The precautions given in this manual are concerned with this product only. For the safety precautions of the programmable controller system, refer to the MELSEC iQ-R Module Configuration Manual.

In this manual, the safety precautions are classified into two levels: "⚠ WARNING" and "⚠ CAUTION".

 WARNING	Indicates that incorrect handling may cause hazardous conditions, resulting in death or severe injury.
 CAUTION	Indicates that incorrect handling may cause hazardous conditions, resulting in minor or moderate injury or property damage.

Under some circumstances, failure to observe the precautions given under "⚠ CAUTION" may lead to serious consequences.

Observe the precautions of both levels because they are important for personal and system safety.

Make sure that the end users read this manual and then keep the manual in a safe place for future reference.

[Design Precautions]

WARNING

- Configure safety circuits external to the programmable controller to ensure that the entire system operates safely even when a fault occurs in the external power supply or the programmable controller. Failure to do so may result in an accident due to an incorrect output or malfunction.
 - (1) Emergency stop circuits, protection circuits, and protective interlock circuits for conflicting operations (such as forward/reverse rotations or upper/lower limit positioning) must be configured external to the programmable controller.
 - (2) When the programmable controller detects an abnormal condition, it stops the operation and all outputs are:
 - Turned off if the overcurrent or overvoltage protection of the power supply module is activated.
 - Held or turned off according to the parameter setting if the self-diagnostic function of the CPU module detects an error such as a watchdog timer error.
 - (3) All outputs may be turned on if an error occurs in a part, such as an I/O control part, where the CPU module cannot detect any error. To ensure safety operation in such a case, provide a safety mechanism or a fail-safe circuit external to the programmable controller. For a fail-safe circuit example, refer to "General Safety Requirements" in the MELSEC iQ-R Module Configuration Manual.
 - (4) Outputs may remain on or off due to a failure of a component such as a relay and transistor in an output circuit. Configure an external circuit for monitoring output signals that could cause a serious accident.
 - In an output circuit, when a load current exceeding the rated current or an overcurrent caused by a load short-circuit flows for a long time, it may cause smoke and fire. To prevent this, configure an external safety circuit, such as a fuse.
 - Configure a circuit so that the programmable controller is turned on first and then the external power supply. If the external power supply is turned on first, an accident may occur due to an incorrect output or malfunction.
 - Configure a circuit so that the external power supply is turned off first and then the programmable controller. If the programmable controller is turned off first, an accident may occur due to an incorrect output or malfunction.
 - For the operating status of each station after a communication failure, refer to manuals for the network used. For the manuals, please consult your local Mitsubishi representative. Incorrect output or malfunction due to a communication failure may result in an accident.
 - When connecting an external device with a CPU module or intelligent function module to modify data of a running programmable controller, configure an interlock circuit in the program to ensure that the entire system will always operate safely. For other forms of control (such as program modification, parameter change, forced output, or operating status change) of a running programmable controller, read the relevant manuals carefully and ensure that the operation is safe before proceeding. Improper operation may damage machines or cause accidents. When a Safety CPU is used, data cannot be modified while the Safety CPU is in SAFETY MODE.
 - Especially, when a remote programmable controller is controlled by an external device, immediate action cannot be taken if a problem occurs in the programmable controller due to a communication failure. To prevent this, configure an interlock circuit in the program, and determine corrective actions to be taken between the external device and CPU module in case of a communication failure.
-

[Design Precautions]

WARNING

- Do not write any data to the "system area" and "write-protect area" of the buffer memory in the module. Also, do not use any "use prohibited" signals as an output signal from the CPU module to each module. Doing so may cause malfunction of the programmable controller system. For the "system area", "write-protect area", and the "use prohibited" signals, refer to the user's manual for the module used. For areas used for safety communications, they are protected from being written by users, and thus safety communications failure caused by data writing does not occur.
 - If a communication cable is disconnected, the network may be unstable, resulting in a communication failure of multiple stations. Configure an interlock circuit in the program to ensure that the entire system will always operate safely even if communications fail. Incorrect output or malfunction due to a communication failure may result in an accident. When safety communications are used, an interlock by the safety station interlock function protects the system from an incorrect output or malfunction.
-

[Design Precautions]

CAUTION

- Do not install the control lines or communication cables together with the main circuit lines or power cables. Doing so may result in malfunction due to electromagnetic interference. Keep a distance of 100mm or more between those cables.
 - During control of an inductive load such as a lamp, heater, or solenoid valve, a large current (approximately ten times greater than normal) may flow when the output is turned from off to on. Therefore, use a module that has a sufficient current rating.
 - After the CPU module is powered on or is reset, the time taken to enter the RUN status varies depending on the system configuration, parameter settings, and/or program size. Design circuits so that the entire system will always operate safely, regardless of the time.
 - Do not power off the programmable controller or reset the CPU module while the settings are being written. Doing so will make the data in the flash ROM and SD memory card undefined. The values need to be set in the buffer memory and written to the flash ROM and SD memory card again. Doing so also may cause malfunction or failure of the module.
 - When changing the operating status of the CPU module from external devices (such as the remote RUN/STOP functions), select "Do Not Open by Program" for "Opening Method" of "Module Parameter". If "Open by Program" is selected, an execution of the remote STOP function causes the communication line to close. Consequently, the CPU module cannot reopen the line, and external devices cannot execute the remote RUN function.
-

[Security Precautions]

WARNING

- To maintain the security (confidentiality, integrity, and availability) of the programmable controller and the system against unauthorized access, denial-of-service (DoS) attacks, computer viruses, and other cyberattacks from external devices via the network, take appropriate measures such as firewalls, virtual private networks (VPNs), and antivirus solutions.
-

[Installation Precautions]

WARNING

- Shut off the external power supply (all phases) used in the system before mounting or removing the module. Failure to do so may result in electric shock or cause the module to fail or malfunction.
-

[Installation Precautions]

CAUTION

- Use the programmable controller in an environment that meets the general specifications in the MELSEC iQ-R Module Configuration Manual. Failure to do so may result in electric shock, fire, malfunction, or damage to or deterioration of the product.
 - To mount a module, place the concave part(s) located at the bottom onto the guide(s) of the base unit, and push in the module until the hook(s) located at the top snaps into place. Incorrect interconnection may cause malfunction, failure, or drop of the module.
 - To mount a module with no module fixing hook, place the concave part(s) located at the bottom onto the guide(s) of the base unit, push in the module, and fix it with screw(s). Incorrect interconnection may cause malfunction, failure, or drop of the module.
 - When using the programmable controller in an environment of frequent vibrations, fix the module with a screw.
 - Tighten the screws within the specified torque range. Undertightening can cause drop of the component or wire, short circuit, or malfunction. Overtightening can damage the screw and/or module, resulting in drop, short circuit, or malfunction. For the specified torque range, refer to the MELSEC iQ-R Module Configuration Manual.
 - When using an extension cable, connect it to the extension cable connector of the base unit securely. Check the connection for looseness. Poor contact may cause malfunction.
 - When using an SD memory card, fully insert it into the SD memory card slot. Check that it is inserted completely. Poor contact may cause malfunction.
 - Securely insert an extended SRAM cassette or a battery-less option cassette into the cassette connector of the CPU module. After insertion, close the cassette cover and check that the cassette is inserted completely. Poor contact may cause malfunction.
 - Beware that the module could be very hot while power is on and immediately after power-off.
 - Do not directly touch any conductive parts and electronic components of the module, SD memory card, extended SRAM cassette, battery-less option cassette, or connector. Doing so can cause malfunction or failure of the module.
-

[Wiring Precautions]

WARNING

- Shut off the external power supply (all phases) used in the system before installation and wiring. Failure to do so may result in electric shock or cause the module to fail or malfunction.
- After installation and wiring, attach a blank cover module (RG60) to each empty slot before powering on the system for operation. Also, attach an extension connector protective cover^{*1} to each unused extension cable connector as necessary. Directly touching any conductive parts of the connectors while power is on may result in electric shock.

*1 For details, please consult your local Mitsubishi Electric representative.

[Wiring Precautions]

CAUTION

- Individually ground the FG and LG terminals of the programmable controller with a ground resistance of 100 ohms or less. Failure to do so may result in electric shock or malfunction.
 - Use applicable solderless terminals and tighten them within the specified torque range. If any spade solderless terminal is used, it may be disconnected when the terminal screw comes loose, resulting in failure.
 - Check the rated voltage and signal layout before wiring to the module, and connect the cables correctly. Connecting a power supply with a different voltage rating or incorrect wiring may cause fire or failure.
 - Connectors for external devices must be crimped or pressed with the tool specified by the manufacturer, or must be correctly soldered. Incomplete connections may cause short circuit, fire, or malfunction.
 - Securely connect the connector to the module. Poor contact may cause malfunction.
 - Do not install the control lines or communication cables together with the main circuit lines or power cables. Doing so may result in malfunction due to noise. Keep a distance of 100mm or more between those cables.
 - Place the cables in a duct or clamp them. If not, dangling cables may swing or inadvertently be pulled, resulting in malfunction or damage to modules or cables. In addition, the weight of the cables may put stress on modules in an environment of strong vibrations and shocks. Do not clamp the extension cables with the jacket stripped. Doing so may change the characteristics of the cables, resulting in malfunction.
 - Check the interface type and correctly connect the cable. Incorrect wiring (connecting the cable to an incorrect interface) may cause failure of the module and external device.
 - Tighten the terminal screws or connector screws within the specified torque range. Undertightening can cause drop of the screw, short circuit, fire, or malfunction. Overtightening can damage the screw and/or module, resulting in drop, short circuit, fire, or malfunction.
 - When disconnecting the cable from the module, do not pull the cable by the cable part. For the cable with connector, hold the connector part of the cable. For the cable connected to the terminal block, loosen the terminal screw. Pulling the cable connected to the module may result in malfunction or damage to the module or cable.
 - Prevent foreign matter such as dust or wire chips from entering the module. Such foreign matter can cause a fire, failure, or malfunction.
 - When a protective film is attached to the top of the module, remove it before system operation. If not, inadequate heat dissipation of the module may cause a fire, failure, or malfunction.
-

[Wiring Precautions]

CAUTION

- Programmable controllers must be installed in control panels. Connect the main power supply to the power supply module in the control panel through a relay terminal block. Wiring and replacement of a power supply module must be performed by qualified maintenance personnel with knowledge of protection against electric shock. For wiring, refer to the MELSEC iQ-R Module Configuration Manual.
 - For Ethernet cables to be used in the system, select the ones that meet the specifications in the user's manual for the module used. If not, normal data transmission is not guaranteed.
-

[Startup and Maintenance Precautions]

WARNING

- Do not touch any terminal while power is on. Doing so will cause electric shock or malfunction.
 - Correctly connect the battery connector. Do not charge, disassemble, heat, short-circuit, solder, or throw the battery into the fire. Also, do not expose it to liquid or strong shock. Doing so will cause the battery to produce heat, explode, ignite, or leak, resulting in injury and fire.
 - Shut off the external power supply (all phases) used in the system before cleaning the module or retightening the terminal screws, connector screws, or module fixing screws. Failure to do so may result in electric shock.
-

[Startup and Maintenance Precautions]

CAUTION

- When connecting an external device with a CPU module or intelligent function module to modify data of a running programmable controller, configure an interlock circuit in the program to ensure that the entire system will always operate safely. For other forms of control (such as program modification, parameter change, forced output, or operating status change) of a running programmable controller, read the relevant manuals carefully and ensure that the operation is safe before proceeding. Improper operation may damage machines or cause accidents.
 - Especially, when a remote programmable controller is controlled by an external device, immediate action cannot be taken if a problem occurs in the programmable controller due to a communication failure. To prevent this, configure an interlock circuit in the program, and determine corrective actions to be taken between the external device and CPU module in case of a communication failure.
 - Do not disassemble or modify the modules. Doing so may cause failure, malfunction, injury, or a fire.
 - Use any radio communication device such as a cellular phone or PHS (Personal Handy-phone System) more than 25cm away in all directions from the programmable controller. Failure to do so may cause malfunction.
 - Shut off the external power supply (all phases) used in the system before mounting or removing the module. Failure to do so may cause the module to fail or malfunction.
 - Tighten the screws within the specified torque range. Undertightening can cause drop of the component or wire, short circuit, or malfunction. Overtightening can damage the screw and/or module, resulting in drop, short circuit, or malfunction.
 - After the first use of the product, do not perform each of the following operations more than 50 times (IEC 61131-2/JIS B 3502 compliant). Exceeding the limit may cause malfunction.
 - Mounting/removing the module to/from the base unit
 - Inserting/removing the extended SRAM cassette or battery-less option cassette to/from the CPU module
 - Mounting/removing the terminal block to/from the module
 - Connecting/disconnecting the extension cable to/from the base unit
 - After the first use of the product, do not insert/remove the SD memory card to/from the CPU module more than 500 times. Exceeding the limit may cause malfunction.
 - Do not touch the metal terminals on the back side of the SD memory card. Doing so may cause malfunction or failure of the module.
 - Do not touch the integrated circuits on the circuit board of an extended SRAM cassette or a battery-less option cassette. Doing so may cause malfunction or failure of the module.
 - Do not drop or apply shock to the battery to be installed in the module. Doing so may damage the battery, causing the battery fluid to leak inside the battery. If the battery is dropped or any shock is applied to it, dispose of it without using.
 - Startup and maintenance of a control panel must be performed by qualified maintenance personnel with knowledge of protection against electric shock. Lock the control panel so that only qualified maintenance personnel can operate it.
-

[Startup and Maintenance Precautions]

CAUTION

- Before handling the module, touch a conducting object such as a grounded metal to discharge the static electricity from the human body. Wearing a grounded antistatic wrist strap is recommended. Failure to discharge the static electricity may cause the module to fail or malfunction.
 - After unpacking, eliminate static electricity from the module to prevent electrostatic discharge from affecting the module. If an electrostatically charged module comes in contact with a grounded metal object, a sudden electrostatic discharge of the module may cause failure.
For details on how to eliminate static electricity from the module, refer to the following.
Antistatic Precautions Before Using MELSEC iQ-R Series Products (FA-A-0368)
 - Use a clean and dry cloth to wipe off dirt on the module.
-

[Operating Precautions]

CAUTION

- When changing data and operating status, and modifying program of the running programmable controller from an external device such as a personal computer connected to an intelligent function module, read relevant manuals carefully and ensure the safety before operation. Incorrect change or modification may cause system malfunction, damage to the machines, or accidents.
 - Do not power off the programmable controller or reset the CPU module while the setting values in the buffer memory are being written to the flash ROM in the module. Doing so will make the data in the flash ROM and SD memory card undefined. The values need to be set in the buffer memory and written to the flash ROM and SD memory card again. Doing so can cause malfunction or failure of the module.
-

[Disposal Precautions]

CAUTION

- When disposing of this product, treat it as industrial waste.
 - When disposing of batteries, separate them from other wastes according to the local regulations. For details on battery regulations in EU member states, refer to the MELSEC iQ-R Module Configuration Manual.
-

[Transportation Precautions]

CAUTION

- When transporting lithium batteries, follow the transportation regulations. For details on the regulated models, refer to the MELSEC iQ-R Module Configuration Manual.
 - The halogens (such as fluorine, chlorine, bromine, and iodine), which are contained in a fumigant used for disinfection and pest control of wood packaging materials, may cause failure of the product. Prevent the entry of fumigant residues into the product or consider other methods (such as heat treatment) instead of fumigation. The disinfection and pest control measures must be applied to unprocessed raw wood.
-

CONDITIONS OF USE FOR THE PRODUCT

- (1) MELSEC programmable controller ("the PRODUCT") shall be used in conditions;
- i) where any problem, fault or failure occurring in the PRODUCT, if any, shall not lead to any major or serious accident; and
 - ii) where the backup and fail-safe function are systematically or automatically provided outside of the PRODUCT for the case of any problem, fault or failure occurring in the PRODUCT.
- (2) The PRODUCT has been designed and manufactured for the purpose of being used in general industries. MITSUBISHI ELECTRIC SHALL HAVE NO RESPONSIBILITY OR LIABILITY (INCLUDING, BUT NOT LIMITED TO ANY AND ALL RESPONSIBILITY OR LIABILITY BASED ON CONTRACT, WARRANTY, TORT, PRODUCT LIABILITY) FOR ANY INJURY OR DEATH TO PERSONS OR LOSS OR DAMAGE TO PROPERTY CAUSED BY the PRODUCT THAT ARE OPERATED OR USED IN APPLICATION NOT INTENDED OR EXCLUDED BY INSTRUCTIONS, PRECAUTIONS, OR WARNING CONTAINED IN MITSUBISHI ELECTRIC USER'S, INSTRUCTION AND/OR SAFETY MANUALS, TECHNICAL BULLETINS AND GUIDELINES FOR the PRODUCT.
- ("Prohibited Application")
- Prohibited Applications include, but not limited to, the use of the PRODUCT in;
- Nuclear Power Plants and any other power plants operated by Power companies, and/or any other cases in which the public could be affected if any problem or fault occurs in the PRODUCT.
 - Railway companies or Public service purposes, and/or any other cases in which establishment of a special quality assurance system is required by the Purchaser or End User.
 - Aircraft or Aerospace, Medical applications, Train equipment, transport equipment such as Elevator and Escalator, Incineration and Fuel devices, Vehicles, Manned transportation, Equipment for Recreation and Amusement, and Safety devices, handling of Nuclear or Hazardous Materials or Chemicals, Mining and Drilling, and/or other applications where there is a significant risk of injury to the public or property.
- Notwithstanding the above restrictions, Mitsubishi Electric may in its sole discretion, authorize use of the PRODUCT in one or more of the Prohibited Applications, provided that the usage of the PRODUCT is limited only for the specific applications agreed to by Mitsubishi Electric and provided further that no special quality assurance or fail-safe, redundant or other safety features which exceed the general specifications of the PRODUCTS are required. For details, please contact the Mitsubishi Electric representative in your region.
- (3) Mitsubishi Electric shall have no responsibility or liability for any problems involving programmable controller trouble and system trouble caused by DoS attacks, unauthorized access, computer viruses, and other cyberattacks.

CONSIDERATIONS FOR USE

This section explains the following considerations.

- ☞ Page 10 Considerations for network connection
- ☞ Page 10 Considerations for performance/specifications
- ☞ Page 11 Considerations for data logging, event logging, and report functions
- ☞ Page 12 Considerations for other functions
- ☞ Page 12 Considerations for accessing a high speed data logger module
- ☞ Page 13 Considerations for security
- ☞ Page 13 Considerations for using SD memory cards
- ☞ Page 15 Considerations for using a redundant system
- ☞ Page 15 Considerations for the recipe function

Considerations for network connection

■Mail server and FTP server connections

When immediately powering ON after powering OFF, connection to mail servers or FTP servers may fail. Power the programmable controller OFF, wait several minutes then power it ON.

Considerations for performance/specifications

■Sequence scan time of CPU module

When using the high speed data logger module, the CPU module sequence scan time may increase. Design your system and programs keeping in mind this increase in sequence scan time of the CPU module.

■Network connection using Ethernet

- When connecting to Ethernet network, basically configure the communication route to the access target via Ethernet (twisted pair) cables and hubs. Note that when accessing via wireless LAN (Wi-Fi) or router, an error such as timeout or missing data occurs, and cannot be communicated properly depending on the status of the equipment (wireless LAN or router) on the network or the access route.
- When the access to the high speed data logger module is overloaded, errors and missing data may occur. Creating logging files, report files might take time, and communication with the module might not be possible. Reduce the load on the Ethernet network which is connected to the high speed data logger module.

■Time handled on the high speed data logger module

Time handled on the high speed data logger module is the time on the CPU module. For errors and the optimum timing for setting the time, refer to the following:



- ☞ Page 23 Performance Specifications
- 📖 MELSEC iQ-R High Speed Data Logger Module User's Manual (Application)

■High speed sampling



The high speed sampling function is not supported by CPU modules on other stations via a network.

Considerations for data logging, event logging, and report functions



■Data logging, event logging, and report functions

- The data logging, event logging, and report functions are best effort functions. Since the processing time of a module varies depending on the setting and the status of other devices, these functions may not perform at the set sampling interval. Run the system by fully verifying the processing time of each function when constructing it. For processing time, refer to the following:
(MELSEC iQ-R High Speed Data Logger Module User's Manual (Application))
- If data logging function, event logging function, or report function are used, they affect the sequence scan time of the access target CPU module. Run the system by verifying how the sequence scan time is affected when configuring the system.
(MELSEC iQ-R High Speed Data Logger Module User's Manual (Application))
- If exponential format is selected for the data output format with the data logging, event logging, or report setting, rounding errors will occur in the range of the number of digits that exceed the number of digits set for the decimal part.
- If the result of the linear function transformation with the scaling function exceeds the maximum or minimum range of the specified output format, the maximum or minimum value will be output in binary format. Therefore, when outputting in the binary format, errors may occur in the output values.
- The file transfer/e-mail transmission via the file transfer function/e-mail function may take from a few seconds to tens of seconds depending on the network line or transmission size. Target files may be deleted before file transfer/e-mail transmission is completed depending on the settings. Review the file switching timing and the setting for the number of saved files and lengthen the time until the file is deleted.
(MELSEC iQ-R High Speed Data Logger Module User's Manual (Application))
- When a CSV file is opened with Excel[®], the date column format is displayed in the default setting of Excel. Set the cell format as necessary.
- Since general sampling specified data and report current value data are sampled asynchronously with the sequence scan, data separation may occur. If data separation must be prevented, set the number of device points sampled at one time to less than the access units, or set the module to use high speed sampling.

■Data logging function

- When the number of device points to be sampled by the trigger logging function exceeds the access units and general sampling is specified for the data sampling method, device values sampled in another sequence scan as the one where the trigger occurred may be included in one data row. To avoid this, the number of device points that can be sampled at once should be less than the access units or high speed sampling should be used. For the access units, refer to the following:
( Page 43 Access units)
- Immediately after switching the programmable controller system ON, if a trigger occurs before sampling the number of lines of data before the trigger, the data before the trigger may be a few lines less than the specified amount.
- When triggers continuously occur with the trigger logging function, triggers may not be detected or the number of lines of data specified before the trigger may not be output. For operation when triggers continuously occur, refer to the following:
(MELSEC iQ-R High Speed Data Logger Module User's Manual (Application))

■Report function

- Immediately after switching the programmable controller system ON, if a creation trigger occurs when data does not exist in the data logging file, an error occurs in the high speed data logger module. Configure and construct the system so that the creation trigger occurs after data is saved in the data logging file.
- Report output takes time. Therefore, according to the data logging save setting, the data logging file including the data when the creation trigger occurs, may be deleted before the report output is completed. In this situation, the data for the specified number of records are not output, and an error occurs in the high speed data logger module. Check the Point in the following manual when configuring and constructing the system.
(MELSEC iQ-R High Speed Data Logger Module User's Manual (Application))
- When the creation triggers continuously occurred, they may not be detected. For operation when the creation trigger continuously occurred, refer to the following:
(MELSEC iQ-R High Speed Data Logger Module User's Manual (Application))

- When using Microsoft® Excel 2010 (32-bit version), Microsoft Excel 2013 (32-bit version), Microsoft Excel 2016 (32-bit version), Microsoft Excel 2019 (32-bit version/64-bit version), or Microsoft 365 (32-bit version/64-bit version), install Visual Basic® for Applications (abbreviated as VBA below). If VBA is not installed, the error message below will be displayed when the "Layout setting" screen is started, and the layout settings cannot be configured.
"This workbook has lost its VBA Project, ActiveX Controls and any other programmability-related features."
- The saving format of a report file output by the report function is the xls format. Some of the functions added to Microsoft Excel 2007 and later cannot be used.
- Microsoft Excel 2010 (64-bit version) is not supported.
- Microsoft Excel 2013 (64-bit version) is not supported.
- Microsoft Excel 2016 (64-bit version) is not supported.

Considerations for other functions

■Access target CPU setting

- When rewriting the settings in Configuration Tool, turning the power OFF and ON, or resetting a CPU module, a high speed data logger module is prepared to communicate with an access target CPU module. Therefore, if a large number of access target CPU modules are set, several minutes are required for this preparation.
- The following conditions may affect the general sampling, file transfer function, and e-mail function: a CPU module that does not exist is set as an access target CPU module, or a high speed data logger module cannot communicate with the access target CPU module temporarily because of the power interruption of access target CPU module or network failure. Before using a high speed data logger module, make sure that the module can communicate with a CPU module set as an access target.

■Time synchronization function

- If implementing the time synchronization with the CPU module, it will change the time of the high speed data logger module. When the CPU module's time is changed, the high speed data logger module's time may be greatly changed.
- Since there is inaccuracy in the clock element of the CPU module and the high speed data logger module, the time may be moved slightly forward or backward when the time is synchronized. Since changing the time of the high speed data logger module affects the time stamp, as well as the following determination of the cycles and of the time: data logging, event logging, and reports, configure the module to synchronize its time at the required minimum range.

Considerations for accessing a high speed data logger module

■Web browser operations and settings

- In the local area network (LAN) setting of the web browser, do not set a proxy server for the local address.
(☞ Page 53 Online startup)

■FTP server function

- Because of FTP client side application restrictions, if the user name or password is input incorrectly, end the FTP operation and redo the FTP connection from the beginning. FTP may not operate correctly by reentering the correct user name or password with the 'user' FTP command.
- The maximum number of simultaneous connections to the FTP server is 10. However, depending on the FTP client, it may make multiple simultaneous connections, so an FTP client may not be able to login even if 10 clients are not connected. In this situation, shutdown all the FTP clients, then restart and connect them.
- When transferring many files at once with FTP, a 426 error (data connection error) may occur. In this situation, split the files into multiple parts then transfer them separately.
- When a web browser is used for FTP access, the user authentication screen may not be displayed due to the specification of the web browser. In this case, enter the address of a high speed data logger module in the following format.
ftp://<user name>:<password>@<the address of a high speed data logger module or host name>/

- When a web browser is used for FTP access, data logging files, event logging files, report files, and recipe files may not be opened directly due to the specification of the web browser. Make sure to open the files after saving them to a personal computer.
- When a web browser is used for FTP access, due to the specification of the web browser, errors may not be displayed even if the transfer failed when files are transferred to the SD memory card which does not have enough free space. Update the display and check if the files are transferred normally.
- When a web browser is used for FTP access, a retry may be performed at user authentication failure due to the specification of the web browser. Note that unintentional repeated entry of wrong passwords may lock the module.
- The following port numbers (communication protocol) are used for the FTP server function.
Port for transferring data: 20 (TCP/IP)
Port for controlling communications: 21 (TCP/IP)

■Replacement of an older version of a module

- When replacing an older version of a high speed data logger module, delete temporary internet files (caches) of a web browser before accessing a newer version of the module.

■Connecting GX LogViewer

- The maximum number of connections for GX LogViewer to access the high speed data logger modules simultaneously is 2.
- The following port numbers (communication protocols) are used for the online function.
Connection via a hub: 49900, 49902 to 49906 (TCP/IP)
Direct connection: 49900 (UDP)
High speed data logger module search: 49901 (UDP)

■Connection with Configuration Tool

- Note that a module may be in an unintended status when operating it in multiple pieces of Configuration Tool at the same time.
- The following port numbers (communication protocols) are used for the online function.
Connection via a hub: 49900, 49902 to 49906 (TCP/IP)
Direct connection: 49900 (UDP)
High speed data logger module search: 49901 (UDP)

Considerations for security

- Although the high speed data logger module supports basic authentication (account setting) using user names and passwords, it does not completely protect the system from illegal access. Avoid accounts (user name, password) consisting of simple alphanumeric characters only, and include some non-alphanumeric characters (\$, &, ?) to create a complicated user name and password.

Considerations for using SD memory cards

■SD memory card file/directory

- Do not create files (excluding module operating files and recipe files) or folders on the SD memory card with a personal computer. If files or folders are created on the SD memory card with a personal computer, they may be deleted.

■SD memory card to be used

- Use SD memory cards manufactured by Mitsubishi Electric Corporation. If any other SD memory cards are used, a failure such as data corruption on the SD memory card or a system shutdown (module major error (error code: 2450H) occurs in the CPU module) may occur during an operation. ( Page 70 Connectable Devices)

■Turning the power OFF or resetting a CPU module

- When a CPU module is powered OFF or reset while writing data to an SD memory card, the processing to write data to the SD memory card may not be completed. It may cause a loss of logging data during the processing, corruption of data in the SD memory card that is being accessed, or occurrence of a file system error. The file is automatically recovered when the high speed data logger module is powered ON again, but it will not succeed in some cases.

The operation, powering OFF or resetting the CPU module after stopping file access, should be considered. For the important data, a periodic backup is recommended.

(☞ Page 64 Methods for stopping file access)

■Removing or replacing an SD memory card

- Make sure to stop file access before removing or replacing the SD memory card.
(☞ Page 64 Methods for stopping file access)
- Not following the procedure may cause a loss of logging data during processing, corruption of data in the SD memory card that is being accessed, a file system error, or false recognition of the mounting status of the SD memory card.
(☞ Page 62 Operations for removing or reinserting an SD memory card)
- If an error occurs on the SD memory card, refer to the following:
(📖 MELSEC iQ-R High Speed Data Logger Module User's Manual (Application))
- High speed data logger module settings are saved to the SD memory card. Therefore, the high speed data logger module's IP address returns to the initial status (192.168.3.3) when the SD memory card is not inserted in the module or when the power is turned OFF to ON or the CPU module is reset, without the settings written to the SD memory card. When necessary, read the current settings before removing the SD memory card and after replacing the card, promptly write those settings to the new card.

■SD memory card capacity

- Access speed to the SD memory card is affected by the amount of saved files. In particular, access speed becomes extremely slow when files are saved up to the capacity limit of the SD memory card. Use the SD memory card maintaining 10% or more free space on the card.
- A minimum size occupied by the files on the hard disk varies depending on the SD memory card capacity. Therefore, the actual file size and the occupied file size on the hard disk may differ.

■SD memory card diagnostic time

- The high speed data logger module performs diagnostics (file recovery, etc.) of the inserted SD memory card contents at the times listed below.
When powering OFF to ON or resetting the CPU module
When inserting an SD memory card while the power is ON
- The SD memory card diagnostic time takes longer when there are more files on the card. 100 files takes approximately 5 seconds, and 1000 files takes approximately 10 seconds.
- Saving many files on an SD memory card increases the following time. Delete unnecessary files.
Time until 'SD memory card status' (X1) rises
Time until a high speed data logger module starts processing ('Module READY' (X0) or 'Module operating status' (X5) rises)

■Formatting SD memory card

- Use the format function of Configuration Tool to format an SD memory card.
- Do not format an SD memory card using the format function of Windows®.
- Do not reset the control CPU or turn the power OFF when formatting an SD memory card.
- High speed data logger module settings are saved to an SD memory card. Therefore, all settings are lost when formatting the SD memory card. When necessary, read the current settings before formatting, and promptly write those settings after formatting. The IP address of the high speed data logger module returns to the initial status (192.168.3.3) when turning the power OFF to ON or when resetting the module without writing the settings to the SD memory card.

■SD memory card life (limit on writing)

- An SD memory card has a life (a limit on the number of times for writing data). For details, refer to the following:
( MELSEC iQ-R High Speed Data Logger Module User's Manual (Application))

■RECIPE folder

- The maximum number of recipe files that can be stored in the RECIPE folder is 256. Storing large numbers of files in the RECIPE folder causes a longer processing time for the following operations. Delete unnecessary files.
 - Displaying or operating the file browser
 - Displaying a file list of recipe execution operation
 - Recipe execution operation
- Do not store any files other than recipe files in the RECIPE folder.

■Write protect switch

- Make sure that the write protect switch of an SD memory card is in the unlocked position. When the write protect switch is in the locked position, no files can be written to the SD memory card.

Considerations for using a redundant system

■Mountable base units

- A high speed data logger module must be mounted on an extension base unit*¹ or a redundant extension base unit. It cannot be mounted on the main base unit in a redundant system.

*¹ Only the extension level 2 to 7 are available.

■Access target CPUs

- There are restrictions on accessible routes. For details, refer to the following:
( Page 35 Accessible routes)

■Dedicated instructions

- When mounting a high speed data logger module to a process CPU (redundant mode), dedicated instructions cannot be used. If a dedicated instruction is used, "Operation error (redundant function)" occurs in the process CPU (redundant mode).

■Resetting a CPU module

- When mounting a high speed data logger module to a process CPU (redundant mode), reset CPU modules of both systems for a function that requires resetting the CPU modules.

Considerations for the recipe function

■Recipe files

- For recipe file names, use the characters usable in file names and folder (directory) names only.

■Recipe execution operation

- Before performing the recipe execution operation, write the settings of a high speed data logger module in Configuration Tool, then set the module operating status to "In operation". The module operating status can be checked in the "Module Diagnostic" screen.
( MELSEC iQ-R High Speed Data Logger Module User's Manual (Application))
- The recipe execution operation can be performed to the control CPU only. It cannot be performed to a CPU module on another station.
- Do not power OFF or reset the CPU module during the recipe execution operation. The recipe file being edited may be damaged. Power OFF or reset the CPU module after confirming the completion of the recipe execution operation.

INTRODUCTION

Thank you for purchasing the Mitsubishi Electric MELSEC iQ-R series programmable controllers.

This manual describes the performance specifications, procedures up to operation, wiring, and operation examples to use the module listed below.

Before using this product, please read this manual and the relevant manuals carefully and develop familiarity with the functions and performance of the MELSEC iQ-R series programmable controller to handle the product correctly.

When applying the program examples provided in this manual to an actual system, ensure the applicability and confirm that it will not cause system control problems.

Note that the menu names and operating procedures may differ depending on an operating system in use and its version.

When reading this manual, replace the names and procedures with the applicable ones as necessary.

Please make sure that the end users read this manual.

Point

The program examples shown in this manual are the examples in which a high speed data logger module (RD81DL96) is assigned to the input/output No. X/Y0 to X/Y1F unless otherwise specified. To use the program examples shown in this manual, the input/output number assignment is required. For details on the assignment of input/output number, refer to the following:

 MELSEC iQ-R Module Configuration Manual



Relevant product

RD81DL96

COMPLIANCE WITH EMC AND LOW VOLTAGE DIRECTIVES

Method of ensuring compliance



To ensure that Mitsubishi Electric programmable controllers maintain the EMC and Low Voltage Directives or other regulations when incorporated into other machinery or equipment, certain measures may be necessary. Please refer to one of the following manuals.

-  MELSEC iQ-R Module Configuration Manual (SH-081262ENG)
-  Safety Guidelines (IB-0800525)

Certification marks on the side of the programmable controller indicate compliance with the relevant regulations.

Additional measures

To ensure that this product maintains the EMC and Low Voltage Directives or other regulations, please refer to the following.

-  MELSEC iQ-R Module Configuration Manual (SH-081262ENG)
-  Safety Guidelines (IB-0800525)

CONTENTS

SAFETY PRECAUTIONS	1
CONDITIONS OF USE FOR THE PRODUCT	9
CONSIDERATIONS FOR USE	10
INTRODUCTION	16
COMPLIANCE WITH EMC AND LOW VOLTAGE DIRECTIVES	16
RELEVANT MANUALS	19
TERMS	20
GENERIC TERMS AND ABBREVIATIONS	20
CHAPTER 1 PART NAMES	21
CHAPTER 2 SPECIFICATIONS	23
2.1 Performance Specifications	23
Transmission and interface specifications	23
Functional specifications	24
2.2 Access Specifications for a CPU Module	34
Accessible CPU modules	34
Accessible routes	35
Accessible devices	40
Bit specification/digit specification of devices	42
Device specification with labels/comments	43
Access units	43
2.3 File Structure	44
Folder structure of the SD memory card	44
Folder structure at the time of file transfer	45
2.4 Range of Values per Output Format	47
CHAPTER 3 FUNCTION LISTS	48
3.1 High Speed Data Logger Module	48
3.2 Configuration Tool	50
CHAPTER 4 PROCEDURES BEFORE OPERATION	51
4.1 Start up of High Speed Data Logger Module	51
Procedure to operate by installing Configuration Tool	51
Procedure to operate without installing Configuration Tool	51
Configuration Tool	53
Parameter setting	60
4.2 SD Memory Card	62
Operation for inserting an SD memory card	62
Operations for removing or reinserting an SD memory card	62
Operations for replacing an SD memory card	63
Methods for stopping file access	64
Insertion/removal method of an SD memory card	65
CHAPTER 5 SYSTEM CONFIGURATION	66
5.1 System Configuration	66
Overall system configuration	66
Software configuration of the high speed data logger module tool	67

System configuration for the initial setup, maintenance, and inspection	67
System configuration during operation	68
5.2 Connectable Devices	70
5.3 Operating Environment	71
5.4 Considerations for System Configuration	72
Considerations for using a C Controller module	72
Considerations when using a process CPU (redundant mode)	72
5.5 Supported Software Packages	72
CHAPTER 6 WIRING	73
6.1 Wiring of an Ethernet Cable	73
6.2 Wiring Precautions	74
CHAPTER 7 INSTALLATION AND UNINSTALLATION	75
7.1 Installation Procedure	75
Environment after installation	75
7.2 Uninstallation Procedure	75
Environment after uninstallation	75
CHAPTER 8 OPERATION EXAMPLE	77
8.1 Preparing for Operation	77
Preparing equipment	77
System construction	78
8.2 Logging Data before and after Trigger Occurrence	79
Equipment figure	79
Operation flow	79
Data logging settings (trigger logging)	80
Write settings	86
Graphical display of data	88
8.3 Creating Reports from Continuously Logged Data	91
Equipment figure	91
Operation flow	91
Data logging settings (continuous logging)	92
Report settings	98
Write settings	107
Checking created report	109
APPENDIX	112
Appendix 1 External Dimensions	112
INDEX	114
REVISIONS	116
WARRANTY	117
TRADEMARKS	118
COPYRIGHTS	118

RELEVANT MANUALS

Manual name [manual number]	Description	Available form
MELSEC iQ-R High Speed Data Logger Module User's Manual (Startup) [SH-081561ENG] (this manual)	Specifications, procedures before operation, wiring, and operation examples of a high speed data logger module	Print book e-Manual PDF
MELSEC iQ-R High Speed Data Logger Module User's Manual (Application) [SH-081562ENG]	Functions, Configuration Tool, parameter setting, troubleshooting, I/O signal, and buffer memory of a high speed data logger module	Print book e-Manual PDF
GX Works3 Operating Manual [SH-081215ENG]	System configurations, parameter settings, and operation methods for the online function in GX Works3	e-Manual PDF
MELSEC iQ-R Module Configuration Manual [SH-081262ENG]	The combination of the MELSEC iQ-R series modules, common information on the installation/wiring in the system, and specifications of the power supply module, base unit, SD memory card, and battery	Print book e-Manual PDF

This manual does not include detailed information on the following:

- General specifications
- Applicable combinations of CPU modules and the other modules, and the number of mountable modules
- Applicable combinations of remote head modules and the other modules, and the number of mountable modules
- Installation

For details, refer to the following:

 MELSEC iQ-R Module Configuration Manual

Point

e-Manual refers to the Mitsubishi Electric FA electronic book manuals that can be browsed using a dedicated tool.

e-Manual has the following features:

- Required information can be cross-searched in multiple manuals.
- Other manuals can be accessed from the links in the manual.
- Hardware specifications of each part can be found from the product figures.
- Pages that users often browse can be bookmarked.
- Sample programs can be copied to an engineering tool.

TERMS

Unless otherwise specified, this manual uses the following terms.

Term	Description
Engineering tool	A tool for setting, programming, debugging, and maintaining programmable controllers. For the supported tools, refer to the following:  MELSEC iQ-R Module Configuration Manual
Process CPU (process mode)	A Process CPU that operates in the process mode. Process control function blocks and the online module change function can be executed.
Process CPU (redundant mode)	A Process CPU operating in redundant mode. A redundant system is configured with this CPU module. Process control function blocks and the online module change function can be used even in this mode.

GENERIC TERMS AND ABBREVIATIONS

Unless otherwise specified, this manual uses the following generic terms and abbreviations.

Generic term/abbreviation	Description
Configuration Tool	MELSEC iQ-R High Speed Data Logger Module Configuration Tool. This tool configures and maintains the high speed data logger module.
High speed data logger module	A MELSEC iQ-R high speed data logger module
LCPU	A MELSEC-L series CPU module
Logging file	A data logging file and an event logging file
QCPU (Q mode)	A MELSEC-Q series CPU module and a MELSEC-Q series C Controller module
RCPU	A MELSEC iQ-R series CPU module and a MELSEC iQ-R series C Controller module

1 PART NAMES

This chapter shows the part names of a high speed data logger module.

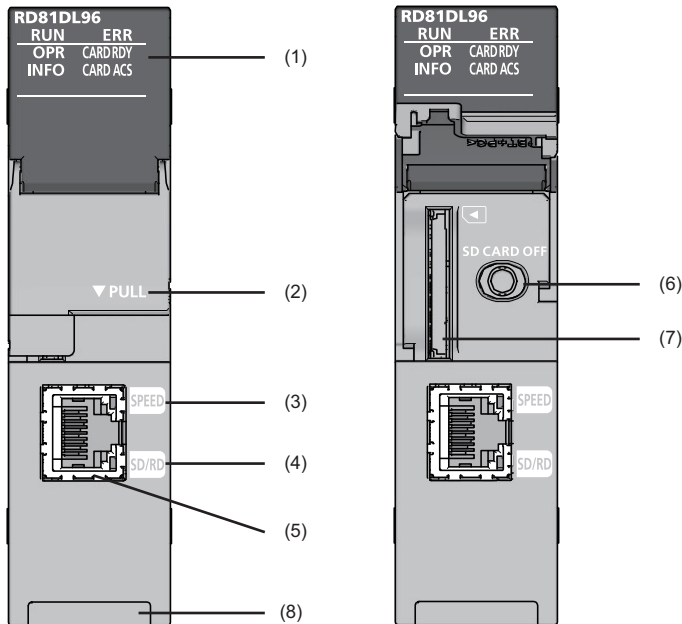

No.	Name	Description
(1)	RUN LED	Indicates the operating status. <ul style="list-style-type: none"> • ON: In operation • Flashing: Checking module or selecting the module for online module change (Flashes for 10 seconds in "Checking module" when the [Checking module] button is clicked in the "Find High Speed Data Logger Module" screen of Configuration Tool.) • OFF: Watchdog timer error (hardware failure), module replacement allowed in the process of the online module change
	ERR LED	Indicates the error status. <ul style="list-style-type: none"> • ON: Minor error or watchdog timer error (hardware failure) • Flashing: Moderate error or major error • OFF: In normal status
	OPR LED	Indicates the status of a module. <ul style="list-style-type: none"> • ON: Module operating status is in operation • Flashing: Module operating status is initializing (update settings, etc.) and stopping • OFF: Module operating status is stopped
	INFO LED	Indicates the warning occurrence status. <ul style="list-style-type: none"> • ON: Warning • OFF: In normal status
	CARD RDY LED	Indicates the accessibility of an SD memory card. <ul style="list-style-type: none"> • ON: Accessible (mounted) • Flashing: Being mounted/unmounted/formatted • OFF: Inaccessible (not inserted/unmounted)
	CARD ACS LED	Indicates the access status of an SD memory card. <ul style="list-style-type: none"> • ON: Being accessed • OFF: Not accessed
(2)	Slot cover	A cover of the SD memory card slot and the SD memory card lock switch. Open this cover to insert/remove an SD memory card or to operate the switch. Close the cover unless inserting/removing an SD memory card or operating the switch to prevent foreign material intrusion such as dust.
(3)	SPEED LED	Indicates the communication speed and the link status for Ethernet. <ul style="list-style-type: none"> • ON (orange): Linking-up (1 Gbps) • ON (green): Linking-up (100 Mbps) • OFF: Linking-down or linking-up (10 Mbps)
(4)	SD/RD LED	Indicates the data sending/receiving status in Ethernet. <ul style="list-style-type: none"> • ON: Being sent/received • OFF: Not being sent/received

No.	Name	Description
(5)	Ethernet port	A port for connecting a high speed data logger module to 10BASE-T/100BASE-TX/1000BASE-T (A high speed data logger module distinguishes among 10BASE-T, 100BASE-TX, and 1000BASE-T depending on an external device.)
(6)	SD memory card lock switch (SD CARD OFF button)	A switch for disabling access to an SD memory card to remove it. Removing an SD memory card is prohibited while the CARD RDY LED is ON or flashing. For inserting and removing an SD memory card, refer to the following:  Page 62 SD Memory Card
(7)	SD memory card slot	A slot for inserting an SD memory card. (SD, SDHC standards-compliant: 2 GB (SD) to 16 GB (SDHC))
(8)	Product information marking	Displays the product information (16 digits) of a module.

Point 

- When checking the module at online module change, the RUN LED of the high speed data logger module and the READY LED of the CPU module flash for more than 10 seconds at the same time. Make sure to check not only the RUN LED also the READY LED of the CPU module.
- An INFO LED lighting factor can be checked in the INFO LED information in the "Module Diagnostics" screen or the buffer memory. Check the factor and take corrective action. ( MELSEC iQ-R High Speed Data Logger Module User's Manual (Application))

2 SPECIFICATIONS

This chapter explains the specifications of a high speed data logger module.

2.1 Performance Specifications

This section shows the performance specifications of a high speed data logger module.

Transmission and interface specifications

Item		Specification	
Ethernet	Interface	<ul style="list-style-type: none"> • 1000BASE-T • 100BASE-TX • 10BASE-T 	
	Data transmission speed	1000BASE-T	1 Gbps
		100BASE-TX	100 Mbps
		10BASE-T	10 Mbps
	Transmission method		Base band
	Number of cascade connections (When using a repeater hub)	1000BASE-T	Consult the manufacturer of the repeater hub used.
		100BASE-TX	2 levels maximum
		10BASE-T	4 levels maximum
Maximum segment length		100 m (length between a hub and a node)	
Supported function		Auto-negotiation (automatic recognition of the communication speed/communication method) Auto-MDI/MDI-X (automatic recognition of a straight/crossover cable)	
IP version		IPv4 supported	
SD memory card slot	Power supply voltage	3.3 VDC	
	Power supply capacity	Up to 200 mA	
	Interface	SD memory card/SDHC memory card	
	Number of insertable cards	1 card	
Number of occupied I/O points		32 points (I/O assignment: Intelligent 32 points)	
Clock		Acquired from a CPU module (CPU No.1 in a multiple CPU system). Time accuracy after obtaining the time, daily error of ± 9.504 seconds	
5 VDC internal current consumption		1.1 A	
External dimensions	Height	106 mm	
	Width	27.8 mm	
	Depth	110 mm	
Weight		0.24 kg	

Functional specifications

Data sampling

The following table lists the specifications for the data sampling used for the data logging function, the event logging function, and the report function.

Item		Specifications	
Data sampling	Number of access target CPUs	Maximum 64 CPUs	
	Sampling interval	High speed sampling	<ul style="list-style-type: none"> Sequence scan time synchronization 0.5 to 0.9 milliseconds, 1 to 32767 milliseconds (for trigger logging) 2 to 32767 milliseconds (for continuous logging)
		General sampling	<ul style="list-style-type: none"> 0.1 to 0.9 seconds, 1 to 32767 seconds Time interval specification (specify hour/minute/second)
	Number of units of sampled data ^{*1} *2*3	High speed sampling	Total number of units of data: 32768 (per setting: 1024) Total number of device points: 32768 ^{*4} *5 (per setting: 4096)
		General sampling	Total number of units of data: 65536 (per setting: 1024) Total number of device points: 262144 (per setting: 4096)
	Data type ^{*6}	<ul style="list-style-type: none"> Bit Word [Signed] Double Word [Signed] Word [Unsigned]/Bit String [16-bit] Double Word [Unsigned]/Bit String [32-bit] FLOAT [Single Precision] FLOAT [Double Precision] 16bit BCD 32bit BCD String: 1 to 8192 characters ^{*7} Raw: 1 to 8192 bytes 	
Data output format ^{*8} (Unicode [®] text file, CSV file)	<ul style="list-style-type: none"> Bit Decimal format: 0 to 14 digits after the decimal point Exponential format: 0 to 14 digits after the decimal point Hexadecimal format String Raw <p>■For trigger logging (output only one line after triggering), following conditions can be specified.</p> <ul style="list-style-type: none"> Time/Total time Decimal format: 0 to 4 digits after the decimal point Count/Total count Decimal format: 0 digit after the decimal point 		
Scaling ^{*9}	Basic arithmetic operations: calculations combining (×, ÷) and (+, -)		

*1 The number of device points available for a piece of data differs depending on the data type.

*2 The total number of sampling data of data logging, event logging, and report data.

*3 The total number of units of sampled data per setting is as follows only when the creation trigger and current value data are not synchronized in the report setting.

Total number of units of data (per setting): 65535, device points (per setting): 65535

However, note that the number of device points per setting of data excluding the current value data is up to 4096.

*4 In high-speed sampling, target data is sampled by synchronizing with a sequence scan from a control CPU module by using the sequence scan synchronization sampling function of a control CPU module.

When multiple intelligent function modules use the sequence scan synchronization sampling function, note the total number of points for target data. If it exceeds the number of points that can be sampled, an error may occur in registration processing of an intelligent function module registered later.

*5 If the number of device points for high speed sampling is increased, an error may occur when updating the settings. If an error occurred, take the following corrective action.

· Check the settings of other intelligent function modules controlled by the control CPU module, and adjust it so that the total number of device points for the sequence scan synchronization sampling function does not exceed the number of points that can be sampled.

· Power OFF to ON, or reset the control CPU.

· Return the number of device points to the original settings.

*6 The data type when reading data from the device memory in the CPU module.

*7 The number of characters is determined by the specified size.

For Unicode text file and binary file format, the maximum number of characters is 4096 characters because one character contains two bytes.

*8 The format when data is output to Unicode text file or CSV file with data logging or event logging.

Binary files are output in the binary format.

Reports are output in Excel cell format.

*9 A function to perform data scaling and offset calculations.

■ Target sampling data

Type	Data type
Data logging	Logging target data, trigger condition data, period condition data, file switching condition data, saved file name data, saved folder name data, e-mail transmission data
Event logging	Monitoring data, period condition data, file switching condition data, saved file name data, saved folder name data, e-mail transmission data
Report	Current value data, creation trigger condition data, period condition data, saved file name data, saved folder name data, e-mail transmission data

Point

The data logging, event logging, and report functions are best effort functions.

Since module processing time changes according to the settings and status of other devices, it may not operate with the set data sampling interval.

Run the system by fully verifying the processing time of each function when constructing it.



For processing time, refer to the following:

 MELSEC iQ-R High Speed Data Logger Module User's Manual (Application)

Data logging

Item		Specifications	
Data logging	Number of settings	Up to 64 ^{*1}	
	Logging type	<ul style="list-style-type: none"> • Continuous logging • Trigger logging (output only one line after triggering) • Trigger logging (output the lines before and after triggering) 	
	File format ^{*2}	<ul style="list-style-type: none"> • Unicode text file (extension: .TXT) • CSV file (extension: .CSV) • Binary file (extension: .BIN)^{*3} 	
	Period	Specify the applicable period or exclusion period. <ul style="list-style-type: none"> • Data condition: Bit ON/OFF, compare data to constant value, compare data to data • Date range: Specify the start and end in month and day • Time range: Specify the start and end in hour, minute, and second • Day of the week/Week of the month conditions: Specify the day of the week and week 	
	Trigger logging	Trigger condition (Single condition)	<ul style="list-style-type: none"> • Data conditions (comparison): Bit ON/OFF, compare data to constant value, compare data to data • Data conditions (value change) • Fixed cycle: 1 to 86400 seconds • Time interval specification: Specify hour/minute/second • Time specification: Specify month, day, hour, minute, second • At module startup
		Trigger condition (Compound condition - OR combine)	<ul style="list-style-type: none"> • Data conditions (comparison): Bit ON/OFF, compare data to constant value, compare data to data • Data conditions (value change) • Fixed cycle: 1 to 86400 seconds • Time interval specification: Specify hour/minute/second • Time specification: Specify month, day, hour, minute, second • At module startup
		Trigger condition (Compound condition - AND combine)	<ul style="list-style-type: none"> • Data conditions (comparison): Bit ON/OFF, compare data to constant value, compare data to data
		Trigger condition (Compound condition - Number of times)	Specify the start condition, terminal condition, and count condition. (Up to 3 conditions) <ul style="list-style-type: none"> • Data conditions (comparison): Bit ON/OFF, compare data to constant value, compare data to data • Data conditions (value change)
		Trigger condition (Compound condition - Order)	Specify the start condition and order (1st condition, 2nd condition, or 3rd condition). (Up to 4 conditions) <ul style="list-style-type: none"> • Data conditions (comparison): Bit ON/OFF, compare data to constant value, compare data to data • Data conditions (value change)
		Number of logging lines ^{*4}	<ul style="list-style-type: none"> • Before trigger occurs: 0 to 65534 lines • After trigger occurs: 1 to 65535 lines The sum of lines of before and after trigger occurrence is up to 65535 lines.
File switching timing	Number of lines (number of records) specification	100 to 100000 lines	
	File size specification	10 to 16384 KB	
	Condition specification	<ul style="list-style-type: none"> • Data conditions (comparison): Bit ON/OFF, compare data to constant value, compare data to data • Data conditions (value change) • Fixed cycle: 1 to 86400 seconds • Time interval specification: Specify hour/minute/second • Time specification: Specify month, day, hour, minute, second • At module startup 	
	Trigger logging unit	At the time of trigger logging file output completion	

Item		Specifications
Data logging	Number of saved files ^{*5}	1 to 65535
	Saved file name	<ul style="list-style-type: none"> ■ Simple setting <ul style="list-style-type: none"> • Add the name • Add the date (4-digit year, month, day) • Add the time (hour, minute, second) • Add the sequential number ■ Detailed setting <ul style="list-style-type: none"> • 4-digit year/2-digit year, month, day, day of the week, hour, minute, second • Device value (two types) • Sequential number
	Folder switching timing	Condition specification
Saved folder name		<ul style="list-style-type: none"> ■ Simple setting <ul style="list-style-type: none"> • Add the name • Add the date (4-digit year, month, day) • Add the time (hour, minute, second) • Add the sequential number ■ Detailed setting <ul style="list-style-type: none"> • 4-digit year/2-digit year, month, day, day of the week, hour, minute, second • Device value (two types) • Sequential number

- *1 Up to 64 settings can be configured by combining data logging, event logging, and report function. Of these, up to 32 settings can be configured for data logging, event logging, and report function when high speed sampling is specified.
- *2 For the output file format, refer to the following:
 MELSEC iQ-R High Speed Data Logger Module User's Manual (Application)
- *3 By using the report function, data can be output again in Excel file format.
- *4 The number of logging lines setting is affected by the amount of memory (trigger buffer) where sampled data is temporarily saved. Since the amount of trigger buffer has an upper limit, there may be situations where the listed number of logging lines cannot be set. Confirm the trigger buffer usage amount as given below. Do not exceed the upper limit.
 MELSEC iQ-R High Speed Data Logger Module User's Manual (Application)
- *5 When a subfolder is not created in the save folder, the number of saved files is in the range of 1 to 256.

■ Restrictions on data logging

The restrictions on performance specifications of data logging are as follows.

Item	High speed sampling	General sampling
Total trigger buffer size	Up to 20 MB in total using 32 settings ^{*1}	Up to 20 MB in total using 64 settings ^{*1}
Total number of period condition, trigger condition, file switching condition, and folder switching condition	Up to combination of 5 conditions	Up to combination of 10 conditions
Period condition	Up to 4 conditions	Up to 8 conditions
Trigger condition	Up to 4 conditions	Up to 8 conditions
File switching condition	Up to 4 conditions	Up to 8 conditions
Folder switching condition	Up to 4 conditions	Up to 8 conditions

- *1 Size of the combined high speed sampling and general sampling.
When 20 MB is used for high speed sampling, trigger logging of general sampling cannot be added.

Event logging

Item		Specifications	
Event logging	Number of settings	Up to 64 ^{*1}	
	Number of events	Up to 256 per event logging setting	
	File format ^{*2}	<ul style="list-style-type: none"> Unicode text file (extension: .TXT) CSV file (extension: .CSV) Binary file (extension: .BIN) 	
	Event condition	Event condition (Single condition)	<ul style="list-style-type: none"> Data conditions (comparison): Bit ON/OFF, compare data to constant value, compare data to data Data conditions (value change)
		Event condition (Compound condition - Comparison - AND combine)	<ul style="list-style-type: none"> Data conditions (comparison): Bit ON/OFF, compare data to constant value, compare data to data
		Event condition (Compound condition - Comparison - OR combine)	<ul style="list-style-type: none"> Data conditions (comparison): Bit ON/OFF, compare data to constant value, compare data to data
		Event condition (Compound condition - Number of times)	Specify the start condition, terminal condition, and count condition. (Up to 3 conditions) <ul style="list-style-type: none"> Data conditions (comparison): Bit ON/OFF, compare data to constant value, compare data to data Data conditions (value change)
		Event condition (Compound condition - Order)	Specify the start condition and order (1st condition, 2nd condition, or 3rd condition). (Up to 4 conditions) <ul style="list-style-type: none"> Data conditions (comparison): Bit ON/OFF, compare data to constant value, compare data to data Data conditions (value change)
	Period	Specify the applicable period or exclusion period. <ul style="list-style-type: none"> Data condition: Bit ON/OFF, compare data to constant value, compare data to data Date range: Specify the start and end in month and day Time range: Specify the start and end in hour, minute, and second Day of the week/Week of the month conditions: Specify the day of the week and week 	
	File switching timing	Number of lines (number of records) specification	100 to 100000 lines
		File size specification	10 to 16384 KB
		Condition specification	<ul style="list-style-type: none"> Data conditions (comparison): Bit ON/OFF, compare data to constant value, compare data to data Data conditions (value change) Fixed cycle: 1 to 86400 seconds Time interval specification: Specify hour/minute/second Time specification: Specify month, day, hour, minute, second At module startup
	Number of saved files ^{*3}	1 to 65535	
Saved file name	<ul style="list-style-type: none"> ■Simple setting <ul style="list-style-type: none"> Add the name Add the date (4-digit year, month, day) Add the time (hour, minute, second) Add the sequential number ■Detailed setting <ul style="list-style-type: none"> 4-digit year/2-digit year, month, day, day of the week, hour, minute, second Device value (two types) Sequential number 		
Folder switching timing	Condition specification	<ul style="list-style-type: none"> Data conditions (comparison): Bit ON/OFF, compare data to constant value, compare data to data Data conditions (value change) Fixed cycle: 1 to 86400 seconds Time interval specification: Specify hour/minute/second Time specification: Specify month, day, hour, minute, second At module startup 	

Item		Specifications
Event logging	Saved folder name	<ul style="list-style-type: none"> ■ Simple setting <ul style="list-style-type: none"> • Add the name • Add the date (4-digit year, month, day) • Add the time (hour, minute, second) • Add the sequential number ■ Detailed setting <ul style="list-style-type: none"> • 4-digit year/2-digit year, month, day, day of the week, hour, minute, second • Device value (two types) • Sequential number

- *1 Up to 64 settings can be configured by combining data logging, event logging, and report function.
Of these, up to 32 settings can be configured for data logging, event logging, and report function when high speed sampling is specified.
- *2 For the output file format, refer to the following:
 MELSEC iQ-R High Speed Data Logger Module User's Manual (Application)
- *3 When a subfolder is not created in the save folder, the number of saved files is in the range of 1 to 256.

■ Restrictions on event logging

The restrictions on performance specifications of event logging are as follows.

Item	High speed sampling	General sampling
Total number of event condition, period condition, file switching condition, and folder switching condition	Up to combination of 5 conditions	Up to combination of 10 conditions
Event condition	Up to 4 conditions	
Period condition	Up to 4 conditions	Up to 8 conditions
File switching condition	Up to 4 conditions	Up to 8 conditions
Folder switching condition	Up to 4 conditions	Up to 8 conditions

Report

Item		Specifications	
Report	Number of settings	Up to 64 ^{*1}	
	File format	Excel file (extension: .xls)	
	Output data type	<ul style="list-style-type: none"> Data inside data logging file^{*2} Current value data Creation time 	
	Number of units of output data	64 layouts per report setting, 65535 cells in total	
	Creation trigger	Trigger condition (Single condition)	<ul style="list-style-type: none"> Data conditions (comparison): Bit ON/OFF, compare data to constant value, compare data to data Data conditions (value change) Fixed cycle: 1 to 86400 seconds Time interval specification: Specify hour/minute/second Time specification: Specify month, day, hour, minute, second At module startup At the data logging file switching
		Trigger condition (Compound condition - OR combine)	<ul style="list-style-type: none"> Data conditions (comparison): Bit ON/OFF, compare data to constant value, compare data to data Data conditions (value change) Fixed cycle: 1 to 86400 seconds Time interval specification: Specify hour/minute/second Time specification: Specify month, day, hour, minute, second At module startup At the data logging file switching
		Trigger condition (Compound condition - AND combine)	<ul style="list-style-type: none"> Data conditions (comparison): Bit ON/OFF, compare data to constant value, compare data to data
		Trigger condition (Compound condition - Number of times)	Specify the start condition, terminal condition, and count condition. (Up to 3 conditions) <ul style="list-style-type: none"> Data conditions (comparison): Bit ON/OFF, compare data to constant value, compare data to data Data conditions (value change)
		Trigger condition (Compound condition - Order)	Specify the start condition and order (1st condition, 2nd condition, or 3rd condition). (Up to 4 conditions) <ul style="list-style-type: none"> Data conditions (comparison): Bit ON/OFF, compare data to constant value, compare data to data Data conditions (value change)
	Period	Specify the applicable period or exclusion period. <ul style="list-style-type: none"> Data condition: Bit ON/OFF, compare data to constant value, compare data to data Date range: Specify the start and end in month and day Time range: Specify the start and end in hour, minute, and second Day of the week/Week of the month conditions: Specify the day of the week and week 	
	Layout file size	Maximum 10 MB	
	Number of saved files	1 to 65535	
	Saved file name	<ul style="list-style-type: none"> ■ Simple setting <ul style="list-style-type: none"> Add the name Add the date (4-digit year, month, day) Add the time (hour, minute, second) Add the sequential number ■ Detailed setting <ul style="list-style-type: none"> 4-digit year/2-digit year, month, day, day of the week, hour, minute, second Device value (two types) Sequential number 	
	Folder switching timing	Condition specification	<ul style="list-style-type: none"> Data conditions (comparison): Bit ON/OFF, compare data to constant value, compare data to data Data conditions (value change) Fixed cycle: 1 to 86400 seconds Time interval specification: Specify hour/minute/second Time specification: Specify month, day, hour, minute, second At module startup

Item		Specifications
Report	Saved folder name	<ul style="list-style-type: none"> ■Simple setting <ul style="list-style-type: none"> • Add the name • Add the date (4-digit year, month, day) • Add the time (hour, minute, second) • Add the sequential number ■Detailed setting <ul style="list-style-type: none"> • 4-digit year/2-digit year, month, day, day of the week, hour, minute, second • Device value (two types) • Sequential number

- *1 Up to 64 settings can be configured by combining data logging, event logging, and report function.
Of these, up to 32 settings can be configured for data logging, event logging, and report function when high speed sampling is specified.
- *2 Only binary format data logging can be output in a report.

■Restrictions on report function

The restrictions on performance specifications of report are as follows.

Item	High speed sampling	General sampling
Total of layout file sizes	Up to 10 MB in total using 32 settings	Up to 10 MB in total using 64 settings
Total number of period condition, creation trigger condition, and folder switching condition	Up to combination of 5 conditions	Up to combination of 10 conditions
Period condition	Up to 4 conditions	Up to 8 conditions
Creation trigger condition	Up to 4 conditions	Up to 8 conditions
Folder switching condition	Up to 4 conditions	Up to 8 conditions

Other functions

Item		Specifications	
E-mail	Application	<ul style="list-style-type: none"> Notification when event occurs Transmit saved file 	
	Subject	<ul style="list-style-type: none"> Event notification e-mail: User specified Saved file transmission e-mail: Automatically created/user specified 	
	Body	<ul style="list-style-type: none"> Event notification e-mail: User specified Saved file transmission e-mail: Automatically created/user specified 	
	Attachment	<ul style="list-style-type: none"> Event notification e-mail: None Saved file transmission e-mail: Saved file (Unicode text file, binary file, CSV file, or Excel file), up to 512 KB 	
	Attachment format	MIME format	
	MIME version	1.0	
	Communications with mail server	Port number	25, 587, other (1 to 65535)
		Authentication method	<ul style="list-style-type: none"> No authentication SMTP-AUTH (PLAIN, LOGIN, CRAM-MD5) POP before SMTP
	Target address	Up to 16 groups	
	Operability verified e-mail client software	Microsoft Outlook 2013	
FTP server* ¹	Application	<ul style="list-style-type: none"> Read and delete saved files Write, read, and delete recipe files 	
	Operability verified FTP client software	Microsoft Edge Windows Internet Explorer 11.0 Windows Internet Explorer 10.0 Windows Internet Explorer 9.0 Windows Internet Explorer 8.0	
	Session count* ²	10	
FTP transfer* ³ (client)	Application	Transfer saved files	
	Operability verified FTP server software	Microsoft Internet Information Services	
	Number of transfer destination settings	Up to 16 settings* ⁴	
Shared folder transfer	Application	Transfer saved files	
	Operability verified operating system	Windows 10 (Home, Pro, Enterprise, Education) Windows 8.1, Windows 8.1 (Pro, Enterprise) Windows 8, Windows 8 (Pro, Enterprise) Windows 7 (Starter, Home Premium, Professional, Ultimate, Enterprise)	
	Number of transfer destination settings	Up to 16 settings* ⁴	
Recipe	Number of units of data	Up to 256 data	
	Number of records	Up to 256 records	
	Data type	<ul style="list-style-type: none"> Bit Word [Signed] Double Word [Signed] Word [Unsigned]/Bit String [16-bit] Double Word [Unsigned]/Bit String [32-bit] FLOAT [Single Precision] FLOAT [Double Precision] 16bit BCD 32bit BCD 	
	Recipe file* ⁵	CSV file (extension: .CSV), maximum 256 files	
	Execution type	Dedicated instructions (ladder program), Configuration Tool	

*1 A function to access the high speed data logger module (FTP server) from a personal computer's FTP client software. For the corresponding FTP command, refer to the following:

📖 MELSEC iQ-R High Speed Data Logger Module User's Manual (Application)

*2 The upper limit of the number of simultaneous connections to the high speed data logger module from FTP client software. FTP client software may use multiple connections per single access session.

*3 A function to access the personal computer's FTP server software from the high speed data logger module (FTP client).

*4 The sum of transfer destination settings in the FTP client and shared folder is up to 16 settings.

*5 For the output file format, refer to the following:

📖 MELSEC iQ-R High Speed Data Logger Module User's Manual (Application)

2.2 Access Specifications for a CPU Module

This section shows the access specifications for a CPU module.

Accessible CPU modules

Series		Model name	Data sampling method
RCPU* ¹	Programmable controller CPU	RnCPU	R00CPU* ² , R01CPU* ² , R02CPU* ² , R04CPU, R08CPU, R16CPU, R32CPU, R120CPU
		RnENCPU	R04ENCPU, R08ENCPU, R16ENCPU, R32ENCPU, R120ENCPU
	Safety CPU* ³		R08SF CPU, R16SF CPU, R32SF CPU, R120SF CPU
	Process CPU (process mode)		R08PCPU, R16PCPU, R32PCPU, and R120PCPU
	Process CPU (redundant mode)* ⁴		
C Controller module* ⁵		R12CCPU-V	
QCPU (Q mode)	Programmable controller CPU	Q00JCPU, Q00UJCPU, Q00CPU, Q00UCPU, Q01CPU, Q01UCPU, Q02CPU, Q02HCPU, Q02UCPU, Q03UDCPU, Q03UDECPU, Q03UDVCPU, Q04UDHCPU, Q04UDEHCPU, Q04UDVCPU, Q06HCPU, Q06UDHCPU, Q06UDEHCPU, Q06UDVCPU, Q10UDHCPU, Q10UDEHCPU, Q12HCPU, Q13UDHCPU, Q13UDEHCPU, Q13UDVCPU, Q20UDHCPU, Q20UDEHCPU, Q25HCPU, Q26UDHCPU, Q26UDEHCPU, Q26UDVCPU, Q50UDEHCPU, and Q100UDEHCPU	
	Process CPU	Q02PHCPU, Q04UDPVCPU, Q06PHCPU, Q06UDPVCPU, Q12PHCPU, Q13UDPVCPU, Q25PHCPU, Q26UDPVCPU	
	C Controller module* ⁵		Q12DCCPU-V* ⁶ , Q24DHCCPU-V, Q24DHCCPU-LS, and Q24DHCCPU-VG
LCPU	Programmable controller CPU	L02CPU, L02CPU-P, L02SCPU, L06CPU, L26CPU, L26CPU-BT, and L26CPU-PBT	

- *1 When using high speed sampling, use a CPU module supporting the sequence scan synchronization sampling function. For a CPU module supporting the sequence scan synchronization sampling function, refer to the manual for the CPU module.
- *2 Use a high speed data logger module the firmware version of which is '05' or later.
- *3 Use a high speed data logger module the firmware version of which is '07' or later.
- *4 Use a high speed data logger module the firmware version of which is '15' or later.
- *5 Cannot be used as a relay station.
- *6 Only a module with a serial number of which the first five digits are 12042 or higher can be accessed.



When using a multiple CPU system, refer to the following:

MELSEC iQ-R Module Configuration Manual



Accessible routes

The following shows the accessible routes from a high speed data logger module.

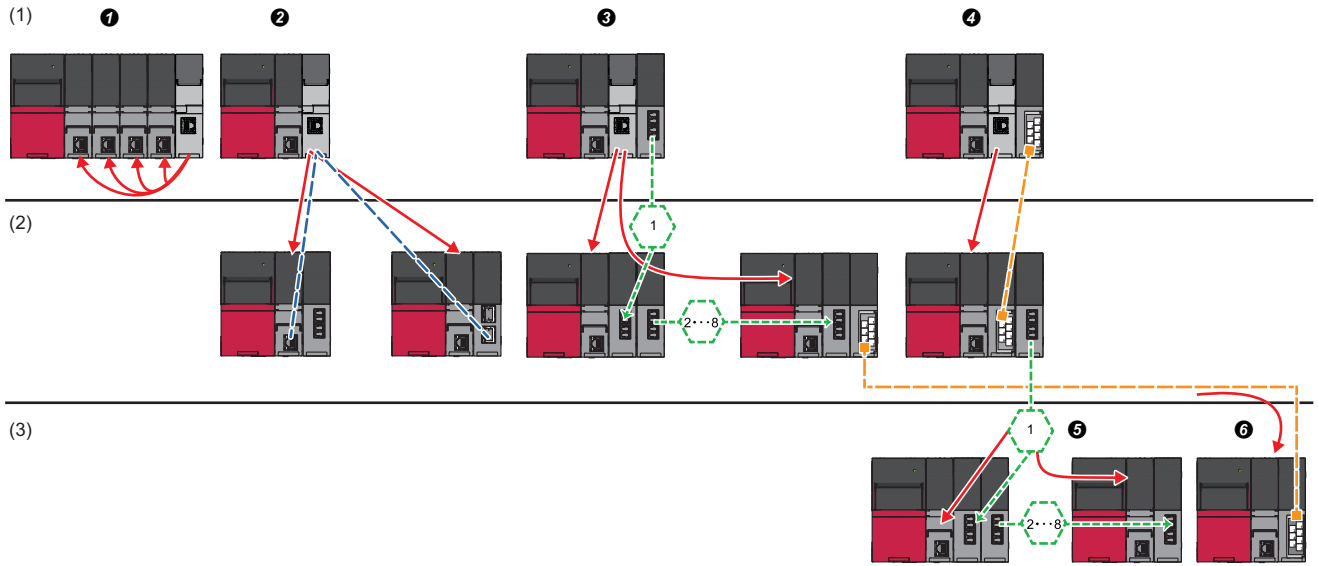
- ← : Access route from a high speed data logger module
- - - : Connection with an Ethernet port of a high speed data logger module
- - - : Connection by specifying the network number and the station number of a target station in each module
- - - : Connection by specifying the start I/O number and the station number of a target station in each module



Accessible routes		Reference	
(1)	Own station (Control CPU, other CPUs in multiple CPUs)	Page 37 Own station (Control CPU, other CPUs in multiple CPUs)	
(2)	Another station via single network	② Access from an Ethernet port of a high speed data logger module.	Page 37 Access from the Ethernet port of a high speed data logger module
		③ Access by specifying the network number and the station number of a target station.	Page 38 Access by specifying the network number and station number of the target station
		④ Access by specifying the start I/O number of a module and the station number of a target station for accessing the target station.	Page 38 Access by specifying the start I/O number of the module for accessing the target station and station number of the target station
(3)	Another station via co-existence network	⑤ Access from the station accessed in ④ by specifying the network number and the station number of the target station.	Page 39 Access by specifying the network number and station number, via another station on CC-Link or C24
		⑥ Access from the station accessed in ⑤ by specifying the start I/O number of the module and the station number of the target station.	Page 39 Access to another station on CC-Link or C24 from another station on which the network number and the station number are specified

-
- When using a high speed data logger module with a redundant extension base unit, only the own station can be accessed. (Other stations cannot be accessed.)
 - If network load is high, data will not be processed on the device on the access route (including access target CPU) and a timeout error may occur and data sampling may fail. If a timeout error occurs, adjust the network load.
 - For the module names that can be used for the access route to another station, refer to the following:
( MELSEC iQ-R Module Configuration Manual)
 - When accessing another station via CC-Link IE TSN from a high speed data logger module, use a high speed data logger module the firmware version of which is '16' or later and High Speed Data Logger Module Configuration Tool the software version of which is '1.08J' or later.
 - When accessing another station via CC-Link IE TSN with a route other than another station via a co-existence network (access from another station specified by the network number and the station number on CC-Link), there are restrictions on the firmware version of an access target CPU.
For the firmware version of the CPU module, refer to the following:
( MELSEC iQ-R Programmable Controller CPU Module User's Manual)
-

Own station (Control CPU, other CPUs in multiple CPUs)

The following table shows the accessible route to a CPU module of the high speed data logger module-mounted station.

○: Accessible, —: Not applicable

Access route	Access target CPU module (series)					
	RCPU			QCPU (Q mode)		LCPU
	Programmable controller CPU/ Process CPU (process mode)/ Safety CPU	Process CPU (redundant mode)	C Controller module	Programmable controller CPU/ Process CPU	C Controller module	Programmable controller CPU
Control CPU	○	○	○	—	—	—
Other CPUs in multiple CPUs	○ ^{*1} (CPU No.1 to No.4)	—	○ (CPU No.1 to No.4)	—	—	—

*1 RnENCPU is not applicable.

Another station via single network

■ Access from the Ethernet port of a high speed data logger module

The following table shows the accessible route when accessing from an Ethernet port of a high speed data logger module in the status where an access target CPU is connected to a network.

A CPU module (Ethernet port), Ethernet module, or CC-Link IE TSN module can be specified as the communication target from an Ethernet port of a high speed data logger module.

○: Accessible, ×: Not accessible, —: Not applicable

Access route	Access target CPU module (series)						
	RCPU				QCPU (Q mode)		LCPU
	Programmable controller CPU/ Process CPU (process mode)/ Safety CPU	Process CPU (process mode)	Process CPU (redundant mode)	C Controller module	Programmable controller CPU/ Process CPU	C Controller module	Programmable controller CPU
Ethernet • High speed data logger module Ethernet port → CPU module (Ethernet port) • High speed data logger module Ethernet port → Ethernet module	○ (CPU No.1 to No.4)	○ (CPU No.1 to No.4)	×	○ (CPU No.1 to No.4)	○ ^{*1*2} (CPU No.1 to No.4)	○ ^{*3} (Host CPU)	○ ^{*2}
Ethernet • High speed data logger module Ethernet port → CC-Link IE TSN module	—	—	—	—	—	—	—

*1 An Ethernet module-mounted station or built-in Ethernet CPU can be accessed. Access via relay station is not possible.

*2 UDP (MELSOFT Connection) needs to be added to the open setting for a built-in Ethernet port of an access target CPU.

*3 When accessing an Ethernet port of Q12DCCPU-V (Basic mode) directly, MELSOFT connection needs to be permitted in the Q12DCCPU-V (Basic mode) setting.

For details on the setting, refer to the following:

📖 C Controller Module User's Manual (Utility Operation, Programming)

■ Access by specifying the network number and station number of the target station

The following table shows the accessible route when an access target CPU module can be specified by a network number and a station number (or CPU number) from the high speed data logger module-mounted station, in the status where the target device is connected to a network.

The access to the CPU module that is mounted on the eighth network is available via a relay station of RCP or QCPU (Q mode).

○: Accessible, ×: Not accessible, —: Not applicable

Access route		Access target CPU module (series)						
		RCP				QCPU (Q mode)		LCP
		Program mable controller CPU	Process CPU (process mode)	Process CPU (redundant mode)	Safety CPU	C Controller module	Program mable controller CPU/ Process CPU	C Controller module
CC-Link IE Controller Network	○ (CPU No.1 to No.4)	○ (CPU No.1 to No.4)	×	○ (CPU No.1 to No.4)	○ (CPU No.1 to No.4)	○ (CPU No.1 to No.4)	○ (Host CPU)	—
CC-Link IE Field Network								○
MELSECNET/H								—
CC-Link IE TSN								—
Ethernet* ¹	Via own Ethernet module	○ (CPU No.1 to No.4)	×	○ (CPU No.1 to No.4)	—	○ (CPU No.1 to No.4)	—	○

*1 Only Ethernet modules can be accessed from the own station.

■ Access by specifying the start I/O number of the module for accessing the target station and station number of the target station

The following table shows the accessible route when connecting an access target CPU module and the side on which high speed data logger module is mounted directly.

○: Accessible, ×: Not accessible

Access route		Access target CPU module (series)					
		RCP			QCPU (Q mode)		LCP
		Programmable controller CPU/ Process CPU (process mode)/ Safety CPU	Process CPU (redundant mode)	C Controller module	Programmable controller CPU/ Process CPU	C Controller module	Programmable controller CPU
CC-Link	○ (CPU No.1 to No.4)	×	○ (CPU No.1 to No.4)	○ (CPU No.1 to No.4)	○ (Host CPU)	○	
C24			×				×

Another station via co-existence network

■ Access by specifying the network number and station number, via another station on CC-Link or C24

The following table shows the accessible route when accessing by specifying a network number and a station number via other stations (the first route) on CC-Link or C24 from the side on which a high speed data logger module is mounted.

○: Accessible, ×: Not accessible, —: Not applicable

First access route	Second access route (Co-existence network)	Access target CPU module (series)												
		RCPU					QCPU (Q mode)		LCPU					
		Programmable controller CPU	Process CPU (process mode)	Process CPU (redundant mode)	Safety CPU	C Controller module	Programmable controller CPU/ Process CPU	C Controller module	Programmable controller CPU					
CC-Link C24	CC-Link IE Controller Network	○ (CPU No.1 to No.4)	○ (CPU No.1 to No.4)	×	○ (CPU No.1 to No.4)	○ (CPU No.1 to No.4)	○ (CPU No.1 to No.4)	○ (CPU No.1 to No.4)	○ (Host CPU)	—				
	CC-Link IE Field Network				○									
	MELSECNET/H				×					—				
	CC-Link IE TSN				—					—	○ (CPU No.1 to No.4)	—	—	—
	Ethernet (via Ethernet module)				○ (CPU No.1 to No.4)					×	○ (CPU No.1 to No.4)	○ (CPU No.1 to No.4)	—	○

■ Access to another station on CC-Link or C24 from another station on which the network number and the station number are specified

The following table shows the accessible route when accessing other stations on CC-Link or C24 via a station (the first route) specified by a network number and a station number from the side on which a high speed data logger module is mounted.

○: Accessible, ×: Not accessible

First access route	Second access route (Co-existence network)	Access target CPU module (series)							
		RCPU					QCPU (Q mode)		LCPU
		Programmable controller CPU/ Process CPU (process mode)	Process CPU (redundant mode)	Safety CPU	C Controller module	Programmable controller CPU/ Process CPU	C Controller module	Programmable controller CPU	
CC-Link IE Controller Network	CC-Link	○ (CPU No.1 to No.4)	×	○ (CPU No.1 to No.4)	○ (CPU No.1 to No.4)	○ (CPU No.1 to No.4)	○ (CPU No.1 to No.4)	○ (Host CPU)	○
MELSECNET/H				×					
CC-Link IE Field Network				○ (CPU No.1 to No.4)					
Ethernet (via Ethernet module)				○ (CPU No.1 to No.4)					
CC-Link IE TSN				○ (CPU No.1 to No.4)					
CC-Link IE Controller Network	C24	○ (CPU No.1 to No.4)	×	○ (CPU No.1 to No.4)	○ (CPU No.1 to No.4)	○ (CPU No.1 to No.4)	○ (CPU No.1 to No.4)	○ (Host CPU)	○
MELSECNET/H				×					
CC-Link IE Field Network				○ (CPU No.1 to No.4)					
Ethernet (via Ethernet module)				○ (CPU No.1 to No.4)					
CC-Link IE TSN				○ (CPU No.1 to No.4)					

Accessible devices

The following tables lists the accessible devices.

High speed sampling is possible only for the RCPUC that controls the high speed data logger module.

○: Accessible, ×: Not accessible

Device*1 (Device name)		Access target CPU module (series)					
		RCPUC		C Controller module	QCPU (Q mode)		LCPUC
		Programmable controller CPU/Process CPU*2/Safety CPU*3			Programma ble controller CPU/ Process CPU	C Controller module	Programma ble controller CPU
General sampling	High speed sampling						
Function input (FX)		×	×	×	×	×	×
Function output (FY)		×	×	×	×	×	×
Function register (FD)		×	×	×	×	×	×
Special relay (SM)		○	○	○	○	○*4	○
Special register (SD)		○	○	○	○	○*4	○
Input relay (X)		○	○	○	○	○*4	○
Output relay (Y)		○	○	○	○	○*4	○
Internal relay (M)		○	○	○	○	○*4	○
Latch relay (L)		○	○	×	○	×	○
Annunciator (F)		○	○	×	○	×	○
Edge relay (V)		○	○	×	○	×	○
Link relay (B)		○	○	○	○	○*5	○
Data register (D)		○	○	○	○	○*4	○
Link register (W)		○	○	○	○	○*5	○
Extended data register (D)*6		×	×	×	○	○*4	○
Extended link register (W)*6		×	×	×	○	○*4	○
Timer	Contact (TS)	○	○	×	○	×	○
	Coil (TC)	○	○	×	○	×	○
	Current value (T/TN)*7	○	○	×	○	×	○
Long timer	Contact (LTS)	○	○	×	×	×	×
	Coil (LTC)	○	○	×	×	×	×
	Current value (LT/LTN)*7	○	○	×	×	×	×
Counter	Contact (CS)	○	○	×	○	×	○
	Coil (CC)	○	○	×	○	×	○
	Current value (C/CN)*7	○	○	×	○	×	○
Long counter	Contact (LCS)	○	○	×	×	×	×
	Coil (LCC)	○	○	×	×	×	×
	Current value (LC/LCN)*7	○	○	×	×	×	×
Retentive timer	Contact (STS, SS)*8	○	○	×	○	×	○
	Coil (STC, SC)*8	○	○	×	○	×	○
	Current value (ST/STN, ST/SN)*8*7	○	○	×	○	×	○
Long retentive timer	Contact (LSTS)	○	○	×	×	×	×
	Coil (LSTC)	○	○	×	×	×	×
	Current value (LST/ LSTN)*7	○	○	×	×	×	×
Link special relay (SB)		○	○	○	○	×	○
Link special register (SW)		○	○	○	○	×	○
Step relay (S)		×	×	×	×	×	×
Direct input (DX)		×	×	×	×	×	×
Direct output (DY)		×	×	×	×	×	×
Index register (Z)		○	○	×	○	×	○

Device*1 (Device name)		Access target CPU module (series)					
		RCPU		C Controller module	QCPU (Q mode)		LCPU
		Programmable controller CPU/Process CPU*2/Safety CPU*3			Programmable controller CPU/Process CPU	C Controller module	
General sampling	High speed sampling						
Long index register (LZ)		○	○	×	×	×	×
File register	(R)	○	○*9	×	○*10	×	○
	(ZR)	○	○*9	○	○*10	×	○
	(ERnR)	×	×	×	×	×	×
Link direct device	Link input (JnX)	○	×	○	○	○	○
	Link output (JnY)	○	×	○	○	○	○
	Link relay (JnB)	○	×	○	○	○	○
	Link special relay (JnSB)	○	×	○	○	○	○
	Link register (JnW)	○	×	○	○	○	○
	Link special register (JnSW)	○	×	○	○	○	○
Refresh data register (RD)		○	○	×	×	×	×
Module access device	Module access device/ Intelligent function module device (UnG)	○	×	○	○	○	○
	Multiple CPU shared device (U3EnG)	×	×	○	○	○	○
CPU buffer memory access device	CPU buffer memory access device (U3EnG)	○	×	×	×	×	×
	CPU buffer memory access device (fixed cycle communication area) (U3EnHG)	○*11	×	×	×	×	×

*1 The local devices and file registers for individual programs cannot be accessed by specifying the program name.

Do not use local devices and file registers for individual programs since they may not be read/written correctly.

*2 Process CPU does not support high speed sampling.

*3 Safety devices cannot be accessed.

*4 For Q12DCCPU-V (Basic mode), select "Use device function" on a C Controller module.

*5 For Q12DCCPU-V, only Q12DCCPU-V (Extended mode) can be accessed.

*6 The extended data register (D) and extended link register (W) can be accessed by the following two methods.

· Directly specify in the device name of extended data register (D) and extended link register (W)

· Access to the file register (ZR) area assigned to the extended data register (D) and extended link register (W)

*7 Either of the device names can be specified.

*8 A device name for QCPUs (Q mode), LCPUs, and MELSEC-Q series C Controller modules

*9 When accessing out of the range of the file register (ZR) area, the value of -1(FFFFH) is sampled.

*10 It is not accessible when using Q00JCPU and Q00UJCPU.

*11 RnENCPU and safety CPUs have no device.

Bit specification/digit specification of devices

The following table shows the availability of bit specification and digit specification of each device.

When using the high speed sampling function and recipe function, bit specified/digit specified devices cannot be used.

Bit specified/digit specified devices cannot be used for the current value data in the reports.

○: Available, ×: Not available

Device (device name)		Bit specification	Digit specification
Special relay (SM)		×	○
Special register (SD)		○	×
Input relay (X)		×	○
Output relay (Y)		×	○
Internal relay (M)		×	○
Latch relay (L)		×	○
Annunciator (F)		×	○
Edge relay (V)		×	○ ^{*1}
Link relay (B)		×	○
Data register (D)		○	×
Link register (W)		○	×
Extended data register (D)		○	×
Extended link register (W)		○	×
Timer	Contact (TS)	×	×
	Coil (TC)	×	×
	Current value (T/TN)	×	×
Long timer	Contact (LTS)	×	×
	Coil (LTC)	×	×
	Current value (LT/LTN)	×	×
Counter	Contact (CS)	×	×
	Coil (CC)	×	×
	Current value (C/CN)	×	×
Long counter	Contact (LCS)	×	×
	Coil (LCC)	×	×
	Current value (LC/LCN)	×	×
Retentive timer	Contact (STS, SS ^{*2})	×	×
	Coil (STC, SC ^{*2})	×	×
	Current value (ST/STN, ST/SN ^{*2})	×	×
Long retentive timer	Contact (LSTS)	×	×
	Coil (LSTC)	×	×
	Current value (LST/LSTN)	×	×
Link special relay (SB)		×	○
Link special register (SW)		○	×
Index register (Z)		×	×
Long index register (LZ)		×	×
File register	(R)	○	×
	(ZR)	○	×
Link direct device	Link input (Jn\X)	×	○
	Link output (Jn\Y)	×	○
	Link relay (Jn\B)	×	○
	Link special relay (Jn\SB)	×	○
	Link register (Jn\W)	○	×
	Link special register (Jn\SW)	○	×
Refresh data register (RD)		○	×
Module access device	Module access device/Intelligent function module device (Un\G)	○	×
	Multiple CPU shared device (U3En\G)	○	×

Device (device name)		Bit specification	Digit specification
CPU buffer memory access device	CPU buffer memory access device (U3En\G)	○	×
	CPU buffer memory access device (fixed cycle communication area) (U3En\HG)	○	×

*1 Not available for RCPUs.

*2 A device name for QCPUs (Q mode), LCPUs, and MELSEC-Q series C Controller modules

Device specification with labels/comments

A device can be specified with a label or a comment by importing global labels (including module labels) set with an engineering tool to a project of Configuration Tool.

For details on importing labels, refer to the following:

📖 MELSEC iQ-R High Speed Data Logger Module User's Manual (Application)

Access units

The following table shows the number of device points (access units) that can be accessed in a single process when sampling the device values in the CPU module.

When the number of sampling device points are lower than the access units, the device values of the same sequence scan are sampled.

Since device values are sampled over multiple sequence scans when the number of sampling device points exceed the access units, data inconsistency (old data and new data overlap) may occur.

To prevent data inconsistency, set the number of devices sampled at one time to less than the access units, or use high speed sampling.

For the operation when the number of device points sampled by the trigger logging function exceeds the access units and general sampling is specified for the data sampling method, refer to the following:

📖 MELSEC iQ-R High Speed Data Logger Module User's Manual (Application)

Series		High speed sampling	General sampling	Report current value data	Recipe read	Recipe write
RCPU	Programmable controller CPU	Samples all device values in the same sequence scan.	118 points ^{*1} 58 points ^{*2}	960 points ^{*3,4} (480 points ^{*5} , 240 points ^{*6}) 480 points (240 points ^{*5} , 120points ^{*6})	118 points	78 points
	Safety CPU					
	Process CPU (process mode)	Not supported.				
	Process CPU (redundant mode)					
	C Controller module ^{*7}			949 points ^{*3,4} 480 points		
QCPU (Q mode)	Excluding basic model QCPU		96 points ^{*1} 48 points ^{*2}	960 points ^{*4} 480 points	—	—
	Basic model QCPU ^{*8}		64 points	240 points		
	C Controller module ^{*7}		96 points ^{*1} 48 points ^{*2}	960 points ^{*4} 480 points		
LCPU	Programmable controller CPU		96 points ^{*1} 48 points ^{*2}	960 points ^{*4} 480 points		

*1 When accessing from other than the Ethernet port of a high speed data logger module

*2 When accessing from the Ethernet port of a high speed data logger module

*3 When "Own station" is selected in the [Station specification] tab of the access target CPU setting.

*4 When "CC-Link Module" or "Serial Communication Module" is selected for the module type of the access source system under the [Network route] tab of the access target CPU setting, and "Use the co-existence network route" is unselected.

*5 When accessing long counter

*6 When accessing long timer and long retentive timer

*7 To prevent data inconsistency, use the MELSEC data link functions such as mdSendEx to write devices of the C Controller.

*8 Indicates Q00JCPU, Q00CPU, and Q01CPU

2.3 File Structure

It shows the file and folder structure to be created by the high speed data logger module.

Folder structure of the SD memory card

The following figure shows the directory structure of the SD memory card inserted in the high speed data logger module. When accessed with the FTP function, below '/' is the SD memory card root directory.

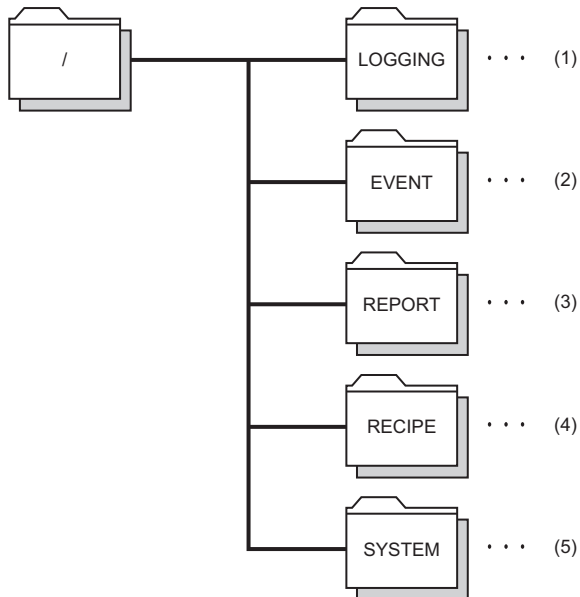

- (1) Data logging file storage directory
- (2) Event logging file storage directory
- (3) Report file storage directory
- (4) Recipe file storage directory
- (5) Directory used by the system

For accesses authority of each directory, refer to the following:

 MELSEC iQ-R High Speed Data Logger Module User's Manual (Application)

Folder structure at the time of file transfer

When using file transfer function, the folder saved on the SD memory card in the high speed data logger module will be saved in the directory of file server.

The following figure shows the directory structure.

When creating subfolder

Create a setting type folder and subfolder specified by the user on the file server, and transfer logging files at the time of the file switching.

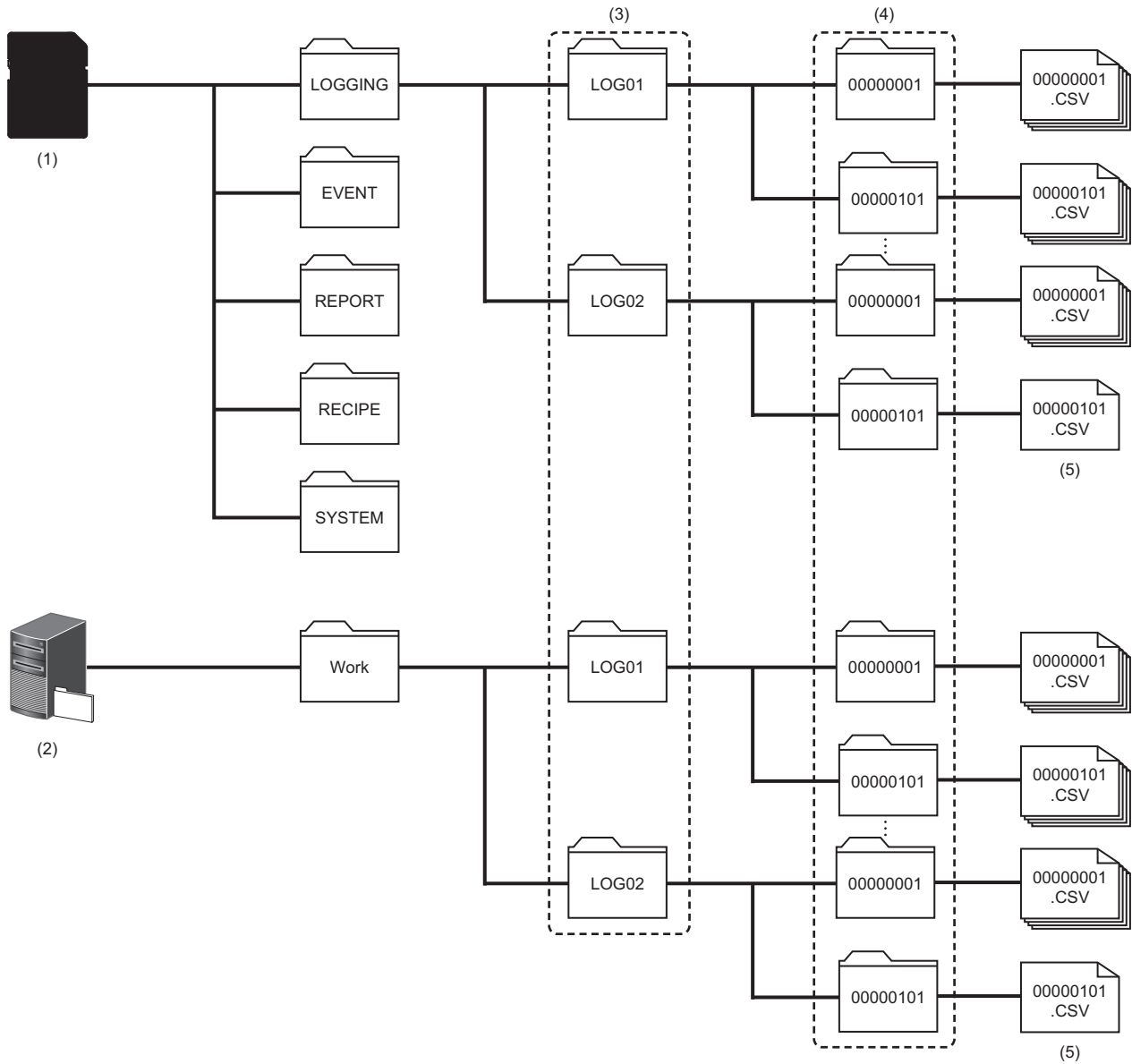

- (1) SD memory card
- (2) File server (FTP server, shared folder)
- (3) Setting type folder
- (4) Subfolder
- (5) Latest saved file

When not creating subfolder

Create only a setting type folder specified by the user on the file server, and transfer logging files at the time of the file switching.

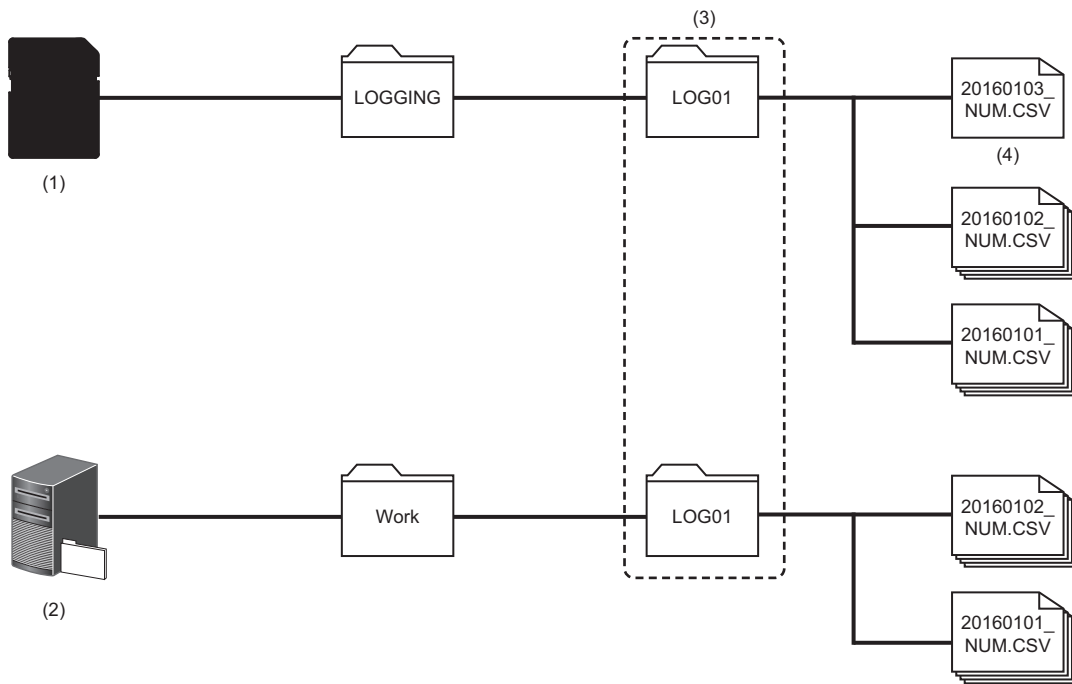

- (1) SD memory card
- (2) File server (FTP server, shared folder)
- (3) Setting type folder
- (4) Accumulating file

2.4 Range of Values per Output Format

This section shows the range of values that can be output for each output format.

Integer type

The ranges of the values that can be represented in each integer type are as follows.

Output format	Lower limit	Upper limit
Word [Signed]	-32768	32767
Double Word [Signed]	-2147483648	2147483647
Word [Unsigned]/Bit String [16-bit]	0	65535
Double Word [Unsigned]/Bit String [32-bit]	0	4294967295
16bit BCD	0000	9999
32bit BCD	00000000	99999999

Point

If device values or values after scaling exceed the range, they are rounded within the range.

- If the value exceeds the upper limit value, the upper limit value is output.
- If the value is lower than the lower limit value, the lower limit value is output.

Float type

The ranges of the values that can be represented in each float type are as follows.

Output format	Negative values		Positive values	
	Lower limit	Upper limit	Lower limit	Upper limit
FLOAT [Single Precision]	-3.4028235E+38	-1.401298E-45	1.401298E-45	3.4028235E+38
FLOAT [Double Precision]	-1.79769313486231570E+308	-4.94065645841246544E-324 ^{*1}	4.94065645841246544E-324 ^{*2}	1.79769313486231570E+308

*1 -1.79769313486231570E-308 with the report function.

*2 1.79769313486231570E-308 with the report function.

Point

If device values or values after scaling exceed the range, the data is output as follows:

- If the value exceeds the upper limit value of positive value, '+Inf' is output.
- If the value is lower than the lower limit value of negative value, '-Inf' is output.
- For values in a range between the upper limit value of negative value and the lower limit value of positive value, '0' is output.

Output format	-Inf	0	+Inf
FLOAT [Single Precision]	0xff800000	0x00000000	0x7f800000
FLOAT [Double Precision]	0xffff000000000000	0x0000000000000000	0x7ff0000000000000

Count/Time

The value ranges that can be represented when the output value other than "value" is specified with trigger logging of data logging are as follows.

Output value	Lower limit	Upper limit
Value	☞ Page 47 Integer type ☞ Page 47 Float type	
Count	0	4294967295
Total count	0	4294967295
Time ^{*1}	0	4294967295
Total time ^{*1}	0	4294967295

*1 A unit specified in Configuration Tool is applied (in seconds or milliseconds).

3 FUNCTION LISTS

This chapter shows the function lists of a high speed data logger module and Configuration Tool.



For details on the functions, refer to the following:

📖 MELSEC iQ-R High Speed Data Logger Module User's Manual (Application)

3.1 High Speed Data Logger Module

This section shows the function list of a high speed data logger module.

Function	Description
Data logging function	—
Data sampling function	To log device values in a CPU module at a specified sampling interval.
Continuous logging function	To sample device values from an access target CPU module. The sampling interval that can be specified differs depending on the data sampling method.
Trigger logging function	To continuously log device values in a CPU module at a specified sampling interval.
Scaling function	To log device values in a CPU module before and after a trigger occurs (a specified condition is satisfied) for a specified number of rows.
Save function	To use linear function transformation for sampled device values.
Event logging function	To save target data for data logging to an SD memory card in the Unicode text file format, CSV file format, or binary file format.
Event logging function	—
Data sampling function	To monitor device values sampled from a CPU module and log events that occurred.
Scaling function	To sample device values from an access target CPU module. The sampling interval that can be specified differs depending on the data sampling method.
E-mail notification function	To use linear function transformation for sampled device values.
Save function	To notify a specified e-mail address of an event by e-mail each time it occurs.
Report function	To save target data for event logging to an SD memory card in the Unicode text file format, CSV file format, or binary file format.
Report function	—
Data sampling function	To output data sampled by a high speed data logger module in Excel file format. By using Excel graphs and calculation formulas, easy-to-read reports can be created.
Current value sampling function	To sample device values from an access target CPU module. The sampling interval that can be specified differs depending on the data sampling method.
Creation trigger function	To sample data to output to a report when a trigger occurs.
Scaling function	To start report creation at a specified timing.
Save function	To use linear function transformation for sampled device values.
Recipe function	To save report files to an SD memory card.
Recipe function	To execute the following operations by using a recipe file stored in an SD memory card. <ul style="list-style-type: none"> • Transfer device values in a recipe file to a device in a CPU module. • Transfer device values in a CPU module to a recipe file.
Security function	—
Access authentication function	To prevent assets stored in a high speed data logger module from being stolen, falsified, operated incorrectly, and executed improperly due to unauthorized access from a third party.
IP filter function	To restrict access to a high speed data logger module by authenticating a user name and password.
	To restrict access to a high speed data logger module by identifying the IP address of an access source.

Function	Description	
Other functions	Time synchronization function	To synchronize the time of a high speed data logger module with that of a CPU module.
	Auto logging function	To automatically start the data logging function, event logging function, and report function when an SD memory card to which the auto logging settings are written in advance is inserted in a running high speed data logger module.
	File access function	To download data logging files, event logging files, report files, and recipe files from an SD memory card inserted in a high speed data logger module to a personal computer or delete them.
	File transfer function	To automatically transfer saved logging files and report files to an FTP server or a shared folder.
	E-mail function	To automatically send saved logging files and report files or report event occurrence.
	Firmware update function	To update the firmware of a high speed data logger module. For details, refer to the following:  MELSEC iQ-R Module Configuration Manual
	Initialization function	To initialize a firmware update-prohibited password retained in a high speed data logger module.
	Event history function	To record events that occurred in a high speed data logger module in an event history file.
	Free space adjustment function	To delete old logging files and report files when the free space of an SD memory card reaches a specified free space.
	FTP server function	To access a file in an SD memory card inserted in a high speed data logger module from a personal computer by using an FTP client.
	Self-diagnostic function	To perform a self-diagnostic test to check the hardware of a high speed data logger module.
	Online module change	To replace a module with another without stopping a running system. For the procedure, refer to the following:  MELSEC iQ-R Online Module Change Manual

3.2 Configuration Tool

This section shows the function list of Configuration Tool.

Function		Description
Project management function	—	To create or edit a setting file (project file) of a high speed data logger module.
	Import function	To import an arbitrary setting from a project file or CSV file (setting information file) saved in a personal computer.
	Export function	To output a project edited in Configuration Tool as a setting information file in CSV file format or Unicode text file format. It can also be output to an SD memory card inserted in a personal computer in a module-operable format.
	Project file conversion function	To convert a project file created by using a Q series high speed data logger module into a project file of a high speed data logger module.
Data logging setting function		To configure the settings to use the data logging function of a high speed data logger module.
Event logging setting function		To configure the settings to use the event logging function of a high speed data logger module.
Report setting function	—	To configure the settings to use the report function of a high speed data logger module.
	Excel layout setting function	To set the layout of a report file to be created by using the report function on Excel.
Common setting function	—	To configure the settings to use the security function and other functions of a high speed data logger module.
	Network setting function	To set an IP address and network connection settings of a high speed data logger module.
	Time synchronization setting function	To configure the settings to use the time synchronization function of a high speed data logger module.
	Access target CPU setting function	To set a target CPU module from which data is sampled by a high speed data logger module.
	File transfer setting function	To set information on a file server to transfer created files.
	E-mail setting function	To set an SMTP server and destination address to send created files or report events.
	Security setting function	To configure the settings to use the access authentication function and IP filter function of a high speed data logger module.
	Logging operation setting function	To configure the settings to use the auto logging function of a high speed data logger module. Operation start wait time of a high speed data logger module can be specified.
SD memory card setting function	To configure the settings to use the free space adjustment function.	
Online startup function		To start Configuration Tool online from a high speed data logger module by connecting a personal computer to the high speed data logger module. It is not necessary to install Configuration Tool on the personal computer.
Online function	—	To read and write parameters, and check the operation by connecting a high speed data logger module from Configuration Tool.
	Module search function	To search for and connect to a high speed data logger module on the network.
	Direct connection function	To connect a personal computer to a high speed data logger module on a 1:1 basis by using an Ethernet cable. They can easily be connected without concerning the IP address.
	Module diagnostics function	To check the operating status of a high speed data logger module and operate it. The error status of a high speed data logger module can be checked, and access to an SD memory card can be stopped or restarted.
	File browser function	To access a file in an SD memory card inserted in a high speed data logger module from a personal computer with the exclusive browser.
	Recipe execution function	To manipulate recipe files saved in an SD memory card inserted in a high speed data logger module.
	Management function	To display and change the prohibition state of the firmware update set in a high speed data logger module.
Recipe file edit function		To create and edit recipe files used for the recipe function of a high speed data logger module.
Global label/Device comment import function		To import global labels and device comments set in an engineering tool to the setting of a high speed data logger module.

4 PROCEDURES BEFORE OPERATION

This chapter shows the procedures before operation for using a high speed data logger module.

4.1 Start up of High Speed Data Logger Module

Procedure to operate by installing Configuration Tool

This section shows the procedure for using a high speed data logger module by installing Configuration Tool.

—: No operation required

Step	High speed data logger module ^{*1}	Configuration personal computer
1	Mount a high speed data logger module on the base unit. ^{*2}	Install Configuration Tool. (☞ Page 75 INSTALLATION AND UNINSTALLATION)
2	Connect the high speed data logger module to a configuration personal computer on a 1:1 basis. (☞ Page 67 System configuration for the initial setup, maintenance, and inspection)	
3	Turn the power of the system ON. (The RUN LED turns ON.)	—
4	Insert an SD memory card. (☞ Page 62 SD Memory Card)	—
5	—	Start Configuration Tool. (☞ Page 53 Offline startup)
6	—	Select "Direct connection" in the "Transfer setup" screen. ^{*3}
7	—	Format the SD memory card as necessary. ^{*3}
8	—	Set the common setting. ^{*3}
9	—	Set the data logging setting, the event logging setting, and the report setting. ^{*3}
10	—	Write the settings to the high speed data logger module. ^{*3}
11	Connect the high speed data logger module and configuration personal computer to the network according to the network settings set in Configuration Tool.	
12	Start the operation.	

*1 Perform the self-diagnostic test as necessary. (☞ MELSEC iQ-R High Speed Data Logger Module User's Manual (Application))

*2 Do not use an electric screwdriver to attach and remove module fixing screws.

*3 For the operation methods of Configuration Tool, refer to the following:

☞ MELSEC iQ-R High Speed Data Logger Module User's Manual (Application)

Procedure to operate without installing Configuration Tool

This section shows the procedure for using a high speed data logger module without installing Configuration Tool.

—: No operation required

Step	High speed data logger module ^{*1}	Configuration personal computer
1	Mount a high speed data logger module on the base unit. ^{*2}	—
2	Connect the high speed data logger module to a configuration personal computer on a 1:1 basis. (☞ Page 67 System configuration for the initial setup, maintenance, and inspection, Page 52 Network setting for connection)	
3	Turn the power of the system ON. (The RUN LED turns ON.)	—
4	Insert an SD memory card. (☞ Page 62 SD Memory Card)	—
5	—	Configure the web browser. (☞ Page 55 Internet Explorer settings)
6	—	Connect to the high speed data logger module with the web browser. (☞ Page 56 Connecting with a web browser)
7	—	Start Configuration Tool. (☞ Page 56 Starting Configuration Tool)
8	—	Select "Connection via hub" in the "Transfer Setup" screen. ^{*3}
9	—	Format the SD memory card as necessary. ^{*3}
10	—	Set the common setting. ^{*3}
11	—	Set the data logging setting, the event logging setting, and the report setting. ^{*3}
12	—	Write the settings to the high speed data logger module. ^{*3}
13	Connect the high speed data logger module and configuration personal computer to the network according to the network settings set in Configuration Tool.	
14	Start the operation.	

- *1 Perform the self-diagnostic test as necessary. (MELSEC iQ-R High Speed Data Logger Module User's Manual (Application))
- *2 Do not use an electric screwdriver to attach and remove module fixing screws.
- *3 For the operation methods of Configuration Tool, refer to the following:
MELSEC iQ-R High Speed Data Logger Module User's Manual (Application)

Network setting for connection

Operating procedure

1. Set such that the network portion of the configuration personal computer and the configuration tool is the same.

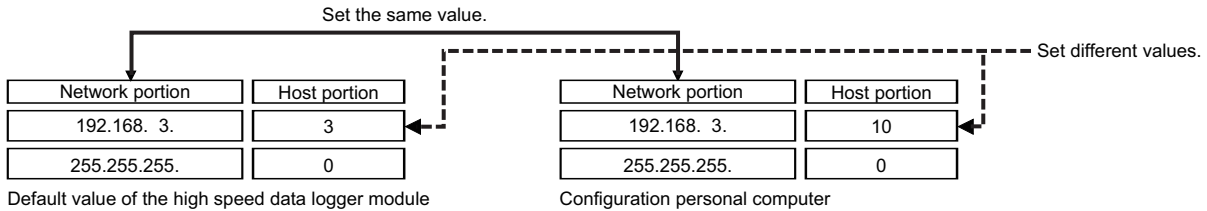

2. Set the network setting for the configuration personal computer on the "Internet Protocol Version 4 (TCP/IPv4) Properties" screen.

(Example) Windows 7 Ultimate

- 1 Select [Control Panel] ⇒ [Network and Internet] ⇒ [Network and Sharing Center] ⇒ [Change adapter settings].
 - 2 Select "Local Area Connection" and click [Properties] on the right click menu.
 - 3 On the "Local Area Connection Properties" screen, select "Internet Protocol Version 4 (TCP/IPv4)", then click the [Properties] button.
 - 4 The "Internet Protocol Version 4 (TCP/IPv4) Properties" screen appears.
3. Restart the personal computer to enable the network setting.

Configuration Tool

A tool that performs the following operations.

- Edit the settings of the module.
- Write the settings to the module.
- Read the settings from the module.
- Display the operating status of the running module.
- Operate the running module.

For details on Configuration Tool, refer to the following:

 MELSEC iQ-R High Speed Data Logger Module User's Manual (Application)

Startup method

The following methods show the startup method of Configuration Tool.

Startup method	Features	Reference
Offline startup	<ul style="list-style-type: none">• Start Configuration Tool installed on a configuration personal computer from Windows Start.• Can be started without a high speed data logger module.• Can be connected to a high speed data logger module without setting the IP address.• Can be connected to a high speed data logger module even if the subnet mask differs between a configuration personal computer and high speed data logger module.	Page 53 Offline startup
Online startup	<ul style="list-style-type: none">• Start Configuration Tool directly from a high speed data logger module.• Not necessary to install Configuration Tool on a configuration personal computer.	Page 53 Online startup

Offline startup

Operating procedure

Start MELSEC iQ-R High Speed Data Logger Module Configuration Tool from "MELSOFT" in Windows Start.

Online startup

■ Operating procedure before online startup

- 1.** Connect a configuration personal computer to the high speed data logger module.

 Page 67 System configuration for the initial setup, maintenance, and inspection

- 2.** Configure the web browser.

 Page 55 Internet Explorer settings

 Page 54 Microsoft Edge settings

- 3.** Connect with the web browser.

 Page 56 Connecting with a web browser

- 4.** Start Configuration Tool.

 Page 56 Starting Configuration Tool

■ Microsoft Edge settings

Point

The setting procedure and the name for each setting item may differ depending on its version.
For details, contact Microsoft Corporation.

- Setting proxy setup
 1. Click [...] (Settings and more) in the upper-right corner of Microsoft Edge.
 2. Select [Settings] ⇒ [System and performance] ⇒ [Open your computer's proxy settings].
 3. Set "Automatically detect settings" and "Use setup script" under "Automatic proxy setup," and "Use a proxy server" under "Manual proxy setup" to 'Off.'
- Deleting temporary internet files
 1. Click [...] (Settings and more) in the upper-right corner of Microsoft Edge.
 2. Select [History] ⇒ [Clear browsing data].
 3. Under "Time range," select a time range including when the online startup function of a high speed data logger module was used previously.
 4. Select the checkbox of "Browsing history."
 5. Click the [Clear now] button.
- Disabling SmartScreen
 1. Click [...] (Settings and more) in the upper-right corner of Microsoft Edge.
 2. Select [Settings] ⇒ [Privacy, search, and services].
 3. Turn off "Microsoft Defender SmartScreen" under "Security."Disable Windows SmartScreen as well. ( Disabling SmartScreen)
- Enabling ClickOnce
 1. Enter the following in the address bar of Microsoft Edge.
"edge://flags/#edge-click-once"
 2. Set "ClickOnce Support" to "Enabled."
 3. Restart Microsoft Edge to apply the settings.
- Setting Internet Explorer mode
 1. Click [...] (Settings and more) in the upper-right corner of Microsoft Edge.
 2. Select [Settings] ⇒ [Default browser].
 3. Set "Allow sites to be reloaded in Internet Explorer mode" under "Internet Explorer compatibility" to "Allow."
 4. If a URL is added for "Internet Explorer mode pages," the set page is opened in Internet Explorer mode.

Point

Even if a URL is not added for "Internet Explorer mode pages," the screen displayed on Microsoft Edge can be opened in Internet Explorer mode by the following operation.

- Right-click a tab of a screen, and select [Reload tab in Internet Explorer mode] from the shortcut menu.

■Internet Explorer settings

The following shows the procedure to configure the web browser.

- Setting a local area network (LAN)

Unselect the "Automatically detect settings", "Use automatic configuration script", and "Use a proxy server for your LAN" on the "Local Area Network (LAN) Settings" screen.

Ex.

Windows 7, Internet Explorer 10.0

Select [Tool] ⇒ [Internet Options] ⇒ [Connections] tab, click the [LAN Settings] button to display the "Local Area Network (LAN) Settings".

- Setting temporary internet files

Select the "Every time I visit the webpage" on the "Website Data Settings" screen.

Ex.

Windows 7, Internet Explorer 10.0

Select [Tool] ⇒ [Internet Options] ⇒ [General] tab, click the [Settings] button under "Browsing history".

- Deleting temporary internet files

Select "Temporary Internet files and website files" on the "Delete Browsing History" screen.

Ex.

Internet Explorer 10.0

Select [Tool] ⇒ [Internet Options] ⇒ [General] tab, click the [Delete] button under "Browsing history".

- Setting security

In the [Security] tab on the "Internet Options" screen, set the "Security level for this zone" to "Medium" or lower.

Ex.

Internet Explorer 10.0

Select [Tool] ⇒ [Internet Options] ⇒ [Security] tab.

- Disabling SmartScreen

For Windows 8, Windows 8.1, and Windows 10, disable SmartScreen according to the following procedures.

Windows 8, Windows 8.1

1. Select [System and Security] in the control panel of Windows.
2. Select "Action Center" on the "System and Security" screen.
3. Select "Change Windows SmartScreen settings" on the "Action Center" screen.
4. Select "Don't do anything (turn off Windows SmartScreen)".

Windows 10

1. Select [Update & Security] ⇒ [Windows Security], and click the [Open Windows Security] button in Windows settings.
2. Select [App & browser control] and set "Check apps and files," "SmartScreen for Microsoft Edge," and "SmartScreen for Windows Store apps" to 'Off.'

■Connecting with a web browser

Start a web browser*1, and enter the address of a high speed data logger module (http://192.168.3.3) in the address bar. If the IP address is changed, specify the IP address set in the network settings. (MELSEC iQ-R High Speed Data Logger Module User's Manual (Application))

*1 When using Internet Explorer mode on Microsoft Edge, it may take time to display the main page.

Point

If the high speed data logger module cannot be connected normally, issue the PING command from the personal computer to the high speed data logger module to verify the connection.

■Starting Configuration Tool

The following shows the procedure to start Configuration Tool.

Operating procedure

1. Click "Start the Configuration Tool" in the screen of a web browser.
 2. Click the [Run] button in the "Application Run - Security Warning" screen.
- Configuration Tool is downloaded from the high speed data logger module and started.

Screen configuration

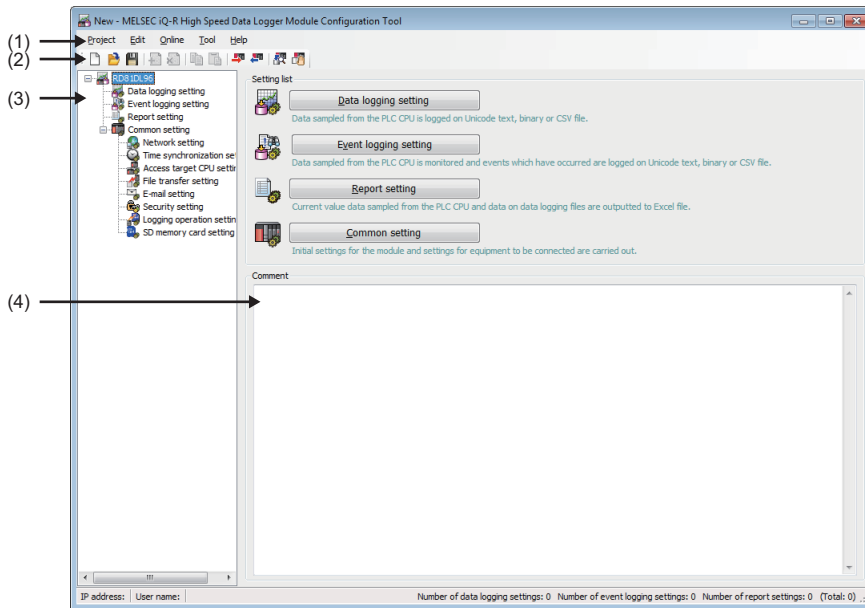

- (1) Menu
- (2) Toolbar
- (3) Edit item tree
- (4) Comment

■ Menu configuration











The following table shows the menu configuration of Configuration Tool.

Item	Description			
Project	New	Discards the project being edited and creates a new project.		
	Open	Opens a project file saved in the personal computer.		
	Save	Overwrites and saves the project being edited in a file.		
	Save as	Saves the project which is being edited under a new file name.		
	Open Q-Series High Speed Data Logger Module (QD81DL96) project		Opens the project file created using Q series High Speed Data Logger Module Configuration Tool.	
	Import	Project file	Imports an arbitrary setting from a project file saved in the personal computer.	
		CSV file	Imports an arbitrary setting from a CSV file saved in the personal computer.	
	Export	Module operating file		Exports the project which is being edited to the SD memory card inserted in the personal computer in a module-operable format.
		Text file	Unicode text file	Exports the settings of the project being edited in the Unicode text file format.
			CSV file	Exports the settings of the project being edited in the CSV file format.
Recent files	Opens files which were recently used by Configuration Tool. (Maximum 5 files)			
Exit	Exits Configuration Tool.			
Edit	Add item	Adds the item selected in the edit item tree to the setting. The index of the items to be added is the smallest number of the setting.		
	Delete item	Deletes the item selected in the edit item tree.		
	Replicate item	Adds an item selected in the edit item tree by copying it. The index of the copied item is the smallest number of the setting.		
	Copy settings	Copies table format settings.		
	Paste settings	Pastes the copied table format settings.		
	Move settings up to top	Moves the selected table format settings upward.		
	Device batch replacement	Replaces all the setting devices.		
	Import global label	Imports global labels as data from the project file of an engineering tool.		
	Release relation to global label	Disables relations between the data and import source global labels.		
	Update data related to global label	Updates the values of data when the values of import source global labels are changed.		
	Import common device comment	Imports common device comments as data from the project file of an engineering tool.		

Item		Description
Online	Transfer setup	Configures the communications settings when connecting to the high speed data logger module.
	Read	Reads the settings from the high speed data logger module.
	Write	Writes the settings to the high speed data logger module.
	Verify	Verifies Configuration Tool setting data with the high speed data logger module.
	Diagnostics	Connects to a high speed data logger module, and performs diagnostics of the module .
	Manage	Displays information on a high speed data logger module and perform operations to it.
	File browser	Connects to a high speed data logger module, and uploads or downloads files on the inserted SD memory card inserted in the high speed data logger module.
	Recipe execution operation	Connects to a high speed data logger module, and reads/writes recipe files on the SD memory card inserted in the high speed data logger module.
Tool	Start GX LogViewer	Starts GX LogViewer.
	Display recipe editor	Displays the "Recipe Editor" screen.
Help	About configuration tool	Displays the version information of Configuration Tool.
	Connection to MITSUBISHI ELECTRIC FA Global Website	Open the MITSUBISHI ELECTRIC FA Global website in a web browser.
	MELSEC iQ-R High Speed Data Logger Module Help	Displays the user's manual of the high speed data logger module.

■Toolbar configuration

The toolbar configuration of Configuration Tool is as shown below.

Icon	Corresponding menu
	[Project] ⇒ [New]
	[Project] ⇒ [Open]
	[Project] ⇒ [Save]
	[Edit] ⇒ [Add item]
	[Edit] ⇒ [Delete item]
	[Edit] ⇒ [Copy settings]
	[Edit] ⇒ [Paste settings]
	[Online] ⇒ [Write]
	[Online] ⇒ [Read]
	[Online] ⇒ [Diagnostics]
	[Online] ⇒ [File browser]

■Comment

Write comments (up to 2048 characters) related to the project.

The first line (up to 160 characters) up to the comment linefeed is displayed in "Comment" on the "Find High Speed Data Logger Module" screen.

Operations using the edit item tree

The edit item tree shows the overall project settings in a tree display.

The operations using the edit item tree is as shown below.

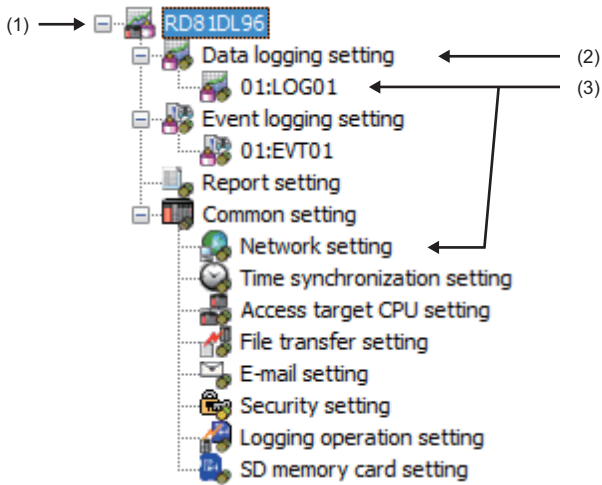

- (1) Project root
- (2) Setting type
- (3) Item

■Selecting an item

Items are displayed by double clicking each setting type.

Select the displayed item to display the editing screen for the selected item on the detailed setting editing screen.

■Adding an item

Select the setting type, and select [Edit] ⇒ [Add item] to add the item.

When the item is added normally, it is automatically selected and the editing screen switches to the one for the added item.

■Deleting an item

Select the item to be deleted, and select [Edit] ⇒ [Delete item] to delete the item.

■Replicating an item

Select the item to copy, and select [Edit] ⇒ [Replicate item] to add a copy of the item.

When the item is added normally, it is automatically selected and the editing screen switches to the one for the added item.

Parameter setting

Configure the mode setting and default operation settings of the high speed data logger module in the parameter setting of an engineering tool.

For details on the parameter setting, refer to the following:

📖 MELSEC iQ-R High Speed Data Logger Module User's Manual (Application)

Startup method

Operating procedure

Start GX Works3 from "MELSOFT" in Windows Start.

Parameter setting

Operating procedure

1. Create a new project.

🖱️ Select [Project] ⇒ [New].

2. Select "Series", "Type", and "Program Language", and click the [OK] button.

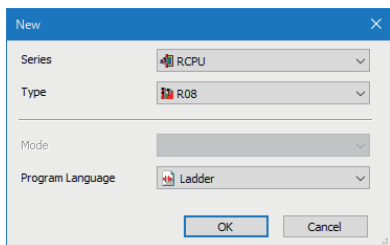

3. Set whether to use module labels and sample comments, click the [OK] button.

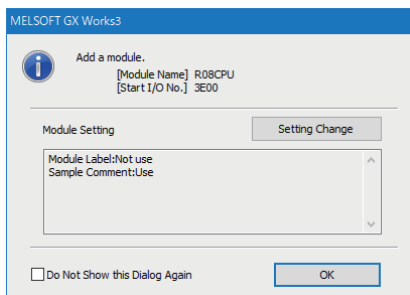

4. Displays the "Add New Module" screen.

🖱️ Select [Parameter] on the Navigation window, right-click the "Module Information" and select [Add New Module].

5. Add a high speed data logger module.

Item	Description
Module Type	Select "Information Module".
Module Name	Select "RD81DL96".
Mounting Slot No.	Select the slot No. where the high speed data logger module is mounted.
Start I/O No. Specification	Select "Not Set" when not specifying the start I/O number of a high speed data logger module; otherwise, select "Set."
Start I/O No.	When "Set" is selected in "Start I/O No. Specification", enter the start I/O number of the high speed data logger module.

6. Set whether to use module labels and sample comments, click the [OK] button.

7. Set the module parameters of a high speed data logger module.

[Navigation window] ⇒ [Parameter] ⇒ [Module Information] ⇒ [RD81DL96]

8. After setting the parameter, write the setting to a CPU module from an engineering tool.

9. Reset the CPU module or turn the power OFF and ON to apply the setting.

4.2 SD Memory Card

This section shows an SD memory card used for a high speed data logger module.

For supported SD memory cards and considerations, refer to the following:

☞ Page 70 SD memory card (sold separately, required)

☞ Page 13 Considerations for using SD memory cards

Operation for inserting an SD memory card

Follow the procedure below to insert an SD memory card.

1. Insert an SD memory card. (☞ Page 65 Insertion procedure)
2. Turn the power of a programmable controller ON if it is OFF.
3. Check if the SD memory card is correctly inserted into the high speed data logger module. (If the CARD RDY LED is ON, it is correctly inserted.)

Point

The SD memory card insertion status can be checked with the input signal.

If 'SD memory card status' (X1) is ON, the SD memory card has been correctly inserted.

Operations for removing or reinserting an SD memory card

Follow the procedure below to remove or reinsert an SD memory card. Also, make sure to stop file access before removing the SD memory card.

Removing

1. Turn the power of a programmable controller ON if it is OFF.
2. Stop file access to prohibit reading/writing to an SD memory card. (☞ Page 64 Methods for stopping file access)
3. Remove the SD memory card. (☞ Page 65 Removal procedure)

Reinserting

1. Perform the operation for removing. (☞ Page 62 Removing)
2. Reinsert an SD memory card. (☞ Page 65 Insertion procedure)
3. Check if the SD memory card is correctly inserted into the high speed data logger module. (If the CARD RDY LED is ON, it is correctly inserted.)
4. When the auto logging function is not set on the SD memory card inserted, execute "Update settings" in Configuration Tool.*1*2

*1 When inserting the SD memory card on which the auto logging function has been set, the logging starts as the card is inserted.

*2 Update the settings in "Module diagnostics" of Configuration Tool. (MELSEC iQ-R High Speed Data Logger Module User's Manual (Application))

Point

- Not following the procedure shown above may cause a loss of logging data during processing, corruption of data, or occurrence of a file system error on the SD memory card while accessing.
- If an error occurs on an SD memory card, refer to the following:
(MELSEC iQ-R High Speed Data Logger Module User's Manual (Application))
- High speed data logger module settings are saved on the SD memory card. Therefore, the IP address of the high speed data logger module returns to the initial status (192.168.3.3) when turning the power OFF to ON or resetting the CPU module without a SD memory card inserted in the module or without the settings written to the SD memory card.

As necessary, read the current settings before removing the SD memory card and after replacing the card, promptly write those settings to the new card.

Operations for replacing an SD memory card

Follow the procedure below to replace the SD memory card with a new card. Also, make sure to stop file access before removing the SD memory card.

1. Turn the power of a programmable controller ON if it is OFF.
2. Start Configuration Tool, and read settings.*1
3. Stop file access to prohibit reading/writing to an SD memory card. (☞ Page 64 Methods for stopping file access)
4. Remove the SD memory card. (☞ Page 65 Removal procedure)
5. Insert a new SD memory card. (☞ Page 65 Insertion procedure)
6. Check if the SD memory card is correctly inserted into the high speed data logger module. (If the CARD RDY LED is ON, it is correctly inserted.)
7. When the auto logging function is not set on the SD memory card inserted, write settings and execute "Update settings" in Configuration Tool.*2*3

*1 Can be omitted if the auto logging function is set on a newly inserted SD memory card.

*2 When inserting the SD memory card on which the auto logging function has been set, the logging starts as the card is inserted.

*3 Update the settings in "Module diagnostics" of Configuration Tool. (📖MELSEC iQ-R High Speed Data Logger Module User's Manual (Application))

Point

- Not following the procedure shown above may cause a loss of logging data during processing, corruption of data, or occurrence of a file system error on the SD memory card while accessing.
- If an error occurs on an SD memory card, refer to the following:
(📖MELSEC iQ-R High Speed Data Logger Module User's Manual (Application))
- High speed data logger module settings are saved on the SD memory card. Therefore, the IP address of the high speed data logger module returns to the initial status (192.168.3.3) when turning the power OFF to ON or resetting the CPU module without a SD memory card inserted in the module or without the settings written to the SD memory card.

As necessary, read the current settings before removing the SD memory card and after replacing the card, promptly write those settings to the new card.

Methods for stopping file access

The following are the methods for stopping file access.

- Switch operation on the front of a module
- Input/output (X/Y) signal operation
- Online operation in Configuration Tool

Switch operation on the front of a module

1. Press the SD memory card lock switch for one second or more.
2. Check that the CARD RDY LED is turned OFF.

Input/output (X/Y) signal operation

1. Turn from OFF to ON 'File access stop request' (Y2).
2. Check that 'File access status' (X2) turns from OFF to ON, or the CARD RDY LED turns OFF.

When 'File access status' (X2) turns ON, 'SD memory card status' (X1) turns OFF.

Turn 'File access stop request' (Y2) from ON to OFF as necessary.

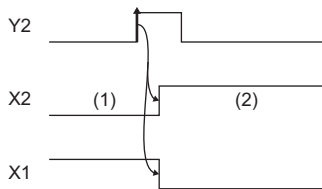

(1) In operation

(2) Stopped

Y2: File access stop request

X2: File access status

X1: SD memory card status

If 'File access stop request' (Y2) is turned ON by mistake, turn ON 'Clear file access stop request' (Y3) and 'Setting renew request' (Y8).

Online operation in Configuration Tool

1. Perform diagnostics.
 - ☞ Select [Online] ⇒ [Diagnostics].
2. Stop file access.
 - ☞ Select "Access stop" from "SD memory card operation" in "SD memory card diagnostics," and click the [Execute] button.

Insertion/removal method of an SD memory card

Make sure to stop file access when removing or replacing an SD memory card.

Insertion procedure

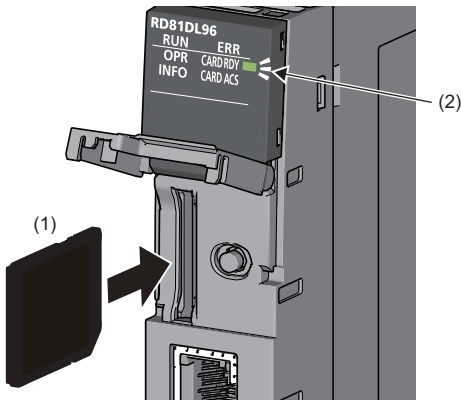

- 1.** Insert an SD memory card (1) straight into the SD memory card slot with its cutout pointed down.
Make sure it is not uplifted after inserting it.
If it is inserted insufficiently, it may cause malfunction due to poor contact.
- 2.** The CARD RDY LED (2) keeps flashing until the SD memory card is ready to be used. Once the CARD RDY LED (2) turns ON, the SD memory card can be used.

4

Removal procedure

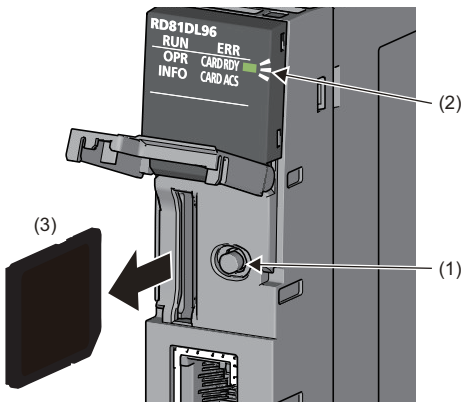

- 1.** Press the SD memory card lock switch (1) for one second or longer to stop the SD memory card access. (📖 Page 64 Methods for stopping file access)
- 2.** The CARD RDY LED (2) is flashing while stopping the file access, and it turns OFF once the processing is completed.
- 3.** Push the SD memory card (3) in once, and pull it out straight.

5 SYSTEM CONFIGURATION

This chapter shows the system configuration of a high speed data logger module.

5.1 System Configuration

Overall system configuration

The following figure shows the overall system configuration when using a high speed data logger module.

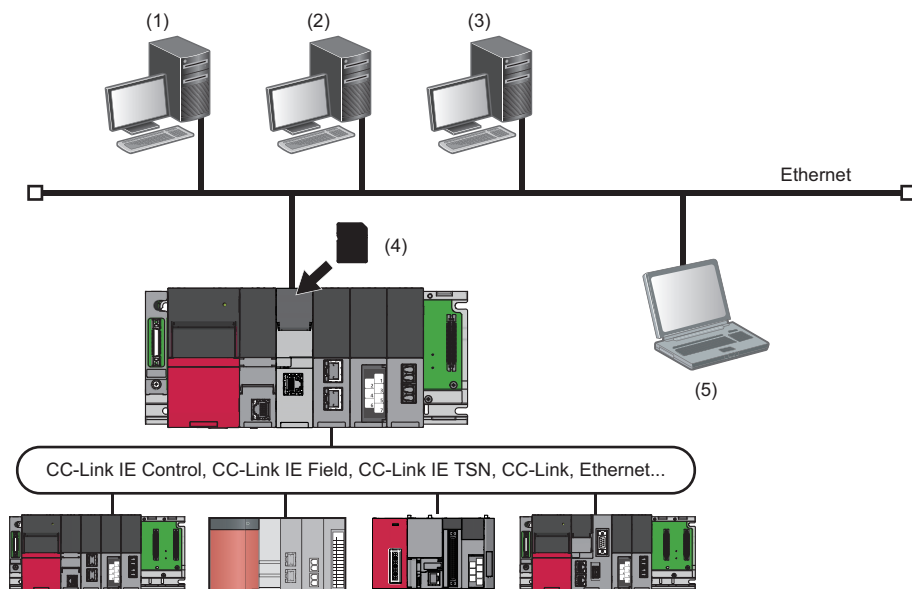

- (1) Mail server^{*1}
- (2) File server (FTP server, shared folder)^{*2}
- (3) DHCP server^{*3}
- (4) SD memory card (sold separately, required)
- (5) Configuration personal computer (Configuration Tool, GX LogViewer)

*1 Required when sending e-mail.

*2 Required when externally saving logged files.

*3 Required when automatically acquiring the IP address of the high speed data logger module.



For available CPU modules and the number of mountable ones, refer to the following:

MELSEC iQ-R Module Configuration Manual

Software configuration of the high speed data logger module tool

The following shows the software configuration of the high speed data logger module tool.

Item	Description
High speed data logger module tool	This installer is for installing the following software. • High Speed Data Logger Module Configuration Tool
High Speed Data Logger Module Configuration Tool	This software configures the high speed data logger module. Install on a configuration personal computer. This software can perform online startup by the high speed data logger module without installing it on a configuration personal computer.

System configuration for the initial setup, maintenance, and inspection

Connect a high speed data logger module and a configuration personal computer directly to perform an initial setup, maintenance, and inspection. (☞ Page 68 Direct connection, Page 69 Considerations for direct connection)



- (1) High speed data logger module
- (2) Ethernet (twisted pair cable)
- (3) Configuration personal computer

System configuration during operation

The following shows the system configurations when operating a high speed data logger module.

Connection via a hub

Connect a high speed data logger module to a configuration personal computer via a hub in a local area network. When connecting to server personal computers such as FTP server or mail server, it must be connected via a hub. The IP address of a high speed data logger module needs to be specified.

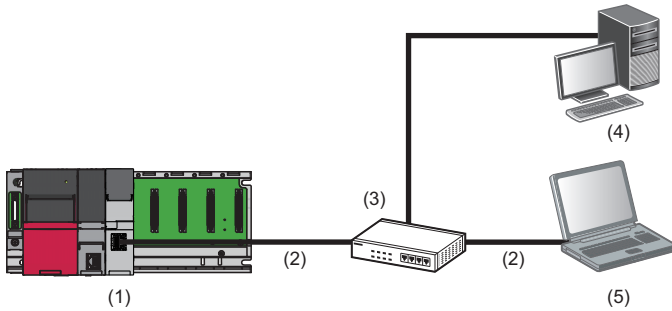

- (1) High speed data logger module
- (2) Ethernet (twisted pair cable)
- (3) Hub
- (4) Server personal computer
- (5) Configuration personal computer

Restriction

The operation of a high speed data logger module with the following connection methods is not guaranteed.

- Connection using Internet (general public line) (Internet-access service offered by an Internet service provider or a telecommunications carrier)
- Connection using a firewall device
- Connection using a broadband router
- Connection using a wireless LAN

Direct connection

A high speed data logger module can directly be connected to a configuration personal computer on a 1:1 basis with an Ethernet cable (crossover cable) without a hub.

When maintaining the equipment or monitoring by GX LogViewer in the environments that are not connected with server personal computers, configure the direct connection.

Communication can be established without specifying the IP address of a high speed data logger module. (Broadcast is used.)

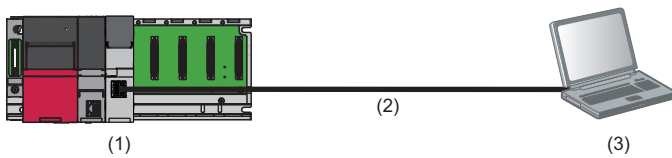

- (1) High speed data logger module
- (2) Ethernet (twisted pair cable)
- (3) Configuration personal computer

Considerations for direct connection

■Connecting to a LAN line

Do not perform communication by connecting to a LAN line directly.

This may increase the line load and affect any communication of other devices.

■Connections which are not direct connections

Do not configure the direct connection in the configuration where a single high speed data logger module and a single configuration personal computer are connected to a hub.

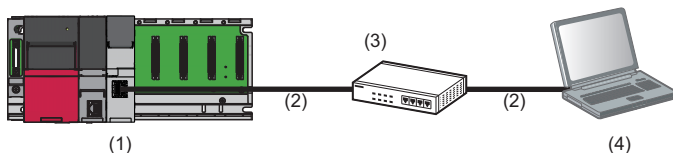

- (1) High speed data logger module
- (2) Ethernet (twisted pair cable)
- (3) Hub
- (4) Configuration personal computer

■Conditions where communication cannot be established by direct connection

If the following condition is satisfied, the communication by direct connection may not be established. In that case, review the settings of the high speed data logger module and configuration personal computer.

- When all the bits of the high speed data logger module IP address corresponding to the '0' parts of the configuration personal computer subnet mask are ON or OFF

Ex.

High speed data logger module IP address: 64.64.255.255

Configuration personal computer IP address: 64.64.1.1

Configuration personal computer subnet mask: 255.255.0.0

- When all the bits of the high speed data logger module IP address corresponding to the host address of each class for the configuration personal computer IP address are ON or OFF

Ex.

High speed data logger module IP address: 64.64.255.255

Configuration personal computer IP address: 192.168.0.1

Configuration personal computer subnet mask: 255.0.0.0

- When the high speed data logger module IP address is automatically acquired by DHCP

Point

- The IP address of each class are as follow.
Class A: 0.x.x.x to 127.x.x.x, Class B: 128.x.x.x to 191.x.x.x, Class C: 192.x.x.x to 223.x.x.x
- The host address of each class is the 0 portion below.
Class A: 255.0.0.0, Class B: 255.255.0.0, Class C: 255.255.255.0

■Other considerations

- When the Windows firewall setting of the configuration personal computer is enabled

Disable the Windows firewall setting.

- When multiple IP addresses are enabled in configuration personal computer

In the configuration where multiple IP addresses are enabled at the same time as shown below, do not configure the settings for direct connection.

- When IP address is assigned to the respective configuration personal computer with multiple Ethernet ports
- When a wireless LAN setting is enabled in addition to Ethernet port of the configuration personal computer
- When multiple IP addresses are assigned to one network device (Ethernet port) of a configuration personal computer
- When selecting "Acquire automatically" for the IP address setting in the network setting in the high speed data logger module

Change the IP address settings to "Specify". Or prepare a DHCP server and connect via a hub.

5.2 Connectable Devices

This section shows the connectable devices to a high speed data logger module.

SD memory card (sold separately, required)

One SD memory card is required for using a high speed data logger module.

Use one of the following SD memory cards manufactured by Mitsubishi Electric.

Model name	Capacity
NZ1MEM-2GBSD	2 GB
NZ1MEM-4GBSD	4 GB
NZ1MEM-8GBSD	8 GB
NZ1MEM-16GBSD	16 GB

When using an SD memory card, make sure to refer to the following: ( Page 13 Considerations for using SD memory cards)

Ethernet (twisted pair) cable (sold separately)

The Ethernet cables compliant with IEEE802.3 1000BASE-T/100BASE-TX/10BASE-T standards can be used.

Transmission speed	Unshielded twisted pair cable (UTP cable) Shielded twisted pair cable (STP cable)	
	Straight cable	Crossover cable
1 Gbps	Category 5e or higher	Category 5e
100 Mbps	Category 5 or higher	Category 5 or 5e
10 Mbps	Category 3 or higher	Category 3 to 5e

When using an Ethernet cable, make sure to refer to the following: ( Page 74 Wiring Precautions)

5.3 Operating Environment

This section shows the operating environment for Configuration Tool.

Item	Description	
Personal computer	—	A personal computer on which Microsoft Windows operates
	CPU	Intel® Core™ 2 Duo Processor 2GHz or more recommended
	Required memory	64-bit OS: 2 GB or more recommended 32-bit OS: 1 GB or more recommended
Display	Resolution 1024 × 768 pixels or higher	
Free hard disk space	512 MB or more	
Operating system ^{*1*2} (32-bit version and 64-bit version are supported.)	Windows 10 (Home, Pro, Enterprise, Education) ^{*3} Windows 8.1 ^{*3} , Windows 8.1 (Pro, Enterprise) ^{*3} Windows 8 ^{*3} , Windows 8 (Pro, Enterprise) ^{*3} Windows 7 (Starter, Home Premium, Professional, Ultimate, Enterprise) ^{*4*5}	
Interface	Ethernet port	
Web browser ^{*6}	Microsoft Edge Windows Internet Explorer 11.0 Windows Internet Explorer 10.0 Windows Internet Explorer 9.0 Windows Internet Explorer 8.0	
Excel ^{*7*8}	Microsoft Excel 2010 (32-bit version) Microsoft Excel 2013 (32-bit version) Microsoft Excel 2016 (32-bit version) Microsoft Excel 2019 (32-bit version/64-bit version) Microsoft 365 (32-bit version/64-bit version) ^{*9}	

- *1 When the following functions are used, this product may not run properly.
Application start-up in Windows compatibility mode
Fast user switching
Remote desktop
Windows XP Mode
Touch function
Modern UI
Client Hyper-V
Virtual desktop
Tablet mode
Windows hibernate or standby
Text cursor indicator
- *2 In the following case, the screen of this product may not work properly.
The size of the text and other items in the screen is other than 100% (96 DPI, 9 pt etc.).
- *3 Disable SmartScreen.
- *4 At the time of online startup of Configuration Tool, .Net Framework4.5 must be installed.
- *5 Cannot be used if the user is logged on with parental control enabled.
- *6 Required for Configuration Tool online startup.
- *7 Required for report setting.
- *8 Install the VBA function.
- *9 The version the operation of which has been checked is 'Semi-Annual Enterprise Channel Version 2108.'

5.4 Considerations for System Configuration

This section shows the considerations for system configuration.

Considerations for using a C Controller module

The following shows the considerations for using a C Controller module.

Network communication route

When the network module is mounted on the C Controller module, the network module cannot be used as a relay station.

Considerations when using a process CPU (redundant mode)

The following shows the considerations for using a process CPU (redundant mode).

Mountable base units

A high speed data logger module must be mounted on an extension base unit*¹ or a redundant extension base unit. It cannot be mounted on the main base unit in a redundant system.

*¹ Only the extension level 2 to 7 are available.

Access target CPUs

There are restrictions on accessible routes. For details, refer to the following:

☞ Page 35 Accessible routes

Dedicated instructions

When mounting a high speed data logger module to a process CPU (redundant mode), dedicated instructions cannot be used.

If a dedicated instruction is used, "Operation error (redundant function)" occurs in the process CPU (redundant mode).

Resetting a CPU module

When mounting a high speed data logger module to a process CPU (redundant mode), reset CPU modules of both systems for a function that requires resetting the CPU modules.

5.5 Supported Software Packages

This section shows the software packages supported by a high speed data logger module.

Software package	Software version
GX Works3	1.020W or later
GX LogViewer	1.54G or later

6 WIRING

This chapter shows the method for connecting an Ethernet cable to a high speed data logger module.
For connectable Ethernet cables, refer to the following:.

☞ Page 70 Ethernet (twisted pair) cable (sold separately)

6.1 Wiring of an Ethernet Cable

This section shows the procedures for connecting and disconnecting an Ethernet cable.

Connecting procedure

1. Check the insertion direction, and insert an Ethernet cable into the Ethernet port of a high speed data logger module until it clicks.
2. Lightly pull the cable to check that it is securely connected.
3. Check the SPEED LED lighting status of the Ethernet port connected with the Ethernet cable. (☞ Page 21 PART NAMES)

Point

- The time required from when an Ethernet cable is connected to when the SPEED LED turns ON may vary. Normally, it turns ON in a few seconds. However, it may take longer because the linking-up processing is repeated due to the device condition on the line.
- When the SPEED LED does not turn ON, check if the connected Ethernet cable has any failure.
- The SPEED LED turns OFF when connecting with an Ethernet device on the network the data transmission speed of which is 10 Mbps. Check the communication status by performing the PING test, etc.

Disconnecting procedure

Pull out the Ethernet cable while pinching a clip on the connector.

Considerations for 1000BASE-T/100BASE-TX connection

A communication error may occur due to high-frequency noise generated from devices other than the programmable controller depending on the installation environment.

The following shows the measures to be taken on the high speed data logger module side to prevent the influence of high frequency noise.

- Do not bundle a cable with the main circuit or power cable, or do not place it near those lines.
- Place a cable in a duct.
- In the environment where a cable is susceptible to noise, use the STP cable.
- Change a target device connected with a high speed data logger module to one which communicates at 10 Mbps, and decrease the data transmission speed.

6.2 Wiring Precautions

- To establish a reliable system and fully use the functions of a module, a wiring that does not easily receive the effects of noise is required.
- Sufficient safety measures must be taken when constructing the IEEE802.3 1000BASE-T/100BASE-TX/10BASE-T networks.
Consult a specialist when handling the terminal processing of connection cable, installing trunk cables, etc.
- Use a cable compliant with IEEE802.3 1000BASE-T/100BASE-TX/10BASE-T standards. (☞ Page 70 Ethernet (twisted pair) cable (sold separately))
- For the connection on the target device side, check the specifications of the target device in advance.
- Place an Ethernet cable in a duct or clamp it.
Otherwise, the dangling cable may swing or inadvertently be pulled. It may cause a module or the cable to damage or malfunction due to poor contact.
- Protect the core wire in the connector of a cable or the port of a module to prevent touching by hand and sticking dirt or dust.
If any oil from your hand, dirt or dust sticks the core wire, it may increase the transmission loss and fail a data link.
- Check if an Ethernet cable used is disconnected, a short-circuit is generated, and the connector is properly connected.
- Do not use an Ethernet cable with a broken clip.
Doing so may cause the unplugged cable or malfunction.
- Hold the connector of an Ethernet cable when connecting or disconnecting it.
If the cable is pulled while being connected to a module, it may cause the module or Ethernet cable to damage or malfunction due to poor contact.
- Attach the provided connector cover to protect an unused Ethernet port from dirt and dust.
- The maximum segment length of an Ethernet cable is 100 m. However, the length may be shorter depending on the use environment of the cable. For details, contact the manufacturer of the cable used.
- The bend radius of an Ethernet cable is limited. For details, check the specifications of the Ethernet cable used.

7 INSTALLATION AND UNINSTALLATION

This chapter explains the procedures for installing and uninstalling the high speed data logger module tool.

Considerations for installation/uninstallation

- Log on to a personal computer as a user with the administrator authority.
- Before the installation, end all running applications on the operating system.
If software is installed while other applications are running, the product may not run normally.
- Install the software after changing the settings to prevent starting an update program automatically.
The installer may not run normally because the update program of an operating system or other software, such as Windows Update or Java® update, may start automatically.
- For Windows 8, Windows 8.1, and Windows 10, disable SmartScreen.

7.1 Installation Procedure

This section shows the installation procedure of the high speed data logger module tool.

Operating procedure

1. Decompress the acquired compressed file.
2. Start the installer.
Double-click the "setup.exe" in the decompressed folder.
3. Enter or select the necessary information according to the instructions shown on the screen.

Environment after installation

High Speed Data Logger Module Configuration Tool is installed to a specified folder and registered in the start menu. The following table shows the startup method and the maximum number of software, which can start at the same time, after installation.

Software	Startup method	Maximum No.
High Speed Data Logger Module Configuration Tool	MELSEC iQ-R High Speed Data Logger Module Configuration Tool can be started from "MELSOFT" in Windows Start.	5

7.2 Uninstallation Procedure

Uninstall the high speed data logger module configuration tool from the control panel of Windows.

Environment after uninstallation

The installed program file, folder, and start menu are deleted after uninstallation. If there is a new file added by a user after installation, the file/folder will not be deleted.

8 OPERATION EXAMPLE

This chapter shows the operation example of simple logging operation in the system configuration including a high speed data logger module.

8.1 Preparing for Operation

Preparing equipment

The following equipment and software is used in the operation examples.

Device/Software	Production name/Description	Reference
Main base unit	R35B	□□MELSEC iQ-R Module Configuration Manual
Power supply module	R61P	
CPU module	R08CPU	Page 34 Accessible CPU modules
High speed data logger module	RD81DL96	—
SD memory card	NZ1MEM-nGBSD ('n' indicates a number of bytes.)	Page 70 SD memory card (sold separately, required)
USB cable	For connecting personal computer and CPU module	□□GX Works3 Operating Manual
Ethernet cable	For connecting personal computer and the high speed data logger module	Page 70 Ethernet (twisted pair) cable (sold separately)
Personal computer	Microsoft Windows 7 Professional Operating System (32-bit version)	Page 71 Operating Environment
Excel	Microsoft Excel 2010 (32-bit version)	
GX Works3	SWnDND-GXW3 ('n' indicates its version.)	□□GX Works3 Operating Manual
GX LogViewer ^{*1}	SWnDNN-VIEWER ('n' indicates its version.)	□□GX LogViewer Version 1 Operating Manual
High speed data logger module tool ^{*1}	SW1DNN-RDLUTL	—
Sample data for operation examples ^{*1}	Sequence program (sh081561eng-program_a.gx3)	GX Works3 project file
	Layout file (sh081561eng-layout_a.xls)	Excel format file for report

*1 To acquire the software and sample data, please contact your local Mitsubishi Electric sales office or representative.

System construction

Configure the programmable controller system used in operation examples.

System configuration

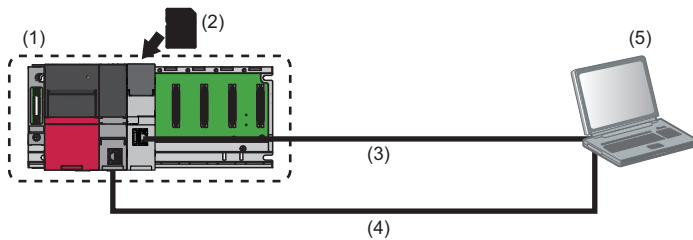

- (1) Programmable controller system
- (2) SD memory card
- (3) Ethernet cable
- (4) USB cable
- (5) Personal computer

Mounting and wiring modules

Operating procedure

- 1.** Insert an SD memory card in a high speed data logger module.
☞ Page 65 Insertion/removal method of an SD memory card
- 2.** Mount all the modules to the main base unit, and wire the power supply.
📖 MELSEC iQ-R Module Configuration Manual
- 3.** Connect the CPU module and the personal computer with the USB cable.
📖 MELSEC iQ-R CPU Module User's Manual (Startup)
- 4.** Connect the high speed data logger module and the personal computer with the Ethernet cable.
☞ Page 73 Wiring of an Ethernet Cable

Activating the system

Operating procedure

- 1.** Power ON the power supply module.
- 2.** Write the sequence program (sh081561eng-program_a.gx3) to the CPU module using GX Works3.
- 3.** Switch the mode of the CPU module to 'RUN'.

8.2 Logging Data before and after Trigger Occurrence

This section explains how to perform the trigger logging using the equipment shown in the figure below as an example.

Equipment figure

The following equipment is a winder for packaging film.

The sensor position moves up and down according to variation in the feeding reel speed, and a trigger (error) occurs when the allowable range is exceeded.

Each 100 line (record) of data before and after the trigger occurrence is saved in one file.

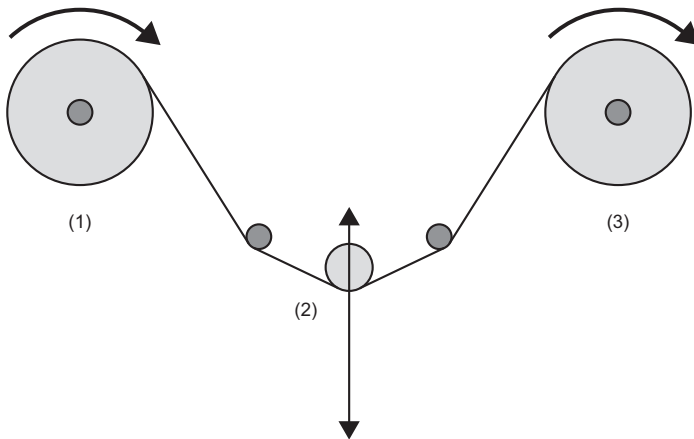

- (1) Feeding reel
- (2) Sensor (The sensor position moves up and down by the film slack.)
- (3) Winding reel

Operation flow

Perform the operations in the order below.

1. Data logging settings (trigger logging)

Configure the data logging settings with Configuration Tool.

2. Write settings

Write the data logging settings to the high speed data logger module.

3. Graphical display of data

Display logged data in a graph using GX LogViewer, and check the values.

Data logging settings (trigger logging)

Configure the data logging settings with Configuration Tool.

Starting Configuration Tool

Start MELSEC iQ-R High Speed Data Logger Module Configuration Tool from "MELSOFT" in Windows Start.

Configure the data logging settings

1. Click the [Data logging setting] button.

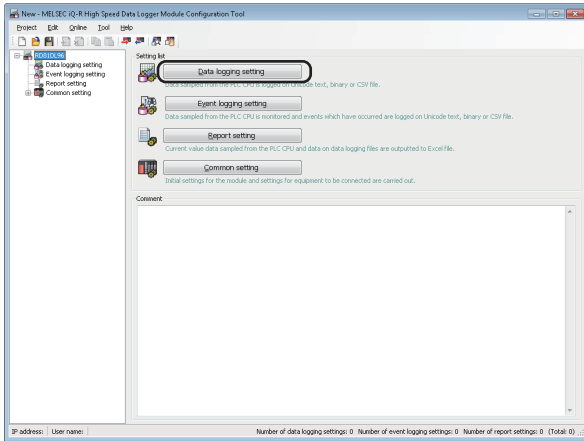

2. Click the [Edit] button.

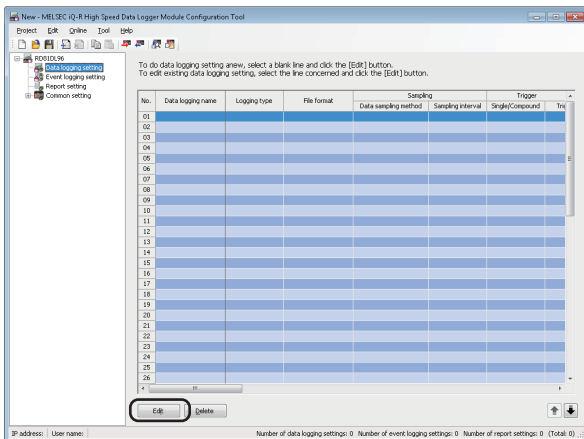

3. Select "Trigger logging" for the logging type, "CSV file" for the file format, and "Output lines before and after the trigger", then click the [Next] button.

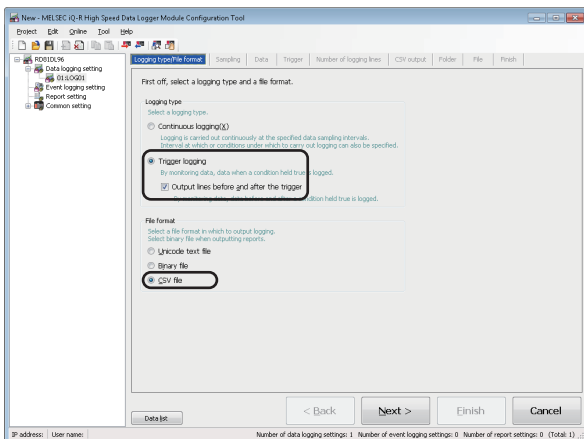

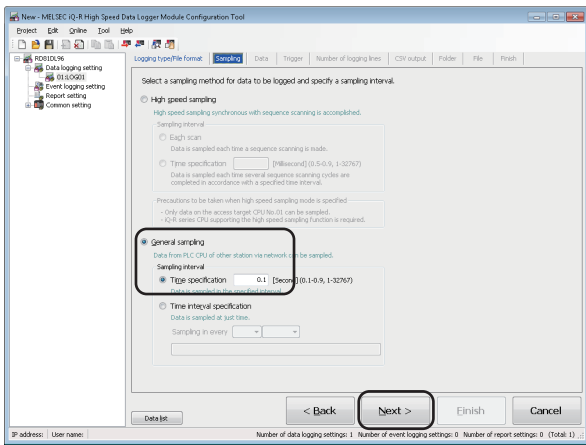

4. Enter '0.1' for the time specification of "General sampling", and click the [Next] button.

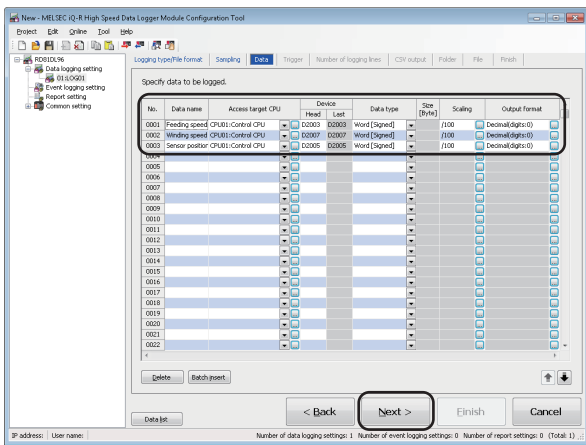

5. Set each setting item according to the following table, and click the [Next] button.

Data name	Device (Head)	Scaling
Feeding speed	D2003	/100
Winding speed	D2007	/100
Sensor position	D2005	/100

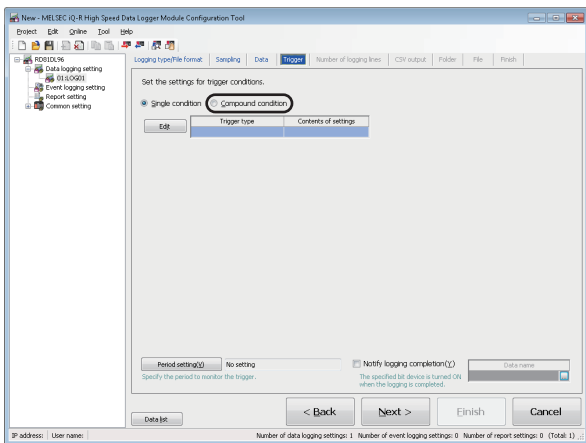

6. Select "Compound condition".

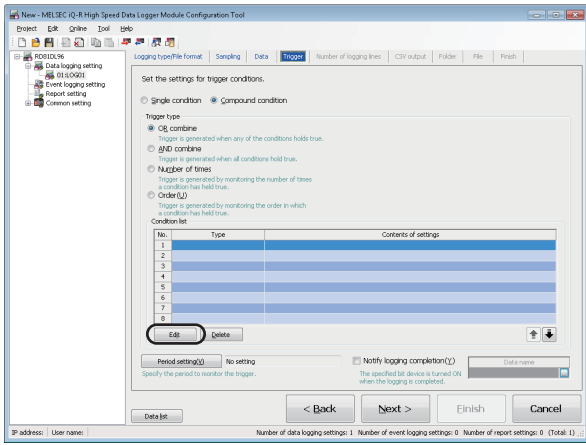

7. Click the [Edit] button.

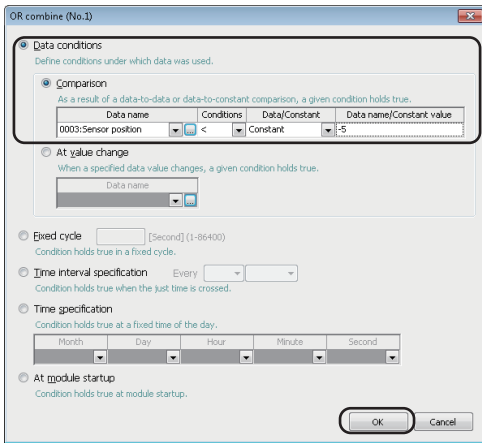

8. Set each setting item according to the following table, and click the [OK] button.

Data name	Conditions	Data/Constant	Data name/Constant value
0003:Sensor position	<	Constant	-5

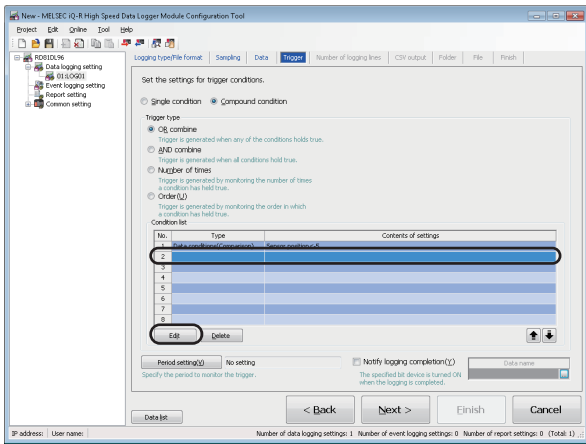

9. Select the second line in the condition list, and click the [Edit] button.

10. Set each setting item according to the following table, and click the [OK] button.

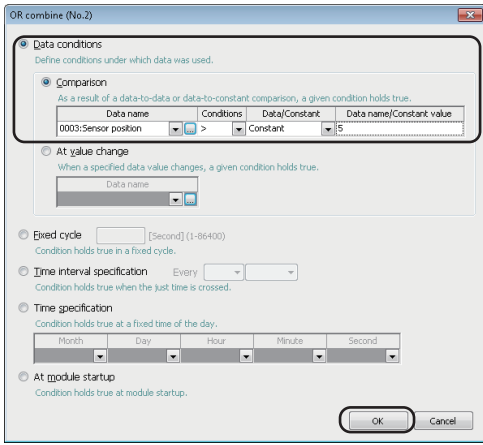

Data name	Conditions	Data/Constant	Data name/Constant value
0003:Sensor position	>	Constant	5

11. Click the [Next] button.

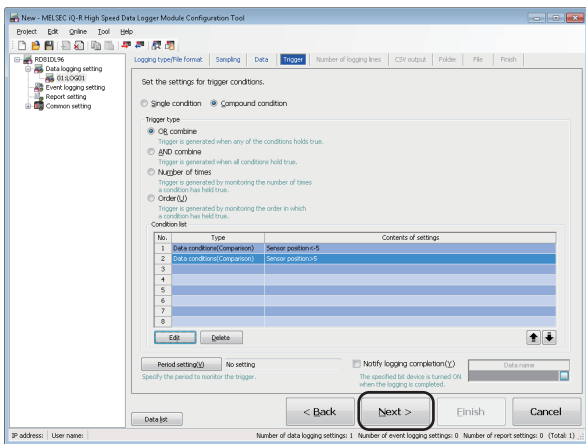

12. Enter '100' for "Before trigger" and "After trigger", and click the [Next] button.

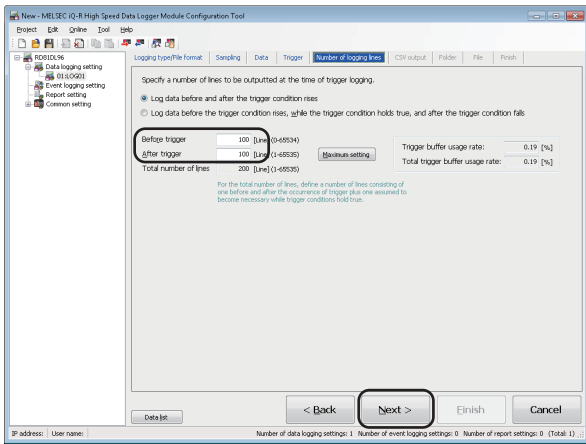

13. Click the [Next] button.

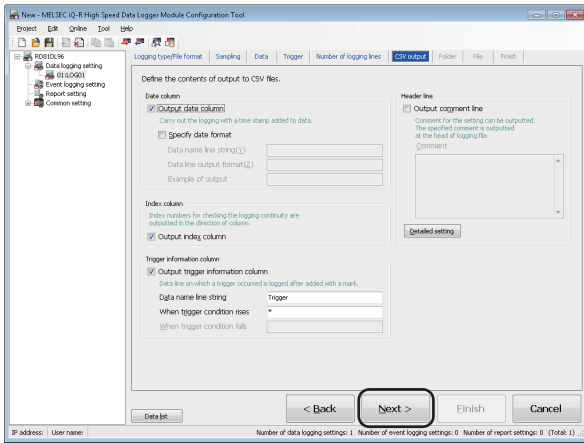

14. Enter 'Trigger_LOG' for the setting type folder name, and click the [Next] button.

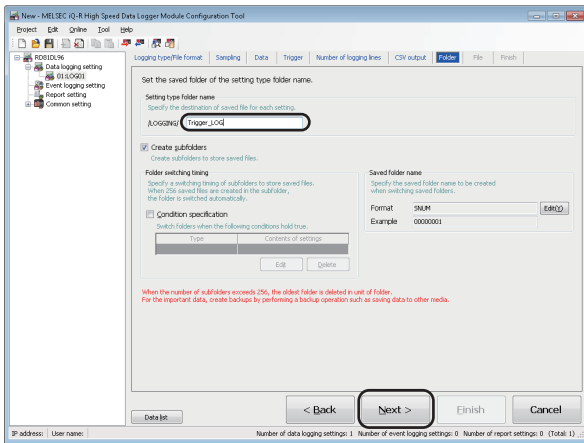

15. Select "Trigger logging unit" and enter '5' for the number of saved files, then click the [Edit] button.

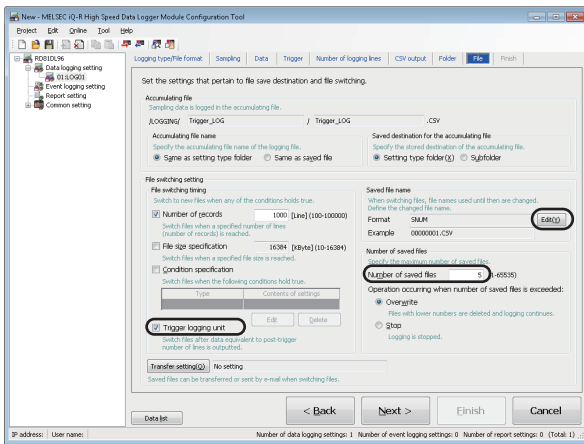

16. Select "Add the name", and click the [OK] button.

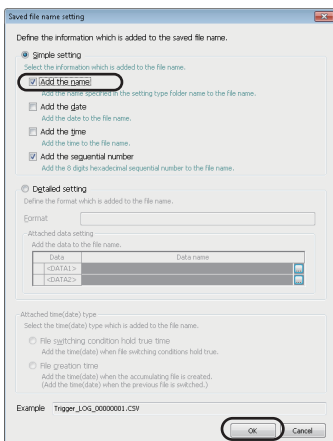

17. Click the [Next] button.

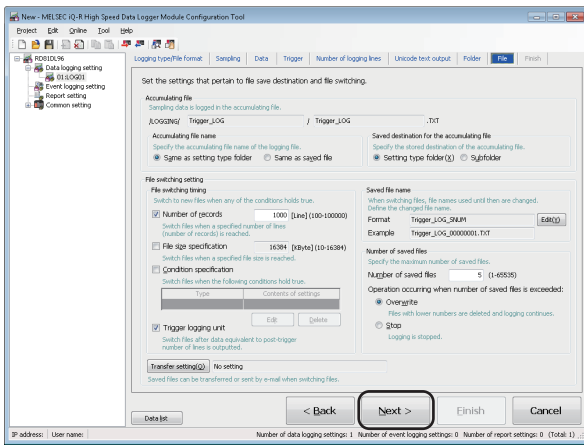

18. Enter 'Winder (Control data)' for the data logging name, and click the [Finish] button.

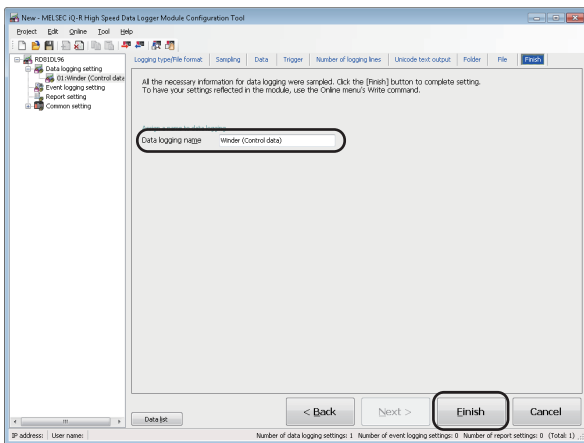

Write settings

Write the data logging settings to the high speed data logger module.

Specify the target module

1. Select [Online] ⇒ [Transfer setup].

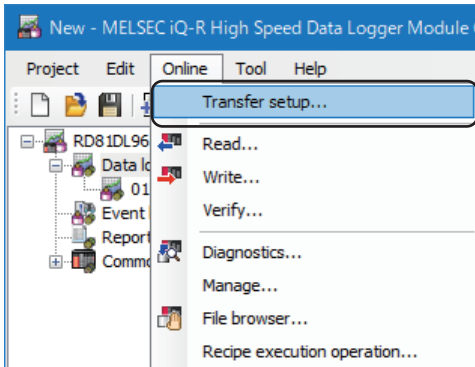

2. Select "Direct connection", and click the [Communication test] button.

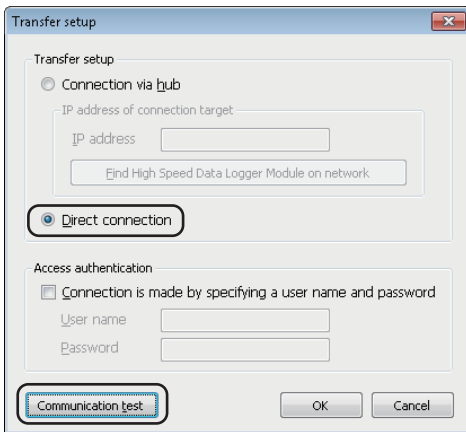

3. Click the [OK] button.

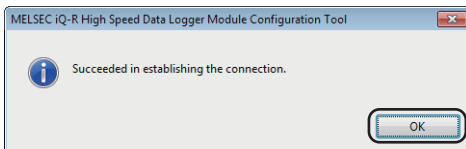

4. Click the [OK] button.

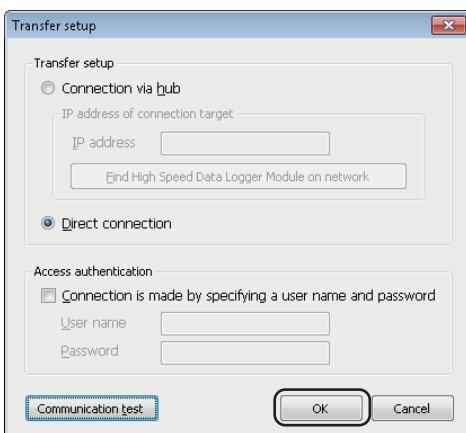

Write the settings

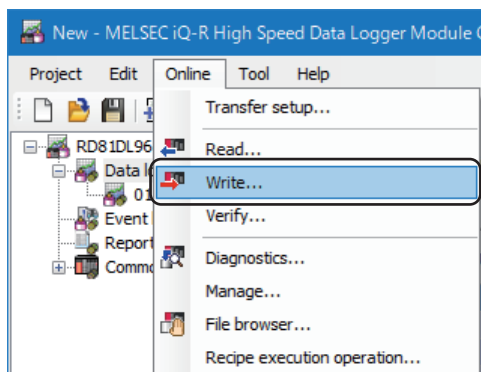

1. Select [Online] ⇒ [Write].

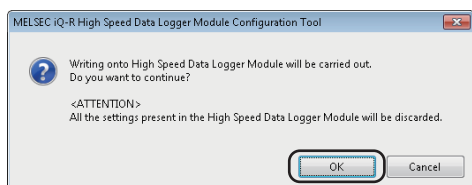

2. Click the [OK] button.

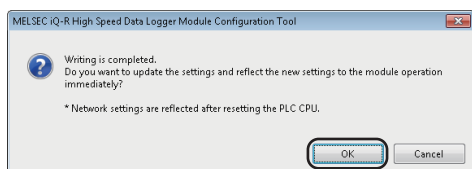

3. Click the [OK] button.

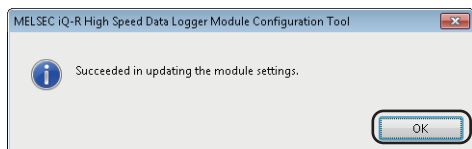

4. Click the [OK] button.

Graphical display of data

Display logged data in a graph using GX LogViewer, and check the values.

Start GX LogViewer

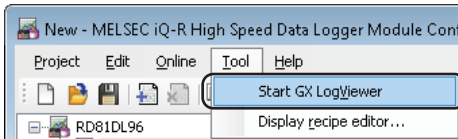

Select [Tool] ⇒ [Start GX LogViewer] to start GX LogViewer.

Specify the data to be displayed

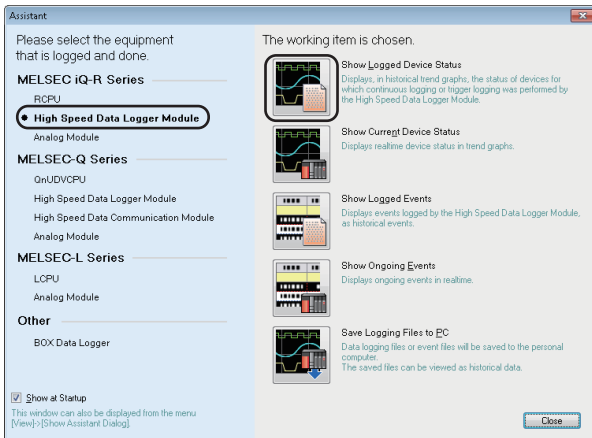

1. Select "High Speed Data Logger Module" of "MELSEC iQ-R Series", and click the icon of "Show Logged Device Status"

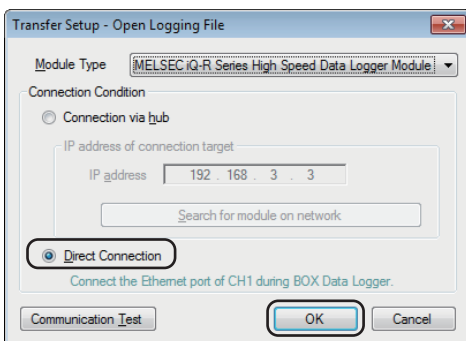

2. Select "Direct Connection", and click the [OK] button.

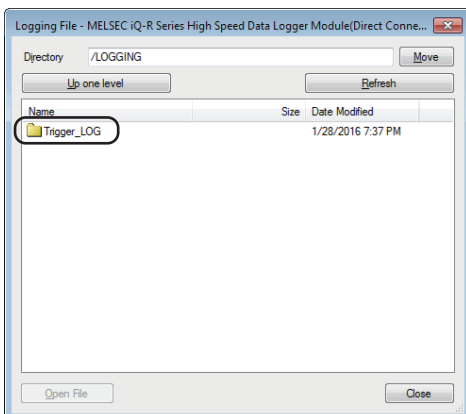

3. Double-click each folder in the following order:
"Trigger_LOG" → "00000001"

Point

Click the [Refresh] button when the folder is not displayed in the list.

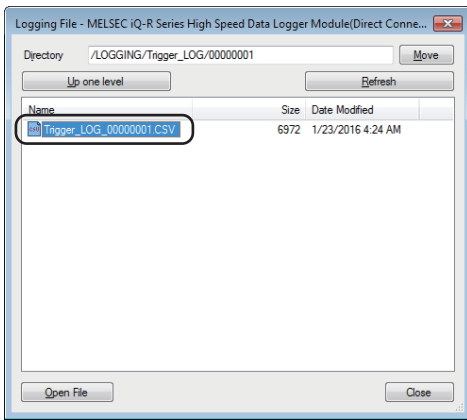

4. Select the displayed CSV file, and click the [Open File] button, then click the [Close] button.

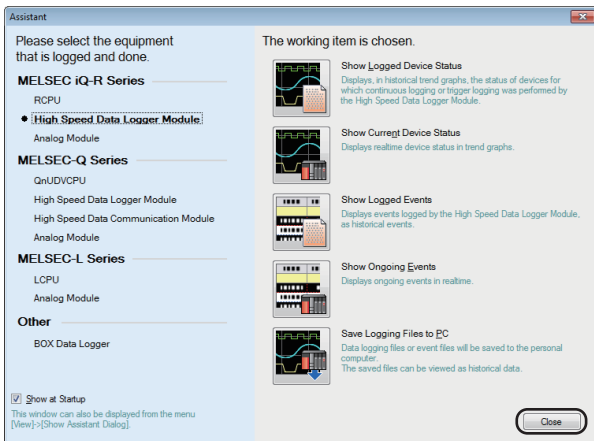

5. Click the [Close] button.

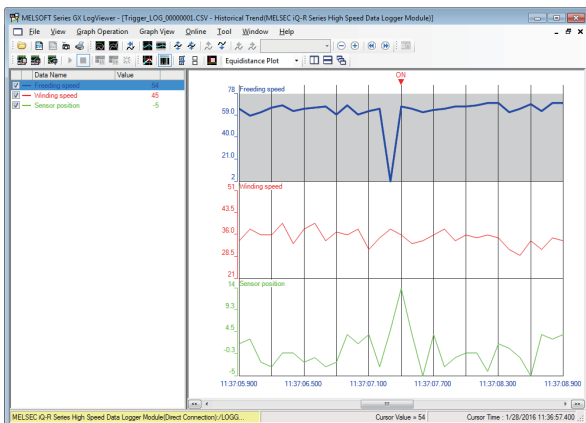

The data specified as target data in the data logging settings are displayed in the graph legend area and the graph area.

Point

Note that, in this operation examples, the background color was changed to white by the graph properties ([Graph View] ⇒ [Graph Properties]).

Colors of graph lines can be also changed in graph properties.

Display multiple cursors

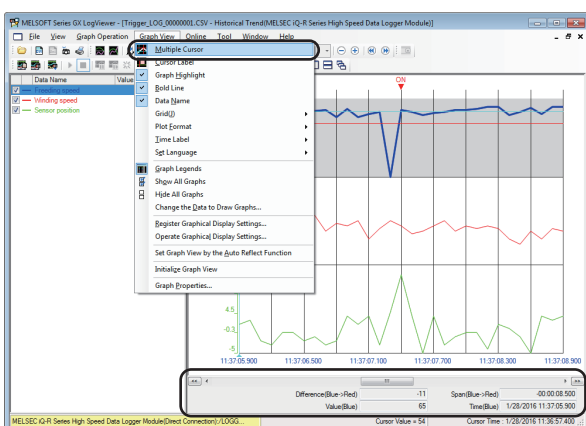

Select [Graph View] ⇒ [Multiple Cursor].
The difference information area is displayed.

Check data using the cursors

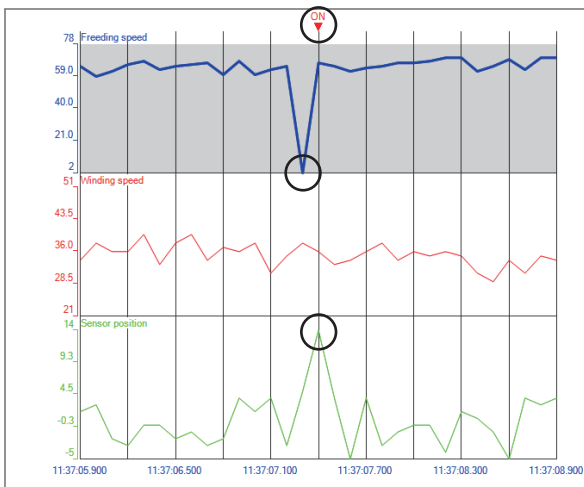
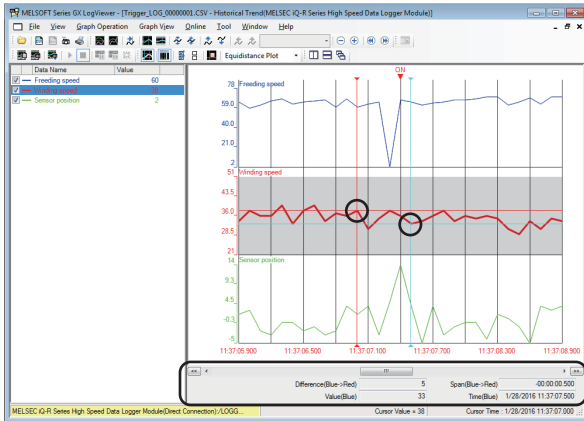
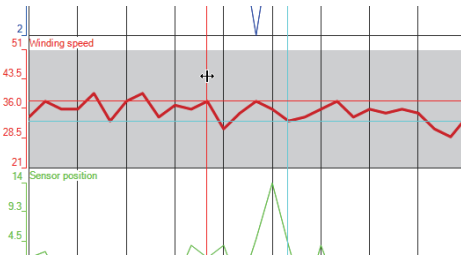

1. Select a graph. Move the red and blue cursors, located at the left edge of the graph, to the desired positions and check their respective values.

Point

For an easier operation, select [Move Red Cursor Here] or [Move Blue Cursor Here] from the menu displayed by right-clicking on a graph area.

2. Check the differences of respective values and times in the difference information area at the lower area of the screen.

The elapsed time and the value difference between the two cursors (blue to red) are displayed.

In addition, the value and time of each cursor's position are also displayed.

3. Analyze the cause of error from the graphs

- The sensor position rose rapidly, and a trigger occurred.
- The feeding speed drastically decreased immediately before the rise in sensor position, and thus, this could have caused the trigger.

8.3 Creating Reports from Continuously Logged Data

This section explains continuous logging function and report creation using Xbar-R management chart as an example.

Equipment figure

The film thickness (measured data) is measured at four points, and output it to the report (Excel format) named Xbar-R management chart.

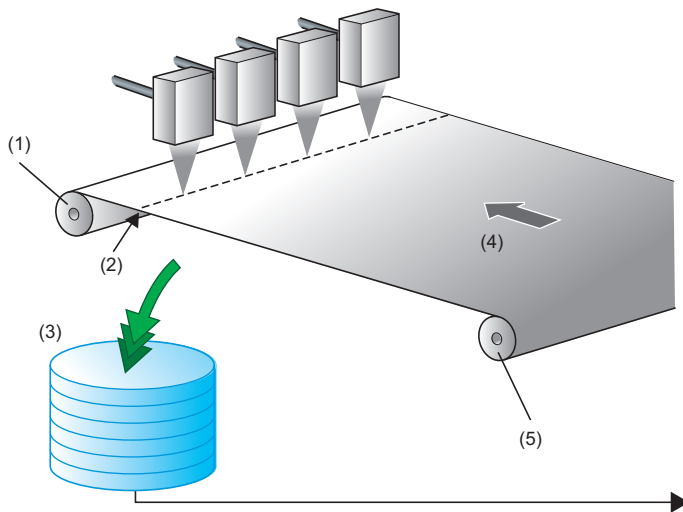

- (1) Winder
- (2) Position (length from the core of the feeder)
- (3) Logging data
- (4) Direction
- (5) Feeder

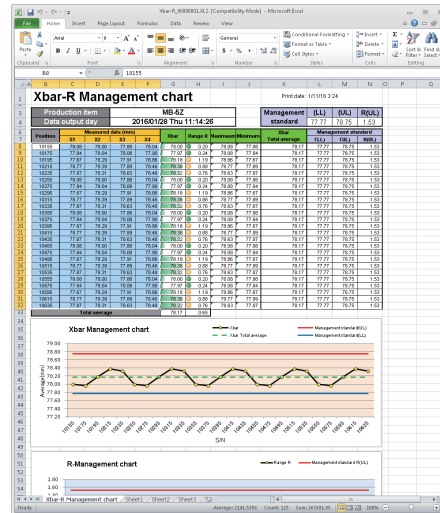

Operation flow

Perform the operations in the order below.

- 1. Data logging settings (continuous logging)**
Configure the data logging settings with Configuration Tool.
- 2. Report settings**
Configure the report settings with Configuration Tool.
- 3. Write settings**
Write the data logging settings and the report settings to the high speed data logger module.
- 4. Check created report**
Check the report created in an SD memory card which is inserted in the high speed data logger module on Excel.

Data logging settings (continuous logging)

Configure the data logging settings with Configuration Tool.

Starting Configuration Tool

Start MELSEC iQ-R High Speed Data Logger Module Configuration Tool from "MELSOFT" in Windows Start.

Configure the data logging settings

1. Click the [Data logging setting] button.

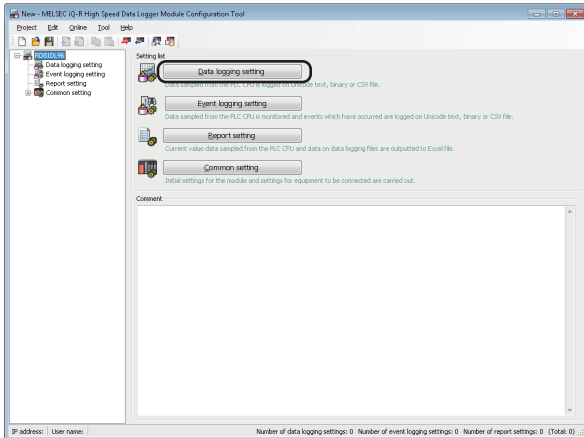

2. Click the [Edit] button.

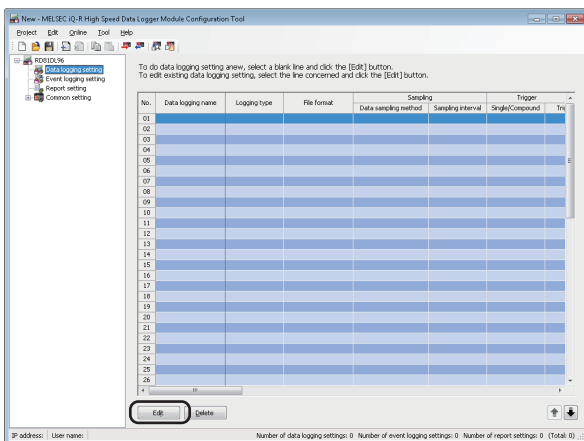

3. Select "Continuous logging" for logging type, and "Binary file" for file format, then click the [Next] button.

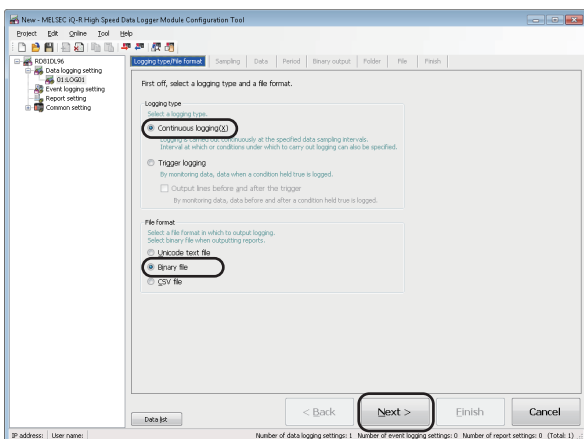

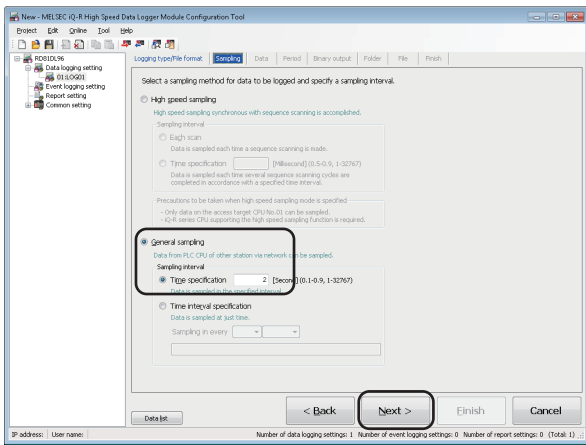

4. Enter '2' for the time specification of "General sampling", and click the [Next] button.

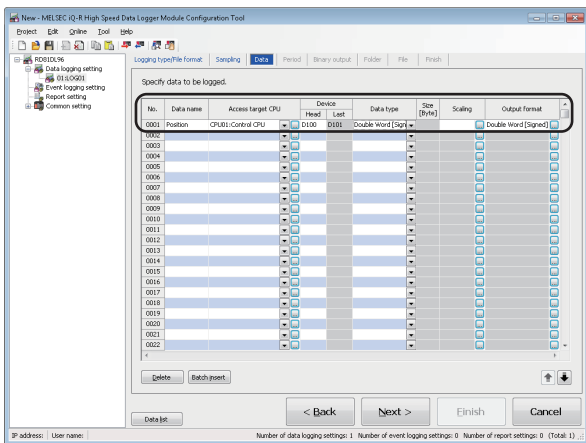

5. Set each setting item according to the following table.

Data name	Device (Head)	Data type
Position	D100	Double Word [Signed]

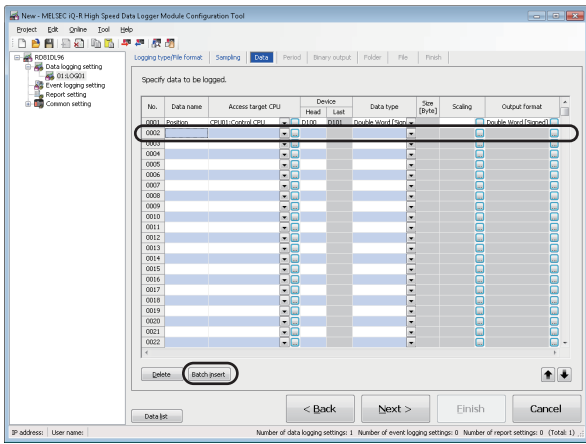

6. Select the second line in the data list, and click the [Batch insert] button.

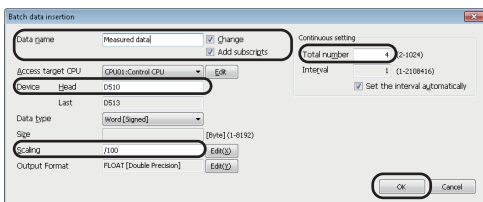

7. Set each setting item according to the following table, and click the [OK] button.

Setting item		Setting content
Data name	—	Measured data
	Change	Select
	Add subscripts	Select
Device (Head)		D510
Scaling		/100
Continuous setting	Total number	4

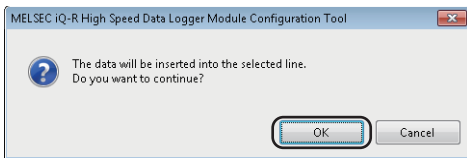

8. Click the [OK] button.

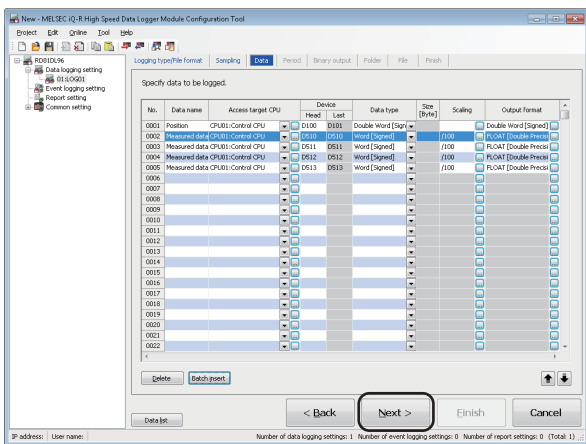

9. Click the [Next] button.

10. Click the [Next] button.

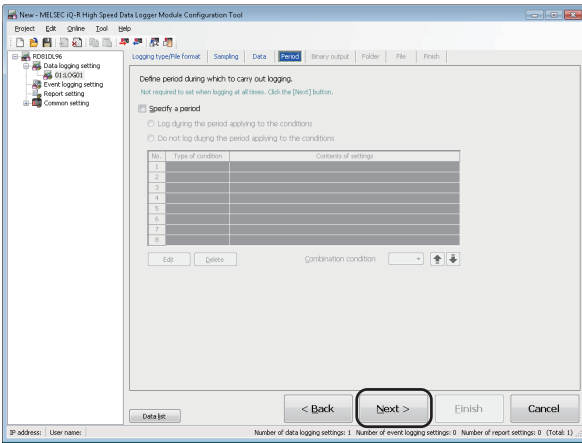

11. Click the [Next] button.

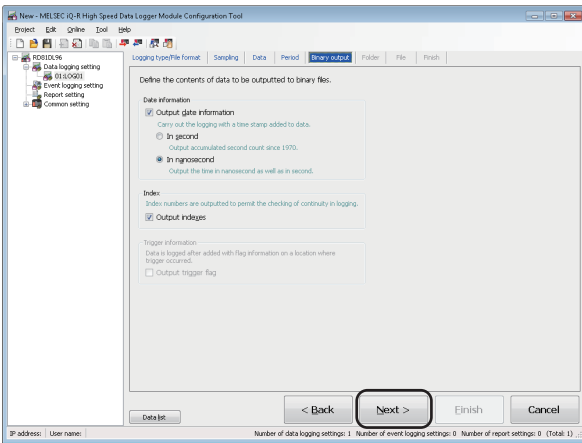

12. Enter 'Xbar-R' for the setting type folder name, and click the [Next] button.

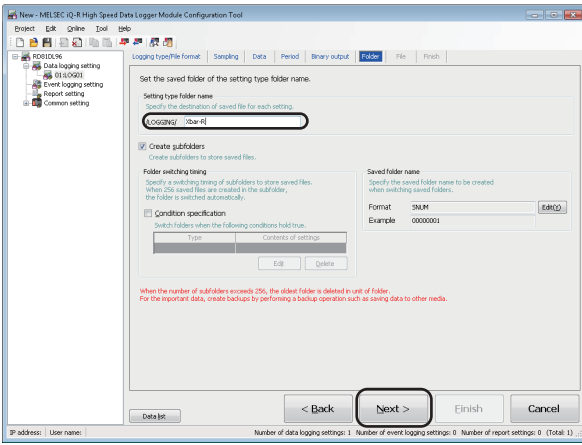

13. Select "Condition specification", and click the [Edit] button.

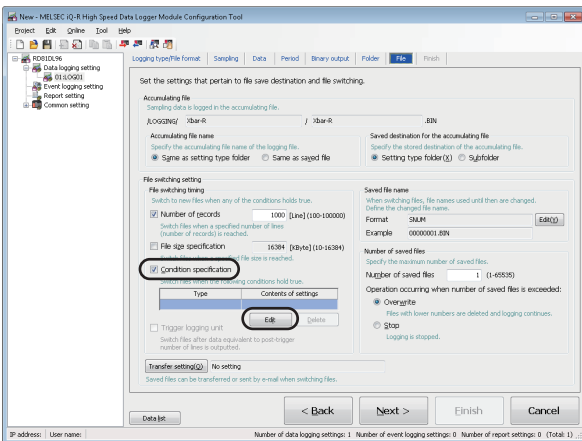

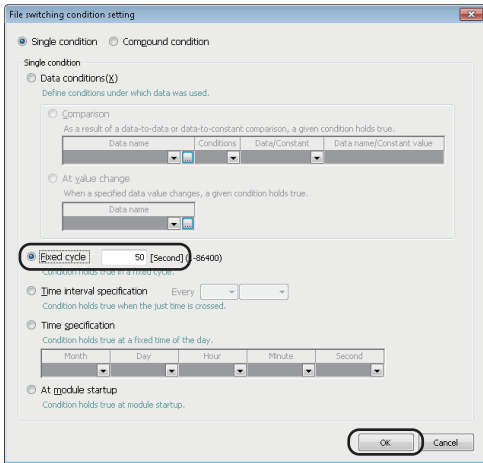

14. Select "Fixed cycle", enter '50', and click the [OK] button.

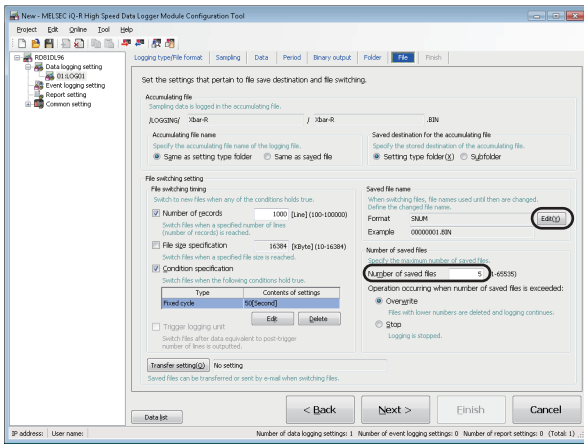

15. Enter '5' for the number of saved files, and click the [Edit] button.

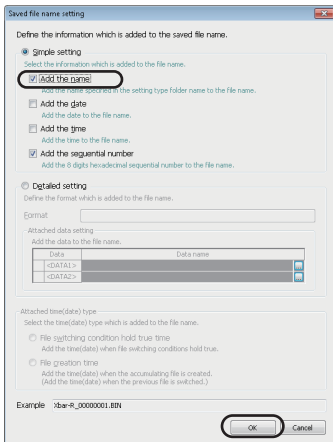

16. Select "Add the name", and click the [OK] button.

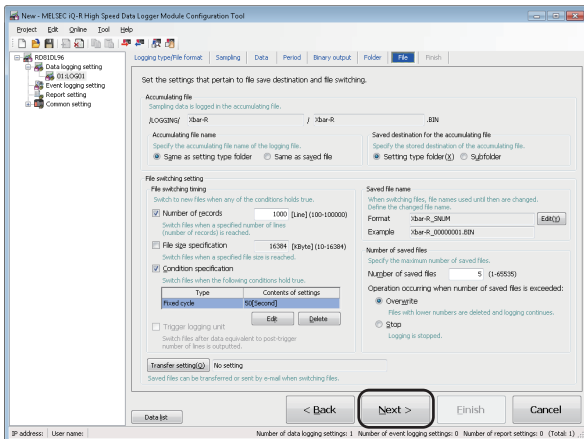

17. Click the [Next] button.

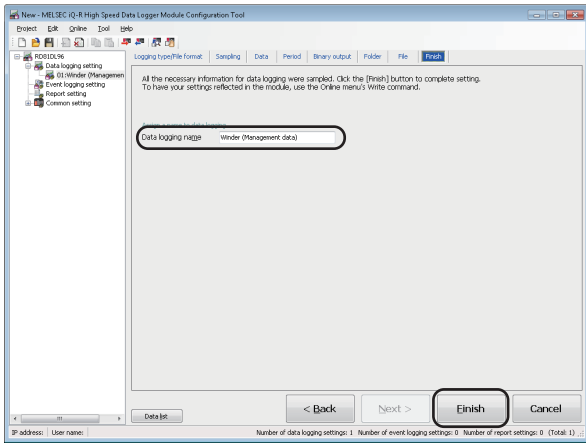

18. Enter 'Winder (Management data)' for the data logging name, and click the [Finish] button.

Report settings

Configure the report settings with Configuration Tool.

Configure the report settings

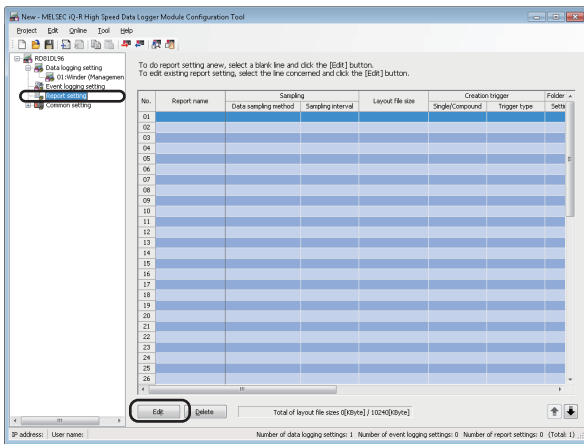

1. Click "Report setting" on the edit items tree, and click the [Edit] button.

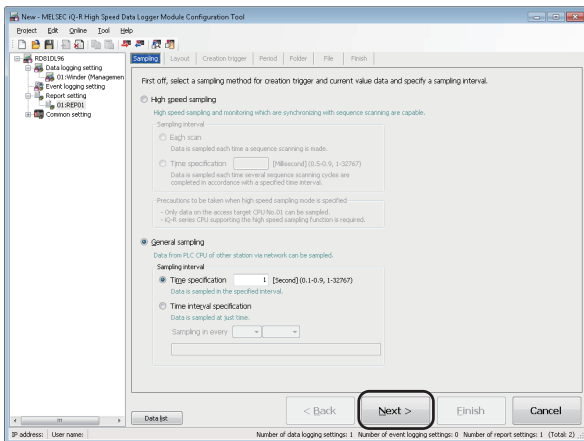

2. Click the [Next] button.

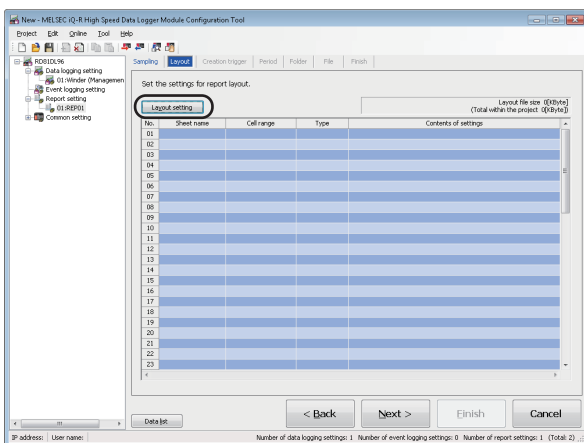

3. Click the [Layout setting] button.

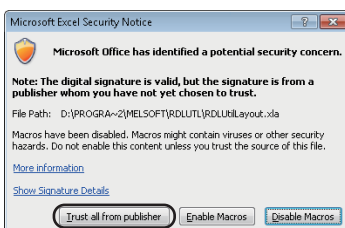

4. Click the [Trust all from publisher] button.

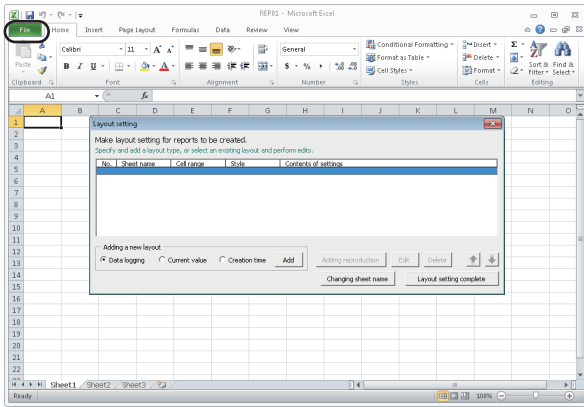

5. Select [File] ⇒ [Open].

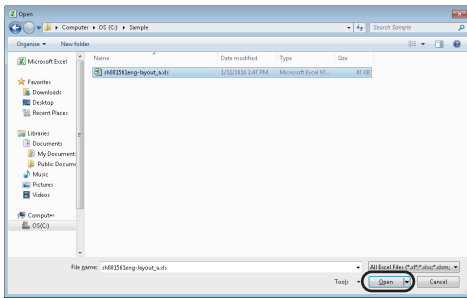

6. Select the acquired "sh081561eng-layout_a.xls" file, and click the [Open] button.

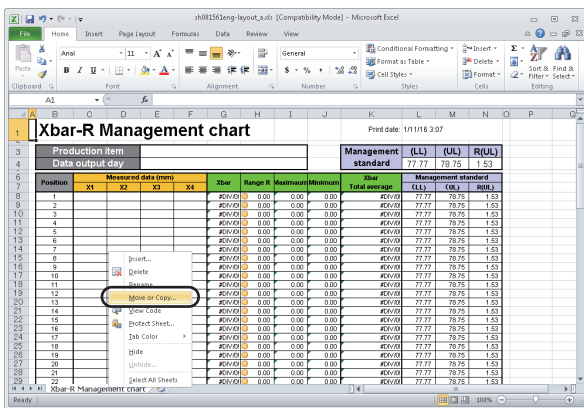

7. Right-click on the sheet tab, and select [Move or Copy].

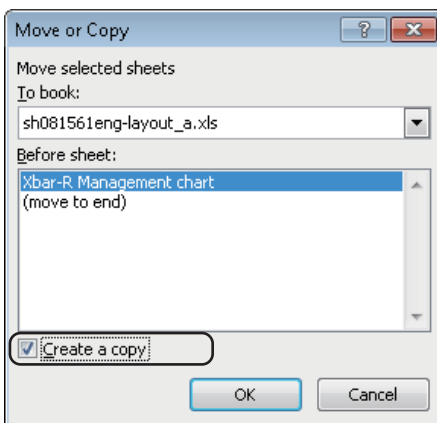

8. Select "Create a copy".

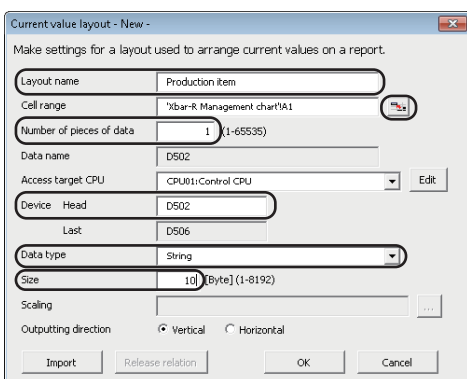
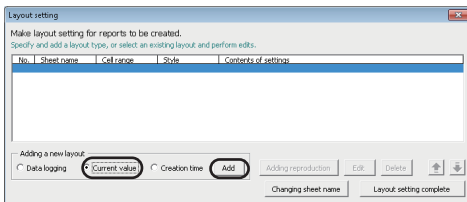
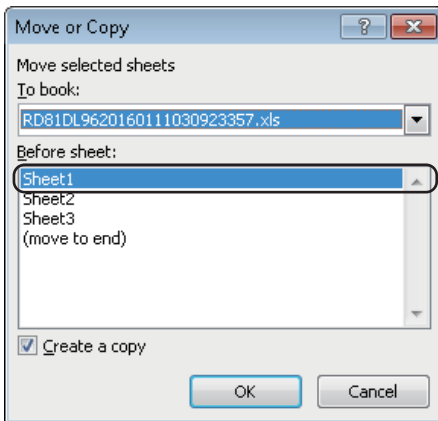
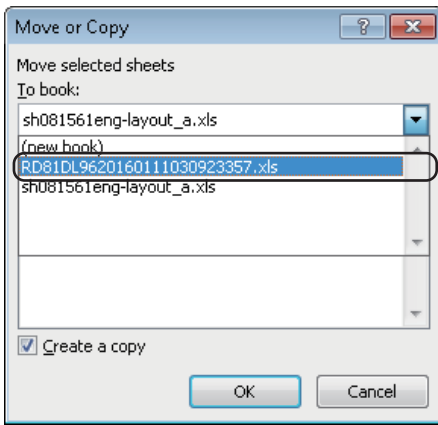

9. Select "RD81DL96YYYYMMDD....xls" from the list of "To book".

10. Select "Sheet1" from the list of "Before sheet", and click the [OK] button.

The "Xbar-R Management chart" sheet is copied to the file "REP01" on which the layout settings are configured. Close "sh081561eng-layout_a.xls" because it is not used for the later operation.

Restriction

A sheet name must be changed by using the [Changing sheet name] button on the "Layout setting" screen.

If the sheet name is changed using other methods, the layout settings will not configure properly.

11. Select "Current value", and click the [Add] button.

12. Set each setting item according to the following table, and click the  button.

Setting item	Setting content
Layout name	Production item
Number of pieces of data	1
Device (Head)	D502
Data type	String
Size	10

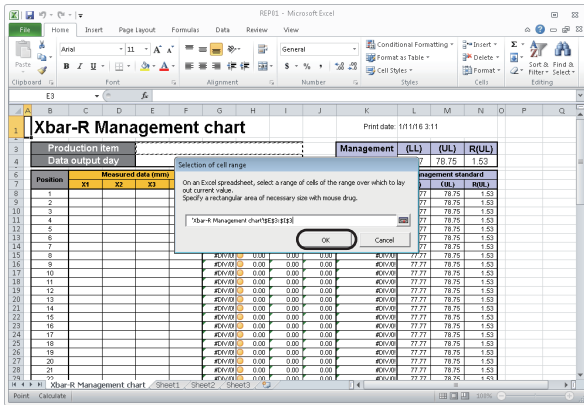

13. Select the cell to the right of "Production item", and click the [OK] button.

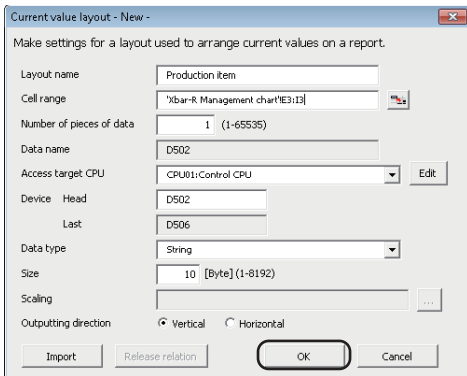

14. Click the [OK] button.

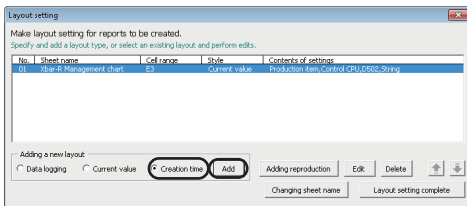

15. Select "Creation time", and click the [Add] button.

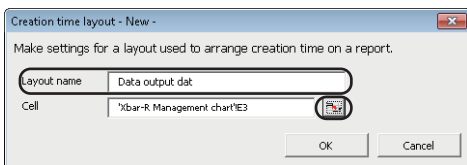

16. Enter 'Data output day' for layout name, and click the [OK] button.

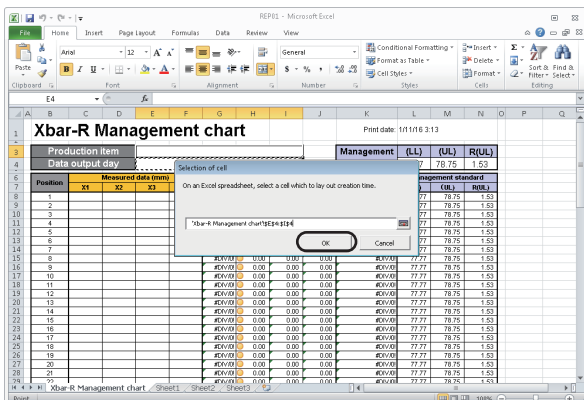

17. Select the cell to the right of "Data output day", and click the [OK] button.

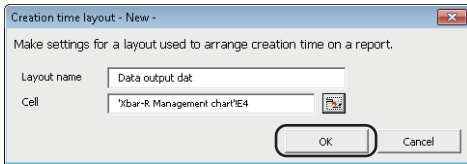

18. Click the [OK] button.

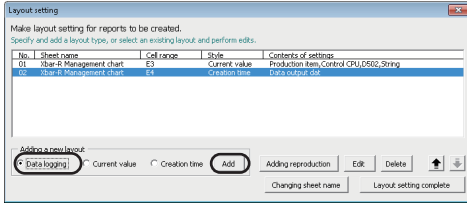

19. Select "Data logging", and click the [Add] button.

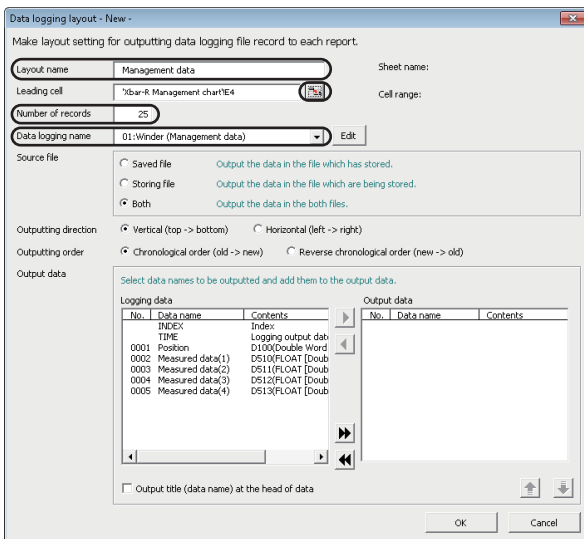

20. Set each setting item according to the following table, and click the [OK] button.

Setting item	Setting content
Layout name	Management data
Number of records	25
Data logging name	01:Winder (Management data)

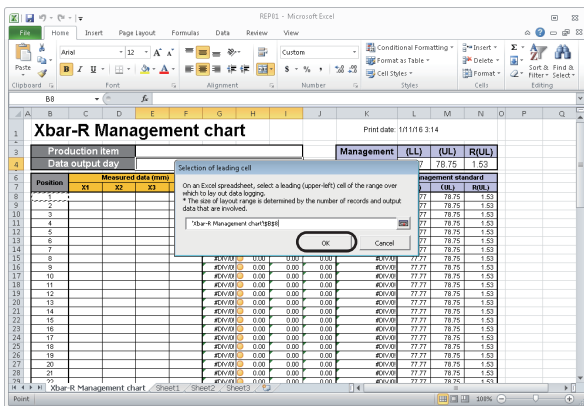

21. Select the cell under "Position", and click the [OK] button.

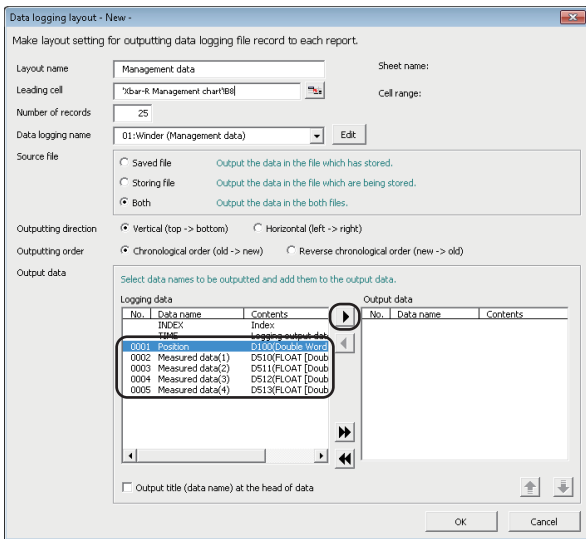

22. Select the logging data from No. 0001 to 0005 one by one, and click [▶] button. (Repeat the operation for each data.)

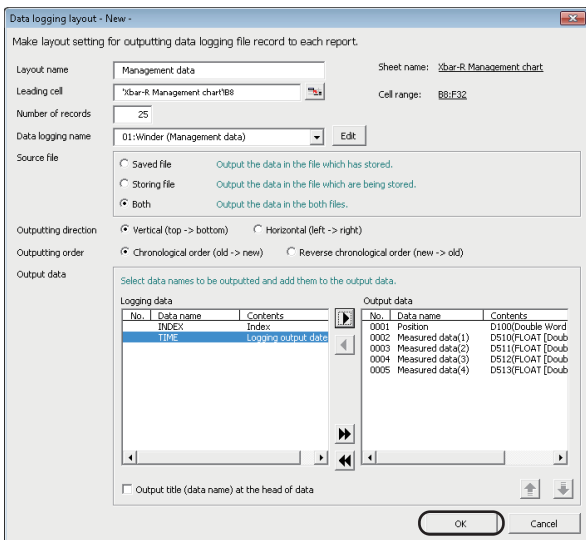

23. Click the [OK] button.

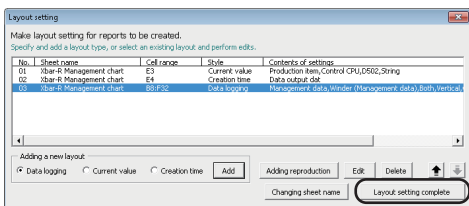

24. Click the [Layout setting complete] button.

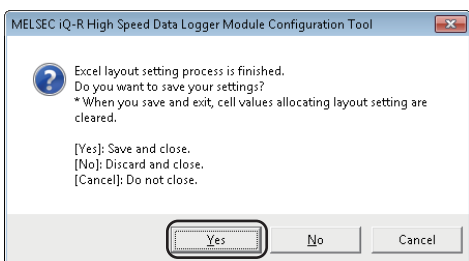

25. Click the [Yes] button.

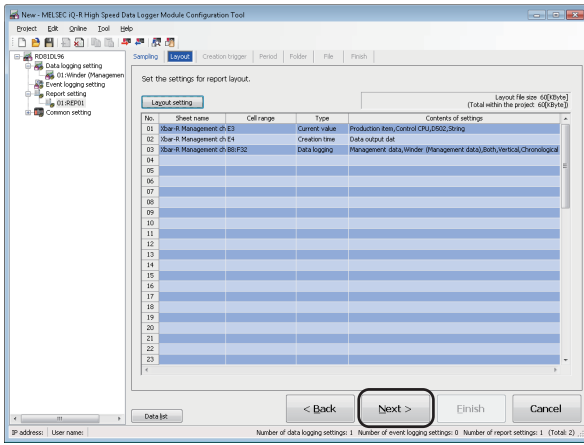

26. Click the [Next] button.

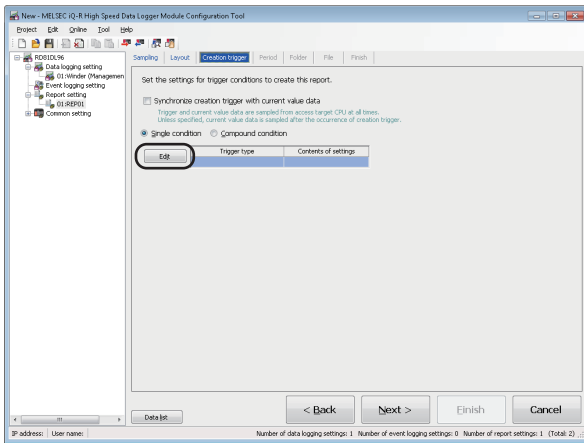

27. Click the [Edit] button.

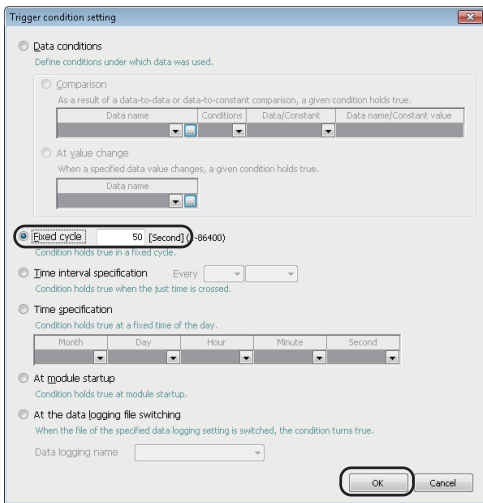

28. Select "Fixed cycle", enter '50', and click the [OK] button.

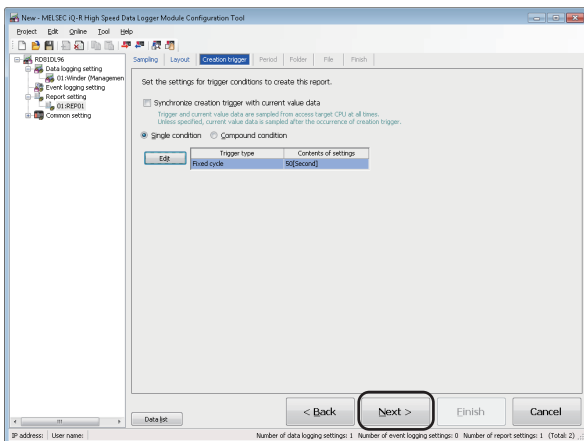

29. Click the [Next] button.

30. Click the [Next] button.

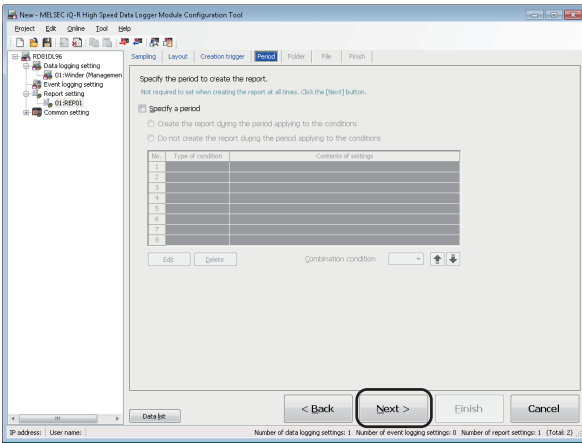

31. Enter 'Xbar-R' for the setting type folder name, and click the [Next] button.

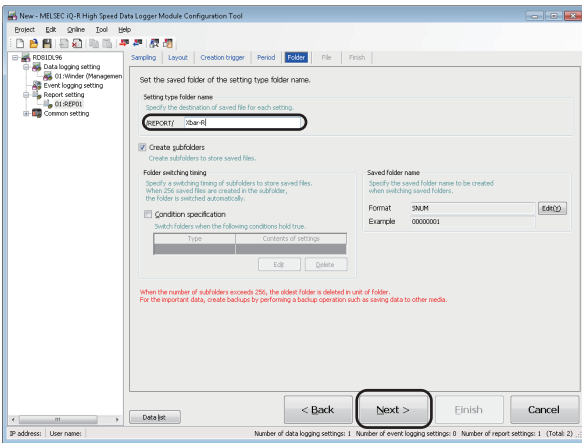

32. Enter '5' for the number of saved files, and click the [Edit] button.

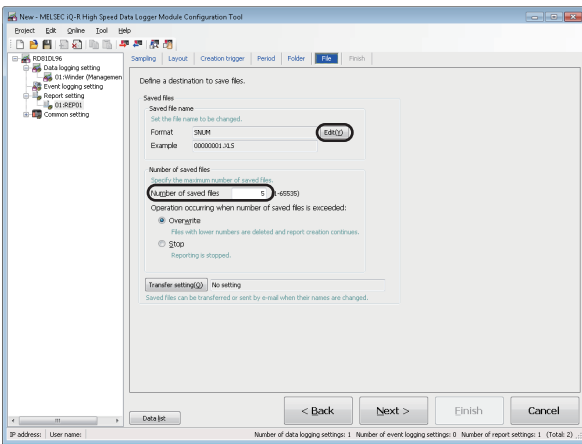

33. Select "Add the name", and click the [OK] button.

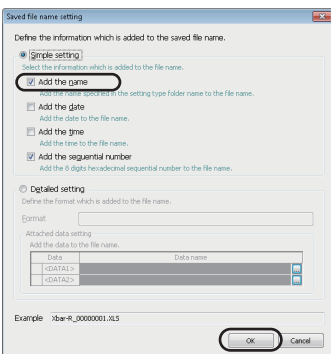

34. Click the [Next] button.

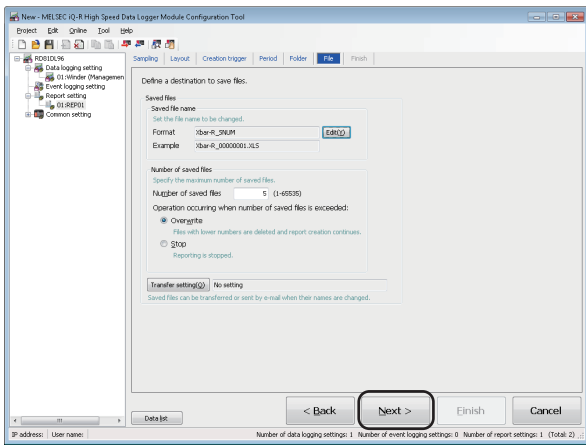

35. Enter 'Winder (Management chart)' for the report name, and click the [Finish] button.

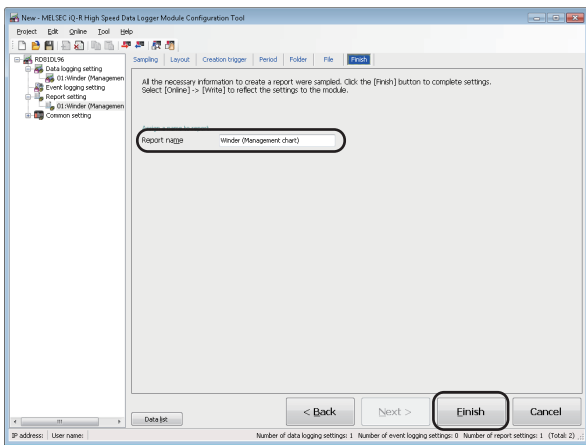

Write settings

Write the data logging settings and the report settings to the high speed data logger module.

Specify the target module

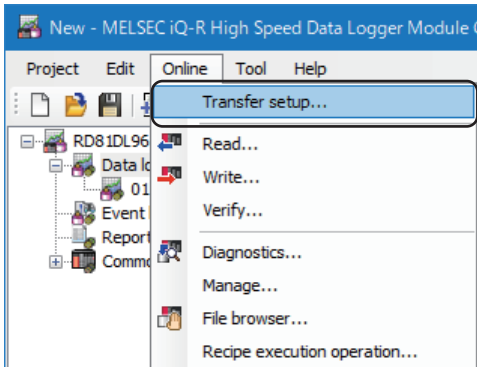

1. Select [Online] ⇒ [Transfer setup].

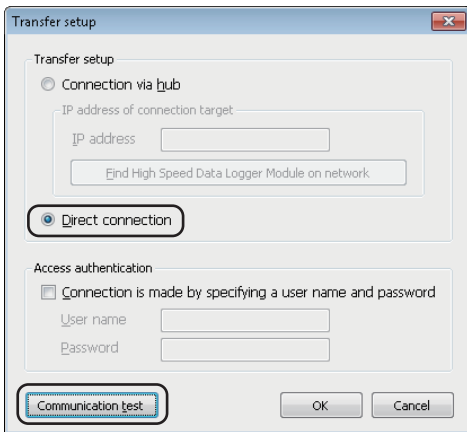

2. Select "Direct connection", and click the [Communication test] button.

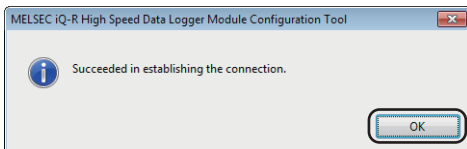

3. Click the [OK] button.

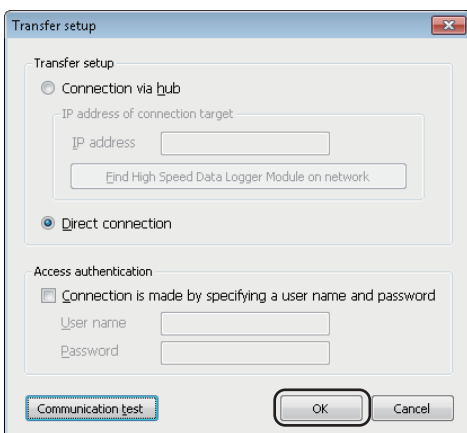

4. Click the [OK] button.

Write the settings

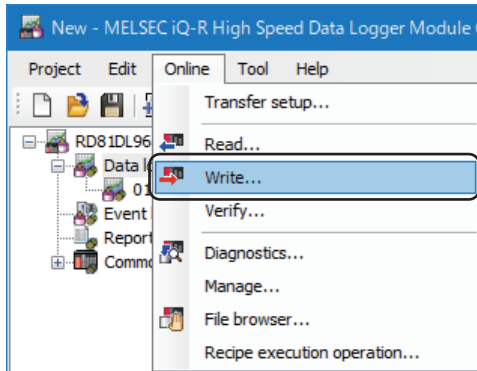

1. Select [Online] ⇒ [Write].

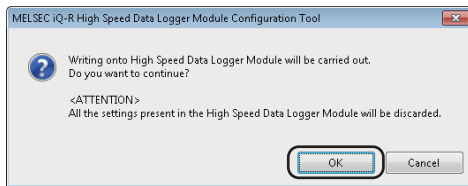

2. Click the [OK] button.

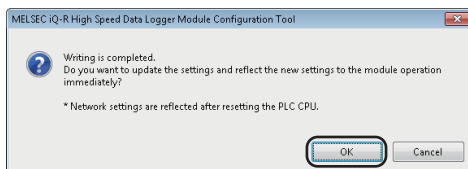

3. Click the [OK] button.

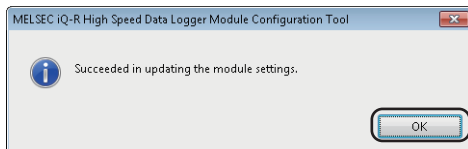

4. Click the [OK] button.

Checking created report

Check the report created in an SD memory card which is inserted in the high speed data logger module on Excel.

Saves the report file to a personal computer

1. Select [Online] ⇒ [File browser].

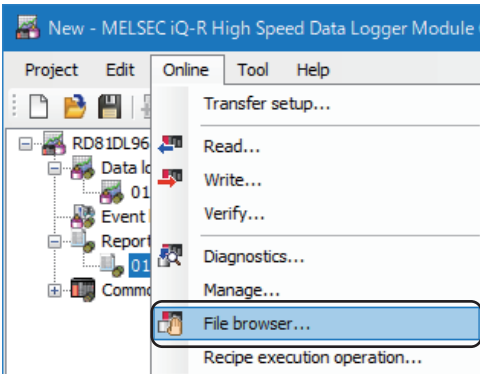

2. Double-click each folder in the following order:
"REPORT" → "Xbar-R" → "00000001"

Point

Click the [Refresh] button when the folder is not displayed in the list.

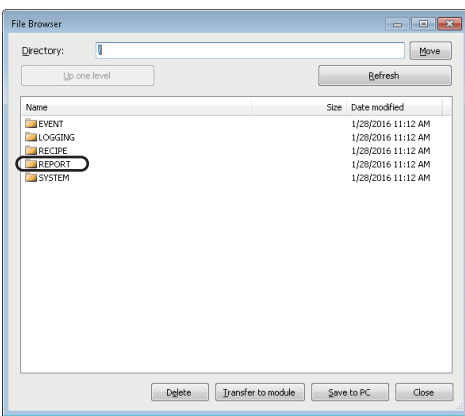

3. Select an Excel file, and click the [Save to PC] button.

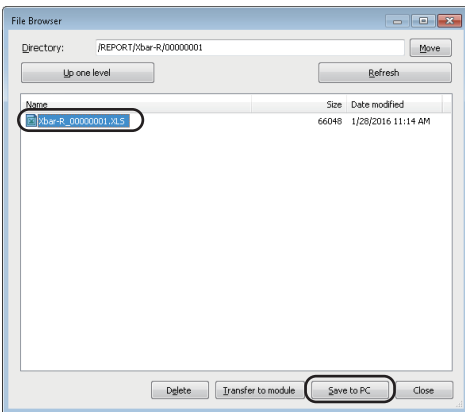

4. Specify the save destination (option), and click the [Save] button.

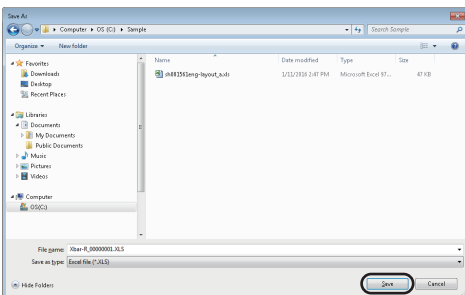

5. Click the [Close] button.

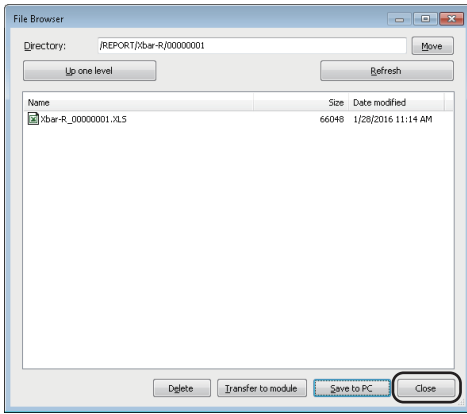

Check a report on Excel

1. Open an Excel file saved in a personal computer.
2. Check that the logged data are applied to the table and graphs on the "Xbar-R Management chart" sheet.

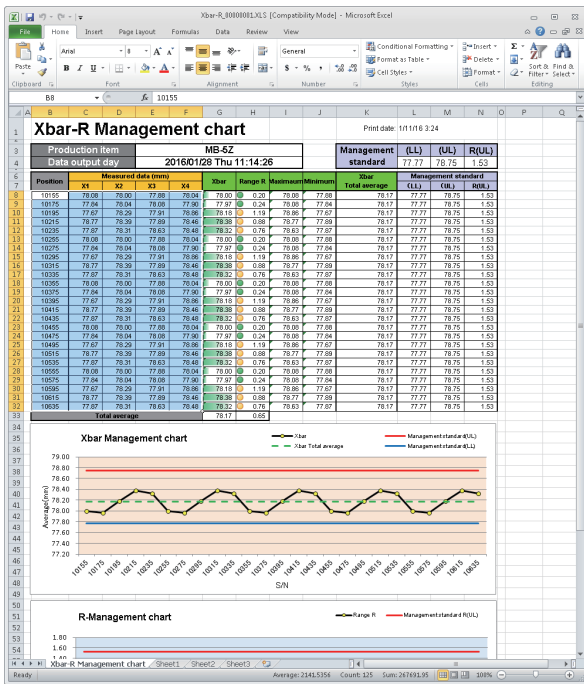

APPENDIX

Appendix 1 External Dimensions

The following figures show the external dimensions of a high speed data logger module.

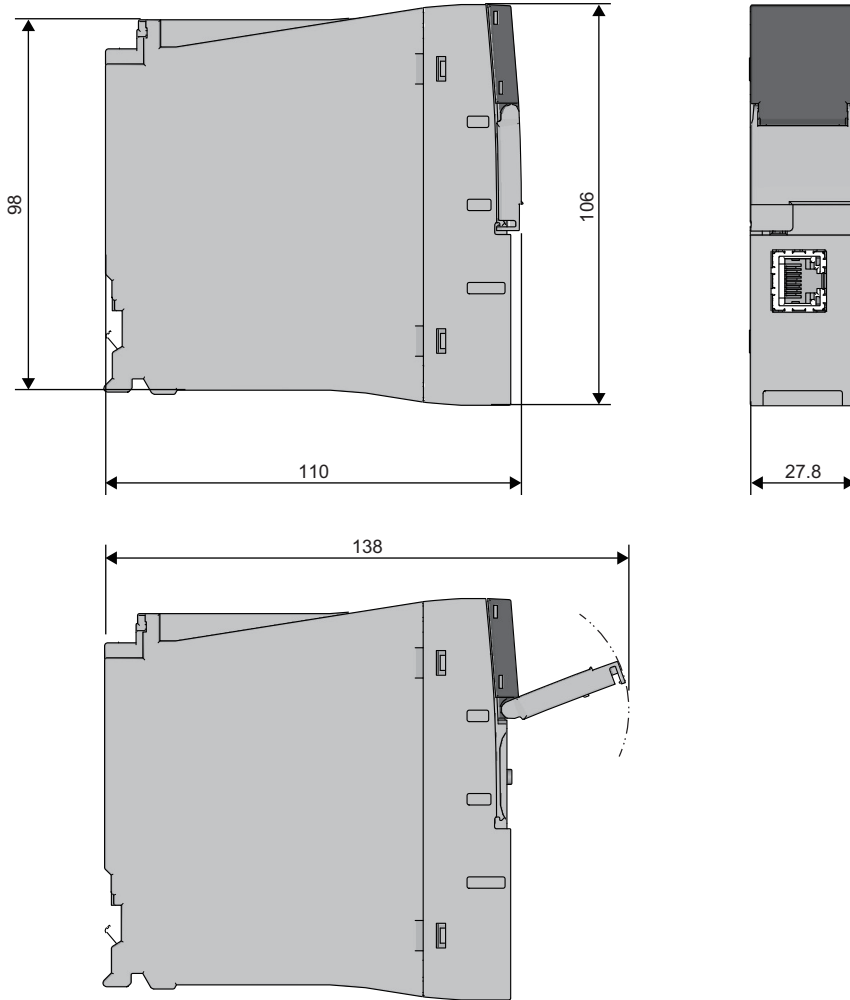

(Unit: mm)

MEMO

A

INDEX

D

Direct connection 68

E

Edit item tree 57,59

Ethernet (twisted pair) cable. 70

I

Item. 59

O

Offline startup 53

Online module change. 49

Online startup 53

S

SD memory card 62,70

SD memory card format. 14

Self-diagnostic 49

MEMO

REVISIONS

*The manual number is given on the bottom left of the back cover.

Revision date	*Manual number	Description
December 2015	SH(NA)-081561ENG-A	First edition
April 2016	SH(NA)-081561ENG-B	■Added or modified parts CONSIDERATIONS FOR USE, Section 2.1, Section 3.1, Section 4.1, Section 5.3, Section 7.1
December 2016	SH(NA)-081561ENG-C	■Added or modified parts CONSIDERATIONS FOR USE, Section 2.2, Section 5.1, Section 5.3
October 2017	SH(NA)-081561ENG-D	■Added or modified parts Section 2.1, Section 2.2
July 2019	SH(NA)-081561ENG-E	■Added or modified parts CONSIDERATIONS FOR USE, Section 2.2
April 2020	SH(NA)-081561ENG-F	■Added or modified parts Section 3.1, Section 3.2, Section 4.1
October 2020	SH(NA)-081561ENG-G	■Added or modified parts SAFETY PRECAUTIONS, CONDITIONS OF USE FOR THE PRODUCT, Section 3.2, Section 4.1
March 2022	SH(NA)-081561ENG-H	■Added or modified parts CONSIDERATIONS FOR USE, Section 2.1, Section 4.1, Section 5.3
August 2022	SH(NA)-081561ENG-I	■Added or modified parts CONSIDERATIONS FOR USE, INTRODUCTION, Section 2.2, Section 4.1, Section 5.4, COPYRIGHTS
March 2023	SH(NA)-081561ENG-J	■Added or modified parts Section 2.1, Section 5.1

Japanese manual number: SH-081559-J

This manual confers no industrial property rights or any rights of any other kind, nor does it confer any patent licenses. Mitsubishi Electric Corporation cannot be held responsible for any problems involving industrial property rights which may occur as a result of using the contents noted in this manual.

© 2015 MITSUBISHI ELECTRIC CORPORATION

WARRANTY

Please confirm the following product warranty details before using this product.

1. Gratis Warranty Term and Gratis Warranty Range

If any faults or defects (hereinafter "Failure") found to be the responsibility of Mitsubishi occurs during use of the product within the gratis warranty term, the product shall be repaired at no cost via the sales representative or Mitsubishi Service Company.

However, if repairs are required onsite at domestic or overseas location, expenses to send an engineer will be solely at the customer's discretion. Mitsubishi shall not be held responsible for any re-commissioning, maintenance, or testing on-site that involves replacement of the failed module.

[Gratis Warranty Term]

The gratis warranty term of the product shall be for one year after the date of purchase or delivery to a designated place. Note that after manufacture and shipment from Mitsubishi, the maximum distribution period shall be six (6) months, and the longest gratis warranty term after manufacturing shall be eighteen (18) months. The gratis warranty term of repair parts shall not exceed the gratis warranty term before repairs.

[Gratis Warranty Range]

- (1) The range shall be limited to normal use within the usage state, usage methods and usage environment, etc., which follow the conditions and precautions, etc., given in the instruction manual, user's manual and caution labels on the product.
- (2) Even within the gratis warranty term, repairs shall be charged for in the following cases.
 1. Failure occurring from inappropriate storage or handling, carelessness or negligence by the user. Failure caused by the user's hardware or software design.
 2. Failure caused by unapproved modifications, etc., to the product by the user.
 3. When the Mitsubishi product is assembled into a user's device, Failure that could have been avoided if functions or structures, judged as necessary in the legal safety measures the user's device is subject to or as necessary by industry standards, had been provided.
 4. Failure that could have been avoided if consumable parts (battery, backlight, fuse, etc.) designated in the instruction manual had been correctly serviced or replaced.
 5. Failure caused by external irresistible forces such as fires or abnormal voltages, and Failure caused by force majeure such as earthquakes, lightning, wind and water damage.
 6. Failure caused by reasons unpredictable by scientific technology standards at time of shipment from Mitsubishi.
 7. Any other failure found not to be the responsibility of Mitsubishi or that admitted not to be so by the user.

2. Onerous repair term after discontinuation of production

- (1) Mitsubishi shall accept onerous product repairs for seven (7) years after production of the product is discontinued. Discontinuation of production shall be notified with Mitsubishi Technical Bulletins, etc.
- (2) Product supply (including repair parts) is not available after production is discontinued.

3. Overseas service

Overseas, repairs shall be accepted by Mitsubishi's local overseas FA Center. Note that the repair conditions at each FA Center may differ.

4. Exclusion of loss in opportunity and secondary loss from warranty liability

Regardless of the gratis warranty term, Mitsubishi shall not be liable for compensation to:

- (1) Damages caused by any cause found not to be the responsibility of Mitsubishi.
- (2) Loss in opportunity, lost profits incurred to the user by Failures of Mitsubishi products.
- (3) Special damages and secondary damages whether foreseeable or not, compensation for accidents, and compensation for damages to products other than Mitsubishi products.
- (4) Replacement by the user, maintenance of on-site equipment, start-up test run and other tasks.

5. Changes in product specifications

The specifications given in the catalogs, manuals or technical documents are subject to change without prior notice.

TRADEMARKS

Intel is either registered trademarks or trademarks of Intel Corporation in the United States and/or other countries. Microsoft, Excel, Internet Explorer, Microsoft Edge, Visual Basic, and Windows are trademarks of the Microsoft group of companies.

Oracle and Java are registered trademarks of Oracle and/or its affiliates.

Unicode is either a registered trademark or a trademark of Unicode, Inc. in the United States and other countries.

The company names, system names and product names mentioned in this manual are either registered trademarks or trademarks of their respective companies.

In some cases, trademark symbols such as [™] or [®] are not specified in this manual.

COPYRIGHTS

The screens (screenshots) are used in accordance with the Microsoft Corporation guideline.

SH(NA)-081561ENG-J(2303)KWIX

MODEL: RD81DL96-U-IN-E

MODEL CODE: 13JX40

MITSUBISHI ELECTRIC CORPORATION

HEAD OFFICE: TOKYO BLDG., 2-7-3, MARUNOUCHI, CHIYODA-KU, TOKYO 100-8310, JAPAN
NAGOYA WORKS: 1-14, YADA-MINAMI 5-CHOME, HIGASHI-KU, NAGOYA 461-8670, JAPAN

When exported from Japan, this manual does not require application to the
Ministry of Economy, Trade and Industry for service transaction permission.

Specifications subject to change without notice.