

Programmable Controller

MELSEC iQ-R
series

MELSEC iQ-R High Speed Data Logger Module User's Manual (Application)

-RD81DL96
-SW1DNN-RDLUTL (High Speed Data Logger Module Tool)



SAFETY PRECAUTIONS

(Read these precautions before using this product.)

Before using this product, please read this manual and the relevant manuals carefully and pay full attention to safety to handle the product correctly. If products are used in a different way from that specified by manufacturers, the protection function of the products may not work properly.

The precautions given in this manual are concerned with this product only. For the safety precautions of the programmable controller system, refer to the MELSEC iQ-R Module Configuration Manual.

In this manual, the safety precautions are classified into two levels: "⚠ WARNING" and "⚠ CAUTION".

 WARNING	Indicates that incorrect handling may cause hazardous conditions, resulting in death or severe injury.
 CAUTION	Indicates that incorrect handling may cause hazardous conditions, resulting in minor or moderate injury or property damage.

Under some circumstances, failure to observe the precautions given under "⚠ CAUTION" may lead to serious consequences.

Observe the precautions of both levels because they are important for personal and system safety.

Make sure that the end users read this manual and then keep the manual in a safe place for future reference.

[Design Precautions]

WARNING

- Configure safety circuits external to the programmable controller to ensure that the entire system operates safely even when a fault occurs in the external power supply or the programmable controller. Failure to do so may result in an accident due to an incorrect output or malfunction.
 - (1) Emergency stop circuits, protection circuits, and protective interlock circuits for conflicting operations (such as forward/reverse rotations or upper/lower limit positioning) must be configured external to the programmable controller.
 - (2) When the programmable controller detects an abnormal condition, it stops the operation and all outputs are:
 - Turned off if the overcurrent or overvoltage protection of the power supply module is activated.
 - Held or turned off according to the parameter setting if the self-diagnostic function of the CPU module detects an error such as a watchdog timer error.
 - (3) All outputs may be turned on if an error occurs in a part, such as an I/O control part, where the CPU module cannot detect any error. To ensure safety operation in such a case, provide a safety mechanism or a fail-safe circuit external to the programmable controller. For a fail-safe circuit example, refer to "General Safety Requirements" in the MELSEC iQ-R Module Configuration Manual.
 - (4) Outputs may remain on or off due to a failure of a component such as a relay and transistor in an output circuit. Configure an external circuit for monitoring output signals that could cause a serious accident.
 - In an output circuit, when a load current exceeding the rated current or an overcurrent caused by a load short-circuit flows for a long time, it may cause smoke and fire. To prevent this, configure an external safety circuit, such as a fuse.
 - Configure a circuit so that the programmable controller is turned on first and then the external power supply. If the external power supply is turned on first, an accident may occur due to an incorrect output or malfunction.
 - Configure a circuit so that the external power supply is turned off first and then the programmable controller. If the programmable controller is turned off first, an accident may occur due to an incorrect output or malfunction.
 - For the operating status of each station after a communication failure, refer to manuals for the network used. For the manuals, please consult your local Mitsubishi representative. Incorrect output or malfunction due to a communication failure may result in an accident.
 - When connecting an external device with a CPU module or intelligent function module to modify data of a running programmable controller, configure an interlock circuit in the program to ensure that the entire system will always operate safely. For other forms of control (such as program modification, parameter change, forced output, or operating status change) of a running programmable controller, read the relevant manuals carefully and ensure that the operation is safe before proceeding. Improper operation may damage machines or cause accidents. When a Safety CPU is used, data cannot be modified while the Safety CPU is in SAFETY MODE.
 - Especially, when a remote programmable controller is controlled by an external device, immediate action cannot be taken if a problem occurs in the programmable controller due to a communication failure. To prevent this, configure an interlock circuit in the program, and determine corrective actions to be taken between the external device and CPU module in case of a communication failure.
-

[Design Precautions]

WARNING

- Do not write any data to the "system area" and "write-protect area" of the buffer memory in the module. Also, do not use any "use prohibited" signals as an output signal from the CPU module to each module. Doing so may cause malfunction of the programmable controller system. For the "system area", "write-protect area", and the "use prohibited" signals, refer to the user's manual for the module used. For areas used for safety communications, they are protected from being written by users, and thus safety communications failure caused by data writing does not occur.
 - If a communication cable is disconnected, the network may be unstable, resulting in a communication failure of multiple stations. Configure an interlock circuit in the program to ensure that the entire system will always operate safely even if communications fail. Incorrect output or malfunction due to a communication failure may result in an accident. When safety communications are used, an interlock by the safety station interlock function protects the system from an incorrect output or malfunction.
-

[Design Precautions]

CAUTION

- Do not install the control lines or communication cables together with the main circuit lines or power cables. Doing so may result in malfunction due to electromagnetic interference. Keep a distance of 100mm or more between those cables.
 - During control of an inductive load such as a lamp, heater, or solenoid valve, a large current (approximately ten times greater than normal) may flow when the output is turned from OFF to ON. Therefore, use a module that has a sufficient current rating.
 - After the CPU module is powered ON or is reset, the time taken to enter the RUN status varies depending on the system configuration, parameter settings, and/or program size. Design circuits so that the entire system will always operate safely, regardless of the time.
 - Do not power off the programmable controller or reset the CPU module while the settings are being written. Doing so will make the data in the flash ROM and SD memory card undefined. The values need to be set in the buffer memory and written to the flash ROM and SD memory card again. Doing so also may cause malfunction or failure of the module.
 - When changing the operating status of the CPU module from external devices (such as the remote RUN/STOP functions), select "Do Not Open by Program" for "Opening Method" of "Module Parameter". If "Open by Program" is selected, an execution of the remote STOP function causes the communication line to close. Consequently, the CPU module cannot reopen the line, and external devices cannot execute the remote RUN function.
-

[Security Precautions]

WARNING

- To maintain the security (confidentiality, integrity, and availability) of the programmable controller and the system against unauthorized access, denial-of-service (DoS) attacks, computer viruses, and other cyberattacks from external devices via the network, take appropriate measures such as firewalls, virtual private networks (VPNs), and antivirus solutions.
-

[Installation Precautions]

WARNING

- Shut off the external power supply (all phases) used in the system before mounting or removing the module. Failure to do so may result in electric shock or cause the module to fail or malfunction.
-

[Installation Precautions]

CAUTION

- Use the programmable controller in an environment that meets the general specifications in the MELSEC iQ-R Module Configuration Manual. Failure to do so may result in electric shock, fire, malfunction, or damage to or deterioration of the product.
 - To mount a module, place the concave part(s) located at the bottom onto the guide(s) of the base unit, and push in the module until the hook(s) located at the top snaps into place. Incorrect interconnection may cause malfunction, failure, or drop of the module.
 - To mount a module with no module fixing hook, place the concave part(s) located at the bottom onto the guide(s) of the base unit, push in the module, and fix it with screw(s). Incorrect interconnection may cause malfunction, failure, or drop of the module.
 - When using the programmable controller in an environment of frequent vibrations, fix the module with a screw.
 - Tighten the screws within the specified torque range. Undertightening can cause drop of the component or wire, short circuit, or malfunction. Overtightening can damage the screw and/or module, resulting in drop, short circuit, or malfunction. For the specified torque range, refer to the MELSEC iQ-R Module Configuration Manual.
 - When using an extension cable, connect it to the extension cable connector of the base unit securely. Check the connection for looseness. Poor contact may cause malfunction.
 - When using an SD memory card, fully insert it into the SD memory card slot. Check that it is inserted completely. Poor contact may cause malfunction.
 - Securely insert an extended SRAM cassette or a battery-less option cassette into the cassette connector of the CPU module. After insertion, close the cassette cover and check that the cassette is inserted completely. Poor contact may cause malfunction.
 - Beware that the module could be very hot while power is on and immediately after power-off.
 - Do not directly touch any conductive parts and electronic components of the module, SD memory card, extended SRAM cassette, battery-less option cassette, or connector. Doing so can cause malfunction or failure of the module.
-

[Wiring Precautions]

WARNING

- Shut off the external power supply (all phases) used in the system before installation and wiring. Failure to do so may result in electric shock or cause the module to fail or malfunction.
- After installation and wiring, attach a blank cover module (RG60) to each empty slot before powering on the system for operation. Also, attach an extension connector protective cover^{*1} to each unused extension cable connector as necessary. Directly touching any conductive parts of the connectors while power is on may result in electric shock.

*1 For details, please consult your local Mitsubishi Electric representative.

[Wiring Precautions]

CAUTION

- Individually ground the FG and LG terminals of the programmable controller with a ground resistance of 100 ohms or less. Failure to do so may result in electric shock or malfunction.
 - Use applicable solderless terminals and tighten them within the specified torque range. If any spade solderless terminal is used, it may be disconnected when the terminal screw comes loose, resulting in failure.
 - Check the rated voltage and signal layout before wiring to the module, and connect the cables correctly. Connecting a power supply with a different voltage rating or incorrect wiring may cause fire or failure.
 - Connectors for external devices must be crimped or pressed with the tool specified by the manufacturer, or must be correctly soldered. Incomplete connections may cause short circuit, fire, or malfunction.
 - Securely connect the connector to the module. Poor contact may cause malfunction.
 - Do not install the control lines or communication cables together with the main circuit lines or power cables. Doing so may result in malfunction due to noise. Keep a distance of 100mm or more between those cables.
 - Place the cables in a duct or clamp them. If not, dangling cables may swing or inadvertently be pulled, resulting in malfunction or damage to modules or cables. In addition, the weight of the cables may put stress on modules in an environment of strong vibrations and shocks. Do not clamp the extension cables with the jacket stripped. Doing so may change the characteristics of the cables, resulting in malfunction.
 - Check the interface type and correctly connect the cable. Incorrect wiring (connecting the cable to an incorrect interface) may cause failure of the module and external device.
 - Tighten the terminal screws or connector screws within the specified torque range. Undertightening can cause drop of the screw, short circuit, fire, or malfunction. Overtightening can damage the screw and/or module, resulting in drop, short circuit, fire, or malfunction.
 - When disconnecting the cable from the module, do not pull the cable by the cable part. For the cable with connector, hold the connector part of the cable. For the cable connected to the terminal block, loosen the terminal screw. Pulling the cable connected to the module may result in malfunction or damage to the module or cable.
 - Prevent foreign matter such as dust or wire chips from entering the module. Such foreign matter can cause a fire, failure, or malfunction.
 - When a protective film is attached to the top of the module, remove it before system operation. If not, inadequate heat dissipation of the module may cause a fire, failure, or malfunction.
-

[Wiring Precautions]

CAUTION

- Programmable controllers must be installed in control panels. Connect the main power supply to the power supply module in the control panel through a relay terminal block. Wiring and replacement of a power supply module must be performed by qualified maintenance personnel with knowledge of protection against electric shock. For wiring, refer to the MELSEC iQ-R Module Configuration Manual.
 - For Ethernet cables to be used in the system, select the ones that meet the specifications in the user's manual for the module used. If not, normal data transmission is not guaranteed.
-

[Startup and Maintenance Precautions]

WARNING

- Do not touch any terminal while power is on. Doing so will cause electric shock or malfunction.
 - Correctly connect the battery connector. Do not charge, disassemble, heat, short-circuit, solder, or throw the battery into the fire. Also, do not expose it to liquid or strong shock. Doing so will cause the battery to produce heat, explode, ignite, or leak, resulting in injury and fire.
 - Shut off the external power supply (all phases) used in the system before cleaning the module or retightening the terminal screws, connector screws, or module fixing screws. Failure to do so may result in electric shock.
-

[Startup and Maintenance Precautions]

CAUTION

- When connecting an external device with a CPU module or intelligent function module to modify data of a running programmable controller, configure an interlock circuit in the program to ensure that the entire system will always operate safely. For other forms of control (such as program modification, parameter change, forced output, or operating status change) of a running programmable controller, read the relevant manuals carefully and ensure that the operation is safe before proceeding. Improper operation may damage machines or cause accidents.
 - Especially, when a remote programmable controller is controlled by an external device, immediate action cannot be taken if a problem occurs in the programmable controller due to a communication failure. To prevent this, configure an interlock circuit in the program, and determine corrective actions to be taken between the external device and CPU module in case of a communication failure.
 - Do not disassemble or modify the modules. Doing so may cause failure, malfunction, injury, or a fire.
 - Use any radio communication device such as a cellular phone or PHS (Personal Handy-phone System) more than 25cm away in all directions from the programmable controller. Failure to do so may cause malfunction.
 - Shut off the external power supply (all phases) used in the system before mounting or removing the module. Failure to do so may cause the module to fail or malfunction.
 - Tighten the screws within the specified torque range. Undertightening can cause drop of the component or wire, short circuit, or malfunction. Overtightening can damage the screw and/or module, resulting in drop, short circuit, or malfunction.
 - After the first use of the product, do not perform each of the following operations more than 50 times (IEC 61131-2/JIS B 3502 compliant). Exceeding the limit may cause malfunction.
 - Mounting/removing the module to/from the base unit
 - Inserting/removing the extended SRAM cassette or battery-less option cassette to/from the CPU module
 - Mounting/removing the terminal block to/from the module
 - Connecting/disconnecting the extension cable to/from the base unit
 - After the first use of the product, do not insert/remove the SD memory card to/from the CPU module more than 500 times. Exceeding the limit may cause malfunction.
 - Do not touch the metal terminals on the back side of the SD memory card. Doing so may cause malfunction or failure of the module.
 - Do not touch the integrated circuits on the circuit board of an extended SRAM cassette or a battery-less option cassette. Doing so may cause malfunction or failure of the module.
 - Do not drop or apply shock to the battery to be installed in the module. Doing so may damage the battery, causing the battery fluid to leak inside the battery. If the battery is dropped or any shock is applied to it, dispose of it without using.
 - Startup and maintenance of a control panel must be performed by qualified maintenance personnel with knowledge of protection against electric shock. Lock the control panel so that only qualified maintenance personnel can operate it.
-

[Startup and Maintenance Precautions]

CAUTION

- Before handling the module, touch a conducting object such as a grounded metal to discharge the static electricity from the human body. Wearing a grounded antistatic wrist strap is recommended. Failure to discharge the static electricity may cause the module to fail or malfunction.
 - After unpacking, eliminate static electricity from the module to prevent electrostatic discharge from affecting the module. If an electrostatically charged module comes in contact with a grounded metal object, a sudden electrostatic discharge of the module may cause failure.
For details on how to eliminate static electricity from the module, refer to the following.
Antistatic Precautions Before Using MELSEC iQ-R Series Products (FA-A-0368)
 - Use a clean and dry cloth to wipe off dirt on the module.
-

[Operating Precautions]

CAUTION

- When changing data and operating status, and modifying program of the running programmable controller from an external device such as a personal computer connected to an intelligent function module, read relevant manuals carefully and ensure the safety before operation. Incorrect change or modification may cause system malfunction, damage to the machines, or accidents.
 - Do not power off the programmable controller or reset the CPU module while the setting values in the buffer memory are being written to the flash ROM in the module. Doing so will make the data in the flash ROM and SD memory card undefined. The values need to be set in the buffer memory and written to the flash ROM and SD memory card again. Doing so can cause malfunction or failure of the module.
-

[Disposal Precautions]

CAUTION

- When disposing of this product, treat it as industrial waste.
 - When disposing of batteries, separate them from other wastes according to the local regulations. For details on battery regulations in EU member states, refer to the MELSEC iQ-R Module Configuration Manual.
-

[Transportation Precautions]

CAUTION

- When transporting lithium batteries, follow the transportation regulations. For details on the regulated models, refer to the MELSEC iQ-R Module Configuration Manual.
 - The halogens (such as fluorine, chlorine, bromine, and iodine), which are contained in a fumigant used for disinfection and pest control of wood packaging materials, may cause failure of the product. Prevent the entry of fumigant residues into the product or consider other methods (such as heat treatment) instead of fumigation. The disinfection and pest control measures must be applied to unprocessed raw wood.
-

CONDITIONS OF USE FOR THE PRODUCT

- (1) MELSEC programmable controller ("the PRODUCT") shall be used in conditions;
- i) where any problem, fault or failure occurring in the PRODUCT, if any, shall not lead to any major or serious accident; and
 - ii) where the backup and fail-safe function are systematically or automatically provided outside of the PRODUCT for the case of any problem, fault or failure occurring in the PRODUCT.
- (2) The PRODUCT has been designed and manufactured for the purpose of being used in general industries. MITSUBISHI ELECTRIC SHALL HAVE NO RESPONSIBILITY OR LIABILITY (INCLUDING, BUT NOT LIMITED TO ANY AND ALL RESPONSIBILITY OR LIABILITY BASED ON CONTRACT, WARRANTY, TORT, PRODUCT LIABILITY) FOR ANY INJURY OR DEATH TO PERSONS OR LOSS OR DAMAGE TO PROPERTY CAUSED BY the PRODUCT THAT ARE OPERATED OR USED IN APPLICATION NOT INTENDED OR EXCLUDED BY INSTRUCTIONS, PRECAUTIONS, OR WARNING CONTAINED IN MITSUBISHI ELECTRIC USER'S, INSTRUCTION AND/OR SAFETY MANUALS, TECHNICAL BULLETINS AND GUIDELINES FOR the PRODUCT.
- ("Prohibited Application")
- Prohibited Applications include, but not limited to, the use of the PRODUCT in;
- Nuclear Power Plants and any other power plants operated by Power companies, and/or any other cases in which the public could be affected if any problem or fault occurs in the PRODUCT.
 - Railway companies or Public service purposes, and/or any other cases in which establishment of a special quality assurance system is required by the Purchaser or End User.
 - Aircraft or Aerospace, Medical applications, Train equipment, transport equipment such as Elevator and Escalator, Incineration and Fuel devices, Vehicles, Manned transportation, Equipment for Recreation and Amusement, and Safety devices, handling of Nuclear or Hazardous Materials or Chemicals, Mining and Drilling, and/or other applications where there is a significant risk of injury to the public or property.
- Notwithstanding the above restrictions, Mitsubishi Electric may in its sole discretion, authorize use of the PRODUCT in one or more of the Prohibited Applications, provided that the usage of the PRODUCT is limited only for the specific applications agreed to by Mitsubishi Electric and provided further that no special quality assurance or fail-safe, redundant or other safety features which exceed the general specifications of the PRODUCTS are required. For details, please contact the Mitsubishi Electric representative in your region.
- (3) Mitsubishi Electric shall have no responsibility or liability for any problems involving programmable controller trouble and system trouble caused by DoS attacks, unauthorized access, computer viruses, and other cyberattacks.

CONSIDERATIONS FOR USE

This section explains the following considerations.

- ☞ Page 10 Considerations for network connection
- ☞ Page 10 Considerations for performance/specifications
- ☞ Page 11 Considerations for data logging, event logging, and report functions
- ☞ Page 12 Considerations for other functions
- ☞ Page 12 Considerations for accessing a high speed data logger module
- ☞ Page 13 Considerations for security
- ☞ Page 13 Considerations for using SD memory cards
- ☞ Page 15 Considerations for using a redundant system
- ☞ Page 15 Considerations for the recipe function

Considerations for network connection

■Mail server and FTP server connections

When immediately powering ON after powering OFF, connection to mail servers or FTP servers may fail. Power the programmable controller OFF, wait several minutes then power it ON.

Considerations for performance/specifications

■Sequence scan time of the CPU module

When using the high speed data logger module, the CPU module sequence scan time may increase. Design your system and programs keeping in mind this increase in sequence scan time of the CPU module.

■Network connection using Ethernet

- When connecting to Ethernet network, basically configure the communication route to the access target via Ethernet (twisted pair) cables and hubs. Note that when accessing via wireless LAN (Wi-Fi) or router, an error such as timeout or missing data occurs, and cannot be communicated properly depending on the status of the equipment (wireless LAN or router) on the network or the access route.
- When the access to the high speed data logger module is overloaded, errors and missing data may occur. Creating logging files, report files might take time, and communication with the module might not be possible. Reduce the load on the Ethernet network which is connected to the high speed data logger module.

■Time handled on the high speed data logger module

Time handled on the high speed data logger module is the time on the CPU module.

For errors and the optimum timing for setting the time, refer to the following:

- ☞ Page 91 Time Synchronization Function
- 📖 MELSEC iQ-R High Speed Data Logger Module User's Manual (Startup)

■High speed sampling

The high speed sampling function is not supported by CPU modules on other stations via a network.

Considerations for data logging, event logging, and report functions

■Data logging, event logging, and report functions

- The data logging, event logging, and report functions are best effort functions. Since the processing time of a module varies depending on the setting and the status of other devices, these functions may not perform at the set sampling interval. Run the system by fully verifying the processing time of each function when constructing it. For processing time, refer to the following:
(☞ Page 346 Processing Time)
- If data logging function, event logging function, or report function are used, they affect the sequence scan time of the access target CPU module. Run the system by verifying how the sequence scan time is affected when configuring the system.
(☞ Page 354 Influence on the sequence scan time)
- If exponential format is selected for the data output format with the data logging, event logging, or report setting, rounding errors will occur in the range of the number of digits that exceed the number of digits set for the decimal part.
- If the result of the linear function transformation with the scaling function exceeds the maximum or minimum range of the specified output format, the maximum or minimum value will be output in binary format. Therefore, when outputting in the binary format, errors may occur in the output values.
- The file transfer/e-mail transmission via the file transfer function/e-mail function may take from a few seconds to tens of seconds depending on the network line or transmission size. Target files may be deleted before file transfer/e-mail transmission is completed depending on the settings. Review the file switching timing and the setting for the number of saved files and lengthen the time until the file is deleted.
(☞ Page 52 File switching timing)
- When a CSV file is opened with Excel®, the date column format is displayed in the default setting of Excel. Set the cell format as necessary.
- Since general sampling specified data and report current value data are sampled asynchronously with the sequence scan, data separation may occur. If data separation must be prevented, set the number of device points sampled at one time to less than the access units, or set the module to use high speed sampling.

■Data logging function

- When the number of device points to be sampled by the trigger logging function exceeds the access units and general sampling is specified for the data sampling method, device values sampled in another sequence scan as the one where the trigger occurred may be included in one data row. To avoid this, the number of device points that can be sampled at once should be less than the access units or high speed sampling should be used. For the access units, refer to the following:
(☞ MELSEC iQ-R High Speed Data Logger Module User's Manual (Startup))
- Immediately after switching the programmable controller system ON, if a trigger occurs before sampling the number of lines of data before the trigger, the lines of the data before the trigger may be fewer than the specified number of lines.
- When triggers continuously occur with the trigger logging function, triggers may not be detected or the number of lines of data specified before the trigger may not be output. For operation when triggers continuously occur, refer to the following:
(☞ Page 30 Trigger logging function)

■Report function

- Immediately after switching the programmable controller system ON, if a creation trigger occurs when data does not exist in the data logging file, an error occurs in the high speed data logger module. Configure and construct the system so that the creation trigger occurs after data is saved in the data logging file.
- Report output takes time. Therefore, according to the data logging save setting, the data logging file including the data when the creation trigger occurs, may be deleted before the report output is completed. In this situation, the specified number of records worth of data is not output, and an error occurs in the high speed data logger module. Check the Point in the following section when configuring and constructing the system.
(☞ Page 75 Creation trigger function)
- When the creation triggers continuously occurred, they may not be detected. For operation when the creation trigger continuously occurred, refer to the following:
(☞ Page 75 Creation trigger function)

- When using Microsoft® Excel 2010 (32-bit version), Microsoft Excel 2013 (32-bit version), Microsoft Excel 2016 (32-bit version), Microsoft Excel 2019 (32-bit version/64-bit version), or Microsoft 365 (32-bit version/64-bit version), install Visual Basic® for Applications (abbreviated as VBA below). If VBA is not installed, the error message below will be displayed when the "Layout setting" screen is started, and the layout settings cannot be configured.
"This workbook has lost its VBA Project, ActiveX Controls and any other programmability-related features."
- The saving format of a report file output by the report function is the xls format. Some of the functions added to Microsoft Excel 2007 and later cannot be used.
- Microsoft Excel 2010 (64-bit version) is not supported.
- Microsoft Excel 2013 (64-bit version) is not supported.
- Microsoft Excel 2016 (64-bit version) is not supported.

Considerations for other functions

■Access target CPU setting

- When rewriting the settings in Configuration Tool, turning the power OFF and ON, or resetting a CPU module, a high speed data logger module is prepared to communicate with an access target CPU module. Therefore, if a large number of access target CPU modules are set, several minutes are required for this preparation.
- The following conditions may affect the general sampling, file transfer function, and e-mail function: a CPU module that does not exist is set as an access target CPU module, or a high speed data logger module cannot communicate with the access target CPU module temporarily because of the power interruption of access target CPU module or network failure. Before using a high speed data logger module, make sure that the module can communicate with a CPU module set as an access target.

■Time synchronization function

- If implementing the time synchronization with the CPU module, it will change the time of the high speed data logger module. When the CPU module's time is changed, the high speed data logger module's time may be greatly changed.
- Since there is inaccuracy in the clock element of the CPU module and the high speed data logger module, the time may be moved slightly forward or backward when the time is synchronized. Since changing the time of the high speed data logger module affects the time stamp, as well as the following determination of the cycles and of the time: data logging, event logging, and reports, configure the module to synchronize its time at the required minimum range.

Considerations for accessing a high speed data logger module

■Web browser operations and settings

- In the local area network (LAN) setting of the web browser, do not set a proxy server for the local address.
( MELSEC iQ-R High Speed Data Logger Module User's Manual (Startup))

■FTP server function

- Because of FTP client side application restrictions, if the user name or password is input incorrectly, end the FTP operation and redo the FTP connection from the beginning. FTP may not operate correctly by reentering the correct user name or password with the 'user' FTP command.
- The maximum number of simultaneous connections to the FTP server is 10. However, depending on the FTP client, it may make multiple simultaneous connections, so an FTP client may not be able to login even if 10 clients are not connected. In this situation, shutdown all the FTP clients, then restart and connect them.
- When transferring many files at once with FTP, a 426 error (data connection error) may occur. In this situation, split the files into multiple parts then transfer them separately.
- When a web browser is used for FTP access, the user authentication screen may not be displayed due to the specification of the web browser. In this case, enter the address of a high speed data logger module in the following format.
ftp://<user name>:<password>@<the address of a high speed data logger module or host name>/

- When a web browser is used for FTP access, data logging files, event logging files, report files, and recipe files may not be opened directly due to the specification of the web browser. Make sure to open the files after saving them to a personal computer.
- When a web browser is used for FTP access, due to the specification of the web browser, errors may not be displayed even if the transfer failed when files are transferred to the SD memory card which does not have enough free space. Update the display and check if the files are transferred normally.
- When a web browser is used for FTP access, a retry may be performed at user authentication failure due to the specification of the web browser. Note that unintentional repeated entry of wrong passwords may lock the module.
- The following port numbers (communication protocol) are used for the FTP server function.
Port for transferring data: 20 (TCP/IP)
Port for controlling communications: 21 (TCP/IP)

■Replacement of an older version of a module

- When replacing an older version of a high speed data logger module, delete temporary internet files (caches) of a web browser before accessing a newer version of the module.

■Connecting GX LogViewer

- The maximum number of connections for GX LogViewer to access the high speed data logger modules simultaneously is 2.
- The following port numbers (communication protocols) are used for the online function.
Connection via a hub: 49900, 49902 to 49906 (TCP/IP)
Direct connection: 49900 (UDP)
High speed data logger module search: 49901 (UDP)

■Connection with Configuration Tool

- Note that a module may be in an unintended status when operating it in multiple pieces of Configuration Tool at the same time.
- The following port numbers (communication protocols) are used for the online function.
Connection via a hub: 49900, 49902 to 49906 (TCP/IP)
Direct connection: 49900 (UDP)
High speed data logger module search: 49901 (UDP)

Considerations for security

- Although the high speed data logger module supports basic authentication (account setting) using user names and passwords, it does not completely protect the system from illegal access. Avoid accounts (user name, password) consisting of simple alphanumeric characters only, and include some non-alphanumeric characters (\$, &, ?) to create a complicated user name and password.

Considerations for using SD memory cards

■SD memory card file/directory

- Do not create files (excluding module operating files and recipe files) or folders on the SD memory card with a personal computer. If files or folders are created on the SD memory card with a personal computer, they may be deleted.

■SD memory card to be used

- Use SD memory cards manufactured by Mitsubishi Electric Corporation in the manual below. If any other SD memory cards are used, a failure such as data corruption on the SD memory card or a system shutdown (module major error (error code: 2450H) occurs in the CPU module) may occur during an operation.
(IMELSEC iQ-R High Speed Data Logger Module User's Manual (Startup))



■Turning the power OFF or resetting a CPU module

- When a CPU module is powered OFF or reset while writing data to an SD memory card, the processing to write data to the SD memory card may not be completed. It may cause a loss of logging data during the processing, corruption of data in the SD memory card that is being accessed, or occurrence of a file system error. The file is automatically recovered when the high speed data logger module is powered ON again, but it will not succeed in some cases.

The operation, powering OFF or resetting the CPU module after stopping file access, should be considered. For the important data, a periodic backup is recommended.

( MELSEC iQ-R High Speed Data Logger Module User's Manual (Startup))

■Removing or replacing an SD memory card

- Make sure to stop file access before ejecting or replacing the SD memory card.
( MELSEC iQ-R High Speed Data Logger Module User's Manual (Startup))
- Not following the procedure may cause a loss of logging data during processing, corruption of data in the SD memory card that is being accessed, a file system error, or false recognition of the mounting status of the SD memory card.
( MELSEC iQ-R High Speed Data Logger Module User's Manual (Startup))
- If an error occurs on the SD memory card, refer to the following:
( Page 255 Troubleshooting on an SD memory card)
- High speed data logger module settings are saved to the SD memory card. Therefore, the high speed data logger module's IP address returns to the initial status (192.168.3.3) when the SD memory card is not inserted in the module or when the power is turned OFF to ON or the CPU module is reset, without the settings written to the SD memory card. When necessary, read the current settings before ejecting the SD memory card and after replacing the card, promptly write those settings to the new card.

■SD memory card capacity

- Access speed to the SD memory card is affected by the amount of saved files. In particular, access speed becomes extremely slow when files are saved up to the capacity limit of the SD memory card. Use the SD memory card maintaining 10% or more free space on the card.
- A minimum size occupied by the files on the hard disk varies depending on the SD memory card capacity. Therefore, the actual file size and the occupied file size on the hard disk may differ.

■SD memory card diagnostic time

- The high speed data logger module performs diagnostics (file recovery, etc.) of the inserted SD memory card contents at the times listed below.
When powering OFF to ON or resetting the CPU module
When inserting an SD memory card while the power is ON
- The SD memory card diagnostic time takes longer when there are more files on the card. 100 files takes approximately 5 seconds, and 1000 files takes approximately 10 seconds.
- Saving many files on an SD memory card increases the following time. Delete unnecessary files.
Time until 'SD memory card status' (X1) rises
Time until a high speed data logger module starts processing ('Module READY' (X0) or 'Module operating status' (X5) rises)

■Formatting SD memory card

- Use the format function of Configuration Tool to format an SD memory card.
( Page 223 SD memory card diagnostics)
- Do not format an SD memory card using the format function of Windows®.
- Do not reset the control CPU or turn the power OFF when formatting an SD memory card.
- High speed data logger module settings are saved to an SD memory card. Therefore, all settings are lost when formatting the SD memory card. When necessary, read the current settings before formatting, and promptly write those settings after formatting. The IP address of the high speed data logger module returns to the initial status (192.168.3.3) when turning the power OFF to ON or when resetting the module without writing the settings to the SD memory card.

■SD memory card life (limit on writing)

- An SD memory card has a life (a limit on the number of times for writing data). For details, refer to the following:
(📖 Page 432 SD Memory Card Life)

■RECIPE folder

- The maximum number of recipe files that can be stored in the RECIPE folder is 256. Storing large numbers of files in the RECIPE folder causes a longer processing time for the following operations. Delete unnecessary files.
 - Displaying or operating the file browser
 - Displaying a file list of recipe execution operation
 - Recipe execution operation
- Do not store any files other than recipe files in the RECIPE folder.

■Write protect switch

- Make sure that the write protect switch of an SD memory card is in the unlocked position. When the write protect switch is in the locked position, no files can be written to the SD memory card.

Considerations for using a redundant system

■Mountable base units

- A high speed data logger module must be mounted on an extension base unit*¹ or a redundant extension base unit. It cannot be mounted on the main base unit in a redundant system.

*1 Only the extension level 2 to 7 are available.

■Access target CPUs

- There are restrictions on accessible routes. For details, refer to the following:
(📖MELSEC iQ-R High Speed Data Logger Module User's Manual (Startup))

■Dedicated instructions

- When mounting a high speed data logger module to a process CPU (redundant mode), dedicated instructions cannot be used. If a dedicated instruction is used, "Operation error (redundant function)" occurs in the process CPU (redundant mode).

■Resetting a CPU module

- When mounting a high speed data logger module to a process CPU (redundant mode), reset CPU modules of both systems for a function that requires resetting the CPU modules.

Considerations for the recipe function

■Recipe files

- For recipe file names, use the characters usable in file names and folder (directory) names only.

■Recipe execution operation

- Before performing the recipe execution operation, write the settings of a high speed data logger module in Configuration Tool, then set the module operating status to "In operation". The module operating status can be checked in the "Module Diagnostic" screen.
(📖 Page 218 Module diagnostics)
- The recipe execution operation can be performed to the control CPU only. It cannot be performed to a CPU module on another station.
- Do not power OFF or reset the CPU module during the recipe execution operation. The recipe file being edited may be damaged. Power OFF or reset the CPU module after confirming the completion of the recipe execution operation.

INTRODUCTION

Thank you for purchasing the Mitsubishi Electric MELSEC iQ-R series programmable controllers.

This manual describes the functions, Configuration Tool, and troubleshooting to use the modules listed below.

Before using this product, please read this manual and the relevant manuals carefully and develop familiarity with the functions and performance of the MELSEC iQ-R series programmable controller to handle the product correctly.

When applying the program examples provided in this manual to an actual system, ensure the applicability and confirm that it will not cause system control problems.

Note that the menu names and operating procedures may differ depending on an operating system in use and its version.

When reading this manual, replace the names and procedures with the applicable ones as necessary.

Please make sure that the end users read this manual.

Point

The program examples shown in this manual are the examples in which a high speed data logger module (RD81DL96) is assigned to the input/output No. X/Y0 to X/Y1F unless otherwise specified. To use the program examples shown in this manual, the input/output number assignment is required. For details on the assignment of input/output number, refer to the following:

 MELSEC iQ-R Module Configuration Manual

Relevant product

RD81DL96

CONTENTS

SAFETY PRECAUTIONS	1
CONDITIONS OF USE FOR THE PRODUCT	9
CONSIDERATIONS FOR USE	10
INTRODUCTION	16
RELEVANT MANUALS	22
TERMS	23
GENERIC TERMS AND ABBREVIATIONS	23
CHAPTER 1 FUNCTION	24
1.1 Data Logging Function	24
Target data	25
Sampling function	26
Continuous logging function	30
Trigger logging function	30
Trigger conditions	41
Period specification	48
Scaling function	49
Save function	50
Data missing	62
1.2 Event Logging Function	63
Event	64
Sampling function	68
Period specification	68
Scaling function	68
E-mail notification function	69
Save function	70
1.3 Report Function	71
Target data	72
Creation trigger and current value data sampling	75
Period specification	76
Scaling function	76
Save function	77
1.4 Recipe Function	78
Read	79
Write	79
Recipe file	80
Execution procedure of the recipe function	82
Operation at recipe execution	83
1.5 Security Function	85
Access authentication function	86
IP filter function	90
1.6 Time Synchronization Function	91
1.7 Auto Logging Function	93
1.8 File Access Function	94
1.9 File Transfer Function	95
1.10 E-mail Function	98
1.11 Event History Registration Function	101
1.12 Free Space Adjustment Function	102

1.13	FTP Server Function	104
1.14	Self-diagnostic Function	106
1.15	Initialization Function	107
CHAPTER 2 HIGH SPEED DATA LOGGER MODULE CONFIGURATION TOOL		108
2.1	High Speed Data Logger Module Configuration Tool	108
	Setting operations overview	108
2.2	Common Operations	109
	Operations on wizard screen	109
	Data list	110
	Device batch replacement	112
	Data setting	113
	Importing global labels and common device comments	115
2.3	Project Management	125
	Creating a new project	125
	Opening a project	125
	Saving a project	125
	Opening a Q-series high speed data logger module (QD81DL96) project	126
	Importing settings	127
	Exporting settings	130
2.4	Common Setting	131
	Network setting	132
	Time synchronization setting	133
	Access target CPU setting	134
	File transfer setting	137
	E-mail setting	140
	Security setting	142
	Logging operation setting	145
	SD memory card setting	146
2.5	Data Logging Setting	147
	Data logging setting	149
	Logging type/file format	150
	Sampling	151
	Data	152
	Period	156
	Trigger	158
	Number of logging lines	161
	Unicode text output	162
	Binary output	164
	CSV output	165
	Folder	168
	File	171
	Finish	176
2.6	Event Logging Setting	177
	Event logging setting	178
	File format	179
	Sampling	180
	Event	181
	Period	186
	Unicode text output	187

Binary output	188
CSV output	189
Folder	190
File	191
E-mail notice	192
Finish	193
2.7 Report Setting	194
Report setting	195
Sampling	196
Layout	197
Creation trigger	209
Period	210
Folder	211
File	212
Finish	213
2.8 Online	214
Transfer setup	214
Online data operation	216
Diagnostics	217
Management	230
File browser	231
Recipe execution operation	232
2.9 Editing Recipe File	233
Screen configuration	233
Creating recipe files	235
Editing recipe file	236
2.10 Help	238
CHAPTER 3 PARAMETER SETTING	239
3.1 Parameter Setting Procedure	239
3.2 Basic Settings	239
Operation settings	240
3.3 Refresh Setting	242
CHAPTER 4 TROUBLESHOOTING	243
4.1 Checking Method for Error Descriptions	243
4.2 Checking the Module Status	244
Error information	244
Module information list	245
Self-diagnostic tests	246
4.3 Troubleshooting by Symptom	248
Troubleshooting on LED indication and input/output signals	248
Troubleshooting on data logging, event logging, and reports	249
Troubleshooting on network connection	253
Troubleshooting on FTP and file transfer	254
Troubleshooting on e-mails	254
Troubleshooting on communication between a high speed data logger module and access target module	255
Troubleshooting on an SD memory card	255
Troubleshooting on Configuration Tool	257
Troubleshooting on the recipe function	261

4.4	Error Code List	263
4.5	Event List	292

APPENDIX **293**

Appendix 1	Module Label	293
Appendix 2	Input/Output Signals	294
	Input/output signal list	295
	Input signal details	296
	Output signal details	300
Appendix 3	Buffer Memory	302
	Buffer memory list	302
	Buffer memory details	312
Appendix 4	Dedicated Instructions	340
	Dedicated instruction list	340
Appendix 5	Usable Characters	341
	Usable characters on the setting screen	341
	Usable characters while outputting the file	344
Appendix 6	Numerical Type Comparison Accuracy	345
Appendix 7	Processing Time	346
	Processing time	346
	Checking method for the processing time	351
	Checking sampling process time	352
	Checking data logging process time	353
	Checking event logging process time	353
	Checking report process time	353
	Influence on the sequence scan time	354
Appendix 8	Supported FTP Command	355
Appendix 9	Data Logging File Format	357
	File version	357
	Unicode text file/CSV file	357
	Binary file	367
Appendix 10	Event Logging File Format	370
	File version	370
	Unicode text file/CSV file	370
	Binary file	380
Appendix 11	Recipe File Format	383
Appendix 12	Setting Information File Format	385
Appendix 13	Data Sampling Method for CPU Modules that cannot be Accessed Directly	428
Appendix 14	Sampling Processes of High Speed Data Logger Module	430
	Data changes between data sampling processes	430
	Detecting data condition establishment	430
Appendix 15	SD Memory Card Life	432
Appendix 16	When Using a Redundant System	434
	Restrictions	434
	Consideration	434
Appendix 17	Added and Changed Functions	435

INDEX **436**

REVISIONS	438
WARRANTY	439

TRADEMARKS440
COPYRIGHTS.....440

RELEVANT MANUALS

Manual name [manual number]	Description	Available form
MELSEC iQ-R High Speed Data Logger Module User's Manual (Application) [SH-081562ENG] (this manual)	Functions, Configuration Tool, parameter setting, troubleshooting, I/O signal, and buffer memory of a high speed data logger module	Print book e-Manual PDF
MELSEC iQ-R High Speed Data Logger Module User's Manual (Startup) [SH-081561ENG]	Specifications, procedures before operation, wiring, and operation examples of a high speed data logger module	Print book e-Manual PDF
GX Works3 Operating Manual [SH-081215ENG]	System configurations, parameter settings, and operation methods for the online function in GX Works3	e-Manual PDF
MELSEC iQ-R Module Configuration Manual [SH-081262ENG]	The combination of the MELSEC iQ-R series modules, common information on the installation/wiring in the system, and specifications of the power supply module, base unit, SD memory card, and battery	Print book e-Manual PDF

Point

e-Manual refers to the Mitsubishi Electric FA electronic book manuals that can be browsed using a dedicated tool.

e-Manual has the following features:

- Required information can be cross-searched in multiple manuals.
- Other manuals can be accessed from the links in the manual.
- Hardware specifications of each part can be found from the product figures.
- Pages that users often browse can be bookmarked.
- Sample programs can be copied to an engineering tool.

TERMS

Unless otherwise specified, this manual uses the following terms.

Term	Description
Engineering tool	A tool for setting, programming, debugging, and maintaining programmable controllers. For the supported tools, refer to the following:  MELSEC iQ-R Module Configuration Manual
Process CPU (redundant mode)	A Process CPU operating in redundant mode. A redundant system is configured with this CPU module. Process control function blocks and the online module change function can be used even in this mode.

GENERIC TERMS AND ABBREVIATIONS

Unless otherwise specified, this manual uses the following generic terms and abbreviations.

Generic term/abbreviation	Description
Configuration Tool	MELSEC iQ-R High Speed Data Logger Module Configuration Tool. This tool configures and maintains the high speed data logger module.
High speed data logger module	A MELSEC iQ-R high speed data logger module
LCPU	A MELSEC-L series CPU module
Logging file	A data logging file and an event logging file
QCPU (Q mode)	A MELSEC-Q series CPU module and a MELSEC-Q series C Controller module
RCPU	A MELSEC iQ-R series CPU module and a MELSEC iQ-R series C Controller module

1 FUNCTION

This chapter explains the details on the functions of a high speed data logger module.

1.1 Data Logging Function

The data logging function logs device values in a CPU module at a specified sampling interval.

Logged data is saved as a data logging file to an SD memory card inserted in a high speed data logger module.

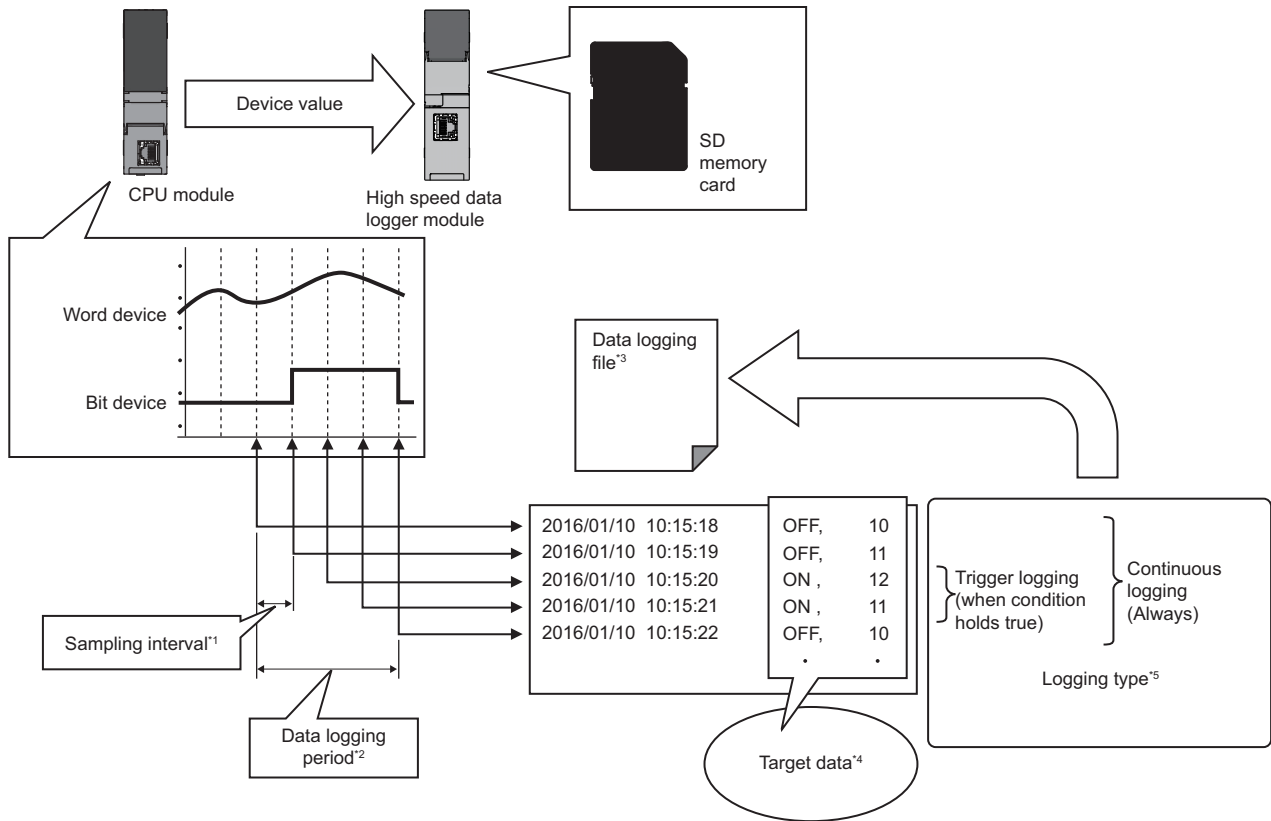

*1 Page 26 Sampling function

*2 Page 48 Period specification

*3 Page 50 Save function

*4 Page 25 Target data

*5 Page 30 Continuous logging function, Page 30 Trigger logging function

"Data logging setting" is the group of target data and sampling interval of the data logging function.

Up to 64 data logging settings can be configured in the whole data logging function.

For the settings of the data logging function, refer to the following:

Page 147 Data Logging Setting

Target data

Target data indicates the data used for logging that saves the content of device memory in a CPU module to an SD memory card along with time stamps and for trigger condition judgment.

Target data for data logging

The following data can be logged by data logging.

- Device memory in a control CPU
- Device memory in a CPU on another station in a multiple CPU configuration
- Device memory in a CPU on another station via a network

For details, refer to the following:

📖 MELSEC iQ-R High Speed Data Logger Module User's Manual (Startup)

Data type

Target data for data logging can be logged as the data types shown in the following table.

Data type	Number of device points
Bit	1 point
Word [Signed]	1 point
Double Word [Signed]	2 points
Word [Unsigned]/Bit String [16-bit]	1 point
Double Word [Unsigned]/Bit String [32-bit]	2 points
FLOAT [Single Precision]	2 points
FLOAT [Double Precision]	4 points
16bit BCD	1 point
32bit BCD	2 points
String	(Specified size ÷ 2) points ^{*1*2}
Raw ^{*3}	(Specified size ÷ 2) points ^{*1*2}

*1 If the size is in odd number, the device point will be rounded up by adding 1 point.

*2 For double word device, the device becomes 2 points for each 4 bytes. The fraction should be rounded up to 2 points.
(Assign 2 points if size is 4 and 4 points if size is 5)

*3 A hexadecimal representation is converted to a string by byte unit, and it is output with a space removed.
(For start device D0, D0: 0x8A6B, D1: 0x41C2 4-byte raw type, 6B8AC241 is output.)

■String type data

Data is output in the following character codes depending on the file format to be output.

Unicode[®] text files, binary files, report files: UTF-16 (little endian)

CSV files: ASCII

The considerations when logging string type data are as follows.

- Data character code of saved folder name settings, saved file name settings, and E-mail content settings is in ASCII format regardless of the format in which the file is to be output.
- To specify the size (byte unit), consider the size required for the character code.
- To create character string data in a CPU module, use the instruction (\$MOV or \$MOV_WS) which supports character code.
- If the data with a different character code is output to the same file, some characters may be replaced with a period (.) or may be corrupted.

Number of target data settings

Up to 1024 target data can be set for one "Data logging setting".

Sampling function

This function samples target data from the access target CPU module.

The data sampling methods are as follows. The sampling interval that can be specified differs depending on the data sampling method.

Data sampling method		Overview	Reference
High speed sampling	Each scan	Data is sampled in each sequence scan of a CPU module.	Page 28 Timing of data sampling when "Each scan" is specified
	Time specification	Data is sampled at a specified interval (in milliseconds).	Page 28 Timing of data sampling when "Time specification" is specified
General sampling	Time specification	Data is sampled at a specified interval (in seconds).	Page 29 Timing of data sampling when "Time specification" is specified
	Time interval specification	Data is sampled at a specified time interval (hour, minute, or second) from exactly midnight everyday, exact hour, or exact minute.	Page 29 Timing of processing when "Time interval specification" is specified

Point

- In order to perform high speed sampling, a CPU module which supports the high speed sampling function is required.
- The data logging, event logging, and report functions of a high speed data logger module are best effort functions.
Since the processing time of a module varies depending on the setting and the status of other devices, these functions may not perform at the set sampling interval.
Run the system by fully verifying the processing time of each function when constructing it.
- Data changes occurred between the data sampling processes are not sampled because the high speed data logger module samples the data only at the specified sampling interval. ( Page 430 Sampling Processes of High Speed Data Logger Module)

High speed sampling

This function samples target data by synchronizing with the sequence scan from a control CPU by using the sequence scan synchronization sampling function of a control CPU.

It also transfers device values to a high speed data logger module at the END processing of each scan in a control CPU, then stores them in the temporary area in the module.

Either "Each scan" or "Time specification"*¹ can be specified for the sampling interval.

*1 Trigger logging: 0.5 to 0.9, 1 to 32767 ms

Continuous logging: 2 to 32767 ms

System configuration which supports high speed sampling

The high speed sampling is supported only by the control CPU (other stations via network are not available).

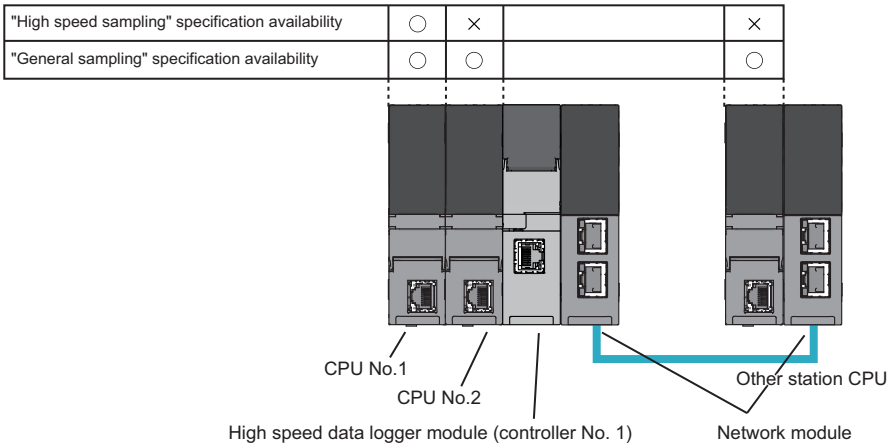

Point

- For the CPU modules and devices that can be accessed at high speed sampling, refer to the following:
 📖 MELSEC iQ-R High Speed Data Logger Module User's Manual (Startup)
- For the sequence scan synchronization sampling function, refer to the following:
 📖 MELSEC iQ-R CPU Module User's Manual (Application)

■Timing of data sampling when "Each scan" is specified

Target data is sampled in each sequence scan time of a CPU module.

When a CPU module is stopped, target data is not sampled.

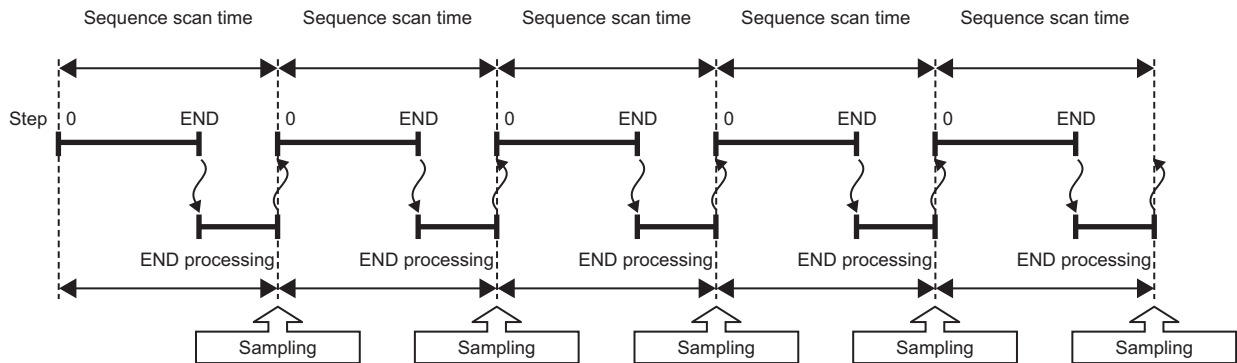

When "Each scan" is specified, scan time increases because of the data transfer from the CPU module to the high speed data logger module.

For details on delay time, refer to the following:

☞ Page 354 Influence on the sequence scan time

■Timing of data sampling when "Time specification" is specified

The target data is sampled in each sequence scan after passing the specified interval.

When the CPU module is stopped, the target data is sampled at each specified interval.

The data sampling timing differs depending on the specified interval and the sequence scan time of the CPU module.

- When the sequence scan time is shorter than the specified interval

The data is sampled after the first sequence scan of the CPU module for which the specified interval has elapsed.

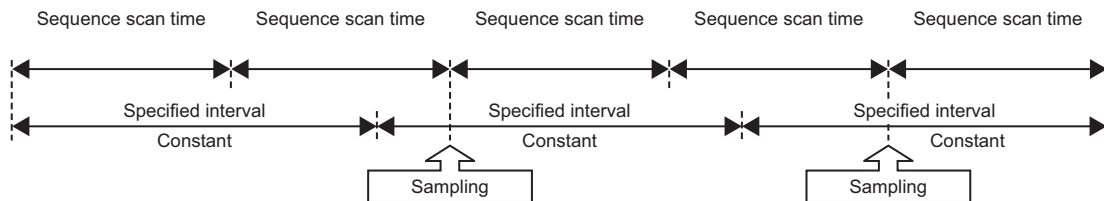

- When the sequence scan time is longer than the specified interval

Data is sampled at each sequence scan time.

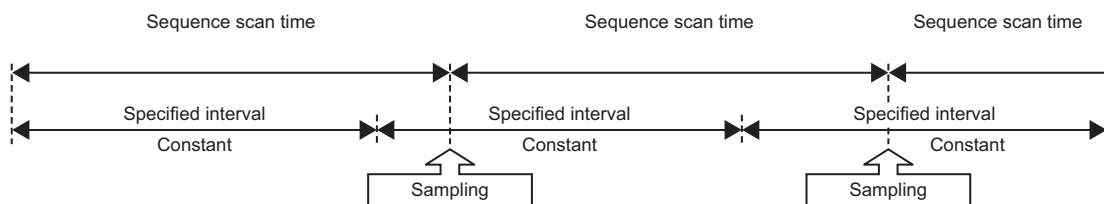

Precautions

When the following conditional expression is true, data is sampled, not with a sequence scan time (ST), but with a sampling interval (ST').

- Conditional expression

$$\alpha > 1$$

$$\alpha (\text{Round up after the decimal point}) = (0.4 \times \text{Number of settings where the high speed sampling is specified} - 0.2) \div \text{ST} [\text{ms}]$$

- Sampling interval

$$\text{ST}' = \text{ST} \times \alpha$$

Ex.

When there are 20 settings (the total of data logging setting, event logging setting, and report setting) in which the high speed sampling is specified and the sequence scan time is 3 ms

$$\alpha = (0.4 \times 20 - 0.2) \div 3 = 3 \text{ (Round up after the decimal point of 2.6)}$$

When $\alpha > 1$, sampling interval (ST') = $3 \times 3 = 9$

Data is sampled, not with a sequence scan time (3 ms), but with the sampling interval (9 ms).

General sampling

This function samples data from the control CPU, other CPU in a multiple CPU configuration, or a CPU module on other stations.

The sampling interval can be specified in seconds unit (0.1 to 32767) or at the best time possible.

Point

Since general sampling is not synchronized with the control CPU's sequence scan, data inconsistency may occur. To synchronize the data sampling to the sequence scan, use high speed sampling.

For details on the data inconsistency, refer to the following:

([MELSEC iQ-R High Speed Data Logger Module User's Manual \(Startup\)](#))

■Timing of data sampling when "Time specification" is specified

Data is sampled at each specified interval.

If the data cannot be sampled at the specified interval, it will be sampled with the time interval required to acquire the data.

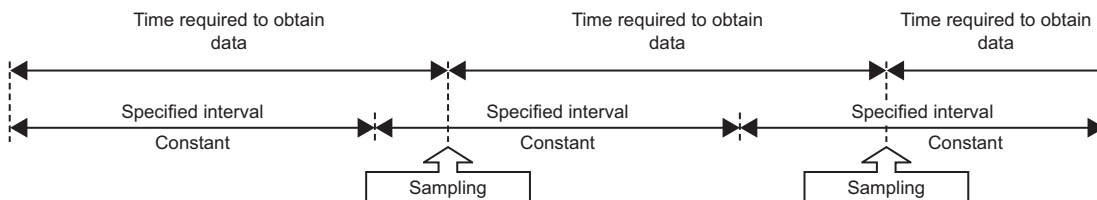

■Timing of processing when "Time interval specification" is specified

Samples data at the specified time interval (hour, minute, or second) from exactly midnight everyday, exact hour, or exact minute.

- Available time units and intervals

Unit	Interval
Hour	1, 2, 3, 4, 6, 8, 12, 24
Minute	1, 2, 3, 4, 5, 6, 10, 12, 15, 20, 30, 60
Second	1, 2, 3, 4, 5, 6, 10, 12, 15, 20, 30, 60

Ex.

When the time interval of 30 minutes is specified and power ON at 10:15.

Data is sampled at the intervals of 30 minutes from 10:30.

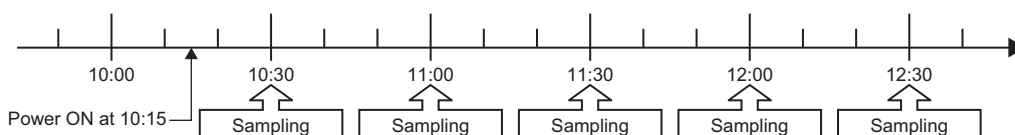

Continuous logging function

This function continuously logs target data at the specified sampling interval. The sampled values are written in the logging file whenever target data is sampled.

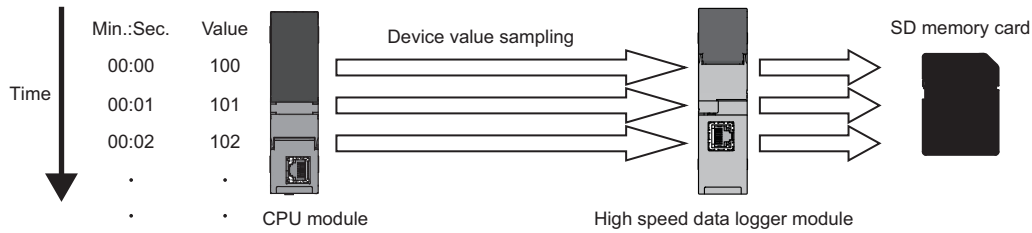

Trigger logging function

This function logs target data at trigger occurrence (specified condition is satisfied) or before and after the trigger occurrence. When logging device values before and after the trigger occurrence, the number of logging lines can be specified.

For trigger conditions, refer to the following:

☞ Page 41 Trigger conditions

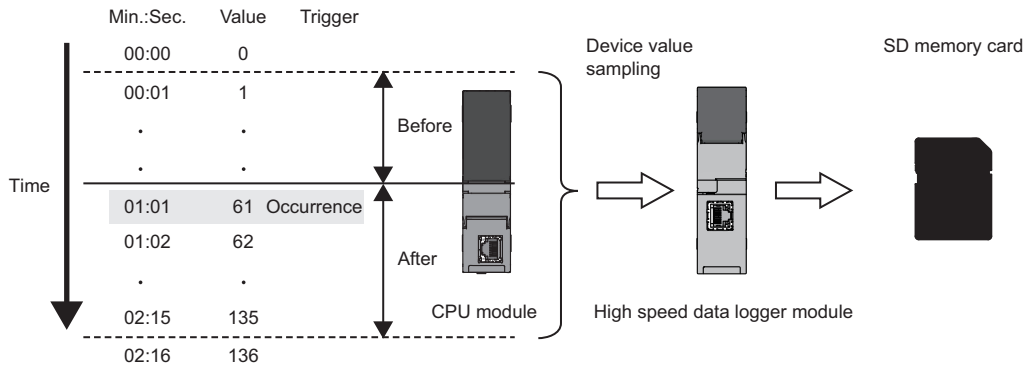

Point

When the number of device points to be sampled exceeds the access units and general sampling is specified for the data sampling method, device values are sampled over multiple sequence scans, and the values are logged as one data row. Therefore, device values sampled in another sequence scan as the one where the trigger occurred may be included in one data row. To avoid this, the number of device points that can be sampled at once should be less than the access units or high speed sampling should be used.

For the access units, refer to the following:

📖 MELSEC iQ-R High Speed Data Logger Module User's Manual (Startup)

Logging device values at the rise of a trigger condition

The device values at the rise of a trigger condition are logged.

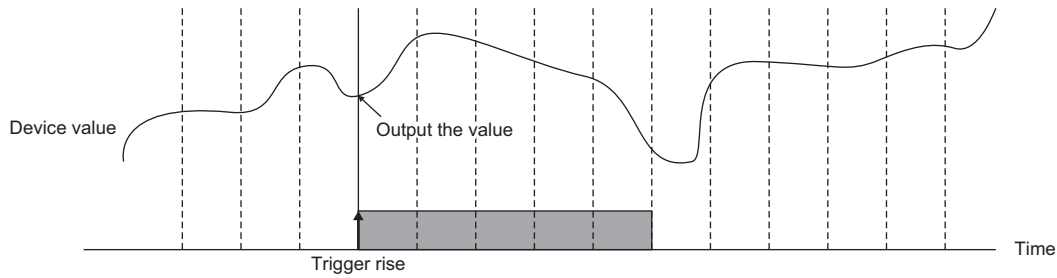

This function can be effectively utilized for outputting data in individual controls such as control data at the completion of a process.

In addition, the changes of the device values between two subsequent trigger occurrences are monitored, and the result of the device value changes can be output at the trigger occurrence.

Since the frequency of ON activations of the I/O signal or the time required for a single control processing can be output, this function can be effectively utilized for detecting failures depending on the durability during the continuous operation, or recording of the continuous operating time.

The device values, the number of times the counting condition has held true, and the time when the counting condition has held true can be output.

Point

With the following settings, the device values at the rise of a trigger condition can be logged.

- Unselect "Output lines before and after the trigger" with the [Logging type/File format] tab on the "Data logging setting" screen.

■ Device values

The device values sampled from the CPU module is output to a file.

■ Number of times the counting condition has held true

The count conditions are monitored for each sampling interval, and the count value is increased by adding 1 whenever the specified count condition is satisfied.

When the trigger logging condition is satisfied, the added count value is output. When the trigger logging condition is satisfied, the count value will be cleared to 0.

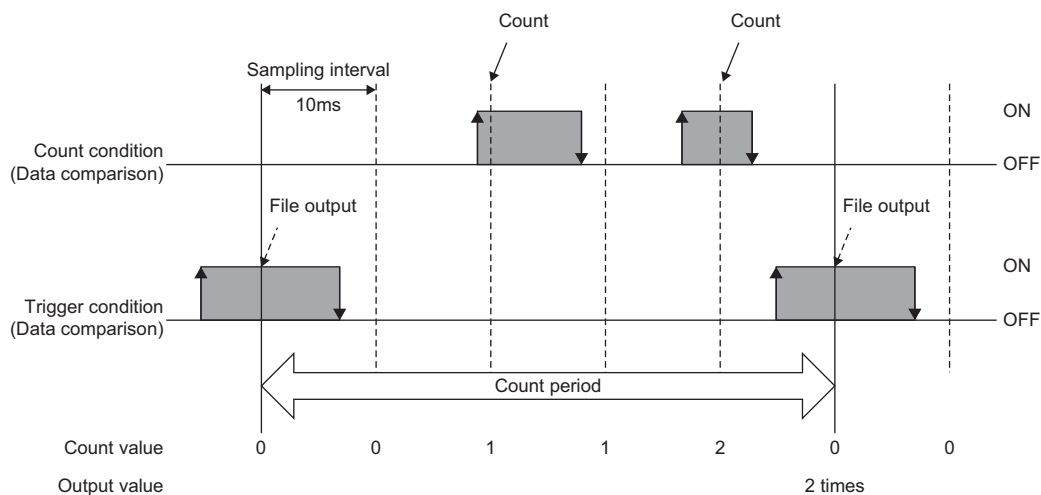

If the count condition and trigger condition are satisfied simultaneously, the count value is added and output to the file, then cleared to 0.

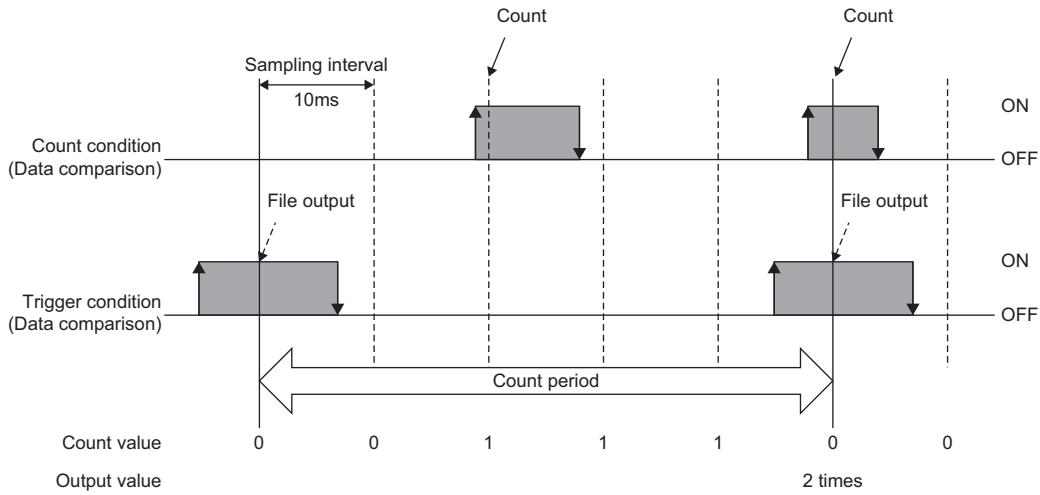

When the trigger logging condition is satisfied, the total count can also be output without clearing the count value. The count value is added even after the trigger logging conditions are satisfied and the total count is saved to the SD memory card.

When clearing the total number of times, clear the total number of times/total time operation of the data logging diagnostics.

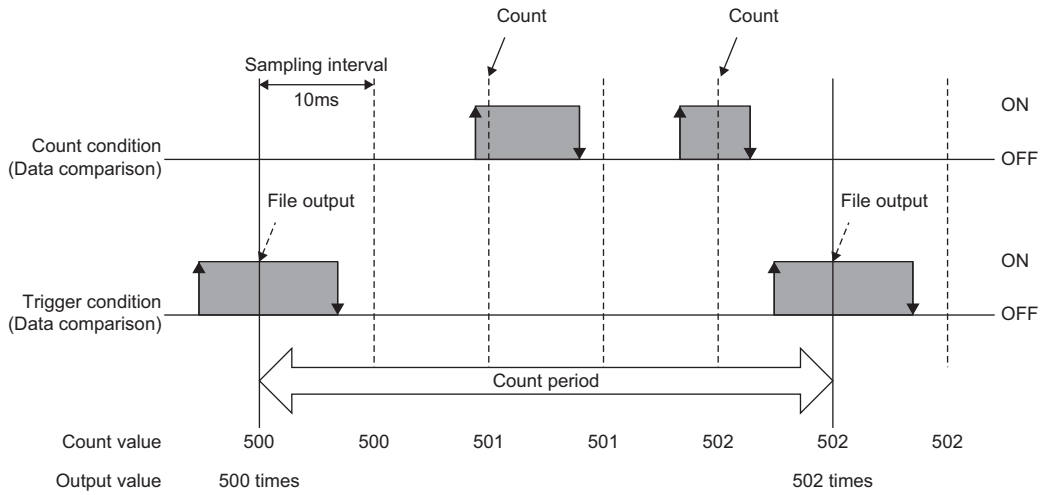

Time when the counting condition has held true

The count conditions are monitored for each sampling interval, and the time (sampling interval value when satisfying the count condition) when the specified count condition is satisfied, is added to the count time.

When the trigger logging condition is satisfied, the period during which the condition has been satisfied is output. When the trigger logging condition is satisfied, the count time is cleared to 0.

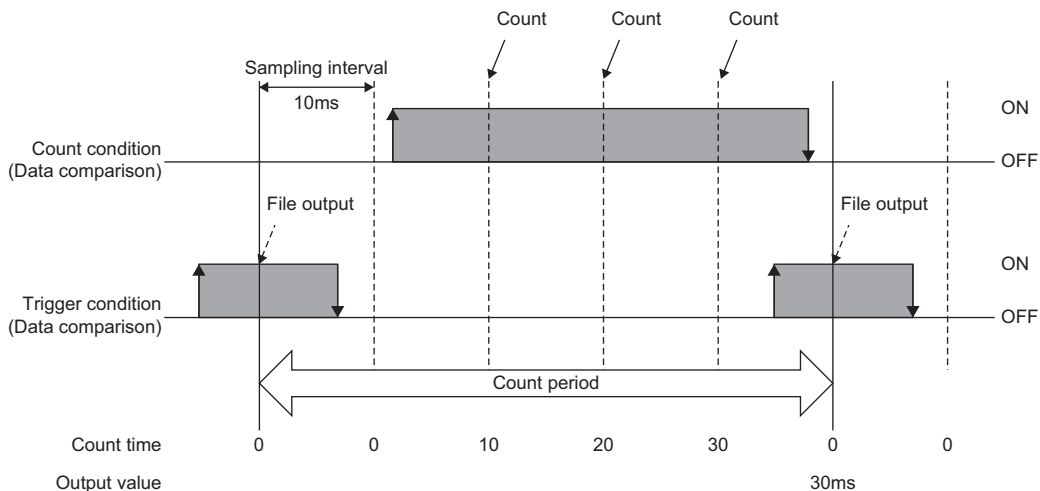

The time measurement depends on the sampling interval. Hence, if the data sampling is delayed, the delayed time is also added.

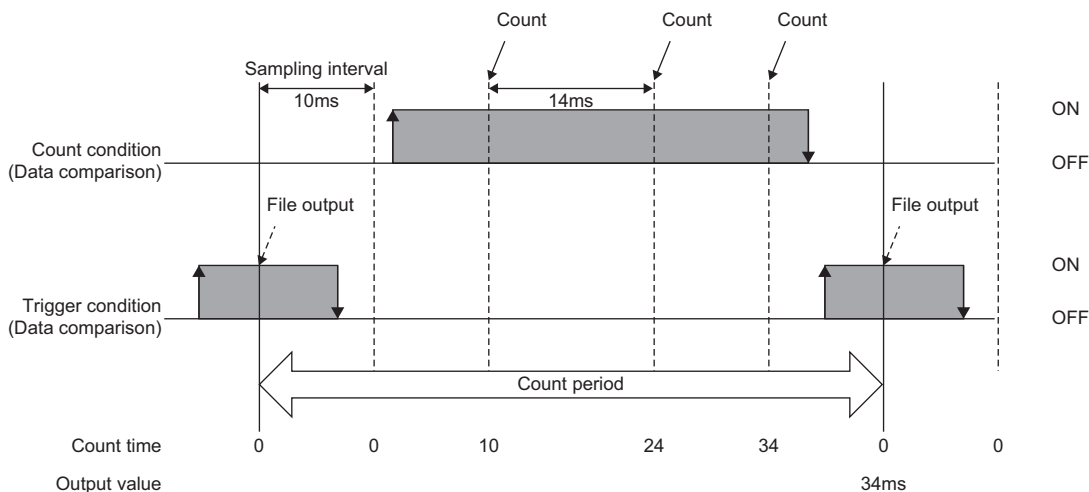

If the count condition and trigger condition are satisfied simultaneously, the count time is added and output to the file, then cleared to 0.

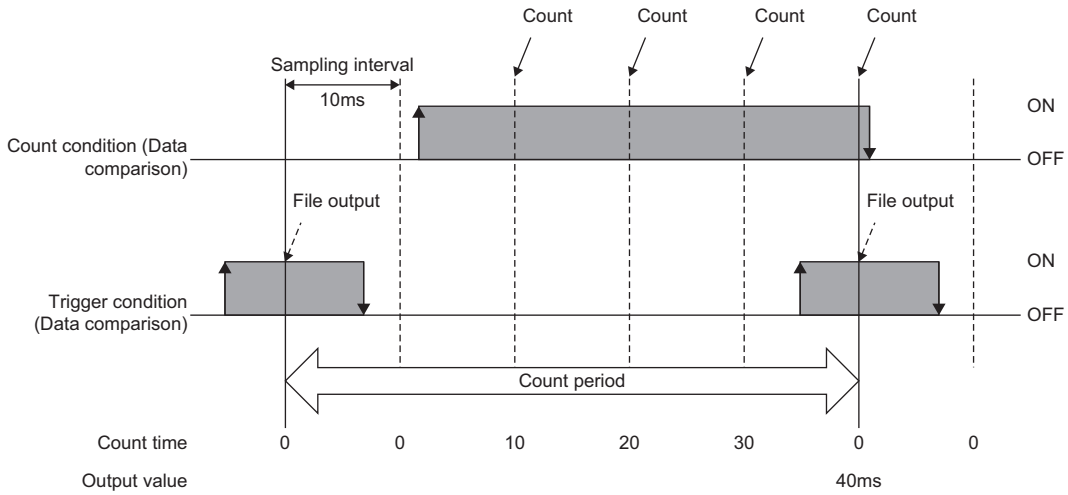

When the trigger logging condition is satisfied, the total time can also be output without clearing the count time. The count time is added even after the trigger logging conditions are satisfied and total count is saved to the SD memory card. When clearing the total time, clear the total number of times/total time operation of the data logging diagnostics.

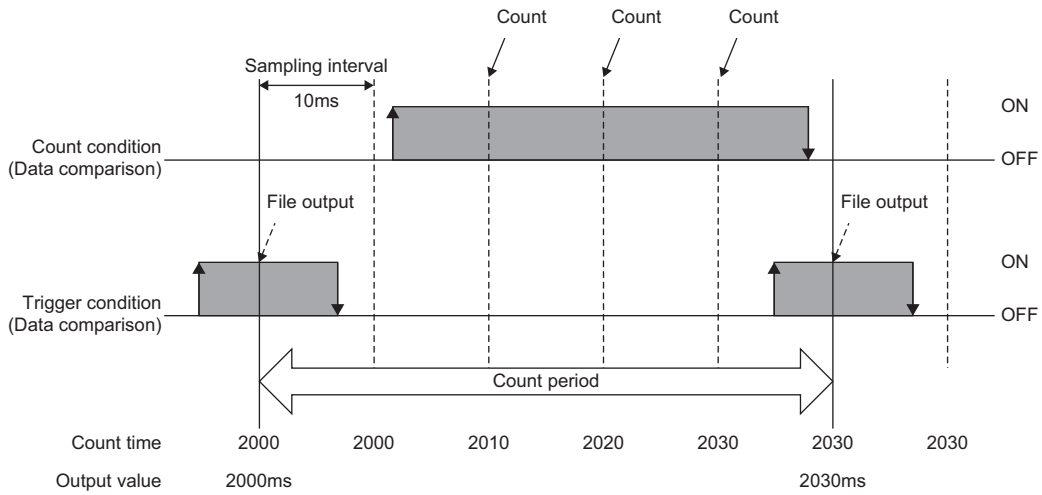

Data changes occurred between the data sampling processes are not sampled because the high speed data logger module samples the data only at the specified sampling interval from CPU module.

Therefore, even if the multiple count conditions are satisfied between the data sampling processes, the satisfaction of a count condition is judged only at the time of data sampling.

When the count condition is not satisfied at the time of data sampling, the values of the number of times and the time will not updated.

The maximum count value of the number of times and the time will be 4294967295. If the value exceeds 4294967295, the count value will be fixed to 4294967295.

- For number of times

When the count condition is satisfied at the time of data sampling, the count value is increased by adding '1'.

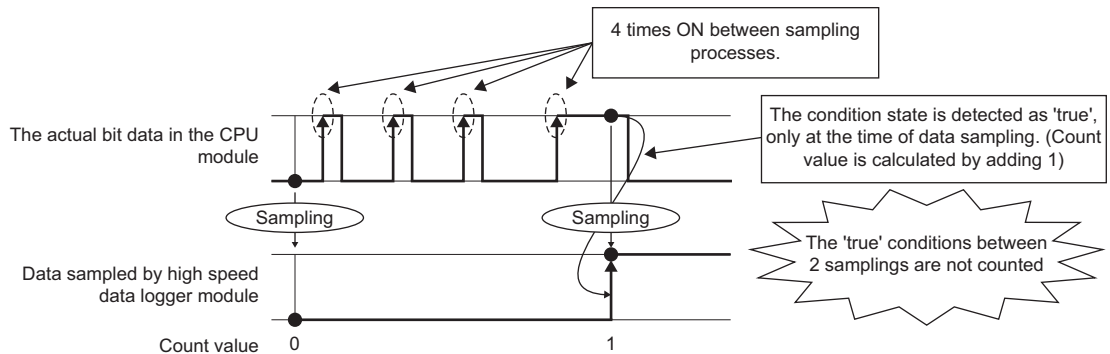

- For time

The count time depends on the sampling interval. Even if the count condition is not always satisfied between the data sampling processes and when the count condition is satisfied at the time of data sampling, the time for the sampling interval is added to the count time. Therefore, the actual time when the counting condition has held true may differ from the time to be output to the file.

The condition holds true immediately after the previous sampling

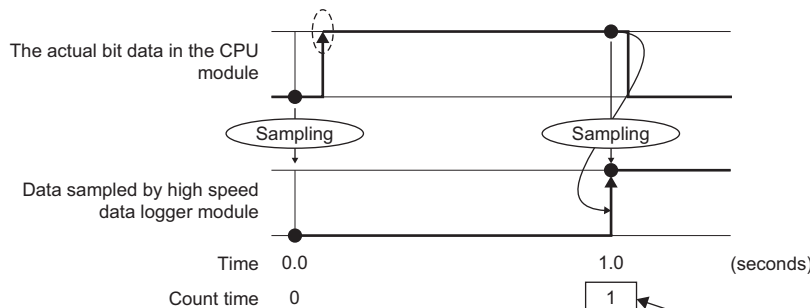

The condition holds true immediately before the sampling

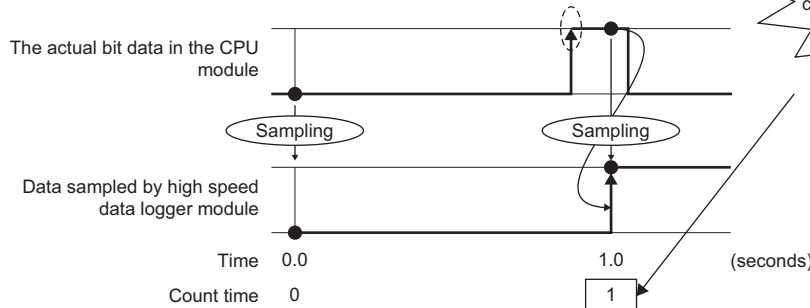

Logging device values before and after the rise of a trigger condition

The device values before and after the rise of a trigger condition for the number of specified logging lines are logged. Only device values can be output. The number of times the counting condition has held true and the time when the counting condition has held true cannot be output.

There are two methods for specifying the number of logging lines.

■ Logging device values before and after the rise of a trigger condition

Specify the number of lines before and after the rise of a trigger condition.

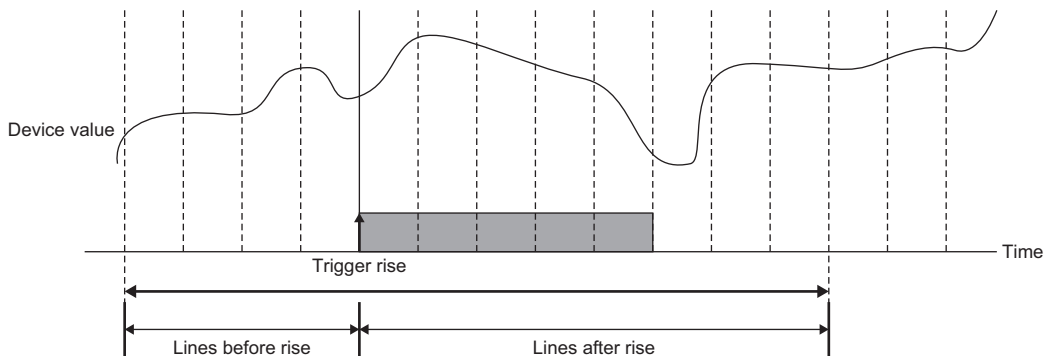

The device values before and after the specified lines are output based on the rise of a trigger.

■ Logging data before the rise of a trigger condition, while a trigger condition is satisfied, and after the fall of a trigger condition

Specify the number of lines before the rise of a trigger, the number of lines after the fall of a trigger, and the total number of lines.

The total number of lines indicates the maximum number of lines that can log data with a single trigger rise.

Set the value more than the total number of lines before the rise of a trigger and after the fall of a trigger.

The lines exceeding the total number of lines before the rise of a trigger and after the fall of a trigger are assigned to the logging lines on which the trigger condition is satisfied.

It can be specified in the case of the following settings.

- When "Single condition" is selected in the trigger setting, and "Comparison" is selected in the data condition.
- When "Compound condition" is selected in the trigger setting, and "AND combine" is selected in the trigger type.

With this setting, the logging range differs according to the length of time the trigger condition is satisfied.

- The time that the trigger condition is satisfied is short.

The total number of lines before and after the rise of the specified trigger condition and while the trigger condition is satisfied are logged.

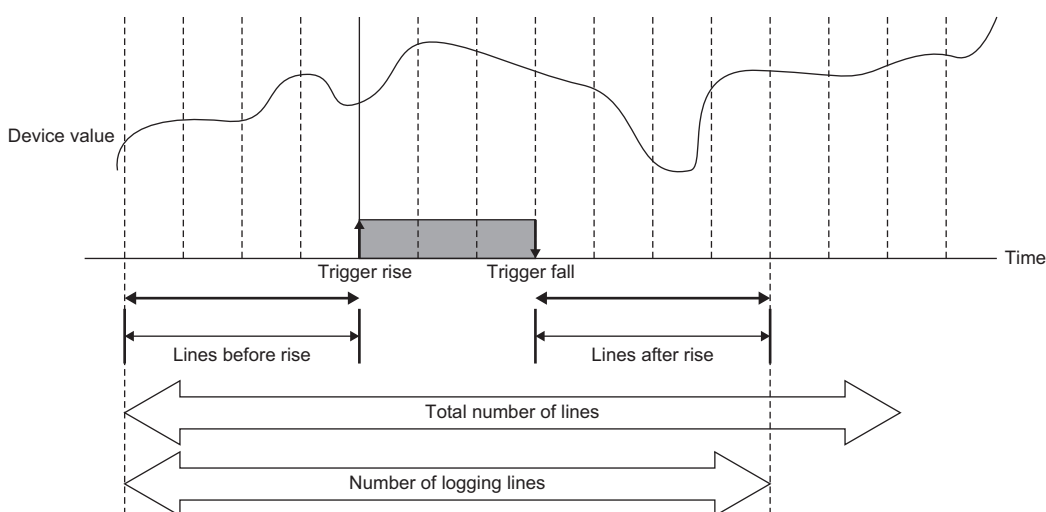

- The time that the trigger condition is satisfied is long.
The number of lines worth of data is logged.

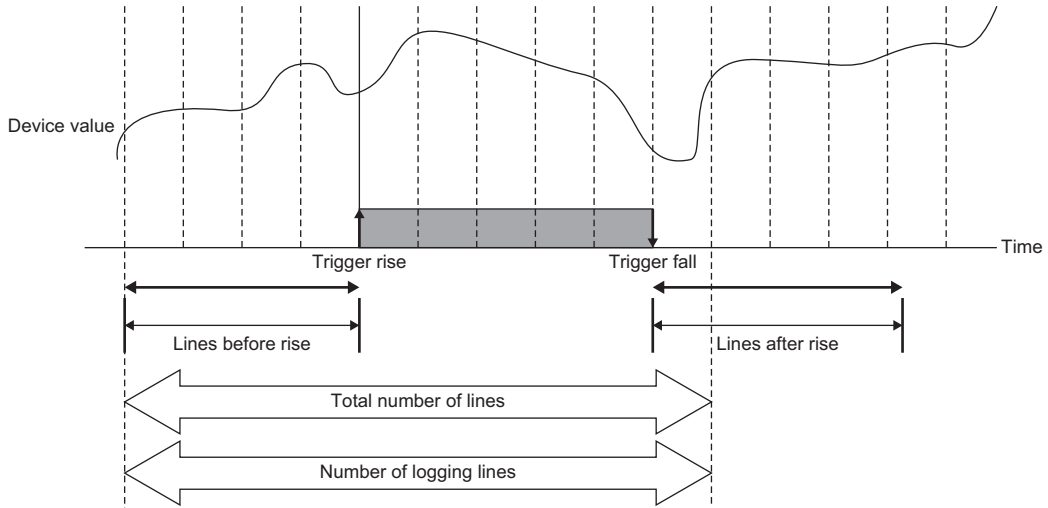

Immediately after switching the programmable controller system ON, if a trigger occurs before sampling the number of lines of data before the trigger, the lines of the data before the trigger will be fewer than the specified number of lines.

Continuous trigger occurrence leads to the following operations.

- After a trigger occurs, if the next trigger occurs before sampling the specified number of lines after a trigger occurrence, the next trigger will not be detected (the trigger occurrence is ignored).

The number of times that the trigger is ignored can be checked by the trigger reoccurrence count, 'data logging information 1 to 64' (Un\G2030 to 2989) in the buffer memory.

(Example) When sampling interval: 10 ms, Number of lines after a trigger occurs: 100 lines

Any trigger that occurs within 1000 ms after the first trigger will not be processed.

- After the first trigger occurs, triggers which occur after the number of lines worth of data is sampled, are detected. However, if the number of lines of data before the second trigger overlaps with the number of lines of data after the first trigger, the time data output by the first trigger will not be output in the second trigger.

Therefore, the number of lines of data before the second trigger may be shortened.

(Example) Sampling interval: 10 ms, Period when a trigger occurs: 1500 ms, Number of lines before a trigger occurs: 100 lines, Number of lines after a trigger occurs: 100 lines

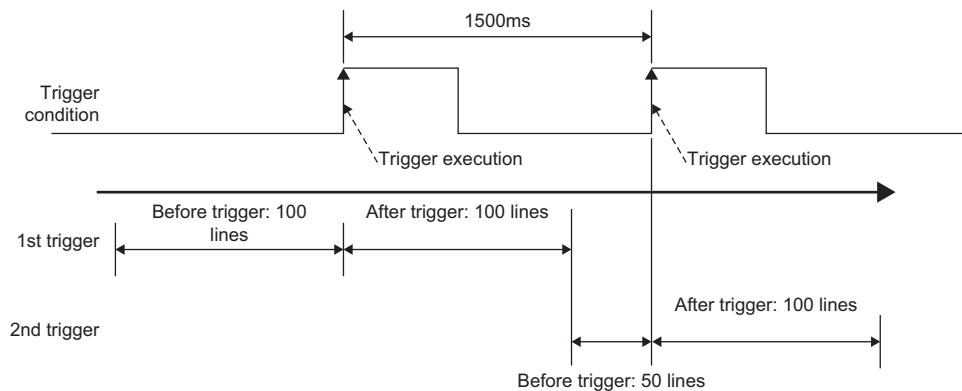

- Between a trigger occurrence and output to a file, only one other trigger is processed. While two triggers are being processed to be output to a file, trigger detection is not performed. Thus, if any other trigger (third or later trigger counting from the first trigger) occurs, the trigger is not detected. During this period, subsequent processing is not catching up with the data sampling speed, and the processing gets overloaded. To check the processing overload count, refer to the trigger recurrence count of the 'data logging information 1 to 64' (Un\G2030 to 2989) in the buffer memory. Check whether the data is being output to a file based on the 'data logging execution information' (Un\G2008 to 2011) in the buffer memory.

For the approximate time required for the data to be output to a file, refer to the following:

(Page 346 Processing Time)

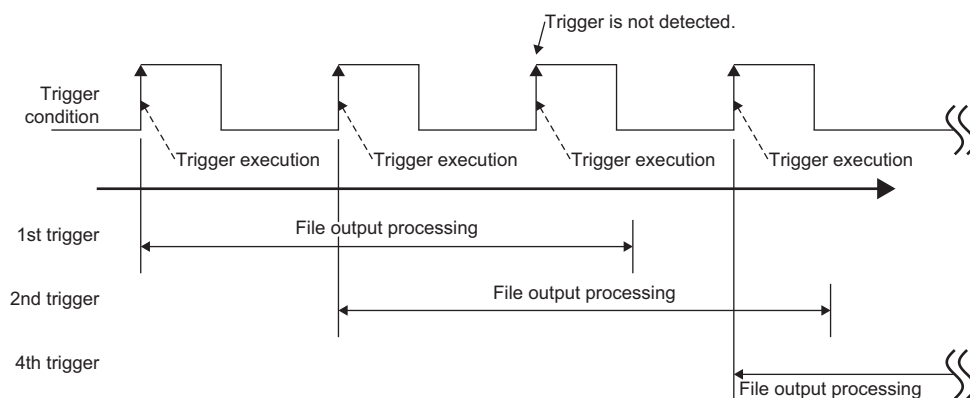

Trigger buffer utilization

When the trigger logging is specified, the internal memory (trigger buffer) of the high speed data logger module is used to temporarily store the data before and after the trigger occurrence.

The setting which exceeds the total trigger buffer utilization (20 MB (20971520 bytes)) on the high speed data logger module cannot be configured.

The trigger buffer utilization can be obtained by the following formula.

Trigger buffer utilization per single data logging = $((\text{device points} \times 2 + 88) \times (\text{total number of lines} + 1)) \times 2$

■Number of device points

The device points of data types per one data logging are as follows:

Data type	Number of device points
Bit	1 point
Word [Signed]	1 point
Double Word [Signed]	2 points
Word [Unsigned]/Bit String [16-bit]	1 point
Double Word [Unsigned]/Bit String [32-bit]	2 points
FLOAT [Single Precision]	2 points
FLOAT [Double Precision]	4 points
16bit BCD	1 point
32bit BCD	2 points
String	(Specified size ÷ 2) points ^{*1*2}
Raw	(Specified size ÷ 2) points ^{*1*2}

*1 If the size is in odd number, the device point will be rounded up by adding 1 point.

*2 For double word device, the device becomes 2 points for each 4 bytes. The fraction should be rounded up to 2 points.
(Assign 2 points if size is 4 and 4 points if size is 5)

■Total number of lines

The total number of lines indicates the value set in the [Number of Logging Lines] tab on the "Data logging setting" screen.
( Page 161 Number of logging lines)

However, calculate as 100 lines if the total number of lines is less than 100 lines for high speed sampling. Calculate as 30 lines if the total number of lines is less than 30 lines for general sampling.

Ex.

When performing trigger logging in high speed sampling with all the 64 words [Signed] and on total 100 lines

Trigger buffer utilization per single data logging = $((64 \times 1) \times 2 + 88) \times (100 + 1) \times 2 = 43632$

Trigger buffer usage rate = $43632 / 20971520 \approx 0.2\%$

Completion notification of trigger logging

When the output to a file is completed after the trigger condition of the trigger logging is satisfied, the specified device value can be changed and the completion of the trigger logging can be notified.

The operation example to notify the completion of the trigger logging is as follows:

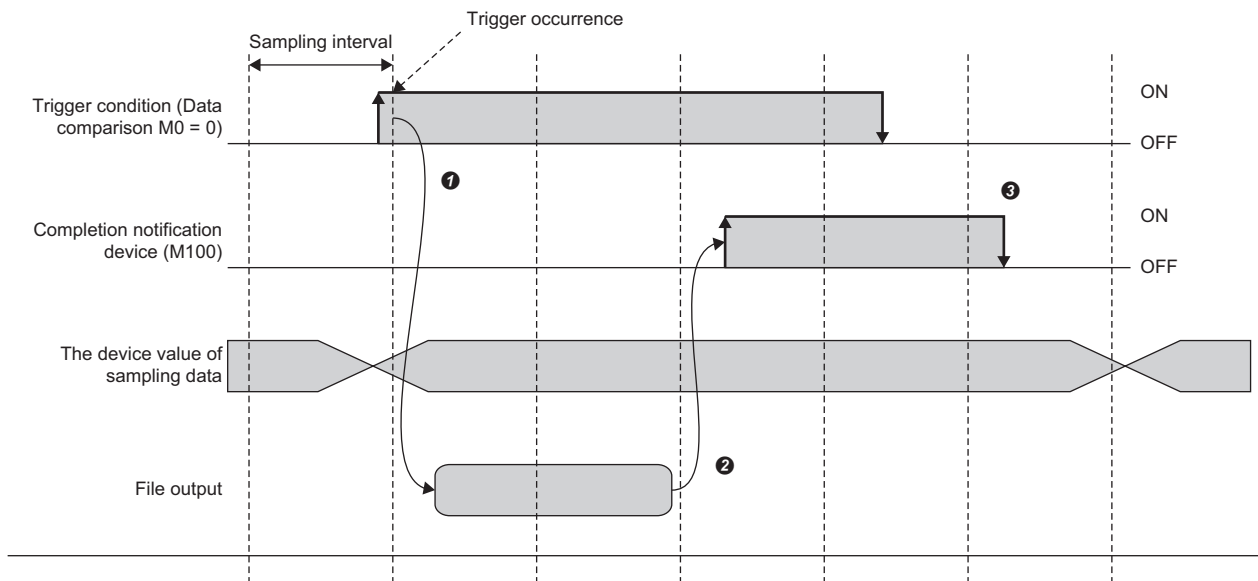

- ❶ Check whether the trigger condition is satisfied with the sampling interval. In the example above, a trigger occurs and starts logging when the trigger condition M0 is ON by the ladder program of the CPU module.
- ❷ High speed data logger module will output the sampled data to file when 'M0 is ON' is detected (logging processing). After completing the output to a file, the high speed data module turns ON the 'completion notification device' M100.
- ❸ Check that M100 is ON, and the trigger condition M0 and the 'completion notification device' M100 is OFF by the ladder program of the CPU module.

The value of the completion notification device is changed in the high speed data logger module after the completion of logging. The value of the completion notification device is not updated until the device value on the CPU module side is changed. To receive a completion notification again, be sure to change the value of completion notification device before the next trigger occurs.

After a trigger condition is satisfied, if the trigger condition is satisfied again before the completion notification device is turned ON, the second trigger completion notification request will be ignored until the first completion notification is completed. Check that the completion notification device is ON first, then satisfy the trigger condition again after the completion notification device is turned OFF.

The completion notification device can be specified only for the bit devices of the own station CPU and another station CPU.

Point

- Do not change the device value of sampled data until the completion notification device is ON.
- If the data sampling method is the high speed sampling, the 'completion notification device' cannot be specified.

Trigger conditions

Conditions shown in the following table can be selected as the trigger conditions.

Condition	Trigger type	Detailed condition	Reference
Single condition	—	—	Page 41 Single condition
Compound condition	OR combine	—	Page 44 OR combine
	AND combine	—	Page 44 AND combine
	Number of times	When a terminal condition holds true	Page 45 Number of times
		When a specified number of times is exceeded	
	Order	Abnormal pattern is detected	Page 46 Order
		Normal pattern is detected	
		Detect timeout	

Single condition

For single condition, triggers occur by satisfying a single condition.

Select one condition from the conditions in the following table.

Condition	Description	Reference
Data conditions* ¹	Comparison	Compares device values or a device value and constant. A trigger occurs when a condition is satisfied. ($>$, \geq , $<$, \leq , $=$, \neq)
	At value change	
Fixed cycle	A trigger occurs at a fixed cycle (seconds).	Page 158 Trigger (single condition)
Time interval specification	A trigger occurs at the specified time interval (hour, minute, or second) from exactly midnight everyday, exact hour, or exact minute.	
Time specification	A trigger occurs at the specified time.	
At module startup	The condition is satisfied at either of the following timing. <ul style="list-style-type: none"> At the power ON of the CPU module After the CPU module is reset 	

*1 Since the conditions are judged based on the data sampled at the specified sampling interval, a trigger will not be detected if the condition is not satisfied at the time of data sampling.

■ Data conditions (comparison)

Device values or a device value and constant are compared. A trigger occurs when a condition is satisfied.

When the comparison is specified in the condition, the trigger occurrence timing is as follows:

- For bit device ($M0 = ON$)

A trigger occurs when $M0$ is turned OFF \rightarrow ON.

To judge the rise of a bit device, turn OFF the $M0$ once, then turn it ON again to make a trigger occur.



- When word device ($D0 > 100$)

A trigger occurs when $D0 > 100$.

A trigger occurs when the value of $D0$ is less than 100, then it becomes more than 100.

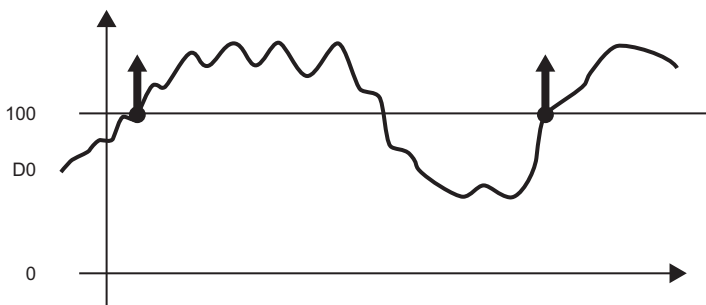

■Data conditions (value changes)

A trigger occurs when the device value is changed.

The timing of the trigger occurrences when "At value change" is specified as the condition is as follows:

- For bit device (M0)

A trigger occurs when M0 is turned OFF → ON, and ON → OFF.



- For word device (D0)

A trigger occurs when device value of D0 is changed.

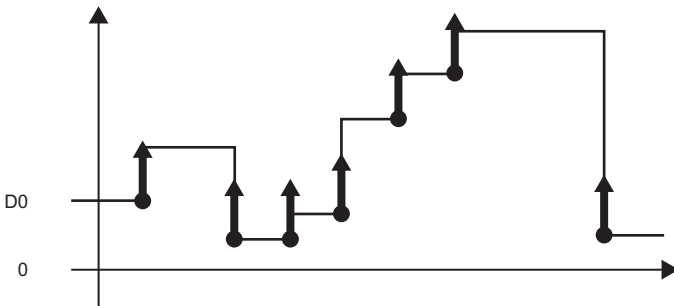

■Fixed cycle

A trigger occurs at a fixed cycle (seconds).

A trigger occurs at the specified interval after power is ON or settings are updated (after OPR LED is ON).

However, when the interval specified in a fixed cycle and the data sampling timing do not match, a trigger occurs at the time of first data sampling after the specified fixed cycle interval has elapsed.

The cycle that can be specified is 1 to 86400 seconds.

- When the fixed cycle of 10 seconds is specified

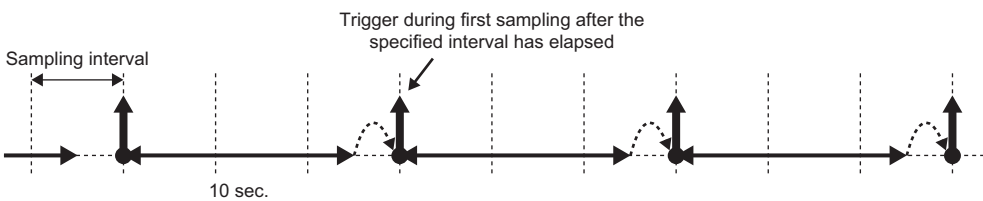

■Time interval specification

A trigger occurs at the specified time interval (hour, minute, or second) from exactly midnight everyday, exact hour, or exact minute.

The available time units and intervals are as follows:

Unit	Interval
Hour	1, 2, 3, 4, 6, 8, 12, 24
Minute	1, 2, 3, 4, 5, 6, 10, 12, 15, 20, 30, 60
Second	1, 2, 3, 4, 5, 6, 10, 12, 15, 20, 30, 60

Only one unit and its interval can be specified to the time interval. When hour is specified to the unit, only one interval can be specified from 1, 2, 3, 4, 6, 8, 12, and 24.

- When the time interval of 30 minutes is specified and powered ON at 10:15

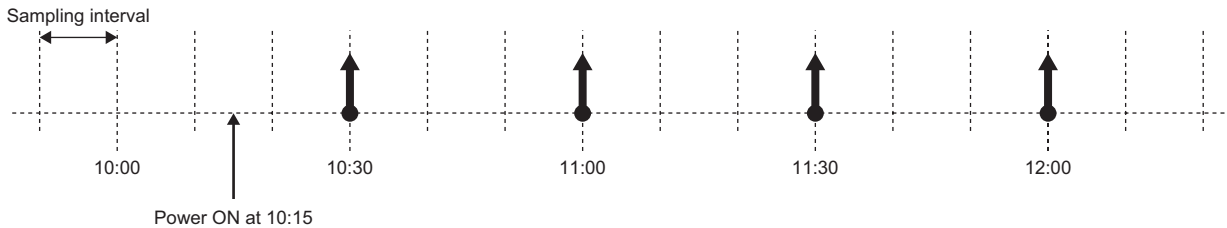

■Time specification

A trigger occurs at the specified time.

However, when the specified time and the data sampling timing do not match, a trigger occurs at the first time of data sampling for which the specified time has elapsed.

The date and time that can be specified are as follows:

Unit	Interval
Month	1 to 12, every month
Day	1 to 31, last day, every day
Hour	0 to 23, every hour
Minute	0 to 59, every minute
Second	0 to 59

When specifying every day, every hour, and every minute, set the respective values of date and time for every month, every day, and every hour. (When every hour is set, set the value for every month and every day.)

- When every month, every day, every hour, 0 min., and 5 sec are specified.



Compound condition

For compound condition, triggers occur by satisfying multiple conditions.

The conditions which compose compound conditions are the same as following section.

Trigger condition	Conditions that can be specified	Reference
OR combine	<ul style="list-style-type: none"> Data conditions (comparison)^{*1} Data conditions (value changes)^{*1} Fixed cycle Time interval specification Time specification At module startup 	Page 44 OR combine
AND combine	<ul style="list-style-type: none"> Data conditions (comparison)^{*1} 	Page 44 AND combine
Number of times	<ul style="list-style-type: none"> Data conditions (comparison)^{*1} Data conditions (value changes)^{*1} 	Page 45 Number of times
Order	<ul style="list-style-type: none"> Data conditions (comparison)^{*1} Data conditions (value changes)^{*1} 	Page 46 Order

*1 Since the conditions are judged based on the data sampled at the specified sampling interval, a trigger will not be detected if the condition is not satisfied at the time of data sampling.

For details on the conditions that can be specified, refer to the following:

📖 Page 41 Single condition

For the number of conditions which can be specified for the compound condition, refer to the following:

📖 MELSEC iQ-R High Speed Data Logger Module User's Manual (Startup)

■OR combine

Triggers occur by satisfying any of the set conditions.

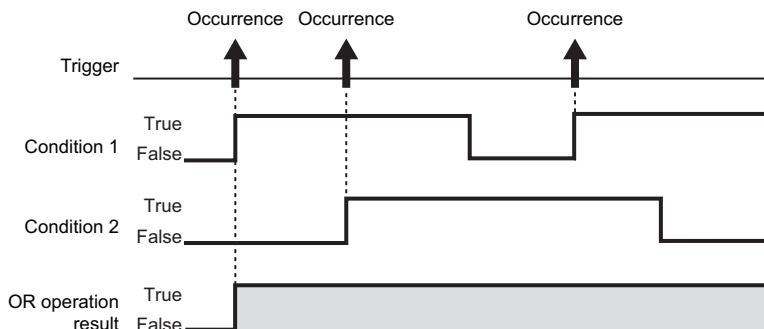

■AND combine

Triggers occur by satisfying all of the set conditions.

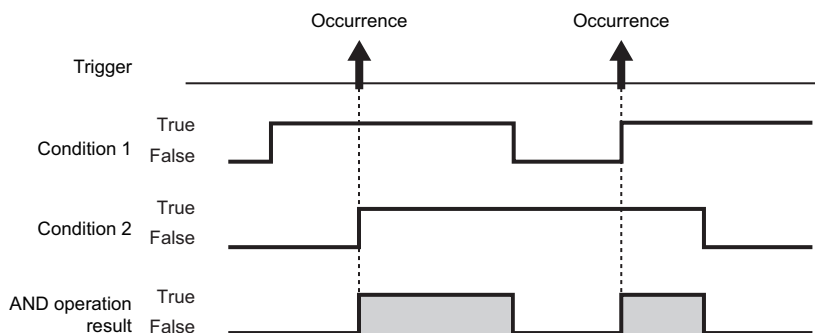

■ Number of times

The number of times the condition is satisfied (number of counts) is compared with the specified number of times. A trigger occurs when the condition is satisfied.

The conditions for the trigger occurrence are as follows:

Conditions for the occurrence of a trigger = [Number of times the count condition is satisfied] (=, ≠, ≤, ≥, <, >) [Specified number of times]

The timing to compare the number of counts and the specified number of times can be selected from "When a terminal condition holds true" and "When a specified number of times is exceeded".

- When a terminal condition holds true

The number of times the count condition is satisfied is counted from when the start condition has been satisfied to when the terminal condition has been satisfied (count period).

When a terminal condition is satisfied, the conditions for the occurrence of a trigger are judged. If the conditions are satisfied, a trigger occurs.

After that, the number of counts is reset when the start condition has been satisfied, and the next count is started.

The start condition, terminal condition, and count condition determine the rise of conditions.

Ex.

Conditions for the occurrence of a trigger = Number of times the count condition is satisfied > 2

The number of counts at the time of the terminal condition satisfaction is 3, and the occurrence condition is fulfilled.

The trigger occurs when the terminal condition is satisfied.

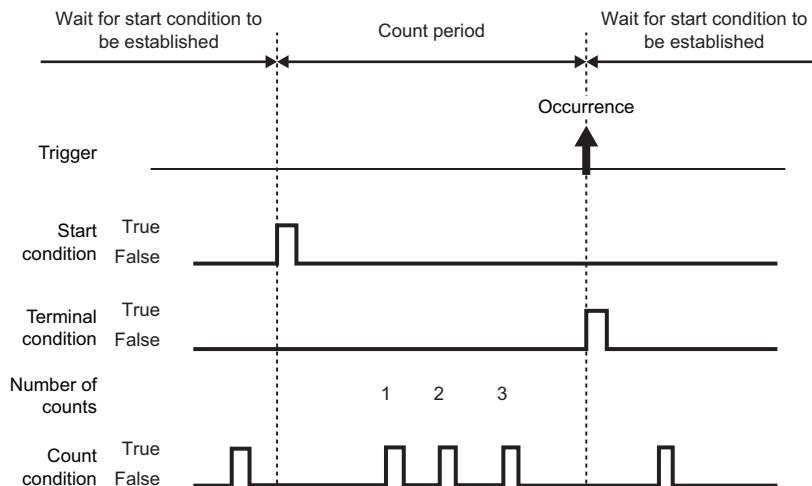

- When a specified number of times is exceeded

The number of times the count condition is satisfied is counted from when the start condition has been satisfied to when the terminal condition has been satisfied (count period).

During the count period, the conditions for the occurrence of a trigger are always judged. If the conditions are satisfied, a trigger will occur immediately.

If trigger occurs once, the terminal condition is satisfied, and until the start condition is satisfied again, a trigger does not occur.

When a terminal condition is satisfied and a start condition is satisfied again, the number of counts is reset and the next count is started.

The start condition, terminal condition, and count condition determine the rise of conditions.

Ex.

Conditions for the occurrence of a trigger = Number of times the count condition is satisfied > 2

A trigger occurs when the number of times the count condition is satisfied three times.

Then, even if the count condition is satisfied, a trigger does not occur.

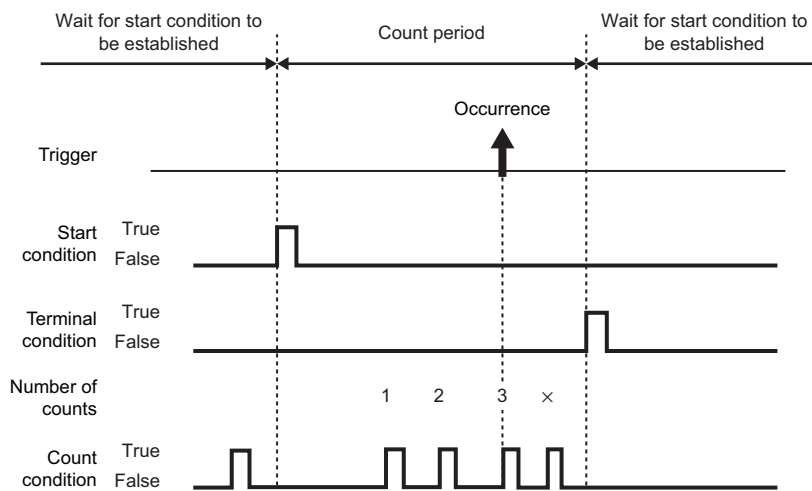

■Order

A trigger occurs when the order is wrong (abnormal pattern is detected), when the order is correct (normal pattern is detected), or when a timeout is detected by monitoring the order of multiple conditions satisfaction.

- Abnormal pattern is detected

After starting the monitoring of sequential order once the start condition is satisfied, patterns that are satisfied in such a order which differs from the order of 1st condition, 2nd condition and 3rd condition, are detected.

A trigger occurs when the condition is satisfied in a order which differs from the specified order.

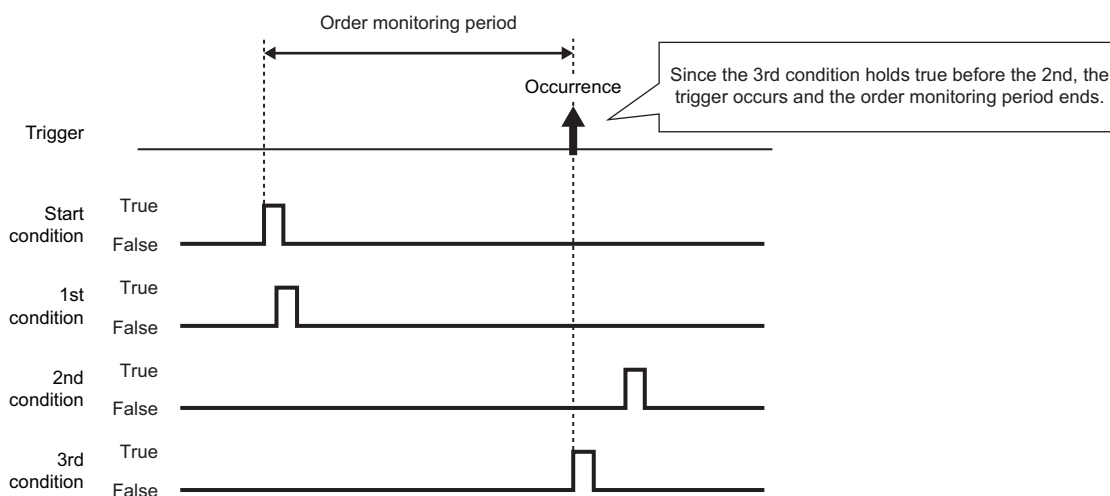

• Normal pattern is detected

After starting the monitoring of sequential order once the start condition is satisfied, patterns that are satisfied in the order of 1st condition, 2nd condition and 3rd condition, are detected.

A trigger occurs when the condition is satisfied in the specified order.

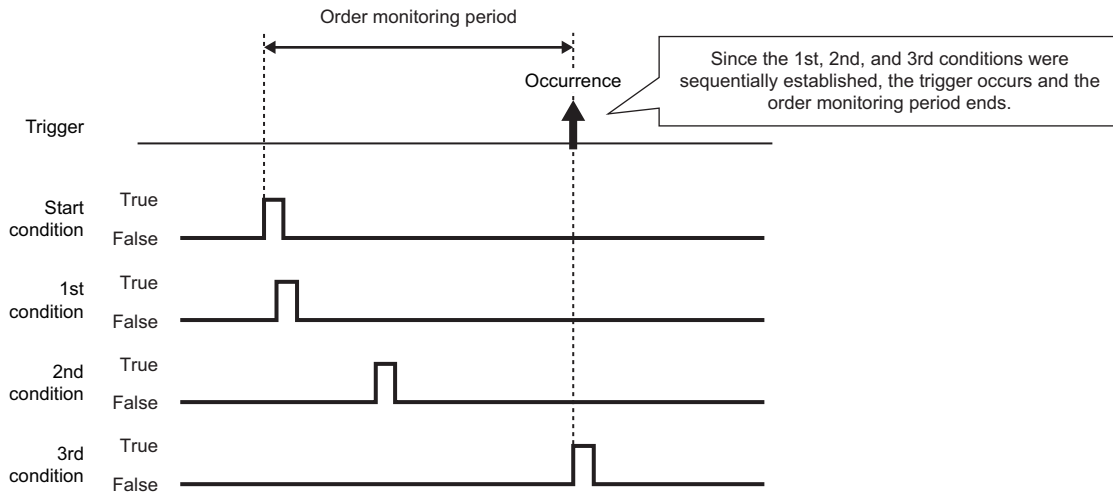

• Detect timeout

The condition until the next condition is satisfied, is monitored after one condition has been satisfied.

If the specified monitoring timeout time elapses and the next condition is not satisfied, this is considered as a timeout and sequential monitoring ends, and it again waits for the start condition to be satisfied sequentially.

The time that can be specified in the monitoring timeout is 0.1 to 0.9 sec. and 1 to 32767 sec.

For the diagram below, it will be a monitoring timeout since the 2nd condition is not satisfied within the monitoring timeout time after the 1st condition has been satisfied.

In addition, a trigger occurs at the same time as the timeout is detected.

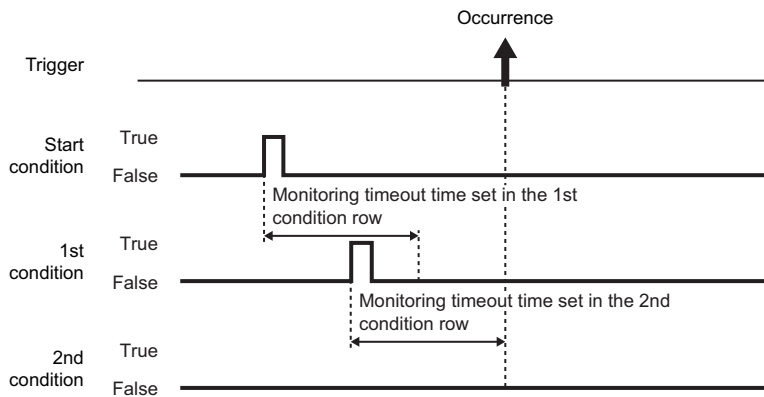

When the setting value of monitoring timeout is smaller than that of the sampling interval, a timeout occurs.

Period specification

When the specified conditions are satisfied, the period to perform logging and the period not to perform logging can be specified.

For trigger logging, the period to monitor trigger and the period not to monitor trigger can be specified.

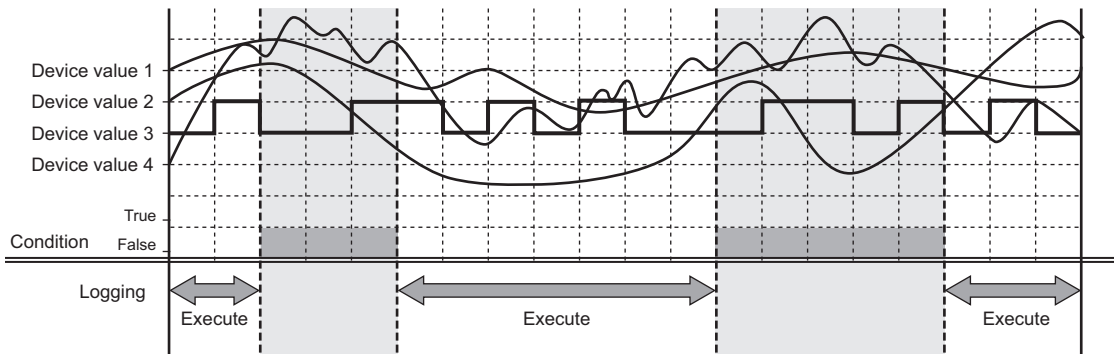

The conditions to specify period can be selected from the following and can be specified by combining multiple conditions.

- ❶ Data conditions
- ❷ Date range
- ❸ Time range
- ❹ Day of the week/Week of the month conditions

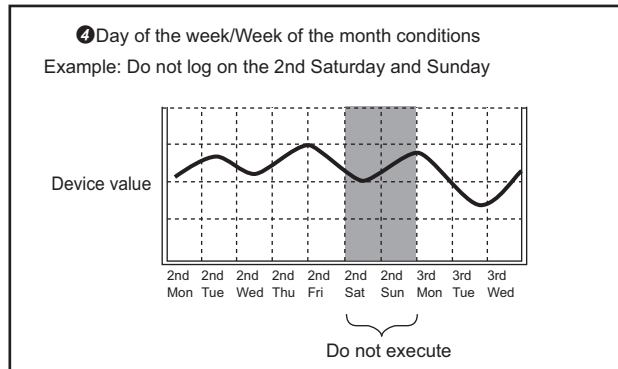
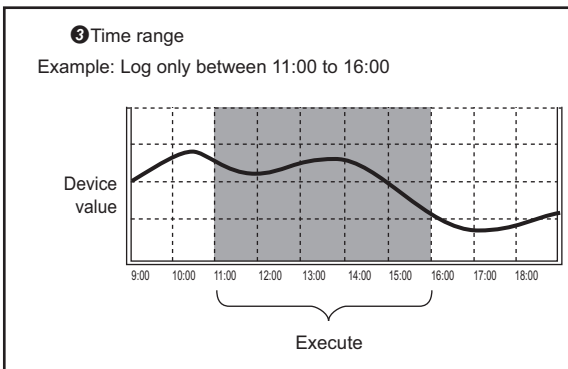
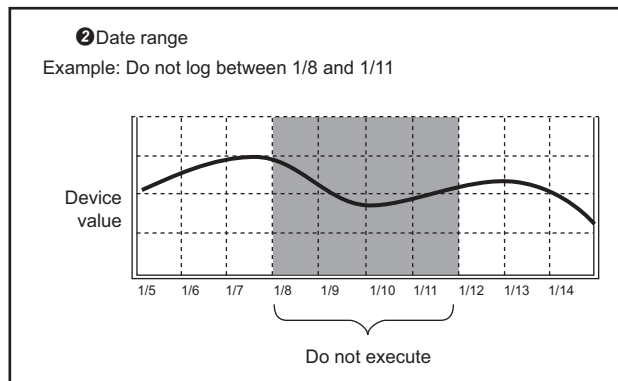
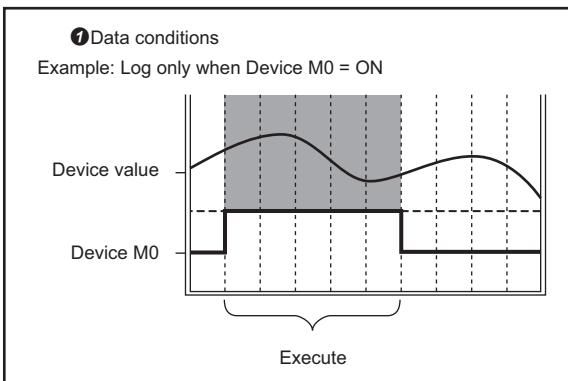

For the number of conditions which can be specified for the compound condition, refer to the following:

📖 MELSEC iQ-R High Speed Data Logger Module User's Manual (Startup)

OR combine

When any of the set period conditions is satisfied, the logging is either performed or not performed.

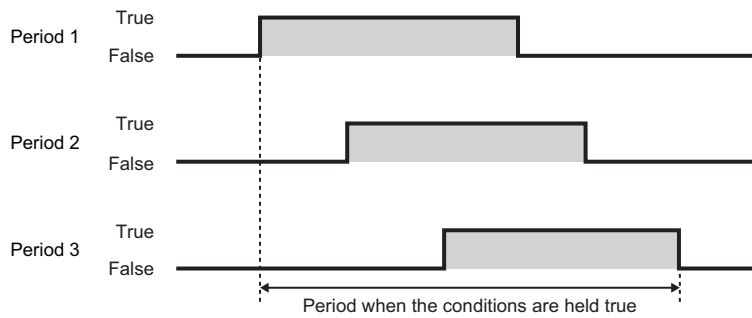

AND combine

When all the set period conditions are satisfied, the logging is either performed or not performed.

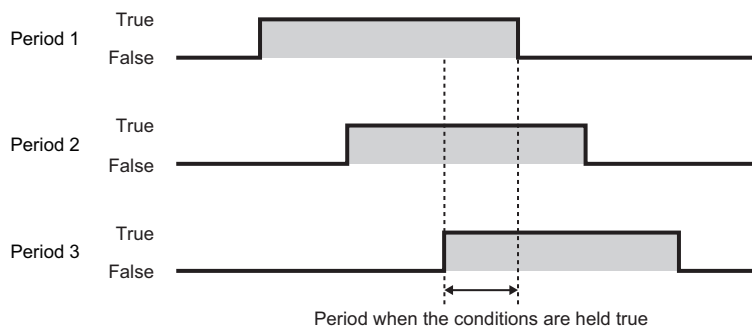

Scaling function

This function uses linear function transformation for sampled device values.

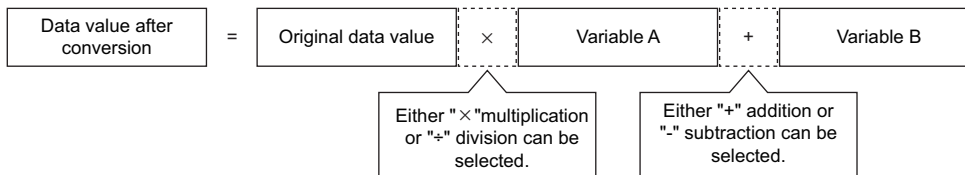

Point

- For scaling, all values are calculated as double precision floating point numbers, and the result is output with the specified output format.
- When the operation result is over the maximum value or under the minimum value for the specified output format range, the data to be output differs depending on the file format.

Save function

This function saves data logging target data in the data logging file.

Data logging file save format

Data logging files can be saved in the following three types of format on a high speed data logger module.

- Unicode text file format (extension: .TXT)
- Binary file format (extension: .BIN)
- CSV file format (extension: .CSV)

For details on each file format, refer to the following:

 Page 357 Data Logging File Format

■Unicode text file format

Unicode text file format is a file format that can be opened by a general application such as Excel and notepad.

It can also be viewed with GX LogViewer.

■Binary file format

High-speed file access is possible with this format because it is smaller in size than the CSV file format.

It can be viewed with GX LogViewer.

■CSV file format

CSV file format is a file format that can be opened by a general application such as Excel and notepad.

It can also be viewed with GX LogViewer.

Saving data logging files

The high speed data logger module temporarily saves the target data of the sampled data logging to the accumulating file on the inserted SD memory card.

Since the size of an accumulating file becomes larger with time, a file is switched with the specified conditions.

File switching names accumulating file to change it to a save file. (A new accumulating file is created after the file name is changed.)

It is also possible to save a file with a file name saved in advance when creating a new accumulating file.

The specified information such as date and time can be added to the file name.

Save files can be saved to the SD memory card up to the specified number of files. When the specified number of files exceeds, the operation to either; delete the oldest file in order or stop module, can be selected.

Ex.

If the upper limit of the number of files is 3, save the data logging file

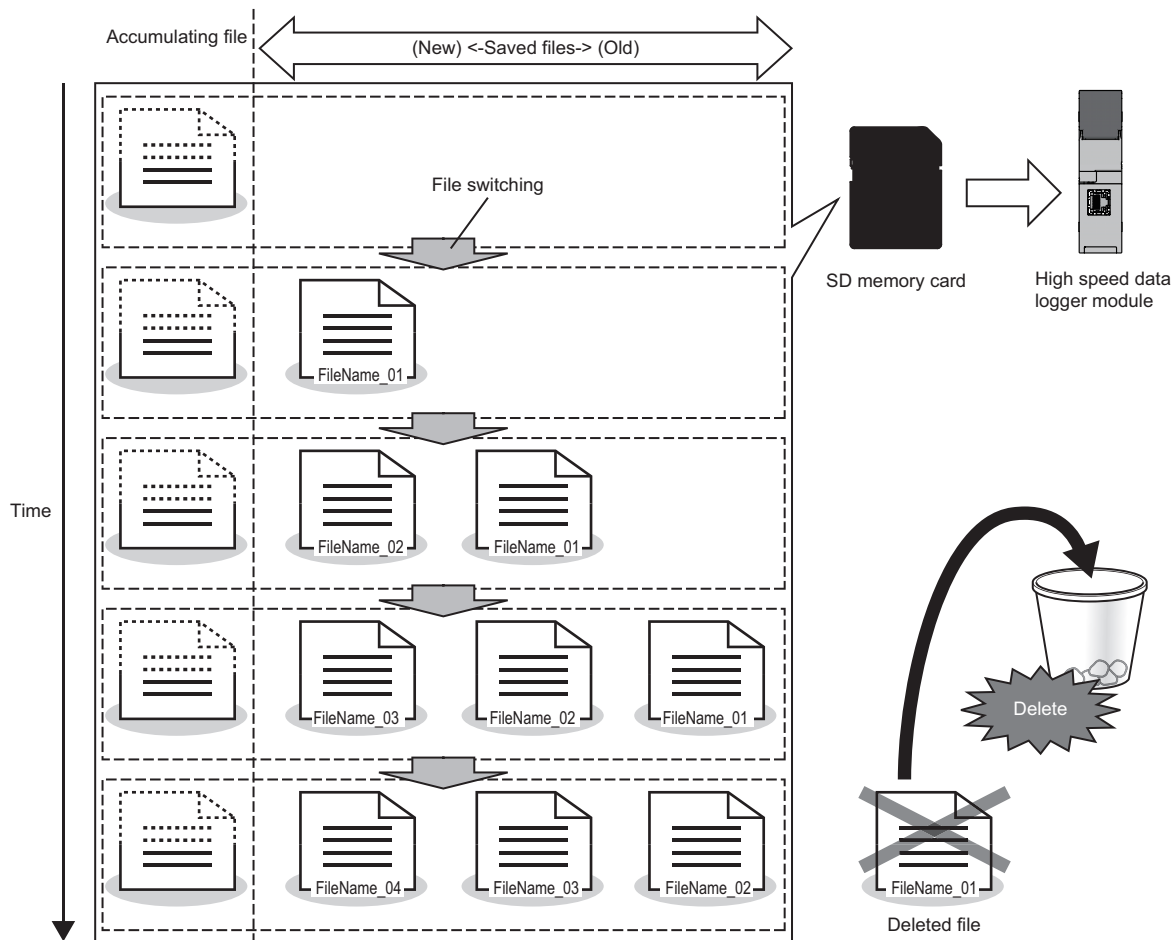

■Data logging file save location

A data logging file is saved in the SD memory card.

For the SD memory card directory structure, refer to the following:

📖 MELSEC iQ-R High Speed Data Logger Module User's Manual (Startup)

■ File switching timing

File switch timing can be specified from the following.

- Number of records
- File size specification
- Data conditions (comparison)*1
- Data conditions (value changes)*1
- Fixed cycle
- Time interval specification
- Time specification
- At module startup
- Trigger logging unit

(A file is switched after the number of lines after the trigger worth of data is output)

*1 Since the conditions are judged based on the data sampled at the specified sampling interval, a trigger will not be detected if the condition is not satisfied at the time of data sampling.

Up to 8 conditions can be combined. However, up to 10 conditions can be combined when combining the trigger condition, period specification, and folder switching timing. When the high speed sampling is specified to the sampling method, the number of conditions that can be specified differs. For the number of conditions that can be specified, refer to the following:

📖 MELSEC iQ-R High Speed Data Logger Module User's Manual (Startup)

When there is a change in the header line of the data logging file after the module is started or settings are updated, perform a file switching to create a new accumulating file.

If the saved file name created at the time of file switching becomes the same name as the file name already exists, the sequential number (1, 2) will be added to the end of the file name, then the INFO LED will turn ON.

Precautions

- When the file names are the same, the files with sequential numbers from 1 to 16 are created. However, for the files having sequential number after 16, an error occurs and the file switching is not performed. Adjust the system so that it does not have the same file name.
- When the saved file to which the sequential number of subscripts is added is deleted with a file browser or FTP, the specified number of saved files to be created after that may not be created. Configure and adjust the system so that they do not have the same file name. When the specified number of saved files are not created, clear the logging file in the "Diagnostics" screen. (📖 Page 223 SD memory card diagnostics)

● Operation example

The operation examples of each file switch timing is as follows.

The file switching (processing described below) is performed at the timing of ★ in each operation example.

- Creating a saved file
- Deleting data in the accumulating file (A header-only file is created)
- Transferring the saved file to the FTP server and shared folder or mail server (When the transfer setting is set)

Ex.

Number of records: 1000 lines

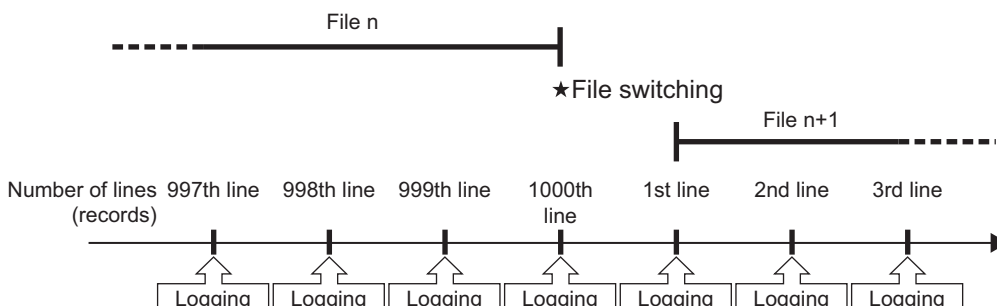

Ex.

File size specification: 512 KB

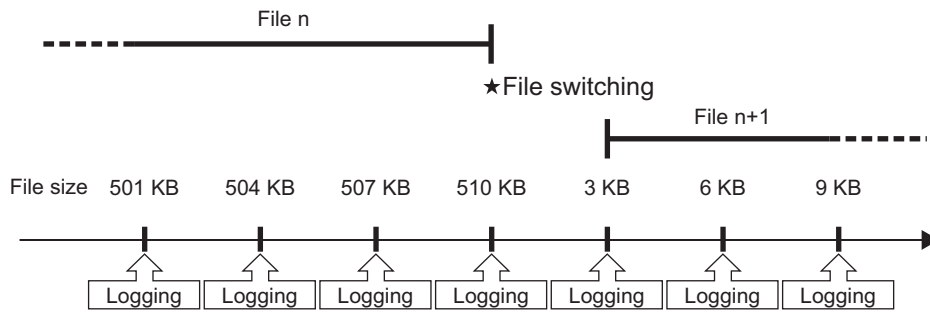

A file is switched at the timing before the file size exceeds the specified size. Since the output size of one line (record) vary depending on the data value when the file format is CSV, the file switching timing is determined by predicting the next output size on the basis of the present output time.

Ex.

Data conditions: M0 = ON

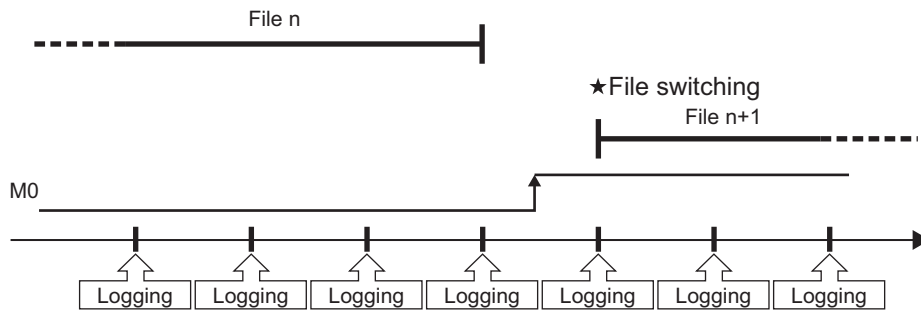

Ex.

Time specification: 0:00

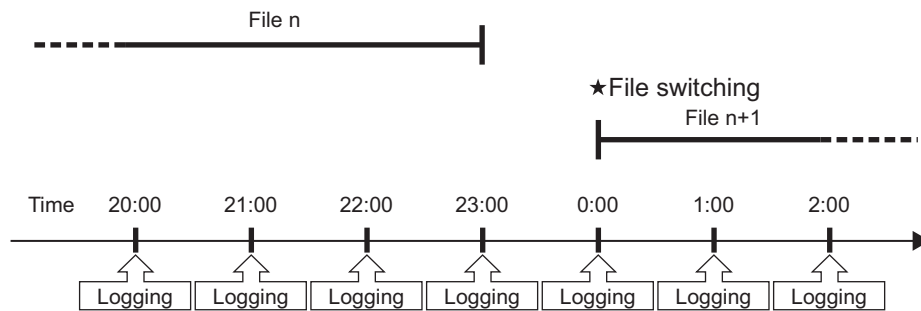

Ex.

Time specification: 0:00, logging period: 1:00 to 22:00

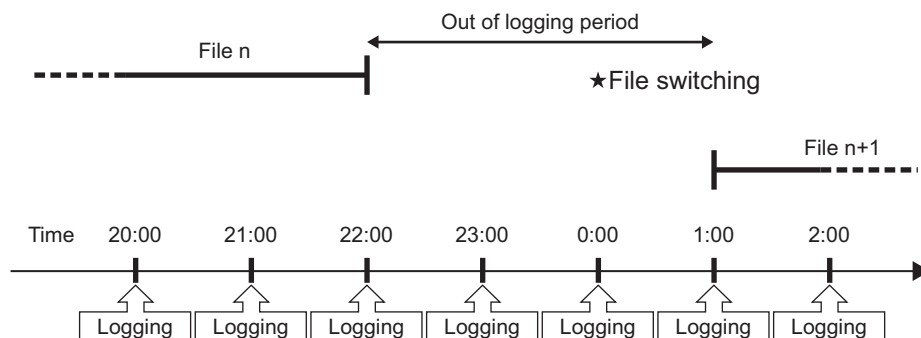

Ex.

Time specification: The programmable controller system was powered OFF at 0:00 and from 22:30 to 0:30

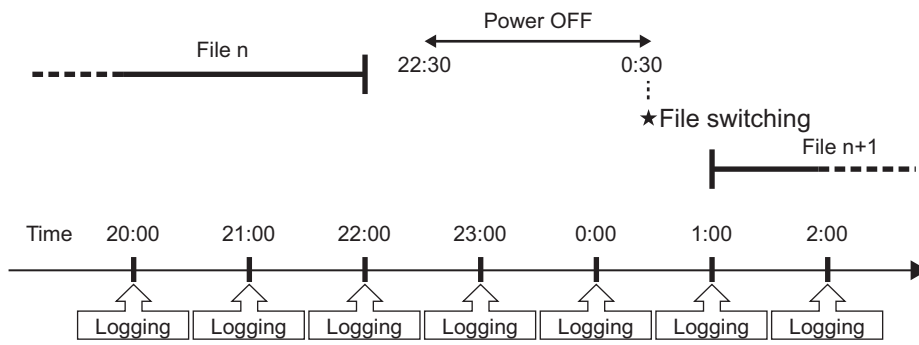

Ex.

At module startup

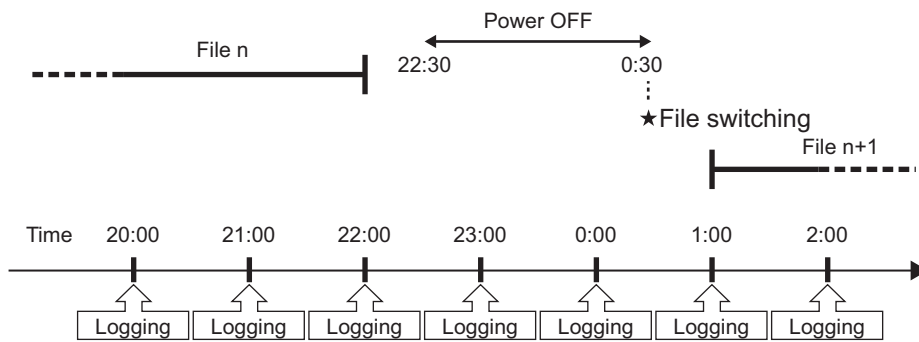

Ex.

Trigger conditions: When M0 = ON, Number of lines before trigger: 100 lines, Number of lines after trigger: 50 lines

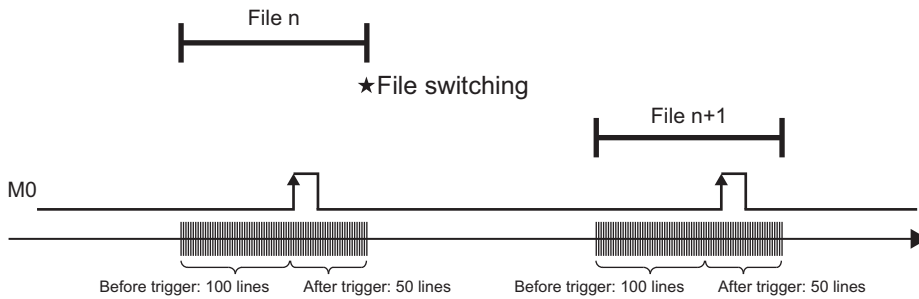

Edit Function of the saved folder

A setting type folder or a subfolder to which information can be added, can be specified for a saved folder to store saved files.

- When specifying setting type folder

Create saved file in the folder where the accumulating file is created.

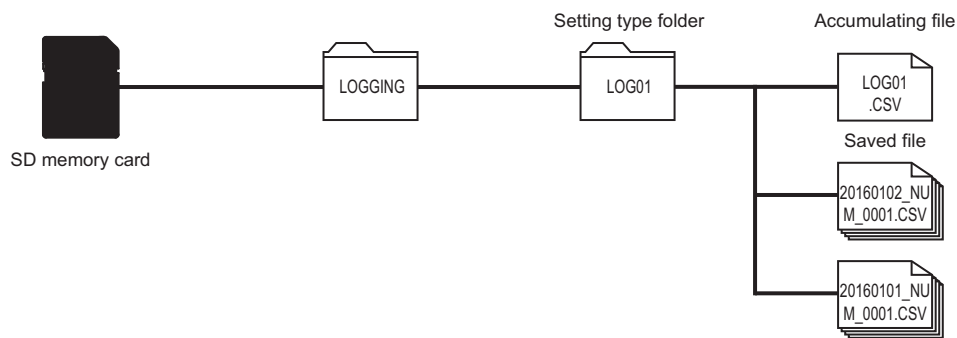

- When specifying subfolder

Using the setting type folder, a folder can be created where information can be added in the following hierarchy such as specified date and time.

A setting type folder or subfolder can be specified for the location to create accumulating files.

When a subfolder is specified, the accumulating file name is created having the additional specified information in the saved file name.

The following example shows the file structure specified for the settings type folder in the location where the accumulating file is created.

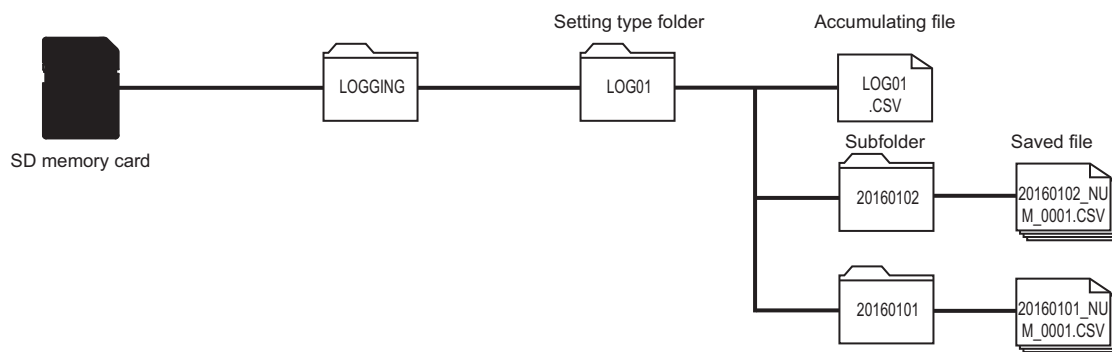

The following example shows the file structure specified for the subfolder in the location where the accumulating file is created.

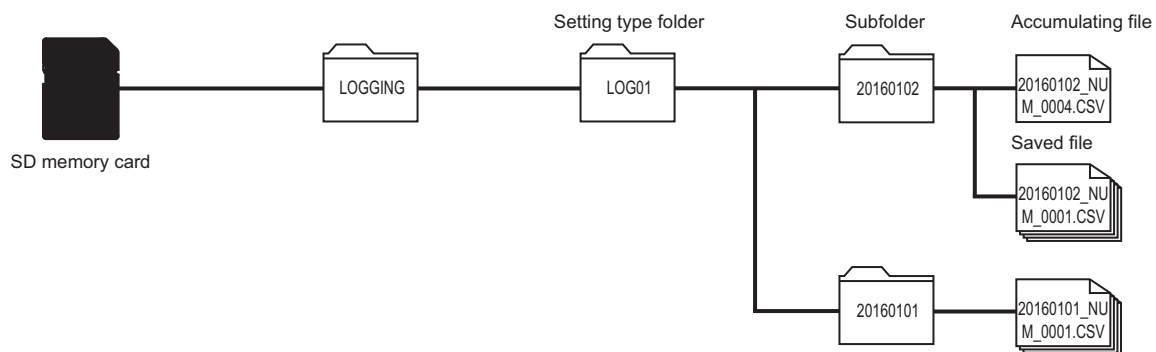

■ Folder switching

Folder switching is changing the subfolders that store the saved files.

A subfolder is switched with the specified conditions.

Up to 256 subfolders are stored in the SD memory card. If it exceeds 256 then the old folders will be deleted sequentially.

If, because of the specified number of files that can be saved, a file in the subfolder has been deleted, the entire subfolder will be deleted.

When sequential numbers are added to a subfolder, an 8-digit sequentially numbered folder is created, and an 8-digit sequential number is always added to the saved file name.

The sequential number to be added to the subfolders will be the sequential number of the saved files that are initially stored in a subfolder.

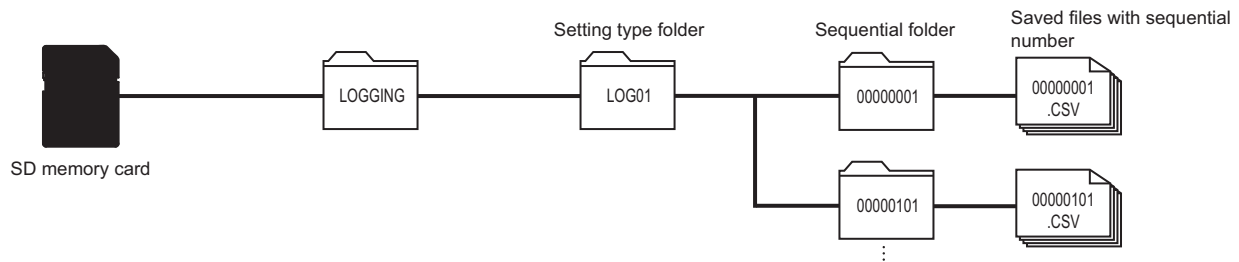

The 8-digit sequential number added to a subfolder and a saved file are not cleared even if the settings are updated.

To clear the added 8-digit sequential number, either change the name of the setting type folder or clear the logging file on the "Diagnostics" screen.

Point

In the following timing, a folder is switched only once apart from the specified folder switching conditions.

- If settings are updated after a data logging setting is added.
- If the setting type folder name, which stores the subfolder, is changed by configured data logging settings.

If the subfolders created at the above given times are deleted in the file browser or FTP, a subfolder will be created when the file is switched or when the logging file is created.

■ Folder switching timing

Folder switching timing can be specified from the following.

- Data conditions (comparison)^{*1}
- Data conditions (value changes)^{*1}
- Fixed cycle
- Time interval specification
- Time specification
- At module startup

^{*1} Since the conditions are judged based on the data sampled at the specified sampling interval, a trigger will not be detected if the condition is not satisfied at the time of data sampling.

Up to 8 conditions can be combined. However, up to 10 conditions can be combined when combining the trigger condition, period specification, and file switching timing. When the high speed sampling is specified in the sampling method, the number of conditions that can be specified differs. For the number of conditions that can be specified, refer to the following:

📖 MELSEC iQ-R High Speed Data Logger Module User's Manual (Startup)

When the file switching timing and the folder switching timing are satisfied at the same time, the folder is switched first, then the file is switched later. Even if the folder switching timing is satisfied and the file switching timing is not satisfied, the switching order will be the same.

If the subfolder name created at the time of folder switching becomes the same name as the folder name already exists, the sequential number (1, 2) will be added to the end of the folder name, then the INFO LED will turn ON.

Point

Up to 256 saved files can be stored in the subfolder. If it exceeds 256 files, the folder is switched.

If the specified number of saved files is less than 255, the folder switching will not occur according to the number of saved files because the number of saved files does not exceed 256.

When the specified number of saved file is more than 256, the folder switching is determined by the total number of saved files created in the subfolder.

Therefore, even if 256 saved files do not exist in the subfolder because some saved files have been deleted due to the excess of the set number of saved files or the SD memory card setting, a folder will be switched when the saved files are created and the total number of saved files reaches 256.

Precautions

- When the folder names are the same, the folder with sequential numbers from 1 to 16 are created. However, for the folders having the sequential number after 16, an error occurs and the folder switching is not performed. Configure and adjust the system so that it does not have the same folder name.
- The file is switched after switching folder, however, when the accumulating files which are to be switched have only header lines, neither file switching nor folder switching is performed. When switching the folder, configure and adjust the system so that the folder is switched after data is output to the accumulating file.

■ Sequentially numbered folder name when the number of saved files is set to 255 or less

- Since the number of saved files to be stored in a sequentially numbered folder does not exceed 256 when it is set to 255 or less, the subfolder is not switched and the sequentially numbered folder name is not updated.

Ex.

When the number of saved files is set to 100, and "Add the sequential number" is selected in the saved file name setting. When performing file switching after 100 saved files are created, the oldest saved file is deleted.

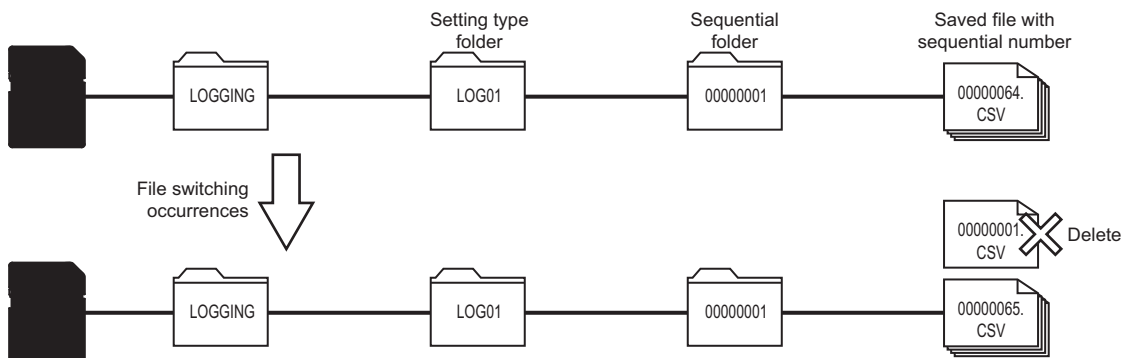

The sequentially numbered folders are not switched even if the sequential number added to the saved file exceeds 256.

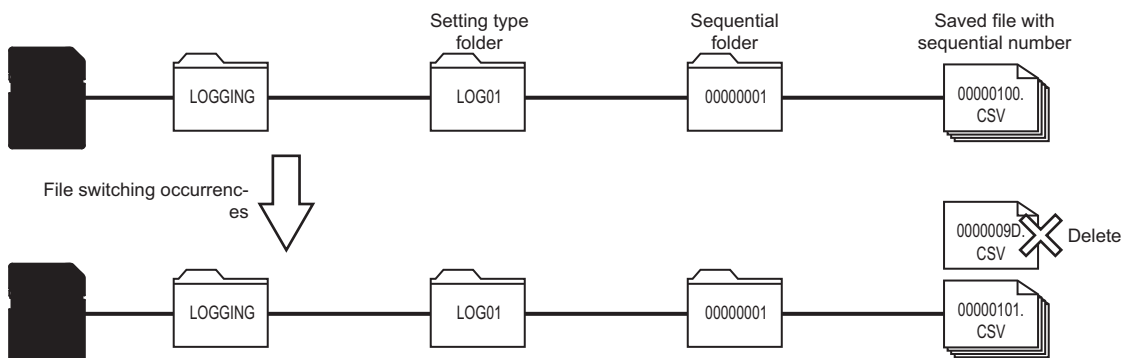

- When performing folder switching at the specified timing, a sequential number of the saved file to be stored in a new sequentially numbered folder is added to the sequentially numbered folder.

Ex.

When "Same as setting type folder" is selected in the accumulating file name, the number of saved files is set to "100", and "Add the sequential number" is selected in the saved file name setting

When a folder is switched, the accumulating file created before switching folder is stored as a saved file in the folder which is not switched. The sequential number of a saved file name to be created next is added to a new sequentially numbered folder name.

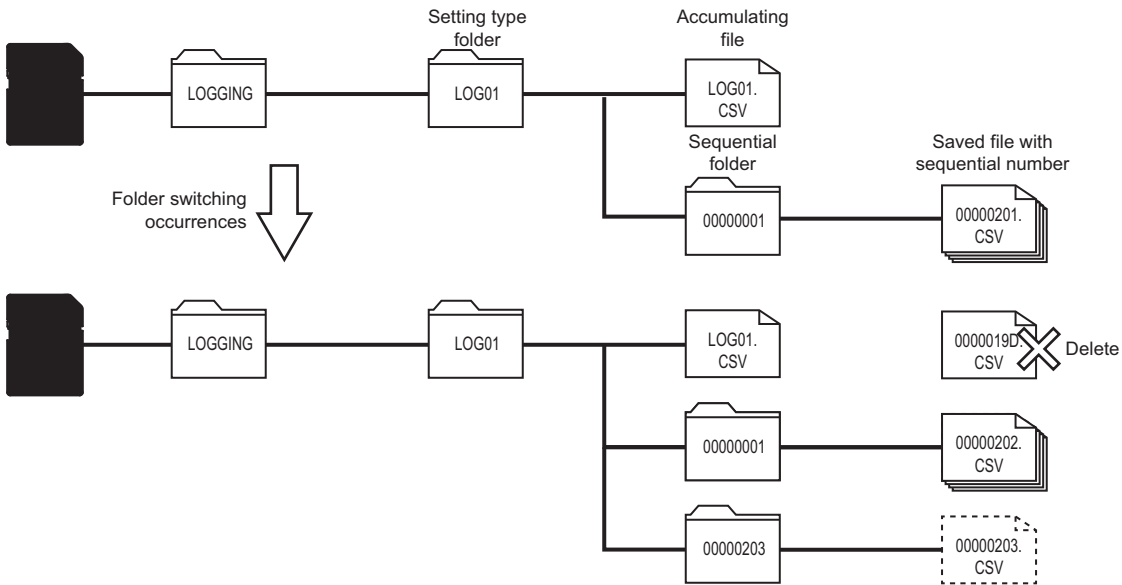

■ Sequentially numbered folder name when the number of saved files is set to 256 or more

- 256 saved files are created in the sequentially numbered folder, then the folder is switched automatically.

Ex.

When the number of saved files is set to 300, and "Add the sequential number" is selected in the saved file name setting

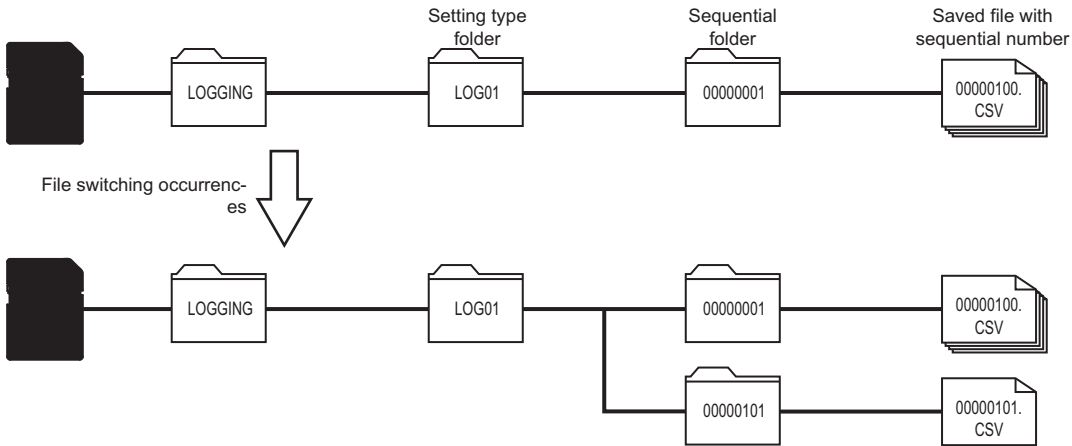

If the number of saved files exceeds 256, a new sequentially numbered file is stored in a next sequentially numbered folder.

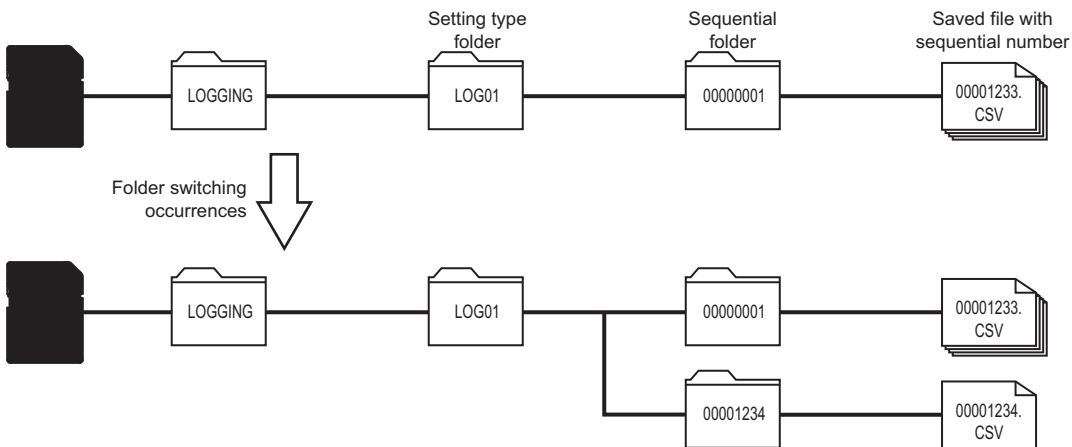

■ Sequentially numbered folder name when a saved file is deleted

The following shows the examples of folder configuration before and after deleting saved files.

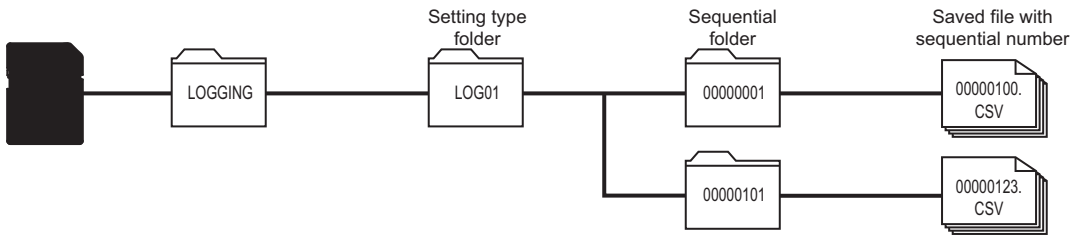

- When a sequentially numbered folder or saved file is deleted by using the file browser etc., a next saved file is created with the sequential number following the number of the file before deleting. When a sequentially numbered folder storing a saved file is deleted, the sequentially numbered folder created last is created again and a saved file is stored in the newly created folder.

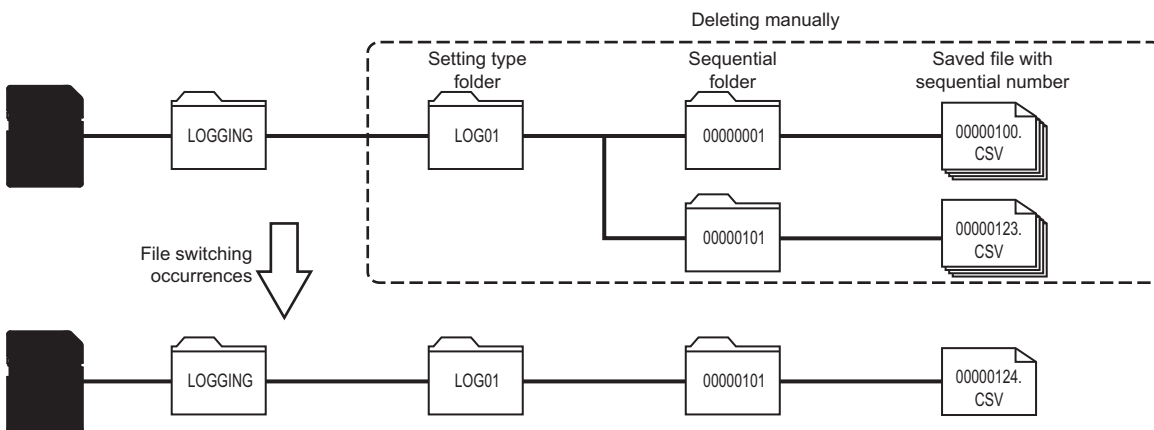

- When a logging file is deleted by the logging file clear in the "Diagnostics" screen of Configuration Tool, a folder and file are created by clearing the numbers of the saved file and sequentially numbered folder.

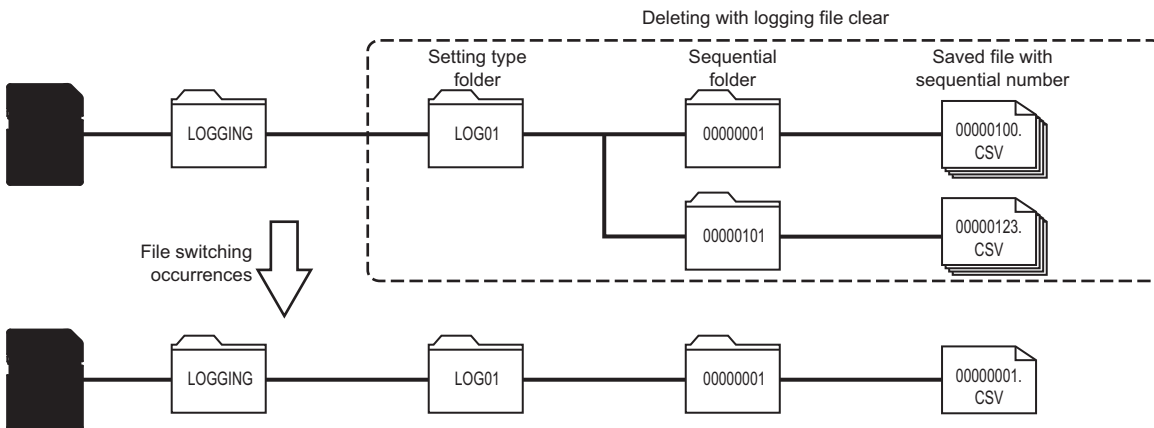

■ Add the sequential number of subscripts

- If files or folders with a same name exist in the SD memory card inserted in the high speed data logger module when creating a subfolder, saved file, and accumulating file, a sequential number of subscripts is added.

Ex.

When a device value is added to the saved file name, and a file is switched without updating the device value

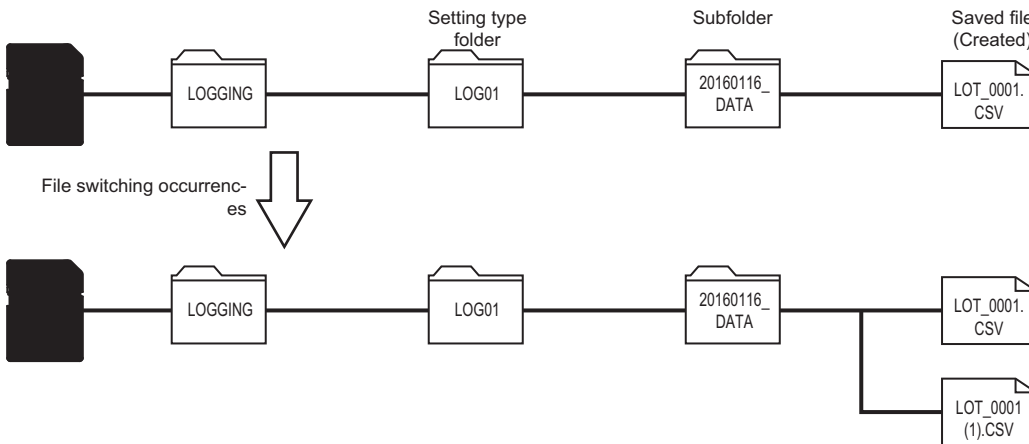

- If the setting is written to a file with a same name and updated when the logging file created in the past setting exists in the SD memory card inserted in the high speed data logger module, a sequential number may be added to the accumulating file or saved file.

Ex.

When the "LOG01" folder and the accumulating file "LOG01.CSV" exist in the inserted SD memory card, the setting name under the same name as the setting type folder name and the accumulating file in the SD memory card are written and updated

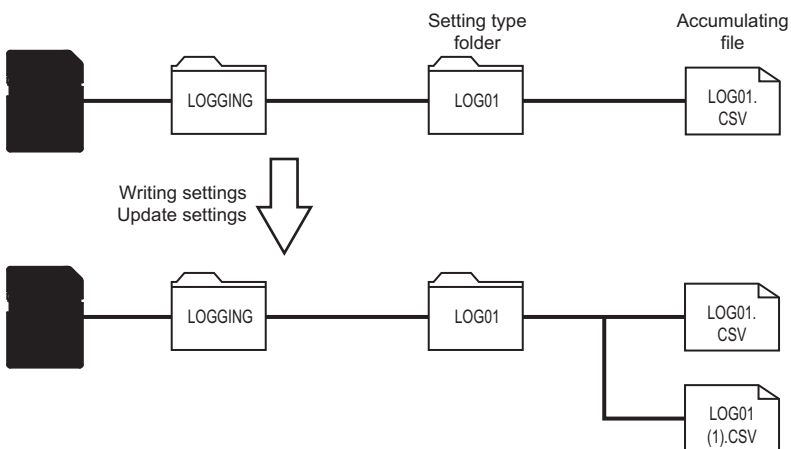

Transferring data logging files

Data logging files can be automatically transferred to an FTP server or shared folder, or mail server.

There are two methods for transferring event logging files.

- Transferring to the FTP server and shared folder (☞ Page 95 File Transfer Function, Page 137 File transfer setting)
- Sending e-mail (☞ Page 98 E-mail Function, Page 140 E-mail setting)

When transferring files to the FTP server and shared folder, the data logging file destination defers depending on the saved folder specifications.

For details of each folder structure at the time of file transfer, refer to the following:

📖 MELSEC iQ-R High Speed Data Logger Module User's Manual (Startup)

Display the previous and next files consecutively in GX LogViewer

Create file names in the dictionary order (in the order of number, symbol, alphabet, and others) by adding date and time, etc.

(☞ Page 341 ASCII characters)

If do not create a subfolder, not only the saved files also the accumulating files are displayed on the previous and next trend graphs consecutively.

In the following case, since the continuity of the files is not guaranteed, the previous and next trend graphs may not be displayed properly.

- Day of the week is added at the beginning of the saved folder name or saved file name
- A setting type folder name is specified to the accumulating file without creating a subfolder

Ex.

When "123.TXT" and "A23.TXT" is compared, "123.TXT" will be treated as an old saved file because "1" = 30, "A" = 41.

Data missing

Data missing means that sampled data is lacking and not continuous.

Whether data is missing or not can be checked by the following items.

- Index information of data logging file
- Two vertical dashed-dotted lines displayed in the trend window of GX LogViewer
(📖 GX LogViewer Version 1 Operating Manual)

Data is missing in the following cases:

○: Occurs, —: Does not occur

Item	Description	Data logging	Realtime trend graph
High speed sampling failure*1	When the high speed sampling was specified, the high speed sampling failed because the data sampling could not catch up with the specified sampling interval. ☞ Page 352 Checking sampling process time	○	○
Processing overload*1	A processing overload error occurred because the data logging processing (trigger judgement and file saving) could not catch up with the specified sampling interval.	○	○
Sampling error	An error occurred in the sampling process due to the cause such as the connection cable being disconnected.	○	○
CPU module operation	When the high speed sampling (each scan) was specified, the control CPU was switched from STOP to RUN.	○	○
	When the high speed sampling was specified, the PLC parameter was written to the control CPU.	○	○
Module operation	The high speed data logger module settings were updated.	○	○
	The high speed data logger module operation was restarted.	○	○
Data logging period	When a data logging period has been specified, the sampled data was not saved to a file because they are outside the period.	○	—
Trigger logging	The sampled data between triggers was not output to a file	○	—
Realtime trend graph	The acquisition/display of GX LogViewer data did not catch up with the specified sampling interval.	—	○

*1 INFO LED turns ON.

1.2 Event Logging Function

The event logging function monitors device values sampled from a CPU module and logs events that occurred. The logged target data is saved as an event logging file in the SD memory card inserted in a high speed data logger module. Occurred events can be notified by e-mail.

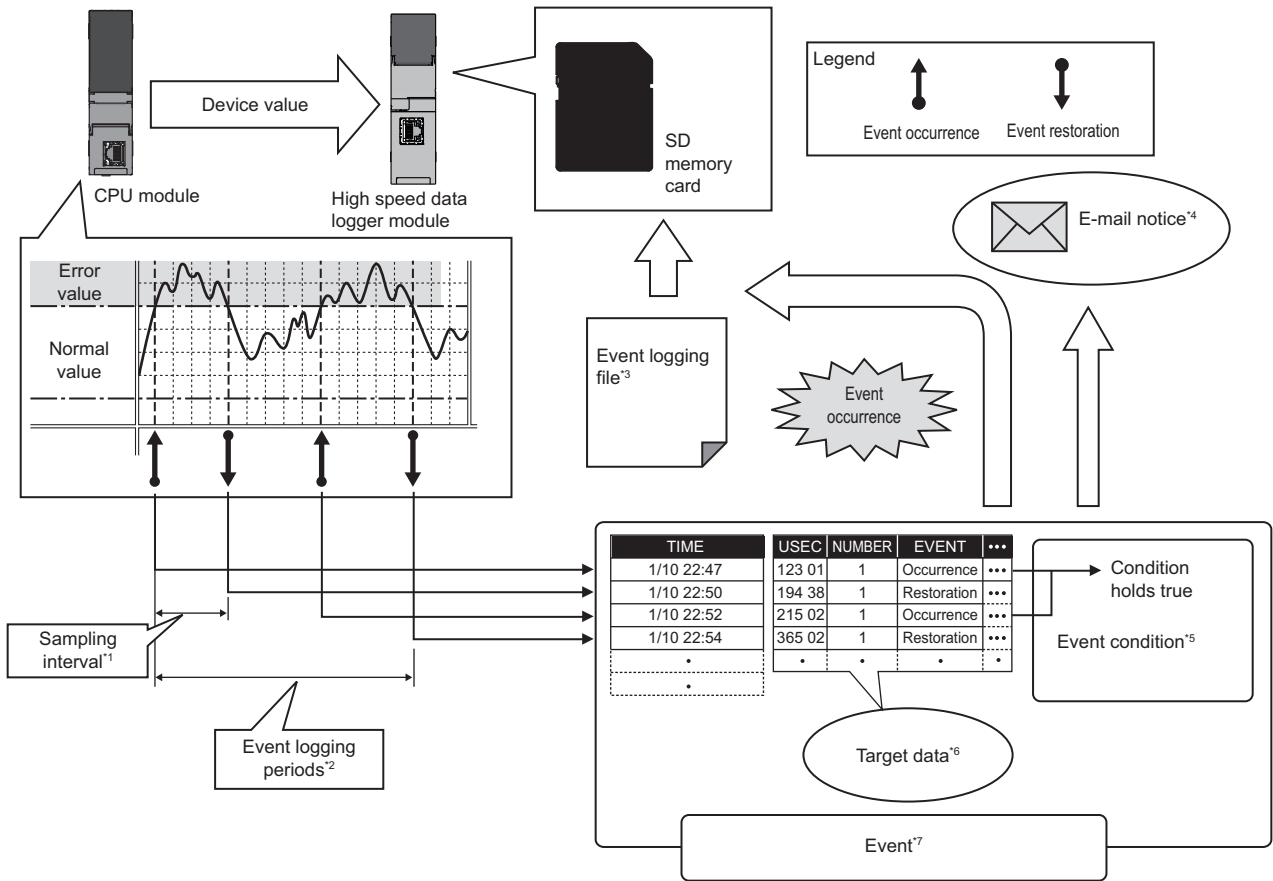

- *1 Page 68 Sampling function
- *2 Page 68 Period specification
- *3 Page 70 Save function
- *4 Page 69 E-mail notification function
- *5 Page 65 Event condition
- *6 Page 64 Target data
- *7 Page 64 Event

"Event logging setting" is the group of target data and sampling interval of event logging function.

Up to 64 event logging settings can be configured in the whole event logging function.

For the settings of the event logging function, refer to the following:

Page 177 Event Logging Setting

Event

Event is a combination of the target data and event conditions.

☞ Page 64 Target data

☞ Page 65 Event condition

Target data

Target data is the data to be saved with a time stamp to an SD memory card when a condition is satisfied by comparing the device values that have been sampled from a CPU module with event conditions.

■Target data for event logging

The following data can be logged by event logging.

- Device memory in a control CPU
- Device memory in a CPU on another station in a multiple CPU configuration
- Device memory in a CPU on another station via a network

For details, refer to the following:

📖 MELSEC iQ-R High Speed Data Logger Module User's Manual (Startup)

■Data type

Target data for event logging can be logged as the data types shown in the following table.

Data type	Number of device points
Bit	1 point
Word [Signed]	1 point
Double Word [Signed]	2 points
Word [Unsigned]/Bit String [16-bit]	1 point
Double Word [Unsigned]/Bit String [32-bit]	2 points
FLOAT [Single Precision]	2 points
FLOAT [Double Precision]	4 points
16bit BCD	1 point
32bit BCD	2 points
String	(Specified size ÷ 2) points ^{*1*2}
Raw ^{*3}	(Specified size ÷ 2) points ^{*1*2}

*1 If the size is in odd number, the device point will be rounded up by adding 1 point.

*2 For double word device, the device becomes 2 points for each 4 bytes. The fraction should be rounded up to 2 points.
(Assign 2 points if size is 4 and 4 points if size is 5)

*3 A hexadecimal representation is converted to a string by byte unit, and it is output with a space removed.
(For start device D0, D0: 0x8A6B, D1: 0x41C2 4-byte raw type, 6B8AC241 is output.)

■String type data

Data is output in the following character codes depending on the file format to be output.

Unicode text files, binary files, report files: UTF-16 (little endian)

CSV files: ASCII

The considerations when logging string type data are as follows.

- Data character code of saved folder name settings, saved file name settings, and E-mail content settings is in ASCII format regardless of the format in which the file is to be output.
- To specify the size (byte unit), consider the size required for the character code.
- To create character string data in a CPU module, use the instruction (\$MOV or \$MOV_WS) which supports character code.
- If the data with a different character code is output to the same file, some characters may be replaced with a period (.) or may be corrupted.

■Number of target data settings

Up to 1024 target data can be set for one "Event logging setting".

Event condition

Conditions shown in the following table can be selected as the event conditions.

Event condition	Event type	Detailed condition	Reference
Single condition	—	—	Page 65 Single condition
Compound condition	Comparison	AND combine	Page 67 Compound condition
		OR combine	
	Number of times	When a terminal condition holds true	
		When a specified number of times is exceeded	
	Order	Abnormal pattern is detected	
		Normal pattern is detected	
Detect timeout			

Since data conditions are judged based on the data sampled at the specified sampling interval, a trigger will not be detected if the condition is not satisfied at the time of data sampling.

If the value of the target data cannot be represented in the specified data type, an event does not occur when the condition is satisfied.

For the number of conditions which can be specified for the compound condition, refer to the following:

📖 MELSEC iQ-R High Speed Data Logger Module User's Manual (Startup)

■Single condition

A single condition compares monitoring data and trigger values (limited to constant values) with the monitoring condition.

An event occurs when the condition changes from not being satisfied to being satisfied.

When the condition also changes from being satisfied to not being satisfied, the event is restored.

- For bit device (M0 = ON)

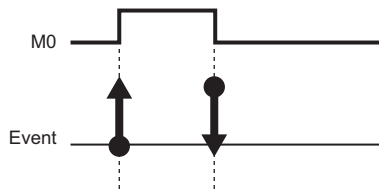

- For word device value (D0>100) (No restoration value specification)

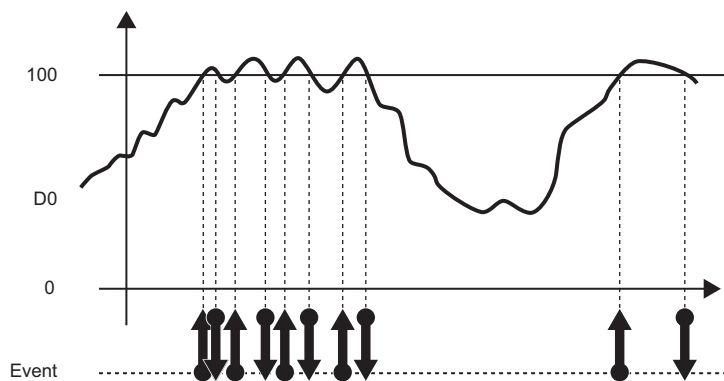

- For word device value (D0 > 100) (restoration value: 70)

When the numeric value changes minutely, the repetitions of event occurrence/restoration can be prevented many times by specifying a restoration value as follows:

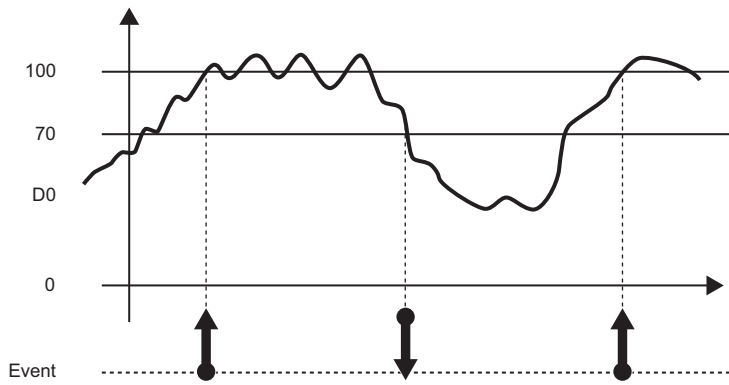

- For word device (D0 "Value change")

An event occurs when the value of D0 changes. The event is not restored.

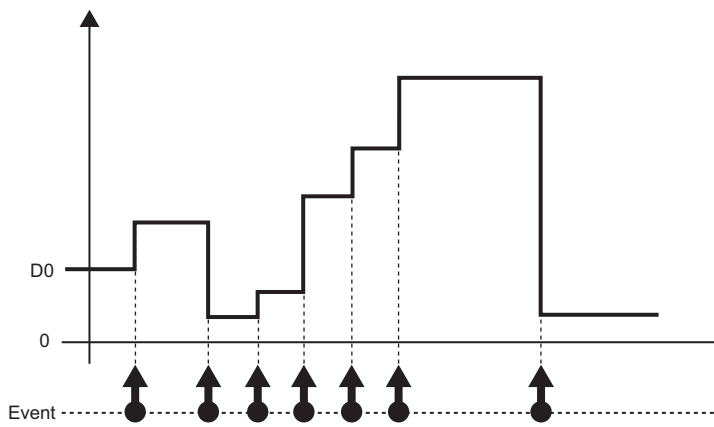

■ Compound condition

- AND combine

Events occur by satisfying all of the set conditions.

Up to 4 single conditions can be combined.

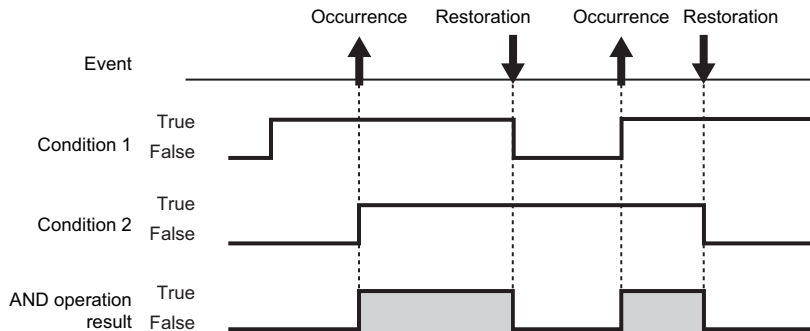

- OR combine

An event occurs by satisfying any of the set conditions.

Up to 4 single conditions can be combined.

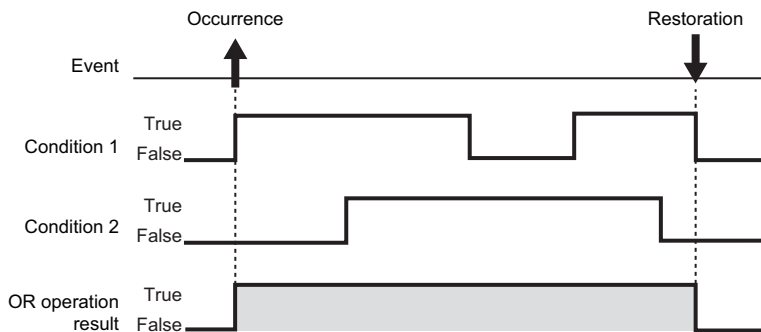

- Number of times

The number of times the condition is satisfied (number of counts) is compared with the specified number of times, then an event occurs when the condition is satisfied.

The timing to compare the number of counts and the specified number of times can be selected from "When a terminal condition holds true" and "When a specified number of times is exceeded".

For details on the number of times, refer to the following:

Page 45 Number of times

- Order

An event occurs when the order is wrong (abnormal pattern is detected), when the order is correct (normal pattern is detected), or when a timeout is detected by monitoring the order of multiple conditions satisfaction.

For details on order, refer to the following:

Page 46 Order

Point

A combination of AND combine and OR combine cannot be specified for the event.

Sampling function

This function samples target data from the access target CPU module.

The data sampling methods are as follows. The sampling interval that can be specified differs depending on the data sampling method.

Data sampling method		Overview
High speed sampling	Each scan	Samples data in each sequence scan of the CPU module.
	Time specification	Samples data at the specified interval (milliseconds).
General sampling	Time specification	Samples data at the specified interval (seconds).
	Time interval specification	Samples data at the specified time interval (hour, minute, or second) from exactly midnight everyday, exact hour, or exact minute.

The system configuration and the processing timing for each data sampling method is the same as those of the data logging data sampling method. For more details, refer to the following:

 Page 26 Sampling function

Period specification

When the specified conditions are satisfied, the period to perform logging and the period not to perform logging can be specified.

Events are monitored only during the period of the logging.

The conditions to specify period can be selected from the following and can be specified by combining multiple conditions.

- ❶ Data conditions
- ❷ Date range
- ❸ Time range
- ❹ Day of the week/Week of the month conditions

For details, refer to the following:

 Page 48 Period specification

Scaling function

This function uses linear function transformation for sampled device values.

For details, refer to the following:

 Page 49 Scaling function

E-mail notification function

This function notifies event occurrences to the specified e-mail address by e-mail. It can be resent automatically when the e-mail send failed.

If the e-mail notification function is used, the file format should be CSV file.

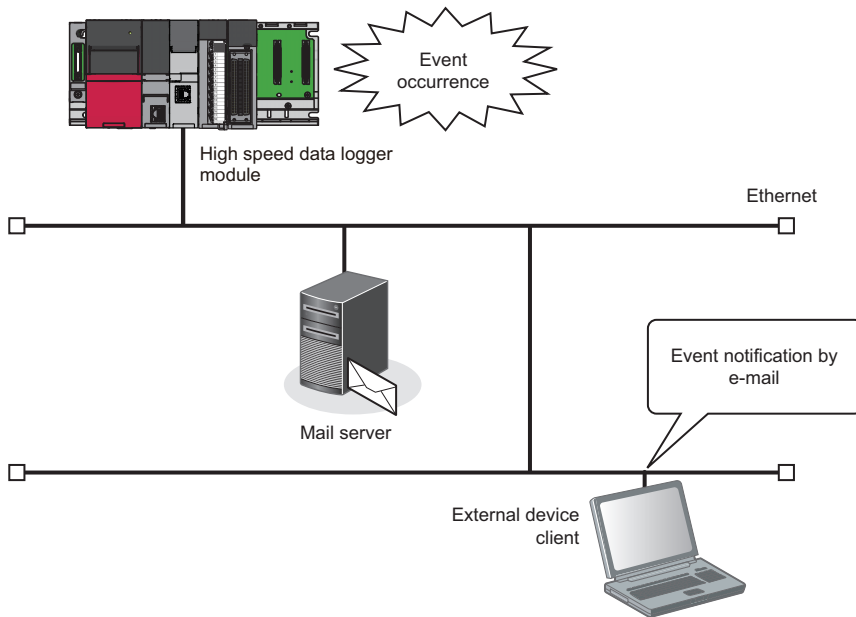

Ex.

An example of sent e-mail

E-mail header	From: RD81DL96 [xxx@xxx.co.jp] Date: 06/01/2016 20:52 To: xxx@xxx.co.jp Subject: First factory information 06/01/2016 20:52:23
E-mail text	The following error has occurred. (The header specified in Configuration Tool) Furnace No. 1 Temperature decrease Occurrence (The event name specified in Configuration Tool)*1 Perform the recovery operation promptly. (The footer specified in Configuration Tool)

*1 The event name and the comment at event occurrence/comment at event restoration of the occurred event are written in the e-mail text. If multiple events occur simultaneously, the occurrence, restoration of every event is given in the e-mail text. If more than 64 events occur simultaneously, up to 64 event occurrences and restorations will be listed in the e-mail text in the ascending order of the setting number (1 to 256) of the event list.

Save function

This function saves event logging target data in the event logging file.

Event logging file save format

Event logging files can be saved in the following three types of format on a high speed data logger module.

- Unicode text file format (extension: .TXT)
- Binary file format (extension: .BIN)
- CSV file format (extension: .CSV)

For details on each file format, refer to the following:

 Page 370 Event Logging File Format

■Unicode text file format

Unicode text file format is a file format that can be opened by a general application such as Excel and notepad.

It can also be viewed with GX LogViewer.

■Binary file format

High-speed file access is possible with this format because it is smaller in size than the CSV file format.

It can be viewed with GX LogViewer.

■CSV file format

CSV file format is a file format that can be opened by a general application such as Excel and notepad.

It can also be viewed with GX LogViewer.

Saving event logging files

The high speed data logger module temporarily saves events to the 'accumulating file' on the SD memory card that is inserted in the high speed data logger module.

Since the size of an accumulating file becomes larger with time, a file is switched with the specified conditions.

The specified information such as date and time can be added to the file name.

The method for file switching and saving files is the same as that of the data logging file. For more details, refer to the following:

However, "Trigger logging unit" cannot be specified for the file switching timing.

 Page 51 Saving data logging files

■Event logging file save location

Event logging files are saved in the SD memory card.

For the SD memory card directory structure, refer to the following:

 MELSEC iQ-R High Speed Data Logger Module User's Manual (Startup)

Edit function of the saved folder

A setting type folder or a subfolder to which information can be added, can be specified for a saved folder to store saved files.



The edit function of the saved folder is same as the data logging file. For more details, refer to the following:

 Page 55 Edit Function of the saved folder

Transferring event logging files

Event logging files can be automatically transferred to an FTP server or shared folder, or mail server.

There are two methods for transferring event logging files.

- Transferring to the FTP server and shared folder ( Page 95 File Transfer Function, Page 137 File transfer setting)
- Sending e-mail ( Page 98 E-mail Function, Page 140 E-mail setting)

When transferring files to the FTP server and shared folder, the event logging file destination defers depending on the saved folder specifications.

For details of each folder structure at the time of file transfer, refer to the following:

 MELSEC iQ-R High Speed Data Logger Module User's Manual (Startup)

1.3 Report Function

The report function outputs reports laid out with graphs and calculation formulas as Excel files. Set the Excel file layout in advance and create a report with values and graphs from data logging files and current value data sampled by a CPU module. Combined with graphs, the changes in data can be summarized in an easy-to-understand manner.

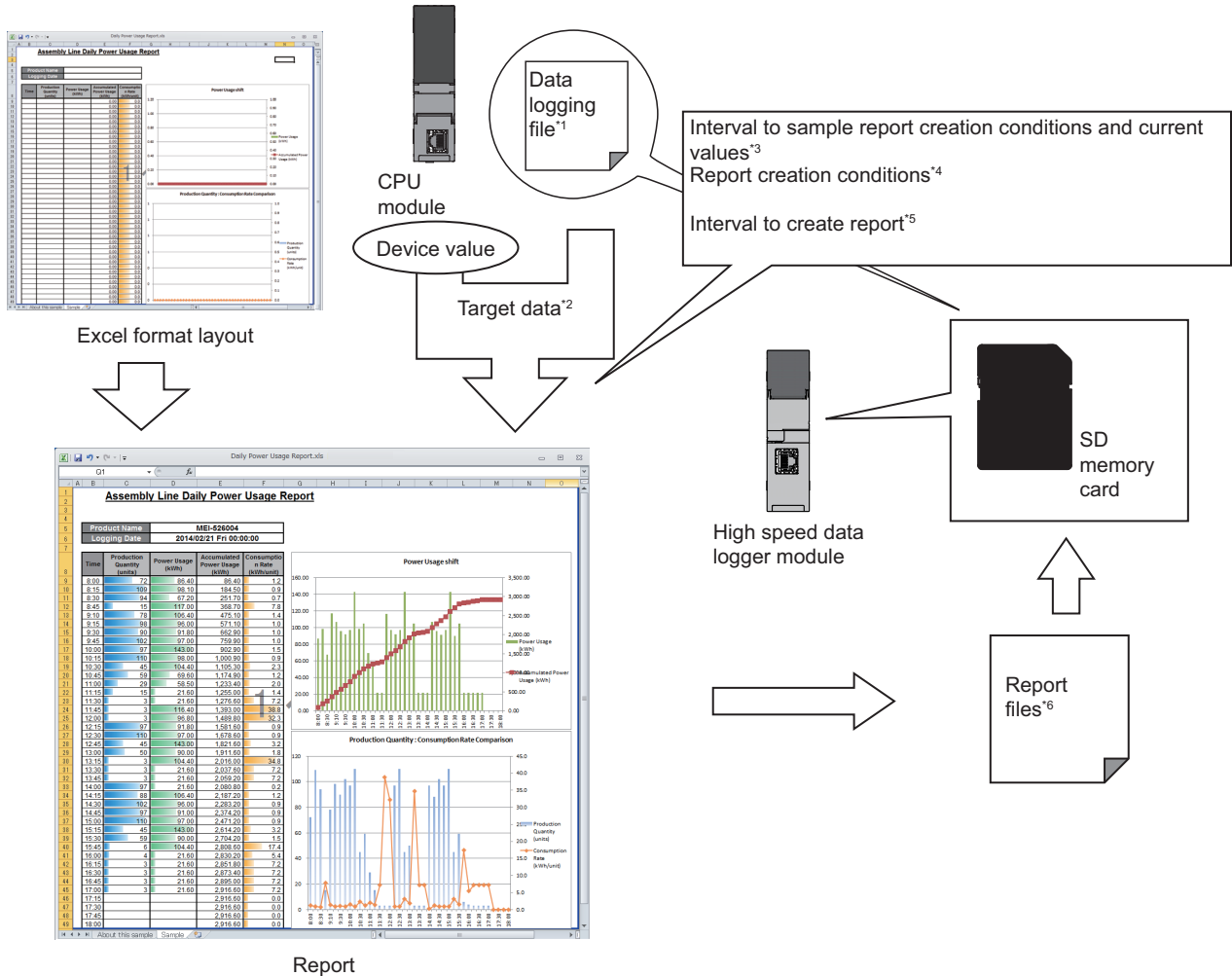

- *1 Page 50 Save function
 - *2 Page 72 Target data
 - *3 Page 75 Creation trigger and current value data sampling
 - *4 Page 75 Creation trigger function
 - *5 Page 76 Period specification
 - *6 Page 77 Save function
- For the settings of the Report function, refer to the following:
 Page 194 Report Setting

Target data

Target data is the data which can be laid out on a report.

Target data types

The types of target data are as follows:

Target data types	Description
Data logging	The data in a data logging file created with the data logging function can be selected. (Page 50 Save function) The specified number of records worth of data is read from the data logging file, then output to the report.
Current value	Device data of a CPU module at the time when the report was created.
Creation time	The date and time when the report was created.

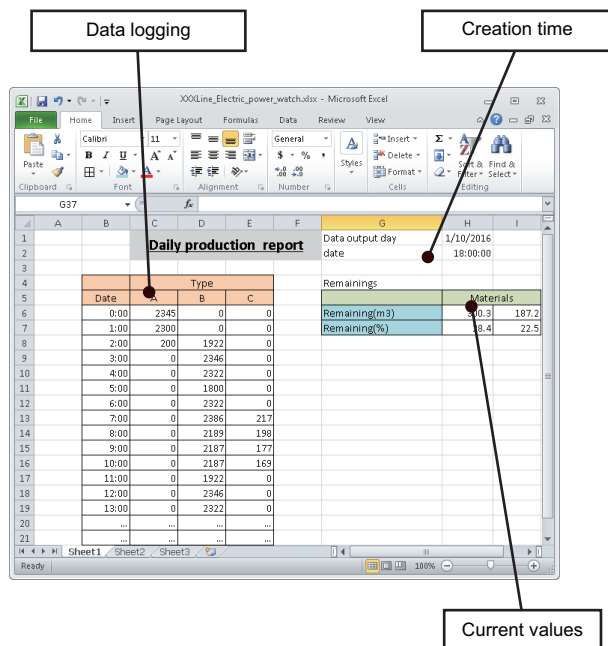

Precautions

The following are the considerations when laying out logged data in a report.

■The data logging file format

The data logging file must be in binary file format.

■Record output

If the total number of records in the output source files is less than the specified number of records, only the records that exist in the output source files will be output.

■When data does not exist in the data logging file

Immediately after switching the programmable controller system ON, if a creation trigger occurs when data does not exist in the data logging file, an error occurs in the high speed data logger module.

Configure and construct the system so that the creation trigger occurs after data is saved in the data logging file.

■Report output

Report output takes time.

According to the data logging save setting, the data logging file including the data when the creation trigger occurs, may be deleted before outputting the report as completed.

The specified number of records worth of data is not output and an error occurs in a high speed data logger module.

Configure and construct the system as follows.

- Set a large number of lines (number of records) to the file switch timing in the save settings of the data logging to be output to the report.
- After running the system and generating reports for a number of times, check the report creation time in the buffer memory. (☞ Page 328 Report creation information 1 to 64 (Un\G4030 to 4989))
- Set the file switch timing so that the time from the data logging file switch to the next file switch is much longer than the report creation time (two times or more).

Ex.

When the report creation time is 2 seconds and data logging sampling interval is 5 milliseconds

$(2000 \text{ [ms]} \times 2) / 5 \text{ [ms]} = 800 \text{ [lines]}$

Set the file switch timing to 800 lines or more.

Outputting direction and order

■For data logging

When the target data is a data logging file, the outputting direction and outputting order can be combined to output in 4 types of sequences.

- When outputting direction is "Vertical (top → bottom)", and outputting order is "Chronological order (old → new)"



Time	DATA1	DATA2
0:01		
0:02		
0:03		

- When outputting direction is "Vertical (top → bottom)", and outputting order is "Reverse chronological order (new → old)"



Time	DATA1	DATA2
0:03		
0:02		
0:01		

- When outputting direction is "Horizontal (left → right)", and outputting order is "Chronological order (old → new)"

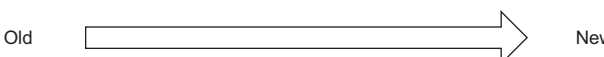

Time	0:01	0:02	0:03
DATA1			
DATA2			

- When outputting direction is "Horizontal (left → right)", and outputting order is "Reverse chronological order (new → old)"

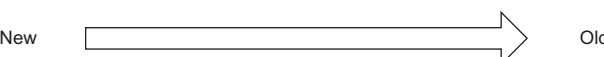

Time	0:03	0:02	0:01
DATA1			
DATA2			

■ For current value

When the target data are current values, the values can be output with two types of orders according to the outputting directions.

- When outputting direction is "Horizontal (left → right)"

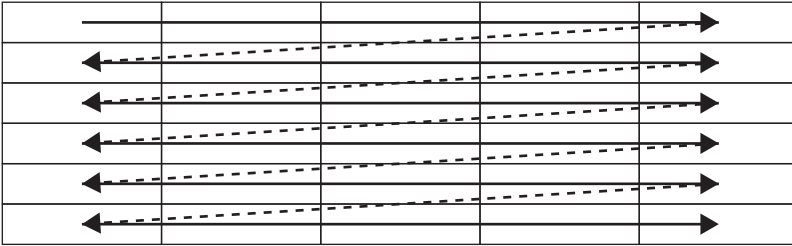

- When outputting direction is "Vertical (top → bottom)"

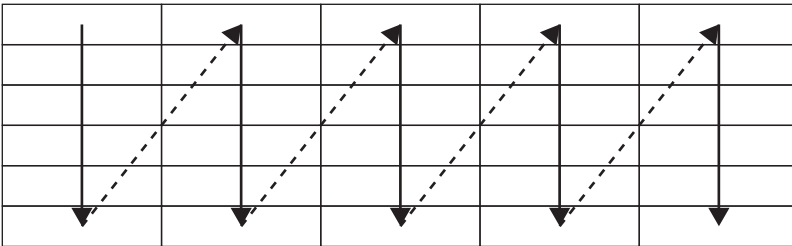

Creation trigger and current value data sampling

When creating a report, the data is sampled with the data sampling method and sampling interval in which the current value data and creation trigger are specified.

The data sampling methods are as follows. The sampling interval that can be specified differs depending on the data sampling method.

Data sampling method		Overview
High speed sampling	Each scan	Samples data in each sequence scan of the CPU module.
	Time specification	Samples data at the specified interval (milliseconds).
General sampling	Time specification	Samples data at the specified interval (seconds).
	Time interval specification	Samples data at the specified time interval (hour, minute, or second) from exactly midnight everyday, exact hour, or exact minute.

The system configuration and the processing timing for each data sampling method is the same as those of the data logging data sampling method. For more details, refer to the following:

 Page 26 Sampling function

Creation trigger function

Creation trigger function starts report creation at the specified timing.

Creates a report file when the condition is satisfied to create the trigger.

The method for specifying the creation trigger is the same as that of the trigger conditions of the data logging function. For more details, refer to the following:

 Page 41 Trigger conditions

Point

The following are the operations when creation triggers continuously occur.

- After a creation trigger occurs, if the next creation trigger occurs while the report file is being created, report creation processing will not be performed (the creation trigger is ignored).
The number of times that the creation trigger is ignored can be checked by the creation trigger reoccurrence count of 'report creation information 1 to 64' (Un\G4030 to 4989) in the buffer memory.
- Check whether the report is being created based on the 'report creation information' (Un\G4008 to 4011) in the buffer memory. Also, the time required for reporting can be confirmed by the report creation time of the 'report creation information 1 to 64' (Un\G4030 to 4989) in the buffer memory.

When "At module startup" is selected for creation trigger, data logging files, which have been output before turning OFF the power last time, can be output to the report by setting the data logging output. However, when configuring this setting when there are no data logging files, an error occurs in the high speed data logger module because no output target data exists at time of module startup.

Current value sampling function

This function samples data to be output to a report when creation trigger is generated.

After a creation trigger occurs, current value data is acquired in the next sampling period and is output in the report file.

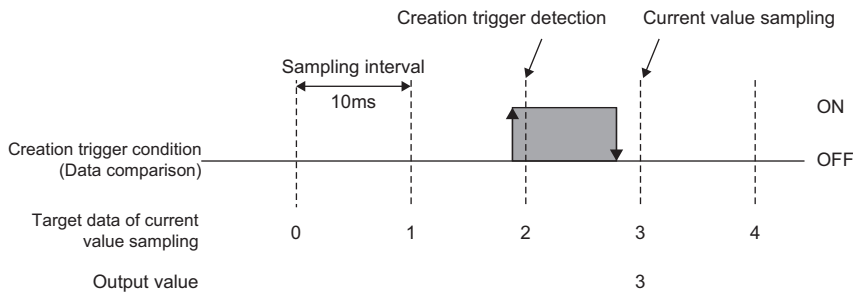

When data conditions are specified to the creation trigger, current value and creation trigger can be sampled in the same interval.

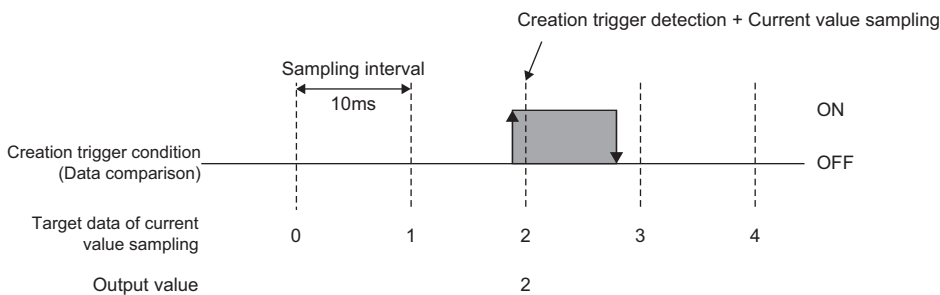

Period specification

When the specified conditions are satisfied, the period to create report and the period not to create report can be specified. Creation trigger can be monitored only during the period to create.

The conditions to specify period can be selected from the following and can be specified by combining multiple conditions.

- ① Data conditions
- ② Date range
- ③ Time range
- ④ Day of the week/Week of the month conditions

For details, refer to the following:

Page 48 Period specification

Scaling function

This function uses linear function transformation for sampled device values.

For details, refer to the following:

Page 49 Scaling function

Save function

This function saves sampled data to a report file in Excel format.

Saving Report files

The high speed data logger module saves report files to the SD memory card inserted in the high speed data logger module. When the number of report files exceeds the specified number of files, the operation to either; delete the oldest file in order or stop module, can be selected.

The specified information such as date and time can be added to the file name.

■Report file save location

Report files are saved in the SD memory card.

For the SD memory card directory structure, refer to the following:

📖 MELSEC iQ-R High Speed Data Logger Module User's Manual (Startup)

Edit function of the saved folder

A setting type folder or a subfolder to which information can be added, can be specified for a saved folder to store saved files. The operation of the folder switching is the same as data logging file. For more details, refer to the following:

📖 Page 56 Folder switching

📖 Page 56 Folder switching timing

Precautions

- The folder switching of the report function is performed when the creation trigger of a report is established after the folder switching conditions are satisfied. When switching a folder, configure and adjust the system so that the report file is created after the folder switching conditions are satisfied.
- An accumulating file is not created with the report function. Additionally, a file switching is not performed at folder switching.

Transferring report files

Report file can be automatically transferred to an FTP server or shared folder, or mail server.

There are two methods for transferring event logging files.

- Transferring to the FTP server and shared folder (📖 Page 95 File Transfer Function, Page 137 File transfer setting)
- Sending e-mail (📖 Page 98 E-mail Function, Page 140 E-mail setting)

When transferring files to the FTP server and shared folder, the report file destination defers depending on the saved folder specifications.

For details of each folder structure at the time of file transfer, refer to the following:

📖 MELSEC iQ-R High Speed Data Logger Module User's Manual (Startup)

1.4 Recipe Function

The recipe function performs the following operations according to the content of the recipe file saved in an SD memory card.

- Read process: Transfers device values written on a Recipe file to devices in CPU module.
- Write process: Transfers device values in a CPU module to a recipe file.

Both operations above are performed with dedicated instructions or the recipe execution operation of Configuration Tool.

With the recipe function, the information of each production process can be read from recipe files and reflect them to devices in the CPU module.

In addition, after the adjustment of the system, the specified device values can also be written and saved to a recipe file.

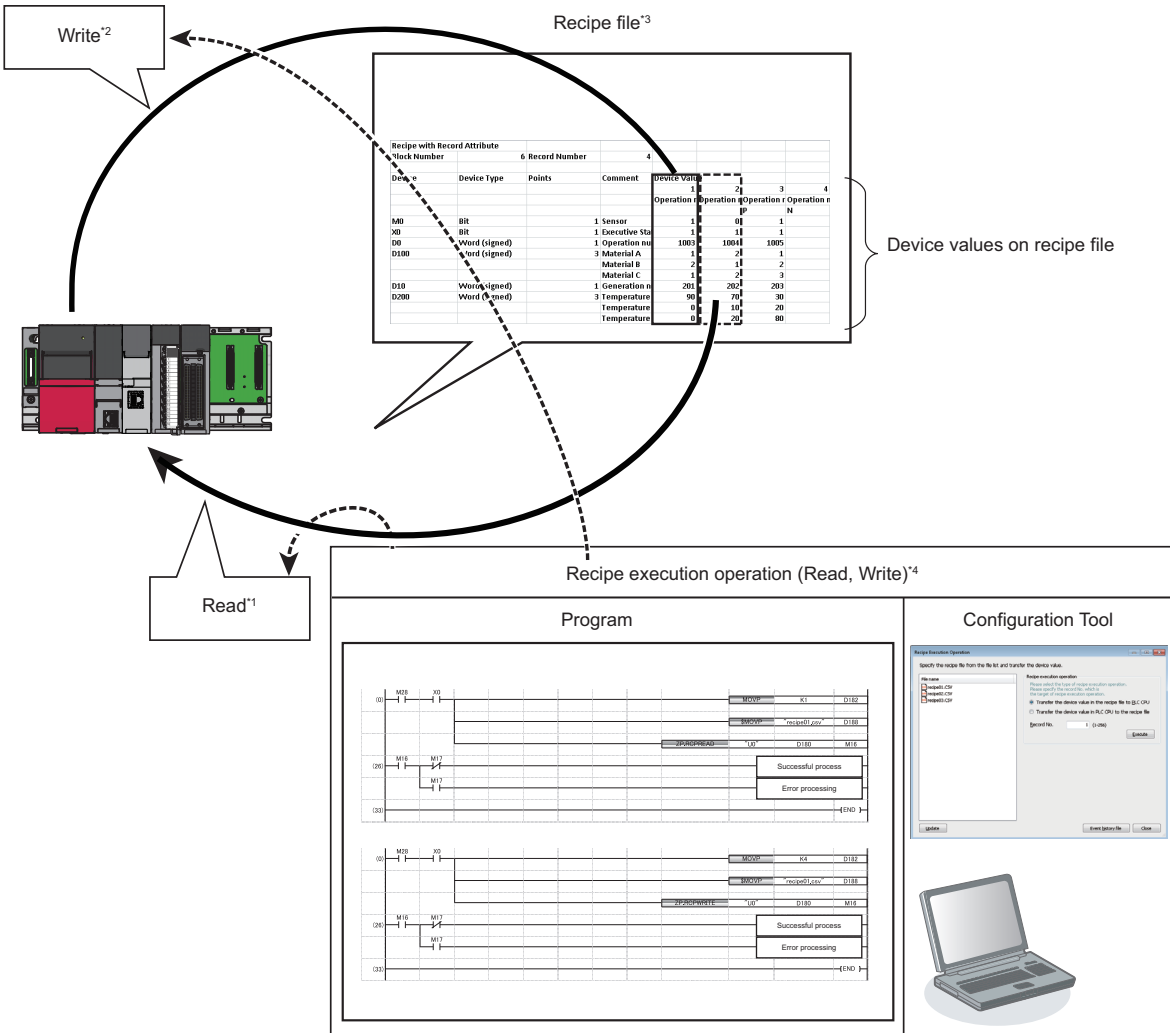

*1 Page 79 Read

*2 Page 79 Write

*3 Page 80 Recipe file

*4 Page 83 Operation at recipe execution

The format of the Recipe file is as follows:

Page 383 Recipe File Format

For the settings of the Recipe function, refer to the following:

Page 233 Editing Recipe File

Read

Transfer device values written in a recipe file to devices in a CPU module.

Ex.

Read from the record number 1 (a recipe to change D10 to 100, and D11 to 200)

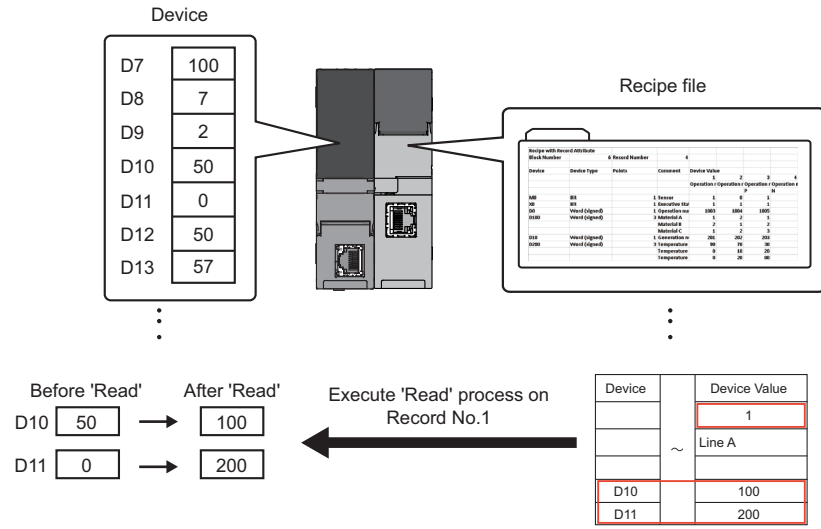

Write

Transfer the device values in a CPU module to the recipe file.

Ex.

Write to the record number 1 (write values of D100 and D101 to Recipe file)

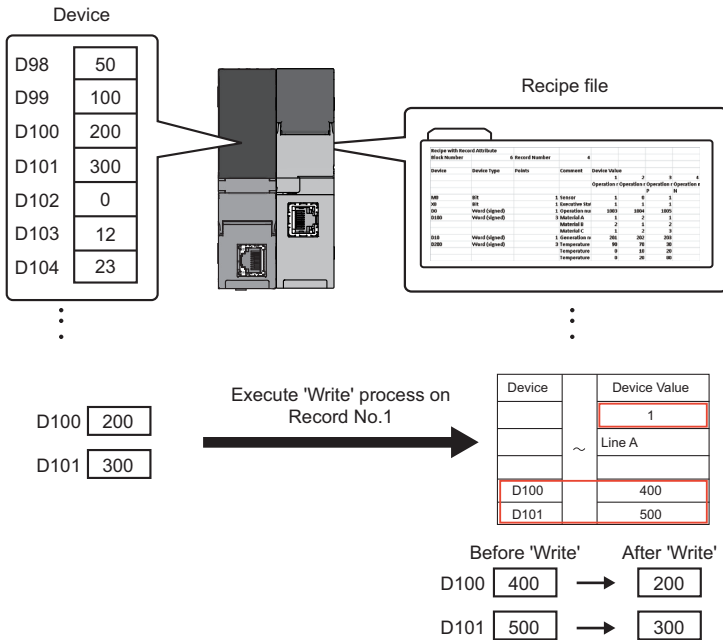

Recipe file

'Recipe file' is a CSV format file to which source data for the read and write processes of the recipe function are written. It can be created in the "Recipe Editor" screen of Configuration Tool. (Page 235 Creating recipe files)
Units called 'Block' and 'Record', and attribute called 'Record attribute' are used for recipe files.

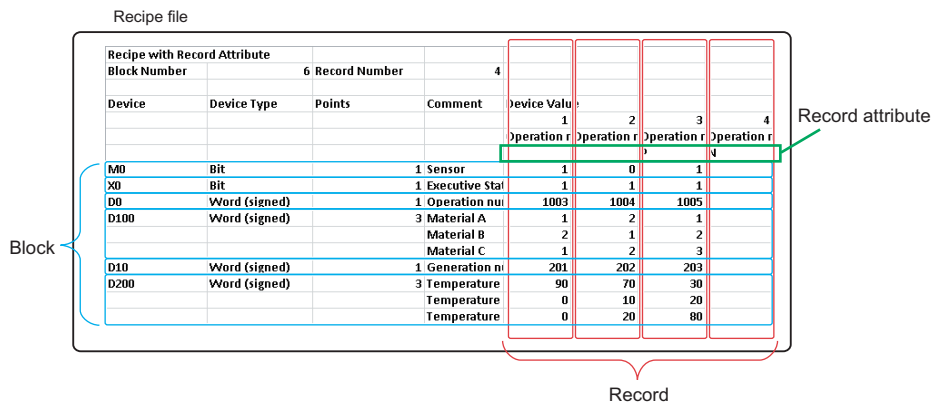
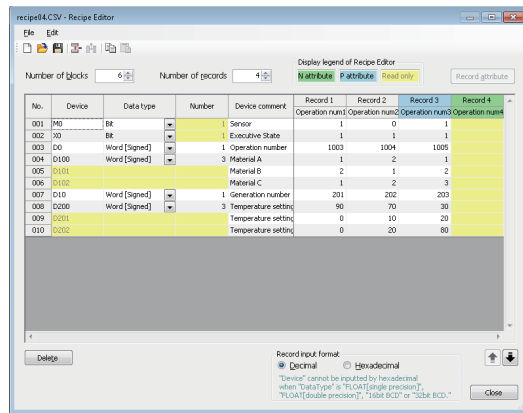

Block

A block is a unit used to set inconsecutive device numbers and different data types. One device and data type can be specified in one block. The following settings are possible by adding a block.

- 1 A mix of devices with multiple data types.
- 2 A mix of consecutive and inconsecutive devices.

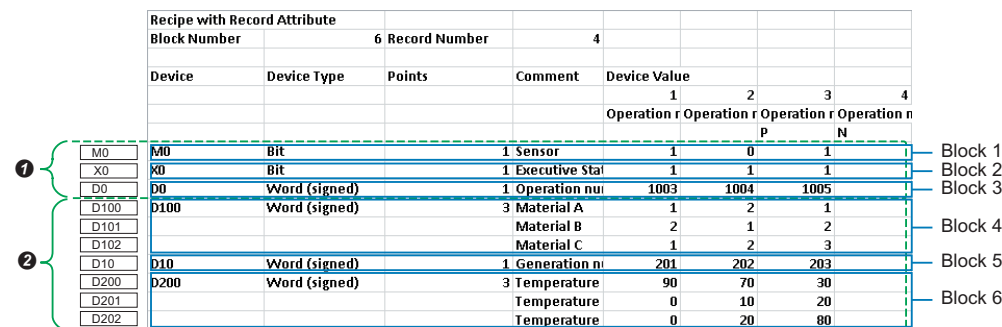

Record

A record is a unit used to distinguish the group of device values on which the read/write processing is performed. By specifying a record number, different values can be set for the same device. One record consists of a record No., a record comment, a record attribute and a device value. Processing is executed by this record unit during recipe execution operation. Multiple records cannot read/written at the same time.

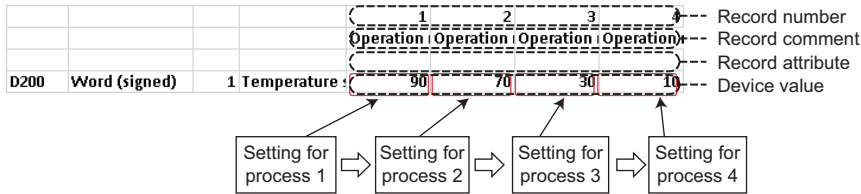

Fields of device values cannot be left blank except when N is specified for the record attribute. Set device value for corresponding blocks and data that are specified on the "Recipe Editor" screen.

Record attribute

There are three types of attribute for record as follows:

■No attribute

'Read' and 'Write' can be processed.

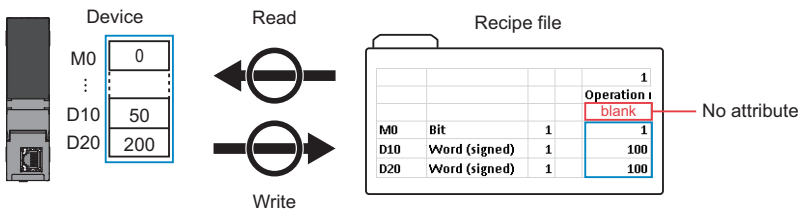

■N attribute

Only the write process can be performed. However, after performing the write process, the attribute type will be changed to no attribute.

Any device values are not entered in the recipe file before performing the write processing.

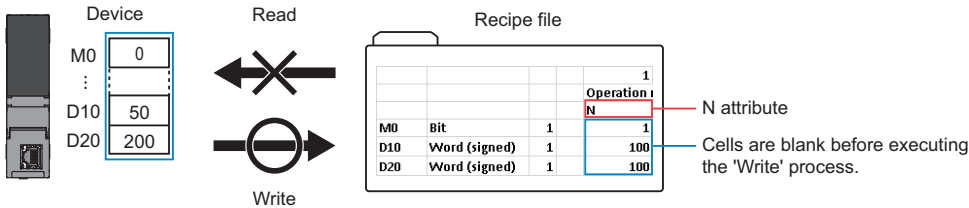

■P attribute

Only the read process can be performed.

Set this attribute to prevent changing device values in a recipe file with dedicated instructions or the recipe execution operation of Configuration Tool.

To change device values in a recipe file, edit the data in Configuration Tool, Excel, or a text editor.

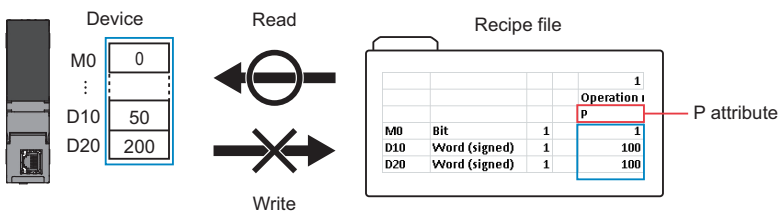

Execution procedure of the recipe function

This section explains the procedure for executing the recipe function.

There are two methods to execute the recipe function.

- Method for executing the recipe function automatically with dedicated instructions
- Method for executing the recipe function manually in Configuration Tool

Before executing the recipe function, refer to the following manual to ready for the operation.

📖 MELSEC iQ-R High Speed Data Logger Module User's Manual (Startup)

Execution of the recipe function automatically with dedicated instructions

Operating procedure

1. Set the recipe setting in Configuration Tool.

📖 Page 235 Creating recipe files

2. Store a recipe file into a RECIPE folder in an SD memory card by any of the following methods.

- Transfer a file by using a file browser (📖 Page 231 Transferring recipe files to module)
- Save a file via FTP server (📖 Page 104 FTP Server Function)
- Insert an SD memory card to a personal computer and save a file.

3. Create a ladder program with dedicated instructions in an engineering tool.

📖 Page 340 Dedicated Instructions

4. Make the recipe function available with "Write to PLC".

5. The recipe function is automatically executed with dedicated instructions.

Execution of the recipe function manually in Configuration Tool

Operating procedure

1. Set the recipe setting in Configuration Tool.

📖 Page 235 Creating recipe files

2. Store a recipe file into a RECIPE folder in an SD memory card by any of the following methods.

- Transfer a file by using a file browser (📖 Page 231 Transferring recipe files to module)
- Save a file via FTP server (📖 Page 104 FTP Server Function)
- Insert an SD memory card to a personal computer and save a file.

3. Execute the recipe function in Configuration Tool.

📖 Page 232 Recipe execution operation

Operation at recipe execution

When a recipe execution operation request occurs, the value of 'recipe execution information' (Un\G810) in the buffer memory will become '1'. When the read/write processing of the recipe data is completed, the value of 'recipe execution information' (Un\G810) will become '0' and the recipe execution operation will be completed.

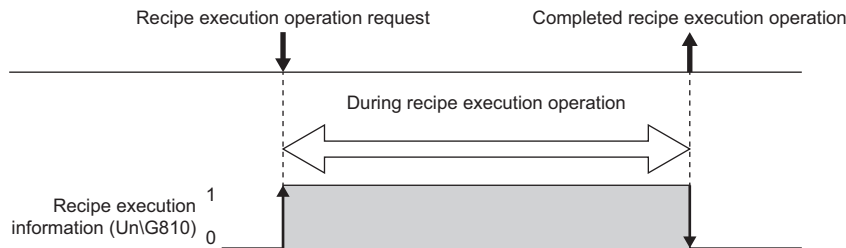

- A recipe execution operation request is performed during the recipe execution operation

When the next recipe execution operation request occurs during the recipe execution operation, the new request cannot be processed, and an error will occur.

- The recipe execution operation is performed at the same time

Only one recipe execution operation is processed and other recipe execution operations will be in errors. The recipe file that is currently being processed can be checked in the buffer memory. (☞ Page 318 Recipe file area (Un\G810 to 841))

Precautions

- Recipe operations cannot be executed when the operation status of the module is 'stop', or when the access status of the SD memory card is 'access stop'.
Check the operation status of the module from the following:
OPR LED and CARD RDY LED
Input signal (X1, X2, and X5) and buffer memory ('Module operation status' (Un\G20))
Module diagnostics and SD memory card diagnostics
- A file with an extension of ".TMP" will be created in the RECIPE folder of the high speed data logger module during the process of writing the recipe.
- The file with the extension ".TMP" may remain in the RECIPE folder of the high speed data logger module when the power of the programmable controller system is turned OFF during recipe execution operations.
- Store only files with the extension '.CSV' in the RECIPE folder of the high speed data logger module. The files with other extensions than '.CSV' may be deleted during the recipe execution operation.
- The file size of one recipe file is up to 512 KB.
- The recipe execution operation starts performing from the beginning of the recipe file. It may not operate according to the settings when the device reads duplicate recipe files.
- The recipe execution operation can be performed only when control CPU is the target CPU module. It cannot be executed from CPU modules other than the control CPU.
- Do not access the Recipe file to overwrite or delete during the recipe execution operation.
- Do not power OFF or reset the CPU module during the recipe execution operation. The Recipe file being created may be damaged. Power OFF or reset the CPU module after confirming the completion of the Recipe processing.
- If Float (Single Precision) or Float (Double Precision) is specified to the data type, the values of the range which can be used in the CPU module can only be set for reading. If the value which cannot be used in the CPU module is read, the following value will be stored to the device in the CPU module.
If a positive value is set: "0" is stored.
If a negative value is set: The value that only the first bit of the last device is turned ON is stored.

Ex.

When D0 is specified in the device, Float (double precision) is specified in the data type, and values outside the range of negative values are set in the device value.

Store the value when only the start bit (15th bit) is ON to D3, and store '0' to D0 to D2.

- When mounting a high speed data logger module to a process CPU (redundant mode), dedicated instructions cannot be used. If a dedicated instruction is used, "Operation error (redundant function)" occurs in the process CPU (redundant mode).

1.5 Security Function

The security function prevents assets stored in a high speed data logger module from being stolen, falsified, operated incorrectly, and executed improperly due to unauthorized access from a third party.

Precautions

The security function is one of the methods for preventing illegal access (such as program or data corruption) from an external device. However, this function does not prevent illegal access completely. Incorporate measures other than this function if the programmable controller system's safety must be maintained against illegal access from an external device. Mitsubishi Electric Corporation cannot be held responsible for any system problems that may occur from illegal access.

Examples of measures for illegal access are shown below.

- Install a firewall.
- Install a personal computer as a relay station, and control the relay of send/receive data with an application program.
- Install an external device for which the access rights can be controlled as a relay station. (For details on the external devices for which access rights can be controlled, consult the network provider or equipment dealer.)

Access authentication function

This function authenticates with a user name and password to restrict the access to the high speed data logger module. To perform access authentication, configure the account settings. (☞ Page 143 Account setting)
 Access authority can be selected from among three types of users; administrator, maintenance user, and normal user.

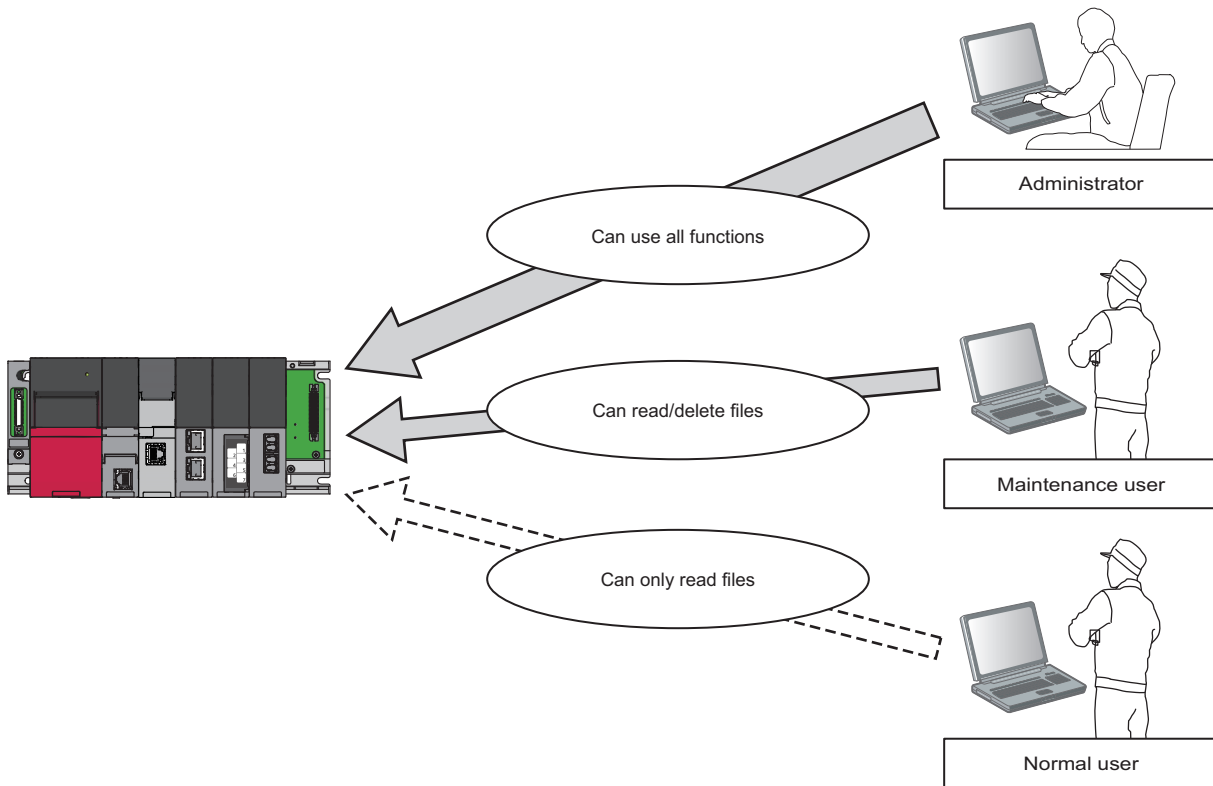

The restrictions for the number of users, user name, and password are as follows.

Item	Specified range
Number of users	0 to 16 users
User name*1	1 to 20 characters
Password*1	6 to 32 characters

*1 For the characters that can be used, refer to the following:

☞ Page 341 Usable characters on the setting screen

Access authentication of the high speed data logger module is performed when connecting with any of the following tools.

- High Speed Data Logger Module Configuration Tool
- FTP client software (Internet Explorer or Microsoft Edge)
- GX LogViewer

File access authority (when using a file browser or FTP)

The following table shows the access authority of administrators, maintenance users and normal users on Configuration Tool and FTP access.

○: Authorized, △: Can be changed on the "account setting" screen, ×: Not authorized

Operation	Directory	Access authority		
		Administrator	Maintenance user	Normal user
Write file (File browser: Transfer to module)	/LOGGING	×	×	×
	/EVENT	×	×	×
	/REPORT	×	×	×
	/RECIPE	○	△	×
	/SYSTEM	×	×	×
Read file (File browser: Save to personal computer)	/LOGGING	○	○	○
	/EVENT	○	○	○
	/REPORT	○	○	○
	/RECIPE	○	○	○
	/SYSTEM	×	×	×
Delete file (File browser: Delete)	/LOGGING	○	△	×
	/EVENT	○	△	×
	/REPORT	○	△	×
	/RECIPE	○	△	×
	/SYSTEM	×	×	×

Access authority of Configuration Tool

The following table shows the access authority of the administrator, maintenance user and normal user.

○:Authorized, ×:Not authorized

Item	Function	Access authority		
		Administrator	Maintenance user	Normal user
Access target CPU setting [Common setting]	Communication test	○	×	×
File transfer setting [Common setting]	File transfer test	○	×	×
E-mail setting [Common setting]	E-mail sending test	○	×	×
Online operation [Online] ⇒ [Read]/[Write]/[Verify]	Read	○	×	×
	Write	○	×	×
	Verify	○	×	×
"Diagnostics" screen	Module time display	○	○	○
Module diagnostics [Online] ⇒ [Diagnostics]	Module status display	○	○	○
	Module operation	○	×	×
	Error information display	○	○	○
	Error/Event details display	○	○	○
	Error release	○	×	×
	Event history file display	○	×	×
	Event history file clear	○	×	×
	INFO LED information	○	○	○
CPU access diagnostics [Online] ⇒ [Diagnostics]	CPU access status display	○	○	○
File transfer diagnostics [Online] ⇒ [Diagnostics]	File transfer status display	○	○	○
	File resending buffering status display	○	○	○
	File resending buffer clear	○	×	×
E-mail send diagnostics [Online] ⇒ [Diagnostics]	E-mail sending status display	○	○	○
	E-mail resending buffering status display	○	○	○
	E-mail resending buffer clear	○	×	×
SD memory card diagnostics [Online] ⇒ [Diagnostics]	SD memory card information display	○	○	○
	SD memory card operation	○	×	×
	SD memory card access status display	○	○	○
	SD memory card format	○	×	×
	Logging file clear	○	×	×
Data logging diagnostics [Online] ⇒ [Diagnostics]	Data logging operation status display	○	○	○
	Total count/total time clear	○	×	×
	Total count/total time backup	○	×	×
	Total count/total time restore	○	×	×
Event logging diagnostics [Online] ⇒ [Diagnostics]	Event logging operation status display	○	○	○
Report diagnostics [Online] ⇒ [Diagnostics]	Report operation status display	○	○	○
Ping test [Online] ⇒ [Diagnostics]	Ping test	○	×	×
	Ping test result display	○	×	×
Product information [Online] ⇒ [Diagnostics]	Product information marking	○	○	○
	Firmware version display	○	○	○
Recipe execution operation [Online] ⇒ [Recipe execution operation]	File list display	○	○	○
	Read	○	×	×
	Write	○	×	×

Lockout setting

If unlocking by password fails for a certain number of times, the module will always be locked out for a fixed period of time. Frequency of lockout, and lockout time cannot be changed.

Operation overview

While unlocking the password, the module will lockout when incorrect passwords are entered consecutively for several times. Even if a password is entered, an error response will be shown at constant time intervals. After a certain interval of time has elapsed, lockout will be cleared and the password can be unlocked.

Since any password unlock operations are not accepted during lockout, password input errors are not counted even if the password input errors have been made.

The number of password input errors are counted when the power is on. This count is cleared when the module is reset or if the power is turned OFF → ON.

The lockout intervals which occur at the time of password errors are as follows:

Number of password input error ^{*1}	Lockout time
1st time to 5th time	0 minute
6th time	1 minutes
7th time	5 minutes
8th time	15 minutes
9th time or later	60 minutes

*1 Once the correct password is entered, the number of password input error will be cleared.

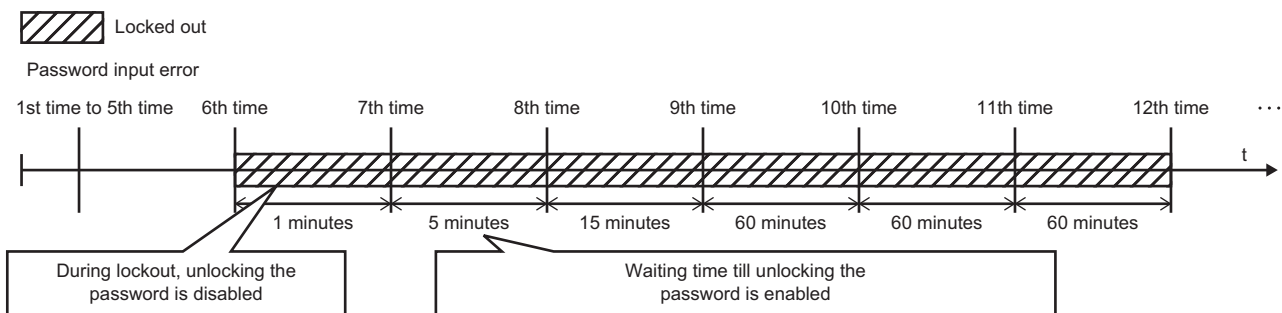

Point

The password input error will not be counted during lockout. Therefore, the lockout time will not be extended additionally by one minute even if the 7th input error occurs before one minute has passed since the 6th.

IP filter function

This function prevents access from unauthorized IP addresses by filtering the IP address of the communication target.

There are two IP filter functions.

Allow function: Allows access only from the specified IP addresses.

Deny function: Denies access only from the specified IP addresses.

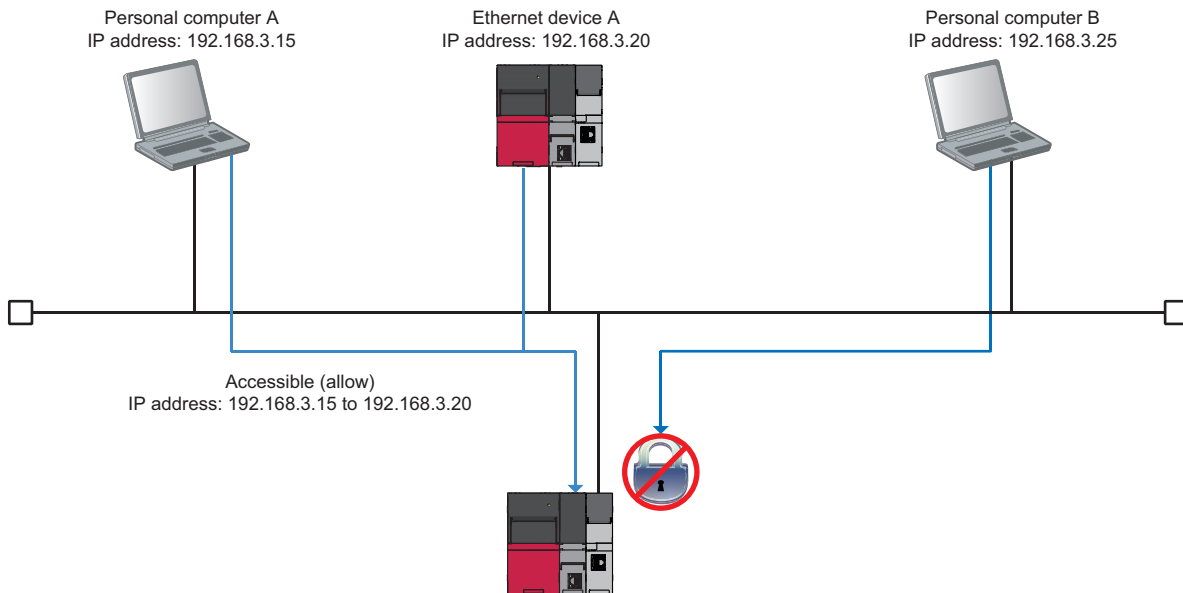

The IP filter function is applied to all accesses from Configuration Tool or FTP clients to a high speed data logger module.

1.6 Time Synchronization Function

The time synchronization function synchronizes the time of a high speed data logger module with that of a CPU module (CPU No.1 in a multiple CPU system).

Time information is used for the logging data time stamp, time of event occurrence/restoration, and report creation time, and date and time information of the "Diagnostics" screen.

Time synchronization timings

Time synchronization timings are as follows:

■Timing specified in Configuration Tool

Time is synchronized at the timing specified in the time synchronization setting in Configuration Tool.

The synchronization timing can be specified in fixed cycles (interval in minutes) or in fixed time (time and day of the week).

■Module startup

Time is synchronized at the timing when a high speed data logger module is started or restarted after performing any of the following operations.

- Powering OFF and ON
- Resetting a CPU module
- Upgrading a setting

■Time synchronization request

Time is synchronized at the timing when the 'time synchronization request' (YB) is turned OFF to ON.

Daylight saving time

If daylight saving time is set in the CPU module, the clock will be set ahead by 1 hour when the daylight saving time starts, and it will set back to the original time when the daylight saving time ends.

Ex.

If the daylight saving time starts from 02:00

The clock will be set ahead by 1 hour at the start time.

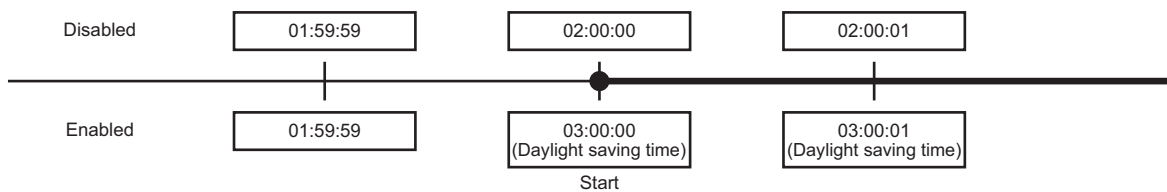

Ex.

If the daylight saving time ends at 02:00

The clock will be set back to the original time at the end time.

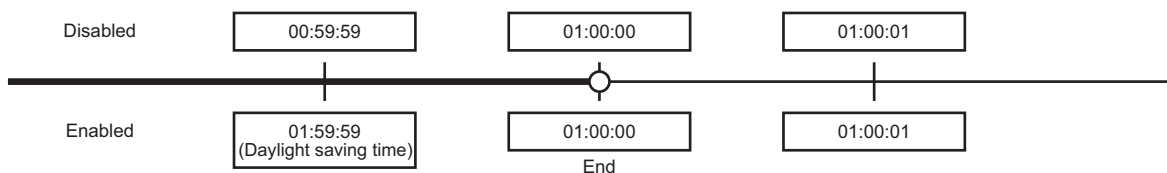

When specifying the time of one hour before and one hour after both the start and end time of daylight saving time with the data logging setting, event logging setting, or report setting, there may be situations where the correct time cannot be judged. When a "Time interval specification" is specified, the data cannot be sampled because the correct time cannot be judged for that one last hour of the daylight saving time, when the time is adjusted back.

Operation for time synchronization

When implementing synchronization with CPU module time, high speed data logger module's time is changed.

As a result, high speed data logger module's time may be greatly changed.

Since there is inaccuracy in the clock element in CPU module and high speed data logger module, the time may be moved slightly forward or backward when the time is synchronized.

However, data is sampled at a fixed cycle.

2015/1/15 15:48:32.8	1028	1	100	15.9
2015/1/15 15:48:32.9	1029	1	101	16.0
2015/1/15 15:48:31.5	1030	1	102	16.1
2015/1/15 15:48:31.6	1031	0	103	16.2
2015/1/15 15:48:31.7	1032	0	104	16.3

Time is synchronized →

Data are normally sampled in 100 milliseconds interval

■When the time of high speed data logger module is set forward by time synchronization

- Cycle determination: Sampling and condition satisfaction time may be shorter than the specified cycle.
- Time determination: Conditions may be satisfied immediately after the time updates.

■When the time of high speed data logger module is set back by time synchronization

- Cycle determination: Sampling and condition satisfaction time may be longer than the specified cycle.
- Time determination: Conditions have been satisfied may be satisfied again.

Considerations for time synchronization function

- Before using the high speed data logger module, set the time data of CPU No. 1.
For the time data settings, refer to the user's manual of the CPU module used.
- There is a deviation in the time data of CPU No. 1 used by the high speed data logger module.
For the time data accuracy, refer to the user's manual of the CPU module used.
- When the high speed data logger module acquires the time data from CPU No. 1, a maximum of one second of delay occurs as the transfer time.
Therefore, a one-second deviation may occur in logging data time when setting the time.
- The time zone cannot be specified in the time synchronization function of the high speed data logger module because the clock data follows the time zone set in the CPU module. When the time zone needs to be specified, set it in the CPU module.

1.7 Auto Logging Function

The auto logging function automatically starts the data logging function, event logging function, and report function when an SD memory card to which the auto logging settings are written in advance is inserted in a running high speed data logger module.

The data logging can be stopped automatically by specifying the time to perform data logging.

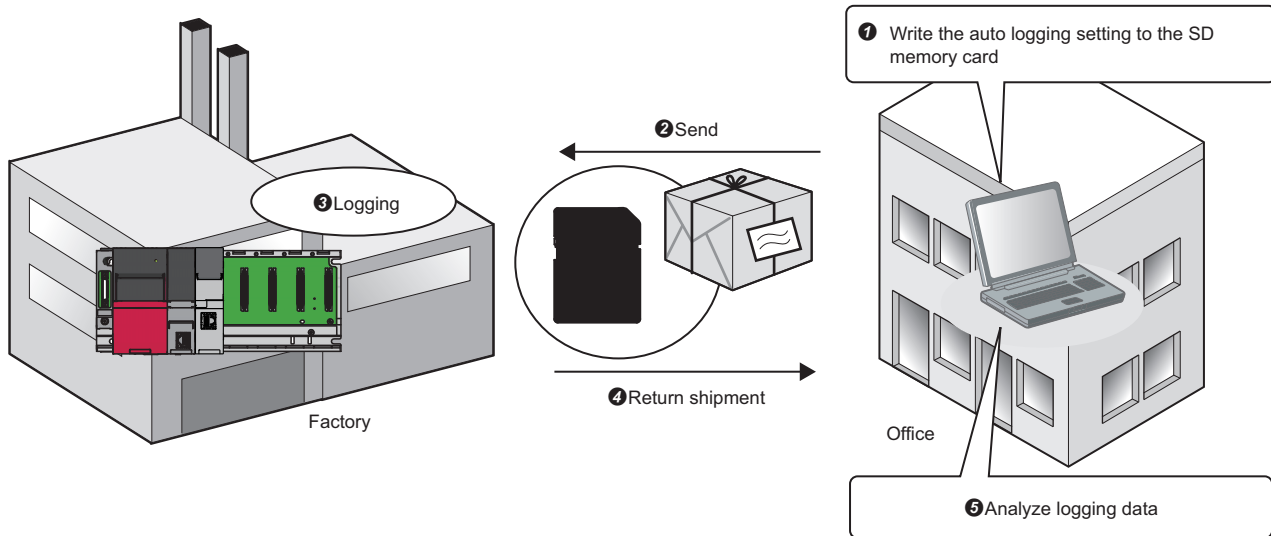

Precautions

When using the auto logging function, do not connect the high speed data logger module to LAN.

In addition, do not set to transfer files and e-mails in the data logging setting, the event logging setting, and the report setting.

Procedure to use

The following shows the procedure to use of the auto logging function.

Before executing the auto logging function, set the auto logging setting in Configuration Tool.

☞ Page 145 Logging operation setting

1. Insert an SD memory card in a personal computer.
2. Write the auto logging setting to the inserted SD memory card.

☞ Page 130 Exporting module operating file

3. Remove the SD memory card from the personal computer.
4. Insert an SD memory card in a high speed data logger module.
The CARD RDY LED of the high speed data logger module turns ON and the auto logging starts.
5. 'File access stop request' (Y2) turns ON when any conditions for stopping a module operation is not set.
The CARD RDY LED of the high speed data logger module turns ON and the auto logging stops.
6. Remove the SD memory card from the high speed data logger module.

Point

To terminate the auto logging function forcibly, stop a file access by any of the following methods.

- Switch operation on the front of a module
- Input/output (X/Y) signal operation
- Online operation in Configuration Tool

1.8 File Access Function

The file access function accesses files in an SD memory card inserted in a high speed data logger module from a personal computer by using a file browser of Configuration Tool or an FTP client.

Via network, logging files and report files can be acquired or deleted, and recipe file can be written.

File browser function

This function enables access from the file browser.

This function can be used when the connection method is a direct connection or a connection via a hub.

For details on the file browser, refer to the following:

☞ Page 231 File browser

FTP server function

This function enables access from the FTP client.

This function can only be used when the connection method is a connection via a hub.

For details on the FTP server function, refer to the following:

☞ Page 104 FTP Server Function

1.9 File Transfer Function

The file transfer function transfers logging files or report files to an FTP server or a file server that has a shared folder. There are three file transfer functions as follows:

- Transfer Function: Transfers logging files to the specified file server at the file switching timing.
- Resend function: Resends logging files to the specified file server when a file transfer is failed.
- Transfer completion notification function: Notifies the transfer completion by transferring a transfer completion file to the specified file server.

Transfer function

This function transfers the latest saved file to the file server when the file is switched.

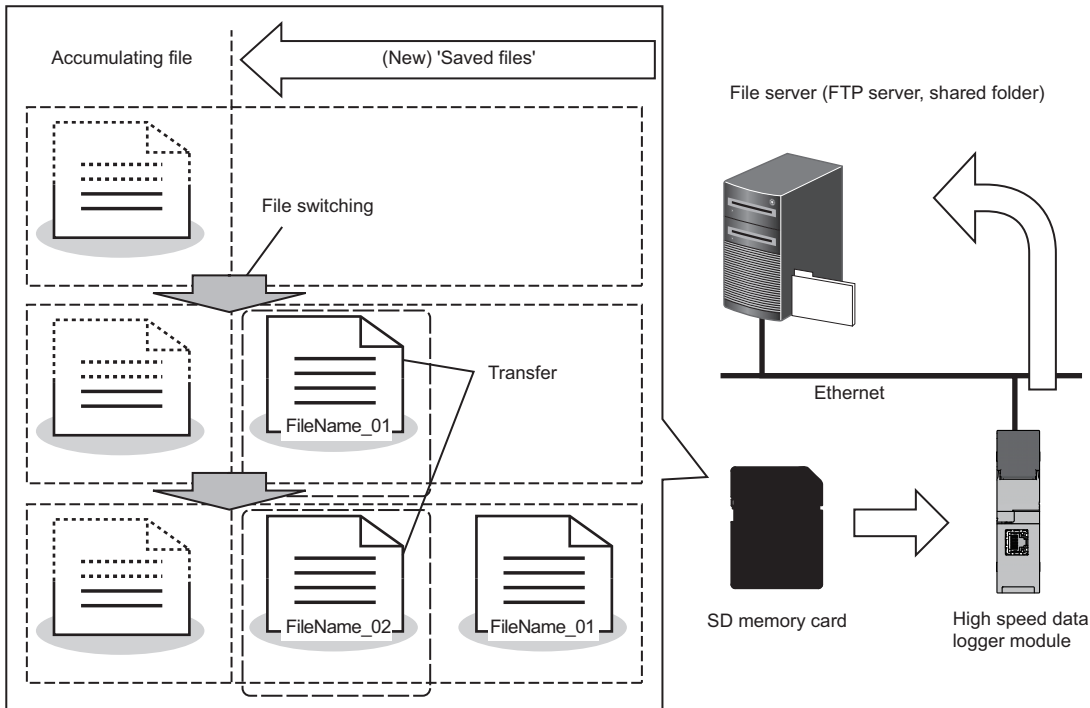

To save a file on the file server having same saved file name, the transfer function will overwrite the file on the server to the saved file.

For details on the folder configuration after a file transfer, refer to the following:

📖 MELSEC iQ-R High Speed Data Logger Module User's Manual (Startup)

Precautions

The file on the transfer destination may get corrupted if the CPU module is turned OFF or reset when the file is being transferred.

If any problem arises, turn OFF the power or reset the CPU module after stopping the file access.

Resend function

A file resend is attempted every 10 seconds when a module cannot access the file server and the file transfer is failed due to a network failure.

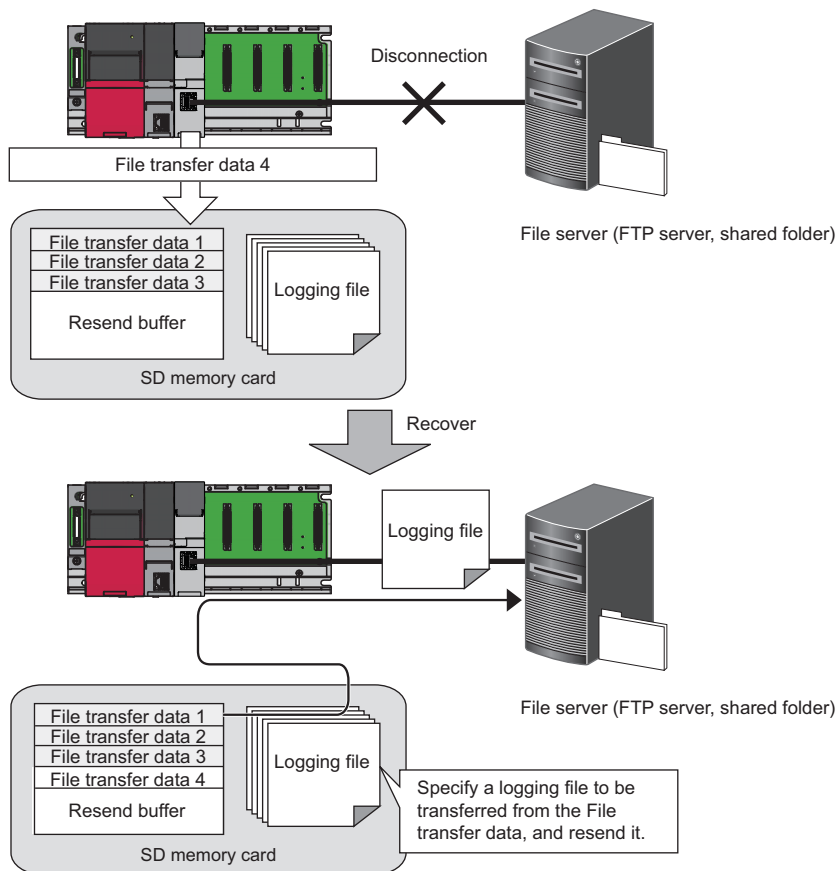

When the resend function is set to enabled, the information required for this function will be saved to the SD memory card. Therefore, the free space in the SD memory card is reduced depending on the number of specified data.

In addition, if the power of a module is turned OFF during network disconnection with a file server, a file resend is performed when the access to the file server is restored and the power of the module is turned ON.

Precautions

- When resend function is 'enabled', a file transfer error will not occur even if transfer fails without accessing the server. However, even when the resend function is enabled, if transfer fails and a processing error occurs on the server side due to issues like server overload, a file transfer error will occur similar to when the resend function is disabled.
- When the files to be transferred are deleted while resending, the no transfer file error occurs. Set a sufficiently large number of saved files for logging files and report files so that the resend source files are not deleted.
- When the resend target number exceeds the number specified to the resend buffer size, the resend buffer excess error occurs. After the occurrence of the error, the file that failed to transfer is not newly added to the resend buffer, and it does not become the resend target. Specify a sufficiently large resend buffer size. (👉 Page 137 File transfer setting)
- The usage rate of the resend buffer memory can be checked, and the buffer can be cleared in Configuration Tool. (👉 Page 221 File transfer diagnostics)
And, the resend buffer will be cleared when settings are written, the CPU module is reset or if the settings are updated.
- Even if the file transfer test fails, the file will not be resent.
- A transfer by the resend function is performed per file. Therefore, when the transfer function is performed during a file resend, a transfer by the transfer function is performed even if all the file resend of logging files and report files is not completed. If the transfers by the transfer function and the resend function occur at the same time, they are performed randomly.

Transfer completion notification function

This function is used to write the transfer completion notification file that indicates that the transfer is completed when files such as the data logging files are transferred by using the file transfer function.

Complete transfer of files like the logging files can be confirmed by checking the existence of the transfer completion notification file.

This function is used to detect the transfer completion of the logging file at the server side and process automatically after the logging file was transferred to the server.

The transfer completion notification file is an empty file (file size is 0 bytes). It will be transferred to the same folder as the transfer file storage destination.

The transfer completion notification file will have the same name as the transferred file. Only the file extension will be different. The extensions for transfer files and transfer completion notification files are as follows:

Extension for transfer file	Extension for transfer completion notification file
.TXT	.TTC
.CSV	.CTC
.BIN	.BTC
.XLS	.XTC

1.10 E-mail Function

The e-mail function automatically sends logging files and report files by an e-mail, or reports event occurrence. E-mail function has the following 3 functions.

- Transmission function: Send logging files automatically.
- Resend function: Resend logging files when the e-mail sending failed.
- Notification function: Notifies event occurrences to the specified e-mail address.

Transmission function

When the file is switched, this function attaches the latest saved file to the e-mail, and sends it to the mail server.

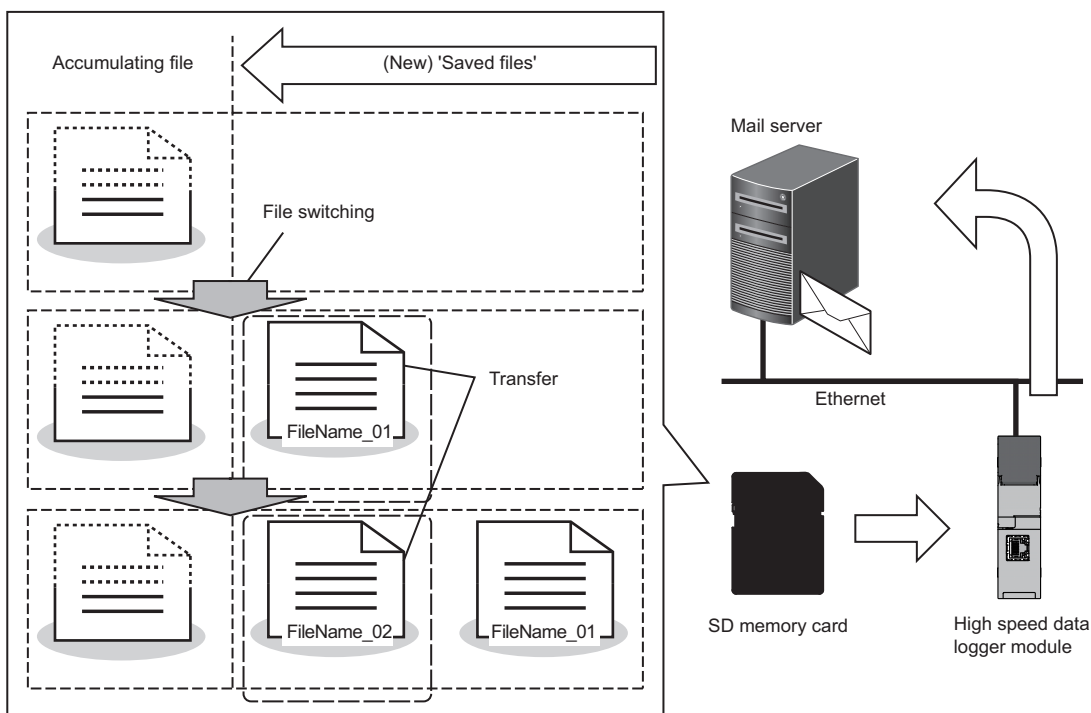

Ex.

An example of sent e-mail

E-mail header*1	From: RD81DL96 [xxx@xxx.co.jp] Date: 06/01/2016 20:52 To: xxx@xxx.co.jp Subject: XXLOG_00000008.CSV 2016/1/6 20:52:23
E-mail text*1	XXLOG_00000008.CSV 2016/1/6 20:52:23
Attached file	[XXLOG_00000008.CSV]

*1 The character codes that can be used are available in ASCII range.

Resend function

An e-mail resend is attempted every 10 seconds when a module cannot access the mail server and the e-mail sending failed due to a network failure.

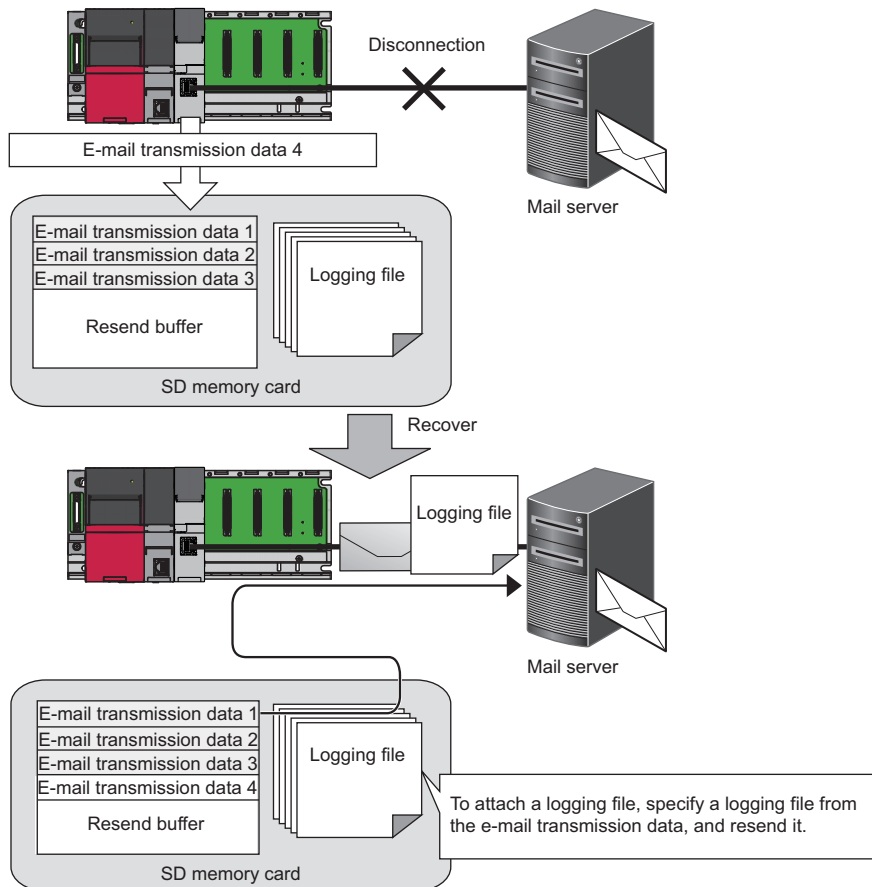

When the resend function is set to enabled, the information required for this function will be saved to the SD memory card. Therefore, the free space in the SD memory card is reduced depending on the number of specified data.

In addition, if the power of a module is turned OFF during network disconnection with a mail server, an e-mail resend is performed when the access to the mail server is restored and the power of the module is turned ON.

Precautions

- When the resend function is enabled, the e-mail transmission error will not occur even if e-mail sending fails due to the failure of the e-mail server access. However, even when the resend function is enabled, if e-mail sending fails and a processing error occurs on the server side due to issues such as server overload, the e-mail transmission error will occur similar to when the resend function is disabled.
- When the file to be sent is deleted when resending e-mail, the no attached file error occurs. Set a sufficiently large number of saved files for logging files and report files so that the resend source files are not deleted.
- When the resend target number exceeds the number specified to the resend buffer size, the resend buffer excess error occurs. After the occurrence of the error, the file that failed to send e-mail is not newly added to the resend buffer, and it does not become the resend target. Specify a sufficiently large resend buffer size. (☞ Page 140 E-mail setting)
- The usage rate of the resend buffer memory can be checked, and the buffer can be cleared in Configuration Tool. (☞ Page 222 E-mail send diagnostics)
And, the resend buffer will be cleared when settings are written, the CPU module is reset or if the settings are updated.
- Even if the e-mail sending test fails, the e-mail will not be resent.
- A transfer by the resend function is performed per file. Therefore, when the transmission function is performed during an e-mail resend, a transmission by the transmission function is performed even if all the e-mail resend of logging files and report files is not completed. If the transmissions by the transmission function and the resend function occur at the same time, they are performed randomly.

Notification function

Refer to the e-mail notification function of the event logging function.

☞ Page 69 E-mail notification function

1.11 Event History Registration Function

The event history registration function saves event information, such as errors detected by a high speed data logger module and operations performed to a high speed data logger module, to an SD memory card.

The operation conditions of the module can be checked because the registered errors and events are not deleted even when the power is turned OFF.

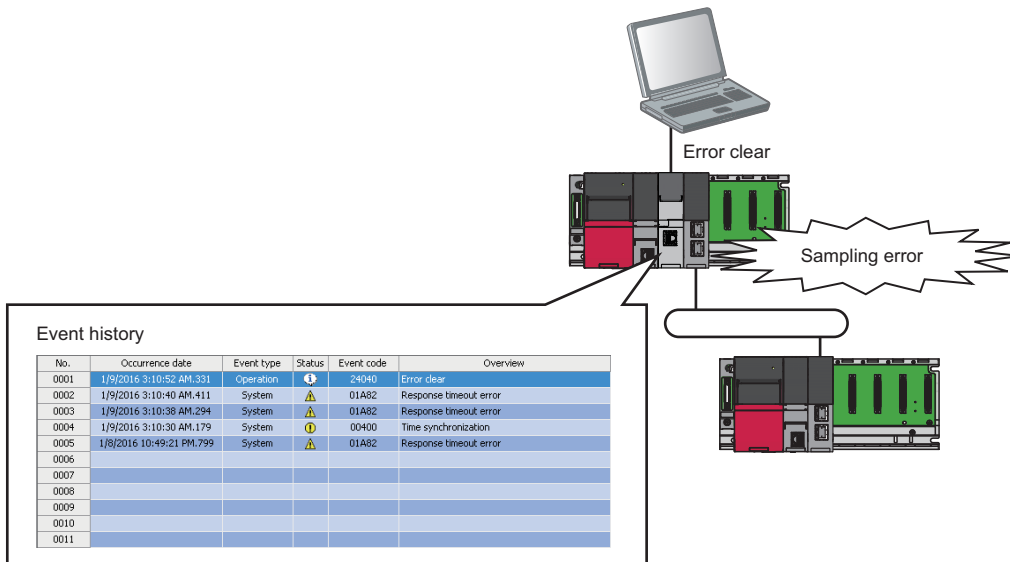

For errors and events registered by the high speed data logger module, refer to the following:

📖 Page 263 Error Code List, Page 292 Event List

1.12 Free Space Adjustment Function

The free space adjustment function deletes old logging files and report files when the free space of an SD memory card reaches a specified free space.

Configure the settings to prevent a logging stop due to the capacity shortage in the SD memory card.

The range of free space that can be specified is as follows.

Specification method	Specified range
Percent specification	10 to 50 %
Size specification ^{*1}	50 MB to 4096 MB

*1 If the specified size specification value exceeds 50% of the total capacity of the inserted SD memory card, the behavior of the function will be similar to when 50% is specified to the percent specification.
(Example) When 1500 MB is specified to the size specification while the SD memory card which has a total capacity of 2 GB is inserted, the free space adjustment function will operate to delete the saved files when the free space of the SD memory card is 1 GB or less.

Operation overview

The following processes are performed when the amount of free space is set to the SD memory card settings.

- Check the free space in the SD memory card in 10-second periods.
- Delete the saved files of any of the data logging, event logging, or report which takes the greatest share in the following rate. (The number of files saved in the SD memory card)/(The specified number of saved files)

If the rates are the same, saved files of any of the data logging, event logging or report of which the specified number of saved files is the greatest are deleted. If the specified numbers of saved files are the same, the saved files of the data logging, event logging and report in that order from the smallest setting number are deleted.

■Files for deletion

The objects of deletion are saved files created by the data logging, event logging or report function operated on high speed data logger module.

■Files not for deletion

The following files are not deleted. When the size excluding the total size of the files not to be deleted from the total space of the inserted SD memory card is larger than the specified size of free space, the free space of the SD memory card is not the specified size.

- Accumulating file
- Latest saved file
- The saved files of data logging, event logging, and report for which 'Stop' is set for the operation when number of saved files exceeds
- The saved files created by the data logging, event logging, or report function which are not set on the high speed data logger module
- Recipe file

Ex.

When the free space in the SD memory card exceeds the specified limit due to the following settings

Setting	Saved files	
	Specified number of saved files	Number of saved files on the SD memory card
Data logging 01	10	7
Data logging 02	10	5
Report 01	5	5

(1) to (14): The order in which saved files are deleted

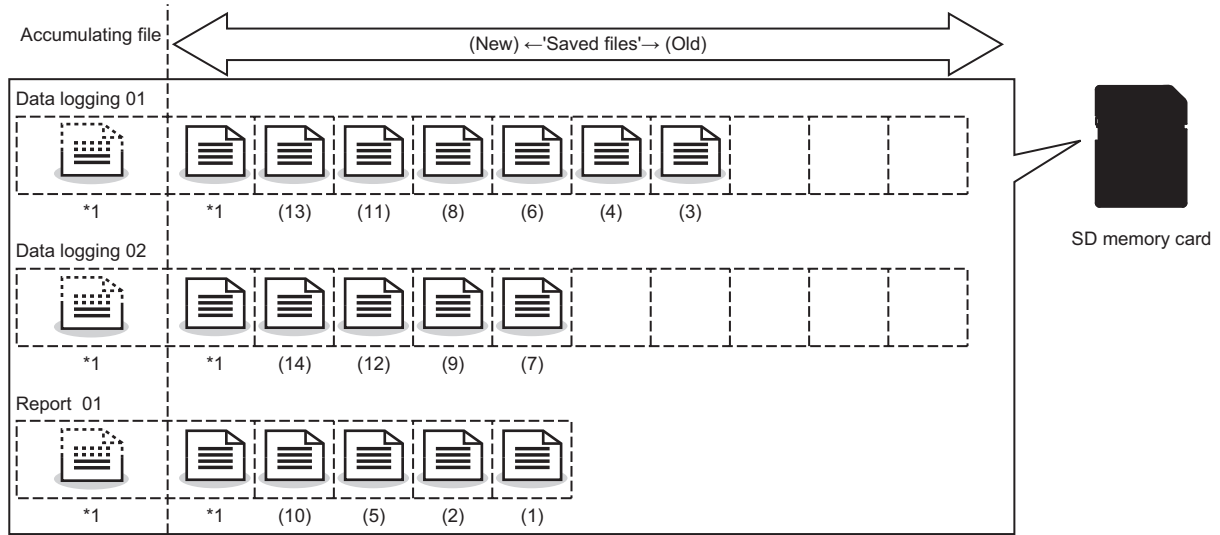

*1 Accumulating files and the latest saved files are not included in the target of deletion

1.13 FTP Server Function

The FTP server function accesses files in an SD memory card inserted in a high speed data logger module by using an FTP client from a personal computer.

This function can only be used when the connection method is a connection via a hub.

While using the FTP server function, configure the settings for temporary internet files. (MELSEC iQ-R High Speed Data Logger Module User's Manual (Startup))

For the supported FTP commands, refer to the following:

Page 355 Supported FTP Command

Operating procedure

1. Start a web browser from a personal computer, and enter the address of a high speed data logger module (http://192.168.3.3*1).

*1 If the IP address is changed, specify the IP address set in the network settings. (Page 132 Network setting)

2. Click "Open the list of files (FTP)" from the active screen.

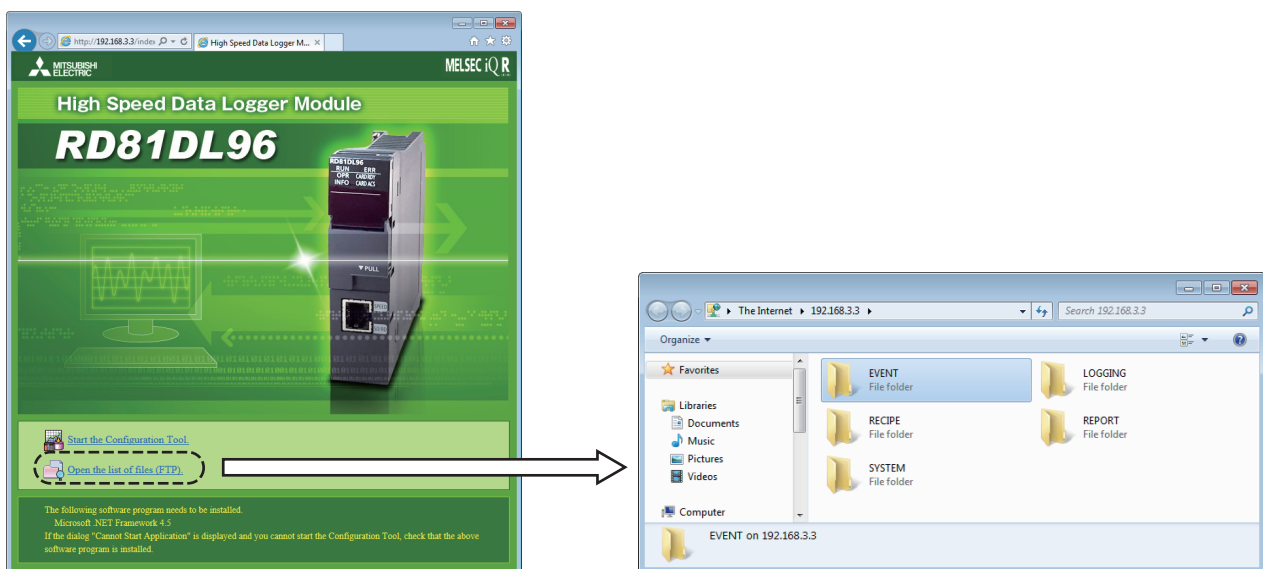

Precautions

■Microsoft Edge

For Microsoft Edge, use Internet Explorer mode.

When using Internet Explorer mode, it may take time to display the main page.

■File list (FTP)

The high speed data logger module files are displayed in text format.

Some functions cannot be used when files are displayed in text format. Open the FTP site in Explorer format.*1

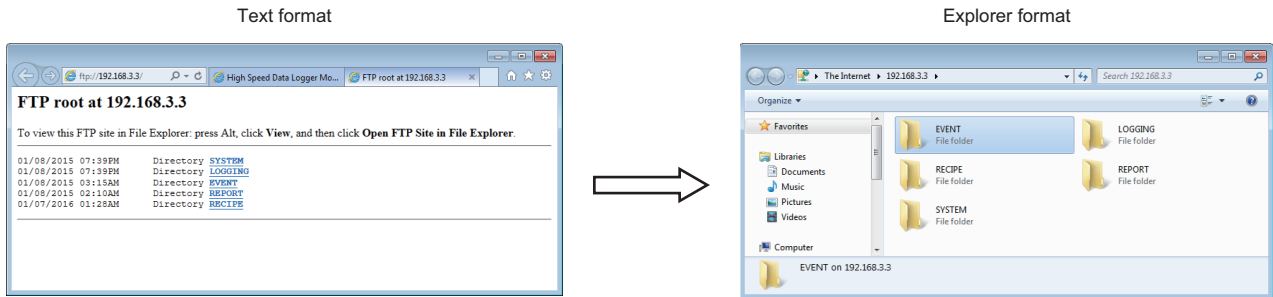

*1 When using Windows 10 and Microsoft Edge, the site may not open in Explorer format. In this case, start Explorer and enter the address of the high speed data logger module (ftp://192.168.3.3) in the address bar.

If the IP address is changed, specify the IP address set in the network settings. (📖 Page 132 Network setting)

■RECIPE folder

A file with the '.TMP' extension may be displayed when the RECIPE folder is displayed during the write process of the recipe function.

This TMP file is deleted at the completion of the write process.



For details on the write process of the recipe function, refer to the following:

📖 Page 78 Recipe Function

1.14 Self-diagnostic Function

The self-diagnostic function performs a self-diagnostic test to check the hardware of a high speed data logger module.

The following tests are included in the self-diagnostics:

- Automatic hardware test ( Page 246 Automatic hardware test)
- Hardware test for LED check ( Page 247 Hardware test for LED check)

1.15 Initialization Function

The initialization function initializes a firmware update-prohibited password retained in a high speed data logger module.

Operating procedure

1. Select "Module Initialization Setting" in "Basic Settings" ⇨ "Various Operations Settings" ⇨ "Mode Settings" for a high speed data logger module in an engineering tool. (📖 Page 239 Basic Settings)
2. Set the CPU module to the STOP state, and write the parameters.
3. Reset the CPU module.
After the CPU module is reset, a firmware update-prohibited password is initialized automatically. The LED display for the initialization is as follows:

Status		RUN LED status	ERR LED status
Initialization completed	Normal completion	ON	OFF
	Abnormal completion	ON	ON

4. When the initialization is completed normally, return the mode setting changed in step 1 to "Online" and reset the CPU module.
5. When the initialization is completed abnormally, check if measures are taken to reduce noise of the programmable controller system, and perform the initialization again. If it is completed abnormally again, a hardware failure may occur in a high speed data logger module. Please contact your local Mitsubishi Electric sales office or representative.
Do not use an electric screwdriver when removing the module. Loosen the module fixing screws completely to remove the module.

2 HIGH SPEED DATA LOGGER MODULE CONFIGURATION TOOL

This chapter explains High Speed Data Logger Module Configuration Tool.

2.1 High Speed Data Logger Module Configuration Tool

High Speed Data Logger Module Configuration Tool is used for the following operations: creating various settings that are required for operating a high speed data logger module, writing and reading the settings, diagnosing the operation of a module in operation, and stopping and restarting a module operation.

In addition, the following operations can also be performed in Configuration Tool.

- Editing the module setting
- Writing the module setting
- Reading the module setting
- Displaying the module information while a module is running
- Operating a module while it is running

For the startup method and screen configuration in Configuration Tool, refer to the following:

📖 MELSEC iQ-R High Speed Data Logger Module User's Manual (Startup)

Setting operations overview

The following shows the procedure to set each setting in Configuration Tool.

1. Set the common settings.

📖 Page 131 Common Setting

2. Set various logging settings.

📖 Page 147 Data Logging Setting

📖 Page 177 Event Logging Setting

📖 Page 194 Report Setting

3. Write the settings to a high speed data logger module.

📖 Page 216 Write

2.2 Common Operations

This section explains common operations of High Speed Data Logger Module Configuration Tool.

Operations on wizard screen

The title of each wizard screen is displayed in the 'edit item bar' in the upper portion of the detailed setting screen. Setting operations are performed in order from the items to the left in the edit item bar to those in the right.

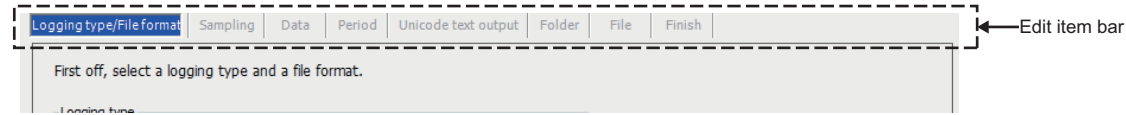

Wizard display and operations

■ Edit item status

The setting status of the wizards on the edit item bar can be checked by color.

Status	Text color	Background color	Example
Configured	Blue	White	Logging type/File format
Being edited	White	Blue	Sampling
Not configured	Gray	White	Data

■ Screen transitions with the [Back]/[Next] buttons

Switch between edit item screens with the [Back]/[Next] buttons.

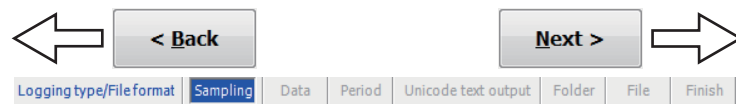

■ Screen transitions with mouse

The setting screen for configured items can be moved directly by clicking the 'edit item bar'.

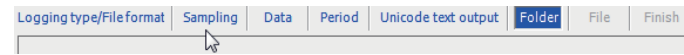

Data list

Display the list of data used for the settings being edited.

Window

Select the data logging (event logging, report) setting to be displayed in the edit items tree, and click the [Data list] button on the detailed setting screen.

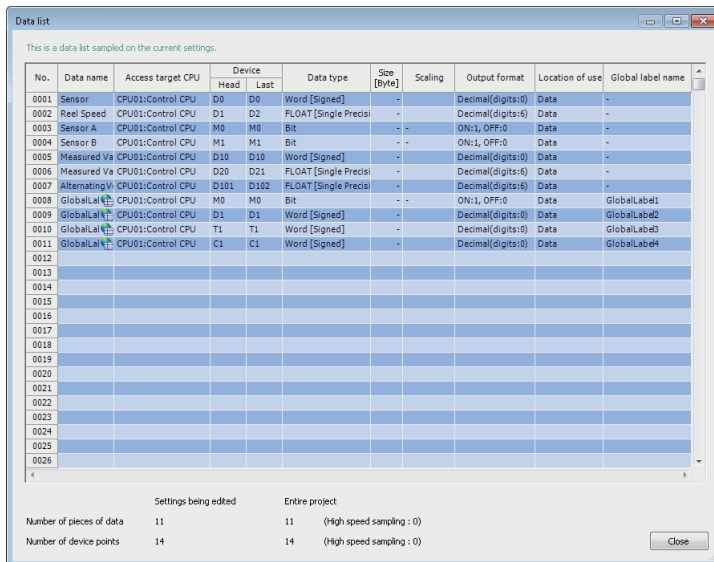

Displayed items

Item	Description	Reference
No.	Displays the data index.	Page 111 No. (index)
Data name	Displays the data name. For related data, an icon (🌐) is displayed.	—
Access target CPU	Displays the access target CPU.	—
Device	Displays the start device and the end device.	—
Data type	Displays the data type.	—
Size	Displays the data size.	—
Output value ^{*1}	Displays output value of data.	—
Scaling	Displays the conversion equation for the scaling conversion.	—
Output format	Displays the output format (such as decimal format, exponential format).	—
Count condition ^{*1}	Displays the conditions to count the output value. "-" is displayed when the output value is "Value."	—
Location of use	Displays the location of data being used.	Page 111 Location of use display
Global label name	Displays the global label name for related data.	—
Number of pieces of data	Displays the total number of units of data while editing the settings and the number of units of data in the entire project (data logging, event logging, and report).	—
Number of device points	Displays the total number of devices while editing the settings and number of units of data in the entire project (data logging, event logging, and report).	—

*1 Displayed in the case of data logging (trigger logging).

■No. (index)

Displays data index in the formats below according to the data type.

Data type	Format
Logging data (data logging) Monitoring data (event logging) Current value data (report)	nnnn
Additional data*1*2	*nnnn

*1 Data that is added by selecting "(Add)" from the list box and clicking the [...] button.

*2 The data added by completion notification of the trigger logging, saved folder name settings, and saved file name settings can only be used with added settings.

■Location of use display

Display the location of device data being used.

When multiple locations are specified, they are displayed with a comma (,).

Ex.

When D0 is used for trigger condition and D1 is used for period condition in which the trigger is monitored by trigger logging

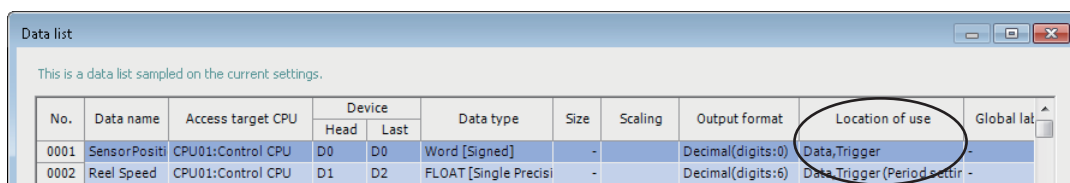

Device batch replacement

Replace the devices used in the data logging setting, the event logging setting, or the report setting in Configuration Tool at once.

Window

Select [Edit] ⇨ [Device batch replacement].

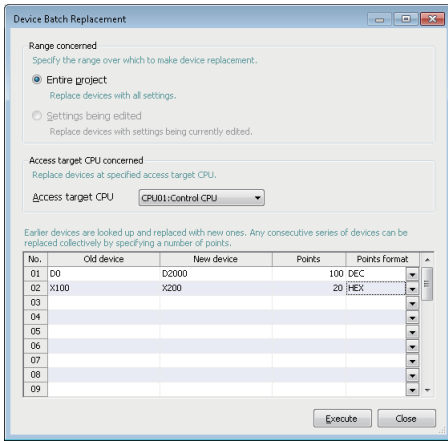

Displayed items

Item		Description
Range concerned	Entire project	Select this to set the replacement target to the entire project.
	Settings being edited	Select this to set the replacement target to the settings being edited (data logging/event logging/report setting).
Access target CPU concerned		Specify the access target CPU of the devices to be replaced.
Replace device list	Old device	Specify the replacement target start device.
	New device	Specify the start device after replacement.
	Points	Specify the number of device points for the replacement target.
	Points format	Select the specification format of points.
[Execute] button		Executes device batch replacement.

Data setting

Set the data of CPU module.

To set the data of CPU module on various Setting screens, set it on common screen.

Window

Select "(Add)" for data name on each setting screen and click [...].

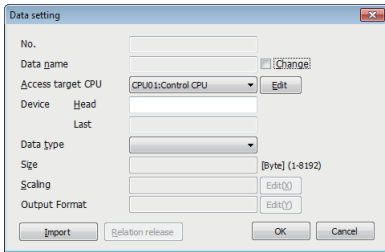

Displayed items

Item	Description
No.* ¹	Displays the index of data to be set.
Data name	— Change
	Displays the data name, or used to change the data name. For related data, an icon is displayed. Select this to specify a data name. When it is not selected, displays the start device.
Device	Head* ¹ Last* ¹
	Set the start device. Displays the end device calculated from the data type and size.
Access target CPU* ¹	Select the access target CPU. To add an access target CPU, select "(Add CPU)" and click the [...] button. Page 134 Access target CPU setting
Data type* ¹ * ² * ³ * ⁴	Select the data type.
Size* ¹ * ⁵ * ⁶	If the data type is "String" or "Raw," the size must be specified.
Scaling* ¹	Set the scale conversion equation for data. Click the [...] button on the right of the input field and set on the displayed "Scaling" screen. Page 153 Scaling ■When setting saved folder name or saved file name • Values after the scaling conversion are rounded off to the whole number. • When the data type is Word [Signed] or Double Word [Signed] and if values after scaling exceed the value range of Double word [Signed], they are rounded to within the range. • When the data type is not Word [Signed] or Double Word [Signed] and if values after scaling exceed the value range of Double Word [Unsigned]/Bit String [32-bit], they are rounded to within the range. For details of the numerical range of output values, refer to the following: MELSEC iQ-R High Speed Data Logger Module User's Manual (Startup)
Output format* ¹	Displays the format (such as decimal format, exponential format) when outputting data to a file. To change the output format, click the [...] button on the right of the input field and change it on the displayed "Output format" screen. Page 153 Output format
[Import] button	Imports global labels or device comments. Page 116 Importing global labels Page 123 Importing common device comments
[Relation release] button	Disables relations with global labels. Page 121 Release relations to global labels
[OK] button	Reflects the settings and closes the screen.

- *1 These items cannot be edited for related data.
- *2 The usable ASCII characters with the specified strings are the same as those in file name and folder (directory) name. (☞ Page 343 File name and folder (directory) name)
If characters other than usable ASCII characters are output to a saved folder name or a saved file name, it is replaced with "_" (under bar).
If a string terminator (0) is used halfway in the data, the subsequent data is replaced with "_" (underscore).
- *3 String is output in the following character codes depending on the file format to be output.
Unicode text files, binary files: UTF-16 (little endian)
CSV files: ASCII
- *4 When outputting string, the character code of data in the saved folder name setting, saved file name setting, and e-mail content setting, is ASCII.
- *5 If the file type is a Unicode text file or a binary file, its size should be an even number.
- *6 When using the string type data, specify the size considering the character code. (☞ Page 25 String type data)

Importing global labels and common device comments

Import global labels (including module labels) and common device comments set in an engineering tool into a project in Configuration Tool.

Data imported from global labels are called relation data.

Related devices can be updated corresponding to the changes of global labels in the Engineering tool project.

Applicable data

○: Applicable, ×: Not applicable, —: No data

Item	Engineering tool
Common device comment	○
Each program device comment	×
Global label (Global)	○
Module label (M+Global)	○
Local label	×
System label	—

For details of global labels and device comments, refer to the following:

 GX Works3 Operating Manual

Considerations for importing data

■Importing global label

- Engineering tool (GX Works3 Version 1.020W or later) must be installed to import global labels or update related data.
- Global labels of devices (data types) which cannot be set to Configuration Tool are not imported. (Even though they are displayed in the list of global labels/common device comments to be imported.)
- When the global labels are set 32769 or more in 1 project, the global labels which exceed 32768 are not displayed in the list of global labels to be imported.
- Do not import global labels during the save process of an engineering tool project. If attempted, the engineering tool project may not be stored normally.
- The global label for which devices or labels are not assigned are not in the scope of import.
- GX Works3 projects that require entering a user name and password or cannot be opened in an installed GX Works3 cannot be imported.

■Importing common device comment

- Engineering tool (GX Works3 Version 1.020W or later) must be installed to import common device comments.
- When the common device comments are set 32769 or more in 1 project, the common device comments which exceed 32768 are not displayed in the list of common device comments to be imported.
- Do not import common device comments during the save process of an engineering tool project. If attempted, the engineering tool project may not be stored normally.
- GX Works3 projects that require entering a user name and password or cannot be opened in an installed GX Works3 cannot be imported.

Importing global labels

Import global labels set with an engineering tool as data.

If the global labels created by using the engineering tool are edited, they are updated in batch. It is therefore necessary to link the global labels.

Operating procedure

1. Open the "Import global label" screen or the "Import" screen by one of the following methods.
 - Select [Edit] ⇒ [Import global label]*¹.
 - Click the [Import] button*² on each screen.
2. Select a global label import source project*³ on the "Import global label" screen or "Import" screen, and click the [OK] button.
3. Select global labels to be imported on the "Import global label" screen, and click the [OK] button.

*1 The menu is valid in the following conditions only.
 When the "Data" screen of Data logging setting is displayed.
 When the "Recipe Editor" screen is displayed.

*2 This button can be found on the following screens.
 "Data setting" screen displayed from "Data name" on the "Trigger condition setting" screen, "OR combine" screen, "AND combine" screen, "Number of times" screen, "Order" screen, "Period setting" screen, "File switching condition setting" screen, "Folder switching condition setting" screen, "Saved file name setting" screen, "Saved folder name setting" screen, "E-mail content setting" screen, and "E-mail notice" screen
 "Event setting" screen
 "Current value layout" screen

*3 When "(No setting)" is selected, the "Global label/Common device comment import setting" screen is displayed. Select the import source project.

☞ Page 117 "Global label/Common device comment import setting" screen

■ "Import global label" screen

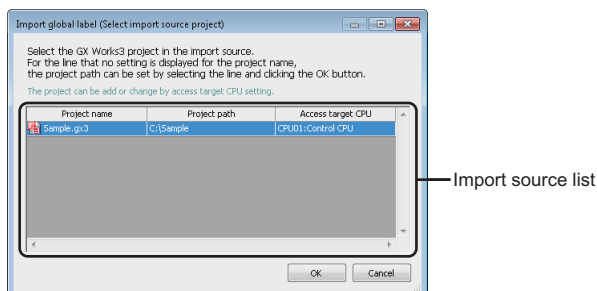

Displayed items

Item	Description
Import source list	Displays the Engineering tool project and the access target CPU which are set as global label import source. When the project is not set for the access target CPU, "(no setting)" is displayed.
[OK] button	Reflects the settings and displays the screen to specify the import target global labels. When "(no setting)" is selected, the "Global label import setting" screen is displayed. ☞ Page 117 "Global label/Common device comment import setting" screen

■ "Global label/Common device comment import setting" screen

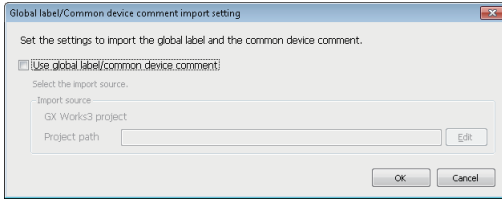

Displayed items

Item	Description
Use global label/common device comment	Select this to import global labels and common device comments.
Import source	Displays the project path specified for the import source.
[Edit] button	Displays the "GX Works3 project selection" screen.
[OK] button	Imports global labels.

■ "Import global label" screen

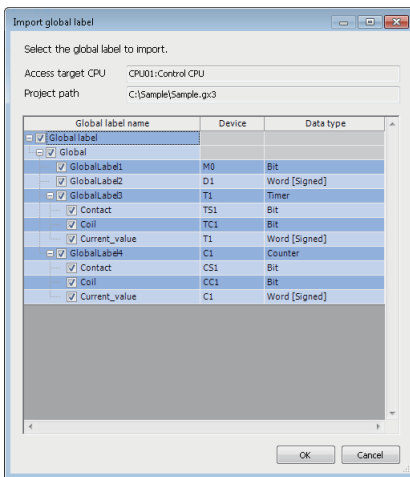

Displayed items

Item	Description
Access target CPU	Displays the access target CPU selected on the "Global label/Common device comment import setting" screen.
Project path	Displays the path of project selected on the "Global label/Common device comment import setting" screen.
Global label name	Displays global label names (set in an engineering tool). Select the global labels to be imported.
Device	Displays start device of global label.
Data type	Displays data type of global label.
[OK] button	Imports the specified global labels and closes the screen.

■ Global label name

- Elementary data

The following table shows the display example when a global label is an elementary data and the data name example when importing the data.

○: Available, ×: Not available

Type	Global label name display example	Import ^{*1}	Data name example ^{*2}
Elementary data	GlobalLabel1	○	GlobalLabel1

*1 Global labels can be imported only when ○ is marked for both importing into global labels and importing into data types.

*2 If the number of characters in the data name exceeds 32, the numbers beyond 32 are deleted from the beginning to match the number to 32.

Ex.

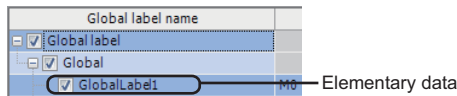

- Array

The following table shows the display example when a global label is an array and the data name example when importing the data.

○: Available, ×: Not available

Type	Global label name display example	Import ^{*1}	Data name example ^{*2}
Array data	GlobalLabel2[0..1]	×	—
Array element	GlobalLabel2[1]	○	GlobalLabel2[1]

*1 Global labels can be imported only when ○ is marked for both importing into global labels and importing into data types.

*2 If the number of characters in the data name exceeds 32, the numbers beyond 32 are deleted from the beginning to match the number to 32.

Ex.

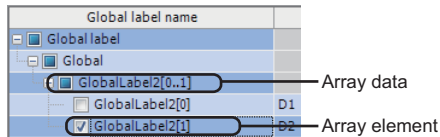

- Structure

The following table shows the display example when a global label is a structure and the data name example when importing the data.

○: Available, ×: Not available

Type	Global label name display example	Import ^{*1}	Data name example ^{*2}
Structure data	GlobalLabel3	×	—
Structure element	Element1	○	GlobalLabel3.Element1
Structure element [Array]	Element2[0..1]	×	—
Array element	Element2[1]	○	GlobalLabel3.Element2[1]

*1 Global labels can be imported only when ○ is marked for both importing into global labels and importing into data types.

*2 If the number of characters in the data name exceeds 32, the numbers beyond 32 are deleted from the beginning to match the number to 32. If the number of characters in the data with an expanded structure exceeds 32, the element name is used as the data name. If the number of characters in the element name exceeds 32, the numbers beyond 32 are deleted from the beginning to match the number to 32.

Ex.

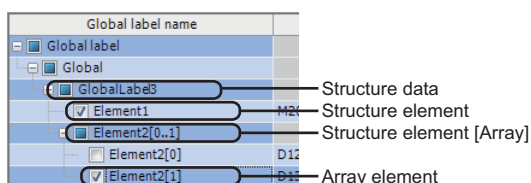

• Structured array

The following table shows the display example when a global label is a structured array and the data name example when importing the data.

○: Available, ×: Not available

Type	Global label name display example	Import ^{*1}	Data name example ^{*2}
Structured array data	GlobalLabel4[0..1]	×	—
Structured array element	GlobalLabel4[0]	×	—
Structure element	Element1	○	GlobalLabel4[0].Element1
Structure element [Array]	Element2[0..1]	×	—
Array element	Element2[1]	○	GlobalLabel4[1].Element2[1]

*1 Global labels can be imported only when ○ is marked for both importing into global labels and importing into data types.

*2 If the number of characters in the data name exceeds 32, the numbers beyond 32 are deleted from the beginning to match the number to 32. If the number of characters in the data with an expanded structure exceeds 32, the element name is used as the data name. If the number of characters in the element name exceeds 32, the numbers beyond 32 are deleted from the beginning to match the number to 32.

Ex.

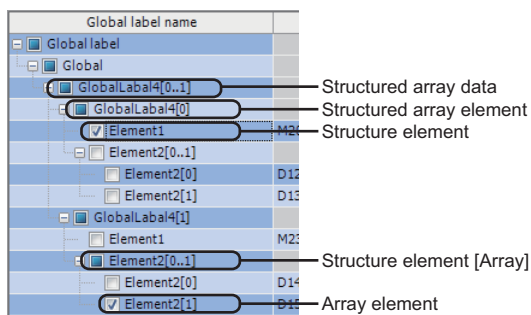

• Timer/Counter/Retentive timer

The following table shows a display example when the global label is timer/counter/retentive timer and the data name example at the time of importing.

○: Available, ×: Not available

Type	Global label name display example	Import ^{*1}	Data name example ^{*2}
Timer	—	×	—
	Contact	○	Timer_Label.Contact
	Coil	○	Timer_Label.Coil
	Current value	○	Timer_Label.Current_value
Counter	—	×	—
	Contact	○	Counter_Label.Contact
	Coil	○	Counter_Label.Coil
	Current value	○	Counter_Label.Current_value
Retentive timer	—	×	—
	Contact	○	Retentive_timer_Label.Contact
	Coil	○	Retentive_timer_Label.Coil
	Current value	○	Current_value

*1 Global labels can be imported only when ○ is marked for both importing into global labels and importing into data types.

*2 If the number of characters in the label name exceeds 32, the numbers beyond 32 are deleted from the beginning to match the number to 32. If the number of characters in the data (contacts, coils, current values) with an expanded timer/counter/retentive timer exceeds 32, the element name is used as the label name.

Ex.

Global label name	Device	Data type
Global label		
Global		
Timer_Label	T1	Timer
Contact	TS1	Bit
Coil	TC1	Bit
Current_value	T1	Word [Signed]

■Assigning devices and labels to global labels

Devices displayed on the "Import global label" screen changes by the engineering tool setting.

- Importing global labels to which devices are assigned
The device column enlists assigned devices.
- Importing global labels to which labels (alias) are assigned
The device column enlists assigned labels.
- Importing global labels for which devices or labels are not assigned
The device column becomes blank.

■Availability of global label import by data type

The following table shows the availability of global label import by data type set in an engineering tool.

○: Available, ×: Not available

Data type in an engineering tool	Availability ^{*1}	Data type in Configuration Tool
Bit	○ ^{*2}	Bit
Word [Signed]	○	Word [Signed]
Double Word [Signed]	○	Double Word [Signed]
Word [Unsigned]/Bit String [16-bit]	○	Word [Unsigned]/Bit String [16-bit]
Double Word [Unsigned]/Bit String [32-bit]	○	Double Word [Unsigned]/Bit String [32-bit]
FLOAT [Single Precision]	○ ^{*2}	FLOAT [Single Precision]
FLOAT [Double Precision]	○ ^{*2}	FLOAT [Double Precision]
String (n) ^{*3}	○ ^{*3*4}	String
String [Unicode] (n) ^{*3}	○ ^{*3*5}	String
Time	×	—
Timer	○	Contact: Bit
Counter	○	Coil: Bit
Retentive timer	○	Current value: Word [Signed]
Long timer	○	Contact: Bit
Long counter	○	Coil: Bit
Long retentive timer	○	Current value: Double Word [Signed]
Pointer	×	—

*1 Global labels can be imported only when ○ is marked for both importing into global labels and importing into data types.

*2 Global labels cannot be imported into the saved file name data.

*3 "n" indicates the number of characters. Global labels can be imported into the saved file name data only when a number between 1 to 16 is applied to 'n'.

*4 Global labels can be imported into the saved file name data when the file format is Unicode text file or binary file or the file format is a CSV file.

*5 Global labels can be imported into data other than the saved file name data when the file format is Unicode text file or binary file or the file format is the CSV file.

Release relations to global labels

Disable the relations between the global labels of an engineering tool and related data.

Operating procedure

Select the related data, and release the relation by one of the following methods.

- Select [Edit] ⇒ [Release relation to global label]^{*1}.
- Click the [Relation release] button^{*2} on each screen.

*1 The menu is valid in the following conditions only.
When the "Data" screen of Data logging setting is displayed.

*2 This button can be found on the following screens.

"Data setting" screen displayed from "Data name" on the "Trigger condition setting" screen, "OR combine" screen, "AND combine" screen, "Number of times" screen, "Order" screen, "Period setting" screen, "File switching condition setting" screen, "Folder switching condition setting" screen, "Saved file name setting" screen, "Saved folder name setting" screen, "E-mail content setting" screen, and "E-mail notice" screen
"Event setting" screen
"Current value layout" screen

Updating related data of global labels

Update the data related to global labels of an engineering tool project to the most recent value.

If data cannot be updated, the relation is released.

Operating procedure

1. Select [Edit] ⇒ [Update data related to global label].
2. Select a project to be updated on the "Update data related to global label" screen, and click the [OK] button.
3. Select global labels to be updated on the "Update data" screen, and click the [OK] button.

■"Update data related to global label" screen

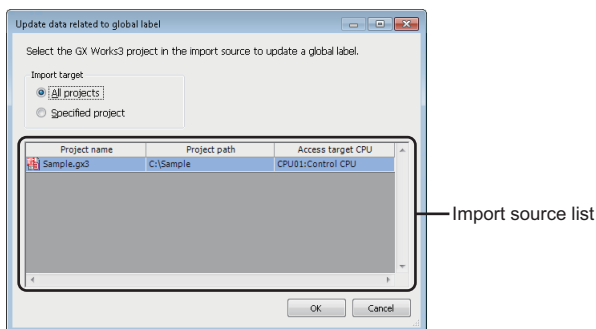

Displayed items

Item	Description
All projects	Select this to update the related data of all projects.
Specified project	Select this to update related data of specified project.
Import source list	Displays the Engineering tool project and the access target CPU which are set as global label import source. When the project is not set for the access target CPU, "(no setting)" is displayed.
[OK] button	Reflects the settings and displays the screen on which global labels to be updated are specified.

■ "Update data" screen

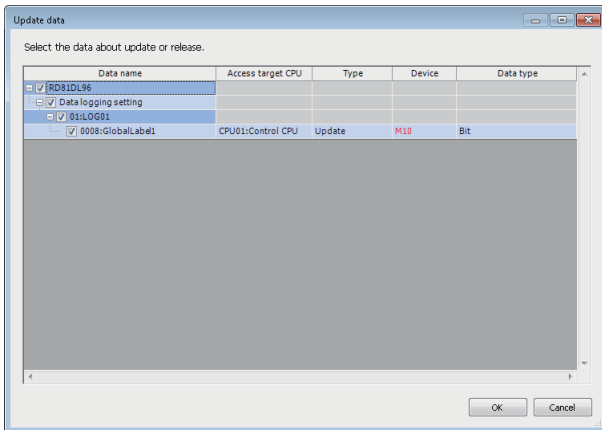

Displayed items

Item	Description
Data name	Displays various setting names and related data names. Select the settings or related data to be updated.
Access target CPU	Displays the access target CPU.
Type	Displays the update status. <ul style="list-style-type: none"> • Update: Updates devices and data types to the most recent value. • Relation release: Relations are released when the related data cannot be found or inconsistency occurs by the update.
Device	Displays the start device after the update. When the start device is changed after the update, the device name is displayed in red.
Data type	Displays the data type after the update. When the data type or size is changed after the update, the data name is displayed in red.
[OK] button	Updates the specified related data, or releases the relations.

Importing common device comments

Import the common device comments set with an engineering tool as data.

Operating procedure

1. Open the "Import common device comment" screen or the "Import" screen by one of the following methods.
 - Select [Edit] ⇒ [Import common device comment]^{*1}.
 - Click the [Import] button^{*2} on each screen.
2. Select a common device comment import source project^{*3} on the "Import common device comment" screen or the "Import" screen, and click the [OK] button.
3. Select common device comments to be imported on the "Import common device comment" screen, and click the [OK] button.

*1 The menu is valid in the following conditions only.

When the "Data" screen of Data logging setting is displayed.

When the "Recipe Editor" screen is displayed.

*2 This button can be found on the following screens.

"Data setting" screen displayed from "Data name" on the "Trigger condition setting" screen, "OR combine" screen, "AND combine" screen, "Number of times" screen, "Order" screen, "Period setting" screen, "File switching condition setting" screen, "Saved file name setting" screen, "Saved folder name setting" screen, "E-mail content setting" screen, and "E-mail notice" screen

"Event setting" screen

"Current value layout" screen

*3 When "(No setting)" is selected, the "Global label/Common device comment import setting" screen is displayed. Select the import source project.

☞ Page 117 "Global label/Common device comment import setting" screen

■ "Import common device comment" screen

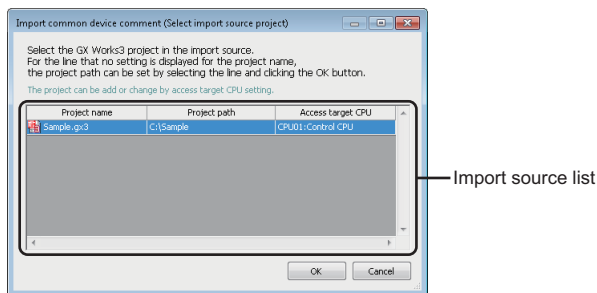

Displayed items

Item	Description
Import source list	Displays the Engineering tool project and the access target CPU which are set as common device comment import source. When the project is not set for the access target CPU, "(no setting)" is displayed.
[OK] button	Reflects the settings and displays the screen to specify the import target common device comment. When "(No setting)" is selected, the "Global label/Common device comment import setting" screen is displayed. ☞ Page 117 "Global label/Common device comment import setting" screen

■ "Global label/Common device comment import setting" screen



The settings are same as mentioned in the following section.

☞ Page 117 "Global label/Common device comment import setting" screen

■ "Import common device comment" screen

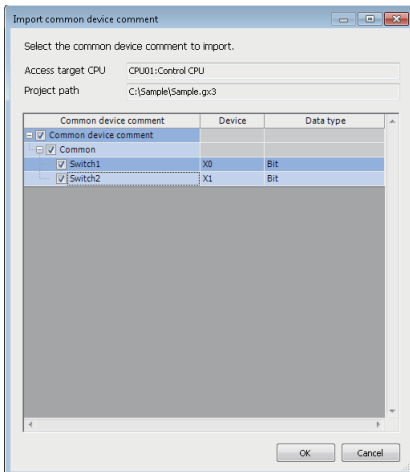

Displayed items

Item	Description
Access target CPU	Displays the access target CPU selected on the "Global label/Common device comment import setting" screen.
Project path	Displays the path of project selected on the "Global label/Common device comment import setting" screen.
Common device comment	Displays common device comments (set in Engineering tool). Select the common device comments to be imported.
Device	Displays devices contain common device comments.
Data type	Displays data type of "Device." Bit device: Bit Word device: Word [Signed]
[OK] button	Imports the specified common device comments and closes the screen.

2.3 Project Management

In Configuration Tool, settings which is to be written to a high speed data logger module can be created as a project. This section explains how to create, open, save, import, and export the project.

Creating a new project

Create a new project.

The project being edited is discarded.

Operating procedure

Select [Project] ⇒ [New].

Opening a project

Read a saved project.

Operating procedure

1. Select [Project] ⇒ [Open].
2. Select the file to be opened on the "Open" screen, then click the [Open] button.

Saving a project

Save the settings being edited to a project file.

Saving a project

Operating procedure

Select [Project] ⇒ [Save].

Naming and saving a project

Operating procedure

1. Select [Project] ⇒ [Save As].
2. On the "Save as" screen, specify the save location and file name and then click the [Save] button.

Opening a Q-series high speed data logger module (QD81DL96) project

Read a saved project.

Operating procedure

1. Select [Project] ⇒ [Open Q-Series High Speed Data Logger Module (QD81DL96) project].
2. Select the target file on the "Open Q Series High Speed Data Logger Module (QD81DL96) project" screen, then click the [Open] button.

The settings to be changed are as follows:

Setting name	Changed content	Applied setting
Network setting	A host name is changed to the default (RD81DL96).	Network setting
Time synchronization setting	This setting is changed to the default.	Time synchronization setting
Access target CPU setting	The series of own station CPU is changed to RCPHU. The series of other CPUs is changed to QCPU/LCPU.	Access target CPU setting
	Import source of global labels and device comments is disabled. All the relations between the related data are canceled.	Access target CPU setting Data logging setting Event logging setting Report setting
	If the access target CPU name is duplicated, the suffixes ((1), (2), ...) will be added to all the duplicated access target CPU names.	Access target CPU setting Data logging setting Event logging setting Report setting
FTP setting	This setting is applied to the file transfer setting. • FTP server name → Host name • Login user name → User name • Directory path → Path	File transfer setting
Auto logging setting	This setting is applied to the logging operation setting.	Logging operation setting
Data logging setting Event logging setting Report setting	The following data types of data and devices are changed: • Word [unsigned]→Word [Unsigned]/Bit String [16-bit] • Double Word [Unsigned] → Double Word [Unsigned]/Bit String [32-bit]	Data logging setting Event logging setting Report setting
	"Add the sequential number" is specified in the simple setting of the saved file name setting. "_SNUM" is added at the end of the format in the detailed setting of the saved file name setting.	Data logging setting Event logging setting Report setting
	The size of the character string will be changed as follows. When size is even number: No change When size is odd number: Changes to size + 1	Data logging setting ^{*1} Event logging setting ^{*1} Report setting
Event logging setting	If the file is in binary format, the option "Send a notifying e-mail when an event occurs" of mail notification settings becomes disable.	Event logging setting

*1 For only binary files.

Precautions

- Default values are set under the settings which do not exist in the MELSEC iQ-R series high speed data logger module (RD81DL96) project.
- The own station CPU (access target CPU No. 01) series of access target CPU is changed to RCPHU. Access target CPU No. 02 to 64 series is changed to QCPU/LCPU. When the target setting of access target CPU No. 02 to 64 is CPU module of MELSEC iQ-R series, change the series as necessary.

Importing settings

Read the settings from a project file or CSV file (setting information file) saved in a personal computer and reflect them to the setting being edited.

Individual settings can also be read and reflected.

Importing from a project file

Select an arbitrary setting from a saved project and import it to the setting of project being currently edited.

This function is used to import the settings of the saved project.

Operating procedure

1. Select [Project] ⇒ [Import] ⇒ [Project file].
2. On the "Open" screen, specify the project to be imported and click the button.
3. Select settings for importing from "Import source."

Settings are reflected in "Import destination" by clicking the [▶] button.

Reflection of the item selected under "Import destination" gets cleared by clicking the [◀] button.

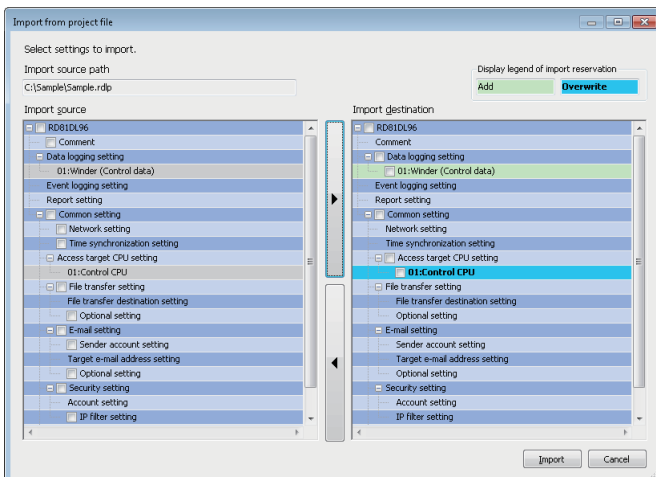

4. Items are imported by clicking the [Import] button.

Importing from a CSV file

Import a CSV file (setting information file) in which the setting information is described.

Select an arbitrary setting from the CSV file edited with an application such as spreadsheet software, and import it to the setting of a project being currently edited.

For details of the formats of the setting information file, refer to the following:

📖 Page 385 Setting Information File Format

Operating procedure

1. Select [Project] ⇒ [Import] ⇒ [CSV file].
2. In the "Browse For Folder" screen, specify the folder where the CSV file to be imported is stored, and click the [OK] button.
3. Select settings for importing from "Import source."

Settings are reflected in "Import destination" by clicking the [▶] button.

Reflection of the item selected under "Import destination" gets cleared by clicking the [◀] button.

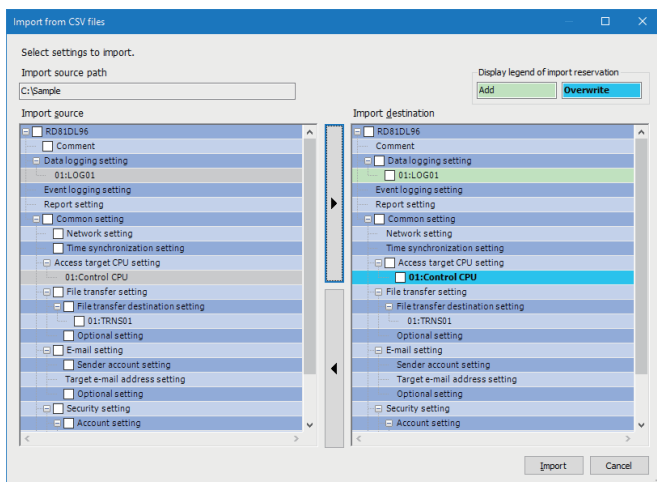

4. Items are imported by clicking the [Import] button.



Report settings cannot be imported from the CSV file.

To use the report function, import the settings from the saved project or create new settings.

Considerations for importing

■Importing referenced settings

Some settings in the high speed data logger module are referenced.

When a referenced setting is selected in the import source area, the settings related to the referenced setting are also selected.

To avoid importing the referenced settings, unselect them.

Ex.

Data logging setting: Access target CPUs are referenced from data settings.

■Note on same access target CPU names

The same access target CPU names can be assigned to the multiple settings in a single project. However, in such a case, the import function cannot be used.

When using the import function, do not use the same access target CPU name in the projects of import source and import destination.

■When importing access target CPU settings

The No. 01 item of the access target CPU (default name: control CPU) cannot be overwritten with the item other than the No. 01 item of the import source.

■Importing transfer destination setting of file transfer setting

- All settings are imported additionally when the total number of settings after the import is 16 or less.
- Only the referenced settings are imported additionally when the total number of settings after the import exceeds 16.
- Settings cannot be imported when only the referenced settings are imported and the total number of settings after the import exceeds 16.

Exporting settings

Export settings of the project being edited to a Unicode text file or CSV file.

Export the project being edited in a module-operable format.

Exporting to CSV file

Export settings of the project being edited to the CSV file (setting information file).

For details of the setting information file format, refer to the following:

☞ Page 385 Setting Information File Format

If characters that cannot be displayed in the ASCII code are included in the setting information, such characters will not be exported to a CSV file. Export contents to Unicode text files.

Operating procedure

1. Select [Project] ⇒ [Export] ⇒ [Text file] ⇒ [CSV file].
2. On the "Browse For Folder" screen, specify the export destination and click the [OK] button.

Exporting to Unicode text file

Export settings of the project being edited to the Unicode text file (setting information file).

For details of the setting information file format, refer to the following:

☞ Page 385 Setting Information File Format

Operating procedure

1. Select [Project] ⇒ [Export] ⇒ [Text file] ⇒ [Unicode text file].
2. On the "Browse For Folder" screen, specify the export destination and click the [OK] button.

Exporting module operating file

Export the project being edited in a module-operable format.

The project is exported to a SD memory card inserted in the personal computer and data can be used on the module as it is.

Operating procedure

1. Select [Project] ⇒ [Export] ⇒ [Module operating file].
2. Select the export destination drive and click the [Export] button on the "Exporting files for the operation of module" screen.

2.4 Common Setting

Set the initial settings to use a high speed data logger module.

Window

Click "Common setting" on the edit items tree.

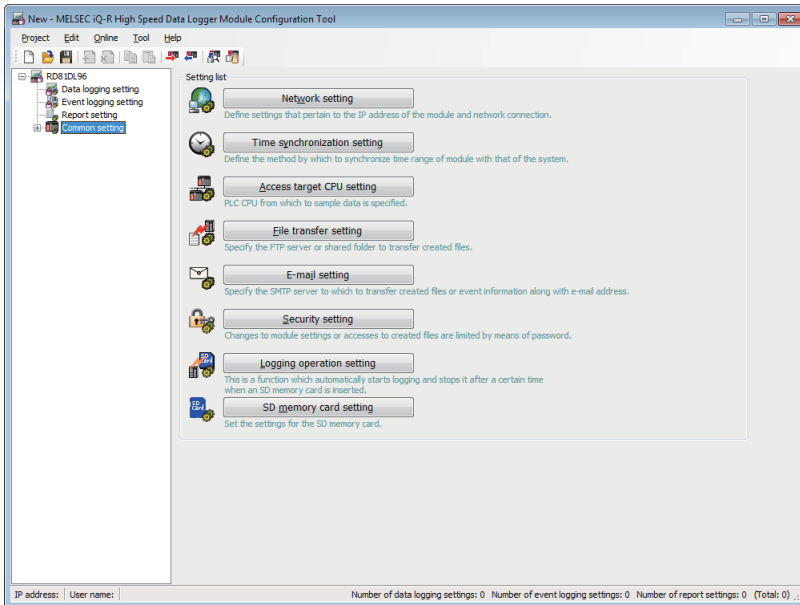

Displayed items

Item	Description	Reference	
Setting list	[Network setting] button	Open the "Network setting" screen.	Page 132 Network setting
	[Time synchronization setting] button	Open the "Time synchronization setting" screen.	Page 133 Time synchronization setting
	[Access target CPU setting] button	Open the "Access target CPU setting" screen.	Page 134 Access target CPU setting
	[File transfer setting] button	Open the "File transfer setting" screen.	Page 137 File transfer setting
	[E-mail setting] button	Open the "E-mail setting" screen.	Page 140 E-mail setting
	[Security setting] button	Open the "Security setting" screen.	Page 142 Security setting
	[Logging operation setting] button	Open the "Logging operation setting" screen.	Page 145 Logging operation setting
	[SD memory card setting] button	Open the "SD memory card setting" screen.	Page 146 SD memory card setting

Network setting

This section explains the settings required for high speed data logger module to establish network connections. When the network settings are changed, settings are enabled by turning the power OFF→ON or by resetting the CPU module.

Window

Click "Common setting" on the edit items tree, then click the [Network setting] button.

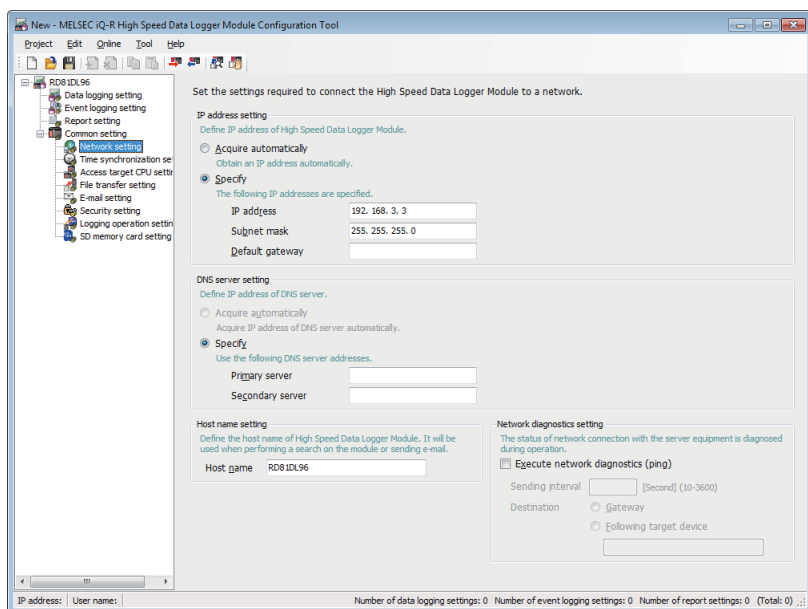

Displayed items

Item			Description
IP address setting ^{*1}	Acquire automatically		Select this to specify the IP address by automatically acquiring it.
	Specify	—	Select this to specify the IP address by directly entering it.
		IP address	Set the IP address of the high speed data logger module in decimal notation.
		Subnet mask	Set the subnet mask in decimal notation when used. All devices on the same network must use the common subnet mask.
		Default gateway	Set the default gateway in decimal notation. Only one address can be registered on the high speed data logger module. ^{*2}
DNS server setting	Acquire automatically		Select this to specify the IP address of the DNS server by automatically acquiring it.
	Specify	—	Select this to specify the IP address of the DNS server by directly entering it.
		Primary server	Set the IP address of the primary DNS server in decimal notation. ^{*3}
		Secondary server	Set the IP address of the secondary DNS server in decimal notation. ^{*4}
Host name setting	Host name		Set the host name for the high speed data logger module. (Up to 32 characters) '\ ' cannot be set. Used when performing a search on the module or sending e-mail.
Network diagnostics setting	Execute network diagnostics (ping)		Select this to perform network diagnostics and send a ping packet (1 packet) regularly. ^{*5}
	Sending interval		Set the Ping packet transmission interval. ^{*6}
	Destination	Gateway	Select this to send a Ping packet to the gateway.
		Following target device	Select this to send a Ping packet to the specified target device. Set the IP address or host name. (Up to 32 characters)

*1 "Acquire automatically" cannot be set in "Common setting" ⇒ "Access target CPU setting" when another station is specified to the type in the access target CPU and "High Speed Data Logger Module Ethernet Port" is set in the "Module type" under "Access source system" in the [Network route] tab.

- *2 Can be omitted if only accessing the same network.
- *3 To obtain an IP address from a domain name, the IP address is searched in order from the DNS server specified as a primary DNS server.
- *4 When obtaining an IP address from a domain name, if it cannot be obtained from the primary DNS server, the IP address is searched from the DNS server specified as a secondary DNS server.
- *5 When there is no response from the destination within 5 seconds, retries once. If there is still no response after that, the module error occurs.
- *6 Set the transmission interval considering the load on the network.

Time synchronization setting

Configure the time to be used in a high speed data logger module.

Obtain the time to be used in a high speed data logger module from a CPU module (CPU No. 1 in a multiple CPU system) then use it.

For details of the time synchronization setting function, refer to the following:

☞ Page 91 Time Synchronization Function

Window

Click "Common setting" on the edit items tree, then click the [Time synchronization setting] button.

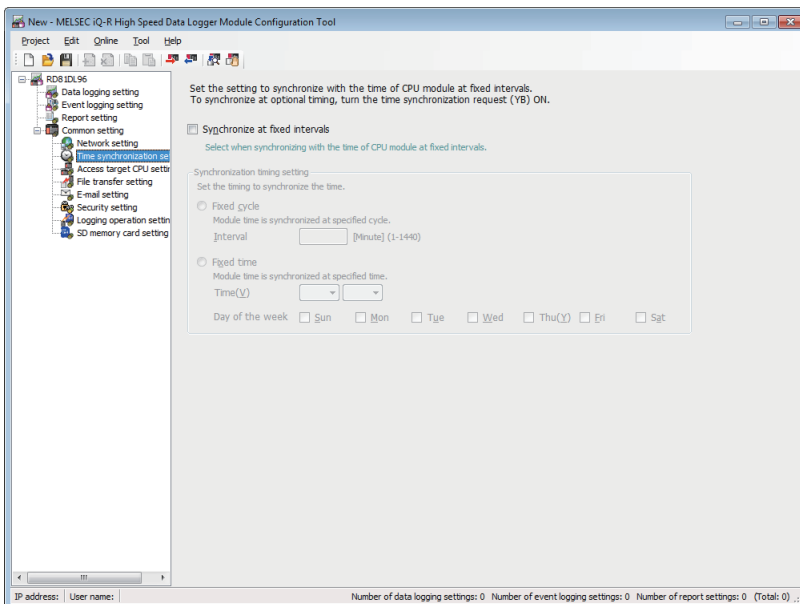

Displayed items

Item	Description		
Synchronize at fixed intervals	Select this to synchronize the time of CPU module at the fixed interval.		
Synchronization timing setting	Fixed cycle	—	Select this to synchronize time at the specified time interval (minutes).
		Interval	Specify the intervals to synchronize the time in minute.
	Fixed time	—	Select this to synchronize time at the specified time.
		Time	Select the time (hour, minutes) to synchronize the time.
	Day of the week	Select the day of the week for time synchronization. If no checkboxes are selected, the time synchronization will be applied everyday.	

Access target CPU setting

Configure the CPU module that accesses a high speed data logger module.

Window

Click "Common setting" on the edit items tree, then click the [Access target CPU setting] button.

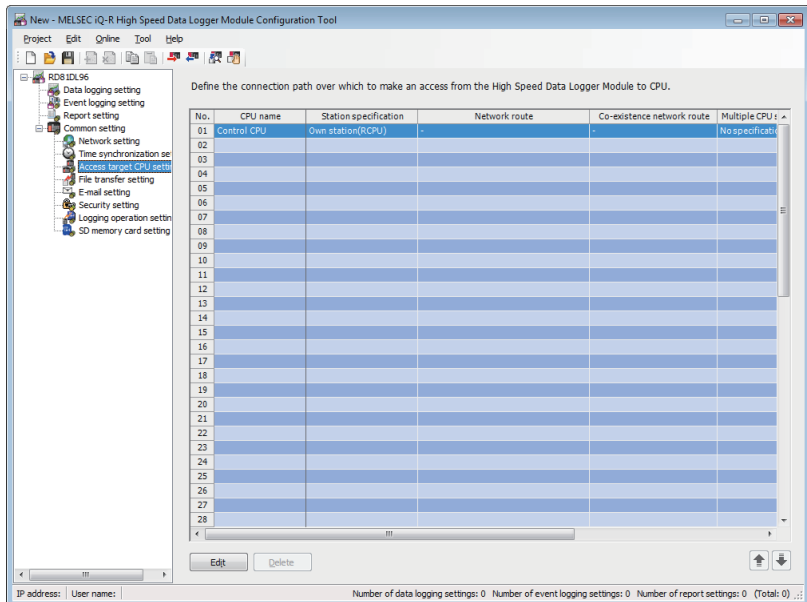

Displayed items

Item	Description
CPU name	Displays the access target CPU name.
Station specification	Displays the station (own/other) specified for access target CPU.
Network route	Displays the accessed network information when another station is specified.
Co-existence network route	Displays the co-existence network information for accessing a co-existence network when another station is specified.
Multiple CPU specification	Displays the CPU number when the access target CPU is a multiple CPU.
Response monitoring time	Displays the response monitoring time when accessing the target CPU.
Import setting	Displays the settings of "Global label/Common device comment import setting" screen.
[Edit] button	Displays the setting screen to edit the selected access target CPU setting. Page 135 Access target CPU setting
[Delete] button	Deletes the selected access target CPU setting.*1

*1 Not valid when "Control CPU" is selected.

Point

The following conditions may affect the general sampling, file transfer function, and e-mail function.

- When the CPU which does not exist in the access target CPU is set.
- When the high speed data logger module cannot communicate with the access target CPU temporary because of the power interruption of access target CPU or network failure.

Use high speed data logger modules with the status that can communicate with the CPU module set as access target CPU.

[Page 317 General sampling delay time area \(Un\G800 to 805\)](#)

Access target CPU setting

Set the connection route from a high speed data logger module to the CPU module to be accessed.

Window

Click the [Edit] button on the access target CPU setting list.

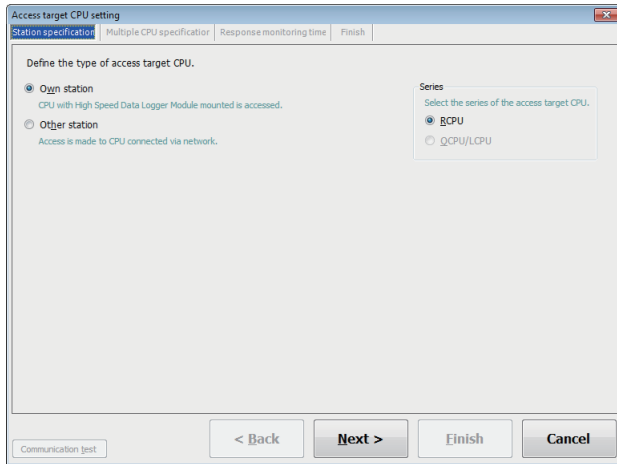

■[Station specification] tab

Item	Description
Own station	Select this to access the CPU module on the system in which high speed data logger modules are installed.
Other station	Select this to access CPU module connected via the network.
Series	Select the series of access target CPU module.*1
[Back] button	Moves back to the previous setting tab.
[Next] button	Moves forward to the next setting tab.
[Finish] button	Reflects the settings.

*1 If an incorrect series is specified, the data may not be sampled correctly.

■[Network route] tab

Item	Description		
Access source system	Module type	Set the module type on the access source system side.	
	Module setting	Head I/O	Set the start I/O number of the module on the access source system side.
		Station No.	Set the station number of the module on the access source system side.
Access target (routed) system	Module type	Display or select the module type on the access target (routed) system side.	
	Module setting	IP address	Set the IP address of the module on the access target (routed) system side.
		Network No.	Set the network number of the module on the access target (routed) system side.
		Station No.	Set the station number of the module on the access target (routed) system side.
Use the co-existence network route	Select this to access a module on a different network via the system configured with the access target (routed) system settings.		

■[Co-existence network route] tab

Item		Description	
Intervening system	Module type	Select the module type on the routed system side.	
	Module setting	Head I/O	Set the start I/O number of the module on the routed system side.
Access target system	Module type	Displays the module type on the access target system side.	
	Module setting	Network No.	Set the network number of the module on the access target system side.
		Station No.	Set the station number of the module on the access target system side.

■[Multiple CPU specification] tab

Item	Description
Multiple CPU specification	Select the CPU number when the access target CPU is a multiple CPU system.

■[Response monitoring time] tab

Item	Description
Timeout time	Set the timeout time from when the high speed data logger module sends a request to the access target CPU until it receives a reply. When there is no response within the set time from the access target CPU, the response timeout error (error code: 1A82H) occurs. *1

*1 If the general sampling delay occurs, the response timeout error occurrence may be extended by a maximum of the general sampling delay time.

For details on the general sampling delay time, refer to the following:

☞ Page 317 General sampling delay time area (Un\G800 to 805)

■[Finish] tab

Item	Description
Access target CPU name	Set the access target CPU name. (Up to 32 characters) If the access target CPU setting name is duplicated, the suffixes ((1), (2), ...) will be added.
[Global label/Common device comment import setting] button	Open the "Global label/Common device comment import setting" screen. ☞ Page 117 "Global label/Common device comment import setting" screen
[Communication test] button	Conducts a connection test to the CPU module with the configured settings.

Point

For the module names that can be used for the module types specified in "Access source system" or "Access target (routed) system," refer to the following:

📖 MELSEC iQ-R Module Configuration Manual

File transfer setting

Set the settings required to access the FTP server and shared folders from a high speed data logger module.

For details of the file transfer function, refer to the following:

☞ Page 95 File Transfer Function

Window

Click "Common setting" on the edit items tree, then click the [File transfer setting] button.

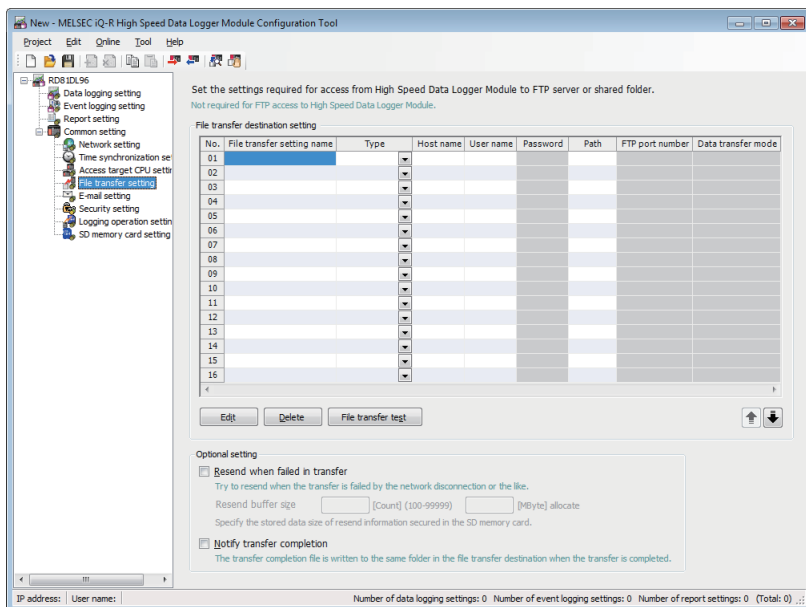

Displayed items

Item	Description	
File transfer setting	File transfer setting name	Displays the file transfer setting name.*1
	Type	Displays the transfer destination of the file (FTP server/shared folder).
	Host name	Displays the host name of the file transfer destination.*1
	User name	Displays the user name logged in/on to the file server.*1
	Password	Displays the login password or logon password for the file server.
	Path	Displays the directory path or folder path of the file transfer destination.*1
	FTP port number	Displays port number used to access the FTP server.*1
	Data transfer mode	Displays the data transfer mode (PORT mode/PASV mode) of the FTP server.
	[Edit] button	Displays the setting screen to edit the selected file transfer setting. ☞ Page 138 File transfer setting
	[Delete] button	Deletes the selected file transfer setting.
Optional setting	[File transfer test] button	Performs a file transfer test to the selected file server.*2*3
	Resend when failed in transfer	Select this to perform the transfer processing again when the file transfer failed.
	Resend buffer size	The files to be resent are saved in the resend buffer in the SD memory card until the resend is completed. Specify the maximum size to be reserved for resend buffer.
	Notify transfer completion	Select this to transfer the file that indicates a file transfer completion to a file server at the file transfer completion.

*1 The cell can be directly edited by selecting and double clicking the cell (or the pressing **F2** key).

*2 The results of the file transfer test are not reflected to the buffer memory and on the "File transfer diagnostics" screen.

*3 If the network setting is changed, reset the CPU module after writing the settings, and then perform the file transfer test.

File transfer setting

Configure the detailed settings to use the file transfer function of a high speed data logger module.

Window

Click the [Edit] button on the file transfer setting list.

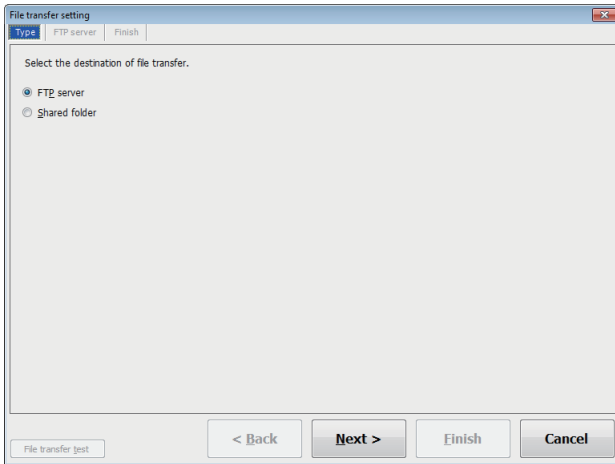

■[Type] tab

Item	Description
FTP server	Select this to transfer the file to FTP server.
Shared folder	Select this to transfer the file to the shared folder.
[Back] button	Moves back to the previous setting tab.
[Next] button	Moves forward to the next setting tab.
[Finish] button	Reflects the settings.

■[FTP server] tab

Item	Description
Host name	Set the host name of the file transfer destination as an IP address or domain name. (Up to 64 characters)* ¹
User name	Set the login user name to the file server. (Up to 32 characters)
Password	Set the login password to the file server. (Up to 16 characters)
Confirm password	Set the login password again for verification. (Up to 16 characters)
Path	Set the file directory path of the file transfer destination. (Up to 64 characters)* ^{2,3}
FTP port number	Set the port number to be used to access the FTP server.
Data transfer mode	Select the data transfer mode of the FTP server.* ⁴

*1 When set with a domain name, the DNS server must be set in "DNS server setting" of the Network settings.

*2 The transfer destination folder is not created. Create the transfer destination folder in advance.

If the transfer destination folder does not exist, an error occurs during file transfer.

*3 Use '/' or '\' as the delimiter between directories.

*4 Normally select the "PORT mode." Select "PASV mode" when communications with the FTP server are only allowed in "PASV mode" by Windows firewall or other firewalls.

■[Shared folder] tab

Item	Description
Host name	Set the host name of the file transfer destination as an IP address or domain name. (Up to 64 characters) ^{*1}
User name	Set the logon user name to the file server. (Up to 20 characters) ^{*2}
Password	Set the logon password to the file server. (Up to 127 characters)
Confirm password	Set the logon password again for verification. (Up to 127 characters)
Path	Set the folder path (up to 256 characters) of the file transfer destination. ^{*3*4*5}

*1 When set with a domain name, the DNS server must be set in "DNS server setting" of the Network settings.

*2 The file cannot be transferred by specifying the user name that is involved in AD (Active Directory) domain. Specify the user name that is not involved in AD domain.

*3 The transfer destination folder is not created. Create the transfer destination folder in advance.
If the transfer destination folder does not exist, an error occurs during file transfer.

*4 Use '/' as the delimiter between directories.

*5 Set the path so that the total length of "Host name" + "\" + "Folder path" + "\" + "Setting type folder name" + "\" + "Subfolder name" + "Logging file name/report file name with extension" is up to 256 characters. (If the folder is other than Windows shared folder, then the length can be up to 300 characters.)

The folder path has number of characters that includes the path (full path) starting from drive name up to shared folder.

■[Finish] tab

Item	Description
File transfer setting name	Set the file transfer setting name. (Up to 32 characters) If the file transfer setting name is duplicated, the suffixes ((1), (2), ...) will be added.
[File transfer test] button	Performs a file transfer test to the set file server. ^{*1*2}

*1 The results of the file transfer test are not reflected to the buffer memory and on the "File transfer diagnostics" screen.

*2 If the network setting is changed, reset the CPU module after writing the settings, and then perform the file transfer test.

E-mail setting

Set the settings required to use the e-mail service.

For details of the e-mail function, refer to the following:

☞ Page 98 E-mail Function

Window

Click "Common setting" on the edit items tree, then click the [E-mail setting] button.

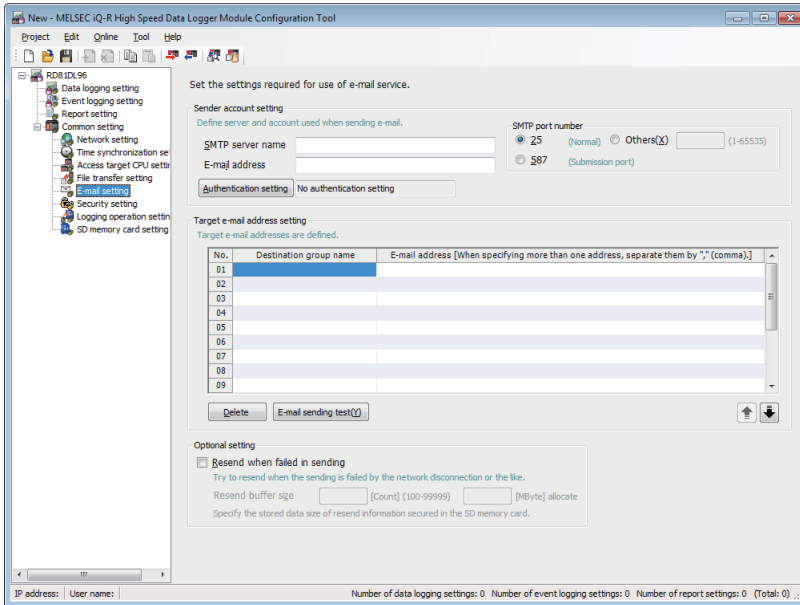

Displayed items

Item	Description	
Sender account setting	SMTP server name	Set the SMTP server name with an IP address or a domain name. (Up to 64 characters)
	E-mail address	Set the e-mail address for the high speed data logger module. (Up to 64 characters)
	SMTP port number	Specify the port number when accessing the SMTP server.
	[Authentication setting] button	Displays the "Authentication setting" screen. ☞ Page 141 Authentication setting
Target e-mail address setting	Destination group name	Set the group name for managing destinations as a group. (Up to 32 characters) ^{*1}
	E-mail address	Set the destination e-mail addresses. (Up to 128 characters) ^{*1} When specifying multiple destinations, separate them with a comma (,).
	[Delete] button	Deletes the selected destination e-mail address setting.
	[E-mail sending test] button	Performs an e-mail transmission test to the selected destination group. ^{**3}
Optional setting	Resend when failed in sending	Select this to perform resend processing when an e-mail send failed.
	Resend buffer size	The files to be resent are saved in the resend buffer in the SD memory card until the resend is completed. Specify the maximum size to be reserved for resend buffer.

*1 The cell can be directly edited by selecting and double clicking the cell (or the pressing **[F2]** key).

*2 The results of the e-mail transmission test are not reflected in the buffer memory and on the "E-mail transmission diagnostics" screen.

*3 If the network setting is changed, reset the CPU module after writing the settings, and then perform the e-mail transmission test.

- Calculating resend buffer size
Calculate the resend buffer size using the following equation.
Usage area [MB] = (14 [KB] × Number of files) / 1024
- Setting resend buffer size
Depending on the size of free space in the SD memory card, the specified size for resend buffer may not be reserved in the SD memory card.
- Based on the specified maximum size for resend buffer, spaces in the SD memory card are occupied according to the number of buffered data.
- The SMTP server name needs to be set with an IP address when using the resend function.

Authentication setting

Set authentication settings to send an e-mail.

Window

Click the [Authentication setting] button on the "E-mail setting" screen.

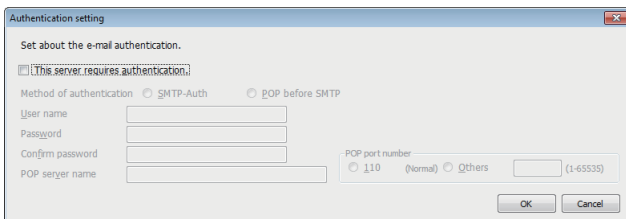

Displayed items

Item	Description
This server requires authentication.	Select this to authenticate when sending an e-mail.
Method of authentication	Select the authentication method when sending e-mail.*1
User name	Set the mail server user name used for authentication when sending e-mail. (Up to 32 characters)
Password	Set the mail server password used for authentication when sending e-mail. (Up to 16 characters)
Confirm password	Enter the password again for verification.
POP server name	Set the POP server name. (Up to 64 characters)*2
POP port number	Specify the port number when accessing the POP server.*2
[OK] button	Reflects the settings and closes the screen.

*1 Set the authentication method according to the mail server.

*2 Required when the authentication method is set to "POP before SMTP."

Security setting

Set the account for the authentication used to access high speed data logger module, and IP address of an external device that can access the high speed data logger module via Ethernet.

For details of the security function, refer to the following:

☞ Page 85 Security Function

When the IP filter function settings are changed, the settings are enabled by turning the power OFF→ON or by resetting the CPU module.

Window

Click "Common setting" on the edit items tree, then click the [Security setting] button.

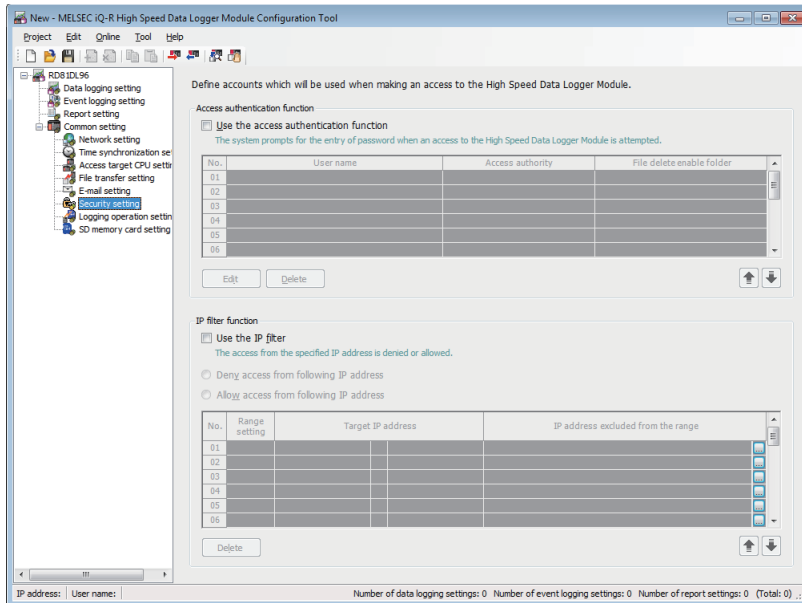

Displayed items

Item		Description
Access authentication function	Use the access authentication function	Select this to authenticate users accessing the high speed data logger module and restrict the access.*1
	User name	Displays the user name.*2
	Access authority	Displays any of administrator, maintenance user, or normal user.
	File delete enable folder	Displays folders where file deletion is permitted.
	[Edit] button	Displays the setting screen to edit the selected account setting. ☞ Page 143 Account setting
	[Delete] button	Deletes the selected account setting.
IP filter function	Use the IP filter	Select this to use the IP filter function.
	Deny access from following IP address	Select this to block the target IP address.
	Allow access from following IP address	Select this to allow the target IP address.
	Range setting	Select this to specify the IP address range for the IP filter function.
	Target IP address	Specify the target IP address for the IP filter function.
	IP address excluded from the range	Displays the exceptional IP address when the range is specified. Click [...] to set an IP address on the "IP address to be deleted from the range" screen. ☞ Page 144 IP address excluded from the range
	[Delete] button	Deletes the selected IP filter setting.

*1 When using the access authentication function, configure one or more users with administrator's access authority.

*2 User name for an account should be unique.

Account setting

Set detailed settings for the account for authentication to be used when accessing a high speed data logger module.

Window

Click the [Edit] button on the "Security setting" screen.

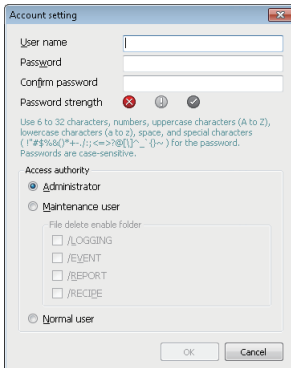

Displayed items

Item	Description	
User name	Set the user name. (1 to 20 characters)	
Password	Set the password. (6 to 32 characters)	
Confirm password	Enter the password again for verification.	
Password strength	Display the password strength with an icon. The [OK] button cannot be clicked in the status.	
Access authority	—	Select the access authority for the account.*1
	File delete enable folder	Select the folders where files can be deleted.*2
[OK] button	Reflects the settings and closes the screen.	

*1 For the available operations for each access authority, refer to the following:

Page 86 Access authentication function

*2 This item can be selected when "Maintenance user" is selected for access authority.

■ Password strength

The password strength is displayed with an icon according to the character type and number of characters used in the entered password.

Entered password	Password strength	Display Icon
The entered password is too short (within 0 to 5 characters).	Setting error	
6 or more characters and 2 or less types of characters are used.	Weak	
The password contains at least 8 characters of at least 3 types.	Strong	

IP address excluded from the range

Set the IP addresses to be excluded from the specified range when specifying the range in the IP filter function.

Window

Click the [...] button on the "Security setting" screen.

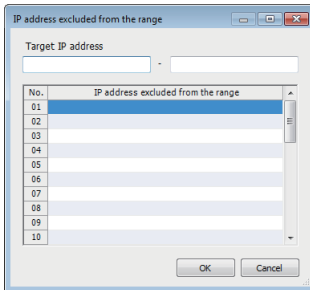

Displayed items

Item	Description
Target IP address	Displays the specified range of IP addresses. Can be edited directly.
IP address excluded from the range	Set the IP addresses to be excluded from the target IP address range. ^{*1*2}
[OK] button	Reflects the settings and closes the screen.

*1 The cell can be directly edited by selecting and double clicking the cell (or the pressing **F2** key).

*2 The address is top-aligned after clicking the [OK] button.

Logging operation setting

Set the settings related to the logging operation of high speed data logger modules.

Window

Click "Common setting" on the edit items tree, then click the [Logging operation setting] button.

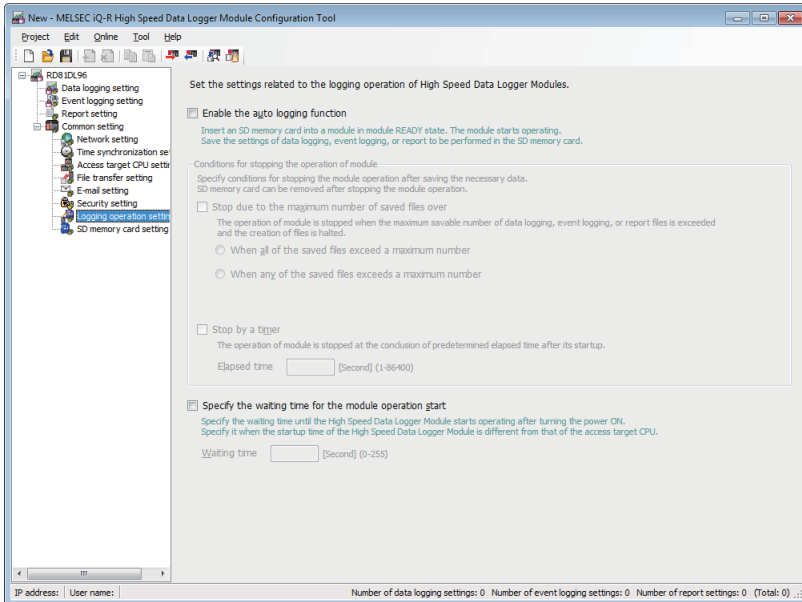

Displayed items

Item	Description	
Enable the auto logging function	Select this to use the auto logging function.	
Conditions for stopping the operation of module	Stop due to the maximum number of saved files over	Select the stop condition to stop the module operation when the maximum number of data logging, event logging, or report saved files is exceeded.
	[Change all settings to stop] button	Changes the "Operation occurring when number of saved files is exceeded" to "Stop" in all the data logging settings, event logging settings, and report settings.
	Stop by a timer	Select this to stop module operation when the set time elapses after module operation starts. Specify the amount of time until the module stops.
Specify the waiting time for the module operation start	Select this when waiting a certain period of time until the module operation starts after powering ON. Specify the waiting time that was required until the operation starts.	

Point

- By exporting setting in which auto logging function is enabled, to the SD memory card, logging can be started without updating settings when the SD memory card is replaced.
- CARD RDY LED turns OFF when the module operation stops and the SD memory card is ready to be removed.
- When "Stop effected by a timer" is specified, specify the elapsed time more than five seconds longer than the period of logging time. When module operation stops, unprocessed data are not logged. (Page 320 Number of saved files exceeded information (Un\G2016 to 2019))
- When starting high speed data logger module (powering ON or resetting a CPU module) without inserting an SD memory card to use the auto logging function, pay attention to the following:
Do not connect high speed data logger module to LAN.
Do not set to transfer files and send e-mails in the data logging setting, event logging setting, and report setting.
High speed data logger module operates with the default IP address (192.168.3.3).
- When connecting Configuration Tool with the auto logging function, follow the descriptions in 'System configuration when performing initial setup, maintenance, and inspection'.
(MELSEC iQ-R High Speed Data Logger Module User's Manual (Startup))

SD memory card setting

Delete saved files by specifying an arbitrary capacity to ensure the free space in the SD memory card.

Configure the settings to prevent a logging stop due to the capacity shortage in the SD memory card.

For details of the free space adjustment function, refer to the following:

☞ Page 102 Free Space Adjustment Function

Window

Click "Common setting" on the edit items tree, then click the [SD memory card setting] button.

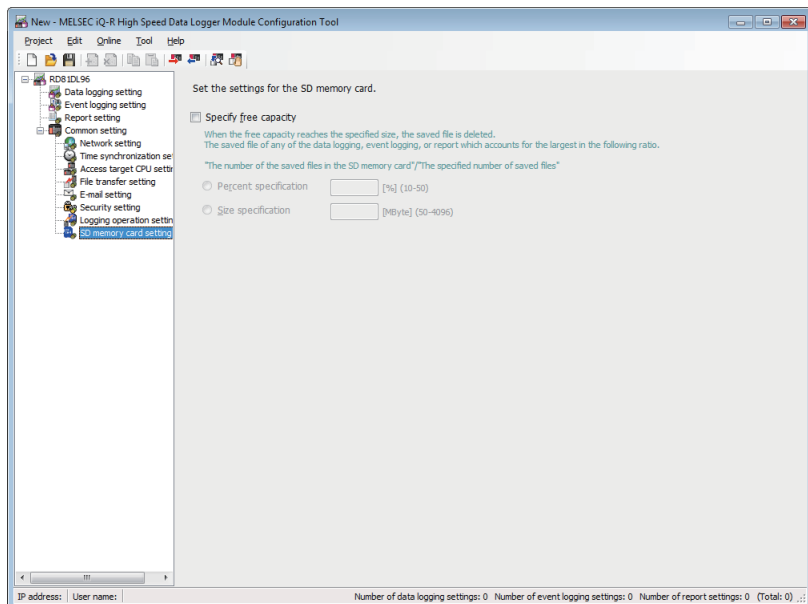

Displayed items

Item		Description
Specify free capacity	—	Select this to delete saved files in the SD memory card automatically.
	Percent specification	Set the free capacity of the SD memory card in a percentage from which the files are to be deleted.
	Size specification	Set the free capacity of the SD memory card in a size from which the files are to be deleted.

2.5 Data Logging Setting

This section explains the settings for the data logging function.
For details of the data logging function, refer to the following:

☞ Page 24 Data Logging Function

Window

Click "Data logging setting" on the edit items tree.

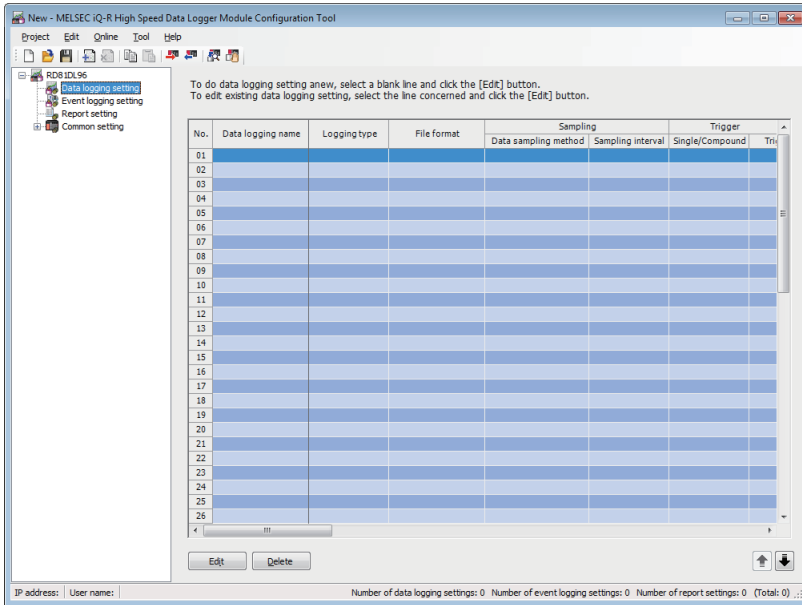

Displayed items

Item		Description
Data logging name		Displays the data logging name.
Logging type		Displays the data logging type.
File format		Displays the file format of the data logging file.
Sampling	Data sampling method	Displays the data sampling method for data logging.
	Sampling interval	Displays the sampling interval of the target data.
Trigger	Single/Compound	Displays "Single" or "Compound" conditions.
	Trigger type	Displays the trigger type.
Number of logging lines	Before trigger	Displays the number of output lines before the trigger.
	After trigger	Displays the number of output lines after the trigger.
	Total number of lines	Displays the total number of lines to output at the time of trigger logging.
Unicode text output	Date	Displays if the date/time (time stamp) is output.
	Trigger information	Displays if trigger information is output.
Binary output	Date	Displays if the date/time (time stamp) is output.
	Trigger information	Displays if trigger information is output.
CSV output	Date	Displays if the date/time (time stamp) is output.
	Trigger information	Displays if trigger information is output.
Folder	Setting type folder name	Displays the destination of saved files for each setting.
	Folder switching timing	Displays the switching timing for the subfolder.
	Saved folder name	Displays the information to be added to a subfolder name.
File	Accumulating file name	Displays how to specify the file names being accumulated.
	Saved destination for the accumulating file	Displays where the files being accumulated are stored.
	File switching timing	Displays the switching timing for the saved file.
	Saved file name	Displays the information to be added to a logging file name.
	Number of saved files	Displays the number of saved files and the operation when the number of saved files is exceeded.
Transfer	File transfer	Displays if there is a file transfer.
	E-mail sending	Displays if there is an e-mail transmission.
[Edit] button		Displays the setting screen to edit the selected data logging setting.  Page 149 Data logging setting
[Delete] button		Deletes the selected data logging setting.

Data logging setting

Configure the settings of the data logging function in a wizard format.

Window

Click the [Edit] button on the data logging setting list.

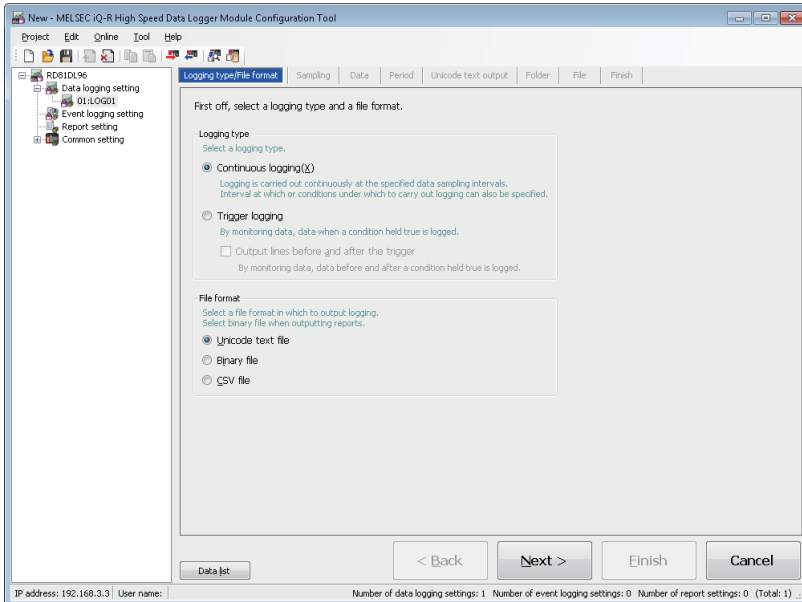

Displayed items

Item	Description	Reference
[Logging type/File format] tab	Set the data logging settings type and the file format for the logging data.	Page 150 Logging type/file format
[Sampling] tab	Select a data sampling method for the logging target data, then set the sampling interval.	Page 151 Sampling
[Data] tab	Set the data to be logged.	Page 152 Data
[Period] tab	Set a period for continuous data logging.	Page 156 Period
[Trigger] tab	Set a trigger condition at the time of trigger logging.	Page 158 Trigger
[Number of logging lines] tab	Set the number of lines to be output at the time of trigger logging.	Page 161 Number of logging lines
[Unicode text output] tab	Set contents to output to Unicode text files.	Page 162 Unicode text output
[Binary output] tab	Set contents to output to binary files.	Page 164 Binary output
[CSV output] tab	Set contents to output to CSV files.	Page 165 CSV output
[Folder] tab	Set the save destination of the saved file and switching timing of the saved folder.	Page 168 Folder
[File] tab	Set the save destination of the data logging file, and switching timing of the saved file.	Page 171 File
[Finish] tab	Set a data logging name.	Page 176 Finish
[Data list] button	Displays a list of data used in all the data logging settings.	Page 110 Data list
[Back] button	Moves back to the previous setting tab.	—
[Next] button	Moves forward to the next setting tab.	—
[Finish] button	Reflects the settings and closes the screen.	—

Logging type/file format

Set the data logging settings type and the file format for the logging data.

Window

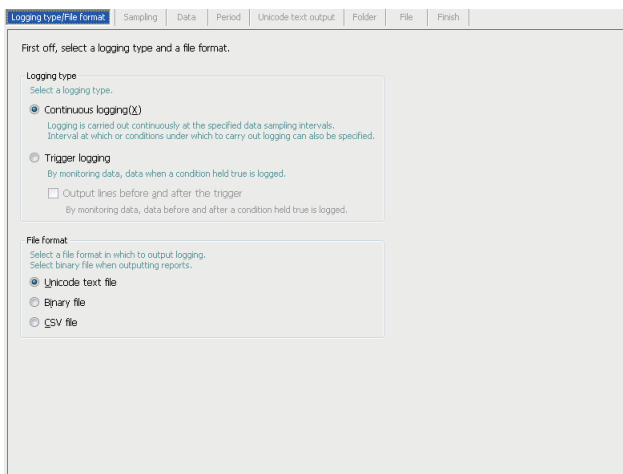

Displayed items

Item		Description
Logging type	Continuous logging	Select this to log data all the time with the specified interval.
	Trigger logging	Select this to log data at the time when the condition is satisfied during monitoring.
	Output lines before and after the trigger	Select this to log data at the time when the condition is satisfied during monitoring.
File format	Unicode text file	Select this to save data in the Unicode text file format.
	Binary file	Select this to save data in the binary file format.
	CSV file	Select this to save data in the CSV file format.

Sampling

Select a data sampling method for the logging target data, then set the sampling interval.

Window

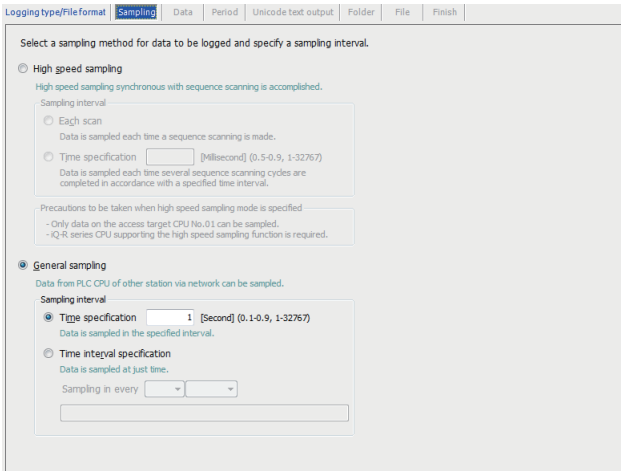

Displayed items

Item		Description	
High speed sampling	—	Select this to perform high-speed data logging that is synchronized with a sequence scan.	
	Sampling interval	Each scan	Select this to sample data in each sequence scan.
		Time specification	Select this to sample data with the specified interval. Specify a sampling interval.
General sampling	—	Select this to perform data logging that is not synchronized with a sequence scan.	
	Sampling interval	Time specification	Select this to sample data with the specified interval. Specify a sampling interval.
		Time interval specification	Select this to sample data with the specified time interval (hour, minute, or second) from exactly midnight everyday, exact hour, or exact minute. Specify the sampling interval and time unit.

Data

Set the data to be logged.

Window

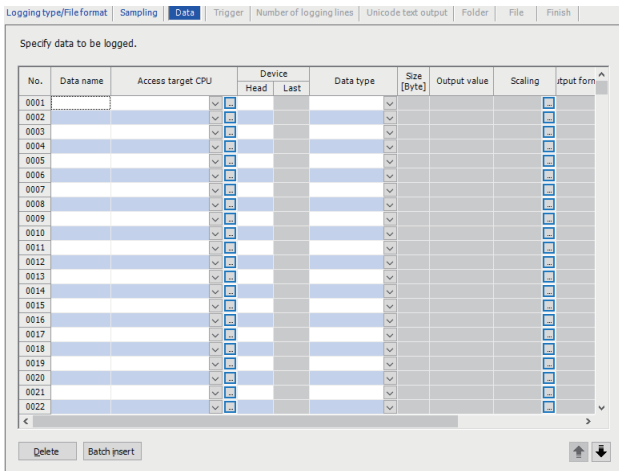

Displayed items

Item	Description	
Data name	Set the data name. (Up to 32 characters. Can be blank) For related data, an icon (🌐) is displayed.	
Access target CPU ^{*1}	Select the access target CPU. To add an access target CPU, select "(Add CPU)" and click the [...] button. 📖 Page 135 Access target CPU setting	
Device	Head ^{*1}	Set the start device.
	Last	Displays the end device calculated from the data type and size.
Data type ^{*1*2*3}	Select the data type.	
Size ^{*1*4*5}	If the data type is "String" or "Raw", the size must be specified. (1 to 8192 bytes)	
Output value ^{*6}	Select the value to be output in the file when "Output lines before and after the trigger" is not selected.	
Scaling	Set the scale conversion equation for data. ^{*7} The "Scaling" screen is displayed by clicking the [...] button. 📖 Page 153 Scaling	
Output format	Specify the format (such as decimal format and exponential format) when the data is output to a file. The "Output format" screen is displayed by clicking the [...] button. 📖 Page 153 Output format	
Count condition ^{*8}	Specify the condition to count output values. 📖 Page 153 Count condition	
[Delete] button	Delete the settings of the selected line data.	
[Batch insert] button	Set the data of consecutive devices in a batch. 📖 Page 154 Batch data insertion	

*1 These items cannot be edited for related data.

*2 Match to the data type with the one used for writing device values using a sequence program or HMI.

*3 String is output in the following character codes depending on the file format to be output.

Unicode text files, binary files: UTF-16 (little endian)

CSV files: ASCII

*4 If the file type is a Unicode text file or a binary file, its size should be an even number.

*5 When using the string type data, specify the size considering the character code. (📖 Page 25 String type data)

*6 If the data type is "Raw", option other than "Value" can not be selected.

*7 The cell can be directly edited by selecting and double clicking the cell (or the pressing **F2** key).

*8 Cannot be specified, when output value is "Value."



Scaling

Set sampled device values to execute linear function transformation.

Operating procedure

1. Click the [...] button for "Scaling" in the [Data] tab on the "Data logging setting" screen.
2. Set "Operand 1", "Value 1", "Operand 2", and "Value 2" on the "Scaling" screen and click the [OK] button.

Point

- When the data which is specified for scaling is used in other settings, the value after performing the scaling conversion is applied to the data.
- For operation processing specified in the scaling, all values are calculated as double precision floating point numbers.
The result is output with the specified output format.
- When the calculation result is over the maximum value or under the minimum value for the specified output format range, the data to be output differs.
(Unicode text file, CSV file:  Page 365 Data line)
(Binary file:  Page 367 Binary file)

Output format

Specify the format (such as decimal format and exponential format) when the data is output to a file.

Operating procedure

1. Click the [...] button for "Output format" in the [Data] tab on the "Data logging setting" screen.
2. Specify the output format on the "Output format" screen and click the [OK] button.

Precautions

- When outputting data to a folder name or a file name
If Word [Signed], Double Word [Signed] is specified to the data type, the negative values may get output to the file name or the folder name depending on the device value of the CPU module.
If a negative value is output, "-" will be added to the number of digits of zero padding even when the number of total digits is specified in "zero-padding."
When fixing the file or folder name length, specify Word [Unsigned]/Bit String [16-bit], Double Word [Unsigned]/Bit String [32-bit] and not Word [Signed] or Double Word [Signed] for the data type, and specify the number of digits of zero padding.

Count condition

Specify the condition to count output values.

Operating procedure

1. Click the [...] button for "Count condition" in the [Data] tab on the "Data logging setting" screen.
2. Specify the "Count condition" and "Count value" on the "Count condition" screen and click the [OK] button.

Point

String type data/string constants are compared by the following character code.
Unicode text files, binary files: UTF-16 (little endian)
CSV files: ASCII

Batch data insertion

Set the data of consecutive devices in a batch.

Window

Click the [Batch insert] button on the [Data] tab of data logging setting screen.

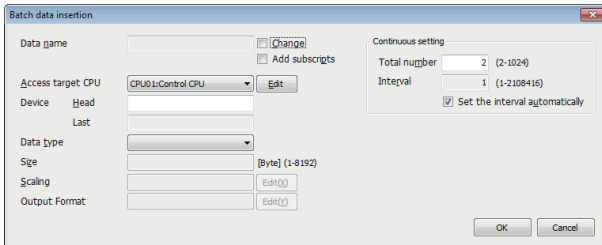

Displayed items

Item		Description
Data name	—	Displays the data name, or used to change the data name.
	Change	Select this to change the data name. When it is not selected, the data name is automatically set to the start device.
	Add subscripts	Select this to add a consecutive numbers to the data names set by the user.
Access target CPU		Select the access target CPU. To add an access target CPU, select "(Add CPU)" and click the [Edit] button. Page 134 Access target CPU setting
Device	Head	Set the start device.
	Last	Displays the end device calculated from the data type and size.
Data type		Select the data type.
Size		If the data type is "String" or "Raw", the size must be specified.
Scaling		Set the scale conversion equation for data. The "Scaling" screen is displayed by clicking the [Edit] button. Page 153 Scaling
Output format		Specify the format (such as decimal format and exponential format) when the data is output to a file. The "Output format" screen is displayed by clicking the [Edit] button. Page 153 Output format
Continuous setting	Total number	Specify the total amount of data to batch insert.
	Interval	Specify the device interval for the data to batch insert.
	Set the interval automatically	Select this to set the interval automatically in order to avoid gaps between the devices to be batch inserted.

■Data names and subscripts in the continuous setting

The following shows how the data name is set by the "Change" and "Add subscripts" checkboxes.

Ex.

Data name = DATA

Start device = D0

Continuous setting total number = 3

Continuous setting interval = 1

For the above settings, devices are set as shown below.

Item	Example 1	Example 2	Example 3
Change	Unselected	Selected	Selected
Add subscripts	Unselected	Unselected	Selected
Data name	D0	DATA	DATA(1)
	D1	DATA	DATA(2)
	D2	DATA	DATA(3)

■Total number and interval in the continuous setting

Configure when setting devices by leaving a fixed interval.

Ex.

Data name = DATA (Add subscripts)

Start device = D0

Continuous setting total number = 3

Continuous setting interval = 10

For the above settings, devices are set as shown below.

No.	Data name	Access target CPU	Device	
			Head	Last
0001	DATA(1)	CPU01:Control CPU	D0	D0
0002	DATA(2)	CPU01:Control CPU	D10	D10
0003	DATA(3)	CPU01:Control CPU	D20	D20

Period

Set a period for continuous data logging.
 In the case of trigger logging, the trigger monitoring period is set.

Window

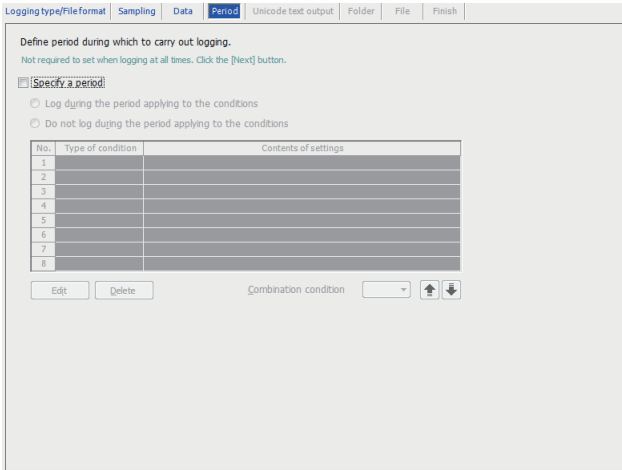

Displayed items

Item	Description
Specify a period	Select this to specify a period for logging.
Log during the period applying to the conditions	Select this to execute continuous logging and monitors trigger logging triggers during the period corresponding to the conditions displayed in the list.
Do not log during the period applying to the conditions	Select this to not execute continuous logging or monitor trigger logging triggers during the period corresponding to the conditions displayed in the list.
Type of condition	Displays the condition type. ^{*1}
Contents of settings	Displays the overview of the condition. ^{*1}
[Edit] button	Displays the setting screen to edit the selected period setting.  Page 157 Period setting
[Delete] button	Deletes the selected period setting.
Combination condition	Select how to combine the rows of conditions.

*1 The address is top-aligned after completing the logging setting.

Period setting

Set a logging period.

Window

Click the [Edit] button on the [Period] tab of data logging setting screen.

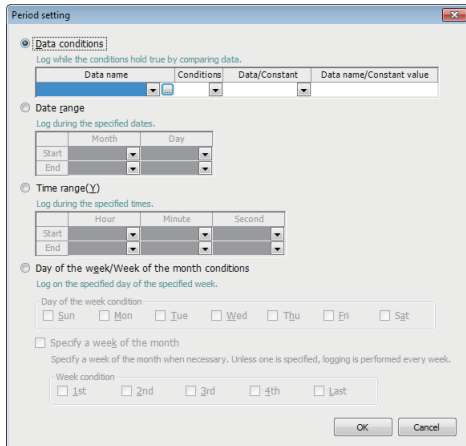

Displayed items

Item		Description
Data conditions ^{*1*2}	—	Select this to compare and log data during the period when a condition is satisfied.
	Data name	Select the target data. To add data, select "(Add)" and click the [...] button. Page 113 Data setting
	Conditions ^{*3}	Select a comparison operator.
	Data/Constant	Select the type of data to compare to the target data.
	Data name/Constant value	Set data or constant data (up to 16 characters) to be compared to the target data. To add data, select "(Add)" and click the [...] button. Page 113 Data setting
Date range ^{*4}	—	Select this to log data during the specified date period.
	Start	Specify the day and month to start logging.
	End	Specify the day and month to exit logging.
Time range	—	Select this to log data during the specified time period.
	Start	Specify the hour, minute, and second to start logging.
	End	Specify the hour, minute and second to exit logging.
Day of the week/Week of the month conditions	—	Select this to log data on the specified day of the week and week. The period can be specified by combining the day of the week and week.
	Day of the week condition	Select the day of the week to log data.
	Specify a week of the month	Select this to log data in combination with the week and day of the week.
	Week condition	Select the week to log data. 1st: From the 1st to the 7th day 2nd: From the 8th to the 14th day 3rd: From the 15th to the 21st day 4th: From the 22nd to the 28th day Last: The 7 days at the end of the month for the corresponding month

*1 Only the data to which "Value" is set for the "Output value" can be used for the data conditions.

*2 String type data/string constants are compared by the following character code.

Unicode text files, binary files: UTF-16 (little endian)

CSV files: ASCII

*3 When data of different data types are compared, the condition may not be satisfied because of the difference in internal representations.

For numerical type comparison accuracy, refer to the following:

[Page 345 Numerical Type Comparison Accuracy](#)

*4 February 29 cannot be directly set. To specify February 29, select 'last day of February.'

Trigger

Set a trigger condition at the time of trigger logging.

There are two types of trigger conditions depending on the number of conditions combined.

- Single condition (when the number of conditions is 1)
- Compound condition (if multiple conditions are combined)

Trigger (single condition)

Window

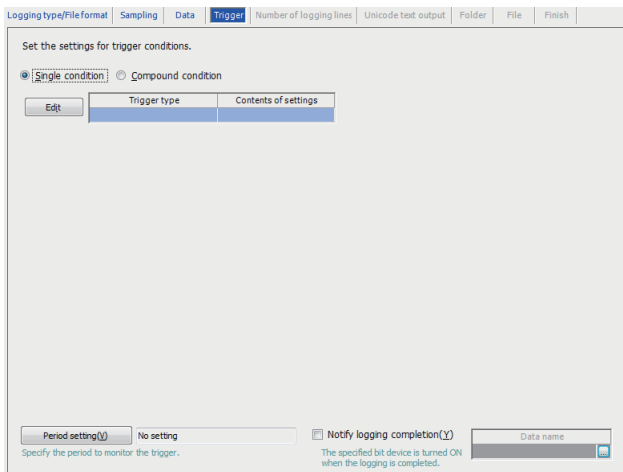

Displayed items

Item	Description
[Edit] button	Displays the "Trigger condition setting" screen. Page 159 Trigger condition setting
Trigger type	Displays the specified type of trigger condition.
Contents of settings	Displays the overview of the trigger condition.
[Period setting] button	Specify the trigger monitoring period. Page 156 Period
Notify the logging completion	Select this to turn ON the specified bit device after the trigger occurs and logging is completed. If the data sampling method is "General sampling" then it can be set.
Data name	Select the data to be turned ON when the logging is completed. To add data, select "(Add)" and click the [...] button. Page 113 Data setting

Trigger condition setting

Window

Click the [Edit] button on the [Trigger] tab of data logging setting screen.

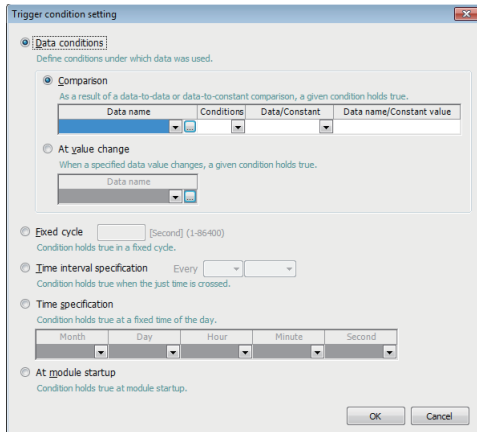

2

Displayed items

Item	Description
Data conditions ^{*1,2}	— Select this to set the conditions under which data was used.
Comparison ^{*3,4}	— Select this to compare data and make a trigger occur at the satisfaction of the condition.
	Data name Select the target data. To add data, select "(Add)" and click the [...] button. Page 113 Data setting
	Condition Select a comparison operator.
	Data/Constant Select the type of data to compare to the target data.
	Data name/ Constant value Set data or constant data (up to 16 characters) to be compared to the target data. To add data, select "(Add)" and click the [...] button. Page 113 Data setting
	At value change
	Data name Select the data to monitor for the value change. To add data, select "(Add)" and click the [...] button. Page 113 Data setting
Fixed cycle	Select this to make a trigger occur with the specified cycle. Specify the cycle.
Time interval specification	Select this to make a trigger occur with the specified time unit (hour, minute, or second). Specify the interval and time unit.
Time specification ^{*5}	Select this to make a trigger occur with the specified time. Specify the time.
At module startup	Select this to make a trigger occur when powering OFF to ON, or after resetting a CPU module.

*1 Only the data to which "Value" is set for the "Output value" can be used for the data conditions.

*2 String type data/string constants are compared by the following character code.

Unicode text files, binary files: UTF-16 (little endian)

CSV files: ASCII

*3 When data of different data types are compared, the condition may not be satisfied because of the difference in internal representations.

For numerical type comparison accuracy, refer to the following:

[Page 345 Numerical Type Comparison Accuracy](#)

*4 Whether the trigger condition holds true is judged on the rise that the condition holds true. ([Page 41 Data conditions \(comparison\)](#))

*5 February 29 cannot be directly set. To specify February 29, select 'last day of February.'

Trigger (compound condition)

Window

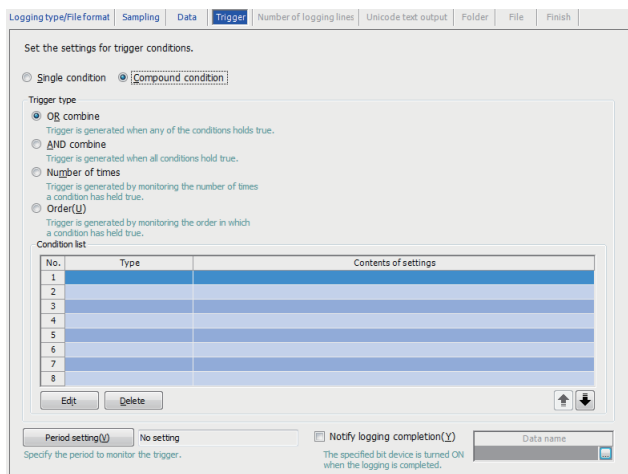

Displayed items

Item	Description	
Trigger type	OR combine	Select this to make a trigger occur when one of the specified conditions is satisfied.
	AND combine	Select this to make a trigger occur when all the specified conditions are satisfied.
	Number of times	Select this to monitor the number of times of the condition satisfaction, and make a trigger occur.
	Order	Select this to make an trigger occur by monitoring the order of the condition satisfaction.
Conditions for occurrence*1	When a terminal condition holds true	Select this to check the number of counts when the termination condition is satisfied, and make a trigger occur when the specified condition is satisfied.
	When a specified number of times is exceeded	Select this to make a trigger occur immediately when the number of counts exceeds the specified count.
	Conditions for the occurrence of a trigger	Specify the conditions (comparison operator and number of times) to compare the number of times the count condition is satisfied (number of counts).
Selecting conditions for occurrence*2	Abnormal pattern is detected	Select this to make a trigger occur if the condition is satisfied with a order different from the specified one.
	Normal pattern is detected	Select this to make a trigger occur if the condition is satisfied with the specified order.
	Detect timeout	Select this to make a trigger occur when any of the conditions are not satisfied within the monitoring timeout.
Condition list	Type	Displays the condition type.
	Contents of settings	Displays the overview of the condition.
	Start condition*1	Displays the condition to start counting for the number of counts.
	Terminal condition*1	Displays the condition to stop counting for the number of counts.
	Count condition*1	Displays the condition to increment the number of counts.
	Start condition*2	Displays the condition to start monitoring the order that the condition is satisfied.
	1st/2nd/3rd condition*2	Displays the conditions to monitor in order.
	Monitoring timeout [Second]*2	Displays the timeout time when monitoring the conditions in each order.
	[Edit] button	Displays the setting screen to edit the selected condition. The settings are same as mentioned in the following section.*3*4 ☞ Page 159 Trigger condition setting
[Delete] button	Deletes the selected condition.	
[Period setting] button	Specify the trigger monitoring period. ☞ Page 156 Period	
Notify the logging completion	Select this to turn ON the specified bit device after a trigger occurred and a logging is completed.	
Data name	Select the data to be turned ON when the logging is completed. To add data, select "(Add)" and click the [...] button. ☞ Page 113 Data setting	

*1 Displayed in the case of "Number of times."

*2 Displayed in the case of "Order."

*3 When selecting "Number of times" or "Order," the conditions which can be set are "Comparison" and "Value change."

*4 When selecting "Order," the monitoring timeout can be specified.

Number of logging lines

Set the number of lines to be output at the time of trigger logging.

This is enabled when "Output lines before and after the trigger" is selected in the [Logging type/File format] tab.

Window

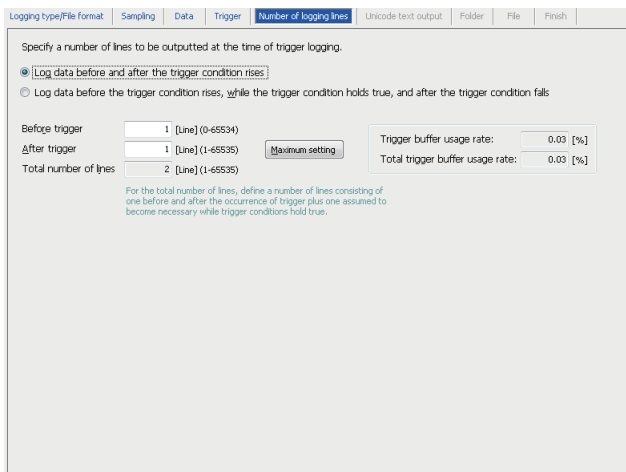

Displayed items

Item	Description
Log data before and after the trigger condition rises	Select this to log data before and after the rise of the trigger condition.
Log data before the trigger condition rises, while the trigger condition holds true, and after the trigger condition falls	Select this to log data before the rise of the trigger condition, while the trigger condition is satisfied, and after the fall of the trigger condition.
Before trigger	Set the number of lines to log data before the rise of the trigger condition.
After trigger	<ul style="list-style-type: none"> When "Log data before and after the rising of trigger condition" is selected: Specify the number of lines to log data after the rise of the trigger condition. When "Log data before the trigger condition rises, while the trigger condition holds true, and after the trigger condition falls" is selected: Specify the number of lines to log data after the fall of the trigger condition.
Total number of lines	Specify the number of lines including the lines before and after the trigger and the lines assumed necessary while the trigger condition is satisfied.
[Maximum setting] button	Set the maximum number of lines which can be set for before trigger and after trigger.
Trigger buffer usage rate	Displays the trigger buffer utilization being used with the data logging setting being edited as a percentage of the total amount.
Total trigger buffer usage rate	Displays the necessary amount of trigger buffer for all data logging settings (including the one being edited) as a percentage of the total amount.

Unicode text output

Set contents to output to Unicode text files.

This is enabled when "Unicode text file" is selected in the [Logging type/File format] tab.

Window

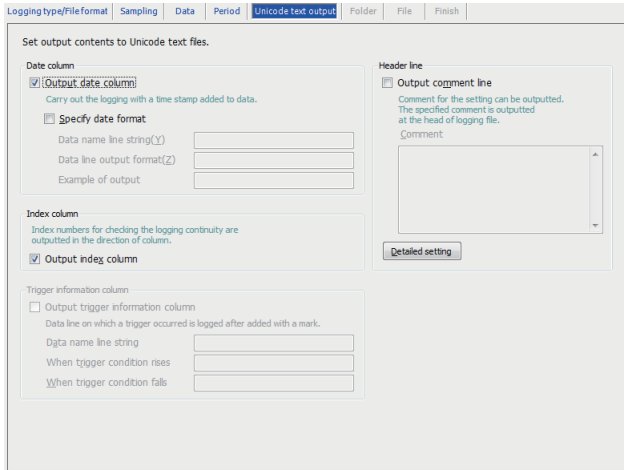

Displayed items

Item			Description
Date column	Output date column		Select this to output the date column to a file.
	Specify date format	—	Select this to specify the format of the date column.
		Data name line string ^{*1}	Specify the title of the date name line of the date column. (Up to 32 characters)
		Data line output format ^{*1*2}	Specify the output format of the data line for the date column. (Up to 32 characters) YYYY: Year (4 digits) YY : Year (2 digits) MM : Month (2 digits) DD : Day (2 digits) hh : Hour (2 digits) mm : Minute (2 digits) ss : Second (2 digits) ms : Millisecond (3 digits) ^{*3} us : Microsecond (6 digits) ^{*3} .ss... : Digits after the decimal point in seconds (1 to 4 digits)
		Example of output	Displays an image of the date column output with the current settings.
Index column	Output index column		Select this to output the index number to a file. The continuity of logging can be checked by the index.
Trigger information column	Output trigger information column	—	Select this to output the trigger information to the data line where a trigger occurred.
		Data name line string	Specify the title of the trigger information column data name line. (Up to 32 characters)
		When trigger condition rises	Specify a string to output at the rise of the trigger condition. (Up to 32 characters)
		When trigger condition falls	Specify the string to output at the fall of the trigger condition. (Up to 32 characters)
Header line	Output comment line	—	Select this to output the comment line to a file.
		Comment	Specify the comment to be output. (Up to 256 characters)
	[Detailed setting] button		Displays the "Header line setting" screen.  Page 163 Header line setting

*1 To output the data name and data from the date column, split it into multiple strings with commas (,). In this case, enter the same number of commas in "Data name line string" and "Data line output format." The comma is replaced with the tab (t) when a file is output.

*2 When a file is opened in Excel, the date column format is displayed in the default setting of Excel. Set the cell format as necessary.

(Example) To display year, month, date, hour, minute, second, and millisecond information

Specify the user defined display format as follows:

m/d/yyyy hh:mm:ss.000

- *3 Data value is rounded to 0.1 millisecond unit when the high speed sampling is specified, and to 100 millisecond unit when the general sampling is specified.

Header line setting

Specify the information to output to the header line.

2

Operating procedure

1. Click the [Detailed setting] button on the [Unicode text output] tab of data logging setting screen.
2. Select the information to output to the header line on the "Header line setting" screen and click the [OK] button.

Point

When "Output data type information line" and "Output data name line" are not selected, the line number corresponding to the file information line remains blank.

Binary output

Set contents to output to binary files.

This is enabled when "Binary file" is selected in the [Logging type/File format] tab.

Window

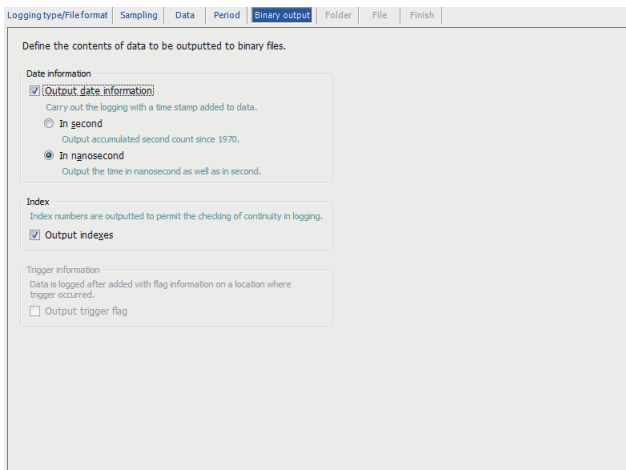

Displayed items

Item			Description
Date information	Output date information	—	Select this to output data with a time stamp added.
		In second	Select this to output only the date information in seconds unit.
		In nanosecond*1	In addition to seconds, select this to output the date information in nanoseconds unit.
Index	Output indexes		Select this to output the index number to a file. The continuity of logging can be checked by the index.
Trigger information	Output trigger flag		Select this to output the occurrence flag at the data position where the trigger occurred.

*1 Data value is rounded to 0.1 millisecond unit when the high speed sampling is specified, and to 100 millisecond unit when the general sampling is specified.

CSV output

Set contents to output to CSV files.

This is enabled when "CSV file" is selected in the [Logging type/File format] tab.

Window

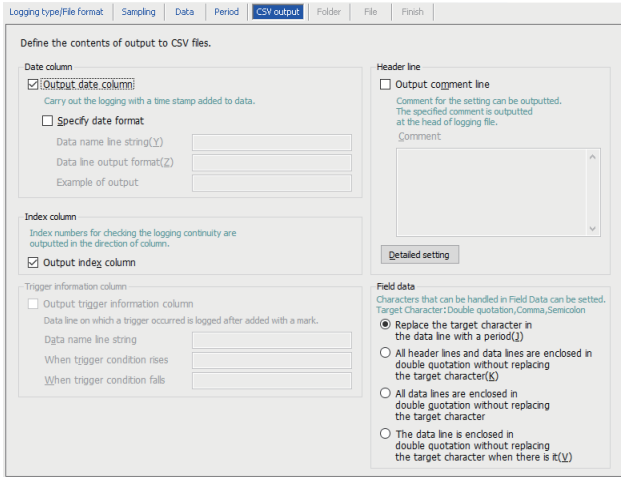

Displayed items

Item			Description	
Date column	Output date column	—	Select this to output the date column to a file.	
	Specify date format	—	Select this to specify the format of the date column.	
		Data name line string ^{*1}	—	Specify the title of the date name line of the date column. (Up to 32 characters)
		Data line output format ^{*1*2}	—	Specify the output format of the data line for the date column. (Up to 32 characters) YYYY: Year (4 digits) YY : Year (2 digits) MM : Month (2 digits) DD : Day (2 digits) hh : Hour (2 digits) mm : Minute (2 digits) ss : Second (2 digits) ms : Millisecond (3 digits) ^{*3} us : Microsecond (6 digits) ^{*3} .ss... : Digits after the decimal point in seconds (1 to 4 digits)
	Example of output	—	Displays an image of the date column output with the current settings.	
Index column	Output index column	—	Select this to output the index number to a file. The continuity of logging can be checked by the index.	
Trigger information column	Output trigger information column	—	Select this to output the trigger information to the data line where a trigger occurred.	
		Data name line string	Specify the title of the trigger information column data name line. (Up to 32 characters)	
		When trigger condition rises	Specify a string to output at the rise of the trigger condition. (Up to 32 characters)	
		When trigger condition falls	Specify the string to output at the fall of the trigger condition. (Up to 32 characters)	
Header line	Output comment line	—	Select this to output the comment line to a file.	
		Comment	Specify the comment to be output. (Up to 256 characters)	
	[Detailed setting] button	—	Displays the "Header line setting" screen.  Page 166 Header line setting	

Item		Description
Field data ^{*4}	Replace the target character in the data line with a period	Select this to output data including a double quote ("), comma (,), semicolon (;) by replacing them with a period (.).
	All header lines and data lines are enclosed in double quotation without replacing the target character ^{*5}	Select this to output a double quote ("), comma (,), semicolon (;) by enclosing the whole field data of all header lines and data lines in double quotes ("). When a double quote (") is included, an escape character (\") is added to just before the double quote.
	All data lines are enclosed in double quotation without replacing the target character ^{*5}	Select this to output a double quote ("), comma (,), semicolon (;) by enclosing the whole data lines in double quotes ("). When a double quote (") is included, an escape character (\") is added to just before the double quote.
	The data line is enclosed in double quotation without replacing the target character when there is it ^{*5}	Select this to output the whole data lines including a double quote ("), comma (,), semicolon (;) by enclosing it with double quotes ("). When a double quote (") is included, an escape character (\") is added to just before the double quote.

*1 To output the data name and data from the date column, split it into multiple strings with commas (,).

In this case, enter the same number of commas in "Data name line string" and "Data line output format."

*2 When a file is opened in Excel, the date column format is displayed in the default setting of Excel.

Set the cell format as necessary.

(Example) To display year, month, date, hour, minute, second, and millisecond information

Specify the user defined display format as follows:

m/d/yyyy hh:mm:ss.000

*3 Data value is rounded to 0.1 millisecond unit when the high speed sampling is specified, and to 100 millisecond unit when the general sampling is specified.

*4 For the output examples to a CSV file according to the field data settings, refer to the following:

 Page 167 Output example to a CSV file

*5 A logging file, which is output by selecting an item other than "Replace the target character in the data line with a period" is not supported by the historical trend function and historical event function of GX LogViewer.

Header line setting

Specify the information to output to the header line.

Operating procedure

1. Click the [Detailed setting] button on the [CSV output] tab of data logging setting screen.
2. Select the information to output to the header line on the "Header line setting" screen and click the [OK] button.

Point

When "Output data type information line" and "Output data name line" are not selected, the line number corresponding to the file information line remains blank.

Output example to a CSV file

The following table shows the output examples to a CSV file according to the field data settings.

Field data	Output example
Replace the target character in the data line with a period	[LOGGING],RD81DL96_1,3,4,5,2 Comment";; DATETIME,INDEX,USHORT[DEC.0],STRING[255] TIME,INDEX,CH1,DATA 2022/8/30 16:44:48,1,0,abcde 2022/8/30 16:44:58,2,100,abcde...
All header lines and data lines are enclosed in double quotation without replacing the target character	"[LOGGING]","RD81DL96_2","3","4","5","2" "Comment";;" "DATETIME","INDEX","USHORT[DEC.0]","STRING[255]" "TIME","INDEX","CH1","DATA" "2022/8/30 16:44:48","1","0","abcde" "2022/8/30 16:44:58","2","100","abcde";;"
All data lines are enclosed in double quotation without replacing the target character	[LOGGING],RD81DL96_2,3,4,5,2 Comment";; DATETIME,INDEX,USHORT[DEC.0],STRING[255] TIME,INDEX,CH1,DATA "2022/8/30 16:44:48","1","0","abcde" "2022/8/30 16:44:58","2","100","abcde";;"
The data line is enclosed in double quotation without replacing the target character when there is it	[LOGGING],RD81DL96_2,3,4,5,2 Comment";; DATETIME,INDEX,USHORT[DEC.0],STRING[255] TIME,INDEX,CH1,DATA 2022/8/30 16:44:48,1,0,abcde 2022/8/30 16:44:58,2,100,"abcde";;"

Folder

Set the save destination of the saved file and switching timing of the saved folder.

Window

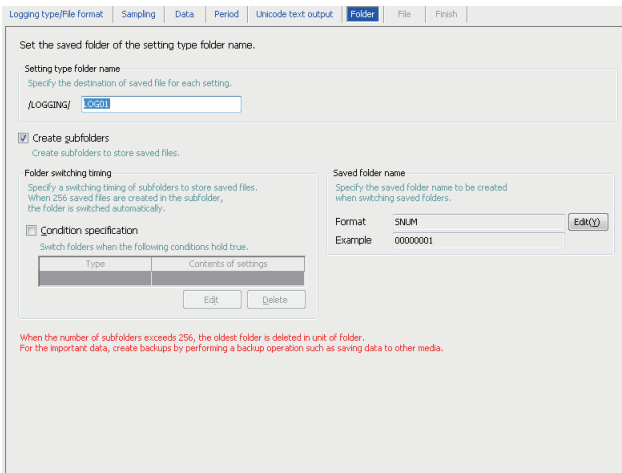

Displayed items

Item	Description	
Setting type folder name	Specify the folder name where the files are to be stored. (Up to 32 characters) Specify a unique name for the setting folders of other data logging settings, event logging settings, and report settings.	
Create subfolders	Select this to create a subfolder to store saved files.	
Folder switching timing	Condition specification	Select this to specify the condition to switch the folder.
	Type	Displays the type of specified condition. The folder will be switched, even if the condition is satisfied during the period when logging is not executed.
	Contents of settings	Displays the overview of the specified condition.
	[Edit] button	Displays the "Folder switching condition setting" screen. The settings are same as mentioned in the following section. *1 Page 158 Trigger (single condition) Page 160 Trigger (compound condition)
	[Delete] button	Deletes the specified condition.
Saved folder name	Format	Display the output format of the saved subfolder name.
	[Edit] button	Displays the "Saved folder name setting" screen. Page 169 Saved folder name setting
	Example	Displays the output image of the saved folder name in a current format.

*1 When selecting the compound condition, "Number of times" and "Order" do not exist for the condition.

Saved folder name setting

Window

Click the [Edit] button on the [Folder] tab of the data logging setting screen.

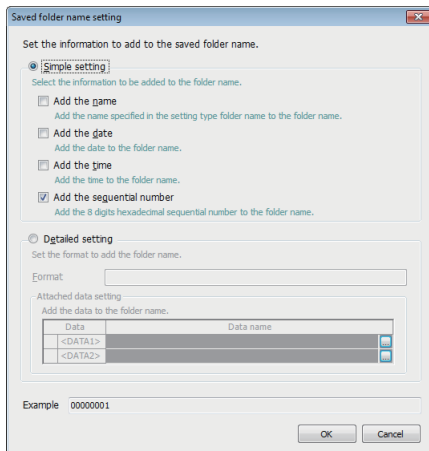

2

Displayed items

Item	Description		
Simple setting ^{*1*2*3}	Add the name	Select this to add the characters specified for each setting folder to the folder name.	
	Add the date	Select this to add a date to a folder name. Year-month-day (YYYYMMDD) is added.	
	Add the time	Select this to add a time to a folder name. Hour-minute-second (hhmmss) is added.	
	Add the sequential number	Select this to add a sequential numbers to folder names. A sequential number corresponding to the saved folder sequential number (00000001 to FFFFFFF01) are added. ^{*4}	
Detailed setting ^{*3*5}	Format	Specify the output format of the information to be added to a folder name. (Up to 48 characters) (Page 343 File name and folder (directory) name) A date and time, and data can be added to the folder name by specifying the following reserved words. ^{*6*7} YYYY: Year (4 digits) YY : Year (2 digits) MM : Month (2 digits) DD : Day (2 digits) ddd : Day of the week ^{*8} (3 digits) hh : Hour (2 digits) mm : Minute (2 digits) ss : Second (2 digits) SNUM: Sequential number (8 digits) <DATA1>:Content of data set to <DATA1> <DATA2>:Content of data set to <DATA2>	
	Attached data setting	Data ^{*9*10}	Select this to add a data to a folder name. Adds "<DATA1>" and "<DATA2>" to the end of the format.
		Data name	Displays the data name set to "<DATA1>" and "<DATA2>". Click the [...] button and set it on the displayed "Data setting" screen. ^{*11} (Page 113 Data setting)
Example	Displays the output image of the folder name in a current format.		

- *1 The format is fixed as follows. When the selected items are outputted in the following sequence, and when there are multiple items specified, they are outputted with "_" in between.
Name_date_time_sequential number
- *2 Adding name only cannot be allowed. Add the combination of any of the date, time, or sequential number.
- *3 When writing the setting after changing the saved folder name setting, updating the setting, or powering OFF → ON, the folder used before changing the setting is switched and the saved file is stored in a new folder.
- *4 For the sequential 8 digit hexadecimal number, the same number as the sequential number of saved file which is stored at file switching is added. (Page 61 Add the sequential number of subscripts)
- *5 Only fixed string cannot be set for a format. Specify a reserved character at least one.
- *6 The number of "<DATA1>" and "<DATA2>" that can be set in the format is one for each.
- *7 A reserved word quoted in double quotes (") is added as a string to the folder name. A double quote (") itself is not added to the folder

name as a string.

The reserved word "<DATA1>" and "<DATA2>" cannot be added to the folder name as a string.

*8 The following abbreviations are output for days of the week.

Monday: Mon, Tuesday: Tue, Wednesday: Wed, Thursday: Thu, Friday: Fri, Saturday: Sat, Sunday: Sun

*9 The data sampled at the time when the folder switching conditions are satisfied is added to the folder name.

If the data cannot be sampled at the time of a file switching, the data sampled right before the file switching is added.

When the sampled data does not exist, "NODATA" (fixed string) is added to the saved folder name.

*10 If Word [Signed], Double Word [Signed] is specified to the data type, the negative values may be output depending on the device value of the CPU module. When negative values are output, the information that has one more character than the number of characters of output example is added since '-' is added.

*11 When the number of digits of data to be output is less than the specified number of digits, the data is zero-padded by specifying "Zero-padding" on the "Output format" screen.

Point 

When specifying "Add the sequential number" in the simple settings for the saved folder name, specifying "Add the sequential number" in the simple settings to the saved folder name is required. In addition, when specifying the reserved word "SNUM" in the detailed settings for the format, specifying the reserved word "SNUM" in the detailed settings for the saved file name is required.

File

Set the save destination of the data logging file, and switching timing of the saved file.

Window

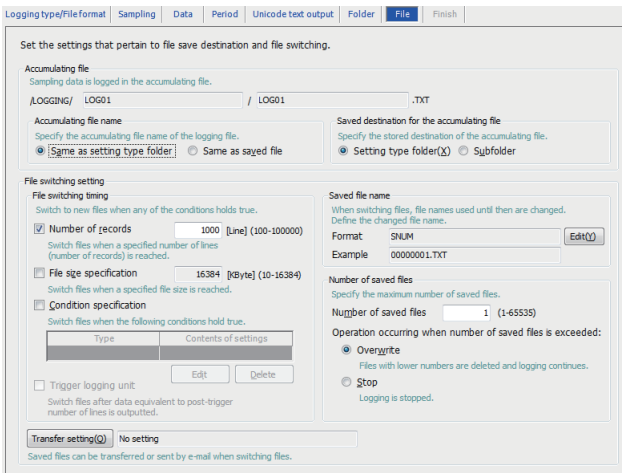

Displayed items

Item			Description
Accumulating file ^{*1}	Accumulating file name	Same as setting type folder	Select this to create accumulating file with an extension to the folder name specified in "Setting type folder name" of the [Folder] tab.
		Same as saved file	Select this to create an accumulating file with the name to which the name specified in "Saved file name" is added.
	Saved destination for the accumulating file	Setting type folder	Select this to create an accumulating file in the setting type folder.
		Subfolder	Select this to create an accumulating file in the subfolder. This setting can be selected when "Create subfolder" is selected in the [Folder] tab.
File switching setting	File switching timing ^{*2}	Number of records	Select this to switch the file when the number of lines (records) reaches the specified number and specify the number of lines.
		File size specification	Select this to switch the file when the specified file size is reached and specify the file size.
		Condition specification	Select this to specify a condition to switch a file.
		Type	Displays the type of specified condition. The file will be switched, even if the condition is satisfied during the period when logging is not executed.
		Contents of settings	Displays the overview of the specified condition.
		[Edit] button	Displays the "File switching condition setting" screen. The settings are same as mentioned in the following section. ^{*3} Page 158 Trigger (single condition) Page 160 Trigger (compound condition)
		[Delete] button	Deletes the specified condition.
	Trigger logging unit	Select this to output the number of lines after the trigger worth of data and to immediately switch a file.	
	Saved file name	Format	Displays the output format of the saved file name.
		[Edit] button	Displays the "Saved file name setting" screen. Page 173 Saved file name setting
Example		Displays the output image of the saved file name in a current format.	

Item			Description
File switching setting	Number of saved files	Number of saved files	Specify the maximum number of saved files excluding accumulating files.*4*5
		Overwrite	Select this to delete the oldest file (the oldest file created by a high speed data logger module) and continue data logging, when the number of saved files has already exceeded the specified number at a file switching. When the folder becomes empty by deleting oldest files, that folder is automatically deleted.
		Stop	Select this to stop data logging when the number of saved files has already exceeded the specified number at the time of file switching.*6 Turns ON the corresponding bit for 'Number of saved files exceeded information' (Un\G2016 to 2019) in the data logging status area of the buffer memory. Logging is restarted when clearing the logging file. (☞ Page 223 SD memory card diagnostics)
[Transfer setting] button			Edit the settings to transfer the saved file or to send it by e-mail. (☞ Page 174 Transfer setting)

- *1 When writing the setting after changing the accumulating file name, updating the setting, or powering OFF → ON, the accumulating file used before changing the setting is switched and a new accumulating file is created.
- *2 The file is switched in the following situations regardless of the set timing.
When the number of lines (number of records for binary) reaches 100000 if the "Number of records" is not selected
When there is no e-mail address setting in the transfer settings and the file size reaches 16 MB if "File size specification" is not selected.
When there is an e-mail address setting in the transfer settings and the file size reaches 512 KB if "File size specification" is not selected.
- *3 When selecting the compound condition, "Number of times" and "Order" do not exist for the condition.
- *4 The upper limit is 255 if a subfolder is not created.
- *5 Up to 256 subfolders are created. When creating the 257th subfolder, the subfolder of which the creation time is the oldest is deleted. Therefore, when specifying the condition for folder switching, the specified number of saved files may not be created.
- *6 The accumulating file and the specified number of saved files are saved on the SD memory card.

Point

When "Fixed cycle" or "Time specification" is selected for the condition specification, the file gets switched at power on when the specified cycle elapses or the specified time reaches during the period from power OFF to power ON.

By setting the following settings, only trigger logging data before and after the rising of trigger condition can be output to a report.

- Select "Trigger logging unit" in the [file] tab of the data logging settings.
- Select "Saved file" in "Source file" on the "Data logging layout" screen of the report settings. (☞ Page 201 Data logging layout)
- Select "At the data logging file switching" on the "Trigger condition setting" screen of report settings. (☞ Page 209 Creation trigger)

Saved file name setting

Window

Click the [Edit] button from the "Format" on the [File] tab of data logging setting screen.



2

Displayed items

Item	Description		
Simple setting ^{*1*2*3}	Add the name	Select this to add the characters specified in the setting type folder name to a file name.	
	Add the date	Select this to add date to the a name. Year-month-day (YYYYMMDD) is added.	
	Add the time	Select this to add a time to a file name. Hour-minute-second (hhmmss) is added.	
	Add the sequential number	Select this to add a sequential numbers to file names. The sequential numbers (00000001 to FFFFFFFF) are added.	
Detailed setting ^{*2*3}	Format	Specify the output format of the information to be added to a file name. (Up to 48 characters) (Page 343 File name and folder (directory) name) A date/time and data can be added to a file name by specifying the following reserved words. ^{*4*5} YYYY: Year (4 digits) YY : Year (2 digits) MM : Month (2 digits) DD : Day (2 digits) ddd : Day of the week ^{*6} (3 digits) hh : Hour (2 digits) mm : Minute (2 digits) ss : Second (2 digits) SNUM: Sequential number (8 digits) <DATA1>:Content of data set to <DATA1> <DATA2>:Content of data set to <DATA2>	
	Attached data setting	Data ^{*7}	Select this to add a data to a file name. Adds "<DATA1>" and "<DATA2>" to the end of the format.
		Data name	Displays the data name set to "<DATA1>" and "<DATA2>." Click the [...] button and set it on the displayed "Data setting" screen. ^{*8} Page 113 Data setting
Attached time (date) type	File switching condition hold true time	Select this to add the date/time when file switching conditions are satisfied to a file name.	
	File creation time ^{*9*10}	Select this to add the date/time (when the previous file is switched) when the accumulating file is created to a file name. When "Same as saved file" is specified to an accumulating file name, the attached time (date) type will be the same as the file creation time.	
Example	Displays the output image of the file name in a current format.		

*1 The format is fixed as follows. When the selected items are outputted in the following sequence, and when there are multiple items specified, they are outputted with "_" in between.

Name_date_time_sequential number

- *2 When selecting only "Add the name" in the simple setting or setting only fixed string for the "Format" in the detailed setting, a file with a same name can continue to be created by setting the number of saved files to 1. (When the number of saved files is set to a value other than 1, a file with a same name is created and the INFO LED turns ON.)
However, when switching, the files are overwritten, and thus, the name cannot be added to an existing file.
- *3 When writing the setting after changing the saved file name setting, updating the setting, or powering OFF → ON, the accumulating file used before changing the setting is switched and a new accumulating file is created.
- *4 The number of "<DATA1>" and "<DATA2>" that can be set in the format is one for each.
- *5 A reserved word quoted in double quotes (") is added as a string to the file name. A double quote (") itself is not added to the file name as a string.
The reserved word "<DATA1>" and "<DATA2>" cannot be added to the file name as a string.
- *6 The following abbreviations are output for days of the week.
Monday: Mon, Tuesday: Tue, Wednesday: Wed, Thursday: Thu, Friday: Fri, Saturday: Sat, Sunday: Sun
- *7 The data sampled at the time when the folder switching conditions are satisfied is added to the file name.
If the data cannot be sampled at the time of a file switching, the data sampled right before the file switching is added.
When the sampled data does not exist, "NODATA" (fixed string) is added to the saved file name.
- *8 When the number of digits of data to be output is less than the specified number of digits, the data is zero-padded by specifying "Zero-padding" on the "Output format" screen.
- *9 The number of seconds of the date/time to be added must be even. If the file creation time is an odd number, it will be reduced by one second, and rounded to the even number.
- *10 If Word [Signed], Double Word [Signed] is specified to the data type, the negative values may be output depending on the device value of the CPU module. When negative values are output, the information that has one more character than the number of characters of output example is added since '-' is added.

Transfer setting

Window

Click the [Transfer settings] button on the [File] tab of the data logging setting screen.

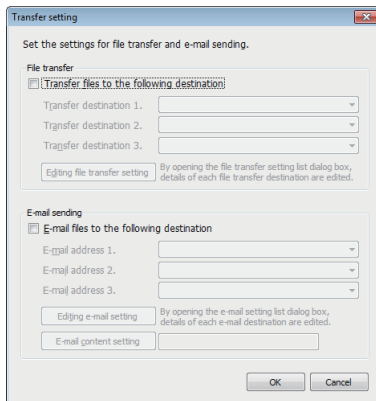

Displayed items

Item		Description
File transfer	Transfer files to the following destination	— Select this to transfer a file to FTP servers or a shared folder.
	Transfer destination 1. to 3.	Select the file transfer destination from the destinations that are registered on the "File transfer setting" screen.
	[Editing file transfer setting] button	Displays the "File transfer setting" screen. ☞ Page 137 File transfer setting
E-mail sending	E-mail files to the following destination	— Select this to attach a file to an e-mail and send it.
	E-mail address 1. to 3.	Select e-mail destinations from the destination group registered on the "E-mail setting" screen.
	[Editing e-mail setting] button	Displays the "E-mail setting" screen. ☞ Page 140 E-mail setting
	[E-mail content setting] button	Displays the "E-mail content setting" screen. ☞ Page 175 E-mail content setting

E-mail content setting

Window

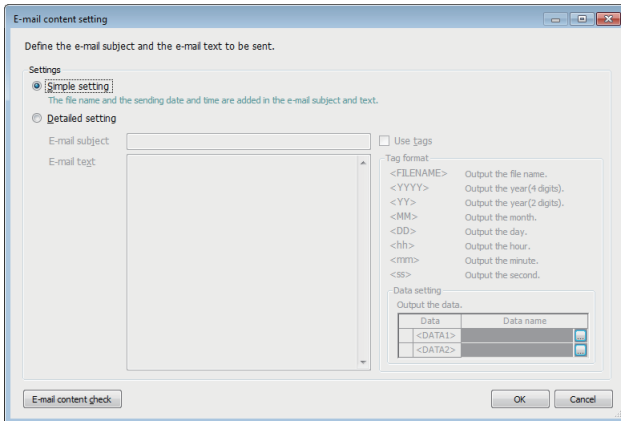

2

Displayed items

Item		Description	
Settings	Simple setting	Select this to add a file name and sent date/time to the e-mail subject or text.	
	Detailed setting	—	Select this to specify the information to be added to an e-mail subject or text.
		E-mail subject* ¹	Specify the format of e-mail subject. (Up to 64 characters)
		E-mail text* ¹	Specify the format of e-mail text. (Up to 2048 characters)
	Use tags	—	Select this to validate tag input. The sent date/time and data can be added by specifying the following tag items. * ² * ³ <YYYY>: Year (4 digits) <YY>: Year (2 digits) <MM>: Month (2 digits) <DD>: Day (2 digits) <hh>: Hour (2 digits) <mm>: Minute (2 digits) <ss>: Second (2 digits) <DATA1>:Content of data set to <DATA1> <DATA2>:Content of data set to <DATA2>
		Data setting	Data
Data name			Displays the data name set to "<DATA1>" and "<DATA2>." Click the [...] button and set it on the displayed "Data setting" screen. ☞ Page 113 Data setting
[E-mail content check] button		Displays the "E-mail content check" screen.	

*1 The character codes that can be used are available in ASCII range.

*2 Total of 16 tags can be set for E-mail subject and E-mail text.

*3 Tags can be invalidated by adding another brackets. (The item enclosed with outer brackets can be handled as a string.)

Finish

Set a data logging name.

Window

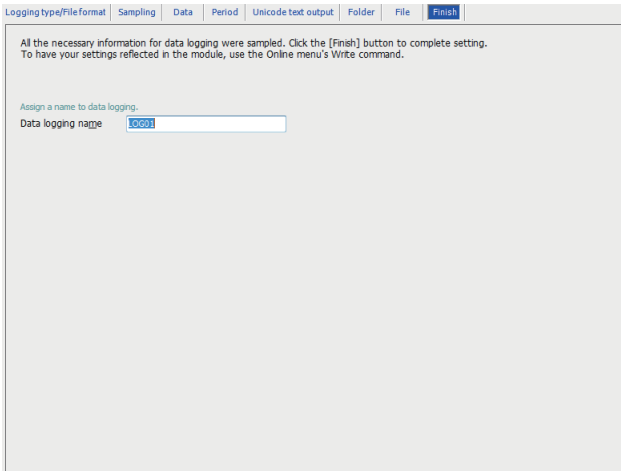

Displayed items

Item	Description
Data logging name	Specify the name of the setting being edited. (Up to 32 characters)

2.6 Event Logging Setting

This section explains the settings for the event logging function.

For details of the event logging function, refer to the following:

☞ Page 63 Event Logging Function

2

Window

Click "Event logging setting" on the edit items tree.

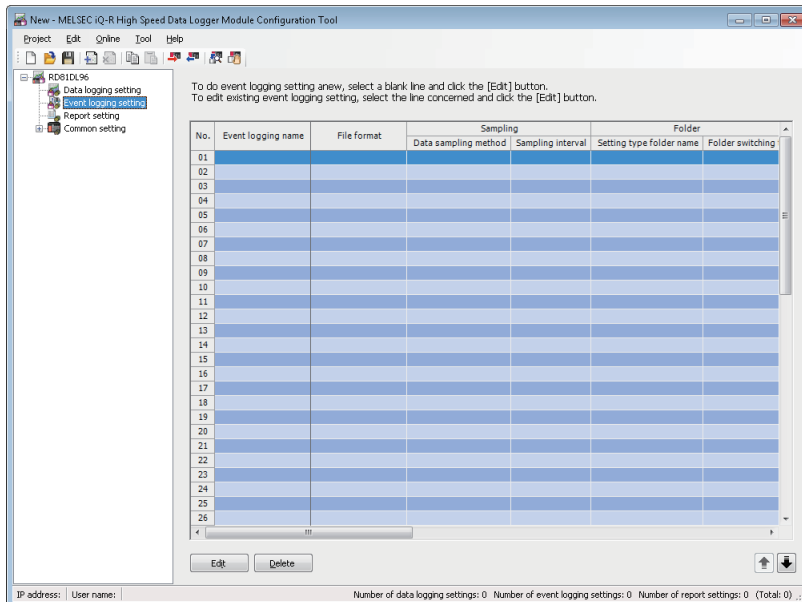

Displayed items

Item	Description	
Event logging name	Displays the event logging name.	
File format	Displays the file format of the data logging file.	
Sampling	Data sampling method	Displays the sampling method for event logging.
	Sampling interval	Displays the sampling interval of the target data.
Folder	Setting type folder name	Displays the destination of saved files for each setting.
	Folder switching timing	Displays the switching timing for the subfolder.
	Saved folder name	Displays the information to be added to a subfolder name.
File	Accumulating file name	Displays how to specify the file names being accumulated.
	Saved destination for the accumulating file	Displays where the files being accumulated are stored.
	File switching timing	Displays the switching timing for the saved file.
	Saved file name	Displays the information to be added to a logging file name.
	Number of saved files	Displays the number of saved files and the operation when the number of saved files is exceeded.
Transfer	File transfer	Displays if there is a file transfer.
	E-mail sending	Displays if there is an e-mail transmission.
E-mail notice	Displays if there is an e-mail notification at an event occurrence.	
[Edit] button	Displays the setting screen to edit the selected event logging setting. ☞ Page 178 Event logging setting	
[Delete] button	Deletes the selected data event logging setting.	

Event logging setting

Configure the settings of the event logging function in a wizard format.

Window

Click the [Edit] button on the event logging setting list.

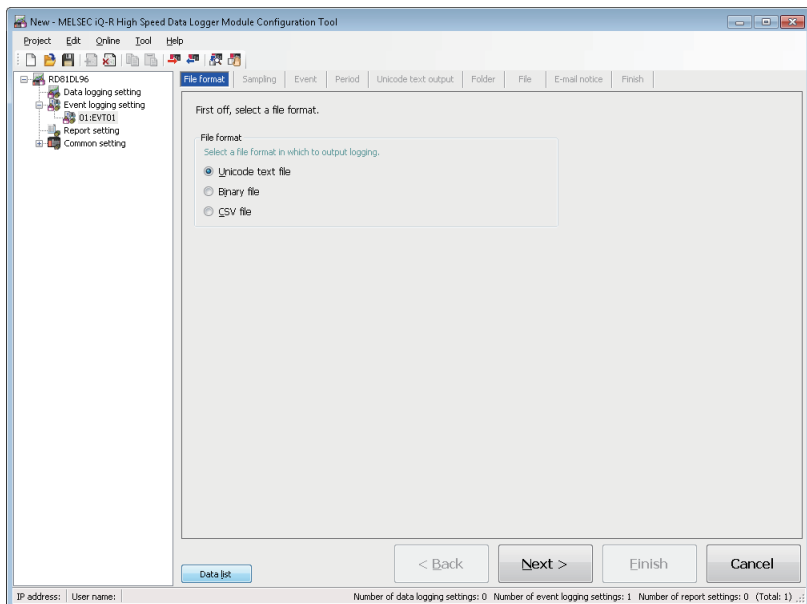

Displayed items

Item	Description	Reference
[File format] tab	Set the file format for the logging data.	Page 179 File format
[Sampling] tab	Select a data sampling method for the event logging target data, then set the sampling interval.	Page 180 Sampling
[Event] tab	Set the information to be output to the event logging file against event occurrence conditions, or at the time of event occurrence and restoration.	Page 181 Event
[Period] tab	Set a period to monitor the event.	Page 186 Period
[Unicode text output] tab	Set contents to output to Unicode text files.	Page 187 Unicode text output
[Binary output] tab	Set contents to output to binary files.	Page 188 Binary output
[CSV output] tab	Set contents to output to CSV files.	Page 189 CSV output
[Folder] tab	Set the save destination of the saved file and switching timing of the saved folder.	Page 190 Folder
[File] tab	Set the save destination of an event logging file and the switching timing of a saved file.	Page 191 File
[E-mail notice] tab	Set the content of e-mail notification at an event occurrence.	Page 192 E-mail notice
[Finish] tab	Set an event logging name.	Page 193 Finish
[Data list] button	Displays a list of all data being used by all the event logging setting.	Page 110 Data list
[Back] button	Moves back to the previous setting tab.	—
[Next] button	Moves forward to the next setting tab.	—
[Finish] button	Reflects the settings and closes the screen.	—

File format

Set the file format for the logging data.

Window

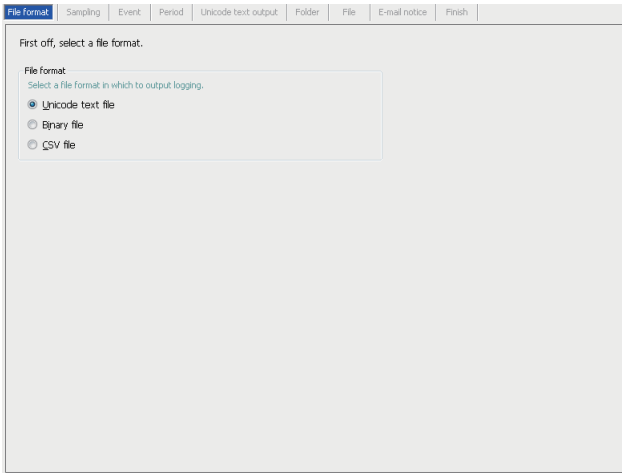

Displayed items

Item		Description
File format	Unicode text file	Select this to save data in the Unicode text file format.
	Binary file	Select this to save data in the binary file format.
	CSV file	Select this to save data in the CSV file format.

Sampling

Select a data sampling method for the event logging target data, then set the sampling interval.

Window

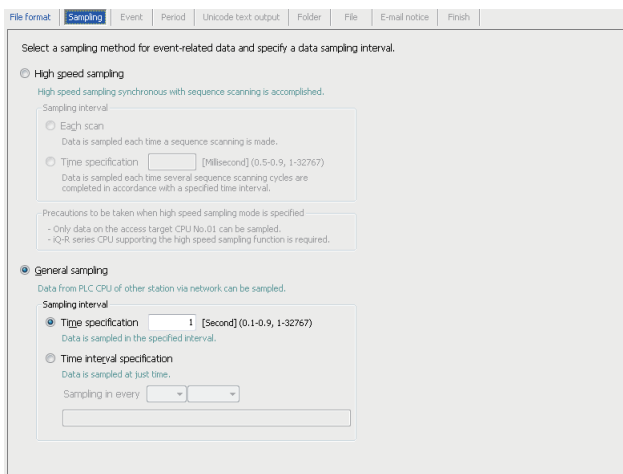

Displayed items

Item		Description	
High speed sampling	—	Select this to perform high-speed event logging that is synchronized with a sequence scan.	
	Sampling interval	Each scan	Select this to sample data in each sequence scan.
		Time specification	Select this to sample data with the specified interval. Specify a sampling interval.
General sampling	—	Select this to perform event logging that is not synchronized with a sequence scan.	
	Sampling interval	Time specification	Select this to sample data with the specified interval. Specify a sampling interval.
		Time interval specification	Select this to sample data with the specified time interval (hour, minute, or second) from exactly midnight everyday, exact hour, or exact minute. Specify the sampling interval and time unit.

Event

Set the information to be output to the event logging file against event occurrence conditions, or at the time of event occurrence and restoration.

Window

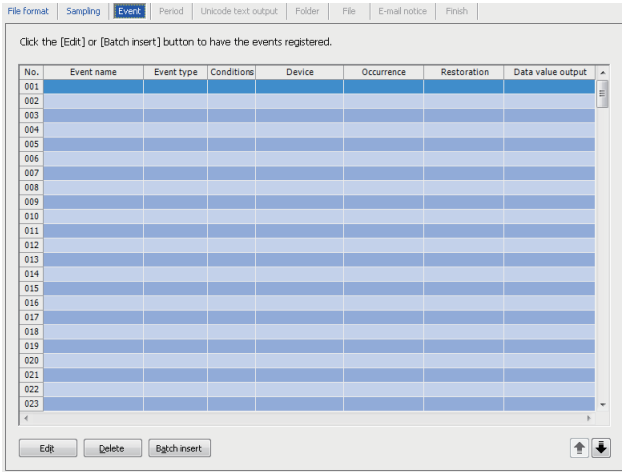

Displayed items

Item	Description
Event name	Displays the event name.
Event type	Displays the type of event.
Conditions	Displays the number of conditions set for the event.
Device	Displays monitoring data used for event conditions.
Occurrence	Displays the comment at an event occurrence.
Restoration	Displays the comment when the event is restored.
Data value output	Displays if the data value is output.
[Edit] button	Displays the setting screen to edit the selected event. Page 182 Event setting
[Delete] button	Deletes the selected event.
[Batch insert] button	Batch insert the event monitoring conditions. Page 185 Event batch insertion

Event setting

Window

Click the [Edit] button on the [Event] tab of event logging setting screen.

Displayed items

Item		Description
Event name	Event name	Set the event name. (Up to 32 characters)
Comment	Comment at event occurrence	Specify the string to be output at an event occurrence. (Up to 32 characters)
	Comment at event restoration	Specify the string to be output at the event restoration. (Up to 32 characters)
Data value output	Output data values	Select this to output data values at an event occurrence.
Single condition		Select this to set a single trigger condition. Page 183 Event setting (single condition)
Compound condition		Select this to set a combination of multiple trigger conditions. Page 184 Event setting (compound condition)

■Event setting (single condition)

Window

2

Displayed items

Item		Description	
Monitoring data	No.	Displays the index of the monitoring target data.	
	Data name	Displays the start device. For related data, an icon (🌐) is displayed.	
	Access target CPU ^{*1}	Select the access target CPU. To add an access target CPU, select "(Add CPU)" and click the [Edit] button. 📖 Page 135 Access target CPU setting	
	Device	Head ^{*1}	Set the start device.
		Last	Displays the end device calculated from the data type and size.
	Data type ^{*1}	Select the data type.	
	Size ^{*1*2}	If the data type is "String" or "Raw", the size must be specified.	
	Scaling	Set the scale conversion equation for data. The "Scaling" screen is displayed by clicking the [...] button. 📖 Page 153 Scaling	
	Output format	Specify the format (such as decimal format and exponential format) when the data is output to a file. The "Output format" screen is displayed by clicking the [...] button. 📖 Page 153 Output format	
[Import] button	Imports global labels or device comments. 📖 Page 116 Importing global labels 📖 Page 123 Importing common device comments		
[Relation release] button	Disables relations with global labels. 📖 Page 121 Release relations to global labels		
Condition ^{*3}		Select the operator used to compare the trigger value with the monitoring data.	
Trigger value	Trigger value	Specify a trigger value. (Up to 16 characters)	
	Specify restoration values	Select this to specify a restoration value to suppress an event occurrence.	
	Restoration value	Set a restoration value. (Up to 16 characters)	

*1 These items cannot be edited for related data.

*2 When using the string type data, specify the size considering the character code. (📖 Page 64 String type data)

*3 An event occurs when the condition changes from not being satisfied to being satisfied. (📖 Page 65 Single condition)

■Event setting (compound condition)

Window

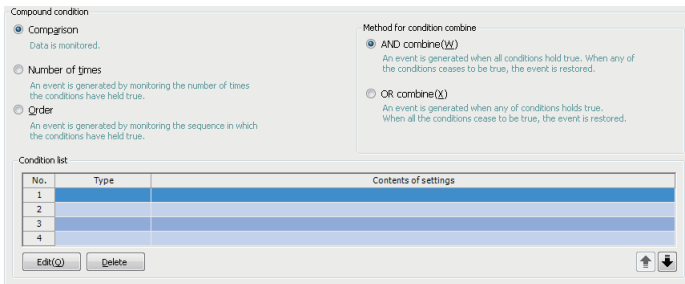

Displayed items

Item		Description
Comparison	—	Select this to make an event occur by comparing monitoring data and the condition is satisfied.
	AND combine	Select this to make an event occur when all the specified conditions in the condition list are satisfied.
	OR combine	Select this to make an event occur when any of the specified conditions in the condition list is satisfied.
Number of times	—	Select this to make an event occur by monitoring the number of times the condition is satisfied.
	When a terminal condition holds true	Select this to check the number of counts when the termination condition is satisfied, and make an event occur when the specified condition is satisfied.
	When a specified number of times is exceeded	Select this to make an event occurs immediately when the number of counts exceeds the specified count.
	Conditions for the occurrence of an event	Specify the conditions (comparison operator and number of times) to compare the number of times the count condition is satisfied (number of counts).
Order	—	Select this to make an event occur by monitoring the order of the condition satisfaction.
	Abnormal pattern is detected	Select this to make an event occur when the condition is satisfied with an order different from the one specified in the condition list.
	Normal pattern is detected	Select this to make an event occur when the condition is satisfied with the order specified in the condition list.
	Detect timeout	Select this to make an event occurs when any of the conditions are not satisfied within the monitoring timeout.
Condition list	Type	Displays the condition type.
	Contents of settings	Displays the overview of the condition.
	Start condition ^{*1}	Displays the condition to start counting for the number of counts.
	Terminal condition ^{*1}	Displays the condition to stop counting for the number of counts.
	Count condition ^{*1}	Displays the condition to increment the number of counts.
	Start condition ^{*2}	Displays the condition to start monitoring the order that the condition is satisfied.
	1st/2nd/3rd condition ^{*2}	Displays the conditions to monitor in order.
	Monitoring timeout [Second] ^{*2}	Displays the timeout time when monitoring the conditions in each order.
[Edit] button	Displays the setting screen to edit the selected condition. The settings are same as mentioned in the following section. ^{*3*4} Comparison: Page 183 Event setting (single condition) Number of times, Order: Page 159 Trigger condition setting	
[Delete] button	Deletes the selected condition.	

*1 Displayed in the case of "Number of times."

*2 Displayed in the case of "Order."

*3 When selecting "Number of times" or "Order," the conditions which can be set are "Comparison" and "Value change."

*4 When selecting "Order", the monitoring timeout can be specified.

Event batch insertion

Window

Click the [Batch insert] button on the [Event] tab on the event logging setting screen.

2

Displayed items

Item		Description
Event name	Event name	Set the event name. (Up to 32 characters)
	Append subscripts to event names	Select this to add a serial number to the event name set by the user. Format of the subscript is "Event name (n)."
Continuous setting	Total number	Specify the total amount of events to batch insert.
	Interval	Specify the device interval of the monitoring data to batch insert.
	Set the interval automatically	Select this to set the interval automatically in order to avoid gaps between the devices of monitoring data to be inserted in batch.
Comment	Comment at event occurrence	Specify the string to be output at an event occurrence. (Up to 32 characters)
	Comment at event restoration	Specify the string to be output at the event restoration. (Up to 32 characters)
Data value output	Output data values	Select this to output data values at an event occurrence.
Condition		Specify the event occurrence condition. The settings are same as mentioned in the following section. *1 Page 183 Event setting (single condition)

*1 [Import] button and [Relation release] button do not exist.

Period

Set a period to monitor the event.

Window

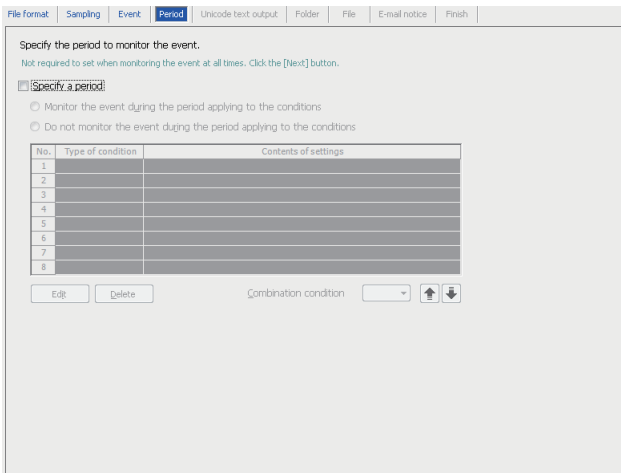

The settings are same as mentioned in the following section.

📖 Page 156 Period

Unicode text output

Set contents to output to Unicode text files.

This is enabled when "Unicode text file" is selected in the [File format] tab.

Window

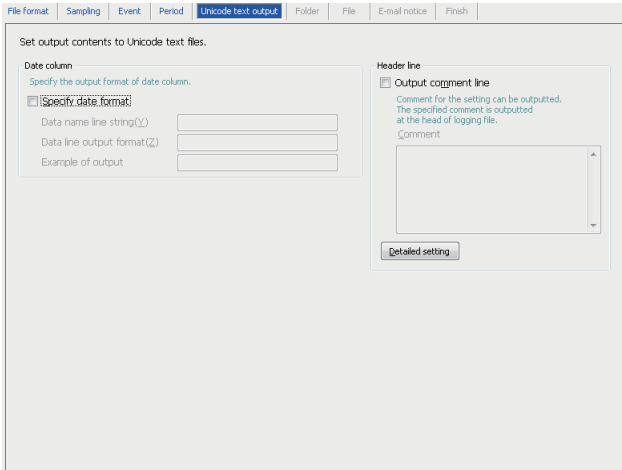

The settings are same as mentioned in the following section.

☞ Page 162 Unicode text output

However, the following items do not exist.

- "Output date column" in the date column
- Index column
- Trigger information column

Binary output

Set contents to output to binary files.

This is enabled when "Binary file" is selected in the [File format] tab.

Window

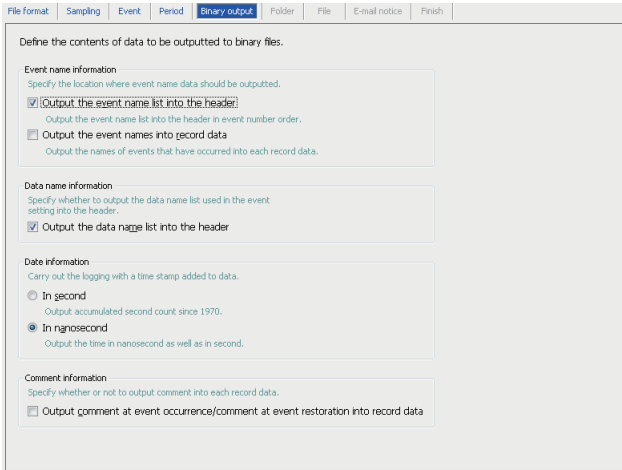

Displayed items

Item		Description
Event name information ^{*1}	Output the event name list into the header	Select this to output the list of event name to the header in event number order.
	Output the event names into record data	Select this to output event names that occurred to the record data.
Data name information	Output the data name list into the header	Select this to output the list of data name used in the event setting to the header.
Date information	In second	Select this to output only the date information in seconds unit.
	In nanosecond ^{*2}	In addition to seconds, select this to output the date information in nanoseconds unit.
Comment information	Output comment at event occurrence and comment at event restoration into record data	Select this to output comments in each record data.

*1 File space can be saved by setting to only output the event name to the header and not to the record. In this case, the event name output to the header can be referred from the event number in the record data.

*2 Data value is rounded to 0.1 millisecond unit when the high speed sampling is specified, and to 100 millisecond unit when the general sampling is specified.

CSV output

Set contents to output to CSV files.

This is enabled when "CSV file" is selected in the [File format] tab.

Window

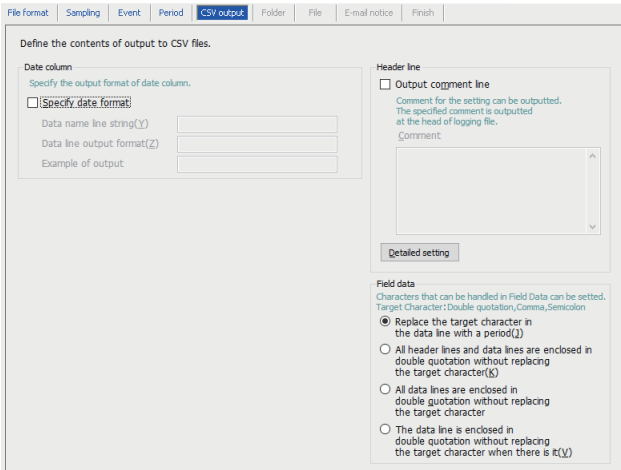

The settings are same as mentioned in the following section.

☞ Page 165 CSV output

However, the following items do not exist.

- "Output date column" in the date column
- Index column
- Trigger information column

Folder

Set the save destination of the saved file and switching timing of the saved folder.

Window

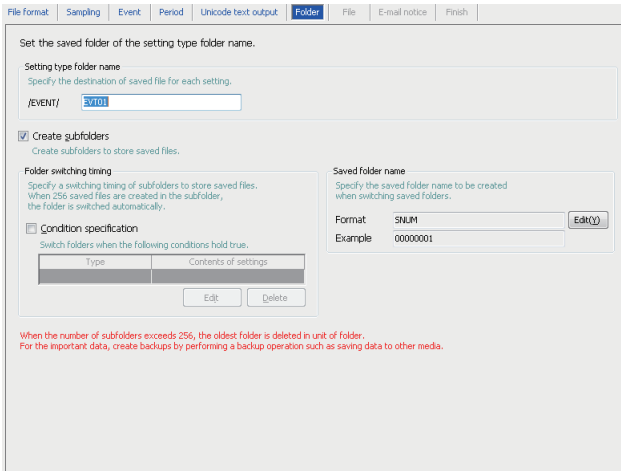

The settings are same as mentioned in the following section.

📖 Page 168 Folder

File

Set the save destination of an event logging file and the switching timing of a saved file.

Window

2

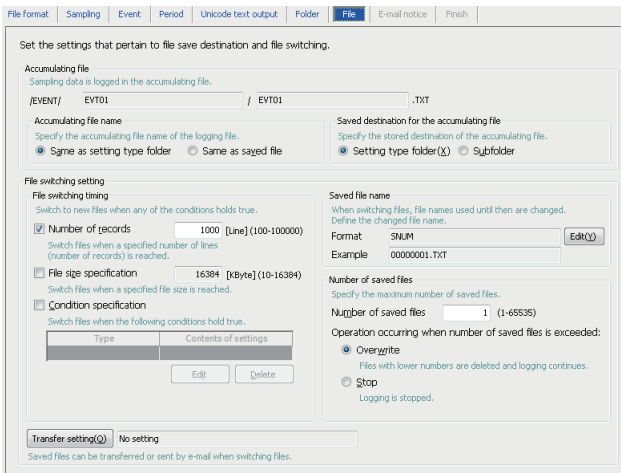

The settings are same as mentioned in the following section.

☞ Page 171 File

However, "Trigger logging unit" cannot be specified for the file switching timing.

E-mail notice

Set the content of e-mail notification at an event occurrence.
 This is enabled when "CSV file" is selected in the [File format] tab.

Window

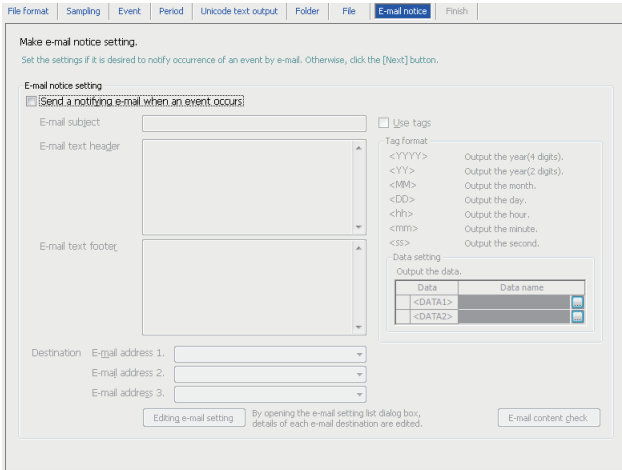

Displayed items

Item	Description		
Send a notifying e-mail when an event occurs	Select this to send a notification e-mail at an event occurrence.		
E-mail subject	Enter the notification e-mail subject. (Up to 64 characters)		
E-mail text header*1	Specify a string for the header portion of the e-mail text. (Up to 512 characters)		
E-mail text footer*1	Specify a string for the footer portion of the e-mail text. (Up to 512 characters)		
Destination	E-mail address 1. to 3.	Select e-mail destinations from the destination group registered on the "E-mail setting" screen.	
	[Editing e-mail setting] button	Displays the "E-mail setting" screen. Page 140 E-mail setting	
Use tags	—	Select this to validate tag input. The sent date/time and data can be added by specifying the following tag items.*2*3 <YYYY>: Year (4 digits) <YY>: Year (2 digits) <MM>: Month (2 digits) <DD>: Day (2 digits) <hh>: Hour (2 digits) <mm>: Minute (2 digits) <ss>: Second (2 digits) <DATA1>:Content of data set to <DATA1> <DATA2>:Content of data set to <DATA2>	
	Data setting	Data	Select this to add a data to an e-mail subject or text.
		Data name	Displays the data name set to "<DATA1>" and "<DATA2>." Click the [...] button and set it on the displayed "Data setting" screen. Page 113 Data setting
[E-mail content check] button	Displays the "E-mail content check" screen.		

*1 The character codes that can be used are available in ASCII range.

*2 Total of 16 tags can be set for E-mail subject and E-mail text.

*3 Tags can be invalidated by adding another brackets. (The item enclosed with outer brackets can be handled as a string.)

Finish

Set an event logging name.

Window

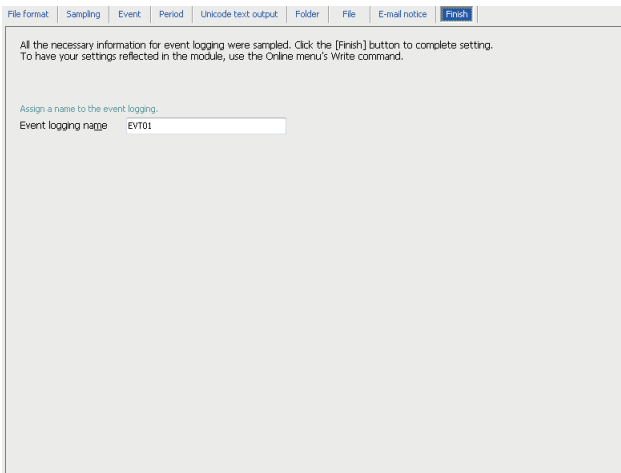

Displayed items

Item	Description
Event logging name	Specify the name of the setting being edited. (Up to 32 characters)

2.7 Report Setting

This section explains the settings for the report function.
 For details of the report function, refer to the following:

☞ Page 71 Report Function

Window

Click "Report setting" on the edit items tree.

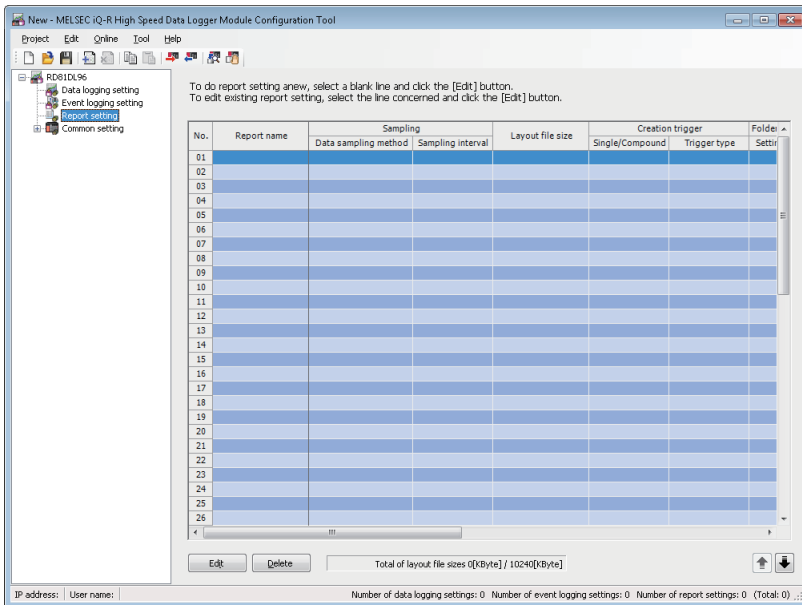

Displayed items

Item	Description	
Report name	Displays the report name.	
Sampling	Data sampling method	Displays the sampling method for report.
	Sampling interval	Displays the sampling interval of the target data.
Layout file size	Displays the size of an Excel layout file.	
Creation trigger	Single/Compound	Displays "Single" or "Compound" conditions.
	Trigger type	Displays the trigger type.
Folder	Setting type folder name	Displays the destination of saved files for each setting.
	Folder switching timing	Displays the switching timing for the subfolder.
	Saved folder name	Displays the information to be added to a subfolder name.
File	Saved file name	Displays the information to be added to a report file name.
	Number of saved files	Displays the number of saved files and the operation when the number of saved files is exceeded.
Transfer	File transfer	Displays if there is a file transfer.
	E-mail sending	Displays if there is an e-mail transmission.
Total of layout file sizes	Displays the total size of the Excel layout file of all report settings.	
[Edit] button	Displays the setting screen to edit the selected report setting. ☞ Page 195 Report setting	
[Delete] button	Deletes the selected report setting.	

Report setting

Configure the settings of the report function in a wizard format.

Window

Click the [Edit] button on the report setting list.

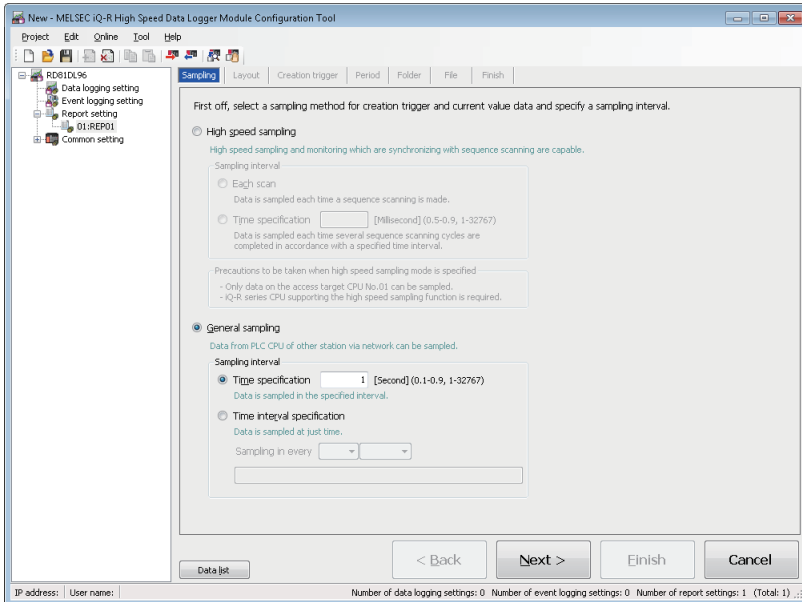

Displayed items

Item	Description	Reference
[Sampling] tab	Set a report creation trigger and interval for sampling current value data.	Page 196 Sampling
[Layout] tab	Set the layout of a report to be created.	Page 197 Layout
[Creation trigger] tab	Set a trigger condition for report creation.	Page 209 Creation trigger
[Period] tab	Set the period to perform report creation at the rise of the creation trigger condition.	Page 210 Period
[Folder] tab	Set the save destination of the saved file and switching timing of the saved folder.	Page 211 Folder
[File] tab	Set the report file save destination and saved file name.	Page 212 File
[Finish] tab	Set a report name.	Page 213 Finish
[Data list] button	Displays a list of data being used by all the report setting.	Page 110 Data list
[Back] button	Moves back to the previous setting tab.	—
[Next] button	Moves forward to the next setting tab.	—
[Finish] button	Reflects the settings and closes the screen.	—

Sampling

Set a report creation trigger and interval for sampling current value data.

Window

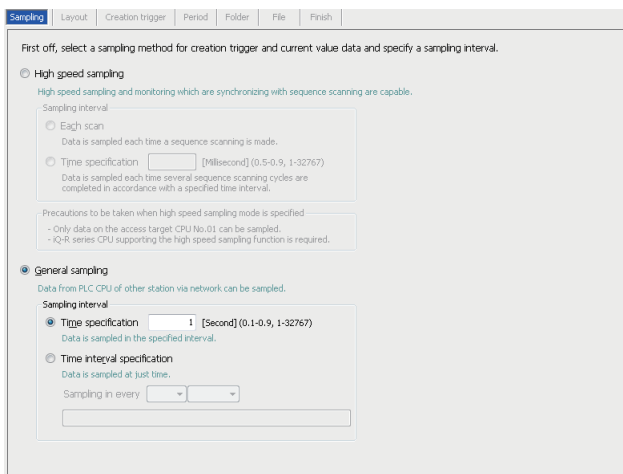

Displayed items

Item		Description			
High speed sampling	—	Select this to monitor the high-speed report creation triggers and sample current values that are synchronized with a sequence scan.			
	Sampling interval	<table border="1"> <tr> <td>Each scan</td> <td>Select this to sample data in each sequence scan.</td> </tr> <tr> <td>Time specification</td> <td>Select this to sample data with the specified interval. Specify a sampling interval.</td> </tr> </table>	Each scan	Select this to sample data in each sequence scan.	Time specification
Each scan	Select this to sample data in each sequence scan.				
Time specification	Select this to sample data with the specified interval. Specify a sampling interval.				
General sampling	—	Select this to monitor the report creation trigger and sample the current values that are not synchronized with a sequence scan.			
	Sampling interval	<table border="1"> <tr> <td>Time specification</td> <td>Select this to sample data with the specified interval. Specify a sampling interval.</td> </tr> <tr> <td>Time interval specification</td> <td>Select this to sample data with the specified time interval (hour, minute, or second) from exactly midnight everyday, exact hour, or exact minute. Specify the sampling interval and time unit.</td> </tr> </table>	Time specification	Select this to sample data with the specified interval. Specify a sampling interval.	Time interval specification
Time specification	Select this to sample data with the specified interval. Specify a sampling interval.				
Time interval specification	Select this to sample data with the specified time interval (hour, minute, or second) from exactly midnight everyday, exact hour, or exact minute. Specify the sampling interval and time unit.				

Point

When selecting "High speed sampling", a device to be sampled at high speed needs to be set in the creation trigger, period, and folder switching timing in the report setting.

When a device to be sampled at high speed is not set, "High speed sampling" is switched to "General sampling" at the report setting completion, since the current value does not need to be sampled at high speed.

Layout

Set the layout of a report to be created.

Excel is required to configure the layout setting.

For the available Excel versions, refer to the following:

📖 MELSEC iQ-R High Speed Data Logger Module User's Manual (Startup)

Window

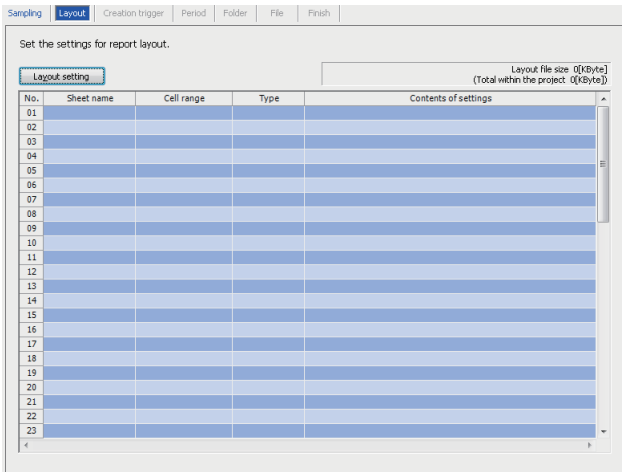

Displayed items

Item	Description
[Layout setting] button	Starts Excel and displays the "Layout setting" screen. 📖 Page 199 Layout setting
Layout file size	Displays the size of the layout file being edited.
Sheet name	Displays the name of the sheet set with the layout.
Cell range	Displays the range of cells set with the layout.
Type	Displays the type of data laid out.
Contents of settings	Displays the contents of the layout setting.

Precautions

- Excel macros must be executed to configure the layout settings. Configure layout settings after setting Excel to execute macros.
 - The layout settings cannot be configured if the VBA function is not installed when installing Excel.
 - Some of the functions added to Excel 2010 and later cannot be used.
 - When activating the "Layout setting" screen by clicking the [Layout setting] button, the "Microsoft Office Excel Security Notice" screen may appear. In that case, click the [Trust all from publisher] button within 60 seconds. An error screen is displayed if this button is not clicked within *160 seconds. In that case, open the "Layout setting" screen with the following procedure.
 - ➊ Click the [OK] button on the error screen and close it.
 - ➋ Click the [Trust all from publisher] button on the "Microsoft Office Excel Security Notice" screen, and close it.
 - ➌ Follow the message on the displayed screen and close Excel.
 - ➍ After closing the Excel, click the [Layout setting] button again to display the "Layout setting" screen.
- *1 When the message that the digital signature has expired appears, click the [Enable Macros] button to open the "Layout setting" screen.
- When activating the "Layout setting" screen by clicking the [Layout setting] button, the "Windows Security" screen may appear. In that case, change the setting with any of the following procedure and activate the "Layout setting" screen.

Adding trusted locations

- ➊ Click the [Cancel] button on the "Windows Security" screen to close the window.
- ➋ Start Excel, and select [File] ⇒ [Options].
- ➌ Click the [Trust Center Settings] button on the [Trust Center] tab.
- ➍ Click the [Add new location] button in the [Trusted Locations] tab.
- ➎ Specify the path where Configuration Tool is installed to "Path" in the "Microsoft Office Trusted Location" screen.
- ➏ Click the [OK] button.
- ➐ After closing Excel, click the [Layout setting] button again to activate the "Layout setting" screen.

Enabling all macros

- ➊ Click the [Cancel] button on the "Windows Security" screen to close the window.
 - ➋ Start Excel, and select [File] ⇒ [Options].
 - ➌ Click the [Trust Center Settings] button on the [Trust Center] tab.
 - ➍ Select "Enable all macros (not recommended; potentially dangerous code can run)" on the [Macro Settings] tab.
 - ➎ After closing Excel, click the [Layout setting] button again to activate the "Layout setting" screen.
 - ➏ After completing the layout setting, return the setting of Excel to the original.
- When activating the "Layout setting" screen by clicking the [Layout setting] button, the report layout setting may not be able to be configured after starting Excel due to add-ins installed in Excel. In this case, disable the add-ins by the following procedure.
 - ➊ Start Excel, and select [File] ⇒ [Options].
 - ➋ Select the target add-in type from "Manage" in the [Add-Ins] tab, and click the [Go] button.
 - ➌ Unselect the checkbox of add-ins, and click the [OK] button.
 - ➍ Close Excel.

Layout setting

Set the report layout by specifying data and cells of Excel to be sampled.

Window

Click the [Layout setting] button on the [Layout] tab on the report setting screen.

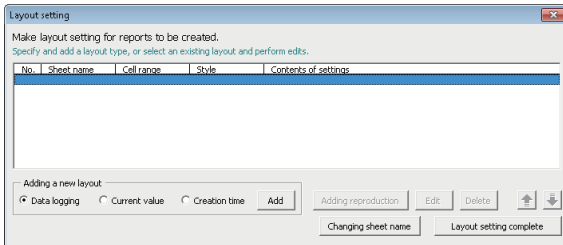

Displayed items

Item	Description	
Layout setting list	Displays a list of contents of the layout setting.	
Adding a new layout	Data logging	Select this to set the data logging file as the layout target data.
	Current value	Select this to set the layout target data to the device value in the CPU module at the time of report creation.
	Creation time	Select this to set the layout target data to the time of report creation.
	[Add] button	Displays the layout screen for the selected target data. Page 201 Data logging layout, Page 207 Current value layout, Page 208 Creation time layout
[Adding reproduction] button	Adds the selected layout by copying it.	
[Edit] button	Displays the setting screen to edit the selected layout.	
[Delete] button	Deletes the selected layout.	
[Changing sheet name] button	Changes the layout file sheet name. The report cannot be created correctly when the sheet name is changed without using this button.	
[Layout setting complete] button	Reflects the settings and closes the screen.	

Precautions

- Configure fixed strings, format settings (such as font type and color), and graphs while the "Layout setting" screen is displayed.
- The layout file size of reports sent by e-mail is up to 512 KB.
- The size of layout files created by the layout settings vary depending on the version of Excel installed. Therefore, the upper limit of the layout file size may be exceeded by editing the project configured with the layout settings on a personal computer installed with a different version of Excel. Plan the layout file with some allowance for its size.
- In the merged cells, specify the upper left cell as a range.

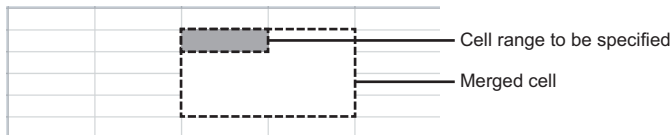

- Do not specify the following types for the format of cells specified in the cell range. If specified, data may not be output normally.
Strings
User defined type contains @
- When clicking the [Layout Setting Complete] button, the values in the cells within the set layout setting range is cleared.
- Do not add the digital signature to the layout file.
The report files to which the digital signatures are added cannot be created.
- Do not use the external data import function of Excel. The report files with the external data import function cannot be created.
- Do not open other Excel files in the Excel same as the layout settings during layout settings. To open other Excel files, start new Excel.

Data logging layout

Configure the layout settings of the records in the data logging file to be output to the report.

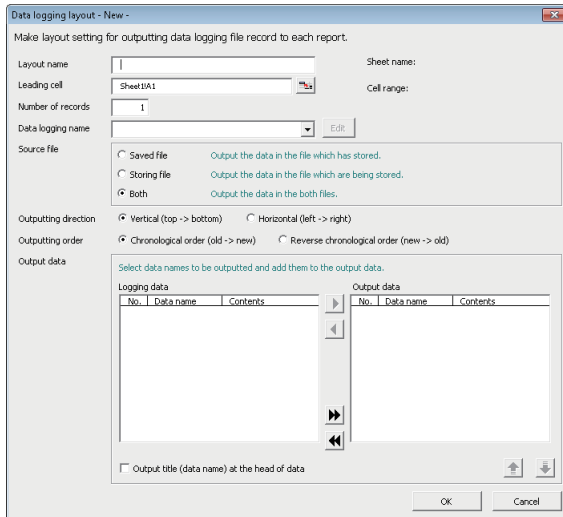

Window

To add new layout, select "Data logging" on the "Layout setting" screen, and click the [Add] button.



2

Displayed items

Item	Description	
Layout name	Enter the name of the layout. (Up to 32 characters)	
Leading cell	Specify the leading cell to output the records in the data logging file. Can also be set with the input assistance button.	
 button (Input assistance button)	By clicking this button, the leading cell can be selected with the mouse.  Page 202 Specifying the leading cell	
Sheet name	Displays the sheet name of the layout being edited.	
Cell range	Displays the cell range of the layout being edited.	
Number of records	Specify the number of records to output from the leading cell.	
Data logging name	Select the data logging name. To add another data logging setting, select "(Add)" and click the [Edit] button.  Page 147 Data Logging Setting	
Source file	Select the file of which data logging records are to be output.	
Outputting direction	Select the direction to output the records of the data logging file.	
Outputting order	Select the order to output the records of the data logging file.	
Output data ^{*1*2*3}	Logging data	Select the data logging name to display output data candidates.
	Output data	Displays the selected output data.
Output title (data name) at the head of data. ^{*4}	Select this to output the title (data name) in the first row (first row when the output direction is vertical) from the leading cell.	

*1 The following format is automatically set in the cell where logging output date/time is set.

yyyy/mm/dd ddd hh:mm:ss

To change the display format of date/time, change the cell format in Excel. However, a display error ± 1 on the value of the last digit may occur due to a rounding error ^{*5}.

(Example) To display year, month, day, hour, minute, second, and millisecond information, specify the user defined display format below.
m/d/yyyy hh:mm:ss.000

*2 When the data type of the logging data is string, characters outside the Unicode Basic Multilingual Plane are output by replacing with a period (.). ( Page 344 Usable characters while outputting the file)

If a string terminator (0) is used halfway in the data, the data is output without replacing a string terminator (0) with a period (.), and the subsequent data is not output.

*3 When using the string type data, specify the size considering the character code. ( Page 25 String type data)

*4 Character strings of "Logging output date" and "Index" are output for the date information and index.

*5 A floating-point type approximate value including an error is stored as date information in Excel. Therefore, the value of the last digit may be displayed shifting ± 1 due to rounding calculation even if the display accuracy of date information in Excel is the same as that of date information in sampled CSV files or date information displayed by GX LogViewer.

Point

When "Saved file" is selected as the output source file, adjust processing so that the creation trigger occurs after the file gets switched once.

By configuring the following settings, report files corresponding to data logging files one-to-one basis can be created.

- Select "Saved file" in "Source file" on the "Data logging layout" screen of the report settings. (Page 201 Data logging layout)
- Select "At the data logging file switching" on the "Trigger condition setting" screen of report settings. (Page 209 Creation trigger)

By setting the following settings, only trigger logging data before and after the rising of trigger condition can be output to a report.

- Select "Trigger logging unit" in the [file] tab of the data logging settings.
- Select "Saved file" in "Source file" on the "Data logging layout" screen of the report settings. (Page 201 Data logging layout)
- Select "At the data logging file switching" on the "Trigger condition setting" screen of report settings. (Page 209 Creation trigger)

Specifying the leading cell

Operating procedure

1. Click the input assistance button on the "Data logging layout" screen.
2. Specify range of cells to layout data with the mouse, and click the [OK] button or the button.

Point

While selecting the cell range, a screen with the title "RefEdit" may be displayed, but ignore it and continue to select the leading cell.

Source file

Select the file of which data logging records are to be output.

Select from accumulating file and saved file in SD memory card.

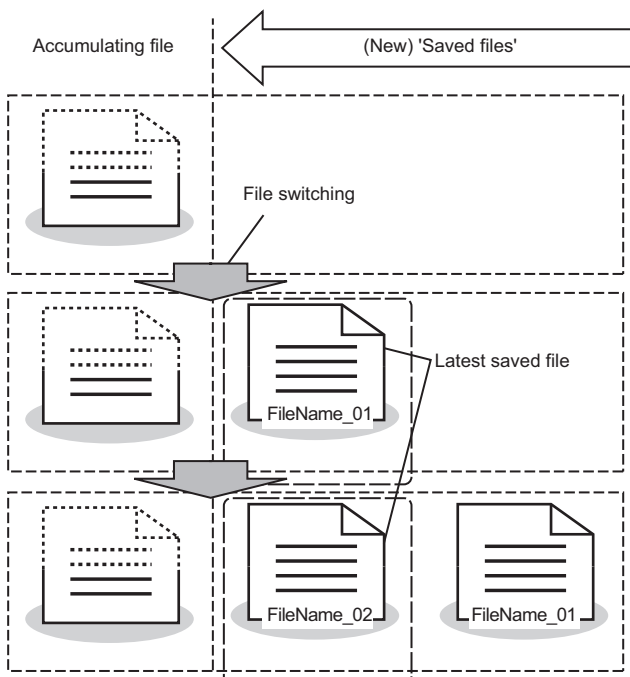

- **Saved file:** Outputs the data that have completed to be stored.

The latest saved file (one file) is output in a report from among the data logging files (saved files), which have completed to be stored with every file switching. Reports can be created from the logging data divided according to the data condition or time, or from the logging data before and after the trigger conditions rise of trigger logging. Reports can be output according to the number of records which may differ in each saved file.

Ex.

Create a per-batch or per-lot report when the data logging file is switched at the timing of the end of a batch or lot.

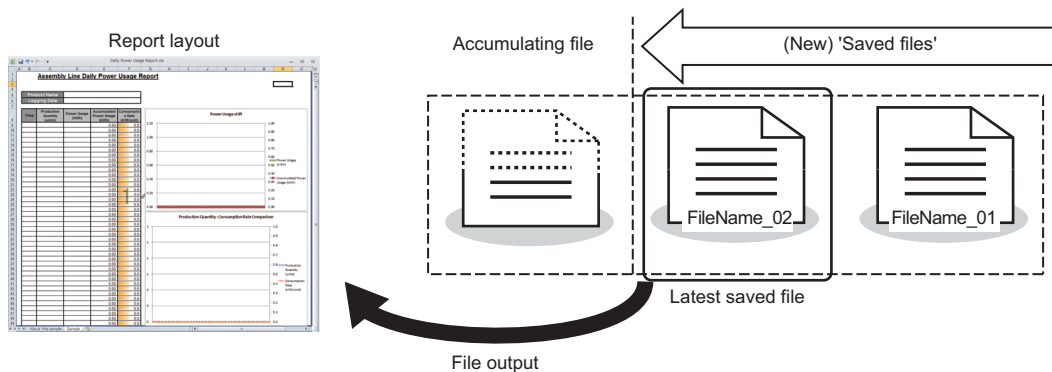

- **Accumulating file:** Accumulating data is output.

A report can be output from the accumulating data logging file. When creating a report file such as daily report or per process report, the processing can be tracked by creating a report file from the data being created.

Ex.

Output the latest logging data which is being stored when the data logging file is switched at the timing of the end of a batch or lot.

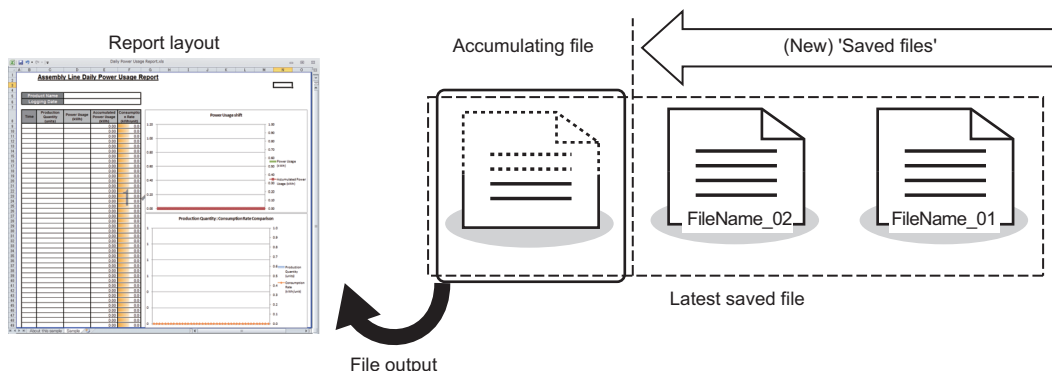

- **Both:** Both the data are output.

A report is created from the data of both the latest saved file and the accumulating file. The latest logging data up to the timing when the creation trigger is satisfied can be output to a report by specifying the number of records.

At this time, set the number of the file switching records of the data logging file so it is always greater than the number of records to be output to a report.

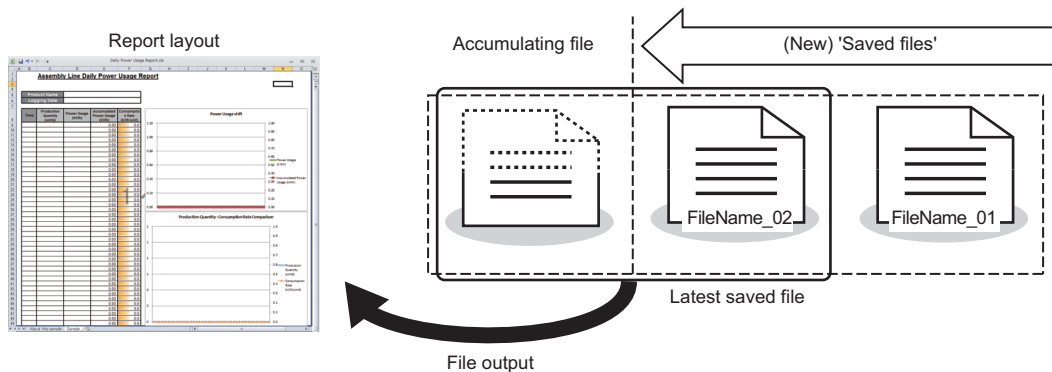

- Difference of report operation due to difference of source files

The following explains the report operation of each source file: "Saved file," "Accumulating file," and "Both."

The following shows how data is output when

-'100' is set to the number of records and "Chronological order (old → new)" is set to the output order in the data logging layout setting

-50 records exist in the saved file and 30 records exist in the accumulating file when a report creation trigger is satisfied.

Ex.

When the source file is "Saved file", 50 records worth of data are output to the report file from the latest saved file. (Because the specified number of records is 100, the remaining 50 records become blank.)

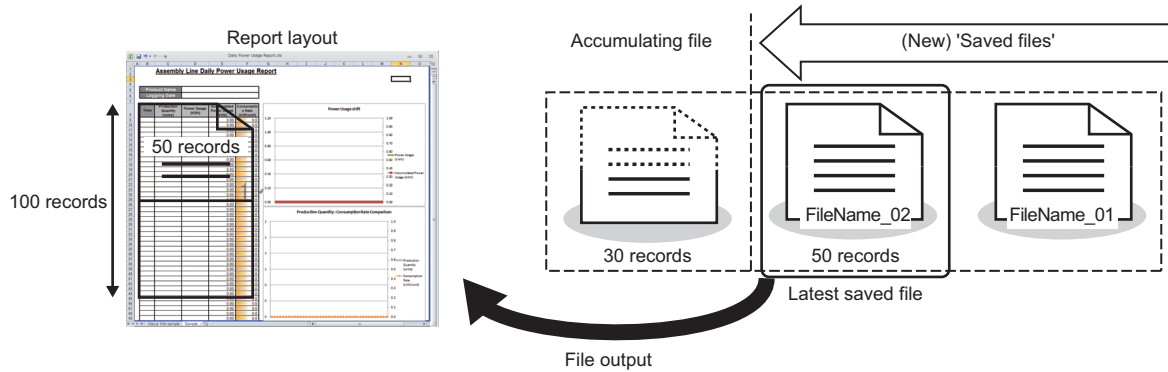

Ex.

When the source file is "Accumulating file", 30 records worth of data are output to the report file from the accumulating file. (Because the specified number of records is 100, the remaining 70 records become blank.)

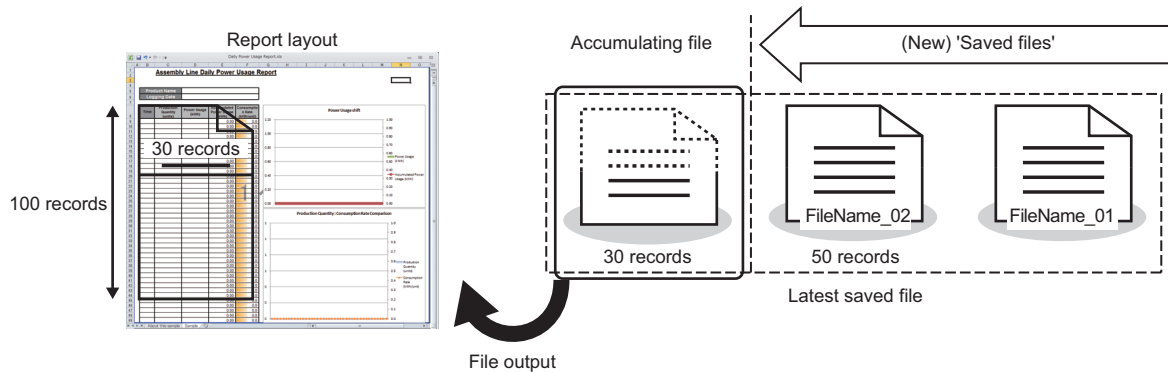

Ex.

When the source file is "Both", a total of 80 records worth of data: 30 records worth of data from the accumulating file and 50 records worth of data from the latest saved file are output to the report file. (Because the specified number of records is 100, the remaining 20 records become blank.)

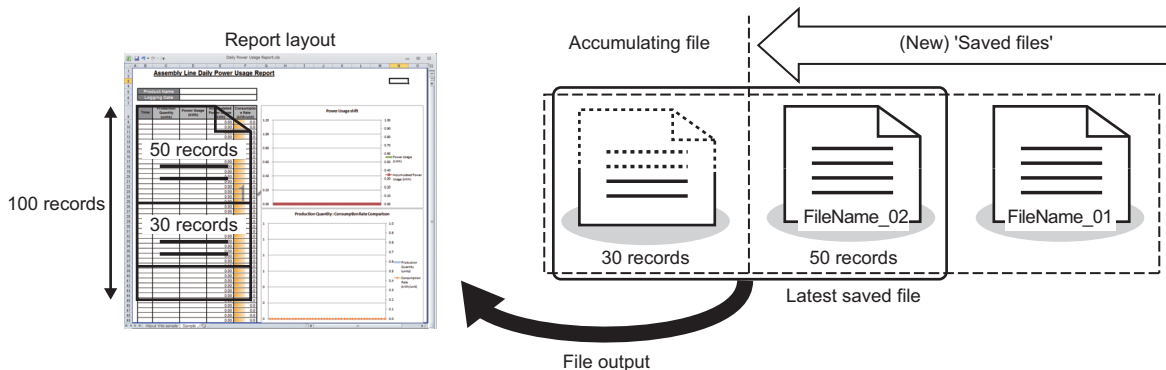

The specified number of records worth of data is read from the accumulating file and output to the report. If the required number of records worth of data does not exist in the accumulating file, data are read from the latest saved file. However, if data does not exist in the accumulating file, data are read from the latest saved file and the saved file one before the accumulating file.

- Number of records in layout is fewer than that in the source files

The number of records specified from the latest saved file or the accumulating file is output.

Ex.

When the source is "Both" and number of layout records is 40, 30 records from the accumulating file and 10 records from the latest saved file are output. (The remaining older 40 records in the latest saved file are not pasted.)

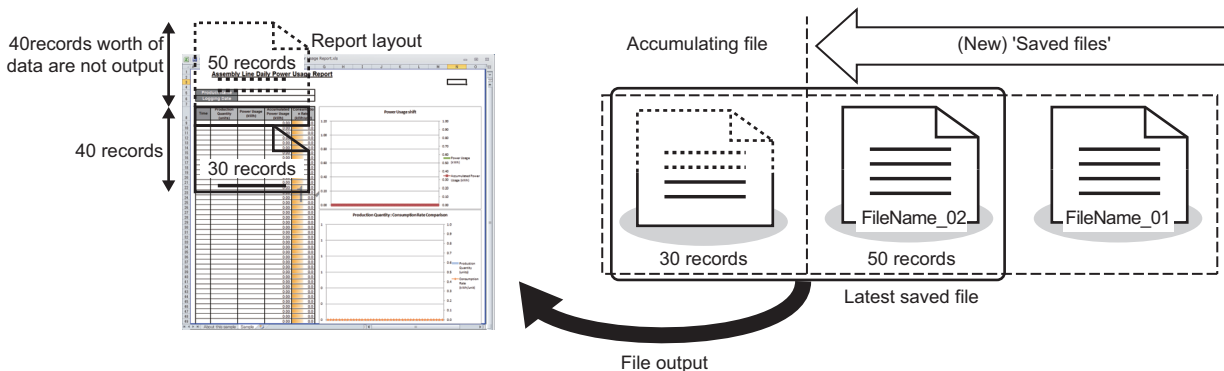

- When the condition of a creation trigger is satisfied immediately after the output target data logging file is switched An unintended operation may occur due to the accumulating file which only has a header or too few number of records. For example, when "At the time of the data logging file is switched" is selected as the creation trigger, only a header or one record worth of data may exist in the accumulating file. Therefore, no record or only one record may output when the source file is set to "Accumulating file."

Adjust the system so that the creation trigger is satisfied with the necessary number of records worth of data exists.

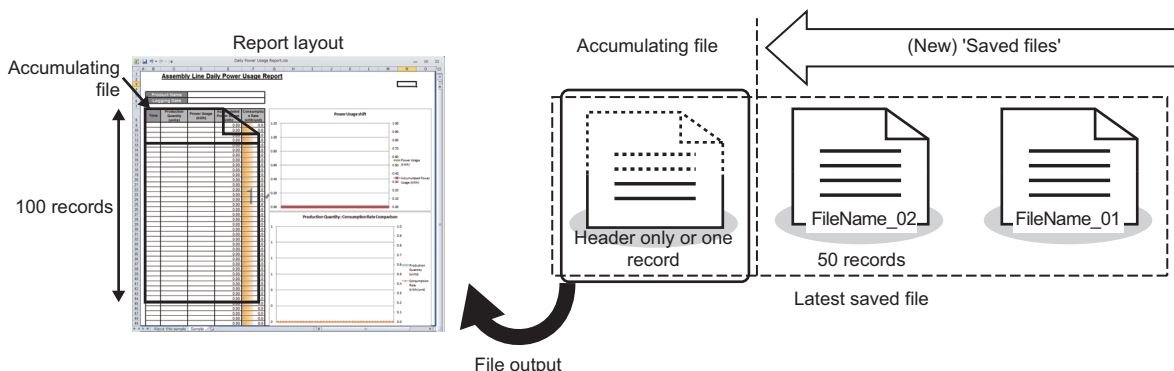

■Outputting direction

Select the direction (vertical/horizontal) to output the records in the data logging file.

- When vertical is specified

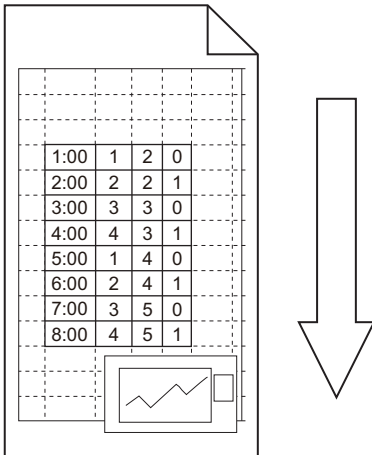

- When horizontal is specified

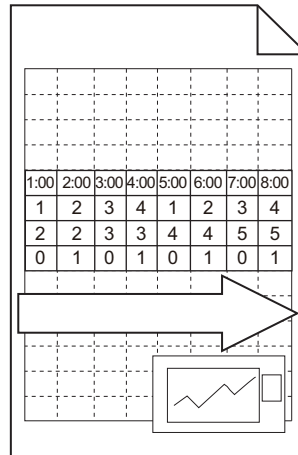

■Outputting order

Select the order to output the records of the data logging file.

- When oldest order is specified

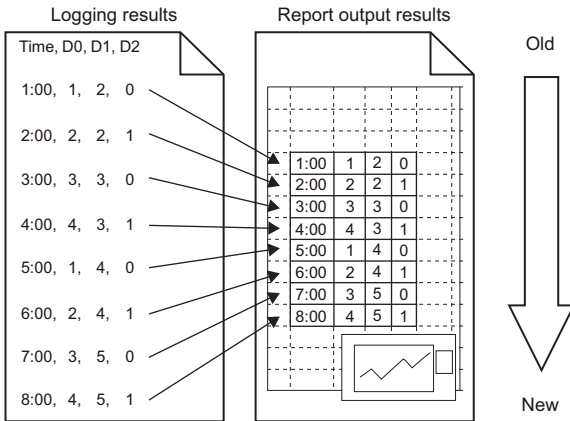

- When newest order is specified

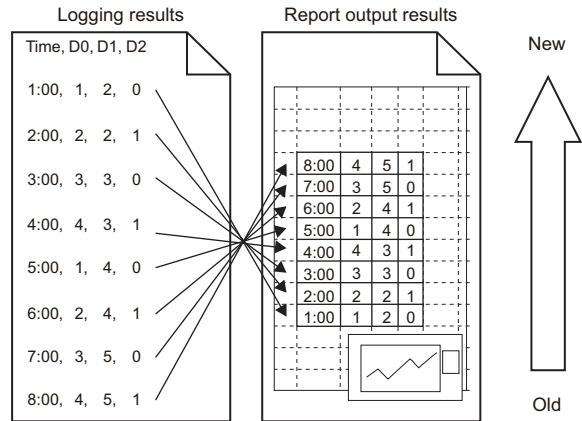

Current value layout

Configure the layout settings of the current value to be output to the report.

Window

To add new layout, select "Current value" on the "Layout setting" screen, and click the [Add] button.

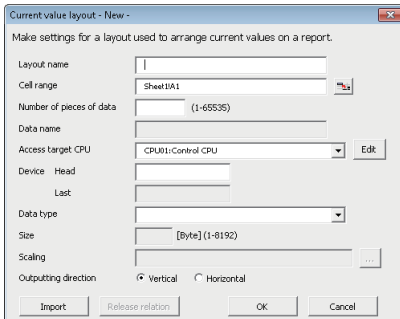

Displayed items

Item	Description	
Layout name	Enter the name of the layout. (Up to 32 characters)	
Cell range	Specify the range of cells to output the current value. Can also be set with the input assistance button.	
button (Input assistance button)	Click to select the range of cells with the mouse.	
Number of pieces of data	Specify the number of consecutive devices to allocate within the cell range. The amount of data specified here is output in the order specified for output direction.	
Data name	Displays the start device. For related data, an icon is displayed.	
Access target CPU ^{*1}	Select the access target CPU. To add an access target CPU, select "(Add CPU)" and click the [...] button. Page 134 Access target CPU setting	
Device	Head ^{*1}	Set the start device.
	Last	Displays the last device calculated from the number of pieces of data, data type, and size.
Data type ^{*1*2}	Select the data type.	
Size ^{*1*3}	If the data type is "String" or "Raw", the size must be specified.	
Scaling	Set the scale conversion equation for data. The "Scaling" screen is displayed by clicking the [...] button. Page 153 Scaling	
Outputting direction	Select the direction to output the records having current value.	
[Import] button	Imports global labels or device comments. Page 116 Importing global labels Page 123 Importing common device comments	
[Relation release] button	Disables relations with global labels. Page 121 Release relations to global labels	

*1 These items cannot be edited for related data.

*2 When the data type is string, characters outside the Unicode Basic Multilingual Plane are output by replacing with a period (.).
If a string terminator (0) is used halfway in the data, the data is output without replacing a string terminator (0) with a period (.), and the subsequent data is not output.

*3 When using the string type data, specify the size considering the character code. (Page 25 String type data)

Creation time layout

Configure the layout settings of the creation time to be output to the report.

Window

To add new layout, select "Creation time" on the "Layout setting" screen, and click the [Add] button.

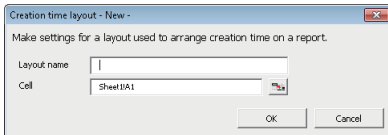

Displayed items

Item	Description
Layout name	Enter the name of the layout. (Up to 32 characters)
Cell	Specify the cell to output the creation time. Can also be set with the input assistance button.
 button (Input assistance button)	Click to select the cell with the mouse.

Point

The following format is automatically set in the cell where creation time is set.

yyyy/mm/dd ddd hh:mm:ss

To change the display format of date/time, change the cell format in Excel. However, a display error ± 1 on the value of the last digit may occur due to a rounding error^{*1}.

(Example) To display year, month, day, hour, minute, second, and millisecond information, specify the user defined display format below.

m/d/yyyy hh:mm:ss.000

*1 A floating-point type approximate value including an error is stored as date information in Excel. Therefore, the value of the last digit may be displayed shifting ± 1 due to rounding calculation even if the display accuracy of date information in Excel is the same as that of date information in sampled CSV files or date information displayed by GX LogViewer.

Creation trigger

Set the trigger conditions for report creation.

There are two types of trigger conditions depending on the number of conditions combined.

- Single condition (when the number of conditions is 1)
- Compound condition (if multiple conditions are combined)

Window

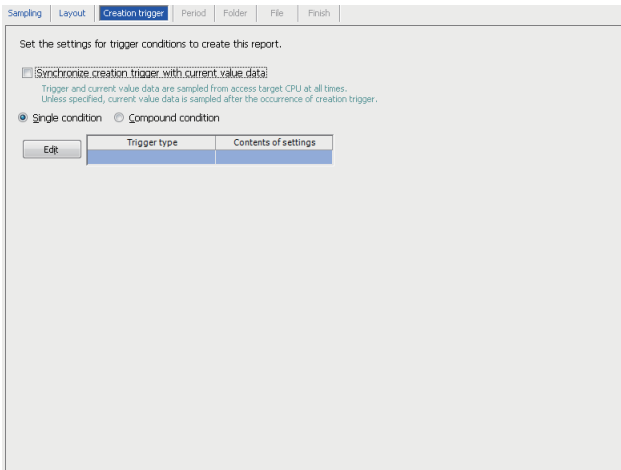

Displayed items

Item	Description
Synchronize creation trigger with current value data	Select this to sample creation triggers and current value data simultaneously at all the time from the access target CPU.
Single condition	Select this to set a single trigger condition. The settings are same as mentioned in the following section. *1 Page 158 Trigger (single condition)
Compound condition	Select this to set a combination of multiple trigger conditions. The settings are same as mentioned in the following section. *1 Page 160 Trigger (compound condition)

*1 "At the data logging file switching" can be selected on the "Trigger condition setting" screen.

Point

By configuring the following settings, report files corresponding to data logging files one-to-one basis can be created.

- Select "Saved file" in "Source file" on the "Data logging layout" screen of the report settings. ([Page 201 Data logging layout](#))
- Select "At the data logging file switching" on the "Trigger condition setting" screen of report settings. ([Page 209 Creation trigger](#))

By setting the following settings, only trigger logging data before and after the rising of trigger condition can be output to a report.

- Select "Trigger logging unit" in the [file] tab of the data logging settings.
- Select "Saved file" in "Source file" on the "Data logging layout" screen of the report settings. ([Page 201 Data logging layout](#))
- Select "At the data logging file switching" on the "Trigger condition setting" screen of report settings. ([Page 209 Creation trigger](#))

Period

Set the period to perform report creation at the rise of the creation trigger condition.

Window

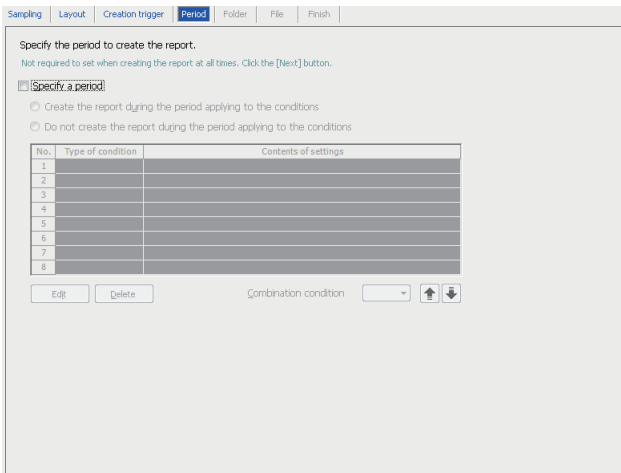

The settings are same as mentioned in the following section.

☞ Page 156 Period

Folder

Set the save destination of the saved file and switching timing of the saved folder.

Window

2

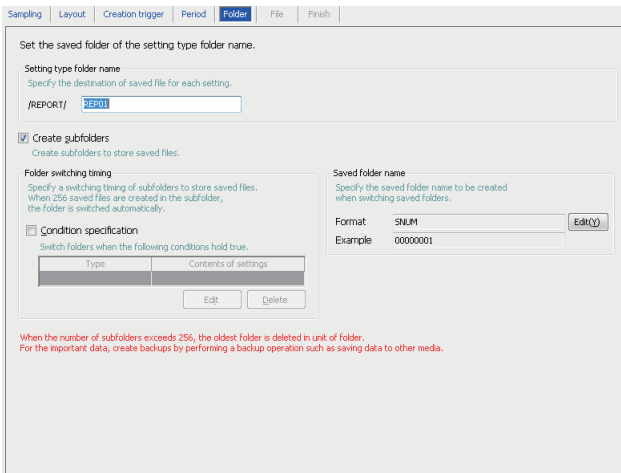

The settings are same as mentioned in the following section.

 Page 168 Folder

File

Set the report file save destination and the saved file name.

Window

The settings are same as mentioned in the following section.

☞ Page 171 File

However, the following items do not exist.

- Accumulating file
- File switching timing

Finish

Set a report name.

Window

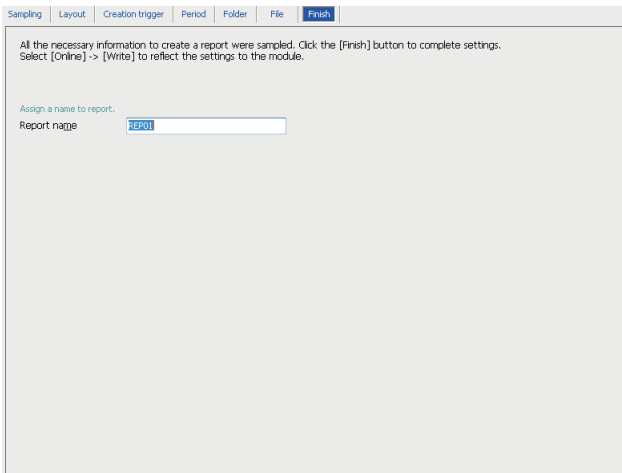

Displayed items

Item	Description
Report name	Specify the name of the setting being edited. (Up to 32 characters)

2.8 Online

Perform online operations for the high speed data logger module connected to the network.

Transfer setup

Set the connection destination information and edit.

Perform access authentication at the time of actual connection.

For access authority of each user, refer to the following:

 Page 88 Access authority of Configuration Tool

Window

Select [Online] ⇒ [Transfer setup].

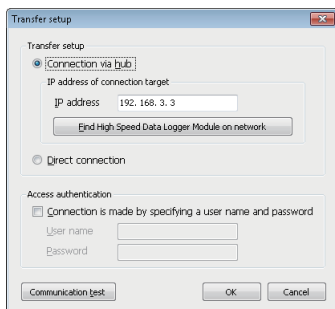

Displayed items

Item		Description	
Transfer setup	Connection via hub	—	Select this to connect via the network.
		IP address	Set the IP address of the connection destination.
		[Find High Speed Data Logger Module on network] button	Displays the "Find High Speed Data Logger Module" screen.  Page 215 Find high speed data logger module
	Direct connection	Select this to connect directly to the high speed data logger module.	
Access authentication	Connection is made by specifying a user name and password	—	Select this to perform the access authentication.
		User name	Specify the user name to login with.
		Password	Specify the password for the user name to login with.
[Communication test] button	Conduct a communication test with the configured connection destination.		

Find high speed data logger module

Search the high speed data logger module on the network that belongs to the configuration computer.

Operating procedure

1. Click the [Find high speed data logger module on the network] button on the "Transfer setup" screen.
2. Select from the list, the high speed data logger module for connection.
3. Click the [OK] button.

Point

The first line (up to 160 characters) up to the comment line feed of the project written in the module is displayed in "Comment."

Precautions

When more than one high speed data logger module having same IP address are displayed, multiple high speed data logger modules with the same IP address may exist on the same network. Correct the IP address of each high speed data logger module.

The high speed data logger module cannot be searched normally in the configuration where multiple IP addresses are enabled at the same time, in the configuration computer.

- IP addresses are assigned to each of multiple Ethernet ports of a configuration personal computer.
- When a wireless LAN setting is enabled in addition to Ethernet port of the configuration personal computer
- Multiple IP addresses are assigned to a single network device (Ethernet port) of a configuration personal computer.

Online data operation

Read, write, and verify the settings (project).

Read

Read the settings from the high speed data logger module set in "Transfer setup."

Operating procedure

Select [Online] ⇒ [Read].

Write

Write the settings to the SD memory card in the high speed data logger module which is set in "Transfer setup."

Operating procedure

Select [Online] ⇒ [Write].

Precautions

While the write (update settings) processing is being performed, all functions including the data logging function, event logging function, and report function stop.

Network settings cannot be reflected by only performing the data write. Update the settings by performing one of the following operations.

- "Update settings" of module diagnostics ( Page 218 Module diagnostics)
- Turning ON from OFF or resetting the CPU Module

Verify

Verify the settings for the project being edited and settings for the high speed data logger module which is set in "Transfer setup."

Operating procedure

Select [Online] ⇒ [Verify].

Diagnostics

Connect a personal computer to the running high speed data logger module, then check the operating status of the module and operate the module.

Window

Select [Online] ⇒ [Diagnostics].

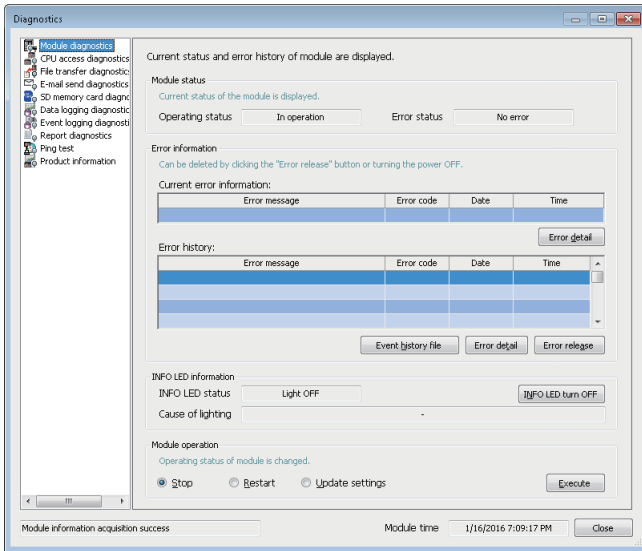

Displayed items

Item	Description	Reference	
Diagnostic item tree	Module diagnostics	Change the operating status of the high speed data logger module. In addition, display the operating status and error logs for the high speed data logger module.	Page 218 Module diagnostics
	CPU access diagnostics	Displays the status of the access target CPU module.	Page 220 CPU access diagnostics
	File transfer diagnostics	Displays the results of file transfer to a file server.	Page 221 File transfer diagnostics
	E-mail send diagnostics	Displays the results of e-mail sending.	Page 222 E-mail send diagnostics
	SD memory card diagnostics	Displays the current status and usage status, changes access status, clears logging files, and formats SD memory card.	Page 223 SD memory card diagnostics
	Data logging diagnostics	Displays the error codes for each data logging.	Page 224 Data logging diagnostics
	Event logging diagnostics	Displays the error codes of each event logging.	Page 226 Event logging diagnostics
	Report diagnostics	Displays the error codes for each report.	Page 227 Report diagnostics
	Ping test	Tests the network connection status of target devices (such as mail server and FTP server) specified by the high speed data logger module.	Page 228 Ping test
Product information	Display the product information of a module.	Page 229 Product information	

Module diagnostics



Change the operating status of the high speed data logger module. In addition, display the operating status and error logs for the high speed data logger module.

Window

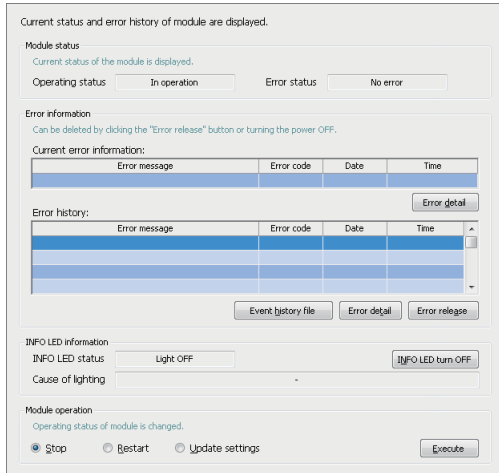
Click "Module Diagnostics" from diagnostic items tree on the "Diagnostic" screen.



Displayed items

Item		Description
Module status	Operating status	Displays current operating status of the module.
	Error status	Displays current error status of the module. <ul style="list-style-type: none"> Continue error: Indicates the status that the module has an error but is operable continuously. Stop error: Indicates the status that the module has an error and is inoperable.
Error information	Current error information	Displays the latest error code and its occurrence time.
	[Error detail] button	Current error details are displayed on the "Error/Event detail" screen.
	Error history	Displays the error history occurred. ^{*1}
	[Event history file] button	Displays the "Event history" screen to check error/event history.  Page 219 Event history
	[Error detail] button	Displays the "Error/Event detail" screen that displays details of the error selected in the error history list.
	[Error release] button	Clear the history of errors which have occurred and latest error information, and turn the "ERR LED" OFF.
INFO LED information	INFO LED status	Display the lighting status of INFO LED.
	[INFO LED turn OFF] button	INFO LED is turned OFF.
	Cause of lighting	Displays the details of turning the "INFO LED" ON . For the corrective actions for lighting factors, refer to the following:  Page 312 Module status area (UnG0 to 20)
Module operation	Stop	Select this to stop the high speed data logger module operations (data logging function, event logging function, and report function).
	Restart	Select this to restart the stopped high speed data logger module operations.
	Update settings	Select this to read the settings on the SD memory card and reflects them. ^{*2} While processing "Update settings," the operating status of the module is "Initialization in progress."
	[Execute] button	Executes the selected operation.

*1 Maximum 15 minor errors and 1 moderate error or major error are displayed.

If 15 minor errors have been displayed and any new minor error occurs, it will not be displayed. If the error of the same code has already been displayed, the date/time of occurrence and the detailed information about the relevant error are not updated.

Even if any new error occurs after a moderate error or major error occurs, it will not be displayed.

*2 While an error is occurring, settings cannot be updated.

While an error is occurring, perform "Update settings" in the following order.

① Execute module operation "Stop."

② Click the [Error release] button in the error information to clear the error status.

③ Execute module operation "Update settings."

Precautions

- While the "Update settings" is being performed, all functions including the Data logging function, Event logging function, and Report function stop.

Event history

Display a list of errors/event histories which have occurred in the module.

Window

Click the [Event history file] button on the "Diagnostic" screen to diagnose the module.

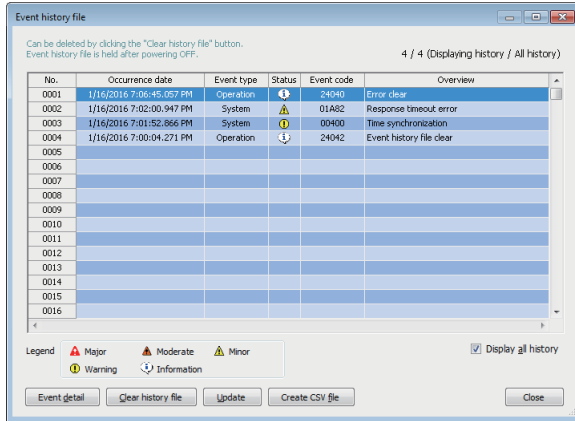

Displayed items

Item	Description
Displaying history/All history	Displays history records being displayed and all history records in the SD memory card.
Error/Event history list	Displays a list of errors/event histories.
[Event detail] button	Displays "Error/Event detail" screen that displays details of the error/event being selected in the error/event history list.
[Clear history file] button	Deletes the Error/Event history list.
[Update] button	Updates the latest Error/Event history list.
[Create CSV file] button	Saves the information of the Error/Event history file as a CSV file. Information about error and event of the Error/Event history displayed is to be saved. Select "Display all history" to save all the information.
Display all history	Select this to display all the history data stored in the SD memory card.

Precautions

- After the module is started, the date and time of the events which occurred till the synchronization of time, is not registered, and "-" is displayed.
- The event history is stored in the SD memory card. When the SD memory card is not inserted or the access status is "Access stop", the event history is not recorded.
- Even if an error, among the errors (maximum 16) registered in the error history, occurs more than once, only one instance will be displayed in the event history. The second and subsequent errors are not notified to the CPU module.
- Maximum 65536 records will be registered in the event history. When the number exceeds 65536, the old records will be deleted sequentially.

CPU access diagnostics

Display the status of the access target CPU module.

Window

Click the "CPU Access Diagnostics" from diagnostic items tree on the "Diagnostic" screen.

Access status of the access target CPU is displayed.

No.	Access target CPU name	Access status	Error code
01	Control CPU	Normal	No error
02			
03			
04			
05			
06			
07			
08			
09			
10			
11			
12			
13			
14			
15			
16			
17			
18			
19			
20			
21			
22			
23			
24			
25			
26			
27			
28			

Displayed items

Item	Description
Access target CPU name	Displays the CPU name of the access target CPU setting.
Access status	Displays the current access target CPU access status.
Error code	Displays the newest error code of the access target CPU. Page 263 Error Code List

File transfer diagnostics

Display the results of transfer to a file server.

Window

Click the "File transfer diagnostics" from diagnostic items tree on the "Diagnostic" screen.

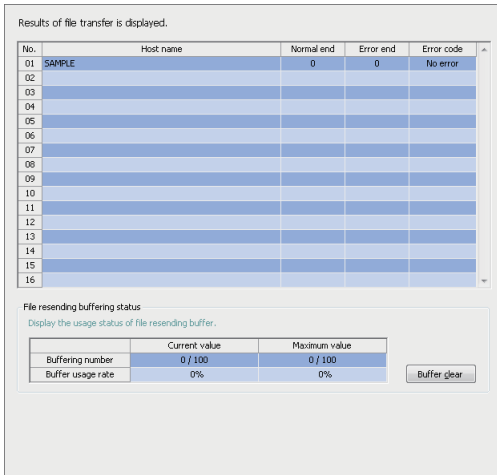

Displayed items

Item	Description	
Host name	Displays the host name.	
Normal end	Displays the number of times the file transfer has completed normally.	
Error end	Displays the number of times the file transfer has completed abnormally.	
Error code	Displays the newest error code of the file transfer. Page 263 Error Code List	
File resending buffering status	Buffering number ^{*1*2}	Displays the number of units of data stored in the file resend buffer memory. <ul style="list-style-type: none"> • Current value: Current number of buffering data/Set number of buffering data • Maximum value: The maximum number of buffering data up to the present/Set number of buffering data
	Buffer usage rate ^{*1*2}	Displays the usage rate of the file resend buffer memory. <ul style="list-style-type: none"> • Current value: Current usage rate • Maximum value: Maximum usage rate up to the present
	[Buffer clear] button	Clears the file resend buffer memory and cancels resending of all the files.

*1 "-" is displayed when "Resend when transfer failed" is not set in the optional setting of the file transfer setting.

*2 The maximum value is cleared when the high speed data logger module is turned OFF.

E-mail send diagnostics

Display the result of e-mail sending.

Window

Click the "E-mail Send Diagnostics" from diagnostic items tree on the "Diagnostic" screen.

Results of e-mail sending are displayed.

Result of e-mail sending to SMTP servers are displayed.
The reception confirmation is executed with the e-mail client.
When the mistake is found in the target e-mail address (Though the transmission to the SMTP server succeeds),
e-mail cannot be received by the e-mail client.

Normal end	Error end	Error code
0	0	No error

E-mail resending buffering status
Display the usage status of e-mail resending buffer.

	Current value	Maximum value
Buffering number	0 / 100	0 / 100
Buffer usage rate	0%	0%

[Buffer clear]

Displayed items

Item	Description	
Normal end	Displays the number of times that sending e-mail has completed normally.	
Error end	Displays the number of times e-mail transmission has completed abnormally.	
Error code	Displays the newest error code of the e-mail transmission. Page 263 Error Code List	
E-mail resending buffering status ^{*1}	Buffering number ^{*2}	Displays the number of units of data stored in the E-mail resend buffer memory. <ul style="list-style-type: none"> Current value: Current number of buffering data/Set number of buffering data Maximum value: The maximum number of buffering data up to the present/Set number of buffering data
	Buffer usage rate ^{*2}	Displays the usage rate of the E-mail resend buffer memory. <ul style="list-style-type: none"> Current value: Current usage rate Maximum value: Maximum usage rate up to the present
	[Buffer clear] button	Clears the e-mail resend buffer memory and cancels resending of all the e-mails.

*1 "-" is displayed when "Resend when sending failed" is not set in the optional setting of the E-mail setting.

*2 The maximum value is cleared when the high speed data logger module is turned OFF.

SD memory card diagnostics

Display the current status and usage status, change access status, clear logging files, and format SD memory card.

Window

Click the "SD Memory Card Diagnostics" from diagnostic items tree on the "Diagnostic" screen.

2

Displayed items

Item		Description
SD memory card information ^{*1*2}	Access status	Displays the current state of the SD memory card.
	Total capacity	Displays the total capacity of the SD memory card.
	Free capacity	Displays the free space on the SD memory card.
	Usage capacity	Displays the used space of the SD memory card.
	Usage rate	Displays the usage rate of the SD memory card.
SD memory card operation	Access stop	Select this to stop accessing the SD memory card. SD memory card can be detached safely from module once the operation is stopped.
	Access restart	Select this to start accessing the SD memory card again.
	[Execute] button	Executes the selected operation.
SD memory card format	Format	Select this to format the SD memory card.
	[Execute] button	Formats the card.
Logging file clear	File clear	Select this to delete data logging files, event logging files, and report files in the SD memory card.
	[Execute] button	Clears the logging file.

*1 Displayed "Free capacity" and "Usage rate" including the size of the file system.

*2 When the access status is other than "accessible," the information of the SD memory card such as total capacity, free space, and usage rate will be displayed as "-."

Point

After executing each operation, to restart the module operation, execute "Restart" of module operation (Page 218 Module diagnostics).

Data logging diagnostics

Display the error codes for each data logging.

Window

Click the "Data Logging Diagnostics" from diagnostic items tree on the "Diagnostic" screen.



Displayed items

Item	Description	
Data logging name	Displays the data logging name.	
Error code	Displays the newest error code of each data logging setting.*1 ☞ Page 263 Error Code List	
Total number of times/total time operation	[Clear] button	Clears the "Total number of times" and "Total time."
	[Backup] button	Stores the current "Total number of times" and "Total time" in the personal computer. ☞ Page 225 Backup
	[Restore] button	Reads the "Total number of times" and "Total time" from the file that is in the computer and reflects it in the module. ☞ Page 225 Restore

*1 When errors related to access target CPU occur, the error code of the access target CPU may be stored to other settings which also use the same access target CPU.

■Backup

The information of "Total number of times" and "Total time" of each 'Data logging setting' is stored in the computer from the currently running high speed data logger module.

By backing up the total number of times and the total times before replacing an SD memory card, these two pieces of information can be obtained after exchanging the card.

Operating procedure

1. Click the [Backup] button on the "Diagnostic" screen to data logging diagnostics.
2. On the "Save as" screen, specify the save location and file name and then click the [Save] button.

■Restore

Reflects the information of "Total number of times" and "Total time" stored on the computer, in the currently running high speed data logger module.

Operating procedure

1. Click the [Restore] button on the "Diagnostic" screen to data logging diagnostics.
2. Select the file to be opened on the "Open" screen, then click the [Open] button.

Precautions

- Restore operation is executed irrespective of high speed data logger module settings. Because of that, no any error occurs in high speed data logger module in operation even if there is no 'Data logging settings' including "Total number of times" and "Total time."
- The information of "Total time" and "Total number of times" are saved in the 'Data logging settings' unit. Restore the data when settings same as the high speed data logger module that executes backup, are configured.

Event logging diagnostics

Display the error codes of each event logging.

Window

Click the "Event Logging Diagnostics" from diagnostic items tree on the "Diagnostic" screen.



Error codes in each event logging are displayed.

No.	Event logging name	Error code
01	EVT01	No error
02		
03		
04		
05		
06		
07		
08		
09		
10		
11		
12		
13		
14		
15		
16		
17		
18		
19		
20		
21		
22		
23		
24		
25		
26		
27		
28		

Displayed items

Item	Description
Event logging name	Displays the event logging name.
Error code	Displays the newest error code of each event logging setting.*1 Page 263 Error Code List

*1 When errors related to access target CPU occur, the error code of the access target CPU may be stored to other settings which also use the same access target CPU.

Report diagnostics

Display the error codes for each report.

Window

Click the "Report Diagnostics" from diagnostic items tree on the "Diagnostic" screen.

2

Error codes in each report are displayed.

No.	Report name	Error code
01	REP01	No error
02		
03		
04		
05		
06		
07		
08		
09		
10		
11		
12		
13		
14		
15		
16		
17		
18		
19		
20		
21		
22		
23		
24		
25		
26		
27		
28		

Displayed items

Item	Description
Report name	Displays the report name.
Error code	Displays the newest error code of each report.*1 Page 263 Error Code List

*1 When errors related to access target CPU occur, the error code of the access target CPU may be stored to other settings which also use the same access target CPU.

Ping test

Test the network connection status of target devices (such as mail server and FTP server) specified by a high speed data logger module.

Window

Click the "Ping Test" from diagnostic items tree on the "Diagnostic" screen.

Displayed items

Item	Description	
Input item	Target device	Specify the IP address (decimal format) or host name ^{*1} (up to 32 characters) of the target device to execute the Ping test.
	Timeout time	Specify the response waiting time when executing the Ping test.
	Number of sending times	Specify the number of packet sending times when executing the Ping test.
	[Execute] button	Sends a ping packet to the specified target device.
Test result	Test result list	Displays the number of ping test results specified for "Sending count."
	Number of sending success times / Number of all packet sending times	Displays the number of sending success times/number of all packet sending times when executing the Ping test.

*1 When specifying a host name, configure the DNS server setting of the network setting.

Product information

Displays product information of the module.

Window

Click the "Product Information" from diagnostic items tree on the "Diagnostic" screen.

2

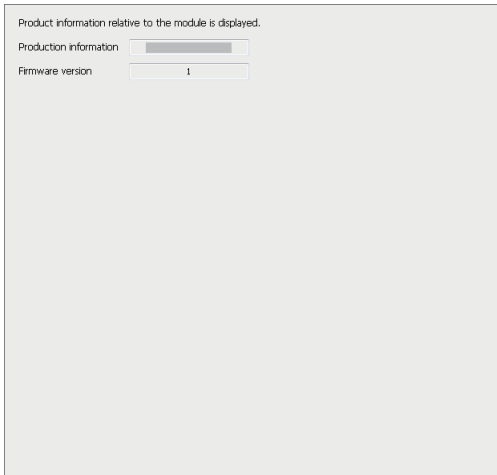

Displayed items

Item	Description
Product information	Displays the product information of the high speed data logger module.
Firmware version	Displays the firmware version of the high speed data logger module.

Management

Information in a high speed data logger module can be displayed and operations can be performed to it.

Firmware update management

The following shows the screen and procedure for displaying and changing the prohibition state of the firmware update set in a high speed data logger module.

Window

Select [Online] ⇒ [Manage].

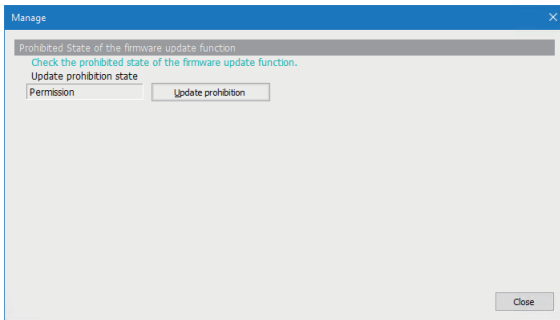

Displayed items

Item	Description
Update prohibition state	The prohibition state of the firmware update is displayed.
[Update prohibition] button*1	Click this to display the "Firmware update function prohibition operation" screen.
[Update prohibition release] button*2	Page 230 Changing the prohibition state of the firmware update

*1 Appears when "Permission" is displayed for "Update prohibition state."

*2 Appears when "Prohibition" is displayed for "Update prohibition state."

■ Changing the prohibition state of the firmware update

Operating procedure

- For setting it to "Prohibition"

1. Set a password for "Prohibition release password" and "Confirm prohibition release password" (8 to 16 characters).
2. Click the [OK] button.

- For setting it to "Permission"

1. Enter a password set for "Prohibition release password."
2. Click the [OK] button.

Point

If a prohibition release password is forgotten, initialize a high speed data logger module. "Update prohibition state" will be set to "Permission."

Page 107 Initialization Function

File browser

By using a file browser, files on the SD memory card inserted in a high speed data logger module can be accessed. This function is used to display/delete files, transfer files to module^{*1}, and save files to personal computer per directory.

*1 For RECIPE folders only.

Window

Select [Online] ⇒ [File browser].

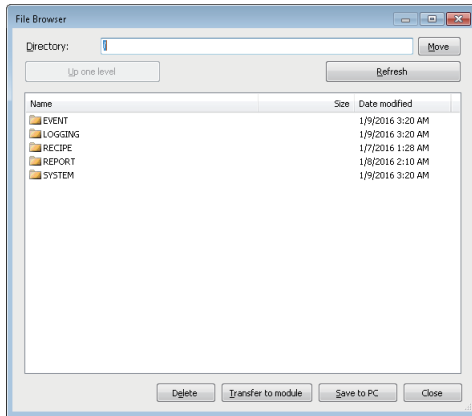

Displayed items

Item	Description
Directory	Displays the currently displayed directory path. The destination directory path can also be specified.
[Move] button	Navigates to the specified directory.
[Up one level] button	Navigates to the directory one level up.
[Refresh] button	Updates the contents displayed in the file view.
File view ^{*1}	Displays a list of the files/folders in the directory path specified in "Directory."
[Delete] button	Deletes the file selected in the file view.
[Transfer to module] button	Transfers the recipe files stored in the personal computer. ☞ Page 231 Transferring recipe files to module
[Save to PC] button	Saves the file selected in the file view to the personal computer.

*1 A file with the ".TMP" extension may be displayed when the RECIPE folder is displayed during the "Write" process of the recipe function. This TMP file is deleted at the completion of the "Write" process.

Transferring recipe files to module

Transfer the recipe files stored in a personal computer to the SD memory card inserted in a high speed data logger module.

Operating procedure

1. Move to the RECIPE folder on the "File Browser" screen.
2. Click the [Transfer to module] button.
3. Select the file to be opened on the "Open" screen, then click the [Open] button.

Precautions

- Access to files on the high speed data logger module is restricted by the access authority granted to a "user" specified in "Transfer Setup." (☞ Page 87 File access authority (when using a file browser or FTP))
- When the recipe file to which the recipe execution operation is being performed is overwritten or deleted, an error may occur. Set the operating status of the module to "Stop" and transfer the recipe file. (☞ Page 218 Module diagnostics)

Recipe execution operation

Read or write recipe files, stored in the SD memory card in a high speed data module, in Configuration Tool.

Window

Select [Online] ⇒ [Recipe execution operation].

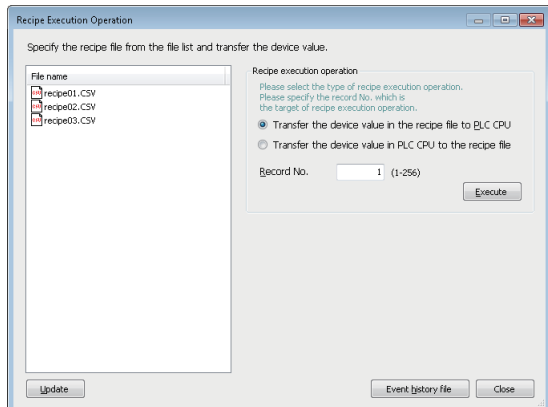

Displayed items

Item	Description								
File list ^{*1*2}	Displays a list of recipe files (CSV file format) stored in the RECIPE folder of SD memory card installed on a high speed data logger module. The Recipe Execution Operation is executed on the selected files in the list. Multiple files cannot be selected.								
Recipe execution operation	<table border="1"> <tr> <td>Transfer the device value in the recipe file to PLC CPU</td> <td>Select this to read the specified recipe file.</td> </tr> <tr> <td>Transfer the device value in PLC CPU to the recipe file</td> <td>Select this to write the specified recipe file.</td> </tr> <tr> <td>Record No.</td> <td>Specify a record number for the recipe execution operation.</td> </tr> <tr> <td>[Execute] button</td> <td>Executes the selected operation.</td> </tr> </table>	Transfer the device value in the recipe file to PLC CPU	Select this to read the specified recipe file.	Transfer the device value in PLC CPU to the recipe file	Select this to write the specified recipe file.	Record No.	Specify a record number for the recipe execution operation.	[Execute] button	Executes the selected operation.
Transfer the device value in the recipe file to PLC CPU	Select this to read the specified recipe file.								
Transfer the device value in PLC CPU to the recipe file	Select this to write the specified recipe file.								
Record No.	Specify a record number for the recipe execution operation.								
[Execute] button	Executes the selected operation.								
[Update] button	Updates the file list.								
[Event history file] button	Displays the "Event history file" screen. Page 219 Event history								

*1 Displays up to 256 files on the file list.

*2 Displays only files whose file name with extension consists 32 characters or less.

2.9 Editing Recipe File

Create and edit recipe files in Configuration Tool.

For details of the recipe function, refer to the following:

☞ Page 78 Recipe Function

Screen configuration

The following figure shows the "Recipe Editor" screen configuration to edit recipe data.

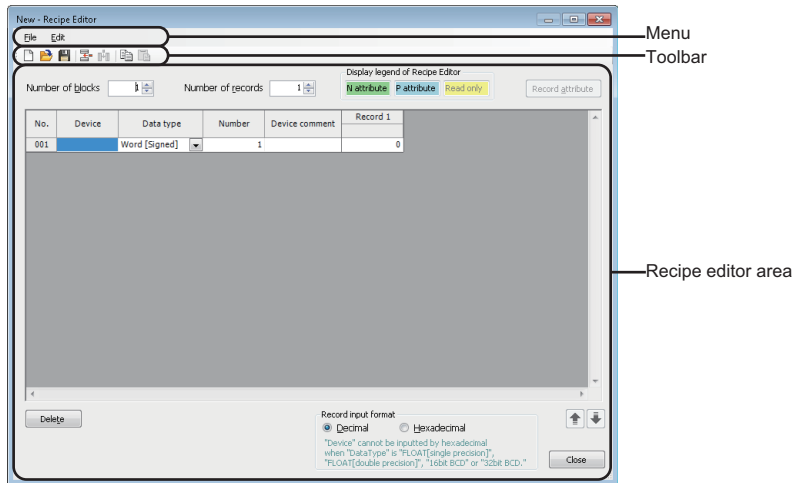

Menu configuration

The information about Menu configurations on the "Recipe editor" screen is as follows:

Item		Description
File	New	Discards the recipe file being edited and creates a new recipe file.
	Open	Opens a recipe file saved to the local disk.
	Save	Saves the edited recipe file.
	Save as	Saves the edited recipe file under a new file name.
	Exit recipe editor	Closes the "Recipe editor" screen and returns to Configuration Tool.
Edit	Insert block	Adds a block in front of the selected block.
	Insert record	Adds a record in front of the selected record.
	Copy settings	Copies the tabular format settings.
	Paste settings	Pastes the copied tabular format settings.
	Clear	Clears the selected blocks, records or data.
	Delete	Deletes the selected blocks or records.
	Import global label	Imports global labels as data from the project file of an engineering tool.
	Import common device comment	Imports common device comments as data from the project file of an engineering tool.

Toolbar configuration

The following shows the toolbar configuration on the "Recipe editor" screen.

Icon	Corresponding menu
	Select [File] ⇒ [New].
	Select [File] ⇒ [Open].
	Select [File] ⇒ [Save].
	Select [Edit] ⇒ [Insert block].
	Select [Edit] ⇒ [Insert record].
	Select [Edit] ⇒ [Copy settings].
	Select [Edit] ⇒ [Paste settings].

Recipe file editing area

The following shows the configuration of the recipe editor area.

Window

The screenshot shows the Recipe Editor interface. At the top, there are controls for 'Number of blocks' (set to 6) and 'Number of records' (set to 4). A 'Display legend of Recipe Editor' section includes buttons for 'N attribute', 'P attribute', 'Read only', and 'Record attribute'. The main table lists 10 records with columns for No., Device, Data type, Number, and Device comment. A pop-up window for 'Record 4' shows a grid for 'Operation num1' through 'Operation num4' with values like 1, 0, 1, 1, 1003, 1004, 1005, etc. Labels on the right point to 'Record number', 'Record comment', 'Device value', and 'Recipe setting list'. At the bottom, there is a 'Delete' button, a 'Record input format' section (with 'Decimal' selected), and a 'Close' button.

Displayed items

Item	Description	
Number of blocks	Displays the number of blocks. It is also used to specify the number of blocks.	
Number of records	Displays the number of records. It is also used to specify the number of records.	
Display legend of Recipe Editor	Displays the colors and contents displayed in a cell of the recipe editor.	
[Record attribute] button	Displays the "Record attribute" screen to edit the record attribute. Page 237 Changing record attribute	
Recipe setting list	Device	Specify devices for the recipe execution operation. When a value of 2 or more is entered to "Data number", consecutive devices are displayed.
	Data type	Select the data type.
	Number ^{*1}	Specify the number of consecutive devices. When a value of 2 or more is entered, rows (the value entered in "Number" - 1) are automatically added under the selected row.
	Device comment	Set device comments. (Up to 32 characters)
	Device value ^{*2}	Set device values which are transferred to the CPU module at the recipe execution operation (reading process).
	Record No.	Displays record No. (Editing disabled)
	Record comment	Displays record comments. Set record comments on the "Record attribute" screen. Page 237 Changing record attribute
[Delete] button	Deletes the selected blocks or records.	
Record input format	Decimal	Select this when inputting the device values in decimal format.
	Hexadecimal	Select this when inputting the device values in hexadecimal format.

*1 For bit devices, only 1 data can be set for a single block.

When setting consecutive bit devices, add blocks.

*2 If Float (Single Precision) or Float (Double Precision) is specified to the data type, the values of the range which can be used in the CPU module can only be set for reading.

Creating recipe files

Starting the "Recipe Editor" screen

Start the "Recipe Editor" screen to edit recipe data.

Operating procedure

Select [Tool] ⇒ [Display recipe editor] in Configuration Tool.

Creating new recipe file

Create a new recipe file.

Operating procedure

Select [File] ⇒ [New].

Opening recipe files

Read the saved recipe file.

Operating procedure

1. Select [File] ⇒ [Open].
2. Select the file to be opened on the "Open file" screen, then click [Open] button.

Precautions

- The maximum file size of recipe file is 512 KB. If the size exceeds 512 KB, the file cannot be opened. Adjust the file size by deleting the records/blocks or changing the device values/comments.

Saving recipe files

Save the recipe file being edited.

■Saving a recipe file

Operating procedure

Select [File] ⇒ [Save].

■Naming and saving a recipe file

Operating procedure

1. Select [File] ⇒ [Save as].
2. Specify the save location and file name (up to 32 single byte characters including extension), and then click the [Save] button on the "Save As" screen.

Point

Saved recipe files can be edited in Excel or text editor.

For details of the recipe file format, refer to the following:

 Page 383 Recipe File Format

Editing recipe file

Edit the recipe files.

Setting recipe data

Set the contents of recipe files.

Operating procedure

Enter data to cells of "Device," "Data type," "Number," "Device comment," "Device values" and "Record comment."



The work hours for setting recipe data can be reduced by the following functions.

- Select [Edit] ⇒ [Import global label].
- Select [Edit] ⇒ [Import common device comment].

☞ Page 115 Importing global labels and common device comments

Adding/deleting blocks

Add/Delete a block.

■Add

Operating procedure

Add a block by using any of the following procedures.

- Enter the number of added blocks in the "Number of blocks."
- Select [Edit] ⇒ [Insert block].

■Delete

Operating procedure

Delete a block by using any of the following procedures.

- Enter the total number of blocks after deletion for "Number of blocks."
- Select the cells on the blocks to be deleted (area for deleting blocks), and click the [Delete] button.

No.	Device	Data type	Number	Device comment	Record 1	Record 2	Record 3	Record 4
					Operation num1	Operation num2	Operation num3	Operation num4
001	M0	Bit	1	Sensor	1	0	1	
002	X0	Bit	1	Executive State	1	1	1	
003	D0	Word [Signed]	1	Operation number	1003	1004	1005	
004	D100	Word [Signed]	3	Material A	1	2	1	
005	D101			Material B	2	1	2	
006	D102			Material C	1	2	3	
007	D10	Word [Signed]	1	Generation number	201	202	203	
008	D200	Word [Signed]	3	Temperature setting	90	70	30	
009	D201			Temperature setting	0	10	20	
010	D202			Temperature setting	0	20	80	

Area for deleting blocks

Adding/deleting records

Add/Delete a record.

■Add

Operating procedure

Add a record by using any of the following procedures.

- Enter the number of added records in the "Number of records."
- Select [Edit] ⇒ [Insert record].

■Delete

Operating procedure

Delete a record by using any of the following procedures.

- Enter the total number of records after deletion for "Number of records."
- Select the cells on the records to be deleted (area for deleting records), and click the [Delete] button.

No.	Device	Data type	Number	Device comment	Record 1	Record 2	Record 3	Record 4
					Operation num1	Operation num2	Operation num3	Operation num4
001	M0	Bit	1	Sensor	1	0	1	
002	X0	Bit	1	Executive State	1	1	1	
003	D0	Word [Signed]	1	Operation number	1003	1004	1005	
004	D100	Word [Signed]	3	Material A	1	2	1	
005	D101			Material B	2	1	2	
006	D102			Material C	1	2	3	
007	D10	Word [Signed]	1	Generation number	201	202	203	
008	D200	Word [Signed]	3	Temperature setting	90	70	30	
009	D201			Temperature setting	0	10	20	
010	D202			Temperature setting	0	20	80	

Area for deleting records

Changing record attribute

Change the record attributes.

For details of the record attribute, refer to the following:

📖 Page 81 Record attribute

Operating procedure

1. Click the [Record attribute] button on the "Recipe Editor" screen, or double-click the record comment.
2. Specify the record attribute on the "Record attribute" screen, and click the [OK] button.

Point

Set the record comment on the "Record attribute" screen. (Up to 32 characters)

2.10 Help

The following operation are executed by using the "Help" function.

- Version information
- Connection to MITSUBISHI ELECTRIC FA Global Website
- Open the user's manual

Version information

The version information of Configuration Tool can be checked.

Operating procedure

Select [Help] ⇒ [About Configuration Tool].

Connection to MITSUBISHI ELECTRIC FA Global Website

Open the MITSUBISHI ELECTRIC FA Global Website in a web browser.

Operating procedure

Select [Help] ⇒ [Connection to MITSUBISHI ELECTRIC FA Global Website].

Open the user's manual

Open the user's manual (operation help).

Operating procedure

Select [Help] ⇒ [MELSEC iQ-R High Speed Data Logger Module Help].

3 PARAMETER SETTING

Various operation settings can be set in the parameter setting of an engineering tool.

3.1 Parameter Setting Procedure

1. Add a high speed data logger module to an engineering tool.
① [Parameters] ⇒ [Module Information] from Navigation window, and right click and select [Add New Module]
2. Set two types of parameter settings, basic settings and refresh settings, by selecting in the tree in the screen displayed by the following operation:
① [Navigation window] ⇒ [Parameter] ⇒ [Module Information] ⇒ [RD81DL96]
3. Write the settings to the CPU module with the engineering tool.
① [Online] ⇒ [Write to PLC]
4. The settings are reflected by resetting the CPU module or turning the power OFF to ON.

3.2 Basic Settings

Configure the various operation settings of the high speed data logger module.

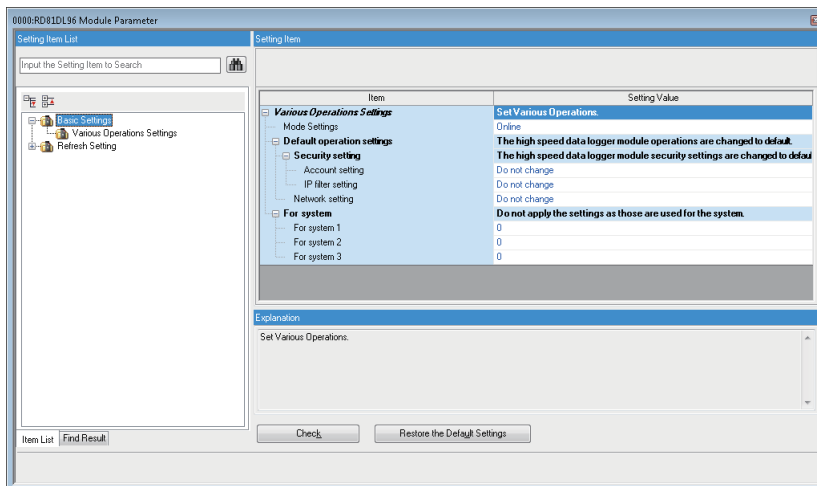

Operation settings

Configure the mode setting and default operation settings of the high speed data logger module.

Item		Description	Setting range	
Mode settings* ¹		<p>The operation mode of the high speed data logger module is set.</p> <ul style="list-style-type: none"> • Online: It is a normal operation mode. • Online(Asynchronous Mode): The high speed data logger module and the CPU module start without synchronization. • Firmware update: To update the firmware of a high speed data logger module. • Module initialization setting: To initialize information retained in a high speed data logger module. • Automatic hardware test: H/W such as ROM/RAM/Ethernet of the high speed data logger module is tested. • Hardware test for LED check: The LED of the high speed data logger module is tested. 	<ul style="list-style-type: none"> • Online • Online(Asynchronous Mode)*² • Firmware update • Module initialization setting • Automatic hardware test • Hardware test for LED check (Default: Online) 	
Default operation settings	Security setting	Account setting	<p>Set whether or not to change the "Account setting" of the high speed data logger module forcibly.</p> <ul style="list-style-type: none"> • Do not change: Operate by using the setting contents specified in the "Account setting" of the Configuration Tool. • Change to default: "Account setting" is disabled and the access authentication function is not used. 	<ul style="list-style-type: none"> • Do not change • Change to default (Default: Do not change)
		IP filter setting	<p>Set whether or not to change the "IP filter setting" of the high speed data logger module forcibly.</p> <ul style="list-style-type: none"> • Do not change: Operate by using the setting contents specified in the "IP filter setting" of the Configuration Tool. • Change to default: "IP filter setting" is disabled and the IP filter function is not used. 	<ul style="list-style-type: none"> • Do not change • Change to default (Default: Do not change)
		Network setting* ³	<p>Set whether or not to change the "Network setting" of the high speed data logger module forcibly.</p> <ul style="list-style-type: none"> • Do not change: Operate by using the setting contents specified in the "Network setting" of the Configuration Tool. • Change to default: Operate by changing the IP address and subnet mask as follows: IP address = 192.168.3.3 Subnet mask = 255.255.255.0 	<ul style="list-style-type: none"> • Do not change • Change to default (Default: Do not change)
For system	For system 1 to 3	Do not apply the settings as those are used for the system.	—	

*1 For the differences between 'online' and 'online (asynchronous mode)', refer to the following:

 Page 241 Online and online (asynchronous mode)

*2 It is available in the following combination.

High speed data logger module: firmware version '06' or later

GX Works3: software version '1.045X' or later

*3 A DNS server is not used.

The network diagnostics (ping) is not executed.

The name specified in the "Network setting" of Configuration Tool is applied to the host name.

Point

The default operation setting is used to change the settings of the high speed data logger module connected to a personal computer on a 1:1 basis.

Online and online (asynchronous mode)

The following explains the differences between 'online' and 'online (asynchronous mode)'.

■Online

A CPU module and a high speed data logger module synchronize each other and complete their start processing, then start at the same time. (A CPU module stands by until a high speed data logger module completes its start processing.)

■Online (asynchronous mode)

A CPU module and a high speed data logger module start individually when their start processing is completed without waiting for the completion of the processing of the other module.

3

Precautions

The following shows the considerations for using 'online (asynchronous mode)'.

- Do not access the buffer memory of a high speed data logger module until the module starts after a CPU module starts. Otherwise, an indefinite value may be acquired and a sequence program may not run as intended. When accessing the buffer memory, make sure that 'Module READY' (X0) is turned ON.
- Do not use dedicated instructions of a high speed data logger module until the module starts after a CPU module starts. Otherwise, the high speed data logger module may not operate as intended. When using dedicated instructions, make sure that 'Module operating status' (X5) is turned ON.

3.3 Refresh Setting

Set the refresh timing for the specified refresh target.

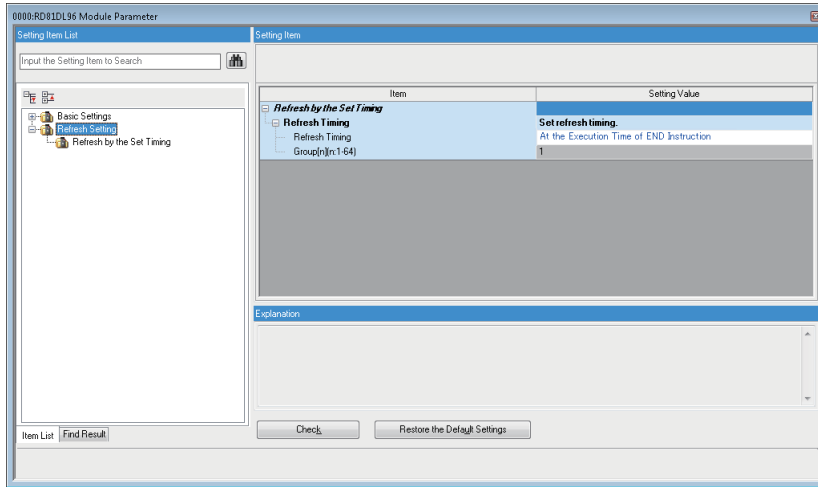

Setting value	Description
At the Execution Time of END Instruction	The setting is refreshed at the END processing in the CPU module.
At the Execution Time of Specified Program	The setting is refreshed when executing the program specified in "Group[n]".

4 TROUBLESHOOTING

This chapter explains the errors which may occur when using a high speed data logger module and the troubleshooting.

4.1 Checking Method for Error Descriptions

The following are the methods for checking error descriptions.

Checking method	Details
System monitor function of the engineering tool	The error codes can be checked by using the system monitor of engineering tool. ☞ Page 244 Checking the Module Status
Buffer memory	Error codes can be checked in the following buffer memory: ☞ Page 314 Current error area (Un\G140 to 149) ☞ Page 315 Error log area (Un\G150 to 311)
High Speed Data Logger Module Configuration Tool	Error codes can be checked by the diagnostics function. ☞ Page 217 Diagnostics



If multiple errors occur at the same time, take corrective action for the errors in chronological order.

Error code type

The status of an error that occurs in a high speed data logger module can be determined with the statuses of the RUN LED and ERR LED.

RUN LED	ERR LED	Error status	Error code	Description
OFF	ON, Flashing	Major error	3C00H to 3FFFH	An error such as a hardware or memory error that causes a module to stop operating.
ON	Flashing	Moderate error	2000H to 3BFFH*1	An error that causes a module to stop operating due to an error such as a memory error.
ON	ON	Minor error	1000H to 1FFFH	An error that continues or stops module operations due to sampling failure or connection failure to the server.

*1 The SD memory card error (error code: 2121H) is notified as a minor error.

Error types

There are two types of errors of a high speed data logger module as follows:

Error types	Module status	Corrective action
Module suspended error	Stop	Take corrective action for the error according to the error code, and turn OFF the ERR LED by any of the following operations: <ul style="list-style-type: none"> • Error clear request (Y10) • Select [Online] ⇒ [Diagnostics] ⇒ "Module diagnostics", and click the [Error release] button. • Power OFF to ON • Reset the CPU module
Module continuation error	Continue	

4.2 Checking the Module Status

The module status can be checked in the "Module Diagnostics" screen of an engineering tool.

Function	Application	Reference
Error information	Contents of error currently occurs are displayed. Errors detected on the high speed data logger module and history of operation executed to the module can be checked by clicking the [Event History] button.	Page 244 Error information
Module information list	Various status information of the high speed data logger module is displayed.	Page 245 Module information list

In addition, the self-diagnostic tests that check the hardware of a high speed data logger module can be performed in an engineering tool. (☞ Page 246 Self-diagnostic tests)

Error information

The description of an error occurring and its corrective action can be checked in the [Error Information] tab.

Window

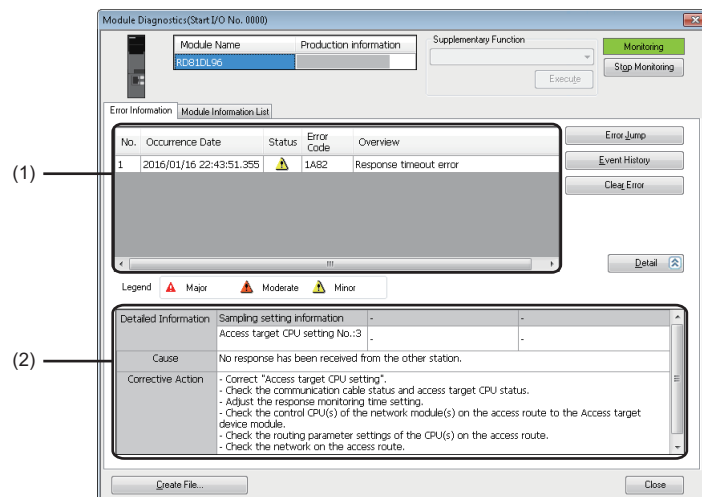

Displayed items

Item	Description	
(1) Error information list	Errors occurring are listed.	
(2) Error detailed information	—	
	Detailed information	Detailed information of an error is displayed. (Up to three pieces)
	Cause	The cause of an error is displayed.
	Corrective action	A corrective action for an error is displayed.

Restriction

An error in a high speed data logger module cannot be cleared with the [Clear Error] button.

Use the diagnostic function of Configuration Tool to clear the error. (☞ Page 218 Module diagnostics)

Module information list

The LED information and switch information can be checked in the [Module Information List] tab.

During a self-diagnostic test, "Automatic hardware is being tested" or "Hardware test for LED check is being executed" is displayed in all the LED information and switch information.

If an error occurs, refer to the following section to take corrective action.

☞ Page 248 Troubleshooting on LED indication and input/output signals

Window

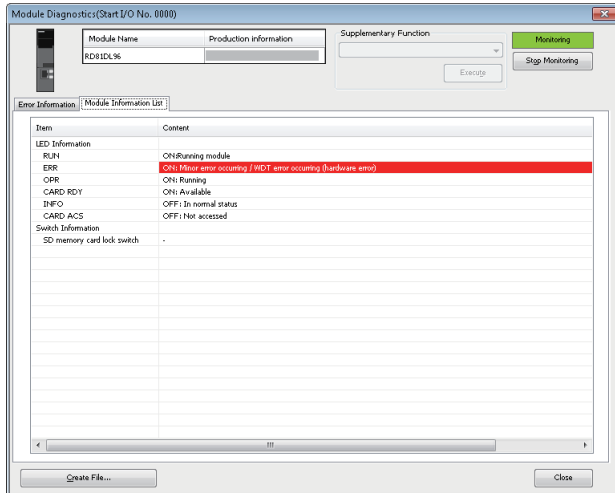

Item		Description
LED Information	RUN	The operating status of a module is displayed.
	ERR	The error status of a module is displayed.
	OPR	The operating status of a module is displayed.
	CARD RDY	The status of an SD memory card is displayed.
	INFO	Information on the module operation is displayed.
	CARD ACS	The access status of an SD memory card is displayed.
Switch Information	SD memory card lock switch	Information on the SD memory card lock switch is displayed.

Self-diagnostic tests

Automatic hardware test

The following explains the test on hardware such as ROM/RAM/Ethernet of a high speed data logger module.

Restriction

- The values in the buffer memory cannot be referenced in an engineering tool during the automatic hardware test.
- If the automatic hardware test is completed abnormally, the error details cannot be checked even if the error code is displayed in an engineering tool.

Operating procedure

1. Select "Automatic hardware test" in "Basic Settings" ⇒ "Various Operations Settings" ⇒ "Mode Settings" for a high speed data logger module in an engineering tool.
2. Disconnect a cable if it is connected to a 1000BASE-T/100BASE-TX/10BASE-T interface.
3. Remove an SD memory card if it is inserted.
4. Set the CPU module to the STOP state, and write the parameters.
5. Reset the CPU module.
After it is reset, the automatic hardware test is performed automatically. The LED display for the automatic hardware test is as follows:

Status		RUN LED status	ERR LED status
Automatic hardware test is in process.		Flashing	OFF
Automatic hardware test is completed.	Normal end	ON	OFF
	Error end	ON	ON

6. When the test is completed normally, return the mode setting changed in step 1 to "Online" and reset the CPU module.
7. When the test is completed abnormally, check if measures are taken to reduce noise of the system, and perform the test again. If it is completed abnormally again, a hardware failure may occur in the high speed data logger module. Please contact your local Mitsubishi Electric sales office or representative.
Do not use an electric screwdriver when removing the module. Loose the module fixing screws completely to remove the module.

Hardware test for LED check

Turn the LED ON to perform the hardware diagnostic of the LED of a high speed data logger module.



The values in the buffer memory cannot be referenced in an engineering tool during the hardware test for LED check.

Operating procedure

1. Select "Hardware test for LED check" in "Basic Settings" ⇒ "Various Operations Settings" ⇒ "Mode Settings" for a high speed data logger module in an engineering tool.
2. Set the CPU module to the STOP state, and write the parameters.
3. Reset the CPU module.
After it is reset, the hardware test for LED check is performed automatically. When the following contents are displayed, check them visually for any errors.

LED name	Display color	Display status
RUN	Green	ON
ERR	Red	ON
OPR	Green	ON
INFO	Green	ON
CARD RDY	Green	ON
CARD ACS	Green	ON

4. When the test is completed normally, change the mode set in the step 1 back to "Online," and reset the CPU module.
5. When the test is completed abnormally (when any color or status is different from the one shown in the table above), check if measures are taken to reduce noise of the system, and perform the test again. If it is completed abnormally again, a hardware failure may occur in the high speed data logger module. Please contact your local Mitsubishi Electric sales office or representative.
Do not use an electric screwdriver when removing the module. Loosen the module fixing screws completely to remove the module.

4.3 Troubleshooting by Symptom

Troubleshooting on LED indication and input/output signals

Symptom	Check point	Corrective action
The RUN LED does not turn ON.	Is the module in preparation?	<ul style="list-style-type: none"> • Wait for the module to start.
	Is 'Module READY' (X0) OFF?	<ul style="list-style-type: none"> • Check if a supported SD memory card is used. If doing so, please contact your local Mitsubishi Electric sales office or representative. (MELSEC iQ-R High Speed Data Logger Module User's Manual (Startup))
	Has a module major error (error code: 2450H) occurred in a CPU module?	
	Has an error occurred in a high speed data logger module?	<ul style="list-style-type: none"> • By the error code, identify the error and take corrective actions. (Page 263 Error Code List)
	Is "Online(Asynchronous Mode)" selected for the mode setting of a high speed data logger module the firmware version of which is '05' or earlier?	<ul style="list-style-type: none"> • Change the mode setting to "Online". (Page 240 Operation settings) • Use a high speed data logger module the firmware version of which is '06' or later.
Does the system configuration satisfy both of the following conditions? <ul style="list-style-type: none"> • The module is used with a recorder module (RD81RC96) or MES interface module (RD81MES96N) in the system. • "Online (Asynchronous Mode)" is selected for the mode setting. 	<ul style="list-style-type: none"> • Change the mode setting to "Online". (Page 240 Operation settings) 	
'Module READY' (X0) does not turn ON, or it takes time to turn ON.	Is there any error in the access target CPU setting?	<ul style="list-style-type: none"> • Correct "Access target CPU setting".
	Is the module in preparation?	<ul style="list-style-type: none"> • Delete the unnecessary access target CPU setting. (Depending on the number of items set in access target CPU settings, it may take several minutes until 'Module READY' (X0) turns ON.)
	Is there any unnecessary access target CPU setting?	
	Is there any abnormality in the connection route between the high speed data logger module and access target CPU?	<ul style="list-style-type: none"> • Check the communication route between the high speed data logger module and the access target CPU.
	Is the number of files in the inserted SD memory card large?	<ul style="list-style-type: none"> • Delete unnecessary files from the SD memory card. (If the number of files in the SD memory card is large, it takes longer to turn ON 'Module READY' (X0).)
The 'SD memory card status' (X1) does not turn ON, or it takes time to turn ON.	Is 'File access status' (X2) ON?	<ul style="list-style-type: none"> • Clear the file access stop.
	Is the number of files in the inserted SD memory card large?	<ul style="list-style-type: none"> • Delete unnecessary files from the SD memory card. (If the number of files in the SD memory card is large, it takes longer time for the 'SD memory card status' (X1) to turn ON.)

Troubleshooting on data logging, event logging, and reports

Symptom	Check point	Corrective action
Cannot sample data in each sequence scan.	Is the 'high speed sampling failure' (X1A) ON?	<ul style="list-style-type: none"> Decrease the number of the specified settings for high speed sampling. Set a constant scan to the CPU module. (Page 346 Processing Time)
	Check the power supply status. (Has a momentary power failure occurred?)	<ul style="list-style-type: none"> Correct the power supply status.
Unable to sample data with the specified data sampling interval. (High speed sampling)	Is the 'high speed sampling failure' (X1A) ON?	<ul style="list-style-type: none"> Set the data sampling interval longer than the following time. (Page 346 Processing Time) Decrease the number of the specified settings for high speed sampling or change the data sampling interval.
	Check the power supply status. (Has a momentary power failure occurred?)	<ul style="list-style-type: none"> Correct the power supply status.
Unable to sample data with the specified data sampling interval. (General sampling)	Is the 'General sampling delay occurrence' (X1E) ON? (Page 317 General sampling delay time area (Un\G800 to 805))	<ul style="list-style-type: none"> Decrease the number of the specified settings for general sampling. Organize data logging settings, event logging settings, and report settings for each access target CPU.
	Has the high speed data logger module's time been changed by the time synchronization function?	<ul style="list-style-type: none"> Reduce the timing of the time synchronization. (Do not synchronize the time while the system is in operation.) (Page 133 Time synchronization setting)
Unable to perform data logging with the specified data sampling interval.	Is the 'high speed sampling failure' (X1A) ON?	<ul style="list-style-type: none"> Decrease the number of the specified settings for high speed sampling. Increase the data sampling interval of high speed sampling. Set a constant scan to the CPU module. (Page 346 Processing Time)
	Has the high speed data logger module's time been changed by the time synchronization function?	<ul style="list-style-type: none"> Reduce the timing of the time synchronization. (Do not synchronize the time while the system is in operation.) (Page 133 Time synchronization setting)
	Is the 'processing overload occurrence' (X1B) ON?	<ul style="list-style-type: none"> Decrease the units of data logging target data. Increase the data sampling interval. Save only the necessary data to the file (Use the trigger logging function). Stop access from GX LogViewer.
	Has an error occurred in data logging?	<ul style="list-style-type: none"> By the error code, identify the error and take corrective actions. (Page 263 Error Code List)
	Has a communication error occurred with the access target CPU?	<ul style="list-style-type: none"> By the error code, identify the error and take corrective actions. (Page 263 Error Code List)
	Check the power supply status. (Has a momentary power failure occurred?)	<ul style="list-style-type: none"> Correct the power supply status.
Data is not logged at the specified data sampling interval. (Immediately after file switching)	Was a saved file deleted from FTP or Configuration Tool after the logging was stopped?	<ul style="list-style-type: none"> Clear the logging file in Configuration Tool.

Symptom	Check point	Corrective action
Unable to output data to a data logging file at the time of trigger logging. (The trigger was not detected)	Is the condition satisfied for a longer time than the data sampling interval when condition is specified in the trigger condition setting?	<ul style="list-style-type: none"> Adjust the system so the time that the creation trigger condition is established is longer than the data sampling interval.
	Is the 'high speed sampling failure' (X1A) ON?	<ul style="list-style-type: none"> Decrease the number of the specified settings for high speed sampling. Increase the data sampling interval of high speed sampling. Set a constant scan to the CPU module. (Page 346 Processing Time)
	Is the 'trigger reoccurrence' (X1C) ON?	<ul style="list-style-type: none"> Adjust the system so that triggers do not occur continuously. (Page 346 Processing Time)
	Is the 'processing overload occurrence' (X1B) ON?	<ul style="list-style-type: none"> Adjust the system so that triggers do not occur continuously. Correct the settings and lessen the processing load. (Page 346 Processing Time)
	Has the high speed data logger module's time been changed by the time synchronization function?	<ul style="list-style-type: none"> Reduce the timing of the time synchronization. (Do not synchronize the time while the system is in operation.) (Page 133 Time synchronization setting)
	Check the power supply status. (Has a momentary power failure occurred?)	<ul style="list-style-type: none"> Correct the power supply status.
When performing trigger logging, the data before the trigger is less than the number of lines specified before the trigger.	Is the trigger occurring before sampling the number of lines of data before the trigger after powering ON or after updating the settings?	<ul style="list-style-type: none"> Adjust the system so the trigger occurs after sampling the number of lines of data after the trigger.
	Is the trigger continuously occurring?	<ul style="list-style-type: none"> Adjust the system so that the trigger occurs after the number of lines after the trigger for the previous trigger and the number of lines before the trigger for the next trigger are both sampled.
When performing the trigger logging, device values sampled in another sequence scan as the one where a trigger occurred is included in one data row.	Is the number of device points less than the access units?	<ul style="list-style-type: none"> Set the number of device points sampled at one time to less than the access units. (MELSEC iQ-R High Speed Data Logger Module User's Manual (Startup))
	Is general sampling being used?	<ul style="list-style-type: none"> Use high speed sampling. Data logging function: (Page 26 Sampling function)
The event was not detected.	Is the time of the satisfied condition longer than the data sampling interval when a data condition is specified?	<ul style="list-style-type: none"> Adjust the system so that the time the event condition is satisfied is longer than the sampling interval.
	Is the 'high speed sampling failure' (X1A) ON?	<ul style="list-style-type: none"> Decrease the number of the specified settings for high speed sampling. Increase the data sampling interval of high speed sampling. Set a constant scan to the CPU module. (Page 346 Processing Time)
	Is the 'processing overload occurrence' (X1B) ON?	<ul style="list-style-type: none"> Correct the settings and lessen the processing load. (Page 346 Processing Time)
	Check the power supply status. (Has a momentary power failure occurred?)	<ul style="list-style-type: none"> Correct the power supply status.

Symptom	Check point	Corrective action
The report file was not created. (The report creation trigger was not detected)	Is the time of the satisfied condition longer than the data sampling interval when a data condition is specified?	<ul style="list-style-type: none"> Adjust the system so that the time to satisfy the creation trigger condition is longer than the data sampling interval.
	Has the high speed data logger module's time been changed by the time synchronization function?	<ul style="list-style-type: none"> Set the minimum synchronization timing required. (Do not perform this while the system is in operation.) (☞ Page 133 Time synchronization setting)
	Is the 'high speed sampling failure' (X1A) ON?	<ul style="list-style-type: none"> Decrease the number of the specified settings for high speed sampling. Increase the data sampling interval of high speed sampling. Set a constant scan to the CPU module. (☞ Page 346 Processing Time)
	Is the 'processing overload occurrence' (X1B) ON?	<ul style="list-style-type: none"> Correct the settings and lessen the processing load. (☞ Page 346 Processing Time)
	Is the 'creation trigger reoccurrence' (X1D) ON?	<ul style="list-style-type: none"> Adjust the system so that creation triggers do not occur continuously. (☞ Page 346 Processing Time)
	Check the power supply status. (Has a momentary power failure occurred?)	<ul style="list-style-type: none"> Correct the power supply status.
Unable to output the number of records worth of data to a report.	When the creation trigger occurred, was the specified number of records worth of data saved to the data logging file?	<ul style="list-style-type: none"> Configure and adjust the system so that the creation trigger occurs after the specified number of records worth of data is saved in the data logging file. (☞ Page 73 Report output)
	Is the creation trigger occurring immediately after powering ON?	
	Was the data logging file, which includes the data at the time the creation trigger occurred, deleted before completing output to the report?	<ul style="list-style-type: none"> Adjust the file switch timing for data logging.
Data separation occurs.	Is the number of device points less than the access units? (☞ MELSEC iQ-R High Speed Data Logger Module User's Manual (Startup))	<ul style="list-style-type: none"> Set the number of device points sampled at one time to less than the access units.
	Is the report creation trigger set to synchronize with the current value data?	<ul style="list-style-type: none"> Select "Synchronize creation trigger with current value data." in the creation trigger settings. (☞ Page 209 Creation trigger)
	Is general sampling being used?	<ul style="list-style-type: none"> Use high speed sampling. Data logging function: (☞ Page 26 Sampling function) Report function: (☞ Page 75 Creation trigger and current value data sampling)
	Was the data changed after the report creation trigger occurred?	<ul style="list-style-type: none"> Configure the settings not to change the devices that sample data as the current value of the report during the period when the buffer memory report creation execution information is ON. Monitor the value of report execution information in the buffer memory so that the data does not change until the report is created.
Unable to display the CSV formatted data logging and event logging time/date information correctly.	Has the cell format been changed when the CSV file was opened with Excel?	<ul style="list-style-type: none"> Set the Excel cell format according to the arbitrary date/time format for display.
The information of milliseconds is not displayed in the cells to which date and time of the report file is output.	Was the cell format configured when the layout was created?	<ul style="list-style-type: none"> Set the Excel cell format according to the desired date/time format for display. (☞ Page 201 Data logging layout, ☞ Page 208 Creation time layout)
Unable to output the data correctly to the report file.	Are the merged cells specified in the cell range where the layout is set?	<ul style="list-style-type: none"> Split the merged cells. Do not specify merged cells in the cell range.
	Are there data lines in the output source file of the data logging layout?	<ul style="list-style-type: none"> Configure and adjust the system so that a creation trigger occurs after data are output to the data logging file which is the output source for the report.
Unable to start the "Layout setting" screen.	Are the permissions granted to the user logged on to Windows sufficient?	<ul style="list-style-type: none"> Log on as a user with a "standard" or higher access authority.
The file cannot be downloaded from the file browser.	Are the permissions granted to the user logged on to Windows sufficient?	<ul style="list-style-type: none"> Log on as a user with a "standard" or higher access authority.
Unable to end the layout settings.	For a file saved in the SD memory card inserted in a high speed data logger module by using FTP connection, check if the file is not directly opened → closed in Excel.	<ul style="list-style-type: none"> After selecting "Do not display" in "Window" in the Excel menu, select "Display again."

Symptom	Check point	Corrective action
The sequential numbers of the subscript are added to the file name of a data logging file, event logging file, and report file and folder name of the subfolder.	Are the files and folders with the same name created in the SD memory card?	<ul style="list-style-type: none"> Review the settings of saved file name and saved folder name. Clear the data logging file of the SD memory card. (☞ Page 223 SD memory card diagnostics)
Unable to create a data logging file, event logging file, and report file.	Is the write protect switch of the SD memory card locked?	<ul style="list-style-type: none"> Unlock the write protect switch of the SD memory card and retry.
	Are the accumulating files only in the header line?	<ul style="list-style-type: none"> Configure and adjust the system so that the file is switched after the data is output to the logging file.
Unable to create a folder.	Are the accumulating files only in the header line?	<ul style="list-style-type: none"> Configure and adjust the system so that the file is switched after the data is output to the logging file.
	Is the latest save folder empty?	<ul style="list-style-type: none"> Configure and adjust the system so that the folder is switched after a report file is created.
Unable to create files for the number of the specified files.	Is the free space specified by the SD memory card settings?	<ul style="list-style-type: none"> Delete unnecessary files from the SD memory card. Replace the SD memory card to a large SD memory card with full capacity.
	Are the saved files not cleared, to which subscript sequential number is added by the file browser or FTP?	<ul style="list-style-type: none"> Clear the logging file in Configuration Tool. Configure and adjust the system so that the sequential number of subscripts is not added.
Unable to operate the completion notifications of a trigger.	Is the completion notification device of the CPU module side OFF after the completion notification is executed?	<ul style="list-style-type: none"> Turn OFF the completion notification device by a program such as a ladder program in the CPU module.
	Is the trigger condition held true again before the trigger completion notification is completed?	<ul style="list-style-type: none"> Configure and adjust the system so that the trigger conditions are not satisfied again until the trigger completion notification is completed.
A corrupted file is created.	Is the free space of the SD memory card sufficient?	<ul style="list-style-type: none"> Clear the logging file in Configuration Tool after backing up the file as necessary.
'Data logging setting information' (Un\G2000 to 2003), 'Event logging setting information' (Un\G3000 to 3003), and 'Report setting information' (Un\G4000 to 4003) are not set after powering ON or after updating the settings.	Has an error occurred in a high speed data logger module?	<ul style="list-style-type: none"> By the error code, identify the error and take corrective actions. (☞ Page 263 Error Code List)

Troubleshooting on network connection

Symptom	Check point	Corrective action
Unable to access the high speed data logger module.	Is the mode setting of RD81DL96 in "Online" mode?	<ul style="list-style-type: none"> Set the mode settings to "Online" with an engineering tool. (Page 240 Operation settings)
	Is there any disconnection in the connection route?	<ul style="list-style-type: none"> Connect the cables properly. Replace the cables to new ones.
	Is the IP address duplicated?	<ul style="list-style-type: none"> Correct the IP address.
	Does a firewall or a proxy server exist in the connection route?	<ul style="list-style-type: none"> Ask your network administrator about the firewall and proxy server settings.
	Is Windows firewall enabled on the personal computer?	<ul style="list-style-type: none"> Disable Windows firewall on the personal computer when using "Find High Speed Data Logger Module" or direct connection.
	Is antivirus software blocking Ethernet communications?	<ul style="list-style-type: none"> Change the antivirus software settings to allow Ethernet communications. Lower the antivirus software's security settings level. Stop the antivirus software.
	Is there any problem on the personal computer?	<ul style="list-style-type: none"> Replace it with another personal computer.
	Are the permissions granted to the user logged on to Windows sufficient?	<ul style="list-style-type: none"> Log on as a user with a standard or higher access authority.
	Is the IP address of high speed data logger module, which is specified by transfer setup is correct? (When turning the power OFF to ON or resetting the CPU module without an SD memory card inserted, the module operates with the IP address in the initial status (192.168.3.3).)	<ul style="list-style-type: none"> Correct the IP address of high speed data logger module, which is specified to the transfer setup. Connect the personal computer directly and specify direct connection on the Transfer Setup screen. (MELSEC iQ-R High Speed Data Logger Module User's Manual (Startup))
	Has an error occurred in the own station CPU module?	<ul style="list-style-type: none"> Check the error code of the CPU module and take corrective actions according to the error code.
	Is a module other than the high speed data logger module set to the slot on which the high speed data logger module is mounted in the system parameter (I/O assignment setting) of the CPU module for the own station?	<ul style="list-style-type: none"> Correct the system parameters (I/O Assignment settings) of CPU module.
	Are the high speed data logger module and personal computer connected to each other via a hub?	<ul style="list-style-type: none"> For a direct connection, connect the high speed data logger module to the personal computer on a 1:1 basis. (MELSEC iQ-R High Speed Data Logger Module User's Manual (Startup))
	Are multiple IP addresses enabled at the same time on the personal computer side?	<ul style="list-style-type: none"> For a direct connection, make sure multiple IP addresses are not enabled at the same time in the personal computer. Disable the wireless LAN function.
Is the access blocked by IP filter function?	<ul style="list-style-type: none"> Correct the security setting of Configuration Tool. Check the IP address of the personal computer. 	
Is the Ethernet network between personal computer and high speed data logger module getting overloaded?	<ul style="list-style-type: none"> Check the status of the Ethernet network and reduce the load. After that, wait for a while and access again. 	
Unable to enable the IP filter function.	Is the power turned OFF → ON or the CPU module reset after configuring the IP filter function?	<ul style="list-style-type: none"> Turn the power OFF → ON or reset the CPU module.

Troubleshooting on FTP and file transfer

Symptom	Check point	Corrective action
Unable to transfer the file.	Is the high speed data logger module correctly connected to the network?	• Check the module status, network connection status of the high speed data logger module.
	Is the user name specified, which is included in AD (Active Directory) domain?	• Correct the setting so that user name not included in the AD domain is specified.
426 error (Data connection error) occurs during the file transfer.	Was the FTP transfer executed specifying a large number of files at one time?	• Decrease the number of files to transfer at one time and execute FTP again.
While sending the file, the no FTP transfer file error (error code: 1B04H) and the no shared folder transfer error (error code: 1B06H) occurs.	Check that the file is not getting deleted.	• Review the settings for the file switching timing, file capacity, and the number of saved files, and lengthen the time until the file is deleted.
The file obtained from the FTP server of the high speed data logger module is old.	Were the settings for temporary internet files of Internet Explorer configured?	• Configure the settings for temporary internet files of Internet Explorer. (LJIMELSEC iQ-R High Speed Data Logger Module User's Manual (Startup))
File transfer may not be performed for a period of time.	Has a response timeout error (error code: 1A82H) occurred? When the error has been occurred, has the access target CPU which does not exist been specified to the access target CPU setting? Or can high speed data logger module communicate with the access target CPU?	• Check the communication cable status and access target CPU status.
Unable to open the transferred file.	Does the full path length of the file exceed 260 characters?	• Shorten the folder name on the file path and set the full path length within 260 characters. • Review the settings so that the full path length of the transferred file is within 260 characters.
A file does not exist in the transfer destination.	Is the referred transfer folder correct?	• Check the transfer folder.
Unable to download FTP from a high speed data logger module by using a web browser.	Is the FTP site opening in text format?	• Open the FTP site in Explorer format.
Although the network was restored, the number of file resend buffered data does not decrease.	Is file switching executed frequently?	• Correct the settings of file switching timing and adjust the file transfer frequency.
Unable to connect to the FTP server of a high speed data logger module by using a web browser.	Are the correct user name and password specified?	• Check if the specified user name and password are correct, and retry. • If the "User Authentication" screen does not appear due to the specification of a web browser, enter the address of a high speed data logger module in the following format. ftp://<user name>:<password>@<the address of a high speed data logger module or host name>/

Troubleshooting on e-mails

Symptom	Check point	Corrective action
Unable to send E-mail.	Is the high speed data logger module correctly connected to the network?	• Check the module status, network connection status of the high speed data logger module.
While sending the file, the no attached file error (error code: 1B15) occurs.	Check that the attached file is not getting deleted.	• Review the settings for the file switching timing, file capacity, and the number of saved files, and lengthen the time until the file is deleted.
A file which does not contain data is transferred.	Has the saved file only in the header line been sent?	• Configure and adjust the system so that the file is switched after the data output.
E-mail may not be sent for a period of time.	Has a response timeout error (error code: 1A82H) occurred? When the error has been occurred, has the access target CPU which does not exist been specified to the access target CPU setting? Or can high speed data logger module communicate with the access target CPU?	• Check the communication cable status and access target CPU status.
An e-mail is not resent.	Is the SMTP server name set with a host name?	• Set the SMTP server name with an IP address.
Although the network was restored, the number of e-mail resend buffered data does not decrease.	Is file switching executed frequently?	• Review the setting for file switching timing, and adjust the frequency of e-mail sending.

Troubleshooting on communication between a high speed data logger module and access target module

Symptom	Check point	Corrective action
Unable to access another station via an Ethernet module and CC-Link IE TSN.	Is a remote password set for the engineering tool communication port (UDP/IP) of the Ethernet module and CC-Link IE TSN module on the target or relay station?	<ul style="list-style-type: none"> Remove the remote password.
	Is a high speed data logger module the firmware version of which is '15' or earlier used when accessing via CC-Link IE TSN?	<ul style="list-style-type: none"> Use a high speed data logger module the firmware version of which is '16' or later.
An error occurs when accessing a process CPU (redundant mode) in a redundant system	Is a process CPU (redundant mode) of another station accessed?	<ul style="list-style-type: none"> Review the system so that the process CPU (redundant mode) of another station is not accessed.
	Has the fast system switching (every 100 ms etc.) occurred continuously after passing the timeout time set with the access target CPU setting?	<ul style="list-style-type: none"> Review the system so that the fast system switching does not occur continuously.
Unable to access another station via the built-in Ethernet port of a high speed data logger module.	Are the devices on the communication route (such as router) operating normally?	<ul style="list-style-type: none"> Check their operating status. Perform the PING test for the high speed data logger module from the access target CPU module side (built-in Ethernet port CPU, Ethernet module, or CC-Link IE TSN module), then turn the power of own station OFF and ON.
	Is the access target a CPU module of Q series or L series? In that case, is UDP (MELSOFT Connection) added to the open setting for a built-in Ethernet port of the access target CPU?	<ul style="list-style-type: none"> Add UDP (MELSOFT Connection).
	Is a high speed data logger module the firmware version of which is '15' or earlier used when using CC-Link IE TSN for the access target?	<ul style="list-style-type: none"> Use a high speed data logger module the firmware version of which is '16' or later.
An error such as timeout or data missing occurs when accessing another station via the built-in Ethernet port of a high speed data logger module.	If a device (such as router) except for Ethernet (twisted pair) cables and hubs exists on the access route, is the device operating normally?	<ul style="list-style-type: none"> Check the status of route and that of device (such as router) on the route. Reconfigure the communication route to the access target CPU with Ethernet (twisted pair) cables and hubs.
"Errors detected in the CPU module" occur when the high speed data logger module is starting up.	Is "4B00H" stored in the source error? Is the other CPU on the multiple CPU system, or the other CPU accessing the other station via the controlled Network module?	<ul style="list-style-type: none"> Clear the error of the high speed data logger module after the CPU on the multiple CPU system is activated.

Troubleshooting on an SD memory card

Symptom	Check point	Corrective action
Unable to format the SD memory card.	Is the SD memory card being accessed?	<ul style="list-style-type: none"> Wait until the SD memory card access is completed.
When SD memory card is accessed by a personal computer, the following items occur. <ul style="list-style-type: none"> File size is displayed as 0 bytes. A space is added to the end of the data in a file. File error, file entry error, file size error messages are displayed and unable to open files. 	Was file access stopped before ejecting or replacing the SD memory card regardless of the power ON/OFF status?	<ul style="list-style-type: none"> Always stop file access before ejecting or replacing the SD memory card regardless of the power ON/OFF status. (MELSEC iQ-R High Speed Data Logger Module User's Manual (Startup))
		<ul style="list-style-type: none"> To repair the SD memory card with errors, perform either of the following options. Insert the SD memory card with errors in the high speed data logger module again. After stopping file access, eject the SD memory card. (MELSEC iQ-R High Speed Data Logger Module User's Manual (Startup)) Execute the chkdsk command on the Windows command prompt.
The files in the SD memory card are vanished when the power interruption occurred.	Is there a problem with the type of SD memory card?	<ul style="list-style-type: none"> Use the available SD memory card. (MELSEC iQ-R High Speed Data Logger Module User's Manual (Startup))
	Was the power turned OFF or control CPU reset when writing data to the SD memory card?	<ul style="list-style-type: none"> Stop file access before turning OFF the power or reset the control CPU. (MELSEC iQ-R High Speed Data Logger Module User's Manual (Startup)) Format SD memory card. (Page 223 SD memory card diagnostics)

Symptom	Check point	Corrective action
Cannot recognize the SD memory card. (CARD RDY LED does not turn ON.)	Is the SD memory card inserted correctly?	• Remove it once and insert again.
	Has the SD memory card been formatted in another device such as a personal computer?	• Format SD memory card by using high speed data logger module.
	Is the control CPU reset or the power is turned OFF during formatting?	
	Was the power turned OFF or control CPU reset when writing data to the SD memory card?	• Stop file access before turning OFF the power or reset the control CPU. (MELSEC iQ-R High Speed Data Logger Module User's Manual (Startup)) • Format SD memory card. (Page 223 SD memory card diagnostics)
	Is the write protect switch of the SD memory card locked?	• Unlock the write protect switch of the SD memory card and insert it again.
The access speed to the SD memory card becomes slower.	Are the files saved up to the capacity limit of the SD memory card?	• Use the SD memory card maintaining 10% or more free space on the card.
The specified size of free space cannot be ensured in the SD memory card.	Are there any files on the SD memory card other than saved files created by the data logging, event logging or report function operated on the high speed data logger module?	• Delete unnecessary files from the SD memory card.
	Is the size excluding the total size of the files not to be deleted from the total space of the inserted SD memory card larger than the specified size of free space?	• Review the settings such that the size excluding the total size of the files not to be deleted from the total space of the inserted SD memory card is smaller than the specified size of free space. (Page 102 Free Space Adjustment Function)
Unable to create the saved files as many as specified.	Is the SD memory card setting configured?	• Check the SD memory card setting. • Delete unnecessary files from the SD memory card.
	Are the files saved up to the capacity limit of the SD memory card?	• Delete unnecessary files from the SD memory card.
The total capacity, free space, and usage rate of the SD memory card are not displayed.	Is the access state 'Access stop'?	• Execute 'Access restart'. (Page 223 SD memory card diagnostics)
	Is the access state 'Formatting'?	• Wait until the access state becomes 'Accessible'.
	Is the access state 'Preparing access'?	
	Is the access state 'Card error detected'?	• Format. (Page 223 SD memory card diagnostics) • Replace the SD memory card.
Unable to start logging when the SD memory card is inserted.	Have the settings already been written to the SD memory card?	• Write the settings to the high speed data logger module. (Page 216 Write) • Export the settings to the inserted SD memory card. (Page 130 Exporting module operating file)
	Have the settings already been updated?	• Update the settings. (Page 218 Module diagnostics)
	Have the settings with the Auto logging function set to be enabled already been written to the SD memory card?	• Set the auto logging function. (Page 145 Logging operation setting)
Unable to write the file.	Is the write protect switch of the SD memory card locked?	• Unlock the write protect switch of the SD memory card and retry.
The CARD RDY LED remains flashing after removing the SD memory card.	Was the SD memory card removed while mounting it (while the CARD RDY LED is flashing)?	• Turn the power OFF → ON or reset the CPU module. (Do not remove the SD memory card while mounting it. Make sure to stop file access before removing the SD memory card.)

Troubleshooting on Configuration Tool

Symptom	Check point	Corrective action
When opening or saving a file, a message such as "Please insert a disk" is displayed.	Is a removable drive or network drive specified at the last time the file was opened or saved?	<ul style="list-style-type: none"> • Reselect an existing drive on the personal computer.
Unable to close other Excel files at the configuration of a layout setting.	Are other Excel files opened in the same Excel as the layout settings?	<ul style="list-style-type: none"> • When opening other Excel files, start Excel from Windows Start.
When configuring the layout settings and selecting the leading cell, cell range, or cell selection, a small window titled "RefEdit" is displayed.	Are other Excel files opened in the same Excel as the layout settings?	<ul style="list-style-type: none"> • Select the cell(s) and click the OK button. • When opening other Excel files, start Excel from Windows Start.
Cannot start Configuration Tool online. (Cannot start in a web browser)	Are the permissions granted to the user logged on to Windows sufficient?	<ul style="list-style-type: none"> • Login with the user having a higher authority than the "Standard user".
	Is the parental control (family safety) enabled for the user logged on to Windows?	<ul style="list-style-type: none"> • Disable the parental control (family safety) for the user logged on to Windows.
	Have the security settings for Internet Explorer been set?	<ul style="list-style-type: none"> • Set the security settings for Internet Explorer to "Medium" or lower. (MELSEC iQ-R High Speed Data Logger Module User's Manual (Startup))
	Is the hard disk out of free space?	<ul style="list-style-type: none"> • Check the free space of the hard disk. (MELSEC iQ-R High Speed Data Logger Module User's Manual (Startup))
	Is the memory or the system resources on the personal computer sufficient?	<ul style="list-style-type: none"> • Increase the necessary memory on the personal computer. (MELSEC iQ-R High Speed Data Logger Module User's Manual (Startup)) • Close other programs and restart Configuration Tool.
	Has .NET Framework4.5 been installed?	<ul style="list-style-type: none"> • Install .NET Framework4.5.
	Is SmartScreen disabled in Windows 8, Windows 8.1, and Windows 10?	<ul style="list-style-type: none"> • Disable SmartScreen.
Unable to start Configuration Tool online. (Source code is displayed.)	Is the message "Application cannot be started. Contact the application vendors" displayed?	<ul style="list-style-type: none"> • Wait for a while and retry. • Delete the cache used for online startup by executing the following command with Windows command prompt. (When the command is executed, all the ClickOnce caches saved in the personal computer are deleted.) rmdir /S /Q %USERPROFILE%\AppData\Local\Apps\2.0
	Does a proxy server exist along the connection route?	<ul style="list-style-type: none"> • Disable the proxy settings in a web browser. (MELSEC iQ-R High Speed Data Logger Module User's Manual (Startup)) • Delete temporary internet files, or reload the screen in which the source code is displayed by pressing the Ctrl + F5 keys and retry online startup. (MELSEC iQ-R High Speed Data Logger Module User's Manual (Startup))
	Are temporary internet files of a web browser deleted?	<ul style="list-style-type: none"> • Delete temporary internet files, or reload the screen in which the source code is displayed by pressing the Ctrl + F5 keys and retry online startup. (MELSEC iQ-R High Speed Data Logger Module User's Manual (Startup))

Symptom	Check point	Corrective action
Unable to communicate with the module. (Cannot operate online)	Are the permissions granted to the user logged on to Windows sufficient?	• Login with the user having a higher authority than the "Standard user".
	Is Windows firewall enabled on the personal computer?	• Disable Windows firewall on the personal computer when using "Find High Speed Data Logger Module" or direct connection.
	Is antivirus software blocking Ethernet communications?	• Change the antivirus software settings to allow Ethernet communications. • Lower the antivirus software's security settings level. • Stop the antivirus software.
	Is direct connection specified for the transfer setup?	• For a direct connection, connect the high speed data logger module to the personal computer on a 1:1 basis. (MELSEC iQ-R High Speed Data Logger Module User's Manual (Startup))
	Are multiple IP addresses enabled at the same time on the personal computer side?	• For a direct connection, make sure multiple IP addresses are not enabled at the same time in the personal computer. • Disable the wireless LAN function.
	Is the Ethernet network between personal computer and high speed data logger module getting overloaded?	• Check the status of the Ethernet network and reduce the load. After that, wait for a while and access again.
	Is the write protect switch of the SD memory card locked?	• Unlock the write protect switch of the SD memory card and retry.
When editing the layout settings, the layout file size becomes larger regardless of not changing the layout.	Are the layout settings edited with a version of Excel different from the one that first set the layout?	• Edit the layout settings with the same version of Excel that was used to first set the layout. (MELSEC iQ-R High Speed Data Logger Module User's Manual (Startup))
Unable to start the "Layout setting" screen.	Is the Excel VBA function installed?	• Install Excel again. At this time, do not set "Do not install" or "Not Available, Hidden, Locked" for the VBA function installation options.
	Is Excel 2010 (64-bit version), Excel 2013 (64-bit version), or Excel 2016 (64-bit version) installed?	• Install Excel 2010 (32-bit version), Excel 2013 (32-bit version), Excel 2016 (32-bit version), Excel 2019 (32-bit version/64-bit version), or Microsoft 365 (32-bit version/64-bit version) again.
	Is the version of Excel earlier than Excel 2010 installed?	
	Are add-ins installed in Excel?	• Disable installed add-ins. (Page 197 Layout)
The characters on the "Layout setting" screen are truncated.	Are the symbols (such as ○, ▲) used for the "Sheet name", "Data logging name", "Data name", "Access target CPU", or "Layout name"?	• Do not use the symbols (such as ○, ▲) for the "Sheet name", "Data logging name", "Data name", "Access target CPU", or "Layout name".
It takes time to communicate with the module.	Are Data logging function, Event logging function, and Report function overloaded? (The number of units of sampled data is large, data sampling interval is less, the layout file size of the report is large, etc.)	• Stop the module operation, communicate with the module, and restart the module operation. • Review the settings and lessen the processing load. (Reducing the number of units of sampled data, extend the data sampling interval, lessen the layout file size of the report, etc.)
	Are the DNS server settings of the personal computer correct? (Check the Internet protocol (TCP/IP) properties of the personal computer.)	• Set the correct DNS server. • If no DNS server exists on the network, do not configure the DNS server (set to blank).
It takes time to start the "Layout setting" screen.	Are the DNS server settings of the personal computer correct? (Check the Internet protocol (TCP/IP) properties of the personal computer.)	• Set the correct DNS server. • If no DNS server exists on the network, do not configure the DNS server (set to blank).
	Is the "Get External Data" function of Excel is used in Excel file of the layout setting?	• Check the reference of the "Get External Data" function of Excel. • Delete the settings on the "Get External Data" function of Excel.
"Unknown Publisher" is displayed for the publisher when using the online startup function of Configuration Tool.	Have the root certificates been updated? (Is the personal computer connected to the Internet?)	• Install the update program for root certificates provided by Microsoft.
The message indicating the certificate date has expired appears when the "Layout setting" screen starts up.		

Symptom	Check point	Corrective action
Unable to start Configuration Tool.	<ul style="list-style-type: none"> Is the memory or the system resources on the personal computer sufficient? Has .NET Framework4.5 been installed? Is SmartScreen disabled in Windows 8, Windows 8.1, and Windows 10? 	<ul style="list-style-type: none"> Increase the necessary memory on the personal computer. (MELSEC iQ-R High Speed Data Logger Module User's Manual (Startup)) Close other programs and restart Configuration Tool. Install .NET Framework4.5. Disable SmartScreen.
Unable to display the screen of Configuration Tool correctly.		
Unable to operate Configuration Tool.		
Forced to terminate Configuration Tool.		
Unable to display the characters on a screen properly.	Is the font size set to "Large Fonts" or "Extra Large Fonts" in Windows display settings?	<ul style="list-style-type: none"> Change the size of the text and other items in the screen to 100% (96 DPI, 9 pt etc.) in Windows display settings.
	Is the DPI setting set to a size other than the normal size in Windows display settings?	
An error message is displayed when opening the logging file of GX LogViewer.	Has a logging file containing only a header line opened?	<ul style="list-style-type: none"> Open the accumulating file after outputting data.
	Is a logging file broken?	<ul style="list-style-type: none"> Check if the file is correct.
	Is a logging file opened whose file version described in the header line is other than 'RD81DL96_1'?	<ul style="list-style-type: none"> Review the CSV output setting of the data logging setting and event logging setting. (Page 165 CSV output, Page 189 CSV output)
A dashed-dotted line is displayed on GX LogViewer.	Has missing data occurred?	<ul style="list-style-type: none"> Review the settings to prevent any data miss. (Page 62 Data missing)
A dashed-dotted line is displayed in the realtime trend graph of GX LogViewer.	Has the logging displayed in the Realtime trend graph stopped because it was over the number of saved files?	<ul style="list-style-type: none"> Delete unnecessary saved files, and restart the logging.
Failed to read (verification).	Is it communicating with the module?	<ul style="list-style-type: none"> Refer to the troubleshooting of "Cannot communicate with the module. (Cannot operate online)" in this table.
	Is a SD memory card to which data have never been written (exported) inserted?	<ul style="list-style-type: none"> Write (export) data to the SD memory card.
	Has a cancel (communication failure occurrence) occurred during writing?	<ul style="list-style-type: none"> Perform the write process again.
	Are there any settings which are not supported by Configuration Tool in the high speed data logger module?	<ul style="list-style-type: none"> Start Configuration Tool directly from the module. Upgrade to the latest version of Configuration Tool.
"The settings were not found in the module. Please write the settings to the module." message is displayed when writing (verifying) settings.	Are there any settings which are not supported by Configuration Tool in the high speed data logger module?	<ul style="list-style-type: none"> Start Configuration Tool directly from the module. Upgrade to the latest version of Configuration Tool.
	Is a SD memory card to which data have never been written (exported) inserted?	<ul style="list-style-type: none"> Write (export) data to the SD memory card.
Failed to select GX Works3 project.	Is GX Works3 installed?	<ul style="list-style-type: none"> Install GX Works3 Version 1.015R or later.
Unable to display GX Works3 projects in the "Workspace/Project list".	Are these GX Works2 projects saved in a Workspace format?	<ul style="list-style-type: none"> Specify the work space/project for GX Works3.
Unable to display GX Works3 projects in the folder list.	Is GX Works3 installed?	<ul style="list-style-type: none"> Install GX Works3 Version 1.020W or later.
Failed to import the global label and the common device comment of the GX Works3.	Is GX Works3 installed?	<ul style="list-style-type: none"> Install GX Works3 Version 1.020W or later.
	Does the import source project file exist?	<ul style="list-style-type: none"> Check the source project imported on the "Global label/Common device comment import setting" screen.
	Is the import source project file corrupted?	<ul style="list-style-type: none"> Check whether the project can be opened in GX Works3.
The data on the "Import global label" screen cannot be imported.	Is the data configurable in Configuration Tool?	<ul style="list-style-type: none"> Check that the start device, the data type, and the number of strings are configurable value in Configuration Tool.
The data cannot be imported on the "Import common device comment" screen.	Is the data configurable in Configuration Tool?	<ul style="list-style-type: none"> Check that the start device is configurable value in Configuration Tool.
Failed to import common device comment of GX Works3.	Is GX Works3 installed?	<ul style="list-style-type: none"> Install GX Works3 Version 1.020W or later.
	Does the import source project file exist?	<ul style="list-style-type: none"> Check the source project imported on the "Global label/Common device comment import setting" screen.
	Is the common device comment file corrupted?	<ul style="list-style-type: none"> Check whether the Common device comment can be displayed in GX Works3.

Symptom	Check point	Corrective action
Failed to update data related to global label.	Is GX Works3 installed?	• Install GX Works3 Version 1.020W or later.
	Does the import source project file of the data to be updated exist?	• Check the source project imported on the "Global label/Common device comment import setting" screen.
	Is the import source project file of the data to be updated corrupted?	• Check whether the project can be opened in GX Works3.
The type on the update data screen is changed to "Relation release".	Does the global label to be updated exist?	• Open the project in GX Works3 and check that the global label to be updated exist.
	Is the global label to be updated configurable in Configuration Tool?	• Open the project in GX Works3 and check that the start device, the data type, and the number of strings of the global label to be updated are configurable value in Configuration Tool.
	Is inconsistency occurred when using the related data in conditional expression?	• Open the project in GX Works3 and check that the related data used in conditional expression has been changed to the data type which is not configurable.
Unable to import a project file.	Is specified project file incorrect?	• Specify the correct project file.
	Is inconsistency occurred by import?	• Review the settings of import source. • Review the settings of import destination. • Correct the settings to be imported. (MELSEC iQ-R High Speed Data Logger Module User's Manual (Startup))
	Is the upper limit of the number of settings exceeded?	• Correct the number of settings. (MELSEC iQ-R High Speed Data Logger Module User's Manual (Startup))
The character strings (Project path) ^{*1} in the exported CSV file are not displayed correctly.	Has the project path ^{*1} of the character string described other than English been set by Configuration Tool?	• Specify the project path ^{*1} of the character string described in the English and then import the project.
A timeout occurs when the settings are updated, or the update of the settings takes long time.	Is there any abnormality in the connection route between the high speed data logger module and access target CPU?	• Check the communication route between the high speed data logger module and the access target CPU.
	Is there any error in the access target CPU setting?	• Correct "Access target CPU setting".
	Is there any unnecessary access target CPU setting?	• Delete the unnecessary access target CPU setting. (Depending on the number of items set in access target CPU settings, it may take several minutes until 'Module READY' (X0) turns ON.)
An error message is displayed when logging file clear is executed.	Is the number of files in the inserted SD memory card large?	• Execute the module operation restart after a while. • When the module restart operation is failed, execute it again after a while.
"Failed in opening project files." message is displayed when opening (importing) a project file.	Is a setting which is not supported by Configuration tool set in a project file?	• Start Configuration Tool directly from the module. • Upgrade to the latest version of Configuration Tool.

*1 Specify from the "Global label/common device comment import setting" screen.

Troubleshooting on the recipe function

Symptom	Check point	Corrective action
Failed to read/write the recipe file.	Does specified record number exist in the Recipe file?	<ul style="list-style-type: none"> Check the setting of the recipe file. Correct the value of the record number to be specified.
	Is the record number which is larger than the number of the records specified?	<ul style="list-style-type: none"> Change the record number of the recipe file.
	Is the order of the record number in the Recipe file in series (1, 2, ... 255, 256)?	<ul style="list-style-type: none"> Correct the record number of the recipe file in series.
	Is the fixed string area as the format?	<ul style="list-style-type: none"> Set the fixed string area as the recipe format. (Page 383 Recipe File Format)
	Is the upper limit of the number of blocks, the number of records, the number of data exceeded?	<ul style="list-style-type: none"> Set each of the number of blocks, the number of records and the number of units of data in one recipe file so it does not exceed 256.
	Does the blank row, the blank column exist between the blocks, the records?	<ul style="list-style-type: none"> Delete the blank row, the blank column between the blocks, the records.
	Is the data written in the record attribute "P"?	<ul style="list-style-type: none"> Review the attribute of the target record. Change the specified record number.
	Does the blank exist in the device value of the record attribute other than 'N'?	<ul style="list-style-type: none"> Set the device value. Add 'N' to the record attribute.
	Is the data read when the device value of the record attribute 'N' is blank?	<ul style="list-style-type: none"> Read the data after writing data.
	Is the device value within the range that can be represented with specified data type?	<ul style="list-style-type: none"> Correct the setting value of the device value.
	Is the data configurable in the Recipe function?	<ul style="list-style-type: none"> Check that the device, the data type, and the number of strings are configurable value in the recipe file.
	Is the inexistent access target CPU specified?	<ul style="list-style-type: none"> Check the settings for the access target CPU of the target high speed data logger module, and set the value for the existing access target CPU.
	Does specified Recipe file exist in the RECIPE folder?	<ul style="list-style-type: none"> Check the files in the RECIPE folder.
	Is the file which is occupied by other dedicated instruction specified?	<ul style="list-style-type: none"> Provide an interlock among dedicated instructions to access the same file.
	Are other dedicated instructions being executed?	<ul style="list-style-type: none"> Execute after other dedicated instruction is completed.
	Is the other recipe execution operation performing?	<ul style="list-style-type: none"> Perform the recipe execution operation after other recipe execution operation is completed.
	Is the access state of the SD memory card "Access stop"?	<ul style="list-style-type: none"> Execute 'Access restart'. (Page 223 SD memory card diagnostics)
Is the module operation in stop status?	<ul style="list-style-type: none"> Perform "Restart" of the module operation. (Page 218 Module diagnostics) Execute "Update Settings" of the module operation. (Page 218 Module diagnostics) 	
Is the write protect switch of the SD memory card locked?	<ul style="list-style-type: none"> Unlock the write protect switch of the SD memory card and retry. 	
The values in the recipe file are not written correctly to the CPU module.	Are FLOAT (Single Precision) or FLOAT (Double Precision) values to be written, usable in the CPU module?	<ul style="list-style-type: none"> Correct the setting value of the device value.
Unable to display a file name in the file list on the "Recipe Execution Operation" screen.	Does a recipe file exist in the RECIPE folder of the SD memory card?	<ul style="list-style-type: none"> Store a recipe file in the RECIPE folder of the SD memory card.
	Is a unsupported character used for a recipe file name?	<ul style="list-style-type: none"> Use available characters for the recipe file name. (Page 343 File name and folder (directory) name)
	Does more than 257 CSV files exist in the RECIPE folder of the SD memory card?	<ul style="list-style-type: none"> Make the number of CSV files in the RECIPE folder of the SD memory card 256 files or less.
The file downloaded from the high speed data logger module is old (data before writing is obtained)	Were the settings for temporary internet files of Internet Explorer configured?	<ul style="list-style-type: none"> Configure the settings for temporary internet files of Internet Explorer. (MELSEC iQ-R High Speed Data Logger Module User's Manual (Startup))

Symptom	Check point	Corrective action
The content of a recipe file stored in the SD memory card inserted in a personal computer is changed.	Was the write process performed to the recipe files using the recipe function?	<ul style="list-style-type: none"> • Check the event history. (☞ Page 219 Event history)
	Was the file access stop performed before removing the SD memory card from the module regardless of the power ON/OFF status?	<ul style="list-style-type: none"> • Store the recipe file after stopping file access. (☞ MELSEC iQ-R High Speed Data Logger Module User's Manual (Startup)) • Save a recipe file from a file browser or FTP client. (☞ Page 231 File browser, Page 104 FTP Server Function)

4.4 Error Code List

Displays the error code list.

Error code	Error name	Error description	Corrective action
1801H to 1802H	Period of time setting error	An invalid setting has been made in the period setting. Or the setting file is corrupted.	<ul style="list-style-type: none"> Write the settings again with the Configuration Tool. Replace the SD memory card.
180BH	Rename error	Failed to rename.	<ul style="list-style-type: none"> Delete unnecessary files on the SD memory card to ensure free space. Replace the SD memory card.
180CH	File open error	Failed to open the file.	<ul style="list-style-type: none"> Delete unnecessary files on the SD memory card to ensure free space. Replace the SD memory card.
180DH	File read error	Failed to read the file.	<ul style="list-style-type: none"> Delete unnecessary files on the SD memory card to ensure free space. Replace the SD memory card.
180FH	File write error	Failed to write the file.	<ul style="list-style-type: none"> Delete unnecessary files on the SD memory card to ensure free space. Replace the SD memory card.
1810H	File creation error	Failed to create the file.	<ul style="list-style-type: none"> Delete unnecessary files on the SD memory card to ensure free space. Replace the SD memory card.
1811H	File write error	Failed to write the file.	<ul style="list-style-type: none"> Delete unnecessary files on the SD memory card to ensure free space. Replace the SD memory card.
181AH	Save file number excess error	The saved file number exceeded FFFFFFFF.	<ul style="list-style-type: none"> Delete all the saved files on the SD memory card. Clear the files by the SD memory card diagnostics of the Configuration Tool. Replace the SD memory card.
181BH	Directory creation error	Failed to create the directory.	<ul style="list-style-type: none"> Delete unnecessary files on the SD memory card to ensure free space. Replace the SD memory card.
181CH	File information acquisition error	Failed to acquire the file information.	<ul style="list-style-type: none"> Delete unnecessary files on the SD memory card to ensure free space. Replace the SD memory card.
181DH	File creation error	Failed to create the file.	<ul style="list-style-type: none"> Delete unnecessary files on the SD memory card to ensure free space. Replace the SD memory card.
1828H to 1836H	File access error	An error occurred when accessing the file.	<ul style="list-style-type: none"> Delete unnecessary files on the SD memory card to ensure free space. Replace the SD memory card.
1837H	File creation error	Failed to create the file.	<ul style="list-style-type: none"> Delete unnecessary files on the SD memory card to ensure free space. Replace the SD memory card.
1838H to 183CH	File access error	An error occurred when accessing the file.	<ul style="list-style-type: none"> Delete unnecessary files on the SD memory card to ensure free space. Replace the SD memory card.
183DH	File creation error	Failed to create the file.	<ul style="list-style-type: none"> Delete unnecessary files on the SD memory card to ensure free space. Replace the SD memory card.
183EH to 1841H	File access error	An error occurred when accessing the file.	<ul style="list-style-type: none"> Delete unnecessary files on the SD memory card to ensure free space. Replace the SD memory card.
1842H	File creation error	Failed to create the file.	<ul style="list-style-type: none"> Delete unnecessary files on the SD memory card to ensure free space. Replace the SD memory card.
1843H to 1850H	File access error	An error occurred when accessing the file.	<ul style="list-style-type: none"> Delete unnecessary files on the SD memory card to ensure free space. Replace the SD memory card.
1862H	Duplicate file/folder name error	The number of file name duplication or the number of folder name duplication have reached the upper limit.	<ul style="list-style-type: none"> Correct "Saved file name setting" or "Saved folder name setting" so that the file name or the folder name do not duplicate.

Error code	Error name	Error description	Corrective action
1884H	Unicode text file check error	Failed to check the Unicode text file.	<ul style="list-style-type: none"> • Replace the SD memory card.
1886H to 1887H	Unicode text file check error	Failed to check the Unicode text file.	<ul style="list-style-type: none"> • Replace the SD memory card.
1888H to 1889H	Unicode text file open error	An error occurred when accessing the Unicode text file.	<ul style="list-style-type: none"> • Delete unnecessary files on the SD memory card to ensure free space. • Replace the SD memory card.
188AH to 188BH	File check error	Failed to check the file.	<ul style="list-style-type: none"> • Delete unnecessary files on the SD memory card to ensure free space. • Replace the SD memory card.
1892H	File open error	An error occurred when accessing the file.	<ul style="list-style-type: none"> • Check if the file in the /SD/SYSTEM directory was directly edited. • Delete unnecessary files on the SD memory card to ensure free space. • Replace the SD memory card.
1893H	File seek error	An error occurred when accessing the file.	<ul style="list-style-type: none"> • Check if the file in the /SD/SYSTEM directory was directly edited. • Write the settings again with the Configuration Tool.
1894H	File write error	An error occurred when accessing the file.	<ul style="list-style-type: none"> • Delete unnecessary files on the SD memory card to ensure free space. • Replace the SD memory card.
1895H	File copy error	An error occurred when accessing the file.	<ul style="list-style-type: none"> • Delete unnecessary files on the SD memory card to ensure free space. • Replace the SD memory card.
1896H	File open error	An error occurred when accessing the file.	<ul style="list-style-type: none"> • Check if the file in the /SD/SYSTEM directory was directly edited. • Delete unnecessary files on the SD memory card to ensure free space. • Replace the SD memory card.
1897H	File write error	An error occurred when accessing the file.	<ul style="list-style-type: none"> • Delete unnecessary files on the SD memory card to ensure free space. • Replace the SD memory card.
1898H	File open error	An error occurred when accessing the file.	<ul style="list-style-type: none"> • Check if the file in the /SD/SYSTEM directory was directly edited. • Delete unnecessary files on the SD memory card to ensure free space. • Replace the SD memory card.
1899H	File read error	Failed to read the file.	<ul style="list-style-type: none"> • Delete unnecessary files on the SD memory card to ensure free space. • Replace the SD memory card.
18A0H	High speed sampling error	Failed to execute the high speed sampling.	<ul style="list-style-type: none"> • Write the settings again with the Configuration Tool. • Replace the SD memory card.
18A1H to 18A2H	High speed sampling unsupported CPU error	The control CPU does not support high speed sampling.	<ul style="list-style-type: none"> • Replace it with a CPU that supports high speed sampling.
18A3H to 18A8H	High speed sampling error	Failed to execute the high speed sampling.	<ul style="list-style-type: none"> • Write the settings again with the Configuration Tool. • Replace the SD memory card.
18A9H	High speed sampling error	An incorrect device is specified. Otherwise an unusable device in the high speed sampling is specified.	<ul style="list-style-type: none"> • Correct the set device.
18AAH	High speed sampling error	A device size out of range is specified.	<ul style="list-style-type: none"> • Specify a device size within range of the high speed sampling size.
18ABH to 18AEH	High speed sampling error	Failed to execute the high speed sampling.	<ul style="list-style-type: none"> • Write the settings again with the Configuration Tool. • Replace the SD memory card.
18AFH	High speed sampling error	<ul style="list-style-type: none"> • Module operation is executed by more than one location at the same time. • Failed to execute the high speed sampling. 	<ul style="list-style-type: none"> • Execute update settings again. • Write the settings again with the Configuration Tool. • Replace the SD memory card.
18B0H to 18B1H	High speed sampling error	Failed to execute the high speed sampling.	<ul style="list-style-type: none"> • Write the settings again with the Configuration Tool. • Replace the SD memory card.
18B2H to 18B3H	High speed sampling unsupported CPU error	The control CPU does not support high speed sampling.	<ul style="list-style-type: none"> • Replace it with a CPU that supports high speed sampling.

Error code	Error name	Error description	Corrective action
18B4H to 18BDH	High speed sampling error	Failed to execute the high speed sampling.	<ul style="list-style-type: none"> Write the settings again with the Configuration Tool. Replace the SD memory card.
18BEH	High speed sampling error	<ul style="list-style-type: none"> Module operation is executed by more than one location at the same time. Failed to execute the high speed sampling. 	<ul style="list-style-type: none"> Execute update settings again. Write the settings again with the Configuration Tool. Replace the SD memory card.
18BFH to 18C0H	High speed sampling error	Failed to execute the high speed sampling.	<ul style="list-style-type: none"> Write the settings again with the Configuration Tool. Replace the SD memory card.
18C1H to 18C2H	High speed sampling unsupported CPU error	The control CPU does not support high speed sampling.	<ul style="list-style-type: none"> Replace it with a CPU that supports high speed sampling.
18C3H to 18CCH	High speed sampling error	Failed to execute the high speed sampling.	<ul style="list-style-type: none"> Write the settings again with the Configuration Tool. Replace the SD memory card.
18CDH	High speed sampling error	<ul style="list-style-type: none"> Module operation is executed by more than one location at the same time. Failed to execute the high speed sampling. 	<ul style="list-style-type: none"> Execute update settings again. Write the settings again with the Configuration Tool. Replace the SD memory card.
18CEH to 18D0H	High speed sampling error	Failed to execute the high speed sampling.	<ul style="list-style-type: none"> Write the settings again with the Configuration Tool. Replace the SD memory card.
18D1H to 18D2H	High speed sampling unsupported CPU error	The control CPU does not support high speed sampling.	<ul style="list-style-type: none"> Replace it with a CPU that supports high speed sampling.
18D3H to 18DCH	High speed sampling error	Failed to execute the high speed sampling.	<ul style="list-style-type: none"> Write the settings again with the Configuration Tool. Replace the SD memory card.
18DDH	High speed sampling error	<ul style="list-style-type: none"> Module operation is executed by more than one location at the same time. Failed to execute the high speed sampling. 	<ul style="list-style-type: none"> Execute update settings again. Write the settings again with the Configuration Tool. Replace the SD memory card.
18DEH to 18E0H	High speed sampling error	Failed to execute the high speed sampling.	<ul style="list-style-type: none"> Write the settings again with the Configuration Tool. Replace the SD memory card.
18E1H to 18E2H	High speed sampling unsupported CPU error	The control CPU does not support high speed sampling.	<ul style="list-style-type: none"> Replace it with a CPU that supports high speed sampling.
18E3H to 18E9H	High speed sampling error	Failed to execute the high speed sampling.	<ul style="list-style-type: none"> Write the settings again with the Configuration Tool. Replace the SD memory card.
18EAH	High speed sampling error	Total device points of each module setting performing 'high speed sampling (synchronizes to the sequence function)' from same control CPU exceeds the maximum points. (Access points is calculated rounding up at 8192 points unit.)	<ul style="list-style-type: none"> Check the number of high speed sampling device points. Change the sampling method to general sampling. Configure the setting of control CPU so that total device points of each module setting using 'high speed sampling (synchronizes to the sequence function)' dose not exceed the maximum points.
18EBH	High speed sampling error	<ul style="list-style-type: none"> Total module number performing 'high speed sampling (synchronizes to the sequence function)' from same control CPU exceeds maximum module number. Module operation is executed by more than one location at the same time. 	<ul style="list-style-type: none"> Change the sampling method to general sampling. Configure the system so that module number using "high speed sampling (synchronizes to the sequence function)" dose not exceed the maximum number. Execute update settings again.
18ECH	High speed sampling error	<ul style="list-style-type: none"> Failed to start high speed sampling. Module operation is executed by more than one location at the same time. 	<ul style="list-style-type: none"> Restore the device points to points before updating setting. Cycle the power of the system where the high speed data logger module is mounted or reset the CPU module. Check the number of high speed sampling device points. Change the sampling method to general sampling. Execute update settings again.

Error code	Error name	Error description	Corrective action
18EDH to 18EFH	High speed sampling error	<ul style="list-style-type: none"> Module operation is executed by more than one location at the same time. Failed to execute the high speed sampling. 	<ul style="list-style-type: none"> Execute update settings again. Write the settings again with the Configuration Tool. Replace the SD memory card.
18F0H to 18F1H	High speed sampling error	Failed to execute the high speed sampling.	<ul style="list-style-type: none"> Write the settings again with the Configuration Tool. Replace the SD memory card.
18FAH to 18FCH	File write error	Failed to write the file.	<ul style="list-style-type: none"> Delete unnecessary files on the SD memory card to ensure free space. Replace the SD memory card.
1907H	Layout type specification error	An invalid layout type has been specified. Or the report setting file is corrupted.	<ul style="list-style-type: none"> Write the settings again with the Configuration Tool. Replace the SD memory card.
1909H	Current value sampling device information acquisition error	An invalid current value sampling device has been set. Or the current value sampling device information cannot be obtained because the report setting file is corrupt.	<ul style="list-style-type: none"> Write the settings again with the Configuration Tool. Replace the SD memory card.
190AH	Layout type specification error	An invalid layout type has been specified. Or the report setting file is corrupted.	<ul style="list-style-type: none"> Write the settings again with the Configuration Tool. Replace the SD memory card.
190FH	File read error	Failed to read the file.	<ul style="list-style-type: none"> Delete unnecessary files on the SD memory card to ensure free space. Replace the SD memory card.
1915H	Data type specified error	An invalid data type has been specified. Or the report setting file is corrupted.	<ul style="list-style-type: none"> Write the settings again with the Configuration Tool. Replace the SD memory card.
191EH	Save file number excess error	The saved file number exceeded FFFFFFFF.	<ul style="list-style-type: none"> Delete all the saved files on the SD memory card. Clear the files by the SD memory card diagnostics of the Configuration Tool. Replace the SD memory card.
191FH	Number of saved files excess error	The number of saved files has reached the upper limit.	<ul style="list-style-type: none"> Delete all the saved files on the SD memory card. Clear the files by the SD memory card diagnostics of the Configuration Tool. Replace the SD memory card.
1920H	Directory creation error	Failed to create the directory.	<ul style="list-style-type: none"> Delete unnecessary files on the SD memory card to ensure free space. Replace the SD memory card.
1921H	Rename error	Failed to rename.	<ul style="list-style-type: none"> Delete unnecessary files on the SD memory card to ensure free space. Check if the data logging file is being deleted before the report is output. Replace the SD memory card.
192BH	Output format specification error	An invalid output format has been specified. Or the report setting file is corrupted.	<ul style="list-style-type: none"> Write the settings again with the Configuration Tool. Replace the SD memory card.
192CH	Data type specified error	An invalid data type has been specified. Or the report setting file is corrupted.	<ul style="list-style-type: none"> Write the settings again with the Configuration Tool. Replace the SD memory card.
1930H to 1931H	Setting file error	There is no setting file. Or the setting file is corrupted.	<ul style="list-style-type: none"> Write the settings again with the Configuration Tool. Replace the SD memory card.
1940H to 1943H	Setting file error	There is no setting file. Or the setting file is corrupted.	<ul style="list-style-type: none"> Write the settings again with the Configuration Tool. Replace the SD memory card. Check if the power turned OFF or reset the programmable controller CPU without stopping file access.
194CH to 194DH	Setting file error	There is no setting file. Or the setting file is corrupted.	<ul style="list-style-type: none"> Write the settings again with the Configuration Tool. Replace the SD memory card.

Error code	Error name	Error description	Corrective action
1950H	File open error	Failed to open the file.	<ul style="list-style-type: none"> • Check if the file in the /SD/SYSTEM directory was directly edited. • Delete unnecessary files on the SD memory card to ensure free space. • Replace the SD memory card.
1951H	File information acquisition error	Failed to acquire the file information.	<ul style="list-style-type: none"> • Replace the SD memory card.
1952H	File seek error	Failed to seek the file.	<ul style="list-style-type: none"> • Check if the file in the /SD/SYSTEM directory was directly edited. • Write the settings again with the Configuration Tool.
1953H	File read error	Failed to read the file.	<ul style="list-style-type: none"> • Delete unnecessary files on the SD memory card to ensure free space. • Replace the SD memory card.
1954H	File write error	Failed to write the file.	<ul style="list-style-type: none"> • Delete unnecessary files on the SD memory card to ensure free space. • Replace the SD memory card.
1955H	File seek error	Failed to seek the file.	<ul style="list-style-type: none"> • Check if the file in the /SD/SYSTEM directory was directly edited. • Write the settings again with the Configuration Tool.
1956H	File read error	Failed to read the file.	<ul style="list-style-type: none"> • Delete unnecessary files on the SD memory card to ensure free space. • Replace the SD memory card.
1957H	File seek error	Failed to seek the file.	<ul style="list-style-type: none"> • Check if the file in the /SD/SYSTEM directory was directly edited. • Write the settings again with the Configuration Tool.
1958H	File write error	Failed to write the file.	<ul style="list-style-type: none"> • Delete unnecessary files on the SD memory card to ensure free space. • Replace the SD memory card.
195AH	File information acquisition error	Failed to acquire the file information.	<ul style="list-style-type: none"> • Check if the file in the /SD/SYSTEM directory was directly edited. • Delete unnecessary files on the SD memory card to ensure free space. • Replace the SD memory card.
195BH to 195CH	File open error	Failed to open the file.	<ul style="list-style-type: none"> • Delete unnecessary files on the SD memory card to ensure free space. • Replace the SD memory card.
195DH	File read error	Failed to read the file.	<ul style="list-style-type: none"> • Delete unnecessary files on the SD memory card to ensure free space. • Replace the SD memory card.
195EH	File write error	Failed to write the file.	<ul style="list-style-type: none"> • Delete unnecessary files on the SD memory card to ensure free space. • Replace the SD memory card.
195FH	File read error	Failed to read the file.	<ul style="list-style-type: none"> • Delete unnecessary files on the SD memory card to ensure free space. • Replace the SD memory card.
1960H	File write error	Failed to write the file.	<ul style="list-style-type: none"> • Delete unnecessary files on the SD memory card to ensure free space. • Replace the SD memory card.
1961H to 1962H	File read error	Failed to read the file.	<ul style="list-style-type: none"> • Delete unnecessary files on the SD memory card to ensure free space. • Replace the SD memory card.
1963H to 1967H	File write error	Failed to write the file.	<ul style="list-style-type: none"> • Delete unnecessary files on the SD memory card to ensure free space. • Replace the SD memory card.
196AH	File read error	Failed to read the file.	<ul style="list-style-type: none"> • Delete unnecessary files on the SD memory card to ensure free space. • Replace the SD memory card.
196BH	File write error	Failed to write the file.	<ul style="list-style-type: none"> • Delete unnecessary files on the SD memory card to ensure free space. • Replace the SD memory card.

Error code	Error name	Error description	Corrective action
196CH to 196FH	File read error	Failed to read the file.	<ul style="list-style-type: none"> • Check if the report layout file is edited with a tool other than the Configuration Tool. • Write the settings again with the Configuration Tool. • Delete unnecessary files on the SD memory card to ensure free space. • Replace the SD memory card.
1970H to 1978H	File write error	Failed to write the file.	<ul style="list-style-type: none"> • Delete unnecessary files on the SD memory card to ensure free space. • Replace the SD memory card.
1979H	Setting file error	The report layout file in the setting files is in unsupported format.	<ul style="list-style-type: none"> • Check if the report layout file is edited with a tool other than the Configuration Tool. • Configure the report layout settings with the Configuration Tool and save the Excel file again. • Write the settings again with the Configuration Tool. • Replace the SD memory card.
197AH	Layout file read error	Failed to read the layout file.	<ul style="list-style-type: none"> • Write the settings again with the Configuration Tool. • Delete unnecessary files on the SD memory card to ensure free space. • Replace the SD memory card.
197DH	Layout file read error	Failed to read the layout file.	<ul style="list-style-type: none"> • Write the settings again with the Configuration Tool. • Delete unnecessary files on the SD memory card to ensure free space. • Replace the SD memory card.
197EH	File read error	Failed to read the file.	<ul style="list-style-type: none"> • Delete unnecessary files on the SD memory card to ensure free space. • Replace the SD memory card.
1985H	Module error	A module error has been detected.	<ul style="list-style-type: none"> • Take measures to reduce noise. • Reset the CPU module and switch it to RUN. If the same error is displayed again, a hardware failure may occur in high speed data logger module. Please consult your local Mitsubishi representative.
1990H to 1997H	Report source file error	Data logging file to be output to the report file cannot be found.	<ul style="list-style-type: none"> • Configure and construct the system so that the creation trigger occurs after the specified number of records worth of data is saved in the data logging file. • Adjust the file switch timing for data logging. • Check if the data logging file is being deleted before the report is output. • Replace the SD memory card.
1999H to 199AH	Report file creation error	An error occurred while creating a report file.	<ul style="list-style-type: none"> • Write the settings again with the Configuration Tool. • Replace the SD memory card.
19B0H	Report source file error	Data logging file to be output to the report file cannot be found.	<ul style="list-style-type: none"> • Adjust the file switch timing for data logging. • Check if the data logging file is being deleted before the report is output. • Replace the SD memory card.
19B1H to 19B5H	File open error	Failed to open the file.	<ul style="list-style-type: none"> • Delete unnecessary files on the SD memory card to ensure free space. • Replace the SD memory card.
19B6H	Report source file error	Data logging file to be output to the report file cannot be found.	<ul style="list-style-type: none"> • Adjust the file switch timing for data logging. • Check if the data logging file is being deleted before the report is output. • Replace the SD memory card.
19B7H to 19B8H	File read error	Failed to read the file.	<ul style="list-style-type: none"> • Delete unnecessary files on the SD memory card to ensure free space. • Replace the SD memory card.
19BAH to 19BBH	File write error	Failed to write the file.	<ul style="list-style-type: none"> • Delete unnecessary files on the SD memory card to ensure free space. • Replace the SD memory card.

Error code	Error name	Error description	Corrective action
19BCH	Setting file error	The report layout file in the setting files is in unsupported format.	<ul style="list-style-type: none"> • Check if the report layout file is edited with a tool other than the Configuration Tool. • Configure the report layout settings with the Configuration Tool and save the Excel file again. • Write the settings again with the Configuration Tool. • Replace the SD memory card.
19BDH	File read error	Failed to read the file.	<ul style="list-style-type: none"> • Delete unnecessary files on the SD memory card to ensure free space. • Replace the SD memory card.
19BEH to 19BFH	File write error	Failed to write the file.	<ul style="list-style-type: none"> • Delete unnecessary files on the SD memory card to ensure free space. • Replace the SD memory card.
19C0H	File read error	Failed to read the file.	<ul style="list-style-type: none"> • Delete unnecessary files on the SD memory card to ensure free space. • Replace the SD memory card.
19C2H to 19C3H	File write error	Failed to write the file.	<ul style="list-style-type: none"> • Delete unnecessary files on the SD memory card to ensure free space. • Replace the SD memory card.
19C5H to 19C6H	File write error	Failed to write the file.	<ul style="list-style-type: none"> • Delete unnecessary files on the SD memory card to ensure free space. • Replace the SD memory card.
19C7H	Setting file error	There is no setting file. Or the setting file is corrupted.	<ul style="list-style-type: none"> • Write the settings again with the Configuration Tool. • Replace the SD memory card.
19D0H	E-mail transmission error	Tried to send a file of which the size exceeds 512 KB by e-mail.	<ul style="list-style-type: none"> • Configure the settings so that the size of report file does not exceed 512 KB.
1A00H	DHCP parameter acquisition error	When set to automatically acquire an IP address in the LAN connection, failed to acquire the network parameter information from the DHCP server.	<ul style="list-style-type: none"> • Check the connection status with the DHCP server. • Check the connection cable. • Check the DHCP server settings.
1A01H	DHCP lease renewal failure	The automatic lease renewal process, which occurs when the IP address lease acquired from the DHCP server expires, failed.	<ul style="list-style-type: none"> • Check the connection cable and status of the DHCP server (start status, secured allocated IP addresses).
1A02H	Network diagnostics error	Network diagnostics (ping transmission) failed.	<ul style="list-style-type: none"> • Check the connection cable, status of the external device. • Check if the destination for the network diagnostics setting in "Network setting" is correct.
1A0AH to 1A50H	Access target CPU communication error	Failed to communicate with access target CPU.	<ul style="list-style-type: none"> • Correct "Access target CPU setting". • Check the communication cable status and access target CPU status. • Adjust the response monitoring time setting. • Check if the control CPU of the network module on the network route to the access target CPU is set to QCPU (Q mode). • Check the routing parameter settings of the CPU(s) on the access route. • Check the network on the access route.
1A51H	Monitor condition dissatisfied error	Reading is not possible because the monitor condition is not established.	<ul style="list-style-type: none"> • Delete the monitor condition with the engineering tool.
1A52H to 1A54H	Access target CPU communication error	Failed to communicate with access target CPU.	<ul style="list-style-type: none"> • Correct "Access target CPU setting". • Check the communication cable status and access target CPU status. • Adjust the response monitoring time setting. • Check if the control CPU of the network module on the network route to the access target CPU is set to QCPU (Q mode). • Check the routing parameter settings of the CPU(s) on the access route. • Check the network on the access route.
1A55H	ROM operation error	Writing a TC setting value was attempted to the programmable controller CPU that was running the ROM.	<ul style="list-style-type: none"> • Change the TC setting value during RAM operation.

Error code	Error name	Error description	Corrective action
1A56H to 1A59H	Access target CPU communication error	Failed to communicate with access target CPU.	<ul style="list-style-type: none"> • Correct "Access target CPU setting". • Check the communication cable status and access target CPU status. • Adjust the response monitoring time setting. • Check if the control CPU of the network module on the network route to the access target CPU is set to QCPU (Q mode). • Check the routing parameter settings of the CPU(s) on the access route. • Check the network on the access route.
1A5AH	Access target CPU connection error	Incorrect IP address is specified in access target CPU. Or failed to communicate with access target CPU.	<ul style="list-style-type: none"> • Correct the Description (IP address) of access target CPU setting. • Check the configuration of the access target CPU. • Correct "Access target CPU setting". • Check the communication cable status and access target CPU status. • Check the network settings. • Adjust the response monitoring time setting. • Check the control CPU(s) of the network module(s) on the access route to the Access target device module. • Check the routing parameter settings of the CPU(s) on the access route. • Check the network on the access route.
1A5BH to 1A5EH	Access target CPU communication error	Failed to communicate with access target CPU.	<ul style="list-style-type: none"> • Correct "Access target CPU setting". • Check the communication cable status and access target CPU status. • Adjust the response monitoring time setting. • Check if the control CPU of the network module on the network route to the access target CPU is set to QCPU (Q mode). • Check the routing parameter settings of the CPU(s) on the access route. • Check the network on the access route.
1A5FH	Incorrect access target error	The setting for the access target CPU is incorrect.	<ul style="list-style-type: none"> • Correct "Access target CPU setting".
1A60H	Communication timeout error	The communication did not established because the access to the other access target CPU failed.	<ul style="list-style-type: none"> • Correct "Access target CPU setting". • Check the communication cable status and access target CPU status.
1A61H to 1A6FH	Access target CPU communication error	Failed to communicate with access target CPU.	<ul style="list-style-type: none"> • Correct "Access target CPU setting". • Check the communication cable status and access target CPU status. • Adjust the response monitoring time setting. • Check if the control CPU of the network module on the network route to the access target CPU is set to QCPU (Q mode). • Check the routing parameter settings of the CPU(s) on the access route. • Check the network on the access route.
1A70H	Station number or network number error	The station or network number is out of range or the setting is wrong.	<ul style="list-style-type: none"> • Check the station and network number in "Access target CPU setting".
1A71H	Access target CPU communication error	Failed to communicate with access target CPU.	<ul style="list-style-type: none"> • Correct "Access target CPU setting". • Check the communication cable status and access target CPU status. • Adjust the response monitoring time setting. • Check if the control CPU of the network module on the network route to the access target CPU is set to QCPU (Q mode). • Check the routing parameter settings of the CPU(s) on the access route. • Check the network on the access route.
1A72H	Memory cassette error	No memory cassette is installed in the accessed CPU module. Or an incorrect memory cassette has been installed.	<ul style="list-style-type: none"> • Check the memory cassette of the access target CPU.

Error code	Error name	Error description	Corrective action
1A73H	Write protect error	The block number of the specified extension file register has been allocated to the write-protect area of the memory cassette.	<ul style="list-style-type: none"> • Check the block number of the extension file register (device type). • Check the write-protect DIP switch on the memory cassette of the access target CPU.
1A74H	Block error	The block number of the specified extension file register is invalid.	<ul style="list-style-type: none"> • Check the block number of the extension file register (device type).
1A75H to 1A7AH	Access target CPU communication error	Failed to communicate with access target CPU.	<ul style="list-style-type: none"> • Correct "Access target CPU setting". • Check the communication cable status and access target CPU status. • Adjust the response monitoring time setting. • Check if the control CPU of the network module on the network route to the access target CPU is set to QCPU (Q mode). • Check the routing parameter settings of the CPU(s) on the access route. • Check the network on the access route.
1A7BH	Size error	The device size exceeded the device range.	<ul style="list-style-type: none"> • Correct the set device number.
1A7CH	CPU error	An invalid station was specified.	<ul style="list-style-type: none"> • Check the settings of the network module on the access route. • Review the station number setting in the access target CPU setting.
1A7DH	Device type error	The device type specified for the access target station is invalid.	<ul style="list-style-type: none"> • Correct the set device type. • Check series of the access target CPU setting.
1A7EH	Device number error	The device number specified for the access target station is out of range.	<ul style="list-style-type: none"> • Correct the set device number. • Check series of the access target CPU setting.
1A7FH to 1A81H	Access target CPU communication error	Failed to communicate with access target CPU.	<ul style="list-style-type: none"> • Correct "Access target CPU setting". • Check the communication cable status and access target CPU status. • Adjust the response monitoring time setting. • Check if the control CPU of the network module on the network route to the access target CPU is set to QCPU (Q mode). • Check the routing parameter settings of the CPU(s) on the access route. • Check the network on the access route.
1A82H	Response timeout error	No response has been received from the other station.	<ul style="list-style-type: none"> • Correct "Access target CPU setting". • Check the communication cable status and access target CPU status. • Adjust the response monitoring time setting. • Check the control CPU(s) of the network module(s) on the access route to the Access target device module. • Check the routing parameter settings of the CPU(s) on the access route. • Check the network on the access route. • Adjust the service processing setting of the access target CPU. • When the load of the network is high, adjust the system and lessen the processing load.
1A83H to 1A84H	Access target CPU communication error	Failed to communicate with access target CPU.	<ul style="list-style-type: none"> • Correct "Access target CPU setting". • Check the communication cable status and access target CPU status. • Adjust the response monitoring time setting. • Check if the control CPU of the network module on the network route to the access target CPU is set to QCPU (Q mode). • Check the routing parameter settings of the CPU(s) on the access route. • Check the network on the access route.
1A85H	Processing code error	The issued processing code cannot be processed on the other end.	<ul style="list-style-type: none"> • Check the CPU(s) on the access route.
1A86H	Station No. specification error	The specified station number is incorrect.	<ul style="list-style-type: none"> • Correct the station number setting in "Access target CPU setting".
1A87H	Receive data error	Data has not been received.	<ul style="list-style-type: none"> • Check the CPU(s) on the access route.

Error code	Error name	Error description	Corrective action
1AC8H to 1AD4H	Access target CPU communication error	Failed to communicate with access target CPU.	<ul style="list-style-type: none"> • Correct "Access target CPU setting". • Check the communication cable status and access target CPU status. • Adjust the response monitoring time setting. • Check if the control CPU of the network module on the network route to the access target CPU is set to QCPU (Q mode). • Check the routing parameter settings of the CPU(s) on the access route. • Check the network on the access route.
1AD5H	Channel number error	The RUN write setting of the Ethernet module is disabled.	<ul style="list-style-type: none"> • Review the Ethernet module setting of the access target CPU.
1AD6H to 1AE4H	Access target CPU communication error	Failed to communicate with access target CPU.	<ul style="list-style-type: none"> • Correct "Access target CPU setting". • Check the communication cable status and access target CPU status. • Adjust the response monitoring time setting. • Check if the control CPU of the network module on the network route to the access target CPU is set to QCPU (Q mode). • Check the routing parameter settings of the CPU(s) on the access route. • Check the network on the access route.
1AE5H	Routing parameter error	No routing parameter has been set.	<ul style="list-style-type: none"> • Set routing parameters on the access route.
1AE6H	Access target CPU communication error	Failed to communicate with access target CPU.	<ul style="list-style-type: none"> • Check the CPU(s) on the access route. • Check the network on the access route.
1AE7H	Access target CPU communication error	Failed to communicate with access target CPU.	<ul style="list-style-type: none"> • When accessing via built-in Ethernet port, check if UDP (MELSOFT Connection) is added to the open setting of a built-in Ethernet port for the access target CPU. • Check the CPU(s) on the access route. • Check the network on the access route.
1AE8H to 1AFFH	Access target CPU communication error	Failed to communicate with access target CPU.	<ul style="list-style-type: none"> • Correct "Access target CPU setting". • Check the communication cable status and access target CPU status. • Adjust the response monitoring time setting. • Check if the control CPU of the network module on the network route to the access target CPU is set to QCPU (Q mode). • Check the routing parameter settings of the CPU(s) on the access route. • Check the network on the access route.
1B03H	FTP file transfer error	<ul style="list-style-type: none"> • An error occurred during the FTP file transfer. 	<ul style="list-style-type: none"> • Correct the file transfer settings. • Check the connection status with the FTP server. • Check the destination FTP server status. • Correct the saved settings (file switch timing, number of saved files).
1B04H	No FTP transfer file error	<ul style="list-style-type: none"> • The saved file was deleted before FTP transfer because of file switching. 	<ul style="list-style-type: none"> • Correct the saved settings (file switch timing, number of saved files).
1B05H	Shared folder transfer error	<ul style="list-style-type: none"> • Failed to execute the shared folder transfer. 	<ul style="list-style-type: none"> • Correct the file transfer settings. • Check the connection status with shared folder. • Check the destination shared folder status. • Correct the saved settings (file switch timing, number of saved files).
1B06H	No shared folder transfer error	<ul style="list-style-type: none"> • The saved file was deleted before shared folder transfer because of file switching. 	<ul style="list-style-type: none"> • Correct the saved settings (file switch timing, number of saved files).
1B07H	FTP server control port connection error	Failed to connect to the FTP server's control port.	<ul style="list-style-type: none"> • Correct the file transfer settings. • Check the network connection status with the PING test. • Check the destination FTP server status. • When turning the power ON immediately after it is turned OFF, wait a few minutes before turning it ON.
1B08H	FTP server control port disconnection error	Failed to disconnect from the FTP server's control port.	<ul style="list-style-type: none"> • Check the connection status with the FTP server. • Check the destination FTP server status.

Error code	Error name	Error description	Corrective action
1B09H	FTP server login error	Failed to login to the FTP server.	<ul style="list-style-type: none"> • Correct the file transfer settings. • Check the connection status with the FTP server. • Check the destination FTP server status.
1B0AH	FTP server command execute error	Failed to execute the FTP command for the FTP server.	<ul style="list-style-type: none"> • Check the connection status with the FTP server. • Check the destination FTP server status. • Check if the write access authority is set on the destination FTP server.
1B0BH	FTP server data transfer port connection error	Failed to connect to the FTP server's data transfer port.	<ul style="list-style-type: none"> • Correct the file transfer settings. • Check the connection status with the FTP server. • Check the destination FTP server status.
1B0CH	FTP server data transfer port disconnection error	Failed to disconnect from the FTP server's data transfer port.	<ul style="list-style-type: none"> • Check the connection status with the FTP server. • Check the destination FTP server status.
1B0DH	Shared folder connecting error	Failed to connecting to shared folder.	<ul style="list-style-type: none"> • Correct the file transfer settings. • Check the network connection status with the PING test. • Check the connection status with shared folder. • Check the destination shared folder status. • When turning the power ON immediately after it is turned OFF, wait a few minutes before turning it ON.
1B0EH	Shared folder disconnecting error	Failed to disconnecting to shared folder.	<ul style="list-style-type: none"> • Check the connection status with shared folder. • Check the destination shared folder status.
1B0FH	File transfer not allowed	Made a file transfer request during "Network setting" default operation.	<ul style="list-style-type: none"> • Clear "Network setting" default operation.
1B10H	E-mail setting file error	Failed to read the "E-mail setting" file. Or failed to resolve the domain name.	<ul style="list-style-type: none"> • Write the settings again with the Configuration Tool. • Correct the "E-mail setting". • Set the "SMTP server name" with an IP address.
1B13H	E-mail transmission error	An error occurred during the e-mail transmission.	<ul style="list-style-type: none"> • Review the E-mail setting. • Check the connection status with the mail server. • Check the destination mail server status. • Configure the authentication settings in E-mail setting. • Correct the saved settings (file switch timing, number of saved files).
1B15H	No attached file error	The saved file to be attached to the e-mail was deleted before transmission because of file switching.	<ul style="list-style-type: none"> • Correct the saved settings (file switch timing, number of saved files).
1B16H	SMTP server login error	Failed to connect to the mail server (SMTP server).	<ul style="list-style-type: none"> • Review the E-mail setting. • Check the connection status with the mail server. • Check the destination mail server status. • When turning the power ON immediately after it is turned OFF, wait a few minutes before turning it ON.
1B17H	E-mail header send error	Failed to send the e-mail header.	<ul style="list-style-type: none"> • Check the connection status with the mail server. • Check the destination mail server status.
1B18H	E-mail main text send error	Failed to send the e-mail body.	<ul style="list-style-type: none"> • Check the connection status with the mail server. • Check the destination mail server status.
1B19H	Attached file send error	Failed to send the attachment.	<ul style="list-style-type: none"> • Check the connection status with the mail server. • Check the destination mail server status.
1B1AH	SMTP server logout error	Failed to disconnect from the mail server (SMTP server).	<ul style="list-style-type: none"> • Check the connection status with the mail server. • Check the destination mail server status.
1B1BH	E-mail sending not possible	Made an e-mail transmission request during "Network setting" default operation.	<ul style="list-style-type: none"> • Clear "Network setting" default operation.

Error code	Error name	Error description	Corrective action
1B1CH	POP server login error	Failed to connect to the mail server (POP server).	<ul style="list-style-type: none"> • Correct the "E-mail setting". • Check the connection status with the mail server. • Check the destination mail server status. • When turning the power ON immediately after it is turned OFF, wait a few minutes before turning it ON.
1B1DH	E-mail transfer error (a part of e-mail addresses)	Failed to send e-mail to a portion of destinations.	<ul style="list-style-type: none"> • Correct the destination e-mail address settings in "E-mail setting".
1B23H	Resend buffer write error	Failed to write files to file resend buffer.	<ul style="list-style-type: none"> • Delete unnecessary files on the SD memory card to ensure free space. • Replace the SD memory card.
1B24H	Resend buffer write error	Failed to write files to file resend buffer.	<ul style="list-style-type: none"> • Write the settings again with the Configuration Tool. • Replace the SD memory card.
1B25H	Resend buffer write error	Failed to write files to file resend buffer.	<ul style="list-style-type: none"> • Write the settings again with the Configuration Tool. • Delete unnecessary files on the SD memory card to ensure free space. • Replace the SD memory card.
1B26H	Resend buffer full error	The number of file resend buffered data has exceeded the resend buffer size set in the Configuration Tool.	<ul style="list-style-type: none"> • Check the network settings. • Clear the buffer by the file transfer diagnostics of the Configuration Tool. • Increase the resend buffer size.
1B2BH	Resend buffer write error	Failed to write files to e-mail resend buffer.	<ul style="list-style-type: none"> • Delete unnecessary files on the SD memory card to ensure free space. • Replace the SD memory card.
1B2CH	Resend buffer write error	Failed to write files to e-mail resend buffer.	<ul style="list-style-type: none"> • Write the settings again with the Configuration Tool. • Replace the SD memory card.
1B2DH	Resend buffer write error	Failed to write files to e-mail resend buffer.	<ul style="list-style-type: none"> • Write the settings again with the Configuration Tool. • Delete unnecessary files on the SD memory card to ensure free space. • Replace the SD memory card.
1B2EH	Resend buffer full error	The number of file resend buffered data has exceeded the resend buffer size set in the Configuration Tool.	<ul style="list-style-type: none"> • Check the network settings. • Clear the buffer by the e-mail send diagnostics of the Configuration Tool. • Increase the resend buffer size.
1B40H to 1B43H	Module error	A module error has been detected.	<ul style="list-style-type: none"> • Take measures to reduce noise. • Reset the CPU module and switch it to RUN. If the same error is displayed again, a hardware failure may occur in high speed data logger module. Please consult your local Mitsubishi representative.
1B44H	Unsupported CPU error	Wrote data to the device on inaccessible CPU.	<ul style="list-style-type: none"> • Correct "Access target CPU setting". • Check the communication cable status and access target CPU status. • Adjust the response monitoring time setting. • Check if the control CPU of the network module on the network route to the access target CPU is set to QCPU (Q mode). • Check the routing parameter settings of the CPU(s) on the access route. • Check the network on the access route.
1B45H to 1B46H	Unsupported CPU error	Unsupported CPU is accessed.	<ul style="list-style-type: none"> • Review the type of access target CPU.
1B47H to 1B48H	Network communication route error	A nonexistent module was specified for the start I/O of the network route in "Access target CPU setting".	<ul style="list-style-type: none"> • Correct the start I/O address in "Access target CPU setting".
1B49H to 1B4AH	Module error	A module error has been detected.	<ul style="list-style-type: none"> • Take measures to reduce noise. • Reset the CPU module and switch it to RUN. If the same error is displayed again, a hardware failure may occur in high speed data logger module. Please consult your local Mitsubishi representative.

Error code	Error name	Error description	Corrective action
1B4BH to 1B4CH	Device write error	Failed to write the data to the device. <ul style="list-style-type: none"> The device type specified for the access target station is invalid. The device number specified for the access target station is out of range. The number of device points specified for the access target station is out of range. Wrote data to the device on inaccessible CPU. 	<ul style="list-style-type: none"> Correct the set device type. Correct the set device number. Correct "Access target CPU setting". Check the communication cable status and access target CPU status. Adjust the response monitoring time setting. Check if the control CPU of the network module on the network route to the access target CPU is set to QCPU (Q mode). Check the routing parameter settings of the CPU(s) on the access route. Check the network on the access route.
1B60H	Access target CPU communication error	Failed to communicate with access target CPU.	<ul style="list-style-type: none"> Correct "Access target CPU setting". Check the communication cable status and access target CPU status. Adjust the response monitoring time setting. Check if the control CPU of the network module on the network route to the access target CPU is set to QCPU (Q mode). Check the routing parameter settings of the CPU(s) on the access route. Check the network on the access route.
1B80H to 1BFFH	Access target CPU communication error	Failed to communicate with access target CPU.	<ul style="list-style-type: none"> Correct "Access target CPU setting". Check the communication cable status and access target CPU status. Adjust the response monitoring time setting. Check if the control CPU of the network module on the network route to the access target CPU is set to QCPU (Q mode). Check the routing parameter settings of the CPU(s) on the access route. Check the network on the access route.
1C00H	SD memory card access error	The access to the SD memory card was attempted when its access state was "Preparing access".	<ul style="list-style-type: none"> Access the SD memory card again when the access state is "Accessible".
1C01H	SD memory card access error	The access to the SD memory card was attempted when the file access was being stopped.	<ul style="list-style-type: none"> Check if a SD memory card is inserted. Execute "Access restart" and retry. Turn the clear file access stop request (Y3) ON, and retry after the file access status (X2) is turned OFF.
1C02H	SD memory card access error	The access to the unformatted SD memory card was attempted.	<ul style="list-style-type: none"> After formatting the SD memory card, store recipe files to the SD memory card, and retry.
1C03H	SD memory card access error	The access to the SD memory card was attempted while it is being formatted.	<ul style="list-style-type: none"> After formatting the SD memory card, store recipe files to the SD memory card, and retry.
1C05H	Record number specification error	A record number out of the range is specified in the RCPREAD instruction.	<ul style="list-style-type: none"> Correct the control data of the RCPREAD instruction.
1C06H	No specified file error	A file name which does not exist is specified.	<ul style="list-style-type: none"> Specify the Recipe file exists in the RECIPE folder.
1C07H	Incorrect file name error	A character which cannot be used for a file name is specified.	<ul style="list-style-type: none"> Correct the control data of the RCPREAD instruction.
1C08H to 1C09H	Recipe file write error	Failed to write the files because of the insufficient SD memory card free space.	<ul style="list-style-type: none"> Delete unnecessary files on the SD memory card to ensure free space. Replace the SD memory card.
1C0AH	Module suspension error	The recipe execution operation was performed when the operation of high speed data logger module was being suspended.	<ul style="list-style-type: none"> Change the operating status of the module to "In operation".
1C0BH	Recipe file error	The recipe file is not correctly formatted. Or corrupted recipe file is specified.	<ul style="list-style-type: none"> Check the format of the specified recipe file.
1C0CH	Incorrect data type error	A data type which is not compatible with the data type of the recipe file is specified.	<ul style="list-style-type: none"> Check the data type of the Recipe file.
1C0DH	Incorrect data type error	A data type other than "Bit" is specified for the data type of bit device.	<ul style="list-style-type: none"> Check the data type of the Recipe file.
1C0EH	File size error	A recipe file whose size exceeds 512 KB is specified.	<ul style="list-style-type: none"> Specify a file whose size is less than 512 KB. Correct the setting of the recipe file to be less than 512 KB.

Error code	Error name	Error description	Corrective action
1C0FH	Number of data error	The total of specified recipe file data exceeded 256.	<ul style="list-style-type: none"> Correct the recipe file to obtain the total of data less than 256.
1C10H	Number of data error	A value other than "1" is specified for the number of bit device data.	<ul style="list-style-type: none"> Change the number of bit device data to "1".
1C11H	Number of blocks error	Incorrect number of blocks is specified.	<ul style="list-style-type: none"> Specify a value within the range.
1C12H	Number of blocks error	Insufficient number of blocks against specified number of blocks.	<ul style="list-style-type: none"> Check the blocks and the number of blocks for Recipe files.
1C13H	Number of records error	Incorrect number of records is specified.	<ul style="list-style-type: none"> Specify a value within the range.
1C14H	Record number error	Record numbers are inconsecutive. Or the same record numbers exist.	<ul style="list-style-type: none"> Check the record numbers of the recipe file.
1C15H	Number of records error	Insufficient number of records against specified number of records.	<ul style="list-style-type: none"> Check the records and the number of records for Recipe files.
1C16H	Record attribute error	An incorrect character is specified for the record attribute.	<ul style="list-style-type: none"> Check the record attribute for recipe file.
1C17H	Record attribute error	Multiple attributes are specified for a specified record. Or an incorrect character is specified for the record attribute.	<ul style="list-style-type: none"> Check the record attribute for recipe file.
1C18H	Incorrect device value error	A value out of the range is specified for the data type "16bit BCD".	<ul style="list-style-type: none"> Specify a value within the range of '16bit BCD' for the device value.
1C19H	Incorrect device value error	A value out of the range is specified for the data type "32bit BCD".	<ul style="list-style-type: none"> Specify a value within the range of '32bit BCD' for the device value.
1C1AH	Incorrect device value error	A value out of the range is specified for the data type "Bit".	<ul style="list-style-type: none"> Specify 0 or 1 for the device value.
1C1BH	Incorrect device value error	A value out of the range is specified for the data type "Double Word [Signed]".	<ul style="list-style-type: none"> Specify a value within the range of "Double Word [Signed]" for the device value.
1C1CH	Incorrect device value error	A value out of the range is specified for the data type "FLOAT [Double Precision]".	<ul style="list-style-type: none"> Specify a value within the range of 'FLOAT [double precision]' for the device value.
1C1DH	Incorrect device value error	A value out of the range is specified for the data type "Double Word [Unsigned]".	<ul style="list-style-type: none"> Specify a value within the range of 'Double word [unsigned]' for the device value.
1C1EH	Incorrect device value error	A value out of the range is specified for the data type "Word [Signed]".	<ul style="list-style-type: none"> Specify a value within the range of "Word [signed]" for the device value.
1C1FH	Incorrect device value error	A value out of the range is specified for the data type "FLOAT [Single Precision]".	<ul style="list-style-type: none"> Specify a value within the range of 'FLOAT [single precision]' for the device value.
1C20H	Incorrect device value error	A value out of the range is specified for the data type "Word [Unsigned]".	<ul style="list-style-type: none"> Specify a value within the range of "Word [Unsigned]" for the device value.
1C21H	Incorrect attribute error	The write process is performed on the record with 'P' attribute.	<ul style="list-style-type: none"> Check the specified record number. Check the specified recipe file name. Check the specified recipe file.
1C22H	Incorrect attribute error	The read process is performed on the record with 'N' attribute.	<ul style="list-style-type: none"> Check the specified record number. Check the specified recipe file name. Check the specified recipe file.
1C23H	Incorrect device value error	A record number whose device value cell is blank is specified.	<ul style="list-style-type: none"> Check the device value of the specified record number.
1C24H	Incorrect data type error	"Bit" is specified for the data type of word device.	<ul style="list-style-type: none"> Check the data type of the Recipe file.
1C25H	No authority error	The recipe execution operation was performed by a user who does not have an administrator's authority.	<ul style="list-style-type: none"> Retry with a user who has an administrator's authority. Uncheck "Use the access authentication function" in the Account setting.
1C26H	SD memory card access error	The access to the SD memory card was attempted when the file access was being stopped.	<ul style="list-style-type: none"> Check if a SD memory card is inserted. Execute "Access restart" and retry. Turn the clear file access stop request (Y3) ON, and retry after the file access status (X2) is turned OFF.
1C27H	Module suspension error	The recipe execution operation was performed when the module suspended error is being occurred.	<ul style="list-style-type: none"> Remove the module suspended error factor, reset the CPU module, and retry.
1C28H	File size error	A recipe file whose file size is '0' is specified.	<ul style="list-style-type: none"> Check the specified recipe file.
1C29H	Module suspension error	The recipe execution operation was performed when the operation of high speed data logger module was being suspended.	<ul style="list-style-type: none"> Change the operating status of the module to "In operation".

Error code	Error name	Error description	Corrective action
1C2AH	Recipe execution operation error	The recipe execution operation is already being performed.	<ul style="list-style-type: none"> • Retry after the recipe execution operation is completed.
1C2BH	Incorrect operation type error	An incompatible recipe execution operation type is specified.	<ul style="list-style-type: none"> • Correct the control data of the RCPREAD instruction.
1C2DH	Device error	An incorrect device is specified.	<ul style="list-style-type: none"> • Check the device of the specified Recipe file.
1C2EH	Number of data error	Number of data out of the range is specified.	<ul style="list-style-type: none"> • Specify 1 for "Number of data" when the data type is "Bit". • Specify 1 to 256 for "Number of data" when the data type is other than "Bit".
1C2FH	Incorrect device value error	Failed to acquire the device value.	<ul style="list-style-type: none"> • Check the device value. • Check the records or blocks of the specified recipe file. • Check the specified recipe file.
1C30H	Device error	An incorrect device is specified.	<ul style="list-style-type: none"> • Check the device of the specified Recipe file.
1C31H	Number of blocks error	Incorrect number of blocks is specified.	<ul style="list-style-type: none"> • Specify a value within the range.
1C32H	Number of records error	Incorrect number of records is specified.	<ul style="list-style-type: none"> • Specify a value within the range.
1C33H	Record number error	An incorrect value is specified for the start value of record number.	<ul style="list-style-type: none"> • Specify 1 for the start value of record number.
1C35H	SD memory card access error	The access to the SD memory card was attempted when its access state was "Preparing access".	<ul style="list-style-type: none"> • Access the SD memory card again when the access state is "Accessible".
1C36H	SD memory card access error	The access to the SD memory card was attempted when the file access was being stopped.	<ul style="list-style-type: none"> • Check if a SD memory card is inserted. • Execute "Access restart" and retry. • Turn the clear file access stop request (Y3) ON, and retry after the file access status (X2) is turned OFF.
1C37H	SD memory card access error	The access to the unformatted SD memory card was attempted.	<ul style="list-style-type: none"> • After formatting the SD memory card, store recipe files to the SD memory card, and retry.
1C38H	SD memory card access error	The access to the SD memory card was attempted while it is being formatted.	<ul style="list-style-type: none"> • After formatting the SD memory card, store recipe files to the SD memory card, and retry.
1C3AH	Module suspension error	The recipe execution operation was performed when the operation of high speed data logger module was being suspended.	<ul style="list-style-type: none"> • Execute "Restart" of "Module operation" and retry. • Execute "Update settings" of "Module operation" and retry.
1C3BH	Module suspension error	The recipe execution operation was performed when the module suspended error is being occurred.	<ul style="list-style-type: none"> • Remove the module suspended error factor, reset the CPU module, and retry.
1C3CH	Module suspension error	The recipe execution operation is executed while the settings are being updated. Or the access to the SD memory card was attempted while it is being formatted.	<ul style="list-style-type: none"> • Retry after the operating status of the module is changed to "In operation". • After formatting the SD memory card, store recipe files to the SD memory card, and retry.
1C3DH	Recipe execution operation error	The recipe execution operation is already being performed.	<ul style="list-style-type: none"> • Retry after the recipe execution operation is completed.
1C3EH	Record number specification error	A record number out of the range is specified in the RCPWRITE instruction.	<ul style="list-style-type: none"> • Correct the control data of the RCPWRITE instruction.
1C3FH	No specified file error	A file name which does not exist is specified.	<ul style="list-style-type: none"> • Specify the Recipe file exists in the RECIPE folder.
1C40H	Incorrect file name error	A character which cannot be used for a file name is specified.	<ul style="list-style-type: none"> • Correct the control data of the RCPWRITE instruction.
1C41H	File size error	A recipe file whose size exceeds 512 KB is specified.	<ul style="list-style-type: none"> • Specify a file whose size is less than 512 KB. • Correct the setting of the recipe file to be less than 512 KB.
1C42H	File size error	The size of recipe file has exceeded 512 KB by writing data.	<ul style="list-style-type: none"> • After writing data, adjust the number of blocks/ records/data not to exceed 512 KB.
1C44H to 1C46H	Recipe file error	The recipe file is not correctly formatted. Or corrupted recipe file is specified.	<ul style="list-style-type: none"> • Check the format of the specified recipe file.
1C49H to 1C5AH	Recipe file error	The recipe file is not correctly formatted. Or corrupted recipe file is specified.	<ul style="list-style-type: none"> • Check the format of the specified recipe file.
1C5BH	SD memory card access error	The access to the SD memory card was attempted when its access state was "Preparing access".	<ul style="list-style-type: none"> • Access the SD memory card again when the access state is "Accessible".

Error code	Error name	Error description	Corrective action
1C5CH	SD memory card access error	The access to the SD memory card was attempted when the file access was being stopped.	<ul style="list-style-type: none"> • Check if a SD memory card is inserted. • Execute "Access restart" and retry. • Turn the clear file access stop request (Y3) ON, and retry after the file access status (X2) is turned OFF.
1C5DH	SD memory card access error	The access to the unformatted SD memory card was attempted.	<ul style="list-style-type: none"> • After formatting the SD memory card, store recipe files to the SD memory card, and retry.
1C5EH	SD memory card access error	The access to the SD memory card was attempted while it is being formatted.	<ul style="list-style-type: none"> • After formatting the SD memory card, store recipe files to the SD memory card, and retry.
1C60H	Module suspension error	The recipe execution operation was performed when the operation of high speed data logger module was being suspended.	<ul style="list-style-type: none"> • Execute "Restart" of "Module operation" and retry. • Execute "Update settings" of "Module operation" and retry.
1C61H	Module suspension error	The recipe execution operation was performed when the module suspended error is being occurred.	<ul style="list-style-type: none"> • Remove the module suspended error factor, reset the CPU module, and retry.
1C62H	Module suspension error	The recipe execution operation is executed while the settings are being updated. Or the access to the SD memory card was attempted while it is being formatted.	<ul style="list-style-type: none"> • Retry after the operating status of the module is changed to "In operation". • After formatting the SD memory card, store recipe files to the SD memory card, and retry.
1C63H	Recipe execution operation error	The recipe execution operation is already being performed.	<ul style="list-style-type: none"> • Retry after the recipe execution operation is completed.
1C64H	SD memory card access error	The access to the SD memory card was attempted when the file access was being stopped.	<ul style="list-style-type: none"> • Check if a SD memory card is inserted. • Execute "Access restart" and retry. • Turn the clear file access stop request (Y3) ON, and retry after the file access status (X2) is turned OFF.
1C65H	SD memory card access error	The access to the SD memory card was attempted when the file access was being stopped.	<ul style="list-style-type: none"> • Check if a SD memory card is inserted. • Execute "Access restart" and retry. • Turn the clear file access stop request (Y3) ON, and retry after the file access status (X2) is turned OFF.
1C66H	File size error	A recipe file whose file size is '0' is specified.	<ul style="list-style-type: none"> • Check the specified recipe file.
1C69H to 1C6AH	Recipe file error	The recipe file is not correctly formatted. Or corrupted recipe file is specified.	<ul style="list-style-type: none"> • Check the format of the specified recipe file.
1C6CH	Number of blocks error	Insufficient number of blocks against specified number of blocks.	<ul style="list-style-type: none"> • Check the blocks and the number of blocks for Recipe files.
1C6DH	Device error	An incorrect device is specified.	<ul style="list-style-type: none"> • Check the device of the specified Recipe file.
1C6EH to 1C6FH	Incorrect data type error	A data type that cannot be used for digit specified bit device is specified.	<ul style="list-style-type: none"> • Check the data type of the Recipe file.
1C70H	Number of records error	Insufficient number of records against specified number of records.	<ul style="list-style-type: none"> • Check the records and the number of records for Recipe files.
1C71H	Number of data error	The cell for the number of data is blank.	<ul style="list-style-type: none"> • Check the number of data.
1C72H	Number of blocks error	The cell for the number of blocks is blank.	<ul style="list-style-type: none"> • Check the number of blocks.
1C73H	Number of records error	The cell for the number of records is blank.	<ul style="list-style-type: none"> • Check the number of records.
1C74H	SD memory card access error	Failed to access to the same sector of the SD memory card in a low. The SD memory card error might occur due to the power off or CPU module reset while writing to the SD memory card. The SD memory card was mounted again.	<ul style="list-style-type: none"> • Execute the stopping file access before power OFF or resetting the CPU module. • If this error occurs repetitively, replace the SD memory card.
1C76H	Incorrect data type error	A data type that cannot be used for double word device is specified.	<ul style="list-style-type: none"> • Check the data type of the recipe file.
1C80H to 1C82H	Module error	A module error has been detected.	<ul style="list-style-type: none"> • Take measures to reduce noise. • Reset the CPU module and switch it to RUN. If the same error is displayed again, a hardware failure may occur in high speed data logger module. Please consult your local Mitsubishi representative.

Error code	Error name	Error description	Corrective action
1C83H to 1C89H	Device error	The device specified for the access target CPU setting is invalid. Or the device of the set data is incorrect.	<ul style="list-style-type: none"> • Check access target CPU of the set data. • Check device and series of the access target CPU setting of the set data. • Correct the set device type. • Correct the set device number. • Correct "Access target CPU setting". • Check the communication cable status and access target CPU status.
1C8AH to 1C8FH	Excessive number of device points for data sampling	The number of data sampling device points exceeded 4096 in a single setting.	<ul style="list-style-type: none"> • Configure so that the number of data sampling device points does not exceed 4096 in a single setting.
1CB0H to 1CB3H	Access target CPU communication error	Failed to communicate with access target CPU.	<ul style="list-style-type: none"> • Check the source error code.
1CB4H	Errors detected in the CPU module	—	<ul style="list-style-type: none"> • Check the source error code in the user's manual of the CPU module.
1CB5H to 1CB6H	Access target CPU communication error	Failed to communicate with access target CPU.	<ul style="list-style-type: none"> • Check the source error code.
1CB7H	Errors detected in the serial communication module	—	<ul style="list-style-type: none"> • Check the source error code in the user's manual of the serial communication module.
1CB8H to 1CBAH	Access target CPU communication error	Failed to communicate with access target CPU.	<ul style="list-style-type: none"> • Check the source error code.
1CBBH	Errors detected in the CC-Link module	—	<ul style="list-style-type: none"> • Check the source error code in the user's manual of CC-Link module.
1CBCH	Errors detected in the Ethernet-equipped module	—	<ul style="list-style-type: none"> • Refer to the user's manual of the Ethernet-equipped module and check the errors displayed in the source error code.
1CBDH	Errors detected in the CC-Link IE Field Network module	—	<ul style="list-style-type: none"> • Check the source error code in the user's manual of CC-Link IE Field Network module.
1CBEH	Errors detected in the CC-Link IE Controller Network module	—	<ul style="list-style-type: none"> • Check the source error code in the user's manual of CC-Link IE Controller Network module.
1CBFH	Errors detected in the MELSECNET/H network module	—	<ul style="list-style-type: none"> • Check the source error code in the user's manual of MELSECNET/H network module.
1CC0H to 1CC3H	Access target CPU communication error	Failed to communicate with access target CPU.	<ul style="list-style-type: none"> • Check the source error code.
1CC4H	Errors detected in the CPU module	—	<ul style="list-style-type: none"> • Check the source error code in the user's manual of the CPU module.
1CC5H to 1CC6H	Access target CPU communication error	Failed to communicate with access target CPU.	<ul style="list-style-type: none"> • Check the source error code.
1CC7H	Errors detected in the serial communication module	—	<ul style="list-style-type: none"> • Check the source error code in the user's manual of the serial communication module.
1CC8H to 1CCAH	Access target CPU communication error	Failed to communicate with access target CPU.	<ul style="list-style-type: none"> • Check the source error code.
1CCBH	Errors detected in the CC-Link module	—	<ul style="list-style-type: none"> • Check the source error code in the user's manual of CC-Link module.
1CCCH	Errors detected in the Ethernet-equipped module or CC-Link IE TSN module	—	<ul style="list-style-type: none"> • Refer to the user's manual of the Ethernet-equipped module or CC-Link IE TSN module and check the errors displayed in the source error code.
1CCDH	Errors detected in the CC-Link IE Field Network module or CC-Link IE TSN module	—	<ul style="list-style-type: none"> • Check the source error code in the user's manual of CC-Link IE Field Network module or CC-Link IE TSN module.
1CCEH	Errors detected in the CC-Link IE Controller Network module	—	<ul style="list-style-type: none"> • Check the source error code in the user's manual of CC-Link IE Controller Network module.
1CCFH	Errors detected in the MELSECNET/H network module	—	<ul style="list-style-type: none"> • Check the source error code in the user's manual of MELSECNET/H network module.

Error code	Error name	Error description	Corrective action
1D00H to 1D02H	Module error	A module error has been detected.	<ul style="list-style-type: none"> Take measures to reduce noise. Reset the CPU module and switch it to RUN. If the same error is displayed again, a hardware failure may occur in high speed data logger module. Please consult your local Mitsubishi representative.
1D50H to 1D54H	Module error	A module error has been detected.	<ul style="list-style-type: none"> Take measures to reduce noise. Reset the CPU module and switch it to RUN. If the same error is displayed again, a hardware failure may occur in high speed data logger module. Please consult your local Mitsubishi representative.
1D56H	Setting file error	There is no setting file. Or the setting file is corrupted.	<ul style="list-style-type: none"> Write the settings again with the Configuration Tool. Replace the SD memory card.
1D57H	Setting file error	The high speed data logger module version is older than the setting file version.	<ul style="list-style-type: none"> Start the Configuration Tool online from the high speed data logger module to be used and write the settings.
1D80H to 1D83H	SD memory card mount failed	The SD memory card mount is failed because a failure was detected.	<ul style="list-style-type: none"> Check if the SD memory card was inserted properly. Replace the SD memory card.
1D90H to 1D93H	Module error	A module error has been detected.	<ul style="list-style-type: none"> Take measures to reduce noise. Reset the CPU module and switch it to RUN. If the same error is displayed again, a hardware failure may occur in high speed data logger module. Please consult your local Mitsubishi representative.
1D94H	SD memory card format error	Failed to format the SD memory card.	<ul style="list-style-type: none"> Check if the SD memory card was inserted properly. Replace the SD memory card.
1D95H	SD memory card check error	Failed to check the SD memory card.	<ul style="list-style-type: none"> Replace the SD memory card.
1D96H	SD memory card response error	Access to the SD memory card timed out while waiting for a response from the card.	<ul style="list-style-type: none"> Replace the SD memory card.
1D97H	SD memory card drive error	The SD memory card mount is failed because a failure was detected. Or the SD memory card drive is in error status because the SD memory card was ejected during file access.	<ul style="list-style-type: none"> Cycle the power of the system where the high speed data logger module is mounted or reset the CPU module. Stop file access, then remove the SD memory card. Check if improper files or folders exist in the SD memory card.
1DA0H	SD memory card mount failed	The SD memory card mount is failed because a failure was detected.	<ul style="list-style-type: none"> Check if the SD memory card was inserted properly. Replace the SD memory card.
1DA1H to 1DA4H	Module error	A module error has been detected.	<ul style="list-style-type: none"> Take measures to reduce noise. Reset the CPU module and switch it to RUN. If the same error is displayed again, a hardware failure may occur in high speed data logger module. Please consult your local Mitsubishi representative.
1DD0H	SD memory card access error	An error occurred when accessing the file.	<ul style="list-style-type: none"> Check if the SD memory card was inserted properly. Replace the SD memory card.
1DD1H	SD memory card response error	Access to the SD memory card timed out while waiting for a response from the card.	<ul style="list-style-type: none"> Check if the SD memory card was inserted properly. Replace the SD memory card.
1E00H	SD memory card access error	The access to the SD memory card was attempted when the file access was being stopped.	<ul style="list-style-type: none"> Turn the clear file access stop request (Y3) ON, and retry after the file access status (X2) is turned OFF.
1E01H	SD memory card access error	Access to the SD memory card was attempted with no card installed.	<ul style="list-style-type: none"> Access after inserting a SD memory card.
1E02H	SD memory card access error	The access to the unformatted SD memory card was attempted.	<ul style="list-style-type: none"> Access after formatting the SD memory card.
1E03H	SD memory card access error	The access to the SD memory card was attempted while it is being formatted.	<ul style="list-style-type: none"> Access after formatting the SD memory card.

Error code	Error name	Error description	Corrective action
1E70H to 1E71H	Module error	A module error has been detected.	<ul style="list-style-type: none"> Take measures to reduce noise. Reset the CPU module and switch it to RUN. If the same error is displayed again, a hardware failure may occur in high speed data logger module. Please consult your local Mitsubishi representative.
1E83H to 1E84H	High speed sampling setting illegal error	An invalid "High speed sampling setting" was configured. Or the setting file is corrupted.	<ul style="list-style-type: none"> Write the settings again with the Configuration Tool. Replace the SD memory card.
1E89H	Device name error	The device name specified in the "Data logging setting", "Event logging setting", or "Report setting" is incorrect. Or an invalid device was specified.	<ul style="list-style-type: none"> Correct the device name specified in the "Data logging setting", "Event logging setting", or "Report setting".
1E8BH	Module error	A module error has been detected.	<ul style="list-style-type: none"> Take measures to reduce noise. Reset the CPU module and switch it to RUN. If the same error is displayed again, a hardware failure may occur in high speed data logger module. Please consult your local Mitsubishi representative.
1E91H	Module error	A module error has been detected.	<ul style="list-style-type: none"> Take measures to reduce noise. Reset the CPU module and switch it to RUN. If the same error is displayed again, a hardware failure may occur in high speed data logger module. Please consult your local Mitsubishi representative.
1E97H to 1E9AH	High speed sampling unsupported CPU error	The control CPU does not support high speed sampling.	<ul style="list-style-type: none"> Replace it with a CPU that supports high speed sampling.
1E9BH	High speed sampling overlap error	Another intelligent function module is performing high speed sampling.	<ul style="list-style-type: none"> Execute either of the followings and cycle the power or reset the CPU module to restart the module. Specify general data sampling and write the settings. Stop high speed sampling on the other intelligent function module.
1E9CH to 1E9DH	Module error	A module error has been detected.	<ul style="list-style-type: none"> Take measures to reduce noise. Reset the CPU module and switch it to RUN. If the same error is displayed again, a hardware failure may occur in high speed data logger module. Please consult your local Mitsubishi representative.
1EA6H	High speed sampling unsupported CPU error	The control CPU does not support high speed sampling.	<ul style="list-style-type: none"> Replace it with a CPU that supports high speed sampling.
1EBBH to 1EBCH	Module error	A module error has been detected.	<ul style="list-style-type: none"> Take measures to reduce noise. Reset the CPU module and switch it to RUN. If the same error is displayed again, a hardware failure may occur in high speed data logger module. Please consult your local Mitsubishi representative.
1EC5H to 1EC6H	Setting file error	There is no setting file. Or the setting file is corrupted.	<ul style="list-style-type: none"> Write the settings again with the Configuration Tool. Replace the SD memory card.
1ED0H to 1ED5H	Device name error	The device name specified in the "Data logging setting", "Event logging setting", or "Report setting" is incorrect. Or an invalid device was specified.	<ul style="list-style-type: none"> Correct the device name specified in the "Data logging setting", "Event logging setting", or "Report setting".
1ED6H	Device error	An incorrect device is specified.	<ul style="list-style-type: none"> Correct the set device.
1ED7H	Module error	A module error has been detected.	<ul style="list-style-type: none"> Take measures to reduce noise. Reset the CPU module and switch it to RUN. If the same error is displayed again, a hardware failure may occur in high speed data logger module. Please consult your local Mitsubishi representative.

Error code	Error name	Error description	Corrective action
1F05H	Module error	A module error has been detected.	<ul style="list-style-type: none"> Take measures to reduce noise. Reset the CPU module and switch it to RUN. If the same error is displayed again, a hardware failure may occur in high speed data logger module. Please consult your local Mitsubishi representative.
1F07H	Module error	A module error has been detected.	<ul style="list-style-type: none"> Take measures to reduce noise. Reset the CPU module and switch it to RUN. If the same error is displayed again, a hardware failure may occur in high speed data logger module. Please consult your local Mitsubishi representative.
1F13H	E-mail send queue full error	The queue for sending e-mails is full.	<ul style="list-style-type: none"> Lower the frequency that e-mails are sent. Decrease the settings that send e-mails. Lower the frequency of file switching. Check the communication cable status and access target CPU status.
1F16H	E-mail send queue full error	The queue for sending e-mails is full.	<ul style="list-style-type: none"> Lower the frequency that e-mails are sent. Decrease the settings that send e-mails. Lower the frequency of file switching. Check the communication cable status and access target CPU status.
1F19H to 1F1AH	Module error	A module error has been detected.	<ul style="list-style-type: none"> Take measures to reduce noise. Reset the CPU module and switch it to RUN. If the same error is displayed again, a hardware failure may occur in high speed data logger module. Please consult your local Mitsubishi representative.
1F1BH	File transfer queue full error	The queue for file transfers is full.	<ul style="list-style-type: none"> Lower the frequency of file transfers. Decrease the settings with file transfers. Lower the frequency of file switching. Check the communication cable status and access target CPU status.
1F20H	File transfer failed	<ul style="list-style-type: none"> An error occurred during the file transfer. The saved file to transfer was deleted before the file transfer by file switching. 	<ul style="list-style-type: none"> Correct the file transfer settings. Check the connection status with the FTP server. Check the destination status. Correct the saved settings (file switch timing, number of saved files).
1F40H	Directory creation error	Failed to create the directory.	<ul style="list-style-type: none"> Delete unnecessary files on the SD memory card to ensure free space. Replace the SD memory card.
1F41H	File open error	Failed to open the file.	<ul style="list-style-type: none"> Delete unnecessary files on the SD memory card to ensure free space. Replace the SD memory card.
1F46H	File write error	Failed to write the file.	<ul style="list-style-type: none"> Delete unnecessary files on the SD memory card to ensure free space. Replace the SD memory card.
1F47H	CSV file write error	Failed to write the CSV file.	<ul style="list-style-type: none"> Delete unnecessary files on the SD memory card to ensure free space. Replace the SD memory card.
1F48H	Binary file write error	Failed to write the binary file.	<ul style="list-style-type: none"> Delete unnecessary files on the SD memory card to ensure free space. Replace the SD memory card.
1F4AH	File write error	Failed to write the file.	<ul style="list-style-type: none"> Delete unnecessary files on the SD memory card to ensure free space. Replace the SD memory card.
1F4BH	File open error	Failed to open the file.	<ul style="list-style-type: none"> Delete unnecessary files on the SD memory card to ensure free space. Replace the SD memory card.
1F4CH to 1F4DH	Module error	A module error has been detected.	<ul style="list-style-type: none"> Take measures to reduce noise. Reset the CPU module and switch it to RUN. If the same error is displayed again, a hardware failure may occur in high speed data logger module. Please consult your local Mitsubishi representative.

Error code	Error name	Error description	Corrective action
1F51H	Setting file error	There is no setting file. Or the setting file is corrupted.	<ul style="list-style-type: none"> Write the settings again with the Configuration Tool. Replace the SD memory card.
1F52H to 1F5FH	Report source file error	Data logging file to be output to the report file cannot be found.	<ul style="list-style-type: none"> Configure and construct the system so that the creation trigger occurs after the specified number of records worth of data is saved in the data logging file. Adjust the file switch timing for data logging. Check if the data logging file is being deleted before the report is output. Replace the SD memory card.
1F62H to 1F65H	Report source file error	Data logging file to be output to the report file cannot be found.	<ul style="list-style-type: none"> Configure and construct the system so that the creation trigger occurs after the specified number of records worth of data is saved in the data logging file. Adjust the file switch timing for data logging. Check if the data logging file is being deleted before the report is output. Replace the SD memory card.
1F67H to 1F68H	Report source file error	Data logging file to be output to the report file cannot be found.	<ul style="list-style-type: none"> Configure and construct the system so that the creation trigger occurs after the specified number of records worth of data is saved in the data logging file. Adjust the file switch timing for data logging. Check if the data logging file is being deleted before the report is output. Replace the SD memory card.
1F6BH to 1F6EH	Report source file error	Data logging file to be output to the report file cannot be found.	<ul style="list-style-type: none"> Configure and construct the system so that the creation trigger occurs after the specified number of records worth of data is saved in the data logging file. Adjust the file switch timing for data logging. Check if the data logging file is being deleted before the report is output. Replace the SD memory card.
1F8AH	Directory creation error	Failed to create the directory.	<ul style="list-style-type: none"> Delete unnecessary files on the SD memory card to ensure free space. Replace the SD memory card.
1F8CH to 1F8FH	CSV file check error	Failed to check the CSV file.	<ul style="list-style-type: none"> Replace the SD memory card.
1F90H to 1F97H	Binary file check error	Failed to check the binary file.	<ul style="list-style-type: none"> Replace the SD memory card.
1F98H	File check error	Failed to check the file.	<ul style="list-style-type: none"> Delete unnecessary files on the SD memory card to ensure free space. Replace the SD memory card.
1F99H to 1F9AH	File open error	Failed to open the file.	<ul style="list-style-type: none"> Delete unnecessary files on the SD memory card to ensure free space. Replace the SD memory card.
1F9BH	File read error	Failed to read the file.	<ul style="list-style-type: none"> Delete unnecessary files on the SD memory card to ensure free space. Replace the SD memory card.
1F9CH	File write error	Failed to write the file.	<ul style="list-style-type: none"> Delete unnecessary files on the SD memory card to ensure free space. Replace the SD memory card.
1F9DH	File read error	Failed to read the file.	<ul style="list-style-type: none"> Delete unnecessary files on the SD memory card to ensure free space. Replace the SD memory card.
1FBCH	File write error	Failed to write the file.	<ul style="list-style-type: none"> Delete unnecessary files on the SD memory card to ensure free space. Replace the SD memory card.
1FBDH	File creation error	Failed to create the file.	<ul style="list-style-type: none"> Delete unnecessary files on the SD memory card to ensure free space. Replace the SD memory card.
1FC2H	CSV file open error	Failed to open the CSV file.	<ul style="list-style-type: none"> Delete unnecessary files on the SD memory card to ensure free space. Replace the SD memory card.

Error code	Error name	Error description	Corrective action
1FC3H	File check error	Failed to check the file.	<ul style="list-style-type: none"> Delete unnecessary files on the SD memory card to ensure free space. Replace the SD memory card.
1FC4H	Binary file creation error	Failed to create the binary file.	<ul style="list-style-type: none"> Delete unnecessary files on the SD memory card to ensure free space. Replace the SD memory card.
1FCAH to 1FCBH	File creation error	Failed to create the file.	<ul style="list-style-type: none"> Delete unnecessary files on the SD memory card to ensure free space. Replace the SD memory card.
1FCCH	Directory creation error	Failed to create the directory.	<ul style="list-style-type: none"> Delete unnecessary files on the SD memory card to ensure free space. Replace the SD memory card.
1FCDH	File access error	An error occurred when accessing the file.	<ul style="list-style-type: none"> Delete unnecessary files on the SD memory card to ensure free space. Replace the SD memory card.
1FD3H	File check error	Failed to check the file.	<ul style="list-style-type: none"> Delete unnecessary files on the SD memory card to ensure free space. Replace the SD memory card.
1FD4H	File open error	Failed to open the file.	<ul style="list-style-type: none"> Delete unnecessary files on the SD memory card to ensure free space. Replace the SD memory card.
1FD5H	File write error	Failed to write the file.	<ul style="list-style-type: none"> Delete unnecessary files on the SD memory card to ensure free space. Replace the SD memory card.
1FD6H	File open error	Failed to open the file.	<ul style="list-style-type: none"> Delete unnecessary files on the SD memory card to ensure free space. Replace the SD memory card.
1FD7H	File information acquisition error	Failed to acquire the file information.	<ul style="list-style-type: none"> Delete unnecessary files on the SD memory card to ensure free space. Replace the SD memory card.
1FD8H to 1FDEH	File access error	An error occurred when accessing the file.	<ul style="list-style-type: none"> Check if the file was deleted by external FTP. Replace the SD memory card.
1FE1H to 1FE4H	Report source file error	Data logging file to be output to the report file cannot be found.	<ul style="list-style-type: none"> Configure and construct the system so that the creation trigger occurs after the specified number of records worth of data is saved in the data logging file. Adjust the file switch timing for data logging. Check if the data logging file is being deleted before the report is output. Replace the SD memory card.
1FE5H to 1FE6H	Module error	A module error has been detected.	<ul style="list-style-type: none"> Take measures to reduce noise. Reset the CPU module and switch it to RUN. If the same error is displayed again, a hardware failure may occur in high speed data logger module. Please consult your local Mitsubishi representative.
1FE7H	Unicode text file write error	Failed to write the Unicode text file.	<ul style="list-style-type: none"> Delete unnecessary files on the SD memory card to ensure free space. Replace the SD memory card.
1FF0H	Saved file name acquisition error	Failed to acquire the saved file name.	<ul style="list-style-type: none"> Check if the file is being deleted. Delete unnecessary files on the SD memory card to ensure free space. Replace the SD memory card.
1FF1H	Saved file name acquisition error	Failed to acquire the saved file name.	<ul style="list-style-type: none"> Write the settings again with the Configuration Tool. Replace the SD memory card.
1FF2H	Saved file name acquisition error	Failed to acquire the saved file name.	<ul style="list-style-type: none"> Delete unnecessary files on the SD memory card to ensure free space. Replace the SD memory card.
1FF3H	Saved file name acquisition error	Failed to acquire the saved file name.	<ul style="list-style-type: none"> Write the settings again with the Configuration Tool. Replace the SD memory card.
1FF4H to 1FF6H	File write error	Failed to write the file.	<ul style="list-style-type: none"> Delete unnecessary files on the SD memory card to ensure free space. Replace the SD memory card.

Error code	Error name	Error description	Corrective action
1FF7H to 1FF8H	Directory creation error	Failed to create the directory.	<ul style="list-style-type: none"> • Check if the file is being deleted. • Delete unnecessary files on the SD memory card to ensure free space. • Replace the SD memory card.
2121H	SD memory card error	An error has been detected in the SD memory card.	<ul style="list-style-type: none"> • Format or reinsert the SD memory card. If the same error is displayed again, a hardware failure may occur in the SD memory card. Replace the SD memory card. • When the write protect switch of the SD memory card is locked, unlock the switch and insert the card.
2440H	Module major error	<ul style="list-style-type: none"> • In the multiple CPU system, the control CPU setting in the system parameters is different from that of other numbered CPU modules. • An error has been detected in the I/O module or intelligent function module during the initial processing. 	<ul style="list-style-type: none"> • Review the system parameters of the second or higher numbered CPU modules and match them with those of the smallest numbered CPU module. • A hardware failure may occur in the module. Please consult your local Mitsubishi representative.
2450H	Module major error	• A major error has been detected from the I/O module or intelligent function module.	<ul style="list-style-type: none"> • Check the connection status of the extension cable. • Check that the I/O module or intelligent function module is mounted correctly. • Reset the CPU module and switch it to RUN. If the same error is displayed again, a hardware failure may occur in the module. Please consult your local Mitsubishi representative.
24C0H to 24C1H	System bus error	An error has been detected on the system bus.	<ul style="list-style-type: none"> • Take measures to reduce noise. • Reset the CPU module and switch it to RUN. If the same error is displayed again, a hardware failure may occur in the CPU module, I/O module, intelligent function module, base unit, or extension cable. Please consult your local Mitsubishi representative.
24C2H	System bus error	An error has been detected on the system bus.	<ul style="list-style-type: none"> • Check the connection status of the extension cable. • Take measures to reduce noise. • Reset the CPU module and switch it to RUN. If the same error is displayed again, a hardware failure may occur in the CPU module, I/O module, intelligent function module, base unit, or extension cable. Please consult your local Mitsubishi representative.
24C3H	System bus error	An error has been detected on the system bus.	<ul style="list-style-type: none"> • Take measures to reduce noise. • Reset the CPU module and switch it to RUN. If the same error is displayed again, a hardware failure may occur in the CPU module, I/O module, intelligent function module, base unit, or extension cable. Please consult your local Mitsubishi representative.
24C4H to 24C5H	System bus error	An error has been detected on the system bus.	<ul style="list-style-type: none"> • Take measures to reduce noise. • Reset the CPU module and switch it to RUN. If the same error is displayed again, a hardware failure may occur in the CPU module, I/O module, intelligent function module, base unit, or extension cable. Please consult your local Mitsubishi representative.
24C6H	System bus error	An error has been detected on the system bus.	<ul style="list-style-type: none"> • Take measures to reduce noise. • Reset the CPU module and switch it to RUN. If the same error is displayed again, a hardware failure may occur in the CPU module or extension cable. Please consult your local Mitsubishi representative.
24C8H	System bus error	An error has been detected on the system bus.	<ul style="list-style-type: none"> • Take measures to reduce noise. • Reset the CPU module and switch it to RUN. If the same error is displayed again, a hardware failure may occur in the I/O module, intelligent function module, or extension cable. Please consult your local Mitsubishi representative.

Error code	Error name	Error description	Corrective action
24E0H	System bus error	An error has been detected on the system bus.	<ul style="list-style-type: none"> Take measures to reduce noise. Reset the CPU module and switch it to RUN. If the same error is displayed again, a hardware failure may occur in the CPU module, or base unit. Please consult your local Mitsubishi representative.
3000H	Period of time setting error	An invalid setting has been made in the period setting. Or the setting file is corrupted.	<ul style="list-style-type: none"> Write the settings again with the Configuration Tool. Replace the SD memory card.
3001H	Trigger condition (the number of times) setting error	An invalid count condition has been set for the count trigger of trigger type in the trigger logging setting. Or the setting file is corrupted.	<ul style="list-style-type: none"> Write the settings again with the Configuration Tool. Replace the SD memory card.
3002H to 3003H	Scaling setting error	An invalid setting has been made in the scaling setting. Or the setting file is corrupted.	<ul style="list-style-type: none"> Write the settings again with the Configuration Tool. Replace the SD memory card.
3004H	Data condition setting error	An invalid setting has been made in the data condition setting. Or the setting file is corrupted.	<ul style="list-style-type: none"> Write the settings again with the Configuration Tool. Replace the SD memory card.
3005H	Compound condition (trigger logging) setting error	An invalid setting has been made in the trigger compound condition setting of the trigger logging setting. Or the setting file is corrupted.	<ul style="list-style-type: none"> Write the settings again with the Configuration Tool. Replace the SD memory card.
3006H to 3007H	Compound condition (event logging) setting error	An invalid setting has been made in the trigger compound condition settings of the "Event logging setting". Or the setting file is corrupted.	<ul style="list-style-type: none"> Write the settings again with the Configuration Tool. Replace the SD memory card.
3008H	Data condition setting error	An invalid setting has been made in the data condition setting. Or the setting file is corrupted.	<ul style="list-style-type: none"> Write the settings again with the Configuration Tool. Replace the SD memory card.
3009H to 300CH	Setting file error	There is no setting file. Or the setting file is corrupted.	<ul style="list-style-type: none"> Write the settings again with the Configuration Tool. Replace the SD memory card.
300DH	Trigger condition setting error	An invalid setting has been made in the trigger condition setting of the trigger logging setting. Or the setting file is corrupted.	<ul style="list-style-type: none"> Write the settings again with the Configuration Tool. Replace the SD memory card.
300EH to 3011H	Data condition setting error	An invalid setting has been made in the data condition setting. Or the setting file is corrupted.	<ul style="list-style-type: none"> Write the settings again with the Configuration Tool. Replace the SD memory card.
3012H to 3013H	Setting file error	There is no setting file. Or the setting file is corrupted.	<ul style="list-style-type: none"> Write the settings again with the Configuration Tool. Replace the SD memory card.
3014H	File switching setting error	An invalid file switch timing has been set in the file switch setting. Or the setting file is corrupted.	<ul style="list-style-type: none"> Write the settings again with the Configuration Tool. Replace the SD memory card.
3015H	Module error	A module error has been detected.	<ul style="list-style-type: none"> Take measures to reduce noise. Reset the CPU module and switch it to RUN. If the same error is displayed again, a hardware failure may occur in high speed data logger module. Please consult your local Mitsubishi representative.
3016H	Setting file error	There is no setting file. Or the setting file is corrupted.	<ul style="list-style-type: none"> Write the settings again with the Configuration Tool. Replace the SD memory card.
3017H to 301EH	Module error	A module error has been detected.	<ul style="list-style-type: none"> Take measures to reduce noise. Reset the CPU module and switch it to RUN. If the same error is displayed again, a hardware failure may occur in high speed data logger module. Please consult your local Mitsubishi representative.
301FH	Unicode text output format setting error	An invalid Unicode text output format has been set. Or the setting file is corrupted.	<ul style="list-style-type: none"> Write the settings again with the Configuration Tool. Replace the SD memory card.

Error code	Error name	Error description	Corrective action
3020H	Data type setting error	An invalid setting has been made in the data type setting. Or the setting file is corrupted.	<ul style="list-style-type: none"> Write the settings again with the Configuration Tool. Replace the SD memory card.
3021H	Module error	A module error has been detected.	<ul style="list-style-type: none"> Take measures to reduce noise. Reset the CPU module and switch it to RUN. If the same error is displayed again, a hardware failure may occur in high speed data logger module. Please consult your local Mitsubishi representative.
3022H	Data type setting error	An invalid setting has been made in the data type setting. Or the setting file is corrupted.	<ul style="list-style-type: none"> Write the settings again with the Configuration Tool. Replace the SD memory card.
3027H to 302AH	Module error	A module error has been detected.	<ul style="list-style-type: none"> Take measures to reduce noise. Reset the CPU module and switch it to RUN. If the same error is displayed again, a hardware failure may occur in high speed data logger module. Please consult your local Mitsubishi representative.
302BH to 302DH	Data sampling method specification error	An invalid data sampling method has been specified. Or the report setting file is corrupted.	<ul style="list-style-type: none"> Write the settings again with the Configuration Tool. Replace the SD memory card.
302EH	Layout type specification error	An invalid layout type has been specified. Or the report setting file is corrupted.	<ul style="list-style-type: none"> Write the settings again with the Configuration Tool. Replace the SD memory card.
302FH to 3036H	Module error	A module error has been detected.	<ul style="list-style-type: none"> Take measures to reduce noise. Reset the CPU module and switch it to RUN. If the same error is displayed again, a hardware failure may occur in high speed data logger module. Please consult your local Mitsubishi representative.
3037H	Setting file error	There is no setting file. Or the setting file is corrupted.	<ul style="list-style-type: none"> Write the settings again with the Configuration Tool. Replace the SD memory card.
3038H	Module error	A module error has been detected.	<ul style="list-style-type: none"> Take measures to reduce noise. Reset the CPU module and switch it to RUN. If the same error is displayed again, a hardware failure may occur in high speed data logger module. Please consult your local Mitsubishi representative.
3039H	Setting file error	There is no setting file. Or the setting file is corrupted.	<ul style="list-style-type: none"> Write the settings again with the Configuration Tool. Replace the SD memory card.
303AH to 3042H	Module error	A module error has been detected.	<ul style="list-style-type: none"> Take measures to reduce noise. Reset the CPU module and switch it to RUN. If the same error is displayed again, a hardware failure may occur in high speed data logger module. Please consult your local Mitsubishi representative.
3043H	E-mail address setting error	The destination specified in the e-mail notification settings for the "Event logging setting" is not registered. Or the setting file is corrupted.	<ul style="list-style-type: none"> Write the settings again with the Configuration Tool. Replace the SD memory card.
3044H	Setting file error	There is no setting file. Or the setting file is corrupted.	<ul style="list-style-type: none"> Write the settings again with the Configuration Tool. Replace the SD memory card.
3045H	E-mail address setting error	The destination specified with the save setting is not registered. Or the setting file is corrupted.	<ul style="list-style-type: none"> Write the settings again with the Configuration Tool. Replace the SD memory card.
3046H	Setting file error	There is no setting file. Or the setting file is corrupted.	<ul style="list-style-type: none"> Write the settings again with the Configuration Tool. Replace the SD memory card.
3047H	File transfer destination setting error	The destination specified with the save setting is not registered. Or the setting file is corrupted.	<ul style="list-style-type: none"> Write the settings again with the Configuration Tool. Replace the SD memory card.

Error code	Error name	Error description	Corrective action
3048H to 304BH	Module error	A module error has been detected.	<ul style="list-style-type: none"> Take measures to reduce noise. Reset the CPU module and switch it to RUN. If the same error is displayed again, a hardware failure may occur in high speed data logger module. Please consult your local Mitsubishi representative.
304DH to 3050H	Setting file error	There is no setting file. Or the setting file is corrupted.	<ul style="list-style-type: none"> Write the settings again with the Configuration Tool. Replace the SD memory card.
3051H to 3053H	Module error	A module error has been detected.	<ul style="list-style-type: none"> Take measures to reduce noise. Reset the CPU module and switch it to RUN. If the same error is displayed again, a hardware failure may occur in high speed data logger module. Please consult your local Mitsubishi representative.
3054H to 3056H	Setting file error	There is no setting file. Or the setting file is corrupted.	<ul style="list-style-type: none"> Write the settings again with the Configuration Tool. Replace the SD memory card.
3057H	Data type setting error	An invalid setting has been made in the data type setting. Or the setting file is corrupted.	<ul style="list-style-type: none"> Write the settings again with the Configuration Tool. Replace the SD memory card.
3058H	Output format setting error	An invalid CSV output format has been set. Or the setting file is corrupted.	<ul style="list-style-type: none"> Write the settings again with the Configuration Tool. Replace the SD memory card.
3059H to 305AH	Data type setting error	An invalid setting has been made in the data type setting. Or the setting file is corrupted.	<ul style="list-style-type: none"> Write the settings again with the Configuration Tool. Replace the SD memory card.
305BH	Output format setting error	An invalid setting has been made in the CSV output setting or the Unicode text output setting. Or the setting file is corrupted.	<ul style="list-style-type: none"> Write the settings again with the Configuration Tool. Replace the SD memory card.
305CH	Data type setting error	An invalid setting has been made in the data type setting. Or the setting file is corrupted.	<ul style="list-style-type: none"> Write the settings again with the Configuration Tool. Replace the SD memory card.
305DH	Output format setting error	An invalid setting has been made in the CSV output setting or the Unicode text output setting. Or the setting file is corrupted.	<ul style="list-style-type: none"> Write the settings again with the Configuration Tool. Replace the SD memory card.
305EH	Data type setting error	An invalid setting has been made in the data type setting. Or the setting file is corrupted.	<ul style="list-style-type: none"> Write the settings again with the Configuration Tool. Replace the SD memory card.
305FH to 3068H	Binary output format setting error	An invalid setting has been made in the binary output setting. Or the setting file is corrupted.	<ul style="list-style-type: none"> Write the settings again with the Configuration Tool. Replace the SD memory card.
3069H to 306AH	Setting file error	There is no setting file. Or the setting file is corrupted.	<ul style="list-style-type: none"> Write the settings again with the Configuration Tool. Replace the SD memory card.
306BH	File format setting error	An invalid setting has been made in the file format. Or the setting file is corrupted.	<ul style="list-style-type: none"> Write the settings again with the Configuration Tool. Replace the SD memory card.
306CH	Setting file error	There is no setting file. Or the setting file is corrupted.	<ul style="list-style-type: none"> Write the settings again with the Configuration Tool. Replace the SD memory card.
306DH to 306EH	Binary output format setting error	An invalid setting has been made in the binary output setting. Or the setting file is corrupted.	<ul style="list-style-type: none"> Write the settings again with the Configuration Tool. Replace the SD memory card.
306FH	File format setting error	An invalid setting has been made in the file format setting. Or the setting file is corrupted.	<ul style="list-style-type: none"> Write the settings again with the Configuration Tool. Replace the SD memory card.
3070H	Data type setting error	An invalid setting has been made in the data type setting. Or the setting file is corrupted.	<ul style="list-style-type: none"> Write the settings again with the Configuration Tool. Replace the SD memory card.
3071H	Binary output format setting error	An invalid setting has been made in the binary output setting. Or the setting file is corrupted.	<ul style="list-style-type: none"> Write the settings again with the Configuration Tool. Replace the SD memory card.

Error code	Error name	Error description	Corrective action
3072H	File access error	An error occurred when accessing the file.	<ul style="list-style-type: none"> Delete unnecessary files on the SD memory card to ensure free space. Replace the SD memory card.
3073H	File format setting error	An invalid setting has been made in the file format setting. Or the setting file is corrupted.	<ul style="list-style-type: none"> Write the settings again with the Configuration Tool. Replace the SD memory card.
3074H	Data type setting error	An invalid setting has been made in the data type setting. Or the setting file is corrupted.	<ul style="list-style-type: none"> Write the settings again with the Configuration Tool. Replace the SD memory card.
3075H	Binary output format setting error	An invalid setting has been made in the binary output setting. Or the setting file is corrupted.	<ul style="list-style-type: none"> Write the settings again with the Configuration Tool. Replace the SD memory card.
3076H	Setting file error	There is no setting file. Or the setting file is corrupted.	<ul style="list-style-type: none"> Write the settings again with the Configuration Tool. Replace the SD memory card.
3100H to 3101H	Module error	A module error has been detected.	<ul style="list-style-type: none"> Take measures to reduce noise. Reset the CPU module and switch it to RUN. If the same error is displayed again, a hardware failure may occur in high speed data logger module. Please consult your local Mitsubishi representative.
3110H	Module error	A module error has been detected.	<ul style="list-style-type: none"> Take measures to reduce noise. Reset the CPU module and switch it to RUN. If the same error is displayed again, a hardware failure may occur in high speed data logger module. Please consult your local Mitsubishi representative.
3111H	Incorrect file transfer destination No. error	The file destination number is out of the range. Or the setting file is corrupted.	<ul style="list-style-type: none"> Write the settings again with the Configuration Tool. Replace the SD memory card.
3112H	File transfer destination No. non-setting error	Made a file transfer request for a file destination number which was not set in the file transfer setting. Or the setting file is corrupted.	<ul style="list-style-type: none"> Write the settings again with the Configuration Tool. Replace the SD memory card.
3113H to 311BH	Module error	A module error has been detected.	<ul style="list-style-type: none"> Take measures to reduce noise. Reset the CPU module and switch it to RUN. If the same error is displayed again, a hardware failure may occur in high speed data logger module. Please consult your local Mitsubishi representative.
3120H	Incorrect e-mail address No. error	The e-mail destination number is out of the range. Or the setting file is corrupted.	<ul style="list-style-type: none"> Write the settings again with the Configuration Tool. Replace the SD memory card.
3121H	E-mail address No. non-setting error	Made an e-mail transmission request for an e-mail destination number which was not set in the "E-mail setting". Or the setting file is corrupted.	<ul style="list-style-type: none"> Write the settings again with the Configuration Tool. Replace the SD memory card.
3122H to 3123H	Module error	A module error has been detected.	<ul style="list-style-type: none"> Take measures to reduce noise. Reset the CPU module and switch it to RUN. If the same error is displayed again, a hardware failure may occur in high speed data logger module. Please consult your local Mitsubishi representative.
3130H to 315CH	Module error	A module error has been detected.	<ul style="list-style-type: none"> Take measures to reduce noise. Reset the CPU module and switch it to RUN. If the same error is displayed again, a hardware failure may occur in high speed data logger module. Please consult your local Mitsubishi representative.
31A0H to 31A1H	Setting file error	There is no setting file. Or the setting file is corrupted.	<ul style="list-style-type: none"> Write the settings again with the Configuration Tool. Replace the SD memory card.

Error code	Error name	Error description	Corrective action
31A2H to 31A3H	Module error	A module error has been detected.	<ul style="list-style-type: none"> Take measures to reduce noise. Reset the CPU module and switch it to RUN. If the same error is displayed again, a hardware failure may occur in high speed data logger module. Please consult your local Mitsubishi representative.
31A4H	Insufficient trigger buffer error	Total trigger buffer usage exceeds 100%.	<ul style="list-style-type: none"> Write the settings again with the Configuration Tool. Replace the SD memory card.
31A5H	Module error	A module error has been detected.	<ul style="list-style-type: none"> Take measures to reduce noise. Reset the CPU module and switch it to RUN. If the same error is displayed again, a hardware failure may occur in high speed data logger module. Please consult your local Mitsubishi representative.
31A6H	Insufficient trigger buffer error	Total trigger buffer usage exceeds 100%.	<ul style="list-style-type: none"> Write the settings again with the Configuration Tool. Replace the SD memory card.
31A7H	Module error	A module error has been detected.	<ul style="list-style-type: none"> Take measures to reduce noise. Reset the CPU module and switch it to RUN. If the same error is displayed again, a hardware failure may occur in high speed data logger module. Please consult your local Mitsubishi representative.
31A8H	Insufficient trigger buffer error	Total trigger buffer usage exceeds 100%.	<ul style="list-style-type: none"> Write the settings again with the Configuration Tool. Replace the SD memory card.
31A9H to 31AFH	Module error	A module error has been detected.	<ul style="list-style-type: none"> Take measures to reduce noise. Reset the CPU module and switch it to RUN. If the same error is displayed again, a hardware failure may occur in high speed data logger module. Please consult your local Mitsubishi representative.
31B4H to 31E4H	Module error	A module error has been detected.	<ul style="list-style-type: none"> Take measures to reduce noise. Reset the CPU module and switch it to RUN. If the same error is displayed again, a hardware failure may occur in high speed data logger module. Please consult your local Mitsubishi representative.
3C00H to 3C03H	Hardware failure	A hardware failure has been detected.	<ul style="list-style-type: none"> Take measures to reduce noise. Reset the CPU module and switch it to RUN. If the same error is displayed again, a hardware failure may occur in high speed data logger module. Please consult your local Mitsubishi representative.
3C0FH	Hardware failure	A hardware failure has been detected.	<ul style="list-style-type: none"> Take measures to reduce noise. Reset the CPU module and switch it to RUN. If the same error is displayed again, a hardware failure may occur in high speed data logger module. Please consult your local Mitsubishi representative.
3C22H	Memory error	An error has been detected in the memory.	<ul style="list-style-type: none"> Take measures to reduce noise. Reset the CPU module and switch it to RUN. If the same error is displayed again, a hardware failure may occur in high speed data logger module. Please consult your local Mitsubishi representative.
3C2FH	Memory error	An error has been detected in the memory.	<ul style="list-style-type: none"> Take measures to reduce noise. Reset the CPU module and switch it to RUN. If the same error is displayed again, a hardware failure may occur in high speed data logger module. Please consult your local Mitsubishi representative.

Error code	Error name	Error description	Corrective action
3C32H	Memory error	An error has been detected in the memory.	<ul style="list-style-type: none"> • Take measures to reduce noise. • Reset the CPU module and switch it to RUN. If the same error is displayed again, a hardware failure may occur in high speed data logger module. Please consult your local Mitsubishi representative.
3E00H to 3E19H	Module error	A module error has been detected.	<ul style="list-style-type: none"> • Take measures to reduce noise. • Reset the CPU module and switch it to RUN. If the same error is displayed again, a hardware failure may occur in high speed data logger module. Please consult your local Mitsubishi representative.
3E20H to 3E26H	Module error	A module error has been detected.	<ul style="list-style-type: none"> • Take measures to reduce noise. • Reset the CPU module and switch it to RUN. If the same error is displayed again, a hardware failure may occur in high speed data logger module. Please consult your local Mitsubishi representative.
3E40H to 3E62H	Module error	A module error has been detected.	<ul style="list-style-type: none"> • Take measures to reduce noise. • Reset the CPU module and switch it to RUN. If the same error is displayed again, a hardware failure may occur in high speed data logger module. Please consult your local Mitsubishi representative.
3F01H to 3F04H	Memory error	An error has been detected in the memory.	<ul style="list-style-type: none"> • Take measures to reduce noise. • Reset the CPU module and switch it to RUN. If the same error is displayed again, a hardware failure may occur in high speed data logger module. Please consult your local Mitsubishi representative.

4.5 Event List

Displays the events that occur in the high speed data logger module.

Event code	Event type	Overview	Cause
20400	Operation	Firmware update completed successfully (intelligent function module)	The firmware of the Intelligent Function Module was successfully updated.
20401	Operation	Firmware update failed (Intelligent Function Module)	The firmware update of the Intelligent Function Module failed.
24001	Operation	Connection failed	Connection to module failed.
24002	Operation	Write settings	Writes the settings to the module.
24003	Operation	Read settings	Settings are read.
24010	Operation	SD memory card enabled	The SD memory card was enabled.
24011	Operation	SD memory card access stop	The SD memory card was ready for removal.
24012	Operation	SD memory card format	The SD memory card was formatted.
24020	Operation	Module operation stop	The operating status was changed to stop.
24021	Operation	Restart module operation	The operating status was changed to running.
24030	Operation	E-mail resending buffer clear	Clears the E-mail resend buffer memory and cancels resending the E-mail transfer.
24031	Operation	File resending buffer clear	Clears the file resend buffer memory and cancels resending the file transfer.
24040	Operation	Error clear	Error clear was executed.
24042	Operation	Event history file clear	Event history file clear was executed.
24043	Operation	Logging file clear	Logging file clear was executed.
24044	Operation	INFO LED OFF	Turned OFF the INFO LED.
24050	Operation	Total count/total time clear	Total count/total time clear was executed.
24051	Operation	Total count/total time backup	Total count/total time backup was executed.
24052	Operation	Total count/total time restore	Total count/total time restore was executed.
24060	Operation	Recipe execution operation	Recipe execution operation was executed.
2A000	Operation	Update settings	Update settings was executed.

APPENDIX

Appendix 1 Module Label

This section shows the module labels used to set the input/output signals and buffer memory of a high speed data logger module.

Module label configuration

The name of a module label is defined in the following configurations:

"Instance name"_"Module number"."Label name"

"Instance name"_"Module number"."Label name"_D

Ex.

DL96_1.stIOSignal.bModuleReady

■ Instance name

The instance name for high speed data logger module (RD81DL96) is "DL96".

■ Module number

A module number is a number starting from 1, which is added to identify a module that has the same instance name.

■ Label name

This is a module unique label name.

■ _D

This indicates that the module label is for direct access. Without this symbol means a label for refresh. There are some differences between refresh and direct access as shown below.

Type	Description	Access timing
Refresh	Values written to/read from a module label are applied to a module in a batch at the time of refresh. This shortens the program execution time.	At the time of refresh
Direct access	Values written to/read from a module label are immediately applied to a module. Although the program execution time is longer than refresh, the responsiveness will be increased.	At the time of writing to/ reading from a module label

A

Appendix 2 Input/Output Signals

This section explains the input/output signals of a high speed data logger module.

The following shows an example of assigning input/output signals when the start input/output number of a high speed data logger module is '0.'

Device X indicates an input signal from a high speed data logger module to a CPU module.

Device Y indicates an output signal from a CPU module to a high speed data logger module.

Precautions

As for input/output signals to a CPU module, do not output (turn ON) 'Use prohibited' signals. Doing so may cause malfunction of a programmable controller system.

Input/output signal list

The following shows the input/output signal list of a high speed data logger module.

For details on the input/output signals, refer to the following:

☞ Page 296 Input signal details

☞ Page 300 Output signal details

Input signals

Device No.	Signal name
X0	Module READY
X1	SD memory card status
X2	File access status
X3 to X4	Use prohibited
X5	Module operating status
X6	Use prohibited
X7	INFO LED status
X8	Setting renew status
X9 to XA	Use prohibited
XB	Time synchronization timing
XC to XF	Use prohibited
X10	ERR LED status
X11	Use prohibited
X12	Data logging error
X13	Event logging error
X14	Report creation error
X15	Use prohibited
X16	Access target unit error
X17	E-mail transmission error
X18	File transfer failed
X19	Other error
X1A	High speed sampling failure
X1B	Processing overload occurrence
X1C	Trigger reoccurrence
X1D	Creation trigger reoccurrence
X1E	General sampling delay occurrence
X1F	Use prohibited

Output signals

Device No.	Signal name
Y0 to Y1	Use prohibited
Y2	File access stop request
Y3	Clear file access stop request
Y4 to Y6	Use prohibited
Y7	Clear INFO LED request
Y8	Setting renew request
Y9 to YA	Use prohibited
YB	Time synchronization request
YC to YF	Use prohibited
Y10	Error clear request
Y11 to 1F	Use prohibited

Input signal details

The following shows the details on the input signals from a high speed data logger module to a CPU module.

Module READY (X0)

This signal turns ON when a high speed data logger module becomes ready after powering OFF to ON or resetting the CPU module.

This signal turns OFF when a watchdog timer error occurred.

SD memory card status (X1)

This signal turns ON when an SD memory card is inserted and 'File access status' (X2) is OFF.

It turns OFF when an SD memory card is not inserted or 'File access status' (X2) is ON.

File access status (X2)

● This signal turns ON while file access is stopped.

The following operation can be performed while file access is stopped.

- SD memory card insertion/ejection (IMELSEC iQ-R High Speed Data Logger Module User's Manual (Startup))

While file access is stopped, the status will be as follows.

- SD memory card read/write-protected
- Module operating status is stopped

● This signal turns OFF when a file becomes accessible.

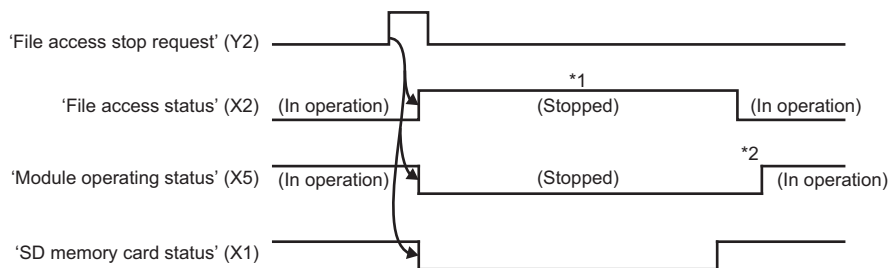

*1 The following operation can be performed.

- Replacement of an SD memory card

*2 This signal turns ON by updating the settings.

Module operating status (X5)

- This signal turns ON when the data logging function, event logging function, and report function are operating.
- This signal turns OFF when the data logging function, event logging function, and report function are stopped.

It will be in stop state in the following situations.

- When a module operation is stopped in Configuration Tool
- When the settings are not written to the high speed data logger module
- When an module stop error occurs
- When file access is stopped (X2 is ON)

The data logging function, event logging function, and report function will start operating again according to the following procedure.

- When a module operation is stopped in Configuration Tool
1. Restart the module operation in Configuration Tool. (☞ Page 218 Module diagnostics)
- When the settings are not written to the high speed data logger module
1. Write settings to the high speed data logger module in Configuration Tool. (☞ Page 216 Write)
 2. Update the settings. (☞ Page 218 Module diagnostics)
- When a module stop error occurs
1. Clear the error in Configuration Tool or 'error clear request' (Y10). (☞ Page 218 Module diagnostics)
 2. Update the settings in Configuration Tool. (☞ Page 218 Module diagnostics)
- When file access is stopped (X2 is ON)
1. Turn ON 'Clear file access stop request' (Y3). (File access starts (X2 turns OFF).
 2. Restart the module operation or update the settings in Configuration Tool. (☞ Page 218 Module diagnostics)

INFO LED status (X7)

This signal turns ON when INFO LED turns ON.

For the factors that the INFO LED is turned ON, refer to the following:

☞ Page 218 Module diagnostics, Page 312 Module status area (Un\G0 to 20)

This signal turns OFF by turning the 'clear INFO LED request' (Y7) ON to turn the INFO LED OFF.

This signal turns OFF by updating the settings.

Setting renew status (X8)

This signal turns ON when settings are updated by turning ON 'Setting renew request' (Y8).

'Setting renew status' (X8) turns OFF when 'Setting renew request' (Y8) is turned OFF after 'Setting renew status' (X8) turns ON.

Time synchronization timing (XB)

This signal turns ON when a time inquiry is successful for the time synchronization request by turning ON 'Time synchronization request' (YB).

If the 'time synchronization timing' (XB) turns ON, then 'time synchronization request' (YB) turns OFF, the 'time synchronization timing' (XB) turns OFF.

ERR LED status (X10)

This signal turns ON when ERR LED is ON (continuation error) or flashing (stop error).

This signal turns OFF by turning the 'error clear request' (Y10) ON to turn the ERR LED OFF.

When the ERR LED is ON or flashing (If X10 is ON), any of X12 to 14 or X16 to 19 (or multiple signals) turn ON.

Data logging error (X12)

This signal turns ON when an error related to data logging occurs.

When this signal is ON, an error code is stored in the data logging status area (Un\G2000 to 2989).

This signal turns OFF by turning ON the 'error clear request' (Y10).

Event logging error (X13)

This signal turns ON when an error related to event logging occurs.

When this signal is ON, an error code is stored in the event logging status area (Un\G3000 to 3989).

This signal turns OFF by turning ON the 'error clear request' (Y10).

Report creation error (X14)

This signal turns ON when an error related to the report function occurs.

When this signal is ON, an error code is stored in the report creation status area (Un\G4000 to 4989).

This signal turns OFF by turning ON the 'error clear request' (Y10).

Access target unit error (X16)

This signal turns ON when an error occurs in communicating with the access target CPU.

When this signal is ON, an error code is stored in the access target CPU setting status area (Un\G1500 to 1593).

This signal turns OFF by turning ON the 'error clear request' (Y10).

E-mail transmission error (X17)

This signal turns ON when an error related to e-mail transmission occurs.

When this signal is ON, an error code is stored in the e-mail transmission status area (Un\G5000 to 5992).

This signal turns OFF by turning ON the 'error clear request' (Y10).

File transfer failed (X18)

This signal turns ON when an error related to file transfer occurs.

When this signal is ON, an error code is stored in the file transfer status area (Un\G6002 to 7457).

This signal turns OFF by turning ON the 'error clear request' (Y10).

Other error (X19)

This signal turns ON when an errors other than those falling under X12 to 18 occur.

When this signal is ON, an error code is stored in the error log area (Un\G150 to 247).

This signal turns OFF by turning ON the 'error clear request' (Y10). (Occurring only continuation error)

High speed sampling failure (X1A)

This signal turns ON when high speed sampling failure occurs in data logging, event logging or report. (Page 346 Processing Time)

This signal turns OFF by updating the settings.

Processing overload occurrence (X1B)

This signal turns ON when a processing overload occurs in data logging, event logging or report. (Page 346 Processing Time)

This signal turns OFF by updating the settings.

Trigger reoccurrence (X1C)

This signal turns ON when trigger reoccurs in data logging. (Page 346 Processing Time)

This signal turns OFF by updating the settings.

Creation trigger reoccurrence (X1D)

This signal turns ON when trigger reoccurs in report. (Page 346 Processing Time)

This signal turns OFF by updating the settings.

General sampling delay occurrence (X1E)

This signal turns ON when a general sampling delay occurs in data logging, event logging, or report. (Page 346 Processing Time)

This signal turns OFF by any of the following operations.

- Updating the settings
- Setting a value more than the general sampling delay time (maximum) in the 'allowed general sampling delay time' (Un\G804 to 805).

Output signal details

The following shows the details on the output signals from a high speed data logger module to a CPU module.

Precautions

Turn ON each output signal after 'Module READY' (X0) turns ON. Otherwise, a setting file may be corrupted or an unintended operation may occur.

Point

The output signal will be enabled when it is turned OFF to ON.

In addition, since the system does not turn the output signal ON to OFF, turn it ON to OFF, and OFF to ON to perform again.

File access stop request (Y2)

When the file access stop request is turned ON, the file access is stopped.

Clear file access stop request (Y3)

Turn this signal ON when the file access stop request is sent by mistake.

After requesting the file access stop, the file access can be restarted when the SD memory card has not been replaced and the file access stop cancel request is turned ON.

The module operation is stopped; therefore, turn ON 'Setting renew request' (Y8), restart the module operation in Configuration Tool, or update the setting in Configuration Tool. (If the auto logging function is enabled, logging will restart by turning ON 'Clear file access stop request' (Y3). Executing a request such as a module operation start request is not required.)

Clear INFO LED request (Y7)

If this signal is turned ON when data is missing, free space of the SD card has decreased, resend buffering has started, or the saved folder names/file names are duplicated, the following operations will be performed.

- INFO LED is turned OFF
- 'INFO LED status' (X7) is turned OFF
- Clear the 'INFO LED indication factor' (Un\G12)

Setting renew request (Y8)

This signal is used to update settings written to a high speed data logger module and allow the module to operate according to the updated settings.

Settings are not updated in the following cases:

- The module operations such as updating settings, stop, restart, and logging file clear are performed using "Diagnostics" screen or output signal
- During module initialization processing
- During module stop processing
- The settings are not written in the high speed data logger module.

Turn this signal OFF after 'Setting renew status' (X8) turns ON.

Time synchronization request (YB)

When the time synchronization request is turned ON, the time of the module will be synchronized according to the time synchronization settings. (When the time of the CPU module has been changed, turn this signal ON after wait for more than 1 second.)

Turn the 'time synchronization request' (YB) OFF after turning it the 'time synchronization timing' (XB) ON.

Error clear request (Y10)

The following will be executed if error clear request (Y10) is turned ON while a module error is occurring.

- ERR LED is turned OFF
- X10, X12 to X14, X16 to X19 are turned OFF
- The latest error code is cleared

Appendix 3 Buffer Memory

This section explains the buffer memory of a high speed data logger module.

Precautions

- Do not write any data in the "system area" of the buffer memory. Doing so may cause malfunction of the programmable controller system.

Buffer memory list

The following table shows the buffer memory list of a high speed data logger module.

R: Read-only, W: Write-only, R/W: Readable/Writable

Address Decimal (Hexadecimal)	Application	Name	Initial value	R/W
0 (0H)	Module status area	RUN LED status	0	R
1 (1H)		ERR LED status	0	R
2 (2H)		CARD RDY LED status	0	R
3 (3H)		CARD ACS LED status	0	R
4 (4H)		OPR LED status	0	R
5 (5H)		LED status	0	R
6 (6H)		System area	—	—
7 (7H)		Default operation setting	0	R
8 to 11 (8H to BH)		System area	—	—
12 (CH)		INFO LED lighting factor	0	R
13 to 19 (DH to 13H)		System area	—	—
20 (14H)		Module operating status	0	R
21 to 22 (15H to 16H)		SD memory card information area	SD memory card total capacity	0
23 to 24 (17H to 18H)	SD memory card free capacity		0	R
25 (19H)	SD memory card usage rate		0	R
26 to 27 (1AH to 1BH)	SD memory card usage capacity		0	R
28 to 46 (1CH to 2EH)	System area	—	—	

Address Decimal (Hexadecimal)	Application	Name	Initial value	R/W
47 to 54 (2FH to 36H)	Network connection status area	IP address (string representation)	—	R
55 to 56 (37H to 38H)		IP address	—	R
57 to 58 (39H to 3AH)		Subnet mask	—	R
59 to 60 (3BH to 3CH)		Default gateway	—	R
61 to 62 (3DH to 3EH)		DNS server (primary)	—	R
63 to 64 (3FH to 40H)		DNS server (secondary)	—	R
65 to 69 (41H to 45H)		System area	—	—
70 (46H)	Common setting status area	IP address specification method	—	R
71 to 72 (47H to 48H)		IP address	—	R
73 to 74 (49H to 4AH)		Subnet mask	—	R
75 to 76 (4BH to 4CH)		Default gateway	—	R
77 to 78 (4DH to 4EH)		DNS server (primary)	—	R
79 to 80 (4FH to 50H)		DNS server (secondary)	—	R
81 to 86 (51H to 56H)		System area	—	—
87 to 99 (57H to 63H)	System area		—	—
100 (64H)	Time synchronization information area	Time synchronization status	—	R
101 to 107 (65H to 6BH)		Time synchronization result	—	R
108 (6CH)		Daylight saving time status	—	R
109 (6DH)		System area	—	—
110 to 139 (6EH to 8BH)	System area		—	—
140 (8CH)	Current error area	Error code	—	R
141 (8DH)		System area	—	—
142 to 147 (8EH to 93H)		Time	—	R
148 to 149 (94H to 95H)		System area	—	—



Address Decimal (Hexadecimal)	Application	Name	Initial value	R/W	
150 (96H)	Error log area	Error count	0	R	
151 (97H)		Error log write pointer	0	R	
152 (98H)		Error log 1	Error code	0	R
153 (99H)			System area	—	—
154 to 159 (9AH to 9FH)			Time	—	R
160 to 161 (A0H to A1H)			System area	—	—
162 to 311 (A2H to 137H)		Error log 2 to 16	Same as error log 1		
312 to 799 (138H to 31FH)	System area		—	—	
800 to 801 (320H to 321H)	General sampling delay time area	General sampling delay time (moving average)	0	R	
802 to 803 (322H to 323H)		General sampling delay time (maximum)	0	R	
804 to 805 (324H to 325H)		Allowed general sampling delay time	0	R/W	
806 to 809 (326H to 329H)	System area		—	—	
810 (32AH)	Recipe file area	Recipe execution information	0	R	
811 (32BH)		Error code	0	R	
812 (32CH)		Type of recipe execution operation	0	R	
813 (32DH)		Record No.	0	R	
814 to 837 (32EH to 345H)		Recipe file name	0	R	
838 to 839 (346H to 347H)		Completed recipe execution operation count	0	R	
840 to 841 (348H to 349H)		Failed recipe execution operation count	0	R	
842 to 1499 (34AH to 5DBH)	System area		—	—	
1500 to 1503 (5DCH to 5DFH)	Access target CPU setting status area	Access target CPU setting information	0	R	
1504 to 1507 (5E0H to 5E3H)		Access target CPU error information	0	R	
1508 to 1529 (5E4H to 5F9H)		System area	—	—	
1530 to 1593 (5FAH to 639H)		Error code of access target CPU 1 to 64	0	R	
1594 to 1999 (63AH to 7CFH)	System area		—	—	

Address Decimal (Hexadecimal)	Application	Name	Initial value	R/W	
2000 to 2003 (7D0H to 7D3H)	Data logging status area	Data logging setting information	0	R	
2004 to 2007 (7D4H to 7D7H)		System area	—	—	
2008 to 2011 (7D8H to 7DBH)		Data logging execution information	0	R	
2012 to 2015 (7DCH to 7DFH)		Data logging error information	0	R	
2016 to 2019 (7E0H to 7E3H)		Number of saved files exceeded information	0	R	
2020 to 2029 (7E4H to 7EDH)		System area	—	—	
2030 (7EEH)		Data logging information 1	Error code	0	R
2031 to 2032 (7EFH to 7F0H)			Number of newest folder	0	R
2033 to 2034 (7F1H to 7F2H)			Number of newest file	0	R
2035 (7F3H)			High speed sampling failure count	0	R
2036 (7F4H)			Processing overload count	0	R
2037 (7F5H)			Unprocessed buffer size	0	R
2038 (7F6H)			Unprocessed data count (current)	0	R
2039 (7F7H)			Unprocessed data count (maximum)	0	R
2040 (7F8H)			Trigger detection count	0	R
2041 (7F9H)			Trigger reoccurrence count	0	R
2042 to 2044 (7FAH to 7FCH)			System area	—	—
2045 to 2989 (7FDH to BADH)	Data logging information 2 to 64	Same as data logging information 1			
2990 to 2999 (BAEH to BB7H)	System area		—	—	



Address Decimal (Hexadecimal)	Application	Name	Initial value	R/W	
3000 to 3003 (BB8H to BBBH)	Event logging status area	Event logging setting information	0	R	
3004 to 3007 (BBCH to BBFH)		System area	—	—	
3008 to 3011 (BC0H to BC3H)		Event logging error information	0	R	
3012 to 3015 (BC4H to BC7H)		Number of saved files exceeded information	0	R	
3016 to 3029 (BC8H to BD5H)		System area	—	—	
3030 (BD6H)		Event logging information 1	Error code	0	R
3031 to 3032 (BD7H to BD8H)			Number of newest folder	0	R
3033 to 3034 (BD9H to BDAH)			Number of newest file	0	R
3035 (BDBH)			High speed sampling failure count	0	R
3036 (BDCH)			Processing overload count	0	R
3037 (BDDH)			Unprocessed buffer size	0	R
3038 (BDEH)			Unprocessed data count (current)	0	R
3039 (BDFH)			Unprocessed data count (maximum)	0	R
3040 to 3044 (BE0H to BE4H)			System area	—	—
3045 to 3989 (BE5H to F95H)			Event logging information 2 to 64	Same as event logging information 1	
3990 to 3999 (F96H to F9FH)	System area	—	—		

Address Decimal (Hexadecimal)	Application	Name	Initial value	R/W	
4000 to 4003 (FA0H to FA3H)	Report creation status area	Report setting information	0	R	
4004 to 4007 (FA4H to FA7H)		System area	—	—	
4008 to 4011 (FA8H to FABH)		Report creation execution information	0	R	
4012 to 4015 (FACH to FAFH)		Report creation error information	0	R	
4016 to 4019 (FB0H to FB3H)		Number of saved files exceeded information	0	R	
4020 to 4029 (FB4H to FBDH)		System area	—	—	
4030 (FBEH)		Report creation information 1	Error code	0	R
4031 to 4032 (FBFH to FC0H)			Number of newest folder	0	R
4033 to 4034 (FC1H to FC2H)			Number of newest file	0	R
4035 (FC3H)			High speed sampling failure count	0	R
4036 (FC4H)			Processing overload count	0	R
4037 (FC5H)			Unprocessed buffer size	0	R
4038 (FC6H)			Unprocessed data count (current)	0	R
4039 (FC7H)			Unprocessed data count (maximum)	0	R
4040 (FC8H)			Creation trigger detection count	0	R
4041 (FC9H)			Creation trigger reoccurrence count	0	R
4042 (FCAH)			Report creation time (newest)	0	R
4043 (FCBH)			Report creation time (maximum)	0	R
4044 (FCCH)			System area	—	—
4045 to 4989 (FCDH to 137DH)			Report creation information 2 to 64	Same as report creation information 1	
4990 to 4999 (137EH to 1387H)	System area		—	—	



Address Decimal (Hexadecimal)	Application	Name	Initial value	R/W	
5000 to 5001 (1388H to 1389H)	E-mail transmission status area	System area	—	—	
5002 (138AH)		Normally completed e-mail count	0	R	
5003 (138BH)		Attachment transmission count	0	R	
5004 (138CH)		Abnormally completed e-mail count	0	R	
5005 (138DH)		Error log write count	0	R	
5006 (138EH)		Error log write pointer	0	R	
5007 (138FH)		Error log 1	Error code	0	R
5008 (1390H)			To	0	R
5009 to 5023 (1391H to 139FH)			Subject	0	R
5024 to 5027 (13A0H to 13A3H)			Date	0	R
5028 to 5342 (13A4H to 14DEH)		Error log 2 to 16	Same as error log 1		
5343 (14DFH)		Transmission log write count	0	R	
5344 (14E0H)		Transmission log write pointer	0	R	
5345 (14E1H)		Transmission log 1	To	0	R
5346 to 5360 (14E2H to 14F0H)			Subject	0	R
5361 to 5364 (14F1H to 14F4H)			Date	0	R
5365 to 5984 (14F5H to 1760H)		Transmission log 2 to 32	Same as transmission log 1		
5985 to 5986 (1761H to 1762H)		Resend buffer size	0	R	
5987 to 5988 (1763H to 1764H)		Buffering number (current value)	0	R	
5989 to 5990 (1765H to 1766H)		Buffering number (maximum value)	0	R	
5991 (1767H)		Buffer usage rate (current value)	0	R	
5992 (1768H)		Buffer usage rate (maximum value)	0	R	
5993 to 5999 (1769H to 176FH)		System area		—	—
6000 (1770H)	FTP server status area	Login success count	0	R	
6001 (1771H)		Login failure count	0	R	

Address Decimal (Hexadecimal)	Application	Name	Initial value	R/W	
6002 to 6003 (1772H to 1773H)	File transfer status area	System area	—	—	
6004 (1774H)		Normally completed file transfer count	0	R	
6005 (1775H)		Abnormally completed file transfer count	0	R	
6006 (1776H)		Transfer result 1	Normally completed count	0	R
6007 (1777H)			Abnormally completed count	0	R
6008 to 6037 (1778H to 1795H)		Transfer result 2 to 16	Same as transfer result 1		
6038 (1796H)		Error log write count	0	R	
6039 (1797H)		Error log write pointer	0	R	
6040 (1798H)		Error log 1	Error code	0	R
6041 (1799H)			Destination	0	R
6042 to 6065 (179AH to 17B1H)			File name	0	R
6066 to 6069 (17B2H to 17B5H)			Date	0	R
6070 to 6519 (17B6H to 1977H)		Error log 2 to 16	Same as error log 1		
6520 (1978H)		Transfer log write count	0	R	
6521 (1979H)		Transfer log write pointer	0	R	
6522 (197AH)		Transfer log 1	Destination	0	R
6523 to 6546 (197BH to 1992H)			File name	0	R
6547 to 6550 (1993H to 1996H)			Date	0	R
6551 to 7449 (1997H to 1D19H)		Transfer log 2 to 32	Same as transfer log 1		
7450 to 7451 (1D1AH to 1D1BH)		Resend buffer size	0	R	
7452 to 7453 (1D1CH to 1D1DH)		Buffering number (current value)	0	R	
7454 to 7455 (1D1EH to 1D1FH)	Buffering number (maximum value)	0	R		
7456 (1D20H)	Buffer usage rate (current value)	0	R		
7457 (1D21H)	Buffer usage rate (maximum value)	0	R		
7458 to 8999 (1D22H to 2327H)	System area	—	—		



Address Decimal (Hexadecimal)	Application	Name			Initial value	R/W		
9000 (2328H)	Firmware update history information	Firmware update completion with/without an error			0	R		
9001 to 9009 (2329H to 2331H)		System area			—	—		
9010 (2332H)		Latest firmware update information	History information	Execution time (year)	0	R		
9011 (2333H)				Execution time (month)	0	R		
9012 (2334H)				Execution time (day)	0	R		
9013 (2335H)				Execution time (hour)	0	R		
9014 (2336H)				Execution time (minute)	0	R		
9015 (2337H)				Execution time (second)	0	R		
9016 (2338H)				Execution time (day of the week)	0	R		
9017 (2339H)				Firmware version after update	0	R		
9018 (233AH)				Firmware version before update	0	R		
9019 (233BH)				Latest firmware update result		Firmware update target	0	R
9020 (233CH)						Firmware update result	0	R
9021 (233DH)		Previous firmware update information	History information	Execution time (year)	0	R		
9022 (233EH)				Execution time (month)	0	R		
9023 (233FH)				Execution time (day)	0	R		
9024 (2340H)				Execution time (hour)	0	R		
9025 (2341H)				Execution time (minute)	0	R		
9026 (2342H)				Execution time (second)	0	R		
9027 (2343H)				Execution time (day of the week)	0	R		
9028 (2344H)				Firmware version after update	0	R		
9029 (2345H)				Firmware version before update	0	R		
9030 (2346H)				Previous firmware update result		Firmware update target	0	R
9031 (2347H)		Firmware update result	0			R		
9032 to 9035 (2348H to 234BH)		System area			—	—		
9036 to 9999 (234CH to 270FH)		System area			—	—		

Address Decimal (Hexadecimal)	Application	Name		Initial value	R/W
10000 (2710H)	Event logging area	Event logging information 1	Event 1 occurrence count	0	R
10001 to 10255 (2711H to 280FH)			Event 2 to 256 occurrence count	0	R
10256 to 26383 (2810H to 670FH)		Event logging information 2 to 64	Same as event logging information 1		
26384 to 26399 (6710H to 671FH)		Event logging status 1	Event occurs status	0	R
26400 to 27407 (6720H to 6B0FH)		Event logging status 2 to 64	Same as event logging status 1		
27408 to 65535 (6B10H to FFFFH)	System area			—	—
65536 to 65539 (10000H to 10003H)	Number of times/Time information area	Data logging 1 number of times/time information	Data 1 information	0	R
65540 to 69631 (10004H to 10FFFFH)			Data 2 information to Data 1024 information	0	R
69632 to 327679 (11000H to 4FFFFH)		Data logging 2 number of times/time information to Data logging 64 number of times/time information	Same as data logging 1 number of times/time information		

Buffer memory details

The following explains the buffer memory details of a high speed data logger module.

Module status area (Un\G0 to 20)

The status of each LED, parameter settings, and operation of a high speed data logger module can be checked.

Buffer memory name	Address	Description
RUN LED status	Un\G0	0: OFF 1: ON 2: Flashing
ERR LED status	Un\G1	0: OFF 1: ON 2: Flashing
CARD RDY LED status	Un\G2	0: OFF 1: ON 2: Flashing
CARD ACS LED status	Un\G3	0: OFF 1: ON
OPR LED status	Un\G4	0: OFF 1: ON 2: Flashing
INFO LED status	Un\G5	0: OFF 1: ON
Default operation setting	Un\G7	b0: ON: Account default setting is enabled b1: ON: IP filter default setting is valid b2: ON: Network default setting is valid
INFO LED lighting factor*1	Un\G12	INFO LED lighting factor is stored. b0: ON: Occurrence of sampling missing b1: ON: SD memory card free capacity decrease b2: ON: Resend buffering start b3: ON: Duplicate file/folder name
Module operating status	Un\G20	0: Initializing 1: In operation 2: Stopping 3: Stopped

*1 Along with checking the INFO LED lighting factor, check the following errors, then take the corrective actions.
INFO LED lighting factor is cleared when the settings are updated.

Cause of lighting	Corrective action
Occurrence of sampling missing	Check whether 'High Speed Sampling Failure' (X1A) and 'Processing Overload Occurrence' (X1B) is ON. Fully verify the processing time for each function of the entire system and adjust so that no data missing occurs as necessary. (☞ Page 346 Processing Time)
Decrease in the free capacity of SD memory card	Check the SD memory card information area (Un\G21 to 27) of buffer memory and check whether the free space available more than 10%. Delete unnecessary files in the SD memory card as necessary.
Resend buffering start	Check the number of bufferings of the e-mail transmission status area (Un\G5000 to 5992) and the file transfer status area (Un\G6002 to 7457) in the buffer memory. If the number of bufferings is not 0, check the status of the network and server.
Duplicate file/folder name	Check if the sequential numbers of subscripts are added to created subfolders, logging files, and report names in the SD memory card. Check the folder switching or file switching conditions. To prevent from assigning the same name to folders or files, perform the following actions as necessary. <ul style="list-style-type: none"> • Review the information added to the folder and file name • Adjust the change timing of device values in the CPU module

SD memory card information area (Un\G21 to 27)

The status of the SD memory card inserted in a high speed data logger module can be checked in this area.

Buffer memory name	Address	Description
SD memory card total capacity	Un\G21 to 22	Stored as a double word (32-bit value). (unit: KB)
SD memory card free capacity	Un\G23 to 24	Stored as a double word (32-bit value). (unit: KB)
SD memory card usage rate	Un\G25	Stored as a word (16-bit value). (unit: %)
SD memory card usage capacity	Un\G26 to 27	Stored as a double word (32-bit value). (unit: KB)

Network connection status area (Un\G47 to 64)

The status of the high speed data logger module's connection to a network can be checked in this area.

Buffer memory name	Address	Description
IP address (string representation)	Un\G47 to 54	Stored as a character string. Initial value is '192.168.3.3'
IP address	Un\G55 to 56	Stored as a double word (32-bit value). Initial value is C0A80303H
Subnet mask	Un\G57 to 58	Stored as a double word (32-bit value). Initial value is 'FFFFFF00H' (255.255.255.0)
Default gateway	Un\G59 to 60	Stored as a double word (32-bit value).
DNS server (primary)	Un\G61 to 62	Stored as a double word (32-bit value).
DNS server (secondary)	Un\G63 to 64	Stored as a double word (32-bit value).

Common setting status area (Un\G70 to 80)

The status of the network setting for the common setting can be checked in this area.

Buffer memory name	Address	Description
IP address specification method	Un\G70	An IP address specification method is stored. 0: Auto-obtain 1: Specify
IP address	Un\G71 to 72	Stored as a double word (32-bit value).
Subnet mask	Un\G73 to 74	Stored as a double word (32-bit value).
Default gateway	Un\G75 to 76	Stored as a double word (32-bit value).
DNS server (primary)	Un\G77 to 78	Stored as a double word (32-bit value).
DNS server (secondary)	Un\G79 to 80	Stored as a double word (32-bit value).

Time synchronization information area (Un\G100 to 108)

Information related to the time synchronization function can be checked in this area.

Buffer memory name	Address	Description	
Time synchronization status	Un\G100	A time synchronization method is stored. 0: Synchronizing with the time of the CPU module	
Time synchronization result	Year	Un\G101	4-digit year data is stored.
	Month	Un\G102	Data from January to December is stored.
	Day	Un\G103	Data from 1st to 31st of the month is stored.
	Hour	Un\G104	Time data from 00 to 23 is stored.
	Minute	Un\G105	Minute data from 00 to 59 is stored.
	Second	Un\G106	Second data from 00 to 59 is stored.
Daylight saving time status	Un\G107	Day data is stored. 0: Sunday, 1: Monday, 2: Tuesday, 3: Wednesday, 4: Thursday, 5: Friday, 6: Saturday	
		0: Not daylight saving time 1: Daylight saving time	
Daylight saving time status	Un\G108	0: Not daylight saving time 1: Daylight saving time	

A

Current error area (Un\G140 to 149)

The latest error code which is currently occurring can be checked in this area.

Buffer memory name	Address	Description
Error code	Un\G140	The error code is stored.
Time	Un\G142	b0 to 7: Time zone and summer time flag b8 to 15: System area
	Un\G143	b0 to 7: Last two digits of the year b8 to 15: Month (January to December)
	Un\G144	b0 to 7: Day (1 to 31) b8 to 15: Hour (00 to 23)
	Un\G145	b0 to 7: Minute (00 to 59) b8 to 15: Seconds (00 to 59)
	Un\G146	b0 to 7: Day of the week (0: Sunday, 1: Monday, 2: Tuesday, 3: Wednesday, 4: Thursday, 5: Friday, 6: Saturday) b8 to 15: First two digits of the year
	Un\G147	b0 to 7: First two digits of the millisecond b8 to 15: Last two digits of the millisecond

■Error code (Un\G140)

The error code is stored.

■Time (Un\G142 to 149)

The time when the error occurred is stored in BCD code.

	b15	...	b8	b7	...	b0
Un\G142	System area			Time zone and summer time flag*1		
Un\G143	Month (01H to 12H)			Year (00H to 99H) last 2 digits		
Un\G144	Hour (00H to 23H)			Day (01H to 31H)		
Un\G145	Second (00H to 59H)			Minute (00H to 59H)		
Un\G146	Year (00H to 99H) first 2 digits			Day of the week (0H to 6H)		
Un\G147	Lower milliseconds (00H to 99H)			Upper milliseconds (00H to 09H)		

*1 Time zone and summer time flag details are as follows.

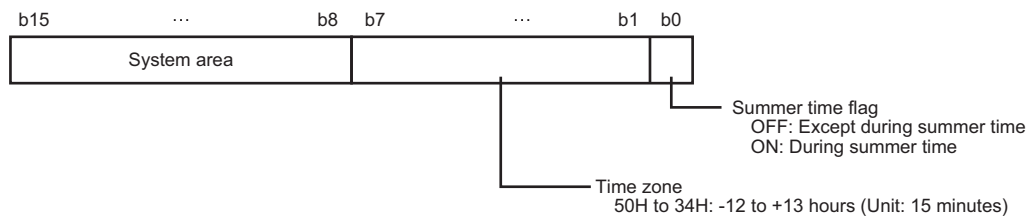

Point

The information of the current error area can be checked on the following diagnostics screens.

- Select [Online] ⇒ [Diagnostics] ⇒ "Module diagnostics" in Configuration Tool (📖 Page 218 Module diagnostics)
- System monitor of the engineering tool (📖 GX Works3 Operating Manual)

The current error area can be cleared with the following methods.

- Select [Online] ⇒ [Diagnostics] ⇒ "Module diagnostics" in Configuration Tool, and click the [Error release] button. (📖 Page 218 Module diagnostics)
- Turn ON 'error clear request' (Y10)
- Power OFF to ON or reset the CPU module

Error log area (Un\G150 to 311)

The history of errors which have occurred in the high speed data logger module can be checked in this area.

Buffer memory name		Address	Description
Error count		Un\G150	The total number of times an error log is registered in the error log area is stored.
Error log write pointer		Un\G151	The error log number where the latest error log is registered is stored. 0: No error 1 to 16: Error log number
Error log 1	Error code	Un\G152	The error code is stored.
	Time	Un\G154	b0 to 7: Time zone and summer time flag b8 to 15: System area
		Un\G155	b0 to 7: Last two digits of the year b8 to 15: Month (January to December)
		Un\G156	b0 to 7: Day (1 to 31) b8 to 15: Hour (00 to 23)
		Un\G157	b0 to 7: Minute (00 to 59) b8 to 15: Seconds (00 to 59)
		Un\G158	b0 to 7: Day of the week (0: Sunday, 1: Monday, 2: Tuesday, 3: Wednesday, 4: Thursday, 5: Friday, 6: Saturday) b8 to 15: First two digits of the year
		Un\G159	b0 to 7: First two digits of the millisecond b8 to 15: Last two digits of the millisecond
Error log 2 to 16		Un\G162 to 311	Details are the same as error log 1.

■Error count (Un\G150)

The total number of times an error log is registered in the error log area is stored.

■Error log write pointer (Un\G151)

The error log number where the latest error log is registered is stored. (For example, when '16' is stored, it indicates that the latest error log is registered in the area of the error log '16'.)

A maximum of 15 continuation errors and 1 Stop error will be registered.

If 15 continuation errors are displayed, new continuation errors will not be registered. If the new error has the same error code as the already registered error, the error occurrence date/time and its detailed information will not be updated.

If any new error occurs after the stop error, the new error will not be registered.

■ Error log 1 to 16 (Un\G152 to 311)

The error history of the errors occurred in a high speed data logger module is stored.

Error log area is comprised of 16 error logs with the same data configuration.

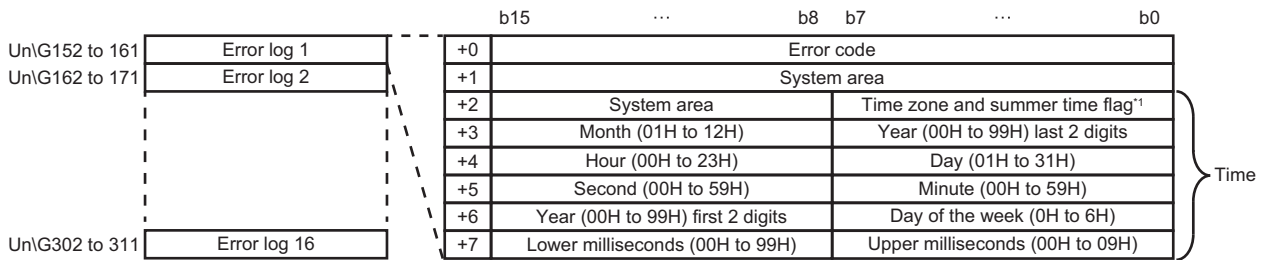

*1 Time zone and summer time flag details are as follows.

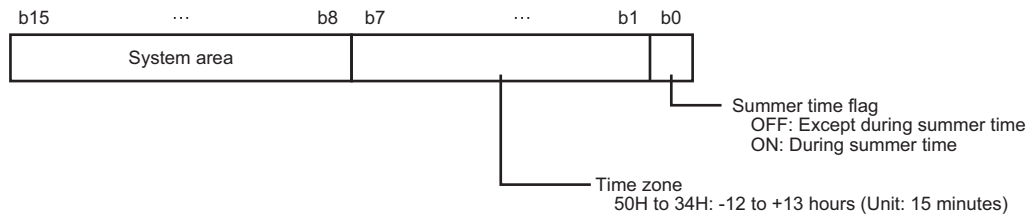

● Error code

The error code is stored.

● Time

The time when the error occurred is stored in BCD code.

Point

The information of the error log area can be checked in the following diagnostics screens.

- Select [Online] ⇒ [Diagnostics] ⇒ "Module diagnostics" in Configuration Tool (☞ Page 218 Module diagnostics)
- Select the [Event History] button on the "Module Diagnostics" screen of the engineering tool (☞ GX Works3 Operating Manual)

The error log area can be cleared with the following methods.

- Select [Online] ⇒ [Diagnostics] ⇒ "Module diagnostics" in Configuration Tool, and click the [Error release] button. (☞ Page 218 Module diagnostics)
- Power OFF to ON or reset the CPU module

General sampling delay time area (Un\G800 to 805)

The data sampling monitoring interval actually operating on the high speed data logger module can be checked in this area. The sampling delay time of data logging, event logging, and report function that are running general sampling can be checked in this area.

Buffer memory name	Address	Description
General sampling delay time (moving average)	Un\G800 to 801	The general sampling delay time is stored as the moving average over 30 times. (unit: milliseconds)
General sampling delay time (maximum)	Un\G802 to 803	The maximum value of general sampling delay time up to the present is stored. (unit: milliseconds)
Allowed general sampling delay time	Un\G804 to 805	The allowed general sampling delay time is stored. (unit: milliseconds)

■General sampling delay time (moving average) (Un\G800 to 801)

The general sampling delay time is stored as the moving average over 30 times. (Unit: milliseconds)

■General sampling delay time (maximum) (Un\G802 to 803)

The maximum value of general sampling delay time up to the present is stored. (Unit: milliseconds)

■Allowed general sampling delay time (Un\G804 to 805)

The allowed general sampling delay time is stored.



When 'general sampling delay time (max)' (Un\G802 to 803) exceeds the allowed time, 'general sampling delay' (X1E) turns ON.

0: Among the data sampling time of data logging, event logging, and report in which the general sampling is specified, the allowed time is half of the shortest sampling time. (Example: When the sampling time is 0.1 seconds, the allowed time will be 50 milliseconds.)

Other than 0: The specified value is the allowed time. (Unit: milliseconds)

Point

About general sampling delay time

- The high speed data logger module performs general sampling of data logging, event logging, and report every 100 milliseconds. If the data sampling interval is set to 0.2 seconds or higher, elapsed time is checked every 100 milliseconds and general sampling is performed as required.
- If there are many general sampling settings or too much data, sampling takes time, and there may be cases in which sampling each 0.1 seconds or checking the elapsed time cannot be done. In this case, the general sampling delay time is set as the actual sampling time minus 100 milliseconds
- When a general sampling is delayed, at maximum, there is the possibility that a sampling delay occurred in the general sampling delay time of data logging, event logging, or report function. ( Page 351 Checking method for the processing time)
- When access target CPU error (power interruption or network failure) is detected, the sampling time will extend to a maximum of the response monitoring time during detection. ( Page 136 [Response monitoring time] tab)

Recipe file area (Un\G810 to 841)

The operation execution status for a recipe file and the execution result can be checked in this area.

Buffer memory name	Address	Description
Recipe execution information	Un\G810	The recipe execution information is stored. 0: Recipe execution operation is not executed 1: Recipe execution operation is executed
Error code	Un\G811	The error code which indicates the error content of the occurred recipe execution operation error is stored.
Type of recipe execution operation	Un\G812	The type of recipe execution operation is stored. 1: Transfer the device value in the recipe file to the programmable controller CPU 100: Transfer the device value of the programmable controller CPU to the recipe file
Record No.	Un\G813	The record No. which is the target of recipe execution operation is stored.
Recipe file name	Un\G814 to 837	The recipe file name which is the target of recipe execution operation is stored.
Completed recipe execution operation count	Un\G838 to 839	The number of completed recipe execution operation after powering ON is stored. When performing the execution operation to different recipe files, the total number of completed recipe execution operation is counted.
Failed recipe execution operation count	Un\G840 to 841	The number of failed recipe execution operation after powering ON is stored.

Access target CPU setting status area (Un\G1500 to 1593)

The setting status of the access target CPU setting can be checked in this area.

Buffer memory name	Address	Description
Access target CPU setting information	Un\G1500 to 1503	The bit corresponding to the configured access target CPU turns ON.
Access target CPU error information	Un\G1504 to 1507	The bit corresponding to the access target CPU where the access target CPU error is occurring turns ON.
Error code of access target CPU 1 to 64	Un\G1530 to 1593	An error code is stored in the area corresponding to the access target CPU setting where the error is occurring. 0: Normal Other: Error code

■ Access target CPU setting information (Un\G1500 to 1503)

The status of an access target CPU setting is stored.

The bit corresponding to the configured access target CPU turns ON.

0: Unset

1: Set

	b15	b14	b13	b12	b11	b10	b9	b8	b7	b6	b5	b4	b3	b2	b1	b0
Un\G1500	16	15	14	13	12	11	10	9	8	7	6	5	4	3	2	1
Un\G1501	32	31	30	29	28	27	26	25	24	23	22	21	20	19	18	17
Un\G1502	48	47	46	45	44	43	42	41	40	39	38	37	36	35	34	33
Un\G1503	64	63	62	61	60	59	58	57	56	55	54	53	52	51	50	49

■ Access target CPU error information (Un\G1504 to 1507)

Access target CPU error information is stored.

The bit corresponding to the access target CPU where the access target CPU error is occurring turns ON.

0: No access target CPU error

1: Access target CPU error

	b15	b14	b13	b12	b11	b10	b9	b8	b7	b6	b5	b4	b3	b2	b1	b0
Un\G1504	16	15	14	13	12	11	10	9	8	7	6	5	4	3	2	1
Un\G1505	32	31	30	29	28	27	26	25	24	23	22	21	20	19	18	17
Un\G1506	48	47	46	45	44	43	42	41	40	39	38	37	36	35	34	33
Un\G1507	64	63	62	61	60	59	58	57	56	55	54	53	52	51	50	49

Ex.

When an error occurred in the access target CPU for access target CPU setting No. 16

'Access target unit error' (X16) turns ON.

The 15th bit of the 'access target CPU error information' (Un\G1504) turns ON.

The error code is stored in the 'error code' (Un\G1545) of access target CPU 16.

■Error code of access target CPU 1 to 64 (Un\G1530 to 1593)

An error code is stored in the area corresponding to the access target CPU setting where the error is occurring. For details on the error codes, refer to the following:

☞ Page 263 Error Code List

Data logging status area (Un\G2000 to 2989)

The status related to the data logging function can be checked in this area.

Buffer memory name		Address	Description
Data logging setting information		Un\G2000 to 2003	The bit corresponding to the configured data logging setting turns ON.
Data logging execution information		Un\G2008 to 2011	The bit corresponding to the data logging setting that is executing logging turns ON.
Data logging error information		Un\G2012 to 2015	The bit corresponding to the data logging setting where a data logging error is occurring turns ON.
Number of saved files exceeded information		Un\G2016 to 2019	The information indicating the number of saved files is exceeding the set number of files is stored.
Data logging information 1	Error code	Un\G2030	An error code is stored in the area corresponding to the data logging setting where the data logging error is occurring. 0: Normal Other: Error code
	Number of newest folder	Un\G2031 to 2032	The number of latest folders is stored.
	Number of newest file	Un\G2033 to 2034	The number of latest files is stored.
	High speed sampling failure count	Un\G2035	The number of times that the module did not catch up with a high speed sampling is stored.
	Processing overload count	Un\G2036	The number of times that the data logging processing did not catch up with the data sampling is stored.
	Unprocessed buffer size	Un\G2037	The buffer size to temporarily accumulate sampled data is stored.
	Unprocessed data count (current)	Un\G2038	The current number of units of data accumulated in the unprocessed buffer is stored.
	Unprocessed data count (maximum)	Un\G2039	The maximum number of units of data accumulated in the unprocessed buffer is stored.
	Trigger detection count	Un\G2040	The number of trigger occurrences detected is stored.
	Trigger reoccurrence count	Un\G2041	The number of triggers that was ignored due to a trigger recurrence while outputting logging before and after a trigger is stored.
Data logging information 2 to 64		Un\G2045 to 2989	Details are the same as data logging information 1.

■Data logging setting information (Un\G2000 to 2003)

The setting status of a data logging setting is stored.

The bit corresponding to the configured data logging setting turns ON.

0: Unset

1: Set

	b15	b14	b13	b12	b11	b10	b9	b8	b7	b6	b5	b4	b3	b2	b1	b0
Un\G2000	16	15	14	13	12	11	10	9	8	7	6	5	4	3	2	1
Un\G2001	32	31	30	29	28	27	26	25	24	23	22	21	20	19	18	17
Un\G2002	48	47	46	45	44	43	42	41	40	39	38	37	36	35	34	33
Un\G2003	64	63	62	61	60	59	58	57	56	55	54	53	52	51	50	49

A

■Data logging execution information (Un\G2008 to 2011)

The information related to data logging execution status is stored.

The bit corresponding to the data logging setting that is executing logging turns ON.

0: Data logging is not executed

1: Data logging is executed

	b15	b14	b13	b12	b11	b10	b9	b8	b7	b6	b5	b4	b3	b2	b1	b0
Un\G2008	16	15	14	13	12	11	10	9	8	7	6	5	4	3	2	1
Un\G2009	32	31	30	29	28	27	26	25	24	23	22	21	20	19	18	17
Un\G2010	48	47	46	45	44	43	42	41	40	39	38	37	36	35	34	33
Un\G2011	64	63	62	61	60	59	58	57	56	55	54	53	52	51	50	49

The timing for data logging to be executed are as follows:

- When the logging type is "Continuous logging", the corresponding bit turns ON during logging (when a period is specified, during the set period).
- When the logging type is "Trigger logging", the corresponding bit turns ON from a trigger occurrence up to the completion of file output.

■Data logging error information (Un\G2012 to 2015)

The data logging error information is stored.

The bit corresponding to the data logging setting where a data logging error is occurring turns ON.

0: No data logging error

1: Data logging error

	b15	b14	b13	b12	b11	b10	b9	b8	b7	b6	b5	b4	b3	b2	b1	b0
Un\G2012	16	15	14	13	12	11	10	9	8	7	6	5	4	3	2	1
Un\G2013	32	31	30	29	28	27	26	25	24	23	22	21	20	19	18	17
Un\G2014	48	47	46	45	44	43	42	41	40	39	38	37	36	35	34	33
Un\G2015	64	63	62	61	60	59	58	57	56	55	54	53	52	51	50	49

Ex.

When an error occurs in logging execution of data logging setting No. 16

'Data logging error' (X12) turns ON.

The 15th bit of the data logging error information area (Un\G2012) turns ON.

The error code is stored in the 'error code' (Un\G2255) of data logging information 16.

Point

- For the cause of an error occurred, check an error code stored in the data logging information 1 to 64 (Un\G2030 to 2989). (Page 321 Data logging information 1 to 64 (Un\G2030 to 2989))
- If there are multiple data logging settings with a common access target CPU set for logging, and when an error related to the CPU occurs, only the corresponding bit of the setting number of data logging in which the error occurred at the first time may turn ON.

■Number of saved files exceeded information (Un\G2016 to 2019)

The information indicating the number of saved files is exceeding the set number of files is stored.

If the operation when the number of saved files exceeds the set number of files is set to "Stop", the system will show inability to create new files when creating a new file after the number of saved files reached the set number of files.

The bit corresponding to the data logging setting whose number of set files is exceeding turns ON.

0: Within setting range

1: Setting exceeded

	b15	b14	b13	b12	b11	b10	b9	b8	b7	b6	b5	b4	b3	b2	b1	b0
Un\G2016	16	15	14	13	12	11	10	9	8	7	6	5	4	3	2	1
Un\G2017	32	31	30	29	28	27	26	25	24	23	22	21	20	19	18	17
Un\G2018	48	47	46	45	44	43	42	41	40	39	38	37	36	35	34	33
Un\G2019	64	63	62	61	60	59	58	57	56	55	54	53	52	51	50	49

To continue logging, delete old files or all files in the directory.

When the number of saved files is less than the set number of files, the corresponding bit turns OFF.

■ Data logging information 1 to 64 (Un\G2030 to 2989)

The information of the error which occurred in the data logging function is stored.

Data logging information area is comprised of 64 pieces of data logging information with the same data configuration.

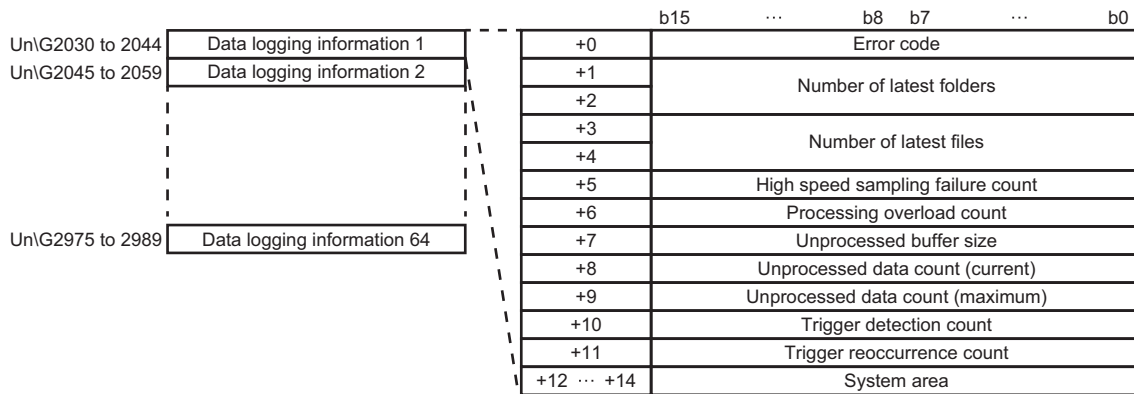

● Error code

An error code is stored in the area corresponding to the data logging setting where the data logging error is occurring.

When errors related to access target CPU occur, the error code of the access target CPU may be stored to other settings which also use the same access target CPU.

● Number of latest folders

The number of latest folders is stored.

● Number of latest files

The number of latest files is stored.

● High speed sampling failure count

When high speed sampling is selected in the sampling setting and when the data sampling speed cannot catch up with the timing of the sequence scan or specified time interval, the total number of times for which the data is lacking is stored.

When high speed sampling fails, the following cases occur.

- Data in the data logging file is lacking
- When a trigger logging is set, trigger establishments may not be detected
- When the data condition is selected in the period setting, the satisfaction of data conditions may not be detected
- Data to be displayed with GX LogViewer is lacking

Take corrective actions by referring to the following:

☞ Page 352 Checking sampling process time

● Processing overload count

When the data logging processing cannot catch up with the data sampling speed, the total number of times for which the data is lacking is stored.

When processing overload occurs, the following symptoms occur.

- Data in the data logging file is lacking
- When a trigger logging is set, trigger establishments may not be detected
- When the data condition is selected in the period setting, the satisfaction of data conditions may not be detected
- Data to be displayed with GX LogViewer is lacking

Take corrective actions by referring to the following:

☞ Page 352 Checking sampling process time

- Unprocessed buffer size

The size of the unprocessed buffer (internal memory), which temporarily accumulates sampled data from the CPU module, is stored. (If the size is 20, the buffer can accumulate 20 times worth of data sampling processing.)

The accumulated data are processed by the data logging processing. For details on the unprocessed buffer, refer to the following:

☞ Page 352 Checking sampling process time

- Unprocessed data count

The amount of data accumulated in the unprocessed data buffer is stored.

Current : The newest unprocessed data count is stored.

Maximum: The maximum value of the unprocessed data count is stored.

If the unprocessed data count reaches the unprocessed buffer size, processing overload count occurs during the next data sampling process. When the unprocessed data count tends to increase, processing overload count may occur from the elapsed time. Take corrective actions by referring to the following:

☞ Page 352 Checking sampling process time

- Trigger detection count

The number of trigger occurrences detected is stored.

The trigger reoccurrence count is not included.

- Trigger reoccurrence count

After a trigger occurs, the number of triggers that was ignored due to the recurrence of the trigger while sampling data for the number of lines after the trigger is stored.

Take corrective actions by referring to the following:

☞ Page 352 Checking sampling process time

For operation when triggers continuously occur, refer to the following:

☞ Page 30 Trigger logging function

Event logging status area (Un\G3000 to 3989)

The status related to the event logging function can be checked in this area.

Buffer memory name		Address	Description
Event logging setting information		Un\G3000 to 3003	The bit corresponding to the configured event logging setting turns ON.
Event logging error information		Un\G3008 to 3011	The bit corresponding to the event logging setting where an event logging error is occurring turns ON.
Number of saved files exceeded information		Un\G3012 to 3015	The information indicating the number of saved files is exceeding the set number of files is stored.
Event logging information 1	Error code	Un\G3030	An error code is stored in the area corresponding to the event logging setting where the event logging error is occurring. 0: Normal Other: Error code
	Number of newest folder	Un\G3031 to 3032	The number of latest folders is stored.
	Number of newest file	Un\G3033 to 3034	The number of latest files is stored.
	High speed sampling failure count	Un\G3035	The total number of times the buffer is full is stored.
	Processing overload count	Un\G3036	The number of times that the event logging processing did not catch up with the data sampling processing is stored.
	Unprocessed buffer size	Un\G3037	The buffer size to temporarily accumulate sampled data is stored.
	Unprocessed data count (current)	Un\G3038	The current number of units of data accumulated in the unprocessed buffer is stored.
	Unprocessed data count (maximum)	Un\G3039	The maximum number of units of data accumulated in the unprocessed buffer is stored.
Event logging information 2 to 64		Un\G3045 to 3989	Details are the same as event logging information 1.

■Event logging setting information (Un\G3000 to 3003)

The setting status of an event logging setting is stored.

The bit corresponding to the configured event logging setting turns ON.

0: Unset

1: Set

	b15	b14	b13	b12	b11	b10	b9	b8	b7	b6	b5	b4	b3	b2	b1	b0
Un\G3000	16	15	14	13	12	11	10	9	8	7	6	5	4	3	2	1
Un\G3001	32	31	30	29	28	27	26	25	24	23	22	21	20	19	18	17
Un\G3002	48	47	46	45	44	43	42	41	40	39	38	37	36	35	34	33
Un\G3003	64	63	62	61	60	59	58	57	56	55	54	53	52	51	50	49

■Event logging error information (Un\G3008 to 3011)

The event logging error information is stored.

The bit corresponding to the event logging setting where an event logging error is occurring turns ON.

0: No event logging error

1: Event logging error

	b15	b14	b13	b12	b11	b10	b9	b8	b7	b6	b5	b4	b3	b2	b1	b0
Un\G3008	16	15	14	13	12	11	10	9	8	7	6	5	4	3	2	1
Un\G3009	32	31	30	29	28	27	26	25	24	23	22	21	20	19	18	17
Un\G3010	48	47	46	45	44	43	42	41	40	39	38	37	36	35	34	33
Un\G3011	64	63	62	61	60	59	58	57	56	55	54	53	52	51	50	49

A

Point

- For the cause of an error occurred, check an error code stored in the event logging information 1 to 64 (Un\G3030 to 3989). (☞ Page 324 Event logging information 1 to 64 (Un\G3030 to 3989))
- If there are multiple event logging settings with a common access target CPU set for logging, and when an error related to the CPU occurs, only the corresponding bit of the setting number of event logging in which the error occurred at the first time may turn ON.

■Number of saved files exceeded information (Un\G3012 to 3015)

The information indicating the number of saved files is exceeding the set number of files is stored.

If the operation when the number of saved files exceeds the set number of files is set to "Stop", the system will show inability to create new files when creating a new file after the number of saved files reached the set number of files.

The bit corresponding to the event logging setting whose number of saved files is exceeding turns ON.

0: Within setting range

1: Setting exceeded

	b15	b14	b13	b12	b11	b10	b9	b8	b7	b6	b5	b4	b3	b2	b1	b0
Un\G3012	16	15	14	13	12	11	10	9	8	7	6	5	4	3	2	1
Un\G3013	32	31	30	29	28	27	26	25	24	23	22	21	20	19	18	17
Un\G3014	48	47	46	45	44	43	42	41	40	39	38	37	36	35	34	33
Un\G3015	64	63	62	61	60	59	58	57	56	55	54	53	52	51	50	49

To continue logging, delete old files or all files in the directory.

When the number of saved files is less than the set number of files, the corresponding bit turns OFF.

■Event logging information 1 to 64 (Un\G3030 to 3989)

Information about the error which occurred in the event logging function is stored.

Event logging information area is comprised of 64 pieces of event logging information with the same data configuration.

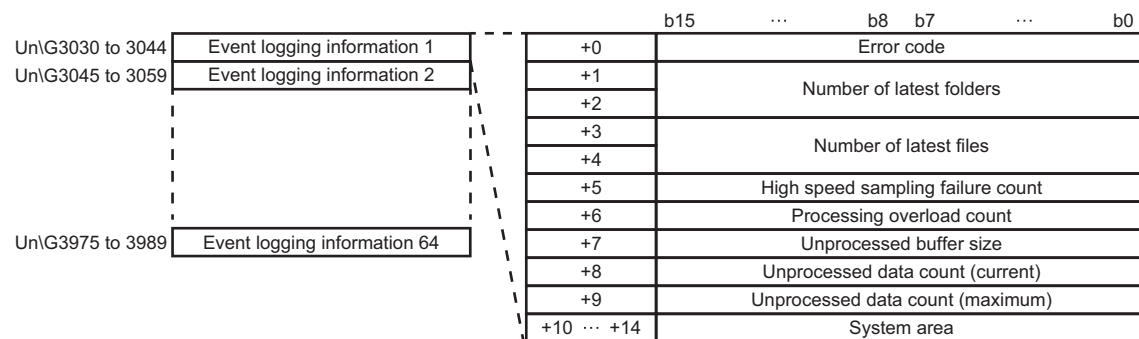

● Error code

An error code is stored in the area corresponding to the event logging setting where the event logging error is occurring.

When errors related to access target CPU occur, the error code of the access target CPU may be stored to other settings which also use the same access target CPU.

● Number of latest folders

The number of latest folders is stored.

● Number of latest files

The number of latest files is stored.

● High speed sampling failure count

When high speed sampling is selected in the sampling setting and when the data sampling speed cannot catch up with the timing of the sequence scan or specified time interval, the total number of times for which the data is lacking is stored.

When high speed sampling fails, the following cases occur.

- An event condition establishment may not be detected
- When the data condition is selected in the period setting, the satisfaction of data conditions may not be detected
- Data to be displayed with GX LogViewer is lacking

Take corrective actions by referring to the following:

☞ Page 352 Checking sampling process time

● Processing overload count

When the event logging processing cannot catch up with the data sampling speed, the total number of times for which the data is lacking is stored.

When processing overload occurs, the following symptoms occur.

- An event condition establishment may not be detected
- When the data condition is selected in the period setting, the satisfaction of data conditions may not be detected
- Data to be displayed with GX LogViewer is lacking

Take corrective actions by referring to the following:

☞ Page 352 Checking sampling process time

● Unprocessed buffer size

The size of the unprocessed buffer (internal memory), which temporarily accumulates sampled data from the CPU module, is stored. (If the size is 20, the buffer can accumulate 20 times worth of data sampling processing.)

The accumulated data are processed by the event logging processing. For details on the unprocessed buffer, refer to the following:

☞ Page 352 Checking sampling process time

● Unprocessed data count

The amount of data accumulated in the unprocessed data buffer is stored.

Current : The newest unprocessed data count is stored.

Maximum: The maximum value of the unprocessed data count is stored.

If the unprocessed data count reaches the unprocessed buffer size, processing overload count occurs during the next data sampling process. When the unprocessed data count tends to increase, processing overload count may occur from the elapsed time. Take corrective actions by referring to the following:

☞ Page 352 Checking sampling process time

Report creation status area (Un\G4000 to 4989)

The status related to the report creation function can be checked in this area.

Buffer memory name		Address	Description
Report setting information		Un\G4000 to 4003	The bit corresponding to the configured report setting turns ON.
Report creation execution information		Un\G4008 to 4011	The bit corresponding to the report setting that executes report creation turns ON.
Report creation error information		Un\G4012 to 4015	The bit corresponding to the report setting where an report creation error is occurring turns ON.
Number of saved files exceeded information		Un\G4016 to 4019	The information indicating the number of saved files is exceeding the set number of files is stored.
Report creation information 1	Error code	Un\G4030	An error code is stored in the area corresponding to the report setting where the report creation error is occurring. 0: Normal Other: Error code
	Number of newest folder	Un\G4031 to 4032	The number of latest folders is stored.
	Number of newest file	Un\G4033 to 4034	The number of latest files is stored.
	High speed sampling failure count	Un\G4035	The total number of times the buffer is full is stored.
	Processing overload count	Un\G4036	The number of times that the report creation processing did not catch up with the data sampling processing is stored.
	Unprocessed buffer size	Un\G4037	The buffer size to temporarily accumulate sampled data is stored.
	Unprocessed data count (current)	Un\G4038	The current number of units of data accumulated in the unprocessed buffer is stored.
	Unprocessed data count (maximum)	Un\G4039	The maximum number of units of data accumulated in the unprocessed buffer is stored.
	Creation trigger detection count	Un\G4040	The number of creation trigger occurrences detected is stored.
	Creation trigger reoccurrence count	Un\G4041	After a creation trigger, 'Creation trigger reoccurrence count' stores the number of creation triggers that occur again during report creation. (The number of creation triggers is not stored when "At the data logging file switching" is set in the conditions of the creation trigger.)
	Report creation time (newest)	Un\G4042	The time required to create the latest report is stored in seconds unit.
	Report creation time (maximum)	Un\G4043	The maximum value of time required to create a report is stored in seconds unit.
Report creation information 2 to 64		Un\G4045 to 4989	Details are the same as report creation information 1.

■ Report setting information (Un\G4000 to 4003)

The setting status of a report setting is stored.

The bit corresponding to the configured report setting turns ON.

0: Unset

1: Set

	b15	b14	b13	b12	b11	b10	b9	b8	b7	b6	b5	b4	b3	b2	b1	b0
Un\G4000	16	15	14	13	12	11	10	9	8	7	6	5	4	3	2	1
Un\G4001	32	31	30	29	28	27	26	25	24	23	22	21	20	19	18	17
Un\G4002	48	47	46	45	44	43	42	41	40	39	38	37	36	35	34	33
Un\G4003	64	63	62	61	60	59	58	57	56	55	54	53	52	51	50	49

■Report creation execution information (Un\G4008 to 4011)

Information related to the report creation execution status is stored.

The bit corresponding to the report setting that executes report creation turns ON.

0: Report creation is not executed

1: Report creation is executed

	b15	b14	b13	b12	b11	b10	b9	b8	b7	b6	b5	b4	b3	b2	b1	b0
Un\G4008	16	15	14	13	12	11	10	9	8	7	6	5	4	3	2	1
Un\G4009	32	31	30	29	28	27	26	25	24	23	22	21	20	19	18	17
Un\G4010	48	47	46	45	44	43	42	41	40	39	38	37	36	35	34	33
Un\G4011	64	63	62	61	60	59	58	57	56	55	54	53	52	51	50	49

The time required to create a report is as follows.

- After a creation trigger occurs, the corresponding bit turns ON from when the report creation is completed to the next monitoring cycle.

■Report creation error information (Un\G4012 to 4015)

The report creation error information is stored.

The bit corresponding to the report setting where an report creation error is occurring turns ON.

0: No report creation error

1: Report creation error

	b15	b14	b13	b12	b11	b10	b9	b8	b7	b6	b5	b4	b3	b2	b1	b0
Un\G4012	16	15	14	13	12	11	10	9	8	7	6	5	4	3	2	1
Un\G4013	32	31	30	29	28	27	26	25	24	23	22	21	20	19	18	17
Un\G4014	48	47	46	45	44	43	42	41	40	39	38	37	36	35	34	33
Un\G4015	64	63	62	61	60	59	58	57	56	55	54	53	52	51	50	49

Ex.

When an error occurs in the report creation execution of report setting No.16

'Report creation error' (X14) turns ON.

The 15th bit in the 'report creation error information area' (Un\G4012) turns ON.

The error code is stored in the 'error code' (Un\G4255) of report creation information 16.

A

Point

- For the cause of an error occurred, check an error code stored in the report creation information 1 to 64 (Un\G4030 to 4989). (☞ Page 328 Report creation information 1 to 64 (Un\G4030 to 4989))
- If there are multiple report settings with a common access target CPU set for logging, and when an error related to the CPU occurs, only the corresponding bit of the setting number of report in which the error occurred at the first time may turn ON.

■Number of saved files exceeded information (Un\G4016 to 4019)

The information indicating the number of saved files is exceeding the set number of files is stored.

If the operation when the number of saved files exceeds the set number of files is set to "Stop", the system will show inability to create new files when creating a new file after the number of saved files reached the set number of files.

The bit corresponding to the report setting whose number of saved files is exceeding turns ON.

0: Within setting range

1: Setting exceeded

	b15	b14	b13	b12	b11	b10	b9	b8	b7	b6	b5	b4	b3	b2	b1	b0
Un\G4016	16	15	14	13	12	11	10	9	8	7	6	5	4	3	2	1
Un\G4017	32	31	30	29	28	27	26	25	24	23	22	21	20	19	18	17
Un\G4018	48	47	46	45	44	43	42	41	40	39	38	37	36	35	34	33
Un\G4019	64	63	62	61	60	59	58	57	56	55	54	53	52	51	50	49

To continue logging, delete old files or all files in the directory.

When the number of saved files is less than the set number of files, the corresponding bit turns OFF.

■ Report creation information 1 to 64 (Un\G4030 to 4989)

Information about the error which occurred in the report creation function is stored.

Report creation information area is comprised of 64 pieces of report creation information with the same data configuration.

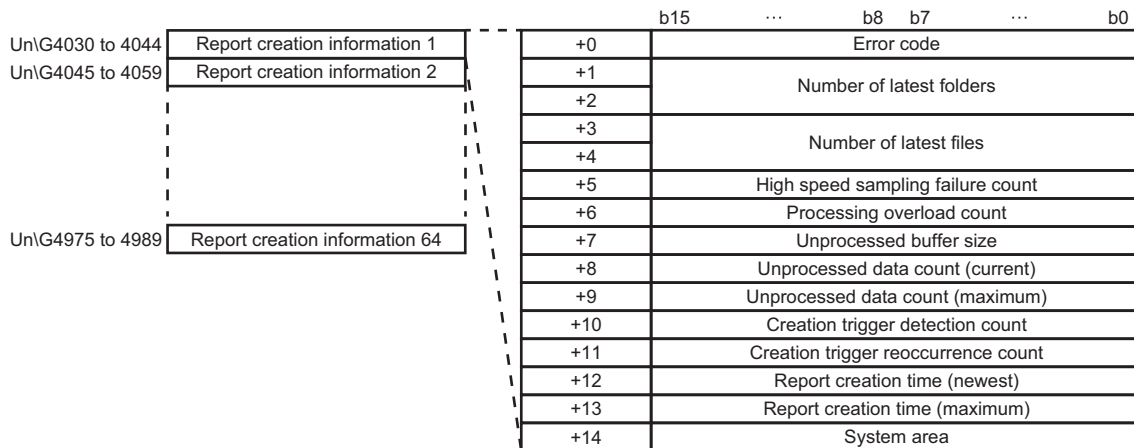

● Error code

An error code is stored in the area corresponding to the report setting where the report creation error is occurring.

When errors related to access target CPU occur, the error code of the access target CPU may be stored to other settings which also use the same access target CPU.

● Number of latest folders

The number of latest folders is stored.

● Number of latest files

The number of latest files is stored.

● High speed sampling failure count

When high speed sampling is selected in the sampling setting and when the data sampling speed cannot catch up with the timing of the sequence scan or specified time interval, the total number of times for which the data is lacking is stored.

When high speed sampling fails, the following cases occur.

- Creation trigger establishment may not be detected
- When the data condition is selected in the period setting, the satisfaction of data conditions may not be detected

Take corrective actions by referring to the following:

☞ Page 352 Checking sampling process time

● Processing overload count

When the report creation processing cannot catch up with the data sampling speed, the total number of times for which the data is lacking is stored.

When processing overload occurs, the following symptoms occur.

- Creation trigger establishment may not be detected
- When the data condition is selected in the period setting, the satisfaction of data conditions may not be detected

Take corrective actions by referring to the following:

☞ Page 352 Checking sampling process time

● Unprocessed buffer size

The size of the unprocessed buffer (internal memory), which temporarily accumulates sampled data from the CPU module, is stored. (If the size is 20, the buffer can accumulate 20 times worth of data sampling processing.)

The accumulated data is processed by the report creation processing. For details on the unprocessed buffer, refer to the following:

☞ Page 352 Checking sampling process time

● Unprocessed data count

The amount of data accumulated in the unprocessed data buffer is stored.

Current : The newest unprocessed data count is stored.

Maximum: The maximum value of the unprocessed data count is stored.

If the unprocessed data count reaches the unprocessed buffer size, processing overload count occurs during the next data sampling process. When the unprocessed data count tends to increase, processing overload count may occur from the elapsed time. Take corrective actions by referring to the following:

☞ Page 352 Checking sampling process time

● Creation trigger detection count

The number of creation trigger occurrences detected is stored.

The creation trigger reoccurrence count is not included.

● Creation trigger reoccurrence count

After the creation trigger occurred, the number of creation triggers that was ignored due to the recurrence of the trigger during report creation is stored. (The number of creation triggers is not stored when "At the data logging file switching" is set to the creation trigger condition.)

Take corrective actions by referring to the following:

☞ Page 352 Checking sampling process time

For operation when the creation trigger continuously occurs, refer to the following:

☞ Page 75 Creation trigger function

● Report creation time

The time required to create a report is stored in seconds unit.

- Newest : The time required to create the newest report
- Maximum: The maximum value of time required to create a report up to the present

E-mail transmission status area (Un\G5000 to 5992)

The status related to the E-mail function can be checked in this area.

Buffer memory name	Address	Description	
Normally completed e-mail count	Un\G5002	The number of times all e-mail transmission is normally completed is stored.	
Attachment transmission count	Un\G5003	The number of times attached file of all e-mail is transmitted (normally completed) is stored.	
Abnormally completed e-mail count	Un\G5004	The number of times all e-mail transmission is abnormally completed is stored.	
Error log write count	Un\G5005	The total number of times an error log is registered in the error log area is stored.	
Error log write pointer	Un\G5006	The error log number where the latest error log is registered is stored. 0: No error 1 to 16: Error log number	
Error log 1	Error code	Un\G5007	The error code is stored.
	To	Un\G5008	The target e-mail address No. is stored.
	Subject	Un\G5009 to 5023	15 words of the Subject is stored in ASCII code.
	Date	Un\G5024	b0 to 7: Last two digits of the year b8 to 15: Month (January to December)
		Un\G5025	b0 to 7: Day (1 to 31) b8 to 15: Hour (00 to 23)
Un\G5026		b0 to 7: Minute (00 to 59) b8 to 15: Seconds (00 to 59)	
Un\G5027		b0 to 7: Day of the week (0: Sunday, 1: Monday, 2: Tuesday, 3: Wednesday, 4: Thursday, 5: Friday, 6: Saturday) b8 to 15: First two digits of the year	
Error log 2 to 16	Un\G5028 to 5342	Details are the same as error log 1.	
Transmission log write count	Un\G5343	The total number of times an transmission log is registered in the transmission log area is stored.	
Transmission log write pointer	Un\G5344	The transmission log number where the latest transmission log is registered is stored. 0: Not sent 1 to 32: Transmission log number	
Transmission log 1	To	Un\G5345	The target e-mail address No. is stored.
	Subject	Un\G5346 to 5360	15 words of the Subject is stored in ASCII code.
	Date	Un\G5361	b0 to 7: Last two digits of the year b8 to 15: Month (January to December)
		Un\G5362	b0 to 7: Day (1 to 31) b8 to 15: Hour (00 to 23)
		Un\G5363	b0 to 7: Minute (00 to 59) b8 to 15: Seconds (00 to 59)
Un\G5364		b0 to 7: Day of the week (0: Sunday, 1: Monday, 2: Tuesday, 3: Wednesday, 4: Thursday, 5: Friday, 6: Saturday) b8 to 15: First two digits of the year	
Transmission log 2 to 32	Un\G5365 to 5984	Details are the same as transmission log 1.	
Resend buffer size	Un\G5985 to 5986	In the optional setting of the e-mail setting, the value specified as a resend buffer size is stored as a double word (32-bit value). (unit: number of items)	
Buffering number (current value)	Un\G5987 to 5988	The number of buffered data (the number of resending e-mails) stored in the current e-mail resending buffer is stored as a double word (32-bit value). (unit: number of items)	
Buffering number (maximum value)	Un\G5989 to 5990	The maximum number of buffered data stored in the e-mail resending buffer up to the present is stored as a double word (32-bit value). (unit: number of items)	
Buffer usage rate (current value)	Un\G5991	The current e-mail resending buffer usage rate is stored as a word (16-bit value). (unit: %)	
Buffer usage rate (maximum value)	Un\G5992	The maximum value of the e-mail resending buffer usage rate up to the present is stored as a word (16-bit value). (unit: %)	

■Normally completed e-mail count (Un\G5002)

The total number of times the high speed data logger module transfers an e-mail to the mail server is stored.

■Attachment transmission count (Un\G5003)

The total number of times the high speed data logger module transmits an e-mail with an attached file is saved.

■Abnormally completed e-mail count (Un\G5004)

The total number of times of communication error which are returned when e-mail transmission is required to the mail server is stored.



About e-mail sending counts

- When e-mails are sent to all valid addresses: Transmission count is added up and stored in 'normally completed e-mail count' (Un\G5002).
- When e-mails are sent to some invalid addresses: Transmission count is added up and stored in 'abnormally completed e-mail count' (Un\G5004).
- When e-mails are sent to all invalid addresses: Transmission count is added up and stored in 'abnormally completed e-mail count' (Un\G5004).

However, depending on the mail server specifications, there may be situations where the transmission count is not added up to 'abnormally completed e-mail count' (Un\G5004) even if an e-mail is sent to an invalid address.

■Error log write count (Un\G5005)

The total number of times an error log is registered in the error log area is stored.

The error code is stored when 'E-mail transmission error' (X17) is ON.

■Error log write pointer (Un\G5006)

The error log number where the latest error log is registered is stored. (For example, when '16' is stored, it indicates that the latest error log is registered in the area of the error log '16'.)

0: No error (No registration of error log)

1 or more: The error log number where the latest error log is registered

When 17 or more errors occur, error logs are registered again from error log 1 area.

■Error log 1 to 16 (Un\G5007 to 5342)

The error log when e-mail transmission is abnormally completed is stored.

Error log area is comprised of 16 error logs with the same data configuration.

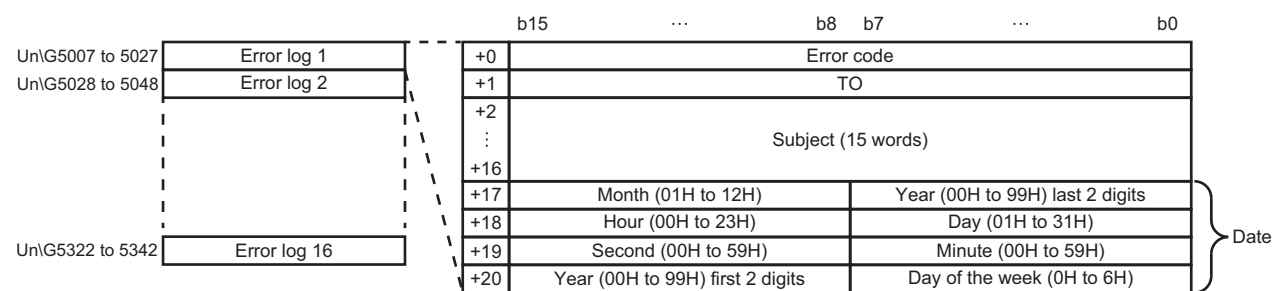

● Error code

The error code is stored.

● To

The target e-mail address No. of the email where an error occurs on the communication with the mail server is stored.

The target e-mail address No. is set in the "Target e-mail address setting" in the e-mail setting.

● Subject

15 words from the beginning of the Subject in an e-mail is stored.

● Date

The time when an e-mail is sent is stored in BCD code.



■Transmission log write count (Un\G5343)

The total number of times an transmission log is registered in the transmission log area is stored.

The transmission log when the high seed data logger module transmits an e-mail to the mail server normally is stored.

■Transmission log write pointer (Un\G5344)

The transmission log No. where the latest transmission log is registered is stored. (For example, when the pointer value is '16', it indicates that the latest transmission log is registered in the area of the transmission log '16'.)

0: Not sent (Not registered in transmission log)

1 or more: The transmission log No. where the latest transmission log is registered

When 33 or more transmission logs occur, transmission logs are registered again from transmission log 1 area.

■Transmission log 1 to 32 (Un\G5345 to 5984)

The transmission log when e-mail transmission is normally completed is stored.

Transmission log area is comprised of 32 transmission logs with the same data configuration.

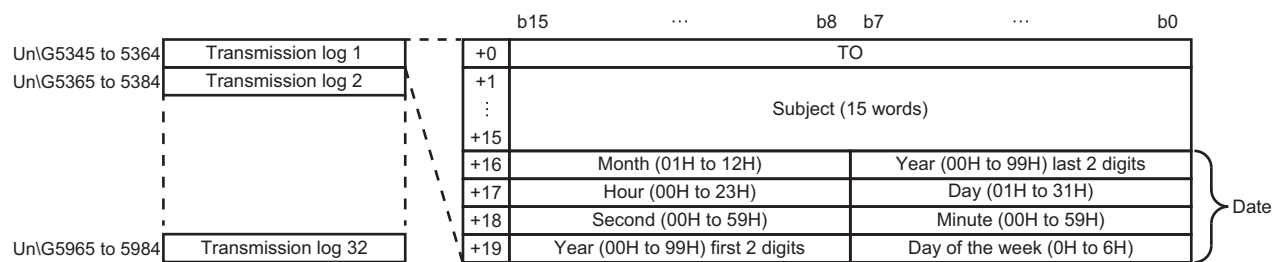

● To

The target e-mail address No. of the e-mail transmitted normally is stored.

The target e-mail address No. is set in the "Target e-mail address setting" in the e-mail setting.

● Subject

15 words from the beginning of the Subject in an e-mail is stored.

● Date

The time when an e-mail is sent is stored in BCD code.

FTP server status area (Un\G6000 to 6001)

The status related to the FTP server function can be checked in this area.

Buffer memory name	Address	Description
Login success count	Un\G6000	The total number of times login to a FTP server is succeeded is stored.
Login failure count	Un\G6001	The total number of times login to a FTP server is failed is stored.

File transfer status area (Un\G6002 to 7457)

The result of file transfers to a file server can be checked in this area.

Buffer memory name		Address	Description
Normally completed file transfer count		Un\G6004	The number of times all file transfer is normally completed is stored.
Abnormally completed file transfer count		Un\G6005	The number of times all file transfer is abnormally completed is stored.
Transfer result 1	Normally completed count	Un\G6006	The number of times transfer is normally completed in the file transfer destination setting No.1 is stored.
	Abnormally completed count	Un\G6007	The number of times transfer is abnormally completed in the file transfer destination setting No.1 is stored.
Transfer result 2 to 16		Un\G6008 to 6037	Details are the same as transfer result 1.
Error log write count		Un\G6038	The total number of times an error log is registered in the error log area is stored.
Error log write pointer		Un\G6039	The error log number where the latest error log is registered is stored. 0: No error 1 to 16: Error log number
Error log 1	Error code	Un\G6040	The error code is stored.
	Destination	Un\G6041	The file transfer destination setting No. is stored.
	File name	Un\G6042 to 6065	24 words of the Subject is stored in ASCII code.
	Date	Un\G6066	b0 to 7: Last two digits of the year b8 to 15: Month (January to December)
		Un\G6067	b0 to 7: Day (1 to 31) b8 to 15: Hour (00 to 23)
		Un\G6068	b0 to 7: Minute (00 to 59) b8 to 15: Seconds (00 to 59)
Un\G6069		b0 to 7: Day of the week (0: Sunday, 1: Monday, 2: Tuesday, 3: Wednesday, 4: Thursday, 5: Friday, 6: Saturday) b8 to 15: First two digits of the year	
Error log 2 to 16		Un\G6070 to 6519	Details are the same as error log 1.
Transfer log write count		Un\G6520	The total number of times an transfer log is registered in the transfer log area is stored.
Transfer log write pointer		Un\G6521	The transfer log number where the latest transfer log is registered is stored. 0: No transfers 1 to 32: Transfer log number
Transfer log 1	Destination	Un\G6522	The file transfer destination setting No. is stored.
	File name	Un\G6523 to 6546	24 words of the Subject is stored in ASCII code.
	Date	Un\G6547	b0 to 7: Last two digits of the year b8 to 15: Month (January to December)
		Un\G6548	b0 to 7: Day (1 to 31) b8 to 15: Hour (00 to 23)
		Un\G6549	b0 to 7: Minute (00 to 59) b8 to 15: Seconds (00 to 59)
		Un\G6550	b0 to 7: Day of the week (0: Sunday, 1: Monday, 2: Tuesday, 3: Wednesday, 4: Thursday, 5: Friday, 6: Saturday) b8 to 15: First two digits of the year
Transfer log 2 to 32		Un\G6551 to 7449	Details are the same as transfer log 1.
Resend buffer size		Un\G7450 to 7451	The value specified to the resend buffer size in the option settings of the file transfer setting is stored as a double words (32-bit value). (unit: number of items)
Buffering number (current value)		Un\G7452 to 7453	The number of buffered data stored in the current file resending buffer is stored as a double word (32-bit value). (unit: number of items)
Buffering number (maximum value)		Un\G7454 to 7455	The maximum number of buffered data stored in the file resending buffer up to the present is stored as a double word (32-bit value). (unit: number of items)
Buffer usage rate (current value)		Un\G7456	The current file resending buffer usage rate is stored as a word (16-bit value). (unit: %)
Buffer usage rate (maximum value)		Un\G7457	The maximum value of the file resending buffer usage rate up to the present is stored as a word (16-bit value). (unit: %)

■ Normally completed file transfer count (Un\G6004)

The total number of times the high speed data logger module transfers an file to the file server is saved.

■ Abnormally completed file transfer count (Un\G6005)

The total number of times of communication error which are returned when the high speed data logger module requests the file server to transfer an file is stored.

■ Transfer result 1 to 16 (Un\G6006 to 6037)

The total number of transfer results is stored for each transfer destination setting number.

Transfer result area is comprised of 16 pieces of transfer results with the same data configuration.

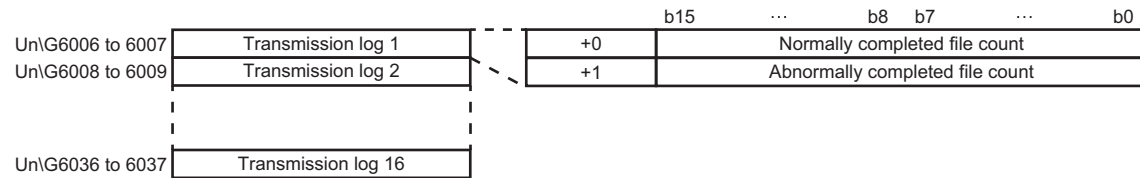

● Normally completed file transfer count

The number of times transfer is normally completed in the transfer destination setting is stored.

● Abnormally completed file transfer count

The number of times transfer is abnormally completed in the transfer destination setting is stored.

■ Error log write count (Un\G6038)

The total number of times an error log is registered in the error log area is stored.

The error code is stored when 'file transfer error' (X18) is ON.

■ Error log write pointer (Un\G6039)

The error log No. where the latest error log is registered is stored. (For example, when the pointer value is '16', it indicates that the latest error log is registered in the area of the error log '16'.)

0: No error (No registration of error log)

1 or more: The error log No. where the latest error log is registered

When 17 or more error logs occur, the error logs are registered again from error log 1 area.

■ Error log 1 to 16 (Un\G6040 to 6519)

The error log when file transfer is abnormally completed is stored.

Error log area is comprised of 16 error logs with the same data configuration.

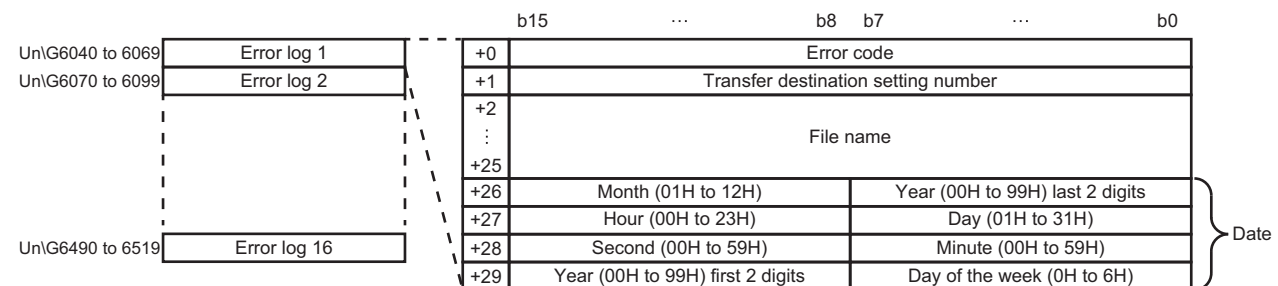

● Error code

The error code is stored.

● Transfer destination setting number

The transfer destination setting No. when communication error occurs is stored.

Transfer destination settings are set in the file transfer destination settings.

● File name

The file name is stored in ASCII code.

● Date

The time when the file was transferred is stored in BCD code.

■ Transfer log write count (Un\G6520)

The total number of times an transfer log is registered in the transfer log area is stored.

The transfer log when the high seed data logger module transfers a file to the file server normally is stored.

■ Transfer log write pointer (Un\G6521)

The transfer log No. where the latest transfer log is registered is stored. (For example, when the pointer value is '16', it indicates that the latest transfer log is registered in the area of the transfer log '16'.)

0: No transfers (Not registered in transfer log)

1 or more: The transfer log No. where the latest transfer log is registered

When 33 or more transfer logs occur, transfer logs are registered again from transfer log 1 area.

■ Transfer log 1 to 32 (Un\G6522 to 7449)

The transfer log when file transfer is normally completed is stored.

Transfer log area is comprised of 32 transfer logs with the same data configuration.

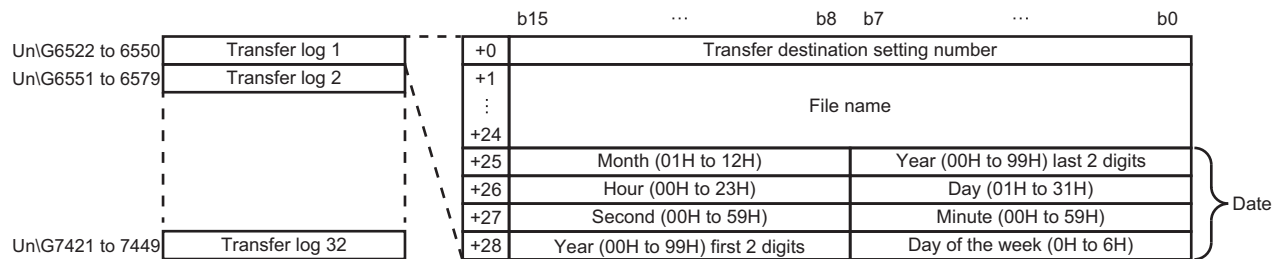

● Setting number

The transfer destination setting No. where file transfer is normally completed is stored.

Transfer destination settings are set in the file transfer destination settings.

● File name

The file name is stored in ASCII code.

● Date

The time when the file was transferred is stored in BCD code.



Firmware update history information (Un\G9000 to 9035)

The firmware update history of a high speed data logger module is stored in this area.

Name		Address	Description
Firmware update completion with/without an error		Un\G9000	The error occurrence state on the firmware update function is stored. <ul style="list-style-type: none"> • 0: Update completed without an error (including successful completion) • 1: Update completed with an error '1' is stored when a value of 'Firmware update result' (Un\G9020) is within 100 to 300H.
System area		Un\G9001 to 9009	Not used
Latest firmware update information	History information	Execution time (year)	Un\G9010 The value of the year (four digits) when the firmware update was executed is stored as a BIN code.
		Execution time (month)	Un\G9011 The value of the month when the firmware update was executed is stored as a BIN code.
		Execution time (day)	Un\G9012 The value of the day when the firmware update was executed is stored as a BIN code.
		Execution time (hour)	Un\G9013 The value of the hour when the firmware update was executed is stored as a BIN code.
		Execution time (minute)	Un\G9014 The value of the minutes when the firmware update was executed is stored as a BIN code.
		Execution time (second)	Un\G9015 The value of the seconds when the firmware update was executed is stored as a BIN code.
		Execution time (day of the week)	Un\G9016 The value of the day of the week when the firmware update was executed is stored as a BIN code. (0: Sunday, 1: Monday, 2: Tuesday, 3: Wednesday, 4: Thursday, 5: Friday, 6: Saturday)
		Firmware version after update	Un\G9017 The firmware version after update is stored. (When the update is completed with an error, '0' is stored.)
		Firmware version before update	Un\G9018 The firmware version before update is stored.
Latest firmware update result	Firmware update target	Un\G9019 The start input/output number of the module where the firmware update was executed is stored.	
	Firmware update result	Un\G9020 The execution result of the firmware update is stored. <ul style="list-style-type: none"> • 1H: Normal end • 100H: Flash ROM error • 200H: Model mismatched • 201H: File invalid • 203H: Firmware update prohibition state • 300H: Firmware data error 	
Previous firmware update information	History information	Execution time (year)	Un\G9021 The value of the year (four digits) when the firmware update was executed is stored as a BIN code.
		Execution time (month)	Un\G9022 The value of the month when the firmware update was executed is stored as a BIN code.
		Execution time (day)	Un\G9023 The value of the day when the firmware update was executed is stored as a BIN code.
		Execution time (hour)	Un\G9024 The value of the hour when the firmware update was executed is stored as a BIN code.
		Execution time (minute)	Un\G9025 The value of the minutes when the firmware update was executed is stored as a BIN code.
		Execution time (second)	Un\G9026 The value of the seconds when the firmware update was executed is stored as a BIN code.
		Execution time (day of the week)	Un\G9027 The value of the day of the week when the firmware update was executed is stored as a BIN code. (0: Sunday, 1: Monday, 2: Tuesday, 3: Wednesday, 4: Thursday, 5: Friday, 6: Saturday)
		Firmware version after update	Un\G9028 The firmware version after update is stored. (When the update is completed with an error, '0' is stored.)
		Firmware version before update	Un\G9029 The firmware version before update is stored.

Name		Address	Description
Previous firmware update result	Firmware update target	Un\G9030	The start input/output number of the module where the firmware update was executed is stored.
	Firmware update result	Un\G9031	The execution result of the firmware update is stored. <ul style="list-style-type: none"> • 1H: Normal end • 100H: Flash ROM error • 200H: Model mismatched • 201H: File invalid • 203H: Firmware update prohibition state • 300H: Firmware data error

Event logging area (Un\G10000 to 27407)

The status related to the event logging function can be checked in this area.

Buffer memory name		Address	Description
Event logging information 1	Event 1 occurrence count	Un\G10000	The total number of times an event occurs is stored.
	Event 2 to 256 occurrence count	Un\G10001 to 10255	Same as event 1 occurrence count.
Event logging information 2 to 64		Un\G10256 to 26383	Details are the same as event logging information 1.
Event logging status 1	Event logging occurring status	Un\G26384 to 26399	The occurrence/restoration status of an event is stored.
Event logging status 2 to 64		Un\G26400 to 27407	Details are the same as event logging status 1.

■Event logging information 1 to 64 (Un\G10000 to 26383)

The number of times an event occurs is stored.

Event logging information area is comprised of 64 pieces of event logging information with the same data configuration.

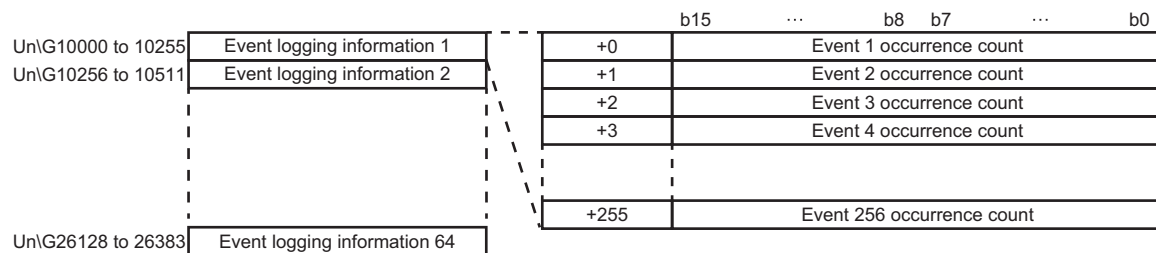

● Event occurrence count

The event occurrence count is counted up for every event occurrence.

■Event logging status 1 to 64 (Un\G26384 to 27407)

The occurrence/restoration status of an event is stored.

The bit corresponding to the event No. occurring turns ON.

If the monitoring condition is "Value change", "Number of times", or "Order", the bit is always OFF.

0: Event restored

1: Event occurred

Event logging status area is comprised of 64 pieces of event logging status with the same data configuration.

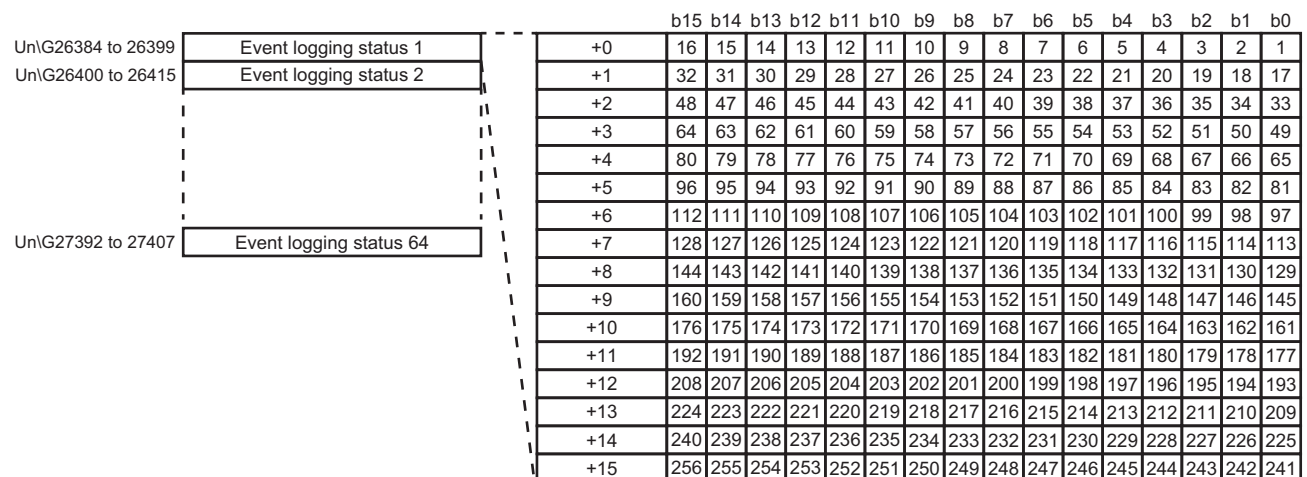

Number of times/Time information area (Un\G65536 to 327679)

The current values of number of times/time in the output value of trigger logging can be checked in this area.

Buffer memory name	Address	Description
Data logging 1 number of times/time information	Data 1 information Un\G65536 to 65539	The values of the current number of times and time are stored when the output value of Data 1 is number of times, total number of times, time and total time.
	Data 2 information to Data 1024 information Un\G65540 to 69631	Same as data 1 information
Data logging 2 to 64 number of times/time information	Un\G69632 to 327679	Details are the same as data logging 1 number of times/time information.

■ Data logging 1 to 64 number of times/time information (Un\G65536 to 327679)

The values of current number of times/time in the output value of trigger logging is stored.

Data logging number of times/time information area is comprised of 64 pieces of data logging number of times/time information with the same data configuration.

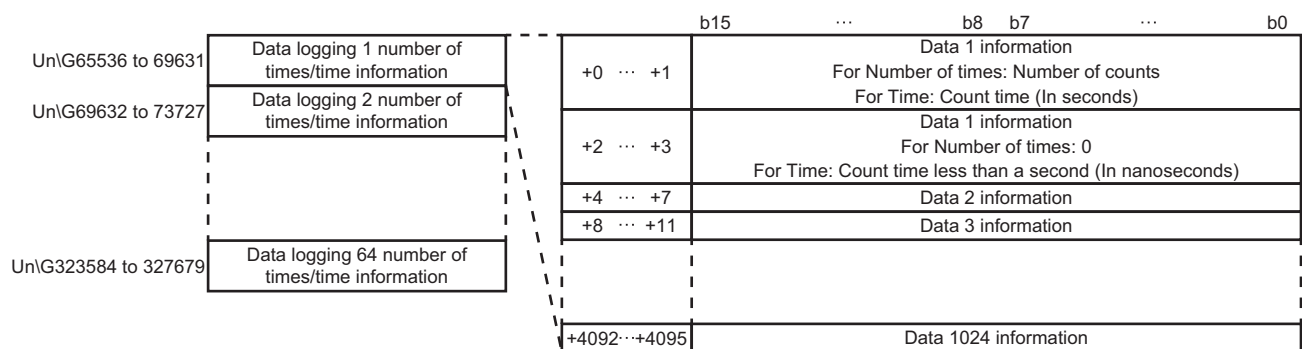

● Data information

The device value is incremented when the count condition of an output value is satisfied.

When the output value is the number of times or time, the data information value becomes 0 at the time that the trigger condition holds true.

When the output value is total number of times or total time, the data information value becomes the total count value.

When the total number of times/time is cleared on the "Data logging diagnostics" screen, the data information value becomes 0.

Appendix 4 Dedicated Instructions

Dedicated instruction is used to simplify programming when using the functions of an intelligent function module.

For details, refer to the following:

📖 MELSEC iQ-R Programming Manual (Module Dedicated Instructions)

Dedicated instruction list

Application	Dedicated instruction	Function overview
File access	RCPWRITE	Writes device values of the CPU module to the specified recipe file in the SD memory card.
	RCPREAD	Reads device values of the specified recipe file in the SD memory card to the CPU module.

Precautions

- Do not change data (control data, request data, etc.) designated by a dedicated instruction until the execution of that instruction is completed.
- When mounting a high speed data logger module to a process CPU (redundant mode), dedicated instructions cannot be used. If a dedicated instruction is used, "Operation error (redundant function)" occurs in the process CPU (redundant mode).

Appendix 5 Usable Characters

Usable characters on the setting screen

This section shows the characters which can be used in the setting items.

ASCII characters

The characters in the shaded area can be used. However, there are some exceptions as shown in the following section.

☞ Page 341 Exception list

The unusable characters cannot be entered in the entry field or an error occurs after entering them.

■ Usable ASCII characters list

	0	1	2	3	4	5	6	7
0	NUL		(SP)	0	@	P	'	p
1			!	1	A	Q	a	q
2			"	2	B	R	b	r
3			#	3	C	S	c	s
4			\$	4	D	T	d	t
5			%	5	E	U	e	u
6			&	6	F	V	f	v
7			'	7	G	W	g	w
8			(8	H	X	h	x
9)	9	I	Y	i	y
A			*	:	J	Z	j	z
B			+	;	K	[k	{
C			,	<	L	\	l	
D			-	=	M]	m	}
E			.	>	N	^	n	~
F			/	?	O	_	o	

■ Exception list

○: Usable, ×: Unusable

No. *1	Corresponding ASCII character																*4	
	(SP)*2	"	'*3	*	+	,	/	:	;	<	>	?	[\]			.
1	×	×	○	×	○	×	○	×	×	×	×	×	○	×	○	×	×	×
2	○	×	○	○	○	×	○	○	×	○	○	○	○	○	○	○	○	○
3	○	×	○	○	○	×	○	○	×	○	○	○	○	○	○	○	○	○*5
4	○	×	○	○	○	○	○	○	×	○	○	○	○	○	○	○	○	×
5	×	×	○	×	○	×	○	×	×	×	×	×	○	○	○	×	×	×
6	×	×	○	×	○	×	×	×	×	×	×	×	○	×	○	×	×	×
7	○	×	○	○	○	×	○	○	×	○	○	○	○	×	○	○	○	×
8	○	○	○	○	○	○*6	○	○	○	○	○	○	○	○	○	○*6	○	×
9	○	×	○	○	○	×	○	×	×	○	○	○	○	○	○	○*6	○	×
10	○	×	○	○	○	×	○	○	×	○	○	○	○	×	○	○	○	○
11	○	×	○	×	○	×	×	×	×	○	○	×	×	×	×	○	○	○
12	○	○	○	○	○	○	○	○	○	○	○	○	○	○	○	○	○	○
13	×	×	○	×	○	○	○	×	×	○	×	×	×	○	○	○	×	○

*1 For the exception corresponding to No., refer to the following:

☞ Page 342 Exception location list

*2 (SP) indicates a space.

*3 Cannot be used in the start/end of No. 11 (sheet name).

*4 Characters that can be represented in Unicode.

*5 The characters cannot be used for the E-mail subject and E-mail text in the "E-mail content setting" screen, and for the device comment and record comment in the "Recipe Editor" screen, or when the file format in the data logging setting or event logging setting is CSV file.

*6 Cannot be used in the "Account setting" and "Firmware update function prohibition operation" screens.

■Exception location list

No.	Exception location
1	<ul style="list-style-type: none"> • Directory [File browser]
2	<ul style="list-style-type: none"> • Trigger value [Event logging setting] • Restoration value [Event logging setting] • Host name [File transfer setting] • E-mail address [E-mail setting] • SMTP server name [E-mail setting] • POP server name [E-mail setting] • Following target device [Network setting] • Data name line string (Trigger information column) [Data logging setting] • Target device [Ping test] • Count value [Data logging setting]
3	<ul style="list-style-type: none"> • Access target CPU name [Access target CPU setting] • Destination group name [E-mail setting] • Data logging name [Data logging setting] • Event logging name [Event logging setting] • Report name [Report setting] • Data name [Data logging setting/Event logging setting/Report setting] • ON (Output format (bit)) [Data logging setting] • OFF (Output format (bit)) [Data logging setting] • When trigger condition rises (Trigger information column) [Data logging setting] • When trigger condition falls (Trigger information column) [Data logging setting] • Event name [Event logging setting] • Comment at event occurrence [Event logging setting] • Comment at event restoration [Event logging setting] • E-mail subject [E-mail content setting] • E-mail text [E-mail content setting] • Device comment [Recipe editor] • Record comment [Recipe editor]
4	<ul style="list-style-type: none"> • Data name line string (Date column) [Data logging setting/Event logging setting] • Data line output format (Date column) [Data logging setting/Event logging setting] • E-mail address [E-mail setting]
5	<ul style="list-style-type: none"> • Path (FTP server) [File transfer setting]
6	<ul style="list-style-type: none"> • Saved destination for the file [Data logging setting/Event logging setting/Report setting]
7	<ul style="list-style-type: none"> • Host name [Network setting]
8	<ul style="list-style-type: none"> • All passwords
9	<ul style="list-style-type: none"> • All user names
10	<ul style="list-style-type: none"> • Layout name (Data logging layout setting) [Report setting] • Layout name (Current value layout setting) [Report setting] • Layout name (Creation time layout setting) [Report setting] • Leading cell (Data logging layout setting) [Report setting] • Cell range (Current value layout setting) [Report setting] • Cell (Creation time layout setting) [Report setting]
11	<ul style="list-style-type: none"> • Sheet name [Report setting]
12	<ul style="list-style-type: none"> • Comment [Main screen] • Save folder path [GX Works3 project selection] • Comment line [Data logging setting/Event logging setting]
13	<ul style="list-style-type: none"> • Path (shared folder) [File transfer setting]

File name and folder (directory) name

The following shows the characters which can be used in the file name of a data logging file, recipe file, and folder (directory) name in the SD memory card.

The characters in the shaded area can be used.

	0	1	2	3	4	5	6	7
0	NUL		(SP)	0	@	P	'	p
1			!	1	A	Q	a	q
2			"	2	B	R	b	r
3			#	3	C	S	c	s
4			\$	4	D	T	d	t
5			%	5	E	U	e	u
6			&	6	F	V	f	v
7			'	7	G	W	g	w
8			(8	H	X	h	x
9)	9	I	Y	i	y
A			*	:	J	Z	j	z
B			+	;	K	[k	{
C			,	<	L	\	l	
D			-	=	M]	m	}
E			.	>	N	^	n	~
F			/	?	O	_	o	

Usable characters while outputting the file

The following shows the usable characters when the high speed data logger module outputs a file.

CSV file

The following shows the characters when the data type is character string in the CSV file.

The characters in the shaded area can be used.

	0	1	2	3	4	5	6	7
0	NUL		(SP)	0	@	P	'	p
1			!	1	A	Q	a	q
2			" *1	2	B	R	b	r
3			#	3	C	S	c	s
4			\$	4	D	T	d	t
5			%	5	E	U	e	u
6			&	6	F	V	f	v
7			'	7	G	W	g	w
8			(8	H	X	h	x
9)	9	I	Y	i	y
A			*	:	J	Z	j	z
B			+	; *1	K	[k	{
C			, *1	<	L	\	l	
D			-	=	M]	m	}
E			.	>	N	^	n	~
F			/	?	O	_	o	

*1 Whether to extend usable characters by enclosing data with double quotes (") or to replace them with a period (.) can be set when outputting a CSV file.

For a high speed data logger module the firmware version of which is '15' or earlier or High Speed Data Logger Module Configuration Tool the software version of which is '1.07H' or earlier, the setting to extend usable characters by enclosing data with double quotes (") when outputting a CSV file cannot be used. If a file is output, the specified characters will be replaced with a period (.).

For details on the settings, refer to the following:

 Page 165 CSV output, Page 189 CSV output

If outputting characters which cannot be used, the characters will be replaced with a period (.).

If a string terminator (0) is used halfway in the data, the data is output without replacing a string terminator (0) with a period (.), and the subsequent data is not output.

Unicode text files and XLS files

The characters in the Basic Multilingual Plane can be used when the data type is character string in Unicode text files and XLS files.

The characters other than Basic Multilingual Plane characters (U + 10000 to U+10FFFF) cannot be used.

Control character codes (U+0000 to U+001F, U+007F to U+00A0, U+00AD) and linefeed codes (U+2028, U+2029) cannot be used. If the file is output, these characters will be replaced with "." (period).

If a string terminator (0) is used halfway in the data, the data is output without replacing a string terminator (0) with a period (.), and the subsequent data is not output.

Appendix 6 Numerical Type Comparison Accuracy

When a numerical type (integer type and float type) data value and a constant are compared with a comparison operator ("=", "≠", "≤", "≥"), the fractional part of the data value is rounded off to the number of digits matched with the one for the comparison target constant.

A data value used for scaling is rounded off after the scaling.

Example) When a data value is: 11.23465673, and a comparison operator is: "≤"

■When a comparison target constant is: 11.23

The data value is rounded off to 11.23, and the condition ($11.23 \leq 11.23$) is established.

■When a comparison target constant is: 11.230

The data value is rounded off to 11.235, and the condition ($11.235 \leq 11.230$) is not established.

Appendix 7 Processing Time

Processing time

This section shows the measurement results for the processing time required for data logging.

Note that the processing time may be increased depending on any of the following factors.

- Sequence scan time
- Network speed and load status
- Target data value (for CSV files, output size varies according to value size.)
- Types of SD memory cards
- The number of files or file capacity in the SD memory card
- Access status from Configuration Tool, GX LogViewer, or FTP client software to a high speed data logger module
- Access status from the personal computer, HMI and other intelligent function module to the CPU module

Use the measurement results as a reference for processing time.

Trigger logging

■ High speed sampling

• Measurement conditions

Item		Description
Access target CPU	CPU module	R04CPU
	Network	Own station (single CPU system configuration)
	Sequence scan time	The sequence scan time that can be sampled is displayed in the measurement result.
Data logging setting	Logging type	Trigger logging
	Sampling	Data logging 01 to 32: High speed sampling (each scan)
	Data	D devices Data type: Word [signed] decimal format (digits: 0)
	Unicode text output	<ul style="list-style-type: none"> A date column is output. An index column is output.
	Binary output	<ul style="list-style-type: none"> Date information is output. An index is output.
	CSV output	<ul style="list-style-type: none"> A date column is output. An index column is output. A target character in the data line is replaced with a period (.).
	File	File switching timing: 1000 lines Number of saved files: 256
Data logging amount	Number of device points 16 to 1024: Data logging 01 Number of device points 4096: Data logging 01 to 04 Number of device points 8192: Data logging 01 to 08 Number of device points 16384: Data logging 01 to 16 Number of device points 32768: Data logging 01 to 32	
SD memory card	NZ1MEM-16GBSD	
Measuring method	Sampling speed	Data is sampled for each scan and the sequence scan time which can perform trigger logging is measured.
	File save time	The time taken from when data corresponding to the number of lines before and after trigger has been sampled up to when saving it to a file is completed is measured.

• Measurement results

Use the measurement results as a reference for processing time.

Processing time changes according to the settings and external factors such as access from GX LogViewer. (Page 346 Processing Time)

Item	Number of device points							
	16	64	256	1024	4096	8192	16384	32768
Sampling speed (milliseconds)	0.5	0.6	0.9	2	6	10	18	32
Trigger logging interval ^{*1} (seconds)	32.8	29.1	15.7	9.8	7.4	6.1	5.5	4.9
File save time ^{*2*} (seconds)	Unicode text file	0.7	0.8	1.2	3	11	25	220
	Binary file	0.5	0.5	0.6	1.6	8	21	120
	CSV file	0.6	0.7	0.7	2.5	10	23	150

*1 The maximum time before/after the trigger where data can be retained and output to a file when a trigger occurs.

*2 The time required to output 100 lines (records) of data before/after the trigger.

*3 If the file switching and folder switching have occurred, the file save time will be longer by one second.

■ General sampling

• Measurement conditions

Item		Description
Access target CPU	CPU module	R04CPU
	Network	Own station (single CPU system configuration)
	Sequence scan time	20 ms
Data logging setting	Logging type	Trigger logging
	Sampling	General sampling Sampling interval: The time when data can be sampled is displayed in the measurement result.
	Data	D devices Data type: Word [signed] decimal format (digits: 0)
	Unicode text output	<ul style="list-style-type: none"> • A date column is output. • An index column is output.
	Binary output	<ul style="list-style-type: none"> • Date information is output. • An index is output.
	CSV output	<ul style="list-style-type: none"> • A date column is output. • An index column is output. • A target character in the data line is replaced with a period (.).
	File	File switching timing: 1000 lines Number of saved files: 256
	Data logging amount	Number of device points 16 to 1024: Data logging 01 Number of device points 4096: Data logging 01 to 04 Number of device points 8192: Data logging 01 to 08 Number of device points 16384: Data logging 01 to 16 Number of device points 32768: Data logging 01 to 32 Number of device points 65536: Data logging 01 to 64
SD memory card		NZ1MEM-16GBSD
Measuring method	Sampling speed	The sampling interval that can perform trigger logging in the specified time is measured.
	File save time	The time taken from when data corresponding to the number of lines before and after trigger has been sampled up to when saving it to a file is completed is measured.

• Measurement results

Use the measurement results as a reference for processing time.

Processing time changes according to the settings and external factors such as access from GX LogViewer. (Page 346 Processing Time)

Item		Number of device points							
		16	64	256	1024	4096	16384	32768	65536
Sampling speed (seconds)		0.1	0.1	0.1	0.3	0.8	3	6	12
Trigger logging interval ^{*1} (seconds)		65535.5	4854.4	1747.5	1472.4	981.6	920.3	920.3	920.3
File save time ^{*2*3} (seconds)	Unicode text file	1.2	1.5	2.2	5	10	32	70	175
	Binary file	0.8	1	1.2	2.5	8.5	21	50	142
	CSV file	0.8	1.1	1.6	4	9	25	60	150

*1 The maximum time before/after the trigger where data can be retained and output to a file when a trigger occurs.

*2 When the number of device points is 16 to 32768: The time required to output 100 lines (records) of data before/after the trigger.
When the number of device points is 65536: The time required to output 75 lines (records) of data before/after the trigger.

*3 If the file switching and folder switching have occurred, the file save time will be longer by one second.

Continuous logging

■ High speed sampling

- Measurement conditions

Item		Description
Access target CPU	CPU module	R04CPU
	Network	Own station (single CPU system configuration)
	Sequence scan time	The sequence scan time that can be sampled is displayed in the measurement result.
Data logging setting	Logging type	Continuous logging
	Sampling	Data logging 01 to 32: High speed sampling (each scan)
	Data	D devices Data type: Word [signed] decimal format (digits: 0)
	Unicode text output	<ul style="list-style-type: none"> • A date column is output. • An index column is output.
	Binary output	<ul style="list-style-type: none"> • Date information is output. • An index is output.
	CSV output	<ul style="list-style-type: none"> • A date column is output. • An index column is output. • A target character in the data line is replaced with a period (.).
	Folder	<ul style="list-style-type: none"> ■ The number of data sampling device points exceeded 4096 Folder switching timing: Fixed cycle for 10 minutes
	File	File switching timing: 1000 lines Number of saved files: 256 <ul style="list-style-type: none"> ■ The number of data sampling device points exceeded 4096 Folder switching timing: Fixed cycle for 5 minutes Number of saved files: 2
Data logging amount	Number of device points 16 to 1024: Data logging 01 Number of device points 4096: Data logging 01 to 04 Number of device points 8192: Data logging 01 to 08 Number of device points 16384: Data logging 01 to 16 Number of device points 32768: Data logging 01 to 32	
SD memory card	NZ1MEM-16GBSD	
Measuring method	Data is sampled for each scan and the sequence scan time which can be continuously logged is measured.	

- Measurement results

Use the measurement results as a reference for processing time.

Processing time changes according to the settings and external factors such as access from GX LogViewer. (Page 346 Processing Time)

(unit: milliseconds)

File format	Number of device points							
	16	64	256	1024	4096	8192	16384	32768
Unicode text file	3	4	11	22	86	172	344	690
Binary file	2	2.5	3	4	15	30	70	220
CSV file	3	4	10	19	41	82	197	492

■ General sampling

• Measurement conditions

Item		Description
Access target CPU	CPU module	R04CPU
	Network	Own station (single CPU system configuration)
	Sequence scan time	20 ms
Data logging setting	Logging type	Continuous logging
	Sampling	General sampling Sampling interval: The time when data can be sampled is displayed in the measurement result.
	Data	D devices Data type: Word [signed] decimal format (digits: 0)
	Unicode text output	<ul style="list-style-type: none"> • A date column is output. • An index column is output.
	Binary output	<ul style="list-style-type: none"> • Date information is output. • An index is output.
	CSV output	<ul style="list-style-type: none"> • A date column is output. • An index column is output. • A target character in the data line is replaced with a period (.).
	Folder	<ul style="list-style-type: none"> ■ The number of data sampling device points exceeded 4096 Folder switching timing: Fixed cycle for 10 minutes
	File	File switching timing: 1000 lines Number of saved files: 256 <ul style="list-style-type: none"> ■ The number of data sampling device points exceeded 4096 Folder switching timing: Fixed cycle for 5 minutes Number of saved files: 2
Data logging amount	Number of device points 16 to 1024: Data logging 01 Number of device points 4096: Data logging 01 to 04 Number of device points 8192: Data logging 01 to 08 Number of device points 16384: Data logging 01 to 16 Number of device points 32768: Data logging 01 to 32 Number of device points 65536: Data logging 01 to 64	
SD memory card	NZ1MEM-16GBSD	
Measuring method	Data is sampled within the specified time and the data sampling interval which can be continuously logged is measured.	

• Measurement results

Use the measurement results as a reference for processing time.

Processing time changes according to the settings and external factors such as access from GX LogViewer. (Page 346

Processing Time)

(unit: seconds)

File format	Number of device points							
	16	64	256	1024	4096	16384	32768	65536
Unicode text file	0.1	0.1	0.1	0.3	0.8	3	6	12
Binary file	0.1	0.1	0.1	0.3	0.8	3	6	12
CSV file	0.1	0.1	0.1	0.3	0.8	3	6	12

Checking method for the processing time

The data logging, event logging, and report functions of a high speed data logger module are best effort functions. Since processing time of the high speed data logger module changes according to the settings and status of other devices, it may not operate with the set data sampling interval. Run the system by fully verifying the processing time of each function when constructing it.

The following figure shows the relationship of the processing from when the high speed data logger module samples the data from the CPU module up to when it outputs them to a file.

This section shows the check points for processing time related to the processing below.

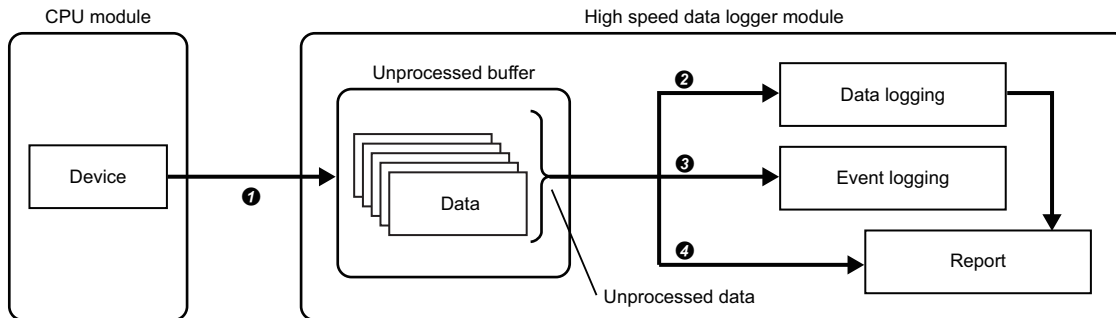

Processing	Description	Check point	Reference
① Sampling process	In the sampling process, data is sampled from the CPU module, and the sampled data is temporarily stored in the unprocessed buffer (internal memory of the module). The sampling process is performed in the specified data sampling interval or by synchronizing with the sequence scan, but it may not be able to operate in the specified data sampling interval depending on the amount of data, network speed, or sequence scan time conditions. (Data will be missed.)	Check if the processing to sample data from the CPU module is operating in the specified data sampling interval.	Page 352 Checking sampling process time
② Data logging process ^{*1}	Save the data stored in the unprocessed buffer to the data logging file. (If a trigger and period are set, determine if the conditions have been satisfied in advance.) When the data logging process is not in time compared to the data sampling process speed, a processing overload occurs and data are missed. (The conditions satisfaction may not be detected during the settings for Trigger and Period of time.)	Check if the sampled data are all being processed.	Page 353 Checking data logging process time
③ Event logging process ^{*1}	Determine if event conditions are satisfied by using the data stored in the unprocessed buffer. Save the events in the event logging file when the conditions are satisfied. When the event logging process is not in time compared with the data sampling process speed, a processing overload occurs and the event conditions satisfaction may not be detected.		Page 353 Checking event logging process time
④ Report process ^{*1}	Determine the creation trigger establishment by using the data stored in the unprocessed buffer. Data is output in the data logging file and the data (current value data) in the unprocessed buffer to an Excel file. When the report process is not in time compared to the data sampling process speed, a processing overload occurs and the creation trigger execution may not be detected.		Page 353 Checking report process time

*1 The data logging process, event logging process, and report process are performed in order. Therefore, if the load is high for any of the functions, it will affect the other function.



Checking sampling process time

Check if the processing to sample data from the CPU module is operating in the specified data sampling interval. Checking the I/O signals, and the processing method when a problem occurs are as follows:

For high speed sampling

I/O signal	Handling method when a problem occurs			
High Speed Sampling Failure' (X1A) ↓if ON Unable to sample data in the specified data sampling interval (each scan, time specification).	Change the settings such that the following conditions are satisfied.			
	<table border="1"> <tr> <td>Each sequence scan</td> <td>Change the number of settings in which the high speed sampling is specified, or set the constant scan to the CPU module. • Sequence scan time (milliseconds) > (0.5 × number of specified settings for high speed sampling + 2.0 × number of real time monitors*1)</td> </tr> <tr> <td>Time specification</td> <td>Change the number of the specified settings for high speed sampling, or set the sampling interval. • Sampling interval (milliseconds) > (0.5 × number of specified settings for high speed sampling + 2.0 × number of real time monitors*1)</td> </tr> </table>	Each sequence scan	Change the number of settings in which the high speed sampling is specified, or set the constant scan to the CPU module. • Sequence scan time (milliseconds) > (0.5 × number of specified settings for high speed sampling + 2.0 × number of real time monitors*1)	Time specification
Each sequence scan	Change the number of settings in which the high speed sampling is specified, or set the constant scan to the CPU module. • Sequence scan time (milliseconds) > (0.5 × number of specified settings for high speed sampling + 2.0 × number of real time monitors*1)			
Time specification	Change the number of the specified settings for high speed sampling, or set the sampling interval. • Sampling interval (milliseconds) > (0.5 × number of specified settings for high speed sampling + 2.0 × number of real time monitors*1)			

*1 Number of windows executing the real time monitor in GX LogViewer.

■Considerations

Data is sampled at the END processing of sequence scan.

Therefore, data sampling is delayed for the specified sampling interval. (In this case, 'High speed sampling failure' (X1A) does not turn ON.)

For general sampling

I/O signal	Handling method when a problem occurs
'General sampling delay occurrence' (X1E) ↓if ON A delay occurred compared to the specified data sampling interval.	Take any of the following actions. <ul style="list-style-type: none"> • Reduce the number of specified settings for general sampling. • Decrease the amount of sampled data. • Organize the data logging setting, event logging setting, and report setting per access target CPU. (When data from multiple access target CPUs is mixed in a single data logging, event logging, or report setting, sampling takes time.) • Mount a high speed logger module in the access target CPU station and execute high speed sampling.

■Considerations

If a delay within the allowed time for general sampling delay occurs, 'General sampling delay occurrence' (X1E) will not turn ON.

The initial value of the allowed general sampling delay time is half of the shortest sampling time among data logging, event logging, or report setting in which the general sampling is specified.

The allowed general sampling delay time can be changed in 'Allowed general sampling delay time' (Un\G804 to 805).

Checking data logging process time

Check if data, sampled with the data logging (continuous logging, trigger logging), can all be processed.

Checking the I/O signals, and the processing method when a problem occurs are as follows:

I/O signal	Processing method when a problem occurs
'Processing overload occurrence' (X1B) ↓if ON Check the processing overload count of 'data logging information 1 to 64' (Un\G2030 to 2989) ↓if not 0 The data logging processing (trigger judgment and file saving) cannot catch up with the sampling speed of the target data.	Take any of the following actions. <ul style="list-style-type: none"> • Decrease the amount of target data. • Lengthen the data sampling interval. • Save only the necessary data to the file. (Use the trigger logging function). • Stop access from GX LogViewer. • Adjust the system so that the next trigger does not immediately occur after a trigger. After taking the action, check that the processing overload count is 0 and the number of unprocessed data (current) does not increase with time.
'Trigger reoccurrence' (X1C) ↓if ON Check the trigger reoccurrence count of 'data logging information 1 to 64' (Un\G2030 to 2989) ↓if not 0 Not processed because the next trigger occurred immediately after a trigger.	Adjust the system so that the next trigger does not immediately occur after a trigger. For operation when triggers continuously occur, refer to the following: ☞ Page 30 Trigger logging function The period that the data is being saved in a file can be checked as per the 'Data logging execution information (Un\G2008 to 2011). For the time from when a trigger occurs up to when saving to the file is completed, refer to the following: ☞ Page 347 High speed sampling

Checking event logging process time

Check if the data, sampled with the event logging, can all be processed.

Checking the I/O signals, and the processing method when a problem occurs are as follows:

I/O signal	Processing method when a problem occurs
'Processing overload occurrence' (X1B) ↓if ON Check the processing overload count of 'event logging information 1 to 64' (Un\G3030 to 3989) ↓if not 0 The event logging processing (event judgment and file saving) cannot catch up with the sampling speed of the target data.	Take any of the following actions. <ul style="list-style-type: none"> • Decrease the number of events. • Lengthen the data sampling interval. • Lower the frequency of event occurrence. • Stop access from GX LogViewer. After taking the action, check that the processing overload count is 0 and the number of unprocessed data (current) does not increase with time.

Checking report process time

Check if the data, sampled with the report, can all be processed.

Checking the I/O signals, and the processing method when a problem occurs are as follows:

I/O signal	Processing method when a problem occurs
'Processing overload occurrence' (X1B) ↓if ON Check the processing overload count of 'report creation information 1 to 64' (Un\G4030 to 4989) ↓if not 0 The report processing (creation trigger judgment) cannot catch up with the sampling speed of the target data.	Take any of the following actions. <ul style="list-style-type: none"> • Decrease the number of reports. • Lengthen the data sampling interval. After taking the action, check that the processing overload count is 0 and the number of unprocessed data (current) does not increase with time.
'Creation trigger reoccurrence' (X1D) ↓if ON Check the trigger reoccurrence count of 'report creation information 1 to 64' (Un\G4030 to 4989) ↓if not 0 Not processed because the next creation trigger occurred immediately after a trigger.	Take any of the following actions. <ul style="list-style-type: none"> • Decrease the number of reports. • Lengthen the data sampling interval. • Adjust the system so that the next creation trigger does not immediately occur after a creation trigger. For operation when triggers continuously occur, refer to the following: ☞ Page 30 Trigger logging function

Influence on the sequence scan time

Using the data logging, event logging, or report function affects the sequence scan time of the access target CPU.

For high speed sampling

For the influence on the sequence scan time, refer to the following:

📖 MELSEC iQ-R CPU Module User's Manual (Application)

For general sampling

The service processing time of the access target CPU is affected.

Refer to the access target CPU user's manual.

Appendix 8 Supported FTP Command

The FTP commands that are supported by the FTP server function of a high speed data logger module are as follows:

FTP commands defined by RFC959

Command	Description
HELP	Help
USER	User name
PASS	Password
CWD	Change working directory
QUIT	Log out
PORT	Data port
PASV	Passive mode
TYPE	Transfer mode
RETR	Retrieve
DELE	Delete
RMD	Remove directory
PWD	Print working directory
LIST	File list
NLST	Name list
SYST	System information
STOR	Store

Windows standard FTP commands

Command	Description
binary	Notifies to transfer data without converting a file.
bye	Disconnects and terminates a connection with an FTP server.
close	Disconnects a connection with an FTP server.
delete	Deletes a file in a high speed data logger module.
dir	Displays the file information of a high speed data logger module.
get	Reads a file from a high speed data logger module.
ls	Displays the file name of a high speed data logger module.
mdir	Stores the file information of a high speed data logger module.
mls	Reads the list of directories and files from a high speed data logger module.
mput	Writes files to a high speed data logger module.
open	Connects an FTP server with a personal computer.
put	Writes files to a high speed data logger module.
pwd	Displays the current directory of a high speed data logger module.
quit	Disconnects and terminates a connection with an FTP server.
quote ^{*1}	Sends a sub command on an FTP server.
rename	Changes the file name of a high speed data logger module.
user	Enters the user name and password of a high speed data logger module.
append	Adds a file to an FTP server.
ascii	Sets the mode of file transfer to ASCII.
cd	Changes the working directory.
disconnect	Returns to a command line by disconnecting a connection with an FTP server.
literal ^{*1}	Sends a sub command on an FTP server.
recv	Acquires a file on an FTP server.
remotehelp	Displays the Help of an FTP command that can be executed on an FTP server.
rmdir	Deletes the directory of an FTP server.
send	Transfers a file to an FTP server.
type	Displays the current file transfer mode. (No FTP command transfer) By specifying a type name, the transfer mode is changed. (With FTP command transfer)

*1 These commands are supported, however, subcommands for high speed data logger modules are not provided.

Appendix 9 Data Logging File Format

This section explains the formats of a data logging file that is created by a high speed data logger module.

File version

File version is used to manage the change related to the data logging file format.

There are restrictions on the software version of GX LogViewer to the file version of a data logging file.

If GX LogViewer whose software version is not supported is used, it may not operate properly.

The following table shows the correspondence between the file version of a data logging file and the software version of GX LogViewer.

—: The file version is not changed

File version of a data logging file		Changed content	Software version of GX LogViewer	Remarks
Unicode text file/ CSV file	Binary file			
RD81DL96_1	1	First edition	'1.54G' or later	GX LogViewer supports MELSEC iQ-R series high speed data logger module (RD81DL96).
RD81DL96_2*1	—	Double quotes ("), comma (,), semicolon (;) are added for the usable characters.	Not supported*2	A data logging file whose file version is 'RD81DL96_2' is not supported by the historical trend function of GX LogViewer.*2

*1 For the conditions under which the file version is "RD81DL96_2," refer to the following:

☞ Page 360 File information line

*2 According to the upgrade of GX LogViewer, it may support the file version of the corresponding data logging file.

Unicode text file/CSV file

Format specification

Format specifications are as follows:

Item name	Description	
	Unicode text file	CSV file
Delimiter	Tab	Comma (,)
Linefeed code	CRLF (0x0D, 0x0A)	
Character code	Unicode	ASCII
Character encoding method	UTF-16 (little endian)	
Field data	Not enclosed in double quotes (").	<ul style="list-style-type: none"> Filed data is output according to the setting of "Field data" in the CSV output setting. (☞ Page 358 Outputs content of field data) Regardless of the above setting, a comma (,) can be included in "Date column" of the CSV output setting. In this case, a comma (,) is also included in the data type information line, data name line, and data line.
Number of lines	Maximum 100004 lines (data lines + 4)	
File size	Maximum 16777216 bytes The size can be specified within the range of (10 to 16384) × 1024 bytes.	

■Outputs content of field data

Field data is output as any of the following output contents:

Switching the output contents can be set in "Filed data" in the [CSV output] tab of the data logging setting.

☞ Page 165 CSV output

Field data output content	Details				
	Header line	Data line			
	Whole field data	Whole field data	Double quote (")	Comma (,)	Semicolon (;)
	(Enclose in double quotes (")/ Do not enclose in double quotes ("))		(Replace with a period (./) Do not replace with a period (./))		
Replace the target character* ¹ in the data line with a period	Do not enclose	Do not enclose	Replace	Replace	Replace
All header lines and data lines are enclosed in double quotation without replacing the target character* ¹	Enclose	Enclose	Do not replace* ²	Do not replace	Do not replace
All data lines are enclosed in double quotation without replacing the target character* ¹	Do not enclose	Enclose	Do not replace* ²	Do not replace	Do not replace
The data line is enclosed in double quotation without replacing the target character* ¹ when there is it	Do not enclose	Enclose* ³	Do not replace* ²	Do not replace	Do not replace

*1 Target character: double quote ("), comma (,), semicolon (;)

*2 An escape character (") is added just before a double quote(").

*3 Only field data including a double quote ("), comma (,), semicolon (;) is enclosed.

Precautions

When using a high speed data logger module or High Speed Data Logger Module Configuration Tool other than the following, the output contents of the field data is "Field data" is "Replace the target character in the data line with a period."

- A high speed data logger module the firmware version of which is '16' or later
- High Speed Data Logger Module Configuration Tool the software version of which is '1.08J' or later

Format overview

The format of Unicode text file is as follows.

For a CSV file, replace the delimiter of each item (\t) with a comma (,).

The date, index, and trigger information column (shaded portions) can be specified not to be output. If they are not output, the items are left aligned.

Date information should serially output from upper to lower in date column. (For example: Date should be output when specifying month and minutes.)

	File type	File version	Data type information line number	Data name line number	Data start line number	Comment line number			
Header	File information line	[LOGGING]	RD81DL96 _1	3	4	5	2	CR+LF	
	Comment line	Logging test						CR+LF	
	Data type information line	DATETIME	INDEX	SHORT [DEC.0]	FLOAT [EXP.3]	BIT[1,0]	TRIGGER	CR+LF
	Data name line	TIME	INDEX	DATA1	DATA2	DATA256	Trigger	CR+LF
Data	Start data line	2016/1/1 10:15:20	1	123	3.567	1	*	CR+LF
	Repeated data			CR+LF
	End data line	2016/1/1 14:27:00	100	97	1.987	0	-	CR+LF
	Date column	Index column	Data column	Data column	Data column	Trigger information column		



Item descriptions

■File information line

Column name	Output content	Size (bytes)		
		Unicode	CSV	
			"Field data" is "Replace the target character in the data line with a period"	"Field data" is other than the left* ¹
File type	Outputs '[LOGGING]'.	18	9	9 or 11
File version	Outputs the file version. When the file is a CSV file and "Field data" is "Replace the target character in the data line with a period," outputs "RD81DL96_1." ² For other cases, outputs "RD81DL96_2."	20	10	10 or 12
Data type information line number	The value indicating the line number of the data type information line is entered. ('3' in the format overview example)	2	1	1 or 3
Data name line number	The value indicating the line number of the data name line is entered. ('4' in the format overview example)	2	1	1 or 3
Data start line number	The value indicating the start line number of the data line is entered. ('5' in the format overview example)	2	1	1 or 3
Comment line number	The value indicating the line number of the comment line is entered. If do not output the comment line, the cell will be blank. ('2' in the format overview example)	0 to 2	0 to 1	0 or 3

*1 Size depends on the setting of the field data.

For the settings of the field data, refer to the following:

☞ Page 165 CSV output

*2 For the settings of the field data, refer to the following:

☞ Page 165 CSV output

The size of file information line can be calculated as shown below. For a CSV file, replace the number of tabs with the number of commas and divide the total size by 2.

When the output content of the field data is "All header lines and data lines are enclosed in double quotation without replacing the target character," add '12' for the size (2 [file type] + 2 [file version] + 2 [data type information line number]+ 2 [data name line number] + 2 [data start line number] + 2 [comment line number]).

Size of the file information line

$$\begin{aligned}
 &= 18 \text{ [file type]} + 20 \text{ [file version]} + 2 \text{ [data type information line number]} \\
 &+ 2 \text{ [data name line number]} + 2 \text{ [data start line number]} + 2 \text{ [comment line number]} \\
 &+ 10 \text{ [number of tabs]} + 4 \text{ [CR+LF]} \\
 &= 60 \text{ [bytes]}
 \end{aligned}$$

■ Comment line

Column name	Output content	Size (bytes)		
		Unicode	CSV	
			"Field data" is "Replace the target character in the data line with a period"	"Field data" is other than the left ^{*1}
Comment	Outputs comments configured in Configuration Tool. (Up to 256 characters can be output. If not configured, blank columns will be output.)	0 to 512	0 to 512	0 to 514

*1 Size depends on the setting of the field data.

For the settings of the field data, refer to the following:

☞ Page 165 CSV output

The size of comment line equals the character size (2 bytes per character) of the set comment + 4 [CR+LF].

(For a CSV file: Character size (1 byte per character) of the set comment + 2 [CR+LF])

When the output content of the field data is "All header lines and data lines are enclosed in double quotation without replacing the target character," add '2' for the size.

■Data type information line

Outputs in the format of (data type)[(additional information)].

- Data type

Column name	Output character	Output content	Size (bytes)		
			Unicode	CSV	
				"Field data" is "Replace the target character in the data line with a period"	"Field data" is other than the left* ¹
Date column	DATETIME	Outputs to the date column.	16	8	8 or 10
Index column	INDEX	Outputs to the index column.	10	5	5 or 7
Data column	BIT	Outputs when "Bit" is specified for the data type.	6	3	3 or 5
	SHORT	Outputs when "Word [Signed]" is specified for the data type.	10	5	5 or 7
	USHORT	Outputs when "Word [Unsigned]/Bit String [16-bit]" is specified for the data type.	12	6	6 or 8
	LONG	Outputs when "Double word [Signed]" is specified for the data type.	8	4	4 or 6
	ULONG	Outputs when "Double Word [Unsigned]/Bit String [32-bit]" is specified for the data type. Outputs when "Number of times" or "Total number of times" is specified in output value.	10	5	5 or 7
	FLOAT	Outputs when "FLOAT [Single Precision]" is specified for the data type.	10	5	5 or 7
	DOUBLE	Outputs when "FLOAT [Double Precision]" is specified for the data type. Outputs when "Number of times" or "Total number of times" is specified in output value.	12	6	6 or 8
	BCD16	Outputs when "16bit BCD" is specified for the data type.	10	5	5 or 7
	BCD32	Outputs when "32bit BCD" is specified for the data type.	10	5	5 or 7
	STRING	Outputs when "String" is specified for the data type.* ²	12	6	6 or 8
RAW	Outputs when "Raw" is specified for the data type.* ³	6	3	3 or 5	
Trigger information column	TRIGGER	Indicates the trigger information column.	14	7	7 or 9

*1 Size depends on the setting of the field data.

For the settings of the field data, refer to the following:

 Page 165 CSV output

*2 Among Unicode Basic Multilingual Plane, the control character codes of U+0000 to U+001F, U+007F to U+00A0, U+00AD and linefeed code of U+2028 and U+2029 are replaced with a period (.).

For CSV files, characters outside the ASCII range are replaced with a period (.). A double quote ("), comma (,), and semicolon (;) are output according to the setting of the field data.

For details on the output contents, refer to the following:

 Page 165 CSV output

However, the string terminator (0) cannot be replaced with a period (.).

*3 Hexadecimal representation is converted to a string by byte unit, and output it with the space removed.

(Example) For starting device D0, 4 bytes raw type

D0: 0x8A6B, D1:0x41C2 → "6B8AC241"

• Additional information

Column name	Output content		Size (bytes)		
			Unicode	CSV	
				"Field data" is "Replace the target character in the data line with a period"	"Field data" is other than the left*1
Date column	Outputs the data line output format specified in the Unicode text output setting/CSV output setting. (Example) [YYYY/MM/DD hh:mm:ss.s]		6 to 68	3 to 34	3 to 36
Index column	No additional information		0	0	0
Data column	[(String when ON);(String when OFF)]	Outputs when "Bit" is specified for the data type.	6 to 66	3 to 33	3 to 35
	[DEC.(digits)]	Outputs when "Decimal format" is specified for the output format. Outputs when other than "Value" is specified in output value using trigger logging.	14 to 16 (Depends on digits)	7 to 8 (Depends on digits)	7 to 10 (Depends on digits)
	[EXP.(digits)]	Outputs when "Exponential format" is specified for the output format.	14 to 16 (Depends on digits)	7 to 8 (Depends on digits)	7 to 10 (Depends on digits)
	[HEX.0]	Outputs when "Hexadecimal format" is specified for the output format.	14	7	7 or 9
	[Size]	Outputs the specified size when "String" or "Raw" is specified for the data type.	2 to 8 (Depends on size)	1 to 4 (Depends on size)	1 to 6 (Depends on size)
Trigger information column	[(Trigger ON string);(Trigger OFF string)]	Outputs the trigger ON string and trigger OFF string specified in the Unicode text output setting/CSV output setting.*2	10 to 134 (Depends on Unicode text output setting)	5 to 67 (Depends on CSV output setting)	5 to 69 (Depends on CSV output setting)

*1 Size depends on the setting of the field data.
For the settings of the field data, refer to the following:
 Page 165 CSV output

*2 Double quotes ("), commas (,), and semicolons (;) cannot be used in a trigger ON string/trigger OFF string.
The size of data type information line is calculated as shown below. For a CSV file, replace the number of tabs with the number of commas and divide the total size by 2.

When the output content of the field data is "All header lines and data lines are enclosed in double quotation without replacing the target character," add '516' for the size (2 [date column] + 2 [index column] + 2 × 256 [data column]).

When logging 256 points worth of signed 16-bit integer, decimal format 0 digit data
(Date column: YYYY/MM/DD hh:mm:ss.s, Index column: output)

Data type information line size
 = (16 + 46) [date column] + 10 [index column] + (10 + 14) × 256 [data column] + 514 [number of tabs] + 4 [CR+LF]
 = 6734 [bytes]



■Data name line

Column name	Output content	Size (bytes)		
		Unicode	CSV	
			"Field data" is "Replace the target character in the data line with a period"	"Field data" is other than the left ^{*1}
Date column	Outputs "Data name line string" specified in the Unicode text output setting/CSV output setting.	2 to 64 (Depends on Unicode text output setting)	1 to 32 (Depends on CSV output setting)	1 to 34 (Depends on CSV output setting)
Index column	Outputs 'INDEX'.	10	5	5 or 7
Data column	Outputs the "Data name" specified by the data setting.	2 to 64 (Depends on data setting)	1 to 32 (Depends on data setting)	1 to 34 (Depends on data setting)
Trigger information column	Outputs "Trigger information column" specified in Unicode text output/CSV output setting.	2 to 64 (Depends on Unicode text output setting)	1 to 32 (Depends on CSV output setting)	1 to 34 (Depends on CSV output setting)

*1 Size depends on the setting of the field data.

For the settings of the field data, refer to the following:

☞ Page 165 CSV output

The size of data name line is calculated as shown below. For a CSV file, replace the number of tabs with the number of commas and divide the total size by 2.

When the output content of the field data is "All header lines and data lines are enclosed in double quotation without replacing the target character," add '516' for the size (2 [date column] + 2 [index column] + 2 × 256 [data column]).

When logging 256 points worth of data with a name length of 10

(Date column: YYYY/MM/DD hh:mm:ss.s, Index column: output)

Data name line size

= 42 [date column] + 10 [index column] + 20 × 256 [data column] + 514 [number of tabs] + 4 [CR+LF]

= 5690 [bytes]

■Data line

Column name	Output content		Size (bytes)			
			Unicode	CSV		
				"Field data" is "Replace the target character in the data line with a period"	"Field data" is other than the left*1	
Date column	Outputs data according to the data line output format specified in the Unicode text output setting/CSV output setting.*2 (Example) 2016/1/15 10:15:20		2 to 64 (Depends on Unicode text output setting)	1 to 32 (Depends on CSV output setting)	1 to 34 (Depends on CSV output setting)	
Index column	Outputs a numerical value starting from 1 incremented in ascending order. When the value exceeds the upper limit of 4294967295, it is returned to 0 and increments again in the range of 0 to 4294967295. When missing sampling data occurs, the index will be renumbered from 1. ☞ Page 62 Data missing		2 to 20 (Depends on index value)	1 to 10 (Depends on index value)	1 to 12 (Depends on index value)	
Data column	Bit	When data is ON: (String when ON) When data is OFF: (String when OFF)	2 to 32 (Depends on data setting)	1 to 16 (Depends on data setting)	1 to 18 (Depends on data setting)	
	Word [Signed] Word [Unsigned]/Bit String [16-bit] 16bit BCD*3*4	Outputs data value according to the output format specified in the data setting.	Decimal format*5	2 to 42 (Depends on data value and digits)	1 to 21 (Depends on data value and digits)	1 to 23 (Depends on data value and digits)
			Exponential format	10 to 42 (Depends on data value and digits)	5 to 21 (Depends on data value and digits)	5 to 23 (Depends on data value and digits)
			Hexadecimal format	2 to 8 (Depends on data value)	1 to 4 (Depends on data value)	1 to 6 (Depends on data value)
	Double Word [Signed] Double Word [Unsigned]/Bit String [32-bit] FLOAT [Single Precision]*3*4 FLOAT [Double Precision]*3*4 32bit BCD*3*4 Number of times Time Total number of times Total time	Outputs data value according to the output format specified in the data setting.	Decimal format*5	2 to 52 (Depends on data value and digits)	1 to 26 (Depends on data value and digits)	1 to 28 (Depends on data value and digits)
			Exponential format	10 to 44 (Depends on data value and digits)	5 to 22 (Depends on data value and digits)	5 to 24 (Depends on data value and digits)
			Hexadecimal format	2 to 16 (Depends on data value)	1 to 8 (Depends on data value)	1 to 10 (Depends on data value)
String	Outputs a string of the specified size.*6	2 to 8192 (Depends on data value and size)	1 to 8192 (Depends on data value and size)	1 to 16386 (Depends on data value and size)		
Raw	Outputs the data values of the specified size in hexadecimal notation. (Example) When outputting raw type data, the size of which is 6 from D0 Device value: D0=1234, D1=5678, D2=9ABC Output: 34127856BC9A	4 to 32768 (Depends on size)	2 to 16384 (Depends on size)	2 to 16386 (Depends on size)		
Trigger information column	When trigger occurs: (Trigger ON string) When trigger clears: (Trigger OFF string) Does not output in other situations. (Outputs CR+LF immediately after the tab or comma.)		0 to 64 (Depends on Unicode text output setting)	0 to 32 (Depends on CSV output setting)	0 to 34 (Depends on CSV output setting)	

*1 Size depends on the field data setting and the data value.

For the settings of the field data, refer to the following:

☞ Page 165 CSV output

*2 When a file is opened in Excel, the date column format is displayed in the default setting of Excel.

Set the cell format as necessary.

(Example) To display year, month, date, hour, minute, second, and millisecond information

Specify the user defined display format as follows:

yyyy/mm/dd hh:mm:ss.000

- *3 If the device data value cannot be represented with the data type specified in "Data type", and the operation result cannot be represented with the specified data type, 'NaN' is output to the data line.
- *4 For arithmetic processing specified with scaling, all values are calculated as double precision floating point numbers, and the result is output in the specified output format.
If the result of the linear function transformation with the scaling function exceeds the double precision floating point type upper limit value, 'Inf' is output. If the value is lower than the lower limit value, '-Inf' is output.
- *5 When the numerical values to be output are outside the range of -2147483648.0 to 2147483647.0, they are expressed in a format same as 'exponential format and 9 digits in the decimal part'.
- *6 If a string terminator (0) is used halfway in the data, the data after it are not output.

The size of the data line (maximum) is calculated as shown below. For a CSV file, replace the number of tabs with the number of commas and divide the total size by 2.

When the output content of the field data is "All header lines and data lines are enclosed in double quotation without replacing the target character" or "All data lines are enclosed in double quotation without replacing the target character," add '516' for the size (2 [date column] + 2 [index column] + 2 × 256 [data column]).

When logging 256 points worth of word [unsigned]/bit string [16-bit] decimal format (0 digit) data

(Date column: YYYY/MM/DD hh:mm:ss.s, Index column: output)

Data line size

= 42 [date column] + 20 [index column] + 12 × 256 [data column] + 514 [number of tabs] + 4 [CR+LF]

= 3652 [bytes]

Binary file

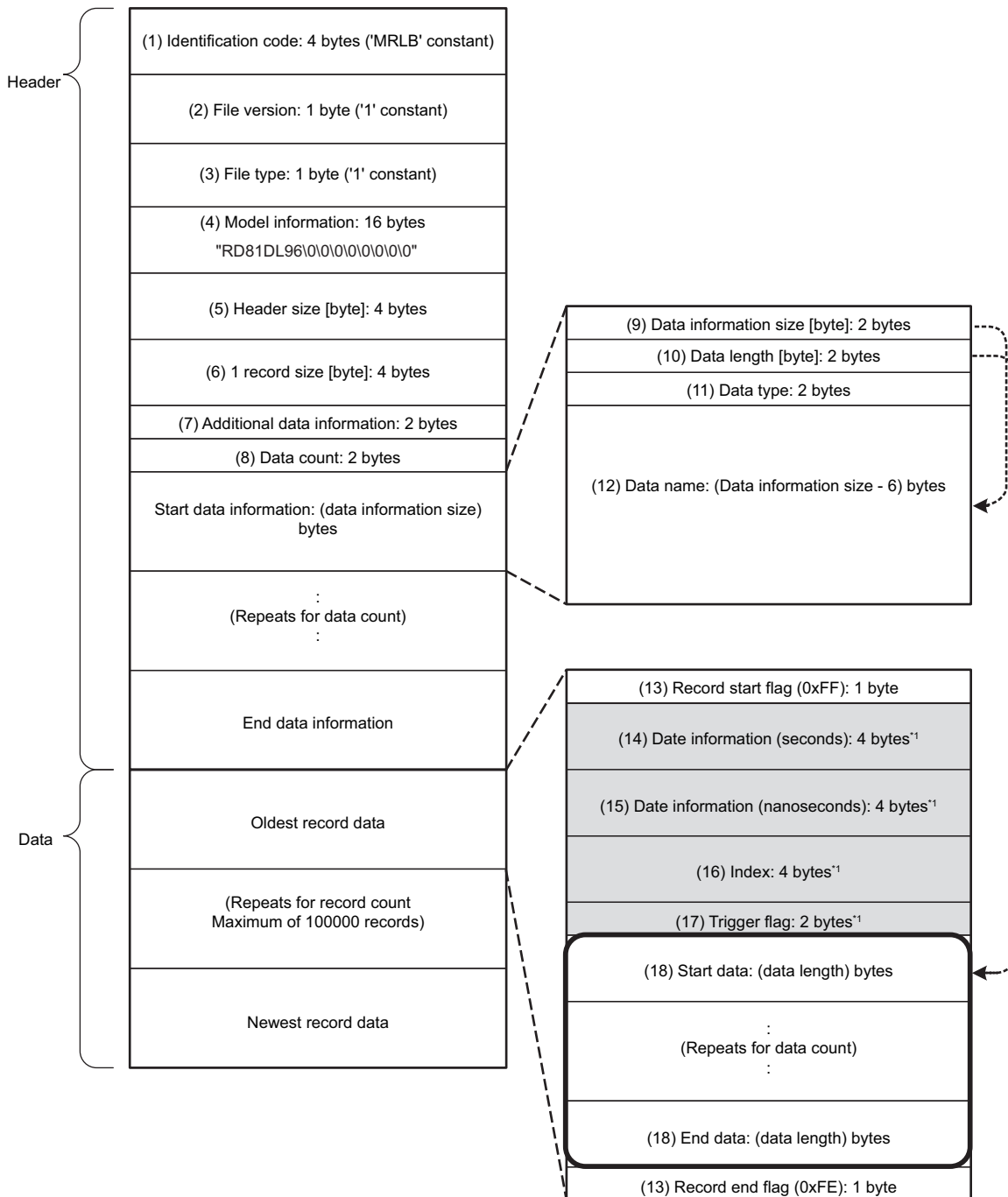

Format overview



*1 Data which can be selected to output

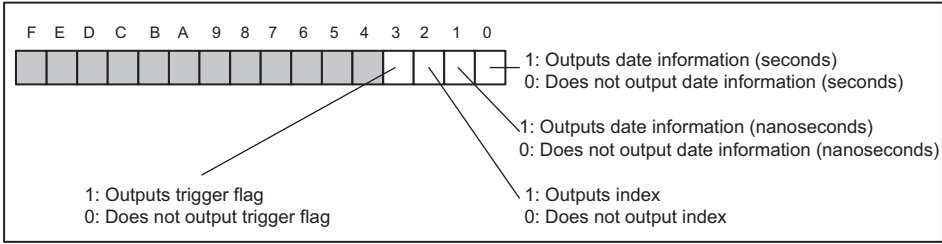

Item descriptions

Item	Description	Size (bytes)
(1) Identification code	Always outputs 'MRLB' for file identification.	4
(2) File version	Outputs '1' as the file version.	1
(3) File type	Outputs the file type. 1: Continuous logging/trigger logging 2: Event logging	1
(4) Model information	Outputs the module model name which output the binary file. Outputs 'RD81DL96' in the first 8 bytes, packed with 0x00 in the second 8 bytes.	16
(5) Header size	Outputs the size of a header part.	4
(6) 1 record size	Outputs the size of 1 record.	4
(7) Additional data information	Outputs the settings for the respective data which can be selected to output. 	2
(8) Number of pieces of data	Outputs the number of pieces of logging data configured in the logging setting.	2
(9) Data information size	Outputs the total size of the data information size (2 bytes) and each of the sizes of (10) data length, (11) data type, (12) data name per logging data.	2
(10) Data length	Outputs the data length of logging data. If the data type is bit type, outputs 1 byte.	2
(11) Data type	Outputs the following values according to the data type specified in output format. 0: Bit 1: Signed integer 2: Unsigned integer 3: Float 4: BCD 5: String 6: Raw ■When other than "Value" is specified in output value using trigger logging, the data type is as follows: • When "Number of times" or "Total number of times" is specified 2: Unsigned integer • When "Time" or "Total time" is specified 3: Float	2
(12) Data name	Outputs the logging data name specified in setting in Unicode.	2 to 64
(13) Record start flag	Outputs flags to identify the start and end of records.	1
(13) Record end flag	Outputs the following constant values according to the start/end of records. 0xFF: Record start 0xFE: Record end	1
(14) Date information (seconds)	Outputs the number of elapsed seconds from January 1st, 1970.	4
(15) Date information (nanoseconds) ¹	Outputs the remainder of time which is less than a second from the number of elapsed seconds from January 1st 1970 in nanoseconds.	4
(16) Index	Outputs a numerical value starting from 1 incremented in ascending order. When the value exceeds the upper limit of 4294967295, it is returned to 0 and increments again in the range of 0 to 4294967295. When missing sampling data occurs, the index will be renumbered from 1.  Page 62 Data missing	4
(17) Trigger flag	Outputs trigger information. 0: Not occurred 1: Occurred 2: Cleared	2

Item	Description	Size (bytes)	
(18) Data ^{*2}	—	Logging data are output in binary according to the data type specified with (10) data length and (11) output format. For details on the numerical range of output values, refer to the following: □□MELSEC iQ-R High Speed Data Logger Module User's Manual (Startup)	—
	Bit	Outputs the following values. When data is ON: 1 When data is OFF: 0	1
	Word [Signed] ^{*2} Word [Unsigned]/Bit String [16-bit] ^{*2} 16bit BCD	Outputs data value in word units.	2
	Double Word [Signed] ^{*2} Double Word [Unsigned]/Bit String [32-bit] ^{*2} FLOAT [Single Precision] ^{*3} 32bit BCD	Outputs data value in double word units.	4
	FLOAT [Double Precision] ^{*3}	Outputs data value in 4-word units.	8
	String	Outputs a string of the specified size. ^{*4}	1 to 8192
	Raw	Outputs data values of the specified size.	1 to 8192

*1 Data value is rounded to 0.1 millisecond unit when the high speed sampling is specified, and to 100 millisecond unit when the general sampling is specified.

*2 If a value which cannot be correctly expressed in the specified data type is stored in the device's data value, '0' is output.

*3 When the output format of device data value is '16bit BCD' or '32bit BCD', if a value which cannot be correctly represented in the BCD type is stored in the data value of a device, the NaN value will be output.

Output format	NaN
FLOAT [Single Precision]	0xffffffff
FLOAT [Double Precision]	0xfffffffffffffff

*4 If a string terminator (0) is used halfway in the data, NULL is output up to the specified size terminator for subsequent data. The size of the data logging binary file is calculated as shown below.

When logging 256 points worth of word [unsigned]/bit string [16-bit] decimal format (0 digit) data
(Data name length: 10, Date information: output in nanosecond units, Index column: output)

File size (maximum)

$$\begin{aligned}
&= 4 [\text{identification code}] + 1 [\text{file version}] + 1 [\text{file type}] + 16 [\text{model information}] + 4 [\text{header size}] \\
&+ 4 [1 \text{ record size}] + 2 [\text{additional data information}] + 2 [\text{number of pieces of data}] \\
&+ (2 [\text{data information size}] + 2 [\text{data length}] + 2 [\text{data type}] + 10 [\text{data name}]) \times 256 [\text{number of pieces of data}] \\
&+ 1 [\text{record start flag}] + 4 [\text{date information (seconds)}] + 4 [\text{date information (nanoseconds)}] + 4 [\text{index}] \\
&+ (2 [\text{data}] \times 256 [\text{number of pieces of data}]) + 1 [\text{record end flag}] \\
&= 4656 [\text{bytes}]
\end{aligned}$$



Appendix 10 Event Logging File Format

This section explains the formats of an event logging file that is created by the high speed data logger module.

File version

File version is used to manage the change related to the event logging file format.

There are restrictions on the software version of GX LogViewer to the file version of an event logging file.

If GX LogViewer whose software version is not supported is used, it may not operate properly.

The following table shows the correspondence between the file version of an event logging file and the software version of GX LogViewer.

—: The file version is not changed

File version of an event logging file		Changed content	Software version of GX LogViewer	Remarks
Unicode text file/ CSV file	Binary file			
RD81DL96_1	1	First edition	'1.54G' or later	GX LogViewer supports MELSEC iQ-R series high speed data logger module (RD81DL96).
RD81DL96_2*1	—	Double quotes ("), comma (,), semicolon (;) are added for the usable characters.	Not supported*2	An event logging file whose file version is 'RD81DL96_2' is not supported by the historical event function of GX LogViewer.*2

*1 For the conditions under which the file version is "RD81DL96_2," refer to the following:

 Page 373 File information line

*2 According to the upgrade of GX LogViewer, it may support the file version of the corresponding event logging file.

Unicode text file/CSV file

Format specification

Format specifications are as follows:

Item name	Description	
	Unicode text file	CSV file
Delimiter	Tab	Comma (,)
Linefeed code	CRLF (0x0D, 0x0A)	
Character code	Unicode	ASCII
Character encoding method	UTF-16 (little endian)	
Field data	Not enclosed in double quotes (").	<ul style="list-style-type: none"> Field data is output according to the setting of "Field data" in the CSV output setting. ( Page 371 Outputs content of field data) Regardless of the above setting, a comma (,) can be included in "Date column" of the CSV output setting. In this case, a comma (,) is also included in the data type information line, data name line, and data line.
Number of lines	Maximum 100004 lines (data lines + 4)	
File size	Maximum 16777216 bytes The size can be specified within the range of (10 to 16384) × 1024 bytes.	

■Outputs content of field data

Field data is output as any of the following output contents:

Switching the output contents can be set in "Filed data" in the [CSV output] tab of the event logging setting.

☞ Page 189 CSV output

Field data output content	Details				
	Header line	Data line			
	Whole field data	Whole field data	Double quote (")	Comma (,)	Semicolon (;)
	(Enclose in double quotes (")/ Do not enclose in double quotes ("))		(Replace with a period (./) Do not replace with a period (.)		
Replace the target character* ¹ in the data line with a period	Do not enclose	Do not enclose	Replace	Replace	Replace
All header lines and data lines are enclosed in double quotation without replacing the target character* ¹	Enclose	Enclose	Do not replace* ²	Do not replace	Do not replace
All data lines are enclosed in double quotation without replacing the target character* ¹	Do not enclose	Enclose	Do not replace* ²	Do not replace	Do not replace
The data line is enclosed in double quotation without replacing the target character* ¹ when there is it	Do not enclose	Enclose* ³	Do not replace* ²	Do not replace	Do not replace

*1 Target character: double quote ("), comma (,), semicolon (;)

*2 An escape character (") is added just before a double quote(").

*3 Only field data including a double quote ("), comma (,), semicolon (;) is enclosed.

Precautions

When using a high speed data logger module or High Speed Data Logger Module Configuration Tool other than the following, the output contents of the field data is "Field data" is "Replace the target character in the data line with a period."

- A high speed data logger module the firmware version of which is '16' or later
- High Speed Data Logger Module Configuration Tool the software version of which is '1.08J' or later

A

Format overview

The format of Unicode text file is as follows.

For a CSV file, replace the delimiter of each item (\t) with a comma (.).

Date information should serially output from upper to lower in date column. (For example: Date should be output when specifying month and minutes.)

	File type	File version	Data type information line number	Data name line number	Data start line number	Comment line number		
Header	File information line	[EVENT]	RD81DL96 _1	3	4	5	2	CR+LF
	Comment line	Event test						CR+LF
	Data type information line	DATETIME	SHORT [DEC.0]	STRING [32]	SHORT [DEC.0]	STRING [32]	STRING [16664]	CR+LF
	Data name line	TIME	NUMBER	EVENT	STATUS	COMMENT	VALUES	CR+LF
Data	Start data line	2016/1/1 10:15:20	0	RD81DL96 Start	1			CR+LF
	Repeated data		CR+LF
	End data line	2016/1/1 14:27:00	20	Temperature abnormality	1	Occurrence	D0=300	CR+LF
	Date column	Event number column	Event name column	Occurrence type column	Occurrence comment column	Monitoring data value column		

Item descriptions

■ File information line

Column name	Output content	Size (bytes)		
		Unicode	CSV	
			"Field data" is "Replace the target character in the data line with a period"	"Field data" is other than the left* ¹
File type	Outputs '[EVENT]'. [TAB]	14	7	7 or 9
File version	Outputs the file version. When the file is a CSV file and "Field data" is "Replace the target character in the data line with a period," outputs "RD81DL96_1." ² For other cases, outputs "RD81DL96_2."	20	10	10 or 12
Data type information line number	The value indicating the line number of the data type information line is entered. ('3' in the format overview example)	2	1	1 or 3
Data name line number	The value indicating the line number of the data name line is entered. ('4' in the format overview example)	2	1	1 or 3
Data start line number	The value indicating the start line number of the data line is entered. ('5' in the format overview example)	2	1	1 or 3
Comment line number	The value indicating the line number of the comment line is entered. If do not output the comment line, the cell will be blank.	0 to 2	0 to 1	1 or 3

*1 Size depends on the setting of the field data.

For the settings of the field data, refer to the following:

☞ Page 189 CSV output

*2 For the settings of the field data, refer to the following:

☞ Page 189 CSV output

The size of file information line can be calculated as shown below. For a CSV file, replace the number of tabs with the number of commas and divide the total size by 2.

When the output content of the field data is "All header lines and data lines are enclosed in double quotation without replacing the target character," add '12' for the size (2 [file type] + 2 [file version] + 2 [data type information line number] + 2 [data name line number] + 2 [data start line number] + 2 [comment line number]).

Size of the file information line

$$\begin{aligned}
 &= 14 \text{ [file type]} + 20 \text{ [file version]} + 2 \text{ [data type information line number]} \\
 &+ 2 \text{ [data name line number]} + 2 \text{ [data start line number]} + 2 \text{ [comment line number]} \\
 &+ 10 \text{ [number of tabs]} + 4 \text{ [CR+LF]} \\
 &= 56 \text{ [bytes]}
 \end{aligned}$$

■ Comment line

Column name	Output content	Size (bytes)		
		Unicode	CSV	
			"Field data" is "Replace the target character in the data line with a period"	"Field data" is other than the left ^{*1}
Comment	Outputs comments configured in Configuration Tool. (Up to 256 characters can be output. If not configured, blank columns will be output.)	0 to 512	0 to 512	0 to 514

*1 Size depends on the setting of the field data.

For the settings of the field data, refer to the following:

 Page 189 CSV output

The size of comment line equals the character size (2 bytes per character) of the set comment + 4 [CR+LF].

(For a CSV file: Character size (1 byte per character) of the set comment + 2 [CR+LF])

When the output content of the field data is "All header lines and data lines are enclosed in double quotation without replacing the target character," add '2' for the size.

■ Data type information line

Outputs in the format of (data type)[(additional information)].

- Data type

Column name	Output character	Output content	Size (bytes)		
			Unicode	CSV	
				"Field data" is "Replace the target character in the data line with a period"	"Field data" is other than the left* ¹
Date column	DATETIME	Outputs to the date column.	16	8	8 or 10
Event number column	SHORT	Indicates that the event number column is a word type.	10	5	5 or 7
Event name column	STRING	Indicates that the event name column is a string type.	12	6	6 or 8
Occurrence type column	SHORT	Indicates that the occurrence type column is a word type.	10	5	5 or 7
Occurrence comment column	STRING	Indicates that the occurrence comment column is a string type.	12	6	6 or 8
Monitoring data value column	STRING	Indicates that the monitoring data value column is a string type.	12	6	6 or 8

*1 Size depends on the setting of the field data.

For the settings of the field data, refer to the following:

☞ Page 189 CSV output

- Additional information

Column name	Output content	Size (bytes)		
		Unicode	CSV	
			"Field data" is "Replace the target character in the data line with a period"	"Field data" is other than the left* ²
Date column	Outputs the data line output format specified in the Unicode text output setting/CSV output setting. (Example) [YYYY/MM/DD hh:mm:ss.s]	6 to 68	3 to 34	3 to 36
Event number column	[DEC.0] (constant)	14	7	7 or 9
Event name column	[32] (constant)	8	4	4 or 6
Occurrence type column	[DEC.0] (constant)	14	7	7 or 9
Occurrence comment column	[32] (constant)	12	6	6 or 8
Monitoring data value column	[16664] (constant)	14	7	7 or 9

*2 Size depends on the setting of the field data.

For the settings of the field data, refer to the following:

☞ Page 189 CSV output

The size of data type information line is calculated as shown below. For a CSV file, replace the number of tabs with the number of commas and divide the total size by 2.

When the output content of the field data is "All header lines and data lines are enclosed in double quotation without replacing the target character," add '12' for the size (2 [data column] + 2 [event number column] + 2 [event name column] + 2 [occurrence type column] + 2 [occurrence comment column] + 2 [monitoring data value column]).

When the date column is "YYYY/MM/DD hh:mm:ss.s"

Data type information line size

$$= (16 + 46) \text{ [date column]} + (10 + 14) \text{ [event number column]} + (12 + 8) \text{ [event name column]} + (10 + 14) \text{ [occurrence type column]} + (12 + 12) \text{ [occurrence comment column]}$$

+ (12 + 14) [monitoring data value column] + 10 [number of tabs] + 4 [CR+LF]
= 194 [bytes]

■Data name line

Column name	Output content	Size (bytes)		
		Unicode	CSV	
			"Field data" is "Replace the target character in the data line with a period"	"Field data" is other than the left ^{*1}
Date column	Outputs "Data name line string" specified in the Unicode text output setting/CSV output setting.	2 to 64	1 to 32	1 to 34
Event number column	Outputs 'NUMBER'.	12	6	6 or 8
Event name column	Outputs 'EVENT'.	10	5	5 or 7
Occurrence type column	Outputs 'STATUS'.	12	6	6 or 8
Occurrence comment column	Outputs 'COMMENT'.	14	7	7 or 9
Monitoring data value column	Outputs 'VALUES'.	12	6	6 or 8

*1 Size depends on the setting of the field data.

For the settings of the field data, refer to the following:

 Page 189 CSV output

The size of data name line is calculated as shown below. For a CSV file, replace the number of tabs with the number of commas and divide the total size by 2.

When the output content of the field data is "All header lines and data lines are enclosed in double quotation without replacing the target character," add '12' for the size (2 [data column] + 2 [event number column] + 2 [event name column] + 2 [occurrence type column] + 2 [occurrence comment column] + 2 [monitoring data value column]).

When the date column is "TIME"

Data name line size

= 8 [date column] + 12 [event number column] + 10 [event name column] + 12 [occurrence type column]
 + 14 [occurrence comment column] + 12 [monitoring data value column] + 10 [number of tabs] + 4 [CR+LF]
 = 82 [bytes]

A

■ Data line

Column name	Output content	Size (bytes)		
		Unicode	CSV	
			"Field data" is "Replace the target character in the data line with a period"	"Field data" is other than the left ^{*1}
Date column	Outputs data according to the data line output format specified in the Unicode text output setting/CSV output setting. ^{*2} (Example) 2016/1/15 10:15:20	2 to 64 (Depends on Unicode text output setting)	1 to 32 (Depends on CSV output setting)	1 to 34 (Depends on CSV output setting)
Event number column	Outputs the number of the event 1 to 256 which occurred or was restored. If the event type is "At module startup", '0' is output.	2 to 6	1 to 3	1 to 5
Event name column	Outputs the name of the event which occurred or was restored. If the event type is "At module startup", 'RD81DL96 Start' is output.	2 to 64	1 to 32	1 to 34
Occurrence type column	Outputs the type of event which occurred or was restored. When occurred : '1' When restored : '0' If the event type is "At startup of module", '1' is output.	2	1	1 or 3
Occurrence comment column	Outputs the comment at event occurrence/comment at event restoration set in the "Event setting" screen. The content is not output when the event type is "At startup of module". (Outputs tab or comma immediately after the tab or comma.)	2 to 64	1 to 32	1 to 34
Monitoring data value column ^{*3*4*5}	The monitoring data value at occurrence/restoration is output in the following format. <ul style="list-style-type: none"> For a single condition '(Data name) = (Monitoring data value)' For a compound condition (comparison) '(Data name) = (Monitoring data value)^{*6} For a compound condition (number of times) 'Count = (Count value); (Data name) = (Monitoring data value)^{*7} For a compound condition (order) '(Completion information); (Data name) = (Monitoring data value)^{*7} Outputs any of the following data in the completion information. When normal pattern is detected: 'Complete' When abnormal pattern or timeout is detected: 'Phase=[condition location]' The condition number which detected the abnormal pattern or timeout is output to condition location. 1: 1st condition 2: 2nd condition 3: 3rd condition When the event type is "At module startup", nothing is output. (CR+LF is output immediately after the tab or a comma.)	0 to 33288	0 to 16644	0 to 33290

*1 Size depends on the field data setting and the data value.

For the settings of the field data, refer to the following:

 Page 189 CSV output

*2 When a file is opened in Excel, the date column format is displayed in the default setting of Excel.

Set the cell format as necessary.

(Example) To display year, month, date, hour, minute, second, and millisecond information

Specify the user defined display format as follows:

yyyy/mm/dd hh:mm:ss.000

*3 If the device data value specified with monitoring data cannot be represented with the type specified for "Data type", "NaN" is output in the data line.

*4 When the monitoring data value is string type data, among Unicode Basic Multilingual Plane, control character codes of U+0000 to U+001F, U+007F to U+00A0, U+00AD, and linefeed code of U+2028 and U+2029 are replaced with a period (.).

For CSV files, characters outside the ASCII range are replaced with a period (.). A double quote ("), comma (,), and semicolon (;) are output according to the setting of the field data.

For details on the output contents, refer to the following:

Page 189 CSV output

If a string terminator (0) is used halfway in the data, the data is output without replacing a string terminator (0) with a period (.), and the subsequent data is not output.

*5 The content is not output when the number of units of data is '0'.

*6 In the underlined part, the information of set amount of event condition is output delimited by a semicolon (;).

*7 In the underlined parts, the information of start condition, end condition, and count condition is output delimited by a semicolon (;).

The data line size is calculated as shown below. For a CSV file, replace the number of tabs with the number of commas, and divide the total size by 2.

When the output content of the field data is "All header lines and data lines are enclosed in double quotation without replacing the target character" or "All data lines are enclosed in double quotation without replacing the target character," add '12' for the size (2 [data column] + 2 [event number column] + 2 [event name column] + 2 [occurrence type column] + 2 [occurrence comment column] + 2 [monitoring data value column]).

For event logging of the word [unsigned]/bit string [16-bit] decimal format 0 digit data

(Date column: YYYY/MM/DD hh:mm:ss.s, event name length: 10, occurrence comment length: 4, monitoring data value column (single condition): "D12000 = -23456")

Data line size

= 42 [date column] + 4 [event number column] + 20 [event name column] + 2 [occurrence type column]

+ 8 [occurrence comment column] + 26 [monitoring data value column] + 10 [number of tabs] + 4 [CR+LF]

= 116 [bytes]

Binary file

Format overview

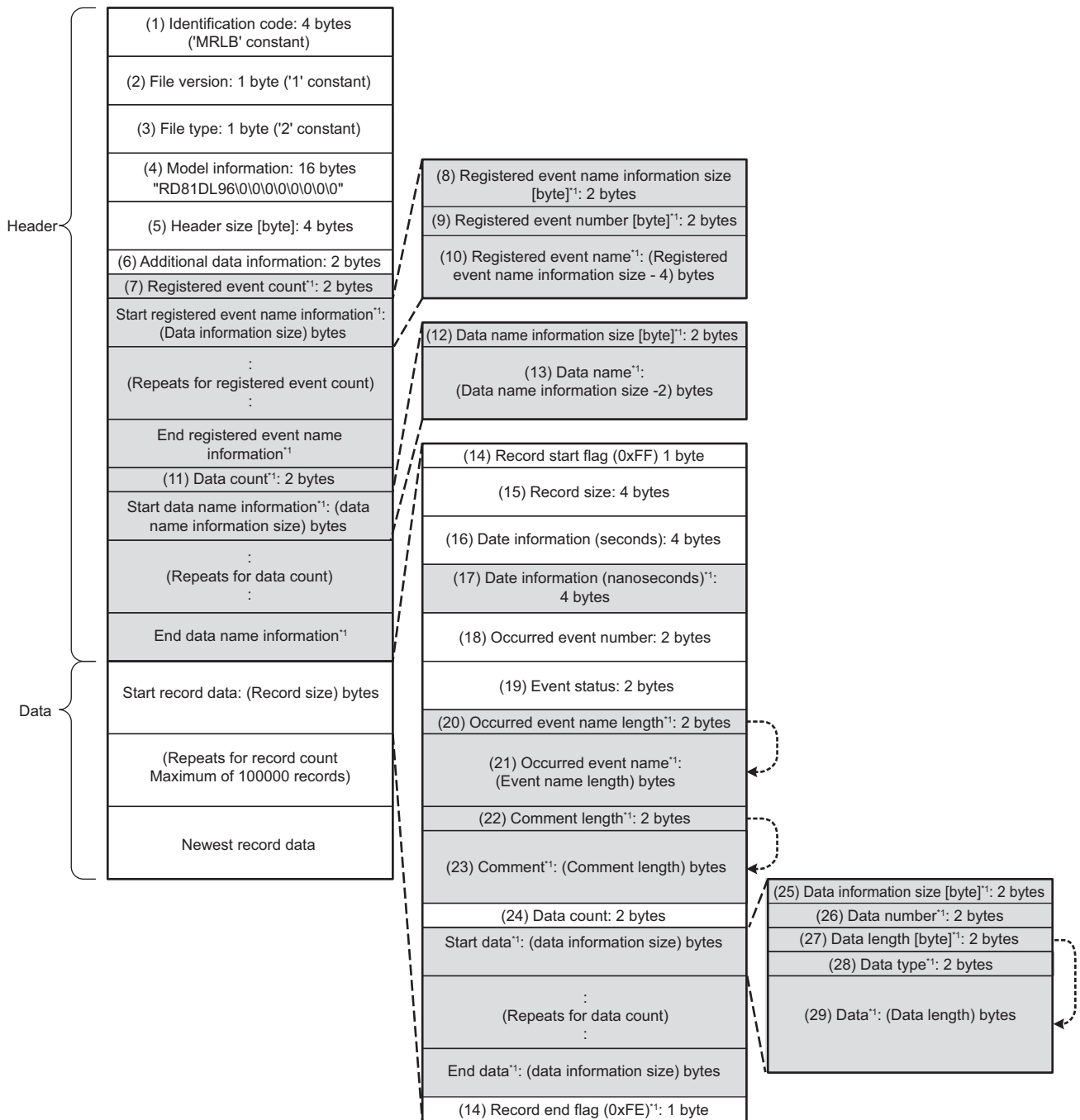

*1 Data which can be selected to output

Binary format details

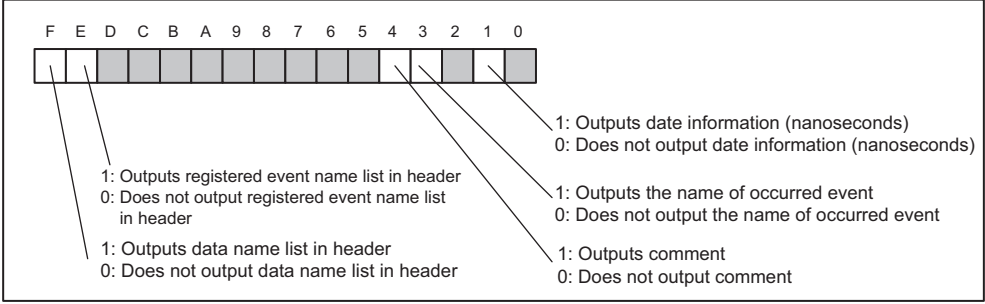
Item	Description	Size (bytes)
(1) Identification code	Always outputs 'MRLB' for file identification.	4
(2) File version	Outputs '1' as the file version.	1
(3) File type	Outputs the file type. 1: Continuous logging/trigger logging 2: Event logging	1
(4) Model information	Outputs the module model name which output the binary file. Outputs 'RD81DL96' in the first 8 bytes, packed with 0x00 in the second 8 bytes.	16
(5) Header size	Outputs the size of a header part.	4
(6) Additional data information	Outputs the settings for the respective data which can be selected to output. 	2
(7) Registered event count	Outputs the number of monitoring events registered in the settings.	2
(8) Registered event name information size	Outputs the size of information on event name including itself (2 bytes).	2
(9) Registered event number	Outputs the event number registered in the settings. Use when obtaining the event name that corresponds to (18) occurred event number for occurred/restored events.	2
(10) Registered event name	Outputs the event name registered by the setting in Unicode. Use when obtaining the event name that corresponds to occurred event number for occurred/restored events.	2 to 64
(11) Number of units of data	Outputs the number of pieces of monitoring data registered in all the event settings.	2
(12) Data name information size	Outputs the data name information size including itself (2 bytes). Use when obtaining the data name that corresponds to (26) data number for occurred/restored events.	2
(13) Data name	Outputs the data name registered by the setting in Unicode. Use when obtaining the data name that corresponds to (26) data number for occurred/restored events.	2 to 64
(14) Record start flag Record end flag	Outputs flags to identify the start and end of records. Outputs the following constant values according to the start/end of records. 0xFF: Record start 0xFE: Record end	1
(15) Record size	Outputs the record size including itself (4 bytes). Since (21) occurred event name, (23) comment, (29) data are output in variable lengths, outputs a different value per record.	4
(16) Date information (seconds)	Outputs the number of elapsed seconds from January 1st, 1970.	4
(17) Date information (nanoseconds)* 1	Outputs the remainder of time which is less than a second from the number of elapsed seconds from January 1st 1970 in nanoseconds.	4
(18) Occurred event number	Outputs the event number for the occurred/restored event. (When the high speed data logger module is restarted, outputs the event number as 0.)	2
(19) Event status	Outputs the following values according to occurrence/restoration. 1: Occurred 0: Restored (When the high speed data logger module is restarted, 1: Occurred is output.)	2

Item	Description	Size (bytes)
(20) Occurred event name length	Outputs the size (bytes) of the event name for the occurred/restored event.	2
(21) Occurred event name	Outputs the event name for occurred/restored events in Unicode. (When the high speed data logger module is restarted, an event name length of 0 is output.)	2 to 64
(22) Comment length	Outputs the size (bytes) of the comment at event occurrence/comment at event restoration for the occurred/restored event.	2
(23) Comment	Outputs the comment at event occurrence/comment at event restoration for the occurred/restored event in Unicode. (When the high speed data logger module is restarted, a comment name length of 0 is output.)	2 to 64
(24) Number of units of data	Outputs the number of pieces of data that the occurred/restored event is monitoring. (If "Output data value" is not specified in the settings, 0 is output.)	2
(25) Data information size	Outputs the total size of (26) data number, (27) data length, (28) data type, and (29) data.	2
(26) Data number	Outputs the data number for the occurred/restored event. By referring to (13) data name, the data name for the data number can be obtained. However, when compound conditions (number of times or order) are configured with event conditions, any of the following data is output. When the number of times is set : 0x1000 When order is set : 0x1001	2
(27) Data length	Outputs the data length of data. If the data type is bit type, outputs 1 byte. However, when compound conditions (number of times or order) are configured with event conditions, 2 is output.	2
(28) Data type	Outputs the following values according to the data type specified in the output format. 0: Bit 1: Signed integer 2: Unsigned integer 3: Float 4: BCD 5: String 6: Raw However, when compound conditions (number of times or order) are configured with event conditions, 2 is output.	2
(29) Data	Outputs monitoring data in binary format according to (27) Data length and (28) Data type. For details on the output data, refer to (18) in the following section.  Page 368 Item descriptions However, when compound conditions (number of times or order) are configured with event conditions, any of the following data is output. When the number of times is set : number of counts (up to 65535) When order is set : 1st condition: 1 2nd condition: 2 3rd condition: 3 Normal completion: 0	Data length

*1 Data value is rounded to 0.1 millisecond unit when the high speed sampling is specified, and to 100 millisecond unit when the general sampling is specified.

The size of the event logging binary file is calculated as shown below.

When monitoring the Word [unsigned]/Bit String [16-bit] decimal format 0 digit data with single condition
(Event name length: 10, data name length: 2, "Output the event names into record data": selected, "Output comment at event occurrence/comment at event restoration into record data": selected, comment length: 10, data length: 2)

File size (maximum)

$$\begin{aligned}
&= 4 [\text{identification code}] + 1 [\text{file version}] + 1 [\text{file type}] + 16 [\text{model information}] \\
&+ 4 [\text{header size}] + 2 [\text{additional data information}] + 2 [\text{registered event count}] \\
&+ (2 [\text{registered event name information size}] + 2 [\text{registered event number}] + 20 [\text{registered event name}]) \times 1 [\text{registered event count}] \\
&+ 2 [\text{data count}] + (2 [\text{data name information size}] + 4 [\text{data name}]) \times 1 [\text{data count}] \\
&+ 1 [\text{record start flag}] + 4 [\text{record size}] + 4 [\text{date information (seconds)}] \\
&+ 4 [\text{date information (nanoseconds)}] + 2 [\text{occurred event number}] + 2 [\text{event status}] + 2 [\text{occurred event name length}] \\
&+ 20 [\text{occurred event name}] + 2 [\text{comment length}] + 20 [\text{comment}] + 2 [\text{data count}] \\
&+ (2 [\text{data information size}] + 2 [\text{data number}] + 2 [\text{data length}] + 2 [\text{data type}] + 2 [\text{data}]) \times 1 [\text{data count}] + 1 [\text{record end flag}] \\
&= 136 [\text{bytes}]
\end{aligned}$$

Appendix 11 Recipe File Format

The file formats of the recipe files created by the high speed data logger module are shown.

Format overview

Recipe file formats are shown.

File format of the recipe files will be CSV format.

Recipe with Record Attribute		(1) Number of block	(2) Number of record		(8) Record attribute				
Block Number	6	Record Number	5	(9) Record comment					
(Linefeed)									(10) Record number
Device	Device Type	Points	Comment	Device Value					
				1	2	3	4	5	
(3) Device	(4) Data type	Process 1 setting / Process 2 setting / Process 3 setting / Process 4 setting / Process 5 setting							
				P			N		
D1	Word (signed)	1	Item name/Item number	1	2	3		5	
D11	Word (signed)	1	All process/Material	1000	2000	3000		5000	
M11	Bit	1	All process/Setting-1	1	1	0		1	
M12	Bit	1	All process/Setting-2	1	0	1		1	
D21	Word (signed)	2	Post-process/Shape	15	25	35		55	
			Post-process/Cast number	224	248	27		227	
M21	Bit	1	Post-process/Setting	1	1	0		0	
Fixed string field	(5) Data count		(6) Device comment		(7) Device value				
Read target field									
Write target field									
Read/Write target field									
Comment field									

- Fixed string field

Fixed strings for the recipe function. Editing the strings causes the malfunction of the recipe execution operation.

- Read target field

Data are read to a CPU module when the data read function is executed. Data do not change even when the data write function is executed.

- Write target field

Device values are written from a CPU module when the data write function is executed. Records with N attribute are the write target field.

After writing, this field will not have any attributes and will become a read/write target field.

- Read/Write target field

Device values are read to the CPU module when the data read function is executed, and device values from the CPU module are written to these fields when the data write function is executed.

- Comment field

Data are not read to the CPU module even when the data read function is executed. The fields can be left blank.

Specify comments to determine the usage of devices and record files within the recipe file.



Item descriptions

Item	Description																														
(1) Number of blocks	Outputs the number of blocks. (1 to 256)																														
(2) Number of records	Outputs the number of records. (1 to 256)																														
(3) Device	Outputs the devices for the recipe execution operation. Specify the start device for data types which require multiple points, or when specifying series of multiple data.																														
(4) Data type	Outputs any of the following data type.																														
	<table border="1"> <thead> <tr> <th>■Notation in a CSV file</th> <th>■Notation in Configuration Tool</th> <th>■Output format at the time of reading</th> </tr> </thead> <tbody> <tr> <td>Bit</td> <td>Bit</td> <td>—</td> </tr> <tr> <td>Word (signed)</td> <td>Word [Signed]</td> <td>Decimal format (digits: 0)</td> </tr> <tr> <td>Double word (signed)</td> <td>Double word [Signed]</td> <td>Decimal format (digits: 0)</td> </tr> <tr> <td>Word (unsigned)</td> <td>Word [Unsigned]/Bit String [16-bit]</td> <td>Decimal format (digits: 0)</td> </tr> <tr> <td>Double word (unsigned)</td> <td>Double Word [Unsigned]/Bit String [32-bit]</td> <td>Decimal format (digits: 0)</td> </tr> <tr> <td>Float (single precision)</td> <td>FLOAT [Single Precision]^{*1}</td> <td>Decimal format (digits: 6)</td> </tr> <tr> <td>Float (double precision)</td> <td>FLOAT [Double Precision]^{*1}</td> <td>Decimal format (digits: 6)</td> </tr> <tr> <td>16bit BCD</td> <td>16bit BCD</td> <td>Decimal format (digits: 0)</td> </tr> <tr> <td>32bit BCD</td> <td>32bit BCD</td> <td>Decimal format (digits: 0)</td> </tr> </tbody> </table>	■Notation in a CSV file	■Notation in Configuration Tool	■Output format at the time of reading	Bit	Bit	—	Word (signed)	Word [Signed]	Decimal format (digits: 0)	Double word (signed)	Double word [Signed]	Decimal format (digits: 0)	Word (unsigned)	Word [Unsigned]/Bit String [16-bit]	Decimal format (digits: 0)	Double word (unsigned)	Double Word [Unsigned]/Bit String [32-bit]	Decimal format (digits: 0)	Float (single precision)	FLOAT [Single Precision] ^{*1}	Decimal format (digits: 6)	Float (double precision)	FLOAT [Double Precision] ^{*1}	Decimal format (digits: 6)	16bit BCD	16bit BCD	Decimal format (digits: 0)	32bit BCD	32bit BCD	Decimal format (digits: 0)
	■Notation in a CSV file	■Notation in Configuration Tool	■Output format at the time of reading																												
	Bit	Bit	—																												
	Word (signed)	Word [Signed]	Decimal format (digits: 0)																												
	Double word (signed)	Double word [Signed]	Decimal format (digits: 0)																												
	Word (unsigned)	Word [Unsigned]/Bit String [16-bit]	Decimal format (digits: 0)																												
	Double word (unsigned)	Double Word [Unsigned]/Bit String [32-bit]	Decimal format (digits: 0)																												
	Float (single precision)	FLOAT [Single Precision] ^{*1}	Decimal format (digits: 6)																												
	Float (double precision)	FLOAT [Double Precision] ^{*1}	Decimal format (digits: 6)																												
16bit BCD	16bit BCD	Decimal format (digits: 0)																													
32bit BCD	32bit BCD	Decimal format (digits: 0)																													
(5) Number of data ^{*2}	Outputs the number of sequential devices. The number of data that can be set varies depending on the device type.(Bit device: 1 point, Devices other than bit: 1 to 256 points)																														
(6) Device comment (option)	Outputs the device comment. (Up to 32 characters)																														
(7) Device values ^{*3*4}	Outputs device values used for the data read/write process. When the data read function is performed, data entered in this field are reflected to the specified devices in the CPU module. For the data write function, the specified devices in the CPU module are reflected to the data in this field.																														
(8) Record attribute	Outputs the record attribute. (☞ Page 81 Record attribute) Blank: No attribute N: N attribute P: P attribute																														
(9) Record comment (option)	Outputs the record comment. (Up to 32 characters)																														
(10) Record number	Outputs the record number. Same record number cannot be set within the same recipe file.																														

*1 The device value, which can be set at read, is in the range that can be used by the CPU module.

*2 The total number of data in a single recipe file is up to 256.

*3 Fields of device values cannot be left blank except when N is specified for the record attribute.

*4 Set the device value in decimal notation.

Point

- The items described above can be edited.
- Set a recipe file name, including an extension, within 32 characters. For the recipe file names, use the characters usable in file names and folder (directory) names only. For the characters that can be used, refer to the following:
(☞ Page 343 File name and folder (directory) name)
- For details on setting items, refer to the following:
(☞ Page 80 Recipe file)

Appendix 12 Setting Information File Format

Format specification

The following table shows the format of setting information file.

Item name	Description	
	Unicode text file	CSV file
Delimiter	Tab	Comma (,)
Linefeed code	CRLF (0x0D, 0x0A)	
Character code	Unicode	ASCII
Character encoding method	UTF-16 (little endian)	—
Field data	<ul style="list-style-type: none">• Not enclosed with double quotes ("). However, when double quotes ("), Comma (,), and CRLF(0x0D, 0x0A) are used in the field, enclose with double quotes (").• When uses double quotes (") as characters, not as delimiter, use double quotes (") two consecutive times.	
Number of lines	Maximum 120000 lines	
File size	Maximum 10485760 bytes	

Format overview

Setting information file is comprised of label column and setting area.

- Example of a setting information file which has been exported

Label column	Setting area
IPADTYPE	
IPADADDRS	
IPADSUBNET	
IPADGATEWAY	
DNSSTYPE	
DNSSPRI	
DNSSEC	
HOSTNAME	
DIAGNOSIS	
DIAGINTV	
DIAGDEST	
DIAGDEVICE	

Restriction

When describing a setting item in each setting information file, all of the characters need to be upper-case. If describing a required item for import in lower-case, an error occurs when importing a file.

When multiple data is registered in one setting item, it becomes array (array area) automatically.

Array area is the range between labels which are enclosed with '[', ']', and comprised of label column, item line and setting area.

- Example of a file that includes array area.

When 3 accounts are registered in the account setting function

(The area between [ACCOUNT_START] and [ACCOUNT_END] in label column becomes array area)

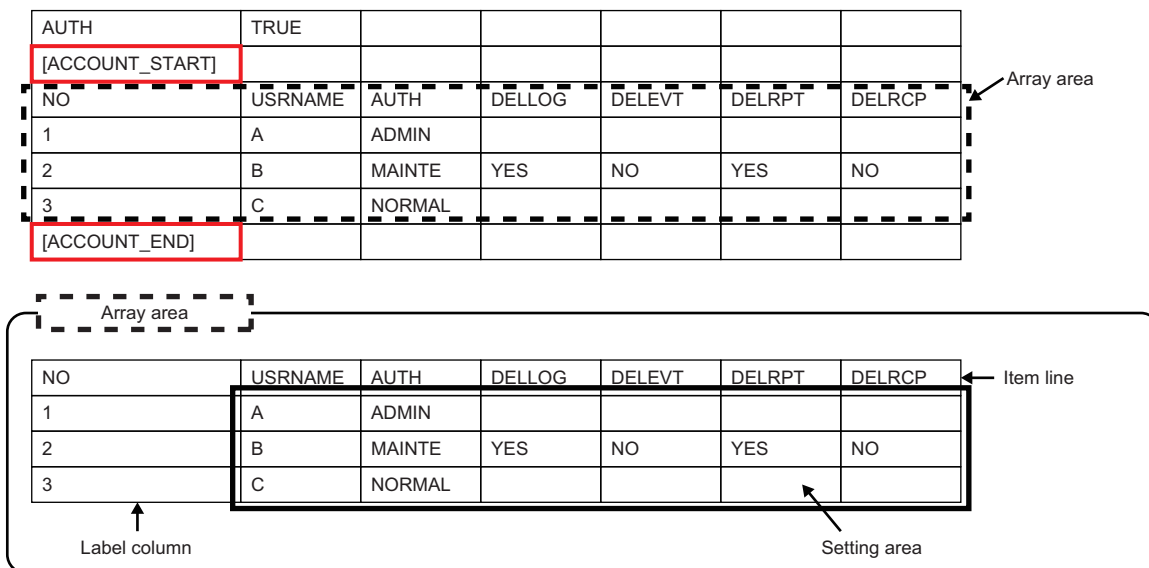

Setting information file list

The following shows the list of setting information files which are exported.

Only existing setting in data logging setting, event logging setting, and report setting are exported.

Setting	File name		Description	Import availability
	Unicode text	CSV		
Common setting	RD81DL96.txt	RD81DL96.csv	Project comment	○
	NETWORK.txt	NETWORK.csv	Network setting	○
	TIME.txt	TIME.csv	Time synchronization setting	○
	ACCESSCPU.txt	ACCESSCPU.csv	Access target CPU setting	○
	FILETRANSFER.txt	FILETRANSFER.csv	File transfer setting	○
	EMAIL.txt	EMAIL.csv	E-mail setting	○
	SECURITY.txt	SECURITY.csv	Security setting	○
	LOGGINGACT.txt	LOGGINGACT.csv	Logging operation setting	○
Data logging setting	SDMEMORY.txt	SDMEMORY.csv	SD memory card setting	○
	CFG_LOG01.txt	CFG_LOG01.csv	Data logging setting No. 1	○
	CFG_LOG02.txt	CFG_LOG02.csv	Data logging setting No. 2	
	:	:	:	
CFG_LOG64.txt	CFG_LOG64.csv	Data logging setting No.64		
Event logging setting	CFG_EVT01.txt	CFG_EVT01.csv	Event logging setting No.1	○
	CFG_EVT02.txt	CFG_EVT02.csv	Event logging setting No.2	
	:	:	:	
	CFG_EVT64.txt	CFG_EVT64.csv	Event logging setting No.64	
Report setting	CFG_REP01.txt	CFG_REP01.csv	Report setting No.01	×*1
	CFG_REP02.txt	CFG_REP02.csv	Report setting No.02	
	:	:	:	
	CFG_REP64.txt	CFG_REP64.csv	Report setting No.64	

*1 To use the report function, import the settings from the saved projects or create new setting.

■Project comment (RD81DL96.txt/csv)

Item	Description	Condition	Setting value	Remarks
CMNT	Project comment	—	Any character string	—

■Network setting (NETWORK.txt/csv)

Item	Description	Condition	Setting value	Remarks
IPADTYPE	IP address setting	Acquire automatically	AUTO	—
		Specify	SPECIFY	
IPADADRS	IP address	IPADTYPE is "SPECIFY"	*.*.* (IP address)	This item is not applied in the following situation. • IPADTYPE is "AUTO"
IPADSUBNET	Subnet mask	IPADTYPE is "SPECIFY"	*.*.* (IP address)	This item is not applied in the following situation. • IPADTYPE is "AUTO"
IPADGATEWAY	Default gateway	IPADTYPE is "SPECIFY"	*.*.* (IP address) or blank	This item is not applied in the following situation. • IPADTYPE is "AUTO"
DNSSTYPE	DNS server setting	Acquire automatically	AUTO	—
		Specify	SPECIFY	
DNSSPRI	Primary server	DNSSTYPE is "SPECIFY"	*.*.* (IP address) or blank	This item is not applied in the following situation. • DNSSTYPE is "AUTO"
DNSSSEC	Secondary server	DNSSTYPE is "SPECIFY"	*.*.* (IP address) or blank	This item is not applied in the following situation. • DNSSTYPE is "AUTO"
HOSTNAME	Host name	—	Any character string	—
DIAGNOSIS	Execute network diagnostics	Selected	YES	—
		Unselected	NO	
DIAGINTV	Sending interval	DIAGNOSIS is "YES"	10 to 3600	This item is not applied in the following situation. • DIAGNOSIS is "NO"
DIAGDEST	Destination	Gateway	GATEWAY	This item is not applied in the following situation. • DIAGNOSIS is "NO"
		Following target device	FOLLOWING	
DIAGDEVICE	Target device	DIAGNOEST is "FOLLOWING"	Any character string	This item is not applied in the following situation. • DIAGNOSIS is "NO" • DIAGNOEST is "GATEWAY"

A

■Time synchronization setting (TIME.txt/csv)

Item	Description	Condition	Setting value	Remarks
SYNC	Synchronize at fixed intervals	Selected	YES	—
		Unselected	NO	
TIMING	Synchronization timing	Fixed cycle	CYCLE	This item is not applied in the following situation. • SYNC is "NO"
		Fixed time	TIME	
INTERVAL	Interval	TIMING is "CYCLE"	1 to 1440	This item is not applied in the following situation. • SYNC is "NO" • TIMING is "TIME"
TIME	Time	TIMING is "TIME"	99 :99	This item is not applied in the following situation. • SYNC is "NO" • TIMING is "CYCLE"
DAYWEEK_SUN	Sun (day of the week)	Selected	YES	This item is not applied in the following situation. • SYNC is "NO" • TIMING is "CYCLE"
		Unselected	NO	
DAYWEEK_MON	Mon (day of the week)	Selected	YES	This item is not applied in the following situation. • SYNC is "NO" • TIMING is "CYCLE"
		Unselected	NO	
DAYWEEK_TUE	Tue (day of the week)	Selected	YES	This item is not applied in the following situation. • SYNC is "NO" • TIMING is "CYCLE"
		Unselected	NO	
DAYWEEK_WED	Wed (day of the week)	Selected	YES	This item is not applied in the following situation. • SYNC is "NO" • TIMING is "CYCLE"
		Unselected	NO	
DAYWEEK_THU	Thu (day of the week)	Selected	YES	This item is not applied in the following situation. • SYNC is "NO" • TIMING is "CYCLE"
		Unselected	NO	
DAYWEEK_FRI	Fri (day of the week)	Selected	YES	This item is not applied in the following situation. • SYNC is "NO" • TIMING is "CYCLE"
		Unselected	NO	
DAYWEEK_SAT	Sat (day of the week)	Selected	YES	This item is not applied in the following situation. • SYNC is "NO" • TIMING is "CYCLE"
		Unselected	NO	

■ Access target CPU setting (ACCESSCPU.txt/csv)

Item	Description	Condition	Setting value	Remarks
[ACCESSCPU_START]	Start of the array area (access target CPU setting)	—	(Blank)	—
((Array area))	Access target CPU setting	—	ACCESSCPU	—
[ACCESSCPU_END]	End of the array area (access target CPU setting)	—	(Blank)	—

• ACCESSCPU

Item	Description		Condition	Setting value	Remarks
NO	No.		—	1 to 64	—
NAME	Finish	Access target CPU name	—	Any character string	—
TYPE	Station specification	Station specification	Own station	OWN	—
			Other station	OTHER	
SERIES		Series	RCPU	RCPU	—
			QCPU/LCPU	QCPU/LCPU	
NT1MOD1	Network route	Module type (access source system)	TYPE is "OWN"	(Blank)	—
			CC-Link IE Controller Network Module	CCIEC	
			CC-Link IE Field Network Module	CCIEF	
			SERIES is 'RCPU,' and NT1MOD1 is CC-Link IE TSN module	CCIETSN	
			MELSECNET/H Module	NETH	
			CC-Link Module	CCLINK	
			Ethernet Module	ETHER	
			Serial Communication Module	SERIAL	
			High Speed Data Logger Module Ethernet Port	RDL	
NT1MOD1IO	Network route	Head I/O (module setting (access source system))	TYPE is "OWN"	(Blank)	—
			NT1MOD1 is any of the following: • "CCIEC" • "CCIEF" • "CCIETSN" • "NETH" • "ETHER" • "RDL"		
			NT1MOD1 is either of the following: • "CCLINK" • "SERIAL"	0 to FE0	
NT1MOD1STNO	Network route	Station No. (module setting (access source system))	TYPE is "OWN"	(Blank)	—
			NT1MOD1 is any of the following: • "CCIEC" • "CCIEF" • "CCIETSN" • "NETH" • "ETHER" • "CCLINK" • "SERIAL"		
			NT1MOD2 is "ETHERCPU"		
			NT1MOD2 is either of the following: • "ETHERMOD" • "ETHERTSN"	1 to 120	

Item	Description		Condition	Setting value	Remarks	
NT1MOD2	Network route	Module type (access target (routed system))	TYPE is "OWN"	(Blank)	—	
			NT1MOD1 is any of the following: • "CCIEC" • "CCIEF" • "CCIETSN" • "NETH" • "ETHER" • "CCLINK" • "SERIAL"			
			Built-in Ethernet CPU			ETHERCPU
			Ethernet Module			ETHERMOD
			SERIES is 'RCPU,' and NT1MOD2 is CC-Link IE TSN module			ETHERTSN
NT1MOD2ADRS	Network route	IP address (module setting (access target (routed system)))	TYPE is "OWN"	(Blank)	—	
			NT1MOD1 is any of the following: • "CCIEC" • "CCIEF" • "CCIETSN" • "NETH" • "ETHER" • "CCLINK" • "SERIAL"			
			NT1MOD1 is "RDL"			*** (IP address)
NT1MOD2NETNO	Network route	Network No. (module setting (access target (routed system)))	TYPE is "OWN"	(Blank)	—	
			NT1MOD1 is any of the following: • "CCIEC" • "CCIEF" • "CCIETSN" • "NETH" • "ETHER"	1 to 239		
			NT1MOD1 is either of the following: • "CCLINK" • "SERIAL"	(Blank)		
			NT1MOD2 is "ETHERCPU"			
			NT1MOD2 is "ETHERMOD"	1 to 239		
			NT1MOD2 is "ETHERTSN"			
NT1MOD2STNO	Network route	Station No. (module setting (access target (routed system)))	TYPE is "OWN"	(Blank)	—	
			NT1MOD1 is any of the following: • "CCIEC" • "CCIEF" • "CCIETSN" • "NETH" • "ETHER"	0 to 120		
			NT1MOD1 is "CCLINK"	0 to 63		
			NT1MOD1 is "SERIAL"	0 to 31		
			NT1MOD2 is "ETHERCPU"	(Blank)		
			NT1MOD2 is "ETHERMOD"	1 to 120		
			NT1MOD2 is "ETHERTSN"			
NT1USECO	Network route	Use the co-existence network route	TYPE is "OWN"	(Blank)	—	
			Selected	YES		
			Unselected	NO		

Item	Description		Condition	Setting value	Remarks
NT2MOD1	Co-existence network route	Module type (intervening system)	TYPE is "OWN"	(Blank)	—
			NT1USECO is "NO"		
			CC-Link IE Controller Network Module	CCIEC	
			MELSECNET/H Module	NETH	
			CC-Link Module	CCLINK	
			Ethernet Module	ETHER	
			Serial Communication module	SERIAL	
			CC-Link IE Field Network Module	CCIEF	
			CC-Link IE TSN module	CCIETSN	
NT2MOD1IO	Co-existence network route	Head I/O (module setting (intervening system))	TYPE is "OWN"	(Blank)	—
			NT1USECO is "NO"		
			NT2MOD1 is any of the following: • "CCIEC" • "CCIEF" • "CCIETSN" • "NETH" • "ETHER"		
			NT2MOD1 is either of the following: • "CCLINK" • "SERIAL"	0 to FE0	
NT2MOD1NETNO	Co-existence network route	Network No. (module setting (access target system))	TYPE is "OWN"	(Blank)	—
			NT1USECO is "NO"		
			NT2MOD1 is any of the following: • "CCIEC" • "CCIEF" • "CCIETSN" • "NETH" • "ETHER"	1 to 239	
			NT2MOD1 is any of the following: • "CCLINK" • "SERIAL"	(Blank)	
NT2MOD1STNO	Co-existence network route	Station No. (module setting (access target system))	TYPE is "OWN"	(Blank)	—
			NT1USECO is "NO"		
			NT2MOD1 is any of the following: • "CCIEC" • "CCIEF" • "CCIETSN" • "NETH" • "ETHER"	0 to 120	
			NT2MOD1 is "CCLINK"	0 to 63	
			NT2MOD1 is "SERIAL"	0 to 31	
MLTCPU	Multiple CPU specification		No specification	NOTSPECIFY	—
			PLC No. 1	1st	
			PLC No. 2	2nd	
			PLC No. 3	3rd	
			PLC No. 4	4th	
TIMEOUT	Response monitoring time		—	1 to 255	—
CMPGLABDCMNT	Finish	Use global label/ common device comment	Selected	YES	—
			Unselected	NO	
CMPGLABDCMNTPAT H		Project path	CMPGLABDCMNT is "NO"	(Blank)	—
			CMPGLABDCMNT is "YES"	Any character string	

■File transfer setting (FILETRANSFER.txt/csv)

Item	Description	Condition	Setting value	Remarks
[FILETRANSFER_START]	Start of the array area (file transfer setting)	—	(Blank)	—
((Array area))	File transfer setting	—	FILETRANSFER	—
[FILETRANSFER_END]	End of the array area (file transfer setting)	—	(Blank)	—
OPTRESEND	Resend when failed in transfer	Selected	YES	—
		Unselected	NO	
OPTRESEENDBUFNUM	Resend buffer size ([Count])	OPTRESEND is "YES"	100 to 99999	This item is not applied in the following situation. • OPTRESEND is "NO"
OPTNOTICOMP	Notify transfer completion	Selected	YES	—
		Unselected	NO	

• FILETRANSFER

Item	Description	Condition	Setting value	Remarks
NO	No.	—	1 to 16	—
NAME	File transfer setting name	—	Any character string	—
TYPE	Type	FTP server	FTP	—
		Shared folder	SHAREDFLD	
HOSTNAME	Host name	—	Any character string	—
USRNAME	User name	—	Any character string	—
PSWD ^{*1}	Password	—	Any character string	—
PATH	Path	—	Any character string	—
FTPPORT	FTP port number	TYPE is "FTP"	1 to 65535	This item is not applied in the following situation. • TYPE is "SHAREDFLD"
TRNMODE	Data transfer mode	PORT mode	PORT	This item is not applied in the following situation. • TYPE is "SHAREDFLD"
		PASV mode	PASV	

*1 A password is not output when exporting a file for security. The password need to be set in a CSV file when importing it.

■E-mail setting (EMAIL.txt/csv)

Item	Description	Condition	Setting value	Remarks
SENDSMTPSRV	SMTP server name (sender account setting)	—	Any character string	—
SENDEMAIL	E-mail address (sender account setting)	—	Any character string	—
SENDSMTPPORT	SMTP port number (sender account setting)	—	1 to 65535	—
SENDAUTH	This server requires authentication. (authentication setting (sender account setting))	Selected	YES	—
		Unselected	NO	
SENDTYPE	Method of authentication (authentication setting (sender account setting))	SMTP-Auth	SMTP	This item is not applied in the following situation. • SENDAUTH is "NO"
		POP before SMTP	POP	
SENDUSRNAME	User name (authentication setting (sender account setting))	SENDAUTH is "YES"	Any character string	This item is not applied in the following situation. • SENDAUTH is "NO"
SENDPSWD*1	Password (authentication setting (sender account setting))	SENDAUTH is "YES"	Any character string	This item is not applied in the following situation. • SENDAUTH is "NO"
SENDPOPSRV	POP server name (authentication setting (sender account setting))	SENDTYPE is "POP"	Any character string	This item is not applied in the following situation. • SENDAUTH is "NO" • SENDTYPE is "SMTP"
SENDPOPPORT	POP port number (authentication setting (sender account setting))	SENDTYPE is "POP"	1 to 65535	This item is not applied in the following situation. • SENDAUTH is "NO" • SENDTYPE is "SMTP"
[MAILTARGET_START]	Start of the array area (target e-mail address setting)	—	(Blank)	—
((Array area))	Target e-mail address setting	—	MAILTARGET	—
[MAILTARGET_END]	End of the array area (target e-mail address setting)	—	(Blank)	—
OPTRESEND	Resend when failed in sending	Selected	YES	—
		Unselected	NO	—
OPTRESENBUFFNUM	Resend buffer size ([Count])	OPTRESEND is "YES"	100 to 99999	This item is not applied in the following situation. • OPTRESEND is "NO"

*1 A password is not output when exporting a file for security. The password need to be set in a CSV file when importing it.

• MAILTARGET

Item	Description	Condition	Setting value	Remarks
NO	No.	—	1 to 16	—
NAME	Destination group name	—	Any character string	—
EMAIL	E-mail address	—	Any character string	—

■ Security setting (SECURITY.txt/csv)

Item	Description	Condition	Setting value	Remarks
ACCOUNTAUTH	Use the access authentication function	Selected	YES	—
		Unselected	NO	—
[ACCOUNT_START]	Start of the array area (account setting)	—	(Blank)	These items are not applied in the following situation. • ACCOUNTAUTH is "NO"
((Array area))	Account setting	ACCOUNTAUTH is "YES"	ACCOUNT	
[ACCOUNT_END]	End of the array area (account setting)	—	(Blank)	
IPFILTER	Use the IP filter	Selected	YES	—
		Unselected	NO	—
IPFILTERTYPE	Deny access from following IP address/Allow access from following IP address	Deny access from following IP address	BLOCK	This item is not applied in the following situation. • IPFILTER is "NO"
		Allow access from following IP address	PASS	
[FILTER_START]	Start of the array area (IP filter setting)	—	(Blank)	These items are not applied in the following situation. • IPFILTER is "NO"
((Array area))	IP filter setting	IPFILTER is "YES"	FILTER	
[FILTER_END]	End of the array area (IP filter setting)	—	(Blank)	

• ACCOUNT

Item	Description	Condition	Setting value	Remarks
NO	No.	—	1 to 16	—
USRNAME	User name	—	Any character string	—
PSWD*1	Password	—	Any character string	—
AUTH	Access authority	Administrator	ADMIN	—
		Maintenance user	MAINTE	
		Normal user	NORMAL	
DELLOG	/LOGGING (file delete enable folder)	AUTH is either of the following: • "ADMIN" • "NORMAL"	(Blank)	—
		Selected	YES	
		Unselected	NO	
DELEVT	/EVENT (file delete enable folder)	AUTH is either of the following: • "ADMIN" • "NORMAL"	(Blank)	—
		Selected	YES	
		Unselected	NO	
DEL RPT	/REPORT (file delete enable folder)	AUTH is either of the following: • "ADMIN" • "NORMAL"	(Blank)	—
		Selected	YES	
		Unselected	NO	
DEL RCP	/RECIPE (file delete enable folder)	AUTH is either of the following: • "ADMIN" • "NORMAL"	(Blank)	—
		Selected	YES	
		Unselected	NO	

*1 A password is not output when exporting a file for security. The password need to be set in a CSV file when importing it.

• FILTER

Item	Description	Condition	Setting value	Remarks
NO	No.	—	1 to 16	—
RANGE	Range setting	Selected	YES	—
		Unselected	NO	
IPADSTART	Target IP address (start)	—	*.*.* (IP address)	—
IPADEND	Target IP address (end)	RANGE is "YES"	*.*.* (IP address)	This item is not applied in the following situation. • RANGE is "NO"
IPAEEXCLD*1	IP address excluded from the range	RANGE is "YES"	*.*.* (IP address) or blank	This item is not applied in the following situation. • RANGE is "NO"

*1 When multiple IP addresses are specified, data is separated with a semicolon and then output.

■Logging operation setting (LOGGINGACT.txt/csv)

Item	Description	Condition	Setting value	Remarks
ATLG	Enable the auto logging function	Selected	YES	—
		Unselected	NO	
STOPFILEMAX	Stop due to the number of saved files over (conditions for stopping the operation of module)	Selected	YES	This item is not applied in the following situation. • ATLG is "NO"
		Unselected	NO	
STOPFILEMAXTYPE	When all of the saved files exceed a maximum number/When any of the saved files exceeds a maximum number (conditions for stopping the operation of module)	When all of the saved files exceed a maximum number	ALL	This item is not applied in the following situation. • ATLG is "NO" • STOPFILEMAX is "NO"
		When any of the saved files exceeds a maximum number	ANY	
STOPTIMER	Stop by a timer (conditions for stopping the operation of module)	Selected	YES	This item is not applied in the following situation. • ATLG is "NO"
		Unselected	NO	
STOPTIMERTIME	Elapsed time (conditions for stopping the operation of module)	STOPTIMER is "YES"	1 to 86400	This item is not applied in the following situation. • ATLG is "NO" • STOPTIMER is "NO"
STARTWAIT	Specify the waiting time for the module operation start	Selected	YES	—
		Unselected	NO	
STARTWAITTIME	Waiting time	STARTWAIT is "YES"	0 to 255	This item is not applied in the following situation. • STARTWAIT is "NO"

■SD memory card setting (SDMEMORY.txt/csv)

Item	Description	Condition	Setting value	Remarks
FRCP	Specify free capacity	Selected	YES	—
		Unselected	NO	
TYPE	Percent specification/Size specification	Percent specification	PERCENT	This item is not applied in the following situation. • FRCP is "NO"
		Size specification	SIZE	
PERCENT	Percent specification	TYPE is "PERCENT"	10 to 50	This item is not applied in the following situation. • FRCP is "NO" • TYPE is "SIZE"
SIZE	Size specification	TYPE is "SIZE"	50 to 4096	This item is not applied in the following situation. • FRCP is "NO" • TYPE is "PERCENT"



■Data logging setting (CFG_LOGnn.txt/csv)

Item	Description	Condition	Setting value	Remarks
NAME	Data logging name	—	Any character string	—
TFFLGTP	Logging type	Continuous logging	CONT	—
		Trigger logging	TRIGGER	
TRGLINE	Output lines before and after the trigger	Selected	YES	This item is not applied in the following situation. • TFFLGTP is "CONT"
		Unselected	NO	
TFFFILE	File format	Unicode text file	UNICODE	—
		Binary file	BINARY	
		CSV file	CSV	
SMPTYPE	Sampling	High speed sampling	HIGHSPEED	—
		General sampling	GENERAL	
SMPHSPDTYPE	Sampling interval (high speed sampling)	Each scan	EACHSCAN	This item is not applied in the following situation. • SMPTYPE is "GENERAL"
		Time specification	TIME	
SMPHSPDTIME	Time specification (high speed sampling-sampling interval)	SMPHSPDTYPE is "TIME"	0.5 to 0.9, 1 to 32767	This item is not applied in the following situation. • SMPTYPE is "GENERAL" • SMPHSPDTYPE is "EACHSCAN"
SMPGNRLTYPE	Sampling interval (general sampling)	Time specification	TIME	This item is not applied in the following situation. • SMPTYPE is "HIGHSPEED"
		Time interval specification	ONHR	
SMPGNRLTIME	Time specification (general sampling-sampling interval)	SMPGNRLTYPE is "TIME"	0.1 to 0.9, 1 to 32767	This item is not applied in the following situation. • SMPTYPE is "HIGHSPEED" • SMPGNRLTYPE is "ONHR"
SMPGNRLONHRTIME	Time interval specification (interval) (general sampling-sampling interval)	SMPGNRLTYPE is "ONHR"	1, 2, 3, 4, 5, 6, 8, 10, 12, 15, 20, 24, 30, 60	This item is not applied in the following situation. • SMPTYPE is "HIGHSPEED" • SMPGNRLTYPE is "TIME"
SMPGNRLONRUNIT	Time interval specification (unit) (general sampling-sampling interval)	Hour	HOUR	This item is not applied in the following situation. • SMPTYPE is "HIGHSPEED" • SMPGNRLTYPE is "TIME"
		Minute	MIN	
		Second	SEC	
[DAT_START]	Start of the array area (data setting)	—	(Blank)	—
((Array area))	Data setting	—	 DATA	—
[DAT_END]	End of the array area (data setting)	—	(Blank)	—
PRD	Specify a period	Selected	YES	—
		Unselected	NO	
PRDTYPE	Log during the period applying to the conditions (monitor the trigger)/Do not log during the period applying to the conditions (do not monitor the trigger)	Log during the period applying to the conditions (monitor the trigger)	CARRYOUT	This item is not applied in the following situation. • PRD is "NO"
		Do not log during the period applying to the conditions (do not monitor the trigger)	NOTCARRYOUT	
PRDCOMB	Combination condition	AND	AND	This item is not applied in the following situation. • PRD is "NO"
		OR	OR	
[PRDCOND_START]	Start of the array area (period and condition)	—	(Blank)	This item is not applied in the following situation. • PRD is "NO"
((Array area))	Period and conditions	PRD is "YES"	 PERIODOFT IMECONDITION	This item is not applied in the following situation. • PRD is "NO"
[PRDCOND_END]	End of the array area (period and condition)	—	(Blank)	This item is not applied in the following situation. • PRD is "NO"
TRGCONDTYPE	Single condition/Compound condition	Single condition	SINGLE	This item is not applied in the following situation. • TFFLGTP is "CONT"
		Compound condition	COMBINE	

Item	Description	Condition	Setting value	Remarks
TRGCOMPTYPE	Trigger type (compound condition only)	OR combine	OR	This item is not applied in the following situation. • TFFLGTP is "CONT" • TRGCONDTYPE is "SINGLE"
		AND combine	AND	
		Number of times	TIMES	
		Order	ORDER	
TRGCOMPTIMESTYPE	Conditions for occurrence (number of times)	When a terminal condition holds true	TERMINAL	This item is not applied in the following situation. • TFFLGTP is "CONT" • TRGCONDTYPE is "SINGLE" • TRGCOMPTYPE is other than "TIMES"
		When a specified number of times is exceeded	EXCEED	
TRGCOMPTIMESNUM OPE	Number of counts (symbols)	=	EQUAL	This item is not applied in the following situation. • TFFLGTP is "CONT" • TRGCONDTYPE is "SINGLE" • TRGCOMPTYPE is other than "TIMES" • TRGCOMPTIMESTYPE is "EXCEED"
		≠	NOTEQUAL	
		≥	GREATERTHAN EQUAL	
		>	GREATERTHAN	
		≤	LESSTHANEQUAL	
		<	LESSTHAN	
TRGCOMPTIMESNUM	Number of counts (numerals)	—	0 to 32767	This item is not applied in the following situation. • TFFLGTP is "CONT" • TRGCONDTYPE is "SINGLE" • TRGCOMPTYPE is other than "TIMES"
TRGCOMPORDERTYPE	Conditions for occurrence (order)	Abnormal pattern is detected	ABNORMAL	This item is not applied in the following situation. • TFFLGTP is "CONT" • TRGCONDTYPE is "SINGLE" • TRGCOMPTYPE is other than "ORDER"
		Normal pattern is detected	NORMAL	
TRGCOMPORDERTIMEOUT	Detect timeout	Selected	YES	This item is not applied in the following situation. • TFFLGTP is "CONT" • TRGCONDTYPE is "SINGLE" • TRGCOMPTYPE is other than "ORDER"
		Unselected	NO	
[TRGCOND_START]	Start of the array area (trigger condition)	—	(Blank)	This item is not applied in the following situation. • TFFLGTP is "CONT"
((Array area))	Trigger condition	TFFLGTP is "TRIGGER"	 TRIGGERCONDITION	This item is not applied in the following situation. • TFFLGTP is "CONT"
[TRGCOND_END]	End of the array area (trigger condition)	—	(Blank)	This item is not applied in the following situation. • TFFLGTP is "CONT"
TRGCOMPNOTICE	Notify the logging completion	Selected	YES	This item is not applied in the following situation. • TFFLGTP is "CONT" • SMPTYPE is "HIGHSPEED"
		Unselected	NO	
TRGCOMPDATA	Data name	TRGCOMPNOTICE is "YES"	*0001 to *1024	This item is not applied in the following situation. • TFFLGTP is "CONT" • SMPTYPE is "HIGHSPEED" • TRGCOMPNOTICE is "NO"
LLNTYPE	Log data before and after the trigger condition rises/log data before the trigger condition rises, while the trigger condition holds true, and after the trigger condition falls	Log data before and after the trigger condition rises	RIBERIAF (RIBE: before the rising, RIAF: after the rising)	This item is not applied in the following situation. • TFFLGTP is "CONT"
		Log data before the trigger condition rises, while the trigger condition holds true, and after the trigger condition falls	RIBERIZEFLAF (RIBE: before the rising, RIZE: holding true, FLAD: after the rising)	

Item	Description	Condition	Setting value	Remarks
LLNBEFOR	Before trigger	TFFLGTP is "TRIGGER"	0 to 65534	This item is not applied in the following situation. • TFFLGTP is "CONT"
LLNAFTER	After trigger	TFFLGTP is "TRIGGER"	1 to 65535	This item is not applied in the following situation. • TFFLGTP is "CONT"
LLNTOTAL	Total number of lines	TFFLGTP is "TRIGGER"	1 to 65535	This item is not applied in the following situation. • TFFLGTP is "CONT"
UNIDATE	Output date column	Selected	YES	This item is not applied in the following situation. • TFFFILE is "BINARY" • TFFFILE is "CSV"
		Unselected	NO	
UNIDATESPFRMT	Specify date format	Selected	YES	This item is not applied in the following situation. • TFFFILE is "BINARY" • TFFFILE is "CSV" • UNIDATE is "NO"
		Unselected	NO	
UNIDATEDATSTR	Data name line string	UNIDATESPFRMT is "YES"	Any character string	This item is not applied in the following situation. • TFFFILE is "BINARY" • TFFFILE is "CSV" • UNIDATE is "NO" • UNIDATESPFRMT is "NO"
UNIDATEFRMT	Data line output format	UNIDATESPFRMT is "YES"	Any character string	This item is not applied in the following situation. • TFFFILE is "BINARY" • TFFFILE is "CSV" • UNIDATE is "NO" • UNIDATESPFRMT is "NO"
UNITRIG	Output trigger information column	Selected	YES	This item is not applied in the following situation. • TFFLGTP is "CONT" • TFFFILE is "BINARY" • TFFFILE is "CSV"
		Unselected	NO	
UNITRIGDATSTR	Data name line string	UNITRIG is "YES"	Any character string	This item is not applied in the following situation. • TFFLGTP is "CONT" • TFFFILE is "BINARY" • TFFFILE is "CSV" • UNITRIG is "NO"
UNITRIGRISE	When trigger condition rises	UNITRIG is "YES"	Any character string	This item is not applied in the following situation. • TFFLGTP is "CONT" • TFFFILE is "BINARY" • TFFFILE is "CSV" • UNITRIG is "NO"
UNITRIGFALL	When trigger condition falls	UNITRIG is "YES"	Any character string	This item is not applied in the following situation. • TFFLGTP is "CONT" • TFFFILE is "BINARY" • TFFFILE is "CSV" • UNITRIG is "NO"
UNIINDX	Output index column	Selected	YES	This item is not applied in the following situation. • TFFLGTP is "CONT" • TFFFILE is "BINARY" • TFFFILE is "CSV"
		Unselected	NO	
UNICMNT	Output comment line	Selected	YES	This item is not applied in the following situation. • TFFFILE is "BINARY" • TFFFILE is "CSV"
		Unselected	NO	
UNICMNTSTR	Comment	UNICMNT is "YES"	Any character string	This item is not applied in the following situation. • TFFFILE is "BINARY" • TFFFILE is "CSV" • UNICMNT is "NO"

Item	Description	Condition	Setting value	Remarks
UNIHEADFILE	Output file information line	Selected	YES	This item is not applied in the following situation. • TFFFILE is "BINARY" • TFFFILE is "CSV"
		Unselected	NO	
UNIHEADDATATYPE	Output data type information line	Selected	YES	This item is not applied in the following situation. • TFFFILE is "BINARY" • TFFFILE is "CSV"
		Unselected	NO	
UNIHEADDATANAME	Output data name line	Selected	YES	This item is not applied in the following situation. • TFFFILE is "BINARY" • TFFFILE is "CSV"
		Unselected	NO	
CSVDATE	Output date column	Selected	YES	This item is not applied in the following situation. • TFFFILE is "UNICODE" • TFFFILE is "BINARY"
		Unselected	NO	
CSVDATESPFRMT	Specify date format	Selected	YES	This item is not applied in the following situation. • TFFFILE is "UNICODE" • TFFFILE is "BINARY" • CSVDATE is "NO"
		Unselected	NO	
CSVDATEDATSTR	Data name line string	CSVDATESPFRMT is "YES"	Any character string	This item is not applied in the following situation. • TFFFILE is "UNICODE" • TFFFILE is "BINARY" • CSVDATE is "NO" • CSVDATESPFRMT is "NO"
CSVDATEFRMT	Data line output format	CSVDATESPFRMT is "YES"	Any character string	This item is not applied in the following situation. • TFFFILE is "UNICODE" • TFFFILE is "BINARY" • CSVDATE is "NO" • CSVDATESPFRMT is "NO"
CSVTRIG	Output trigger information column	Selected	YES	This item is not applied in the following situation. • TFFLGTP is "CONT" • TFFFILE is "UNICODE" • TFFFILE is "BINARY"
		Unselected	NO	
CSVTRIGDATSTR	Data name line string	CSVTRIG is "YES"	Any character string	This item is not applied in the following situation. • TFFLGTP is "CONT" • TFFFILE is "UNICODE" • TFFFILE is "BINARY" • CSVTRIG is "NO"
CSVTRIGRISE	When trigger condition rises	CSVTRIG is "YES"	Any character string	This item is not applied in the following situation. • TFFLGTP is "CONT" • TFFFILE is "UNICODE" • TFFFILE is "BINARY" • CSVTRIG is "NO"
CSVTRIGFALL	When trigger condition falls	CSVTRIG is "YES"	Any character string	This item is not applied in the following situation. • TFFLGTP is "CONT" • TFFFILE is "UNICODE" • TFFFILE is "BINARY" • CSVTRIG is "NO"
CSVINDEX	Output index column	Selected	YES	This item is not applied in the following situation. • TFFLGTP is "CONT" • TFFFILE is "UNICODE" • TFFFILE is "BINARY"
		Unselected	NO	
CSVCMNT	Output comment line	Selected	YES	This item is not applied in the following situation. • TFFFILE is "UNICODE" • TFFFILE is "BINARY"
		Unselected	NO	



Item	Description	Condition	Setting value	Remarks
CSVCMNTSTR	Comment	CSVCMNT is "YES"	Any character string	This item is not applied in the following situation. <ul style="list-style-type: none"> • TFFFILE is "UNICODE" • TFFFILE is "BINARY" • CSVCMNT is "NO"
CSVHEADFILE	Output file information line	Selected	YES	This item is not applied in the following situation. <ul style="list-style-type: none"> • TFFFILE is "UNICODE" • TFFFILE is "BINARY"
		Unselected	NO	
CSVHEADDATATYPE	Output data type information line	Selected	YES	This item is not applied in the following situation. <ul style="list-style-type: none"> • TFFFILE is "UNICODE" • TFFFILE is "BINARY"
		Unselected	NO	
CSVHEADDATANAME	Output data name line	Selected	YES	This item is not applied in the following situation. <ul style="list-style-type: none"> • TFFFILE is "UNICODE" • TFFFILE is "BINARY"
		Unselected	NO	
CSVFLDDEDATA	Field data	Replace the target character in the data line with a period	REPLACEPERIOD	When the item is not set, it is "REPLACEPERIOD."
		All header lines and data lines are enclosed in double quotation without replacing the target character	ENCLOSEALL	
		All data lines are enclosed in double quotation without replacing the target character	ENCLOSEALLDATA	
		The data line is enclosed in double quotation without replacing the target character when there is it	ENCLOSETARGETDATA	
BINDATE	Output date information	Selected	YES	This item is not applied in the following situation. <ul style="list-style-type: none"> • TFFFILE is "UNICODE" • TFFFILE is "CSV"
		Unselected	NO	
BINDATETYPE	In seconds/In nanoseconds	In seconds	SEC	This item is not applied in the following situation. <ul style="list-style-type: none"> • TFFFILE is "UNICODE" • TFFFILE is "CSV" • BINDATE is "NO"
		In nanoseconds	NANOSEC	
BININDX	Output indexes	Selected	YES	This item is not applied in the following situation. <ul style="list-style-type: none"> • TFFFILE is "UNICODE" • TFFFILE is "CSV"
		Unselected	NO	
BINTRIG	Output trigger flag	Selected	YES	This item is not applied in the following situation. <ul style="list-style-type: none"> • TFFLGTP is "CONT" • TFFFILE is "UNICODE" • TFFFILE is "CSV"
		Unselected	NO	
SAVDEST	Setting type folder name	—	Any character string	—
SAVSUBFLD	Create subfolders	Selected	YES	—
		Unselected	NO	
SAVFLDSWICTMNTYPECOND	Condition specification	Selected	YES	This item is not applied in the following situation. <ul style="list-style-type: none"> • SAVSUBFLD is "NO"
		Unselected	NO	
SAVFLDSWICTMNCNDTYPE	Single condition/Compound condition	Single condition	SINGLE	This item is not applied in the following situation. <ul style="list-style-type: none"> • SAVSUBFLD is "NO" • SAVFLDSWICTMNTYPECOND is "NO"
		Compound condition	COMBINE	

Item	Description	Condition	Setting value	Remarks
SAVFLDSWICTMNCOMPTYPE	Compound condition	OR combine	OR	This item is not applied in the following situation. • SAVSUBFLD is "NO" • SAVFLDSWICTMNTYPECOND is "NO" • SAVFLDSWICTMNCNDTYPE is "SINGLE"
		AND combine	AND	
[SAVFLDSWICTMNCND_START]	Start of the array area (folder switching condition (each condition))	—	(Blank)	These items are not applied in the following situation. • SAVSUBFLD is "NO" • SAVFLDSWICTMNTYPECOND is "NO"
((Array area))	Folder switching condition (each condition)	SAVFLDSWICTMNTYPECOND is "YES"	TRIGGER CONDITION	
[SAVFLDSWICTMNCND_END]	End of the array area (folder switching condition (each condition))	—	(Blank)	
SAVFLDNAMESTYPE	Saved folder name setting	Simple setting	SIMPLE	This item is not applied in the following situation. • SAVSUBFLD is "NO"
		Detailed setting	DETAILED	
SAVFLDNAMEIMPNAME	Add a name	Selected	YES	This item is not applied in the following situation. • SAVSUBFLD is "NO" • SAVFLDNAMESTYPE is "DETAILED"
		Unselected	NO	
SAVFLDNAMEIMPDATE	Add a date	Selected	YES	This item is not applied in the following situation. • SAVSUBFLD is "NO" • SAVFLDNAMESTYPE is "DETAILED"
		Unselected	NO	
SAVFLDNAMEIMPTIME	Add a time	Selected	YES	This item is not applied in the following situation. • SAVSUBFLD is "NO" • SAVFLDNAMESTYPE is "DETAILED"
		Unselected	NO	
SAVFLDNAMEIMPNUM	Add a sequential number	Selected	YES	This item is not applied in the following situation. • SAVSUBFLD is "NO" • SAVFLDNAMESTYPE is "DETAILED"
		Unselected	NO	
SAVFLDNAMEDETLFRMT	Format	SAVFLDNAMESTYPE is "DETAILED"	Any character string	This item is not applied in the following situation. • SAVSUBFLD is "NO" • SAVFLDNAMESTYPE is "SIMPLE"
SAVFLDNAMEDETLDATA1	Attached data setting<DATA1>	Selected	*001 to *1024	This item is not applied in the following situation. • SAVSUBFLD is "NO" • SAVFLDNAMESTYPE is "SIMPLE"
		Unselected	NO	
SAVFLDNAMEDETLDATA2	Attached data setting<DATA2>	Selected	*001 to *1024	This item is not applied in the following situation. • SAVSUBFLD is "NO" • SAVFLDNAMESTYPE is "SIMPLE"
		Unselected	NO	
STOREDFILENAME	Accumulating file name	Same as setting type folder	SAVTYPEFLDNAME	—
		Same as saved file	SAVFILENAME	
STOREDFILEDEST	Saved destination for the accumulating file	Setting type folder	SAVTYPEFLD	—
		Subfolder	SUBFLD	
SAVSWICTMNTYPE	File switching timing	Selected ("Number of records" only)	RECORD	—
		Selected ("File size specification" only)	FILESIZE	
		Selected ("Condition specification" only)	CONDITION	
		Selected ("Trigger logging unit" only)	TRIGGER	
		Selected (multiple)	MULTI	

Item	Description	Condition	Setting value	Remarks
SAVSWICTMNTYPEPEREC	Number of records	Selected	YES	This item is not applied in the following situation. • SAVSWICTMNTYPE is other than "MULTI"
		Unselected	NO	
SAVSWICTMNTYPEFILE	File size specification	Selected	YES	This item is not applied in the following situation. • SAVSWICTMNTYPE is other than "MULTI"
		Unselected	NO	
SAVSWICTMNTYPECOND	Condition specification	Selected	YES	This item is not applied in the following situation. • SAVSWICTMNTYPE is other than "MULTI"
		Unselected	NO	
SAVSWICTMNTYPETRIGGER	Trigger logging unit	Selected	YES	This item is not applied in the following situation. • TFFLGTP is "CONT" • SAVSWICTMNTYPE is other than "MULTI"
		Unselected	NO	
SAVSWICTMNTYPENUMBER	Number of records	SAVSWICTMNTYPE is "RECORD"	100 to 100000	This item is not applied other than the situations written on the left.
		SAVSWICTMNTYPE is "MULTI", and SAVSWICTMNTYPEPEREC is "YES"		
SAVSWICTMNTYPEFILESIZE	File size	SAVSWICTMNTYPE is "FILESIZE"	10 to 16384	This item is not applied other than the situations written on the left.
		SAVSWICTMNTYPE is "MULTI", and SAVSWICTMNTYPEFILE is "YES"		
SAVSWICTMNTYPECONDITION	Single condition/Compound condition	Single condition	SINGLE	This item is not applied in the following situation. • SAVSWICTMNTYPE is "RECORD", "FILESIZE", or "TRIGGER" • SAVSWICTMNTYPE is "MULTI", and SAVSWICTMNTYPECOND is "NO"
		Compound condition	COMBINE	
SAVSWICTMNTYPECOMPTYPE	Trigger type (compound condition only)	OR combine	OR	This item is not applied in the following situation. • SAVSWICTMNTYPE is "RECORD", "FILESIZE", or "TRIGGER" • SAVSWICTMNTYPE is "MULTI", and SAVSWICTMNTYPECOND is "NO" • SAVSWICTMNTYPECONDITION is "SINGLE"
		AND combine	AND	
[SAVSWICTMNTYPECONDITION_START]	Start of the array area (file switching condition (each condition))	—	(Blank)	This item is not applied in the following situation. • SAVSWICTMNTYPE is "RECORD", "FILESIZE", or "TRIGGER" • SAVSWICTMNTYPE is "MULTI", and SAVSWICTMNTYPECOND is "NO"
((Array area))	File switching condition (each condition)	—	 TRIGGERCONDITION	This item is not applied in the following situation. • SAVSWICTMNTYPE is "RECORD", "FILESIZE", or "TRIGGER" • SAVSWICTMNTYPE is "MULTI", and SAVSWICTMNTYPECOND is "NO"

Item	Description	Condition	Setting value	Remarks
[SAVSWICTMNCND_ END]	End of the array area (file switching condition (each condition))	—	(Blank)	This item is not applied in the following situation. <ul style="list-style-type: none"> SAVSWICTMNTYPE is "RECORD", "FILESIZE", or "TRIGGER" SAVSWICTMNTYPE is "MULTI", and SAVSWICTMNTYPECOND is "NO"
SAVNAMEYPE	Saved file name setting	Simple setting	SIMPLE	—
		Detailed setting	DETAILED	
SAVNAMEIMPNAME	Add a name	Selected	YES	This item is not applied in the following situation. <ul style="list-style-type: none"> SAVNAMEYPE is "DETAILED"
		Unselected	NO	
SAVNAMEIMPDATE	Add a date	Selected	YES	This item is not applied in the following situation. <ul style="list-style-type: none"> SAVNAMEYPE is "DETAILED"
		Unselected	NO	
SAVNAMEIMPTIME	Add a time	Selected	YES	This item is not applied in the following situation. <ul style="list-style-type: none"> SAVNAMEYPE is "DETAILED"
		Unselected	NO	
SAVNAMEIMPNUM	Add a sequential number	Selected	YES	This item is not applied in the following situation. <ul style="list-style-type: none"> SAVNAMEYPE is "DETAILED"
		Unselected	NO	
SAVNAMEDETLFRMT	Format	SAVNAMEYPE is "DETAILED"	Any character string	This item is not applied in the following situation. <ul style="list-style-type: none"> SAVNAMEYPE is "SIMPLE"
SAVNAMEDETLDATA1	Attached data setting<DATA1>	Selected	*001 to *1024	This item is not applied in the following situation. <ul style="list-style-type: none"> SAVNAMEYPE is "SIMPLE"
		Unselected	NO	
SAVNAMEDETLDATA2	Attached data setting<DATA2>	Selected	*001 to *1024	This item is not applied in the following situation. <ul style="list-style-type: none"> SAVNAMEYPE is "SIMPLE"
		Unselected	NO	
SAVNAMEIMTYPE	Attached time (date) type	File switching condition hold true time	CONDITION	This item is not applied in the following situation. <ul style="list-style-type: none"> SAVNAMEYPE is "SIMPLE", and SAVNAMEIMPDATE and SAVNAMEIMPTIME are "NO" When SAVNAMEYPE is "DETAILED", and SAVNAMEDETLFRMT does not include time (date) information
		File creation time	FILECREATE	
SAVFNUM	Number of saved files	—	1 to 65535	—
SAVFNUMTYPE	Operation occurring when number of saved files is exceeded	Overwrite	OVERWRITE	—
		Stop	STOP	
SAVFILETRN	Transfer files to the following destination	Selected	YES	—
		Unselected	NO	
SAVFILETRN1	Transfer destination 1	SAVFILETRN is "YES"	1 to 16, NO	This item is not applied in the following situation. <ul style="list-style-type: none"> SAVFILETRN is "NO"
SAVFILETRN2	Transfer destination 2	SAVFILETRN is "YES"	1 to 16, NO	This item is not applied in the following situation. <ul style="list-style-type: none"> SAVFILETRN is "NO"
SAVFILETRN3	Transfer destination 3	SAVFILETRN is "YES"	1 to 16, NO	This item is not applied in the following situation. <ul style="list-style-type: none"> SAVFILETRN is "NO"
SAVMAIL	E-mail files to the following destination	Selected	YES	—
		Unselected	NO	
SAVMAIL1	E-mail address 1	SAVMAIL is "YES"	1 to 16, NO	This item is not applied in the following situation. <ul style="list-style-type: none"> SAVMAIL is "NO"
SAVMAIL2	E-mail address 2	SAVMAIL is "YES"	1 to 16, NO	This item is not applied in the following situation. <ul style="list-style-type: none"> SAVMAIL is "NO"



Item	Description	Condition	Setting value	Remarks
SAVMAIL3	E-mail address 3	SAVMAIL is "YES"	1 to 16, NO	This item is not applied in the following situation. • SAVMAIL is "NO"
SAVMAILTYPE	E-mail content setting	Simple setting	SIMPLE	This item is not applied in the following situation. • SAVMAIL is "NO"
		Detailed setting	DETAILED	
SAVMAILSUB	E-mail subject	SAVMAIL is "DETAILED"	Any character string	This item is not applied in the following situation. • SAVMAIL is "NO" • SAVMAILTYPE is "SIMPLE"
SAVMAILBODY	E-mail text	SAVMAIL is "DETAILED"	Any character string	This item is not applied in the following situation. • SAVMAIL is "NO" • SAVMAILTYPE is "SIMPLE"
SAVMAILTAGUSE	Use tags	Selected	YES	This item is not applied in the following situation. • SAVMAIL is "NO" • SAVMAILTYPE is "SIMPLE"
		Unselected	NO	
SAVMAILDATA1	Data setting 1	Selected	*001 to *1024	This item is not applied in the following situation. • SAVMAIL is "NO" • SAVMAILTYPE is "SIMPLE" • SAVMAILTAGUSE is "NO"
		Unselected	NO	
SAVMAILDATA2	Data setting 2	Selected	*001 to *1024	This item is not applied in the following situation. • SAVMAIL is "NO" • SAVMAILTYPE is "SIMPLE" • SAVMAILTAGUSE is "NO"
		Unselected	NO	

• DATA

Item	Description	Condition	Setting value	Remarks
NO	No.	—	001 to 1024, *001 to *1024	The total number of settings is 1024
NAME	Name	—	Any character string	—
LBL	Relation data	Related data	YES	—
		Not related data	NO	—
CPU	Access target CPU	—	1 to 64	—
DEVICE	Device head	—	Any character string	—
TYPE	Data type	Bit	BIT	—
		Word [Signed]	SWORD	—
		Double Word [Signed]	SDWORD	—
		Word [Unsigned]/Bit String [16-bit]	UWORD	—
		Double Word [Unsigned]/Bit String [32-bit]	UDWORD	—
		FLOAT [Single Precision]	FLOAT	—
		FLOAT [Double Precision]	DFLOAT	—
		16bit BCD	16BCD	—
		32bit BCD	32BCD	—
		String	STRING	—
	Raw	RAW	—	
SIZE	Size	TYPE is either of the following: • "STRING" • "RAW"	1 to 8192	—
		Other than the above	(Blank)	—
OUTVAL	Output value	TFFLGTP is "CONT"	(Blank)	—
		TRGLINE is "YES"		
		Value	VALUE	
		Number of times	COUNT	
		Time	TIME	
		Total number of times	TOTALCOUNT	
		Total time	TOTALTIME	
SCAL	Scaling	TYPE is either of the following: • "SWORD" • "SDWORD" • "UWORD" • "UDWORD" • "FLOAT" • "DFLOAT" • "16BCD" • "32BCD"	Any character string	—
		Other than the above	(Blank)	
OUTWORDXTTYPE	Unicode text/CSV output format (word)	TFFFILE is "BINARY" and is not referred at E-mail content setting	(Blank)	—
		Both of the following conditions are satisfied • TYPE is "STRING" or "BIT" • OUTVAL is "VALUE"		
		TYPE is "RAW"		
		Decimal format	DECIMAL	
		Exponential format	EXPONENTIAL	
	Hexadecimal format	HEXADECIMAL		



Item	Description	Condition	Setting value	Remarks
OUTWORDTXTDISIT	Number of digits in decimal part	TFFFILE is "BINARY" and is not referred at E-mail content setting	(Blank)	—
		Both of the following conditions are satisfied • TYPE is "STRING" or "BIT" • OUTVAL is "VALUE"		
		TYPE is "RAW"		
		OUTWORDTXTTYPE is "HEXADECIMAL"		
		Other than the above	0 to 14	—
OUTWORDBINTYPE	Binary output format	TFFFILE is either of the following: • "UNICODE" • "CSV"	(Blank)	—
		Both of the following conditions are satisfied • TYPE is "STRING" or "BIT" • OUTVAL is "VALUE"		
		TYPE is "RAW"		
		Word [Signed]	SWORD	—
		Double Word [Signed]	SDWORD	—
		Word [Unsigned]/Bit String [16-bit]	UWORD	—
		Double Word [Unsigned]/Bit String [32-bit]	UDWORD	—
		FLOAT [Single Precision]	FLOAT	—
		FLOAT [Double Precision]	DFLOAT	—
		16bit BCD	16BCD	—
		32bit BCD	32BCD	—
OUTBITXTTYPE	Unicode text/CSV output format (bit)	TFFFILE is "BINARY" and is not referred at E-mail content setting	(Blank)	—
		TYPE is other than "BIT"		
		Default	DEFAULT	—
		Specify	SPECIFY	—
OUTBITXTON	String when Unicode text/ CSV output format is ON	TFFFILE is "BINARY" and is not referred at E-mail content setting	(Blank)	—
		TYPE is other than "BIT"		
		OUTBITXTTYPE is "DEFAULT"		
		OUTBITXTTYPE is "SPECIFY"	Any character string	—
OUTBITXTOFF	String when Unicode text/ CSV output format is OFF	TFFFILE is "BINARY" and is not referred at E-mail content setting	(Blank)	—
		TYPE is other than "BIT"		
		OUTBITXTTYPE is "DEFAULT"		
		OUTBITXTTYPE is "SPECIFY"	Any character string	—

Item	Description	Condition	Setting value	Remarks
OUTSAVEATYPE	Output format (data which is to be attached to the saved file name)	The situation in which data is not attached to the saved file name	(Blank)	—
		Decimal	DECIMALINT	
		Hexadecimal format	HEXADECIMAL	
OUTSAVEZEROFILL	Zero padding (output format data which is to be attached to the saved file name)	The situation in which data is not attached to the saved file name	(Blank)	
		Selected	YES	
		Unselected	NO	
OUTSAVEEDISIT	Total number of digits (output format data which is to be attached to the saved file name)	The situation in which data is not attached to the saved file name	(Blank)	
		OUTSAVEZEROFILL is "NO"		
		OUTSAVEZEROFILL is "YES"	2 to 10	
OUTTIMEUNIT	Time specification	TFFLGTP is "CONT"	(Blank)	—
		TRGLINE is "YES"		
		OUTVAL is other than below • TIME • TOTALTIME		
		Second	SEC	
		Millisecond	MILLISEC	
COUNTCONDITION	Count condition	TFFLGTP is "CONT"	(Blank)	—
		TRGLINE is "YES"		
		OUTVAL is "VALUE"		
		=	EQUAL	
		≠	NOTEQUAL	
		≥	GREATERTHAN EQUAL	
		>	GREATERTHAN	
		≤	LESSTHANEQU AL	
<	LESSTHAN			
COUNTVALUE	Count value	TFFLGTP is "CONT"	(Blank)	—
		TRGLINE is "YES"		
		OUTVAL is "VALUE"		
		Other than the above	Any character string	
LBLNAME	Label name	—	Any character string	—



• PERIODOFTIMECONDITION

Item	Description	Condition	Setting value	Remarks
NO	No.	—	1 to 8	—
TYPE	Type of condition	Data conditions	DATA	—
		Date range	DATE	
		Time range	TIME	
		Day of the week/Week of the month conditions	WEEK	
DATA1	Data name	TYPE is other than "DATA"	(Blank)	—
		TYPE is DATA	001 to 1024, *001 to *1024	
DATAOPE	Condition	TYPE is other than "DATA"	(Blank)	—
		=	EQUAL	
		≠	NOTEQUAL	
		≥	GREATERTHAN EQUAL	
		>	GREATERTHAN	
		≤	LESSTHANEQUAL	
		<	LESSTHAN	
DATA2TYPE	Data/Constant	TYPE is other than "DATA"	(Blank)	—
		Data	DATA	
		Constant	CONST	
DATA2	Data name (data name/constant value)	TYPE is other than "DATA"	(Blank)	—
		DATA2TYPE is "CONST"		
		DATA2TYPE is "DATA"	001 to 1024, *001 to *1024	
DATA2CONST	Constant value (data name/constant value)	TYPE is other than "DATA"	(Blank)	—
		DATA2TYPE is "DATA"		
		DATA2TYPE is "CONST"	Any character string	
DATES_MONTH	Start - Month	TYPE is other than "DATA"	(Blank)	—
		January	JAN	
		February	FEB	
		March	MAR	
		April	APR	
		May	MAY	
		June	JUN	
		July	JUL	
		August	AUG	
		September	SEP	
		October	OCT	
		November	NOV	
		December	DEC	
		Every month	EVERY	
DATES_DAY	Start - Day	TYPE is other than "DATE"	(Blank)	—
		TYPE is "DATE"	1 to 31, LAST	

Item	Description	Condition	Setting value	Remarks
DATEE_MONTH	End - Month	TYPE is other than "DATE"	(Blank)	—
		January	JAN	
		February	FEB	
		March	MAR	
		April	APR	
		May	MAY	
		June	JUN	
		July	JUL	
		August	AUG	
		September	SEP	
		October	OCT	
		November	NOV	
		December	DEC	
		Every month	EVERY	
DATEE_DAY	End - Day	TYPE is other than "DATE"	(Blank)	—
		TYPE is "DATE"	1 to 31, LAST	
TIMES_HOUR	Start - Hour	TYPE is other than "TIME"	(Blank)	—
		TYPE is "TIME"	0 to 23, EVERY	
TIMES_MIN	Start - Minute	TYPE is other than "TIME"	(Blank)	—
		TYPE is "TIME"	0 to 59, EVERY	
TIMES_SEC	Start - Second	TYPE is other than "TIME"	(Blank)	—
		TYPE is "TIME"	0 to 59	
TIMEE_HOUR	End - Hour	TYPE is other than "TIME"	(Blank)	—
		TYPE is "TIME"	0 to 23, EVERY	
TIMEE_MIN	End - Minute	TYPE is other than "TIME"	(Blank)	—
		TYPE is "TIME"	0 to 59, EVERY	
TIMEE_SEC	End - Second	TYPE is other than "TIME"	(Blank)	—
		TYPE is "TIME"	0 to 59	
WEEKSUN	Day of the week condition (Sun)	TYPE is other than "WEEK"	(Blank)	—
		Selected	YES	
		Unselected	NO	
WEEKMON	Day of the week condition (Mon)	TYPE is other than "WEEK"	(Blank)	—
		Selected	YES	
		Unselected	NO	
WEEKTUE	Day of the week condition (Tue)	TYPE is other than "WEEK"	(Blank)	—
		Selected	YES	
		Unselected	NO	
WEEKWED	Day of the week condition (Wed)	TYPE is other than "WEEK"	(Blank)	—
		Selected	YES	
		Unselected	NO	
WEEKTHU	Day of the week condition (Thu)	TYPE is other than "WEEK"	(Blank)	—
		Selected	YES	
		Unselected	NO	
WEEKFRI	Day of the week condition (Fri)	TYPE is other than "WEEK"	(Blank)	—
		Selected	YES	
		Unselected	NO	
WEEKSAT	Day of the week condition (Sat)	TYPE is other than "WEEK"	(Blank)	—
		Selected	YES	
		Unselected	NO	
WEEKSPECIFY	Specify a week of the month	TYPE is other than "WEEK"	(Blank)	—
		Selected	YES	
		Unselected	NO	



Item	Description	Condition	Setting value	Remarks
WEEK1ST	Week condition (1st)	TYPE is other than "WEEK"	(Blank)	—
		WEEKSPECIFY is "NO"		
		Selected	YES	
		Unselected	NO	
WEEK2ND	Week condition (2nd)	TYPE is other than "WEEK"	(Blank)	—
		WEEKSPECIFY is "NO"		
		Selected	YES	
		Unselected	NO	
WEEK3RD	Week condition (3rd)	TYPE is other than "WEEK"	(Blank)	—
		WEEKSPECIFY is "NO"		
		Selected	YES	
		Unselected	NO	
WEEK4TH	Week condition (4th)	TYPE is other than "WEEK"	(Blank)	—
		WEEKSPECIFY is "NO"		
		Selected	YES	
		Unselected	NO	
WEEKLAST	Week condition (last)	TYPE is other than "WEEK"	(Blank)	—
		WEEKSPECIFY is "NO"		
		Selected	YES	
		Unselected	NO	

• TRIGGERCONDITION

Item	Description	Condition	Setting value	Remarks
NO	No.	—	1 to 8	—
TYPE	Type of condition	Data conditions (comparison)	DATACOMP	—
		Data conditions (value change)	DATACHANGE	
		Fixed cycle	CYCLE	
		Time interval specification	ONHR	
		Time specification	TIME	
		At module startup	STARTMODULE	
		At the data logging file switching	DATALOGCHANGE	
DATA1	Data name	TYPE is any of the following: • "CYCLE" • "ONHR" • "TIME" • "STARTMODULE" • "DATALOGCHANGE"	(Blank)	—
		TYPE is either of the following: • "DATACOMP" • "DATACHANGE"	001 to 1024, *001 to *1024	
DATAOPE	Condition	TYPE is other than "DATACOMP"	(Blank)	—
		=	EQUAL	
		≠	NOTEQUAL	
		≥	GREATERTHAN EQUAL	
		>	GREATERTHAN	
		≤	LESSTHANEQUAL	
		<	LESSTHAN	
DATA2TYPE	Data/Constant	TYPE is other than "DATACOMP"	(Blank)	—
		Data	DATA	
		Constant	CONST	

Item	Description	Condition	Setting value	Remarks
DATA2	Data name (data name/constant value)	TYPE is other than "DATACOMP"	(Blank)	—
		DATA2TYPE is "CONST"		
		DATA2TYPE is "DATA"	001 to 1024, *001 to *1024	
DATA2CONST	Constant value (data name/constant value)	TYPE is other than "DATACOMP"	(Blank)	—
		DATA2TYPE is "DATA"		
		DATA2TYPE is "CONST"	Any character string	
CYCL	Fixed cycle	TYPE is other than "CYCLE"	(Blank)	—
		TYPE is "CYCLE"	1 to 86400	
ONHRTIME	Time interval specification (interval)	TYPE is other than "ONHR"	(Blank)	—
		TYPE is "ONHR"	1, 2, 3, 4, 5, 6, 8, 10, 12, 15, 20, 24, 30, 60	
ONHRUNIT	Time interval specification (unit)	TYPE is other than "ONHR"	(Blank)	—
		Hour	HOUR	
		Minute	MIN	
		Second	SEC	
TIMEMONTH	Month	TYPE is other than "TIME"	(Blank)	—
		January	JAN	
		February	FEB	
		March	MAR	
		April	APR	
		May	MAY	
		June	JUN	
		July	JUL	
		August	AUG	
		September	SEP	
		October	OCT	
		November	NOV	
		December	DEC	
Every month	EVERY			
TIMEDAY	Day	TYPE is other than "TIME"	(Blank)	—
		TYPE is "TIME"	1 to 31, LAST, EVERY	
TIMEHOUR	Hour	TYPE is other than "TIME"	(Blank)	—
		TYPE is "TIME"	0 to 23, EVERY	
TIMEMINUTE	Minute	TYPE is other than "TIME"	(Blank)	—
		TYPE is "TIME"	0 to 59, EVERY	
TIMESECOND	Second	TYPE is other than "TIME"	(Blank)	—
		TYPE is "TIME"	0 to 59	
ORDDTIMEOUT	Monitoring timeout	TRGCOMPTYPE is other than "ORDER"	(Blank)	—
		NO is "1"		
		NO is "2" to "4"	0.1 to 0.9, 1 to 32767	
DATALOG	Data logging name	TYPE is other than "DATALOGCHANGE"	(Blank)	—
		TYPE is "DATALOGCHANGE"	1 to 64	

■Event logging setting (CFG_EVTnn.txt/csv)

Item	Description	Condition	Setting value	Remarks
NAME	Event logging name	—	Any character string	—
TFFFILE	File format	Unicode text file	Unicode	—
		Binary file	BINARY	
		CSV file	CSV	
SMPTYPE	Sampling	High speed sampling	HIGHSPEED	—
		General sampling	GENERAL	
SMPHSPDTYPE	Sampling interval (high speed sampling)	Each scan	EACHSCAN	This item is not applied in the following situation. • SMPTYPE is "GENERAL"
		Time specification	TIME	
SMPHSPDTIME	Time specification (high speed sampling-sampling interval)	SMPHSPDTYPE is "TIME"	1 to 32767	This item is not applied in the following situation. • SMPTYPE is "GENERAL" • SMPHSPDTYPE is "EACHSCAN"
SMPGNRLTYPE	Sampling interval (general sampling)	Time specification	TIME	This item is not applied in the following situation. • SMPTYPE is "HIGHSPEED"
		Time interval specification	ONHR	
SMPGNRLTIME	Time specification (general sampling-sampling interval)	SMPGNRLTYPE is "TIME"	0.1 to 0.9, 1 to 32767	This item is not applied in the following situation. • SMPTYPE is "HIGHSPEED" • SMPGNRLTYPE is "ONHR"
SMPGNRLONHRTIME	Time interval specification (interval)	SMPGNRLTYPE is "ONHR"	1, 2, 3, 4, 5, 6, 8, 10, 12, 15, 20, 24, 30, 60	This item is not applied in the following situation. • SMPTYPE is "HIGHSPEED" • SMPGNRLTYPE is "TIME"
SMPGNRLONHRUNIT	Time interval specification (unit)	Hour	HOUR	This item is not applied in the following situation. • SMPTYPE is "HIGHSPEED" • SMPGNRLTYPE is "TIME"
		Minute	MIN	
		Second	SEC	
[DAT_START]	Start of the array area (data setting)	—	(Blank)	—
((Array area))	Data setting	—	 DATA	—
[DAT_END]	End of the array area (data setting)	—	(Blank)	—
[EVT_START]	Start of the array area (event)	—	(Blank)	—
((Array area))	Event	—	 EVENT	—
[EVT_END]	End of the array area (event)	—	(Blank)	—
[EVTCOND_START]	Start of the array area (event condition)	—	(Blank)	—
((Array area))	Event condition	—	 EVENTCOND	—
[EVTCOND_END]	End of the array area (event condition)	—	(Blank)	—
PRD	Specify a period	Selected	YES	—
		Unselected	NO	
PRDTYPE	Monitor the event during the period applying to the conditions/Do not monitor the event during the period applying to the conditions	Monitor the event during the period applying to the conditions	CARRYOUT	This item is not applied in the following situation. • PRD is "NO"
		Do not monitor the event during the period applying to the conditions	NOTCARRYOUT	
PRDCOMB	Combination condition	AND	AND	This item is not applied in the following situation. • PRD is "NO"
		OR	OR	
[PRDCOND_START]	Start of the array area (period and condition)	—	(Blank)	This item is not applied in the following situation. • PRD is "NO"
((Array area))	Period and conditions	PRD is "YES"	 PERIODOFTIMECONDITION	—
[PRDCOND_END]	End of the array area (period and condition)	—	(Blank)	This item is not applied in the following situation. • PRD is "NO"

Item	Description	Condition	Setting value	Remarks
UNIDATESPFRMT	Specify date format	Selected	YES	This item is not applied in the following situation. • TFFFILE is "BINARY" • TFFFILE is "CSV"
		Unselected	NO	
UNIDATEDATSTR	Data name line string	UNIDATESPFRMT is "YES"	Any character string	This item is not applied in the following situation. • TFFFILE is "BINARY" • TFFFILE is "CSV" • UNIDATESPFRMT is "NO"
UNIDATEFRMT	Data line output format	UNIDATESPFRMT is "YES"	Any character string	This item is not applied in the following situation. • TFFFILE is "BINARY" • TFFFILE is "CSV" • UNIDATESPFRMT is "NO"
UNICMNT	Output comment line	Selected	YES	This item is not applied in the following situation. • TFFFILE is "BINARY" • TFFFILE is "CSV"
		Unselected	NO	
UNICMNTSTR	Comment	UNICMNT is "YES"	Any character string	This item is not applied in the following situation. • TFFFILE is "BINARY" • TFFFILE is "CSV" • UNICMNT is "NO"
UNIHEADFILE	Output file information line	Selected	YES	This item is not applied in the following situation. • TFFFILE is "BINARY" • TFFFILE is "CSV"
		Unselected	NO	
UNIHEADDATATYPE	Output data type information line	Selected	YES	This item is not applied in the following situation. • TFFFILE is "BINARY" • TFFFILE is "CSV"
		Unselected	NO	
UNIHEADDATANAME	Output data name line	Selected	YES	This item is not applied in the following situation. • TFFFILE is "BINARY" • TFFFILE is "CSV"
		Unselected	NO	
CSVDATESPFRMT	Specify date format	Selected	YES	This item is not applied in the following situation. • TFFFILE is "UNICODE" • TFFFILE is "BINARY"
		Unselected	NO	
CSVDATEDATSTR	Data name line string	CSVDATESPFRMT is "YES"	Any character string	This item is not applied in the following situation. • TFFFILE is "UNICODE" • TFFFILE is "BINARY" • CSVDATESPFRMT is "NO"
CSVDATEFRMT	Data line output format	CSVDATESPFRMT is "YES"	Any character string	This item is not applied in the following situation. • TFFFILE is "UNICODE" • TFFFILE is "BINARY" • CSVDATESPFRMT is "NO"
CSVCMNT	Output comment line	Selected	YES	This item is not applied in the following situation. • TFFFILE is "UNICODE" • TFFFILE is "BINARY"
		Unselected	NO	
CSVCMNTSTR	Comment	CSVCMNT is "YES"	Any character string	This item is not applied in the following situation. • TFFFILE is "UNICODE" • TFFFILE is "BINARY" • CSVCMNT is "NO"
CSVHEADFILE	Output file information line	Selected	YES	This item is not applied in the following situation. • TFFFILE is "UNICODE" • TFFFILE is "BINARY"
		Unselected	NO	
CSVHEADDATATYPE	Output data type information line	Selected	YES	This item is not applied in the following situation. • TFFFILE is "UNICODE" • TFFFILE is "BINARY"
		Unselected	NO	

Item	Description	Condition	Setting value	Remarks
CSVHEADDATANAME	Output data name line	Selected	YES	This item is not applied in the following situation. • TFFFILE is "UNICODE" • TFFFILE is "BINARY"
		Unselected	NO	
CSVFIELDATA	Field data	Replace the target character in the data line with a period	REPLACEPERIOD	When the item is not set, it is "REPLACEPERIOD."
		All header lines and data lines are enclosed in double quotation without replacing the target character	ENCLOSEALL	
		All data lines are enclosed in double quotation without replacing the target character	ENCLOSEALLDATA	
		The data line is enclosed in double quotation without replacing the target character when there is it	ENCLOSETARGETDATA	
BINEVTNHEADLIST	Output the event name list into the header	Selected	YES	This item is not applied in the following situation. • TFFFILE is "UNICODE" • TFFFILE is "CSV"
		Unselected	NO	
BINEVTNRECEVTNAME	Output the event names into record data	Selected	YES	This item is not applied in the following situation. • TFFFILE is "UNICODE" • TFFFILE is "CSV"
		Unselected	NO	
BINDATNHEADLIST	Output the data name list into the header	Selected	YES	This item is not applied in the following situation. • TFFFILE is "UNICODE" • TFFFILE is "CSV"
		Unselected	NO	
BINDATETYPE	In seconds/In nanoseconds	In seconds	SEC	This item is not applied in the following situation. • TFFFILE is "UNICODE" • TFFFILE is "CSV"
		In nanoseconds	NANOSEC	
BINCMNTREC	Output comment at event occurrence and comment at event restoration into record data	Selected	YES	This item is not applied in the following situation. • TFFFILE is "UNICODE" • TFFFILE is "CSV"
		Unselected	NO	
SAVDEST	Setting type folder name	—	Any character string	—
SAVSUBFLD	Create subfolders	Selected	YES	—
		Unselected	NO	
SAVFLDSWICTMNTYPECOND	Condition specification	Selected	YES	This item is not applied in the following situation. • SAVSUBFLD is "NO"
		Unselected	NO	
SAVFLDSWICTMNCNDTYPE	Single condition/Compound condition	Single condition	SINGLE	This item is not applied in the following situation. • SAVSUBFLD is "NO" • SAVFLDSWICTMNTYPECOND is "NO"
		Compound condition	COMBINE	
SAVFLDSWICTMNCNDMPTYPE	Compound condition	OR combine	OR	This item is not applied in the following situation. • SAVSUBFLD is "NO" • SAVFLDSWICTMNTYPECOND is "NO" • SAVFLDSWICTMNCNDMPTYPE is "SINGLE"
		AND combine	AND	
[SAVSWICTMNCND_START]	Start of the array area (folder switching condition (each condition))	—	(Blank)	These items are not applied in the following situation. • SAVSUBFLD is "NO" • SAVFLDSWICTMNTYPECOND is "NO"
((Array area))	Folder switching condition (each condition)	SAVFLDSWICTMNTYPECOND is "YES"	TRIGGERCONDITION	
[SAVSWICTMNCND_END]	End of the array area (folder switching condition (each condition))	—	(Blank)	

Item	Description	Condition	Setting value	Remarks
SAVFLDNAME TYPE	Saved folder name setting	Simple setting	SIMPLE	This item is not applied in the following situation. • SAVSUBFLD is "NO"
		Detailed setting	DETAILED	
SAVFLDNAME SIM NAME	Add a name	Selected	YES	This item is not applied in the following situation. • SAVSUBFLD is "NO" • SAVFLDNAME TYPE is "DETAILED"
		Unselected	NO	
SAVFLDNAME SIM DATE	Add a date	Selected	YES	This item is not applied in the following situation. • SAVSUBFLD is "NO" • SAVFLDNAME TYPE is "DETAILED"
		Unselected	NO	
SAVFLDNAME SIM TIME	Add a time	Selected	YES	This item is not applied in the following situation. • SAVSUBFLD is "NO" • SAVFLDNAME TYPE is "DETAILED"
		Unselected	NO	
SAVFLDNAME SIM NUMBER	Add a sequential number	Selected	YES	This item is not applied in the following situation. • SAVSUBFLD is "NO" • SAVFLDNAME TYPE is "DETAILED"
		Unselected	NO	
SAVFLDNAME DETL FORMAT	Format	SAVFLDNAME TYPE is "DETAILED"	Any character string	This item is not applied in the following situation. • SAVSUBFLD is "NO" • SAVFLDNAME TYPE is "SIMPLE"
SAVFLDNAME DETL DATA1	Attached data setting<DATA1>	Selected	*001 to *1024	This item is not applied in the following situation. • SAVSUBFLD is "NO" • SAVFLDNAME TYPE is "SIMPLE"
		Unselected	NO	
SAVFLDNAME DETL DATA2	Attached data setting<DATA2>	Selected	*001 to *1024	This item is not applied in the following situation. • SAVSUBFLD is "NO" • SAVFLDNAME TYPE is "SIMPLE"
		Unselected	NO	
STORED FILE NAME	Accumulating file name	Same as setting type folder	SAVTYPEFLDNAME	—
		Same as saved file	SAVFILENAME	
STORED FILE DEST	Saved destination for the accumulating file	Setting type folder	SAVTYPEFLD	—
		Subfolder	SUBFLD	
SAVSWICTMNTYPE	File switching timing	Selected ("Number of records" only)	RECORD	—
		Selected ("File size specification" only)	FILESIZE	—
		Selected ("Condition specification" only)	CONDITION	—
		Selected (multiple)	MULTI	—
SAVSWICTMNTYPE REC	Number of records	Selected	YES	This item is not applied in the following situation. • SAVSWICTMNTYPE is other than "MULTI"
		Unselected	NO	
SAVSWICTMNTYPE FILE	File size specification	Selected	YES	This item is not applied in the following situation. • SAVSWICTMNTYPE is other than "MULTI"
		Unselected	NO	
SAVSWICTMNTYPE COND	Condition specification	Selected	YES	This item is not applied in the following situation. • SAVSWICTMNTYPE is other than "MULTI"
		Unselected	NO	



Item	Description	Condition	Setting value	Remarks
SAVSWICTMNTRECNUM	Number of records	SAVSWICTMNTYPE is "RECORD"	100 to 100000	This item is not applied other than the situations written on the left.
		SAVSWICTMNTYPE is "MULTI", and SAVSWICTMNTYPEPEREC is "YES"		
SAVSWICTMNTFILESIZE	File size	SAVSWICTMNTYPE is "FILESIZE"	10 to 16384	This item is not applied other than the situations written on the left.
		SAVSWICTMNTYPE is "MULTI", and SAVSWICTMNTYPEFILE is "YES"		
SAVSWICTMNTCONDTYPE	Single condition/Compound condition	Single condition	SINGLE	This item is not applied in the following situation. • SAVSWICTMNTYPE is "RECORD" or "FILESIZE" • SAVSWICTMNTYPE is "MULTI", and SAVSWICTMNTYPEFILE is "NO"
		Compound condition	COMBINE	
SAVSWICTMNTCOMPTYPE	Trigger type (compound condition only)	OR combine	OR	This item is not applied in the following situation. • SAVSWICTMNTYPE is "RECORD" or "FILESIZE" • SAVSWICTMNTYPE is "MULTI", and SAVSWICTMNTYPECOND is "NO" • SAVSWICTMNTCONDTYPE is "SINGLE"
		AND combine	AND	
[SAVSWICTMNTCOND_START]	Start of the array area (file switching condition (each condition))	—	(Blank)	This item is not applied in the following situation. • SAVSWICTMNTYPE is "RECORD" or "FILESIZE" • SAVSWICTMNTYPE is "MULTI", and SAVSWICTMNTYPECOND is "NO"
((Array area))	File switching condition (each condition)	—	TRIGGER CONDITION	This item is not applied in the following situation. • SAVSWICTMNTYPE is "RECORD", "FILESIZE", or "TRIGGER" • SAVSWICTMNTYPE is "MULTI", and SAVSWICTMNTYPECOND is "NO"
[SAVSWICTMNTCOND_END]	End of the array area (file switching condition (each condition))	—	(Blank)	This item is not applied in the following situation. • SAVSWICTMNTYPE is "RECORD" or "FILESIZE" • SAVSWICTMNTYPE is "MULTI", and SAVSWICTMNTYPECOND is "NO"
SAVNAMEATYPE	Saved file name setting	Simple setting	SIMPLE	—
		Detailed setting	DETAILED	
SAVNAMEASIMPNAME	Add a name	Selected	YES	This item is not applied in the following situation. • SAVNAMEATYPE is "DETAILED"
		Unselected	NO	
SAVNAMEASIMPDATE	Add a date	Selected	YES	This item is not applied in the following situation. • SAVNAMEATYPE is "DETAILED"
		Unselected	NO	
SAVNAMEASIMPTIME	Add a time	Selected	YES	This item is not applied in the following situation. • SAVNAMEATYPE is "DETAILED"
		Unselected	NO	
SAVNAMEASIMPNUM	Add a sequential number	Selected	YES	This item is not applied in the following situation. • SAVNAMEATYPE is "DETAILED"
		Unselected	NO	

Item	Description	Condition	Setting value	Remarks
SAVNAMEDETLFRMT	Format	SAVNAMETYPE is "DETAILED"	Any character string	This item is not applied in the following situation. • SAVNAMETYPE is "SIMPLE"
SAVNAMEDETLDATA1	Attached data setting<DATA1>	Selected	*001 to *1024	This item is not applied in the following situation. • SAVNAMETYPE is "SIMPLE"
		Unselected	NO	
SAVNAMEDETLDATA2	Attached data setting<DATA2>	Selected	*001 to *1024	This item is not applied in the following situation. • SAVNAMETYPE is "SIMPLE"
		Unselected	NO	
SAVNAMETIMETYPE	Attached time (date) type	File switching condition hold true time	CONDITION	This item is not applied in the following situation. • SAVNAMETYPE is "SIMPLE", and SAVNAMESIMPDATE and SAVNAMESIMPTIME are "NO" • When SAVNAMETYPE is "DETAILED", and SAVNAMEDETLFRMT does not include time (date) information
		File creation time	FILECREATE	
SAVFNUM	Number of saved files	—	1 to 65535	—
SAVFNUMTYPE	Operation occurring when number of saved files is exceeded	Overwrite	OVERWRITE	—
		Stop	STOP	
SAVFILETRN	Transfer files to the following destination	Selected	YES	—
		Unselected	NO	
SAVFILETRN1	Transfer destination 1	SAVFILETRN is "YES"	1 to 16, NO	This item is not applied in the following situation. • SAVFILETRN is "NO"
SAVFILETRN2	Transfer destination 2	SAVFILETRN is "YES"	1 to 16, NO	This item is not applied in the following situation. • SAVFILETRN is "NO"
SAVFILETRN3	Transfer destination 3	SAVFILETRN is "YES"	1 to 16, NO	This item is not applied in the following situation. • SAVFILETRN is "NO"
SAVMAIL	E-mail files to the following destination	Selected	YES	—
		Unselected	NO	
SAVMAIL1	E-mail address 1	SAVMAIL is "YES"	1 to 16, NO	This item is not applied in the following situation. • SAVMAIL is "NO"
SAVMAIL2	E-mail address 2	SAVMAIL is "YES"	1 to 16, NO	This item is not applied in the following situation. • SAVMAIL is "NO"
SAVMAIL3	E-mail address 3	SAVMAIL is "YES"	1 to 16, NO	This item is not applied in the following situation. • SAVMAIL is "NO"
SAVMAILTYPE	E-mail content setting	Simple setting	SIMPLE	This item is not applied in the following situation. • SAVMAIL is "NO"
		Detailed setting	DETAILED	
SAVMAILSUB	E-mail subject	SAVMAILTYPE is "DETAILED"	Any character string	This item is not applied in the following situation. • SAVMAIL is "NO" • SAVMAILTYPE is "SIMPLE"
SAVMAILBODY	E-mail text	SAVMAILTYPE is "DETAILED"	Any character string	This item is not applied in the following situation. • SAVMAIL is "NO" • SAVMAILTYPE is "SIMPLE"
SAVMAILTAGUSE	Use tags	Selected	YES	This item is not applied in the following situation. • SAVMAIL is "NO" • SAVMAILTYPE is "SIMPLE"
		Unselected	NO	
SAVMAILDATA1	Data setting 1	Selected	*001 to *1024	This item is not applied in the following situation. • SAVMAIL is "NO" • SAVMAILTYPE is "SIMPLE" • SAVMAILTAGUSE is "NO"
		Unselected	NO	

Item	Description	Condition	Setting value	Remarks
SAVMAILDATA2	Data setting 2	Selected	*001 to *1024	This item is not applied in the following situation. • SAVMAIL is "NO" • SAVMAILTYPE is "SIMPLE" • SAVMAILTAGUSE is "NO"
		Unselected	NO	
MLN	Send a notifying e-mail when an event occurs	Selected	YES	—
		Unselected	NO	
MLNSUB	E-mail subject	MLN is "YES"	Any character string	This item is not applied in the following situation. • MLN is "NO"
MLNHEAD	E-mail text header	MLN is "YES"	Any character string	This item is not applied in the following situation. • MLN is "NO"
MLNFOOT	E-mail text footer	MLN is "YES"	Any character string	This item is not applied in the following situation. • MLN is "NO"
MLNDEST1	E-mail address 1	MLN is "YES"	1 to 16, NO	This item is not applied in the following situation. • MLN is "NO"
MLNDEST2	E-mail address 2	MLN is "YES"	1 to 16, NO	This item is not applied in the following situation. • MLN is "NO"
MLNDEST3	E-mail address 3	MLN is "YES"	1 to 16, NO	This item is not applied in the following situation. • MLN is "NO"
MLNTAGUSE	Use tags	Selected	YES	This item is not applied in the following situation. • MLN is "NO"
		Unselected	NO	
MLNDATA1	Data setting 1	Selected	001 to 1024, *001 to *1024	This item is not applied in the following situation. • MLN is "NO" • MLNTAGUSE is "NO"
		Unselected	NO	
MLNDATA2	Data setting 2	Selected	001 to 1024, *001 to *1024	This item is not applied in the following situation. • MLN is "NO" • MLNTAGUSE is "NO"
		Unselected	NO	

• EVENT

Item	Description	Condition	Setting value	Remarks
NO	No.	—	1 to 256	—
NAME	Event name	—	Any character string	—
CMNTOCCUR	Comment at event occurrence	—	Any character string	—
CMNTRESTOR	Comment at event restoration	CONDTYPE is "SINGLE" and corresponding TYPE of EVENTCOND is "DATACHANGE"	(Blank)	—
		COMPTYPE is either of the following: • "TIMES" • "ORDER"		
		Other than the above	Any character string	
OUTD	Output data values	Selected	YES	—
		Unselected	NO	
CONDTYPE	Single condition/Compound condition	Single condition	SINGLE	—
		Compound condition	COMBINE	
COMPTYPE	Compound condition	CONDTYPE is "SINGLE"	(Blank)	—
		OR combine	OR	
		AND combine	AND	
		Number of times	TIMES	
COMPTIMESTYPE	Conditions for occurrence (number of times)	CONDTYPE is "SINGLE"	(Blank)	—
		COMPTYPE is other than "TIMES"		
		When a terminal condition holds true	TERMINAL	
		When a specified number of times is exceeded	EXCEED	
COMPTIMESNUMOPE	Number of counts (symbols)	CONDTYPE is "SINGLE"	(Blank)	—
		COMPTYPE is other than "TIMES"		
		COMPTIMESTYPE is "EXCEED"		
		=	EQUAL	
		≠	NOTEQUAL	
		≥	GREATERTHAN EQUAL	
		>	GREATERTHAN	
		≤	LESSTHANEQUAL	
<	LESSTHAN			
COMPTIMESNUM	Number of counts (numerals)	CONDTYPE is "SINGLE"	(Blank)	—
		COMPTYPE is other than "TIMES"		
		Other than the above	0 to 32767	
COMPORDERTYPE	Conditions for occurrence (order)	CONDTYPE is "SINGLE"	(Blank)	—
		COMPTYPE is other than "ORDER"		
		Abnormal pattern is detected	ABNORMAL	
		Normal pattern is detected	NORMAL	





Item	Description	Condition	Setting value	Remarks
COMPORDERTIMEOUT	Detect timeout	CONDTYPE is "SINGLE"	(Blank)	—
		COMPTYPE is other than "ORDER"		
		Selected	YES	
		Unselected	NO	

• EVENTCOND

Item	Description	Condition	Setting value	Remarks
NO	No.	—	1-1 to 1-4 : 256-1 to 256-4	—
TYPE	Type of condition (comparison/value change)	Data conditions (comparison)	DATACOMP	—
		Data conditions (value change) COMBTYPE of EVENT is "TIMES" or "ORDER", and CONDTYPE of EVENT is "SINGLE"	DATACHANGE	
DATA1	Monitoring data	—	001 to 1024, *001 to *1024	—
DATAOPE	Condition	=	EQUAL	This item is not applied in the following situation. • TYPE is "DATACHANGE"
		≠	NOTEQUAL	
		≥	GREATERTHAN EQUAL	
		>	GREATERTHAN	
		≤	LESSTHANEQUAL	
		<	LESSTHAN	
DATA2TYPE	Data/Constant	Data	DATA	This item is not applied in the following situation. • COMBTYPE of EVENT is other than "TIMES" or "ORDER" • TYPE is "DATACHANGE"
		Constant	CONST	
DATA2	Data name (data name/constant value)	DATA2TYPE is "DATA"	001 to 1024, *001 to *1024	This item is not applied in the following situation. • COMBTYPE of EVENT is other than "TIMES" or "ORDER" • TYPE is "DATACHANGE" • DATA2TYPE is "CONST"
DATA2CONST	Constant value (data name/constant value)	—	Any character string	This item is not applied in the following situation. • TYPE is "DATACHANGE" • COMBTYPE of EVENT is "TIMES" or "ORDER", and DATA2TYPE is "DATA"
DATA2REST	Specify restoration values	Selected	YES	This item is not applied in the following situation. • COMBTYPE of EVENT is "TIMES" or "ORDER" • TYPE is "DATACHANGE" • DATAOPE is "EQUAL", or "NOTEQUAL"
		Unselected	NO	
DATA2RESTVALUE	Restoration values	DATA2REST is "YES"	Any character string	This item is not applied in the following situation. • COMBTYPE of EVENT is "TIMES" or "ORDER" • TYPE is "DATACHANGE" • DATAOPE is "EQUAL", or "NOTEQUAL" • DATA2REST is "NO"
ORDDTIMEOUT	Monitoring timeout	—	0.1 to 0.9, 1 to 32767	This item is not applied in the following situation. • COMBTYPE of EVENT is other than "ORDER" • NO is "-1"



■Report setting (CFG_REPnn.txt/csv)

Item	Description	Condition	Setting value	Remarks
NAME	Report name	—	Any character string	—
SMPTYPE	Sampling	High speed sampling	HIGHSPEED	—
		General sampling	GENERAL	
SMPHSPDTYPE	Sampling interval (high speed sampling)	Each scan	EACHSCAN	This item is not applied in the following situation. • SMPTYPE is "GENERAL"
		Time specification	TIME	
SMPHSPDTYPE	Time specification (high speed sampling-sampling interval)	SMPHSPDTYPE is "TIME"	1 to 32767	This item is not applied in the following situation. • SMPTYPE is "GENERAL" • SMPHSPDTYPE is "EACHSCAN"
SMPGNRLTYPE	Sampling interval (general sampling)	Time specification	TIME	This item is not applied in the following situation. • SMPTYPE is "HIGHSPEED"
		Time interval specification	ONHR	
SMPGNRLTIME	Time specification (general sampling-sampling interval)	SMPGNRLTYPE is "TIME"	0.1 to 0.9, 1 to 32767	This item is not applied in the following situation. • SMPTYPE is "HIGHSPEED" • SMPGNRLTYPE is "ONHR"
SMPGNRLONHRTIME	Time interval specification (interval)	SMPGNRLTYPE is "ONHR"	1, 2, 3, 4, 5, 6, 8, 10, 12, 15, 20, 24, 30, 60	This item is not applied in the following situation. • SMPTYPE is "HIGHSPEED" • SMPGNRLTYPE is "TIME"
SMPGNRLONHRUNIT	Time interval specification (unit)	Hour	HOUR	This item is not applied in the following situation. • SMPTYPE is "HIGHSPEED" • SMPGNRLTYPE is "TIME"
		Minute	MIN	
		Second	SEC	
[DAT_START]	Start of the array area (data setting)	—	(Blank)	—
((Array area))	Data setting	—	 DATA	—
[DAT_END]	End of the array area (data setting)	—	(Blank)	—
[LAYOUT_START]	Start of the array area (layout setting)	—	(Blank)	—
((Array area))	Layout setting	—	 LAYOUT	—
[LAYOUT_END]	End of the array area (layout setting)	—	(Blank)	—
TRGSYSC	Synchronize creation trigger with current value data	Selected	YES	—
		Unselected	NO	
TRGCONDTYPE	Single condition/Compound condition	Single condition	SINGLE	—
		Compound condition	COMBINE	
TRGCOMPTYPE	Trigger type (compound condition only)	OR combine	OR	This item is not applied in the following situation. • TRGCONDTYPE is "SINGLE"
		AND combine	AND	
		Number of times	TIMES	
		Order	ORDER	
TRGCOMPTIMESTYPE	Conditions for occurrence (number of times)	When a terminal condition holds true	TERMINAL	This item is not applied in the following situation. • TRGCONDTYPE is "SINGLE" • TRGCOMPTYPE is other than "TIMES"
		When a specified number of times is exceeded	EXCEED	
TRGCOMPTIMESNUM OPE	Number of counts (symbols)	=	EQUAL	This item is not applied in the following situation. • TRGCONDTYPE is "SINGLE" • TRGCOMPTYPE is other than "TIMES" • TRGCOMPTIMESTYPE is "EXCEED"
		≠	NOTEQUAL	
		≥	GREATERTHAN EQUAL	
		>	GREATERTHAN	
		≤	LESSTHANEQUAL	
		<	LESSTHAN	
TRGCOMPTIMESNUM	Number of counts (numerals)	—	0 to 32767	This item is not applied in the following situation. • TRGCONDTYPE is "SINGLE" • TRGCOMPTYPE is other than "TIMES"

Item	Description	Condition	Setting value	Remarks
TRGCOMPORDERTYPE	Conditions for occurrence (order)	Abnormal pattern is detected	ABNORMAL	This item is not applied in the following situation. • TRGCONDTYPE is "SINGLE" • TRGCOMPTYPE is other than "ORDER"
		Normal pattern is detected	NOMAL	
TRGCOMPORDERTIMEOUT	Detect timeout	Selected	YES	This item is not applied in the following situation. • TRGCONDTYPE is "SINGLE" • TRGCOMPTYPE is other than "ORDER"
		Unselected	NO	
[TRGCOND_START]	Start of the array area (creation trigger condition)	—	(Blank)	—
((Array area))	Creation trigger condition	—	☞ TRIGGERCONDITION	—
[TRGCOND_END]	End of the array area (creation trigger condition)	—	(Blank)	—
PRD	Specify a period	Selected	YES	—
		Unselected	NO	
PRDTYPE	Create the report during the period applying to the conditions/Do not create the report during the period applying to the conditions	Create the report during the period applying to the conditions	CARRYOUT	This item is not applied in the following situation. • PRD is "NO"
		Do not create the report during the period applying to the conditions	NOTCARRYOUT	
PRDCOMB	Combination condition	AND	AND	This item is not applied in the following situation. • PRD is "NO"
		OR	OR	
[PRDCOND_START]	Start of the array area (period and condition)	—	(Blank)	This item is not applied in the following situation. • PRD is "NO"
((Array area))	Period and conditions	PRD is "YES"	☞ PERIODOF TIMECONDITION	This item is not applied in the following situation. • PRD is "NO"
[PRDCOND_END]	End of the array area (period and condition)	—	(Blank)	This item is not applied in the following situation. • PRD is "NO"
SAVDEST	Setting type folder name	—	Any character string	—
SAVSUBFLD	Create subfolders	Selected	YES	—
		Unselected	NO	
SAVFLDSWICTMNTYPECOND	Condition specification	Selected	YES	This item is not applied in the following situation. • SAVSUBFLD is "NO"
		Unselected	NO	
SAVFLDSWICTMNCNDTYPE	Single condition/Compound condition	Single condition	SINGLE	This item is not applied in the following situation. • SAVSUBFLD is "NO" • SAVFLDSWICTMNTYPECOND is "NO"
		Compound condition	COMBINE	
SAVFLDSWICTMNCNDMPTYPE	Compound condition	OR combine	OR	This item is not applied in the following situation. • SAVSUBFLD is "NO" • SAVFLDSWICTMNTYPECOND is "NO" • SAVFLDSWICTMNCNDTYPE is "SINGLE"
		AND combine	AND	
[SAVSWICTMNCND_START]	Start of the array area (folder switching condition (each condition))	—	(Blank)	These items are not applied in the following situation. • SAVSUBFLD is "NO" • SAVFLDSWICTMNTYPECOND is "NO"
((Array area))	Folder switching condition (each condition)	SAVFLDSWICTMNTYPECOND is "YES"	☞ TRIGGERCONDITION	
[SAVSWICTMNCND_END]	End of the array area (folder switching condition (each condition))	—	(Blank)	

Item	Description	Condition	Setting value	Remarks
SAVFLDNAMETYPE	Saved folder name setting	Simple setting	SIMPLE	This item is not applied in the following situation. • SAVSUBFLD is "NO"
		Detailed setting	DETAILED	
SAVFLDNAMESIMPNAME	Add a name	Selected	YES	This item is not applied in the following situation. • SAVSUBFLD is "NO" • SAVFLDNAMETYPE is "DETAILED"
		Unselected	NO	
SAVFLDNAMESIMPDATE	Add a date	Selected	YES	This item is not applied in the following situation. • SAVSUBFLD is "NO" • SAVFLDNAMETYPE is "DETAILED"
		Unselected	NO	
SAVFLDNAMESIMPTIME	Add a time	Selected	YES	This item is not applied in the following situation. • SAVSUBFLD is "NO" • SAVFLDNAMETYPE is "DETAILED"
		Unselected	NO	
SAVFLDNAMESIMPNUM	Add a sequential number	Selected	YES	This item is not applied in the following situation. • SAVSUBFLD is "NO" • SAVFLDNAMETYPE is "DETAILED"
		Unselected	NO	
SAVFLDNAMEDETLFRMT	Format	SAVFLDNAMETYPE is "DETAILED"	Any character string	This item is not applied in the following situation. • SAVSUBFLD is "NO" • SAVFLDNAMETYPE is "SIMPLE"
SAVFLDNAMEDETLDATA1	Attached data setting<DATA1>	Selected	*001 to *1024	This item is not applied in the following situation. • SAVSUBFLD is "NO" • SAVFLDNAMETYPE is "SIMPLE"
		Unselected	NO	
SAVFLDNAMEDETLDATA2	Attached data setting<DATA2>	Selected	*001 to *1024	This item is not applied in the following situation. • SAVSUBFLD is "NO" • SAVFLDNAMETYPE is "SIMPLE"
		Unselected	NO	
SAVNAMETYPE	Saved file name setting	Simple setting	SIMPLE	—
		Detailed setting	DETAILED	
SAVNAMESIMPNAME	Add a name	Selected	YES	This item is not applied in the following situation. • SAVNAMETYPE is "DETAILED"
		Unselected	NO	
SAVNAMESIMPDATE	Add a date	Selected	YES	This item is not applied in the following situation. • SAVNAMETYPE is "DETAILED"
		Unselected	NO	
SAVNAMESIMPTIME	Add a time	Selected	YES	This item is not applied in the following situation. • SAVNAMETYPE is "DETAILED"
		Unselected	NO	
SAVNAMESIMPNUM	Add a sequential number	Selected	YES	This item is not applied in the following situation. • SAVNAMETYPE is "DETAILED"
		Unselected	NO	
SAVNAMEDETLFRMT	Format	SAVNAMETYPE is "DETAILED"	Any character string	This item is not applied in the following situation. • SAVNAMETYPE is "SIMPLE"
SAVNAMEDETLDATA1	Attached data setting<DATA1>	Selected	*001 to *1024	This item is not applied in the following situation. • SAVNAMETYPE is "SIMPLE"
		Unselected	NO	
SAVNAMEDETLDATA2	Attached data setting<DATA2>	Selected	*001 to *1024	This item is not applied in the following situation. • SAVNAMETYPE is "SIMPLE"
		Unselected	NO	
SAVFNUM	Number of saved files	—	1 to 65535	—
SAVFNUMTYPE	Operation occurring when number of saved files is exceeded	Overwrite	OVERWRITE	—
		Stop	STOP	
SAVFILETRN	Transfer files to the following destination	Selected	YES	—
		Unselected	NO	

Item	Description	Condition	Setting value	Remarks
SAVFILETRN1	Transfer destination 1	SAVFILETRN is "YES"	1 to 16, NO	This item is not applied in the following situation. • SAVFILETRN is "NO"
SAVFILETRN2	Transfer destination 2	SAVFILETRN is "YES"	1 to 16, NO	This item is not applied in the following situation. • SAVFILETRN is "NO"
SAVFILETRN3	Transfer destination 3	SAVFILETRN is "YES"	1 to 16, NO	This item is not applied in the following situation. • SAVFILETRN is "NO"
SAVMAIL	E-mail files to the following destination	Selected	YES	—
		Unselected	NO	
SAVMAIL1	E-mail address 1	SAVMAIL is "YES"	1 to 16, NO	This item is not applied in the following situation. • SAVMAIL is "NO"
SAVMAIL2	E-mail address 2	SAVMAIL is "YES"	1 to 16, NO	This item is not applied in the following situation. • SAVMAIL is "NO"
SAVMAIL3	E-mail address 3	SAVMAIL is "YES"	1 to 16, NO	This item is not applied in the following situation. • SAVMAIL is "NO"
SAVMAILTYPE	E-mail content setting	Simple setting	SIMPLE	This item is not applied in the following situation. • SAVMAIL is "NO"
		Detailed setting	DETAILED	
SAVMAILSUB	E-mail subject	SAVMAILTYPE is "DETAILED"	Any character string	This item is not applied in the following situation. • SAVMAIL is "NO" • SAVMAILTYPE is "SIMPLE"
SAVMAILBODY	E-mail text	SAVMAILTYPE is "DETAILED"	Any character string	This item is not applied in the following situation. • SAVMAIL is "NO" • SAVMAILTYPE is "SIMPLE"
SAVMAILTAGUSE	Use tags	Selected	YES	This item is not applied in the following situation. • SAVMAIL is "NO" • SAVMAILTYPE is "SIMPLE"
		Unselected	NO	
SAVMAILDATA1	Data setting 1	Selected	*001 to *1024	This item is not applied in the following situation. • SAVMAIL is "NO" • SAVMAILTYPE is "SIMPLE" • SAVMAILTAGUSE is "NO"
		Unselected	NO	
SAVMAILDATA2	Data setting 2	Selected	*001 to *1024	This item is not applied in the following situation. • SAVMAIL is "NO" • SAVMAILTYPE is "SIMPLE" • SAVMAILTAGUSE is "NO"
		Unselected	NO	



• LAYOUT

Item	Description	Condition	Setting value	Remarks
NO	No.	—	1 to 64	—
NAME	Layout name	—	Any character string	—
TYPE	Data logging/Current value/Creation time	Data logging	DATALOG	—
		Current value	CURRENT	
		Creation time	CREATION	
CELLRNG	Cell range	—	A1 reference style	—
RECNUM	Number of records	TYPE is either of the following: • "CURRENT" • "CREATION"	(Blank)	—
		TYPE is "DATALOG"	1 to 65535	
DATALOG	Data logging name	TYPE is either of the following: • "CURRENT" • "CREATION"	(Blank)	—
		TYPE is "DATALOG"	1 to 64	
SRCFILE	Source file	TYPE is either of the following: • "CURRENT" • "CREATION"	(Blank)	—
		Saved files	SAVED	
		Accumulating file	STORING	
		Both	BOTH	
DIRC	Outputting direction	TYPE is "CREATION"	(Blank)	—
		Vertical (top → bottom)	VERTICAL	
		Horizontal (left → right)	HORIZONTAL	
ORDER	Outputting order	TYPE is either of the following: • "CURRENT" • "CREATION"	(Blank)	—
		Chronological order (old → new)	CHRONO	
		Reverse chronological order (new → old)	REVERSE	
DATALIST	Output data	TYPE is either of the following: • "CURRENT" • "CREATION"	(Blank)	—
		TYPE is "DATALOG"	Numerals separated by spaces (001 to 1024, INDEX, TIME)	
OUTTITLE	Output title (data name) at the head of data	TYPE is either of the following: • "CURRENT" • "CREATION"	(Blank)	—
		Selected	YES	
		Unselected	NO	
DATANUM	Number of pieces of data	TYPE is either of the following: • "DATALOG" • "CREATION"	(Blank)	—
		TYPE is "CURRENT"	1 to 65535	

Item	Description	Condition	Setting value	Remarks
CURRENTDATA	Current value data	TYPE is either of the following: • "DATALOG" • "CREATION"	(Blank)	—
		TYPE is "CURRENT"	001 to 064	

Appendix 13 Data Sampling Method for CPU Modules that cannot be Accessed Directly

This section explains the method for collecting data from CPU modules that cannot be accessed directly (hereafter, explained with the motion CPU).

Performing refresh by using CPU buffer in a multiple CPU system

By performing refresh between an RCPU and motion CPU in a multiple CPU system, device data in the motion CPU can be read to the RCPU.

By registering the device values read to RCPU in the data logging target device, data in the motion CPU can be logged.

Settings required for auto refresh

Set the number of points to be sent by each CPU module and a device to store data in "Refresh Setting between Multiple CPUs" of an engineering tool.

 [Parameter] ⇒ (CPU module) ⇒ [CPU Parameter] ⇒ [Refresh Setting between Multiple CPUs] on the Navigation window

For refresh settings, refer to the following:

 MELSEC iQ-R CPU Module User's Manual (Application)

Acquisition example of device data in a motion CPU

System configuration

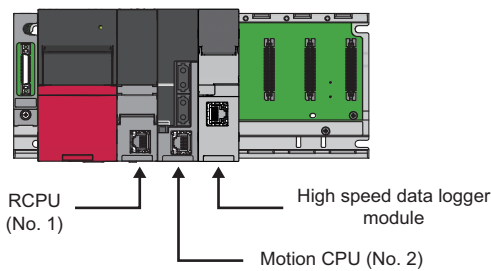

Refresh settings for an RCPU (CPU No.1)

Set a device on an RCPU to store data in the CPU buffer memory and the number of send points in "Refresh Setting (At the END)" of the RCPU.

Ex.

CPU buffer memory → D256 to D511 (256 points) of an RCPU

Setting No.	Device		
	Points	Start	End
□ No. 1(Send)			
□ No. 2(Receive)			
□ Total	256/522240 Points		
1	256	D256	D511
2			
3			

■ Refresh settings for a motion CPU (CPU No.2)

Set a device to be stored in the CPU buffer memory and the number of send points in "Refresh (END) Setting" of the motion CPU.

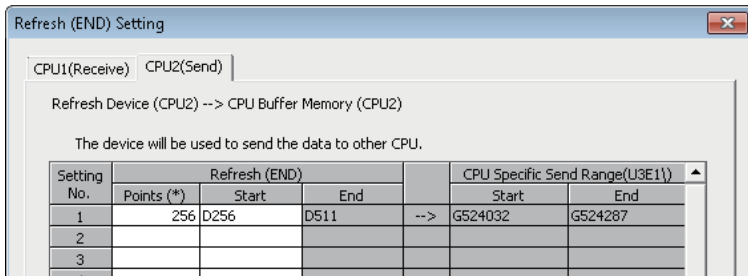

■ Settings for a high speed data logger module

Set devices of an RCP (CPU No.1) which are set in the refresh setting as data logging target devices.

Ex.

Setting D256 to D511 of an RCP (CPU No.1) as data logging target devices

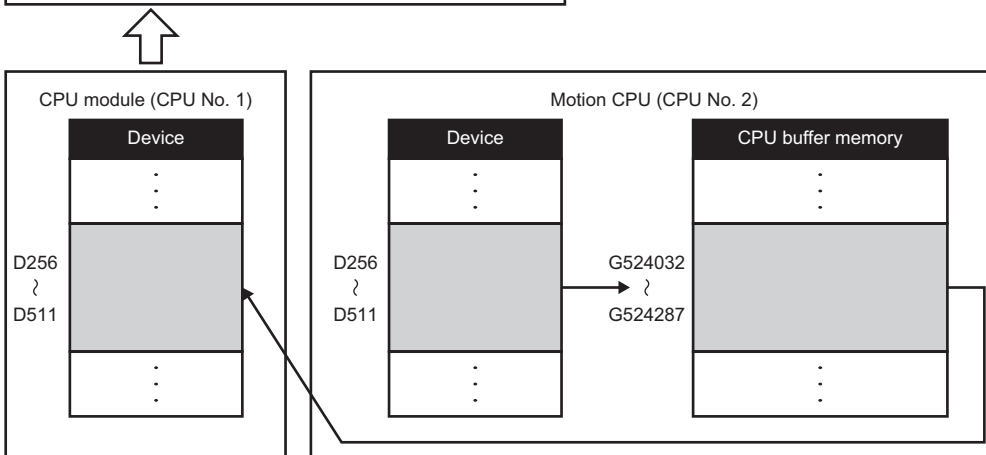
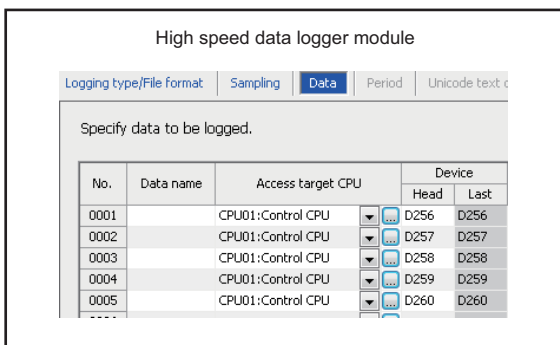

A

Appendix 14 Sampling Processes of High Speed Data Logger Module

Data changes between data sampling processes

Data changes occurred between the data sampling processes are not sampled because a high speed data logger module only samples data from a CPU module at the specified data sampling intervals.

Adjust the data sampling interval according to data to be sampled.

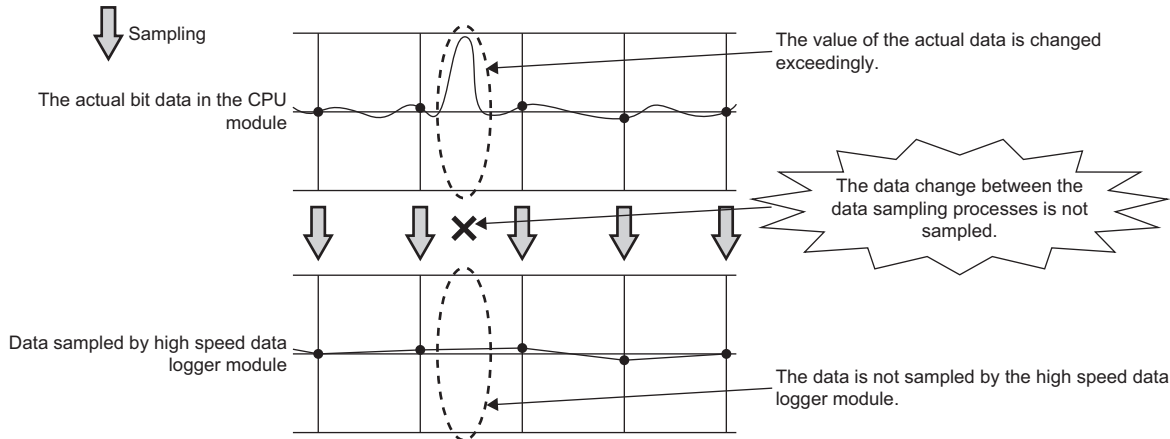

Detecting data condition establishment

The determination of the data condition is executed with the data sampled at the specified data sampling interval.

When the data condition is specified for the trigger, event, or file switching, the determination of the data condition is not detected if the condition is not established at the data sampling.

Set a longer time for the condition establishment time than the data sampling interval.

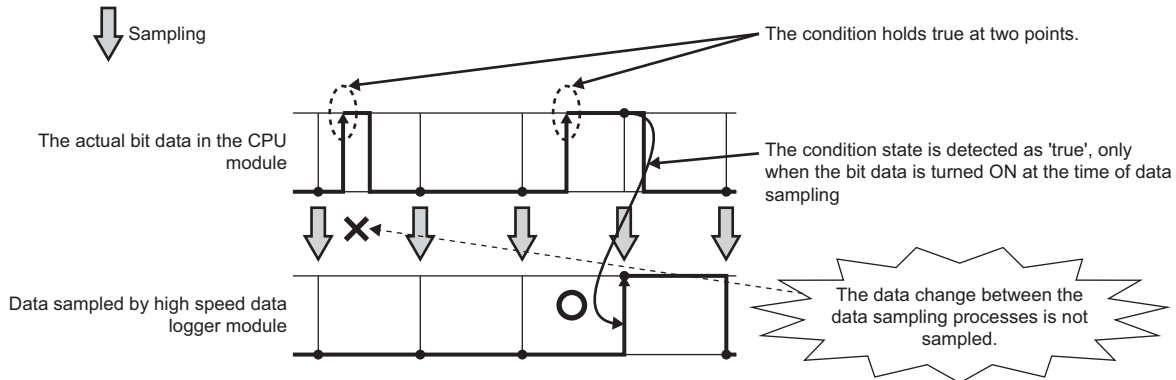

Appendix 15 SD Memory Card Life

An SD memory card has a life (a limit on the number of times for writing data). The following shows the method for calculating the life of an SD memory card.

Note that the actual life depends on the operating conditions and environment. Use the following calculation as a guide to determine the time for replacement.

Calculation formula of SD memory card life

SD memory card life (year) = Total size of writable data (GB) ÷ Size of data written per year (GB/year)

Total writable size

Capacity × Number of writes^{*1}

^{*1} For the capacity of applicable SD memory cards and the number of writes, refer to the following:
📖 MELSEC iQ-R Module Configuration Manual

Size of data written per year

The size of data written per year is obtained by the following formula:

Size of data written per year (GB/year) = $(DS1^{*1} + 6144) \times DN1 + \dots + (DSn^{*1} + 6144) \times DNn + (DCS1^{*1} + 6144) \times DCN1 + \dots + (DCSn^{*1} + 6144) \times DCNn + (ES1^{*1} + 6144) \times EN1 + \dots + (ESn^{*1} + 6144) \times ENn + (ECS1^{*1} + 6144) \times ECN1 + \dots + (ECSn^{*1} + 6144) \times ECNn + (RS1 \times RN1 + \dots + RSn \times RNn) \div 1073741824$

^{*1} Round up DS_n, DCS_n, ES_n and ECS_n to a multiple of 512.

DS_n, DN_n, DCS_n, DCN_n, ES_n, EN_n, ECS_n, ECN_n, RS_n, and RN_n are obtained as follows.

■ One record size for data logging (DS_n)

Unicode text file format and CSV file output format: Refer to the data line. (📖 Page 357 Unicode text file/CSV file)

Binary output format: Refer to the data. (📖 Page 367 Binary file)

■ Number of records written for data logging per year (DN_n)

Continuous logging: $DNn = 60 \times 60 \times 24 \times 365 \div \text{Collection interval and timing (seconds)}^{*1} \times \text{Operating rate}^{*2}$

Trigger logging: $DNn = \text{Total number of records}^{*3} \times \text{trigger occurrence count for 1 year}^{*4}$

^{*1} The value that is determined depending on the condition set in "Sampling" when "Continuous logging" is selected for the logging type. (When the value is determined in milliseconds, convert the value into seconds. When each scan is specified, check the scan time of the control CPU.)

^{*2} Calculate the rate using the system operating time. For example, if the operating time per year is 5000 hours, the operating rate is calculated as follows: $5000 \div (24 \times 365) = 0.57$.

^{*3} The value set when "Trigger logging" is selected for the logging type.

^{*4} This value is calculated by the anticipated count according to system operation.

■ Header size for data logging (DCS_n)

Unicode text file format and CSV file output format: Refer to the file information line to data name line. (📖 Page 357 Unicode text file/CSV file)

Binary output format: Refer to the header. (📖 Page 367 Binary file)

■ Number of file switches for data logging per year (DCN_n)

Calculate the number by the anticipated count according to the file switching setting and system operation. For example, when 1000 records are set in "Number of records" of "File switching timing" in the [File] tab and "Each scanning cycle" is specified for "Sampling interval" in the [Sampling] tab, the time interval of the file switching is obtained by multiplying the scan time by 1000. Therefore, the number of file switching times for the data logging per year is obtained by the following formula:

$60 \times 60 \times 24 \times 365 \div (\text{Scan time (second)} \times 1000)$

■1 record size for event logging (ESn)

Unicode text file format and CSV file output format: Refer to the data line. (☞ Page 370 Unicode text file/CSV file)

Binary output format: Refer to the data. (☞ Page 380 Binary file)

■Number of written records (lines) for event logging for 1 year (ENn)

Calculate the anticipated occurrence count of an event as the number of records according to the event setting and system operation.

■Header size for event logging (ECSn)

Unicode text file format and CSV file output format: Refer to the file information line to data name line. (☞ Page 370 Unicode text file/CSV file)

Binary output format: Refer to the header. (☞ Page 380 Binary file)

■Number of file switches for event logging for 1 year (ECNn)

Calculate the number by the anticipated count according to the file switching setting and system operation.

■File size of report (RSn)

File size of report (RSn) is obtained by the following formula.

File size of report (byte) = $LS \times 4 + (SS + BS) \times 2$

$SS = SS1 + \dots + SSn$

$SSn = (SNn \times 2) + ((SNn \times 2) \div 8192)^{*1} \times 6$

$BS = BS1 + \dots + BSm$

$BSm = (BNm \times 4) + ((BNm \times 2) \div 8192)^{*1} \times 6$

*1 Round up the results of division to a whole number.

LS: Layout size (displayed in the report layout list screen)

SS: String type data additional size

SSn: Size of output range of nth string type data set in the layout setting

SNn: Size of nth string type data set in the layout setting

BS: Raw type data additional size

BSm: Size of output range of mth raw type data set in the layout setting

BNm: Size of mth raw type data set in the layout setting

■Number of reports created for 1 year (RNn)

Calculate the number by the anticipated count according to the creation trigger setting and system operation.

Appendix 16 When Using a Redundant System

This section explains restrictions and consideration when using a high speed data logger module in a redundant system.

Restrictions

The following shows the restricted functions and specifications of when using a redundant system.

Mountable base units

A high speed data logger module must be mounted on an extension base unit^{*1} or a redundant extension base unit. It cannot be mounted on the main base unit in a redundant system.

*1 Only the extension level 2 to 7 are available.

Access target CPUs

There are restrictions on accessible routes. For details, refer to the following:

📖 MELSEC iQ-R High Speed Data Logger Module User's Manual (Startup)

Dedicated instructions

Dedicated instructions for a high speed data logger module cannot be used.

If a dedicated instruction is used, "Operation error (redundant function)" occurs in the process CPU (redundant mode).

Consideration

The following shows the consideration when using a redundant system.

Resetting a CPU module

Reset CPU modules of both systems for a function that requires resetting the CPU modules.

Appendix 17 Added and Changed Functions

This section shows the added or changed functions of RD81DL96 or Configuration Tool.

Added/changed contents	Firmware version	Software version	Reference
Windows 10 is supported.	'02' or later	'1.01B' or later	MELSEC iQ-R High Speed Data Logger Module User's Manual (Startup)
Excel 2016 is supported.	'05' or later	'1.02C' or later	
MELSEC iQ-R CPU modules are supported. • R00CPU, R01CPU, R02CPU			
Online (asynchronous mode) is supported.	'06' or later	—	Page 240 Operation settings
MELSEC iQ-R CPU modules are supported. • Safety CPU	'07' or later	—	MELSEC iQ-R High Speed Data Logger Module User's Manual (Startup)
The firmware update function is supported.	'08' or later	'1.03D' or later	Page 230 Firmware update management MELSEC iQ-R Module Configuration Manual
The CSV file import function is supported.	'09' or later	'1.04E' or later	Page 128 Importing from a CSV file
Excel 2019 is supported.	'14' or later	'1.07H' or later	MELSEC iQ-R High Speed Data Logger Module User's Manual (Startup)
Microsoft 365 is supported.			
Microsoft Edge is supported.			
The redundant system with a redundant extension base unit is supported.	'15' or later	—	Page 434 When Using a Redundant System MELSEC iQ-R High Speed Data Logger Module User's Manual (Startup)
" (double quotes), ; (semicolon), and , (comma) are added for usable characters of a CSV format logging file.	'16' or later	'1.08J' or later	Page 165 CSV output Page 189 CSV output Page 357 Data Logging File Format Page 370 Event Logging File Format
CC-Link IE TSN is added for accessible routes.			MELSEC iQ-R High Speed Data Logger Module User's Manual (Startup)

INDEX

A

Access authority	87,88
Account setting	143
Accumulating file	51
Administrator	86
Automatic hardware test	246

B

Block	80
-----------------	----

C

Creation trigger	75
----------------------------	----

D

Data logging file	24,50
Data missing	62
DNS server setting	132

E

Event condition	65
Event logging file	63,70

F

File switching	51
Find high speed data logger module	215
Firmware update management	230
Folder switching	56

G

General sampling	29
----------------------------	----

H

Hardware test for LED check	247
High speed sampling	27

M

Maintenance user	86
Module operating file	130

N

N attribute	81
Normal user	86

P

P attribute	81
Ping	132,228
Product information	229

R

Record	81
Record attribute	81
Relation data	115
Report file	77
Resend function	96,99

S

Saved file	51
Scaling	49,153
Setting type folder	55
Subfolder	55

T

Transfer completion notification function	97
---	----

U

Updating setting	218
----------------------------	-----

MEMO

REVISIONS

* The manual number is given on the bottom left of the back cover.

Revision date	*Manual number	Description
December 2015	SH(NA)-081562ENG-A	First edition
April 2016	SH(NA)-081562ENG-B	■Added or modified parts CONSIDERATIONS FOR USE, Section 1.2, Section 1.5, Section 1.12, Section 1.13, Section 2.5, Section 4.3, Section 4.4, Appendix 5, Appendix 16
December 2016	SH(NA)-081562ENG-C	■Added or modified parts CONSIDERATIONS FOR USE, Section 1.1, Section 1.3, Section 2.7, Section 4.3, Section 4.4, Appendix 2, Appendix 8, Appendix 9, Appendix 16
December 2017	SH(NA)-081562ENG-D	■Added or modified parts Appendix 2, Appendix 16
April 2018	SH(NA)-081562ENG-E	■Added or modified parts Section 3.2, Section 4.3, Appendix 16
July 2019	SH(NA)-081562ENG-F	■Added or modified parts CONSIDERATIONS FOR USE, Section 1.1, Section 2.2, Section 4.3, Appendix 16
April 2020	SH(NA)-081562ENG-G	■Added or modified parts Section 1.15, Section 2.8, Section 3.2, Section 4.5, Appendix 3, Appendix 5, Appendix 16
June 2020	SH(NA)-081562ENG-H	■Added or modified parts Section 4.3
October 2020	SH(NA)-081562ENG-I	■Added or modified parts SAFETY PRECAUTIONS, CONDITIONS OF USE FOR THE PRODUCT, Section 2.3, Section 4.4, Appendix 12
March 2022	SH(NA)-081562ENG-J	■Added or modified parts CONSIDERATIONS FOR USE, Section 1.5, Section 1.13, Section 2.4, Section 4.3, Appendix 3, Appendix 16
August 2022	SH(NA)-081562ENG-K	■Added or modified parts CONSIDERATIONS FOR USE, INTRODUCTION, Section 1.4, Section 1.9, Section 1.10, Section 2.2, Section 2.7, Section 4.3, Appendix 4, Appendix 9, Appendix 10, Appendix 16, Appendix 17, COPYRIGHTS
March 2023	SH(NA)-081562ENG-L	■Added or modified parts Section 2.4, Section 2.5, Section 4.3, Section 4.4, Appendix 5, Appendix 7, Appendix 9, Appendix 10, Appendix 12, Appendix 17

Japanese manual number: SH-081560-L

This manual confers no industrial property rights or any rights of any other kind, nor does it confer any patent licenses. Mitsubishi Electric Corporation cannot be held responsible for any problems involving industrial property rights which may occur as a result of using the contents noted in this manual.

© 2015 MITSUBISHI ELECTRIC CORPORATION

WARRANTY

Please confirm the following product warranty details before using this product.

1. Gratis Warranty Term and Gratis Warranty Range

If any faults or defects (hereinafter "Failure") found to be the responsibility of Mitsubishi occurs during use of the product within the gratis warranty term, the product shall be repaired at no cost via the sales representative or Mitsubishi Service Company.

However, if repairs are required onsite at domestic or overseas location, expenses to send an engineer will be solely at the customer's discretion. Mitsubishi shall not be held responsible for any re-commissioning, maintenance, or testing on-site that involves replacement of the failed module.

[Gratis Warranty Term]

The gratis warranty term of the product shall be for one year after the date of purchase or delivery to a designated place. Note that after manufacture and shipment from Mitsubishi, the maximum distribution period shall be six (6) months, and the longest gratis warranty term after manufacturing shall be eighteen (18) months. The gratis warranty term of repair parts shall not exceed the gratis warranty term before repairs.

[Gratis Warranty Range]

- (1) The range shall be limited to normal use within the usage state, usage methods and usage environment, etc., which follow the conditions and precautions, etc., given in the instruction manual, user's manual and caution labels on the product.
- (2) Even within the gratis warranty term, repairs shall be charged for in the following cases.
 1. Failure occurring from inappropriate storage or handling, carelessness or negligence by the user. Failure caused by the user's hardware or software design.
 2. Failure caused by unapproved modifications, etc., to the product by the user.
 3. When the Mitsubishi product is assembled into a user's device, Failure that could have been avoided if functions or structures, judged as necessary in the legal safety measures the user's device is subject to or as necessary by industry standards, had been provided.
 4. Failure that could have been avoided if consumable parts (battery, backlight, fuse, etc.) designated in the instruction manual had been correctly serviced or replaced.
 5. Failure caused by external irresistible forces such as fires or abnormal voltages, and Failure caused by force majeure such as earthquakes, lightning, wind and water damage.
 6. Failure caused by reasons unpredictable by scientific technology standards at time of shipment from Mitsubishi.
 7. Any other failure found not to be the responsibility of Mitsubishi or that admitted not to be so by the user.

2. Onerous repair term after discontinuation of production

- (1) Mitsubishi shall accept onerous product repairs for seven (7) years after production of the product is discontinued. Discontinuation of production shall be notified with Mitsubishi Technical Bulletins, etc.
- (2) Product supply (including repair parts) is not available after production is discontinued.

3. Overseas service

Overseas, repairs shall be accepted by Mitsubishi's local overseas FA Center. Note that the repair conditions at each FA Center may differ.

4. Exclusion of loss in opportunity and secondary loss from warranty liability

Regardless of the gratis warranty term, Mitsubishi shall not be liable for compensation to:

- (1) Damages caused by any cause found not to be the responsibility of Mitsubishi.
- (2) Loss in opportunity, lost profits incurred to the user by Failures of Mitsubishi products.
- (3) Special damages and secondary damages whether foreseeable or not, compensation for accidents, and compensation for damages to products other than Mitsubishi products.
- (4) Replacement by the user, maintenance of on-site equipment, start-up test run and other tasks.

5. Changes in product specifications

The specifications given in the catalogs, manuals or technical documents are subject to change without prior notice.

TRADEMARKS

Microsoft, Excel, Internet Explorer, Microsoft Edge, Visual Basic, and Windows are trademarks of the Microsoft group of companies.

Unicode is either a registered trademark or a trademark of Unicode, Inc. in the United States and other countries.

The company names, system names and product names mentioned in this manual are either registered trademarks or trademarks of their respective companies.

In some cases, trademark symbols such as [™] or [®] are not specified in this manual.

COPYRIGHTS

The screens (screenshots) are used in accordance with the Microsoft Corporation guideline.

SH(NA)-081562ENG-L(2303)KWIX

MODEL: RD81DL96-U-OU-E

MODEL CODE: 13JX41

MITSUBISHI ELECTRIC CORPORATION

HEAD OFFICE: TOKYO BLDG., 2-7-3, MARUNOUCHI, CHIYODA-KU, TOKYO 100-8310, JAPAN
NAGOYA WORKS: 1-14, YADA-MINAMI 5-CHOME, HIGASHI-KU, NAGOYA 461-8670, JAPAN

When exported from Japan, this manual does not require application to the
Ministry of Economy, Trade and Industry for service transaction permission.

Specifications subject to change without notice.