

Programmable Controller

MELSEC iQ-R
series

MELSEC iQ-R CC-Link IE TSN User's Manual (Startup)

-RJ71GN11-T2
-RJ71GN11-SX



SAFETY PRECAUTIONS

(Read these precautions before using this product.)

Before using this product, please read this manual and the relevant manuals carefully and pay full attention to safety to handle the product correctly.

The precautions given in this manual are concerned with this product only. For the safety precautions of the programmable controller system, refer to the MELSEC iQ-R Module Configuration Manual.

In this manual, the safety precautions are classified into two levels: "⚠️ WARNING" and "⚠️ CAUTION".

 WARNING	Indicates that incorrect handling may cause hazardous conditions, resulting in death or severe injury.
 CAUTION	Indicates that incorrect handling may cause hazardous conditions, resulting in minor or moderate injury or property damage.

Under some circumstances, failure to observe the precautions given under "⚠️ CAUTION" may lead to serious consequences.

Observe the precautions of both levels because they are important for personal and system safety.

Make sure that the end users read this manual and then keep the manual in a safe place for future reference.

[Design Precautions]

WARNING

- Configure safety circuits external to the programmable controller to ensure that the entire system operates safely even when a fault occurs in the external power supply or the programmable controller. Failure to do so may result in an accident due to an incorrect output or malfunction.
 - (1) Emergency stop circuits, protection circuits, and protective interlock circuits for conflicting operations (such as forward/reverse rotations or upper/lower limit positioning) must be configured external to the programmable controller.
 - (2) When the programmable controller detects an abnormal condition, it stops the operation and all outputs are:
 - Turned off if the overcurrent or overvoltage protection of the power supply module is activated.
 - Held or turned off according to the parameter setting if the self-diagnostic function of the CPU module detects an error such as a watchdog timer error.
 - (3) All outputs may be turned on if an error occurs in a part, such as an I/O control part, where the CPU module cannot detect any error. To ensure safety operation in such a case, provide a safety mechanism or a fail-safe circuit external to the programmable controller. For a fail-safe circuit example, refer to "General Safety Requirements" in the MELSEC iQ-R Module Configuration Manual.
 - (4) Outputs may remain on or off due to a failure of a component such as a relay and transistor in an output circuit. Configure an external circuit for monitoring output signals that could cause a serious accident.
 - In an output circuit, when a load current exceeding the rated current or an overcurrent caused by a load short-circuit flows for a long time, it may cause smoke and fire. To prevent this, configure an external safety circuit, such as a fuse.
 - Configure a circuit so that the programmable controller is turned on first and then the external power supply. If the external power supply is turned on first, an accident may occur due to an incorrect output or malfunction.
 - When the programmable controller is turned off, configure a circuit so that the external power supply is turned off first and then the programmable controller. If the programmable controller is turned off first, an accident may occur due to an incorrect output or malfunction.
 - For the operating status of each station after a communication failure, refer to manuals for the network used. For the manuals, please consult your local Mitsubishi representative. Incorrect output or malfunction due to a communication failure may result in an accident.
-

[Design Precautions]

WARNING

- When connecting an external device with a CPU module or intelligent function module to modify data of a running programmable controller, configure an interlock circuit in the program to ensure that the entire system will always operate safely. For other forms of control (such as program modification, parameter change, forced output, or operating status change) of a running programmable controller, read the relevant manuals carefully and ensure that the operation is safe before proceeding. Improper operation may damage machines or cause accidents. When a Safety CPU is used, data cannot be modified while the Safety CPU is in SAFETY MODE.
 - Especially, when a remote programmable controller is controlled by an external device, immediate action cannot be taken if a problem occurs in the programmable controller due to a communication failure. To prevent this, configure an interlock circuit in the program, and determine corrective actions to be taken between the external device and CPU module in case of a communication failure.
 - Do not write any data to the "system area" and "write-protect area" of the buffer memory in the module. Also, do not use any "use prohibited" signals as an output signal from the CPU module to each module. Doing so may cause malfunction of the programmable controller system. For the "system area", "write-protect area", and the "use prohibited" signals, refer to the user's manual for the module used. For areas used for safety communications, they are protected from being written by users, and thus safety communications failure caused by data writing does not occur.
 - If a communication cable is disconnected, the network may be unstable, resulting in a communication failure of multiple stations. Configure an interlock circuit in the program to ensure that the entire system will always operate safely even if communications fail. Incorrect output or malfunction due to a communication failure may result in an accident. When safety communications are used, an interlock by the safety station interlock function protects the system from an incorrect output or malfunction.
 - To maintain the safety of the programmable controller system against unauthorized access from external devices via the network, take appropriate measures. To maintain the safety against unauthorized access via the Internet, take measures such as installing a firewall.
-

[Design Precautions]

CAUTION

- Do not install the control lines or communication cables together with the main circuit lines or power cables. Doing so may result in malfunction due to electromagnetic interference. Keep a distance of 100mm or more between those cables.
 - During control of an inductive load such as a lamp, heater, or solenoid valve, a large current (approximately ten times greater than normal) may flow when the output is turned from off to on. Therefore, use a module that has a sufficient current rating.
 - After the CPU module is powered on or is reset, the time taken to enter the RUN status varies depending on the system configuration, parameter settings, and/or program size. Design circuits so that the entire system will always operate safely, regardless of the time.
 - Do not power off the programmable controller or reset the CPU module while the settings are being written. Doing so will make the data in the flash ROM and SD memory card undefined. The values need to be set in the buffer memory and written to the flash ROM and SD memory card again. Doing so also may cause malfunction or failure of the module.
 - When changing the operating status of the CPU module from external devices (such as the remote RUN/STOP functions), select "Do Not Open by Program" for "Opening Method" of "Module Parameter". If "Open by Program" is selected, an execution of the remote STOP function causes the communication line to close. Consequently, the CPU module cannot reopen the line, and external devices cannot execute the remote RUN function.
-

[Security Precautions]

WARNING

- To maintain the security (confidentiality, integrity, and availability) of the programmable controller and the system against unauthorized access, denial-of-service (DoS) attacks, computer viruses, and other cyberattacks from external devices via the network, take appropriate measures such as firewalls, virtual private networks (VPNs), and antivirus solutions.
-

[Installation Precautions]

WARNING

- Shut off the external power supply (all phases) used in the system before mounting or removing the module. Failure to do so may result in electric shock or cause the module to fail or malfunction.
-

[Installation Precautions]

CAUTION

- Use the programmable controller in an environment that meets the general specifications in the Safety Guidelines (IB-0800525). Failure to do so may result in electric shock, fire, malfunction, or damage to or deterioration of the product.
 - To mount a module, place the concave part(s) located at the bottom onto the guide(s) of the base unit, and push in the module until the hook(s) located at the top snaps into place. Incorrect interconnection may cause malfunction, failure, or drop of the module.
 - To mount a module with no module fixing hook, place the concave part(s) located at the bottom onto the guide(s) of the base unit, push in the module, and fix it with screw(s). Incorrect interconnection may cause malfunction, failure, or drop of the module.
 - When using the programmable controller in an environment of frequent vibrations, fix the module with a screw.
 - Tighten the screws within the specified torque range. Undertightening can cause drop of the component or wire, short circuit, or malfunction. Overtightening can damage the screw and/or module, resulting in drop, short circuit, or malfunction. For the specified torque range, refer to the MELSEC iQ-R Module Configuration Manual.
 - When using an extension cable, connect it to the extension cable connector of the base unit securely. Check the connection for looseness. Poor contact may cause malfunction.
 - When using an SD memory card, fully insert it into the SD memory card slot. Check that it is inserted completely. Poor contact may cause malfunction.
 - Securely insert an extended SRAM cassette or a battery-less option cassette into the cassette connector of the CPU module. After insertion, close the cassette cover and check that the cassette is inserted completely. Poor contact may cause malfunction.
 - Do not directly touch any conductive parts and electronic components of the module, SD memory card, extended SRAM cassette, battery-less option cassette, or connector. Doing so can cause malfunction or failure of the module.
-

[Wiring Precautions]

WARNING

- Shut off the external power supply (all phases) used in the system before installation and wiring. Failure to do so may result in electric shock or cause the module to fail or malfunction.
- After installation and wiring, attach a blank cover module (RG60) to each empty slot before powering on the system for operation. Also, attach an extension connector protective cover^{*1} to each unused extension cable connector as necessary. Directly touching any conductive parts of the connectors while power is on may result in electric shock.

*1 For details, please consult your local Mitsubishi Electric representative.

[Precautions for using CC-Link IE TSN (when optical fiber cables are used)]

- The optical transmitter and receiver of the CC-Link IE TSN master/local module (1000BASE-SX model) use laser diodes (class 1 in accordance with IEC 60825-1/JIS C6802). Do not look directly at a laser beam. Doing so may harm your eyes.
-

[Wiring Precautions]

CAUTION

- Individually ground the FG and LG terminals of the programmable controller with a ground resistance of 100 ohms or less. Failure to do so may result in electric shock or malfunction.
 - Use applicable solderless terminals and tighten them within the specified torque range. If any spade solderless terminal is used, it may be disconnected when the terminal screw comes loose, resulting in failure.
 - Check the rated voltage and signal layout before wiring to the module, and connect the cables correctly. Connecting a power supply with a different voltage rating or incorrect wiring may cause fire or failure.
 - Connectors for external devices must be crimped or pressed with the tool specified by the manufacturer, or must be correctly soldered. Incomplete connections may cause short circuit, fire, or malfunction.
 - Securely connect the connector to the module. Poor contact may cause malfunction.
 - Do not install the control lines or communication cables together with the main circuit lines or power cables. Doing so may result in malfunction due to noise. Keep a distance of 100mm or more between those cables. (Except for the RJ71GN11-SX)
 - Place the cables in a duct or clamp them. If not, dangling cables may swing or inadvertently be pulled, resulting in malfunction or damage to modules or cables.
In addition, the weight of the cables may put stress on modules in an environment of strong vibrations and shocks.
Do not clamp the extension cables with the jacket stripped. Doing so may change the characteristics of the cables, resulting in malfunction.
 - Check the interface type and correctly connect the cable. Incorrect wiring (connecting the cable to an incorrect interface) may cause failure of the module and external device.
-

[Wiring Precautions]

CAUTION

- Tighten the terminal screws or connector screws within the specified torque range. Undertightening can cause drop of the screw, short circuit, fire, or malfunction. Overtightening can damage the screw and/or module, resulting in drop, short circuit, fire, or malfunction.
- When disconnecting the cable from the module, do not pull the cable by the cable part. For the cable with connector, hold the connector part of the cable. For the cable connected to the terminal block, loosen the terminal screw. Pulling the cable connected to the module may result in malfunction or damage to the module or cable.
- Prevent foreign matter such as dust or wire chips from entering the module. Such foreign matter can cause a fire, failure, or malfunction.
- When a protective film is attached to the top of the module, remove it before system operation. If not, inadequate heat dissipation of the module may cause a fire, failure, or malfunction.
- Programmable controllers must be installed in control panels. Connect the main power supply to the power supply module in the control panel through a relay terminal block. Wiring and replacement of a power supply module must be performed by qualified maintenance personnel with knowledge of protection against electric shock. For wiring, refer to the MELSEC iQ-R Module Configuration Manual.
- For Ethernet cables to be used in the system, select the ones that meet the specifications in the user's manual for the module used. If not, normal data transmission is not guaranteed.

[Precautions for using CC-Link IE TSN (when optical fiber cables are used)]

- For optical fiber cables to be used in the system, select the ones that meet the specifications in the MELSEC iQ-R CC-Link IE TSN User's Manual (Startup). If not, normal data transmission is not guaranteed.

[Startup and Maintenance Precautions]

WARNING

- Do not touch any terminal while power is on. Doing so will cause electric shock or malfunction.
 - Correctly connect the battery connector. Do not charge, disassemble, heat, short-circuit, solder, or throw the battery into the fire. Also, do not expose it to liquid or strong shock. Doing so will cause the battery to produce heat, explode, ignite, or leak, resulting in injury and fire.
 - Shut off the external power supply (all phases) used in the system before cleaning the module or retightening the terminal screws, connector screws, or module fixing screws. Failure to do so may result in electric shock.
-

[Startup and Maintenance Precautions]

CAUTION

- When connecting an external device with a CPU module or intelligent function module to modify data of a running programmable controller, configure an interlock circuit in the program to ensure that the entire system will always operate safely. For other forms of control (such as program modification, parameter change, forced output, or operating status change) of a running programmable controller, read the relevant manuals carefully and ensure that the operation is safe before proceeding. Improper operation may damage machines or cause accidents.
 - Especially, when a remote programmable controller is controlled by an external device, immediate action cannot be taken if a problem occurs in the programmable controller due to a communication failure. To prevent this, configure an interlock circuit in the program, and determine corrective actions to be taken between the external device and CPU module in case of a communication failure.
 - Do not disassemble or modify the modules. Doing so may cause failure, malfunction, injury, or a fire.
 - Use any radio communication device such as a cellular phone or PHS (Personal Handy-phone System) 25cm or more away in all directions from the programmable controller. Failure to do so may cause malfunction.
 - Shut off the external power supply (all phases) used in the system before mounting or removing the module. Failure to do so may cause the module to fail or malfunction.
 - Tighten the screws within the specified torque range. Undertightening can cause drop of the component or wire, short circuit, or malfunction. Overtightening can damage the screw and/or module, resulting in drop, short circuit, or malfunction.
 - After the first use of the product, do not perform each of the following operations more than 50 times (IEC 61131-2/JIS B 3502 compliant).
Exceeding the limit may cause malfunction.
 - Mounting/removing the module to/from the base unit
 - Inserting/removing the extended SRAM cassette or battery-less option cassette to/from the CPU module
 - Mounting/removing the terminal block to/from the module
 - After the first use of the product, do not insert/remove the SD memory card to/from the CPU module more than 500 times. Exceeding the limit may cause malfunction.
 - Do not touch the metal terminals on the back side of the SD memory card. Doing so may cause malfunction or failure of the module.
 - Do not touch the integrated circuits on the circuit board of an extended SRAM cassette or a battery-less option cassette. Doing so may cause malfunction or failure of the module.
 - Do not drop or apply shock to the battery to be installed in the module. Doing so may damage the battery, causing the battery fluid to leak inside the battery. If the battery is dropped or any shock is applied to it, dispose of it without using.
-

[Startup and Maintenance Precautions]

CAUTION

- Startup and maintenance of a control panel must be performed by qualified maintenance personnel with knowledge of protection against electric shock. Lock the control panel so that only qualified maintenance personnel can operate it.
 - Before handling the module, touch a conducting object such as a grounded metal to discharge the static electricity from the human body. Wearing a grounded antistatic wrist strap is recommended. Failure to discharge the static electricity may cause the module to fail or malfunction.
 - After unpacking, eliminate static electricity from the module to prevent electrostatic discharge from affecting the module. If an electrostatically charged module comes in contact with a grounded metal object, a sudden electrostatic discharge of the module may cause failure. For details on how to eliminate static electricity from the module, refer to the following.
Antistatic Precautions Before Using MELSEC iQ-R Series Products (FA-A-0368)
 - Use a clean and dry cloth to wipe off dirt on the module.
-

[Operating Precautions]

CAUTION

- When changing data and operating status, and modifying program of the running programmable controller from an external device such as a personal computer connected to an intelligent function module, read relevant manuals carefully and ensure the safety before operation. Incorrect change or modification may cause system malfunction, damage to the machines, or accidents.
 - Do not power off the programmable controller or reset the CPU module while the setting values in the buffer memory are being written to the flash ROM in the module. Doing so will make the data in the flash ROM and SD memory card undefined. The values need to be set in the buffer memory and written to the flash ROM and SD memory card again. Doing so can cause malfunction or failure of the module.
-

[Disposal Precautions]

CAUTION

- When disposing of this product, treat it as industrial waste.
 - When disposing of batteries, separate them from other wastes according to the local regulations. For details on battery regulations in EU member states, refer to the MELSEC iQ-R Module Configuration Manual.
-

[Transportation Precautions]

CAUTION

- When transporting lithium batteries, follow the transportation regulations. For details on the regulated models, refer to the MELSEC iQ-R Module Configuration Manual.
 - The halogens (such as fluorine, chlorine, bromine, and iodine), which are contained in a fumigant used for disinfection and pest control of wood packaging materials, may cause failure of the product. Prevent the entry of fumigant residues into the product or consider other methods (such as heat treatment) instead of fumigation. The disinfection and pest control measures must be applied to unprocessed raw wood.
-

CONDITIONS OF USE FOR THE PRODUCT

(1) MELSEC programmable controller ("the PRODUCT") shall be used in conditions;

- i) where any problem, fault or failure occurring in the PRODUCT, if any, shall not lead to any major or serious accident; and
- ii) where the backup and fail-safe function are systematically or automatically provided outside of the PRODUCT for the case of any problem, fault or failure occurring in the PRODUCT.

(2) The PRODUCT has been designed and manufactured for the purpose of being used in general industries.

MITSUBISHI ELECTRIC SHALL HAVE NO RESPONSIBILITY OR LIABILITY (INCLUDING, BUT NOT LIMITED TO ANY AND ALL RESPONSIBILITY OR LIABILITY BASED ON CONTRACT, WARRANTY, TORT, PRODUCT LIABILITY) FOR ANY INJURY OR DEATH TO PERSONS OR LOSS OR DAMAGE TO PROPERTY CAUSED BY THE PRODUCT THAT ARE OPERATED OR USED IN APPLICATION NOT INTENDED OR EXCLUDED BY INSTRUCTIONS, PRECAUTIONS, OR WARNING CONTAINED IN MITSUBISHI ELECTRIC USER'S, INSTRUCTION AND/OR SAFETY MANUALS, TECHNICAL BULLETINS AND GUIDELINES FOR the PRODUCT.

("Prohibited Application")

Prohibited Applications include, but not limited to, the use of the PRODUCT in;

- Nuclear Power Plants and any other power plants operated by Power companies, and/or any other cases in which the public could be affected if any problem or fault occurs in the PRODUCT.
- Railway companies or Public service purposes, and/or any other cases in which establishment of a special quality assurance system is required by the Purchaser or End User.
- Aircraft or Aerospace, Medical applications, Train equipment, transport equipment such as Elevator and Escalator, Incineration and Fuel devices, Vehicles, Manned transportation, Equipment for Recreation and Amusement, and Safety devices, handling of Nuclear or Hazardous Materials or Chemicals, Mining and Drilling, and/or other applications where there is a significant risk of injury to the public or property.

Notwithstanding the above restrictions, Mitsubishi Electric may in its sole discretion, authorize use of the PRODUCT in one or more of the Prohibited Applications, provided that the usage of the PRODUCT is limited only for the specific applications agreed to by Mitsubishi Electric and provided further that no special quality assurance or fail-safe, redundant or other safety features which exceed the general specifications of the PRODUCTS are required. For details, please contact the Mitsubishi Electric representative in your region.

(3) Mitsubishi Electric shall have no responsibility or liability for any problems involving programmable controller trouble and system trouble caused by DoS attacks, unauthorized access, computer viruses, and other cyberattacks.

INTRODUCTION

Thank you for purchasing the Mitsubishi Electric MELSEC iQ-R series programmable controllers.

This manual describes the procedures, system configuration, and wiring of the relevant product listed below.

Before using this product, please read this manual and the relevant manuals carefully and develop familiarity with the functions and performance of the MELSEC iQ-R series programmable controller to handle the product correctly.

When applying the program examples provided in this manual to an actual system, ensure the applicability and confirm that it will not cause system control problems.

Note that the menu names and operating procedures may differ depending on an operating system in use and its version.

When reading this manual, replace the names and procedures with the applicable ones as necessary.

Please make sure that the end users read this manual.

Relevant product

RJ71GN11-T2

RJ71GN11-SX

COMPLIANCE WITH EMC AND LOW VOLTAGE DIRECTIVES

Method of ensuring compliance

To ensure that Mitsubishi Electric programmable controllers maintain the EMC and Low Voltage Directives or other regulations when incorporated into other machinery or equipment, certain measures may be necessary. Please refer to one of the following manuals.

- MELSEC iQ-R Module Configuration Manual (SH-081262ENG)
- Safety Guidelines (IB-0800525)

Certification marks on the side of the programmable controller indicate compliance with the relevant regulations.

Additional measures

To ensure that this product maintains the EMC and Low Voltage Directives or other regulations, please refer to the following.

- MELSEC iQ-R Module Configuration Manual (SH-081262ENG)
- Safety Guidelines (IB-0800525)

CONTENTS

SAFETY PRECAUTIONS	1
CONDITIONS OF USE FOR THE PRODUCT	11
INTRODUCTION	12
COMPLIANCE WITH EMC AND LOW VOLTAGE DIRECTIVES	12
RELEVANT MANUALS	15
TERMS	16
GENERIC TERMS AND ABBREVIATIONS	17
CHAPTER 1 PART NAMES	18
1.1 RJ71GN11-T2	18
1.2 RJ71GN11-SX	20
CHAPTER 2 SPECIFICATIONS	22
2.1 Performance Specifications of CC-Link IE TSN	22
2.2 Performance Specifications of Ethernet	24
2.3 Hardware Specifications	24
CHAPTER 3 FUNCTION LIST	25
CHAPTER 4 PROCEDURES BEFORE OPERATION	30
CHAPTER 5 SYSTEM CONFIGURATION (RJ71GN11-T2)	32
5.1 Structure with CC-Link IE TSN Class B Devices Only	34
Connectable devices (for unicast mode)	35
Connectable devices (for multicast mode)	36
Structure with modules on CC-Link IE TSN only	38
Structure with modules on CC-Link IE TSN and Ethernet devices	43
5.2 Structure with CC-Link IE TSN Class B/A Devices	45
Connectable devices (for unicast mode)	47
Connectable devices (for multicast mode)	49
Structure with modules on CC-Link IE TSN only	51
Structure with modules on CC-Link IE TSN and Ethernet devices	60
5.3 Structure of the CC-Link IE TSN and CC-Link IE Field Network	62
5.4 Structure When CC-Link IE TSN Communication Software Is Used	63
5.5 Precautions for System Configuration	65
CHAPTER 6 SYSTEM CONFIGURATION (RJ71GN11-SX)	67
CHAPTER 7 WIRING	69
7.1 Ethernet Cables	69
Wiring methods	69
Wiring products	70
7.2 Switching Hub (RJ71GN11-T2 Only)	70
7.3 Optical Fiber Cables	71
Wiring methods	71
Wiring products	71

CHAPTER 8 COMMUNICATION EXAMPLES	72
8.1 RJ71GN11-T2 Communication Example	72
System configuration	72
Link device assignment	72
Setting in the master station	76
Settings in the local stations	79
Checking the network status	81
Program example (At unicast mode)	82
Program example (At multicast mode)	86
8.2 RJ71GN11-SX Communication Example	90
System configuration	90
Link device assignment	90
Setting in the master station	92
Settings in the local stations	96
Checking the network status	98
Program examples	99
APPENDICES	107
Appendix 1 System Configuration with CC-Link IE TSN Class B/A Devices (Protocol Version 2.0/1.0) (RJ71GN11-T2)	107
Device time synchronization method and connection specifications	108
Appendix 2 System Configuration with CC-Link IE TSN Class B/A Devices (Protocol Version 1.0 Only) (RJ71GN11-T2)	111
Connectable devices (for unicast mode)	113
Connectable devices (for multicast mode)	115
Structure with modules on CC-Link IE TSN only	117
Structure with modules on CC-Link IE TSN and Ethernet devices	125
Appendix 3 External Dimensions	127
RJ71GN11-T2	127
RJ71GN11-SX	127
INDEX	128
REVISIONS	130
WARRANTY	131
TRADEMARKS	132

RELEVANT MANUALS

Manual name [manual number]	Description	Available form
MELSEC iQ-R CC-Link IE TSN User's Manual (Startup) [SH-082127ENG] (this manual)	Specifications, procedures before operation, system configuration, wiring, and communication examples of CC-Link IE TSN	Print book e-Manual PDF
MELSEC iQ-R Module Configuration Manual [SH-081262ENG]	The combination of the MELSEC iQ-R series modules, common information on the installation/wiring in the system, and specifications of the power supply module, base unit, SD memory card, and battery	Print book e-Manual PDF
MELSEC iQ-R CC-Link IE TSN User's Manual (Application) [SH-082129ENG]	Functions, parameter settings, troubleshooting, I/O signals, and buffer memory of CC-Link IE TSN	Print book e-Manual PDF
MELSEC iQ-R Programming Manual (Module Dedicated Instructions) [SH-081976ENG]	Dedicated instructions for the intelligent function modules	e-Manual PDF
MELSEC iQ-R Ethernet, CC-Link IE, and MELSECNET/H Function Block Reference [BCN-P5999-0381]	Specifications of the following MELSEC iQ-R series module FBs: Ethernet-equipped module FBs, CC-Link IE TSN module FBs, CC-Link IE Controller Network module FBs, CC-Link IE Field Network module FBs, and MELSECNET/H network module FBs	e-Manual PDF
GX Works3 Operating Manual [SH-081215ENG]	System configuration, parameter settings, and online operations of GX Works3	e-Manual PDF
SLMP Reference Manual [SH-080956ENG]	The protocol used to access an SLMP-compatible device from an external device (such as a personal computer or HMI (Human Machine Interface)) or an SLMP-compatible module (such as the Ethernet-equipped module or modules on CC-Link IE TSN)	Print book e-Manual PDF
CC-Link IE TSN Industrial Managed Ethernet Switch User's Manual [SH-082449ENG]	Specifications, procedures before operation, system configuration, installation, wiring, parameter settings, functions, and troubleshooting of the managed switch	Print book e-Manual PDF
MELSEC iQ-R System Recorder Co-recording Function Reference Manual [SH-082553ENG]	Function, system configuration, parameter settings, and troubleshooting for co-recording	e-Manual PDF

This manual does not include detailed information on the following:

- General specifications
- Applicable combinations of CPU modules and the other modules, and the number of mountable modules
- Installation

For details, refer to the following.

 MELSEC iQ-R Module Configuration Manual

Point



e-Manual refers to the Mitsubishi Electric FA electronic book manuals that can be browsed using a dedicated tool.

e-Manual has the following features:

- Required information can be cross-searched in multiple manuals.
- Other manuals can be accessed from the links in the manual.
- The hardware specifications of each part can be found from the product figures.
- Pages that users often browse can be bookmarked.
- Sample programs can be copied to an engineering tool.

TERMS

Unless otherwise specified, this manual uses the following terms.

Term	Description
Buffer memory	Memory in an intelligent function module to store data such as setting values and monitor values. For CPU modules, it refers to memory to store data such as setting values and monitor values of the Ethernet function, or data used for data communication of the multiple CPU system function.
CC-Link IE TSN Class ^{*1}	A group of devices and switching hubs compatible with CC-Link IE TSN, ranked according to the functions and performance by the CC-Link Partner Association. For CC-Link IE TSN Class, refer to the CC-Link IE TSN Installation Manual (BAP-C3007ENG-001) published by the CC-Link Partner Association.
CC-Link IE TSN Protocol version 1.0	This protocol is used to perform communications by using the time sharing method defined by IEEE 802.1AS or IEEE 1588 for time synchronization.
CC-Link IE TSN Protocol version 2.0	This protocol is used to perform communications by using the time sharing method defined by IEEE 802.1AS and time-managed polling method for time synchronization. Supporting this protocol version mitigates restrictions when "Mixture of CC-Link IE TSN Class B/A or CC-Link IE TSN Class A Only" is set in the system configuration, and increases the number of connectable devices.
Dedicated instruction	An instruction that simplifies programming for using functions of intelligent function modules
Device	A memory of a CPU module to store data. Devices such as X, Y, M, D, and others are provided depending on the intended use.
Device station	A station other than a master station: a local station and a remote station
Engineering tool	A tool used for setting up programmable controllers, programming, debugging, and maintenance
General-purpose hub	A CC-Link IE TSN Class A switching hub authorized by the CC-Link Partner Association ( Page 70 Switching Hub (RJ71GN11-T2 Only))
Global label	A label that is valid for all the program data when multiple program data are created in the project. There are two types of global label: a module specific label (module label), which is generated automatically by GX Works3, and an optional label, which can be created for any specified device.
Intelligent function module	A module that has functions other than an input or output, such as an A/D converter module and D/A converter module
Link device	A device (RX, RY, RWr, RWw, LB, or LW) in a module on CC-Link IE TSN.
Link refresh	Processing of data transfer between link devices of the network module and CPU module devices. Link refresh is performed in "END processing" of the sequence scan of the CPU module.
Local station	A station that performs cyclic transmission and transient transmission with the master station and other local stations
Master station	A station that controls the entire network. This station can perform cyclic transmission and transient transmission with all stations. Only one master station can be used in a network.
Module label	A label that represents one of memory areas (I/O signals and buffer memory areas) specific to each module in a given character string. For the module used, GX Works3 automatically generates this label, which can be used as a global label.
Multicast filter	A filter function that selects whether to send cyclic data of multicast mode received by the own station to the subsequent stations. Setting parameters for this function are not required because the master station automatically sets the parameters according to the system configuration.
Multicast mode	A communication mode used to send cyclic data to multiple stations
Relay station	A station in which multiple network modules are mounted on one programmable controller to relay data link to other stations
Remote station	A station that exchanges I/O signals (bit data) and I/O data (word data) with another station by cyclic transmission. This station can perform transient transmission.
Safety communications	A function to exchange safety data between safety stations on the same network
Safety connection	A connection established for safety communication
Safety data	Data exchanged through safety communication
SLMP	SeamLess Message Protocol. This protocol is used to access an SLMP-compatible device or a programmable controller connected to an SLMP-compatible device from an external device.
Standard communications	Communications other than safety communications, such as cyclic transmission and transient transmission of CC-Link IE TSN
TSN hub	A CC-Link IE TSN Class B switching hub authorized by the CC-Link Partner Association ( Page 70 Switching Hub (RJ71GN11-T2 Only))
Unicast mode	A communication mode used to send cyclic data to one station



*1 The term has been changed for standardization among manuals and software applications related to CC-Link IE TSN. However, the term used in some CC-Link IE TSN related software windows may remain unchanged and may be different from the term used in this manual.

In case of inconsistency, refer to the following.

Term used in software window	Term after change
Authentication Class	CC-Link IE TSN Class

GENERIC TERMS AND ABBREVIATIONS

Unless otherwise specified, this manual uses the following generic terms and abbreviations.

Generic term/abbreviation	Description
CC-Link IE	A generic term for the following items: <ul style="list-style-type: none"> • CC-Link IE TSN • CC-Link IE Controller Network ( MELSEC iQ-R CC-Link IE Controller Network User's Manual (Application)) • CC-Link IE Field Network ( MELSEC iQ-R CC-Link IE Field Network User's Manual (Application))
CC-Link IE Field Network-equipped master/local module	A generic term for the RJ71GF11-T2 CC-Link IE Field Network master/local module and the following modules when the CC-Link IE Field Network function is used: <ul style="list-style-type: none"> • RJ71EN71 • RnENCPU
Data link	A generic term for cyclic transmission and transient transmission
Ethernet device	A generic term for the devices supporting IP communication (such as a personal computer, a vision sensor, and a bar code reader)
Ethernet-equipped module	A generic term for the following modules when the Ethernet function is used: <ul style="list-style-type: none"> • RJ71EN71 • CPU module
LB	An abbreviation for a link relay of a link device. Bit data sent from each station of the network.
LW	An abbreviation for a link register of a link device. Word data sent from each station of the network.
Network module	A generic term for the following modules: <ul style="list-style-type: none"> • Ethernet interface module • A module on CC-Link IE TSN (a CC-Link IE TSN master/local module, a CC-Link IE TSN master/local module (1000BASE-SX model), a CC-Link IE TSN Plus master/local module, and a module on a remote station) • CC-Link IE Controller Network module • A module on CC-Link IE Field Network (a master/local module, and a module on a remote I/O station, a remote device station, and an intelligent device station) • MELSECNET/H network module • MELSECNET/10 network module • RnENCPU (network part)
Protocol version	An abbreviation for CC-Link IE TSN Protocol version
RJ71GN11	A generic term for the RJ71GN11-T2 and RJ71GN11-SX
RWr	An abbreviation for a remote register of a link device. Word data (16-bit data) input from a device station to the master station. (For some areas in a local station, data are input in the opposite direction.)
RWw	An abbreviation for a remote register of a link device. Word data (16-bit data) output from the master station to a device station (For some areas in a local station, data are output in the opposite direction.)
RX	An abbreviation for remote input of a link device. Bit data input from a device station to the master station. (For some areas in a local station, data are input in the opposite direction.)
RY	An abbreviation for remote output of a link device. Bit data output from the master station to a device station (For some areas in a local station, data are output in the opposite direction.)
Safety CPU	A generic term for the R08SFCPU, R16SFCPU, R32SFCPU, and R120SFCPU
Safety station	A generic term for a station that performs safety communications and standard communications
SB	An abbreviation for a link special relay. Bit data that indicates the operating status and data link status of a module on CC-Link IE.
SW	An abbreviation for a link special register. Word data that indicates the operating status and data link status of a module on CC-Link IE.

1 PART NAMES

1.1 RJ71GN11-T2

This chapter describes the names of each part of the RJ71GN11-T2.

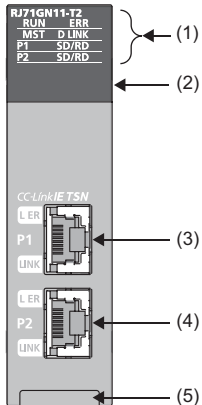

No.	Name	Description
(1)	RUN LED	Indicates the operating status. On: Normal operation Off: Error (MELSEC iQ-R CC-Link IE TSN User's Manual (Application))
	ERR LED ^{*1}	Indicates the error status of the module. (MELSEC iQ-R CC-Link IE TSN User's Manual (Application)) On: Error detected in all stations ^{*2} Flashing (500ms interval): Data link faulty station detected <ul style="list-style-type: none"> • Unicast mode: Flashing only at the master station • Multicast mode: Flashing at the master station and local station. However, the LED does not flash at the local station if a data link error occurs at the CC-Link IE TSN Class A remote station during data link. (The LED remains off.) Flashing (200ms interval): Error Off: Normal operation
	MST LED	Indicates the operating status. On: Operating as a master station Off: Operating as a local station
	D LINK LED ^{*1}	Indicates the cyclic transmission status. On: Cyclic transmission being performed Flashing: Cyclic transmission stopped Off: Disconnected
	P1 SD/RD LED	Indicates the data sending/receiving status. On: Data being sent or received Off: Data not sent nor received
	P2 SD/RD LED	
(2)	Dot matrix LED	Displays the station number set for the module. Station number or parameter not set: "— — —" Master station: 0 Local station: 1 to 120 ■ In module communication test mode Displays the module communication test result. (MELSEC iQ-R CC-Link IE TSN User's Manual (Application)) ■ In offline mode Displays "...". ■ When the module status setting is "Empty" Nothing is displayed.
(3)	P1	Port for CC-Link IE TSN connection. Connect an Ethernet cable. For wiring methods and wiring precautions, refer to the following. (Page 69 WIRING)
	L ER LED ^{*1}	Indicates the port status. On: Abnormal data received or loopback being performed ^{*3} Off: Normal data received and loopback not performed
	LINK LED	Indicates the link status. On: Link-up Off: Link-down

No.	Name	Description
(4)	P2	Same as P1
	L ER LED*1	
	LINK LED	
(5)	Production information marking	Shows the production information (16 digits) of the module.

*1 The LED is always off in offline mode.

*2 If used as a local station, the ERR LED may turn on and remain on until the module is refreshed with the CPU module normally ('Data link error status of own station' (SB0049) is turned off (normal)) after the system is started and the first cyclic transmission starts.

*3 If a station for which loopback is being performed is a station whose station number has not been set, the L ER LED of that station turns on.

If a station whose station number has not been set enters the ring structure, the L ER LED of the loopback station does not turn on.

1.2 RJ71GN11-SX

This section describes the names of each part of the RJ71GN11-SX.

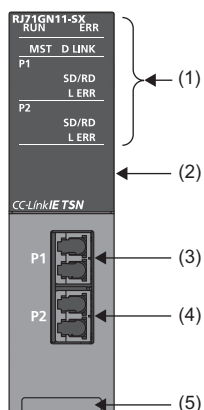

No.	Name	Description	
(1)	RUN LED	Indicates the operating status. On: Normal operation Off: Error (☐ MELSEC iQ-R CC-Link IE TSN User's Manual (Application))	
	ERR LED ^{*1}	Indicates the error status of the module. (☐ MELSEC iQ-R CC-Link IE TSN User's Manual (Application)) On: Error detected in all stations ^{*3} Flashing (500ms interval): Data link faulty station detected • Unicast mode: Flashing only at the master station • Multicast mode: Flashing at the master station and local station. Flashing (200ms interval): Error Off: Normal operation	
	MST LED	Indicates the operating status. On: Operating as a master station, or a local station is currently operating as a master station Off: Operating as a local station	
	D LINK LED ^{*1}	Indicates the cyclic transmission status. On: Cyclic transmission being performed Flashing: Cyclic transmission stopped Off: Disconnected	
	P1	SD/RD LED	Indicates the data sending/receiving status. On: Data being sent or received Off: Data not sent nor received
		L ERR LED ^{*1}	Indicates the line error status. (☐ MELSEC iQ-R CC-Link IE TSN User's Manual (Application)) On: The following errors are occurring in the line connected to the own station port. • A receive data is faulty (receive frame error). • Loopback is performed in the own station. ^{*2} Off: The module or line is in the following status. • A received data is normal (receive frame normal) • Loopback is not performed in the own station.
P2	SD/RD LED	Same as P1	
	L ERR LED ^{*1}		
(2)	Dot matrix LED	Displays the station number set for the module. Station number or parameter not set: "— — —" Master station: 0 Local station: 1 to 120 ■ In module communication test mode Displays the module communication test result. (☐ MELSEC iQ-R CC-Link IE TSN User's Manual (Application)) ■ In offline mode Displays "...".	
(3)	P1	Port for CC-Link IE TSN connection. Connect an optical fiber cable. (☞ Page 69 WIRING)	
(4)	P2	Same as P1	
(5)	Production information marking	Shows the production information (16 digits) of the module.	

*1 The LED is always off in offline mode.

*2 The L ERR LED does not turn on for loopback stations whose station number has not been set.

If a station whose station number has not been set enters the ring structure, the L ERR LED of the loopback station does not turn on.

*3 If used as a local station, the ERR LED may turn on and remain on until the CPU module is refreshed normally ('Data link error status of own station' (SB0049) is turned off (normal)) after the system is started and the first cyclic transmission starts.

2 SPECIFICATIONS

2.1 Performance Specifications of CC-Link IE TSN

The following table lists the performance specifications of CC-Link IE TSN of the RJ71GN11.

Item		RJ71GN11-T2	RJ71GN11-SX	
Maximum number of link points per network ^{*1}	RX	16K points (16384 points, 2K bytes)	16K points (16384 points, 2K bytes) ^{*4}	
	RY	16K points (16384 points, 2K bytes)	16K points (16384 points, 2K bytes) ^{*4}	
	RWr	8K points (8192 points, 16K bytes)	8K points (8192 points, 16K bytes) ^{*4}	
	RWw	8K points (8192 points, 16K bytes)	8K points (8192 points, 16K bytes) ^{*4}	
	LB		32K points (32768 points, 4K bytes)	
			—	When the number of link points is extended: 128K points (131072 points, 16K bytes)
LW		16K points (16384 points, 32K bytes)		
		—	When the number of link points is extended: 512K points (524288 points, 1024K bytes)	
Maximum number of link points per station (Master station and local stations)	RX	16K points (16384 points, 2K bytes)	16K points (16384 points, 2K bytes) ^{*4}	
	RY	16K points (16384 points, 2K bytes)	16K points (16384 points, 2K bytes) ^{*4}	
	RWr	8K points (8192 points, 16K bytes)	8K points (8192 points, 16K bytes) ^{*4}	
	RWw	8K points (8192 points, 16K bytes)	8K points (8192 points, 16K bytes) ^{*4}	
	LB		32K points (32768 points, 4K bytes)	
			—	When the number of link points is extended: 128K points (131072 points, 16K bytes)
LW		16K points (16384 points, 32K bytes)		
		—	When the number of link points is extended: 512K points (524288 points, 1024K bytes)	
Transient transmission capacity		Maximum 1920 bytes		
Safety communications ^{*2}	Maximum number of safety connections per station	<ul style="list-style-type: none"> • Master station: 120 connections • Local station: 1 connection 	—	
	Maximum number of safety connections per the same communication destination station	1 connection	—	
	Maximum number of link points per safety connection	<ul style="list-style-type: none"> • Input: 8 words • Output: 8 words 	—	
Communication speed		<ul style="list-style-type: none"> • 1Gbps • 100Mbps^{*2} 	1Gbps	
Minimum synchronization cycle		125.00μs		
CC-Link IE TSN Class		CC-Link IE TSN Class B device		
CC-Link IE TSN Protocol version		Protocol version 2.0/1.0 ^{*3}		
Communication method		Time sharing method/time-managed polling method	Time sharing method	
Laser class (JIS C6802, IEC 60825-1)		—	Class 1 laser product	
Network topology		Line topology, star topology, coexistence of line and star topologies, ring topology	Ring topology	
Communication cable		Ethernet cable which satisfies standard: (☞ Page 70 Wiring products)	Optical fiber cable which satisfies standard: (☞ Page 71 Wiring products)	
Maximum station-to-station distance		100m	550m	
Overall cable distance	Line topology	12000m (when 121 stations are connected)	—	
	Ring topology	12100m (when 121 stations are connected)	66550m (when 121 stations are connected)	
	Others	Depends on the system configuration.		
Maximum number of connectable stations		121 stations (master station: 1, device stations: 120, extension modules included)	121 stations (master station: 1, local stations: 120)	
Maximum number of connectable CC-Link IE TSN Communication Software		2 ^{*2}	—	
Maximum number of networks		239		

Item	RJ71GN11-T2	RJ71GN11-SX
Multicast filter	Supported	

- *1 The maximum number of points for all link devices may not be used simultaneously depending on the number of device stations, or the number of points and assignments of the link devices that are set in the "CC-Link IE TSN Configuration" window.
- *2 Availability depends on the firmware version. (📖 MELSEC iQ-R CC-Link IE TSN User's Manual (Application))
- *3 If the remote station is protocol version 1.0, it may operate under protocol version 1.0.
- *4 When using the master station switch function, cyclic transmission cannot be performed using RX, RY, RWw, and RWr. The number of points for RX, RY, RWw, and RWr is 0.

2.2 Performance Specifications of Ethernet

The following table lists the performance specifications of Ethernet of the RJ71GN11-T2.

Item		Description	
Transmission specifications	Data transmission speed	<ul style="list-style-type: none"> • 1Gbps • 100Mbps*4 	
	Communication mode	<ul style="list-style-type: none"> • 1000BASE-T • 100BASE-TX*4 Full-duplex	
	Interface	RJ45 connector (Auto MDI/MDI-X)	
	Maximum frame size	1518 bytes	
	Jumbo frame	Not available	
	Maximum segment length	100m (distance between a switching hub and a station)*1	
	Number of cascade connections	*2	
	IP version	Compatible with IPv4	
Sending/receiving data storage memory	Number of simultaneous open connections (maximum number of connections)	Connection with MELSOFT products and a GOT	8 connections*3
		Connection to SLMP-compatible devices	8 connections*3

*1 For maximum segment length (length between switching hubs), consult the manufacturer of the switching hub used.

*2 Consult the manufacturer of the switching hub used.

*3 When one connection is for one device, up to eight devices can be connected.

*4 This speed can be used for the firmware version "04" or later.

Point

The operation of commercial devices used for the following applications is not guaranteed. Check the operation before using the module.

- Internet (general public line) (Internet-access service offered by an Internet service provider or a telecommunications carrier)
- Firewall device(s)
- Broadband router(s)
- Wireless LAN

2.3 Hardware Specifications

The following table lists the hardware specifications for the RJ71GN11-T2 and the RJ71GN11-SX.

Item		RJ71GN11-T2	RJ71GN11-SX
Number of occupied I/O points		32 points (I/O assignment: Intelligent 32 points)	
Internal current consumption (5VDC)		0.81A	0.80A
External dimensions	Height	106mm (Base unit mounting side: 98mm)	
	Width	27.8mm	
	Depth	110mm	
Weight		0.2kg	0.17kg

3 FUNCTION LIST

The following table lists the functions of CC-Link IE TSN. For details on these functions, refer to the following.

📖 MELSEC iQ-R CC-Link IE TSN User's Manual (Application)

The ○, △, and × symbols in the table have the following meanings.

○: Available, △: Partially available, ×: Not available

Cyclic transmission

This function allows periodic data communications among stations on the network using link devices.

Function		Description	RJ71GN11-T2		RJ71GN11-SX	
			Master station	Local station	Master station	Local station
Communications using RX, RY, RWr, and RWw		This allows data to be exchanged in units of bits and in units of words between the master station and device station.	○	○	○	○
Communications using LB and LW		Communicates data in units of bits and words between the master station and local stations.	○	○	○	○
Link points extended		Extend the maximum number of link points per network. LB: 32K points → 128K points, LW: 16K points → 512K points	×	×	○	○
Link refresh		Automatically transfers data between the link devices of the RJ71GN11 and the devices of the CPU module.	○	○	○	○
Direct access to link devices		The corresponding data is directly read or written from/to link devices of the RJ71GN11 using the program.	○	○	○	○
Cyclic data assurance		Assures the cyclic data integrity in units of 32 bits or station-based units.	○	○	○	○
Communication cycle coexistence		When device stations with different communication cycles are included in the network, multiple communication cycles according to each device station are used for communications.	○	○	○	○
Interlink transmission		Transfers data in the link devices of the master station to another network module on a relay station.	○	×	○	○
I/O maintenance settings	Output mode upon CPU error	Sets whether to hold or clear output when a stop error occurs in the CPU module. Set it on the sending side.	○	○	○	○
	Output hold/clear setting during CPU STOP	Sets whether to hold or clear output when the status of the CPU module changes from RUN to STOP. Set it on the sending side.	○	○	○	○
	Data link faulty station setting	Sets whether to clear or hold input from a disconnected station. Set it on the receiving side.	○	○	○	○
Remote device test		Arbitrarily turns on or off the output of the remote station when the CPU module is in STOP state.	○	×	×	×
CANopen communications		Controls a servo amplifier that supports the CANopen profile.	○	×	×	×

Transient transmission

This function is used for communications at any timing and has the following three functions.

Function		Description	RJ71GN11-T2		RJ71GN11-SX	
			Master station	Local station	Master station	Local station
Communications using a dedicated instruction		Reads/writes data from the master station or local station to devices in a CPU module of the local station or the buffer memory areas of a remote station by the dedicated instructions. (MELSEC iQ-R Programming Manual (Module Dedicated Instructions))	○	△	△	△
Communications using the SLMP		Reads/writes data from the RJ71GN11 and the external device such as a personal computer or HMI (Human Machine Interface) to devices in the CPU module of the master station and local station and the buffer memory areas of the remote station via an SLMP. (SLMP Reference Manual)	○	○	○	○
Communications using the engineering tool		Configures the settings of or monitors each station using the engineering tool. This function allows seamless communications with stations on different types networks.	○	○	○	○

Ethernet connection

This function connects an Ethernet device to a module without interfering with CC-Link IE TSN.

Function		Description	RJ71GN11-T2		RJ71GN11-SX	
			Master station	Local station	Master station	Local station
Connection with MELSOFT products and a GOT	Connection via HUB	Allows programming and monitoring of the programmable controller using the engineering tool, and monitoring and testing of the programmable controller from the GOT via Ethernet.	○	○	×	×
Searching modules on the network		Searches for the RJ71GN11 control CPUs on the same network.	○	○	×	×
Connection with SLMP-compatible devices		Allows SLMP-compatible devices (such as a personal computer or a vision sensor) to be connected to the RJ71GN11.	○	○	×	×

Security

This function ensures security according to the network environment by restricting access for each communication path to the CPU module.

Function		Description	RJ71GN11-T2		RJ71GN11-SX	
			Master station	Local station	Master station	Local station
IP filter		Identifies the IP address of the access source, and prevents unauthorized access.	○	○	○	○
Remote password		Permits or prohibits access from the external device to the CPU module via the RJ71GN11.	○	○	○	○

RAS

RAS stands for Reliability, Availability, and Serviceability. This function improves overall usability of automated equipment.

Function	Description	RJ71GN11-T2		RJ71GN11-SX	
		Master station	Local station	Master station	Local station
Device station disconnection	Stops data link of the station where an error occurred, and continues data link only for stations that are operating normally.	○	×	○	×
Automatic return	Restarts the data link automatically when the device station that was disconnected due to an error becomes normal again.	○	○	○	○
Loopback function	Continues data link with normally operating stations even if a cable disconnection or faulty station occurs in a ring topology network configuration.	○	○	○	○
Master station duplication detection	If one network has multiple master stations, duplication is detected.	○	×	○	×
IP address duplication detection	If one network has stations with the same IP address, duplication is detected.	○	○	○	○
Time synchronization	This function synchronizes the time of device stations with the time synchronization source (CPU module of the master station).	○	○	○	○
Master station switch function	Even if the master station is disconnected, the local station continues to control the entire network in place of the master station.	×	×	○	○

3

Synchronous communications

This function adjusts the timing with the timing of different device stations connected on the same network.

Function	Description	RJ71GN11-T2		RJ71GN11-SX	
		Master station	Local station	Master station	Local station
CC-Link IE TSN network synchronous communication function	Synchronizes control cycles between device stations over CC-Link IE TSN according to the inter-module synchronization cycle specified in the master station. This allows different device stations on the same network to operate with the same timing.	○	○	×	×

Safety communications

This function allows safety data to be exchanged between safety stations on the same network.





Function	Description	RJ71GN11-T2		RJ71GN11-SX	
		Master station	Local station	Master station	Local station
Safety communications	Establishes a safety connection and enables one-on-one safety communications periodically between safety stations in the same network.	○	○	×	×

Troubleshooting

This function checks the status of modules and networks by executing diagnostics and operation tests using the engineering tool.

Function	Description	RJ71GN11-T2		RJ71GN11-SX	
		Master station	Local station	Master station	Local station
Module communication test	Checks the module hardware when communication using the RJ71GN11 is unstable.	<input type="radio"/>	<input type="radio"/>	<input type="radio"/>	<input type="radio"/>
CC-Link IE TSN/CC-Link IE Field diagnostics	Monitors the status of CC-Link IE TSN. The network maps, stations where data link is not operating, selected station communications status monitor and so on are displayed on the engineering tool.	<input type="radio"/>	<input type="radio"/>	<input type="radio"/>	<input type="radio"/>
Communication test	Checks if transient transmission data can be properly routed from the own station to the communication target.	<input type="radio"/>	<input type="radio"/>	<input type="radio"/>	<input type="radio"/>

Others

Function		Description	RJ71GN11-T2		RJ71GN11-SX	
			Master station	Local station	Master station	Local station
"CC-Link IE TSN Configuration" window	Parameter setting of a device station	Sets parameters of device stations (the number of points and assignment of link devices) in the master station.	○	×	○	×
	Detection of connected/disconnected devices	Detects connected device stations and the stations are displayed on the "CC-Link IE TSN Configuration" window.	○	×	×	×
	Parameter processing of a device station	Reads and saves the parameters from the device station, and writes the saved parameters to the device station.	○	×	×	×
	Command execution to device stations	Commands to a device station (Error clear request, Error history clear request) are executed.	○	×	×	×
	IP address setting of a device station	Sets the IP address of the device station connected to the master station.	○	×	×	×
Reserved station setting		Reserved station is a device station that is set in the parameters and included as a station in the network when its number is counted. This station reserved for network extension in the future, and thus the station is not actually connected, and is not detected as a faulty station despite being not connected.	○	×	○	×
Error invalid station setting		An error invalid station is a device station that is set to be not detected as a faulty station by the master station.	○	×	○	×
Device station parameter automatic setting		Saves parameters of the device station to the master station, and sets the parameters automatically when the device station is connected or returned to the network.	○	×	×	×
Station number setting using a program		Sets a station number and IP address using a program to the own station with no station number and IP address setting. This function allows project data items of stations with the same program and network parameters (excluding the station numbers and IP addresses) to be the same, leading to reduced development work hours. ( MELSEC iQ-R Programming Manual (Module Dedicated Instructions))	○	○	○	○
Data collection using CC-Link IE TSN Communication Software		Receives cyclic data on CC-Link IE TSN using CC-Link IE TSN Communication Software.  CC-Link IE TSN Communication Software for Windows User's Manual	○	○	×	×
Co-recording		The master station or the RJ71GN11 of the local station relays a co-recording trigger among the recording devices on the base unit of the own station and those of other stations.  MELSEC iQ-R System Recorder Co-recording Function Reference Manual	○	○	○	○
Firmware update		Enables users to change the firmware of modules by obtaining firmware update files from the users' local Mitsubishi representatives. ( MELSEC iQ-R Module Configuration Manual)	○	○	○	○

4 PROCEDURES BEFORE OPERATION

This chapter describes the procedures before operation.

1. Network configuration

Configure the system and set the parameters which are required for start-up.

- Wiring (👉 Page 69 WIRING)
- Parameter Setting (📖 MELSEC iQ-R CC-Link IE TSN User's Manual (Application))

2. Network diagnostics

Use CC-Link IE TSN/CC-Link IE Field diagnostics to check that cables are connected properly and that modules are communicating correctly with the set parameters. (📖 MELSEC iQ-R CC-Link IE TSN User's Manual (Application))

3. Programming

Create a program. (👉 Page 72 COMMUNICATION EXAMPLES, 📖 MELSEC iQ-R CC-Link IE TSN User's Manual (Application))

Point

When multiple device stations and the master station are powered on simultaneously, the startup time of the device stations may vary. In such a case, the networks are connected in turn, resulting the time may be longer to complete data links at all stations.

Power on all device stations, and then, power on the master station to prevent this case.

5 SYSTEM CONFIGURATION (RJ71GN11-T2)

RJ71GN11-T2 is configured using Ethernet cables. (☞ Page 69 Ethernet Cables).

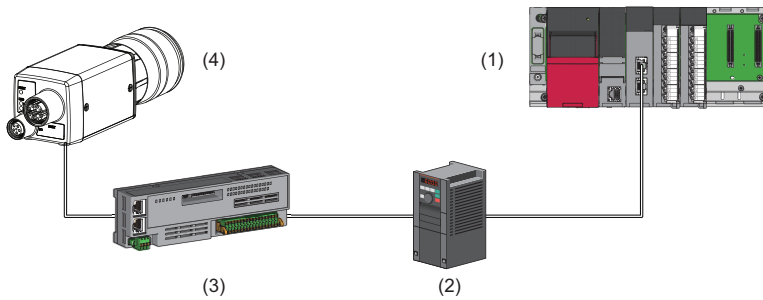

- (1) RJ71GN11-T2
- (2) Inverter device
- (3) Remote I/O module
- (4) Ethernet device (such as a vision sensor)

System configuration list

The following lists the system configurations.

Connection device	Reference
Modules on CC-Link IE TSN (CC-Link IE TSN Class B only), Ethernet devices	Page 34 Structure with CC-Link IE TSN Class B Devices Only
Modules on CC-Link IE TSN (mixture of CC-Link IE TSN Class B/A or Class A only), Ethernet devices	Page 45 Structure with CC-Link IE TSN Class B/A Devices
Modules on CC-Link IE TSN, modules on CC-Link IE Field Network, Ethernet devices	Page 62 Structure of the CC-Link IE TSN and CC-Link IE Field Network
CC-Link IE TSN Communication Software, modules on CC-Link IE TSN	Page 63 Structure When CC-Link IE TSN Communication Software Is Used
Modules on CC-Link IE TSN (protocol version 2.0/1.0 mixed), Ethernet devices	Page 107 System Configuration with CC-Link IE TSN Class B/A Devices (Protocol Version 2.0/1.0) (RJ71GN11-T2)
Modules on CC-Link IE TSN (protocol version 1.0 only), Ethernet devices	Page 111 System Configuration with CC-Link IE TSN Class B/A Devices (Protocol Version 1.0 Only) (RJ71GN11-T2)

Precautions

A dedicated TSN hub may be required depending on parameter settings or the network topology used to connect modules on CC-Link IE TSN.

Unicast mode and multicast mode

Cyclic transmission differs depending on the communication mode set by the module parameter of the master station. The communication modes are as follows:



- Unicast mode
- Multicast mode

For details, refer to the following.

 MELSEC iQ-R CC-Link IE TSN User's Manual (Application)

CC-Link IE TSN Class settings

From "Connection Device Information" under "Basic Settings" of the engineering tool, select either of the following items according to devices to be connected.

Connected device information	System configuration	Supported standard
CC-Link IE TSN Class B Only	Select this if the system is to be configured without connecting the CC-Link IE TSN Class A device. <ul style="list-style-type: none">•  Page 38 Connection with modules on CC-Link IE TSN only•  Page 43 Connection with modules on CC-Link IE TSN and Ethernet devices	IEEE 802.1AS
Mixture of CC-Link IE TSN Class B/A or CC-Link IE TSN Class A Only	Select this if a CC-Link IE TSN Class A device is to be connected or if a system to which a CC-Link IE TSN Class A device is to be connected will be configured in the future. (Can be connected with a CC-Link IE TSN Class B device only configuration)  Page 45 Structure with CC-Link IE TSN Class B/A Devices	IEEE 802.1AS or IEEE 1588 ^{*1}

- *1 When the firmware version is a master station of "13" or earlier, IEEE 1588 is used.
When the firmware version is a master station of "14" or later, IEEE 802.1AS or IEEE 1588 is used depending on the protocol version of the devices to be connected. For details, refer to the following.
 Page 108 Device time synchronization method and connection specifications

Ethernet connection

For connection with MELSOFT products and a GOT, and connection with SLMP-compatible devices, refer to the following.

 MELSEC iQ-R CC-Link IE TSN User's Manual (Application)

With the Safety CPU

When the RJ71GN11-T2 is used with the Safety CPU, the safety communications are available in addition to the standard communications (cyclic transmission and transient transmission).

For details on the safety communications, refer to the following.

 MELSEC iQ-R CC-Link IE TSN User's Manual (Application)

5.1 Structure with CC-Link IE TSN Class B Devices Only

This section describes the system configuration when "Connection Device Information" under "Basic Settings" of the engineering tool is set to "CC-Link IE TSN Class B Only".

When "Connection Device Information" under "Basic Settings" of the master station is set to "CC-Link IE TSN Class B Only", up to 121 devices (1 master station and 120 device stations) can be connected.

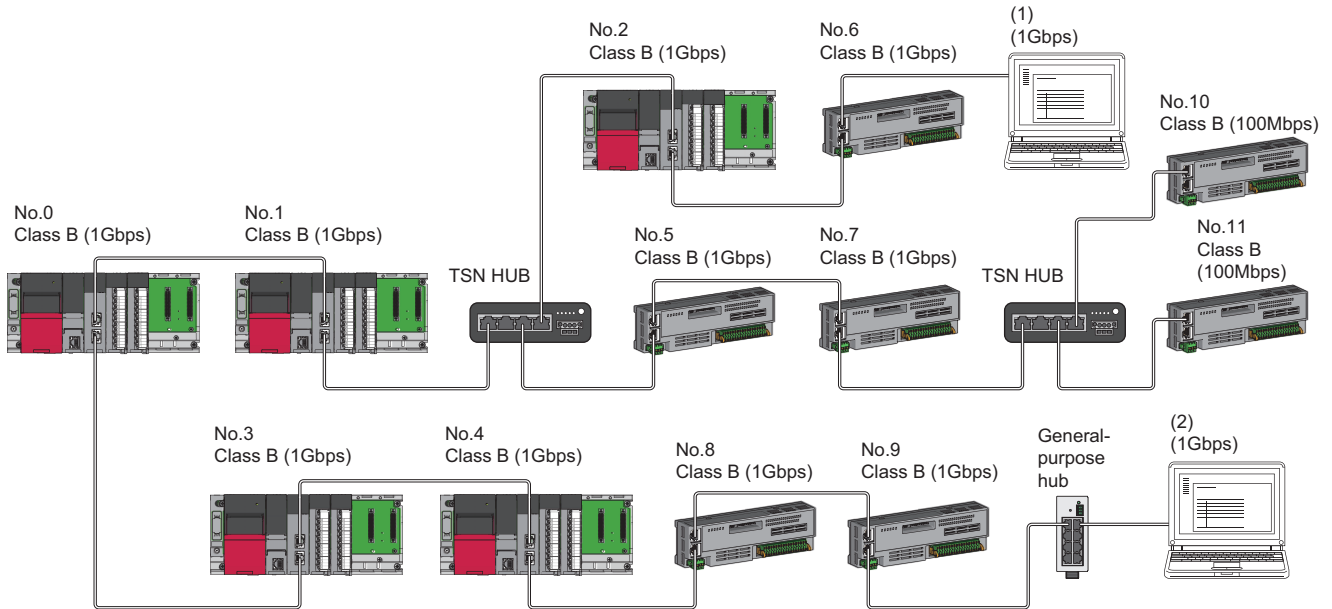

- No.0: Master station
- No.1, No.2, No.3, and No.4: Local station
- No.5, No.6, No.7, No.8, No.9, No.10, and No.11: Remote station
- (1), (2): Ethernet device
- Class B: CC-Link IE TSN Class B device

The availability of connection of network configuration devices varies depending on the communication mode and communication speed.

- Unicast mode

☞ Page 35 When the communication speed for the master station is set to 1Gbps

☞ Page 35 When the communication speed for the master station is set to 100Mbps

- Multicast mode

☞ Page 36 When the communication speed for the master station is set to 1Gbps

☞ Page 37 When the communication speed for the master station is set to 100Mbps

The following terms are used to describe the terms in the tables referenced.

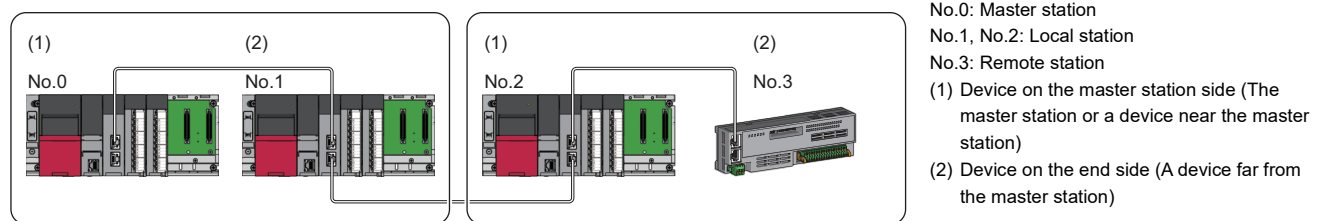

- No.0: Master station
- No.1, No.2: Local station
- No.3: Remote station
- (1) Device on the master station side (The master station or a device near the master station)
- (2) Device on the end side (A device far from the master station)

Connectable devices (for unicast mode)

This section describes the connectable devices when "Communication Mode" under "Application Settings" is set to "Unicast".

When the communication speed for the master station is set to 1Gbps

This mode indicates the availability of connection with a network configuration device when "Communication Speed" of the master station is set to "1Gbps".

○: Connection available, △: Connection available via a switching hub, ×: Connection not available

S: TSN hub available

H: General-purpose hub available

Device on the master station side (A device near the master station)		Device on the end side (A device far from the master station)					
		Local station (CC-Link IE TSN Class B device)		Remote station (CC-Link IE TSN Class B device)		Ethernet device	
		1Gbps	100Mbps	1Gbps	100Mbps	1Gbps	100Mbps
Master station (CC-Link IE TSN Class B device)	1Gbps	○S	×	○S	△S ^{*1*3}	○SH	△SH ^{*3}
	100Mbps	×	×	×	×	×	×
Local station (CC-Link IE TSN Class B device)	1Gbps	○S	×	○S	△S ^{*1*2*3}	○SH	△SH ^{*3}
	100Mbps	×	×	×	×	×	×
Remote station (CC-Link IE TSN Class B device)	1Gbps	○S	×	○S	△S ^{*1*2*3}	○SH	△SH ^{*3}
	100Mbps	×	×	×	○S ^{*1*2*3}	×	○SH ^{*3}

- *1 For a device station with a communication speed of 100Mbps, set "Communication Period Setting" to "Low-Speed".
- *2 A connection cannot be established if the total cyclic data size of all device stations on the 100Mbps device side exceeds 2K bytes. This includes the devices with a communication speed of 100Mbps that form a boundary between the communication speed of 1Gbps and 100Mbps. (Page 66 Calculation of the total cyclic data size)
- *3 When the firmware version of the master station is "11" or earlier, only one of P1 or P2 can be used. (To use both P1 and P2 of the master station, set up a multicast mode structure.)

Precautions

When a TSN hub is used, check the TSN hub specifications on the CC-Link Partner Association website (www.cc-link.org).

When the communication speed for the master station is set to 100Mbps

This mode indicates the availability of connection with a network configuration device when "Communication Speed" of the master station set to "100Mbps".

○: Connection available, △: Connection available via a switching hub, ×: Connection not available

S: TSN hub available

H: General-purpose hub available

Device on the master station side (A device near the master station)		Device on the end side (A device far from the master station)					
		Local station (CC-Link IE TSN Class B device)		Remote station (CC-Link IE TSN Class B device)		Ethernet device	
		1Gbps	100Mbps	1Gbps	100Mbps	1Gbps	100Mbps
Master station (CC-Link IE TSN Class B device)	100Mbps	×	○S ^{*1}	×	○S ^{*1}	×	○SH
	1Gbps	×	×	×	×	×	×
Local station (CC-Link IE TSN Class B device)	1Gbps	×	×	×	×	×	×
	100Mbps	×	○S ^{*1}	×	○S ^{*1}	×	○SH
Remote station (CC-Link IE TSN Class B device)	1Gbps	×	×	×	×	×	×
	100Mbps	×	○S ^{*1}	×	○S ^{*1}	×	○SH

- *1 For a device station with a communication speed of 100Mbps, set "Communication Period Setting" to "Basic Period" or "Normal-Speed".

Precautions

When a TSN hub is used, check the TSN hub specifications on the CC-Link Partner Association website (www.cc-link.org).

Connectable devices (for multicast mode)

This section describes the connectable devices when "Communication Mode" under "Application Settings" is set to "Multicast".

When the communication speed for the master station is set to 1Gbps

This mode indicates the availability of connection with a network configuration device when "Communication Speed" of the master station is set to "1Gbps".

○: Connection available, △: Connection available via a switching hub, ×: Connection not available

S: TSN hub available

H: General-purpose hub available

Device on the master station side (A device near the master station)		Device on the end side (A device far from the master station)					
		Local station (CC-Link IE TSN Class B device)		Remote station (CC-Link IE TSN Class B device)		Ethernet device	
		1Gbps	100Mbps	1Gbps	100Mbps	1Gbps	100Mbps
Master station (CC-Link IE TSN Class B device)	1Gbps	○S ^{*2}	×	○S ^{*2}	△S ^{*1*2*5}	○SH ^{*2*3}	△SH ^{*2*3*5}
	100Mbps	×	×	×	×	×	×
Local station (CC-Link IE TSN Class B device)	1Gbps	○S ^{*2}	×	○S ^{*2}	△S ^{*1*2*4*6}	○SH ^{*2*6}	△SH ^{*2*6}
	100Mbps	×	×	×	×	×	×
Remote station (CC-Link IE TSN Class B device)	1Gbps	○S ^{*2}	×	○S ^{*2}	△S ^{*1*2*4*6}	○SH ^{*2*6}	△SH ^{*2*6}
	100Mbps	×	×	×	○S ^{*1*2*4}	×	○SH ^{*2*6}

*1 For a device station with a communication speed of 100Mbps, set "Communication Period Setting" to "Low-Speed".

*2 When the device is connected on the end side via the switching hub as shown below, communication may not be possible depending on the type of the device.

The communication will be enabled by configuring settings with the switching hub so that the multicast frame (with multicast MAC address 09:00:70:00:10:02 and 09:00:70:00:10:05) will not be transferred to the ports specified below.

Connection structure that cannot be communicated	Port that prohibits multicast frame transfer
Device stations with different communication speeds of 1Gbps and 100Mbps coexist.	Connection port of the device station with communication speed of 100Mbps
A local station and Ethernet device coexist.	Connection port of the Ethernet device
The remote station and Ethernet device coexist.	

*3 Since cyclic data is sent to the Ethernet device when the Ethernet device is connected to the master station with firmware version "13" or earlier, communication may not be possible depending on the type of the Ethernet device.

*4 A connection cannot be established if the total cyclic data size of all device stations on the 100Mbps device side exceeds 2K bytes. This includes the devices with a communication speed of 100Mbps that form a boundary between the communication speed of 1Gbps and 100Mbps. (☞ Page 66 Calculation of the total cyclic data size)

*5 When the firmware version of the master station is "13" or earlier, only one of P1 or P2 can be used.

*6 For a local station or remote station of a device on the master station side, use a device supporting the multicast filter. (☞ Manual for the device used)

Precautions

When a TSN hub is used, check the TSN hub specifications on the CC-Link Partner Association website (www.cc-link.org).

When the communication speed for the master station is set to 100Mbps

This mode indicates the availability of connection with a network configuration device when "Communication Speed" of the master station set to "100Mbps".

○: Connection available, △: Connection available via a switching hub, ×: Connection not available

S: TSN hub available

H: General-purpose hub available

Device on the master station side (A device near the master station)		Device on the end side (A device far from the master station)					
		Local station (CC-Link IE TSN Class B device)		Remote station (CC-Link IE TSN Class B device)		Ethernet device	
		1Gbps	100Mbps	1Gbps	100Mbps	1Gbps	100Mbps
Master station (CC-Link IE TSN Class B device)	100Mbps	×	○S ^{*1*3}	×	○S ^{*1*3}	×	○SH ^{*2*3}
Local station (CC-Link IE TSN Class B device)	1Gbps	×	×	×	×	×	×
	100Mbps	×	○S ^{*1*3}	×	○S ^{*1*3}	×	○SH ^{*3*4}
Remote station (CC-Link IE TSN Class B device)	1Gbps	×	×	×	×	×	×
	100Mbps	×	○S ^{*1*3}	×	○S ^{*1*3}	×	○SH ^{*3*4}

*1 For a device station with a communication speed of 100Mbps, set "Communication Period Setting" to "Basic Period" or "Normal-Speed".

*2 Since cyclic data is sent to the Ethernet device when the Ethernet device is connected to the master station with firmware version "13" or earlier, communication may not be possible depending on the type of the Ethernet device.

*3 When the device is connected on the end side via the switching hub as shown below, communication may not be possible depending on the type of the device.

The communication will be enabled by configuring settings with the switching hub so that the multicast frame (with multicast MAC address 09:00:70:00:10:02 and 09:00:70:00:10:05) will not be transferred to the ports specified below.

Connection structure that cannot be communicated	Port that prohibits multicast frame transfer
A local station and Ethernet device coexist.	Connection port of the Ethernet device
The remote station and Ethernet device coexist.	

*4 For a local station or remote station of a device on the master station side, use a device supporting the multicast filter. (Manual for the device used)

Precautions

When a TSN hub is used, check the TSN hub specifications on the CC-Link Partner Association website (www.cc-link.org).

Structure with modules on CC-Link IE TSN only

Connection with modules on CC-Link IE TSN only

■Line topology

The network is configured in a line topology. A TSN hub is not required.

When an error occurs in a device station, the stations connected after the faulty station will be disconnected.

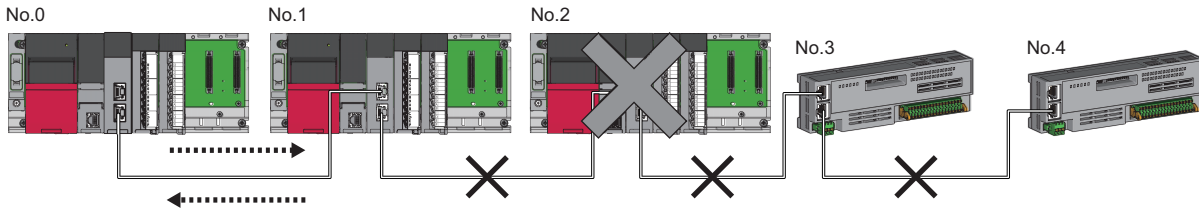

No.0: Master station
No.1, No.2: Local station
No.3, No.4: Remote station

■Star topology

The network is configured in a star topology via a TSN hub. This allows devices to be added easily.

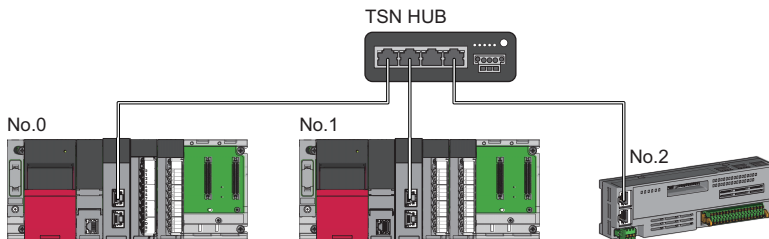

No.0: Master station
No.1: Local station
No.2: Remote station

Even when an error occurs in a device station, a data link can be continued with the stations that are operating normally.

■Coexistence of line and star topologies

Line and star topologies can be mixed in the same network configuration.

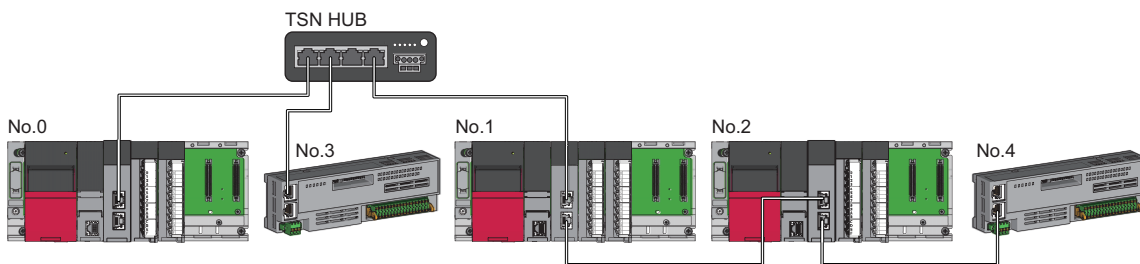

No.0: Master station
No.1, No.2: Local station
No.3, No.4: Remote station

■Ring topology

The network is configured in a ring topology.

For the devices supporting a ring topology, refer to the CC-Link Partner Association website (www.cc-link.org).

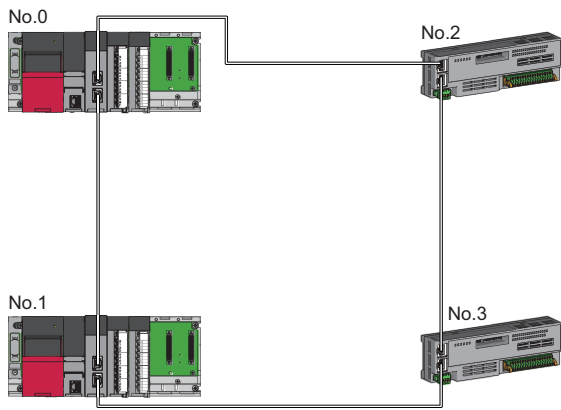

No.0: Master station
No.1: Local station
No.2, No.3: Remote station

Connection with modules on CC-Link IE TSN with a communication speed of 100Mbps

This section describes the network topology when "Communication Speed" under "Application Settings" is set to "100Mbps".

Line topology

The network is configured in a line topology.

- Adjust the communication speed of each module.
- When connecting modules with different communication speeds, connect the modules via a TSN hub.

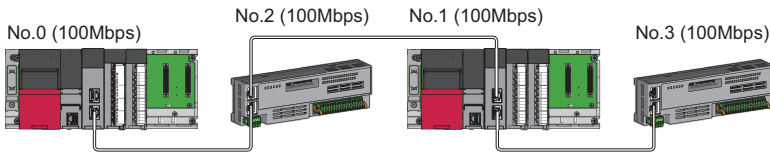

No.0: Master station
 No.1: Local station
 No.2, No.3: Remote station

Star topology

The network is configured in a star topology via a switching hub.

- When the master station with a communication speed of 1Gbps and a remote station with a communication speed of 100Mbps exist in the structure, set "Communication Period Setting" to "Low-Speed" for the remote station with a communication speed of 100Mbps.

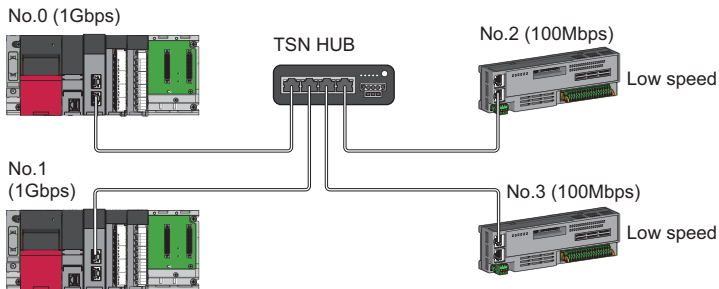

No.0: Master station
 No.1: Local station
 No.2, No.3: Remote station

- Connect the master station and local station at the same communication speed.

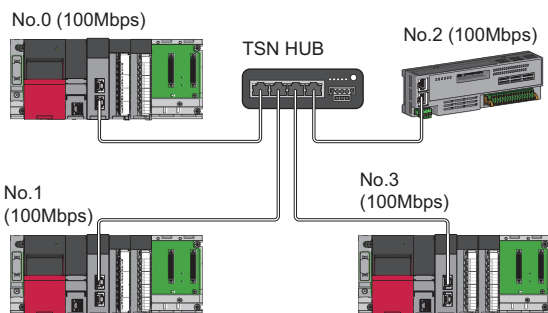
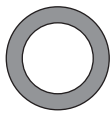

No.0: Master station
 No.1, No.3: Local station
 No.2: Remote station

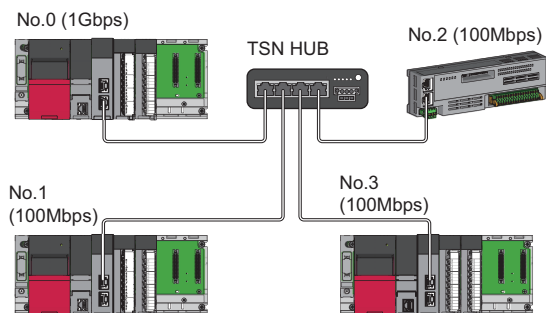

- When "Communication Mode" is set to "Multicast" and "Communication Speed" of the master station is set to "1Gbps", communication may not be possible depending on the type of the device if device stations with 1Gbps and 100Mbps coexist on the end side via the switching hub. The communication will be enabled by configuring settings with the TSN hub so that the multicast frame (with multicast MAC address 09:00:70:00:10:02 and 09:00:70:00:10:05) will not be transferred to the device station with 100Mbps.

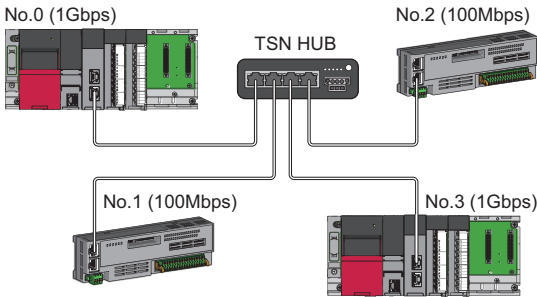

No.0: Master station
 No.1, No.2: Remote station
 No.3: Local station

Coexistence of line and star topologies

Line and star topologies can be mixed in the same network configuration.

- When the master station with a communication speed of 1Gbps and a remote station with a communication speed of 100Mbps exist in the structure, set "Communication Period Setting" to "Low-Speed" for the remote station with a communication speed of 100Mbps.

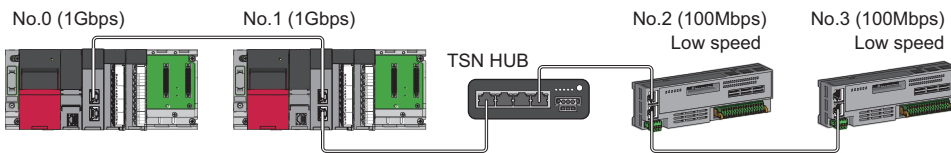

No.0: Master station
 No.1: Local station
 No.2, No.3: Remote station

- When the communication speed of the master station is 1Gbps, a connection cannot be established if the total cyclic data size of all device stations on the 100Mbps device side exceeds 2K bytes. This includes the devices with a communication speed of 100Mbps that form a boundary between the communication speed of 1Gbps and 100Mbps.

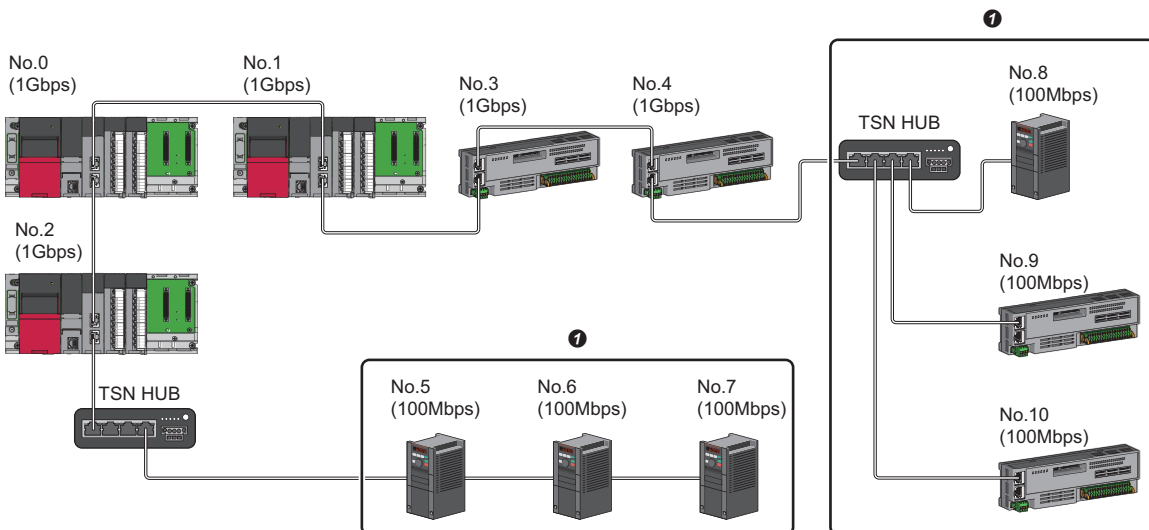

No.0: Master station
 No.1, No.2: Local station
 No.3, No.4, No.5, No.6, No.7, No.8, No.9, and No.10: Remote station
 1 Set the total cyclic data size within 2K bytes.

■ Ring topology

The network is configured in a ring topology.

- Connect each module based on the same communication speed.
- For the devices supporting a ring topology, refer to the CC-Link Partner Association website (www.cc-link.org).

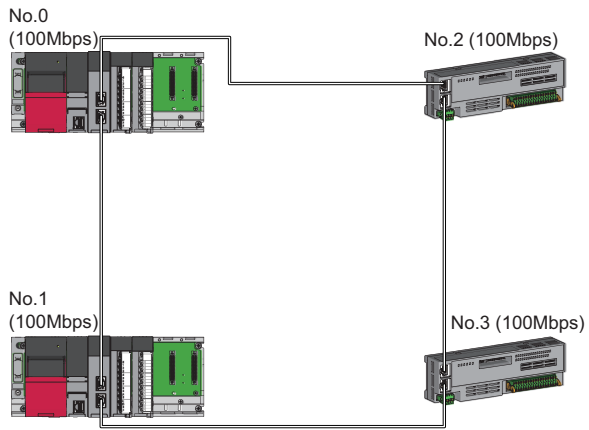

No.0: Master station
No.1: Local station
No.2, No.3: Remote station

Structure with modules on CC-Link IE TSN and Ethernet devices

Connection with modules on CC-Link IE TSN and Ethernet devices

Line topology

The network with modules and devices is configured in a line topology. A TSN hub is not required. Connect Ethernet devices to the end of the network.

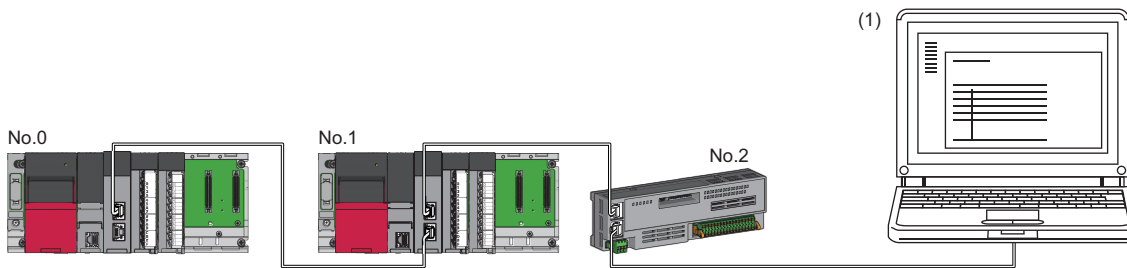

No.0: Master station
No.1: Local station
No.2: Remote station
(1) Ethernet device (such as a personal computer)

When an error occurs in a device station, the stations connected after the faulty station will be disconnected.

Star topology

The network is configured in a star topology via a switching hub.

Device stations cannot be connected with a general-purpose hub. Line and star topologies should be mixed in the same network configuration.

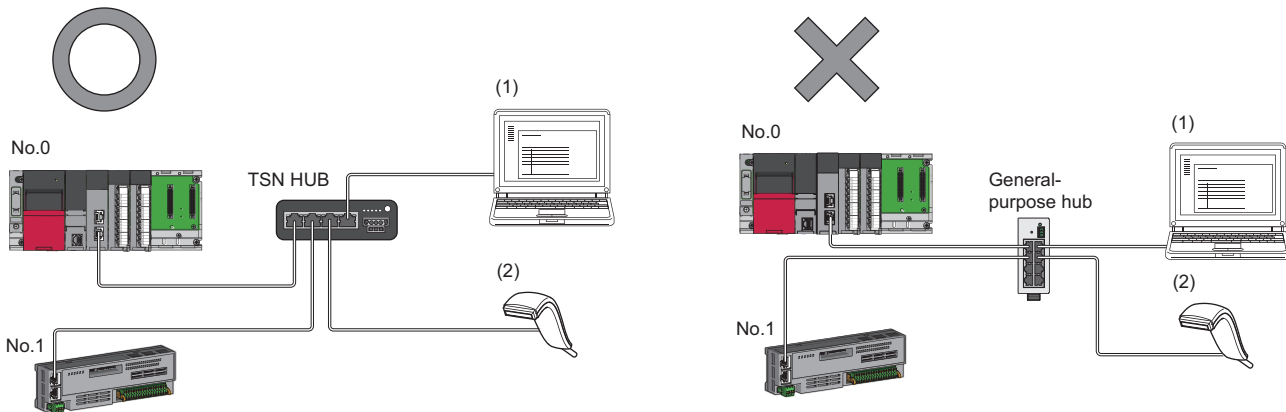

No.0: Master station
No.1: Remote station
(1), (2): Ethernet device

Coexistence of line and star topologies

Line and star topologies can be mixed in the same network configuration.

- Connect Ethernet devices to the end of the network.

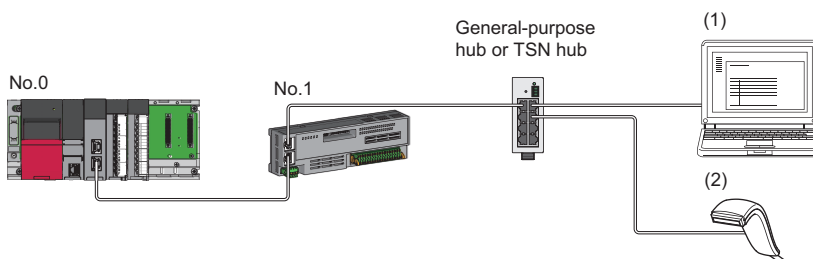

No.0: Master station
No.1: Remote station
(1), (2): Ethernet device

■Ring topology

Mixed ring topology of Ethernet devices is not possible with the "CC-Link IE TSN Class B Only" system configuration.

5.2 Structure with CC-Link IE TSN Class B/A Devices

This section describes the system configuration in the following cases.

- The RJ71GN11-T2 supports the protocol version 2.0
- The CC-Link IE TSN module supports the protocol version 2.0 only
- Set "Connection Device Information" under "Basic Settings" of the engineering tool to "Mixture of CC-Link IE TSN Class B/A or CC-Link IE TSN Class A Only"

When "Connection Device Information" under "Basic Settings" of the master station is set to "Mixture of CC-Link IE TSN Class B/A or CC-Link IE TSN Class A Only", up to 121 stations (1 master station and 120 device stations) can be connected.



If the RJ71GN11-T2 with the firmware version "13" or earlier or a CC-Link IE TSN module with the protocol version 1.0 is to be connected, refer to the following.

☞ Page 107 System Configuration with CC-Link IE TSN Class B/A Devices (Protocol Version 2.0/1.0) (RJ71GN11-T2)

☞ Page 111 System Configuration with CC-Link IE TSN Class B/A Devices (Protocol Version 1.0 Only) (RJ71GN11-T2)

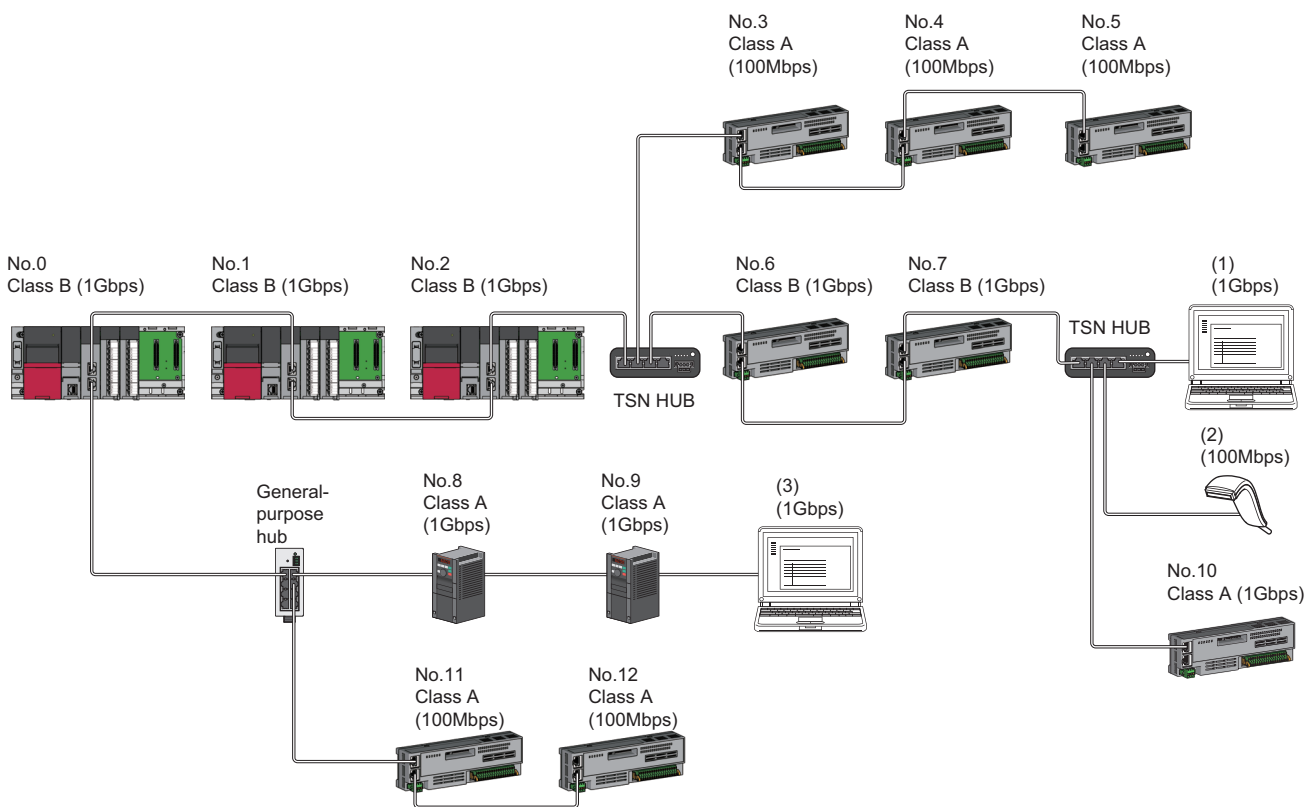

No.0: Master station
 No.1, No.2: Local station
 No.3 to No.12: Remote station
 (1), (2), and (3): Ethernet device

The availability of connection of network configuration devices varies depending on the communication mode and communication speed.

- Unicast mode

☞ Page 47 When the communication speed for the master station is set to 1Gbps

☞ Page 48 When the communication speed for the master station is set to 100Mbps

- Multicast mode

☞ Page 49 When the communication speed for the master station is set to 1Gbps

☞ Page 50 When the communication speed for the master station is set to 100Mbps

The following terms are used to describe the terms in the tables referenced.

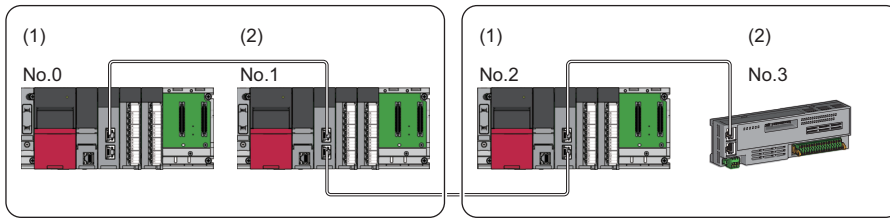

No.0: Master station

No.1, No.2: Local station

No.3: Remote station

(1) Device on the master station side (The master station or a device near the master station)

(2) Device on the end side (A device far from the master station)

Connectable devices (for unicast mode)

This section describes the connectable devices when "Communication Mode" under "Application Settings" is set to "Unicast".

When the communication speed for the master station is set to 1Gbps

This mode indicates the availability of connection with a network configuration device when "Communication Speed" of the master station is set to "1Gbps".

○: Connection available, △: Connection available via a switching hub, ×: Connection not available

S: TSN hub available

H: General-purpose hub available

Device on the master station side (A device near the master station)		Device on the end side (A device far from the master station)							
		Local station (CC-Link IE TSN Class B device)		Remote station (CC-Link IE TSN Class B device)		Remote station (CC-Link IE TSN Class A device)		Ethernet device	
		1Gbps	100Mbps	1Gbps	100Mbps	1Gbps	100Mbps	1Gbps	100Mbps
Master station (CC-Link IE TSN Class B device)	1Gbps	○S	×	○S	△S ^{*1}	○SH	△SH ^{*1}	○SH	△SH
	100Mbps	×	×	×	×	×	×	×	×
Local station (CC-Link IE TSN Class B device)	1Gbps	○S	×	○S	△S ^{*1*2}	○SH	△SH ^{*1}	○SH	△SH
	100Mbps	×	×	×	×	×	×	×	×
Remote station (CC-Link IE TSN Class B device)	1Gbps	○S	×	○S	△S ^{*1*2}	○SH	△SH ^{*1}	○SH	△SH
	100Mbps	×	×	×	○S ^{*1*2}	×	○SH ^{*1*2}	×	○SH
Remote station (CC-Link IE TSN Class A) device	1Gbps	×	×	×	×	○SH	△SH ^{*1}	○SH	△SH
	100Mbps	×	×	×	×	×	○SH ^{*1}	×	○SH

*1 For a device station with a communication speed of 100Mbps, set "Communication Period Setting" to "Low-Speed".

*2 A connection cannot be established if the total cyclic data size of all device stations on the 100Mbps device side exceeds 2K bytes. This includes the devices with a communication speed of 100Mbps that form a boundary between the communication speed of 1Gbps and 100Mbps. (☞ Page 66 Calculation of the total cyclic data size)

Precautions

When a TSN hub is used, check the TSN hub specifications on the CC-Link Partner Association website (www.cc-link.org).

When the communication speed for the master station is set to 100Mbps

This mode indicates the availability of connection with a network configuration device when "Communication Speed" of the master station set to "100Mbps".

○: Connection available, △: Connection available via a switching hub, ×: Connection not available

S: TSN hub available

H: General-purpose hub available

Device on the master station side (A device near the master station)		Device on the end side (A device far from the master station)							
		Local station (CC-Link IE TSN Class B device)		Remote station (CC-Link IE TSN Class B device)		Remote station (CC-Link IE TSN Class A device)		Ethernet device	
		1Gbps	100Mbps	1Gbps	100Mbps	1Gbps	100Mbps	1Gbps	100Mbps
Master station (CC-Link IE TSN Class B device)	100Mbps	×	○S ^{*1}	×	○S ^{*1}	×	○SH	×	○SH
Local station (CC-Link IE TSN Class B device)	1Gbps	×	×	×	×	×	×	×	×
	100Mbps	×	○S ^{*1}	×	○S ^{*1}	×	○SH	×	○SH
Remote station (CC-Link IE TSN Class B device)	1Gbps	×	×	×	×	×	×	×	×
	100Mbps	×	○S ^{*1}	×	○S ^{*1}	×	○SH	×	○SH
Remote station (CC-Link IE TSN Class A device)	1Gbps	×	×	×	×	×	×	×	×
	100Mbps	×	×	×	×	×	○SH	×	○SH

*1 Set "Communication Period Setting" to "Basic Period Setting" or "Normal-Speed".

Precautions

When a TSN hub is used, check the TSN hub specifications on the CC-Link Partner Association website (www.cc-link.org).

Connectable devices (for multicast mode)

This section describes the connectable devices when "Communication Mode" under "Application Settings" is set to "Multicast".

When the communication speed for the master station is set to 1Gbps

This mode indicates the availability of connection with a network configuration device when "Communication Speed" of the master station is set to "1Gbps".

○: Connection available, △: Connection available via a switching hub, ×: Connection not available

S: TSN hub available

H: General-purpose hub available

Device on the master station side (A device near the master station)		Device on the end side (A device far from the master station)							
		Local station (CC-Link IE TSN Class B device)		Remote station (CC-Link IE TSN Class B device)		Remote station (CC-Link IE TSN Class A device)		Ethernet device	
		1Gbps	100Mbps	1Gbps	100Mbps	1Gbps	100Mbps	1Gbps	100Mbps
Master station (CC-Link IE TSN Class B device)	1Gbps	○S ^{*2}	×	○S ^{*2}	△S ^{*1*2}	○SH ^{*2}	△SH ^{*1*2}	○SH ^{*2}	△SH ^{*2}
Local station (CC-Link IE TSN Class B device)	1Gbps	○S ^{*2}	×	○S ^{*2}	△S ^{*1*2*3*4}	○SH ^{*2*3}	△SH ^{*1*2*3}	○SH ^{*2*3}	△SH ^{*2*3}
	100Mbps	×	×	×	×	×	×	×	×
Remote station (CC-Link IE TSN Class B device)	1Gbps	○S ^{*2}	×	○S ^{*2}	△S ^{*1*2*3*4}	○SH ^{*2*3}	△SH ^{*1*2*3}	○SH ^{*2*3}	△SH ^{*2*3}
	100Mbps	×	×	×	○S ^{*1*2*4}	×	○SH ^{*1*2*3*4}	×	○SH ^{*2*3}
Remote station (CC-Link IE TSN Class A) device	1Gbps	×	×	×	×	○SH ^{*2}	△SH ^{*1*2}	○SH	△SH
	100Mbps	×	×	×	×	×	○SH ^{*1*2}	×	○SH

- *1 For a device station with a communication speed of 100Mbps, set "Communication Period Setting" to "Low-Speed".
- *2 When the device is connected on the end side via the switching hub as shown below, communication may not be possible depending on the type of the device.
The communication will be enabled by configuring settings with the switching hub so that the multicast frame (with multicast MAC address 09:00:70:00:10:02 and 09:00:70:00:10:05) will not be transferred to the ports specified below.

Connection structure that cannot be communicated	Port that prohibits multicast frame transfer
Device stations with different communication speeds of 1Gbps and 100Mbps coexist.	Connection port of the device station with communication speed of 100Mbps
A local station and Ethernet device coexist.	Connection port of the Ethernet device
The local station and CC-Link IE TSN Class A remote station are mixed.	Connection port of CC-Link IE TSN Class A remote station

- *3 For a local station or remote station of a device on the master station side, use a device supporting the multicast filter. (Manual for the device used)
- *4 A connection cannot be established if the total cyclic data size of all device stations on the 100Mbps device side exceeds 2K bytes. This includes the devices with a communication speed of 100Mbps that form a boundary between the communication speed of 1Gbps and 100Mbps. (Page 66 Calculation of the total cyclic data size)

Precautions

When a TSN hub is used, check the TSN hub specifications on the CC-Link Partner Association website (www.cc-link.org).

When the communication speed for the master station is set to 100Mbps

This mode indicates the availability of connection with a network configuration device when "Communication Speed" of the master station set to "100Mbps".

○: Connection available, △: Connection available via a switching hub, ×: Connection not available

S: TSN hub available

H: General-purpose hub available

Device on the master station side (A device near the master station)		Device on the end side (A device far from the master station)							
		Local station (CC-Link IE TSN Class B device)		Remote station (CC-Link IE TSN Class B device)		Remote station (CC-Link IE TSN Class A device)		Ethernet device	
		1Gbps	100Mbps	1Gbps	100Mbps	1Gbps	100Mbps	1Gbps	100Mbps
Master station (CC-Link IE TSN Class B device)	100Mbps	×	○S ^{*1*2}	×	○S ^{*1*2}	×	○SH ^{*2}	×	○SH ^{*2}
Local station (CC-Link IE TSN Class B device)	1Gbps	×	×	×	×	×	×	×	×
	100Mbps	×	○S ^{*1*2}	×	○S ^{*1*2}	×	○SH ^{*2*3}	×	○SH ^{*2*3}
Remote station (CC-Link IE TSN Class B device)	1Gbps	×	×	×	×	×	×	×	×
	100Mbps	×	○S ^{*1*2}	×	○S ^{*1*2}	×	○SH ^{*2*3}	×	○SH ^{*2*3}
Remote station (CC-Link IE TSN Class A) device	1Gbps	×	×	×	×	×	×	×	×
	100Mbps	×	×	×	×	×	○SH ^{*2}	×	○SH

*1 For a device station with a communication speed of 100Mbps, set "Communication Period Setting" to "Basic Period" or "Normal-Speed".

*2 When the device is connected on the end side via the switching hub as shown below, communication may not be possible depending on the type of the device.

The communication will be enabled by configuring settings with the switching hub so that the multicast frame (with multicast MAC address 09:00:70:00:10:02 and 09:00:70:00:10:05) will not be transferred to the ports specified below.

Connection structure that cannot be communicated	Port that prohibits multicast frame transfer
A local station and Ethernet device coexist.	Connection port of the Ethernet device
The local station and CC-Link IE TSN Class A remote station are mixed.	Connection port of CC-Link IE TSN Class A remote station

*3 For a local station or remote station of a device on the master station side, use a device supporting the multicast filter. (Manual for the device used)

Precautions

When a TSN hub is used, check the TSN hub specifications on the CC-Link Partner Association website (www.cc-link.org).

Structure with modules on CC-Link IE TSN only

Connection with modules on CC-Link IE TSN only

■Line topology

The network is configured in a line topology.

- When connecting a CC-Link IE TSN Class A device, connect to the end of the CC-Link IE TSN Class B device.

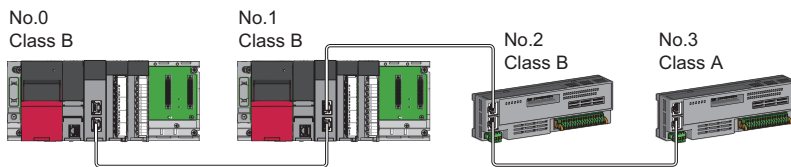

No.0: Master station
No.1: Local station
No.2, No.3: Remote station
Class A: CC-Link IE TSN Class A device
Class B: CC-Link IE TSN Class B device

■Star topology

The network is configured in a star topology via a switching hub.

- When connecting a CC-Link IE TSN Class B device in a star topology, use a TSN hub.

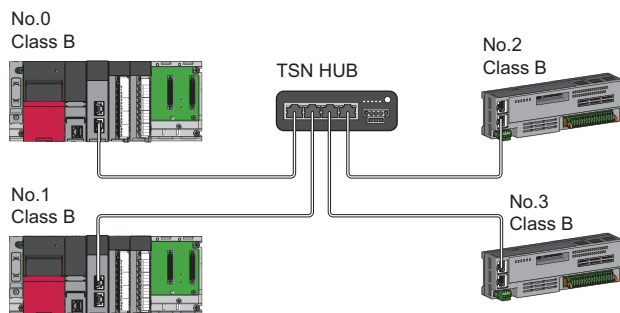

No.0: Master station
No.1: Local station
No.2, No.3: Remote station
Class B: CC-Link IE TSN Class B device

- When connecting a CC-Link IE TSN Class A device to a CC-Link IE TSN Class B device or a CC-Link IE TSN Class A device to another CC-Link IE TSN Class A device in a star topology, connect them via a switching hub.

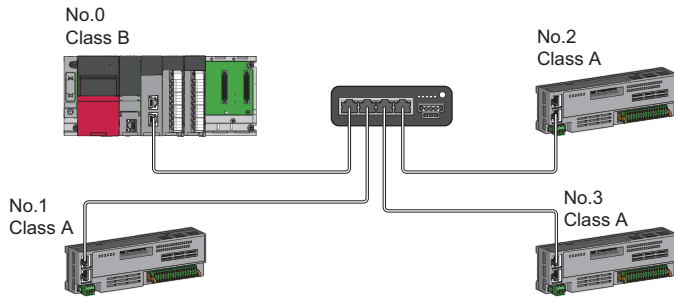

No.0: Master station
 No.1, No.2, and No.3: Remote station
 Class A: CC-Link IE TSN Class A device
 Class B: CC-Link IE TSN Class B device

- When the "Communication Mode" is "Multicast", communication may not be possible depending on the communication device if a local station is connected with a CC-Link IE TSN Class A remote station as a mixture on the end side via a switching hub. The communication will be enabled by configuring settings with the switching hub so that the multicast frame (with multicast MAC address 09:00:70:00:10:02 and 09:00:70:00:10:05) will not be transferred to the CC-Link IE TSN Class A remote station port.

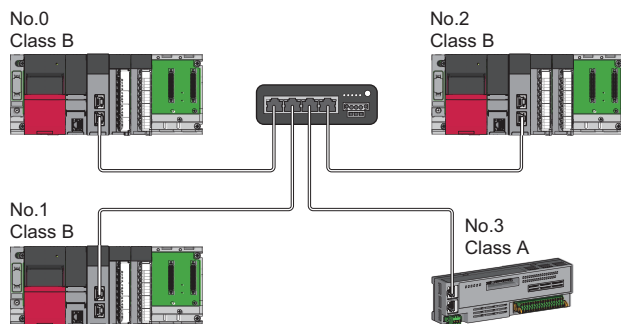

No.0: Master station
 No.1, No.2: Local station
 No.3: Remote station
 Class A: CC-Link IE TSN Class A device
 Class B: CC-Link IE TSN Class B device

■ Coexistence of line and star topologies

Line and star topologies can be mixed according to the connection requirements described below.

- When connecting a CC-Link IE TSN Class B device in a star topology, use a TSN hub.

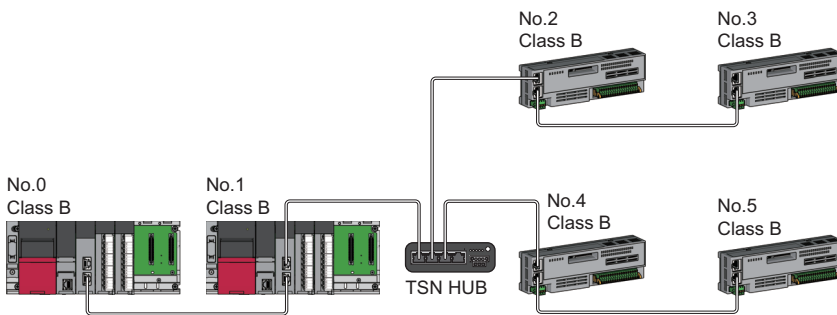

No.0: Master station
 No.1: Local station
 No.2, No.3, No.4, and No.5: Remote station
 Class B: CC-Link IE TSN Class B device

- When connecting a CC-Link IE TSN Class A device only structure in a star topology, use a general-purpose hub.

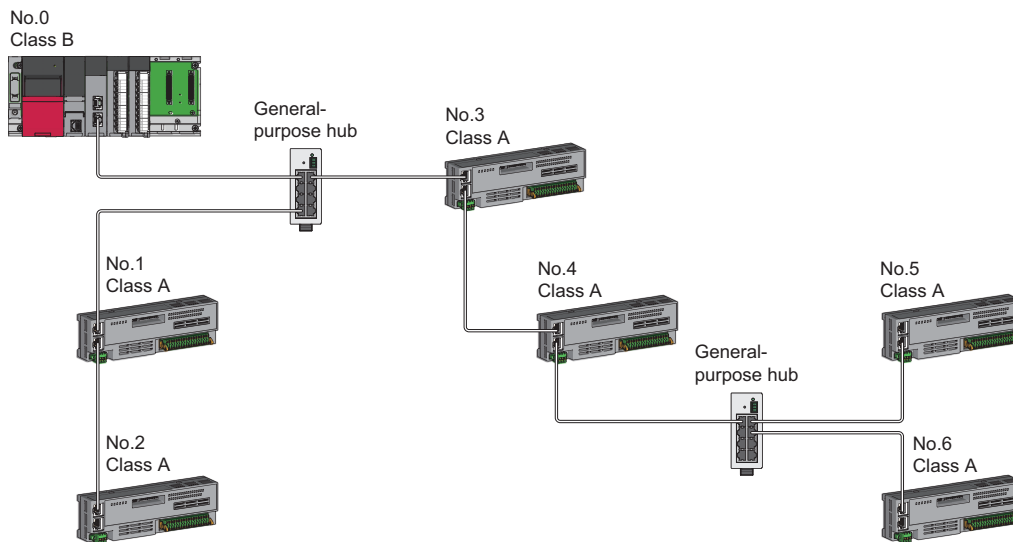

No.0: Master station
 No.1, No.2, No.3, No.4, No.5, and No.6: Remote station
 Class A: CC-Link IE TSN Class A device
 Class B: CC-Link IE TSN Class B device

- In a CC-Link IE TSN Class B/A mixed structure, when connecting a CC-Link IE TSN Class B device in a star topology, connect the CC-Link IE TSN Class A device via a TSN hub.

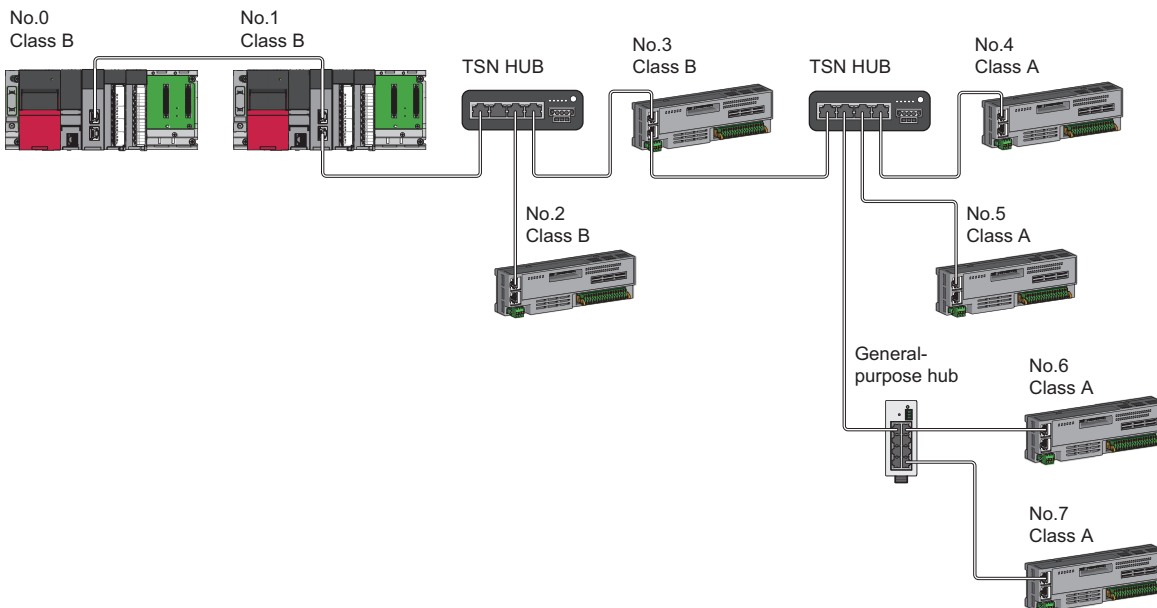

No.0: Master station
 No.1: Local station
 No.2, No.3, No.4, No.5, No.6, No.7: Remote station
 Class A: CC-Link IE TSN Class A device
 Class B: CC-Link IE TSN Class B device

- In a CC-Link IE TSN Class B/A mixed structure, the CC-Link IE TSN Class A device can be connected from the TSN hub between the CC-Link IE TSN Class B devices.

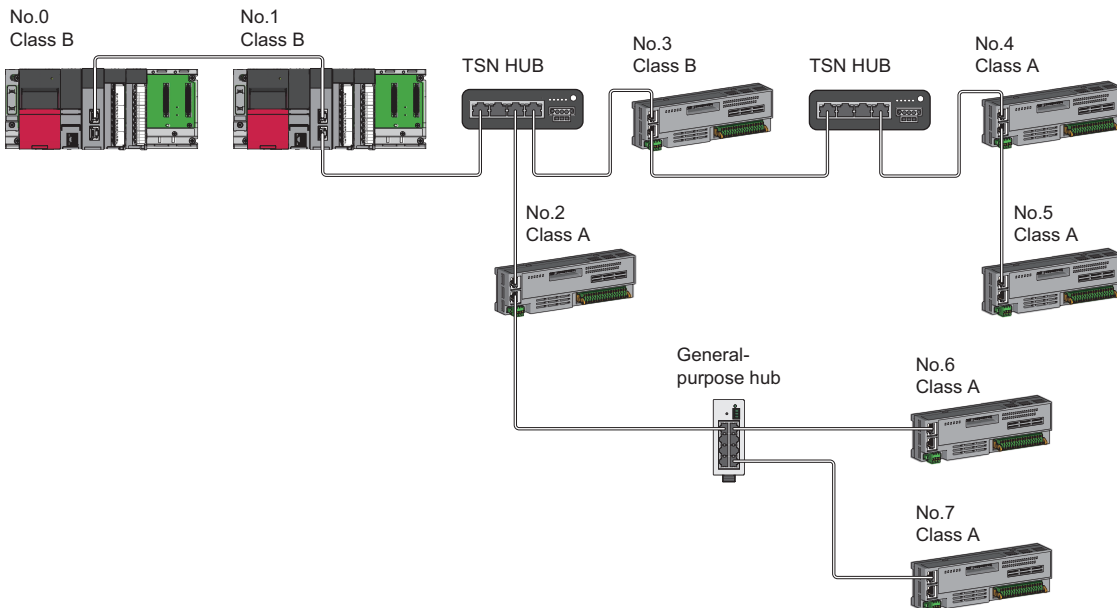

No.0: Master station
 No.1: Local station
 No.2, No.3, No.4, No.5, No.6, No.7: Remote station
 Class A: CC-Link IE TSN Class A device
 Class B: CC-Link IE TSN Class B device

- In a CC-Link IE TSN Class B/A mixed structure, when connecting a CC-Link IE TSN Class B device in a line topology, connect the CC-Link IE TSN Class A device directly or via a general-purpose hub.

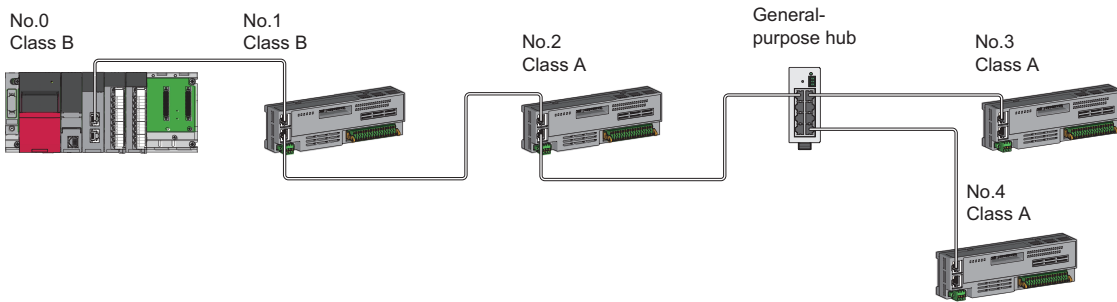

No.0: Master station
 No.1, No.2, No.3, and No.4: Remote station
 Class A: CC-Link IE TSN Class A device
 Class B: CC-Link IE TSN Class B device

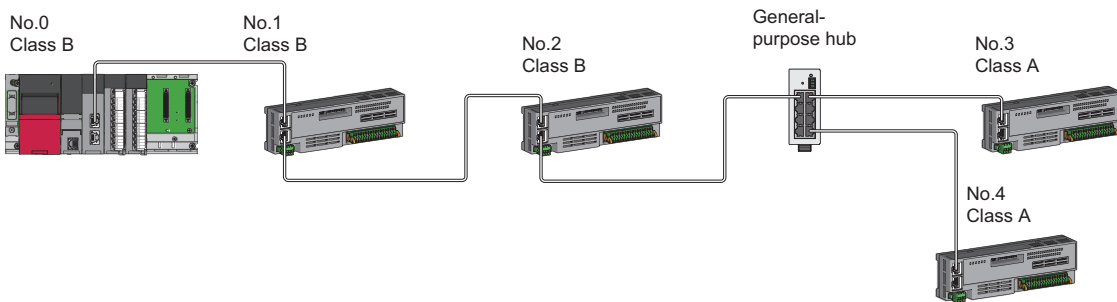

No.0: Master station
 No.1, No.2, No.3, and No.4: Remote station
 Class A: CC-Link IE TSN Class A device
 Class B: CC-Link IE TSN Class B device

- In a CC-Link IE TSN Class B/A mixed structure, when a CC-Link IE TSN Class B device is connected in a star topology using a TSN hub, the CC-Link IE TSN Class A device station can be connected to another port of the master station directly or via a general-purpose hub. (Example: P1 is a CC-Link IE TSN Class A device, and P2 is a CC-Link IE TSN Class B device)

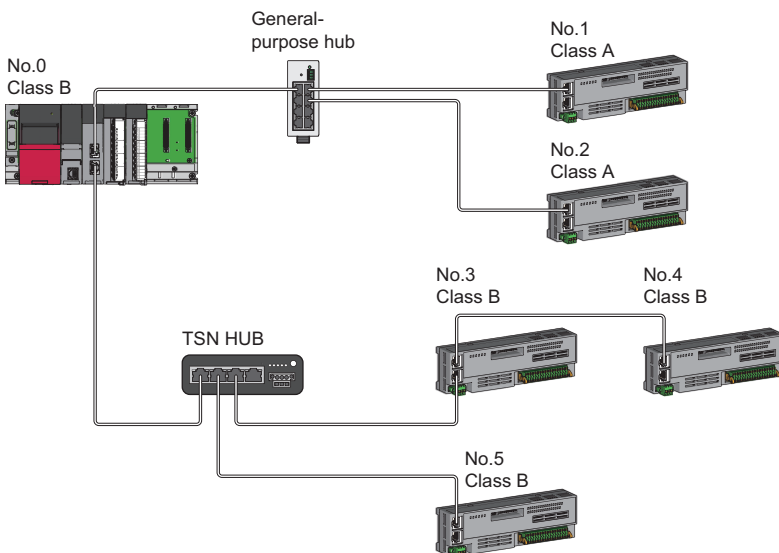

No.0: Master station
 No.1, No.2, No.3, No.4, and No.5: Remote station
 Class A: CC-Link IE TSN Class A device
 Class B: CC-Link IE TSN Class B device

Precautions

In a CC-Link IE TSN Class B/A mixed structure, set whether to use a TSN hub in the "TSN HUB Setting" of "Connection Device Information" under "Basic Settings". If the "TSN HUB Setting" and the system structure differ in whether a TSN hub is present, the CC-Link IE TSN Class A device may not perform a data link.

Ex.

When connecting a CC-Link IE TSN Class B device in a line topology

- Set "TSN HUB Setting" of "Connection Device Information" under "Basic Settings" to "Not to Use TSN HUB".
- CC-Link IE TSN Class B and CC-Link IE TSN Class A devices are connected by a general-purpose hub.

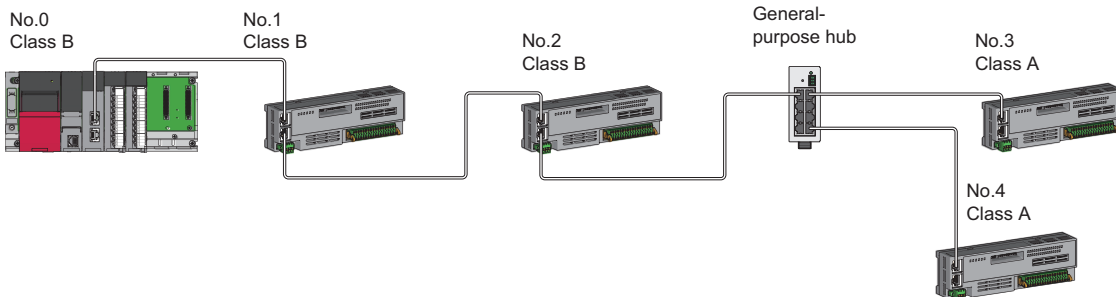

Ex.

When connecting a CC-Link IE TSN Class B device in a star topology

- Set "TSN HUB Setting" of "Connection Device Information" under "Basic Settings" to "Use TSN HUB".
- CC-Link IE TSN Class B and CC-Link IE TSN Class A devices are connected by a TSN hub.

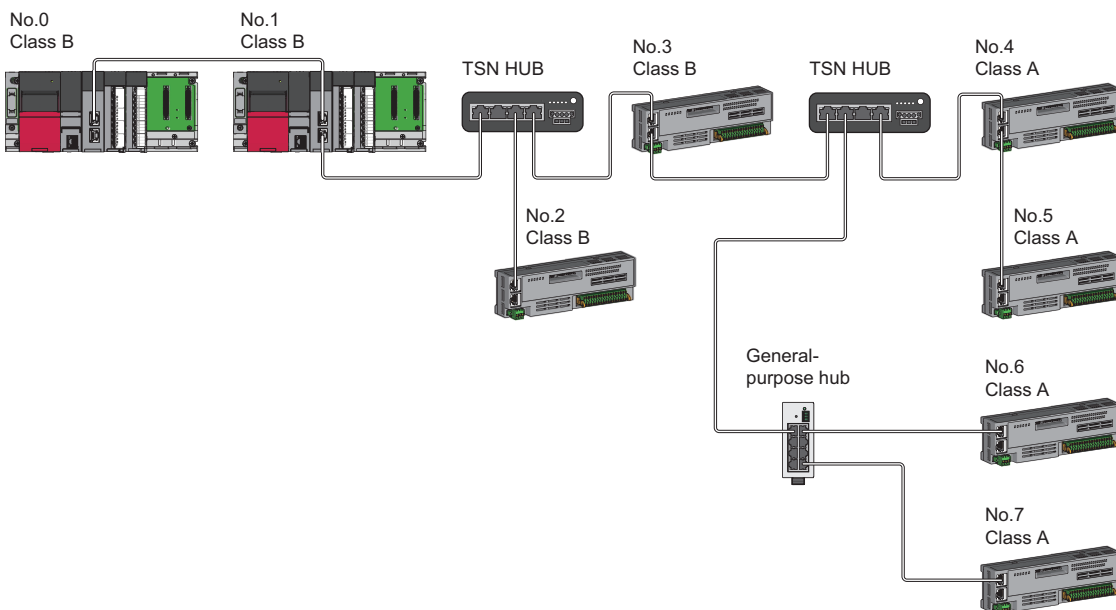

■ Ring topology

Ring topology is not possible with "Mixture of CC-Link IE TSN Class B/A or CC-Link IE TSN Class A Only" system configuration.

Connection with modules on CC-Link IE TSN with a communication speed of 100Mbps

This section describes the network topology when "Communication Speed" under "Application Settings" is set to "100Mbps".

Line topology

The network is configured in a line topology.

- Adjust the communication speed of the module.
- When connecting modules with different communication speeds, connect the modules via a switching hub.

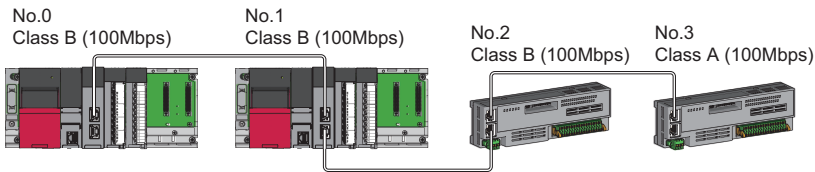

No.0: Master station
No.1: Local station
No.2, No.3: Remote station
Class A: CC-Link IE TSN Class A device
Class B: CC-Link IE TSN Class B device

Star topology

The network is configured in a star topology via a switching hub.

- When the master station with a communication speed of 1Gbps and a local or remote station with a communication speed of 100Mbps exist in the structure, set "Communication Period Setting" to "Low-Speed" for the local or remote station with a communication speed of 100Mbps.

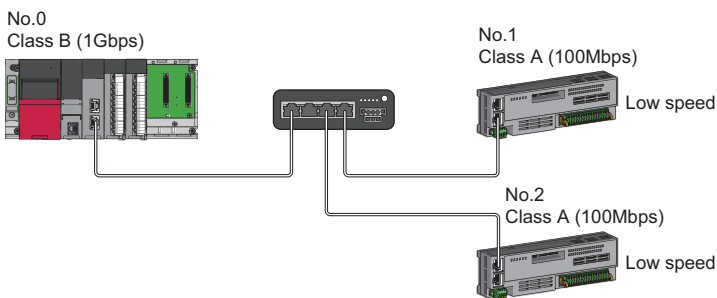

No.0: Master station
No.1, No.2: Remote station
Class A: CC-Link IE TSN Class A device
Class B: CC-Link IE TSN Class B device

- Connect the master station and local station at the same communication speed.

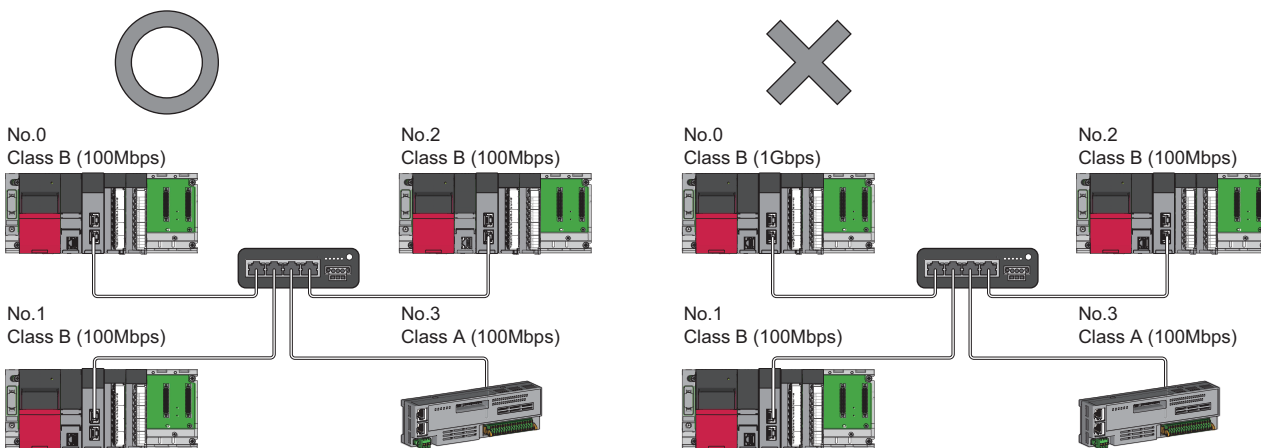

No.0: Master station
 No.1, No.2: Local station
 No.3: Remote station
 Class B: CC-Link IE TSN Class B device

- When "Communication Mode" is set to "Multicast" and the communication speed of the master station is 1Gbps, communication may not be possible depending on the type of the device if device stations with 1Gbps and 100Mbps coexist on the end side via the switching hub. The communication will be enabled by configuring settings with the switching hub so that the multicast frame (with multicast MAC address 09:00:70:00:10:02 and 09:00:70:00:10:05) will not be transferred to the port of the device station with 100Mbps.

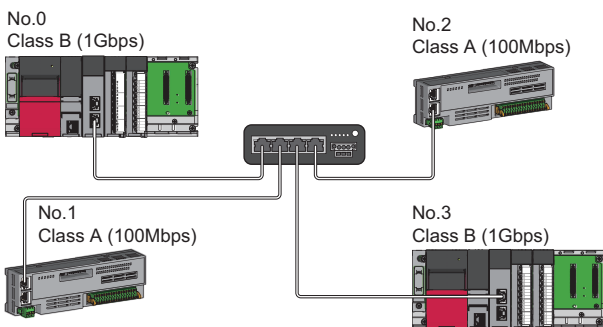

No.0: Master station
 No.1, No.2: Remote station
 No.3: Local station
 Class A: CC-Link IE TSN Class A device
 Class B: CC-Link IE TSN Class B device

■ Coexistence of line and star topologies

Line and star topologies can be mixed in the same network configuration.

- When the master station with a communication speed of 1Gbps and a local or remote station with a communication speed of 100Mbps exist in the structure, set "Communication Period Setting" to "Low-Speed" for the local or remote station with a communication speed of 100Mbps.

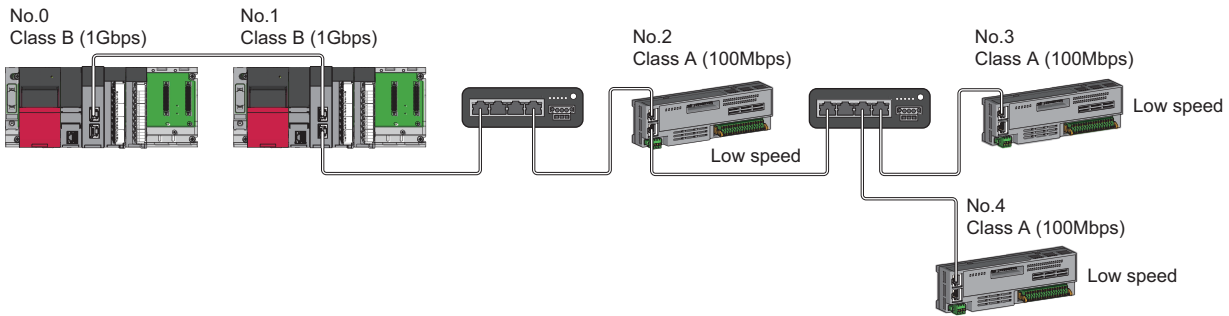

No.0: Master station
 No.1: Local station
 No.2, No.3, and No.4: Remote station
 Class A: CC-Link IE TSN Class A device
 Class B: CC-Link IE TSN Class B device

- When the communication speed of the master station is 1Gbps, a connection cannot be established if the total cyclic data size of device stations on the 100Mbps device side exceeds 2K bytes. This includes the devices with a communication speed of 100Mbps that form a boundary between the communication speed of 1Gbps and 100Mbps.

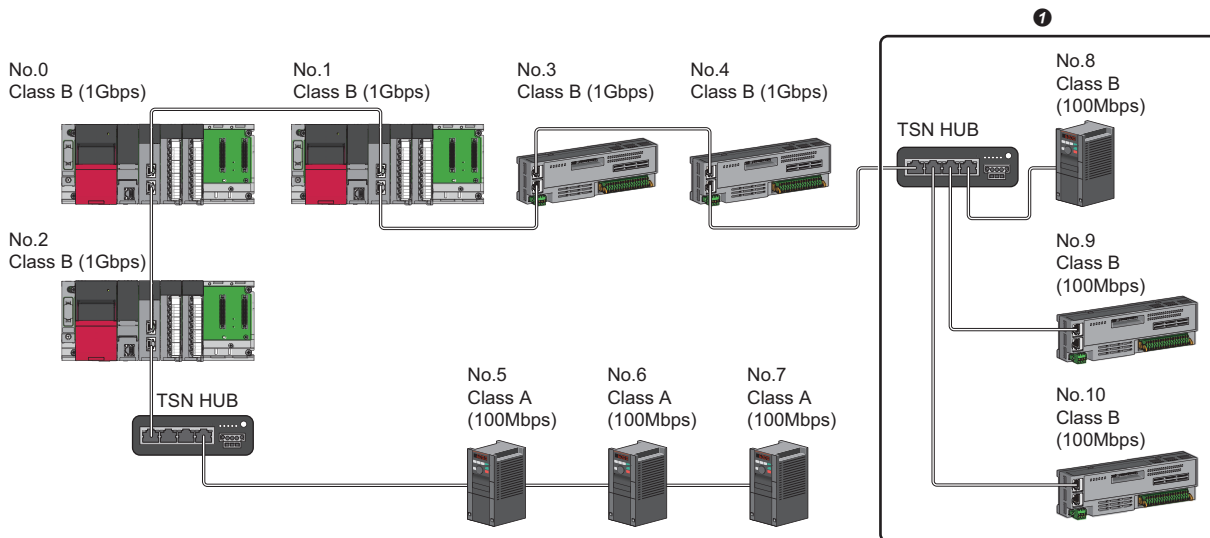

No.0: Master station
 No.1, No.2: Local station
 No.3 to No.10: Remote station
 Class A: CC-Link IE TSN Class A device
 Class B: CC-Link IE TSN Class B device
 ❶ Set the total cyclic data size within 2K bytes.

■ Ring topology

Ring topology is not possible with "Mixture of CC-Link IE TSN Class B/A or CC-Link IE TSN Class A Only" system configuration.

Structure with modules on CC-Link IE TSN and Ethernet devices

Connection with modules on CC-Link IE TSN and Ethernet devices

Line topology

Connect Ethernet devices to the end of the network.

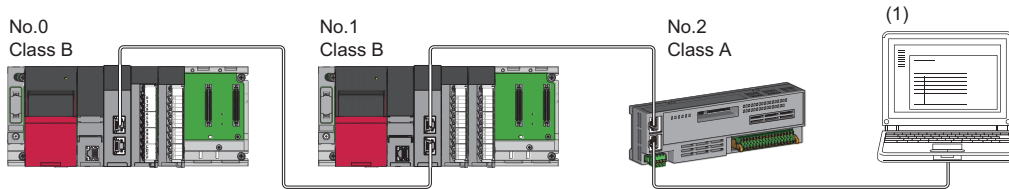

No.0: Master station
No.1: Local station
No.2: Remote station
(1) Ethernet device
Class A: CC-Link IE TSN Class A device
Class B: CC-Link IE TSN Class B device

Star topology

Modules or Ethernet devices are connected in a star topology via a switching hub.

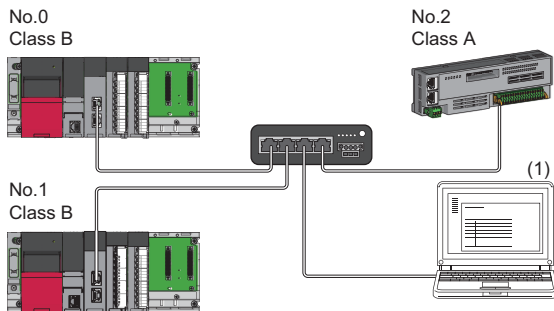

No.0: Master station
No.1: Local station
No.2: Remote station
(1) Ethernet device
Class A: CC-Link IE TSN Class A device
Class B: CC-Link IE TSN Class B device

Point

Since cyclic data is sent to an Ethernet device when "Communication Mode" is set to "Multicast" and a local station is used with an Ethernet device on the end side via a switching hub, communication may not be possible depending on the type of an Ethernet device.

The communication will be enabled by configuring settings with the TSN hub so that the multicast frame (with multicast MAC address 09:00:70:00:10:02 and 09:00:70:00:10:05) will not be transferred to the port of the Ethernet device.

■ Coexistence of line and star topologies

Line and star topologies can be mixed according to the connection requirements described below.

- Connect Ethernet devices at the end of line topology.
- When connecting the Ethernet device in a star topology, connect the Ethernet device to a switching hub.

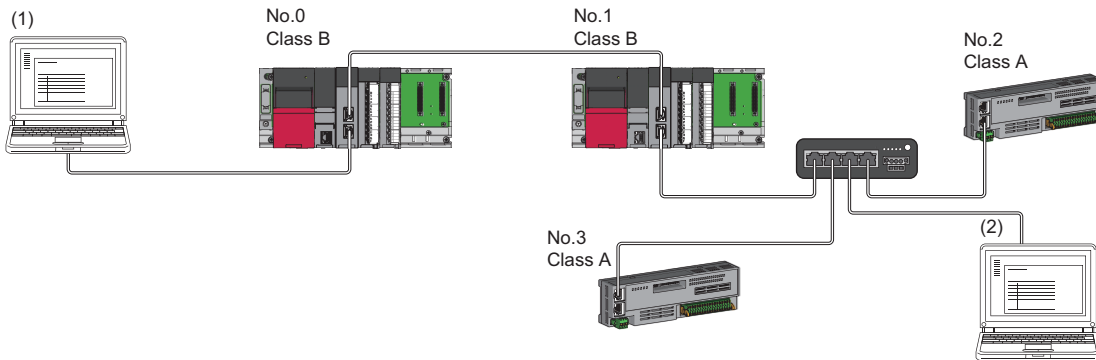

No.0: Master station
No.1: Local station
No.2, No.3: Remote station
(1), (2): Ethernet device
Class A: CC-Link IE TSN Class A device
Class B: CC-Link IE TSN Class B device

■ Ring topology



Ring topology is not possible with "Mixture of CC-Link IE TSN Class B/A or CC-Link IE TSN Class A Only" system configuration.

5.3 Structure of the CC-Link IE TSN and CC-Link IE Field Network

Set the RJ71GN11-T2 and CC-Link IE Field Network master/local-equipped modules to different network numbers, and mount the master station of each network to the same base unit.

Connect Ethernet devices to the end of the network.

For details on the CC-Link IE Field Network, refer to the following.

-  MELSEC IQ-R Ethernet/CC-Link IE User's Manual (Startup)
-  MELSEC IQ-R CC-Link IE Field Network User's Manual (Application)

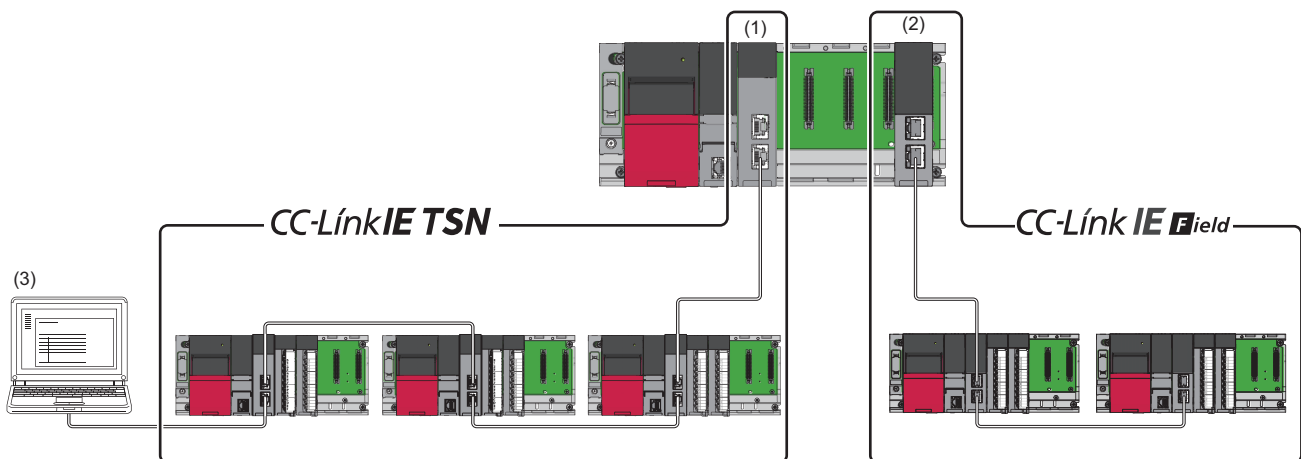

- (1) Master station (Network No.1)
- (2) Master station (Network No.3)
- (3) Ethernet device



The communication data of the CC-Link IE TSN and CC-Link IE Field Network are transferred between master stations.

5.4 Structure When CC-Link IE TSN Communication Software Is Used

Connection specifications

CC-Link IE TSN Communication Software can be connected to a port of the CC-Link IE TSN Class B device (supporting CC-Link IE TSN) or a TSN hub.

Up to two CC-Link IE TSN Communication Software can be connected.

Line topology

Connect a cable for CC-Link IE TSN Communication Software to the end of the network.

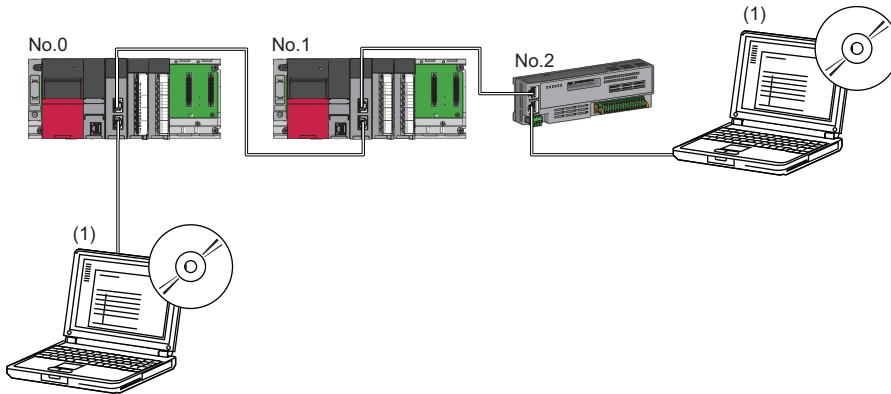

- No.0: Master station
- No.1: Local station
- No.2: Remote station
- (1) CC-Link IE TSN Communication Software

Star topology

Connect a cable for CC-Link IE TSN Communication Software to a port of the TSN hub.

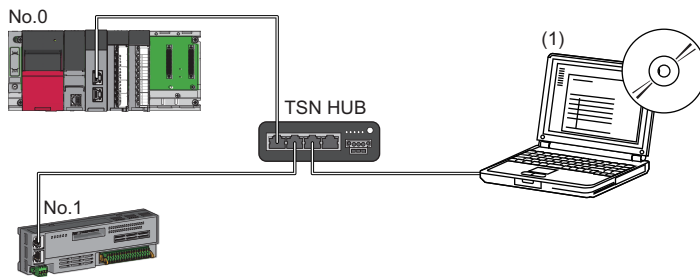

- No.0: Master station
- No.1: Remote station
- (1) CC-Link IE TSN Communication Software

■ Coexistence of line and star topologies

Connect a cable for CC-Link IE TSN Communication Software to a port of the TSN hub or the end of the network.

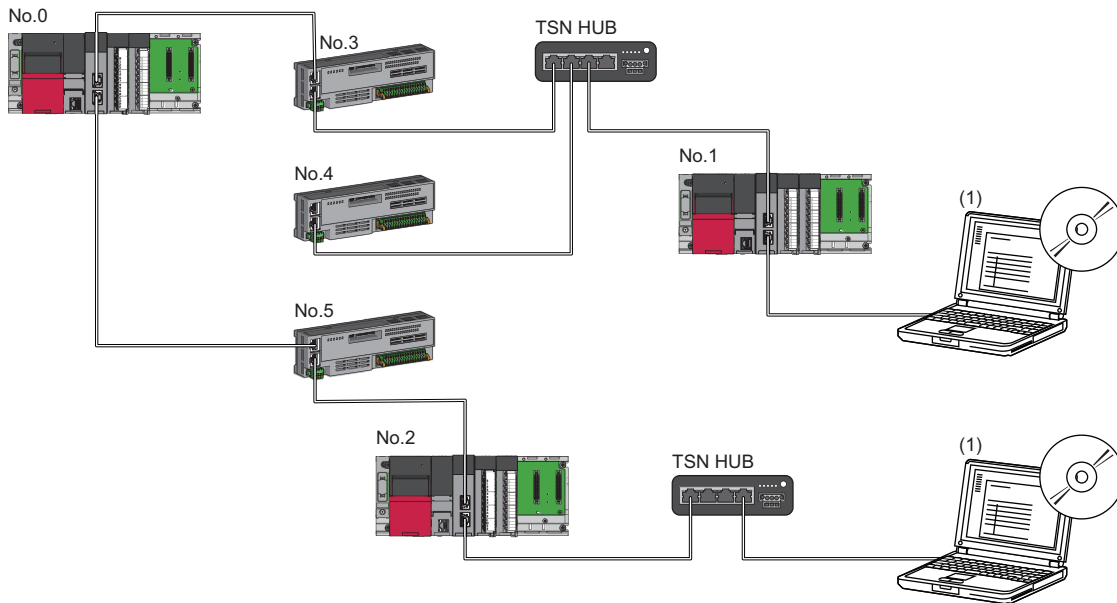

- No.0: Master station
- No.1, No.2: Local station
- No.3, No.4, No.5: Remote station
- (1) CC-Link IE TSN Communication Software

5.5 Precautions for System Configuration

Firmware version limitations due to combination of master and local stations

The master station and a local station cannot be used in the following combination.

- The combination of the master station with firmware version "03" or earlier and a local station with firmware version "04" or later
- The combination of the master station with firmware version "04" or later and a local station with firmware version "03" or earlier

Update the RJ71GN11-T2 with firmware version "03" or earlier to firmware version "04" or later before use.

The following describes how to update the firmware.

 MELSEC iQ-R Module Configuration Manual

The following describes the operation of each station according to the firmware version when the master station is combined with a local station.

Master station	Local station	
	Firmware version "03" or earlier	Firmware version "04" or later
Firmware version "03" or earlier	Normal operation	Master station side • The local station with firmware version "04" or later is disconnected. There is no impact on the local station with firmware version "03" or earlier. Local station side • The error code 300AH occurs and the station is disconnected.
Firmware version "04" or later	Master station side • The local station with firmware version "03" or earlier is disconnected. There is no impact on the local station with firmware version "04" or later. Local station side • The error code 300AH occurs and the station is disconnected.	Normal operation

Ring topology limitations

For a ring topology, use the RJ71GN11-T2 with a firmware version of "10" or later. If the firmware version is earlier than "10", a data link is not performed.

The following table lists the operations when "Network Topology" under "Basic Settings" is set to "Ring", and the setting network topology is different from the actual connection status.

Actual connection status	Communication speed	Operation
Line topology	Mixture of different communication speeds	A data link is not performed.
	Same communication speed used by all stations	A data link is performed in a state in which a loopback station is available.
Star topology	—	A data link is not performed.
Coexistence of line and star topologies	—	
Ring topology	Mixture of different communication speeds	Normal operation
	Same communication speed used by all stations	

Devices connected to the same network

Do not connect the devices as described below. Doing so may cause the disconnection of all stations.

- A module on CC-Link IE TSN and a device having different network types (such as CC-Link IE Controller Network or CC-Link IE Field Network) other than an Ethernet device are connected to the same network.
- A module on CC-Link IE TSN and an Ethernet device such as a personal computer, both of which are on different networks, are connected to one switching hub.

Adding a device station with no IP address setting

In a line topology, do not connect the device station with no IP address setting at a place other than the end of the network. A data link may not be performed in the device stations after the device station with no IP address setting.

CC-Link IE TSN/CC-Link IE Field diagnostics

If the following operations are performed, the actual network configuration and the network map of the CC-Link IE TSN/CC-Link IE Field diagnostics may be a mismatch.

Network configuration	Operation
Star topology	<ul style="list-style-type: none">• Powering off and on a device station or switching hub• Connecting/disconnecting an Ethernet cable connected to the switching hub• Disconnecting an Ethernet cable from a device station and connecting it to another device station or a switching hub• Disconnecting more than 9 stations, or half the number of device stations or more in the system• Changing the network topology when adding a device station
Line topology	<ul style="list-style-type: none">• Simultaneously powering off or on multiple stations• Simultaneously connecting/disconnecting Ethernet cables to/from multiple stations (When a data link faulty station returns, a data link error will occur in all the stations.)• Disconnecting more than 9 stations, or half the number of device stations or more in the system• Changing the network topology when adding a device station

Point

The actual network configuration and network map can be matched by executing the network map update of the CC-Link IE TSN/CC-Link IE Field diagnostics. ( MELSEC iQ-R CC-Link IE TSN User's Manual (Application))

Calculation of the total cyclic data size

The following shows the calculation formula of the total cyclic data size. The part of the variable enclosed in double quotes (" ") is the setting value of the "CC-Link IE TSN Configuration" window.

Total cyclic data size = 256 + (146 × Number of local stations) + (106 × Number of remote stations) + (Number of "RX setting" points ÷ 8) + (Number of "RWr setting" points × 2) + (Number of "LB setting" points ÷ 8) + (Number of "LW setting" points × 2) [byte]

6 SYSTEM CONFIGURATION (RJ71GN11-SX)

The RJ71GN11-SX uses an optical fiber cable for ring topology. ( Page 71 Optical Fiber Cables)

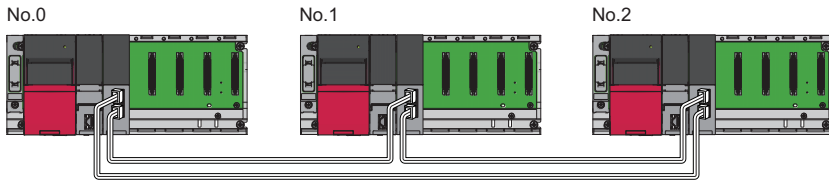

No.0: Master station
No.1, No.2: Local station

Unicast mode and multicast mode

Cyclic transmission differs depending on the communication mode set by the module parameter of the master station. The communication modes are as follows:

- Unicast mode
- Multicast mode

For details, refer to the following.

 MELSEC iQ-R CC-Link IE TSN User's Manual (Application)

Ring topology limitations

"Network Topology" in "Basic Settings" is fixed to "Ring". The following table lists the operations when the setting and the actual connection status are different.

Actual connection status	Communication speed	Operation
Line topology	Mixture of different communication speeds	A data link is not performed.
	Same communication speed used by all stations	A data link is performed in a state in which a loopback station is available.
Star topology	—	A data link is not performed.
Coexistence of line and star topologies	—	
Ring topology	Mixture of different communication speeds	Normal operation
	Same communication speed used by all stations	

Devices connected to the same network

Do not connect the devices as described below. All stations in the network may be disconnected.

- Connection of devices with different network types (such as CC-Link IE Controller Network) to the same network
- Connection using a switching hub

MEMO

7 WIRING

This chapter describes the wiring methods and wiring products for Ethernet cables, switching hubs, and optical fiber cables.

7.1 Ethernet Cables

Wire the RJ71GN11-T2 with Ethernet cables.

Wiring methods

The following describes connection and disconnection of the Ethernet cable.

Connecting the cable

1. Push the Ethernet cable connector into P1 or P2 until it clicks, paying attention to its orientation.
2. Lightly pull it to check that it is securely connected.
3. Check whether the LINK LED of P1 or P2 connected with an Ethernet cable is on.*¹

*¹ The time between the cable connection and the LINK LED turning on may vary. The LINK LED usually turns on in a few seconds. Note, however, that the time may be extended further if the link-up processing is repeated depending on the status of the device on the line. If the LINK LED does not turn on, refer to the following and take corrective actions.

 MELSEC iQ-R CC-Link IE TSN User's Manual (Application)

Point

Both P1 and P2 can be used.

- When only one of P1 and P2 connectors is used in a star topology, either P1 or P2 is applicable.
- When both connectors are used in a line topology, P1-P1, P2-P2, and P1-P2 connections are acceptable.

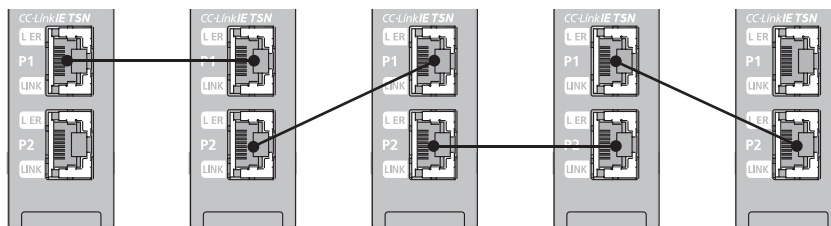

Disconnecting the cable

1. Press the latch down and unplug the Ethernet cable.

Precautions

Be sure to follow the precautions for wiring. Otherwise, some functions may not operate normally. (It may operate normally temporarily.)

- Place the Ethernet cable in a duct or clamp them. If not, dangling cable may swing or inadvertently be pulled, resulting in damage to the module or cables or malfunction due to poor contact.
- Do not touch the core of the cable-side or module-side connector, and protect it from dirt or dust. If oil from your hand, dirt or dust is attached to the core, it can increase transmission loss, arising a problem in a data link.
- Check that the Ethernet cable is not disconnected or not shorted and there is no problem with the connector connection.
- Before connecting the Ethernet cables, check also the CC-Link IE TSN Installation Manual available on the CC-Link Partner Association website (www.cc-link.org). Failure to follow the instructions in the manual may cause malfunctions.
- Do not use Ethernet cables with broken latches. Doing so may cause the cable to unplug or malfunction.
- Hold the connector part when connecting and disconnecting the Ethernet cable. Pulling the cable connected to the module may result in malfunction or damage to the module or cable.
- The maximum station-to-station distance of the Ethernet cable is 100m. However, the length may be shorter depending on the operating environment of the cable. For details, contact the manufacturer of the cable used.
- The bend radius of the Ethernet cable is limited. For details, check the specifications of the Ethernet cable to be used.

Wiring products

Use Ethernet cable that meets the following standards.

Communication speed	Type	Type	Connector
1Gbps	Category 5e or higher, straight cable (shielded, STP)	The following conditioning cables: • IEEE 802.3 (1000BASE-T) • ANSI/TIA/EIA-568-B (Category 5e)	RJ45 connector
100Mbps	Category 5 or higher, straight cable (shielded, STP)	The following conditioning cables: • IEEE 802.3 (100BASE-TX) • ANSI/TIA/EIA-568-B (Category 5)	

Cables for CC-Link IE TSN are available from Mitsubishi Electric System & Service Co., Ltd. (Catalogs for cable are also available.)

In addition, the connector processing of cable length is available for your preference. Please consult your local Mitsubishi representative.

Communication speed	Type	Model (Manufacturer)
1Gbps	Category 5e or higher, straight cable (double shielded, STP)	SC-E5EW series (Mitsubishi Electric System & Service Co., Ltd.)

Point

A communication error may occur due to high-frequency noise from devices other than a programmable controller in a given connection environment. The following describes countermeasures to be taken on the RJ71GN11-T2 side to avoid high-frequency noise influence.

Wiring

- Use a duplex shield type cable.
- Do not bundle the cable with the main circuit or power cable or do not place it near those lines.
- Place the cable in a duct.

7.2 Switching Hub (RJ71GN11-T2 Only)

Use the following industrial switching hubs for wiring the RJ71GN11-T2.

Term	Description	CC-Link IE TSN Class
TSN hub ^{*1*}	For the models and usage methods of the switching hubs, refer to the CC-Link Partner Association website (www.cc-link.org).	CC-Link IE TSN Class B device
General-purpose hub ^{*3}		CC-Link IE TSN Class A device

*1 When using a TSN hub, use the RJ71GN11-T2 with a firmware version of "05" or later.

*2 Use of the following is recommended for TSN hub:

*3 When connecting a CC-Link IE TSN Class A device that supports the protocol version 2.0 to a general-purpose hub, set the VLAN function of the general-purpose hub to "Disabled". If it is set to "Enabled", cyclic transmission cannot be performed with CC-Link IE TSN Class A devices supporting the protocol version 2.0.

Type	Model (Manufacturer)	Reference
CC-Link IE TSN industrial managed switch	NZ2MHG-TSNT□ (Mitsubishi Electric Corporation)	 CC-Link IE TSN Industrial Managed Ethernet Switch User's Manual

A switching hub can be used for cascade connection.

When the switching hub is used for cascade connection, check the specifications of the switching hub used.

Precautions

- Since there are different restrictions for system configuration using a TSN hub and system configuration using a general-purpose hub, setting with an engineering tool is required. ( Page 32 SYSTEM CONFIGURATION (RJ71GN11-T2))
- Do not configure a ring topology when modules are connected to a switching hub. Doing so, all stations will fail and data links cannot be performed.
- Incorrectly configured ring topology can be detected an error on the CC-Link IE TSN/CC-Link IE Field diagnostics and event history. However, if the system is configured with a switching hub, the error may not be detected.
- For the restrictions on the switching hub, refer to the manual for the product used.

7.3 Optical Fiber Cables

Wire the RJ71GN11-SX with optical fiber cables.

Wiring methods

The following describes connection and disconnection of the optical fiber cable.

Connecting the cable

1. Push the optical cable connector into P1 or P2 until it clicks, paying attention to its orientation.
2. Lightly pull it to check that it is securely connected.



Both P1 and P2 can be used.

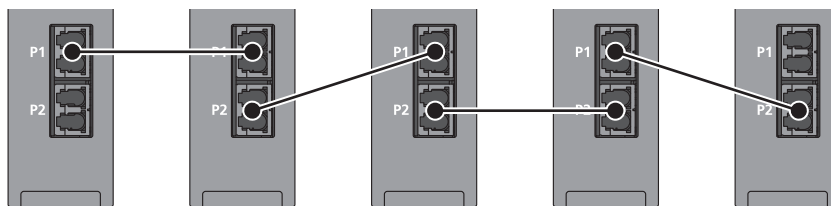

Disconnecting the cable

1. Press the connector hook down and unplug the optical fiber cable.

Precautions

- Place the optical fiber cable in a duct or clamp them. If not, dangling cable may swing or inadvertently be pulled, resulting in damage to the cables or malfunction due to poor contact.
- Do not touch the optical fiber core of the optical fiber cable side connector, and protect it from dirt or dust. If oil from your hand, dirt or dust is attached to the core, it can increase transmission loss, arising a problem in data link.
- Check that the optical fiber cable is not disconnected and there is no problem with the connector connection.
- Place the attached cover on the unused optical fiber port to prevent foreign matter such as dirt or dust.
- The bend radius of the optical fiber cable is limited. For details, check the specifications of the cable to be used.
- The laser class (JIS C 6802, IEC 60825-1) is class 1. Do not look directly at a laser beam. Doing so may harm your eyes.

Wiring products

Use optical fiber cables and connectors certified by the CC-Link Partner Association.

For details, check the CC-Link Partner Association website (www.cc-link.org).

Communication speed	Optical fiber cable		Optical fiber connector	
	Type and standard	Description	Type and standard	Description
1Gbps	IEEE 802.3z 1000BASE-SX compatible GI type silica glass multimode optical fiber cable IEC 60793-2-10 A1a.1 compliant	Outside diameter of the core/clad: 50μm/125μm Transmission loss: 3.5dB/km or lower [λ=850nm] Transmission band: 500MHz·km or more [λ=850nm]	Duplex LC connector IEC 61754-20 TypeLC compliant	Connection loss: 0.3dB or lower Polished surface: PC (Physical Contact) polishing

Optical fiber cables with connectors are available from Mitsubishi Electric System & Service Co., Ltd.

8 COMMUNICATION EXAMPLES

8.1 RJ71GN11-T2 Communication Example

The following shows an example of a cyclic transmission program using the RJ71GN11-T2 master station and local station.

System configuration

- Power supply module: R61P
- CPU module: R04CPU
- Master/local module: RJ71GN11-T2 (start I/O number: 0000H to 001FH)

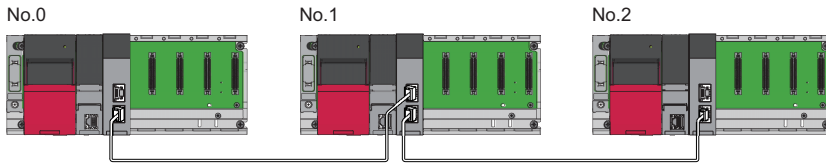

No.0: Master station (station No.0)
 No.1: Local station (station No.1)
 No.2: Local station (station No.2)

Link device assignment

For RX, RY, RWr, and RWW, 256 points are assigned to each station.
 For LB and LW, 512 points are assigned to each station.

Unicast mode

■RX/RX assignment

Each of the following No.0 to No.2 represents a station number.
 No.0 is master station, and No.1 and No.2 are local stations.

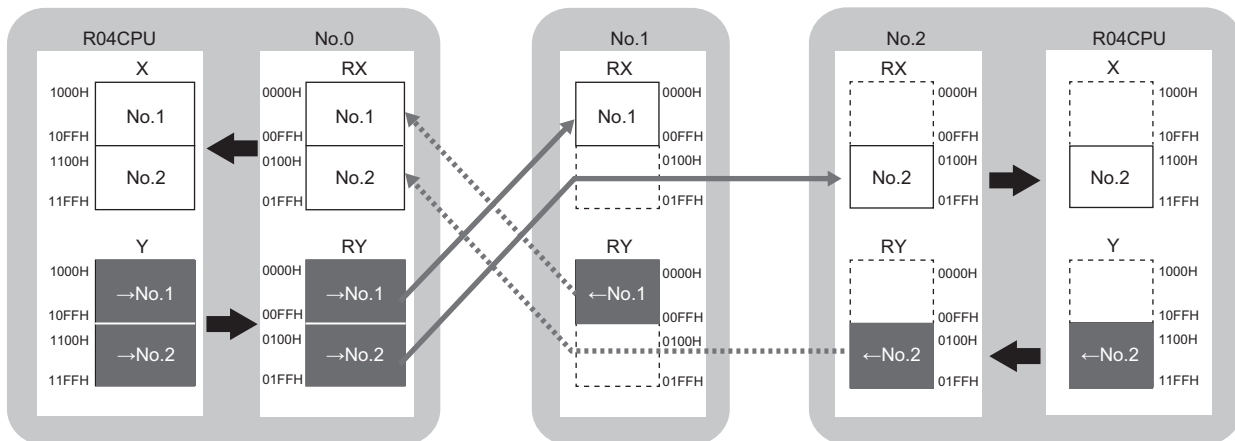

→No.1, →No.2: Send range to station No.1, send range to station No.2
 ←No.1, ←No.2: Send range from station No.1, send range from station No.2

■RWr/RWw assignment

Each of the following No.0 to No.2 represents a station number.

No.0 is master station, and No.1 and No.2 are local stations.

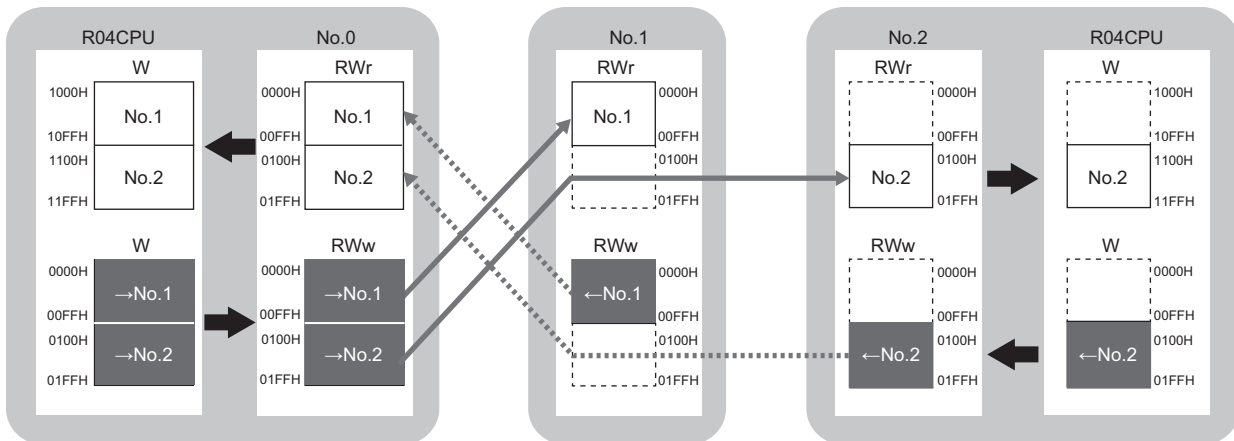

→No.1, →No.2: Send range to station No.1, send range to station No.2

←No.1, ←No.2: Send range from station No.1, send range from station No.2

■LB/LW assignment

Each of the following No.0 to No.2 represents a station number.

No.0 is master station, and No.1 and No.2 are local stations.

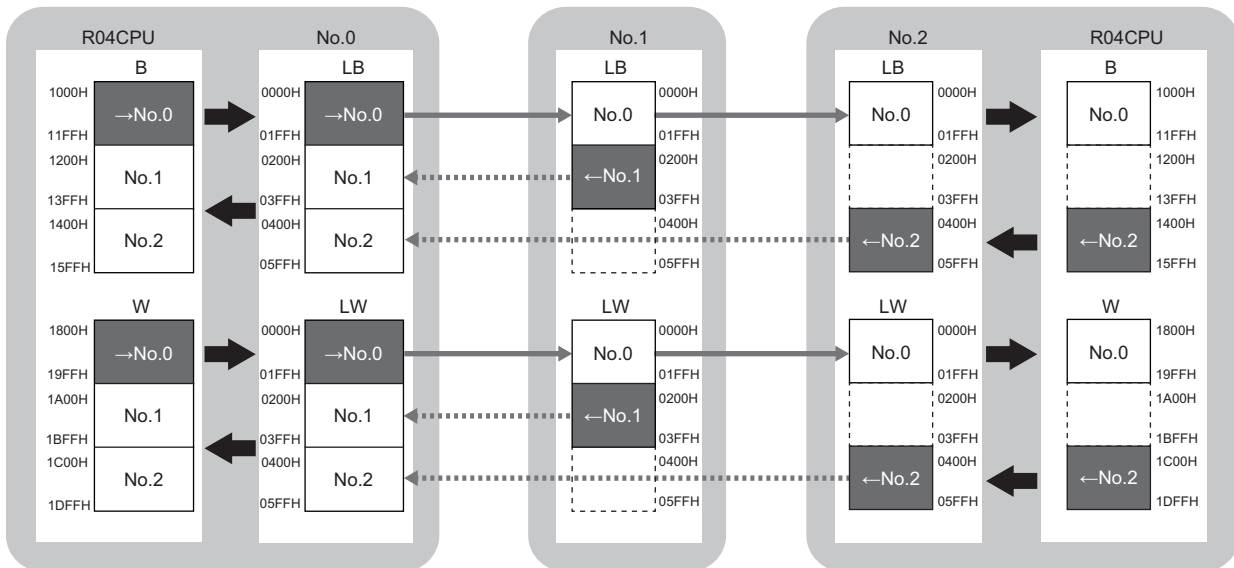

→No.0: Send range from station No.0

←No.1, ←No.2: Send range from station No.1, send range from station No.2

Multicast mode

■RX/RX assignment

Each of the following No.0 to No.2 represents a station number.

No.0 is master station, and No.1 and No.2 are local stations.

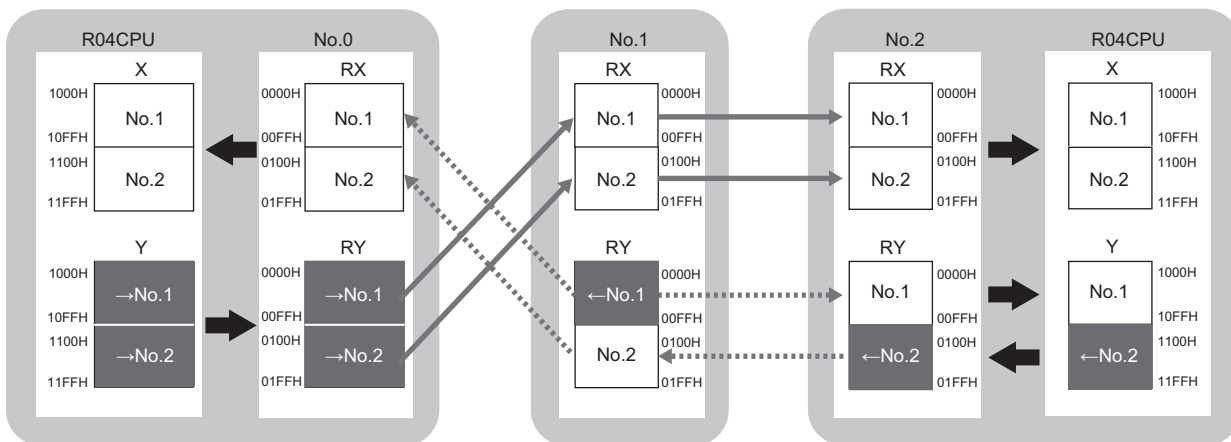

→No.1, →No.2: Send range to station No.1, send range to station No.2

←No.1, ←No.2: Send range from station No.1, send range from station No.2

■RWw/RWw assignment

Each of the following No.0 to No.2 represents a station number.

No.0 is master station, and No.1 and No.2 are local stations.

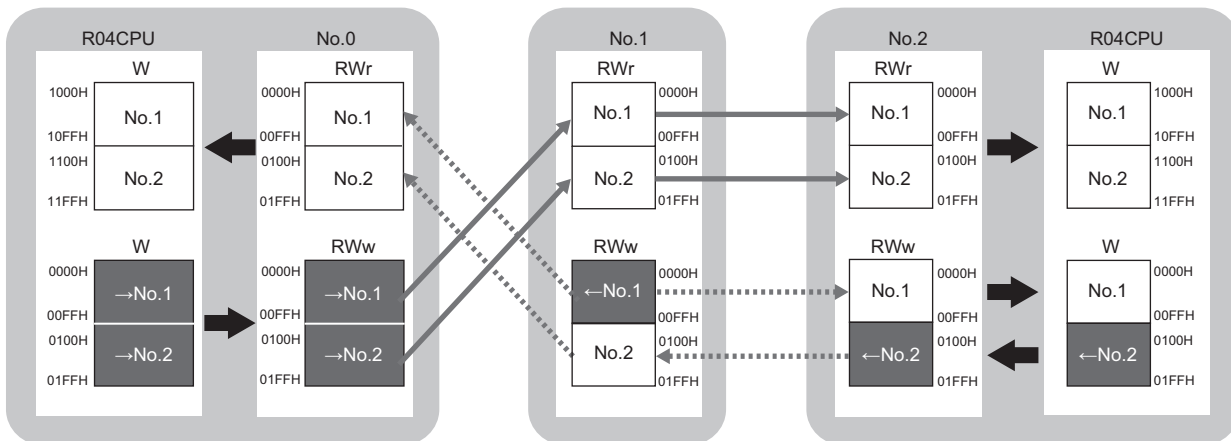

→No.1, →No.2: Send range to station No.1, send range to station No.2

←No.1, ←No.2: Send range from station No.1, send range from station No.2

■LB/LW assignment

Each of the following No.0 to No.2 represents a station number.

No.0 is master station, and No.1 and No.2 are local stations.

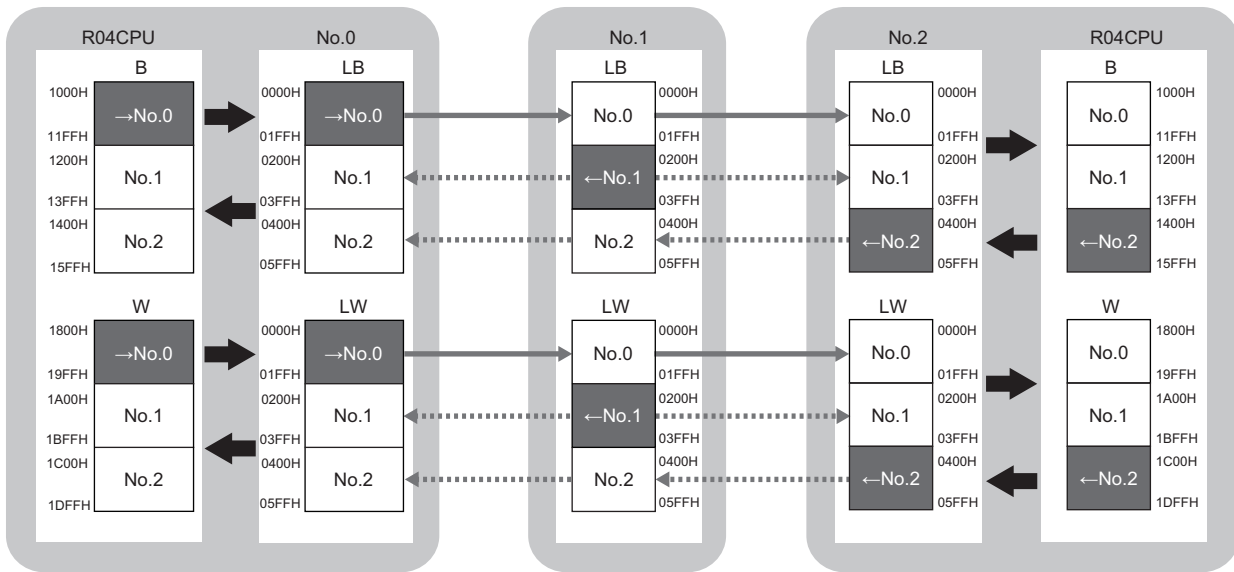

→No.0: Send range from station No.0

←No.1, ←No.2: Send range from station No.1, send range from station No.2

Setting in the master station

Connect the engineering tool to the CPU module on the master station and set the parameters.

1. Set the CPU module as follows.

 [Project] ⇒ [New]

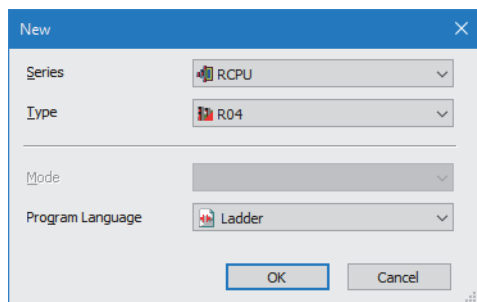

2. Click the [Setting Change] button and set the item that is to use module labels.

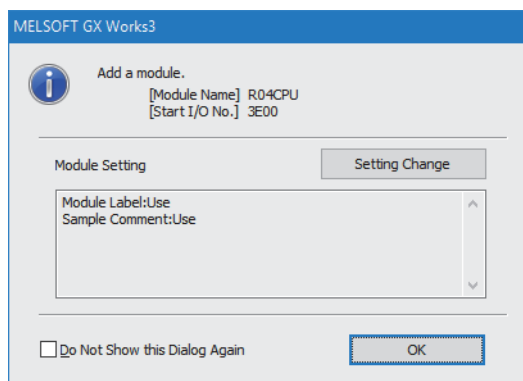

3. Set "Link Direct Device Setting" in "CPU Parameter" to "Extended Mode (iQ-R Series Mode)".

 [CPU Parameter] ⇒ [Memory/Device Setting] ⇒ [Link Direct Device Setting] ⇒ [Link Direct Device Setting]

Item	Setting
<div style="border: 1px solid gray; padding: 2px;"> <div style="background-color: #e0e0e0; padding: 2px;">Link Direct Device Setting</div> <div style="padding: 2px;">Link Direct Device Setting</div> </div>	Extended Mode (iQ-R Series Mode)

Restriction

To write module parameters of the RJ71GN11-T2 on a CPU module using an engineering tool, set "Link Direct Device Setting" to "Extended Mode (iQ-R Series Mode)".

If "Link Direct Device Setting" is "Q Series Compatible Mode", "Write to PLC" cannot be executed.

4. Set the RJ71GN11-T2 as follows.

[Navigation window] ⇒ [Parameter] ⇒ [Module Information] ⇒ Right-click ⇒ [Add New Module]

5. Click the [OK] button to add a module label of the RJ71GN11-T2.

6. Set the items in "Required Settings" as follows.

[Navigation window] ⇒ [Parameter] ⇒ [Module Information] ⇒ [RJ71GN11-T2] ⇒ [Required Settings]

Item	Setting
Station Type	
Station Type	Master Station
Network No.	
Network No.	1
Parameter Setting Method	
Setting Method of Basic/Application Settings	Parameter Editor
Station No./IP Address Setting	
Station No./IP Address Setting Method	Parameter Editor
Station No.	
Station No.	0
IP Address	
IP Address	192 . 168 . 3 . 253
Subnet Mask	. . .
Default Gateway	. . .

7. Set the network configuration settings on the "CC-Link IE TSN Configuration" window. (Set the IP address for each station.)

[Navigation window] ⇒ [Parameter] ⇒ [Module Information] ⇒ [RJ71GN11-T2] ⇒ [Basic Settings] ⇒ [Network Configuration Settings]

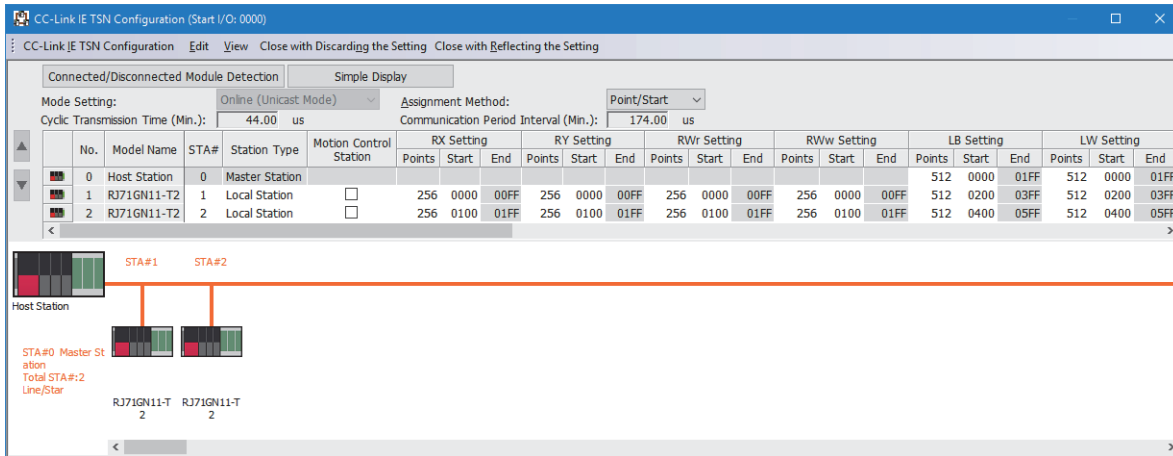

8. Click the [Close with Reflecting the Setting] button to close the "CC-Link IE TSN Configuration" window.

9. Set the refresh settings as follows.

[Navigation window] ⇒ [Parameter] ⇒ [Module Information] ⇒ [RJ71GN11-T2] ⇒ [Basic Settings] ⇒ [Refresh Setting]

No.	Link Side						CPU Side				
	Device Name	Points	Start	End	Target		Device Name	Points	Start	End	
-	SB	4096	00000	00FFF	↔	Module Label					
-	SW	4096	00000	00FFF	↔	Module Label					
1	RX	512	00000	001FF	↔	Specify Device	X	512	01000	011FF	
2	RY	512	00000	001FF	↔	Specify Device	Y	512	01000	011FF	
3	RWw	512	00000	001FF	↔	Specify Device	W	512	00000	001FF	
4	RWr	512	00000	001FF	↔	Specify Device	W	512	01000	011FF	
5	LB	1536	00000	005FF	↔	Specify Device	B	1536	01000	015FF	
6	LW	1536	00000	005FF	↔	Specify Device	W	1536	01800	01DFF	

10. In "Communication Mode" under "Application Settings", set "Unicast" or "Multicast".

[Navigation window] ⇒ [Parameter] ⇒ [Module Information] ⇒ [RJ71GN11-T2] ⇒ [Application Settings] ⇒ [Communication Mode]

11. Click the [Apply] button.

12. Write the set parameters to the CPU module on the master station. Then, reset the CPU module or power off and on the system.

[Online] ⇒ [Write to PLC]

Point

In this example, default values are used for parameters that are not shown above. For the parameters, refer to the following.

📖 MELSEC iQ-R CC-Link IE TSN User's Manual (Application)

Settings in the local stations

Connect the engineering tool to the CPU module on the local station and set parameters. Set the station number 1 and 2 to the same setting.

1. Set the CPU module and add a module label of the CPU module. The setting method of the CPU module and addition method of the module label are the same as those of the master station. (☞ Page 76 Setting in the master station)
2. Set the RJ71GN11-T2 as follows.

☞ [Navigation window] ⇒ [Parameter] ⇒ [Module Information] ⇒ Right-click ⇒ [Add New Module]

Module Selection	
Module Type	Network Module
Module Name	RJ71GN11-T2
Station Type	Local Station

Advanced Settings	
Mounting Position	
Mounting Base	Main Base
Mounting Slot No.	0
Start I/O No. Specification	Not Set
Start I/O No.	0000 H
Number of Occupied Points per 1 Slot	32 Points

Station Type	
Select station type.	

3. Add the module labels of the RJ71GN11-T2. The addition method of the module label is the same as that of the master station. (☞ Page 76 Setting in the master station)

4. Set the items in "Required Settings" as follows.

[Navigation window] ⇒ [Parameter] ⇒ [Module Information] ⇒ [RJ71GN11-T2] ⇒ [Required Settings]

- For the station No.1

Setting Item	
Item	Setting
Station Type	
Station Type	Local Station
Network No.	
Network No.	1
Parameter Setting Method	
Setting Method of Basic/Application Settings	Parameter Editor
Station No./IP Address Setting	
Station No./IP Address Setting Method	Parameter Editor
Station No.	
Station No.	1
IP Address	
IP Address	192 . 168 . 3 . 1
Subnet Mask
Default Gateway

- For the station No.2

Setting Item	
Item	Setting
Station Type	
Station Type	Local Station
Network No.	
Network No.	1
Parameter Setting Method	
Setting Method of Basic/Application Settings	Parameter Editor
Station No./IP Address Setting	
Station No./IP Address Setting Method	Parameter Editor
Station No.	
Station No.	2
IP Address	
IP Address	192 . 168 . 3 . 2
Subnet Mask
Default Gateway

5. Set the refresh settings as follows. Set the station number 1 and 2 of the local station to the same refresh settings.

[Navigation window] ⇒ [Parameter] ⇒ [Module Information] ⇒ [RJ71GN11-T2] ⇒ [Basic Settings] ⇒ [Refresh Settings] ⇒ [Detailed Setting]

No.	Link Side					CPU Side				
	Device Name	Points	Start	End		Target	Device Name	Points	Start	End
-	SB	4096	00000	00FFF	↔	Module Label				
-	SlW	4096	00000	00FFF	↔	Module Label				
1	RX	512	00000	001FF	↔	Specify Device	X	512	01000	011FF
2	RY	512	00000	001FF	↔	Specify Device	Y	512	01000	011FF
3	RWw	512	00000	001FF	↔	Specify Device	W	512	00000	001FF
4	RWr	512	00000	001FF	↔	Specify Device	W	512	01000	011FF
5	LB	1536	00000	005FF	↔	Specify Device	B	1536	01000	015FF
6	LW	1536	00000	005FF	↔	Specify Device	W	1536	01800	01DFF

6. Click the [Apply] button.

7. Write the set parameters to the CPU module on the local station. Then, reset the CPU module or power off and on the system.

[Online] ⇒ [Write to PLC]

Point

In this example, default values are used for parameters that are not shown above. For the parameters, refer to the following.

📖 MELSEC iQ-R CC-Link IE TSN User's Manual (Application)

Checking the network status

Once parameters are set for the master station and local station, check whether data links between the master station and local station is normally operating. For the check, use the CC-Link IE TSN/CC-Link IE Field diagnostics of the engineering tool.

1. Connect the engineering tool to the CPU module on the master station.
2. Start the CC-Link IE TSN/CC-Link IE Field diagnostics.

 [Diagnostics] ⇒ [CC-Link IE TSN/CC-Link IE Field Diagnostics]

If the following display appears, a data link is normal.

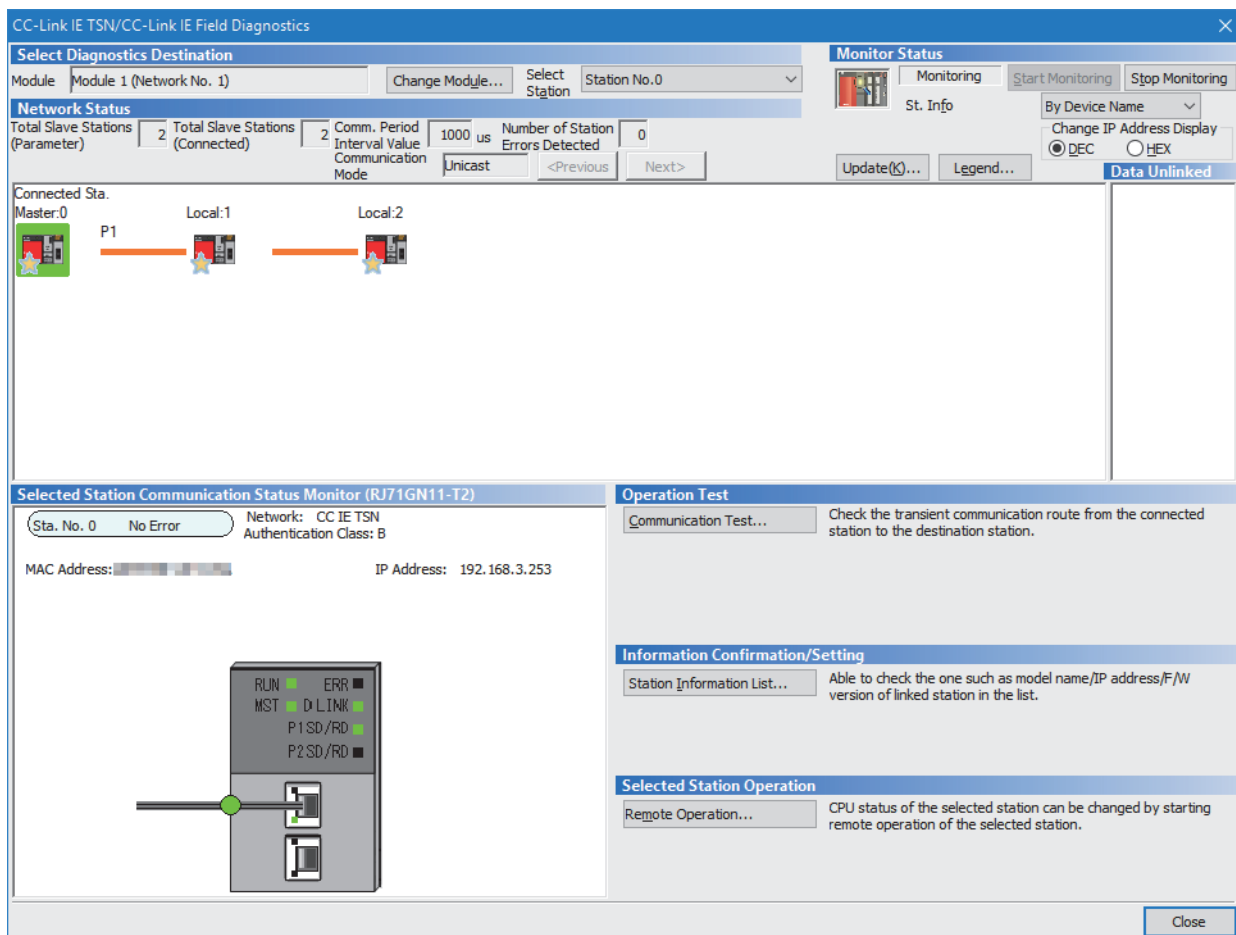

In this manual, "Authentication Class" is described as "CC-Link IE TSN Class".

If an error icon appears in "Network Status" area, use the CC-Link IE TSN/CC-Link IE Field diagnostics to identify the cause of the error and take corrective actions. ( MELSEC iQ-R CC-Link IE TSN User's Manual (Application))

Program example (At unicast mode)

This section describes a program example when "Communication Mode" under "Application Settings" is set to "Unicast".

Master station (station No.0)

Classification	Label name	Description	Device																												
Module label	GN11_1.bnSts_DataLinkError	Data link error status of own station	SB0049																												
	GN11_1.bnSts_DataLinkError_Station[1]	Data link status of each station (station No.1)	SW00B0.0																												
	GN11_1.bnSts_DataLinkError_Station[2]	Data link status of each station (station No.2)	SW00B0.1																												
Label to be defined	Define global labels as shown below:																														
	<table border="1"> <thead> <tr> <th>Label Name</th> <th>Data Type</th> <th>Class</th> <th>Assign (Device/Label)</th> </tr> </thead> <tbody> <tr> <td>bStartDirection_1</td> <td>Bit</td> <td>VAR_GLOBAL</td> <td>M0</td> </tr> <tr> <td>bStartDirection_2</td> <td>Bit</td> <td>VAR_GLOBAL</td> <td>M1</td> </tr> <tr> <td>wnSendDataStationNo1</td> <td>Word [Signed]</td> <td>VAR_GLOBAL</td> <td>D0</td> </tr> <tr> <td>wnRecvDataStationNo1</td> <td>Word [Signed]</td> <td>VAR_GLOBAL</td> <td>D1000</td> </tr> <tr> <td>wnSendDataStationNo2</td> <td>Word [Signed]</td> <td>VAR_GLOBAL</td> <td>D300</td> </tr> <tr> <td>wnRecvDataStationNo2</td> <td>Word [Signed]</td> <td>VAR_GLOBAL</td> <td>D1300</td> </tr> </tbody> </table>			Label Name	Data Type	Class	Assign (Device/Label)	bStartDirection_1	Bit	VAR_GLOBAL	M0	bStartDirection_2	Bit	VAR_GLOBAL	M1	wnSendDataStationNo1	Word [Signed]	VAR_GLOBAL	D0	wnRecvDataStationNo1	Word [Signed]	VAR_GLOBAL	D1000	wnSendDataStationNo2	Word [Signed]	VAR_GLOBAL	D300	wnRecvDataStationNo2	Word [Signed]	VAR_GLOBAL	D1300
Label Name	Data Type	Class	Assign (Device/Label)																												
bStartDirection_1	Bit	VAR_GLOBAL	M0																												
bStartDirection_2	Bit	VAR_GLOBAL	M1																												
wnSendDataStationNo1	Word [Signed]	VAR_GLOBAL	D0																												
wnRecvDataStationNo1	Word [Signed]	VAR_GLOBAL	D1000																												
wnSendDataStationNo2	Word [Signed]	VAR_GLOBAL	D300																												
wnRecvDataStationNo2	Word [Signed]	VAR_GLOBAL	D1300																												

■ Master station (station No.0)

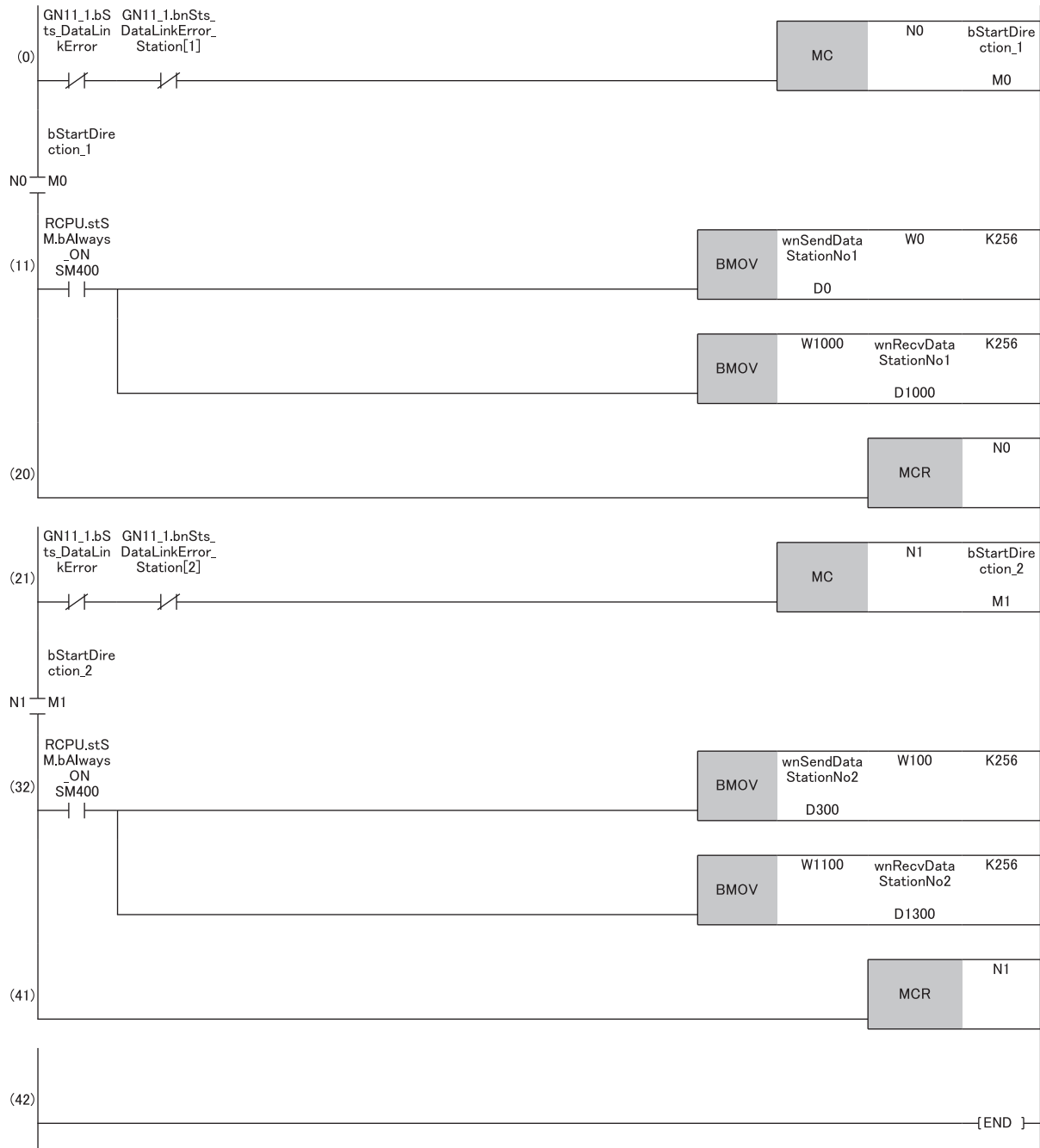

(11)Communication program with a local station (station No.1)

(32)Communication program with a local station (station No.2)

Point

If no response is received for several cycle, 'Data link status of each station' (SW00B0 to SW00B7) is determined to be a cyclic transmission faulty station.

Local station (station No.1, station No.2)

Classification	Label name	Description	Device																
Module label	GN11_1.bSts_DataLinkError	Data link error status of own station	SB0049																
Label to be defined	Define global labels as shown below:																		
	• Local station (station No.1)																		
	<table border="1"> <thead> <tr> <th>Label Name</th> <th>Data Type</th> <th>Class</th> <th>Assign (Device/Label)</th> </tr> </thead> <tbody> <tr> <td>bStartDirection</td> <td>Bit</td> <td>VAR_GLOBAL</td> <td>M0</td> </tr> <tr> <td>wnSendDataMaster</td> <td>Word [Signed]</td> <td>VAR_GLOBAL</td> <td>D1000</td> </tr> <tr> <td>wnRecvDataMaster</td> <td>Word [Signed]</td> <td>VAR_GLOBAL</td> <td>D0</td> </tr> </tbody> </table>	Label Name	Data Type	Class	Assign (Device/Label)	bStartDirection	Bit	VAR_GLOBAL	M0	wnSendDataMaster	Word [Signed]	VAR_GLOBAL	D1000	wnRecvDataMaster	Word [Signed]	VAR_GLOBAL	D0		
Label Name	Data Type	Class	Assign (Device/Label)																
bStartDirection	Bit	VAR_GLOBAL	M0																
wnSendDataMaster	Word [Signed]	VAR_GLOBAL	D1000																
wnRecvDataMaster	Word [Signed]	VAR_GLOBAL	D0																
	• Local station (station No.2)																		
	<table border="1"> <thead> <tr> <th>Label Name</th> <th>Data Type</th> <th>Class</th> <th>Assign (Device/Label)</th> </tr> </thead> <tbody> <tr> <td>bStartDirection</td> <td>Bit</td> <td>VAR_GLOBAL</td> <td>M0</td> </tr> <tr> <td>wnSendDataMaster</td> <td>Word [Signed]</td> <td>VAR_GLOBAL</td> <td>D1300</td> </tr> <tr> <td>wnRecvDataMaster</td> <td>Word [Signed]</td> <td>VAR_GLOBAL</td> <td>D300</td> </tr> </tbody> </table>	Label Name	Data Type	Class	Assign (Device/Label)	bStartDirection	Bit	VAR_GLOBAL	M0	wnSendDataMaster	Word [Signed]	VAR_GLOBAL	D1300	wnRecvDataMaster	Word [Signed]	VAR_GLOBAL	D300		
Label Name	Data Type	Class	Assign (Device/Label)																
bStartDirection	Bit	VAR_GLOBAL	M0																
wnSendDataMaster	Word [Signed]	VAR_GLOBAL	D1300																
wnRecvDataMaster	Word [Signed]	VAR_GLOBAL	D300																

Local station (station No.1)

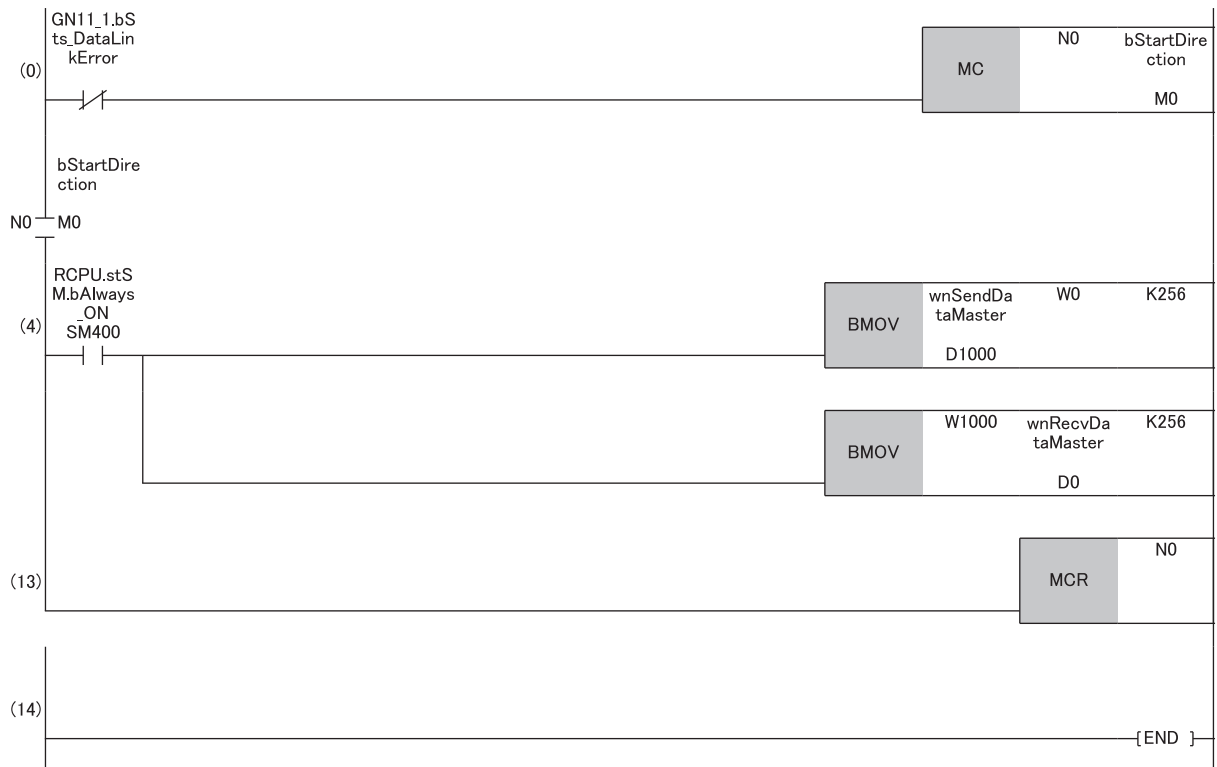

(4) Communication program with the master station (station No.0)

Local station (station No.2)

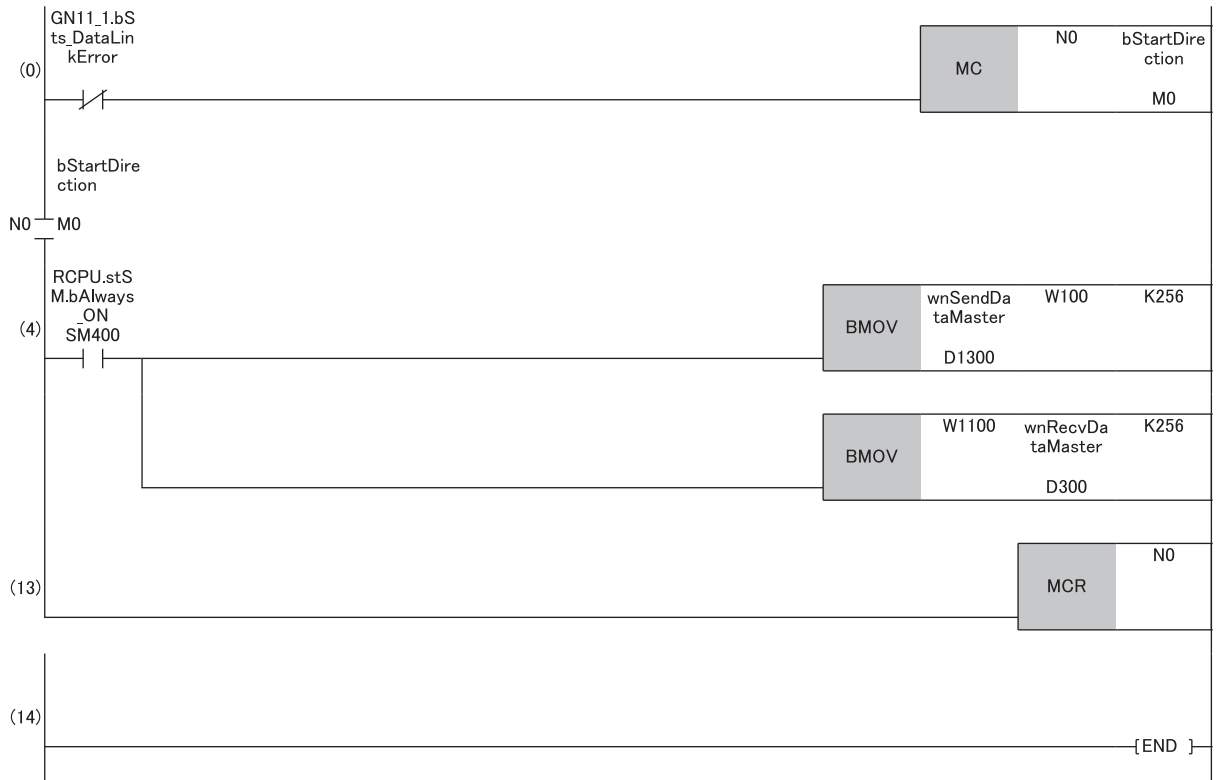

(4) Communication program with the master station (station No.0)

Restriction

When "Communication Mode" is set to "Unicast", 'Data link status of each station' (SW00B0 to SW00B7) cannot be used as an interlock in the local station. Execute communications with other stations, taking into consideration of the operating status in stations to be communicated.

Program example (At multicast mode)

This section describes a program example when "Communication Mode" under "Application Settings" is set to "Multicast".

Master station (station No.0)

Classification	Label name	Description	Device																																			
Module label	GN11_1.bSts_DataLinkError	Data link error status of own station	SB0049																																			
	GN11_1.bnSts_DataLinkError_Station[1]	Data link status of each station (station No.1)	SW00B0.0																																			
	GN11_1.bnSts_DataLinkError_Station[2]	Data link status of each station (station No.2)	SW00B0.1																																			
Label to be defined	Define global labels as shown below:																																					
	<table border="1"> <thead> <tr> <th>Label Name</th> <th>Data Type</th> <th></th> <th>Class</th> <th>Assign (Device/Label)</th> </tr> </thead> <tbody> <tr> <td>bStartDirection_1</td> <td>Bit</td> <td>...</td> <td>VAR_GLOBAL</td> <td>▼ M0</td> </tr> <tr> <td>bStartDirection_2</td> <td>Bit</td> <td>...</td> <td>VAR_GLOBAL</td> <td>▼ M1</td> </tr> <tr> <td>wnSendDataStationNo1</td> <td>Word [Signed]</td> <td>...</td> <td>VAR_GLOBAL</td> <td>▼ D0</td> </tr> <tr> <td>wnRecvDataStationNo1</td> <td>Word [Signed]</td> <td>...</td> <td>VAR_GLOBAL</td> <td>▼ D1000</td> </tr> <tr> <td>wnSendDataStationNo2</td> <td>Word [Signed]</td> <td>...</td> <td>VAR_GLOBAL</td> <td>▼ D300</td> </tr> <tr> <td>wnRecvDataStationNo2</td> <td>Word [Signed]</td> <td>...</td> <td>VAR_GLOBAL</td> <td>▼ D1300</td> </tr> </tbody> </table>	Label Name	Data Type		Class	Assign (Device/Label)	bStartDirection_1	Bit	...	VAR_GLOBAL	▼ M0	bStartDirection_2	Bit	...	VAR_GLOBAL	▼ M1	wnSendDataStationNo1	Word [Signed]	...	VAR_GLOBAL	▼ D0	wnRecvDataStationNo1	Word [Signed]	...	VAR_GLOBAL	▼ D1000	wnSendDataStationNo2	Word [Signed]	...	VAR_GLOBAL	▼ D300	wnRecvDataStationNo2	Word [Signed]	...	VAR_GLOBAL	▼ D1300		
Label Name	Data Type		Class	Assign (Device/Label)																																		
bStartDirection_1	Bit	...	VAR_GLOBAL	▼ M0																																		
bStartDirection_2	Bit	...	VAR_GLOBAL	▼ M1																																		
wnSendDataStationNo1	Word [Signed]	...	VAR_GLOBAL	▼ D0																																		
wnRecvDataStationNo1	Word [Signed]	...	VAR_GLOBAL	▼ D1000																																		
wnSendDataStationNo2	Word [Signed]	...	VAR_GLOBAL	▼ D300																																		
wnRecvDataStationNo2	Word [Signed]	...	VAR_GLOBAL	▼ D1300																																		

■ Master station (station No.0)

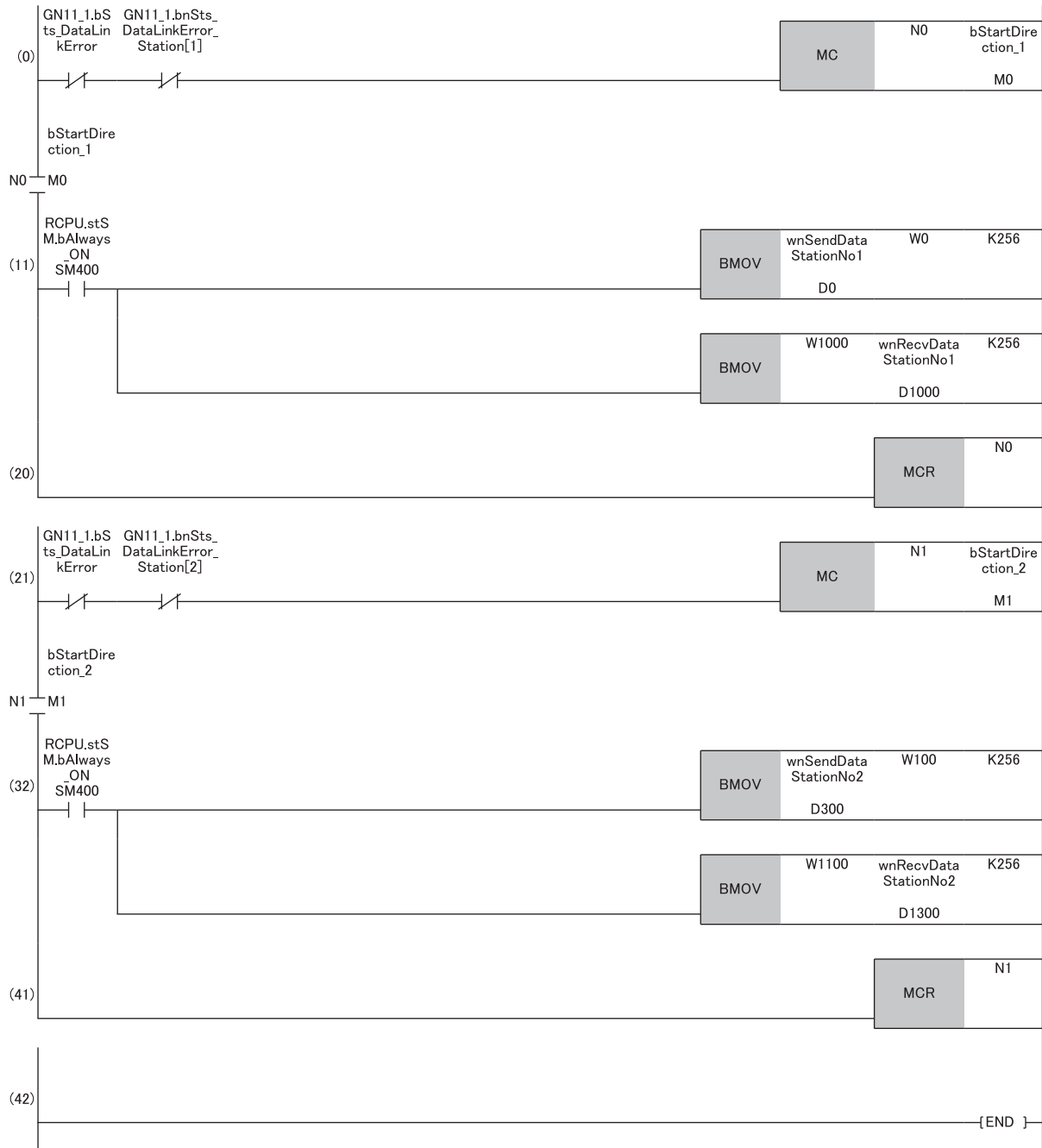

(11)Communication program with a local station (station No.1)

(32)Communication program with a local station (station No.2)

Local station (station No.1, station No.2)

Classification	Label name	Description	Device																								
Module label	GN11_1.bSts_DataLinkError	Data link error status of own station	SB0049																								
Label to be defined	Define global labels as shown below:																										
	• Local station (station No.1)																										
	<table border="1"> <thead> <tr> <th>Label Name</th> <th>Data Type</th> <th>Class</th> <th>Assign (Device/Label)</th> </tr> </thead> <tbody> <tr> <td>bStartDirection</td> <td>Bit</td> <td>VAR_GLOBAL</td> <td>M0</td> </tr> <tr> <td>wnSendDataMaster</td> <td>Word [Signed]</td> <td>VAR_GLOBAL</td> <td>D1000</td> </tr> <tr> <td>wnRecvDataMaster</td> <td>Word [Signed]</td> <td>VAR_GLOBAL</td> <td>D0</td> </tr> <tr> <td>wnRecvDataLocal2</td> <td>Word [Signed]</td> <td>VAR_GLOBAL</td> <td>D2000</td> </tr> <tr> <td>bStartDirection_2</td> <td>Bit</td> <td>VAR_GLOBAL</td> <td>M2</td> </tr> </tbody> </table>	Label Name	Data Type	Class	Assign (Device/Label)	bStartDirection	Bit	VAR_GLOBAL	M0	wnSendDataMaster	Word [Signed]	VAR_GLOBAL	D1000	wnRecvDataMaster	Word [Signed]	VAR_GLOBAL	D0	wnRecvDataLocal2	Word [Signed]	VAR_GLOBAL	D2000	bStartDirection_2	Bit	VAR_GLOBAL	M2		
Label Name	Data Type	Class	Assign (Device/Label)																								
bStartDirection	Bit	VAR_GLOBAL	M0																								
wnSendDataMaster	Word [Signed]	VAR_GLOBAL	D1000																								
wnRecvDataMaster	Word [Signed]	VAR_GLOBAL	D0																								
wnRecvDataLocal2	Word [Signed]	VAR_GLOBAL	D2000																								
bStartDirection_2	Bit	VAR_GLOBAL	M2																								
	• Local station (station No.2)																										
	<table border="1"> <thead> <tr> <th>Label Name</th> <th>Data Type</th> <th>Class</th> <th>Assign (Device/Label)</th> </tr> </thead> <tbody> <tr> <td>bStartDirection</td> <td>Bit</td> <td>VAR_GLOBAL</td> <td>M0</td> </tr> <tr> <td>wnSendDataMaster</td> <td>Word [Signed]</td> <td>VAR_GLOBAL</td> <td>D1300</td> </tr> <tr> <td>wnRecvDataMaster</td> <td>Word [Signed]</td> <td>VAR_GLOBAL</td> <td>D300</td> </tr> <tr> <td>wnRecvDataLocal1</td> <td>Word [Signed]</td> <td>VAR_GLOBAL</td> <td>D2300</td> </tr> <tr> <td>bStartDirection_1</td> <td>Bit</td> <td>VAR_GLOBAL</td> <td>M1</td> </tr> </tbody> </table>	Label Name	Data Type	Class	Assign (Device/Label)	bStartDirection	Bit	VAR_GLOBAL	M0	wnSendDataMaster	Word [Signed]	VAR_GLOBAL	D1300	wnRecvDataMaster	Word [Signed]	VAR_GLOBAL	D300	wnRecvDataLocal1	Word [Signed]	VAR_GLOBAL	D2300	bStartDirection_1	Bit	VAR_GLOBAL	M1		
Label Name	Data Type	Class	Assign (Device/Label)																								
bStartDirection	Bit	VAR_GLOBAL	M0																								
wnSendDataMaster	Word [Signed]	VAR_GLOBAL	D1300																								
wnRecvDataMaster	Word [Signed]	VAR_GLOBAL	D300																								
wnRecvDataLocal1	Word [Signed]	VAR_GLOBAL	D2300																								
bStartDirection_1	Bit	VAR_GLOBAL	M1																								

Local station (station No.1)

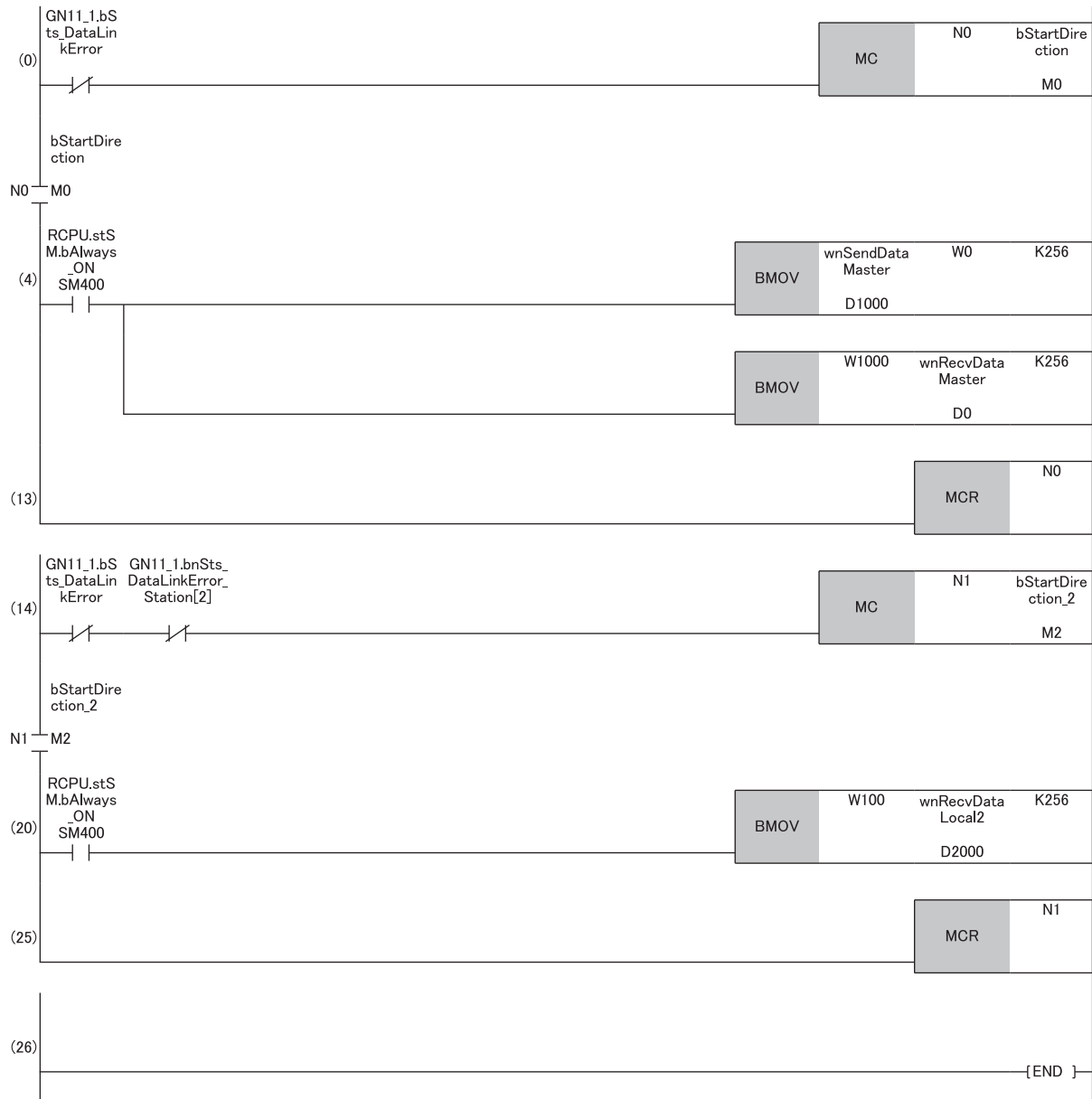

(4) Communication program with the master station (station No.0)

(20) Communication program with a local station (station No.2)

Local station (station No.2)

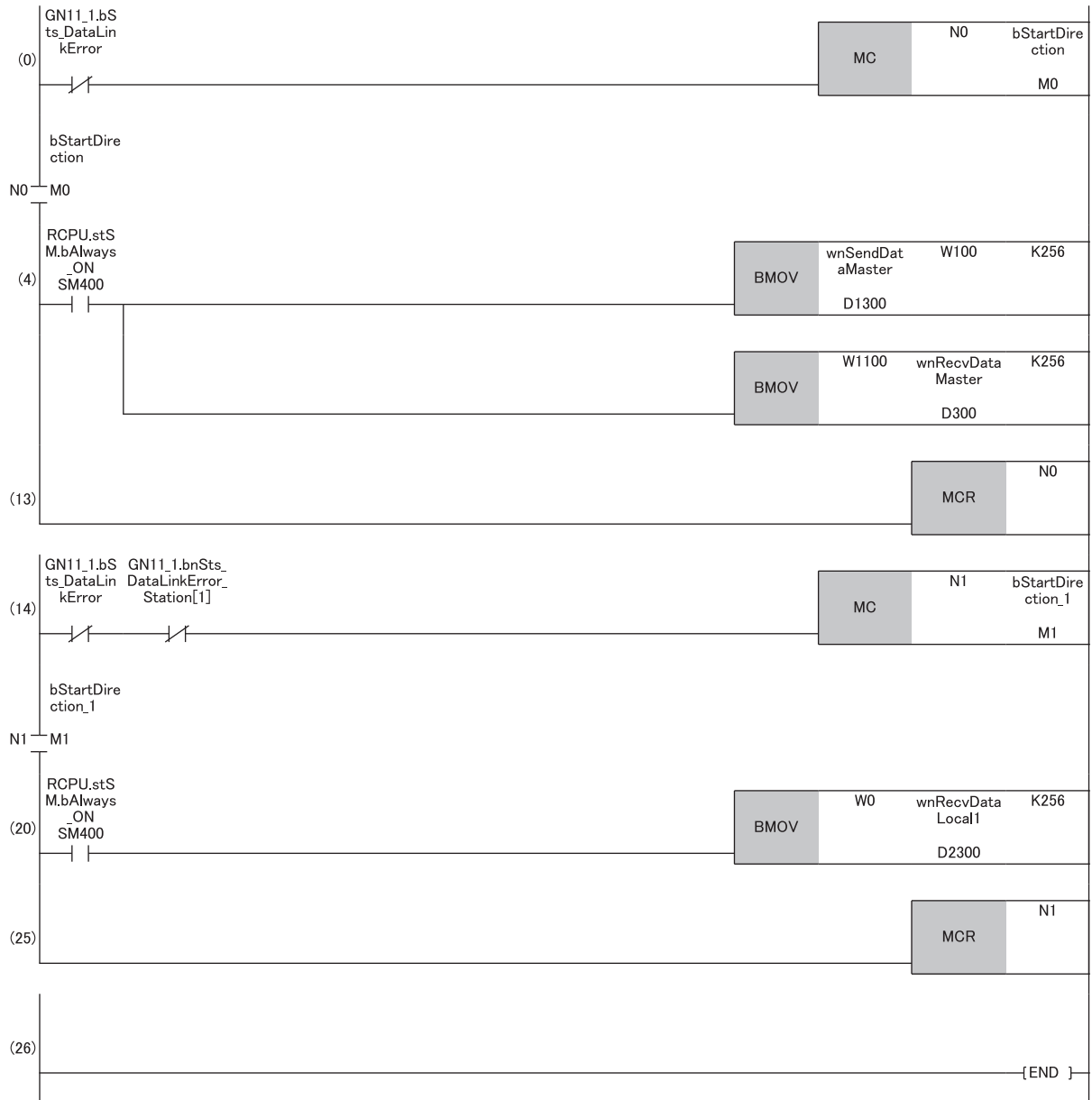

(4) Communication program with the master station (station No.0)

(20) Communication program with a local station (station No.1)

8.2 RJ71GN11-SX Communication Example

The following shows an example of a cyclic transmission program using the RJ71GN11-SX master station and local station when the number of link points is extended.

System configuration

- Power supply module: R61P
- CPU module: R04CPU
- Master/local module: RJ71GN11-SX (start I/O number: 0000H to 001FH)

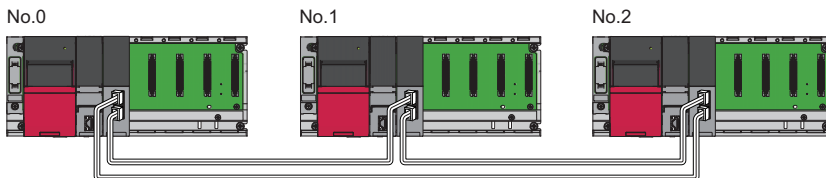

No.0: Master station (station No.0)
 No.1: Local station (station No.1)
 No.2: Local station (station No.2)

Link device assignment

For RX, RY, RWr, and RWw, 256 points are assigned to each station.

For LB and LW, 8192 points are assigned to each station.

Communication mode

In "Communication Mode" under "Application Settings", set "Multicast" (Default).

■RX/RX assignment

Each of the following No.0 to No.2 represents a station number.

No.0 is master station, and No.1 and No.2 are local stations.

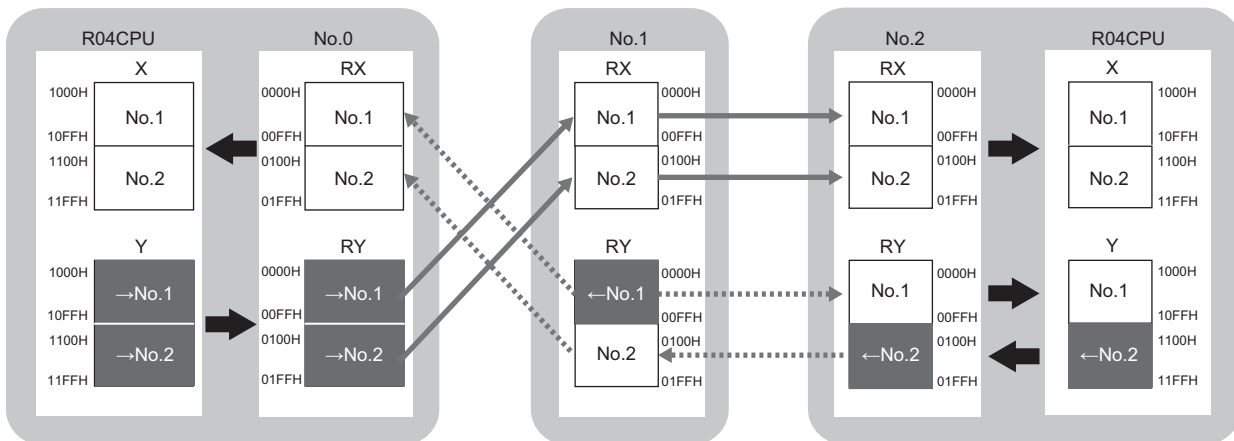

→No.1, →No.2: Send range to station No.1, send range to station No.2
 ←No.1, ←No.2: Send range from station No.1, send range from station No.2

■RWr/RWw assignment

Each of the following No.0 to No.2 represents a station number.

No.0 is master station, and No.1 and No.2 are local stations.

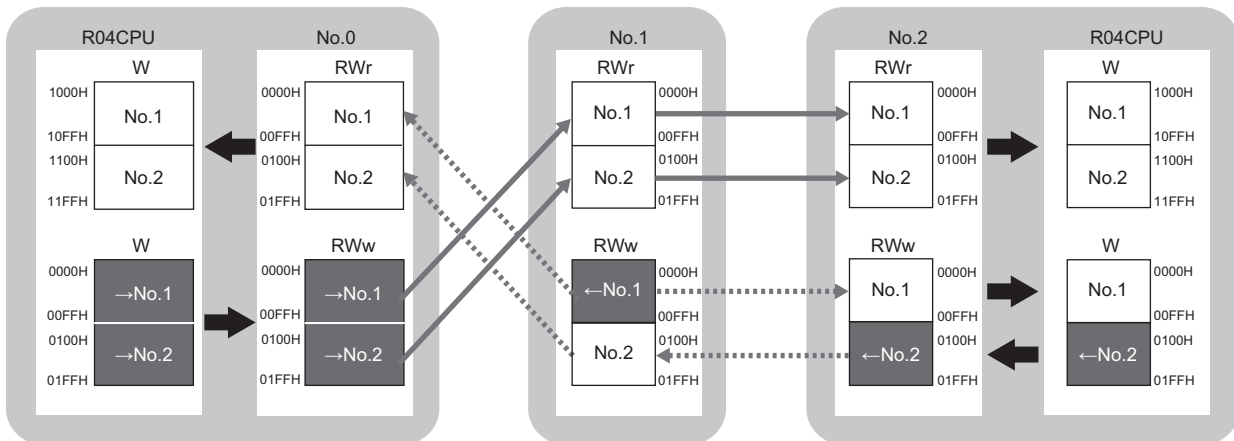

→No.1, →No.2: Send range to station No.1, send range to station No.2

←No.1, ←No.2: Send range from station No.1, send range from station No.2

■LB/LW assignment

Each of the following No.0 to No.2 represents a station number.

No.0 is master station, and No.1 and No.2 are local stations.

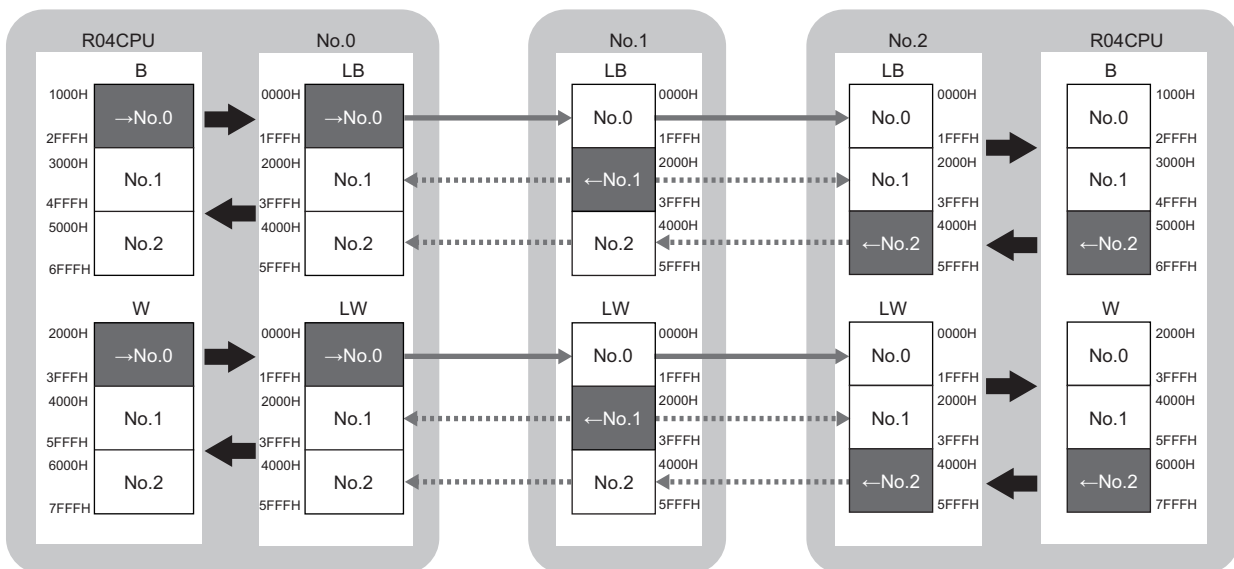

→No.0: Send range from station No.0

←No.1, ←No.2: Send range from station No.1, send range from station No.2

Setting in the master station

Connect the engineering tool to the CPU module on the master station and set the parameters.

1. Set the CPU module as follows.

 [Project] ⇒ [New]

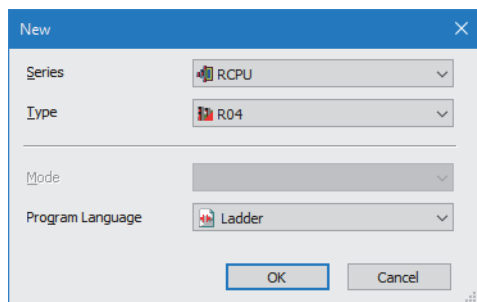

2. Click the [Setting Change] button and set the item that is to use module labels.

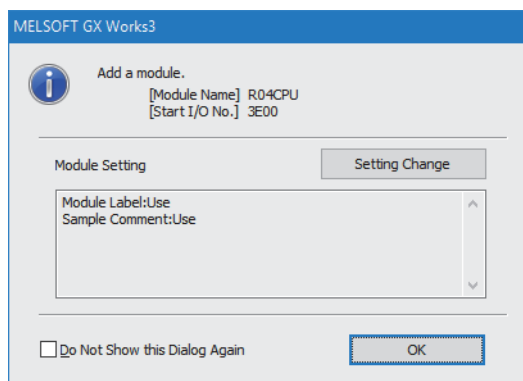

3. Set "Link Direct Device Setting" in "CPU Parameter" to "Extended Mode (iQ-R Series Mode)".

 [CPU Parameter] ⇒ [Memory/Device Setting] ⇒ [Link Direct Device Setting] ⇒ [Link Direct Device Setting]

Item	Setting
 Link Direct Device Setting	
Link Direct Device Setting	Extended Mode (iQ-R Series Mode)

Restriction

To write module parameters of the RJ71GN11-SX on a CPU module using an engineering tool, set "Link Direct Device Setting" to "Extended Mode (iQ-R Series Mode)".

If "Link Direct Device Setting" is "Q Series Compatible Mode", "Write to PLC" cannot be executed.

- Set the value of "Device Area Capacity" in "Device Area" in "CPU Parameter" to 80K word and the value of "File Storage Area Capacity" to 88K word.

[CPU Parameter] ⇒ [Memory/Device Setting] ⇒ [Device/Label Memory Area Setting] ⇒ [Device/Label Memory Area Capacity Setting]

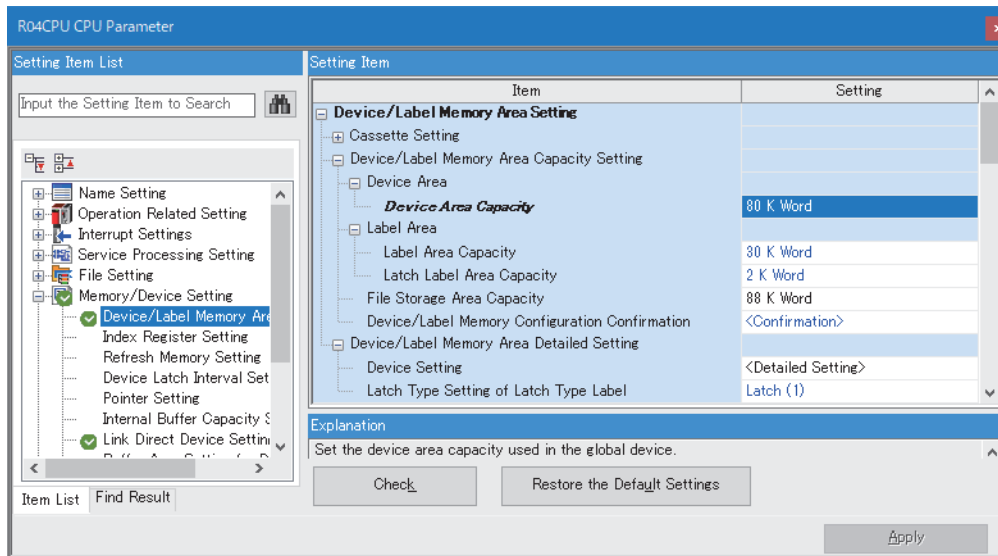

- Set the values of "Points" of "Internal Relay M", "Link Relay B", "Data Register D", and "Link Register W" to 32K in the [Detailed Setting] window in "Device Setting".

[Memory/Device Setting] ⇒ [Device/Label Memory Area Setting] ⇒ [Device/Label Memory Area Detailed Setting]

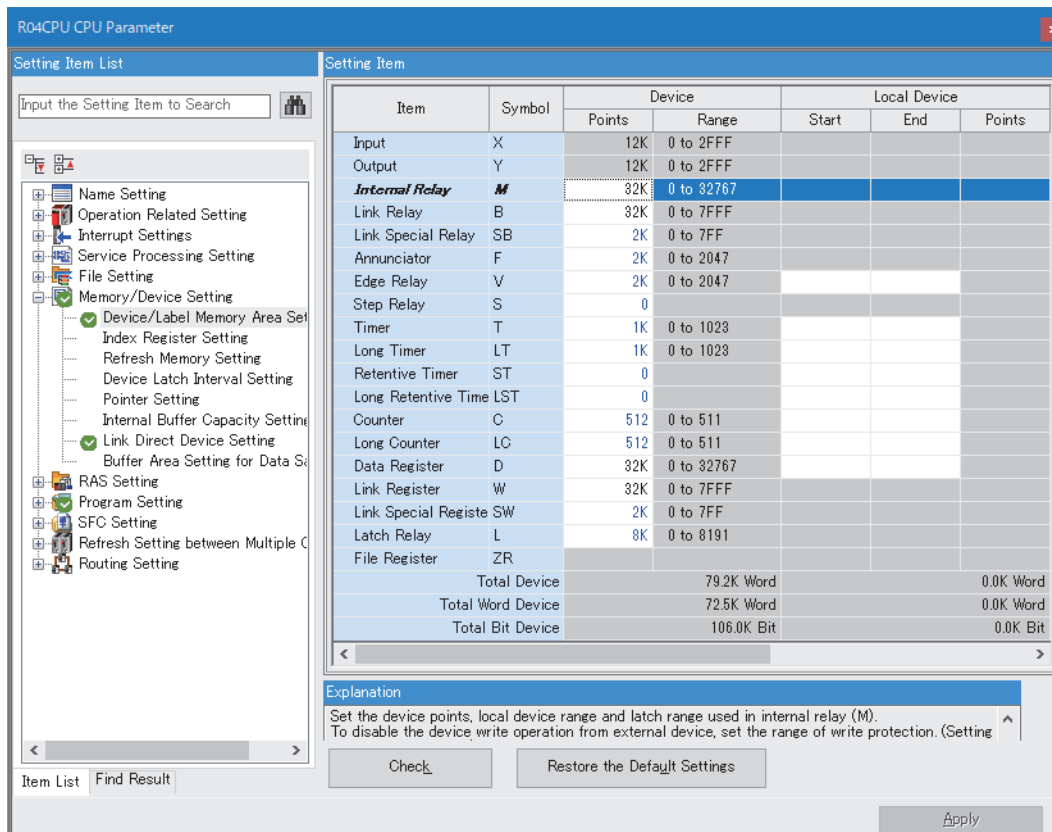

Point

For the R04CPU, if the number of points for the device assignment is greater, the capacity of the device/memory area may be insufficient. In that case, replace the module with a CPU module having larger capacity or insert an extended SRAM cassette.

6. Set the RJ71GN11-SX as follows.

[Navigation window] ⇒ [Parameter] ⇒ [Module Information] ⇒ Right-click ⇒ [Add New Module]

7. Click the [OK] button to add a module label of the RJ71GN11-SX.

8. Set the items in "Required Settings" as follows.

[Navigation window] ⇒ [Parameter] ⇒ [Module Information] ⇒ [RJ71GN11-SX] ⇒ [Required Settings]

Item	Setting
Station Type	
Station Type	Master Station
Network No.	
Network No.	1
Parameter Setting Method	
Setting Method of Basic/Application Settings	Parameter Editor
Station No./IP Address Setting	
Station No./IP Address Setting Method	Parameter Editor
Station No.	
Station No.	0
IP Address	
IP Address	192 . 168 . 3 . 253
Subnet Mask	. . .
Default Gateway	. . .

9. Set "Network Configuration Settings" in the "CC-Link IE TSN Configuration" window.

[Navigation window] ⇒ [Parameter] ⇒ [Module Information] ⇒ [RJ71GN11-SX] ⇒ [Basic Settings] ⇒ [Network Configuration Settings]

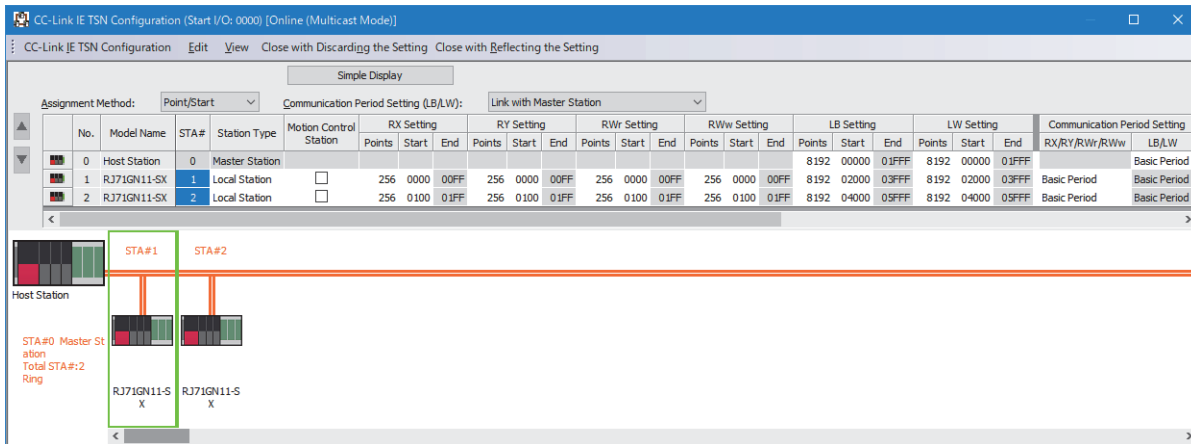

10. Click the [Close with Reflecting the Setting] button to close the "CC-Link IE TSN Configuration" window.

11. Set "Refresh Settings" as follows.

[Navigation window] ⇒ [Parameter] ⇒ [Module Information] ⇒ [RJ71GN11-SX] ⇒ [Basic Settings] ⇒ [Refresh Setting]

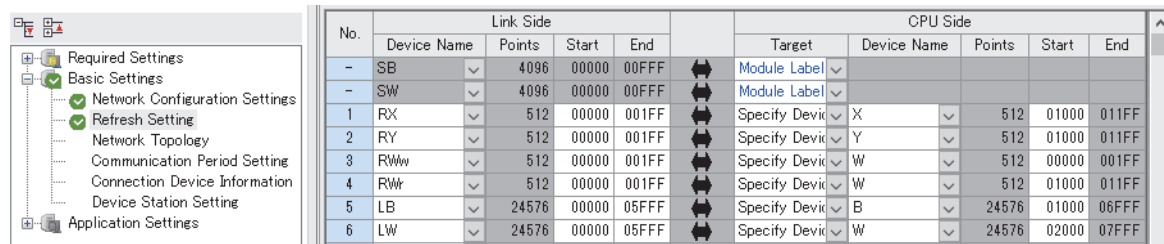

12. Click the [Apply] button.

13. Write the set parameters to the CPU module on the master station. Then, reset the CPU module or power off and on the system.

[Online] ⇒ [Write to PLC]

Point

In this example, default values are used for parameters that are not shown above. For the parameters, refer to the following.

📖 MELSEC iQ-R CC-Link IE TSN User's Manual (Application)

Settings in the local stations

Connect the engineering tool to the CPU modules of the local stations (station number 1 and station number 2) and set parameters for each of them.

1. Set the CPU module and add a module label of the CPU module. The setting method of the CPU module and addition method of the module label are the same as those of the master station. (☞ Page 92 Setting in the master station)
2. Set the RJ71GN11-SX as follows.

☞ [Navigation window] ⇒ [Parameter] ⇒ [Module Information] ⇒ Right-click ⇒ [Add New Module]

3. Add the module labels of the RJ71GN11-SX. The addition method of the module label is the same as that of the master station. (☞ Page 92 Setting in the master station)
4. Set the items in "Required Settings" for the local station (station number 1) as follows. For the local station (station number 2), set 2 for "Station No." and 192.168.3.2 for "IP Address".

☞ [Navigation window] ⇒ [Parameter] ⇒ [Module Information] ⇒ [RJ71GN11-SX] ⇒ [Required Settings]

Item	Setting
Station Type	
Station Type	Local Station
Network No.	
Network No.	1
Parameter Setting Method	
Setting Method of Basic/Application Settings	Parameter Editor
Station No./IP Address Setting	
Station No./IP Address Setting Method	Parameter Editor
Station No.	1
IP Address	
IP Address	192.168.3.1
Subnet Mask	. . .
Default Gateway	. . .

5. Set "Refresh Settings" as follows. Set the same values to the local stations (station number 1 and station number 2).

[Navigation window] ⇒ [Parameter] ⇒ [Module Information] ⇒ [RJ71GN11-SX] ⇒ [Basic Settings] ⇒ [Refresh Settings] ⇒ [Detailed Setting]

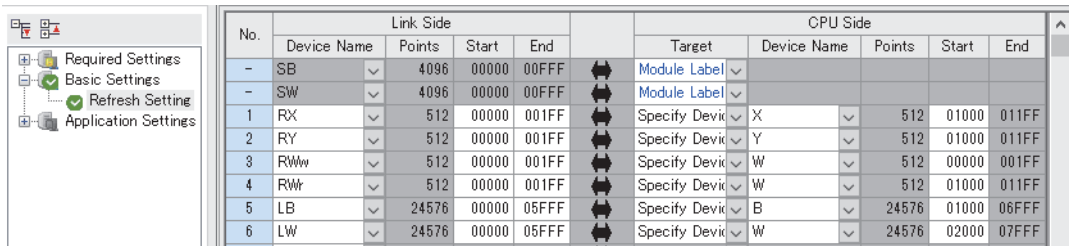

No.	Link Side					CPU Side			
	Device Name	Points	Start	End		Target	Device Name	Points	Start
-	SB	4096	00000	00FFF	Module Label				
-	SW	4096	00000	00FFF	Module Label				
1	RX	512	00000	001FF	Specify Devic	X	512	01000	011FF
2	RY	512	00000	001FF	Specify Devic	Y	512	01000	011FF
3	RWw	512	00000	001FF	Specify Devic	W	512	00000	001FF
4	RWr	512	00000	001FF	Specify Devic	W	512	01000	011FF
5	LB	24576	00000	05FFF	Specify Devic	B	24576	01000	06FFF
6	LW	24576	00000	05FFF	Specify Devic	W	24576	02000	07FFF

6. Click the [Apply] button.

7. Write the set parameters to the CPU modules on the local stations (station number 1 and station number 2). Then, reset the CPU modules or power off and on the system.

[Online] ⇒ [Write to PLC]

Point

In this example, default values are used for parameters that are not shown above. For the parameters, refer to the following.

 MELSEC iQ-R CC-Link IE TSN User's Manual (Application)

Checking the network status

Once parameters are set for the master station and local station, check whether data links between the master station and local station is normally operating. For the check, use the CC-Link IE TSN/CC-Link IE Field diagnostics of the engineering tool.

1. Connect the engineering tool to the CPU module on the master station.
2. Start the CC-Link IE TSN/CC-Link IE Field diagnostics.

 [Diagnostics] ⇒ [CC-Link IE TSN/CC-Link IE Field Diagnostics]

If the following display appears, a data link is normal.

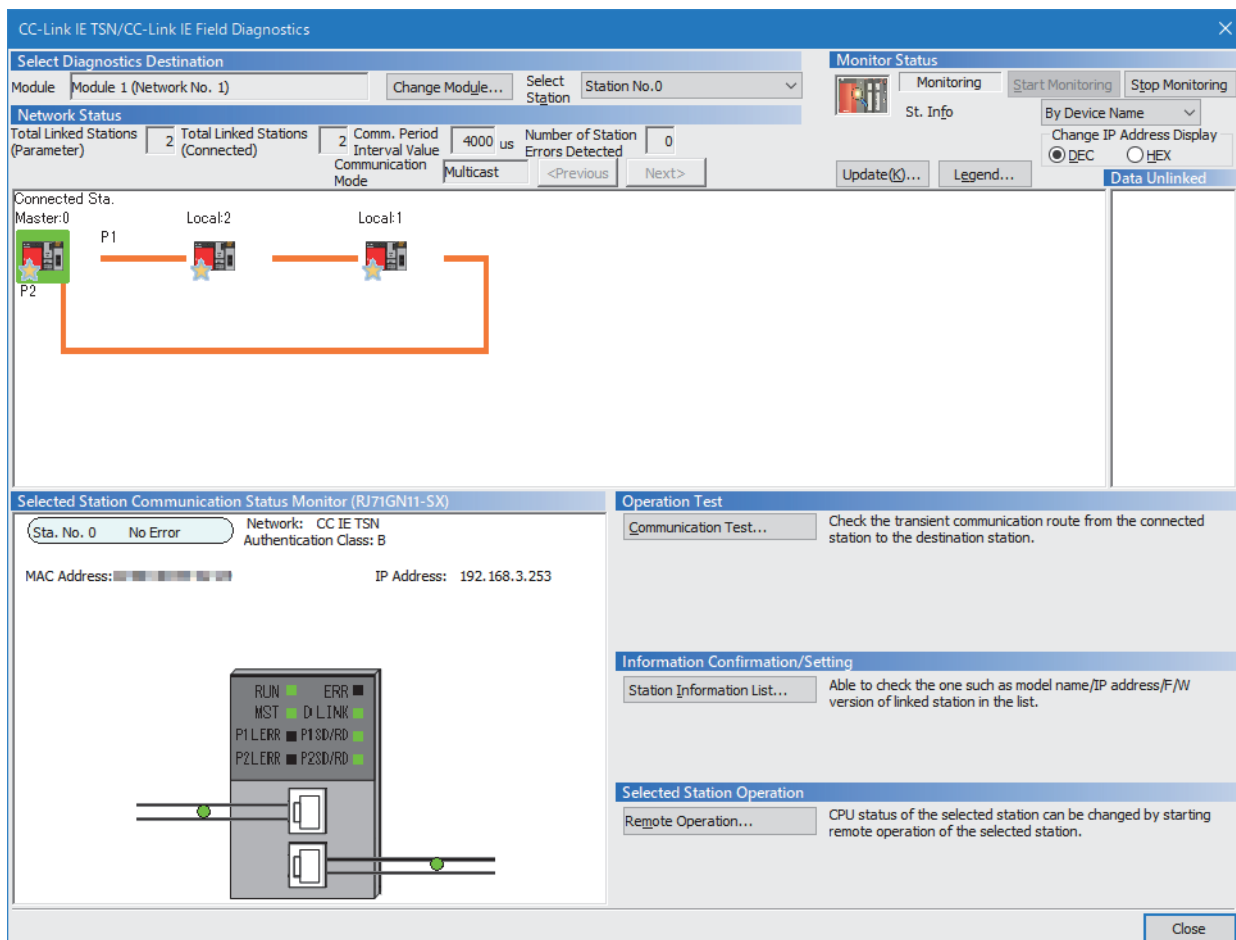

In this manual, "Authentication Class" is described as "CC-Link IE TSN Class".

If an error icon appears in "Network Status" area, use the CC-Link IE TSN/CC-Link IE Field diagnostics to identify the cause of the error and take corrective actions. ( MELSEC iQ-R CC-Link IE TSN User's Manual (Application))

Program examples

This section describes a program example when "Communication Mode" under "Application Settings" is set to "Multicast".

Master station (station No.0)

Classification	Label name*1	Description	Device																																																																																											
Module label	GN11_SX_1.bSts_DataLinkError	Data link error status of own station	SB0049																																																																																											
	GN11_SX_1.bnSts_DataLinkError_Station[1]	Data link status of each station (station No.1)	SW00B0.0																																																																																											
	GN11_SX_1.bnSts_DataLinkError_Station[2]	Data link status of each station (station No.2)	SW00B0.1																																																																																											
Label to be defined	Define global labels as shown below:																																																																																													
	<table border="1"> <thead> <tr> <th></th> <th>Label Name</th> <th>Data Type</th> <th>Class</th> <th>Assign (Device/Label)</th> </tr> </thead> <tbody> <tr><td>1</td><td>bStartDirection</td><td>Bit</td><td>VAR_GLOBAL</td><td>M0</td></tr> <tr><td>2</td><td>bStartDirection_1</td><td>Bit</td><td>VAR_GLOBAL</td><td>M1</td></tr> <tr><td>3</td><td>bStartDirection_2</td><td>Bit</td><td>VAR_GLOBAL</td><td>M2</td></tr> <tr><td>4</td><td>bSendBitDataStationNo1</td><td>Bit</td><td>VAR_GLOBAL</td><td>M1 00</td></tr> <tr><td>5</td><td>bSendBitDataStationNo2</td><td>Bit</td><td>VAR_GLOBAL</td><td>M400</td></tr> <tr><td>6</td><td>bRecvBitDataStationNo1</td><td>Bit</td><td>VAR_GLOBAL</td><td>M700</td></tr> <tr><td>7</td><td>bRecvBitDataStationNo2</td><td>Bit</td><td>VAR_GLOBAL</td><td>M1 000</td></tr> <tr><td>8</td><td>bSendBitDataAllStation</td><td>Bit</td><td>VAR_GLOBAL</td><td>M2 000</td></tr> <tr><td>9</td><td>bRecvBitDataAllStation1</td><td>Bit</td><td>VAR_GLOBAL</td><td>M1 0200</td></tr> <tr><td>10</td><td>bRecvBitDataAllStation2</td><td>Bit</td><td>VAR_GLOBAL</td><td>M1 8400</td></tr> <tr><td>11</td><td>wnSendWordDataStationNo1</td><td>Word [Signed]</td><td>VAR_GLOBAL</td><td>D0</td></tr> <tr><td>12</td><td>wnSendWordDataStationNo2</td><td>Word [Signed]</td><td>VAR_GLOBAL</td><td>D300</td></tr> <tr><td>13</td><td>wnRecvWordDataStationNo1</td><td>Word [Signed]</td><td>VAR_GLOBAL</td><td>D600</td></tr> <tr><td>14</td><td>wnRecvWordDataStationNo2</td><td>Word [Signed]</td><td>VAR_GLOBAL</td><td>D900</td></tr> <tr><td>15</td><td>wnSendWordDataAllStation</td><td>Word [Signed]</td><td>VAR_GLOBAL</td><td>D2000</td></tr> <tr><td>16</td><td>wnRecvWordDataAllStation1</td><td>Word [Signed]</td><td>VAR_GLOBAL</td><td>D1 0200</td></tr> <tr><td>17</td><td>wnRecvWordDataAllStation2</td><td>Word [Signed]</td><td>VAR_GLOBAL</td><td>D1 8400</td></tr> </tbody> </table>					Label Name	Data Type	Class	Assign (Device/Label)	1	bStartDirection	Bit	VAR_GLOBAL	M0	2	bStartDirection_1	Bit	VAR_GLOBAL	M1	3	bStartDirection_2	Bit	VAR_GLOBAL	M2	4	bSendBitDataStationNo1	Bit	VAR_GLOBAL	M1 00	5	bSendBitDataStationNo2	Bit	VAR_GLOBAL	M400	6	bRecvBitDataStationNo1	Bit	VAR_GLOBAL	M700	7	bRecvBitDataStationNo2	Bit	VAR_GLOBAL	M1 000	8	bSendBitDataAllStation	Bit	VAR_GLOBAL	M2 000	9	bRecvBitDataAllStation1	Bit	VAR_GLOBAL	M1 0200	10	bRecvBitDataAllStation2	Bit	VAR_GLOBAL	M1 8400	11	wnSendWordDataStationNo1	Word [Signed]	VAR_GLOBAL	D0	12	wnSendWordDataStationNo2	Word [Signed]	VAR_GLOBAL	D300	13	wnRecvWordDataStationNo1	Word [Signed]	VAR_GLOBAL	D600	14	wnRecvWordDataStationNo2	Word [Signed]	VAR_GLOBAL	D900	15	wnSendWordDataAllStation	Word [Signed]	VAR_GLOBAL	D2000	16	wnRecvWordDataAllStation1	Word [Signed]	VAR_GLOBAL	D1 0200	17	wnRecvWordDataAllStation2	Word [Signed]	VAR_GLOBAL	D1 8400
	Label Name	Data Type	Class	Assign (Device/Label)																																																																																										
1	bStartDirection	Bit	VAR_GLOBAL	M0																																																																																										
2	bStartDirection_1	Bit	VAR_GLOBAL	M1																																																																																										
3	bStartDirection_2	Bit	VAR_GLOBAL	M2																																																																																										
4	bSendBitDataStationNo1	Bit	VAR_GLOBAL	M1 00																																																																																										
5	bSendBitDataStationNo2	Bit	VAR_GLOBAL	M400																																																																																										
6	bRecvBitDataStationNo1	Bit	VAR_GLOBAL	M700																																																																																										
7	bRecvBitDataStationNo2	Bit	VAR_GLOBAL	M1 000																																																																																										
8	bSendBitDataAllStation	Bit	VAR_GLOBAL	M2 000																																																																																										
9	bRecvBitDataAllStation1	Bit	VAR_GLOBAL	M1 0200																																																																																										
10	bRecvBitDataAllStation2	Bit	VAR_GLOBAL	M1 8400																																																																																										
11	wnSendWordDataStationNo1	Word [Signed]	VAR_GLOBAL	D0																																																																																										
12	wnSendWordDataStationNo2	Word [Signed]	VAR_GLOBAL	D300																																																																																										
13	wnRecvWordDataStationNo1	Word [Signed]	VAR_GLOBAL	D600																																																																																										
14	wnRecvWordDataStationNo2	Word [Signed]	VAR_GLOBAL	D900																																																																																										
15	wnSendWordDataAllStation	Word [Signed]	VAR_GLOBAL	D2000																																																																																										
16	wnRecvWordDataAllStation1	Word [Signed]	VAR_GLOBAL	D1 0200																																																																																										
17	wnRecvWordDataAllStation2	Word [Signed]	VAR_GLOBAL	D1 8400																																																																																										

*1 The module label of the first RJ71GN11-SX added using the engineering tool

- Device

Label name	Description
N0	Nesting (own station)
N1	Nesting (station No.1)
N2	Nesting (station No.2)

■ Master station (station No.0)

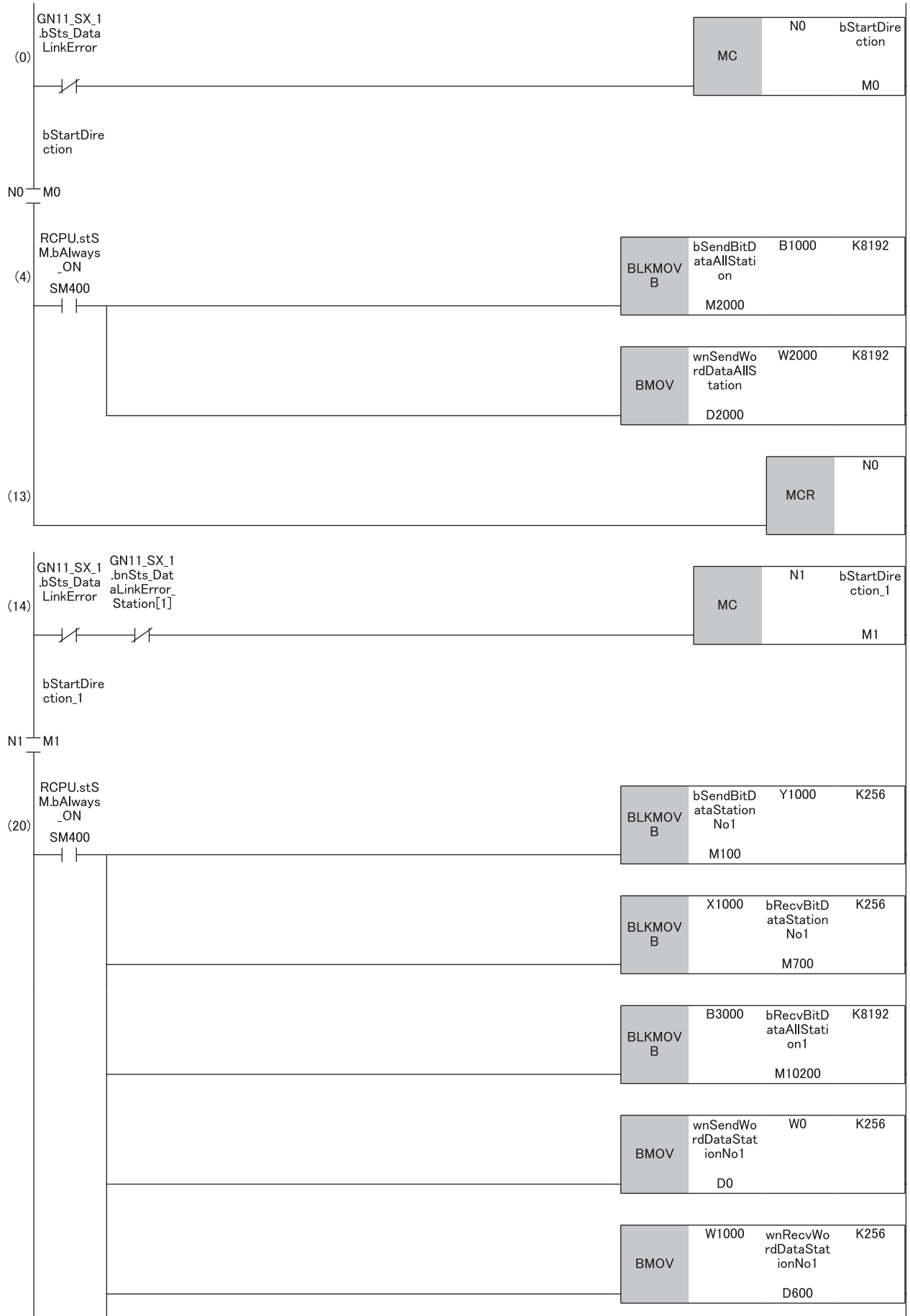

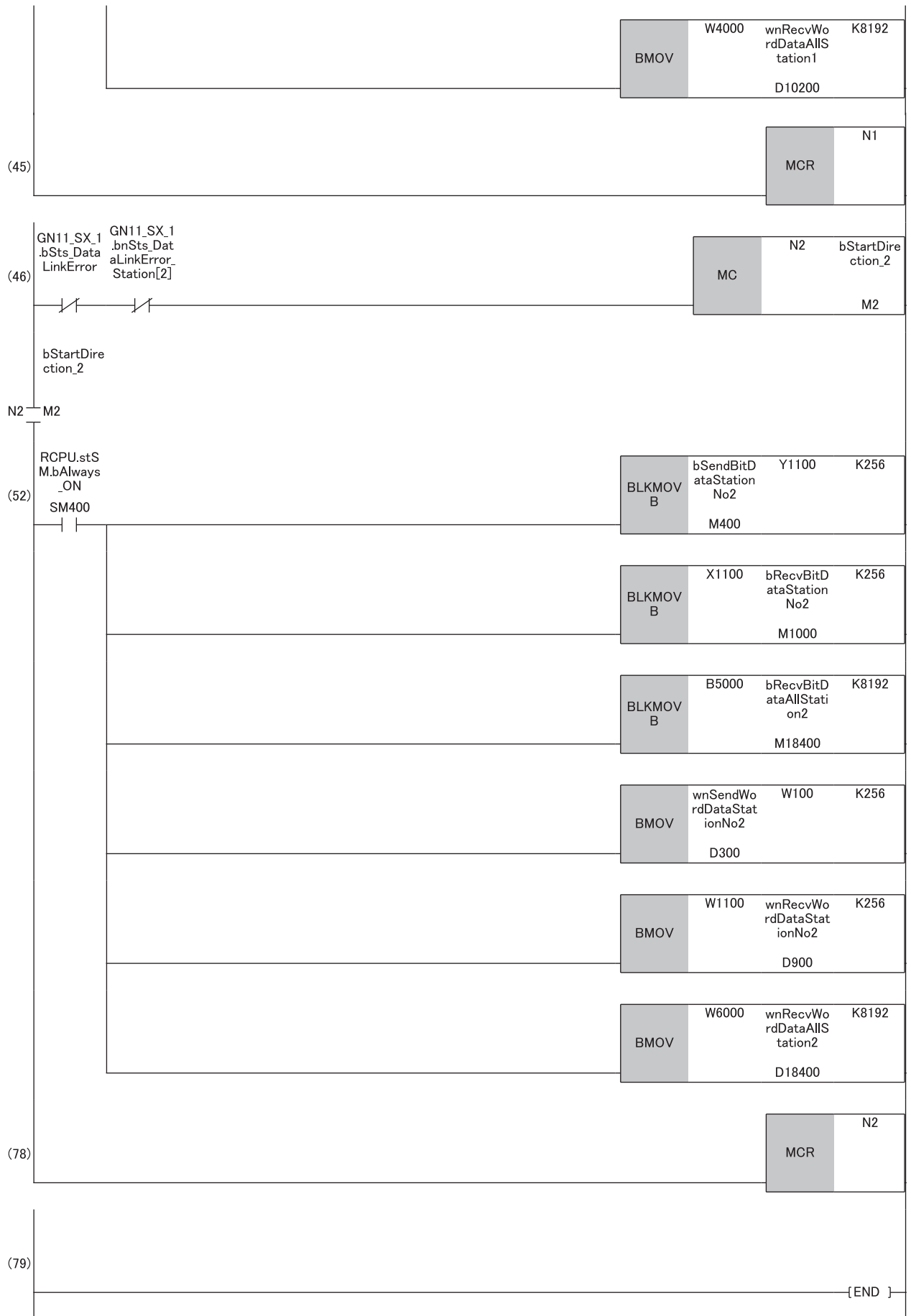

(4) Register the data that the own station will send to the local stations (station No.1 and station No.2).

(20)Communication processing with a local station (station No.1)

(52)Communication processing with a local station (station No.2)

Local station (station No.1, station No.2)

Classification	Label name *1	Description	Device																																																																																																																																																						
Module label	GN11_SX_1.bSts_DataLinkError	Data link error status of own station	SB0049																																																																																																																																																						
Label to be defined	Define global labels as shown below: • Local station (station No.1) <table border="1" data-bbox="411 353 1043 629"> <thead> <tr> <th></th> <th>Label Name</th> <th>Data Type</th> <th>Class</th> <th>Assign (Device/Label)</th> </tr> </thead> <tbody> <tr><td>1</td><td>bStartDirection</td><td>Bit</td><td>VAR_GLOBAL</td><td>M0</td></tr> <tr><td>2</td><td>bStartDirection_2</td><td>Bit</td><td>VAR_GLOBAL</td><td>M2</td></tr> <tr><td>3</td><td>bSendBitDataMaster</td><td>Bit</td><td>VAR_GLOBAL</td><td>M700</td></tr> <tr><td>4</td><td>bRecvBitDataMaster</td><td>Bit</td><td>VAR_GLOBAL</td><td>M100</td></tr> <tr><td>5</td><td>bRecvBitDataStationNo2</td><td>Bit</td><td>VAR_GLOBAL</td><td>M1000</td></tr> <tr><td>6</td><td>bRecvBitDataAllStation</td><td>Bit</td><td>VAR_GLOBAL</td><td>M2000</td></tr> <tr><td>7</td><td>bSendBitDataAllStation1</td><td>Bit</td><td>VAR_GLOBAL</td><td>M10200</td></tr> <tr><td>8</td><td>bRecvBitDataAllStation2</td><td>Bit</td><td>VAR_GLOBAL</td><td>M18400</td></tr> <tr><td>9</td><td>wnSendWordDataMaster</td><td>Word [Signed]</td><td>VAR_GLOBAL</td><td>D600</td></tr> <tr><td>10</td><td>wnRecvWordDataMaster</td><td>Word [Signed]</td><td>VAR_GLOBAL</td><td>D0</td></tr> <tr><td>11</td><td>wnRecvWordDataStationNo2</td><td>Word [Signed]</td><td>VAR_GLOBAL</td><td>D300</td></tr> <tr><td>12</td><td>wnRecvWordDataAllStation</td><td>Word [Signed]</td><td>VAR_GLOBAL</td><td>D2000</td></tr> <tr><td>13</td><td>wnSendWordDataAllStation1</td><td>Word [Signed]</td><td>VAR_GLOBAL</td><td>D10200</td></tr> <tr><td>14</td><td>wnRecvWordDataAllStation2</td><td>Word [Signed]</td><td>VAR_GLOBAL</td><td>D18400</td></tr> </tbody> </table> • Local station (station No.2) <table border="1" data-bbox="411 680 1043 956"> <thead> <tr> <th></th> <th>Label Name</th> <th>Data Type</th> <th>Class</th> <th>Assign (Device/Label)</th> </tr> </thead> <tbody> <tr><td>1</td><td>bStartDirection</td><td>Bit</td><td>VAR_GLOBAL</td><td>M0</td></tr> <tr><td>2</td><td>bStartDirection_1</td><td>Bit</td><td>VAR_GLOBAL</td><td>M1</td></tr> <tr><td>3</td><td>bSendBitDataMaster</td><td>Bit</td><td>VAR_GLOBAL</td><td>M1000</td></tr> <tr><td>4</td><td>bRecvBitDataMaster</td><td>Bit</td><td>VAR_GLOBAL</td><td>M400</td></tr> <tr><td>5</td><td>bRecvBitDataStationNo1</td><td>Bit</td><td>VAR_GLOBAL</td><td>M700</td></tr> <tr><td>6</td><td>bRecvBitDataAllStation</td><td>Bit</td><td>VAR_GLOBAL</td><td>M2000</td></tr> <tr><td>7</td><td>bRecvBitDataAllStation1</td><td>Bit</td><td>VAR_GLOBAL</td><td>M10200</td></tr> <tr><td>8</td><td>bSendBitDataAllStation2</td><td>Bit</td><td>VAR_GLOBAL</td><td>M18400</td></tr> <tr><td>9</td><td>wnSendWordDataMaster</td><td>Word [Signed]</td><td>VAR_GLOBAL</td><td>D900</td></tr> <tr><td>10</td><td>wnRecvWordDataMaster</td><td>Word [Signed]</td><td>VAR_GLOBAL</td><td>D300</td></tr> <tr><td>11</td><td>wnRecvWordDataStationNo1</td><td>Word [Signed]</td><td>VAR_GLOBAL</td><td>D600</td></tr> <tr><td>12</td><td>wnRecvWordDataAllStation</td><td>Word [Signed]</td><td>VAR_GLOBAL</td><td>D2000</td></tr> <tr><td>13</td><td>wnRecvWordDataAllStation1</td><td>Word [Signed]</td><td>VAR_GLOBAL</td><td>D10200</td></tr> <tr><td>14</td><td>wnSendWordDataAllStation2</td><td>Word [Signed]</td><td>VAR_GLOBAL</td><td>D18400</td></tr> </tbody> </table>				Label Name	Data Type	Class	Assign (Device/Label)	1	bStartDirection	Bit	VAR_GLOBAL	M0	2	bStartDirection_2	Bit	VAR_GLOBAL	M2	3	bSendBitDataMaster	Bit	VAR_GLOBAL	M700	4	bRecvBitDataMaster	Bit	VAR_GLOBAL	M100	5	bRecvBitDataStationNo2	Bit	VAR_GLOBAL	M1000	6	bRecvBitDataAllStation	Bit	VAR_GLOBAL	M2000	7	bSendBitDataAllStation1	Bit	VAR_GLOBAL	M10200	8	bRecvBitDataAllStation2	Bit	VAR_GLOBAL	M18400	9	wnSendWordDataMaster	Word [Signed]	VAR_GLOBAL	D600	10	wnRecvWordDataMaster	Word [Signed]	VAR_GLOBAL	D0	11	wnRecvWordDataStationNo2	Word [Signed]	VAR_GLOBAL	D300	12	wnRecvWordDataAllStation	Word [Signed]	VAR_GLOBAL	D2000	13	wnSendWordDataAllStation1	Word [Signed]	VAR_GLOBAL	D10200	14	wnRecvWordDataAllStation2	Word [Signed]	VAR_GLOBAL	D18400		Label Name	Data Type	Class	Assign (Device/Label)	1	bStartDirection	Bit	VAR_GLOBAL	M0	2	bStartDirection_1	Bit	VAR_GLOBAL	M1	3	bSendBitDataMaster	Bit	VAR_GLOBAL	M1000	4	bRecvBitDataMaster	Bit	VAR_GLOBAL	M400	5	bRecvBitDataStationNo1	Bit	VAR_GLOBAL	M700	6	bRecvBitDataAllStation	Bit	VAR_GLOBAL	M2000	7	bRecvBitDataAllStation1	Bit	VAR_GLOBAL	M10200	8	bSendBitDataAllStation2	Bit	VAR_GLOBAL	M18400	9	wnSendWordDataMaster	Word [Signed]	VAR_GLOBAL	D900	10	wnRecvWordDataMaster	Word [Signed]	VAR_GLOBAL	D300	11	wnRecvWordDataStationNo1	Word [Signed]	VAR_GLOBAL	D600	12	wnRecvWordDataAllStation	Word [Signed]	VAR_GLOBAL	D2000	13	wnRecvWordDataAllStation1	Word [Signed]	VAR_GLOBAL	D10200	14	wnSendWordDataAllStation2	Word [Signed]	VAR_GLOBAL	D18400
	Label Name	Data Type	Class	Assign (Device/Label)																																																																																																																																																					
1	bStartDirection	Bit	VAR_GLOBAL	M0																																																																																																																																																					
2	bStartDirection_2	Bit	VAR_GLOBAL	M2																																																																																																																																																					
3	bSendBitDataMaster	Bit	VAR_GLOBAL	M700																																																																																																																																																					
4	bRecvBitDataMaster	Bit	VAR_GLOBAL	M100																																																																																																																																																					
5	bRecvBitDataStationNo2	Bit	VAR_GLOBAL	M1000																																																																																																																																																					
6	bRecvBitDataAllStation	Bit	VAR_GLOBAL	M2000																																																																																																																																																					
7	bSendBitDataAllStation1	Bit	VAR_GLOBAL	M10200																																																																																																																																																					
8	bRecvBitDataAllStation2	Bit	VAR_GLOBAL	M18400																																																																																																																																																					
9	wnSendWordDataMaster	Word [Signed]	VAR_GLOBAL	D600																																																																																																																																																					
10	wnRecvWordDataMaster	Word [Signed]	VAR_GLOBAL	D0																																																																																																																																																					
11	wnRecvWordDataStationNo2	Word [Signed]	VAR_GLOBAL	D300																																																																																																																																																					
12	wnRecvWordDataAllStation	Word [Signed]	VAR_GLOBAL	D2000																																																																																																																																																					
13	wnSendWordDataAllStation1	Word [Signed]	VAR_GLOBAL	D10200																																																																																																																																																					
14	wnRecvWordDataAllStation2	Word [Signed]	VAR_GLOBAL	D18400																																																																																																																																																					
	Label Name	Data Type	Class	Assign (Device/Label)																																																																																																																																																					
1	bStartDirection	Bit	VAR_GLOBAL	M0																																																																																																																																																					
2	bStartDirection_1	Bit	VAR_GLOBAL	M1																																																																																																																																																					
3	bSendBitDataMaster	Bit	VAR_GLOBAL	M1000																																																																																																																																																					
4	bRecvBitDataMaster	Bit	VAR_GLOBAL	M400																																																																																																																																																					
5	bRecvBitDataStationNo1	Bit	VAR_GLOBAL	M700																																																																																																																																																					
6	bRecvBitDataAllStation	Bit	VAR_GLOBAL	M2000																																																																																																																																																					
7	bRecvBitDataAllStation1	Bit	VAR_GLOBAL	M10200																																																																																																																																																					
8	bSendBitDataAllStation2	Bit	VAR_GLOBAL	M18400																																																																																																																																																					
9	wnSendWordDataMaster	Word [Signed]	VAR_GLOBAL	D900																																																																																																																																																					
10	wnRecvWordDataMaster	Word [Signed]	VAR_GLOBAL	D300																																																																																																																																																					
11	wnRecvWordDataStationNo1	Word [Signed]	VAR_GLOBAL	D600																																																																																																																																																					
12	wnRecvWordDataAllStation	Word [Signed]	VAR_GLOBAL	D2000																																																																																																																																																					
13	wnRecvWordDataAllStation1	Word [Signed]	VAR_GLOBAL	D10200																																																																																																																																																					
14	wnSendWordDataAllStation2	Word [Signed]	VAR_GLOBAL	D18400																																																																																																																																																					

*1 The module label of the first RJ71GN11-SX added using the engineering tool

• Device

Label name	Description	
	Station No.1	Station No.2
N0	Nesting (master station)	
N1	Nesting (station No.2)	Nesting (station No.1)

Local station (station No.1)

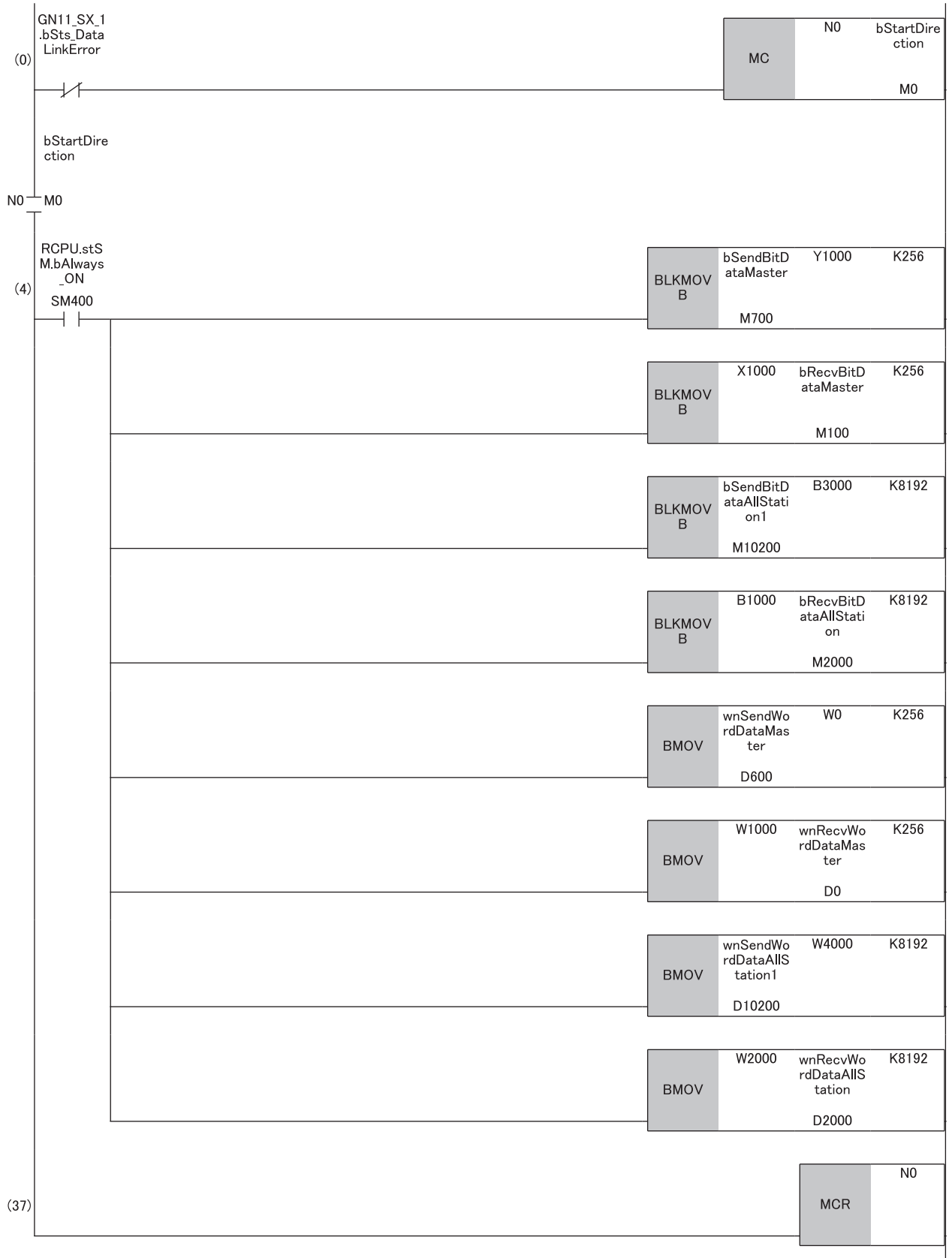

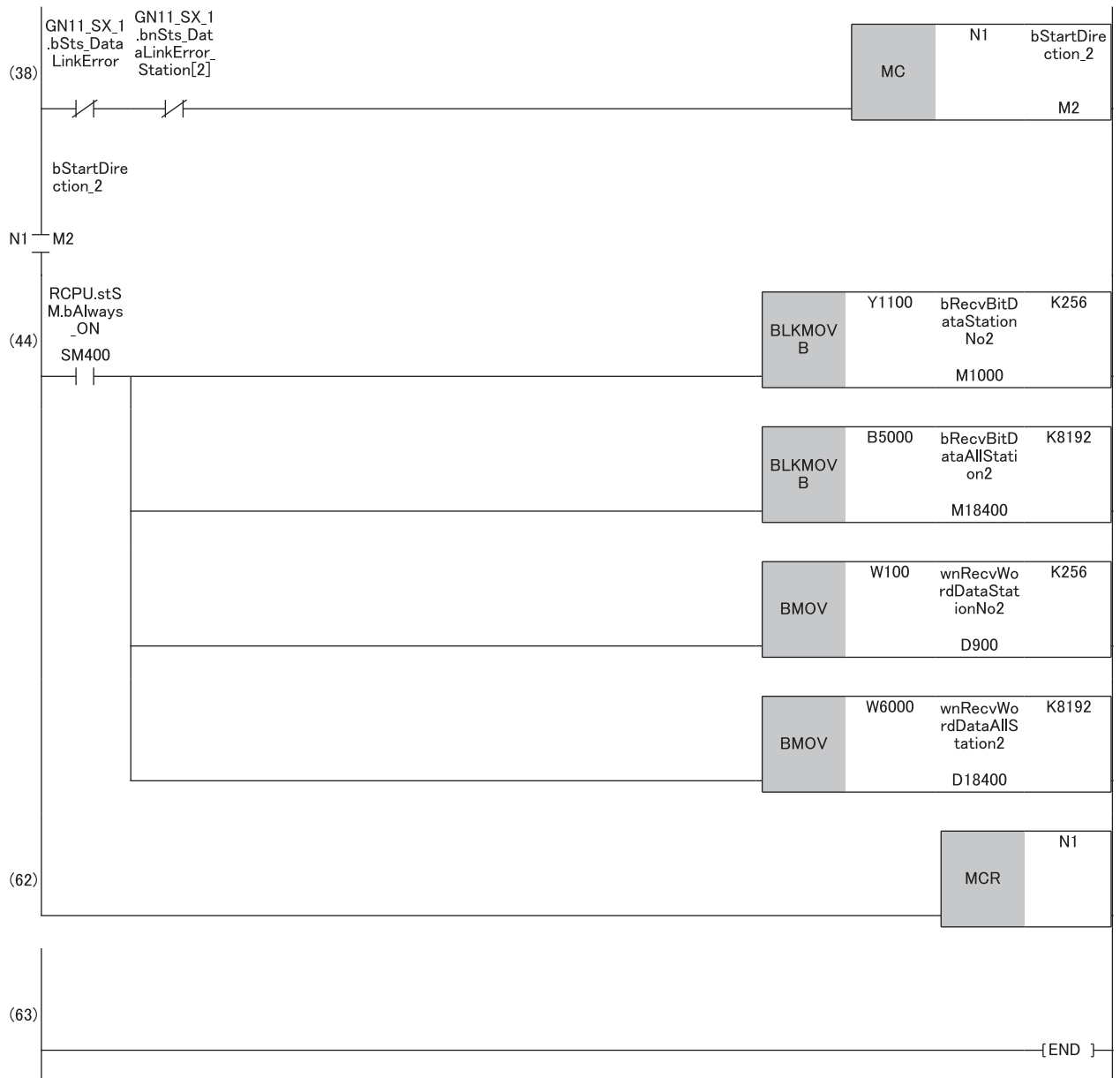

(4) Communication processing with the master station (station No.0)
 (44) Communication processing with a local station (station No.2)

Local station (station No.2)

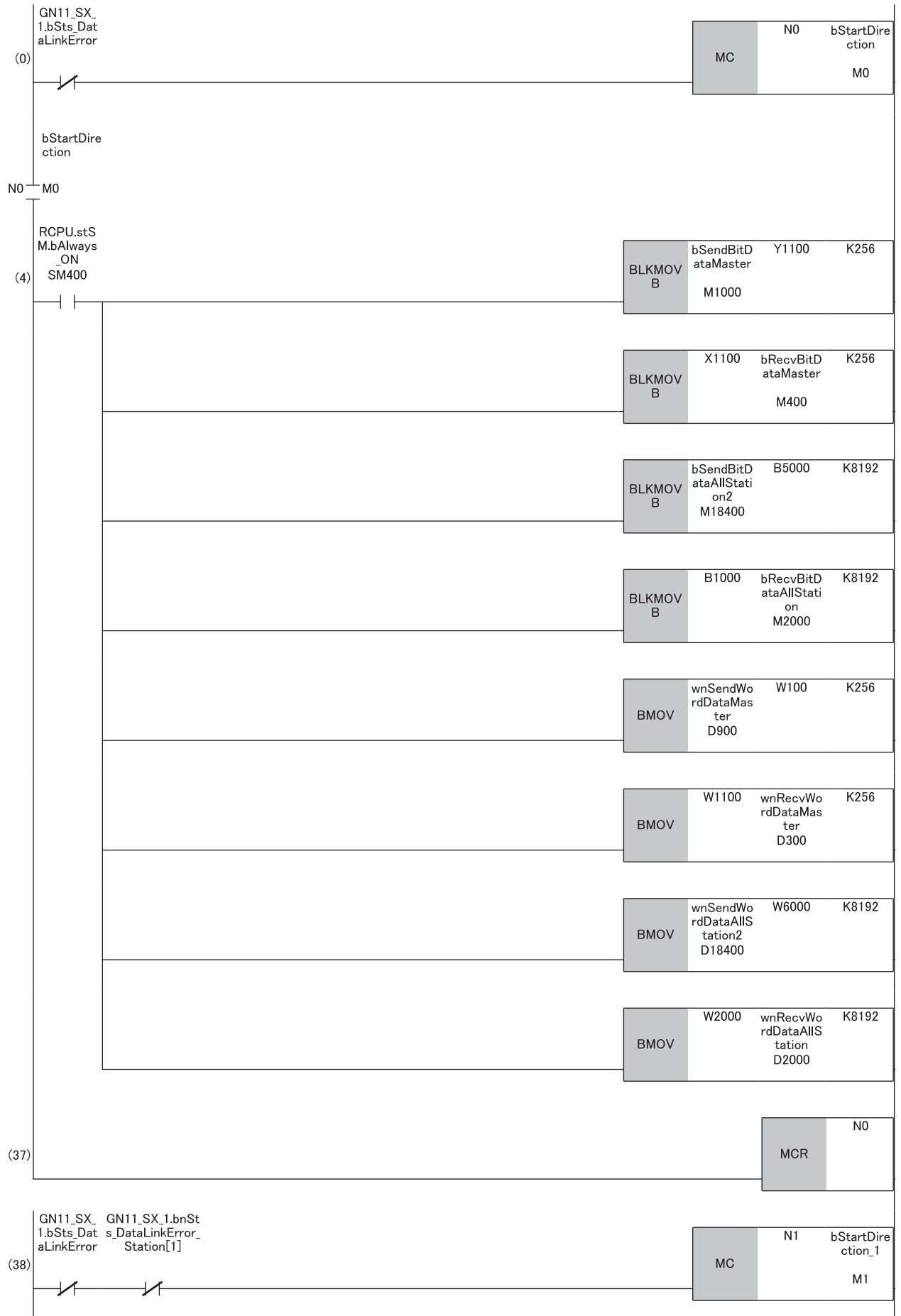

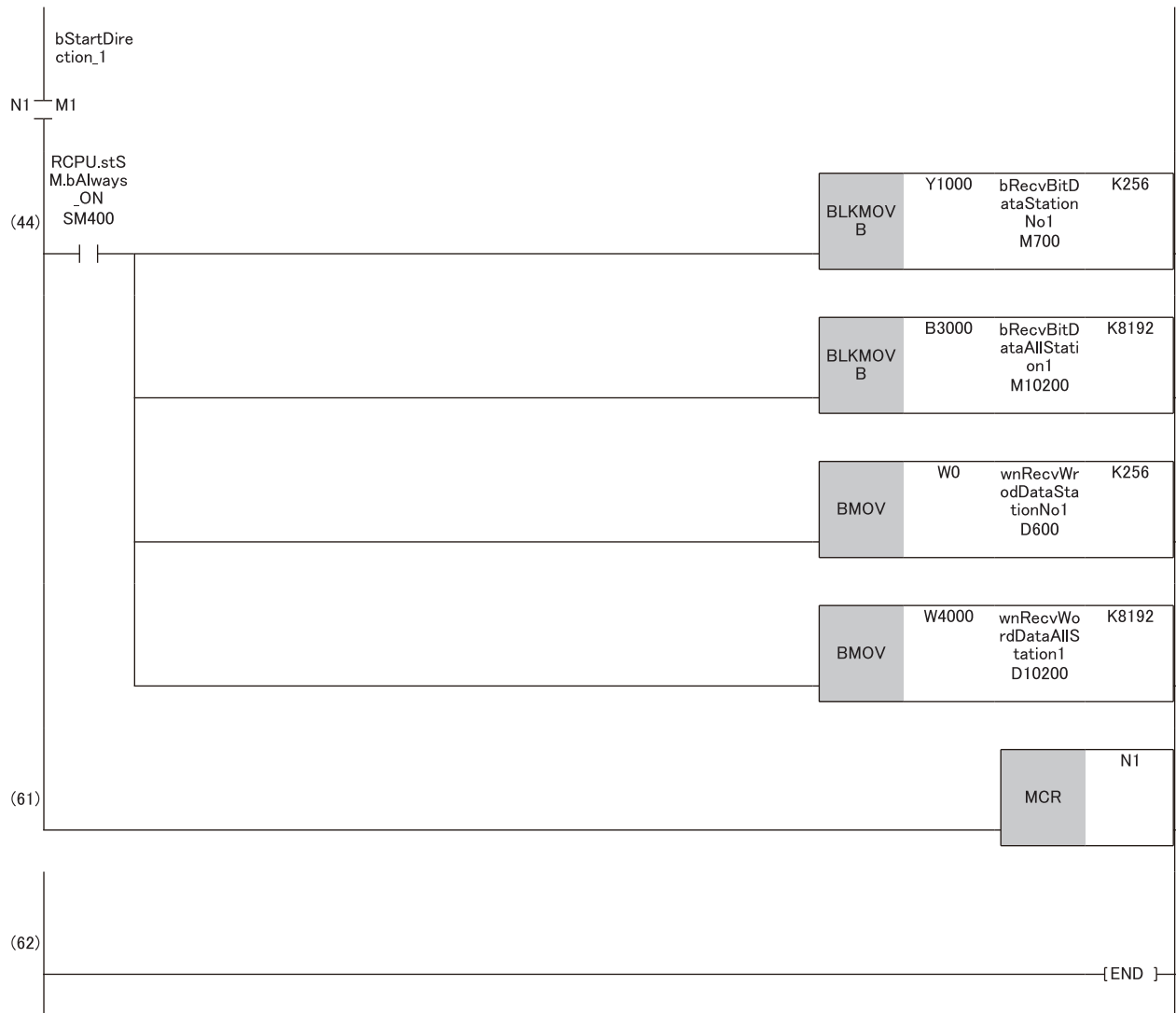

(4) Communication processing with the master station (station No.0)
(44) Communication processing with a local station (station No.1)

APPENDICES

Appendix 1 System Configuration with CC-Link IE TSN Class B/A Devices (Protocol Version 2.0/1.0) (RJ71GN11-T2)

This section shows the system configuration in the following cases.

- The RJ71GN11-T2 supports the protocol version 2.0.
- The modules on CC-Link IE TSN support the protocol version 2.0/1.0 mixed.
- Set "Connection Device Information" under "Basic Settings" of the engineering tool to "Mixture of CC-Link IE TSN Class B/A or CC-Link IE TSN Class A Only".

When "Connection Device Information" under "Basic Settings" of the master station is set to "Mixture of CC-Link IE TSN Class B/A or CC-Link IE TSN Class A Only", up to 121 stations (1 master station and 120 device stations) can be connected.

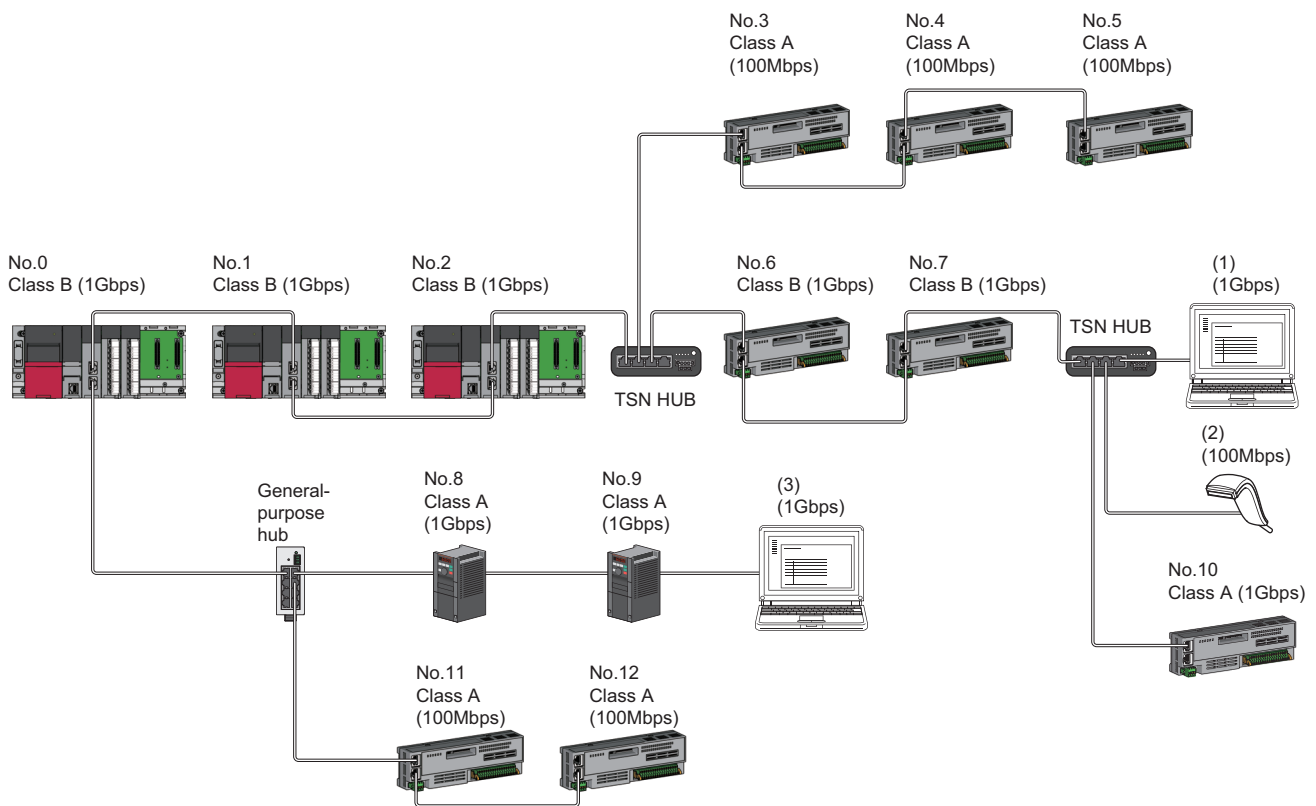

- No.0: Master station
No.1, No.2: Local station
No.3 to No.12: Remote station
(1), (2), and (3): Ethernet device
Class A: CC-Link IE TSN Class A device
Class B: CC-Link IE TSN Class B device

Device time synchronization method and connection specifications

The following describes the time synchronization method and connection specification references according to the protocol version 2.0 compatible conditions of the network configuration device.

Protocol version 2.0 only: Devices which support protocol version 2.0 only

With protocol version 1.0: Includes devices which support the protocol version 1.0

None: Works without time synchronization.

Protocol version 2.0/1.0 mixed of the device station		Time synchronization method for each device				Connection specification reference
CC-Link IE TSN Class B device	CC-Link IE TSN Class A device	CC-Link IE TSN Class B device		CC-Link IE TSN Class A device		
		Protocol version 2.0	Protocol version 1.0	Protocol version 2.0	Protocol version 1.0	
Protocol version 2.0 only	Protocol version 2.0 only	IEEE 802.1AS	—	Not available	—	Page 45 Structure with CC-Link IE TSN Class B/A Devices
With protocol version 1.0		IEEE 802.1AS	IEEE 802.1AS	Not available	—	
Protocol version 2.0 only	With protocol version 1.0	IEEE 1588	—	Not available	IEEE 1588	Page 111 System Configuration with CC-Link IE TSN Class B/A Devices (Protocol Version 1.0 Only) (RJ71GN11-T2)
With protocol version 1.0		IEEE 1588	IEEE 1588	Not available	IEEE 1588	

Precautions

- A device station with the protocol version 1.0 may not perform a data link when the master station is operating with the protocol version 2.0. If a device station that does not support protocol version 2.0 is detected, that station does not perform data link, the event code 00C80 is registered in the master station, and the information on stations that do not support protocol version 2.0 is stored in 'Station protocol version 2.0 support status' (SW01A0 to SW01A7).
- In the system configuration with a mix of the devices that support the protocol version 2.0 and devices that support the protocol version 1.0, if the device supporting the protocol version 1.0 delays to join the network because the power-on order or startup time of the device at the system start-up varies, the master station operates with the protocol version 2.0 and the device supporting the protocol version 1.0 may not perform a data link. (Event code 00C80 is registered in the master station)

Point

- The operating protocol can be checked with 'Protocol operating status' (Un\G1294016).
- When a device station with the firmware version of "15" or later that supports the protocol version 1.0 does not perform a data link, if the system needs to operate with the protocol version 1.0 fixed, set the operating protocol by using buffer memory. (Page 109 Operating protocol setting) Note that, when 'Protocol setting' (Un\G1294018) is set to '1: Protocol version 1.0 fixed', the values of the communication cycle interval and the cyclic transmission time that are stored in 'Communication cycle interval (calculation value)' (SW0072) and 'Cyclic transmission time (calculation value)' (SW0073) are the values for the operation with the protocol version 1.0. For this reason, if a device station that supports the protocol version 2.0 also needs to perform a data link, refer to 'Communication cycle intervals (calculation value)' (Un\G1277444), 'Cyclic transmission time (calculation value)' (Un\G1277445) and 'Transient transmission time (calculation value)' (Un\G1277446), and set appropriate values in "Communication Period Interval Setting", "Cyclic Transmission Time" and "Transient Transmission Time" in "Communication Period Setting" under "Basic Settings".

Setting method

■ Operating protocol setting

The operating protocol for the network with a mix of the devices that support the protocol version 2.0 and devices that support the protocol version 1.0 can be set in 'Protocol information' (Un\G1294016 to Un\G1294031) in the buffer memory. The setting value is enabled after resetting or after the power is turned off and on, and is held by the RJ71GN11-T2. For details on the buffer memory, refer to the following.

 MELSEC iQ-R CC-Link IE TSN User's Manual (Application)

1. Check the protocol currently held by the RJ71GN11-T2 with 'Protocol setting state' (Un\G1294021).
2. If the protocol needs to be changed, store the setting value in 'Protocol setting' (Un\G1294018), and set 'Write request' (Un\G1294017) to 1.
3. Check that 'Write implementation status' (Un\G1294019) is 1 and 'Setting result' (Un\G1294020) is 0. If 'Setting result' (Un\G1294020) is other than 0, check the error code and set the protocol again.
4. Reset the CPU modules or power off and on the system.

Point

- The operating protocol settings can be set in firmware version "15" and later of the RJ71GN11-T2.
- The operating protocol is determined during the initialization sequence and stored in 'Protocol operating status' (Un\G1294016). Also, if the protocol needs to be changed before resetting the CPU module or turning the power off and on in step 4, change the protocol setting value after changing the write request to 0. After the change, change 'Write request' (Un\G1294017) to 1 again.
- When setting the operating protocol, do so without cables connected before running the system. If the settings are changed while the system is running, there is a possibility that the link special relay (SB) and link special register (SW) will temporarily not be updated.

Precautions

- The operating protocol can be checked from 'Protocol operating status' (Un\G1294016).
- When the device station used is set to "CC-Link IE TSN Class A" and "Communication Period Setting" is set to "Low-Speed", depending on the maximum response time during the time-managed polling method, the communication cycle interval, and the setting value of low-speed, send/receive of the cyclic data cannot be guaranteed within the period of the device station set to "Low-Speed" in "Communication Period Setting" and "Low-Speed". In this case, a communication period setting error (error code: 31ABH) occurs, and the RJ71GN11-T2 stops.
- If there is a device station for which "CC-Link IE TSN Class Setting" is set to "CC-Link IE TSN Class A" and "Communication Period Setting" is set to "Low-Speed", parameter values for guaranteeing sending/receiving cyclic data within the "Low-Speed" period to/from the device station with "Communication Period Setting" set to "Low-Speed" are stored in 'Multiple cycle setting (low speed)' (Un\G1277442) and 'Communication cycle intervals (calculation value)' (Un\G1277443). Set the "Multiple Period Setting" to "Low-Speed" and "Communication Period Interval Setting" to values equal to or greater than the values stored in 'Multiple cycle setting (low speed)' (Un\G1277442) and 'Communication cycle intervals (calculation value)' (Un\G1277443). However, if modules selected in the "CC-Link IE TSN Configuration" window are all general CC-Link IE TSN modules, the parameter values are not stored in the buffer memory areas.
- If "CC-Link IE TSN Class Setting" of the general CC-Link IE TSN module added to the "CC-Link IE TSN Configuration" window is set to "CC-Link IE TSN Class A", and "Low-Speed" in "Multiple Period Setting" and "Communication Period Interval Setting" are set to values of 'Multiple cycle setting (low speed)' (Un\G1277442) and 'Communication cycle intervals (calculation value)' (Un\G1277443), the cyclic data may not be sent/received. In this case, add the actual device to be used to the "CC-Link IE TSN Configuration" window or refer to the manual for the device used to check the maximum response time for the time-managed polling method, calculate and set the communication cycle interval setting.

Point

For details on troubleshooting by symptom, refer to the following.

 MELSEC iQ-R CC-Link IE TSN User's Manual (Application)

Operation when the protocol version 2.0 and 1.0 are combined

The following table lists the restrictions when the protocol version 2.0 and 1.0 in connected devices are combined.

Protocol version 2.0/1.0		Restrictions
CC-Link IE TSN Class B device	CC-Link IE TSN Class A device	
Protocol version 2.0 only	Protocol version 2.0 only	Not available
With protocol version 1.0		A connection cannot be made if the total cyclic data size of all device stations on the CC-Link IE TSN Class A device side at the boundary between CC-Link IE TSN Class B and CC-Link IE TSN Class A exceeds 2K bytes.
Protocol version 2.0 only	With protocol version 1.0	<ul style="list-style-type: none"> Up to eight CC-Link IE TSN Class B devices can be connected to each port of a master station. A connection cannot be made if the total cyclic data size of all device stations on the CC-Link IE TSN Class A device side at the boundary between CC-Link IE TSN Class B and CC-Link IE TSN Class A exceeds 2K bytes.
With protocol version 1.0		

Operation when combining versions with other products

The following describes the operation of the parameters used in the RJ71GN11-T2 when a compatible/incompatible product is combined.

■Combination with the engineering tool

- "CC-Link IE TSN Class Setting" of each device station in the "CC-Link IE TSN Configuration" window

Engineering tool	RJ71GN11-T2	Operation
1.080J or earlier	Firmware version "13" or earlier	The module operates with the protocol version 1.0.
	Firmware version "14" or later	The module operates with the protocol version 1.0.
1.085P or later	Firmware version "13" or earlier	The module operates with the protocol version 1.0.
	Firmware version "14" or later	The module operates with the protocol version 2.0/1.0.

- Magnification setting of "Low-Speed" in "Multiple Period Setting" under "Basic Settings"

Engineering tool	RJ71GN11-T2	Operation
1.080J or earlier	Firmware version "13" or earlier	Only "×16" can be set.
	Firmware version "14" or later	Only "×16" can be set.
1.085P or later	Firmware version "13" or earlier	If a value other than "×16" is set, a network parameter error (error code: 2221H) occurs.
	Firmware version "14" or later	"×16", "×32", "×64", "×128" can be selected.

- "TSN HUB Setting" in "Connection Device Information" under "Basic Settings"

Engineering tool	RJ71GN11-T2	Operation
1.080J or earlier	Firmware version "13" or earlier	The setting is not available.
	Firmware version "14" or later	The setting is not available.
1.085P or later	Firmware version "13" or earlier	The module operates with the protocol version 1.0 regardless of the settings.
	Firmware version "14" or later	The module operates with the protocol version 2.0/1.0.

Precautions

When the parameters of a project created with an engineering tool with version 1.080J or earlier is written by using an engineering tool with version 1.085P or later, the module will operate with protocol version 1.0 unless the "CC-Link IE TSN Configuration" window is opened once.

■Combination with a device station

When a CC-Link IE TSN Class A device that supports CANopen profile with the protocol version 2.0 is connected, use the RJ71GN11-T2 with the firmware version "15" or later.

Appendix 2 System Configuration with CC-Link IE TSN Class B/A Devices (Protocol Version 1.0 Only) (RJ71GN11-T2)

This section shows the system configuration in the following cases.

- The RJ71GN11-T2 is protocol version 1.0
- The CC-Link IE TSN module supports protocol version 1.0 only
- Set "Connection Device Information" under "Basic Settings" of the engineering tool to "Mixture of CC-Link IE TSN Class B/A or CC-Link IE TSN Class A Only".

When "Connection Device Information" under "Basic Settings" of the master station is set to "Mixture of CC-Link IE TSN Class B/A or CC-Link IE TSN Class A Only", up to 121 stations (1 master station and 120 device stations) can be connected.

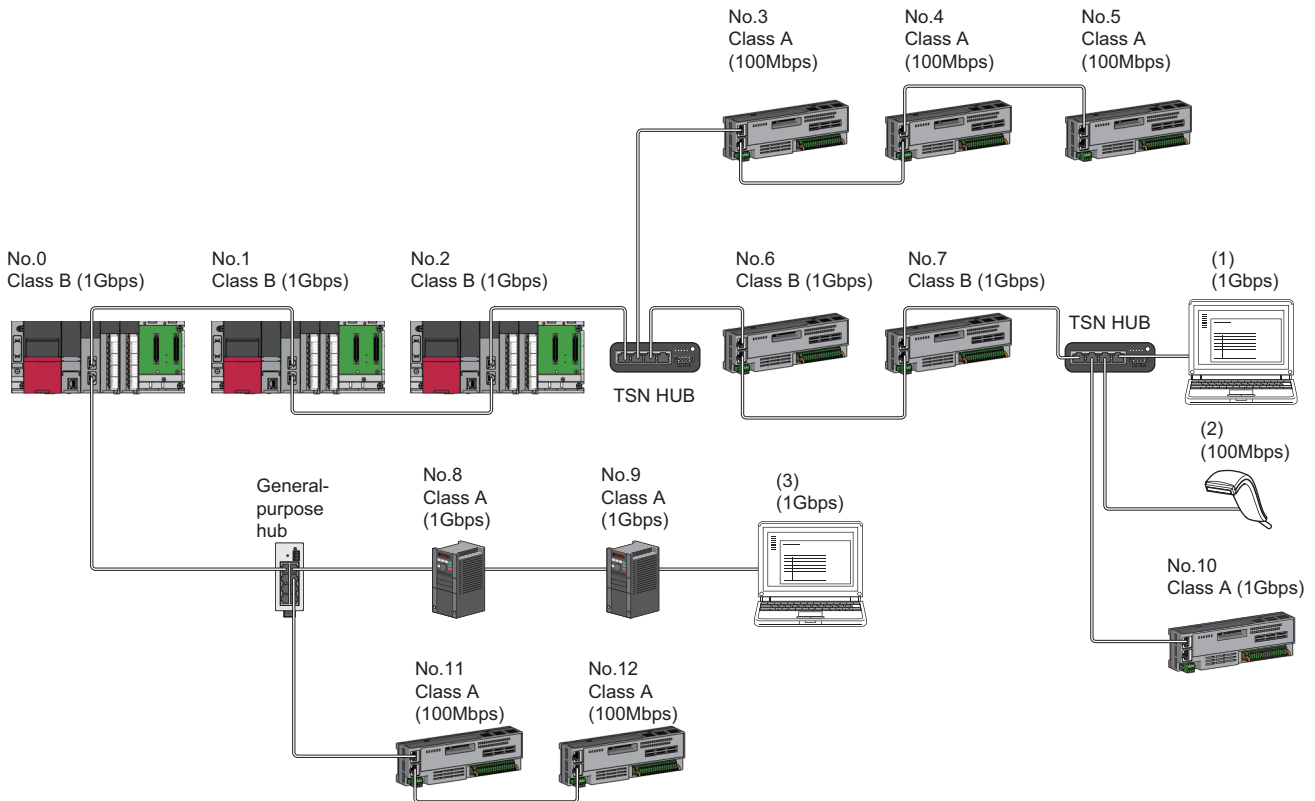

- No.0: Master station
- No.1, No.2: Local station
- No.3 to No.12: Remote station
- (1), (2), and (3): Ethernet device
- Class A: CC-Link IE TSN Class A device
- Class B: CC-Link IE TSN Class B device



The availability of connection of network configuration devices varies depending on the communication mode and communication speed.

- Unicast mode

☞ Page 113 When the communication speed for the master station is set to 1Gbps

☞ Page 114 When the communication speed for the master station is set to 100Mbps

- Multicast mode

☞ Page 115 When the communication speed for the master station is set to 1Gbps

☞ Page 116 When the communication speed for the master station is set to 100Mbps

The following terms are used to describe the terms in the tables referenced.

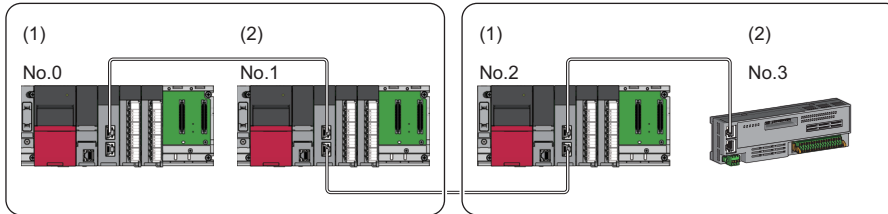

No.0: Master station

No.1, No.2: Local station

No.3: Remote station

(1) Device on the master station side (The master station or a device near the master station)

(2) Device on the end side (A device far from the master station)

Connectable devices (for unicast mode)

This section describes the connectable devices when "Communication Mode" under "Application Settings" is set to "Unicast".

When the communication speed for the master station is set to 1Gbps

This mode indicates the availability of connection with a network configuration device when "Communication Speed" of the master station is set to "1Gbps".

○: Connection available, △: Connection available via a switching hub, ×: Connection not available

S: TSN hub available

H: General-purpose hub available

Device on the master station side (A device near the master station)		Device on the end side (A device far from the master station)							
		Local station (CC-Link IE TSN Class B device)		Remote station (CC-Link IE TSN Class B device)		Remote station (CC-Link IE TSN Class A device)		Ethernet device	
		1Gbps	100Mbps	1Gbps	100Mbps	1Gbps	100Mbps	1Gbps	100Mbps
Master station (CC-Link IE TSN Class B device)	1Gbps	○S	×	○S	△S ^{*1*3}	○SH	△SH ^{*1*3}	○SH	△SH ^{*3}
Local station (CC-Link IE TSN Class B device)	1Gbps	○S	×	○S	△S ^{*1*3*4}	○SH ^{*2}	△SH ^{*1*2*3}	○SH	△SH ^{*3}
	100Mbps	×	×	×	×	×	×	×	×
Remote station (CC-Link IE TSN Class B device)	1Gbps	○S	×	○S	△S ^{*1*3*4}	○SH ^{*2}	△SH ^{*1*2*3}	○SH	△SH ^{*3}
	100Mbps	×	×	×	○S ^{*1*3*4}	×	○S ^{*1*2*3*4}	×	○SH ^{*3}
Remote station (CC-Link IE TSN Class A device)	1Gbps	×	×	×	×	○SH ^{*2}	△SH ^{*1*2*3}	○SH	△SH ^{*3}
	100Mbps	×	×	×	×	×	○SH ^{*1*2*3}	×	○SH ^{*3}

*1 For a device station with a communication speed of 100Mbps, set "Communication Period Setting" to "Low-Speed".

*2 A connection cannot be made if the total cyclic data size of all device stations on the CC-Link IE TSN Class A device side at the boundary between CC-Link IE TSN Class B and CC-Link IE TSN Class A exceeds 2K bytes. (Page 66 Calculation of the total cyclic data size)

*3 When the firmware version of the master station is "11" or earlier, only one of P1 or P2 can be used. (To use both P1 and P2 of the master station, set up a multicast mode structure.)

*4 A connection cannot be established if the total cyclic data size of all device stations on the 100Mbps device side exceeds 2K bytes. This includes the devices with a communication speed of 100Mbps that form a boundary between the communication speed of 1Gbps and 100Mbps. (Page 66 Calculation of the total cyclic data size)

A

Precautions

When a TSN hub is used, check the TSN hub specifications on the CC-Link Partner Association website (www.cc-link.org).

When the communication speed for the master station is set to 100Mbps

This mode indicates the availability of connection with a network configuration device when "Communication Speed" of the master station set to "100Mbps".

○: Connection available, △: Connection available via a switching hub, ×: Connection not available

S: TSN hub available

H: General-purpose hub available

Device on the master station side (A device near the master station)		Device on the end side (A device far from the master station)							
		Local station (CC-Link IE TSN Class B device)		Remote station (CC-Link IE TSN Class B device)		Remote station (CC-Link IE TSN Class A device)		Ethernet device	
		1Gbps	100Mbps	1Gbps	100Mbps	1Gbps	100Mbps	1Gbps	100Mbps
Master station (CC-Link IE TSN Class B device)	100Mbps	×	○S ^{*2}	×	○S ^{*2}	×	○SH	×	○SH
Local station (CC-Link IE TSN Class B device)	1Gbps	×	×	×	×	×	×	×	×
	100Mbps	×	○S ^{*2}	×	○S ^{*2}	×	○SH ^{*1}	×	○SH
Remote station (CC-Link IE TSN Class B device)	1Gbps	×	×	×	×	×	×	×	×
	100Mbps	×	○S ^{*2}	×	○S ^{*2}	×	○SH ^{*1}	×	○SH
Remote station (CC-Link IE TSN Class A device)	1Gbps	×	×	×	×	×	×	×	×
	100Mbps	×	×	×	×	×	○SH ^{*1}	×	○SH

*1 A connection cannot be made if the total cyclic data size of all device stations on the CC-Link IE TSN Class A device side at the boundary between CC-Link IE TSN Class B and CC-Link IE TSN Class A exceeds 2K bytes. (Page 66 Calculation of the total cyclic data size)

*2 For a device station with a communication speed of 100Mbps, set "Communication Period Setting" to "Basic Period" or "Normal-Speed".

Precautions

When a TSN hub is used, check the TSN hub specifications on the CC-Link Partner Association website (www.cc-link.org).

Connectable devices (for multicast mode)

This section describes the connectable devices when "Communication Mode" under "Application Settings" is set to "Multicast".

When the communication speed for the master station is set to 1Gbps

This mode indicates the availability of connection with a network configuration device when "Communication Speed" of the master station is set to "1Gbps".

○: Connection available, △: Connection available via a switching hub, ×: Connection not available

S: TSN hub available

H: General-purpose hub available

Device on the master station side (A device near the master station)		Device on the end side (A device far from the master station)							
		Local station (CC-Link IE TSN Class B device)		Remote station (CC-Link IE TSN Class B device)		Remote station (CC-Link IE TSN Class A device)		Ethernet device	
		1Gbps	100Mbps	1Gbps	100Mbps	1Gbps	100Mbps	1Gbps	100Mbps
Master station (CC-Link IE TSN Class B device)	1Gbps	○S ^{*7}	×	○S ^{*7}	△S ^{*1} ^{*5} ^{*7}	○SH ^{*4} ^{*7} ^{*8}	△SH ^{*1} ^{*4} ^{*5} ^{*7} ^{*8}	○SH ^{*3} ^{*7}	△SH ^{*3} ^{*5} ^{*7}
Local station (CC-Link IE TSN Class B device)	1Gbps	○S ^{*7}	×	○S ^{*7}	△S ^{*1} ^{*6} ^{*7} ^{*9}	○SH ^{*2} ^{*6} ^{*7} ^{*8}	△SH ^{*1} ^{*2} ^{*6} ^{*7} ^{*8}	○SH ^{*6} ^{*7}	△SH ^{*6} ^{*7}
	100Mbps	×	×	×	×	×	×	×	×
Remote station (CC-Link IE TSN Class B device)	1Gbps	○S ^{*7}	×	○S ^{*7}	△S ^{*1} ^{*6} ^{*7} ^{*9}	○SH ^{*2} ^{*6} ^{*7} ^{*8}	△SH ^{*1} ^{*2} ^{*6} ^{*7} ^{*8}	○SH ^{*6} ^{*7}	△SH ^{*6} ^{*7}
	100Mbps	×	×	×	○S ^{*1} ^{*7} ^{*9}	×	○SH ^{*1} ^{*2} ^{*6} ^{*7} ^{*8} ^{*9}	×	○SH ^{*6} ^{*7}
Remote station (CC-Link IE TSN Class A device)	1Gbps	×	×	×	×	○SH ^{*2} ^{*7} ^{*8}	△SH ^{*1} ^{*2} ^{*7} ^{*8}	○SH ^{*7}	△SH ^{*7}
	100Mbps	×	×	×	×	×	○SH ^{*1} ^{*2} ^{*7} ^{*8}	×	○SH ^{*7}

- *1 For a device station with a communication speed of 100Mbps, set "Communication Period Setting" to "Low-Speed".
- *2 A connection cannot be made if the total cyclic data size of all device stations on the CC-Link IE TSN Class A device side at the boundary between CC-Link IE TSN Class B and CC-Link IE TSN Class A exceeds 2K bytes. (☞ Page 66 Calculation of the total cyclic data size)
- *3 Since cyclic data is sent to the Ethernet device when the Ethernet device is connected to the master station with firmware version "13" or earlier, communication may not be possible depending on the type of the Ethernet device.
- *4 Since cyclic data is sent to a CC-Link IE TSN Class A remote station when the master station with firmware version "13" or earlier is connected to a CC-Link IE TSN Class A remote station, communication may not be possible depending on the type of the CC-Link IE TSN Class A remote station.
- *5 When the firmware version of the master station is "13" or earlier, only one of P1 or P2 can be used. (To use both P1 and P2 of the master station, connect the local station or remote station supporting multicast filter as the device on the master station side.)
- *6 For a local station or remote station of a device on the master station side, use a device supporting the multicast filter. (📖 Manual for the device used)
- *7 When the device is connected on the end side via the switching hub as shown below, communication may not be possible depending on the type of the device.
The communication will be enabled by configuring settings with the switching hub so that the multicast frame (with multicast MAC address 09:00:70:00:10:02 and 09:00:70:00:10:05) will not be transferred to the ports specified below.

Connection structure that cannot be communicated	Port that prohibits multicast frame transfer
Device stations with different communication speeds of 1Gbps and 100Mbps coexist.	Connection port of the device station with communication speed of 100Mbps
A local station and Ethernet device coexist.	Connection port of the Ethernet device
When the firmware version of the master station is "14" or later, a local station and CC-Link IE TSN Class A remote station coexist.	Connection port of CC-Link IE TSN Class A remote station
The remote station and Ethernet device coexist.	Connection port of the Ethernet device

- *8 When the firmware version of the master station is "13" or earlier, a local station and CC-Link IE TSN Class A remote station cannot be connected together on the end side via the switching hub.
- *9 A connection cannot be established if the total cyclic data size of all device stations on the 100Mbps device side exceeds 2K bytes. This includes the devices with a communication speed of 100Mbps that form a boundary between the communication speed of 1Gbps and 100Mbps. (☞ Page 66 Calculation of the total cyclic data size)

Precautions

When a TSN hub is used, check the TSN hub specifications on the CC-Link Partner Association website (www.cc-link.org).

When the communication speed for the master station is set to 100Mbps

This mode indicates the availability of connection with a network configuration device when "Communication Speed" of the master station set to "100Mbps".

○: Connection available, △: Connection available via a switching hub, ×: Connection not available

S: TSN hub available

H: General-purpose hub available

Device on the master station side (A device near the master station)		Device on the end side (A device far from the master station)							
		Local station (CC-Link IE TSN Class B device)		Remote station (CC-Link IE TSN Class B device)		Remote station (CC-Link IE TSN Class A device)		Ethernet device	
		1Gbps	100Mbps	1Gbps	100Mbps	1Gbps	100Mbps	1Gbps	100Mbps
Master station (CC-Link IE TSN Class B device)	100Mbps	×	○S ^{*2*6*7}	×	○S ^{*2}	×	○SH ^{*4*6*7}	×	○SH ^{*3*6}
Local station (CC-Link IE TSN Class B device)	1Gbps	×	×	×	×	×	×	×	×
	100Mbps	×	○S ^{*2*6*7}	×	○S ^{*2}	×	○SH ^{*1*5*6*7}	×	○SH ^{*5*6}
Remote station (CC-Link IE TSN Class B device)	1Gbps	×	×	×	×	×	×	×	×
	100Mbps	×	○S ^{*2*6*7}	×	○S ^{*2}	×	○SH ^{*1*5*6*7}	×	○SH ^{*5*6}
Remote station (CC-Link IE TSN Class A device)	1Gbps	×	×	×	×	×	×	×	×
	100Mbps	×	×	×	×	×	○SH ^{*1*6*7}	×	○SH ^{*6}

*1 A connection cannot be made if the total cyclic data size of all device stations on the CC-Link IE TSN Class A device side at the boundary between CC-Link IE TSN Class B and CC-Link IE TSN Class A exceeds 2K bytes. (☞ Page 66 Calculation of the total cyclic data size)

*2 For a device station with a communication speed of 100Mbps, set "Communication Period Setting" to "Basic Period" or "Normal-Speed".

*3 Since cyclic data is sent to the Ethernet device when the Ethernet device is connected to the master station with firmware version "13" or earlier, communication may not be possible depending on the type of the Ethernet device.

*4 Since cyclic data is sent to a CC-Link IE TSN Class A remote station when the master station with firmware version "13" or earlier is connected to a CC-Link IE TSN Class A remote station, communication may not be possible depending on the type of the CC-Link IE TSN Class A remote station.

*5 For a local station or remote station of a device on the master station side, use a device supporting the multicast filter. (☞ Manual for the remote station used)

*6 When the device is connected on the end side via the switching hub as shown below, communication may not be possible depending on the type of the device.

The communication will be enabled by configuring settings with the switching hub so that the multicast frame (with multicast MAC address 09:00:70:00:10:02 and 09:00:70:00:10:05) will not be transferred to the ports specified below.

Connection structure that cannot be communicated	Port that prohibits multicast frame transfer
A local station and Ethernet device coexist.	Connection port of the Ethernet device
When the firmware version of the master station is "14" or later, a local station and CC-Link IE TSN Class A remote station coexist.	Connection port of CC-Link IE TSN Class A remote station

*7 When the firmware version of the master station is "13" or earlier, a local station and CC-Link IE TSN Class A remote station cannot be connected together on the end side via the switching hub.

Precautions

When a TSN hub is used, check the TSN hub specifications on the CC-Link Partner Association website (www.cc-link.org).

Structure with modules on CC-Link IE TSN only

Connection with modules on CC-Link IE TSN only

Line topology

The network is configured in a line topology.

- Up to eight CC-Link IE TSN Class B devices can be connected to P1 or P2 of the master station.

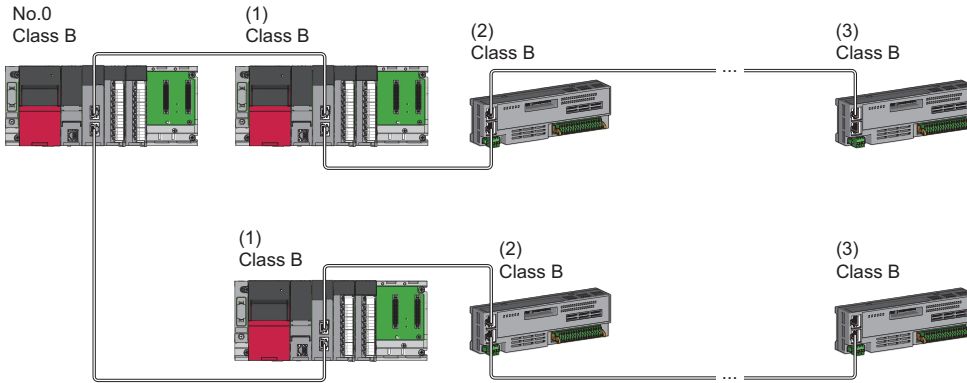

No.0: Master station
 (1) Local station (1st device)
 (2) Remote station (2nd device)
 (3) Remote station (8th device)
 Class B: CC-Link IE TSN Class B device

- A CC-Link IE TSN Class B device cannot be connected to a CC-Link IE TSN Class A device.

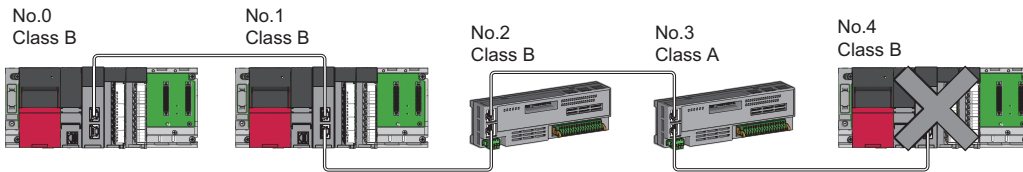

No.0: Master station
 No.1, No.4: Local station
 No.2, No.3: Remote station
 Class A: CC-Link IE TSN Class A device
 Class B: CC-Link IE TSN Class B device



- A connection cannot be made if the total cyclic data size of all device stations on the CC-Link IE TSN Class A device side including the CC-Link IE TSN Class A device that forms the boundary between CC-Link IE TSN Class B and CC-Link IE TSN Class A exceeds 2K bytes.

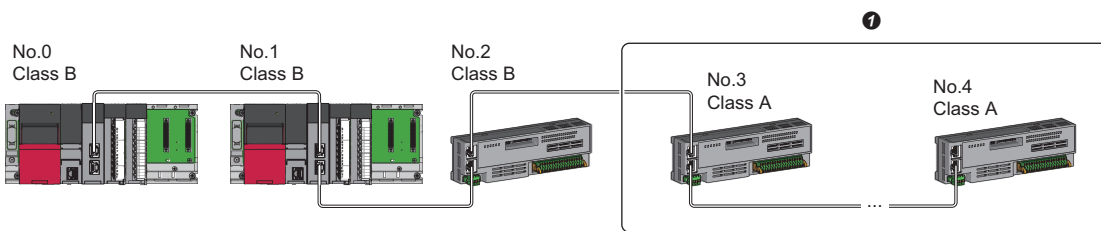

No.0: Master station
 No.1: Local station
 No.2, No.3, and No.4: Remote station
 Class A: CC-Link IE TSN Class A device
 Class B: CC-Link IE TSN Class B device
 ❶ Set the total cyclic data size within 2K bytes.

- When the device stations are CC-Link IE TSN Class A devices only, up to 120 device stations can be connected.

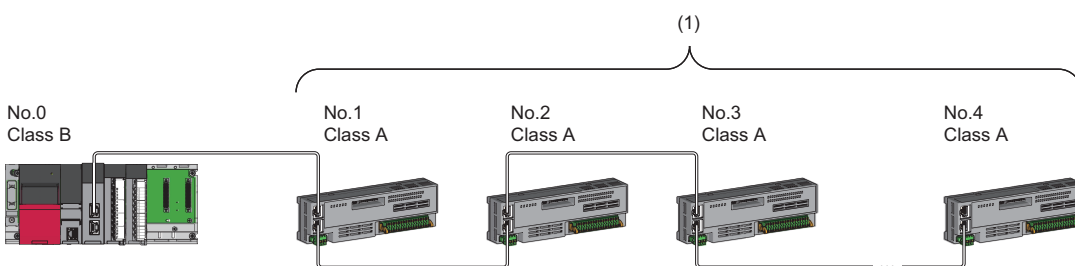

No.0: Master station
 No.1 to No.4: Remote station
 Class A: CC-Link IE TSN Class A device
 Class B: CC-Link IE TSN Class B device
 (1) Total of the device stations: Up to 120

■ Star topology

The network is configured in a star topology via a switching hub.

- When connecting a CC-Link IE TSN Class B device in a star topology, use a TSN hub.

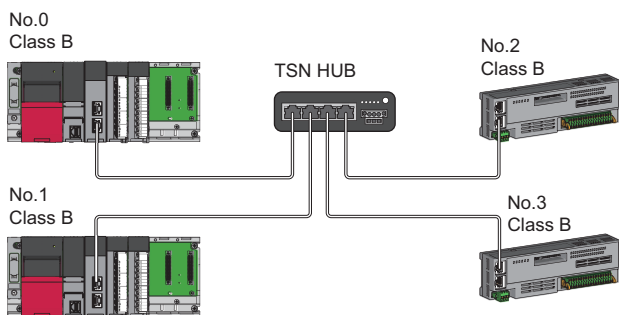

No.0: Master station
 No.1: Local station
 No.2, No.3: Remote station
 Class B: CC-Link IE TSN Class B device

- When connecting a CC-Link IE TSN Class A device to a CC-Link IE TSN Class B device or a CC-Link IE TSN Class A device to another CC-Link IE TSN Class A device in a star topology, connect them via a switching hub.

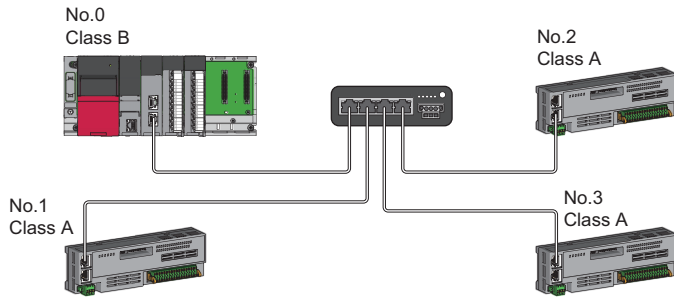

No.0: Master station
 No.1, No.2, and No.3: Remote station
 Class A: CC-Link IE TSN Class A device
 Class B: CC-Link IE TSN Class B device

- When the "Communication Mode" is "Multicast", communication may not be possible depending on the communication device if a local station is connected with a CC-Link IE TSN Class A remote station as a mixture on the end side via a switching hub. The communication will be enabled by configuring settings with the switching hub so that the multicast frame (with multicast MAC address 09:00:70:00:10:02 and 09:00:70:00:10:05) will not be transferred to the CC-Link IE TSN Class A remote station port.

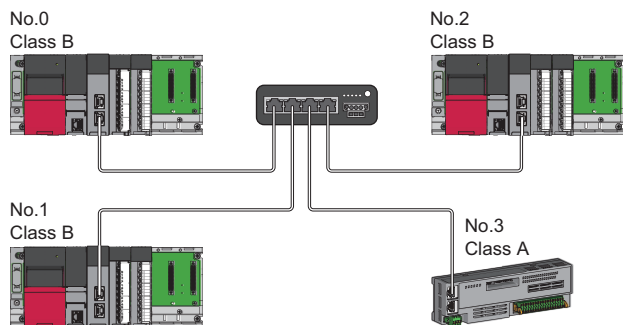

No.0: Master station
 No.1, No.2: Local station
 No.3: Remote station
 Class A: CC-Link IE TSN Class A device
 Class B: CC-Link IE TSN Class B device



■ Coexistence of line and star topologies

Line and star topologies can be mixed according to the connection requirements described below.

- Up to eight CC-Link IE TSN Class B devices including TSN hub can be connected from the master station to the end of each network.
- When connecting a CC-Link IE TSN Class A device, connect to the end of a CC-Link IE TSN Class B device or to a TSN hub. A star topology is also possible using a switching hub.

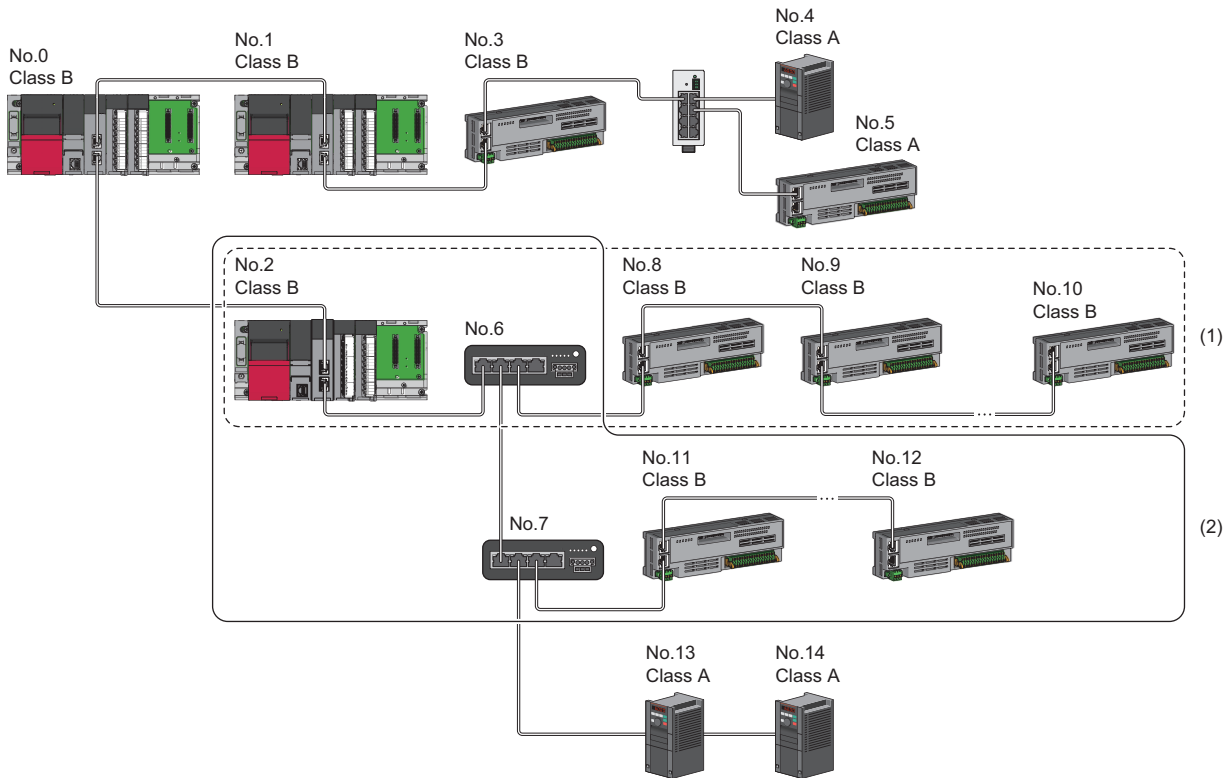

No.0: Master station

No.1, No.3, No.4, No.5, No.13, No.14: Device stations

No.2: Device station (1st device)

No.6: TSN hub (2nd device)

No.7: TSN hub (3rd device)

No.8: Device station (3rd device)

No.9, No.11: Device stations (4th device)

No.10, No.12: Device stations (8th device)

Class A: CC-Link IE TSN Class A device

Class B: CC-Link IE TSN Class B device

(1), (2) Up to eight CC-Link IE TSN Class B devices including TSN hub can be connected.

- A connection cannot be made if the total cyclic data size of all device stations on the CC-Link IE TSN Class A device side at the boundary between CC-Link IE TSN Class B and CC-Link IE TSN Class A exceeds 2K bytes.

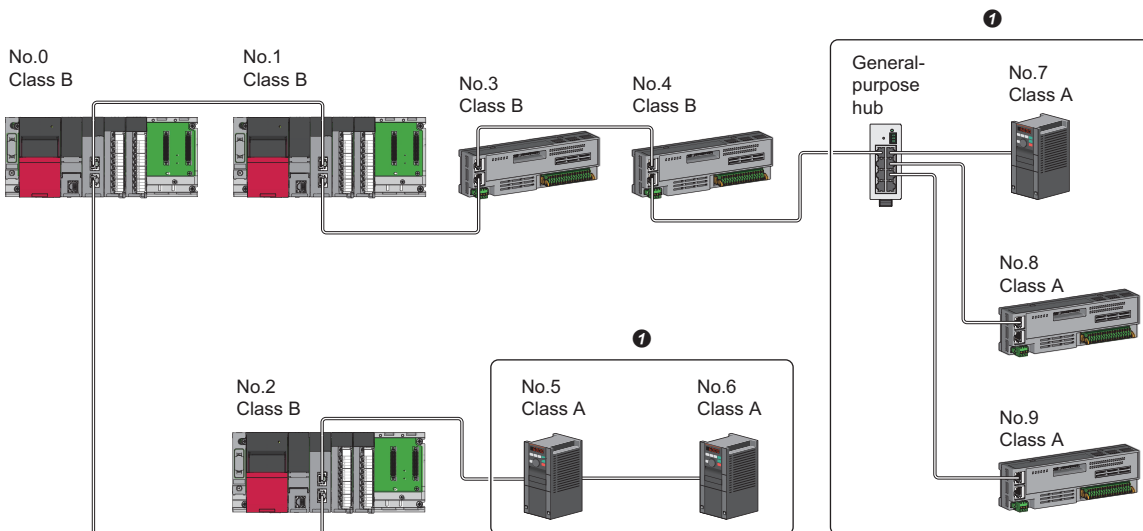

No.0: Master station
 No.1, No.2: Local station
 No.3, No.4, No.5, No.6, No.7, No.8, and No.9: Remote station
 Class A: CC-Link IE TSN Class A device
 Class B: CC-Link IE TSN Class B device
 ❶ Set the total cyclic data size within 2K bytes.

- Up to 120 device stations can be connected by using the appropriate master station port in accordance with the CC-Link IE TSN Class.

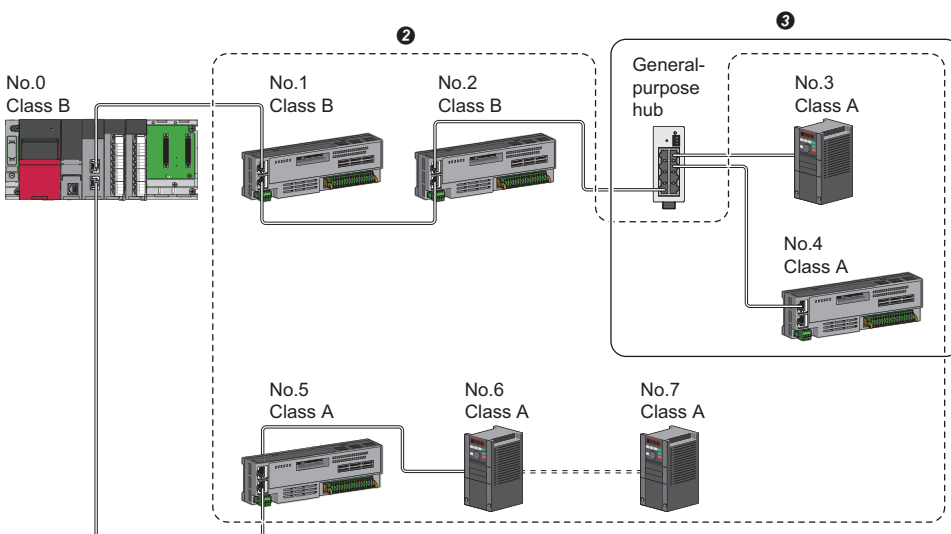

No.0: Master station
 No.1 to No.7: Remote station
 Class A: CC-Link IE TSN Class A device
 Class B: CC-Link IE TSN Class B device
 ❷ Up to 120 devices can be connected in total.
 ❸ Set the total cyclic data size within 2K bytes.

■ Ring topology

Ring topology is not possible with "Mixture of CC-Link IE TSN Class B/A or CC-Link IE TSN Class A Only" system configuration.



Connection with modules on CC-Link IE TSN with a communication speed of 100Mbps

This section describes the network topology when "Communication Speed" under "Application Settings" is set to "100Mbps".

Line topology

The network is configured in a line topology.

- Up to eight CC-Link IE TSN Class B devices can be connected to each of P1 and P2 of the master station.
- Adjust the communication speed of the module.
- When connecting modules with different communication speeds, connect via a general-purpose hub.

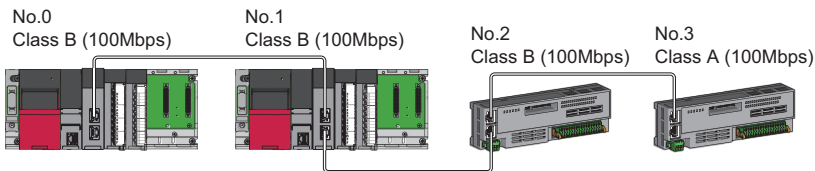

No.0: Master station
 No.1: Local station
 No.2, No.3: Remote station
 Class A: CC-Link IE TSN Class A device
 Class B: CC-Link IE TSN Class B device

Star topology

The network is configured in a star topology via a switching hub.

- When the master station with a communication speed of 1Gbps and a remote station with a communication speed of 100Mbps exist in the structure, set "Communication Period Setting" to "Low-Speed" for the remote station with a communication speed of 100Mbps.

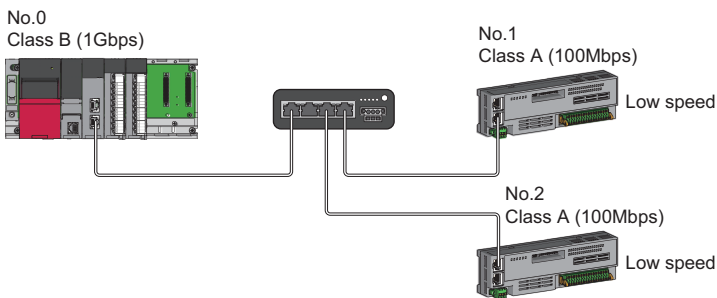

No.0: Master station
 No.1, No.2: Remote station
 Class A: CC-Link IE TSN Class A device
 Class B: CC-Link IE TSN Class B device

- Connect the master station and local station at the same communication speed.

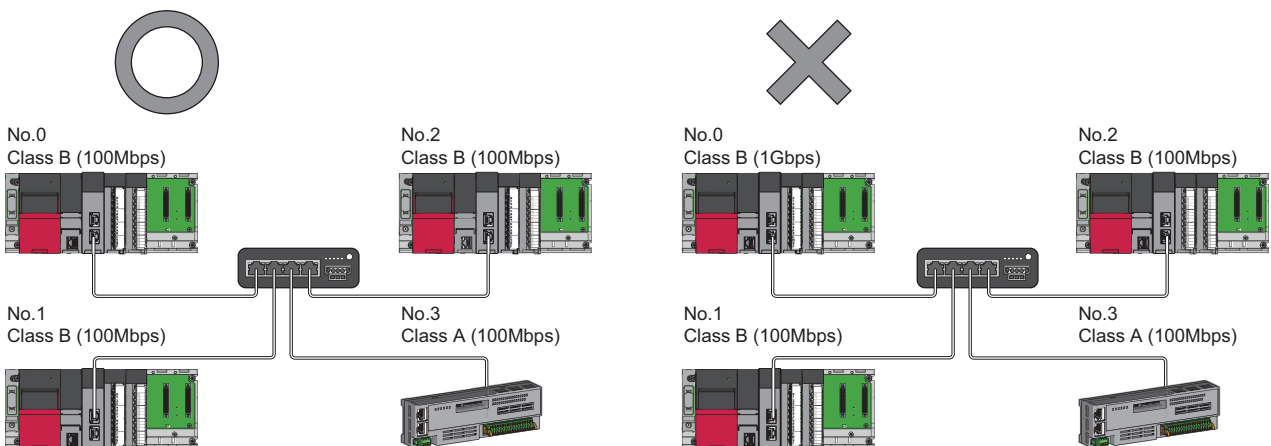

No.0: Master station
 No.1, No.2: Local station
 No.3: Remote station
 Class A: CC-Link IE TSN Class A device
 Class B: CC-Link IE TSN Class B device

- When "Communication Mode" is set to "Multicast" and the communication speed of the master station is 1Gbps, communication may not be possible depending on the type of the device if device stations with different communication speeds of 1Gbps and 100Mbps coexist on the end side via the switching hub. The communication will be enabled by configuring settings with the switching hub so that the multicast frame (with multicast MAC address 09:00:70:00:10:02 and 09:00:70:00:10:05) will not be transferred to the port of the device station with 100Mbps.

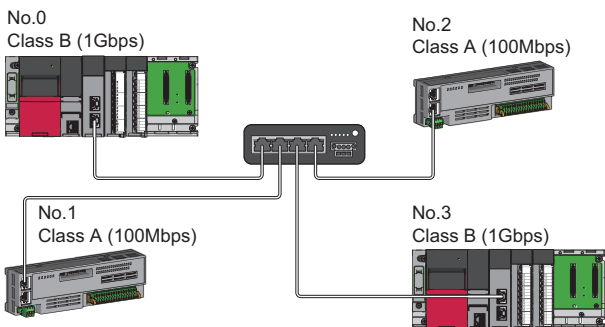

No.0: Master station
 No.1, No.2, and No.3: Remote station
 Class A: CC-Link IE TSN Class A device
 Class B: CC-Link IE TSN Class B device

■ Coexistence of line and star topologies

Line and star topologies can be mixed in the same network configuration.

- Up to eight CC-Link IE TSN Class B devices including TSN hub can be connected from the master station to the end of each network.
- When the master station with a communication speed of 1Gbps and a remote station with a communication speed of 100Mbps exist in the structure, set "Communication Period Setting" to "Low-Speed" for the remote station with a communication speed of 100Mbps.

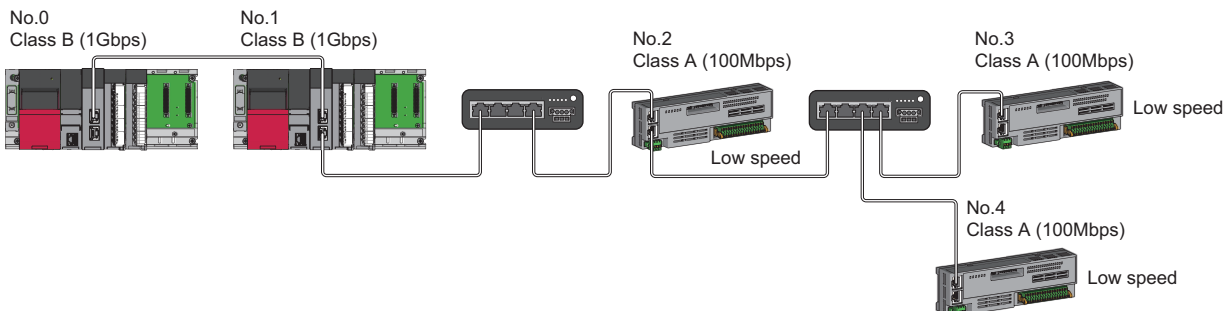

No.0: Master station
 No.1: Local station
 No.2, No.3, and No.4: Remote station
 Class A: CC-Link IE TSN Class A device
 Class B: CC-Link IE TSN Class B device



- When the communication speed of the master station is 1Gbps, a connection cannot be established if the total cyclic data size of all device stations on the 100Mbps device side exceeds 2K bytes. This includes the devices with a communication speed of 100Mbps that form a boundary between the communication speed of 1Gbps and 100Mbps.

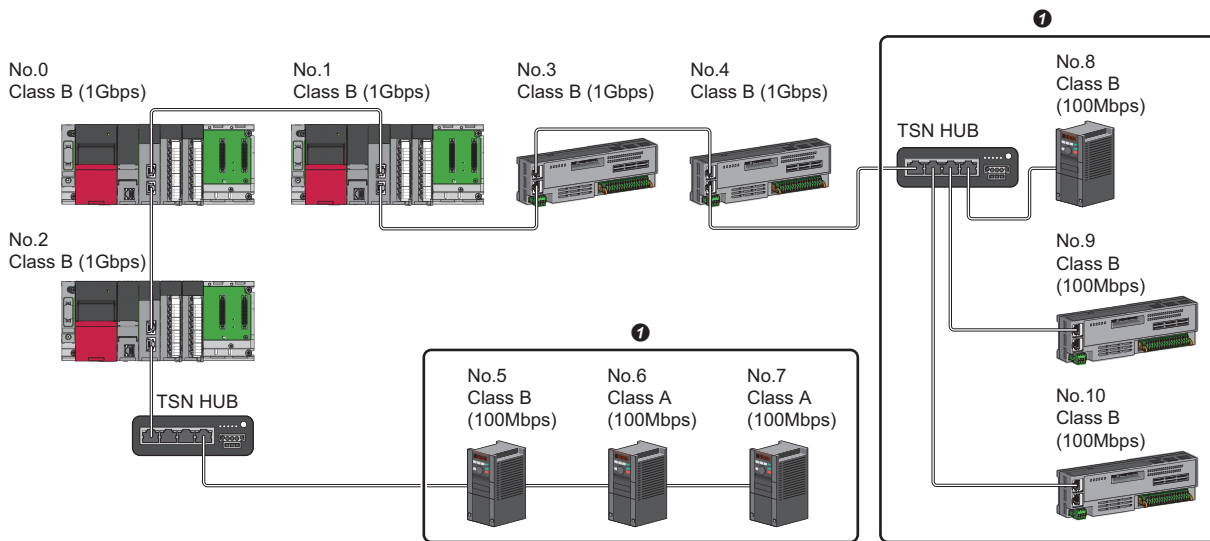

- No.0: Master station
- No.1, No.2: Local station
- No.3 to No.10: Remote station
- Class A: CC-Link IE TSN Class A device
- Class B: CC-Link IE TSN Class B device
- 1 Set the total cyclic data size within 2K bytes.

■Ring topology

Ring topology is not possible with "Mixture of CC-Link IE TSN Class B/A or CC-Link IE TSN Class A Only" system configuration.

Structure with modules on CC-Link IE TSN and Ethernet devices

Connection with modules on CC-Link IE TSN and Ethernet devices

■Line topology

The network with modules and devices is configured in a line topology. A switching hub is not required.

Up to eight CC-Link IE TSN Class B devices can be connected to each of P1 and P2 of the master station.

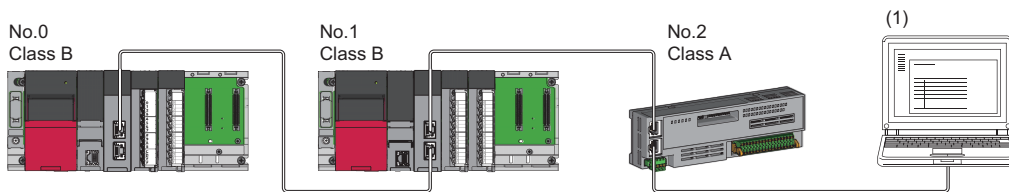

No.0: Master station
No.1: Local station
No.2: Remote station
(1) Ethernet device

Class A: CC-Link IE TSN Class A device
Class B: CC-Link IE TSN Class B device

Connect Ethernet devices to the end of the network.

When an error occurs in a device station, the stations connected after the faulty station will be disconnected.

■Star topology

Modules or devices are connected in a star topology via a switching hub.

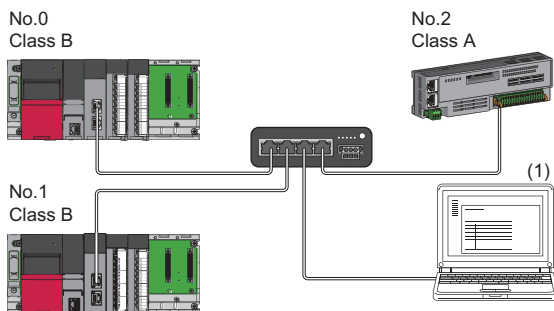

No.0: Master station
No.1: Local station
No.2: Remote station
(1) Ethernet device

Class A: CC-Link IE TSN Class A device
Class B: CC-Link IE TSN Class B device



Since cyclic data is sent to an Ethernet device when "Communication Mode" is set to "Multicast" and a local station is used with an Ethernet device on the end side via a switching hub, communication may not be possible depending on the type of an Ethernet device.

The communication will be enabled by configuring settings with the switching hub so that the multicast frame (with multicast MAC address 09:00:70:00:10:02 and 09:00:70:00:10:05) will not be transferred to the port of the Ethernet device.

■ Coexistence of line and star topologies

Line and star topologies can be mixed according to the connection requirements described below.

- Up to eight CC-Link IE TSN Class B devices including TSN hub can be connected from the master station to the end of each network.
- Connect Ethernet devices at the end of line topology.
- When connecting the Ethernet device in a star topology, connect the Ethernet device to a switching hub.

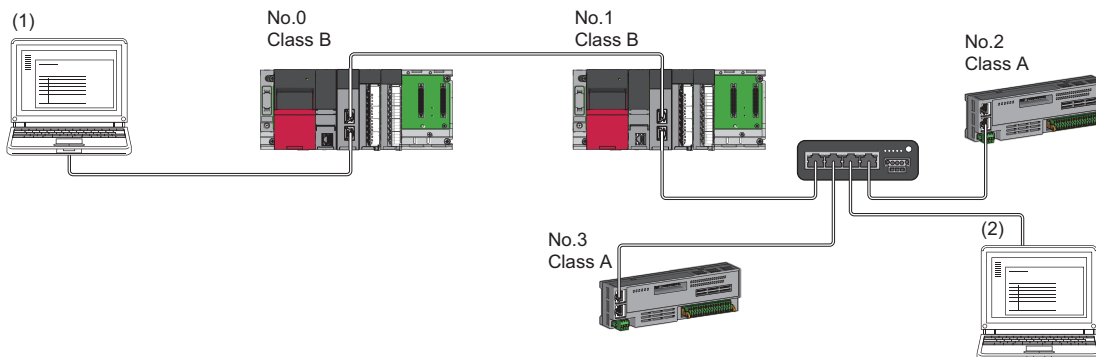

No.0: Master station

No.1: Local station

No.2, No.3: Remote station

(1), (2): Ethernet device

Class A: CC-Link IE TSN Class A device

Class B: CC-Link IE TSN Class B device

■ Ring topology

Ring topology is not possible with "Mixture of CC-Link IE TSN Class B/A or CC-Link IE TSN Class A Only" system configuration.

Appendix 3 External Dimensions

This chapter describes the external dimensions of the RJ71GN11.

RJ71GN11-T2

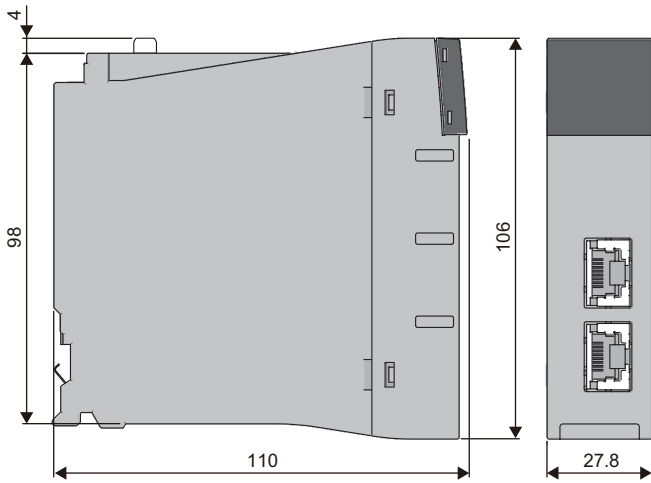

(Unit: mm)

RJ71GN11-SX

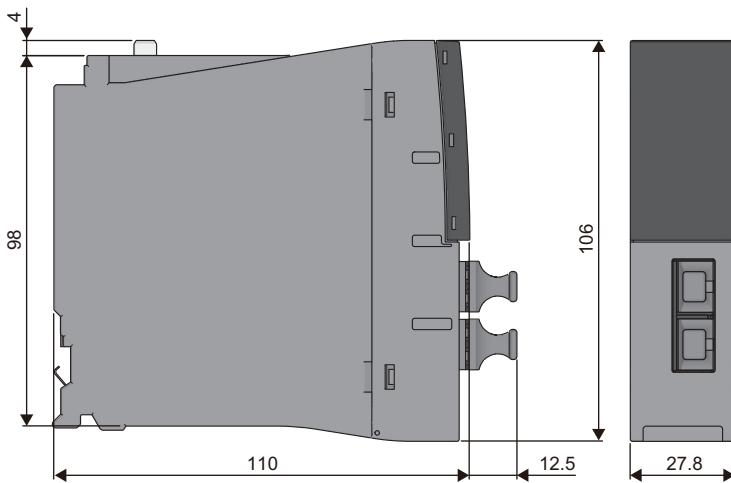

(Unit: mm)

A

INDEX

C

Coexistence of line and star topologies
..... 38,41,43,61,64,120,123,126
Communication mode 24

D

Data transmission speed 24

I

Internal current consumption (5VDC) 24

J

Jumbo frame 24

L

LED..... 18,20
Line topology 38,40,43,60,63,117,122,125

M

Maximum frame size 24
Maximum number of link points per network..... 22
Maximum number of link points per station 22
Maximum number of networks 22
Maximum segment length 24

N

Number of occupied I/O points 24
Number of simultaneous open connections 24

P

P1..... 18,20

R

Ring topology 39,42,44,59,61,121,124,126

S

Sending/receiving data storage memory 24
Star topology ... 38,40,43,51,60,63,118,122,125

T

Transmission specifications 24

W

Weight..... 24
Wiring products..... 70,71

MEMO

REVISIONS

*The manual number is given on the bottom left of the back cover.

Revision date	*Manual number	Description
May 2019	SH(NA)-082127ENG-A	First edition
August 2019	SH(NA)-082127ENG-B	Error correction
November 2019	SH(NA)-082127ENG-C	■Added or modified parts Chapter 1, Section 2.1, 2.2, Chapter 5, Section 5.1, 5.2, 5.3, Chapter 6, Section 7.1
December 2019	SH(NA)-082127ENG-D	■Added or modified part Chapter 6
May 2020	SH(NA)-082127ENG-E	■Added functions CC-Link IE TSN network synchronous communication function, safety communications, loopback function, remote device test, ring topology ■Added or modified parts TERMS, Chapter 1, Section 2.1, Chapter 3, Section 5.1, 5.2, 5.4, Chapter 6
July 2020	SH(NA)-082127ENG-F	■Added function CANopen communications ■Added or modified parts SAFETY PRECAUTIONS, Chapter 3
November 2020	SH(NA)-082127ENG-G	■Added function CC-Link IE TSN Communication Software ■Added or modified parts Section 2.1, Chapter 3, Section 5.1, 5.2, 5.4
October 2021	SH(NA)-082127ENG-H	■Added or modified parts Section 5.1, 5.2
May 2022	SH(NA)-082127ENG-I	■Added or modified parts WHEN USING A SWITCHING HUB WITH CC-Link IE TSN, SAFETY PRECAUTIONS, TERMS, GENERIC TERMS AND ABBREVIATIONS, Chapter 1, Section 2.1, Chapter 5, Section 5.1, 5.2, 5.3, 5.4, Chapter 6, Section 7.1, Appendix 1, 2
November 2022	SH(NA)-082127ENG-J	■Added function Co-recording ■Added or modified parts RELEVANT MANUALS, Chapter 3, Section 5.2, Appendix 1
May 2023	SH(NA)-082127ENG-K	■Added model RJ71GN11-SX ■Added or modified parts SAFETY PRECAUTIONS, TERMS, GENERIC TERMS AND ABBREVIATIONS, Section 1.2, 2.1, 2.3, Chapter 3, 5, 6, Section 7.3, 8.2, Appendix 1, 2, 4
October 2023	SH(NA)-082127ENG-L	■Added functions Master station switch function, IP address setting of a device station ■Added or modified parts Section 1.1, 1.2, 2.1, Chapter 3

Japanese manual number: SH-082126-M

This manual confers no industrial property rights or any rights of any other kind, nor does it confer any patent licenses. Mitsubishi Electric Corporation cannot be held responsible for any problems involving industrial property rights which may occur as a result of using the contents noted in this manual.

© 2019 MITSUBISHI ELECTRIC CORPORATION

WARRANTY

Please confirm the following product warranty details before using this product.

1. Gratis Warranty Term and Gratis Warranty Range

If any faults or defects (hereinafter "Failure") found to be the responsibility of Mitsubishi occurs during use of the product within the gratis warranty term, the product shall be repaired at no cost via the sales representative or Mitsubishi Service Company.

However, if repairs are required onsite at domestic or overseas location, expenses to send an engineer will be solely at the customer's discretion. Mitsubishi shall not be held responsible for any re-commissioning, maintenance, or testing on-site that involves replacement of the failed module.

[Gratis Warranty Term]

The gratis warranty term of the product shall be for one year after the date of purchase or delivery to a designated place. Note that after manufacture and shipment from Mitsubishi, the maximum distribution period shall be six (6) months, and the longest gratis warranty term after manufacturing shall be eighteen (18) months. The gratis warranty term of repair parts shall not exceed the gratis warranty term before repairs.

[Gratis Warranty Range]

- (1) The range shall be limited to normal use within the usage state, usage methods and usage environment, etc., which follow the conditions and precautions, etc., given in the instruction manual, user's manual and caution labels on the product.
- (2) Even within the gratis warranty term, repairs shall be charged for in the following cases.
 1. Failure occurring from inappropriate storage or handling, carelessness or negligence by the user. Failure caused by the user's hardware or software design.
 2. Failure caused by unapproved modifications, etc., to the product by the user.
 3. When the Mitsubishi product is assembled into a user's device, Failure that could have been avoided if functions or structures, judged as necessary in the legal safety measures the user's device is subject to or as necessary by industry standards, had been provided.
 4. Failure that could have been avoided if consumable parts (battery, backlight, fuse, etc.) designated in the instruction manual had been correctly serviced or replaced.
 5. Failure caused by external irresistible forces such as fires or abnormal voltages, and Failure caused by force majeure such as earthquakes, lightning, wind and water damage.
 6. Failure caused by reasons unpredictable by scientific technology standards at time of shipment from Mitsubishi.
 7. Any other failure found not to be the responsibility of Mitsubishi or that admitted not to be so by the user.

2. Onerous repair term after discontinuation of production

- (1) Mitsubishi shall accept onerous product repairs for seven (7) years after production of the product is discontinued. Discontinuation of production shall be notified with Mitsubishi Technical Bulletins, etc.
- (2) Product supply (including repair parts) is not available after production is discontinued.

3. Overseas service

Overseas, repairs shall be accepted by Mitsubishi's local overseas FA Center. Note that the repair conditions at each FA Center may differ.

4. Exclusion of loss in opportunity and secondary loss from warranty liability

Regardless of the gratis warranty term, Mitsubishi shall not be liable for compensation to:

- (1) Damages caused by any cause found not to be the responsibility of Mitsubishi.
- (2) Loss in opportunity, lost profits incurred to the user by Failures of Mitsubishi products.
- (3) Special damages and secondary damages whether foreseeable or not, compensation for accidents, and compensation for damages to products other than Mitsubishi products.
- (4) Replacement by the user, maintenance of on-site equipment, start-up test run and other tasks.

5. Changes in product specifications

The specifications given in the catalogs, manuals or technical documents are subject to change without prior notice.

TRADEMARKS

CiA® and CANopen® are registered Community Trademarks of CAN in Automation e.V.

The company names, system names and product names mentioned in this manual are either registered trademarks or trademarks of their respective companies.

In some cases, trademark symbols such as [™] or [®] are not specified in this manual.

SH(NA)-082127ENG-L(2310)MEE

MODEL: R-CCIETSN-U-IN-E

MODEL CODE: 13JX0E

mitsubishi electric corporation

HEAD OFFICE: TOKYO BLDG., 2-7-3, MARUNOUCHI, CHIYODA-KU, TOKYO 100-8310, JAPAN
NAGOYA WORKS: 1-14, YADA-MINAMI 5-CHOME, HIGASHI-KU, NAGOYA 461-8670, JAPAN

When exported from Japan, this manual does not require application to the
Ministry of Economy, Trade and Industry for service transaction permission.

Specifications subject to change without notice.