

Programmable Controller

MELSEC iQ-R
series

MELSEC iQ-R MES Interface Module User's Manual (Startup)

-RD81MES96N
-RD81MES96
-SW1DND-RMESIF-E(MX MESInterface-R)



SAFETY PRECAUTIONS

(Read these precautions before using this product.)

Before using this product, please read this manual and the relevant manuals carefully and pay full attention to safety to handle the product correctly. If the equipment is used in a manner not specified by the manufacturer, the protection provided by the equipment may be impaired.

The precautions given in this manual are concerned with this product only. For the safety precautions of the programmable controller system, refer to the MELSEC iQ-R Module Configuration Manual.

In this manual, the safety precautions are classified into two levels: "⚠ WARNING" and "⚠ CAUTION".

 WARNING	Indicates that incorrect handling may cause hazardous conditions, resulting in death or severe injury.
 CAUTION	Indicates that incorrect handling may cause hazardous conditions, resulting in minor or moderate injury or property damage.

Under some circumstances, failure to observe the precautions given under "⚠ CAUTION" may lead to serious consequences.

Observe the precautions of both levels because they are important for personal and system safety.

Make sure that the end users read this manual and then keep the manual in a safe place for future reference.

[Design Precautions]

WARNING

- Configure safety circuits external to the programmable controller to ensure that the entire system operates safely even when a fault occurs in the external power supply or the programmable controller. Failure to do so may result in an accident due to an incorrect output or malfunction.
 - (1) Emergency stop circuits, protection circuits, and protective interlock circuits for conflicting operations (such as forward/reverse rotations or upper/lower limit positioning) must be configured external to the programmable controller.
 - (2) When the programmable controller detects an abnormal condition, it stops the operation and all outputs are:
 - Turned off if the overcurrent or overvoltage protection of the power supply module is activated.
 - Held or turned off according to the parameter setting if the self-diagnostic function of the CPU module detects an error such as a watchdog timer error.
 - (3) All outputs may be turned on if an error occurs in a part, such as an I/O control part, where the CPU module cannot detect any error. To ensure safety operation in such a case, provide a safety mechanism or a fail-safe circuit external to the programmable controller. For a fail-safe circuit example, refer to the MELSEC iQ-R Module Configuration Manual.
 - (4) Outputs may remain on or off due to a failure of a component such as a relay and transistor in an output circuit. Configure an external circuit for monitoring output signals that could cause a serious accident.
 - In an output circuit, when a load current exceeding the rated current or an overcurrent caused by a load short-circuit flows for a long time, it may cause smoke and fire. To prevent this, configure an external safety circuit, such as a fuse.
 - Configure a circuit so that the programmable controller is turned on first and then the external power supply. If the external power supply is turned on first, an accident may occur due to an incorrect output or malfunction.
 - Configure a circuit so that the external power supply is turned off first and then the programmable controller. If the programmable controller is turned off first, an accident may occur due to an incorrect output or malfunction.
 - For the operating status of each station after a communication failure, refer to manuals for the network used. For the manuals, please consult your local Mitsubishi representative. Incorrect output or malfunction due to a communication failure may result in an accident.
 - When connecting an external device with a CPU module or intelligent function module to modify data of a running programmable controller, configure an interlock circuit in the program to ensure that the entire system will always operate safely. For other forms of control (such as program modification, parameter change, forced output, or operating status change) of a running programmable controller, read the relevant manuals carefully and ensure that the operation is safe before proceeding. Improper operation may damage machines or cause accidents. When a Safety CPU is used, data cannot be modified while the Safety CPU is in SAFETY MODE.
 - Especially, when a remote programmable controller is controlled by an external device, immediate action cannot be taken if a problem occurs in the programmable controller due to a communication failure. To prevent this, configure an interlock circuit in the program, and determine corrective actions to be taken between the external device and CPU module in case of a communication failure.
-

[Design Precautions]

WARNING

- Do not write any data to the "system area" and "write-protect area" of the buffer memory in the module. Also, do not use any "use prohibited" signals as an output signal from the CPU module to each module. Doing so may cause malfunction of the programmable controller system. For the "system area", "write-protect area", and the "use prohibited" signals, refer to the user's manual for the module used. For areas used for safety communications, they are protected from being written by users, and thus safety communications failure caused by data writing does not occur.
 - If a communication cable is disconnected, the network may be unstable, resulting in a communication failure of multiple stations. Configure an interlock circuit in the program to ensure that the entire system will always operate safely even if communications fail. Incorrect output or malfunction due to a communication failure may result in an accident. When safety communications are used, an interlock by the safety station interlock function protects the system from an incorrect output or malfunction.
-

[Design Precautions]

CAUTION

- Do not install the control lines or communication cables together with the main circuit lines or power cables. Doing so may result in malfunction due to electromagnetic interference. Keep a distance of 100mm or more between those cables.
 - During control of an inductive load such as a lamp, heater, or solenoid valve, a large current (approximately ten times greater than normal) may flow when the output is turned from off to on. Therefore, use a module that has a sufficient current rating.
 - After the CPU module is powered on or is reset, the time taken to enter the RUN status varies depending on the system configuration, parameter settings, and/or program size. Design circuits so that the entire system will always operate safely, regardless of the time.
 - Do not power off the programmable controller or reset the CPU module while the settings are being written. Doing so will make the data in the flash ROM and SD memory card undefined. The values need to be set in the buffer memory and written to the flash ROM and SD memory card again. Doing so also may cause malfunction or failure of the module.
 - When changing the operating status of the CPU module from external devices (such as the remote RUN/STOP functions), select "Do Not Open by Program" for "Opening Method" of "Module Parameter". If "Open by Program" is selected, an execution of the remote STOP function causes the communication line to close. Consequently, the CPU module cannot reopen the line, and external devices cannot execute the remote RUN function.
-

[Security Precautions]

WARNING

- To maintain the security (confidentiality, integrity, and availability) of the programmable controller and the system against unauthorized access, denial-of-service (DoS) attacks, computer viruses, and other cyberattacks from external devices via the network, take appropriate measures such as firewalls, virtual private networks (VPNs), and antivirus solutions.
-

[Installation Precautions]

WARNING

- Shut off the external power supply (all phases) used in the system before mounting or removing the module. Failure to do so may result in electric shock or cause the module to fail or malfunction.
-

[Installation Precautions]

CAUTION

- Use the programmable controller in an environment that meets the general specifications in the MELSEC iQ-R Module Configuration Manual. Failure to do so may result in electric shock, fire, malfunction, or damage to or deterioration of the product.
 - To mount a module, place the concave part(s) located at the bottom onto the guide(s) of the base unit, and push in the module until the hook(s) located at the top snaps into place. Incorrect interconnection may cause malfunction, failure, or drop of the module.
 - To mount a module with no module fixing hook, place the concave part(s) located at the bottom onto the guide(s) of the base unit, push in the module, and fix it with screw(s). Incorrect interconnection may cause malfunction, failure, or drop of the module.
 - When using the programmable controller in an environment of frequent vibrations, fix the module with a screw.
 - Tighten the screws within the specified torque range. Undertightening can cause drop of the component or wire, short circuit, or malfunction. Overtightening can damage the screw and/or module, resulting in drop, short circuit, or malfunction. For the specified torque range, refer to the MELSEC iQ-R Module Configuration Manual.
 - When using an extension cable, connect it to the extension cable connector of the base unit securely. Check the connection for looseness. Poor contact may cause malfunction.
 - When using an SD memory card, fully insert it into the SD memory card slot. Check that it is inserted completely. Poor contact may cause malfunction.
 - Securely insert an extended SRAM cassette or a battery-less option cassette into the cassette connector of the CPU module. After insertion, close the cassette cover and check that the cassette is inserted completely. Poor contact may cause malfunction.
 - Beware that the module could be very hot while power is on and immediately after power-off.
 - Do not directly touch any conductive parts and electronic components of the module, SD memory card, extended SRAM cassette, battery-less option cassette, or connector. Doing so can cause malfunction or failure of the module.
-

[Wiring Precautions]

WARNING

- Shut off the external power supply (all phases) used in the system before installation and wiring. Failure to do so may result in electric shock or cause the module to fail or malfunction.
- After installation and wiring, attach a blank cover module (RG60) to each empty slot before powering on the system for operation. Also, attach an extension connector protective cover^{*1} to each unused extension cable connector as necessary. Directly touching any conductive parts of the connectors while power is on may result in electric shock.

*1 For details, please consult your local Mitsubishi Electric representative.

[Wiring Precautions]

CAUTION

- Individually ground the FG and LG terminals of the programmable controller with a ground resistance of 100 ohms or less. Failure to do so may result in electric shock or malfunction.
 - Use applicable solderless terminals and tighten them within the specified torque range. If any spade solderless terminal is used, it may be disconnected when the terminal screw comes loose, resulting in failure.
 - Check the rated voltage and signal layout before wiring to the module, and connect the cables correctly. Connecting a power supply with a different voltage rating or incorrect wiring may cause fire or failure.
 - Connectors for external devices must be crimped or pressed with the tool specified by the manufacturer, or must be correctly soldered. Incomplete connections may cause short circuit, fire, or malfunction.
 - Securely connect the connector to the module. Poor contact may cause malfunction.
 - Do not install the control lines or communication cables together with the main circuit lines or power cables. Doing so may result in malfunction due to noise. Keep a distance of 100mm or more between those cables.
 - Place the cables in a duct or clamp them. If not, dangling cables may swing or inadvertently be pulled, resulting in malfunction or damage to modules or cables.
In addition, the weight of the cables may put stress on modules in an environment of strong vibrations and shocks.
Do not clamp the extension cables with the jacket stripped. Doing so may change the characteristics of the cables, resulting in malfunction.
 - Check the interface type and correctly connect the cable. Incorrect wiring (connecting the cable to an incorrect interface) may cause failure of the module and external device.
 - Tighten the terminal screws or connector screws within the specified torque range. Undertightening can cause drop of the screw, short circuit, fire, or malfunction. Overtightening can damage the screw and/or module, resulting in drop, short circuit, fire, or malfunction.
 - When disconnecting the cable from the module, do not pull the cable by the cable part. For the cable with connector, hold the connector part of the cable. For the cable connected to the terminal block, loosen the terminal screw. Pulling the cable connected to the module may result in malfunction or damage to the module or cable.
 - Prevent foreign matter such as dust or wire chips from entering the module. Such foreign matter can cause a fire, failure, or malfunction.
-

[Wiring Precautions]

CAUTION

- When a protective film is attached to the top of the module, remove it before system operation. If not, inadequate heat dissipation of the module may cause a fire, failure, or malfunction.
 - Programmable controllers must be installed in control panels. Connect the main power supply to the power supply module in the control panel through a relay terminal block. Wiring and replacement of a power supply module must be performed by qualified maintenance personnel with knowledge of protection against electric shock. For wiring, refer to the MELSEC iQ-R Module Configuration Manual.
 - For Ethernet cables to be used in the system, select the ones that meet the specifications in the user's manual for the module used. If not, normal data transmission is not guaranteed.
-

[Startup and Maintenance Precautions]

WARNING

- Do not touch any terminal while power is on. Doing so will cause electric shock or malfunction.
 - Correctly connect the battery connector. Do not charge, disassemble, heat, short-circuit, solder, or throw the battery into the fire. Also, do not expose it to liquid or strong shock. Doing so will cause the battery to produce heat, explode, ignite, or leak, resulting in injury and fire.
 - Shut off the external power supply (all phases) used in the system before cleaning the module or retightening the terminal screws, connector screws, or module fixing screws. Failure to do so may result in electric shock.
-

[Startup and Maintenance Precautions]

CAUTION

- When connecting an external device with a CPU module or intelligent function module to modify data of a running programmable controller, configure an interlock circuit in the program to ensure that the entire system will always operate safely. For other forms of control (such as program modification, parameter change, forced output, or operating status change) of a running programmable controller, read the relevant manuals carefully and ensure that the operation is safe before proceeding. Improper operation may damage machines or cause accidents.
 - Especially, when a remote programmable controller is controlled by an external device, immediate action cannot be taken if a problem occurs in the programmable controller due to a communication failure. To prevent this, configure an interlock circuit in the program, and determine corrective actions to be taken between the external device and CPU module in case of a communication failure.
 - Do not disassemble or modify the modules. Doing so may cause failure, malfunction, injury, or a fire.
 - Use any radio communication device such as a cellular phone or PHS (Personal Handy-phone System) more than 25cm away in all directions from the programmable controller. Failure to do so may cause malfunction.
 - Shut off the external power supply (all phases) used in the system before mounting or removing the module. Failure to do so may cause the module to fail or malfunction.
 - Tighten the screws within the specified torque range. Undertightening can cause drop of the component or wire, short circuit, or malfunction. Overtightening can damage the screw and/or module, resulting in drop, short circuit, or malfunction.
 - After the first use of the product, do not perform each of the following operations more than 50 times (IEC 61131-2/JIS B 3502 compliant). Exceeding the limit may cause malfunction.
 - Mounting/removing the module to/from the base unit
 - Inserting/removing the extended SRAM cassette or battery-less option cassette to/from the CPU module
 - Mounting/removing the terminal block to/from the module
 - Connecting/disconnecting the extension cable to/from the base unit
 - After the first use of the product, do not insert/remove the SD memory card to/from the CPU module more than 500 times. Exceeding the limit may cause malfunction.
 - Do not touch the metal terminals on the back side of the SD memory card. Doing so may cause malfunction or failure of the module.
 - Do not touch the integrated circuits on the circuit board of an extended SRAM cassette or a battery-less option cassette. Doing so may cause malfunction or failure of the module.
 - Do not drop or apply shock to the battery to be installed in the module. Doing so may damage the battery, causing the battery fluid to leak inside the battery. If the battery is dropped or any shock is applied to it, dispose of it without using.
 - Startup and maintenance of a control panel must be performed by qualified maintenance personnel with knowledge of protection against electric shock. Lock the control panel so that only qualified maintenance personnel can operate it.
 - Before handling the module, touch a conducting object such as a grounded metal to discharge the static electricity from the human body. Wearing a grounded antistatic wrist strap is recommended. Failure to discharge the static electricity may cause the module to fail or malfunction.
-

[Startup and Maintenance Precautions]

CAUTION

- After unpacking, eliminate static electricity from the module to prevent electrostatic discharge from affecting the module. If an electrostatically charged module comes in contact with a grounded metal object, a sudden electrostatic discharge of the module may cause failure.
For details on how to eliminate static electricity from the module, refer to the following.
Antistatic Precautions Before Using MELSEC iQ-R Series Products (FA-A-0368)
 - Use a clean and dry cloth to wipe off dirt on the module.
-

[Operating Precautions]

CAUTION

- When changing data and operating status, and modifying program of the running programmable controller from an external device such as a personal computer connected to an intelligent function module, read relevant manuals carefully and ensure the safety before operation. Incorrect change or modification may cause system malfunction, damage to the machines, or accidents.
 - Do not power off the programmable controller or reset the CPU module while the setting values in the buffer memory are being written to the flash ROM in the module. Doing so will make the data in the flash ROM and SD memory card undefined. The values need to be set in the buffer memory and written to the flash ROM and SD memory card again. Doing so can cause malfunction or failure of the module.
-

[Disposal Precautions]

CAUTION

- When disposing of this product, treat it as industrial waste.
 - When disposing of batteries, separate them from other wastes according to the local regulations. For details on battery regulations in EU member states, refer to the MELSEC iQ-R Module Configuration Manual.
-

[Transportation Precautions]

CAUTION

- When transporting lithium batteries, follow the transportation regulations. For details on the regulated models, refer to the MELSEC iQ-R Module Configuration Manual.
 - The halogens (such as fluorine, chlorine, bromine, and iodine), which are contained in a fumigant used for disinfection and pest control of wood packaging materials, may cause failure of the product. Prevent the entry of fumigant residues into the product or consider other methods (such as heat treatment) instead of fumigation. The disinfection and pest control measures must be applied to unprocessed raw wood.
-

CONDITIONS OF USE FOR THE PRODUCT

- (1) MELSEC programmable controller ("the PRODUCT") shall be used in conditions;
- i) where any problem, fault or failure occurring in the PRODUCT, if any, shall not lead to any major or serious accident; and
 - ii) where the backup and fail-safe function are systematically or automatically provided outside of the PRODUCT for the case of any problem, fault or failure occurring in the PRODUCT.
- (2) The PRODUCT has been designed and manufactured for the purpose of being used in general industries. MITSUBISHI ELECTRIC SHALL HAVE NO RESPONSIBILITY OR LIABILITY (INCLUDING, BUT NOT LIMITED TO ANY AND ALL RESPONSIBILITY OR LIABILITY BASED ON CONTRACT, WARRANTY, TORT, PRODUCT LIABILITY) FOR ANY INJURY OR DEATH TO PERSONS OR LOSS OR DAMAGE TO PROPERTY CAUSED BY the PRODUCT THAT ARE OPERATED OR USED IN APPLICATION NOT INTENDED OR EXCLUDED BY INSTRUCTIONS, PRECAUTIONS, OR WARNING CONTAINED IN MITSUBISHI ELECTRIC USER'S, INSTRUCTION AND/OR SAFETY MANUALS, TECHNICAL BULLETINS AND GUIDELINES FOR the PRODUCT.
- ("Prohibited Application")
- Prohibited Applications include, but not limited to, the use of the PRODUCT in;
- Nuclear Power Plants and any other power plants operated by Power companies, and/or any other cases in which the public could be affected if any problem or fault occurs in the PRODUCT.
 - Railway companies or Public service purposes, and/or any other cases in which establishment of a special quality assurance system is required by the Purchaser or End User.
 - Aircraft or Aerospace, Medical applications, Train equipment, transport equipment such as Elevator and Escalator, Incineration and Fuel devices, Vehicles, Manned transportation, Equipment for Recreation and Amusement, and Safety devices, handling of Nuclear or Hazardous Materials or Chemicals, Mining and Drilling, and/or other applications where there is a significant risk of injury to the public or property.
- Notwithstanding the above restrictions, Mitsubishi Electric may in its sole discretion, authorize use of the PRODUCT in one or more of the Prohibited Applications, provided that the usage of the PRODUCT is limited only for the specific applications agreed to by Mitsubishi Electric and provided further that no special quality assurance or fail-safe, redundant or other safety features which exceed the general specifications of the PRODUCTS are required. For details, please contact the Mitsubishi Electric representative in your region.
- (3) Mitsubishi Electric shall have no responsibility or liability for any problems involving programmable controller trouble and system trouble caused by DoS attacks, unauthorized access, computer viruses, and other cyberattacks.

INTRODUCTION

Thank you for purchasing the Mitsubishi Electric MELSEC iQ-R series programmable controllers.

This manual describes the performance specifications, procedure before operation, wiring, and operation examples to use the module listed below.

Before using this product, please read this manual and the relevant manuals carefully and develop familiarity with the functions and performance of the MELSEC iQ-R series programmable controller to handle the product correctly.

When applying the program examples provided in this manual to an actual system, ensure the applicability and confirm that it will not cause system control problems.

Note that the menu names and operating procedures may differ depending on an operating system in use and its version.

When reading this manual, replace the names and procedures with the applicable ones as necessary.

Please make sure that the end users read this manual.

Point

The program examples shown in this manual are the examples in which an MES interface module (RD81MES96N or RD81MES96) is assigned to the input/output No. X/Y0 to X/Y1F unless otherwise specified. To use the program examples shown in this manual, the input/output number assignment is required. For details on the assignment of input/output number, refer to the following:

 MELSEC iQ-R Module Configuration Manual

Relevant product



RD81MES96N

RD81MES96

COMPLIANCE WITH EMC AND LOW VOLTAGE DIRECTIVES

Method of ensuring compliance



To ensure that Mitsubishi Electric programmable controllers maintain the EMC and Low Voltage Directives or other regulations when incorporated into other machinery or equipment, certain measures may be necessary. Please refer to one of the following manuals.

-  MELSEC iQ-R Module Configuration Manual (SH-081262ENG)
-  Safety Guidelines (IB-0800525)

Certification marks on the side of the programmable controller indicate compliance with the relevant regulations.

Additional measures

To ensure that this product maintains the EMC and Low Voltage Directives or other regulations, please refer to the following.

-  MELSEC iQ-R Module Configuration Manual (SH-081262ENG)
-  Safety Guidelines (IB-0800525)

CONTENTS

SAFETY PRECAUTIONS	1
CONDITIONS OF USE FOR THE PRODUCT	9
INTRODUCTION	10
COMPLIANCE WITH EMC AND LOW VOLTAGE DIRECTIVES	10
RELEVANT MANUALS	13
TERMS	14
GENERIC TERMS AND ABBREVIATIONS	14
DISCONTINUED MODEL	14
CHAPTER 1 PART NAMES	15
CHAPTER 2 SPECIFICATIONS	18
2.1 Performance Specifications	18
Hardware specifications	18
Software specifications	19
2.2 Access Specifications for a CPU Module	24
Accessible CPU modules	24
Accessible routes	26
Accessible devices	31
Bit specification/digit specification of devices	35
Access units	37
2.3 Access Specifications for a Database	39
Accessible databases and supported software	39
Access type	42
2.4 Data Specifications	44
Data category	44
Data type	46
Device tag component or variable	49
Constant	50
Macro	51
CHAPTER 3 FUNCTION LISTS	52
3.1 Function Overview	52
3.2 MES Interface Module	53
3.3 MES Interface Function Configuration Tool	54
3.4 DB Connection Service	55
3.5 DB Connection Service Setting Tool	55
3.6 Project File Conversion Tool	55
CHAPTER 4 PROCEDURE BEFORE OPERATION	56
4.1 Starting a Server	56
DB Connection Service/DB Connection Service Setting Tool	57
4.2 Starting an MES Interface Module and Configuration Personal Computer	59
MES Interface Function Configuration Tool	61
Parameter setting	67
4.3 SD Memory Card	69
Insertion/removal method of an SD memory card	69
Considerations for using an SD memory card	70

CHAPTER 5	SYSTEM CONFIGURATION	71
5.1	System Configuration	71
	Overall system configuration	71
	Software configuration of MX MESInterface-R	72
	System configurations for installation	72
	System configurations for the initial setting	73
5.2	Connectable Devices	75
5.3	Operating Environment	76
	Configuration personal computer	76
	Server (Database server/Application server)	76
	Port number	77
5.4	Considerations for System Configuration	78
5.5	Supported Software Packages	80
CHAPTER 6	WIRING	81
6.1	Wiring of an Ethernet Cable	81
6.2	Wiring Precautions	82
CHAPTER 7	INSTALLATION AND UNINSTALLATION	83
7.1	Installation Procedure	84
	Environment after installation	85
7.2	Uninstallation Procedure	85
	Environment after uninstallation	85
CHAPTER 8	OPERATION EXAMPLE	86
8.1	Overview	86
8.2	Setup	87
	System configuration	87
	Device setup	88
8.3	Creating a Database Table	90
	Database table creation procedure	90
8.4	ODBC Setting	93
	ODBC setting procedure	93
8.5	MES Interface Function Setting	94
	Parameter setting procedure	94
	Operation check	113
APPENDIX		115
Appendix 1	External Dimensions	115
Appendix 2	ODBC Setting	116
INDEX		126
REVISIONS	128
WARRANTY	129
TRADEMARKS	130
COPYRIGHTS	130

RELEVANT MANUALS

Manual name [manual number]	Description	Available form
MELSEC iQ-R MES Interface Module User's Manual (Startup) [SH-081422ENG] (this manual)	Specifications, procedure before operation, wiring, and operation examples of an MES interface module	Print book e-Manual PDF
MELSEC iQ-R MES Interface Module User's Manual (Application) [SH-081423ENG]	Functions, MES Interface Function Configuration Tool, DB Connection Service, parameter setting, troubleshooting, input/output, and buffer memory of an MES interface module	Print book e-Manual PDF
GX Works3 Operating Manual [SH-081215ENG]	System configurations, parameter settings, and operation methods for the online function in GX Works3	e-Manual PDF
MELSEC iQ-R Module Configuration Manual [SH-081262ENG]	The combination of the MELSEC iQ-R series modules, common information on the installation/wiring in the system, and specifications of the power supply module, base unit, SD memory card, and battery	Print book e-Manual PDF

This manual does not include detailed information on the following:

- General specifications
- Applicable combinations of CPU modules and the other modules, and the number of mountable modules
- Applicable combinations of remote head modules and the other modules, and the number of mountable modules
- Installation

For details, refer to the following:

 MELSEC iQ-R Module Configuration Manual

Point

e-Manual refers to the Mitsubishi Electric FA electronic book manuals that can be browsed using a dedicated tool.

e-Manual has the following features:

- Required information can be cross-searched in multiple manuals.
- Other manuals can be accessed from the links in the manual.
- Hardware specifications of each part can be found from the product figures.
- Pages that users often browse can be bookmarked.
- Sample programs can be copied to an engineering tool.

TERMS

Unless otherwise specified, this manual uses the following terms.

Term	Description
Data source	Connection information which is necessary for accessing data using ODBC. With Windows, a data source name is assigned to connection information for management. The database is accessed via ODBC by specifying the data source name with the information linkage function.
Device tag	A data table that contains a set of information (component) required to access device data in each CPU module on a network
Device tag component	A component (device data) which configures a device tag. Data that contains communication routes, data types, devices, etc. required to access device data in each CPU module on a network.
Engineering tool	A tool used for setting up programmable controllers, programming, debugging, and maintenance. For the supported tools, refer to the following:  MELSEC iQ-R Module Configuration Manual
Handshake	For highly reliable processing, devices in a CPU module are used for managing processing between the CPU module and MES interface module.

For definitions of terms for safety CPUs, refer to the following:

 MELSEC iQ-R CPU Module User's Manual (Application)

GENERIC TERMS AND ABBREVIATIONS

Unless otherwise specified, this manual uses the following generic terms and abbreviations.

Generic term/abbreviation	Description
Application server	A computer with a program which runs upon request from an MES interface module
Configuration personal computer	A personal computer to set various settings for an MES interface module. This computer can be shared with a server.
Database server	A computer with a relational database which links information with an MES interface module
FX5CPU	A MELSEC iQ-F series CPU module
FXCPU	A MELSEC-F series CPU module
LCPU	A MELSEC-L series CPU module
MES	Manufacturing Execution Systems. A system for controlling and monitoring the plant status in real time to optimize production activities. The system enables to speed up responses to changes of a production plan and situation that lead to efficient production processes and optimization of production activities.
MES Interface Function Configuration Tool	MELSEC iQ-R series MES Interface Function Configuration Tool
MES interface module	A MELSEC iQ-R MES interface module
QCPU (Q mode)	A MELSEC-Q series CPU module and a MELSEC-Q series C Controller module
RCPU	A MELSEC iQ-R series CPU module and a MELSEC iQ-R series C Controller module
Server	A database server and an application server

DISCONTINUED MODEL

The following model is described in this manual, but has no longer been produced.

For the onerous repair term after discontinuation of production, refer to "WARRANTY" in this manual.

Model name	Production discontinuation
RD81MES96	May 2020

1 PART NAMES

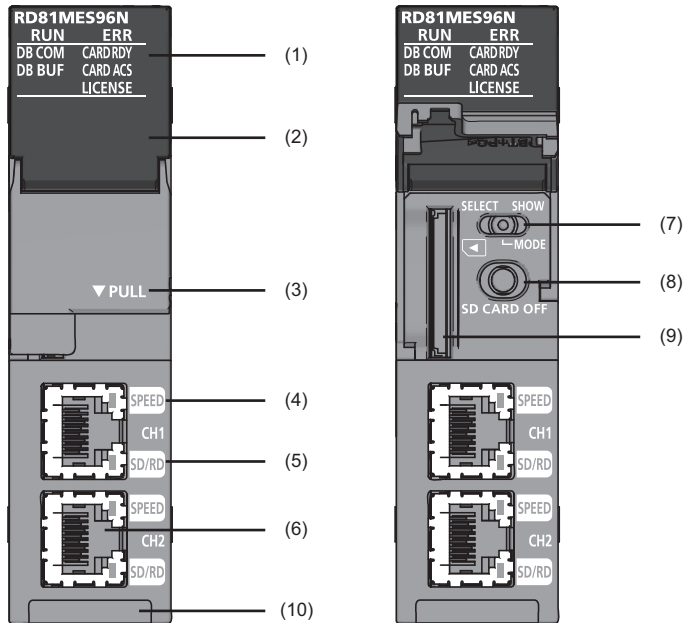

This chapter shows the part names of an MES interface module.

RD81MES96N

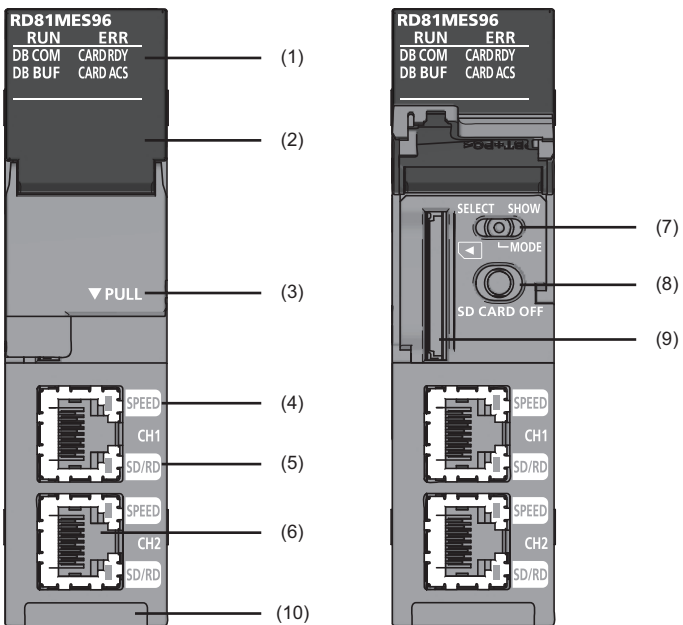

RD81MES96



No.	Name	Description	
		RD81MES96N	RD81MES96
(1)	RUN LED	<p>Indicates the operating status.</p> <ul style="list-style-type: none"> • ON: In operation • Flashing: Checking module or selecting the module for online module change (Flashes for 10 seconds when checking modules by clicking the [Module Confirmation] button in the "MES Interface Module Search" screen of MES Interface Function Configuration Tool.) • OFF: Watchdog timer error (hardware failure), module replacement allowed in the process of the online module change 	
	ERR LED	<p>Indicates the error status of an MES interface module.</p> <ul style="list-style-type: none"> • ON: Module continuation error or watchdog timer error (hardware failure) • Flashing: Module stop error • OFF: In normal status 	
	DB COM LED	<p>Indicates the connection status with a database.</p> <ul style="list-style-type: none"> • ON: Database normal connection status (Communication is normally being established with all databases excluding unconnected databases.) • Flashing: Database communication error status (A communication error is detected in communication with some or all databases.) • OFF: Database not connected status (Communication has never been established with any database after powering ON, resetting a CPU module, or updating the setting.) 	
	DB BUF LED	<p>Indicates the execution status of DB buffering.</p> <ul style="list-style-type: none"> • ON: Being executed (Turns ON when the DB buffering setting is enabled and during buffering, or when either DB buffering setting 1 or 2 is buffering.) • Flashing: DB buffer full (Flashes when the DB buffering setting is enabled and the buffer is full (no capacity), or when either DB buffering setting 1 or 2 is buffer full.) • OFF: Not executed (The DB buffering setting is disabled, or the DB buffering setting is enabled and the buffer is empty.) 	
	CARD RDY LED	<p>Indicates the accessibility of an SD memory card.</p> <ul style="list-style-type: none"> • ON: Accessible • Flashing: Being prepared or formatted • OFF: Inaccessible (removable) <p>For the considerations for using an SD memory card, refer to the following:  Page 70 Considerations for using an SD memory card</p>	
	CARD ACS LED	<p>Indicates the access status of an SD memory card.</p> <ul style="list-style-type: none"> • ON: Being accessed • OFF: Not accessed 	
LICENSE LED	<p>Indicates the certification status of a license when using an option function that requires license certification.</p> <ul style="list-style-type: none"> • ON: Succeeded • Flashing: Temporarily authenticated • OFF: No licenses 	—	
(2)	Dot matrix LED	<p>Displays the contents of each display mode or the results of the self-diagnostic test.</p> <p>The following contents are displayed in each display mode.</p> <ul style="list-style-type: none"> • User specification character: Scrolled and displayed by the width of approximately 3 characters (3.3 characters). • Error code: Displayed in four digits in hexadecimal (When multiple errors occur, only the latest error code is displayed.) • IP address: Scrolled and displayed by four characters in decimal. • DB buffer use rate: Displayed in three digits in decimal + %. <p>For the display when performing the self-diagnostic test, refer to the following:  MELSEC iQ-R MES Interface Module User's Manual (Application)</p>	
(3)	Slot cover	<p>A cover of the SD memory card slot and the switches.</p> <p>Open this cover to insert/remove an SD memory card or to operate the switches.</p> <p>Close the cover unless inserting/removing an SD memory card or operating the switches to prevent foreign material intrusion such as dust.</p>	
(4)	SPEED LED(CH1, CH2)	<p>Indicates the communication speed and the link status for Ethernet.</p> <ul style="list-style-type: none"> • ON (orange): Linking-up (1 Gbps) • ON (green): Linking-up (100 Mbps) • OFF: Linking-down or linking-up (10 Mbps) 	
(5)	SD/RD LED(CH1, CH2)	<p>Indicates the data sending/receiving status in Ethernet.</p> <ul style="list-style-type: none"> • ON: Being sent/received • OFF: Not being sent/received 	

No.	Name	Description	
		RD81MES96N	RD81MES96
(6)	Ethernet port (CH1, CH2) ^{*1}	A port for connecting to an Ethernet device (IEEE802.3, 1000BASE-T/100BASE-TX/10BASE-T standards-compliant)	
(7)	Dot matrix LED display mode switch (SELECT/MODE/SHOW switch)	A switch for switching the display of the dot matrix LED. <ul style="list-style-type: none"> • MODE: To display the display mode name that is currently selected. • SELECT: To select (switch) the display mode. Order: USR → ENo. → IP1 → IP2 → BUF1 → BUF2 → USR • SHOW: To display the contents of a selected display mode. (☞ Page 17 Dot matrix LED display) Put this display mode switch to 'SHOW' during operation, and move it only when switching the display mode.	
(8)	SD memory card lock switch (SD CARD OFF button)	A switch for disabling access to an SD memory card to remove it. Removing an SD memory card is prohibited while the CARD RDY LED is ON or flashing. For the procedures for inserting and removing an SD memory card, refer to the following: ☞ Page 69 Insertion/removal method of an SD memory card	
(9)	SD memory card slot	A slot for inserting an SD memory card. (SD, SDHC standards-compliant: 2 GB (SD) to 16 GB (SDHC))	
(10)	Product information marking	Displays the product information (16 digits) of a module.	

*1 Only CH1 can be connected to MES Interface Function Configuration Tool with direct connection.

Dot matrix LED display

The following table shows the contents of the display mode displayed on the dot matrix LED when switching the display mode to 'SHOW.'

Display mode name	Description
USR	Characters specified in an action are displayed. Substitute characters to display on the S_MATRIXLED_DISP (dot matrix LED display) of the system variable in the action. For details on the action, refer to the following: ☞ MELSEC iQ-R MES Interface Module User's Manual (Application)
ENo.	An error code is displayed.
IP1	The IP address of Ethernet port CH1 is displayed.
IP2	The IP address of Ethernet port CH2 is displayed.
BUF1	The use rate of DB buffer 1 is displayed.
BUF2	The use rate of DB buffer 2 is displayed.

Point

The following display switching of the dot matrix LED can be set in MES Interface Function Configuration Tool.

- Default display mode at power ON (Initial value: USR)
- The display mode is switched to ENo. (error code) forcibly when an error occurs.
- ENo. (error code) is highlighted.

2 SPECIFICATIONS

This chapter explains the specifications of an MES interface module.

2.1 Performance Specifications

This section shows the performance specifications of hardware (MES interface module) and software (MX MESInterface-R).

Hardware specifications

The following table shows the specifications of an MES interface module.

Item		Specification	
SD memory card slot	Interface	SD memory card/SDHC memory card (2 GB to 16 GB)	
	Power supply	+3.3 VDC, up to 200 mA	
Ethernet port	Number of channels	2	
	Interface ^{*1}	<ul style="list-style-type: none"> • 1000BASE-T • 100BASE-TX • 10BASE-T 	
	Data transmission speed	1000BASE-T	1 Gbps
		100BASE-TX	100 Mbps
		10BASE-T	10 Mbps
	Number of cascade connections ^{*2} (When using a repeater hub)	1000BASE-T	Consult the manufacturer of the repeater hub used.
		100BASE-TX	2 levels maximum
		10BASE-T	4 levels maximum
	Communication mode	Full-duplex/half-duplex	
	Transmission method	Base band	
Maximum segment length ^{*3}	100 m (length between a hub and a node)		
Applicable connector for external wiring	RJ45		
Supported function	<ul style="list-style-type: none"> • Auto-negotiation (automatic recognition of 1000BASE-T/100BASE-TX/10BASE-T) • Auto-MDI/MDI-X (automatic recognition of a straight/crossover cable) 		
Number of occupied I/O points	32 points/slot (I/O assignment: Intelligent function module 32 points)		
Clock	Acquired from a CPU module (CPU No.1 in a multiple CPU system).  Page 19 Basic operation specification		
5 VDC internal current consumption	1.25 A		
External dimensions	Height	106 mm	
	Width	27.8 mm	
	Depth	110 mm	
Weight	0.25 kg		

*1 1000BASE-T/100BASE-TX/10BASE-T, and full-duplex/half-duplex communication mode are identified by an MES interface module depending on the hub.

For connection with a hub not having the auto-negotiation function, set the setting on the hub side according to the communication mode.

*2 For a switching hub, consult the manufacturer of the hub used.

*3 For the maximum segment length (length between hubs), consult the manufacturer of the switching hub used.

Software specifications

The following table shows the specifications of MX MESInterface-R.

Item	Description	Reference
Basic operation specification	Specification for the operation (job), startup condition for the job (trigger condition), operation unit of a job (action), and network information.	Page 19 Basic operation specification
Device memory input/output specification	Specification for the accessible target device types and access units (device tags).	Page 20 Device memory input/output
DB input/output specification	Specification for the accessible databases, access units (access table/procedure, access field/procedure argument), and buffering of output data (DB buffering) at the time of disconnection.	Page 21 DB input/output
Variable input/output specification	Specification for freely definable user variables (local variables, global variables), system variables for browsing system information, and data types of variables.	Page 23 Variable input/output
Data operation and processing specification	Specification for the operation processing such as addition and subtraction.	Page 23 Data operation and processing
External communication client	Specification for the communication from an MES interface module to external devices.	Page 23 External communication client
Security	Specification for security.	Page 23 Security

Basic operation specification

Item		Specification	
		RD81MES96N	RD81MES96
Job (number of settings)	Maximum	64 jobs	
Action (number of settings)	Maximum	1920 actions	
	For one job	30 actions • Main processing: 20 actions* ¹ • Pre/post-processing: 10 actions	30 actions • Main processing: 20 actions • Pre/post-processing: 10 actions
Trigger condition	For one job	2 events/conditions	
	Configuration type	<ul style="list-style-type: none"> • Single event • Multiple events • Condition combination event • Precondition × Event • Single handshake • Multiple handshake 	<ul style="list-style-type: none"> • Single event • Multiple events • Condition combination event • Precondition × Event • Single handshake
	Event/condition type	<ul style="list-style-type: none"> • Condition (value monitoring) • Condition (period of time) • Event (value changed) • Event (fixed time) • Event (fixed cycle) (timer interval/time interval) • Event (module monitoring) (MES interface module/control CPU) 	
	Condition combination type	<ul style="list-style-type: none"> • OR combination • AND combination 	
	Trigger buffering count	192 times (A value is cleared due to power interruption/reset/setting update.)	
Time information handling (time information)* ²	Time	Acquired from a CPU module (CPU No.1 in a multiple CPU system).	
	Daylight saving time		
	Time zone		
Ethernet	Connection method	IPv4	
	Number of channels	2 channels (CH1/CH2) (Note that they cannot be connected to a same network, and no routing function between CH1 and CH2.)	
	Number of default gateways	1 (It can be registered only in CH1 or CH2.)	
MES Interface Function Configuration Tool	Number of tools that can be connected simultaneously	5 (Maximum number of connections to a single MES interface module)	

*1 Up to five actions can be set when using a DB communication action with "Multiple Insert" selected.

*2 When using the daylight saving time function of a CPU module for an RD81MES96, use an RD81MES96 with firmware version '03' or later. If using one with firmware version '02' or earlier, it may cause malfunction due to the time information difference with the CPU module.

For information on the firmware version of a CPU module, refer to the manual of a CPU module used.

Device memory input/output

Item		Specification	
		RD81MES96N	RD81MES96
Access target device	Maximum	64 devices	16 devices
	Access target device type	<ul style="list-style-type: none"> • RCPUCPU • QCPU (Q mode) • LCPUCPU • FX5CPU • FXCPU 	<ul style="list-style-type: none"> • RCPUCPU • QCPU (Q mode) • LCPUCPU
Device tag	Maximum	64 device tags	
	Access type	<ul style="list-style-type: none"> • General access • High-speed access (interval specification) • High-speed access (each scan) 	
	Shortest access interval	Each scan	
	Access interval (general access)	<ul style="list-style-type: none"> • 1 to 9 × 100 ms • 1 to 3600 s 	
	Access interval (high-speed access (interval specification))	<ul style="list-style-type: none"> • 1 to 9 ms • 1 to 9 × 10 ms • 1 to 9 × 100 ms • 1 to 60 s 	
	Access interval (high-speed access (each scan))	<ul style="list-style-type: none"> • Each scan 	
Device tag component	Maximum	65536 components/project (64 tags × 1024 components) ^{*1}	
	Maximum (for one device tag)	1024 components	
	Maximum (for one job)	20480 components ^{*2}	
Number of data points (Device tag component)	Maximum number of points (per project) ^{*3}	131072 points (total number without array tag setting) 2621440 points (total number with array tag setting)	
	Maximum number of points (for one device tag component) ^{*3}	40960 points (Multiple Select)	
Number of data points (Job) ^{*4}	Maximum number of points (per project) ^{*1*3}	131072 points (total number excluding the data assignment settings of the Multiple Select setting) 2949120 points (total number only for the data assignment settings of the Multiple Select)	
	Maximum number of points (for one job) ^{*1*3}	46080 points ^{*2} Total size of a character string type: 90000 characters/job (total of a device tag, variable, constant, and macro)	46080 points ^{*2} Total size of a character string type: 2048 characters/job (total of a device tag, variable, constant, and macro)
Access data	Data type	<ul style="list-style-type: none"> • Bit • Word [unsigned]/Bit string [16-bit] • Double word [unsigned]/Bit string [32-bit] • Word [signed] • Double word [signed] • 16bit BCD • 32bit BCD • Single-precision real number • Double-precision real number • Character string [Unicode®] • Character string [ASCII/SJIS] 	

*1 For high-speed access, the following points can be set:

RD81MES96N with firmware version '03' or later: 32768 points

RD81MES96N with firmware version '02' or earlier, or RD81MES96: 8192 points

*2 When the trigger buffering is enabled, the maximum is 8192 components (points).

*3 A digit-specified bit device (K5 to K8) and double-word device are counted as two points.

*4 Counted redundantly when using a device tag component in multiple jobs.

Not counted redundantly when using multiple device tag components in a job.

DB input/output

Item		Specification	
		RD81MES96N	RD81MES96
Access target server	Database type	<ul style="list-style-type: none"> • Oracle • Microsoft SQL Server • Microsoft Access • MySQL • PostgreSQL • MariaDB 	<ul style="list-style-type: none"> • Oracle • Microsoft SQL Server • Microsoft Access • MySQL • PostgreSQL
	Access type	<ul style="list-style-type: none"> • Connection via service • Direct DB connection 	Connection via service
	Maximum number of settings	16 servers	
Access table/ procedure	DB communication type	<ul style="list-style-type: none"> • Select • Insert • Update (Data can be inserted if there is no data to be updated.) • Delete • Multiple Select • Multiple Insert • Stored Procedure 	<ul style="list-style-type: none"> • Select • Insert • Update (Data can be inserted if there is no data to be updated.) • Delete • Multiple Select • Stored Procedure
	Maximum number of settings (for one project)	64 tables and views/procedures	
	Maximum number of settings (for one job)	20 tables and views/procedures	
	Maximum number of settings (for one action)	1 table and view/procedure	
	Maximum number of settings (per access table)	Total length of DB field name: 16384 characters	
Access field/ procedure argument	Maximum number of settings (per project) ^{*1}	65536 settings	
	Maximum number of settings (for one job) ^{*1}	<ul style="list-style-type: none"> • When the trigger buffering is disabled: 20480 settings • When the trigger buffering is enabled: 8192 settings <p>Note that the following limits apply:</p> <ul style="list-style-type: none"> • Date and time type access field/procedure argument: Up to 50 settings • Total number of characters of a character string type: Up to 90000 characters (total number of characters of a character string type for a device tag, variable, and constant) 	<ul style="list-style-type: none"> • When the trigger buffering is disabled: 20480 settings • When the trigger buffering is enabled: 8192 settings <p>Note that the following limits apply:</p> <ul style="list-style-type: none"> • Date and time type access field/procedure argument: Up to 50 settings • Total number of characters of a character string type: Up to 2048 characters (total number of characters of a character string type for a device tag, variable, and constant)
	Maximum number of access field settings (for one table or one view) ^{*2}	1024 fields	
	Maximum number of access procedure argument settings (for one procedure) ^{*2}	256 settings	
	Data type	<ul style="list-style-type: none"> • Integer • Real number^{*3} • Real number [floating point]^{*4} • Real number [fixed point]^{*4} • Character string [Unicode]^{*5} • Character string [Unicode(NCHAR)]^{*6} • Character string [Unicode(CHAR)]^{*6} • Date and time 	<ul style="list-style-type: none"> • Integer • Real number^{*3} • Real number [floating point]^{*4} • Character string [Unicode]^{*5} • Character string [Unicode(NCHAR)]^{*6} • Character string [Unicode(CHAR)]^{*6} • Date and time
	Maximum number of settings (for one action)	Total number of characters of a character string type (total number of characters of a character string type for a device tag, variable, and constant) It differs for each DB communication type. <ul style="list-style-type: none"> • Select: Up to 90000 characters • Insert: Up to 10000 characters • Update: Up to 10000 characters • Delete: Up to 10000 characters • Multiple Select: Up to 90000 characters • Multiple Insert: Up to 20000 characters 	No limit

Item		Specification	
		RD81MES96N	RD81MES96
DB buffer	Number of settings	2 settings	
	Maximum capacity	2048 MB (up to 1024 MB for each buffer)	

- *1 Maximum number of settings in the job setting
- *2 Maximum number of settings in the access table/procedure setting
- *3 The data type when setting a real number for an access procedure argument
- *4 The data type when setting a real number for an access field
- *5 The data type when setting a character string for an access procedure argument
- *6 The data type when setting a character string for an access field

Variable input/output

Item		Specification
Variable type	Type	<ul style="list-style-type: none"> Local variable (retains data only at a job execution and can be used in a same job.) Global variable (retains data until the power supply is turned OFF or a CPU module is reset, and can be used between different jobs.) System variable
Data type	Type	<ul style="list-style-type: none"> Bit Word [unsigned]/Bit string [16-bit] Double word [unsigned]/Bit string [32-bit] Word [signed] Double word [signed] Single-precision real number Double-precision real number Character string [Unicode]
Capacity	Maximum number of settings (per project)	<ul style="list-style-type: none"> Local variable: 1024 words (2048 bytes)^{*1} Global variable: 4096 words (8192 bytes)^{*1} System variable: A defined variable is used.
	Maximum number of settings (for one job) ^{*2}	<ul style="list-style-type: none"> Local variable: 1024 words (2048 bytes) Global variable: 512 words (1024 bytes)

*1 The number of settings depends on the data size. However, 2 bytes are used even when the data type is bit.

*2 The total number of characters of a character string type for one job is up to 2048 characters.

Data operation and processing

Item		Specification
Operator	Substitution	—
	Arithmetic operation	5 types
	Character string operation	8 types
	Bit operation	5 types
	Type conversion	4 types
Maximum number of operation settings	Maximum	38400 settings (600 settings × 64 jobs)
	For one job	600 settings (20 settings × 30 actions)
	For one action	20 settings

External communication client

Item		Specification
External communication client (program execution)	Number of characters for execution command	Up to 127 characters
	Function	<ul style="list-style-type: none"> Return value evaluation Execution completion standby

Security

Item		Specification
Security (user authentication)	Number of accounts	16 accounts

2.2 Access Specifications for a CPU Module

This section shows the access specifications for a CPU module.

Accessible CPU modules

RD81MES96N

Series		Model name	Access type	
RCPU ^{*1}	Programmable controller CPU	RnCPU	<ul style="list-style-type: none"> • General access • High-speed access (interval specification) • High-speed access (each scan) 	
		RnENCPU		
	Process CPU (process mode) ^{*2}		R08PCPU, R16PCPU, R32PCPU, R120PCPU	<ul style="list-style-type: none"> • General access
	Safety CPU		R08SFPCPU, R16SFPCPU, R32SFPCPU, R120SFPCPU	
	C Controller module ^{*3}		R12CCPU-V	
QCPU (Q mode)	Programmable controller CPU		<ul style="list-style-type: none"> • General access 	
	Process CPU			Q02PHCPU, Q04UDPVCPU, Q06PHCPU, Q06UDPVCPU, Q12PHCPU, Q13UDPVCPU, Q25PHCPU, Q26UDPVCPU
	C Controller module ^{*3}			Q12DCCPU-V ^{*4} , Q24DHCCPU-V, Q24DHCCPU-LS, Q24DHCCPU-VG, Q26DHCCPU-LS
LCPU	Programmable controller CPU		L02SCPU, L02SCPU-P, L02CPU, L02CPU-P, L06CPU, L06CPU-P, L26CPU, L26CPU-P, L26CPU-BT, L26CPU-PBT	
FX5CPU			FX5U-32MR/ES, FX5U-32MT/ES, FX5U-32MT/ESS, FX5U-64MR/ES, FX5U-64MT/ES, FX5U-64MT/ESS, FX5U-80MR/ES, FX5U-80MT/ES, FX5U-80MT/ESS, FX5U-32MR/DS, FX5U-32MT/DS, FX5U-32MT/DSS, FX5U-64MR/DS, FX5U-64MT/DS, FX5U-64MT/DSS, FX5U-80MR/DS, FX5U-80MT/DS, FX5U-80MT/DSS, FX5UC-32MT/D, FX5UC-32MT/DSS, FX5UC-32MT/DSS-TS, FX5UC-32MT/DSS-TS, FX5UC-64MT/D, FX5UC-64MT/DSS, FX5UC-96MT/D, FX5UC-96MT/DSS	
FX3CPU			FX3U-16MR/ES, FX3U-16MT/ES, FX3U-16MT/ESS, FX3U-32MR/ES, FX3U-32MT/ES, FX3U-32MT/ESS, FX3U-32MS/ES, FX3U-48MR/ES, FX3U-48MT/ES, FX3U-48MT/ESS, FX3U-64MR/ES, FX3U-64MT/ES, FX3U-64MT/ESS, FX3U-64MS/ES, FX3U-80MR/ES, FX3U-80MT/ES, FX3U-80MT/ESS, FX3U-128MR/ES, FX3U-128MT/ES, FX3U-128MT/ESS, FX3U-16MR/DS, FX3U-16MT/DS, FX3U-16MT/DSS, FX3U-32MR/DS, FX3U-32MT/DS, FX3U-32MT/DSS, FX3U-48MR/DS, FX3U-48MT/DS, FX3U-48MT/DSS, FX3U-64MR/DS, FX3U-64MT/DS, FX3U-64MT/DSS, FX3U-80MR/DS, FX3U-80MT/DS, FX3U-80MT/DSS, FX3U-32MR/UA1, FX3U-64MR/UA1, FX3UC-16MT/D, FX3UC-16MT/DSS, FX3UC-32MT/D, FX3UC-32MT/DSS, FX3UC-64MT/D, FX3UC-64MT/DSS, FX3UC-96MT/D, FX3UC-96MT/DSS, FX3UC-32MT-LT, FX3UC-32MT-LT-2, FX3UC-16MR/D-T, FX3UC-16MR/DS-T, FX3G-14MR/ES, FX3G-14MT/ES, FX3G-14MT/ESS, FX3G-24MR/ES, FX3G-24MT/ES, FX3G-24MT/ESS, FX3G-40MR/ES, FX3G-40MT/ES, FX3G-40MT/ESS, FX3G-60MR/ES, FX3G-60MT/ES, FX3G-60MT/ESS, FX3G-14MR/DS, FX3G-14MT/DS, FX3G-14MT/DSS, FX3G-24MR/DS, FX3G-24MT/DS, FX3G-24MT/DSS, FX3G-40MR/DS, FX3G-40MT/DS, FX3G-40MT/DSS, FX3G-60MR/DS, FX3G-60MT/DS, FX3G-60MT/DSS, FX3GC-32MT/D, FX3GC-32MT/DSS	

Series	Model name	Access type
FXCPU	FX3S-10MR/ES, FX3S-10MT/ES, FX3S-10MT/ESS, FX3S-14MR/ES, FX3S-14MT/ES, FX3S-14MT/ESS, FX3S-20MR/ES, FX3S-20MT/ES, FX3S-20MT/ESS, FX3S-30MR/ES, FX3S-30MT/ES, FX3S-30MT/ESS, FX3S-30MR/ES-2AD, FX3S-30MT/ES-2AD, FX3S-30MT/ESS-2AD, FX3S-10MR/DS, FX3S-10MT/DS, FX3S-10MT/DSS, FX3S-14MR/DS, FX3S-14MT/DS, FX3S-14MT/DSS, FX3S-20MR/DS, FX3S-20MT/DS, FX3S-20MT/DSS, FX3S-30MR/DS, FX3S-30MT/DS, FX3S-30MT/DSS	General access

- *1 When using high-speed access, use a CPU module supporting the sequence scan synchronization sampling function.
For a CPU module supporting the sequence scan synchronization sampling function, refer to the manual for the CPU module.
- *2 Process CPUs (redundant mode) are not supported.
- *3 Cannot be used as a relay station.
- *4 Only a module with a serial number of which the first five digits are 12042 or higher can be accessed.

Point

When using a multiple CPU system, refer to the following:

 MELSEC iQ-R Module Configuration Manual

RD81MES96

Series	Model name	Access type	
RCPU* ¹	Programmable controller CPU	<ul style="list-style-type: none"> General access High-speed access (interval specification) High-speed access (each scan) 	
	RnCPU		R00CPU* ² , R01CPU* ² , R02CPU* ² , R04CPU, R08CPU, R16CPU, R32CPU, R120CPU
		RnENCPU* ³	R04ENCPU, R08ENCPU, R16ENCPU, R32ENCPU, R120ENCPU
	Process CPU (process mode)* ^{3,4}	R08PCPU, R16PCPU, R32PCPU, R120PCPU	<ul style="list-style-type: none"> General access
	Safety CPU* ⁵	R08SFCPU, R16SFCPU, R32SFCPU, R120SFCPU	
C Controller module* ^{3,6}	R12CCPU-V		
QCPU (Q mode)* ³	Programmable controller CPU	Q00JCPU, Q00UJCPU, Q00CPU, Q00UCPU, Q01CPU, Q01UCPU, Q02CPU, Q02HCPU, Q02UCPU, Q03UDCPU, Q03UDECPU, Q03UDVCPU, Q04UDHCPU, Q04UDEHCPU, Q04UDVCPU, Q06HCPU, Q06UDHCPU, Q06UDEHCPU, Q06UDVCPU, Q10UDHCPU, Q10UDEHCPU, Q12HCPU, Q13UDHCPU, Q13UDEHCPU, Q13UDVCPU, Q20UDHCPU, Q20UDEHCPU, Q25HCPU, Q26UDHCPU, Q26UDEHCPU, Q26UDVCPU, Q50UDEHCPU, Q100UDEHCPU	
	Process CPU	Q02PHCPU, Q04UDPVCPU, Q06PHCPU, Q06UDPVCPU, Q12PHCPU, Q13UDPVCPU, Q25PHCPU, Q26UDPVCPU	
	C Controller module* ⁶	Q12DCCPU-V* ⁷ , Q24DHCCPU-V, Q24DHCCPU-LS, Q24DHCCPU-VG, and Q26DHCCPU-LS* ⁵	
LCPU* ³	Programmable controller CPU	L02SCPU, L02SCPU-P, L02CPU, L02CPU-P, L06CPU, L06CPU-P, L26CPU, L26CPU-P, L26CPU-BT, L26CPU-PBT	

- *1 When using high-speed access, use a CPU module supporting the sequence scan synchronization sampling function and an MES interface module with firmware version '03' or later.
For a CPU module supporting the sequence scan synchronization sampling function, refer to the manual for the CPU module.
- *2 Use an MES interface module with firmware version '07' or later.
- *3 Use an MES interface module with firmware version '03' or later.
- *4 Process CPUs (redundant mode) are not supported.
- *5 Use an MES interface module with firmware version '05' or later.
- *6 Cannot be used as a relay station.
- *7 Only a module with a serial number of which the first five digits are 12042 or higher can be accessed.

Point

When using a multiple CPU system, refer to the following:

 MELSEC iQ-R Module Configuration Manual

Accessible routes

The following figure shows accessible routes from an MES interface module.

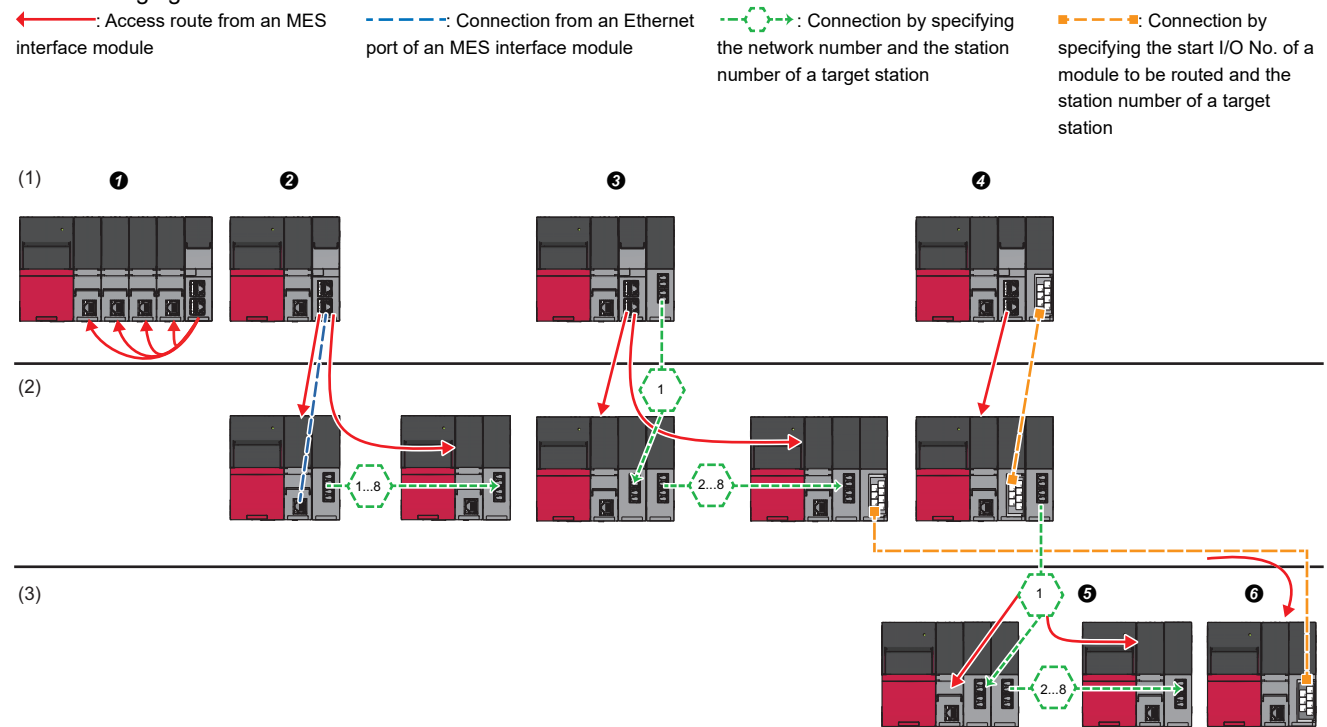

Accessible route		Reference
(1)	Own station (control CPU, another CPU in a multiple CPU system)	<p>① Indicates the own station (control CPU, another CPU in a multiple CPU system)</p> <p>Page 27 Own station (control CPU, another CPU in a multiple CPU system)</p>
(2)	Another station via a single network	<p>② Access via an Ethernet port of an MES interface module</p> <p>Page 28 Access via an Ethernet port of an MES interface module</p>
		<p>③ Access by specifying the network number and the station number of a target station</p> <p>Page 29 Access by specifying the network number and the station number of a target station</p>
		<p>④ Access by specifying the start I/O No. of a module to be routed and the station number of a target station</p> <p>Page 29 Access by specifying the start I/O number of a module to be routed and the station number of a target station</p>
(3)	Another station via a co-existence network	<p>⑤ Access from the station accessed in ④ by specifying the network number and the station number of a target station</p> <p>Page 30 Access by specifying the network number and the station number via another station on CC-Link</p>
		<p>⑥ Access from the station accessed in ③ by specifying the start I/O No. of a module that is routed through and the station number of a target station</p> <p>Page 30 Access from another station specified by the network number and the station number on CC-Link</p>

Own station (control CPU, another CPU in a multiple CPU system)

The following table shows the accessibility to a CPU module of a station on which an MES interface module is mounted.

○: Accessible, —: No combination

Access route	Access target device type (series)						
	RCPU		QCPU (Q mode)		LCPU	FX5CPU	FXCPU
	Program mable controller CPU/ Process CPU/ Safety CPU	C Controller module	Program mable controller CPU/ Process CPU	C Controller module	Program mable controller CPU		
Control CPU	○	○*1	—	—	—	—	—
Another CPU in a multiple CPU system	○*2 (CPU No.1 to 4)	○ (CPU No.1 to 4)	—	—	—	—	—

*1 Can be accessed only when using an RD81MES96.

*2 No combination with RnENCPU.

Another station via a single network

■ Access via an Ethernet port of an MES interface module

A target device can be accessed via an Ethernet port of an MES interface module in the status where the target device is connected to a network.

For the communication destination from an Ethernet port of an MES interface module, an Ethernet interface module or a CPU module (Ethernet port) can be specified.

For accessing a target station, direct access and access via another system^{*1} are available.

*1 Not available when the series of an access target device and a system to be routed differ.

(Example) Access is available when the series of an access target device and a system to be routed are both QCPU.

○: Accessible, —: No combination

Access route			Access target device type (series)						
			RCPU		QCPU (Q mode)		LCPU	FX5CPU	FXCPU
			Program mable controller CPU/ Process CPU/ Safety CPU	C Controller module	Program mable controller CPU/ Process CPU	C Controller module	Program mable controller CPU		
Ethernet	Ethernet port of an MES interface module → Ethernet interface module ^{*2}	Direct	○ ^{*3,4} (CPU No.1 to 4)	—	○ (CPU No.1 to 4)	—	○	—	○ ^{*5,6}
		Via another system	CC-Link IE Controller Network	○ (CPU No.1 to 4)	○ (CPU No.1 to 4)	—	—	—	—
			CC-Link IE Field Network	—	—	○	—	—	—
			MELSECNE T/H network	—	—	—	—	—	—
	Ethernet ^{*7}	—	—	—	○	—	—		
	Ethernet port of an MES interface module → CPU module (Ethernet port)	Direct	○ (CPU No.1 to 4)	—	○ ^{*8} (CPU No.1 to 4)	○	○ ^{*5}	—	—
		Via another system	CC-Link IE Controller Network	—	—	—	—	—	—
			CC-Link IE Field Network	—	—	—	○	○ ^{*5}	—
			MELSECNE T/H network	—	—	—	—	—	—
		Ethernet ^{*7}	—	—	—	○	—	—	

*2 'Ethernet interface block' for accessing an FXCPU

*3 It can access to an RnENCPU only in a single CPU system.

*4 No combination with the MELSECNET/H network for process CPUs and safety CPUs

*5 Can be accessed only when using an RD81MES96N.

*6 When using an FX3U-ENET-ADP as an Ethernet interface block, use Version 1.21 or later.

*7 It is also supported by a QCPU (Q mode) for which the MELSOFT connection extended setting was set.

*8 To access an Ethernet port of Q12DCCPU-V (Basic mode) directly, MELSOFT connection is required to be permitted in the Q12DCCPU-V (Basic mode) setting.

For details on the setting, refer to the following:

📖 C Controller Module User's Manual (Utility Operation, Programming)

■ Access by specifying the network number and the station number of a target station

A target device can be accessed via a relay station when the target device is connected within eight networks from a station, on which an MES interface module is mounted, and can be identified by the network number and the station number (or CPU number).

○: Accessible, —: No combination

Access route	Access target device type (series)						
	RCPU		QCPU (Q mode)		LCPU	FX5CPU	FXCPU
	Program mable controller CPU/ Process CPU/ Safety CPU	C Controller module	Program mable controller CPU/ Process CPU	C Controller module	Program mable controller CPU		
CC-Link IE Controller Network	○ ^{*1*}	○	○	○	—	—	—
CC-Link IE Field Network	(CPU No.1 to 4)	(CPU No.1 to 4)	(CPU No.1 to 4)	(CPU No.1 to 4)	○	○ ^{*3}	
MELSECNET/H network		—			—	—	
Ethernet ^{*4}				—	○		

*1 It can access to an RnENCPU only in a single CPU system.

*2 No combination with the MELSECNET/H network for process CPUs and safety CPUs

*3 Can be accessed only when using an RD81MES96N.

*4 It is also supported by a QCPU (Q mode) for which the MELSOFTE connection extended setting was set.

■ Access by specifying the start I/O number of a module to be routed and the station number of a target station

The following table shows the accessible routes to connect with a target device and a station on which an MES interface module is mounted directly.

○: Accessible, —: No combination

Access route	Access target device type (series)						
	RCPU		QCPU (Q mode)		LCPU	FX5CPU	FXCPU
	Program mable controller CPU/ Process CPU/ Safety CPU	C Controller module	Program mable controller CPU/ Process CPU	C Controller module	Program mable controller CPU		
CC-Link	○ ^{*1} (CPU No.1 to 4)	○ (CPU No.1 to 4)	○ (CPU No.1 to 4)	○ (CPU No.1 to 4)	○	○ ^{*2}	—

*1 It can access to an RnENCPU only in a single CPU system.

*2 Can be accessed only when using an RD81MES96N.

Another station via a co-existence network

Access by specifying the network number and the station number via another station on CC-Link

The following table shows the accessible route to a target station from a station, on which an MES interface module is mounted by specifying the network number and the station number of the target station. In this route, another station on CC-Link is accessed first (first route), then a target station is accessed from there.

○: Accessible, —: No combination

First access route	Second access route (co-existence network)	Access target device type (series)							
		RCPU		QCPU (Q mode)		LCPU	FX5CPU	FXCPU	
		Program mable controller CPU/ Process CPU/ Safety CPU	C Controll er module	Program mable controller CPU/ Process CPU	C Controll er module	Program mable controller CPU			
CC-Link	CC-Link IE Controller Network	○*1*2 (CPU No.1 to 4)	○	○ (CPU No.1 to 4)	○ (CPU No.1 to 4)	○	—	—	—
	CC-Link IE Field Network		○			○	○*3		
	MELSECNET/H network		—			—	—		
	Ethernet*4		—			○	—		

*1 It can access to an RnENCPU only in a single CPU system.

*2 No combination with the MELSECNET/H network for process CPUs and safety CPUs

*3 Can be accessed only when using an RD81MES96N.

*4 It is also supported by a QCPU (Q mode) for which the MELSOFT connection extended setting was set.

Access from another station specified by the network number and the station number on CC-Link

The following table shows the accessible route to a target station from a station, on which an MES interface module is mounted, by specifying the start I/O No. of a module that is routed through and the station number of the target station. In this route, another station on CC-Link is accessed first by specifying the network number and the station number (first route), then the target device is accessed from there.

○: Accessible, —: No combination

First access route	Second access route (co-existence network)	Access target device type (series)							
		RCPU		QCPU (Q mode)		LCPU	FX5CPU	FXCPU	
		Program mable controller CPU/ Process CPU/ Safety CPU	C Controll er module	Program mable controller CPU/ Process CPU	C Controll er module	Program mable controller CPU			
CC-Link IE Controller Network	CC-Link	○*1*2 (CPU No.1 to 4)	○	○ (CPU No.1 to 4)	○ (CPU No.1 to 4)	○ (CPU No.1 to 4)	○	○*3	—
CC-Link IE Field Network									
MELSECNET/H network									
Ethernet*4									

*1 It can access to an RnENCPU only in a single CPU system.

*2 No combination with the MELSECNET/H network for process CPUs and safety CPUs

*3 Can be accessed only when using an RD81MES96N.

*4 It is also supported by a QCPU (Q mode) for which the MELSOFT connection extended setting was set.

Accessible devices

The following table shows the accessible devices.

RD81MES96N

○: Accessible, ×: Not accessible, —: No device

Device name (device)	Access target device type (series)							
	RCPU			QCPU (Q mode)		LCPU	FX5CPU	FXCPU
	Programmable controller CPU/ Process CPU ^{*1} /Safety CPU ^{*1*2}		C Controller module	Program mable controller CPU/ Process CPU	C Controller module	Program mable controller CPU		
	General access	High-speed access						
Function input (FX)	×	×	—	×	—	×	—	—
Function output (FY)	×	×	—	×	—	×	—	—
Function register (FD)	×	×	—	×	—	×	—	—
Special relay (SM)	○	○	○	○	○	○	○	—
Special register (SD)	○	○	○	○	○	○	○	—
Input relay (X)	○	○	○	○	○	○	○	○
Output relay (Y)	○	○	○	○	○	○	○	○
Internal relay (M) (Auxiliary relay)	○	○	○	○	○	○	○	○
Latch relay (L)	○	○	—	○	—	○	○	—
Annunciator (F)	○	○	—	○	—	○	○	—
Edge relay (V)	○	○	—	○	—	○	—	—
Link relay (B)	○	○	○	○	○ ^{*3}	○	○	—
Data register (D)	○	○	○	○	○	○	○	○
Link register (W)	○	○	○	○	○ ^{*3}	○	○	—
Timer	Contact (TS)	○	○	—	○	—	○	○
	Coil (TC)	○	○	—	○	—	○	○
	Current value (T/ TN)	○	○	—	○	—	○	○
Long timer	Contact (LTS)	○	○	—	—	—	—	—
	Coil (LTC)	○	○	—	—	—	—	—
	Current value (LT/ LTN)	○	○	—	—	—	—	—
Counter	Contact (CS)	○	○	—	○	—	○	○
	Coil (CC)	○	○	—	○	—	○	○
	Current value (C/ CN)	○	○	—	○	—	○	○
Long counter	Contact (LCS)	○	○	—	—	—	○	—
	Coil (LCC)	○	○	—	—	—	○	—
	Current value (LC/ LCN)	○	○	—	—	—	○	—
Retentive timer	Contact (STS, SS ^{*4})	○	○	—	○	—	○	—
	Coil (STC, SC ^{*4})	○	○	—	○	—	○	—
	Current value (ST/ STN, ST/SN ^{*4})	○	○	—	○	—	○	—
Long retentive timer	Contact (LSTS)	○	○	—	—	—	—	—
	Coil (LSTC)	○	○	—	—	—	—	—
	Current value (LST/ LSTN)	○	○	—	—	—	—	—
Link special relay (SB)	○	○	—	○	—	○	○	—

Device name (device)		Access target device type (series)							
		RCPU			QCPU (Q mode)		LCPU	FX5CPU	FXCPU
		Programmable controller CPU/ Process CPU ^{*1} /Safety CPU ^{*1*2}		C Controller module	Program mable controller CPU/ Process CPU	C Controller module	Program mable controller CPU	FX5CPU	FXCPU
General access	High-speed access								
Link special register (SW)		○	○	—	○	—	○	○	—
Step relay (S)		×	×	—	×	—	×	×	—
Direct input (DX)		—	—	—	—	—	—	—	—
Direct output (DY)		—	—	—	—	—	—	—	—
Index register (Z, V ^{*5})		○	○	—	○	—	○	○	○
Long index register (LZ)		○	○	—	—	—	—	○	—
File register	(R)	○	○	—	○	—	○	○	○
	(ZR)	○	○	○	○	—	○	—	—
	(ERnR)	—	—	—	—	—	—	—	×
Link direct device	Link input (Jn\X)	○	—	○	○	○	○	—	—
	Link output (Jn\Y)	○	—	○	○	○	○	—	—
	Link relay (Jn\B)	○	—	○	○	○	—	—	—
	Link special relay (Jn\SB)	○	—	○	○	○	○	—	—
	Link register (Jn\W)	○	—	○	○	○	○	—	—
	Link special register (Jn\SW)	○	—	○	○	○	○	—	—
Module access device	Module access device/intelligent function module device (Un\G)	○	×	○	○	○	○	○	—
	Multiple CPU shared device (U3En\G)	—	—	—	○	○	—	—	—
CPU buffer memory access device	CPU buffer memory access device (U3En\G)	○	×	○	—	—	—	—	—
	CPU buffer memory access device (fixed cycle communication area) (U3En\HG)	○ ^{*6}	×	○	—	—	—	—	—
Refresh data register (RD)		○	○	—	—	—	—	—	—

*1 Process CPUs and safety CPUs do not support high-speed access.

*2 Safety devices cannot be accessed.

*3 Q12DCCPU-V (Basic mode) has no device.

*4 A device name for QCPUs (Q mode) and LCPUs

*5 Can be set only for FXCPUs.

*6 RnENCPUs and safety CPUs have no device.

RD81MES96

○: Accessible, ×: Not accessible, —: No device

Device name (device)		Access target device type (series)					
		RCPU		C Controller module	QCPU (Q mode)		LCPU
		Programmable controller CPU/Process CPU ^{*1} /Safety CPU ^{*1*2}			Programma ble controller CPU/ Process CPU	C Controller module	Programma ble controller CPU
General access	High-speed access						
Function input (FX)		×	×	—	×	—	×
Function output (FY)		×	×	—	×	—	×
Function register (FD)		×	×	—	×	—	×
Special relay (SM)		○	○	○	○	○	○
Special register (SD)		○	○	○	○	○	○
Input relay (X)		○	○	○	○	○	○
Output relay (Y)		○	○	○	○	○	○
Internal relay (M)		○	○	○	○	○	○
Latch relay (L)		○	○	—	○	—	○
Annunciator (F)		○	○	—	○	—	○
Edge relay (V)		○	○	—	○	—	○
Link relay (B)		○	○	○	○	○ ^{*3}	○
Data register (D)		○	○	○	○	○	○
Link register (W)		○	○	○	○	○ ^{*3}	○
Timer	Contact (TS)	○	○	—	○	—	○
	Coil (TC)	○	○	—	○	—	○
	Current value (T/TN)	○	○	—	○	—	○
Long timer	Contact (LTS)	×	×	—	—	—	—
	Coil (LTC)	×	×	—	—	—	—
	Current value (LT/LTN)	×	×	—	—	—	—
Counter	Contact (CS)	○	○	—	○	—	○
	Coil (CC)	○	○	—	○	—	○
	Current value (C/CN)	○	○	—	○	—	○
Long counter	Contact (LCS)	×	×	—	—	—	—
	Coil (LCC)	×	×	—	—	—	—
	Current value (LC/LCN)	×	×	—	—	—	—
Retentive timer	Contact (STS, SS ^{*4})	○	○	—	○	—	○
	Coil (STC, SC ^{*4})	○	○	—	○	—	○
	Current value (ST/STN, ST/SN ^{*4})	○	○	—	○	—	○
Long retentive timer	Contact (LSTS)	×	×	—	—	—	—
	Coil (LSTC)	×	×	—	—	—	—
	Current value (LST/LSTN)	×	×	—	—	—	—
Link special relay (SB)		○	○	—	○	—	○
Link special register (SW)		○	○	—	○	—	○
Step relay (S)		×	×	—	×	—	×
Direct input (DX)		—	—	—	—	—	—
Direct output (DY)		—	—	—	—	—	—
Index register (Z)		○	○	—	○	—	○
Long index register (LZ)		×	×	—	—	—	—
File register	(R)	○	○	—	○	—	○
	(ZR)	○	○	○	○	—	○
	(ERnR)	—	—	—	—	—	—

Device name (device)		Access target device type (series)					
		RCPU			QCPU (Q mode)		LCPU
		Programmable controller CPU/Process CPU ^{*1} /Safety CPU ^{*1*2}		C Controller module	Programmable controller CPU/Process CPU	C Controller module	Programmable controller CPU
General access	High-speed access						
Link direct device	Link input (Jn\X)	○	—	○	○	○	○
	Link output (Jn\Y)	○	—	○	○	○	○
	Link relay (Jn\B)	○	—	○	○	○	—
	Link special relay (Jn\SB)	○	—	○	○	○	○
	Link register (Jn\W)	○	—	○	○	○	○
	Link special register (Jn\SW)	○	—	○	○	○	○
Module access device	Module access device/intelligent function module device (Un\G)	○	×	○	○	○	○
	Multiple CPU shared device (U3En\G)	—	—	—	○	○	—
CPU buffer memory access device	CPU buffer memory access device (U3En\G)	○	×	○	—	—	—
	CPU buffer memory access device (fixed cycle communication area) (U3En\HG)	○ ^{*5}	×	○	—	—	—
Refresh data register (RD)		×	×	—	—	—	—

*1 Process CPUs and safety CPUs do not support high-speed access.

*2 Safety devices cannot be accessed.

*3 Q12DCCPU-V (Basic mode) has no device.

*4 A device name for QCPUs (Q mode) and LCPUs

*5 RnENCPUs and safety CPUs have no device.

Bit specification/digit specification of devices

The following table shows the availability of bit specification and digit specification of each device.

These are available for RD81MES96Ns only.

○: Available, ×: Not available

Device (device name)		Bit specification	Digit specification
Function input (FX)		×	×
Function output (FY)		×	×
Function register (FD)		×	×
Special relay (SM)		×	○
Special register (SD)		○	×
Input relay (X)		×	○
Output relay (Y)		×	○
Internal relay/auxiliary relay (M)		×	○
Latch relay (L)		×	○
Annunciator (F)		×	○
Edge relay (V)		×	○ ^{*1}
Link relay (B)		×	○ ^{*1}
Data register (D)		○	×
Link register (W)		○	×
Timer	Contact (TS)	×	×
	Coil (TC)	×	×
	Current value (T/TN)	×	×
Long timer	Contact (LTS)	×	×
	Coil (LTC)	×	×
	Current value (LT/LTN)	×	×
Counter	Contact (CS)	×	×
	Coil (CC)	×	×
	Current value (C/CN)	×	×
Long counter	Contact (LCS)	×	×
	Coil (LCC)	×	×
	Current value (LC/LCN)	×	×
Retentive timer	Contact (STS, SS ^{*2})	×	×
	Coil (STC, SC ^{*2})	×	×
	Current value (ST/STN, ST/SN ^{*2})	×	×
Long retentive timer	Contact (LSTS)	×	×
	Coil (LSTC)	×	×
	Current value (LST/LSTN)	×	×
Link special relay (SB)		×	○
Link special register (SW)		○	×
Index register	(Z)	×	×
	(V)	×	×
Long index register (LZ)		×	×
File register	(R)	○	×
	(ZR)	○	×
Extension file register (ERnR)		×	×
Link direct device	Link input (JnX)	×	○
	Link output (JnY)	×	○
	Link relay (JnB)	×	○
	Link special relay (JnSB)	×	○
	Link register (JnW)	○	×
	Link special register (JnSW)	○	×
Refresh data register (RD)		○	×

Device (device name)		Bit specification	Digit specification
Module access device	Module access device/intelligent function module device (Un\G)	○	×
	Multiple CPU shared device (U3En\G)	○	×
CPU buffer memory access device	CPU buffer memory access device (U3En\G)	○	×
	CPU buffer memory access device (fixed cycle communication area) (U3En\HG)	○	×

*1 Not available for RCPUs.

*2 A device name for QCPUs (Q mode) and LCPUs

Access units

The following table shows the number of accessible device points (access units) in one process (one scanning) when accessing the device memory in a CPU module.

Note that the device memory is accessed in device tag component units when setting any of the following jobs in which only continuous array tags are used and operating an RD81MES96N.

☞ Page 38 Job setting 1, Page 38 Job setting 2, Page 38 Job setting 3

Access units differ from those shown in the following table when setting any of the jobs shown in the above sections and operating an RD81MES96N. (☞ Page 37 Setting a job in which only continuous array tags are used)

Access target device type (series)		Device reading		Device writing
		General access	High-speed access	
RCPU	Programmable controller CPU	118 points ^{*1} 58 points ^{*2}	32768 points ^{*3}	78 points ^{*1} 38 points ^{*2}
	Process CPU		Not supported.	
	C Controller module			
QCPU (Q mode) ^{*4}		96 points ^{*1} 48 points ^{*2}		96 points ^{*1} 48 points ^{*2}
LCPU				
FX5CPU		58 points ^{*1} 29 points ^{*2}		38 points ^{*1} 19 points ^{*2}
FXCPU		128 points		128 points

*1 For access without using an Ethernet port of an MES interface module

*2 For access by using an Ethernet port of an MES interface module

*3 8192 points when using an RD81MES96N with firmware version '02' or earlier, or an RD81MES96

*4 Access units differ for each module type. When data inconsistency is a problem, select "Single Handshake" or "Multiple Handshake" for a trigger condition.

Setting a job in which only continuous array tags are used

When setting any of the following jobs in which only continuous array tags are used and operating an RD81MES96N, the device memory is accessed in device tag component units.

☞ Page 38 Job setting 1, Page 38 Job setting 2, Page 38 Job setting 3

The following table shows the access units when setting any of the jobs shown in the above sections and operating an RD81MES96N.

Access target device type (series)		Device reading		Device writing
		General access	High-speed access	
RCPU	Programmable controller CPU	960 points	32768 points ^{*1}	949 points
	Process CPU		Not supported.	
	C Controller module			
QCPU (Q mode) ^{*2}		480 points		480 points
LCPU				
FX5CPU				469 points
FXCPU		32 points ^{*3} 64 points ^{*4}		32 points ^{*3} 64 points ^{*4}

*1 8192 points when using an RD81MES96N with firmware version '02' or earlier

*2 Access units differ for each module type. When data inconsistency is a problem, select "Single Handshake" or "Multiple Handshake" for a trigger condition.

*3 For access without using an Ethernet port of an RD81MES96N

*4 For access by using an Ethernet port of an RD81MES96N

Precautions

When accessing the device memory in device tag component units, device values may be obtained from multiple sequence scans and applied, which may cause data inconsistency.

When data inconsistency is a problem, refer to the following:

☞ Page 38 When data inconsistency is a problem

■Job setting 1

Action	Details
Operation action (substitution)	Either of the following conditions is satisfied. <ul style="list-style-type: none">• All device tag components are devices other than bit devices.• The array sizes of all device tag components are multiples of 16.

■Job setting 2

Action	Details
DB communication action (Multiple Select)	All device tag components are devices other than bit devices.
Operation action (substitution)	Either of the following conditions is satisfied. <ul style="list-style-type: none">• All device tag components are devices other than bit devices.• The array sizes of all device tag components are multiples of 16.

■Job setting 3

Action	Details
DB communication action (Multiple Select)	All of the following conditions are satisfied. <ul style="list-style-type: none">• All device tag components are bit devices.• The array sizes of all device tag components are multiples of 16.• The checkbox of "Clear the unsubstituted assignment data to 0" is selected under "Operation Setting at the No. of Selected Records Insufficient."
Operation action (substitution)	Either of the following conditions is satisfied. <ul style="list-style-type: none">• All device tag components are devices other than bit devices.• The array sizes of all device tag components are multiples of 16.

Reading/writing in access units

When the number of accessed device points is equal to the access unit or less, device values in a same sequence scan are obtained and applied.

When the number of device points exceeds the access unit, device values may be obtained from multiple sequence scans and applied, which may cause data inconsistency.

■When data inconsistency is a problem

When a sequence program and data must be synchronized and data inconsistency is a problem, set the following:

- Set the number of device points accessed at the same time to the access unit or less.
- Change the access type to high-speed access. (Only for device reading)
- Select "Single Handshake" or "Multiple Handshake" for "Configuration Type" for a trigger condition.

2.3 Access Specifications for a Database

This section shows the specifications for access from an MES interface module to a database in a server.

Accessible databases and supported software

The following table shows the database type and supported software that can be accessed by an MES interface module.

○: Supported, ×: Not supported

Database type	Accessible database type* ¹	Supported software* ¹	Supported edition		RD81MES96N		RD81MES96	
					Direct DB connection	Connection via service	Connection via service	
Database server	Oracle®	Oracle 11g	Express Edition	64-bit version only	○	○	○	
			Standard Edition		○	○	○	
			Enterprise Edition		○	○	○	
		Oracle 12c	Standard Edition		○	○	○	
			Enterprise Edition		○	○	○	
		Oracle 18c	Express Edition		○	○	○	
			Standard Edition		○	○	○	
			Enterprise Edition		○	○	○	
		Oracle 19c	Express Edition		○	○	×	
			Standard Edition		○	○	×	
			Enterprise Edition		○	○	×	
		Oracle 21c	Express Edition		○	○	×	
			Standard Edition		○	○	×	
			Enterprise Edition		○	○	×	
		Microsoft SQL Server	SQL Server 2008 R2 ²		Express Edition	○	○	○
					Standard Edition	○	○	○
					Enterprise Edition	○	○	○
			SQL Server 2012		Express Edition	○	○	○
					Standard Edition	○	○	○
					Enterprise Edition	○	○	○
			SQL Server 2014		Express Edition	○	○	○
	Standard Edition			○	○	○		
	Enterprise Edition			○	○	○		
	SQL Server 2016		Express Edition	○	○	○		
			Standard Edition	○	○	○		
			Enterprise Edition	○	○	○		
	SQL Server 2017		Express Edition	○	○	○		
			Standard Edition	○	○	○		
			Enterprise Edition	○	○	○		
	SQL Server 2019		Express Edition	○	○	×		
			Standard Edition	○	○	×		
			Enterprise Edition	○	○	×		
	SQL Server 2022		Express Edition	○	○	×		
			Standard Edition	○	○	×		
			Enterprise Edition	○	○	×		
	Microsoft Access®* ³	Access 2010	—	32-bit version only	×	○	○	
		Access 2013	—		×	○	○	
		Access 2016	—		×	○	○	
		Access 2019	—	32-bit version/64-bit version	×	○	×	
		Access 2021	—		×	○	×	
	MySQL®	MySQL* ⁴ * ⁵ * ⁶ * ⁷	Community Edition* ⁸	64-bit version only	○	○	○	
			Standard Edition		○	○	○	
—			○		○	○		
PostgreSQL	PostgreSQL* ⁴	—	○	○	○			
MariaDB®	MariaDB* ⁴	Community Edition	64-bit version only	○	○	×		

- *1 Use a same language version for the operating system and software.
 *2 IA-64 cannot be used.
 *3 Access for Microsoft 365 with version up to the same as Access listed in the table can also be used.
 When using Access for Microsoft 365, set either of the following in MES Interface Function Configuration Tool.

Microsoft 365 Semi-Annual Enterprise Channel version	Database type
Before 2102	Access 2019
2102 to 2208	Access 2021

- *4 An open source database. The operation has been checked in the following versions.

○: Supported, ×: Not supported

Database type	Version	RD81MES96N		RD81MES96
		Direct DB connection	Connection via service	Connection via service
MySQL	5.7.10	×	○	○ (Firmware version '05' or later)
	5.7.15	×	○	○ (Firmware version '07' or later)
	5.7.25	○	○	○ (Firmware version '07' or later)
	8.0.31	○	○	×
PostgreSQL	9.4.5	×	○	○ (Firmware version '05' or later)
	9.5.4	×	○	○ (Firmware version '07' or later)
	9.6.12	○	○	○ (Firmware version '07' or later)
	10.7	○	○	○ (Firmware version '07' or later)
	14.2	○	○	×
MariaDB	10.6.5	○	○	×

- *5 For the authentication plugin in MySQL, specify "mysql_native_password".
 *6 When using the DB procedure information browse in MES Interface Function Configuration Tool, disable "ONLY_FULL_GROUP_BY" in MySQL.
 For details on the DB procedure information browse, refer to the following:
 📖 MELSEC iQ-R MES Interface Module User's Manual (Application)
 *7 When the transaction isolation level is "REPEATABLE READ" and an updated value in another session such as MySQL Workbench cannot be selected, change the transaction isolation level to "READ COMMITTED".
 *8 To use Community Edition, use the ODBC driver of MariaDB.

Access type

The following access types can be selected for accessing a database server from an MES interface module.

- Connection via service
- Direct DB connection

Connection via service

A database is accessed via DB Connection Service installed on a database server.

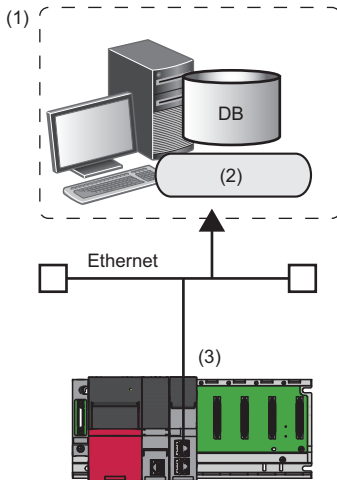

- (1) Database server
- (2) DB Connection Service
- (3) MES interface module

Point

The advantages of selecting "Connection via Service" for "Access Type" are as follows:

- An RD81MES96 can be replaced with an RD81MES96N without changing the settings of an MES interface module and database server.
- A startup time and troubleshooting time can be reduced in a system in which both an RD81MES96 and an RD81MES96N are included, because a database is accessed by using a same access type.

Direct DB connection

A database is accessed directly without using DB Connection Service.

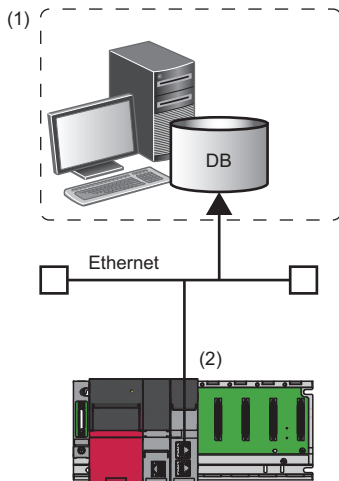

- (1) Database server
(2) MES interface module (RD81MES96N)

Point

The advantages of selecting "Direct DB Connection" for "Access Type" are as follows:

- No need to install DB Connection Service on a database server.
- A database that runs on Linux can be accessed. (☞ Page 43 Confirmed operating system list for the operation)

Precautions

It takes longer for an MES interface module to start than when selecting "Connection via Service." When selecting "Direct DB Connection" for "Access Type," run the system by fully verifying the processing time.

Confirmed operating system list for the operation

The following table shows the combinations of databases and Linux the operations of which are confirmed to access them via direct DB connection.

○: Confirmed, —: Unconfirmed

OS	Oracle				SQL Server				MySQL		PostgreSQL			Maria DB
	11g	18c	19c	21c	2012	2017	2019	2022	5.7.25	8.0.31	9.6.12	10.7	14.2	10.6.5
Ubuntu 16.04 LTS	—	—	—	—	○	○	—	—	○	—	○	○	—	—
Ubuntu 20.04 LTS	—	—	—	—	—	—	—	○	—	○	—	—	○	○
Oracle Linux 7	○	○	○	—	—	—	○	—	—	—	—	—	—	—
Oracle Linux 8	—	—	—	○	—	—	—	—	—	—	—	—	—	—
Red Hat Enterprise Linux 7	○	○	—	—	○	○	—	—	○	—	○	○	—	—
Red Hat Enterprise Linux 8	—	—	—	—	—	—	—	—	—	○	—	—	○	○
SUSE Linux Enterprise Server 12	○	○	—	—	○	○	—	—	○	○	○	○	○	○

2.4 Data Specifications

This section shows the specifications of data category and data type handled by an MES interface module.

Data category

The following shows the data category handled by an MES interface module.

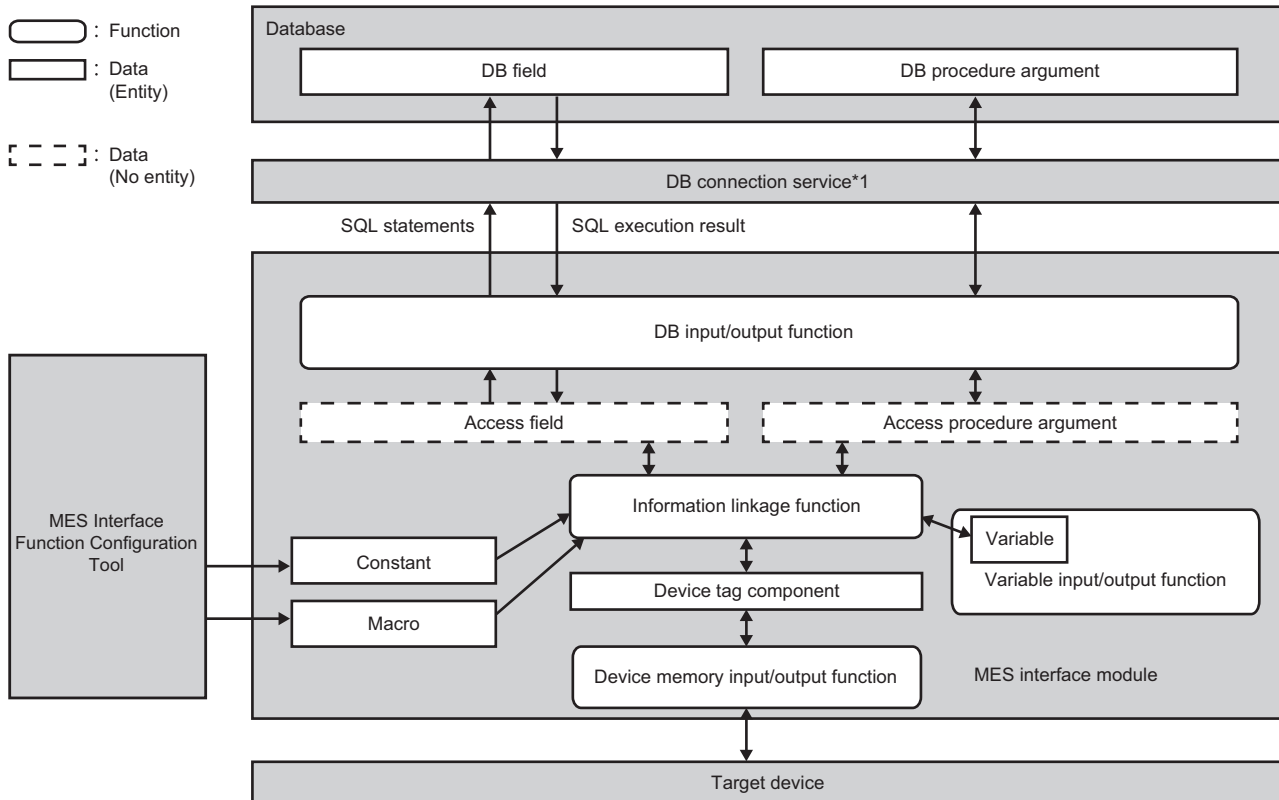

*1 Not used for access when selecting "Direct DB Connection" for "Access Type."

☞ Page 43 Direct DB connection

Data category	Description	Reference
Device tag component	Data associated with data in an access target device such as a CPU module	Page 49 Device tag component or variable
Variable	Data used for storing the operation result in an MES interface module. <ul style="list-style-type: none"> Local variable: Used for sending and receiving data between operations in a same action, and actions in a same job. Global variable: Used for sending and receiving data between jobs. System variable: Used for retaining system information and controlling hardware. 	
Constant	A value set in MES Interface Function Configuration Tool	Page 50 Constant
Macro	A special value set in MES Interface Function Configuration Tool. Since any value is not determined at the setting, MES Interface Function Configuration Tool specifies a macro name not a value.	Page 51 Macro
Access field	Data associated with the DB field. A concept used for checking the setting, and it has no entity.	—
Access procedure argument	Data associated with the DB procedure argument. A concept used for checking the setting, and it has no entity.	
DB field	A data component stored in a table and view in the database. It is associated with the access field.*2	
DB procedure argument	An argument of a stored procedure defined in the database. It is associated with the access procedure argument.	

*2 When the access target server type is Oracle, pseudocolumns listed in the table below can be used.
A pseudocolumn behaves like a regular field in a table, but is not actually stored in the table.
A value can be selected from a pseudocolumn, but cannot be inserted, updated, or deleted for it.

Pseudocolumn	Description
ROWID	A unique ID assigned to each record in a table
ROWNUM	A value numbered from 1 in order from the first result narrowed down by a condition in a WHERE clause

Data type

The following table lists the data type that can be specified in an MES interface module according to the data category and the data type classification.

Numerical value

■RD81MES96N

Data category		Numerical value			
		Integer		Real number	
Device tag component		<ul style="list-style-type: none"> • Bit • Word [unsigned]/Bit string [16-bit] • Double word [unsigned]/Bit string [32-bit] • Word [signed] • Double word [signed] • 16bit BCD • 32bit BCD 		<ul style="list-style-type: none"> • Single-precision real number • Double-precision real number 	
Variable		<ul style="list-style-type: none"> • Bit • Word [unsigned]/Bit string [16-bit] • Double word [unsigned]/Bit string [32-bit] • Word [signed] • Double word [signed] 		<ul style="list-style-type: none"> • Single-precision real number • Double-precision real number 	
Constant		Integer		Real number	
Macro		Any of the data types of the device tag component or variable is determined for each macro.			
Access field		Integer		Real number [floating point]	Real number [fixed point]
Access procedure argument		Integer ^{*1}		Real number ^{*1}	
DB field DB procedure argument	Oracle	—	<ul style="list-style-type: none"> • NUMBER(p) • NUMBER(p, 0) 	<ul style="list-style-type: none"> • NUMBER • BINARY_FLOAT • BINARY_DOUBLE 	• NUMBER(p, s) ^{*2}
	Microsoft SQL Server	<ul style="list-style-type: none"> • bit • tinyint • smallint • int • bigint 	<ul style="list-style-type: none"> • decimal • numeric • decimal(p) • numeric(p) • decimal(p, 0) • numeric(p, 0) 	<ul style="list-style-type: none"> • real • float 	<ul style="list-style-type: none"> • decimal(p, s) • numeric(p, s)
	Microsoft Access ^{*3}	<ul style="list-style-type: none"> • Yes/No type • Number: Byte • Number: Integer • Number: Long Integer 	• Number: Decimal	<ul style="list-style-type: none"> • Number: Single • Number: Double 	• Number: Decimal ^{*2}
	MySQL	<ul style="list-style-type: none"> • TINYINT [UNSIGNED]^{*3} • SMALLINT [UNSIGNED] • MEDIUMINT [UNSIGNED] • INT [UNSIGNED] • BIGINT [UNSIGNED] 	<ul style="list-style-type: none"> • DECIMAL[(M[,0])] • [UNSIGNED] 	<ul style="list-style-type: none"> • FLOAT [UNSIGNED] • DOUBLE [UNSIGNED] 	• DECIMAL(M,D) [UNSIGNED] ^{*2}
	PostgreSQL	<ul style="list-style-type: none"> • smallint • integer • bigint 	• numeric(p[,0])	<ul style="list-style-type: none"> • numeric(p,s) • real • double precision 	• numeric(p, s) ^{*2}
	MariaDB	<ul style="list-style-type: none"> • TINYINT [UNSIGNED] • SMALLINT [UNSIGNED] • MEDIUMINT [UNSIGNED] • INT [UNSIGNED] • BIGINT [UNSIGNED] 	<ul style="list-style-type: none"> • DECIMAL[(M[,0])] • [UNSIGNED] 	<ul style="list-style-type: none"> • FLOAT [UNSIGNED] • DOUBLE [UNSIGNED] 	• DECIMAL(M,D) [UNSIGNED] ^{*2}

*1 The data types of PostgreSQL are as follows:

Data type classification	Access procedure argument data type	Database data type
Integer	Integer [smallint]	smallint
	Integer [integer]	integer
	Integer [bigint]	bigint
Real number	Real number [numeric]	numeric
	Real number [real]	real
	Real number [double precision]	double precision

*2 The data type of an access field 'real number [floating point]' is also supported.

*3 Cannot be used for a DB procedure argument.

■RD81MES96

Data category		Numerical value		
		Integer		Real number
Device tag component		<ul style="list-style-type: none"> • Bit • Word [unsigned]/Bit string [16-bit] • Double word [unsigned]/Bit string [32-bit] • Word [signed] • Double word [signed] • 16bit BCD • 32bit BCD 		<ul style="list-style-type: none"> • Single-precision real number • Double-precision real number
Variable		<ul style="list-style-type: none"> • Bit • Word [unsigned]/Bit string [16-bit] • Double word [unsigned]/Bit string [32-bit] • Word [signed] • Double word [signed] 		<ul style="list-style-type: none"> • Single-precision real number • Double-precision real number
Constant		Integer		Real number
Macro		Any of the data types of the device tag component or variable is determined for each macro.		
Access field		Integer		Real number [floating point]
Access procedure argument		Integer		Real number
DB field DB procedure argument	Oracle	—	<ul style="list-style-type: none"> • NUMBER(p) • NUMBER(p, 0) 	<ul style="list-style-type: none"> • NUMBER(p, s) • NUMBER • BINARY_FLOAT • BINARY_DOUBLE
	Microsoft SQL Server	<ul style="list-style-type: none"> • bit • tinyint • smallint • int • bigint 	<ul style="list-style-type: none"> • decimal • numeric • decimal(p) • numeric(p) • decimal(p, 0) • numeric(p, 0) 	<ul style="list-style-type: none"> • real • float
	Microsoft Access ^{*1}	<ul style="list-style-type: none"> • Yes/No type • Number: Byte • Number: Integer • Number: Long Integer 	<ul style="list-style-type: none"> • Number: Decimal 	<ul style="list-style-type: none"> • Number: Decimal • Number: Single • Number: Double
	MySQL	<ul style="list-style-type: none"> • TINYINT [UNSIGNED] • SMALLINT [UNSIGNED] • MEDIUMINT [UNSIGNED] • INT [UNSIGNED] • BIGINT [UNSIGNED] 	<ul style="list-style-type: none"> • DECIMAL[(M[,0])] [UNSIGNED] 	<ul style="list-style-type: none"> • DECIMAL(M,D) [UNSIGNED] • FLOAT [UNSIGNED] • DOUBLE [UNSIGNED]
	PostgreSQL	<ul style="list-style-type: none"> • smallint • integer • bigint 	<ul style="list-style-type: none"> • numeric(p[,0]) 	<ul style="list-style-type: none"> • numeric[(p,s)] • real • double precision

*1 Cannot be used for a DB procedure argument.

Character string, date and time

Data category		Character string		Date and time	
Device tag component		<ul style="list-style-type: none"> • Character string [Unicode] • Character string [ASCII/SJIS] 		—	
Variable		<ul style="list-style-type: none"> • Character string [Unicode] 			
Constant		<ul style="list-style-type: none"> • Character string [Unicode] 			
Macro		Any of the data types of the device tag component or variable is determined for each macro.			
Access field		<ul style="list-style-type: none"> • Character string [Unicode(NCHAR)] 	<ul style="list-style-type: none"> • Character string [Unicode(CHAR)] 	Date and time [without time zone]	Date and time [with time zone]
Access procedure argument		<ul style="list-style-type: none"> • Character string [Unicode]^{*1} 		Date and time [without time zone] ^{*1}	—
DB field DB procedure argument	Oracle	<ul style="list-style-type: none"> • NCHAR • NVARCHAR2 	<ul style="list-style-type: none"> • CHAR • VARCHAR2 	<ul style="list-style-type: none"> • DATE^{*2} • TIMESTAMP[(p)]^{*2} 	<ul style="list-style-type: none"> • TIMESTAMP[(p)] WITH TIME ZONE^{*2,3}
	Microsoft SQL Server	<ul style="list-style-type: none"> • nchar • nvarchar 	<ul style="list-style-type: none"> • char • varchar 	<ul style="list-style-type: none"> • smalldatetime • datetime • datetime2[(p)] 	<ul style="list-style-type: none"> • datetimeoffset[(p)]^{*3}
	Microsoft Access ^{*4}	—	<ul style="list-style-type: none"> • Text type (short text^{*5}) 	<ul style="list-style-type: none"> • Date/Time 	—
	MySQL	<ul style="list-style-type: none"> • [NATIONAL] CHAR[(M)]^{*6} • [NATIONAL] VARCHAR(M)^{*6} • CHAR[(M)]^{*6,7} • VARCHAR(M)^{*6,7} 	<ul style="list-style-type: none"> • CHAR[(M)]^{*6,8} • VARCHAR(M)^{*6,8} 	<ul style="list-style-type: none"> • DATETIME[(fsp)] • TIMESTAMP[(fsp)] 	—
	PostgreSQL	—	<ul style="list-style-type: none"> • character[(n)] • character varying[(n)] 	<ul style="list-style-type: none"> • timestamp[(p)] [without time zone]^{*9} 	—
	MariaDB	<ul style="list-style-type: none"> • [NATIONAL] CHAR[(M)] • [NATIONAL] VARCHAR(M) • CHAR[(M)]^{*10} • VARCHAR(M)^{*10} 	<ul style="list-style-type: none"> • CHAR[(M)]^{*11} • VARCHAR(M)^{*11} 	<ul style="list-style-type: none"> • DATETIME[(fsp)] • TIMESTAMP[(fsp)] 	—

*1 The data types of PostgreSQL are as follows:

Data type classification	Access procedure argument data type	Database data type
Character string [Unicode]	Character string [character]	character[(n)]
	Character string [character varying]	character varying[(n)]
Date and time [without time zone]	Date and time [timestamp]	timestamp[(p)] [without time zone]

*2 The date from January 1st in 4712 B.C. to December 31st in 9999 A.D. in Julian calendar can be stored. However, the date in B.C. cannot be handled in an MES interface module.

*3 Cannot be specified for a DB procedure argument.

*4 Cannot be used for a DB procedure argument.

*5 Notation in Access 2013 or later

*6 When using it for a DB procedure argument, use the character code utf8, utf8mb3, or utf8mb4.

*7 Can be specified when the character set setting in a field of a database is utf8.

*8 Can be specified when the character set setting in a field of a database is not utf8.

*9 The date from January 1st in 4713 B.C. to December 31st in 294276 A.D. in Gregorian calendar can be stored. However, the date in B.C. cannot be handled in an MES interface module.

*10 Can be specified when the character set setting in a field of a database is utf8mb3.

*11 Can be specified when the character set setting in a field of a database is not utf8mb3.

Device tag component or variable

The following tables show the data type specifications for a device tag component or variable according to the classification.

Data type

Integer

Data type	Variable
Bit	2 bytes
Word [unsigned]/Bit string [16-bit]	2 bytes
Double word [unsigned]/Bit string [32-bit]	4 bytes
Word [signed]	2 bytes
Double word [signed]	4 bytes
16bit BCD	—
32bit BCD	—

Real number

Data type	Variable
Single-precision real number	4 bytes
Double-precision real number	8 bytes

Character string

Data type	Character string length	Character code	Variable
Character string [Unicode]	1 to 255 characters	UTF-16LE ^{*1} *2*3	2 bytes/character
Character string [ASCII/SJIS]	1 to 255 characters	Windows Codepage 932	—

*1 The character other than BMP (U+10000 to U+10FFFF) cannot be used and it has no BOM.

*2 UTF-16LE has no BOM.

*3 Combining characters cannot be used.

System variable list

Variable name	Data type	Write	Description	Description of a value
S_SERVER_STATUS01 to S_SERVER_STATUS16 (Connection status of an access target server)	Word [unsigned]/Bit string [16-bit]	Not writable	Displays a connection status to each access target server.	<ul style="list-style-type: none"> • 0: Not connected • 1: Connected • 2: Disconnected
S_DEVICE_STATUS01 to S_DEVICE_STATUS64 ^{*1} (Connection status of an access target device)	Word [unsigned]/Bit string [16-bit]	Not writable	Displays a connection status to each access target device.	<ul style="list-style-type: none"> • 0: Not connected • 1: Connected • 2: Disconnected
S_MATRIXLED_DISP (Dot matrix LED display)	Character string [Unicode] 32 characters	Writable	Displays the user specification character string of the dot matrix LED. Substitute characters to display in the action. For details on the action, refer to the following: □ MELSEC iQ-R MES Interface Module User's Manual (Application)	Usable characters: U+0020 to U+007E ^{*2} (The initial value is a blank character.)
S_MATRIXLED_MODE (Dot matrix LED display mode)	Word [unsigned]/Bit string [16-bit]	Writable	Displays the dot matrix LED display mode.	<ul style="list-style-type: none"> • 0: USR (user specification character) (initial value) • 1: ENo. (Error code) • 2: IP1 (CH1 IP address) • 3: IP2 (CH2 IP address) • 4: BUF1 (DB buffer 1 use rate) • 5: BUF2 (DB buffer 2 use rate)

*1 'S_DEVICE_STATUS17' to 'S_DEVICE_STATUS64' can be used for an RD81MES96N only.

*2 When specifying a character other than a usable one, it is converted into a period (U+002E) and displayed.

Constant

The following tables show the data type specifications for a constant according to the classification.

Data type

The data type of the constant is checked by MES Interface Function Configuration Tool not an MES interface module.

Integer

Data type	Usable character	Minimum value	Maximum value	Maximum number of characters
Integer	-, 0, 1, 2, 3, 4, 5, 6, 7, 8, 9	-2147483648 (Minimum value of a signed 32-bit integer)	4294967295 (Maximum value of an unsigned 32-bit integer)	11 characters

Real number

Data type	Usable character	Minimum of the absolute values	Maximum of the absolute values	Maximum number of significant digits in the mantissa part	Maximum number of characters
Real number	-, E, .(decimal point), 0, 1, 2, 3, 4, 5, 6, 7, 8, 9	2.22507385850721E-308	1.79769313486231E308	15 digits	22 characters*1

*1 '-123.456789012345e-222' and '0.00000123456789012345' etc. can be set. '1.23456789012345000000' etc. cannot be set.

Character string

Data type	Usable character	Maximum length of character string
Character string [Unicode]	Printable characters including the blank (U + 0020) (Escape sequences are handled without converting into control characters. (\n, etc.))	255 characters

Macro

The data, of which a value is not determined at the job setting such as a date and time when the trigger condition is satisfied, is set with a macro name and replaced to data in an MES interface module.

The following tables show the specifications for a macro according to the classification.

Macro list

■Time at trigger monitoring

Data type	Description
Date and time	A date and time when the monitoring of a trigger condition starts.

■Time at trigger ON

Data type	Description
Date and time	A date and time when the trigger condition of a job is satisfied.

■Job execution start date and time

Data type	Description
Date and time	A date and time when the first action of a job starts.

■Server date and time

Data type	Description
Date and time	<p>A server date and time at DB field insertion/update.</p> <ul style="list-style-type: none"> • Outputs the value as an identifier of the macro to DB Connection Service. • There is no data type, because values are not used in an MES interface module. • It is treated as a date and time when checking the setting for the data assignment function in MES Interface Function Configuration Tool. • It can be used when selecting "Connection via Service" for "Access Type."

■Failure Action No.

Data type	Description
Word [unsigned]/Bit string [16-bit]	<p>An action number executed when a processing failed.</p> <ul style="list-style-type: none"> ■Upper 8 bits (processing type) <ul style="list-style-type: none"> • 1: Pre-processing • 2: Main processing • 3: Post-processing ■Lower 8 bits (action number) <ul style="list-style-type: none"> • 1 to 20: Action number

■Date and time character string

Data type	Description		
Character string [Unicode] Up to 64 characters	<p>A character string converted the time, when the trigger condition is satisfied, based on the specified format.</p> <p>Specifies a format character string when using a macro.</p> <p>The following characters in the format character strings are replaced with numerical values. (Example) YYYY-MM-DD hh:mm:ss.fff OFFSET → 2015-02-01 13:05:43.532 +09:00</p> <table border="0"> <tr> <td style="vertical-align: top;"> <ul style="list-style-type: none"> ■Characters to be replaced <ul style="list-style-type: none"> • YYYY • YY • MM • DD • hh • mm • ss • fff • OFFSET </td> <td style="vertical-align: top;"> <ul style="list-style-type: none"> ■Values to be replaced (When a value has a small number of the digits, '0' is added to the head.) <ul style="list-style-type: none"> • Year (4 digits) • Year (last 2 digits) • Month (01 to 12) • Day (01 to 31) • Hour (00 to 23) • Minute (00 to 59) • Second (00 to 59) • Decimal part of second: Millisecond (000 to 999) • UTC offset [+ -]xx:xx </td> </tr> </table>	<ul style="list-style-type: none"> ■Characters to be replaced <ul style="list-style-type: none"> • YYYY • YY • MM • DD • hh • mm • ss • fff • OFFSET 	<ul style="list-style-type: none"> ■Values to be replaced (When a value has a small number of the digits, '0' is added to the head.) <ul style="list-style-type: none"> • Year (4 digits) • Year (last 2 digits) • Month (01 to 12) • Day (01 to 31) • Hour (00 to 23) • Minute (00 to 59) • Second (00 to 59) • Decimal part of second: Millisecond (000 to 999) • UTC offset [+ -]xx:xx
<ul style="list-style-type: none"> ■Characters to be replaced <ul style="list-style-type: none"> • YYYY • YY • MM • DD • hh • mm • ss • fff • OFFSET 	<ul style="list-style-type: none"> ■Values to be replaced (When a value has a small number of the digits, '0' is added to the head.) <ul style="list-style-type: none"> • Year (4 digits) • Year (last 2 digits) • Month (01 to 12) • Day (01 to 31) • Hour (00 to 23) • Minute (00 to 59) • Second (00 to 59) • Decimal part of second: Millisecond (000 to 999) • UTC offset [+ -]xx:xx 		

3 FUNCTION LISTS

This chapter shows the function lists of an MES interface module, MES Interface Function Configuration Tool, Project File Conversion Tool, DB Connection Service, and DB Connection Service Setting Tool.

For details on each function, refer to the following:

📖 MELSEC iQ-R MES Interface Module User's Manual (Application)

3.1 Function Overview

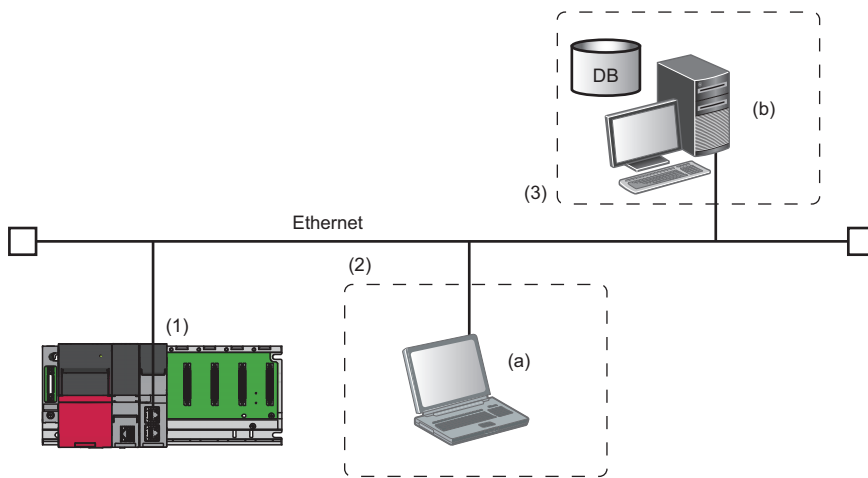

An MES interface module links information between production equipment and host information systems by using each function of MES Interface Function Configuration Tool, Project File Conversion Tool, DB Connection Service, and DB Connection Service Setting Tool.



Name		Description	Reference
(1)	MES interface module	A module for linking information between production equipment and host information systems	Page 53 MES Interface Module
(2)	Configuration personal computer	(a) MES Interface Function Configuration Tool	Page 54 MES Interface Function Configuration Tool
		Project File Conversion Tool	Page 55 Project File Conversion Tool
(3)	Server	(b) DB Connection Service	Page 55 DB Connection Service
		DB Connection Service Setting Tool	Page 55 DB Connection Service Setting Tool

3.2 MES Interface Module

This section shows the function list of an MES interface module.

Function		Description	
Data input/output function	Device memory input/output function	Device memory input function	To read data in the device memory. Data used for trigger judgment is read, and then data used for job is read.
		Device memory output function	To write data written to a device tag in a job to the device memory.
	DB input/output function	DB record input/output function	To read/write data in the database of the host information system.
		DB buffering function	To buffer data sent to the database and resend it after recovery when the data cannot be linked due to the disconnection of the network between an MES interface module and the database or failure of the database, etc.
	Variable input/output function	System variable input/output function	To read/write data of a system variable storing the operating status of a module such as the status of an MES interface module.
		User variable input/output function	To read/write data from/to a user variable (local variable/global variable) which can be registered arbitrarily. • Local variables: Available in a same job • Global variables: Available between jobs
External communication client function	Program execution function	To execute a program on an application server via DB Connection Service.	
Information linkage function	Trigger condition monitoring function	To monitor values such as a time or device tag component, and start a job when a trigger condition changes from false to true (the condition is satisfied).	
	Job execution control function	To control job execution such as the availability of job execution depending on the number of jobs that can be executed at the same time.	
	Trigger buffering function	To buffer information required for job execution in a trigger buffer as trigger information.	
	One-shot execution function	To execute any job at any timing.	
	Data operation and processing function	To perform the substitution ^{*1} , basic arithmetic operations, remainder, and character string operation of a device tag component value.	
	Data linkage function	Data assignment function	To assign and link a device tag, DB data, and a variable which are read by using the data input/output function.
	Communication test function	To check the communication setting between an MES interface module and an access target device or access target server.	
	DB information browse function ^{*2}	To access a database according to a request from MES Interface Function Configuration Tool and acquire a DB table name, DB field name, data type of a DB field, stored procedure name, and argument information of a stored procedure.	
External communication server function	REST server function	To enable job-related operations and job information acquisition from an REST client. In addition, the XML processing function of a MELSEC-Q series MES interface module is supported.	
Security function	User authentication function	To prevent illegal access to an MES interface module by setting a user name and password.	
Other functions	SD memory card management function	To format an SD memory card.	
	Self-diagnostics function	To diagnose whether an MES interface module operates normally.	
	Online module change function	To replace a module with another without stopping a running system. For the procedure, refer to the following:  MELSEC iQ-R Online Module Change Manual	
	Firmware update function ^{*2}	To update the firmware of an MES interface module. For details, refer to the following:  MELSEC iQ-R Module Configuration Manual	
	Initialization function ^{*2}	To initialize a firmware update-prohibited password retained in an MES interface module.	

*1 Array tag components can be substituted only for an RD81MES96N.

*2 Can be used only for an RD81MES96N.

3.3 MES Interface Function Configuration Tool

This section shows the function list of MES Interface Function Configuration Tool.

Function		Description	
Project file function	New	To create a new project file.	
	Open	To open a project file.	
	Save	To save a project file.	
	Import	To import individual settings of another project file. Setting items to be imported can be selected.	
	Open CSV files	To open a CSV file and apply data to a project being edited.	
	Save CSV files	To save a project being edited to a CSV file.	
Information linkage setting function	Project setting function	To display the home screen of MES Interface Function Configuration Tool to start setting.	
	Network setting function	To set two Ethernet ports and a common host name.	
	Device access setting function	Access target device setting	To specify a device type or a CPU number in a multiple CPU system, and set a network communication route to access from an MES interface module.
		Device tag setting	To set a logic name for the device memory of an access target device as a device tag component. A group of device tag components can also be set as a device tag. For a device tag component, global labels and common device comments set in an engineering tool project can be imported.
	Server access setting function	Access target server setting	To set the type of a server, network information, and user authentication information.
		Access table/procedure setting	To set a logic name for the table/procedure and field/procedure arguments of a database as an access table/procedure and access field/procedure arguments.
	DB information browse function	Browse DB table information	To set the DB table name of an access target table by communicating with a database and browsing the DB table name.
		Browse DB field information	To set the DB field name and data type of an access target table by communicating with a database and browsing the DB field name and data type.
		Browse DB procedure information	To set the stored procedure name and argument information by communicating with a database and browsing the stored procedure name and stored procedure argument information.
	Job setting function	Job configuration setting	To set the necessity of the pre/post-processing, etc.
		Trigger condition setting	To set a condition to start a job. Trigger buffering can also be set when trigger conditions are satisfied at a time.
		Read data setting at trigger judgment	To set a method and interval for reading data required to evaluate a trigger condition. Whether to include other data used in a job can also be set.
		Pre-processing setting	To set the pre-processing performed before DB communication.
		Main-processing setting	To set the main-processing to perform DB communication.
		Post-processing setting	To set the post-processing performed after DB communication.
		Verification setting	To set a function used when verifying a job, such as job execution inhibition or log output.
	Action setting function	DB communication action setting	To set a target table and type of DB communication (Select, etc.), and data assignment of DB communication data and an MES interface module.
		External communication action setting	To set a target server for program execution or a command actually executed, etc.
		Operation action setting	To set an operation type (basic arithmetic operations, etc.) and target data (a device tag or variable) in an MES interface module for operation.
	Option setting function	Variable setting	To set the following variables as variables of an MES interface module. <ul style="list-style-type: none"> Local variable using the area for a job Global variable using the user area of the buffer memory
DB buffer setting		To set the capacity, method to resend data in a DB buffer, notification related to other DB buffers, and request for using the DB buffering function.	
Security setting		To set the user authentication for connecting to an MES interface module.	
Dot matrix LED setting		To set the settings related to the dot matrix LED display.	

Function		Description	
Online function	Online data operation function	To perform the following operations to an MES interface module. <ul style="list-style-type: none"> Specify Connection Destination: To set an MES interface module of a connection destination. Read: To read a setting from an MES interface module, and overwrite a project file being edited. Write: To write a project file being edited to an MES interface module. Verify: To verify the contents of a project file being edited with those of a setting in an MES interface module. Update setting: To apply a written setting to an MES interface module. 	
	Diagnostics function	To check various kinds of information of an MES interface module and execution results and detailed contents (actual values, etc.) of jobs for each action, and perform diagnosis and take measures.	
	Management function	Firmware update management ^{*1}	To display and change the prohibition state of the firmware update set in an MES interface module.
	One-shot execution function	To request one-shot execution of a job specified for an MES interface module and display the detailed log.	
Help function	MELSEC iQ-R MES interface module help		To open MELSEC iQ-R MES Interface Module User's Manual.
	Connection to MITSUBISHI ELECTRIC FA Global Website		To connect to the Mitsubishi Electric FA website.
	Version information		To display the version information of MES Interface Function Configuration Tool.

*1 Can be used only when an RD81MES96N is connected.

3.4 DB Connection Service

This section shows the function list of DB Connection Service.

Function	Description
DB connection function	To receive a DB communication request from an MES interface module, perform a DB communication via ODBC, and return the result of a DB communication to an MES interface module.
Program execution function	To receive a program execution request from an MES interface module and execute a command directly to an application server. It is also used to return an execution result to an MES interface module.
DB information browse function	To acquire and return the table information or stored procedure information of a database in response to a request from the table/procedure information browse function of MES Interface Function Configuration Tool.
Security function	To restrict an IP address and service port to limit connectable MES interface modules or applications.
Log output function	To output a communication log with an MES interface module or an SQL failure log when SQL execution fails.

3.5 DB Connection Service Setting Tool

This section shows the function list of DB Connection Service Setting Tool.

Function	Description
DB Connection Service setting function	To set and change the settings of DB Connection Service.
Import/export function	To import/export DB Connection Service setting information from/to a file.
Help function	To display the product information of DB Connection Service Setting Tool and connect to the Mitsubishi Electric FA website.

3.6 Project File Conversion Tool

This section shows the function list of Project File Conversion Tool.

Function	Description
Project file conversion function	To convert a project file of a MELSEC-Q series MES interface module to one of a MELSEC iQ-R series MES interface module.

4 PROCEDURE BEFORE OPERATION

This chapter shows the procedure before operation of an MES interface module.

Operating procedure

1. Starting a server

Start a server used as a database server or application server.

(☞ Page 56 Starting a Server)

2. Starting an MES interface module and a configuration personal computer

Start an MES interface module, and a configuration personal computer on which MES Interface Function Configuration Tool is used.

(☞ Page 59 Starting an MES Interface Module and Configuration Personal Computer)

4.1 Starting a Server

—: No operation required

Step	Database server (Access type: Direct DB connection)	Database server (Access type: Connection via service)	Application server ^{*1}
1	Create a table in a relational database. ^{*2}		Prepare an application program to run.
2	—	Configure the ODBC setting for the database.	Create an account for running the application program.
3	—	Install DB Connection Service and DB Connection Service Setting Tool. ^{*3}	
4	—	Change the setting for DB Connection Service.	
5	Start the operation.		

*1 Set it when using the program execution function. (☞ MELSEC iQ-R MES Interface Module User's Manual (Application))

*2 After installing a relational database, restart a server then create a table.

*3 ☞ Page 83 INSTALLATION AND UNINSTALLATION

Point

- Be sure to log on to an application server with a created account for application program execution once before using the program execution function on the application server.
- For using an application server when using the program execution function, log on with an account other than a created one for the application program execution function.

DB Connection Service/DB Connection Service Setting Tool

The information linkage function of an MES interface module can be used by installing DB Connection Service on a server. For details on DB Connection Service and DB Connection Service Setting Tool, refer to the following:

 MELSEC iQ-R MES Interface Module User's Manual (Application)

Point

- DB Connection Service must be installed on all database servers and application servers accessed from an MES interface module.
- When using DB Connection Service on an application server, an account for application program execution must be created in advance.
- The settings of DB Connection Service can be changed in DB Connection Service Setting Tool.

ODBC setting for database

When using DB Connection Service on a database server, the ODBC setting for a database used must be set in advance. For the ODBC setting method, refer to the following:

 Page 116 ODBC Setting

■ODBC driver

Only the ODBC driver installed at the same time as the installation of the database can be used except for the cases below. 'Microsoft Access Driver(*.mdb)', 'Microsoft ODBC for Oracle', and 'SQL Server' which are supplied with the operating system cannot be used.

- When connecting the database of Oracle using any of the following DB Connection Services, the 32-bit version of Oracle Client for the ODBC setting and the ODBC driver of Oracle need to be installed. Install them as necessary.
The DB Connection Service which is stored to MX MESInterface-R whose software version is '1.03D' or earlier.
The DB Connection Service (32-bit) which is stored to MX MESInterface-R whose software version is '1.04E' or later.
- When using PostgreSQL for a database, install an ODBC driver.

■ODBC Data Source Administrator

When the installation method of Access is Click-to-Run (C2R), install a Microsoft Access database engine first, then start "ODBC Data Source Administrator."

If starting "ODBC Data Source Administrator" without installing an Access database engine, the ODBC driver is not displayed. The version of Access database engine to be installed differs depending on the version of Access to be used. Install an Access database engine with any of the versions listed in the table below.

Due to changes in Access specifications, whether an Access database engine must be installed and its version may be changed. For details, contact Microsoft Corporation.

Access version	Access database engine version
2010	___*1
2013	___*1
2016	2010
2019	2010
2021*2	2013

*1 No Click-to-Run (C2R)

*2 Including LTSC

Startup method

Operating procedure

1. Start DB Connection Service Setting Tool from "MELSOFT" in Windows Start.
2. When using an operating system with the user account control function, a warning message relating to 'DBCnctConf.exe' appears. Click "Allow" or the [Yes] button.

Point

- To prevent a warning message from being displayed, refer to the following:
 📖 MELSEC iQ-R MES Interface Module User's Manual (Application)
- The setting contents of DB Connection Service, which is currently in operation, are displayed during startup.

Screen configuration

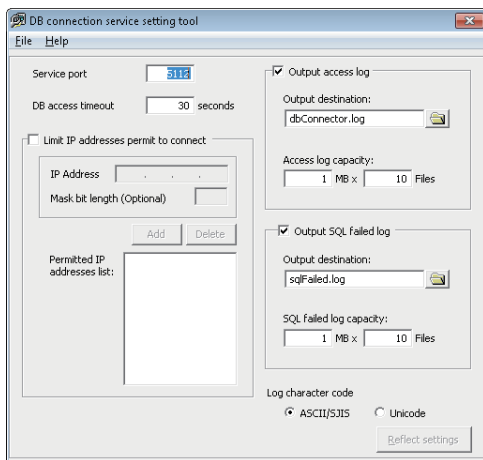

Menu configuration

The following table lists the commands assigned to the menu bar.

Menu name		Description
File	Import	To import a saved file.
	Export	To export setting contents of DB Connection Service Setting Tool to a file.
	End	To end DB Connection Service Setting Tool.
Help	Product information	To display the product information of DB Connection Service Setting Tool.
	Connection to MITSUBISHI ELECTRIC FA Global Website	To display the Mitsubishi Electric FA website.

4.2 Starting an MES Interface Module and Configuration Personal Computer



Start a server before starting an MES interface module and configuration personal computer.

—: No operation required

Step	MES interface module ^{*1}	Configuration personal computer
1	Mount an MES interface module on a base unit. ^{*2}	Install MES Interface Function Configuration Tool. ^{*3}
2	Switch the dot matrix LED display mode switch to the right (SHOW).	—
3	Connect the MES interface module to the configuration personal computer on a 1:1 basis. ^{*4}	—
4	Turn the power of the system ON. (The ERR LED flashes because an SD memory card is not inserted.)	—
5	Insert an SD memory card. ^{*5}	—
6	—	Start MES Interface Function Configuration Tool.
7	—	Configure the network setting for the MES interface module. ^{*6}
8	—	Specify the default IP address, user name, and password for the MES interface module in the "Specify Connection Destination" screen. ^{*6*7}
9	—	Format the SD memory card as necessary. ^{*6}
10	—	Write the settings to the MES interface module to apply them. ^{*6}
11	Connect the MES interface module and configuration personal computer to a network according to the network setting configured in MES Interface Function Configuration Tool.	—
12	—	Configure the setting for the MES interface module. ^{*6}
13	—	Change the setting for the connection destination according to the network setting for the MES interface module. ^{*6}
14	—	Write the settings to the MES interface module to apply them. ^{*6}
15	—	Check the operation result, and review the settings as necessary.
16	Start the operation.	—

*1 Perform the self-diagnostic test as necessary. (MELSEC iQ-R MES Interface Module User's Manual (Application))

*2 Do not use an electric screwdriver to attach and remove module fixing screws.

*3 Page 83 INSTALLATION AND UNINSTALLATION

*4 Use the Ethernet port (CH1) of the MES interface module.

*5 Page 69 Insertion/removal method of an SD memory card

*6 For the operation methods of MES Interface Function Configuration Tool, refer to the following:

MELSEC iQ-R MES Interface Module User's Manual (Application)

*7 Specify the following items (default network setting and security setting) for connection in the "Specify Connection Destination" screen of MES Interface Function Configuration Tool.

· Connection destination setting

IP address: 192.168.3.3

· User authentication setting (optional)

Use the user authentication : Select the checkbox.

User name: RD81MES96

Password: MITSUBISHI



To change the setting for the MES interface module, perform steps 12 to 14.

Network setting for connection

The following shows the network setting for a configuration personal computer when connecting the computer to an MES interface module via a hub.

Operating procedure

1. Set the same value for the network portion of the IP addresses for a configuration personal computer and an MES interface module.

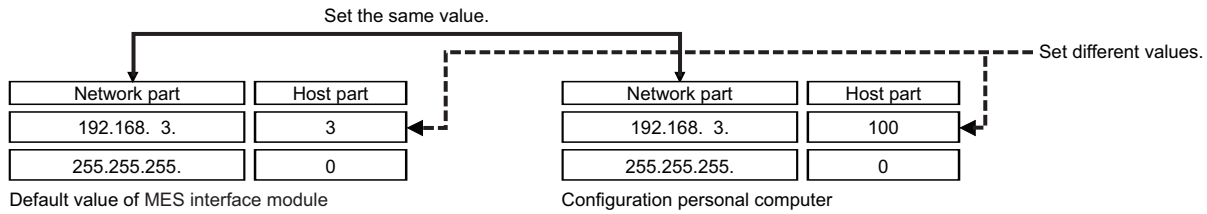

2. Set the network setting for the configuration personal computer in the "Internet Protocol Version 4 (TCP/IPv4) Properties" screen.

(Example) Microsoft Windows 7 Ultimate

- 1 Select [Control Panel] ⇒ [Network and Internet] ⇒ [Network and Sharing Center] ⇒ [Change adapter settings].
 - 2 Select and right-click [Local Area Connection], then select [Properties] from the shortcut menu.
 - 3 Select "Internet Protocol Version 4 (TCP/IPv4)" in the "Local Area Connection Properties" screen, and click the [Property] button.
 - 4 The "Internet Protocol Version 4 (TCP/IPv4) Properties" screen appears.
3. Restart the personal computer to enable the network setting.

MES Interface Function Configuration Tool

MES Interface Function Configuration Tool is a tool to set various settings required for operating an MES interface module. Various operations such as checking each status and the working history, and stopping or restarting MES interface module can be performed.

For details on MES Interface Function Configuration Tool, refer to the following:

📖 MELSEC iQ-R MES Interface Module User's Manual (Application)

Startup method

Operating procedure

Start MELSEC iQ-R Series MES Interface Function Configuration Tool from "MELSOFT" in Windows Start.

4

Screen configuration

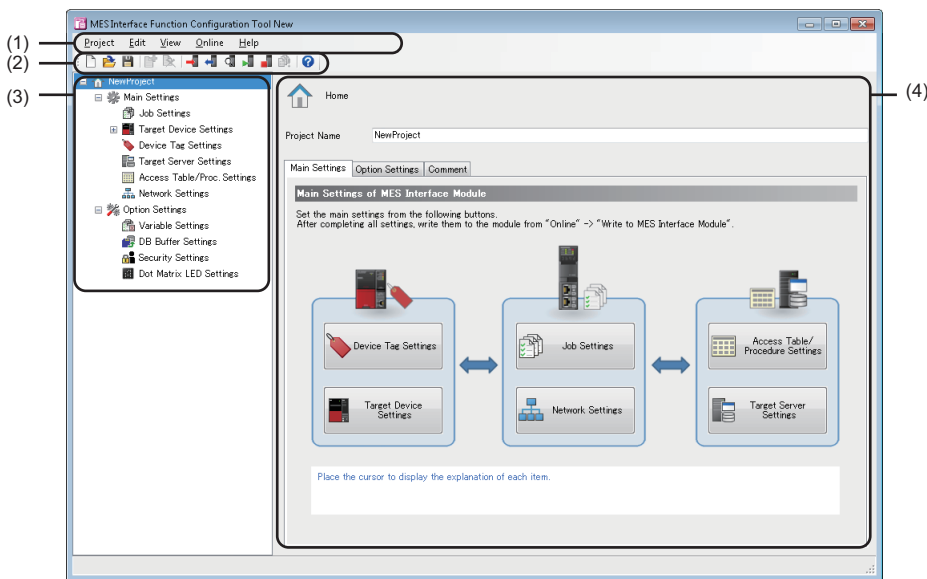

- (1) Menu bar
- (2) Toolbar
- (3) Edit item tree
- (4) Setting edit screen

■ Menu configuration

The following table lists the commands assigned to the menu bar.

Menu name		Description	
Project	New	To discard a project being edited and create a new project.	
	Open	To open a project file saved in the local disk.	
	Save	To overwrite and save an edited project to a file.	
	Save As	To save an edited project under a new file name.	
	Import	Project File	To select and import setting items from a project file saved in the local disk.
	Recently used Project file	To select and open a project file which was recently used in MES Interface Function Configuration Tool.	
	Exit	To exit MES Interface Function Configuration Tool.	
Edit	Add Item	To add an item to a setting selected in the edit item tree. The index of the item to be added is the smallest number of each item.	
	Delete Item	To delete an item selected in the edit item tree.	
	Add CopyItem	To copy and add an item selected in the edit item tree. The index of the item to be added is the smallest number of each item.	
	Update Data Related to Global Label	To update data to the latest value when a value of an import source global label is changed.	
View	Tool Bar	To select whether to display the toolbar.	
	Status Bar	To select whether to display the status bar.	
Online	Specify Connection Destination	To configure the setting for connecting to an MES interface module.	
	Read from MES Interface Module	To read a setting from an MES interface module.	
	Write to MES Interface Module	To write a setting to an MES interface module.	
	Verify with MES Interface Module	To compare a setting written to an MES interface module with one in MES Interface Function Configuration Tool.	
	Update setting of MES Interface Module	To apply a written setting to an MES interface module.	
	Diagnose MES Interface Module	To connect to an MES interface module and perform diagnosis of the module and various operations.	
	Manage MES Interface Module	To display information on an MES interface module and perform operations to it.	
	One-Shot Execution	To execute the one-shot to a selected job after the message "Executes the one-shot. Do you really want to continue?" appears. An execution result is notified in the detailed log display regardless of the verification setting.	
	Communication Test to Target Device	To perform a communication test for a selected access target device.	
	Communication Test to Target Server	To perform a communication test for a selected access target server.	
Help	MELSEC iQ-R MES Interface Module Help	To open the user's manual of an MES interface module.	
	Connection to MITSUBISHI ELECTRIC FA Global Website	To display the Mitsubishi Electric FA website.	
	Version Information	To display the version information (product information) of MES Interface Function Configuration Tool.	

■ Toolbar configuration

The following table lists the commands assigned to the toolbar.

Character string for the tooltip display	Item displayed on the status bar	Description
New (Ctrl+N)	Creates new project.	To discard a project being edited and create a new project.
Open (Ctrl+O)	Opens existing project.	To open a saved project file.
Save (Ctrl+S)	Overwrites and saves the project.	To overwrite and save an edited project to a file.
Add Item (Ctrl+Ins)	Adds the setting item.	To add a setting item of a type selected in the edit item tree.
Delete Item (Ctrl+Del)	Deletes the setting item.	To delete a setting item selected in the edit item tree.
Write to MES Interface Module	Writes the settings to MES interface module.	To write a setting to an MES interface module.
Read from MES Interface Module	Reads the settings from MES interface module.	To read a setting from an MES interface module.
Diagnose MES Interface Module	Displays the diagnostic screen.	To connect to an MES interface module and perform diagnosis and various operations.
Restart the MES Interface Function	The MES interface function is restarted.	To connect to an MES interface module and restart the stopped MES interface function.
Stop the MES Interface Function	The MES interface function is stopped.	To connect to an MES interface module and stop the running MES interface function.
One-Shot Execution	Performs the one-shot execution.	To perform one-shot execution of a job.
Open MELSEC iQ-R MES Interface Module Help	Opens MELSEC iQ-R MES interface module help.	To open the user's manual of an MES interface module.

Operations in the edit item tree

The edit item tree shows overall project settings in a tree.

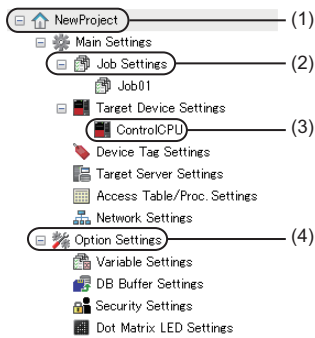

- (1) Project root
- (2) Setting category
- (3) Item
- (4) Setting group

■Selecting an item

1. Double-click the project root or each setting category to display an item.
2. The editing screen of the selected item is displayed on the detailed setting editing screen by selecting the displayed item.

■Adding an item

1. Select an item to be added or a setting category, and perform either of the following operations to add the item.
 - Click 'Add Item' ().
 - Select [Edit] ⇒ [Add Item].
2. When the item is added successfully, the added item is selected automatically and the screen is switched to the editing screen of the added item.

Point

The number of items that can be added is limited depending on the setting type. For details, refer to the description of each item.

■Deleting an item

Select an item to be deleted, and perform either of the following operations to delete the item.

- Click 'Delete Item' ().
- Select [Edit] ⇒ [Delete Item].

Point

- The item cannot be deleted if the selected item is being used in other item.
Check where the item is being used and stop using it in other item according to the displayed error dialog box before deleting.
- The first item (default name: ControlCPU) in the list of "Target Device Settings" cannot be deleted.

■ Copying and adding an item

1. Select an item to be added, and select [Edit] ⇒ [Add CopyItem] to copy and add the item.
2. When the item is added successfully, the added item is selected automatically and the screen is switched to the editing screen of the added item.

Point

The number of items that can be added is limited depending on the setting type. For details, refer to the description of each item.

■ Moving an item

Drag and drop an item to move it.

Point

- Items can be moved only within each setting of the following: "Job Settings," "Target Device Settings," "Device Tag Settings," "Target Server Settings," and "Access Table/Proc. Settings."
 - The first item (default name: ControlCPU) in the list of "Target Device Settings" cannot be moved.
-

Common operation

The following shows the common operations of MES Interface Function Configuration Tool.

■Data setting in the data selection control tree

Perform a simple assignment for the single item such as device tag, variable, and constant.

Operating procedure

1. Click a cell to enter data.

(Example) "DB Communication Action Setting" screen

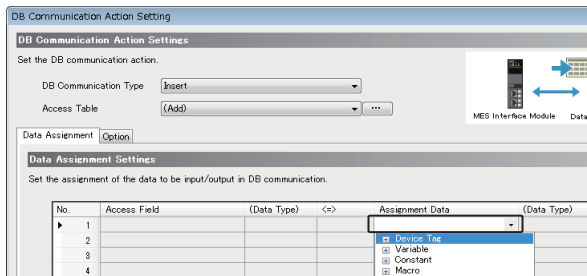

2. Select data to set.

Item			Description
Device Tag	(Device tag name)	(Device tag component name)	Set a selected device tag component.
		[Edit]	Select this to open the "Device Tag Setting" screen of a selected device tag.
	[Add]		Select this to open the "Device Tag Setting" screen for setting a new device tag.
Variable	Local Variable	(Local variable name)	Set a selected local variable.
		[Edit]	Select this to open the "Variable Settings" screen.
	Global Variable	(Global variable name)	Set a selected global variable.
		[Edit]	Select this to open the "Variable Settings" screen.
System Variable	(System variable name)	Set a selected system variable.	
Constant	[Integer]		Select this to open the "Integer Type Constant Settings" screen.
	[Real Number]		Select this to open the "Real Number Type Constant Settings" screen.
	[Character String (Unicode)]		Select this to open the "Character String Type Constant Settings" screen.
Macro	Time at Trigger Monitoring		Set a selected macro.
	Time at Trigger ON		
	Job Execution Start Date and Time		
	Server Date and Time		
	Failure Action No.		
	[Date and Time Character String]		Select this to open the "Date and Time Character String Macro Settings" screen.

- Setting a constant or macro

The following shows the procedure for setting a constant or macro used as data.

Operating procedure

1. Select "[Integer]," "[Real Number]," "[Character String (Unicode)]," or "[Date and Time Character String]" in the data selection control tree to enter a setting value.
2. Click the [OK] button.

Parameter setting

The mode settings, module operations forced change settings, target device response monitoring time settings, and module READY signal delay time settings for an MES interface module can be configured in the parameter setting of an engineering tool.

For details on the parameter setting, refer to the following:

📖 MELSEC iQ-R MES Interface Module User's Manual (Application)

Point

- CW Configurator is not supported.

Startup method

4

Operating procedure

Start GX Works3 from "MELSOFT" in Windows Start.

Parameter setting

Operating procedure

1. Create a new project.

👉 Select [Project] ⇒ [New] from the menu.

2. Select an item for each "Series", "Type", and "Program Language", and click the [OK] button.

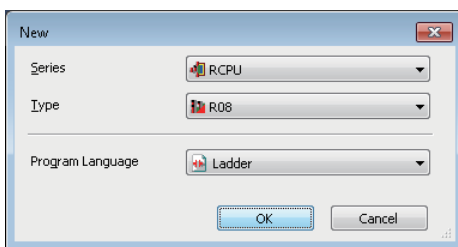

3. Set whether to use module labels and sample comments, and click the [OK] button.

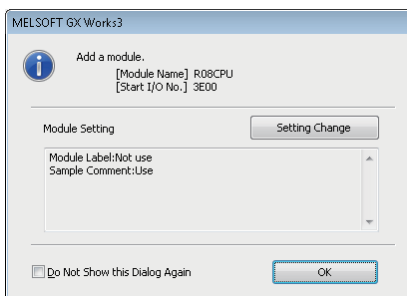

4. Display the "Add New Module" screen.

👉 [Navigation window] ⇒ [Parameter] ⇒ [Module Information] ⇒ right-click ⇒ [Add New Module]

5. Add an MES interface module.

- Select "Information Module" for "Module Type" and "RD81MES96N" or "RD81MES96" for "Module Name" in the "Add New Module" screen.

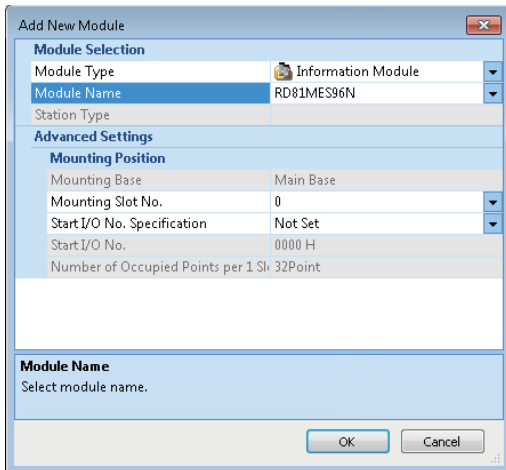

Item	Description
Module Type	Select "Information Module."
Module Name	Select "RD81MES96N" or "RD81MES96."
Mounting Slot No.	Select the slot number where an MES interface module is mounted.
Start I/O No. Specification	Select "Not Set" when not specifying the start I/O number of an MES interface module; otherwise, select "Set."
Start I/O No.	When selecting "Set" for "Start I/O No. Specification," enter the start I/O number of an MES interface module.

6. Set whether to use module labels and sample comments, and click the [OK] button.

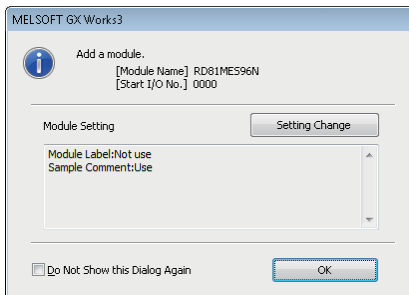

7. Set the module parameters of the MES interface module.

- [Navigation window] ⇨ [Parameter] ⇨ [Module Information] ⇨ target module

8. After setting the parameters, write the setting to a CPU module from an engineering tool.

9. Reset the CPU module or turn the power OFF and ON to apply the setting.

4.3 SD Memory Card

This section shows an SD memory card used for an MES interface module.

For supported SD memory cards and considerations, refer to the following:

☞ Page 75 SD memory card (sold separately, required)

☞ Page 70 Considerations for using an SD memory card

Insertion/removal method of an SD memory card

Make sure to stop file access when removing or replacing an SD memory card.

If the power is OFF and the file access is not stopped, turn the power ON and stop the file access.

Insertion procedure

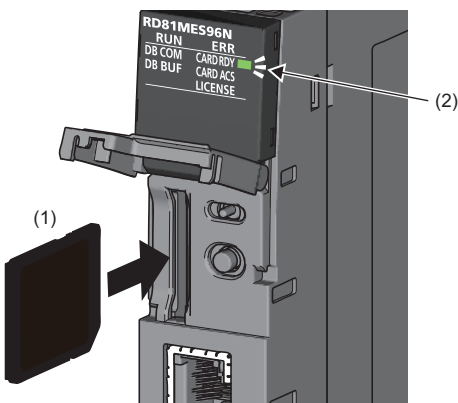

1. Insert an SD memory card (1) straight into the SD memory card slot with its cutout pointed down.
Make sure it is not uplifted after inserting it.
If it is inserted insufficiently, it may cause malfunction due to poor contact.
2. The CARD RDY LED (2) keeps flashing until the SD memory card is ready to be used. Once the CARD RDY LED (2) turns ON, the SD memory card can be used.

Removal procedure

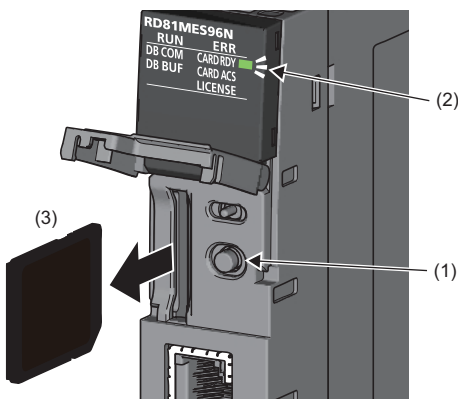

1. Press the SD memory card lock switch (1) for one second or longer to stop the SD memory card access.
2. The CARD RDY LED (2) is flashing while stopping the file access, and it turns OFF once the processing is completed.
3. Push the SD memory card (3) in once, and pull it out straight.

Considerations for using an SD memory card

- For inserting or removing an SD memory card while the power is ON, follow the procedure.
Failure to do so may cause data corruption in the SD memory card.
- If there is any function accessing an SD memory card when removing the SD memory card, the CARD RDY LED turns OFF after the access is completed.
Therefore, the time until the CARD RDY LED turns OFF differs for each function.

SD memory card to be used

Use a supported SD memory card. (☞ Page 75 SD memory card (sold separately, required))

If another SD memory card is used, data in the SD memory card may be corrupted or the system may stop.

When using an SD memory card used for other uses, make sure to format the card in MES Interface Function Configuration Tool. (📖 MELSEC iQ-R MES Interface Module User's Manual (Application))

Formatting an SD memory card

Format an SD memory card in the "SD Memory Card Diagnostics" screen of MES Interface Function Configuration Tool. (📖 MELSEC iQ-R MES Interface Module User's Manual (Application))

Do not format an SD memory card with standard format commands of an operating system such as Windows.

Turning the power OFF or resetting a CPU module

When the CPU module is powered OFF or reset while writing data to an SD memory card, the processing to write data to the SD memory card may not be completed. It may cause a loss of data during DB buffering, corruption of data in the SD memory card that is being accessed, or occurrence of a file system error. The file is automatically recovered when the MES interface module is powered ON again, but it will not succeed in some cases.

The operation, powering OFF or resetting the CPU module after stopping file access, should be considered. For the important data, create backups periodically.

Do not power OFF or reset the CPU module since an SD memory card can be formatted while stopping the file access.

Removing or replacing an SD memory card

Make sure to stop file access before removing or replacing an SD memory card. (If the power is OFF and the file access is not stopped, turn the power ON and stop the file access.)

Otherwise, the data in the SD memory card being accessed may be corrupted or a file system failure may occur.

Check that the SD memory card is not being formatted since it can be formatted while stopping the file access.

The setting of MES interface module is saved in an SD memory card. Therefore, write the setting after the replacement as necessary.

Files in an SD memory card

Do not edit a file or folder in an SD memory card directly by inserting the card in a personal computer.

Make sure to use an SD memory card by inserting in an MES interface module.

SD memory card life

An SD memory card has a life (a limit on the number of times for writing data). For details, refer to the specification of an SD memory card to use.

Generally, an SD memory card life depends on the free capacity. Set the DB buffering capacity, which should be set by a user, so that the SD memory card has a sufficient free capacity. (An SD memory card can be used for long time with enough capacity.)

5 SYSTEM CONFIGURATION

This chapter shows the system configuration of an MES interface module.

5.1 System Configuration

Overall system configuration

The following figure shows the overall system configuration when using an MES interface module.

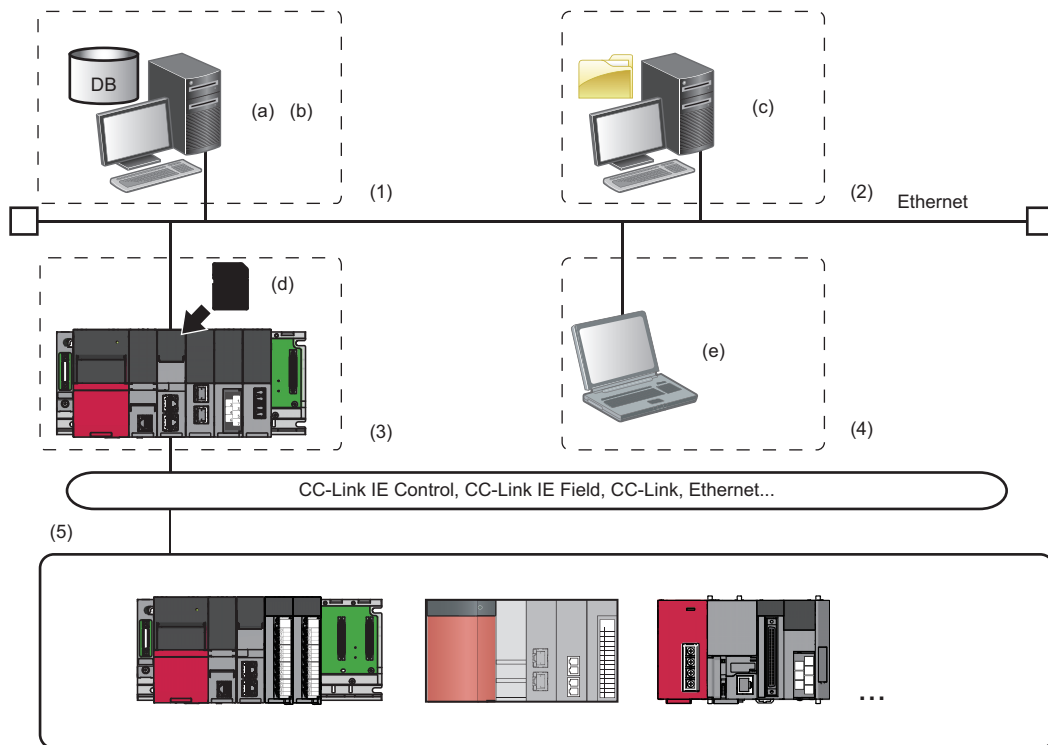

System configuration		Network	
(1) Database server	(a)	<ul style="list-style-type: none"> • DB Connection Service^{*1} • DB Connection Service Setting Tool^{*1} 	Ethernet
	(b)	<ul style="list-style-type: none"> • Oracle • Microsoft SQL Server • Microsoft Access • MySQL • PostgreSQL • MariaDB 	Ethernet
(2) Application server	(c)	<ul style="list-style-type: none"> • DB Connection Service • DB Connection Service Setting Tool 	Ethernet
(3) MES interface module	(d)	SD memory card (required)	CC-Link IE Control, CC-Link IE Field, CC-Link, Ethernet etc.
(4) Configuration personal computer	(e)	<ul style="list-style-type: none"> • MES Interface Function Configuration Tool^{*2} • Project File Conversion Tool 	Ethernet
(5) Programmable controller			CC-Link IE Control, CC-Link IE Field, CC-Link, Ethernet etc.

*1 No need to install it when "Direct DB Connection" is selected as an access route.

*2 When connecting to an RD81MES96N, use MES Interface Function Configuration Tool stored in MX MESInterface-R with software version '1.10L' or later.

- All devices and systems (a server, configuration personal computer, access target device, etc.) connectable via Ethernet can be connected to both Ethernet ports (CH1/CH2) of an MES interface module.
- Ethernet ports (CH1/CH2) cannot be connected to a same network.
- MES interface modules can be connected only by using LAN connection. Connection via the Internet is not available.
- For available CPU modules and the number of mountable ones, refer to the following:
 MELSEC iQ-R Module Configuration Manual

Software configuration of MX MESInterface-R

The following table shows the software stored in MX MESInterface-R.

Item	Description	
MX MESInterface-R	MES Interface Function Configuration Tool	Software that runs in a configuration personal computer and is used to configure various settings required for operating an MES interface module. In addition to the configuration, the following operations are performed. <ul style="list-style-type: none"> • Checking the operating status and working history of the MES interface function • Stopping/restarting the operation of the MES interface function • Creating settings of the MES interface function without modules
	Project File Conversion Tool	Software that runs in a configuration personal computer and converts a MELSEC-Q series MES Interface module project file to a MELSEC iQ-R series MES Interface module project file. This tool is automatically installed when MES Interface Function Configuration Tool is installed.
	DB Connection Service	Software that runs in a server and links a database with an MES interface module. (Required when linking with a database via ODBC of a personal computer with Windows.)
	DB Connection Service Setting Tool	Software that runs in a server and is used to change the operation of DB Connection Service.

System configurations for installation

The following shows the system configurations when installing each piece of software stored in MX MESInterface-R.

When installing MES Interface Function Configuration Tool

Install MES Interface Function Configuration Tool on a configuration personal computer.

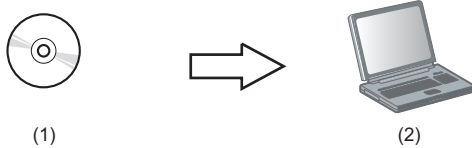

- (1) MX MESInterface-R: MES Interface Function Configuration Tool
 (2) Configuration personal computer: Commercially available product

When installing DB Connection Service and DB Connection Service Setting Tool

Install DB Connection Service and DB Connection Service Setting Tool in the server.

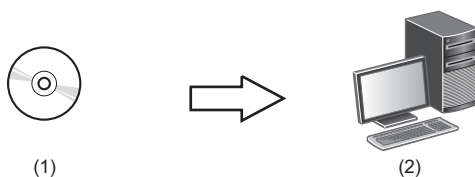

- (1) MX MESInterface-R: DB Connection Service/DB Connection Service Setting Tool
 (2) Server: Commercially available product

System configurations for the initial setting

The following shows the system configurations for the initial setting, maintenance, and inspection.

Direct connection



- (1) MES interface module
- (2) Ethernet (twisted pair cable)
- (3) Configuration personal computer

Connection via a hub

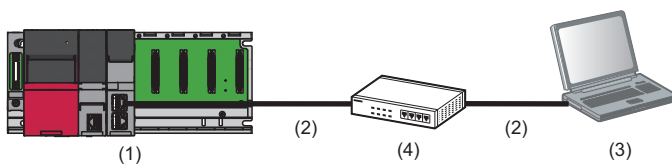

- (1) MES interface module
- (2) Ethernet (twisted pair cable)
- (3) Configuration personal computer
- (4) Hub

An MES interface module and a configuration personal computer can be connected directly or via a hub.

- For direct connection, the Ethernet port (CH1) of an MES interface module can directly be connected to a personal computer on a 1:1 basis with an Ethernet cable (twisted pair cable) without a hub. Connection can be established without specifying the IP address of an MES interface module.
- For connection via a hub, the IP address of an MES interface module needs to be specified.

Point

- For initial setting, only Ethernet port (CH1) can be used.
For using the Ethernet port (CH2), set the network in the "Network Settings" in MES Interface Function Configuration Tool. (MELSEC iQ-R MES Interface Module User's Manual (Application))

Considerations for direct connection

■When connecting to a LAN line

Do not perform communication by connecting to a LAN line directly.

This may increase the line load and affect the communications of other devices.

■When connecting via a hub

Do not set the direct connection while MES interface module and the configuration personal computer are connected via a hub.

■When applying to the condition where communication cannot be performed

The direct connection may not be performed in the following situations.

If it cannot connect, review the settings of MES interface module and the configuration personal computer.

- When all the bits of the MES interface module IP address corresponding to the '0' parts of the configuration personal computer subnet mask are ON or OFF
 - MES interface module IP address: 64.64.255.255
 - Configuration personal computer IP address: 64.64.1.1
 - Subnet mask on the configuration personal computer side: 255.255.0.0
- When all the bits of the MES interface module IP address corresponding to the host address of each class for the configuration personal computer IP address are ON or OFF
 - MES interface module IP address: 64.64.255.255
 - Configuration personal computer IP address: 192.168.0.1
 - Subnet mask on the configuration personal computer side: 255.0.0.0

Point

- The IP addresses of each class are as follows:
Class A: 0.x.x.x to 127.x.x.x, Class B: 128.x.x.x to 191.x.x.x, Class C: 192.x.x.x to 223.x.x.x
- Host addresses of each class are the '0' parts below.
Class A: 255.0.0.0, Class B: 255.255.0.0, Class C: 255.255.255.0

■When the Windows firewall setting is enabled

Disable the Windows firewall setting.

■When multiple IP addresses are enabled at the same time

The setting for direct connection cannot be set in the configurations where multiple IP addresses are enabled at the same time as shown below.

- When an IP address is assigned to each Ethernet port of the configuration personal computer with multiple Ethernet ports
- When a wireless LAN setting is enabled in addition to Ethernet port of the configuration personal computer
- When multiple IP addresses are assigned to one network device (Ethernet port) of the configuration personal computer

5.2 Connectable Devices

This section shows the connectable devices to an MES interface module.

SD memory card (sold separately, required)

One SD memory card is required for using an MES interface module.

Use one of the following SD memory cards manufactured by Mitsubishi Electric.

Model name	Capacity
NZ1MEM-2GBSD	2 GB
NZ1MEM-4GBSD	4 GB
NZ1MEM-8GBSD	8 GB
NZ1MEM-16GBSD	16 GB

When using an SD memory card, make sure to refer to the following: ( Page 70 Considerations for using an SD memory card)

Ethernet (twisted pair) cable (sold separately)

The Ethernet cables compliant with IEEE802.3 1000BASE-T/100BASE-TX/10BASE-T standards can be used.

Transmission speed	Unshielded twisted pair cable (UTP cable) Shielded twisted pair cable (STP cable)	
	Straight cable	Crossover cable
1 Gbps	Category 5e or higher	Category 5e
100 Mbps	Category 5 or higher	Category 5 or 5e
10 Mbps	Category 3 or higher	Category 3 to 5e

When using an Ethernet cable, make sure to refer to the following: ( Page 82 Wiring Precautions)

5.3 Operating Environment

Configuration personal computer

The following table shows the operating environment of MES Interface Function Configuration Tool and Project File Conversion Tool.

Item	Description	
Personal computer	A personal computer on which Microsoft® Windows® operates	
CPU	Windows 11	Intel® Core™ i3-13 2 GHz or more recommended
	Non-Windows 11	Intel® Core™ 2 Duo 2 GHz or more recommended
Memory requirements	Windows 11	4 GB or more recommended
	Non-Windows 11	64-bit OS: 2 GB or more recommended 32-bit OS: 1 GB or more recommended
Display	Resolution 1024 × 768 pixels or higher	
Free hard disk space	512 MB or more	
Disk drive	DVD disk drive	
Communication Interface	Ethernet (IPv4) 1000BASE-T/100BASE-TX/10BASE-T	
Operating system (English version) (32-bit version and 64-bit version are supported.)	Windows 11 (Pro, Enterprise) Windows 10 (Home, Pro, Enterprise, Education) Windows 8.1, Windows 8.1 (Pro, Enterprise) Windows 8, Windows 8 (Pro, Enterprise) Windows 7 (Home Premium, Professional, Ultimate, Enterprise)	

Server (Database server/Application server)

The following table shows the operating environment of DB Connection Service and DB Connection Service Setting Tool.

Item	Description	
Personal computer	A personal computer on which Microsoft Windows operates	
CPU	Windows 11	2 or more cores on a compatible 64-bit processor or System on a Chip (SoC)
	Non-Windows 11	Intel Core2 Duo Processor 2 GHz or more recommended
Memory requirements	Windows 11	4 GB or more recommended
	Non-Windows 11	2 GB or more recommended
Display	Resolution 1024 × 768 pixels or higher	
Free hard disk space	512 MB or more	
Disk drive	DVD disk drive	
Communication Interface	Ethernet (IPv4) 1000BASE-T/100BASE-TX/10BASE-T	
Operating system (English version) (Only 64-bit version is supported.)	Windows 11 (Pro, Enterprise) Windows Server 2022 (Standard) Windows Server 2019 (Standard) Windows Server 2016 (Standard) Windows 10 (Pro, Enterprise) Windows 8.1 (Pro, Enterprise) Windows Server 2012 R2 (Standard) Windows 8 (Pro, Enterprise) Windows Server 2012 (Standard) Windows 7 (Professional, Ultimate, Enterprise) Windows Server 2008 R2 (Standard)	

For accessible databases, refer to the following:

 Page 39 Access Specifications for a Database

Port number

The following table shows port numbers to be used.

Port number list

Communication destination	Port No.	Remarks
DB Connection Service	TCP: 5112	Can be set in DB Connection Service Setting Tool.
MES interface module	TCP: 80	REST server function
	TCP: 50000, 51200 to 65535	Online function (IP address specified connection)
	UDP: 50000, 51200 to 65535	Online function (direct connection)
	UDP: 50001	Online function (module search and confirmation)

Port numbers supporting each function

Communication source	Communication destination	Function	Port No.												
MES interface module	DB Connection Service	DB input/output function	TCP: 5112												
		Program execution function													
MES Interface Function Configuration Tool		Access Table/Procedure Settings		Browse DB Table Information Browse DB Field Information Browse DB Procedure Information											
MES interface module	MES interface module	Online (IP address specified connection)	Specify Connection Destination ⇔ Connection Test	TCP: 50000, 51200 to 65535											
			Read from MES Interface Module												
			Write to MES Interface Module												
			Verify with MES Interface Module												
			Update setting of MES Interface Module												
			Diagnose MES Interface Module												
			One-Shot Execution												
	Online (Direct connection)	Specify Connection Destination ⇔ Connection Test	Read from MES Interface Module	Write to MES Interface Module	Verify with MES Interface Module	Update setting of MES Interface Module	Diagnose MES Interface Module	One-Shot Execution	UDP: 50000, 51200 to 65535						
										Online (Module search and confirmation)	Specify Connection Destination ⇔ MES Interface Module Search	UDP: 50001			
													User application	REST server function	TCP: 80

5.4 Considerations for System Configuration

Considerations for using operating systems

■User authority

For using MX MESInterface-R, logging on to the personal computer as a user with the administrator authority is recommended.

- Installation and uninstallation are available only for a user logging on with the administrator authority.
- When using a configuration personal computer, MX MESInterface-R can be used by a standard user or a user with the administrator authority.
- When using a server, MX MESInterface-R can be used only by a user with the administrator authority.

■Functions that cannot be used

When the following functions are used, this product may not run properly.

- Application start-up in Windows compatibility mode
- Fast user switching
- Remote desktop
- Power save mode (standby, hibernate, sleep)
- Windows XP Mode
- Touch function
- Modern UI
- Client Hyper-V
- Server Core installation (when using a server)
- Virtual environment (VMware®, Windows Virtual PC)
- Tablet mode
- Virtual desktop

In the following cases, the screen of this product may not work properly.

- The size of the text and other items in the screen is other than 100% (96 DPI, 9 pt etc.).
- The resolution of the screen is changed in operation.
- The Windows theme is changed in operation.
- The multi-display is set.

■.NET Framework

- If .NET Framework 4.0 and Visual C++® 2010 SP1 Redistributable Package (x86) are not installed on a personal computer where MES Interface Function Configuration Tool is to be installed, approximately 500 MB of free space is required in the system drive to install them.
- For Windows 11, .NET Framework 4.8 (including .NET 4.0) must be enabled if disabled.
- For Windows 10, .NET Framework 4.6 Advanced Services must be enabled if disabled.
- For Windows 8 and Windows 8.1, .NET Framework 4.5 Advanced Services must be enabled if disabled.

■Others

- When the Windows firewall setting is enabled, the module search function and the direct connection function may not operate properly. Disable the Windows firewall setting.

Considerations for using databases

■Restrictions for using databases

- For using a relational database, a license according to the number of MES interface modules is usually required. (Varies depending on the relational database type and license format.)
For details, consult the relational database vendor.
- The redundant relational database cannot be used.

■When using SQL Server

- Set "SQL Server and Windows Authentication Mode" for the server authentication.
- 🖱️ Right-click the server to be used in the object explorer of SQL Server Management Studio ⇒ [Properties]. Select "SQL Server and Windows Authentication Mode" for the "Server authentication" in the "Security" on the "Server Properties" screen, then restart the SQL Server.
- An output argument, an input/output argument, and a return value of the stored procedure that returns a result set cannot be acquired.
- When installing a software version '1.01B' or earlier of MX MESInterface-R, set the collation sequence of SQL Server to the default (SQL_Latin1_General_CP1_CI_AS).
This is not applied when installing a software version '1.02C' or later of MX MESInterface-R.
- When MX MESInterface-R whose software version is "1.03D" or earlier is installed, use SQL Server with any of the following condition:
 - The owner of the database file created with SQL Server is an SQL Server authenticated user.
 - The server administrator authentication (sysadmin) is not added to the server role of the user whose field information is to be referenced.However, this restriction is not applicable when MX MESInterface-R whose software version is "1.04E" or later is installed.

■When using Access

- Using in the following environments is not recommended.
 - Where under overload
 - Where high reliability, such as non-stop operation for 24 hours, is requiredFor details, refer to the website of Microsoft.
blogs.technet.microsoft.com/officesupportjp/2017/02/08/ace_memory
- The number of fields that can be updated in one communication action is up to 127.
- Multiple accesses cannot be made to one file.
(The access from multiple MES interface modules cannot be made.)

■When using MySQL

- It is an open source database. For the software versions in which the operation has been checked, refer to the following section.
(📖 Page 39 Accessible databases and supported software)

■When using PostgreSQL

- It is an open source database. For the software versions in which the operation has been checked, refer to the following section.
(📖 Page 39 Accessible databases and supported software)

■When using MariaDB

- It is an open source database. For the software versions in which the operation has been checked, refer to the following section.
(📖 Page 39 Accessible databases and supported software)

■When handling "(Blank)" DB fields

- For the considerations when handling a DB field for which "(Blank)" was set, refer to the following manual.
📖 MELSEC iQ-R MES Interface Module User's Manual (Application)

5.5 Supported Software Packages

This section shows the software packages supported by each MES interface module.

MES interface module	Software package		Software version
RD81MES96N	GX Works3		'1.060N' or later
	MX MESInterface-R	MES Interface Function Configuration Tool	'1.10L' or later
		DB Connection Service and DB Connection Service Setting Tool	'1.00A' or later
RD81MES96	GX Works3		'1.020W' or later
	MX MESInterface-R	MES Interface Function Configuration Tool	'1.00A' or later
		DB Connection Service and DB Connection Service Setting Tool	'1.00A' or later

6 WIRING

This chapter shows the method for connecting an Ethernet cable to an MES interface module.

For connectable Ethernet cables, refer to the following:

☞ Page 75 Ethernet (twisted pair) cable (sold separately)

6.1 Wiring of an Ethernet Cable

This section shows the procedures for connecting and disconnecting an Ethernet cable.

Connection procedure

1. Check the insertion direction, and insert an Ethernet cable into an Ethernet port of an MES interface module until it clicks.
2. Lightly pull the cable to check that it is securely connected.
3. Check the SPEED LED lighting status of the Ethernet port connected with the Ethernet cable. (☞ Page 15 PART NAMES)

Point

- The time required from when an Ethernet cable is connected to when the SPEED LED turns ON may vary. Normally, it turns ON in a few seconds. However, it may take longer because the linking-up processing is repeated due to the device condition on the line.
- When the SPEED LED does not turn ON, check if the connected Ethernet cable has any failure.
- The SPEED LED turns OFF when connecting with an Ethernet device on the network the data transmission speed of which is 10 Mbps. Check the communication status by performing the PING test, etc.

Disconnection procedure

Pull out the Ethernet cable while pinching a clip on the connector.

Considerations for 1000BASE-T/100BASE-TX connection

In a high-speed data communication (1 Gbps/100 Mbps) via 1000BASE-T/100BASE-TX connection, a communication error may occur due to the effect of high frequency noise generated from the equipment other than the MES interface module system, depending on the installation environment.

The following shows the measures to be taken on MES interface module side to prevent the influence of high frequency noise when configuring a network system.

- Do not bundle a cable with the main circuit or power cable, or do not place it near those lines.
- Place a cable in a duct.
- In the environment where a cable is susceptible to noise, use the STP cable.
- Change a target device connected with an MES interface module to one which communicates at 10 Mbps, and decrease the data transmission speed.

6.2 Wiring Precautions

- To establish a reliable system and fully use the functions of an MES interface module, a wiring that does not easily receive the effects of noise is required.
- Sufficient safety measures must be taken when constructing the IEEE802.3 1000BASE-T/100BASE-TX/10BASE-T networks.
Consult a specialist when handling the terminal processing of connection cable, installing trunk cables, etc.
- Use a cable compliant with IEEE802.3 1000BASE-T/100BASE-TX/10BASE-T standards. (☞ Page 75 Ethernet (twisted pair) cable (sold separately))
- For the connection on the target device side, check the specifications of the target device in advance.
- Place an Ethernet cable in a duct or clamp it.
Otherwise, the dangling cable may swing or inadvertently be pulled. It may cause an MES interface module or the cable to damage or malfunction due to poor contact.
- Protect the core wire in the connector of an Ethernet cable or a port of an MES interface module to prevent touching by hand and sticking dirt or dust.
If any oil from your hand, dirt or dust sticks the core wire, it may increase the transmission loss and fail a data link.
- Check if an Ethernet cable used is disconnected, a short-circuit is generated, and the connector is properly connected.
- Do not use an Ethernet cable with a broken clip.
Doing so may cause the unplugged cable or malfunction.
- Hold the connector of an Ethernet cable when connecting or disconnecting it.
If the cable is pulled while being connected to an MES interface module, it may cause the module or Ethernet cable to damage or malfunction due to poor contact.
- Attach the provided connector cover to protect an unused Ethernet port from dirt and dust.
- The maximum segment length of an Ethernet cable is 100 m. However, the length may be shorter depending on the use environment of the cable. For details, contact the manufacturer of the cable used.
- The bend radius of an Ethernet cable is limited. For details, check the specifications of the Ethernet cable used.

7 INSTALLATION AND UNINSTALLATION

This chapter shows the methods for installing and uninstalling each piece of execution software of MX MESInterface-R. For the software that can be installed, refer to the following:

☞ Page 72 Software configuration of MX MESInterface-R

Considerations for installation and uninstallation

- Log on to a personal computer as a user with an administrator authority.
- Before the installation, end all running applications on the operating system.
If software is installed while other applications are running, the product may not run normally.
- Install the software after changing the setting to prevent starting the update program automatically.
The installer may not run normally if an update program for either operating system or software of other companies such as Windows Update and Java® update starts automatically.
- After completing the installation, the computer may need to be restarted.
If the restart message appears, restart the computer before using it.

■For installing MES Interface Function Configuration Tool

Use MX MESInterface-R with software version '1.10L' or later when using an RD81MES96N.

■For installing DB Connection Service Setting Tool

- Use DB Connection Service Setting Tool with version 1.14Q or later to connect to a MELSEC iQ-R series MES interface module.
The version can be checked by selecting [Help] ⇒ [Product information].

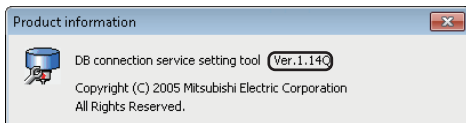

- If the following message appears, install DB Connection Service Setting Tool after executing 'SETUP.EXE' in the 'EnvMEL' folder in the DVD included in MX MESInterface-R.
If the "Program Compatibility Assistant" screen appears after completing the installation, select "This program installed correctly".

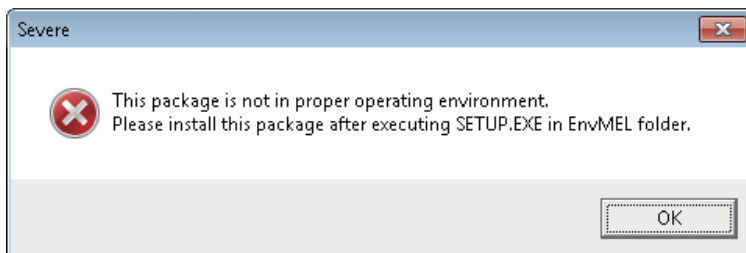

7.1 Installation Procedure

MX MESInterface-R

The following shows the procedure for installing MES Interface Function Configuration Tool, DB Connection Service, and DB Connection Service Setting Tool.

Project File Conversion Tool is automatically installed when MES Interface Function Configuration Tool is installed.

Operating procedure

1. Start the installer.
Double-click 'Setup.exe' in the DVD included in MX MESInterface-R.
2. Select the software to be installed, and click the [Install] button.

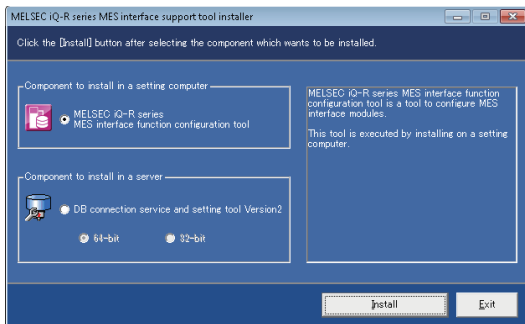

- When using the 32-bit version of Access for a database, select "32-bit."
- When selecting "64-bit", configure the ODBC setting which is supported by a 64-bit version DB connection service. (Page 57 ODBC setting for database)

3. Enter or select the necessary information according to the instructions shown in the screen.

■Windows firewall setting

Perform any of the following operations when the firewall function of the operating system and the security software are enabled.

- ① Set the following programs to the firewall exception.

For the setting methods, refer to the manuals and online help of the operating system or security software used.

Program	Execution file storage destination (operating system is a 64-bit version)
MES Interface Function Configuration Tool ^{*1}	• C:\Program Files(x86)\MELSOFT\RMESIF\RMIFConfigTool.exe
DB Connection Service Setting Tool ^{*1}	• C:\Program Files\MELSOFT\MESIF\DBCnctConf2_64.exe or C:\Program Files(x86)\MELSOFT\MESIF\DBCnctConf2_32.exe • C:\MELSEC\MESIF\DBCnctConf.exe ^{*2}
DB Connection Service ^{*1}	• C:\Program Files\MELSOFT\MESIF\DBConnector2_64.exe or C:\Program Files(x86)\MELSOFT\MESIF\DBConnector2_32.exe • C:\MELSEC\MESIF\DBConnector.exe ^{*2}
	• C:\Program Files\MELSOFT\MESIF\DBCnctClient2_64.exe or C:\Program Files(x86)\MELSOFT\MESIF\DBCnctClient2_32.exe • C:\MELSEC\MESIF\DBCnctClient.exe ^{*2}

*1 This setting is not required when the [Yes] button is selected on the screen below.

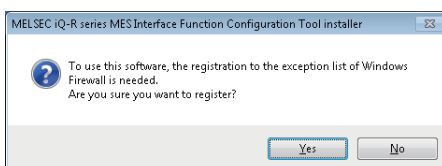

*2 For MX MESInterface-R whose software version is "1.03D" or earlier is installed

- ② Disable the firewall function.

■ Setting to associate the extension (.mu2) of project file and program

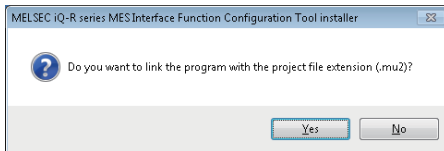

When the [No] button is selected on the screen above, MES Interface Function Configuration Tool does not open by double-clicking the project file with the extension (.mu2). Perform the following operation to open the project file.

Operating procedure

☞ [Project] ⇒ [Open] in the menu of MES Interface Function Configuration Tool

In another way, refer to the online help for an operating system and associate with a program.

Environment after installation

Each piece of software is installed to a specified folder and registered in the start menu.

The following table shows the startup method and the maximum number of software, which can start at the same time, for each piece of software after installing.

Software	Startup method	Maximum No.
MES Interface Function Configuration Tool	Start each piece of software from "MELSOFT" in Windows Start.	5
DB Connection Service Setting Tool (64-bit)		1
DB Connection Service Setting Tool (32-bit)		1
Project File Conversion Tool	Click 'RMESIFCONVMU2toMU2.exe' under the execution file storage destination*1 of MES Interface Function Configuration Tool.	No limit

*1 For 64-bit version operating system, it is installed in the following folder:
C:\Program Files(x86)\MELSOFT\RMESIF

7.2 Uninstallation Procedure

Uninstall from the control panel in Windows.

Project File Conversion Tool is automatically uninstalled when MES Interface Function Configuration Tool is uninstalled.

Disable the Windows firewall if it has been set manually.

For the method to disable the Windows firewall, refer to the manuals and online help of the operating system and the security software used.

Environment after uninstallation

The installed program files, folders, and start menu are deleted after uninstallation.

If a file, which is output after installation such as DB access log, exists in a folder, the file/folder will not be deleted.

8 OPERATION EXAMPLE

This chapter shows the operation example of simple data collection in a system configuration including an MES interface module.

8.1 Overview

The following shows the operation example based on a metal parts manufacturing line automated by a programmable controller system.

Process

Each process of the metal parts manufacturing line is shown below.

Process	Description
Machining	To machine metal materials and manufacture finished parts.
Imprint	To imprint a lot ID code and a specific serial number on each manufactured part.
Inspection	To measure the weight of each completed part.

Operation

The following shows the operation between the control system and the production control database.

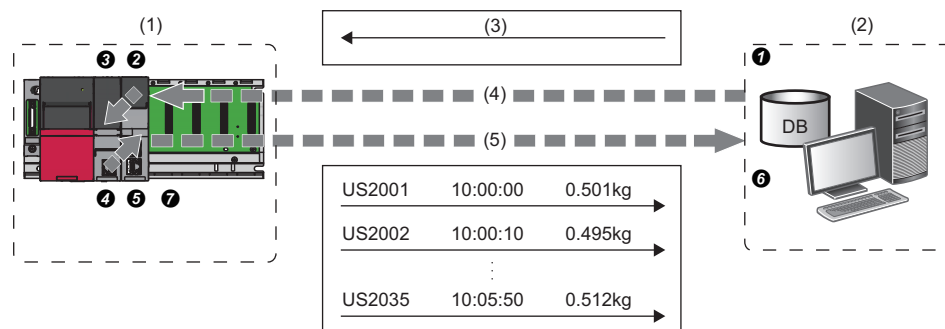

(1) Control system (CPU module, MES interface module)

(2) Production control database

(3) Target manufacturing number 35 units, lot ID code (US)

(4) Acquisition of manufacturing schedule information

(5) Delivering the actual manufacturing information

1. Acquire the manufacturing schedule information.

① Database → ② MES interface module → ③ CPU module

- MES interface module acquires the target manufacturing number and lot ID codes from the table of the production control database before starting the manufacture.
- The parts are manufactured according to the target manufacturing number.
The lot ID code is imprinted in front of the serial number on each part.

2. Deliver the actual manufacturing information.

④ CPU module → ⑤ MES interface module → ⑥ Database

- When each part is moved into the inspection process, the actual data, such as serial numbers, manufacturing time and part weight, are collected by MES interface module and transferred to the production control database.

3. Change the data to use easily.

⑦ Scaling with MES interface module

- The inspection scale notifies the control system of the part weight measured by a positive decimal number in a gram.
The production report from the database information needs to be read in a kilogram.
Therefore, the weight data is converted to g→kg format with MES interface module to prevent control logic changes and extra processing at the database-level.

8.2 Setup

System configuration

This section shows the setting for configuring a sample system including the following devices and software.

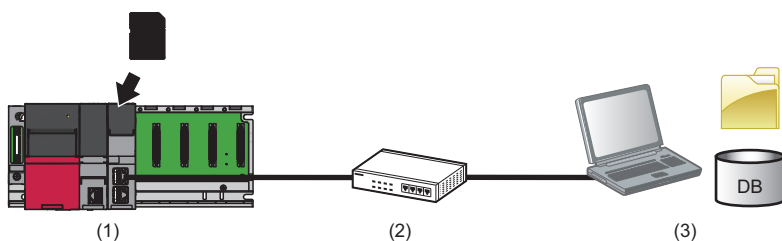

Device/Software		Product name/description	Reference	
(1)	Programmable controller system	Main base unit	R35B	
		Power supply module	R61P	
		CPU module	R08CPU	
		MES interface module	RD81MES96N	
		SD memory card	NZ1MEM-nGBSD ('n' indicates a number of bytes.)	
(2)	Twisted pair cable and hub	A cable and a hub compliant with IEEE802.3 1000BASE-T/100BASE-TX/10BASE-T standards	Page 75 Ethernet (twisted pair) cable (sold separately)	
(3)	Personal computer (shared in a server and configuration personal computer)	A personal computer on which Windows operates	Page 76 Operating Environment	
	Operating system	Microsoft Windows 10 Enterprise Operating System (64-bit version)		
	Relational database	Access for Microsoft 365 (64-bit version)		
	Engineering tool	GX Works3	SWnDND-GXW3 ('n' indicates its version.)	<ul style="list-style-type: none"> GX Works3 Installation Instructions GX Works3 Operating Manual
	MX MESInterface-R Configuration software	<ul style="list-style-type: none"> MES Interface Function Configuration Tool DB Connection Service DB Connection Service Setting Tool 	SW1DND-RMESIF-E	<ul style="list-style-type: none"> Page 72 Software configuration of MX MESInterface-R Page 83 INSTALLATION AND UNINSTALLATION

- The IP address of an MES interface module is '192.168.3.3'.
- The IP address of a personal computer is '192.168.3.100'.

Point

To set a setting of an CPU module, connect a personal computer and the CPU module with a USB cable.

Device setup

The following shows the setup procedures of devices.

Personal computer setting

Operating procedure

1. Install each piece of software (relational database/engineering tool/MX MESInterface-R).
2. Set the IP address of a personal computer to '192.168.3.100'.

It can be set in the "Internet Protocol Version 4 (TCP/IPv4) Properties" screen.

Programmable controller system setting

Operating procedure

1. Mount a power supply module, CPU module, and MES interface module on a main base unit.

 MELSEC iQ-R Module Configuration Manual

2. Insert an SD memory card into the MES interface module.

 Page 69 Insertion/removal method of an SD memory card

3. Set parameters and write them to the CPU module in the engineering tool.

 Page 67 Parameter setting

Point

For details on the parameter setting and programming in the engineering tool, refer to the following:

 GX Works3 Operating Manual

Creating a sample program

When setting parameters in the engineering tool, create a program for simulation and write it to a CPU module.

■Devices used in the sample program

Device name	Device	Description
Special relay	SM400	Always ON signal
	SM402	Manufacturing code acquisition trigger
Data register	D0	Cumulative manufacturing number
	D2	Serial number (numeric value): binary
	D10	Random number
	D11	Random number division result
	D12	Random number remainder
	D100	Manufacturing code ID for products
	D200	Manufacturing instruction number
	D202	Product code
	D300	Serial number
	D400	Product weight (g)
Low-speed timer	T0	Manufacturing execution cyclic signal
Internal relay	M0	Manufacturing execution trigger

■Sample program example

The following program is for simulating the metal parts manufacturing line.

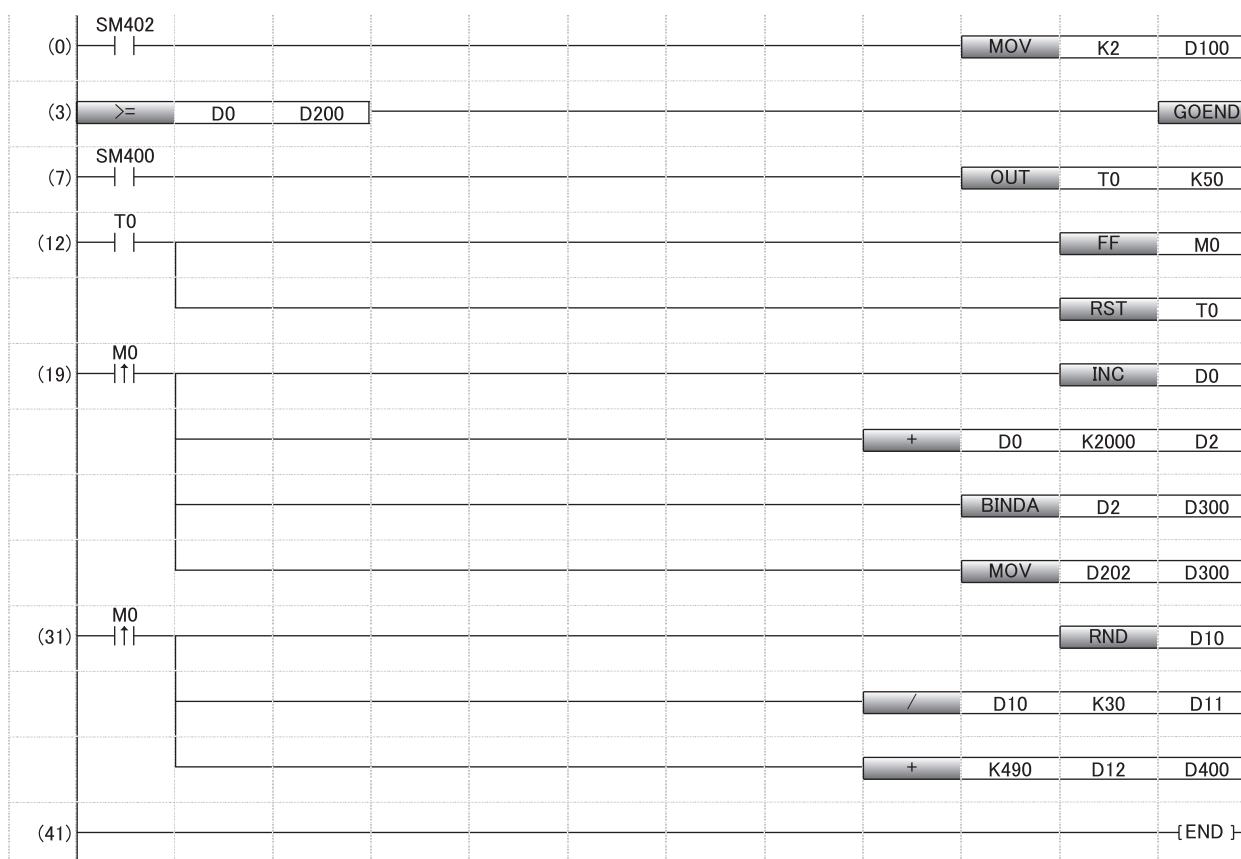

- (0) Manufacturing code setting
- (3) Operation stop when reaching to the manufacturing instruction number
- (7) to (12) 10 seconds cyclic signal generation
- (19) Serial number generation
- (31) Weight measurement (emulation)

8.3 Creating a Database Table

Before setting the ODBC setting and MES interface function setting, create two types of database table in Access for Microsoft 365.

Database table creation procedure

Creating a [OrderTable] table

1. Start Access for Microsoft 365 from Windows Start.
2. Click [New] ⇒ [Blank database] and enter 'Sample_DB.accdb' in the "File Name", then click the [Create] button. (In the operation example, a save location is "C:\MES".)
3. Right-click "Table 1" and select [Design View] from the shortcut menu.
4. Enter 'OrderTable' in the "Table Name" and click the [OK] button.
5. Set each item in the [OrderTable] and [General] tabs according to the following table.
6. Save the file.

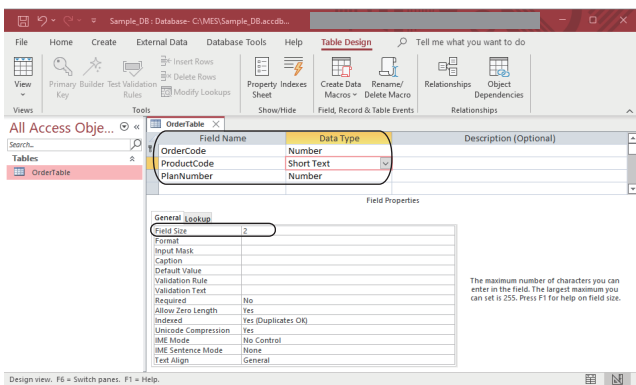
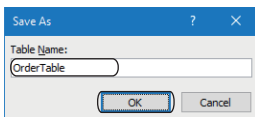
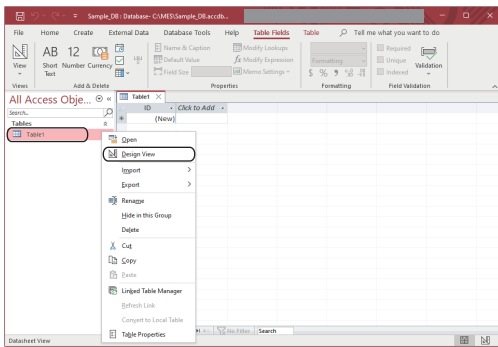
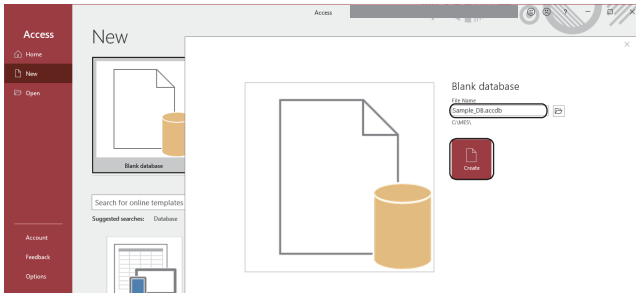

Field Name	Data Type	Field Size
OrderCode	Number	Integer
ProductCode	Short Text	2
PlanNumber	Number	Integer

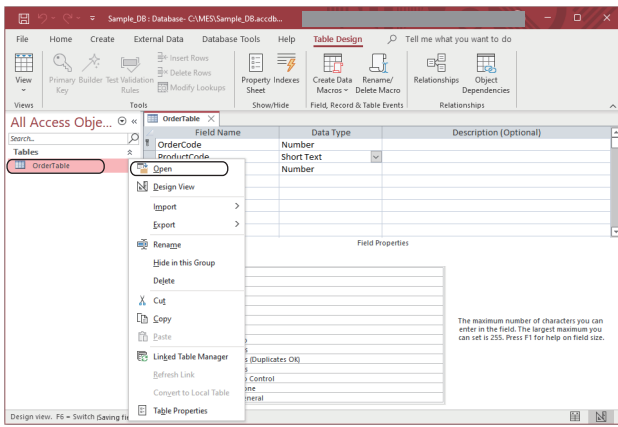

7. Right-click "OrderTable" and select [Open] from the shortcut menu.

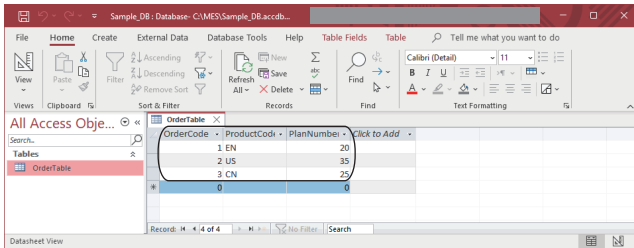

8. Set each item in the [OrderTable] tab according to the following table.

OrderCode	ProductCode	PlanNumber
1	EN	20
2	US	35
3	CN	25

Creating a [History] table

1. Click [Create] ⇒ [Table].
2. Right-click "Table 1" and select [Design View] from the shortcut menu.

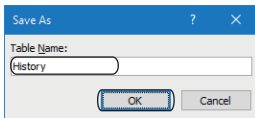
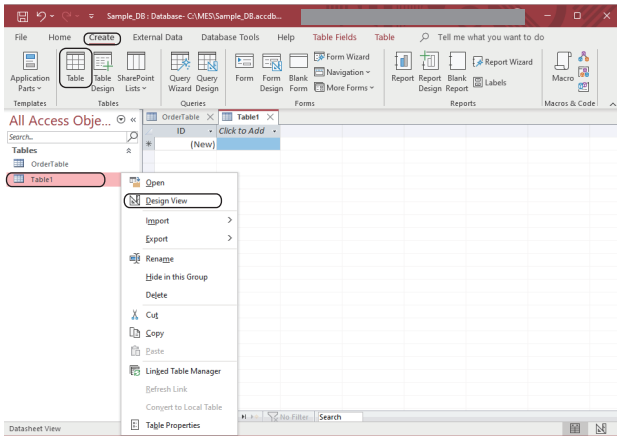

3. Enter 'History' in the "Table Name" and click the [OK] button.

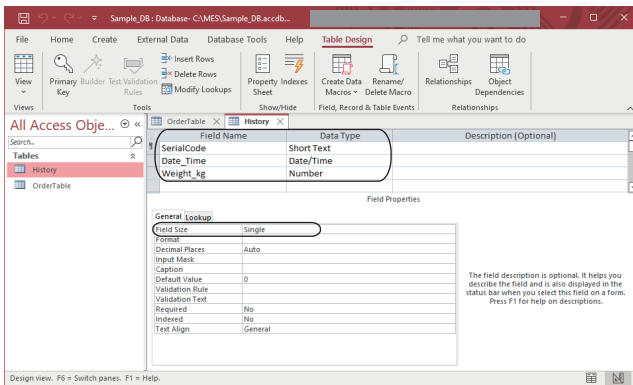

4. Set each item in the [History] and [General] tabs according to the following table.
5. Save the file.

Field Name	Data Type	Field Size
SerialCode	Short Text	6
Date_Time	Date/Time	—
Weight_kg	Number	Single

8.4 ODBC Setting

This section shows the procedure for configuring the ODBC setting before setting parameters in MES Interface Function Configuration Tool.

ODBC setting procedure

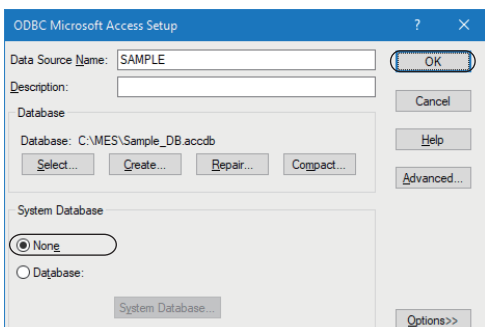
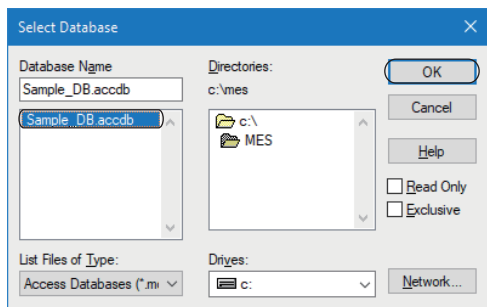
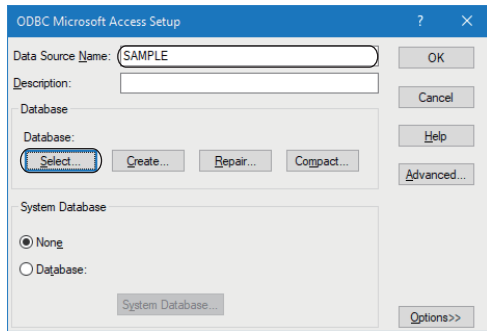
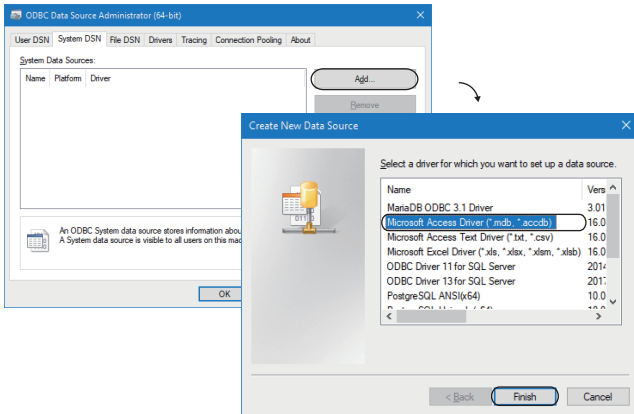
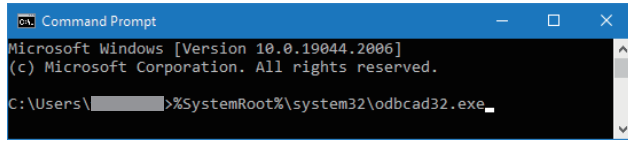

1. Start ODBC Data Source Administrator. Enter the following in the command prompt.
 - %SystemRoot%\system32\odbcad32.exe
2. Select the [System DSN] tab and click the [Add] button.
3. Select "Microsoft Access Driver (*.mdb, *.accdb)", and click the [Finish] button.

4. Enter 'SAMPLE' in the "Data Source Name" and click the [Select] button in the "Database".



Any data source name can be set. The name set above is used for the data source name in the "Target Server Individual Settings" in the "Target Server Settings".

5. Select 'Sample_DB.accdb' in the "Database Name" and click the [OK] button.



The database name is a name for accessing an Access database. Specify a save destination for the created database tables.

6. Select "None" in the "System Database" and click the [OK] button.
7. Click the [OK] button in the "ODBC Data Source Administrator" screen.

8.5 MES Interface Function Setting

Data (SQL statement) communication can be performed without creating a program by setting the parameters of MES Interface Function Configuration Tool.

Parameter setting procedure

Starting MES Interface Function Configuration Tool

Start MELSEC iQ-R Series MES Interface Function Configuration Tool from "MELSOFT" in Windows Start.

Setting a network

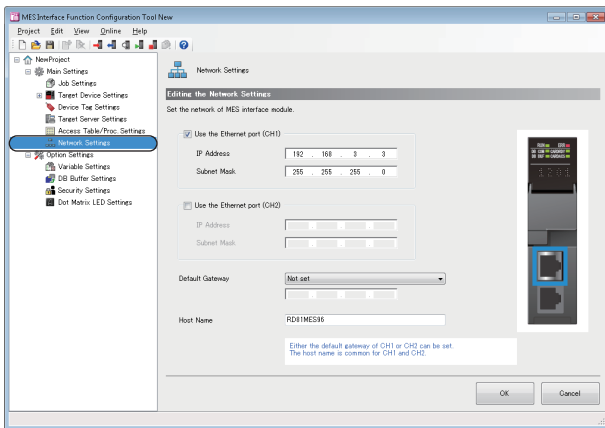

Select "Network Settings" in the edit item tree.



This setting is used as a default.

Setting a target device

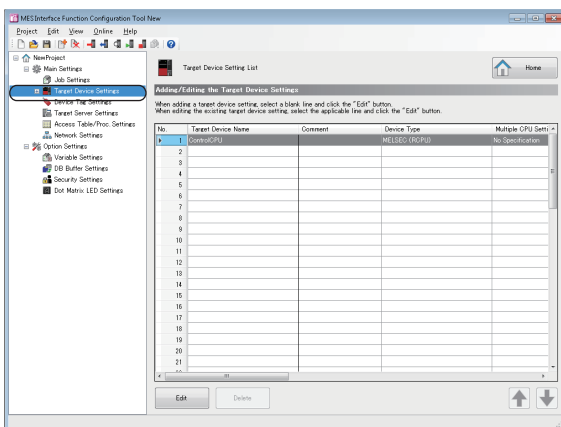

Select "Target Device Settings" in the edit item tree.



This setting is used as a default.

Setting device tags

1. Right-click "Device Tag Settings" in the edit item tree, and select [Add Item] from the shortcut menu.

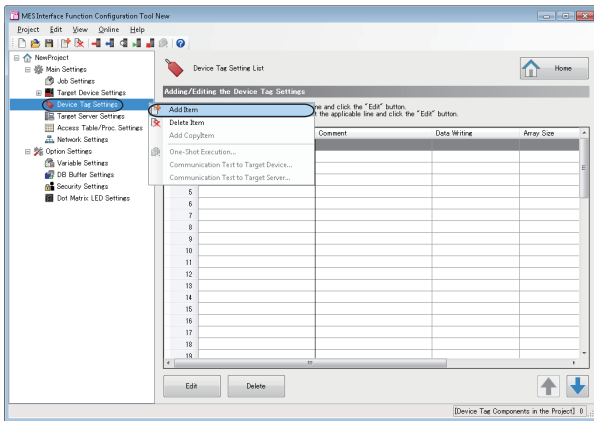

2. Enter 'GettingData' in the "Device Tag Name" and set each setting item according to the following table.

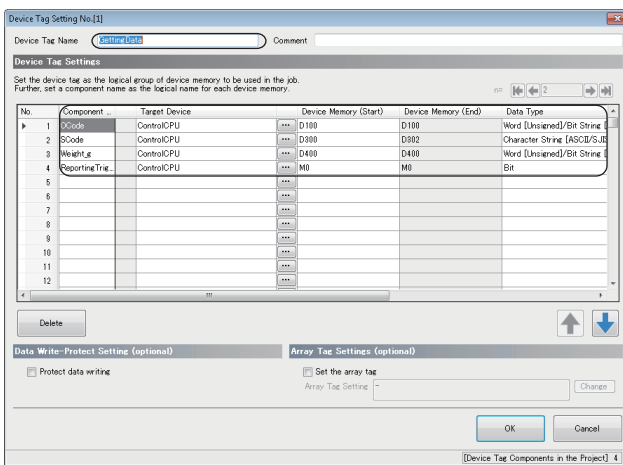

Component Name	Target Device	Device Memory (Start)	Device Memory (End)	Data Type	Length
OCode	ControlCPU	D100	D100	Word [Unsigned]/Bit String [16-bit]	—
SCode	ControlCPU	D300	D302	Character String [ASCII/SJIS]	6
Weight_g	ControlCPU	D400	D400	Word [Unsigned]/Bit String [16-bit]	—
ReportingTrigger	ControlCPU	M0	M0	Bit	—

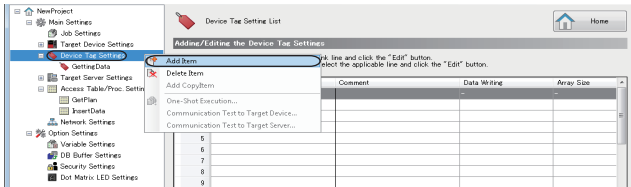

3. Add another device tag.

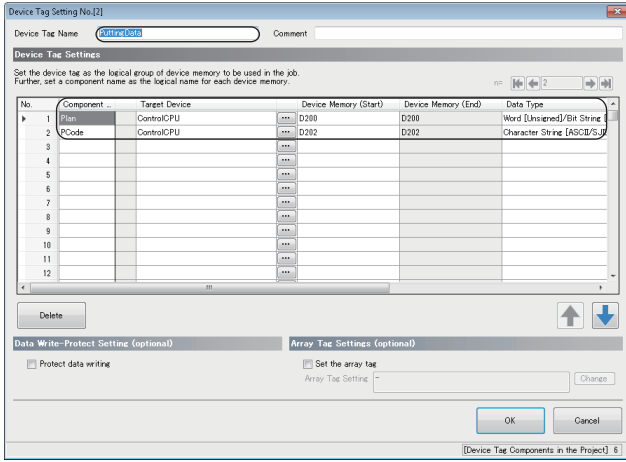

4. Enter 'PuttingData' in the "Device Tag Name" and set each setting item according to the following table.

Component Name	Target Device	Device Memory (Start)	Device Memory (End)	Data Type	Length
Plan	ControlCPU	D200	D200	Word [Unsigned]/Bit String [16-bit]	—
PCode	ControlCPU	D202	D202	Character String [ASCII/SJIS]	2

Setting a target server

1. Right-click "Target Server Settings" in the edit item tree, and select [Add Item] from the shortcut menu.

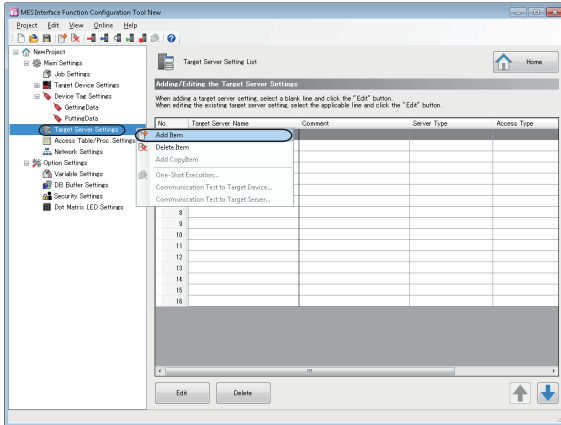

2. Enter 'SampleServer' in the "Target Server Name" and set each setting item according to the following table.

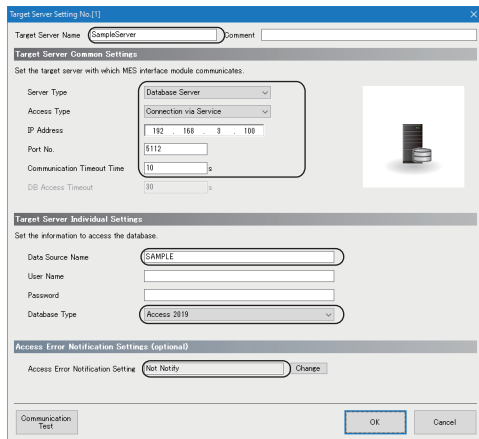

Setting item	Setting content	
Target Server Name	SampleServer	
Target Server Common Settings	Server Type	Database Server
	Access Type	Connection via Service
	IP Address	192.168.3.100 (Set the same IP address as the server.)
	Port No.	5112
	Communication Timeout Time	10
Target Server Individual Settings	Data Source Name	SAMPLE (same name as the one set in the [System DSN] tab in the ODBC setting)
	User Name	—
	Password	—
	Database Type	Access 2019 (Select Access 2019 when using Access for Microsoft 365.)
Access Error Notification Settings (optional)	Access Error Notification Setting	Not Notify

Setting access tables

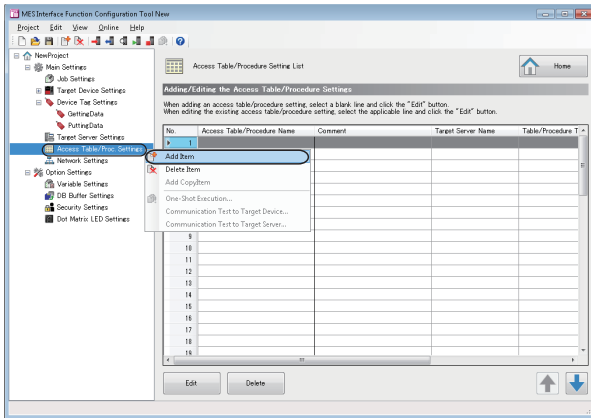

1. Right-click "Access Table/Proc. Settings" in the edit item tree, and select [Add Item] from the shortcut menu.

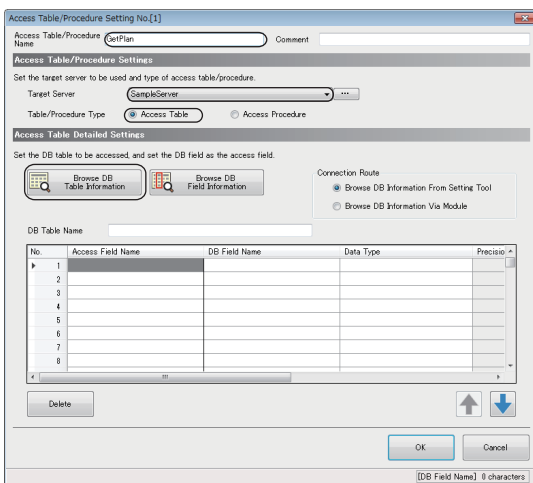

2. Enter 'GetPlan' in the "Access Table/Procedure Name".
3. Select "SampleServer" for "Target Server" under "Access Table/Procedure Settings," and select "Access Table" for "Table/Procedure Type."
4. Click the [Browse DB Table Information] button under "Access Table Detailed Settings."

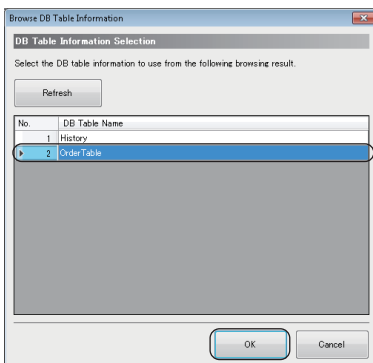

5. Select "OrderTable" and click the [OK] button.

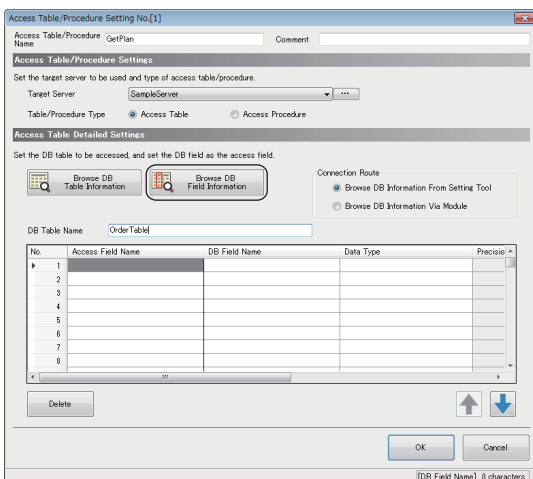

6. Click the [Browse DB Field Information] button under "Access Table Detailed Settings."

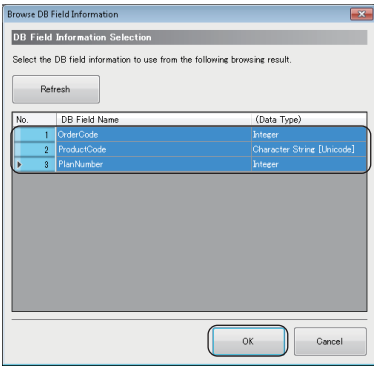

7. Select "OrderCode", "ProductCode", and "PlanNumber", and click the [OK] button.

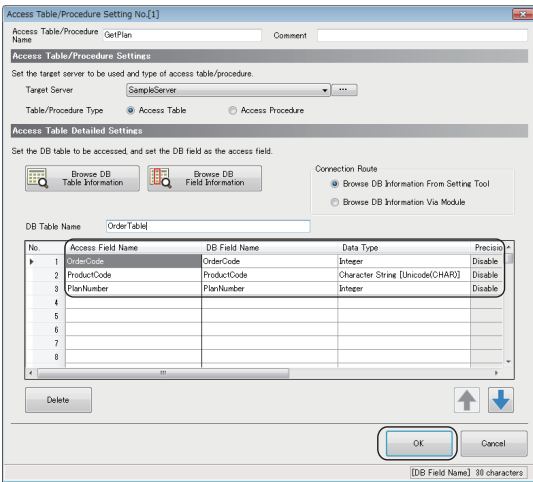

8. Set each item according to the following table, and click the [OK] button.

Access Field Name	DB Field Name	Data Type	Precision Hold	Default Value Setting	Default Value
OrderCode	OrderCode	Integer	Disable	Disable	—
ProductCode	ProductCode	Character String [Unicode(CHAR)]	Disable	Disable	—
PlanNumber	PlanNumber	Integer	Disable	Disable	—

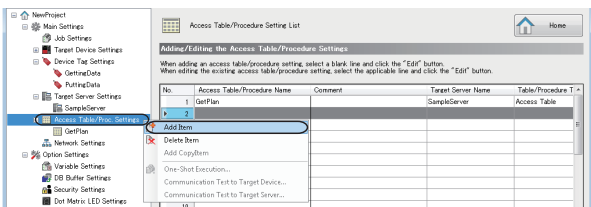

9. Add another access table/procedure.

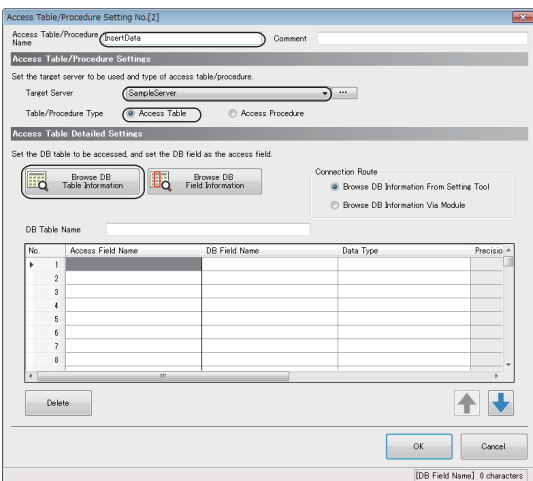

10. Enter 'InsertData' in the "Access Table/Procedure Name".

11. Select "SampleServer" for "Target Server" under "Access Table/Procedure Settings," and select "Access Table" for "Table/Procedure Type."

12. Click the [Browse DB Table Information] button under "Access Table Detailed Settings."

13. Select "History" and click the [OK] button.

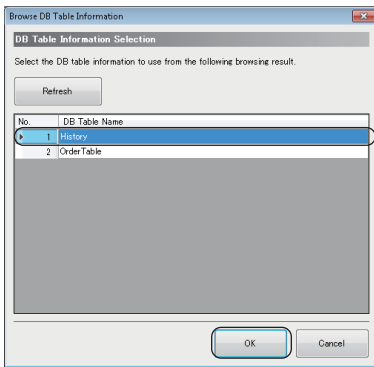

14. Click the [Browse DB Field Information] button under "Access Table Detailed Settings."

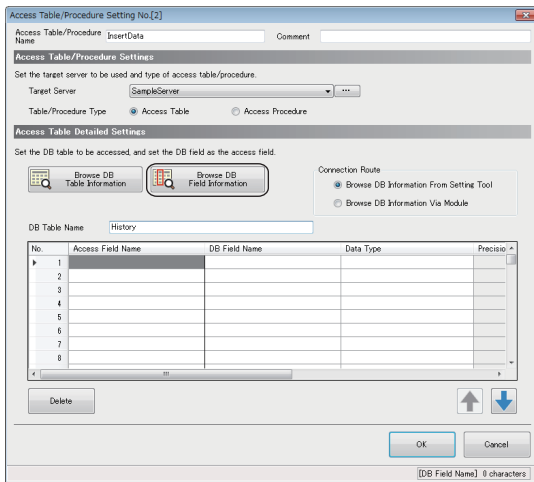

15. Select "SerialCode", "Date_Time", and "Weight_kg" and click the [OK] button.

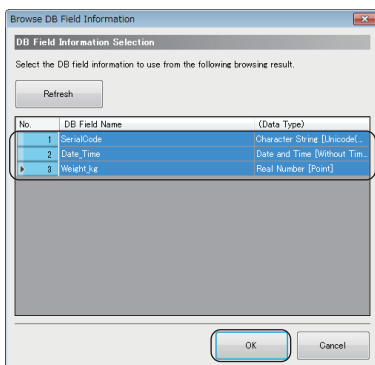

- Set each item according to the following table, and click the [OK] button.

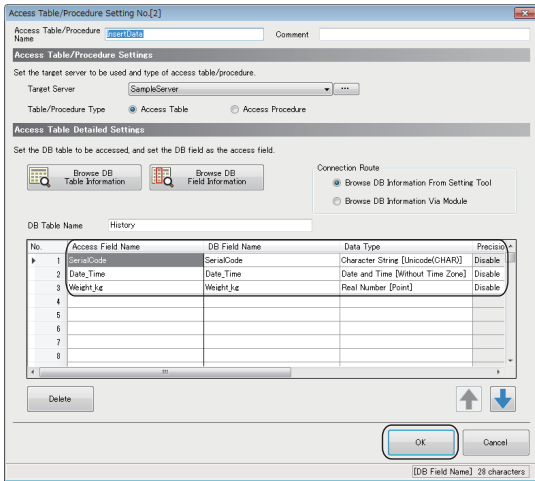

Access Field Name	DB Field Name	Data Type	Precision Hold	Default Value Setting	Default Value
SerialCode	SerialCode	Character String [Unicode(CHAR)]	Disable	Disable	—
Date_Time	Date_Time	Date and Time [Without Time Zone]	Disable	Disable	—
Weight_kg	Weight_kg	Real Number [Point]	Disable	Disable	—

Setting a variable

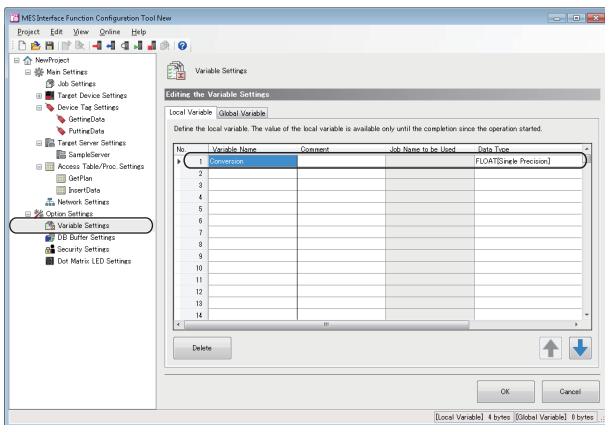

- Select "Variable Settings" in the edit item tree.
- Set a variable in the [Local Variable] tab according to the following table, and click the [OK] button.

Variable Name	Comment	Job Name to be Used	Data Type	Length
Conversion	—	—	FLOAT [Single Precision]	—

Setting jobs (GettingPlan)

■ Job Configuration

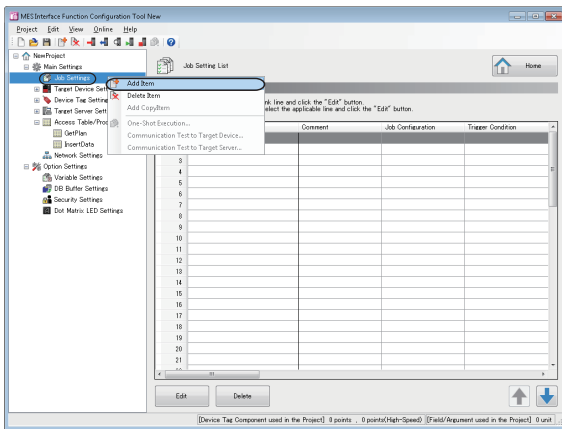

1. Right-click "Job Settings" in the edit item tree, and select [Add Item] from the shortcut menu.

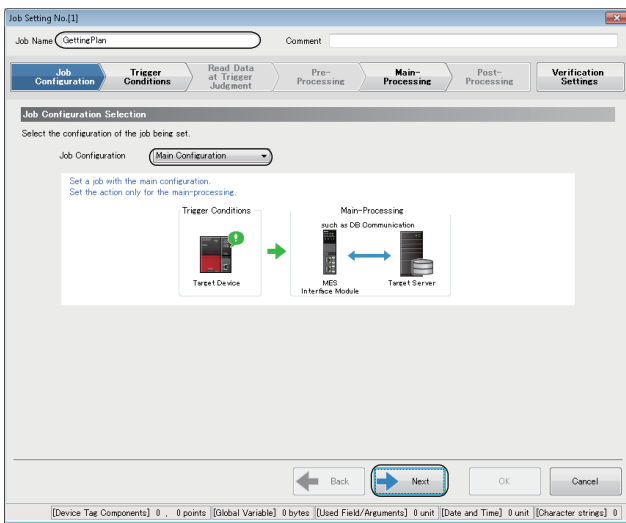

2. Enter 'GettingPlan' in the "Job Name". Select "Main Configuration" in the "Job Configuration" in the "Job Configuration Selection" and click the [Next] button.

Trigger Conditions

1. Set each setting item according to the following table and click the [Edit] button.

Setting item	Setting content	
Trigger Condition Configuration Settings	Configuration Type	Single Event
	Condition Combination Type	—
Trigger Buffering Setting (optional)	Trigger Buffering	Disable

2. Set each item according to the following table, and click the [OK] button.

Setting item	Setting content	
Event/Condition Type Common Settings	Event/Condition Type	Event (Module Monitoring)
	Detail Type	MES Interface Module
Event/Condition Type Individual Settings	At Startup of MES Interface Module	Select
	At Restart/Update of Settings of the MES Interface Function	Select

3. Click the [Next] button.

■ Main-Processing

Setting item	Setting content	Setting content
Operation Settings at Main-Processing Failure (optional)	At Processing Failure	Notification: "Not Set"
DB Buffering Settings (optional)	DB Buffering	No Buffering
	DB Buffer Use Size [byte]	—

1. Set each setting item according to the following table and click the [Edit] button.

2. Click the [DB Communication Action] button in the "Action Type Selection".

3. Select "Select" for "DB Communication Type" under "DB Communication Action Settings," and select "GetPlan.SampleServer" for "Access Table."

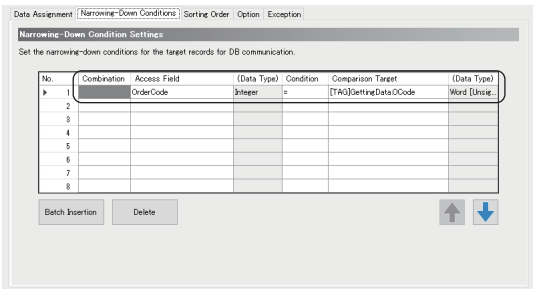
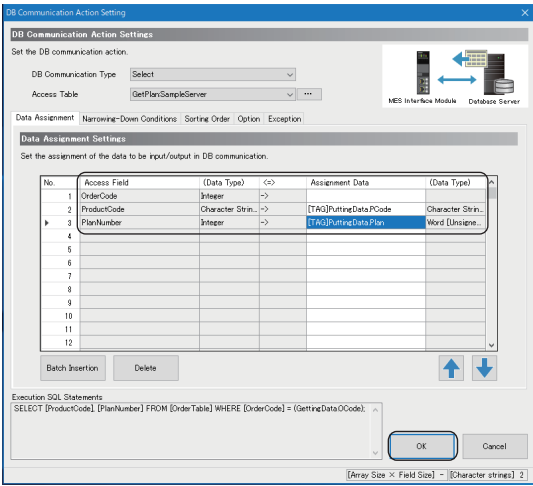

• Data Assignment Settings

Access Field	(Data Type)	\leftrightarrow	Assignment Data	(Data Type)
OrderCode	Integer	→	—	—
ProductCode	Character String [Unicode(CHAR)]	→	[TAG]PuttingData.PCode	Character String [ASCII/SJIS]
PlanNumber	Integer	→	[TAG]PuttingData.Plan	Word [Unsigned]/Bit String [16-bit]

• Narrowing-Down Condition Settings

Combination	Access Field	(Data Type)	Condition	Comparison Target	(Data Type)
—	OrderCode	Integer	=	[TAG]GettingData.OCode	Word [Unsigned]/Bit String [16-bit]

4. Set each item in the [Data Assignment] and [Narrowing-Down Conditions] tabs according to the following table, and click the [OK] button.

5. Click the [Next] button.

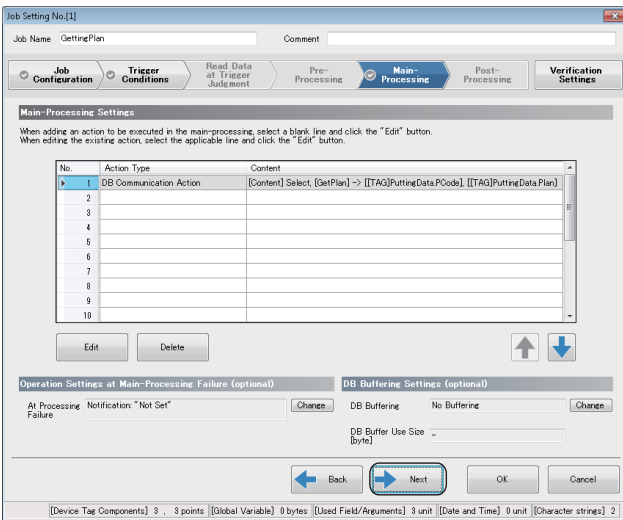

■ Verification Settings

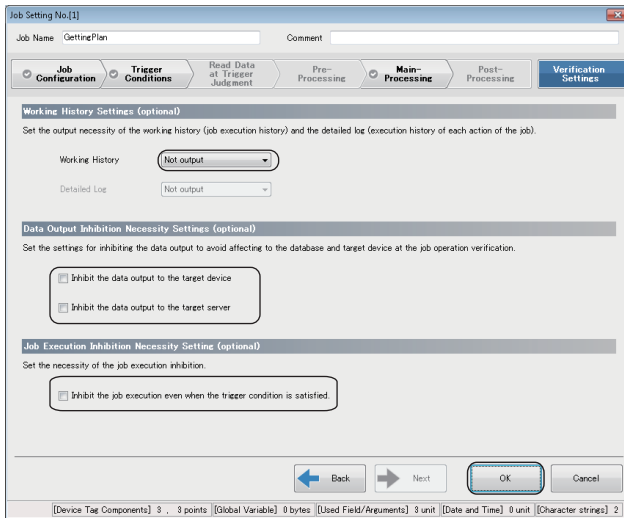

Set each item according to the following table, and click the [OK] button.

Setting item	Setting content	Setting content
Working History Settings (optional)	Working History	Not output
	Detailed Log	—
Data Output Inhibition Necessity Settings (optional)	Inhibit the data output to the target device	Unselected
	Inhibit the data output to the target server	Unselected
Job Execution Inhibition Necessity Settings (optional)	Inhibit the job execution even when the trigger condition is satisfied.	Unselected

Setting jobs (Reporting)

■ Job Configuration

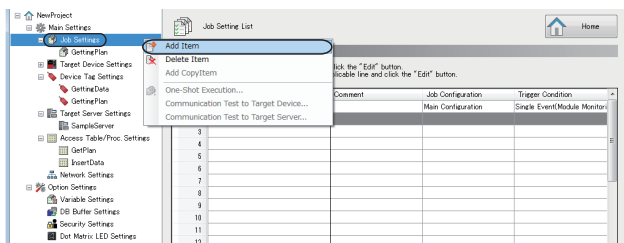

1. Right-click "Job Settings" in the edit item tree, and select [Add Item] from the shortcut menu.

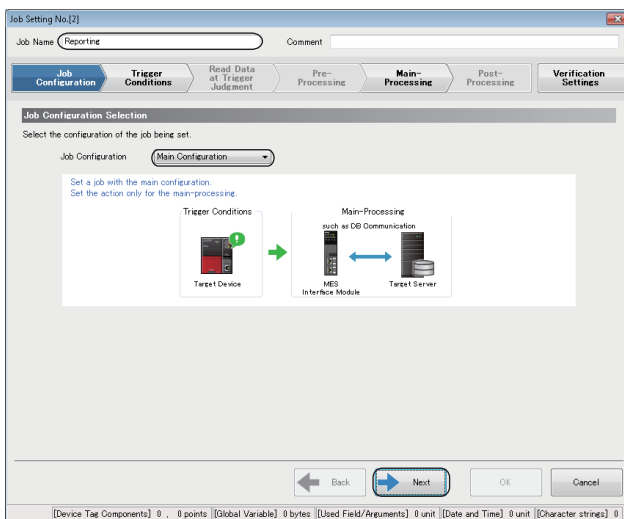

2. Enter 'Reporting' in the "Job Name". Select "Main Configuration" in the "Job Configuration" in the "Job Configuration Selection" and click the [Next] button.

Trigger Conditions

Job Setting No.[2]

Job Name: Reporting Comment: _____

Job Configuration | **Trigger Conditions** | Read Data at Trigger Judgment | Pre-Processing | Main-Processing | Post-Processing | Verification Settings

Trigger Condition Configuration Settings

Select the configuration of the trigger condition.

Configuration Type: **Single Event**

Condition Combination Type: **AND Combination**

The timing of the specified event occurrence is considered as the satisfaction of the trigger condition. In the case of using the condition, the timing of the condition satisfaction is considered as the event occurrence.

Event/Condition Settings

Set each event/condition to be used at Trigger Judgment.

No.	Event/Condition Type	Detail Type	Content
1			

When disabled, even if the trigger condition of the same job is satisfied again while executing the job, the satisfied trigger condition will be disabled.

Trigger Buffering: **Disable**

Back Next OK Cancel

[Device Tag Components] 0 [Global Variable] 0 bytes [Used Field/Arguments] 0 unit [Date and Time] 0 unit [Character strings] 0

1. Set each setting item according to the following table and click the [Edit] button.

Setting item	Setting content	
Trigger Condition Configuration Settings	Configuration Type	Single Event
	Condition Combination Type	—
Trigger Buffering Setting (optional)	Trigger Buffering	Disable

Event/Condition Setting No.[1]

Event/Condition Type: **Condition (Value Monitoring)**

Detail Type: **Timer Interval**

The value of monitoring target (device tag, variable) and comparison target (device tag, variable, constant/macro) is compared and the result will be true or false of the condition.

Event/Condition Type Individual Settings

Set the monitoring target, comparison target and condition that satisfy the condition.

Monitoring Target	(Data Type)	Condition	Comparison Target	(Data Type)
[TAG]GettingData.Repor..._Bit		=	[INT]1	

OK Cancel

2. Set each item according to the following table, and click the [OK] button.

Point

"[INT]1" in "Comparison Target" can be set in the "Integer Type Constant Settings" screen. "Comparison Target" ⇒ "Constant" ⇒ "[Integer]"

8

Integer Type Constant Settings

Integer Settings

Set the value of integer.

1

OK Cancel

Setting item	Setting content	
Event/Condition Type Common Settings	Event/Condition Type	Condition (Value Monitoring)
	Detail Type	—
Event/Condition Type Individual Settings	Monitoring Target	[TAG]GettingData.ReportingTrigger
	(Data Type)	Bit
	Condition	=
	Comparison Target	[INT]1*1
	(Data Type)	—

*1 When the data type of the monitoring target is "Bit", "[INT]1" in the comparison target indicates 'ON'.

3. Click the [Next] button.

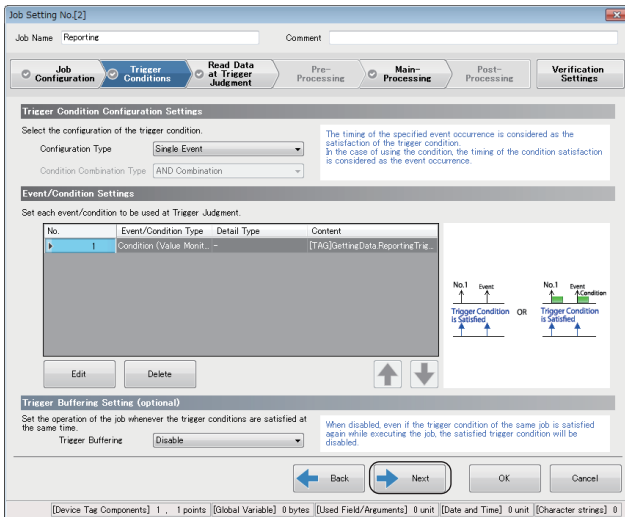

■ Read Data at Trigger Judgment

Set each setting item according to the following table and click the [Next] button.

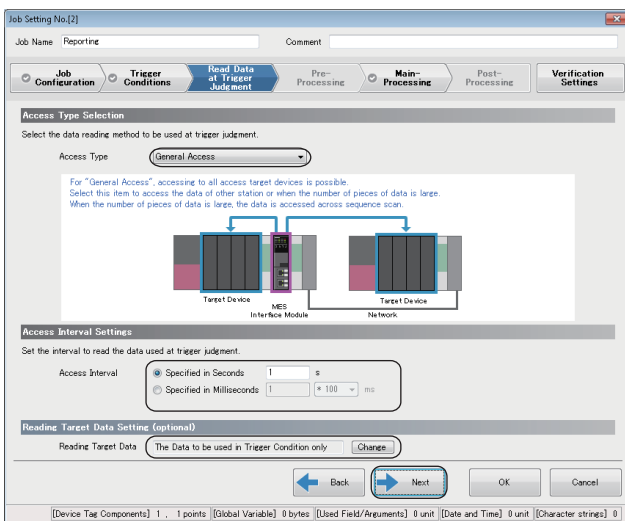

Setting item	Setting content
Access Type Selection	Access Type General Access
Access Interval Settings	Access Interval Seconds Specification: '1' second
Reading Target Data Setting (optional)	Reading Target Data The Data to be used in Trigger Condition only

■ Main-Processing

1. Set each setting item according to the following table and click the [Edit] button.

Setting item	Setting content
Operation Settings at Main-Processing Failure (optional)	At Processing Failure Notification: "Not Set"
DB Buffering Settings (optional)	DB Buffering No Buffering
	DB Buffer Use Size —

2. Click the [Operation Action] button in the "Action Type Selection".

3. Set an operation action according to the following table and click the [OK] button.

Substitution Item	(Data Type)	↔	Operator	First Item	(Data Type)	Second Item	(Data Type)
[LOCAL]Conversion	FLOAT [Single Precision]	←	÷	[TAG]GettingData.Weight_g	Word [Unsigned]/Bit String [16-bit]	[REAL]1000	—

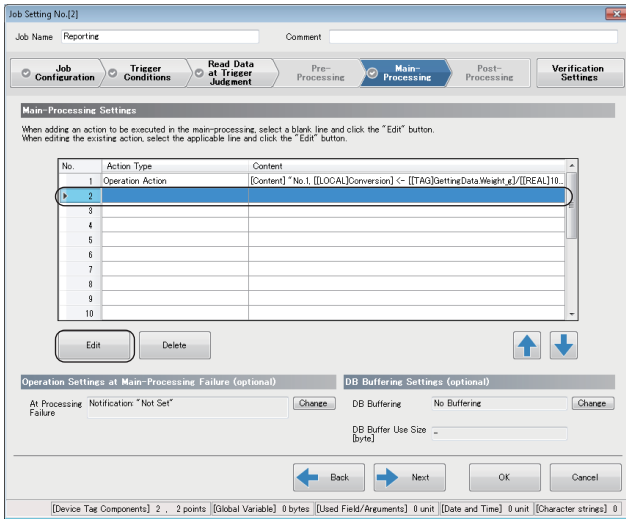

4. Add another action.

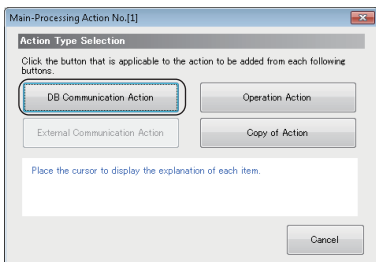

5. Click the [DB Communication Action] button in the "Action Type Selection".

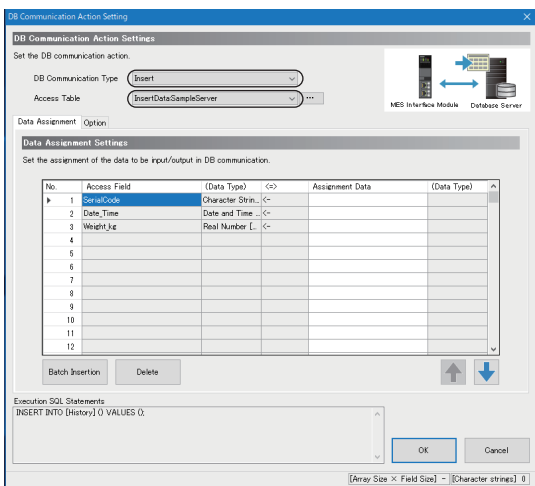

6. Select "Insert" for "DB Communication Type" under "DB Communication Action Settings," and select "Insert.SampleServer" for "Access Table."

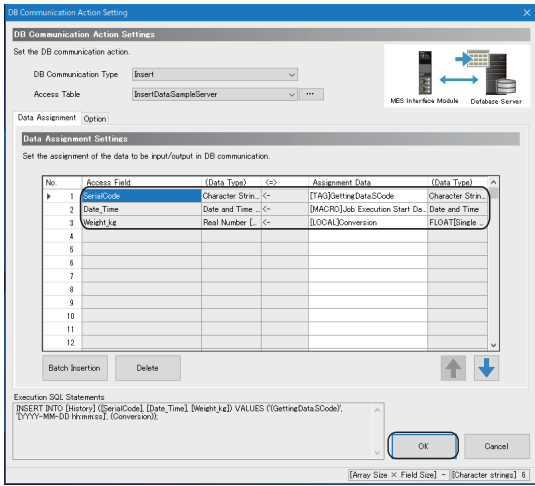

7. Set each item in the [Data Assignment] tab according to the following table, and click the [OK] button.

• Data Assignment Settings

Access Field	(Data Type)	↔	Assignment Data	(Data Type)
SerialCode	Character String [Unicode(CHAR)]	←	[TAG]GettingData.SCode	Character String [ASCII/SJIS]
Date_Time	Date and Time [Without Time Zone]	←	[MACRO]Job Execution Start Date and Time	Date and Time
Weight_kg	Real Number [Point]	←	[LOCAL]Conversion	FLOAT [Single Precision]

8. Click the [Next] button.

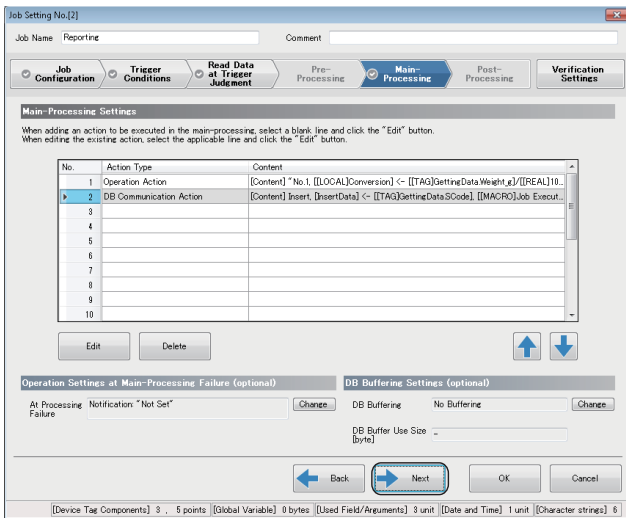

■ Verification Settings

Set each item according to the following table, and click the [OK] button.

Setting item		Setting content
Working History Settings (optional)	Working History	Not output
	Detailed Log	—
Data Output Inhibition Necessity Settings (optional)	Inhibit the data output to the target device	Unselected
	Inhibit the data output to the target server	Unselected
Job Execution Inhibition Necessity Settings (optional)	Inhibit the job execution even when the trigger condition is satisfied.	Unselected

Operation check

The following shows the writing procedure of parameters to MES interface module and checking procedure of the writing result to a DB table.

Writing procedure of parameters to MES interface module

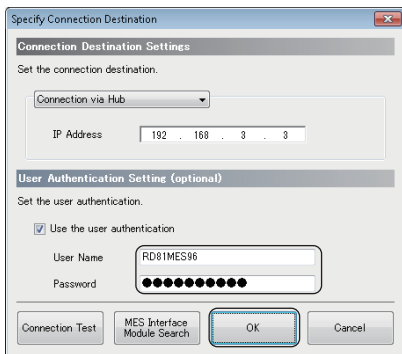
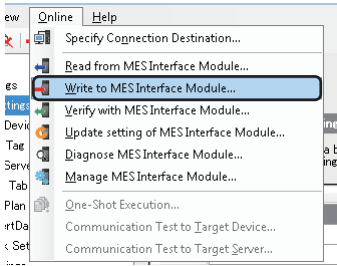

1. Select [Online] ⇒ [Write to MES Interface Module] in MES Interface Function Configuration Tool.
2. When the "Specify Connection Destination" screen appears, enter a user name and password, then click the [OK] button.
The following are set by default.
User Name: RD81MES96
Password: MITSUBISHI
3. After completing the writing, reset the CPU module and start MES interface module.
After resetting the CPU module, turn the status to RUN.
4. The parameters are written to the database automatically after starting MES interface module.

Checking procedure of a writing result to a DB table

1. Open Sample_DB.accdb in Access for Microsoft 365. (C:\MES\Sample_DB.accdb)
2. Right-click "History" and select [Open] from the shortcut menu.
3. The result (manufacturing information), which is inserted to a history table from MES interface module, can be checked.

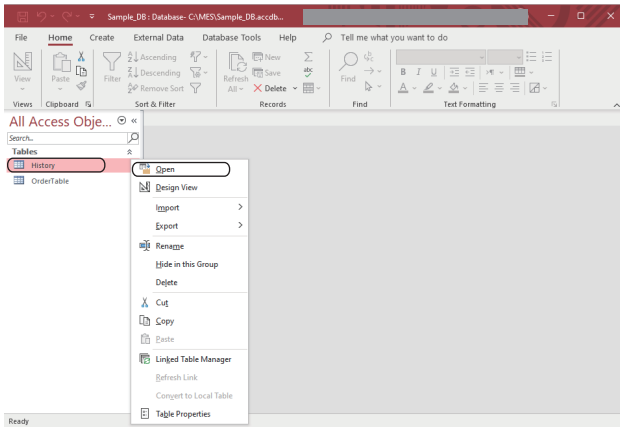

The screenshot shows the 'History' table data in Datasheet View. The table has three columns: 'SerialCode', 'Date_Time', and 'Weight_kg'. The data is as follows:

SerialCode	Date_Time	Weight_kg
US2001	12/21/2022 3:57:00 PM	0.491
US2002	12/21/2022 3:57:10 PM	0.508
US2003	12/21/2022 3:57:20 PM	0.511
US2004	12/21/2022 3:57:30 PM	0.5
US2005	12/21/2022 3:57:40 PM	0.505
US2006	12/21/2022 3:57:50 PM	0.496
US2007	12/21/2022 3:58:00 PM	0.503
US2008	12/21/2022 3:58:10 PM	0.496
US2009	12/21/2022 3:58:20 PM	0.505
US2010	12/21/2022 3:58:30 PM	0.5
US2011	12/21/2022 3:58:40 PM	0.511
US2012	12/21/2022 3:58:50 PM	0.508
US2013	12/21/2022 3:59:00 PM	0.491
US2014	12/21/2022 3:59:10 PM	0.49
US2015	12/21/2022 3:59:20 PM	0.505
US2016	12/21/2022 3:59:30 PM	0.506
US2017	12/21/2022 3:59:40 PM	0.515
US2018	12/21/2022 3:59:50 PM	0.518
US2019	12/21/2022 4:00:00 PM	0.507
US2020	12/21/2022 4:00:10 PM	0.512
US2021	12/21/2022 4:00:20 PM	0.503

APPENDIX

Appendix 1 External Dimensions

The following figures show the external dimensions of an MES interface module.

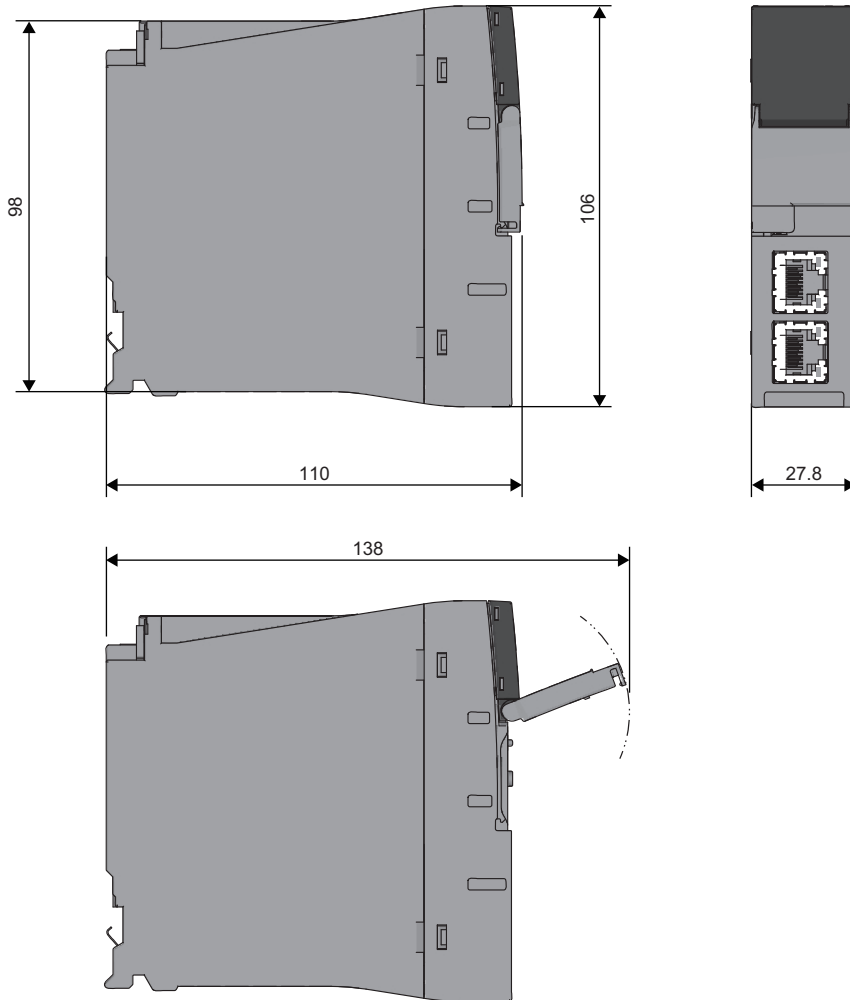

(Unit: mm)

A

Appendix 2 ODBC Setting

When using DB Connection Service on the database server, the ODBC setting for the database used is required to be set in advance.

The following shows the procedures for the ODBC setting.

For details on the setting method, refer to the manuals and online help of the operating system and the security software used.

Starting ODBC Data Source Administrator

Enter the following command in the command prompt in accordance with the software version of MX MESInterface-R and the bit version of DB Connection Service to be used.

Software version	Bit version of DB Connection Service	Command
'1.03D' or earlier	—	"%SystemRoot%\SysWOW64\odbcad32.exe"
'1.04E' or later	32-bit	
	64-bit	"%SystemRoot%\system32\odbcad32.exe"

Oracle

(Example) Windows 7

The following shows the setting example of ODBC setting in the following conditions.

Item	Description
Relational database	Oracle 12c
Data source name*1	SAMPLE
TNS Service Name*2	SAMPLETNS
OracleHome	OraClient12Home1

*1 A data source name can be set arbitrary.

The name set in this setting is used as a name to be entered for "Data Source Name" under "Target Server Individual Settings" in "Target Server Settings."

*2 The TNS service name is a name for accessing an Oracle database.

It is the one entered when installing Oracle or creating database instances.

It can be checked by selecting [Configuration and Migration Tools] ⇒ [Net Manager] ⇒ "Service Naming" in the Oracle attachment tool.

1. Start ODBC Data Source Administrator.

Page 116 Starting ODBC Data Source Administrator

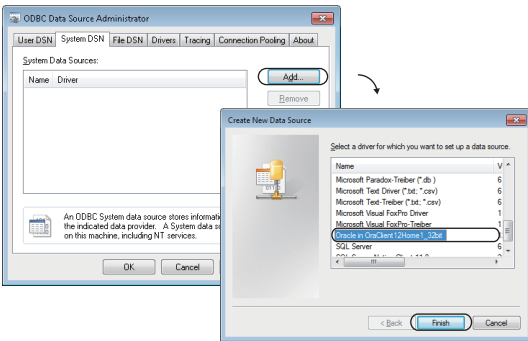
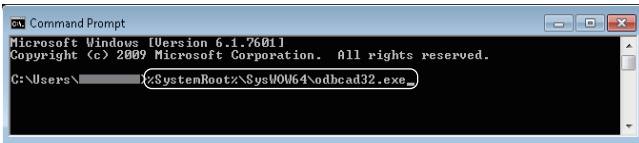

2. Select the [System DSN] tab and click the [Add] button.

3. Select "Oracle in OraClient12Home1", and click the [Finish] button.

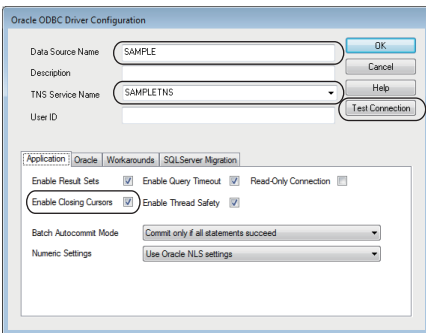

4. Set the following items and click the [Test Connection] button.

- Data Source Name: SAMPLE
- TNS Service Name: SAMPLETNS
- Enable Closing Cursors: Select

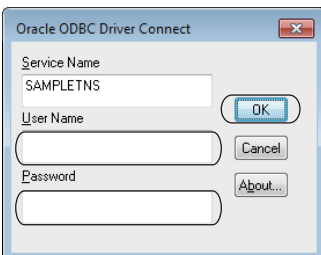

5. Enter a user name and password, and click the [OK] button.

6. When the connection is established normally, the "Testing Connection" screen will appear.

7. Click the [OK] button in the "Oracle ODBC Driver Connect" screen.

8. Click the [OK] button in the "ODBC Data Source Administrator" screen.



SQL Server

(Example) Windows 7

The following shows the setting example of ODBC setting in the following conditions.

Item	Description
Relational database	Microsoft SQL Server 2012
Data source name*1	SAMPLE
Server name*2	SAMPLESRV

- *1 A data source name can be set arbitrary.
The name set in this setting is used as a name to be entered for "Data Source Name" under "Target Server Individual Settings" in "Target Server Settings."
- *2 The server name is a name for accessing a Microsoft SQL Server 2012 database.
It is the one entered when installing Microsoft SQL Server 2012.
It can be checked in SQL Sever Management Studio.

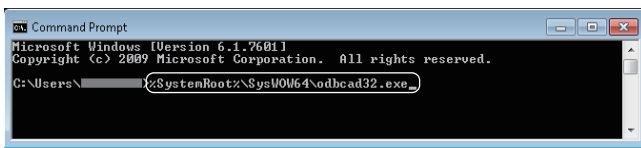

1. Start ODBC Data Source Administrator.
Page 116 Starting ODBC Data Source Administrator

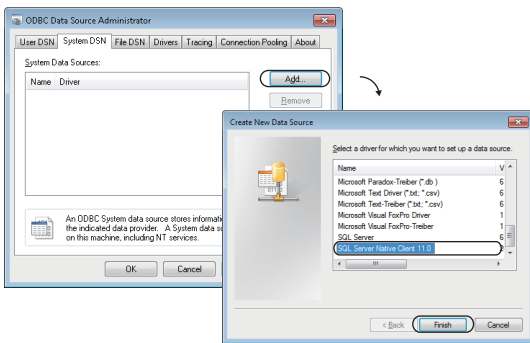

2. Select the [System DSN] tab and click the [Add] button.
3. Select "SQL Server Native Client 11.0", and click the [Finish] button.

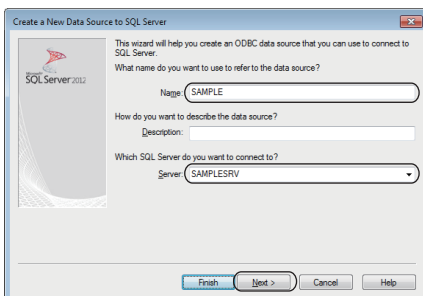

4. Set the following items and click the [Next] button.
 - Data source name: SAMPLE
 - Server name: SAMPLESRV

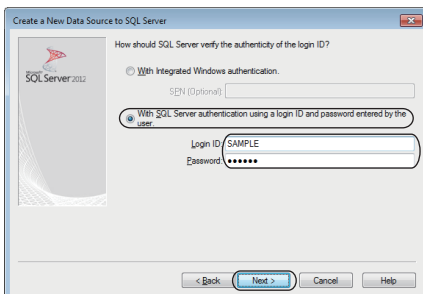

5. Select "With SQL Server authentication using a login ID and password entered by the user.", and enter "Login ID" and "Password", and click the [Next] button.

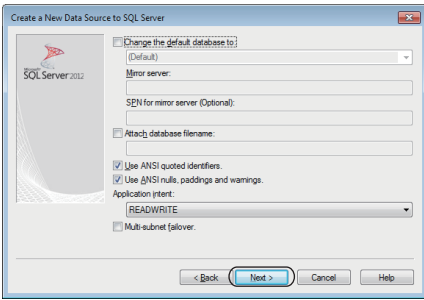

6. Click the [Next] button.

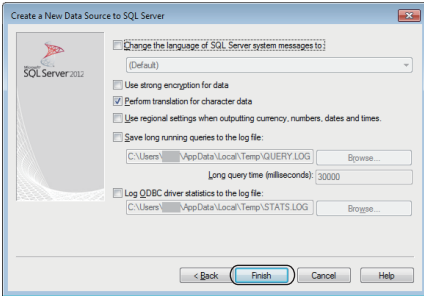

7. Click the [Finish] button.

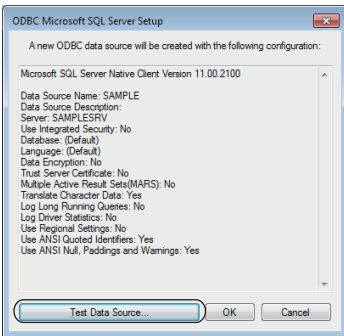

8. Click the [Test Data Source] button, and check if the connection can be established normally.

9. Click the [OK] button in the "SQL Server ODBC Data Source Test" screen.

10. Click the [OK] button in the "ODBC Microsoft SQL Server Setup" screen.

11. Click the [OK] button in the "ODBC Data Source Administrator" screen.



Access

(Example) Windows 7

The following shows the setting example of ODBC setting in the following conditions.

Item	Description
Relational database	Microsoft Access 2010(32bit)
Data source name*1	SAMPLE
Database name*2	C:\MES\Sample_DB.accdb

*1 A data source name can be set arbitrary.

The name set in this setting is used as a name to be entered for "Data Source Name" under "Target Server Individual Settings" in "Target Server Settings."

*2 The database name is a name for accessing a Microsoft Access database.

Specify the file path of the database created with Microsoft Access.

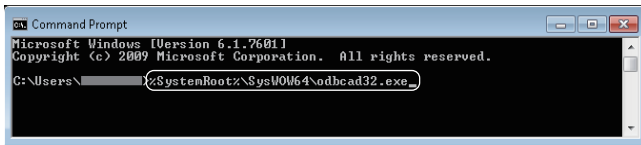

1. Start ODBC Data Source Administrator.
 ↳ Page 116 Starting ODBC Data Source Administrator

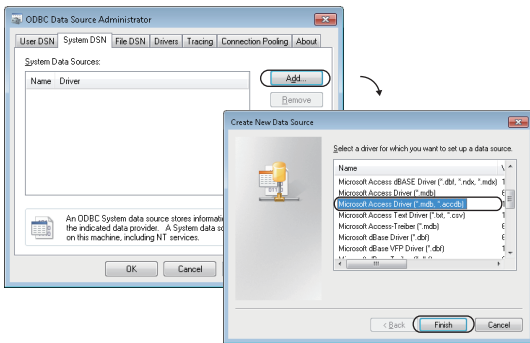

2. Select the [System DSN] tab and click the [Add] button.
3. Select "Microsoft Access Driver (*.mdb, *.accdb)", and click the [Finish] button.

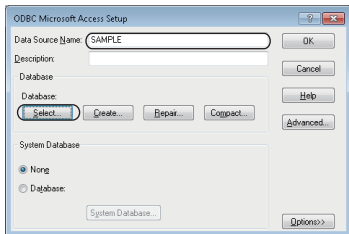

4. Enter 'SAMPLE' in the "Data Source Name" and click the [Select] button in the "Database".

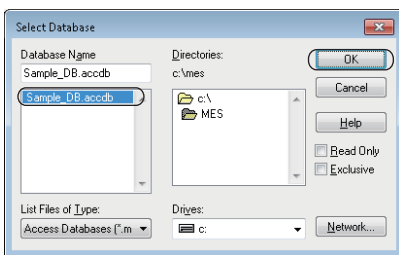

5. Select 'Sample_DB.accdb' in the "Database Name" and click the [OK] button.

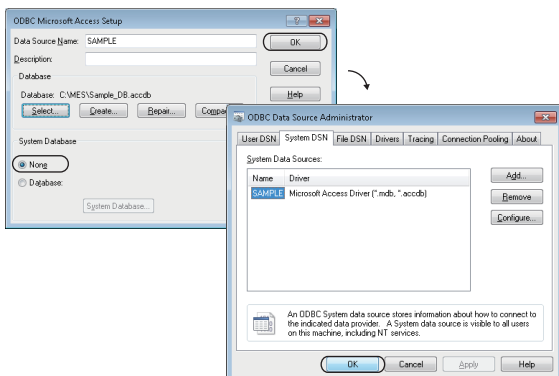

6. Select "None" in the "System Database" and click the [OK] button.
7. Click the [OK] button in the "ODBC Data Source Administrator" screen.

MySQL

(Example) Windows 7

The following shows the setting example of ODBC setting in the following conditions.

Item	Description
Relational database	MySQL
Data source name*1	SAMPLE
Server name*2	SAMPLESRV

*1 A data source name can be set arbitrary.

The name set in this setting is used as a name to be entered for "Data Source Name" under "Target Server Individual Settings" in "Target Server Settings."

*2 The server name is a host name or IP address for accessing a MySQL database.

Point

When using MySQL Community Edition, use an ODBC driver of MariaDB. For details on the ODBC setting of MariaDB, refer to the following:

 Page 124 MariaDB

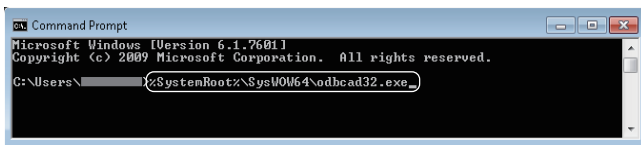

1. Start ODBC Data Source Administrator.

 Page 116 Starting ODBC Data Source Administrator

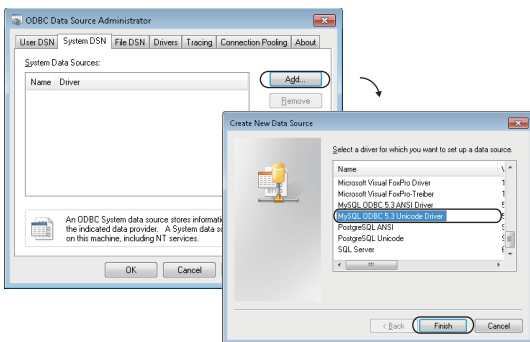

2. Select the [System DSN] tab and click the [Add] button.

3. Select "MySQL ODBC 5.3 Unicode Driver", and click the [Finish] button.

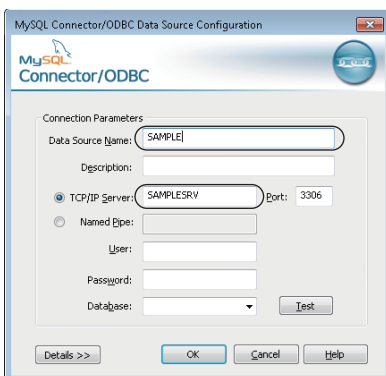

4. Set the following items.

- Data Source Name: SAMPLE
- TCP/IP Server: SAMPLESRV

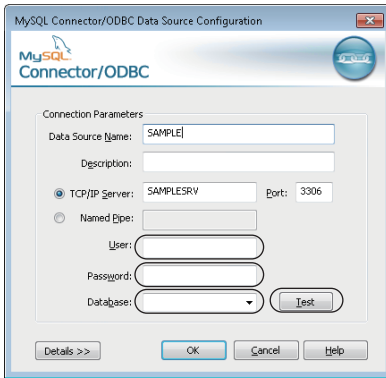

5. Enter "User" and "Password", and select a database to connect in "Database".
6. Click the [Test] button, and check if the connection can be established normally.
7. Click the [OK] button in the "MySQL Connector/ODBC Data Source Configuration" screen.
8. Click the [OK] button in the "ODBC Data Source Administrator" screen.

PostgreSQL

(Example) Windows 7

The following shows the setting example of ODBC setting in the following conditions.

Item	Description
Relational database	PostgreSQL
Data source name*1	SAMPLE
Server name*2	SAMPLESRV

*1 A data source name can be set arbitrary.

The name set in this setting is used as a name to be entered for "Data Source Name" under "Target Server Individual Settings" in "Target Server Settings."

*2 The server name is a host name or IP address for accessing a PostgreSQL database.

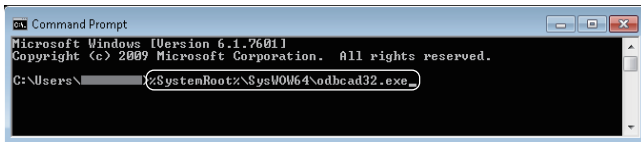

1. Start ODBC Data Source Administrator.

Page 116 Starting ODBC Data Source Administrator

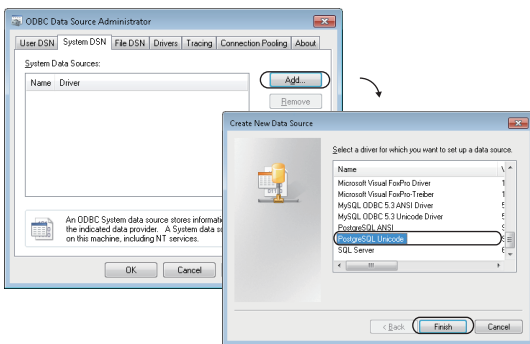

2. Select the [System DSN] tab and click the [Add] button.

3. Select "PostgreSQL Unicode", and click the [Finish] button.

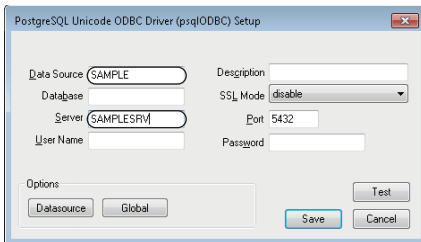

4. Set the following items.

- Data source name: SAMPLE
- Server name: SAMPLESRV

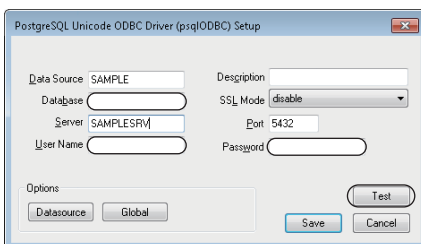

5. Specify a database for "Database", and enter a user name and password.

6. Click the [Test] button. When the connection is established normally, the "Testing Connection" screen will appear.

7. Click the [Save] button in the "PostgreSQL Unicode ODBC Driver (psqlODBC) Setup" screen.

8. Click the [OK] button in the "ODBC Data Source Administrator" screen.



MariaDB

(Example) Windows 10

The following shows the setting example of ODBC setting in the following conditions.

Item	Description
Relational database	MariaDB
Data source name*1	SAMPLEDS
Server name*2	SAMPLESRV

*1 A data source name can be set arbitrary.

The name set in this setting is used as a name to be entered for "Data Source Name" under "Target Server Individual Settings" in "Target Server Settings."

*2 The server name is a host name or IP address for accessing a MariaDB database.

1. Start ODBC Data Source Administrator.

Page 116 Starting ODBC Data Source Administrator

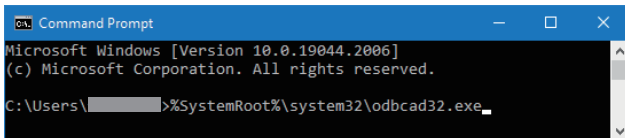

2. Select the [System DSN] tab and click the [Add] button.

3. Select "MariaDB ODBC 3.1 Driver", and click the [Finish] button.

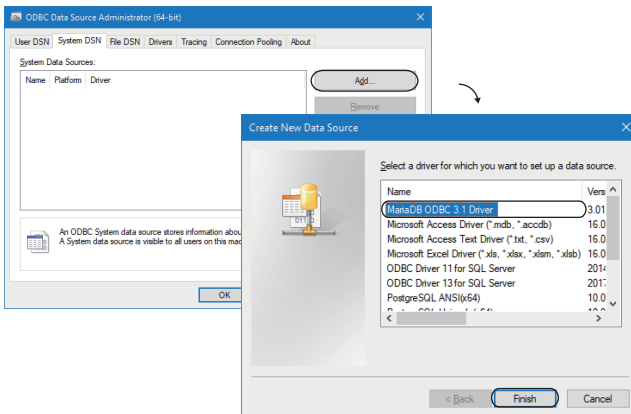

4. Enter 'SAMPLEDS' in "Name" and click the [Next >] button.

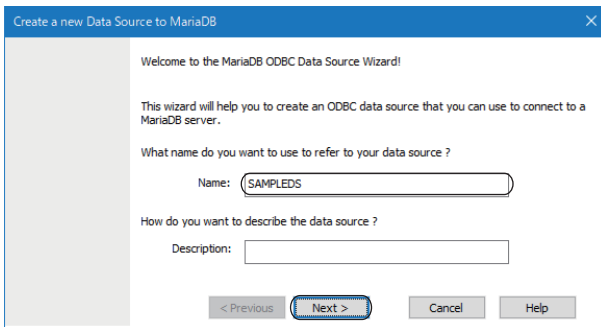

5. Enter 'SAMPLESRV' in "Server Name" and enter a user name and password.

6. Click the [Test DSN] button, and check if the connection can be established normally.

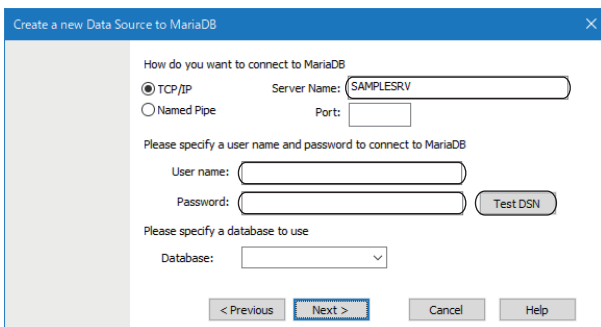

How do you want to connect to MariaDB

TCP/IP Server Name:

Named Pipe Port:

Please specify a user name and password to connect to MariaDB

User name:

Password:

Please specify a database to use

Database:

Do you want to send initial statement(s) after establishing connection to MariaDB?

Statement(s):

Timeouts in sec

Connection: Read: Write: Client is interactive

Enable automatic reconnect Use compression

Don't prompt when connecting Read odbc section from my.cnf

Connection Character Set:

Server RSA public key:

7. Select a database to be connected, and click the [Next >] button.
8. Select "utf8mb4" for "Connection Character Set" and click the [Next >] button.
9. Proceed to the last screen by clicking the [Next >] button, and click the [Finish] button.
10. Click the [OK] button in the "ODBC Data Source Administrator" screen.

INDEX

C

Constant 66

D

Dot matrix LED 16

Dot matrix LED display mode switch 17

E

Ethernet (twisted pair) cable 75

F

Formatting an SD memory card 70

I

Item. 64

M

Macro 66

O

ODBC 57

S

SD memory card 69,75

MEMO

REVISIONS

*The manual number is given on the bottom left of the back cover.

Revision date	*Manual number	Description
December 2015	SH(NA)-081422ENG-A	First edition
July 2016	SH(NA)-081422ENG-B	■Added or modified parts TERMS, Chapter 2, Section 4.1, Section 4.2, Section 5.1, Section 5.2, Section 5.3, Appendix 2
September 2016	SH(NA)-081422ENG-C	■Added or modified parts TERMS, Section 4.1, Section 4.2, Section 5.2, Section 5.3, Section 7.1
March 2017	SH(NA)-081422ENG-D	■Added or modified parts SAFETY PRECAUTIONS, Section 2.1, Section 2.3, Section 2.4, Section 3.3, Section 4.1, Section 4.2, Section 4.3, Section 5.1, Section 5.2, Section 5.3, Section 7.1, Section 8.5, Appendix 2
May 2017	SH(NA)-081422ENG-E	■Added or modified part Section 2.3
October 2017	SH(NA)-081422ENG-F	■Added functions REST server function, project file conversion function ■Added or modified parts Section 2.3, Section 3.1, Section 3.2, Section 3.3, Section 3.6, Section 4.2, Section 5.1, Section 5.2, Section 5.3, Chapter 7, Section 8.5
October 2017	SH(NA)-081422ENG-G	■Added or modified part Section 2.2
May 2018	SH(NA)-081422ENG-H	■Added or modified part Section 5.3
August 2018	SH(NA)-081422ENG-I	■Added or modified part Section 2.3
October 2019	SH(NA)-081422ENG-J	■Added or modified parts TERMS, Chapter 1, Section 2.1, Section 2.2, Section 2.3, Section 2.4, Section 3.2, Section 3.3, Section 4.1, Section 4.2, Section 4.3, Section 5.1, Section 5.2, Section 5.4, Chapter 7, Section 8.5
April 2020	SH(NA)-081422ENG-K	■Added or modified parts Section 2.1, Section 2.2
March 2022	SH(NA)-081422ENG-L	■Added or modified parts SAFETY PRECAUTIONS, CONDITIONS OF USE FOR THE PRODUCT, DISCONTINUED MODEL, Section 2.1, Section 2.2, Section 2.3
February 2023	SH(NA)-081422ENG-M	■Added or modified parts INTRODUCTION, Section 2.1, Section 2.3, Section 2.4, Section 5.1, Section 5.3, Section 5.4, Chapter 7, Section 7.1, Section 8.3, Section 8.5, Appendix 2, COPYRIGHTS
November 2023	SH(NA)-081422ENG-N	■Added or modified parts Section 2.1, Section 2.3, Section 2.4, Section 4.1, Section 5.3, Section 5.4

Japanese manual number: SH-081420-Q

This manual confers no industrial property rights or any rights of any other kind, nor does it confer any patent licenses. Mitsubishi Electric Corporation cannot be held responsible for any problems involving industrial property rights which may occur as a result of using the contents noted in this manual.

© 2015 MITSUBISHI ELECTRIC CORPORATION

WARRANTY

Please confirm the following product warranty details before using this product.

1. Gratis Warranty Term and Gratis Warranty Range

If any faults or defects (hereinafter "Failure") found to be the responsibility of Mitsubishi occurs during use of the product within the gratis warranty term, the product shall be repaired at no cost via the sales representative or Mitsubishi Service Company.

However, if repairs are required onsite at domestic or overseas location, expenses to send an engineer will be solely at the customer's discretion. Mitsubishi shall not be held responsible for any re-commissioning, maintenance, or testing on-site that involves replacement of the failed module.

[Gratis Warranty Term]

The gratis warranty term of the product shall be for one year after the date of purchase or delivery to a designated place. Note that after manufacture and shipment from Mitsubishi, the maximum distribution period shall be six (6) months, and the longest gratis warranty term after manufacturing shall be eighteen (18) months. The gratis warranty term of repair parts shall not exceed the gratis warranty term before repairs.

[Gratis Warranty Range]

- (1) The range shall be limited to normal use within the usage state, usage methods and usage environment, etc., which follow the conditions and precautions, etc., given in the instruction manual, user's manual and caution labels on the product.
- (2) Even within the gratis warranty term, repairs shall be charged for in the following cases.
 1. Failure occurring from inappropriate storage or handling, carelessness or negligence by the user. Failure caused by the user's hardware or software design.
 2. Failure caused by unapproved modifications, etc., to the product by the user.
 3. When the Mitsubishi product is assembled into a user's device, Failure that could have been avoided if functions or structures, judged as necessary in the legal safety measures the user's device is subject to or as necessary by industry standards, had been provided.
 4. Failure that could have been avoided if consumable parts (battery, backlight, fuse, etc.) designated in the instruction manual had been correctly serviced or replaced.
 5. Failure caused by external irresistible forces such as fires or abnormal voltages, and Failure caused by force majeure such as earthquakes, lightning, wind and water damage.
 6. Failure caused by reasons unpredictable by scientific technology standards at time of shipment from Mitsubishi.
 7. Any other failure found not to be the responsibility of Mitsubishi or that admitted not to be so by the user.

2. Onerous repair term after discontinuation of production

- (1) Mitsubishi shall accept onerous product repairs for seven (7) years after production of the product is discontinued. Discontinuation of production shall be notified with Mitsubishi Technical Bulletins, etc.
- (2) Product supply (including repair parts) is not available after production is discontinued.

3. Overseas service

Overseas, repairs shall be accepted by Mitsubishi's local overseas FA Center. Note that the repair conditions at each FA Center may differ.

4. Exclusion of loss in opportunity and secondary loss from warranty liability

Regardless of the gratis warranty term, Mitsubishi shall not be liable for compensation to:

- (1) Damages caused by any cause found not to be the responsibility of Mitsubishi.
- (2) Loss in opportunity, lost profits incurred to the user by Failures of Mitsubishi products.
- (3) Special damages and secondary damages whether foreseeable or not, compensation for accidents, and compensation for damages to products other than Mitsubishi products.
- (4) Replacement by the user, maintenance of on-site equipment, start-up test run and other tasks.

5. Changes in product specifications

The specifications given in the catalogs, manuals or technical documents are subject to change without prior notice.

TRADEMARKS

Intel is either registered trademarks or trademarks of Intel Corporation in the United States and/or other countries.

MariaDB is either a registered trademark or a trademark of MariaDB Corporation Ab.

Microsoft, Microsoft Access, Visual C++, and Windows are trademarks of the Microsoft group of companies.

MySQL is either a registered trademark or a trademark of MySQL AB.

Oracle and Java are registered trademarks of Oracle and/or its affiliates.

Unicode is either a registered trademark or a trademark of Unicode, Inc. in the United States and other countries.

The company names, system names and product names mentioned in this manual are either registered trademarks or trademarks of their respective companies.

In some cases, trademark symbols such as [™] or [®] are not specified in this manual.

COPYRIGHTS

The screens (screenshots) are used in accordance with the Microsoft Corporation guideline.

SH(NA)-081422ENG-N(2311)KWIX

MODEL: R-MES-U-IN-E

MODEL CODE: 13JX23

MITSUBISHI ELECTRIC CORPORATION

HEAD OFFICE: TOKYO BLDG., 2-7-3, MARUNOUCHI, CHIYODA-KU, TOKYO 100-8310, JAPAN
NAGOYA WORKS: 1-14, YADA-MINAMI 5-CHOME, HIGASHI-KU, NAGOYA 461-8670, JAPAN

When exported from Japan, this manual does not require application to the
Ministry of Economy, Trade and Industry for service transaction permission.

Specifications subject to change without notice.