

Programmable Controller

MELSEC iQ-R
series

MELSEC iQ-R MES Interface Module User's Manual (Application)

-RD81MES96N
-RD81MES96
-SW1DND-RMESIF-E(MX MESInterface-R)



SAFETY PRECAUTIONS

(Read these precautions before using this product.)

Before using this product, please read this manual and the relevant manuals carefully and pay full attention to safety to handle the product correctly. If the equipment is used in a manner not specified by the manufacturer, the protection provided by the equipment may be impaired.

The precautions given in this manual are concerned with this product only. For the safety precautions of the programmable controller system, refer to the MELSEC iQ-R Module Configuration Manual.

In this manual, the safety precautions are classified into two levels: "⚠ WARNING" and "⚠ CAUTION".

 WARNING	Indicates that incorrect handling may cause hazardous conditions, resulting in death or severe injury.
 CAUTION	Indicates that incorrect handling may cause hazardous conditions, resulting in minor or moderate injury or property damage.

Under some circumstances, failure to observe the precautions given under "⚠ CAUTION" may lead to serious consequences.

Observe the precautions of both levels because they are important for personal and system safety.

Make sure that the end users read this manual and then keep the manual in a safe place for future reference.

[Design Precautions]

WARNING

- Configure safety circuits external to the programmable controller to ensure that the entire system operates safely even when a fault occurs in the external power supply or the programmable controller. Failure to do so may result in an accident due to an incorrect output or malfunction.
 - (1) Emergency stop circuits, protection circuits, and protective interlock circuits for conflicting operations (such as forward/reverse rotations or upper/lower limit positioning) must be configured external to the programmable controller.
 - (2) When the programmable controller detects an abnormal condition, it stops the operation and all outputs are:
 - Turned off if the overcurrent or overvoltage protection of the power supply module is activated.
 - Held or turned off according to the parameter setting if the self-diagnostic function of the CPU module detects an error such as a watchdog timer error.
 - (3) All outputs may be turned on if an error occurs in a part, such as an I/O control part, where the CPU module cannot detect any error. To ensure safety operation in such a case, provide a safety mechanism or a fail-safe circuit external to the programmable controller. For a fail-safe circuit example, refer to the MELSEC iQ-R Module Configuration Manual.
 - (4) Outputs may remain on or off due to a failure of a component such as a relay and transistor in an output circuit. Configure an external circuit for monitoring output signals that could cause a serious accident.
 - In an output circuit, when a load current exceeding the rated current or an overcurrent caused by a load short-circuit flows for a long time, it may cause smoke and fire. To prevent this, configure an external safety circuit, such as a fuse.
 - Configure a circuit so that the programmable controller is turned on first and then the external power supply. If the external power supply is turned on first, an accident may occur due to an incorrect output or malfunction.
 - Configure a circuit so that the external power supply is turned off first and then the programmable controller. If the programmable controller is turned off first, an accident may occur due to an incorrect output or malfunction.
 - For the operating status of each station after a communication failure, refer to manuals for the network used. For the manuals, please consult your local Mitsubishi representative. Incorrect output or malfunction due to a communication failure may result in an accident.
 - When connecting an external device with a CPU module or intelligent function module to modify data of a running programmable controller, configure an interlock circuit in the program to ensure that the entire system will always operate safely. For other forms of control (such as program modification, parameter change, forced output, or operating status change) of a running programmable controller, read the relevant manuals carefully and ensure that the operation is safe before proceeding. Improper operation may damage machines or cause accidents. When a Safety CPU is used, data cannot be modified while the Safety CPU is in SAFETY MODE.
 - Especially, when a remote programmable controller is controlled by an external device, immediate action cannot be taken if a problem occurs in the programmable controller due to a communication failure. To prevent this, configure an interlock circuit in the program, and determine corrective actions to be taken between the external device and CPU module in case of a communication failure.
-

[Design Precautions]

WARNING

- Do not write any data to the "system area" and "write-protect area" of the buffer memory in the module. Also, do not use any "use prohibited" signals as an output signal from the CPU module to each module. Doing so may cause malfunction of the programmable controller system. For the "system area", "write-protect area", and the "use prohibited" signals, refer to the user's manual for the module used. For areas used for safety communications, they are protected from being written by users, and thus safety communications failure caused by data writing does not occur.
 - If a communication cable is disconnected, the network may be unstable, resulting in a communication failure of multiple stations. Configure an interlock circuit in the program to ensure that the entire system will always operate safely even if communications fail. Incorrect output or malfunction due to a communication failure may result in an accident. When safety communications are used, an interlock by the safety station interlock function protects the system from an incorrect output or malfunction.
-

[Design Precautions]

CAUTION

- Do not install the control lines or communication cables together with the main circuit lines or power cables. Doing so may result in malfunction due to electromagnetic interference. Keep a distance of 100mm or more between those cables.
 - During control of an inductive load such as a lamp, heater, or solenoid valve, a large current (approximately ten times greater than normal) may flow when the output is turned from off to on. Therefore, use a module that has a sufficient current rating.
 - After the CPU module is powered on or is reset, the time taken to enter the RUN status varies depending on the system configuration, parameter settings, and/or program size. Design circuits so that the entire system will always operate safely, regardless of the time.
 - Do not power off the programmable controller or reset the CPU module while the settings are being written. Doing so will make the data in the flash ROM and SD memory card undefined. The values need to be set in the buffer memory and written to the flash ROM and SD memory card again. Doing so also may cause malfunction or failure of the module.
 - When changing the operating status of the CPU module from external devices (such as the remote RUN/STOP functions), select "Do Not Open by Program" for "Opening Method" of "Module Parameter". If "Open by Program" is selected, an execution of the remote STOP function causes the communication line to close. Consequently, the CPU module cannot reopen the line, and external devices cannot execute the remote RUN function.
-

[Security Precautions]

WARNING

- To maintain the security (confidentiality, integrity, and availability) of the programmable controller and the system against unauthorized access, denial-of-service (DoS) attacks, computer viruses, and other cyberattacks from external devices via the network, take appropriate measures such as firewalls, virtual private networks (VPNs), and antivirus solutions.
-

[Installation Precautions]

WARNING

- Shut off the external power supply (all phases) used in the system before mounting or removing the module. Failure to do so may result in electric shock or cause the module to fail or malfunction.
-

[Installation Precautions]

CAUTION

- Use the programmable controller in an environment that meets the general specifications in the MELSEC iQ-R Module Configuration Manual. Failure to do so may result in electric shock, fire, malfunction, or damage to or deterioration of the product.
 - To mount a module, place the concave part(s) located at the bottom onto the guide(s) of the base unit, and push in the module until the hook(s) located at the top snaps into place. Incorrect interconnection may cause malfunction, failure, or drop of the module.
 - To mount a module with no module fixing hook, place the concave part(s) located at the bottom onto the guide(s) of the base unit, push in the module, and fix it with screw(s). Incorrect interconnection may cause malfunction, failure, or drop of the module.
 - When using the programmable controller in an environment of frequent vibrations, fix the module with a screw.
 - Tighten the screws within the specified torque range. Undertightening can cause drop of the component or wire, short circuit, or malfunction. Overtightening can damage the screw and/or module, resulting in drop, short circuit, or malfunction. For the specified torque range, refer to the MELSEC iQ-R Module Configuration Manual.
 - When using an extension cable, connect it to the extension cable connector of the base unit securely. Check the connection for looseness. Poor contact may cause malfunction.
 - When using an SD memory card, fully insert it into the SD memory card slot. Check that it is inserted completely. Poor contact may cause malfunction.
 - Securely insert an extended SRAM cassette or a battery-less option cassette into the cassette connector of the CPU module. After insertion, close the cassette cover and check that the cassette is inserted completely. Poor contact may cause malfunction.
 - Beware that the module could be very hot while power is on and immediately after power-off.
 - Do not directly touch any conductive parts and electronic components of the module, SD memory card, extended SRAM cassette, battery-less option cassette, or connector. Doing so can cause malfunction or failure of the module.
-

[Wiring Precautions]

WARNING

- Shut off the external power supply (all phases) used in the system before installation and wiring. Failure to do so may result in electric shock or cause the module to fail or malfunction.
- After installation and wiring, attach a blank cover module (RG60) to each empty slot before powering on the system for operation. Also, attach an extension connector protective cover^{*1} to each unused extension cable connector as necessary. Directly touching any conductive parts of the connectors while power is on may result in electric shock.

*1 For details, please consult your local Mitsubishi Electric representative.

[Wiring Precautions]

CAUTION

- Individually ground the FG and LG terminals of the programmable controller with a ground resistance of 100 ohms or less. Failure to do so may result in electric shock or malfunction.
 - Use applicable solderless terminals and tighten them within the specified torque range. If any spade solderless terminal is used, it may be disconnected when the terminal screw comes loose, resulting in failure.
 - Check the rated voltage and signal layout before wiring to the module, and connect the cables correctly. Connecting a power supply with a different voltage rating or incorrect wiring may cause fire or failure.
 - Connectors for external devices must be crimped or pressed with the tool specified by the manufacturer, or must be correctly soldered. Incomplete connections may cause short circuit, fire, or malfunction.
 - Securely connect the connector to the module. Poor contact may cause malfunction.
 - Do not install the control lines or communication cables together with the main circuit lines or power cables. Doing so may result in malfunction due to noise. Keep a distance of 100mm or more between those cables.
 - Place the cables in a duct or clamp them. If not, dangling cables may swing or inadvertently be pulled, resulting in malfunction or damage to modules or cables.
In addition, the weight of the cables may put stress on modules in an environment of strong vibrations and shocks.
Do not clamp the extension cables with the jacket stripped. Doing so may change the characteristics of the cables, resulting in malfunction.
 - Check the interface type and correctly connect the cable. Incorrect wiring (connecting the cable to an incorrect interface) may cause failure of the module and external device.
 - Tighten the terminal screws or connector screws within the specified torque range. Undertightening can cause drop of the screw, short circuit, fire, or malfunction. Overtightening can damage the screw and/or module, resulting in drop, short circuit, fire, or malfunction.
 - When disconnecting the cable from the module, do not pull the cable by the cable part. For the cable with connector, hold the connector part of the cable. For the cable connected to the terminal block, loosen the terminal screw. Pulling the cable connected to the module may result in malfunction or damage to the module or cable.
 - Prevent foreign matter such as dust or wire chips from entering the module. Such foreign matter can cause a fire, failure, or malfunction.
-

[Wiring Precautions]

CAUTION

- When a protective film is attached to the top of the module, remove it before system operation. If not, inadequate heat dissipation of the module may cause a fire, failure, or malfunction.
 - Programmable controllers must be installed in control panels. Connect the main power supply to the power supply module in the control panel through a relay terminal block. Wiring and replacement of a power supply module must be performed by qualified maintenance personnel with knowledge of protection against electric shock. For wiring, refer to the MELSEC iQ-R Module Configuration Manual.
 - For Ethernet cables to be used in the system, select the ones that meet the specifications in the user's manual for the module used. If not, normal data transmission is not guaranteed.
-

[Startup and Maintenance Precautions]

WARNING

- Do not touch any terminal while power is on. Doing so will cause electric shock or malfunction.
 - Correctly connect the battery connector. Do not charge, disassemble, heat, short-circuit, solder, or throw the battery into the fire. Also, do not expose it to liquid or strong shock. Doing so will cause the battery to produce heat, explode, ignite, or leak, resulting in injury and fire.
 - Shut off the external power supply (all phases) used in the system before cleaning the module or retightening the terminal screws, connector screws, or module fixing screws. Failure to do so may result in electric shock.
-

[Startup and Maintenance Precautions]

CAUTION

- When connecting an external device with a CPU module or intelligent function module to modify data of a running programmable controller, configure an interlock circuit in the program to ensure that the entire system will always operate safely. For other forms of control (such as program modification, parameter change, forced output, or operating status change) of a running programmable controller, read the relevant manuals carefully and ensure that the operation is safe before proceeding. Improper operation may damage machines or cause accidents.
 - Especially, when a remote programmable controller is controlled by an external device, immediate action cannot be taken if a problem occurs in the programmable controller due to a communication failure. To prevent this, configure an interlock circuit in the program, and determine corrective actions to be taken between the external device and CPU module in case of a communication failure.
 - Do not disassemble or modify the modules. Doing so may cause failure, malfunction, injury, or a fire.
 - Use any radio communication device such as a cellular phone or PHS (Personal Handy-phone System) more than 25cm away in all directions from the programmable controller. Failure to do so may cause malfunction.
 - Shut off the external power supply (all phases) used in the system before mounting or removing the module. Failure to do so may cause the module to fail or malfunction.
 - Tighten the screws within the specified torque range. Undertightening can cause drop of the component or wire, short circuit, or malfunction. Overtightening can damage the screw and/or module, resulting in drop, short circuit, or malfunction.
 - After the first use of the product, do not perform each of the following operations more than 50 times (IEC 61131-2/JIS B 3502 compliant).
Exceeding the limit may cause malfunction.
 - Mounting/removing the module to/from the base unit
 - Inserting/removing the extended SRAM cassette or battery-less option cassette to/from the CPU module
 - Mounting/removing the terminal block to/from the module
 - Connecting/disconnecting the extension cable to/from the base unit
 - After the first use of the product, do not insert/remove the SD memory card to/from the CPU module more than 500 times. Exceeding the limit may cause malfunction.
 - Do not touch the metal terminals on the back side of the SD memory card. Doing so may cause malfunction or failure of the module.
 - Do not touch the integrated circuits on the circuit board of an extended SRAM cassette or a battery-less option cassette. Doing so may cause malfunction or failure of the module.
 - Do not drop or apply shock to the battery to be installed in the module. Doing so may damage the battery, causing the battery fluid to leak inside the battery. If the battery is dropped or any shock is applied to it, dispose of it without using.
 - Startup and maintenance of a control panel must be performed by qualified maintenance personnel with knowledge of protection against electric shock. Lock the control panel so that only qualified maintenance personnel can operate it.
 - Before handling the module, touch a conducting object such as a grounded metal to discharge the static electricity from the human body. Wearing a grounded antistatic wrist strap is recommended. Failure to discharge the static electricity may cause the module to fail or malfunction.
-

[Startup and Maintenance Precautions]

CAUTION

- After unpacking, eliminate static electricity from the module to prevent electrostatic discharge from affecting the module. If an electrostatically charged module comes in contact with a grounded metal object, a sudden electrostatic discharge of the module may cause failure.
For details on how to eliminate static electricity from the module, refer to the following.
Antistatic Precautions Before Using MELSEC iQ-R Series Products (FA-A-0368)
 - Use a clean and dry cloth to wipe off dirt on the module.
-

[Operating Precautions]

CAUTION

- When changing data and operating status, and modifying program of the running programmable controller from an external device such as a personal computer connected to an intelligent function module, read relevant manuals carefully and ensure the safety before operation. Incorrect change or modification may cause system malfunction, damage to the machines, or accidents.
 - Do not power off the programmable controller or reset the CPU module while the setting values in the buffer memory are being written to the flash ROM in the module. Doing so will make the data in the flash ROM and SD memory card undefined. The values need to be set in the buffer memory and written to the flash ROM and SD memory card again. Doing so can cause malfunction or failure of the module.
-

[Disposal Precautions]

CAUTION

- When disposing of this product, treat it as industrial waste.
 - When disposing of batteries, separate them from other wastes according to the local regulations. For details on battery regulations in EU member states, refer to the MELSEC iQ-R Module Configuration Manual.
-

[Transportation Precautions]

CAUTION

- When transporting lithium batteries, follow the transportation regulations. For details on the regulated models, refer to the MELSEC iQ-R Module Configuration Manual.
 - The halogens (such as fluorine, chlorine, bromine, and iodine), which are contained in a fumigant used for disinfection and pest control of wood packaging materials, may cause failure of the product. Prevent the entry of fumigant residues into the product or consider other methods (such as heat treatment) instead of fumigation. The disinfection and pest control measures must be applied to unprocessed raw wood.
-

CONDITIONS OF USE FOR THE PRODUCT

- (1) MELSEC programmable controller ("the PRODUCT") shall be used in conditions;
- i) where any problem, fault or failure occurring in the PRODUCT, if any, shall not lead to any major or serious accident; and
 - ii) where the backup and fail-safe function are systematically or automatically provided outside of the PRODUCT for the case of any problem, fault or failure occurring in the PRODUCT.
- (2) The PRODUCT has been designed and manufactured for the purpose of being used in general industries. MITSUBISHI ELECTRIC SHALL HAVE NO RESPONSIBILITY OR LIABILITY (INCLUDING, BUT NOT LIMITED TO ANY AND ALL RESPONSIBILITY OR LIABILITY BASED ON CONTRACT, WARRANTY, TORT, PRODUCT LIABILITY) FOR ANY INJURY OR DEATH TO PERSONS OR LOSS OR DAMAGE TO PROPERTY CAUSED BY the PRODUCT THAT ARE OPERATED OR USED IN APPLICATION NOT INTENDED OR EXCLUDED BY INSTRUCTIONS, PRECAUTIONS, OR WARNING CONTAINED IN MITSUBISHI ELECTRIC USER'S, INSTRUCTION AND/OR SAFETY MANUALS, TECHNICAL BULLETINS AND GUIDELINES FOR the PRODUCT.
- ("Prohibited Application")
- Prohibited Applications include, but not limited to, the use of the PRODUCT in;
- Nuclear Power Plants and any other power plants operated by Power companies, and/or any other cases in which the public could be affected if any problem or fault occurs in the PRODUCT.
 - Railway companies or Public service purposes, and/or any other cases in which establishment of a special quality assurance system is required by the Purchaser or End User.
 - Aircraft or Aerospace, Medical applications, Train equipment, transport equipment such as Elevator and Escalator, Incineration and Fuel devices, Vehicles, Manned transportation, Equipment for Recreation and Amusement, and Safety devices, handling of Nuclear or Hazardous Materials or Chemicals, Mining and Drilling, and/or other applications where there is a significant risk of injury to the public or property.
- Notwithstanding the above restrictions, Mitsubishi Electric may in its sole discretion, authorize use of the PRODUCT in one or more of the Prohibited Applications, provided that the usage of the PRODUCT is limited only for the specific applications agreed to by Mitsubishi Electric and provided further that no special quality assurance or fail-safe, redundant or other safety features which exceed the general specifications of the PRODUCTS are required. For details, please contact the Mitsubishi Electric representative in your region.
- (3) Mitsubishi Electric shall have no responsibility or liability for any problems involving programmable controller trouble and system trouble caused by DoS attacks, unauthorized access, computer viruses, and other cyberattacks.

INTRODUCTION

Thank you for purchasing the Mitsubishi Electric MELSEC iQ-R series programmable controllers.

This manual describes the functions and programming to use the module listed below.

Before using this product, please read this manual and the relevant manuals carefully and develop familiarity with the functions and performance of the MELSEC iQ-R series programmable controller to handle the product correctly.

When applying the program examples provided in this manual to an actual system, ensure the applicability and confirm that it will not cause system control problems.

Note that the menu names and operating procedures may differ depending on an operating system in use and its version.

When reading this manual, replace the names and procedures with the applicable ones as necessary.

Please make sure that the end users read this manual.

Point

The program examples shown in this manual are the examples in which an MES interface module (RD81MES96N or RD81MES96) is assigned to the input/output No. X/Y0 to X/Y1F unless otherwise specified. To use the program examples shown in this manual, the input/output number assignment is required. For details on the assignment of input/output number, refer to the following:

 MELSEC iQ-R Module Configuration Manual

Relevant product

RD81MES96N

RD81MES96

CONTENTS

SAFETY PRECAUTIONS	1
CONDITIONS OF USE FOR THE PRODUCT	9
INTRODUCTION	10
RELEVANT MANUALS	15
TERMS	16
GENERIC TERMS AND ABBREVIATIONS	16
DISCONTINUED MODEL	16
CHAPTER 1 FUNCTIONS	17
1.1 Data Input/Output Function	23
Device memory input/output function	23
DB input/output function	26
Variable input/output function	43
1.2 External Communication Client Function	44
Program execution function	44
1.3 Information Linkage Function	45
Trigger condition monitoring function	45
Job execution control function	60
Trigger buffering function	63
One-shot execution function	65
Data operation and processing function	67
Data linkage function	86
Communication test function	92
DB information browse function	93
1.4 External Communication Server Function	95
REST server function	95
1.5 Security Function	96
User authentication function	97
1.6 Other Functions	98
SD memory card management function	98
Self-diagnostics function	98
Initialization function	99
1.7 Data Structure	100
Array tag specifications	100
1.8 Internal Operation Check in MES interface module	106
CHAPTER 2 MES Interface Function Configuration Tool	107
2.1 MES Interface Function Configuration Tool	107
2.2 Project File Handling	107
Creating a new project	107
Opening a project	107
Saving a project	108
Importing a setting from a project	109
Opening a project file used recently	110
Opening CSV files	110
Saving CSV files	110
2.3 Project Settings	111
2.4 Job Settings	112

Job setting list	112
Job settings	113
Job configuration	114
Trigger conditions	115
Read data at trigger judgment.	117
Pre-processing	118
Main-processing	119
Post-processing.	121
Verification settings	122
2.5 Action Settings	123
DB communication action setting	124
External communication action settings	130
Operation action settings.	132
Copying an action	133
2.6 Access Target Device Settings	134
Access target device setting list	134
Access target device settings	135
2.7 Device Tag Settings.	137
Device tag setting list.	137
Device tag settings	138
Importing global labels/common device comments.	142
2.8 Target Server Settings	152
Target server setting list.	152
Access target server settings	153
2.9 Access Table/Procedure Settings	155
Access table/procedure setting list	155
Access table/procedure settings	156
2.10 Network Settings	160
2.11 Option Settings	161
Variable settings	161
DB buffer settings	162
Security settings	163
Dot matrix LED settings.	164
2.12 Online	165
Connection destination specification.	165
Online data operation	166
Diagnostics	167
Management	181
One-shot execution	183
2.13 Help.	184
CHAPTER 3 DB CONNECTION SERVICE AND SETTING TOOL	185
<hr/>	
3.1 DB Connection Service Functions.	185
DB connection function	185
Program execution function.	186
DB information browse function.	187
Security function	188
Log output function	188
3.2 Setting Items	189
Service port (required).	190

DB access timeout (required)	190
Limit IP addresses permit to connect	190
Output access log	192
Output SQL failed log	193
Specify the log charset	193
3.3 Importing/Exporting Files	194
Import	194
Export	194
3.4 Help	195
Product information	195
Connection to MITSUBISHI ELECTRIC FA Global Website	195
3.5 Output Log Specifications	196
Access log	197
SQL failure log	201
CHAPTER 4 Project File Conversion Tool	202
<hr/>	
4.1 About Project File Conversion Tool	202
Startup method	202
Conversion procedure	202
Conversion log file	203
4.2 Project Conversion Specifications	204
When a conversion error occurred	204
Situations where setting contents are changed	205
CHAPTER 5 PARAMETER SETTING	206
<hr/>	
5.1 Parameter Setting Procedure	206
5.2 Basic Settings	206
Various operation settings	207
5.3 Refresh Settings	209
CHAPTER 6 API SPECIFICATIONS (REST SERVER FUNCTION)	210
<hr/>	
6.1 Resource List	210
6.2 /v1/job.json(POST)	211
6.3 /v1/jobs.json(GET)	214
6.4 MESXML.CGI(POST)	222
CHAPTER 7 TROUBLESHOOTING	225
<hr/>	
7.1 Checking Method for Error Descriptions	225
7.2 Checking the Module Status	226
Error information	226
Module information list	227
Self-diagnostic tests	228
7.3 Troubleshooting by Symptom	231
Troubleshooting on MES Interface Function Configuration Tool	231
Troubleshooting on DB Connection Service	233
Troubleshooting on LED indication and I/O signals	234
Troubleshooting on network connection	235
Troubleshooting on the target device communication	235
Troubleshooting on the information linkage function	236
Troubleshooting on an SD memory card	240

Troubleshooting on the REST server function	240
Troubleshooting on Project File Conversion Tool	240
7.4 Error Code List	241
Error codes for an MES interface module	241
Error codes for DB Connection Service.	257
Error codes of REST server function response message	265
7.5 Event Code List	268
APPENDIX	269
<hr/>	
Appendix 1 Module Labels	269
Appendix 2 Input/Output Signals	270
Input/output signal list	270
Input signal details.	271
Output signal details	274
Appendix 3 Buffer Memory	275
Buffer memory list	276
Buffer memory details	284
Appendix 4 Usable Characters	297
Appendix 5 Processing Time	298
Processing time required for a DB communication action (when "Single Handshake" is selected in a trigger condition (general access))	299
Processing time required for a DB communication action (when "Single Handshake" is selected in a trigger condition (high-speed access))	301
Processing time required for a DB communication action (when "Condition (Value Monitoring)" is selected in a trigger condition (high-speed access))	303
Appendix 6 CSV File Import/Export Specifications	306
Setting information file	306
Diagnose information file	335
Appendix 7 Data Collection Method for CPU Modules that cannot be Accessed Directly	340
Appendix 8 Warning Messages in Windows	342
Overview of warning messages.	342
Methods for disabling warning messages	342
Appendix 9 Considerations When Handling "(Blank)" DB Fields	343
Inserting "(Blank)" or updating data to "(Blank)"	343
Setting "(Blank)" for a narrow-down condition of SELECT, UPDATE, DELETE, and Multi-SELECT	343
Appendix 10 Replacing an RD81MES96 with an RD81MES96N.	344
Replacement procedure	344
Considerations.	348
Appendix 11 Software Licenses	349
Appendix 12 Added and Changed Functions	364
INDEX	368
<hr/>	
REVISIONS	370
WARRANTY	371
TRADEMARKS	372
COPYRIGHTS	372

RELEVANT MANUALS

Manual name [manual number]	Description	Available form
MELSEC iQ-R MES Interface Module User's Manual (Application) [SH-081423ENG] (this manual)	Functions, MES Interface Function Configuration Tool, DB Connection Service, parameter setting, troubleshooting, input/output, and buffer memory of an MES interface module	Print book e-Manual PDF
MELSEC iQ-R MES Interface Module User's Manual (Startup) [SH-081422ENG]	Specifications, procedure before operation, system configuration, wiring, and operation examples of an MES interface module	Print book e-Manual PDF
GX Works3 Operating Manual [SH-081215ENG]	System configurations, parameter settings, and operation methods for the online function in GX Works3	e-Manual PDF
MELSEC iQ-R Module Configuration Manual [SH-081262ENG]	The combination of the MELSEC iQ-R series modules, common information on the installation/wiring in the system, and specifications of the power supply module, base unit, SD memory card, and battery	Print book e-Manual PDF

Point

e-Manual refers to the Mitsubishi Electric FA electronic book manuals that can be browsed using a dedicated tool.

e-Manual has the following features:

- Required information can be cross-searched in multiple manuals.
- Other manuals can be accessed from the links in the manual.
- Hardware specifications of each part can be found from the product figures.
- Pages that users often browse can be bookmarked.
- Sample programs can be copied to an engineering tool.

TERMS

Unless otherwise specified, this manual uses the following terms.

Term	Description
Data source	Connection information which is necessary for accessing data using ODBC. With Windows, a data source name is assigned to connection information for management. The database is accessed via ODBC by specifying the data source name with the information linkage function.
Device tag	A data table that contains a set of information (component) required to access device data in each CPU module on a network
Device tag component	A component (device data) which configures a device tag. Data that contains communication routes, data types, devices, etc. required to access device data in each CPU module on a network.
Engineering tool	A tool used for setting up programmable controllers, programming, debugging, and maintenance. For the supported tools, refer to the following:  MELSEC iQ-R Module Configuration Manual
Handshake	For highly reliable processing, devices in a CPU module are used for managing processing between the CPU module and MES interface module.

For definitions of terms for safety CPUs, refer to the following:

 MELSEC iQ-R CPU Module User's Manual (Application)

GENERIC TERMS AND ABBREVIATIONS

Unless otherwise specified, this manual uses the following generic terms and abbreviations.

Generic term/abbreviation	Description
Application server	A computer with a program which runs upon request from an MES interface module
Configuration personal computer	A personal computer to set various settings for an MES interface module. This computer can be shared with a server.
Database server	A computer with a relational database which links information with an MES interface module
FX5CPU	A MELSEC iQ-F series CPU module
FXCPU	A MELSEC-F series CPU module
MES	Manufacturing Execution Systems. A system for controlling and monitoring the plant status in real time to optimize production activities. The system enables to speed up responses to changes of a production plan and situation that lead to efficient production processes and optimization of production activities.
MES Interface Function Configuration Tool	MELSEC iQ-R series MES Interface Function Configuration Tool
MES interface module	A MELSEC iQ-R MES interface module
Network module	Includes the following: <ul style="list-style-type: none"> • CC-Link IE Controller Network module • CC-Link IE Field Network module • MELSECNET/H network module • Ethernet interface module • CC-Link module
RCPU	A MELSEC iQ-R series CPU module and a MELSEC iQ-R series C Controller module
Server	A database server and an application server

DISCONTINUED MODEL

The following model is described in this manual, but has no longer been produced.

For the onerous repair term after discontinuation of production, refer to "WARRANTY" in this manual.

Model name	Production discontinuation
RD81MES96	May 2020

1 FUNCTIONS

This chapter explains the details on the functions of an MES interface module.

Operations on MES interface module

MES interface module provides information linkage by operating based on the following settings.

Setting name	Description
Job settings	Set a timing to start linking information and processing (contents to be linked) with a trigger condition and an action.
Device tag settings	Set each piece of data, which is inputted to or outputted from a device such as CPU module by a job, as a device tag component. Set a table of data, in which multiple device tag components are grouped, as a device tag.
Target device settings	Set a CPU module to be accessed from a device tag as a target device.
Access table/procedure settings	Set a table/procedure of a database to be accessed from a job as an access table/procedure.
Target server settings	Set a server, in which a table specified in a access table is included, as a target server. The database server which has a database to be linked and the application server which has an application to be linked can be set.

The information linkage function of an MES interface module provides data linkage between a CPU module and a database by monitoring a trigger condition set to the job settings and executing an action set to the job settings in order when the condition is satisfied.

The information linkage function reads/writes data as a device tag component in order to input/output the device data in the CPU module by using the data input/output function. The data input/output function identifies the target CPU module set in the target device settings.

Additionally, the information linkage function accesses the database as an access table/procedure by using the data input/output function. The data input/output function identifies the target server in the access target server setting.

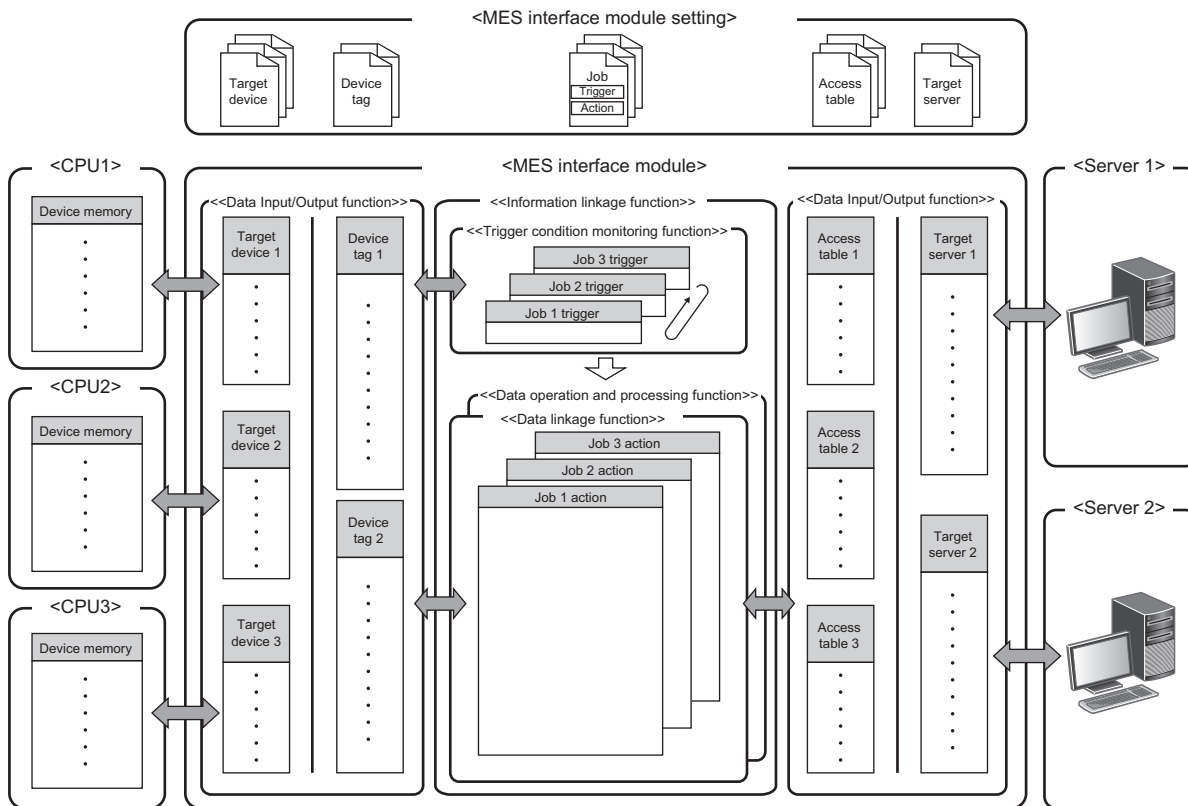

Action execution timing and action types

The following three types of actions can be set for an action in a job setting.

Action type	Description
DB communication action	An action to be specified when inputting/outputting data to the database by using the DB input/output function.
Operation action	An action to be specified when performing data operation and processing by using the data operation and processing function.
External communication action	An action to be specified when linking data with an application server by using the external communication client function.

Basically, specify the sequence processing to the action in the job settings (main configuration). The settings can be configured with pre-processing, main-processing, and post-processing depending on the execution timing and the purpose of the action (extended configuration).

The action types that can be specified for each timing are as follows:

○: Available, ×: Not available

Processing	Description	DB communication action	Operation action	External communication action
Pre-processing	Specify an action executed before sequential processing (such as database operations) in the main-processing. The atomicity of the data processing is not guaranteed. The action is executed sequentially, and the result up to the failure is reflected at failure. The pre-processing is used for executing the processing which prepares data for data linkage in advance in the database.	×	○	○
Main-processing	Specify an action to perform sequential processing (such as database operations) for information linkage. The atomicity of the data processing is guaranteed, and the data is reflected when the sequence actions all succeed. If even one of them fails, the processing result of each action in the main-processing is discarded on both the database side and the device side as job cancellation ^{*1, *2}	○	○	×
Post-processing	Specify an action executed after sequential processing (such as database operations) in the main-processing. The atomicity of the data processing is not guaranteed. The action is executed sequentially, and the result up to the failure is reflected at failure. The post-processing is used for notifying/reflecting data stored in main-processing to the application on the database server.	×	○	○

*1 Job cancel means that when an error occurred in a main processing, the processing result is discarded and the result in both database and device are returned to the previous status.

*2 The atomicity of the assignment for a variable is not guaranteed even in the main-processing as an exception.

Types of job configuration

There are two types of job configurations: main configuration and extended configuration. The availability of each action differs as shown in the following table.

○: Available, ×: Not available

Job configuration	Description	Availability		
		Pre-processing	Main-processing	Post-processing
Main configuration	A basic job configuration which is configured only by main-processing. Specify this when do not specify pre-processing/post-processing.	×	○	×
Extended configuration	A job configuration which is configured by pre-processing, main-processing, and post-processing. Specify this when executing these processing separately.	○	○	○

Data read/write timing for CPU modules at job operation

Read/write data to the CPU module in the following timing using the Data input/output function in order to operate a job with the information linkage function.

The information linkage function prepares data which is required for executing an action in the CPU module in advance.

Data read/write to the CPU module is not performed during the execution of the action. The data is written after the action is executed.

Timing	Operation
① At trigger judgment	When monitoring data in the device with a trigger, the monitored values are read.
② When trigger condition is satisfied/Before action execution	The data to be used for the action is read.
③ After executing action	The data which is acquired by the action is written.

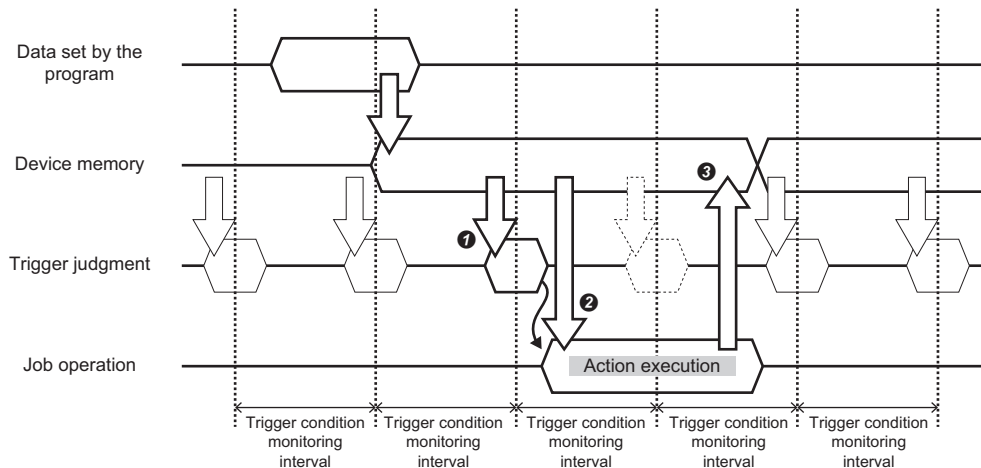

However, the data to be used for the action can be collected at trigger judgment for when the synchronization between the data at trigger judgment and the data to be used for the action is required (when the data must be the same timing data). By collecting data to be used for the action at trigger judgment, the timing of data in the CPU module used for one job execution can be unified.

Ex.

When the present value is overwritten before job execution

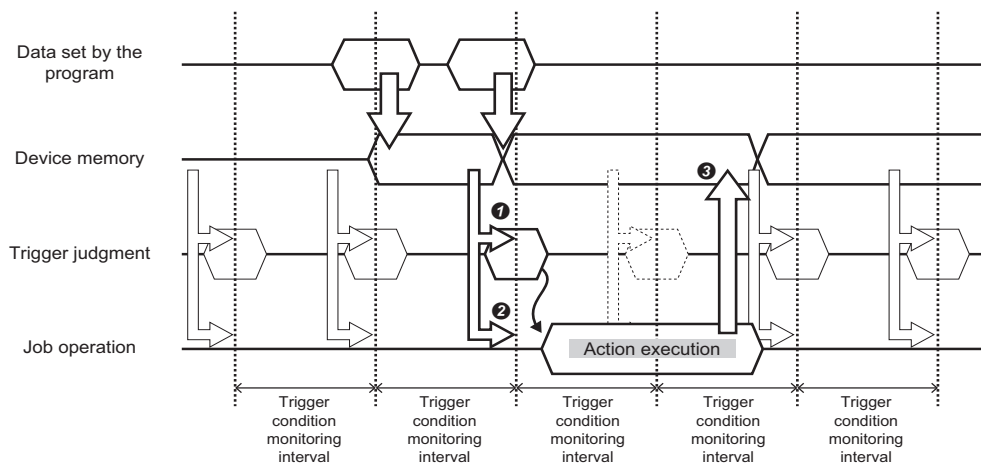

Job operation

A job behaves depends on the execution result of each processing (pre-processing/main-processing/post-processing) which configures the job and the execution result of the action which configures each processing.

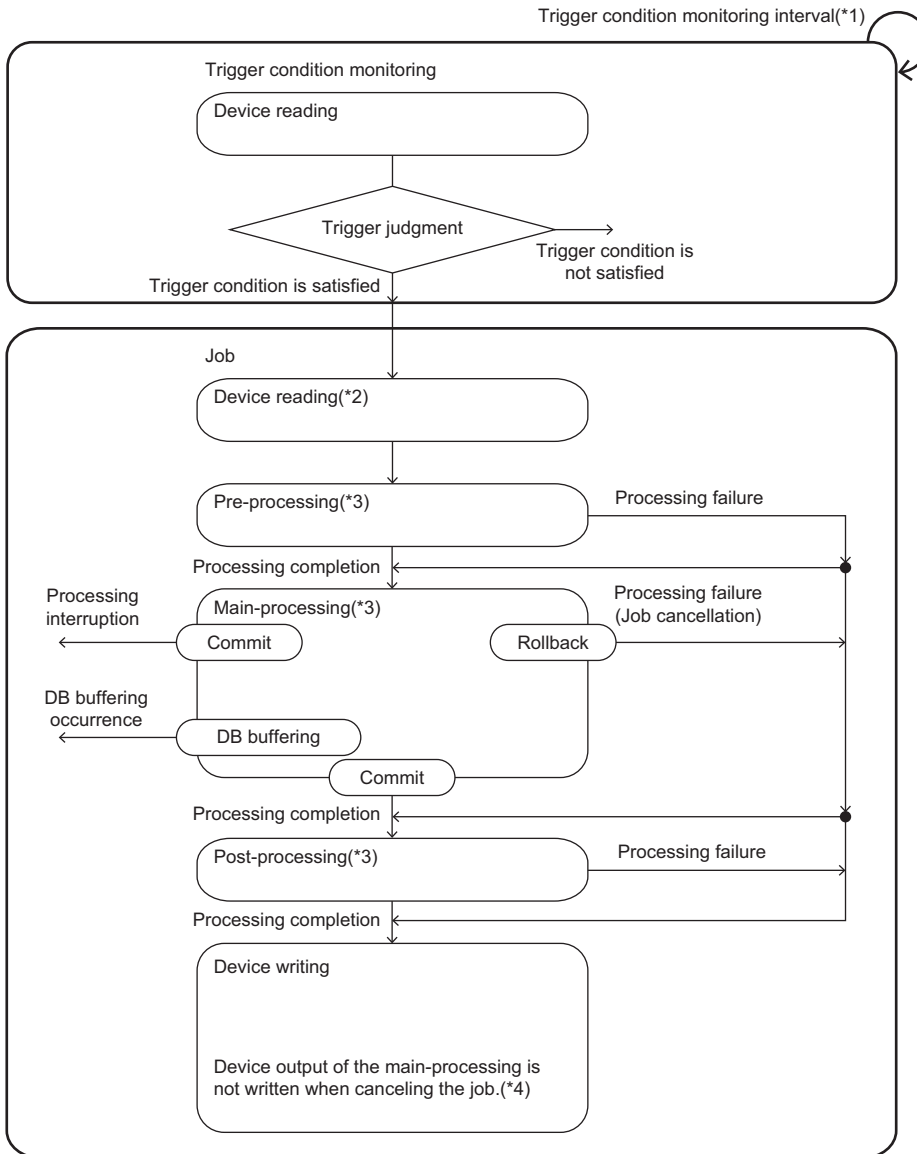

*1 The trigger condition is monitored at the trigger condition monitoring interval.

*2 Devices are not read when reading data used for the job at trigger judgment.

*3 The operations of pre-processing, main-processing, and post-processing are as follows:

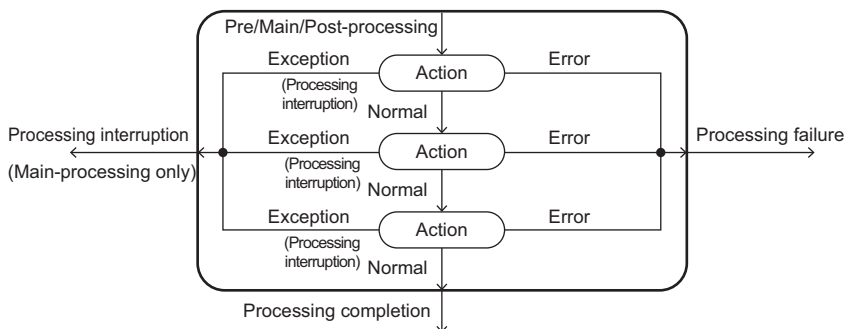

*4 The job cancellation notification will be written.

■ Execution result of processing

The following shows the execution result of the pre-processing, main-processing, and post-processing.

The operations of the processing procedure and the execution for each execution result can be notified.

Status	Description
Processing completion	Indicates that the processing (action in the processing) is completed normally. For main-processing, changed (inserted, updated, or deleted) data is applied (committed) to the database.
Processing failure (Job cancellation)	Indicates that the processing (action in the processing) is failed and interrupted. For main-processing, the change for the database is canceled (Rollback).
Processing interruption	Indicates that the processing (action in the processing) is not failed but interrupted. For main-processing, changed data is applied (committed) to the database.
DB buffering occurrence	Indicates that the processing is completed normally, however, DB buffering occurred.

■ Execution result of action

The following shows the status of the execution result of actions.

Status	Description
Normal	Indicates that the action is completed normally. The next action is executed.
Error	Indicates that an error occurred during the execution of the action. The processing is failed.
Exception	Any of the following processing is performed if an unintended result occurred except for an error during the execution of the action. <ul style="list-style-type: none"> Execute the next action regarding the exception as normal (default). Cancel the processing (job cancellation) regarding the exception as an error. The processing is interrupted without executing the next action. ■Optional function The occurrence of the exception can be notified to the specified data (such as device tag component).

■ Operation specifications at failure/interruption

Status	Description
Pre-processing failure	■Processing type at pre-processing failure <ul style="list-style-type: none"> Execute the main-processing (default). Execute the post-processing. End the job. ■Optional function <ul style="list-style-type: none"> Pre-processing failure notification The failure of pre-processing can be notified for two specified data (such as a device tag component).
Main-processing failure (Job cancellation)	■Processing type at main-processing failure <ul style="list-style-type: none"> Execute the post-processing (default). End the job. ■Optional function <ul style="list-style-type: none"> Main-processing failure notification The failure of main-processing can be notified for two specified data (such as device tag component).
Main-processing interruption	■Processing type at main-processing interruption (required) <ul style="list-style-type: none"> Execute the post-processing (default). End the job. ■Optional function <ul style="list-style-type: none"> Main-processing interruption notification The interruption of main-processing can be notified for two specified data (such as device tag component).
DB buffering occurrence	■Processing type at DB buffering occurrence <ul style="list-style-type: none"> Execute the post-processing (default). Not execute the post-processing ■Optional function <ul style="list-style-type: none"> DB buffering occurrence notification The occurrence of DB buffering can be notified for one specified data (such as device tag component).
Post-processing failure	■Optional function <ul style="list-style-type: none"> Post-processing failure notification The failure of post-processing can be notified for two specified data (such as device tag component).

■Common operation specification for exception

Status	Description
Exception	<ul style="list-style-type: none"> ■Exception processing type <ul style="list-style-type: none"> • Execute the next action regarding the exception as normal (default). • Cancel the processing (job cancellation) regarding the exception as an error. For main-processing, the job and the change of the data is canceled (Rollback). • Interrupt the processing without executing the next action. For main-processing, data is applied (committed). ■Optional function <ul style="list-style-type: none"> • Exception notification <p>The occurrence of the exception can be notified to the specified data (such as device tag component).</p>

Access type at trigger judgment

When monitoring values in the device such as a CPU module at trigger judgment, the information linkage function reads data using the Device memory input/output function.

Access type	Access target	Available interval
General access	All target devices including other stations connected to the network	<ul style="list-style-type: none"> • 1 to 9 × 100 ms • 1 to 3600 s
High-speed access (interval specification)	Control CPU of the MES interface module itself	<ul style="list-style-type: none"> • 1 to 9 ms • 1 to 9 × 10 ms • 1 to 9 × 100 ms • 1 to 60 s
High-speed access (each scan)		<ul style="list-style-type: none"> • Each scan

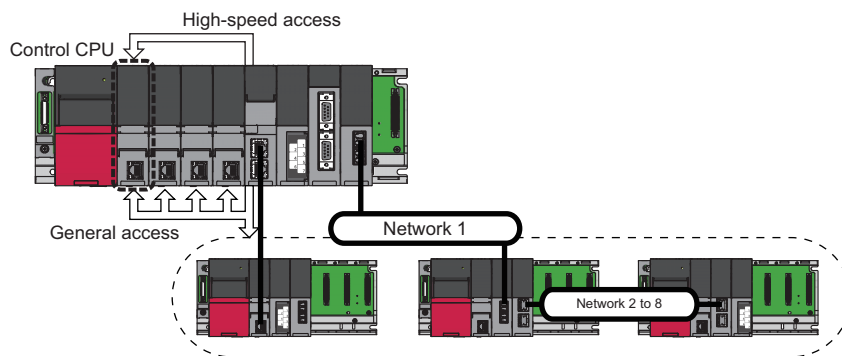

1.1 Data Input/Output Function

Device memory input/output function

The Device memory input/output function acquires or writes data from the device memory of the target device, and inputs or outputs data between the device memory in the target device and the MES interface module. This function is used for the information linkage function at required timing (at trigger judgment, when trigger condition is satisfied, or before/after executing the action).

Not only to the control CPU of the MES interface module itself but also to other CPU of the host station and a CPU module of other station can be accessed.

For the data types that can be input or output, refer to the following:

📖 MELSEC iQ-R MES Interface Module User's Manual (Startup)

Access type

The following table shows the access types for accessing data in an access target device from an MES interface module.

Access type	Description	Access target	Available interval
General access	A function to access a control CPU, other CPU modules except for control CPU, or CPU modules which are connected to the network hierarchically such as CC-Link IE Control and CC-Link IE Field. An access method to read the data in the device memory to MES interface module at the trigger monitoring cycle specified with MES Interface Function Configuration Tool.	All target devices including other stations connected to the network	• 1 to 9 × 100 ms • 1 to 3600 s
High-speed access (interval specification) ^{*1}	An access method to read the data in the device memory by using the sequence scan synchronization sampling function ^{*2} of a control CPU and by synchronizing with the END processing.	Control CPU of the MES interface module itself ^{*4}	• 1 to 9 ms • 1 to 9 × 10 ms • 1 to 9 × 100 ms • 1 to 60 s
High-speed access (each scan) ^{*1}	Access at a speed higher than general access is available, and data inconsistency ^{*3} does not occur in data to be read.		• Each scan

*1 High-speed access pauses when system parameters, CPU parameters, and module parameters are written to a control CPU during high-speed access.

Then it restarts automatically after the writing is completed.

*2 For the sequence scan synchronization sampling function, refer to the following:

📖 MELSEC iQ-R CPU Module User's Manual (Application)

*3 For details on data inconsistency, refer to the following:

📖 MELSEC iQ-R MES Interface Module User's Manual (Startup)

*4 For CPU modules supporting high-speed access, refer to the following:

📖 MELSEC iQ-R MES Interface Module User's Manual (Startup)

■General access

Data in the device memory of a CPU module is acquired at a specified access interval.

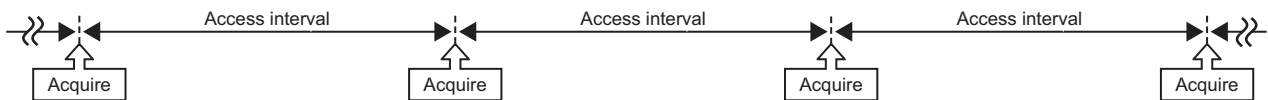

■High-speed access

- High-speed access (interval specification)

Data in the device memory of a CPU module is acquired once by synchronizing with the END processing within a specified access interval. Set an access interval longer than the sequence scan time.

If data fails to be acquired at the first END processing within an access interval, the data will be acquired again at the next END processing. Therefore, an actual access interval is different from a set one.

↔: Sequence scan time

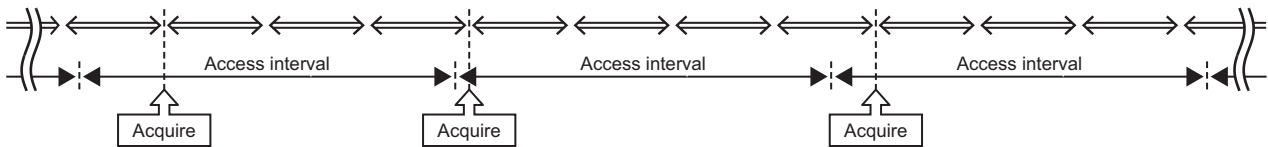

If data never be acquired within an access interval, high-speed access interval overload count will be incremented. (Page 293 Information linkage function area (Un\G12160 to 12418))

- High-speed access (each scan)

Data in the device memory of a CPU module is acquired each time END processing is performed (each scan) only when the CPU module is in the RUN state.

↔: Sequence scan time

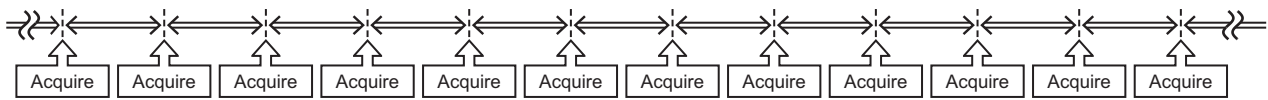

If data cannot be acquired at the END processing, high-speed access interval overload count will be incremented. (Page 293 Information linkage function area (Un\G12160 to 12418))

Data read at trigger judgment

At trigger judgment, data is read by accessing only the data which is required to evaluate the trigger condition.

The data which is required for the execution of an action can also be read at trigger judgment. The data read at trigger judgment can be used uniformly in whole jobs. (At this time, the data access at trigger condition satisfaction/before execution of action is not performed.)

The access timing at trigger judgment differs for each job because it depends on the access interval of each trigger judgment which is specified for each job. (Jobs the access interval/target device of which is the same are accessed separately.

Therefore, the sequential scan is performed over multiple scans and the values may differ even when the same device memory is read.)

Data read when trigger condition is satisfied/before execution of action

After a trigger condition is satisfied, required data for executing action (pre-processing, main-processing, post-processing) is read by using the method of the general access.

Note that the data which has already been accessed during data read at trigger judgment is used and the access is not performed at this timing. (Since the access timing between the data used for trigger judgment and the data to be used only for action are different, the sequential scan is performed over multiple scans and consequently the values may differ.)

Data write after executing all actions

The data substituted for the device tag in each action is written to the target device after executing all the actions. If the execution of an action failed, the content of device tag which has been set to each notification (pre-processing/post-processing) in the job is reflected to the access target device.

For the character string type data, not only effective number of characters (including termination character) but also the number of characters specified in the device tag are written.

The data write order after executing all actions is as follows:

Pattern	Operation
Data write with a job which has multiple actions	Data is assigned to the device tag component in execution order (the data is overwritten), regardless of whether the data is written by an action or notification. After all the action is completed, the data is written to the access target device in order of the access target device number, device tag number, and device tag component number. When different values are assigned to the same device tag components in the multiple actions, the value assigned last is reflected after all the actions are executed.
Data write from multiple jobs which operate simultaneously	Data is applied to an access target device in order from a job all the actions of which have been completed. The information linkage function performs after reading data in an access target device used for an action in advance. Therefore, data write to the same device tag from other job is not reflected to the job which is in execution.
If data fails to be applied to an access target device	Writing data to access target devices other than a failed one is proceeded.*1 Additionally, the failed job and failed target device information are saved in the error log. (The failure of each processing is not notified.)

*1 A part of data may be written to the failed target device.

Access other than job

Other than jobs, various information is notified to device tags/variables in order to notify the current status of MES interface module. The device tags/variables can also be used for issuing a request for MES interface module.

The data which is to be accessed to device memory are as follows:

Item	Description	Access timing	Remarks
DB buffer status	Notifies the existence or non-existence of DB buffer.	When the status of stored DB buffers is changed.	Write-only
Number of stored DB buffers	Notifies the number of buffers stored in DB buffer.	When the number of buffers stored in the DB buffer is changed.	Write-only
DB buffer full	Notifies if DB buffer is full.	When the status of DB buffer full is changed	Write-only
DB buffer use rate	Notifies the use rate (%) of DB buffer	When the use rate of DB buffer is changed	Write-only
Server access error notification	Notification destination at communication error occurrence	When communication error with target server occurred	Write-only
DB buffer resend request	A flag to request a resend of DB buffer.	Data is read every one second. Data is written when ending resending DB buffer.	Read/Write
DB buffer clear request	A flag to request a clear of DB buffer.	Data is read every one second. Data is written when DB buffer has been cleared.	Read/Write

When a device tag component is specified to the notification target, the data is written to the device memory with the above timing immediately. If the access to the device memory failed, an error log is output.

For details on the data values, refer to the following:

- ☞ Page 41 DB buffer notification
- ☞ Page 41 DB buffer resend request
- ☞ Page 41 DB buffer clear request

DB input/output function

The DB input/output function has the following two functions.

Function name	Description	Setting method
DB record input/output function	To acquire, update, and delete data from a database when the information linkage function is required (when a DB communication action is executed).	☞ Page 124 DB communication action setting
DB buffering function	To buffer an SQL statement or stored procedure call information to an SD memory card, and resend it after recovery when communication cannot be established with a database due to the disconnection of the network or failure.	☞ Page 162 DB buffer settings

DB record input/output function

DB record input/output function inputs/outputs information (record) stored in the DB table (accessible to a table and view) to/from a programmable controller system.

The operations that can be input/output are as follows:

Operation	Input/output data	Description
Select (Single record)	Maximum: 1024 fields	To select (acquire) one record from a database.
Insert (Single record)	Maximum: 1024 fields	To insert (add) one record to a database.
Update	Maximum: 1024 fields	To update records in a database. (A function to insert record at update failure is available.)
Delete	—	To delete records in a database.
Multiple Select (Multiple records)	Maximum: Number of records × Number of fields ≤ 40960	To select (acquire) multiple records from a database.
Multiple Insert (Multiple records)	<ul style="list-style-type: none"> ■Oracle <ul style="list-style-type: none"> • Maximum: Number of records × Number of fields ≤ 3072 • Maximum: 1024 fields • Maximum: 1000 records ■Non-Oracle <ul style="list-style-type: none"> • Maximum: Number of records × Number of fields ≤ 10240 • Maximum: 1024 fields • Maximum: 1000 records 	To insert (add) multiple records to a database.
Stored Procedure	Maximum: 256 arguments and 1 return value	To perform processing registered in a database.

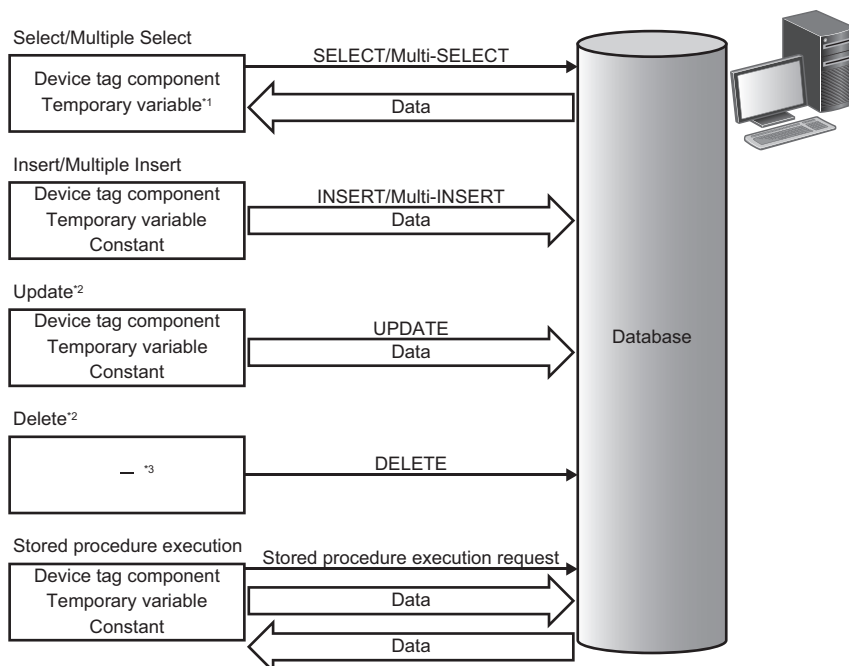

*1 Cannot be used when selecting "Multiple Select."

*2 When accessing a same data while the data is locked in the database, the processing may be waited until the lock is unlocked. Do not access the data which has the potential to be locked over a prolonged period of time.

*3 No data communication.

■Select

The following shows the functions of Select.

Item	Description
Function	Selects a record which meets the narrowing-down (Select) condition from the database, and substitutes the selected data for the assignment target. When the database is Oracle, narrowing-down, sorting, and value selection are available by using the pseudocolumn ROWNUM or ROWID automatically set in the database.
Function (Option)	<p>■Notification of the number of applicable records Notifies the number of records which meet the narrowing-down (Select) condition to the specified data (such as device tag component). The number of records is not output to the detailed log without setting this notification.</p> <p>■Assignment of default values to a null field When a null field (NULL) is selected in the database, default values which have been set to the access field are assigned to the assignment target. If default values have not been set to the access field, nothing is assigned.</p>
Narrowing-Down Conditions	Specify the narrowing-down (Select) condition. (☞ Page 33 Narrowing-down conditions)
Sorting Order	Specify the order of data selection. (☞ Page 34 Sorting order)
Exception	<p>■No applicable record An exception for the case when any records which satisfy the narrowing-down (Select) condition are not found. • Optional function (Clear the assignment target to '0') Data is initialized with any of the following values in accordance with the data type of the assignment target. Numerical value: 0 Character: Data of which length is 0</p> <p>■Multiple applicable records An exception for the case when multiple records which satisfy the narrowing-down (Select) condition are found. • Optional function (select from first record) Selects first one record of data which are sorted into priority order (sort).</p>

Ex.

Narrowing-down condition: KOJI_NO = Process 1. Order number

Database: DB1, Table name: RECIPEDATA

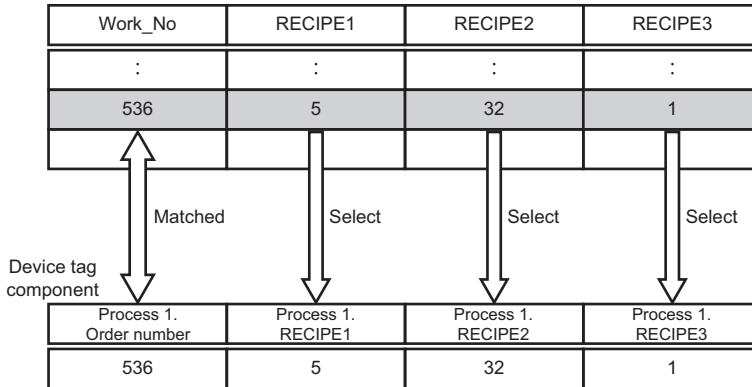

■Insert

The following shows the functions of Insert.

Item	Description
Function	Inserts the assignment source data (such as device tag component) to the database as a new record.
Function (Option)	<p>■Notification of the number of inserted records</p> <p>Notifies the number of records which has been inserted by the database to the specified data (such as device tag component).</p>

Ex.

Database: DB1, Table name: ERRORLOG

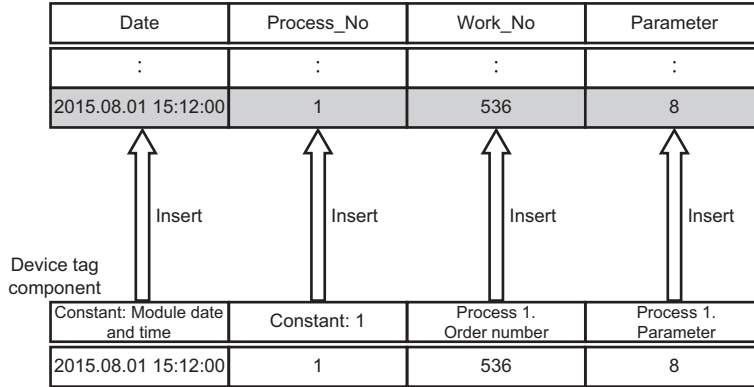

■Update

The following shows the functions of Update.

Item	Description
Function	Updates field values which satisfy the narrowing-down (Update) condition with data (such as device tag component). When the database is Oracle, narrowing-down is available by using the pseudocolumn ROWNUM or ROWID automatically set in the database.
Function (Option)	<ul style="list-style-type: none"> ■Notification of the number of updated records (newly inserted records) Notifies the number of records which has been updated by the database to the specified data (such as device tag component) based on the narrowing-down (Update) condition. When a new record is inserted as an exception for 'no applicable record,' the specified data (such as a device tag component) is notified of the number of records which has been inserted by the database.
Narrowing-Down Conditions	Specify the narrowing-down (Update) condition. (☞ Page 33 Narrowing-down conditions)
Exception	<ul style="list-style-type: none"> ■No applicable record An exception for the case when the records which satisfy the narrowing-down (Update) condition are not found. Depending on the database to be used, an exception may occur when a record is updated (Update) with the same value as a target record. <ul style="list-style-type: none"> • Optional function (Insert New Record (UPSERT)) Inserts a new record according to the narrowing-down condition. The update target data or comparison target for the update condition (condition is "=") can be inserted. However, if a same access field is specified in overlap (update target and update condition is overlapped, or the value among update conditions is overlapped), the value specified first (the value specified for update target, or the value specified first among update conditions) is inserted. Insertion is not performed for the pseudocolumns (ROWNUM and ROWID). If the insertion of the new record has failed, the failed result (Update and Insert) is output to the SQL failure log of the DB Connection Service. <ul style="list-style-type: none"> ■Multiple applicable records An exception when some records which satisfy the narrowing-down (Update) condition are found.

Ex.

Narrowing-down condition: KOJI_NO = Process 1. Order number

Database: DB1, Table name: KANRYOHOKOKU

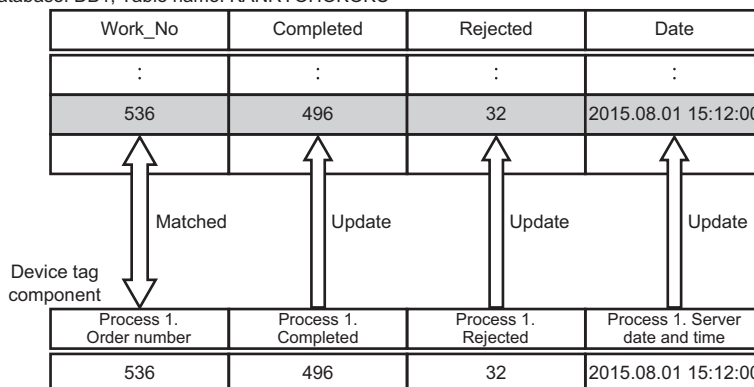

■Delete

The following shows the functions of Delete.

Item	Description
Function	Deletes records which satisfy the narrowing-down (Deletion) condition from the database. When the database is Oracle, narrowing-down is available by using the pseudocolumn ROWNUM or ROWID automatically set in the database.
Function (Option)	<ul style="list-style-type: none"> ■Notification of the number of deleted records Notifies the number of records deleted by the database to the specified data (such as device tag component).
Narrowing-Down Conditions	Specify the narrowing-down (Delete) condition. (☞ Page 33 Narrowing-down conditions)
Exception	<ul style="list-style-type: none"> ■No applicable record An exception for the case when the records which satisfy the narrowing-down (Deletion) condition are not found. <ul style="list-style-type: none"> ■Multiple applicable records An exception for the case when some records which satisfy the narrowing-down (Deletion) condition are found.

Multiple Select

The following shows the functions of Multiple Select.

Item	Description
Function	<p>Selects multiple records which meet the narrowing-down (Select) condition from the database, and substitutes the selected data for the assignment target.</p> <p>When the database is Oracle, narrowing-down, sorting, and value selection are available by using the pseudocolumn ROWNUM or ROWID automatically set in the database.</p>
Function (Option)	<p>■Notification of the number of applicable records Notifies the number of records which meet the narrowing-down (Select) condition to the specified data (such as device tag component). The number of records is not output to the detailed log without setting this notification.</p> <p>■Assignment of default values to a null field When a null field (NULL) is selected in the database, default values which have been set to the access field are assigned to the assignment target. If default values have not been set to the access field, nothing is assigned.</p> <p>■Clear '0' to unassigned target (record unit) When the number of selected records is less than the maximum number of records, the data is initialized with the following value according to the data type of the unassigned target. (If an exception or error occurred, this option is not applied.) Numerical value: 0 Character: Data of which length is 0</p> <p>■Specification of maximum number of records Specify the maximum number of records to be selected with data (such as device tag component). If this option is not set, the maximum number of records will be the number of arrays. If the maximum number of records is '0' or less, or if a value larger than the size of an array tag is specified, the incorrect maximum number of records error (error code: 1C14H or 1C56H) will occur.</p> <p>■Notification of the number of selected records Notifies the number of records which has been selected from the database and assigned to the assignment target to the specified data (such as device tag component). The number of records is not output to the detailed log without setting this notification.</p>
Narrowing-Down Conditions	Specify the narrowing-down (Select) condition. (Page 33 Narrowing-down conditions)
Sorting Order	Specify the order of data selection. (Page 34 Sorting order)
Exception	<p>■No applicable record An exception for the case when any records which satisfy the narrowing-down (Select) condition are not found. • Optional function (Clear the assignment target (up to maximum number of records) to '0') Data is initialized with any of the following values in accordance with the data type of the assignment target. Numerical value: 0 Character: Data of which length is 0</p> <p>■Applicable Record Overflow An exception for the case when the number of records which meet the narrowing-down (Select) condition exceed the number of maximum records. • Optional function (select from first record) Selects records in order from the first record to the maximum record of data which are sorted into priority order (sort).</p>

Ex.

Narrowing-down condition: RECIPE_C = 1

Database: DB1, Table name: RECIPEDATA

Work_No	RECIPE_A	RECIPE_B	RECIPE_C
:	:	:	:
536	5	32	1
537	6	33	0
538	7	34	1
539	8	35	1
540	9	36	0

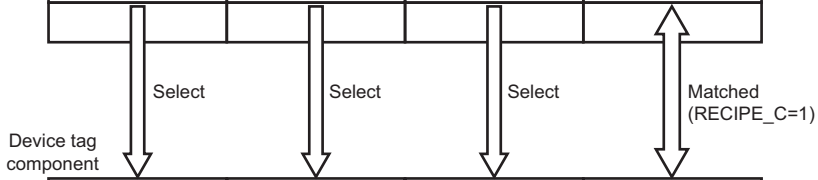

	Process 1. Order number	Process 1. RECIPE_A	Process 1. RECIPE_B	Process 1. RECIPE_C
n=1	536	5	32	1
n=2	538	7	34	1
n=3	539	8	35	1

Multiple Insert

The following shows the functions of Multiple Insert.

Item	Description
Function	Inserts the multiple units of assignment source data (such as device tag component) to the database as a new record.
Function (Option)	<p>■Notification of the number of inserted records Notifies the number of records which has been inserted by the database to the specified data (such as device tag component).</p> <p>■Specification of the number of inserted records Specify the number of records to be inserted with data (such as a device tag component). If this option is not set, the number of inserted records will be the number of arrays. If the number of inserted records is '0' or less, or if a value larger than the size of an array tag is specified, the incorrect number of inserted records error (error code: 1C58H or 1C59H) will occur.</p>
Note	<p>Multiple Insert can be used in the following databases: (It may take time depending on the environment of a database.)</p> <ul style="list-style-type: none"> • Oracle[®]*1 • SQL Server • MySQL[®] • PostgreSQL • MariaDB

*1 A lot of memory spaces in the Oracle shared pool may be used, which may cause an error.

Ex.

Database: DB1, Table name: ERRORLOG

Date	Process_No	Work_No	Parameter
:	:	:	:
2015.08.01 15:12:00	1	536	8
2015.08.01 15:12:01	1	537	9
2015.08.01 15:12:02	1	538	10

Constant: Module date and time	Constant: 1	Process 1. Order number	Process 1. Parameter
2015.08.01 15:12:00	1	536	8
2015.08.01 15:12:01	1	537	9
2015.08.01 15:12:02	1	538	10
2015.08.01 15:12:03	1	539	11
2015.08.01 15:12:04	1	540	12
2015.08.01 15:12:05	1	541	13

Device tag component

↑ Insert ↑ Insert ↑ Insert ↑ Insert

Point

The order of records inserted into a database may differ from that of array tags inserted when selecting "Multiple Insert."

To select records when selecting "Multiple Select" in the order of array tags inserted when selecting "Multiple Insert," perform the following procedure:

- ➊ Add a field (numerical value etc.) indicating an order to a table, and select "Multiple Insert" to insert records.
- ➋ Sort the records in the field, and select "Multiple Select" to select them. (📄 Page 34 Sorting order)

■ Stored Procedure

The following shows the functions of Stored Procedure.

Item	Description
Function	<p>Executes processing (stored procedure) defined in the database.</p> <p>Data transfer with stored procedure is performed using the data (such as device tag component) assigned to the arguments and return value^{*1}.</p> <p>Up to 256 arguments can be specified. The following arguments can be specified.</p> <ul style="list-style-type: none"> • An input argument which passes a value to the procedure • An output argument which receives the execution result of the procedure • An input/output argument which passes the value at execution of procedure and receives the execution result when the execution is completed.
Function (Option)	<p>■Return value notification</p> <p>Notifies the return value of the stored procedure to the specified data (such as device tag component). The return value is not output to the detailed log without setting this notification.</p>
Note	<p>The result set of stored procedures cannot be acquired.</p> <p>■Oracle</p> <p>The stored procedure using commit is not supported.</p> <p>■SQL Server</p> <p>Return value, output argument, and input/output argument of a stored procedure which returns a result set cannot be acquired.</p> <p>When calling the following in the stored procedure, an MES interface module cannot acquire value substituted for an argument as an execution result of the stored procedure.</p> <ul style="list-style-type: none"> • Select, Insert, Update, Delete • Stored procedure including the above • System stored procedure such as sp_who <p>■Access®</p> <p>The stored procedure is not supported.</p> <p>■MySQL, PostgreSQL, MariaDB®</p> <p>The stored procedure using commit is not supported.</p> <p>When using MySQL Standard Edition in connection via service, the usable character code for a stored procedure is within the ASCII range.</p>

*1 Return value is supported only by SQL Server.

Point

- A stored procedure action waits for the execution completion of a procedure and then moves to the next action. Therefore, if the execution of a stored procedure is not completed in a shorter period of time than DB access timeout time, a DB access timeout will occur.
- The result set of a stored procedure cannot be acquired from MES interface module directly, however, it can be acquired by outputting the result set on other table once and performing data selection.

■ Narrowing-down conditions

The following shows the specifications of narrowing-down condition.

Item	Description
Function	<p>Specify the narrowing-down condition for Select, Update, Delete, and Multiple Select with data (such as device tag component).</p> <p>When the database is Oracle, narrowing-down is available by using the pseudocolumn ROWNUM or ROWID automatically set in the database.</p>
Target DB record input/output operation	<p>Select</p> <p>Update</p> <p>Delete</p> <p>Multiple Select</p>
Setting condition	<p>Up to 8 conditions</p>
Condition	<ul style="list-style-type: none"> • = (Matched)^{*1}: Condition is matched with the specified data • ≠ (Unmatched): Condition is unmatched with the specified data • < (Less than), > (Greater than), ≤ (Less than or equal to)^{*1}, ≥ (Greater than or equal to)^{*1}: Condition is matched with the specified data

*1 If the comparison between FLOAT [Single Precision] and FLOAT [Double Precision] is performed, the condition may not be satisfied because of the differences of their precision.

■ Sorting order

The following shows the specifications of sorting order.

Item	Description
Function	Sorts the records of which field values and specified condition are matched in the specified order, and selects data. When the database is Oracle, sorting is available by using the pseudocolumn ROWNUM or ROWID automatically set in the database.
Target DB record input/output operation	Select Multiple Select
Setting condition	Up to 8 conditions
Order specification	<ul style="list-style-type: none"> • Ascending order • Descending order

Ex.

When sorting data in the following order

DELIVERY_DATE: Ascending order

ORDER_NO: Descending order

Database (before sorting)			Database (after sorting)		
ORDER_NO	PRODUCT_CODE	DELIVERY_DATE	ORDER_NO	PRODUCT_CODE	DELIVERY_DATE
200	707	2015-08.09	206	707	2015-08.01
201	662	2015-08.01	204	707	2015-08.01
202	666	2015-08.05	201	662	2015-08.01
203	662	2015-08.09	207	662	2015-08.05
204	707	2015-08.01	205	666	2015-08.05
205	666	2015-08.05	202	666	2015-08.05
206	707	2015-08.01	208	662	2015-08.09
207	662	2015-08.05	203	662	2015-08.09
208	662	2015-08.09	200	707	2015-08.09

① Selected records are sorted in ascending order of DELIVERY_DATE.

② Records of the same DELIVERY_DATE are sorted in descending order of ORDER_NO.

■ Abnormal processing

The error patterns when performing the DB record output function are as follows:

- When a communication error occurred or database is timed out due to communication disconnection with a database server
- When the selected data is out of the available range of the data type for the assignment target data (such as device tag component)
- When non-numeric value, subnormal number, $\pm\infty$, or '-0' is specified as a real number for data update or data insertion
- When an error occurred (such as unique constraint violation at data insertion) at execution of SQL statement

DB buffering function

The DB buffering function buffers SQL statement or stored procedure call information to the DB buffer on an SD memory card when they cannot be sent due to network disconnection or failure of the server on which the database is installed. After the network or server is recovered, the buffered SQL statement or stored procedure call information is resent.

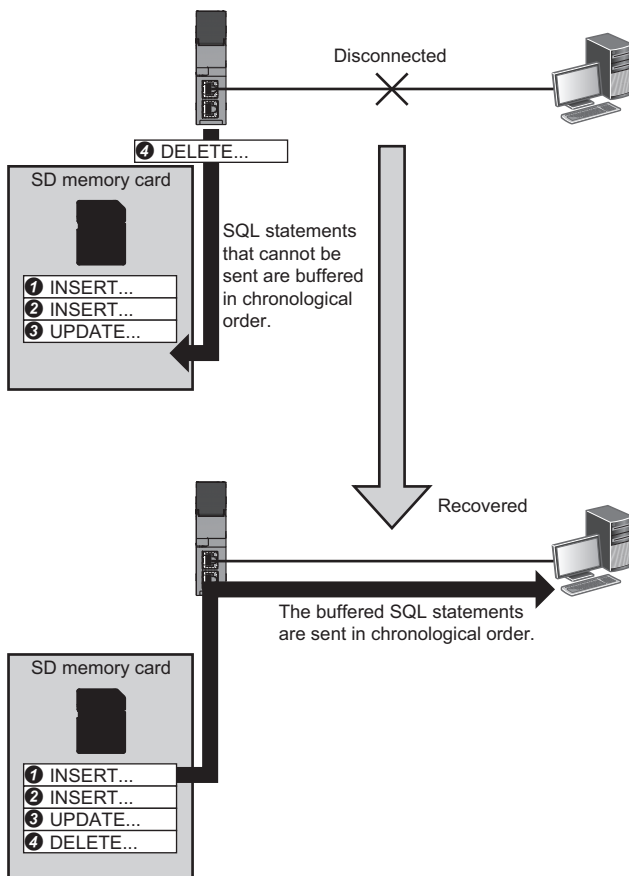

■ Factors for starting DB buffering

DB buffering is performed when SQL statement or stored procedure call information cannot be sent to the database by any of the following factors.

Factor for starting	Main factor
Time for detecting communication timeout*1 (Default: 10 s, range: 1 to 180 s)	<ul style="list-style-type: none"> • Disconnection of network • Failure of server
Time for detecting DB access timeout*2 (Default: 30 s, range: 1 to 3600 s)	<ul style="list-style-type: none"> • Failure of database • SQL statement execution timeout/Stored procedure execution timeout

*1 Use MES Interface Function Configuration Tool to set it. (☞ Page 153 Access target server settings)

*2 When selecting "Connection via Service" for "Access Type", use DB Connection Service Setting Tool to set it. (☞ Page 190 DB access timeout (required))

When selecting "Direct DB Connection" for "Access Type," use MES Interface Function Configuration Tool to set it. (☞ Page 153 Access target server settings)

A job will be in processing while a communication timeout or DB access time out is detected. Therefore, even if a trigger condition is satisfied again, the corresponding job is not executed. (Trigger buffering is executed when the trigger buffering setting is enabled. (☞ Page 63 Trigger buffering function))

If an error occurred in the database due to the incorrect SQL statement or inconsistency between the database definition and SQL statement when the sent SQL statement is executed on the database, an SQL failure log is output to the server without buffering data.

When network disconnection is detected, all the disconnected servers are checked in order if they can be recovered in one second intervals repeatedly.

Available processing for DB buffering

The availability of DB buffering for each DB communication type set in the job is as follows. (External communication action and operation action are not available for DB buffering.)

○: Available, —: Not available

DB communication type	Applicability
Insert/Multiple Insert	○*1
Update	○*1
Delete	○*1
Select/Multiple Select	—
Stored Procedure	○*1

*1 DB communication result cannot be used (notified). (Exception notifications/notification of number of records/output argument of procedure/input or output argument of procedure/return value of procedure)
For the job of which DB buffering setting is enabled, the exception setting cannot be set.

Behavior at DB buffering occurrence

Configure the DB buffering setting for one job. The SQL statement or stored procedure call information which is executed in one job is buffered as one transaction.

When the SQL statement or stored procedure call information could not be sent, the SQL statement or stored procedure call information which has already been executed in the job is rolled back and buffered.

When the SQL statement or stored procedure call information is executed in multiple servers, all the SQL statements or stored procedure call information in the job are rolled back if any one of the SQL statements or stored procedure call information could not be sent.

When DB buffering occurred, the external communication action or operation action in the job is executed at that time, and data is written to the device memory.

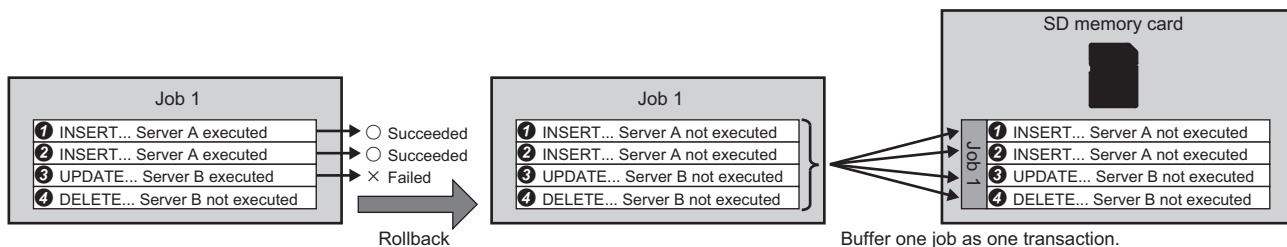

The following shows the operation of a job when a trigger condition is satisfied after DB buffering has been occurred.

Communication status	Data in DB buffer	DB buffering setting		Processing
Transmission impossible (Before line is recovered)	Stored/Not stored	Disable		Job execution is canceled.
		Enable		Data is stored to DB buffer.
Transmission possible (After line is recovered)	Stored	Disable		Data is sent to database.
		Enable	Send immediately (Not add to the Buffered Data)	Data is sent to database.
			Add to the Buffered Data	Data is stored to DB buffer.
	Not stored	Enable/Disable		Data is sent to database.

Precautions

Since multiple jobs can be executed simultaneously after a trigger judgment, DB buffering may not be performed in order of trigger judgment depending on the setting content of the job.

To perform DB buffering in order of the trigger judgment, configure the settings not to execute multiple jobs simultaneously.

■ Settings after recovery

The buffered SQL statement or stored procedure call information is sent in one job units^{*1} from older ones when a network and server are recovered and the resend start condition is satisfied.

*1 If a job which accesses multiple servers is buffered, data for the one job is deleted from the buffer after the communication with all the servers which are accessed from the job is performed properly.

The following operations and timing can be set for the buffered SQL statement or stored procedure call information.

- Operation at recovery

Set the buffered SQL statement or stored procedure call information and the sending order of the SQL statement or stored procedure call information of a job of which trigger condition is newly satisfied after recovery.

Operation at recovery	Description
Send immediately (Not add to the Buffered Data)	<p>After recovery, the SQL statement or stored procedure call information of the job of which trigger condition is newly satisfied is sent first.</p> <ul style="list-style-type: none"> • Send a new SQL statement or stored procedure call information when trigger condition is satisfied. • When the trigger condition is satisfied before the buffered SQL statement or stored procedure call information is sent, a new SQL statement is sent first, and then buffered SQL statement or stored procedure call information is sent.
Add to the Buffered Data	<p>SQL statement or stored procedure call information is always sent in order of the job execution order.</p> <ul style="list-style-type: none"> • When a trigger condition is satisfied, the SQL statement or stored procedure call information is kept buffering until the resend processing is performed. • When the trigger condition has been satisfied before the buffered SQL statement or stored procedure call information is sent, a new SQL statement or stored procedure call information is sent after all the buffered SQL statements or stored procedure call information have been sent.

- Resend mode

Set the mode to start resending buffering data.

Resend mode ^{*1}	Description
Resend automatically	<p>When this item is selected, the buffered data is resent automatically after the line status is recovered.</p> <p>When this item is not selected, the buffered data is resent when DB buffer "Start Resending" operation is performed at arbitrary timing set by user.</p>

*1 If the resend starts when detecting a communication timeout of the resend processing or DB access timeout, the resend processing is not executed because the resend processing is being executed.

■ Operation at recovery

- Behavior when "Add to the Buffered Data" is set
 - DB buffering is executed when SQL statement or stored procedure call information cannot be sent to the database due to the reason such as a network disconnection or failure of database server/database software.
 - After DB buffering is started, DB buffering is executed without checking if the SQL statement or stored procedure call information of the job can be sent to the database every time when the job which uses the same access target server is started.
 - When a network disconnection or failure of database server/database software has been recovered, the buffered SQL statement or stored procedure call information is resent in chronological order.
 - DB buffering is proceeded until the buffered SQL statement or stored procedure call information has been sent. After that, SQL statement or stored procedure call information is sent in order that the trigger condition is satisfied.

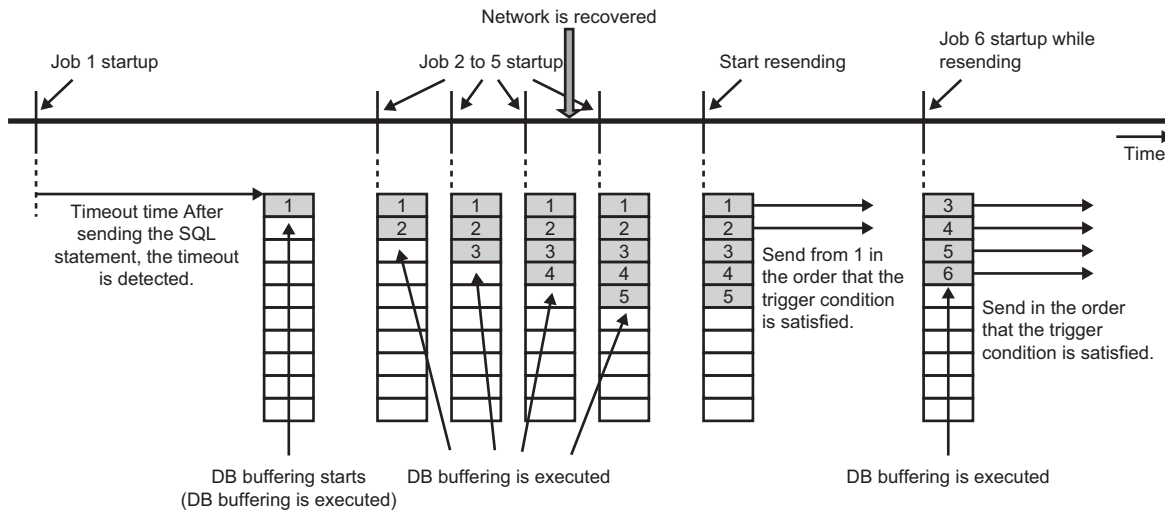

- Behavior when "Send immediately (Not add to the Buffered Data)" is set
 - DB buffering is executed when SQL statement or stored procedure call information cannot be sent to the database due to the reason such as a network disconnection or failure of database server/database software.
 - DB buffering is executed without performing sending processing when the job is started before a network disconnection or failure of database server/database software is recovered.
 - When a network disconnection or failure of database server/database software has been recovered, the SQL statement or stored procedure call information of the started job is sent.
 - When a network disconnection or failure of database server/database software has been recovered, the buffered SQL statement or stored procedure call information is resent in chronological order.
 - When the trigger condition of a job is satisfied before the buffered SQL statement or stored procedure call information has been sent, a new SQL statement or stored procedure call information is sent first.

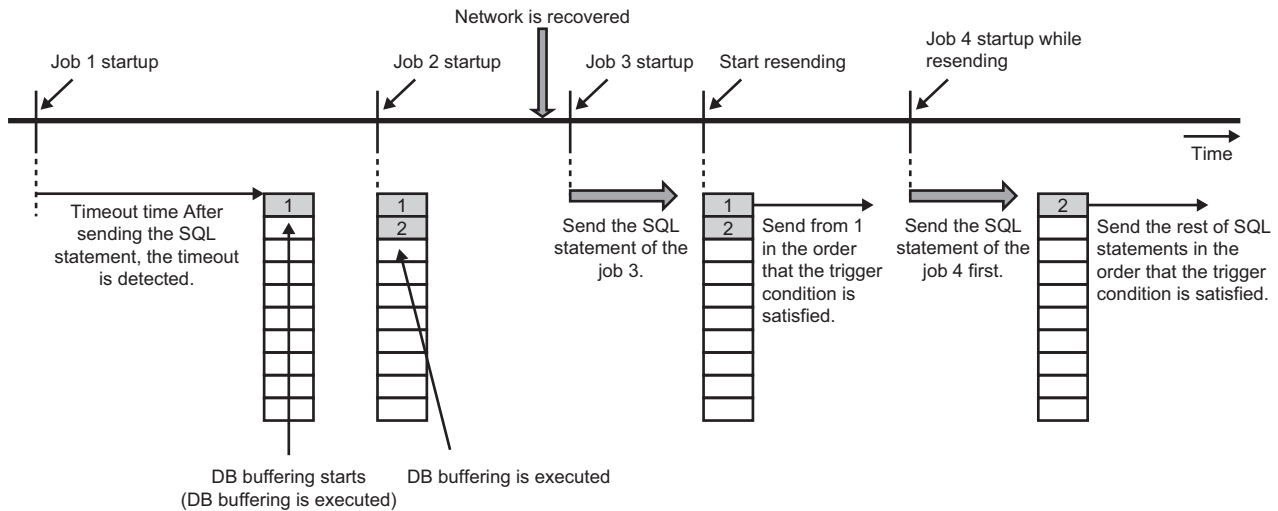

- Note 1

The buffered SQL statement or stored procedure call information is sent in job units.

Therefore, SQL statement or stored procedure call information of the next job is sent after all the SQL statements or stored procedure call information included in the job that belongs to the resending SQL statement or stored procedure call information have been sent.

- Note 2

When resending processing of two BD buffers is restarted, the data is resent from each DB buffer in job units alternately.

■ Behavior according to the resend mode setting

● Behavior when "Resend automatically" is set

- After DB buffering is started, DB buffering data is started resending at recovery of the network.
- When MES interface module is restarted while resending DB buffering data, the network connection is checked and start resending upon the restart of MES interface module.

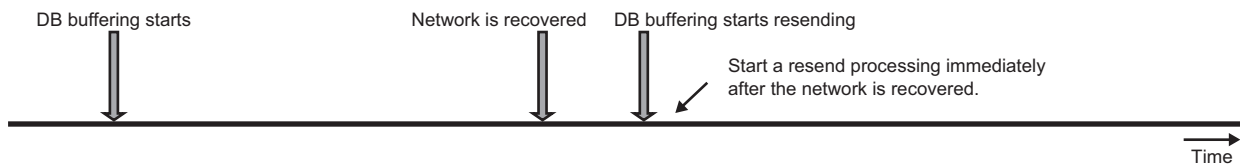

● Behavior when "Resend automatically" is not set

- After DB buffering is started, DB buffering data is started resending when the network has been recovered at manual execution of DB buffering resend operation.
DB buffering resend operation can be performed by turning ON (1) the device tag component which is assigned to the DB buffer diagnostic operation or DB buffer resend request set with MES Interface Function Configuration Tool.
If the network is not recovered at manual execution of DB buffering resend operation, an error log is output and the next DB buffering resend operation is waited.
- When MES interface module is restarted while resending DB buffering data, the network connection is checked and start resending at manual resend operation upon the restart of MES interface module.

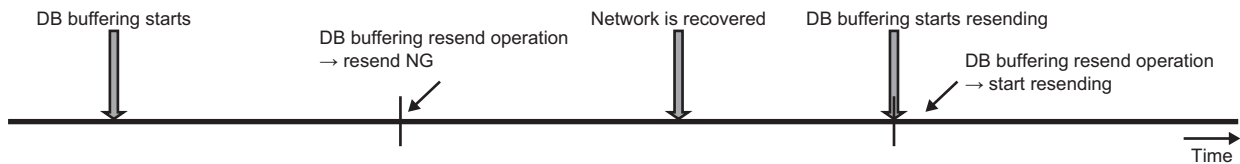

■ Buffer size

Set the size of the area in which the buffering data is to be stored.

The specifications of DB buffer are as follows:

Item	Description
Number of buffers	2 (Setting 1, Setting 2)
Buffer size	Maximum 1024 MB × 2 (Set the size in megabyte (1024 × 1024) units for either of setting 1 and setting 2.)
Usage	Set the DB buffer to be used for each job setting.

■ Clear of DB buffer

DB buffer is cleared by any of the following operations:

- When MES interface module starts operation with new settings (restart of the module/update of the settings after writing the changed settings).
- When clear request is issued using "DB Buffer Diagnostics" in "Diagnostics" from MES Interface Function Configuration Tool. (☞ Page 174 DB buffer diagnostics)
- When a clear request is issued by using 'DB buffer clear request' of the device tag component specified in the DB buffer settings.*1 (☞ Page 162 DB buffer settings)

*1 DB buffer cannot be cleared while the MES interface function operation is "Running".

■ Resend termination of DB buffer

To avoid placing load on the system when DB buffer resend is restarted at high load of the system, the resend of DB buffer can be stopped by the following operation (However, it will be disabled if "Resend automatically" is set for the resend method.)

- When the resend stop request is executed by using "DB buffer diagnostic" in "Diagnostics" from MES Interface Function Configuration Tool. (☞ Page 174 DB buffer diagnostics)

When data to be sent is remained at execution of the resend stop of DB buffer, the resend processing will be stopped after the data is sent for each job.

After stopping it, the resend processing is started at the next timing when a user requests the DB buffering resend operation.

■DB buffer resend request

The following shows the DB buffer resend request function.

Item	Description
Function	Performs resend processing of DB buffer based on the DB buffer resend request data. This request is executed when the information linkage function is 'running'. In DB buffer resend processing, a resend request is disabled if the checkbox of "Resend automatically" is selected for "Resend Mode."
Resend processing operation	When DB buffer resend request is ON (1), resend processing of DB buffer is performed.*1 Normal: After the resend processing is completed, DB buffer resend request data is turned OFF (0). Resend termination request is issued: After the resend termination, the DB buffer resend request data is turned OFF (0). Error: Error log is output and the DB buffer resend request data is turned OFF (0).

*1 DB buffer resend processing is proceeded if the value of the DB buffer resend request data is changed during the resend processing. The processing is performed only when '1' is input to DB buffer resend request. If the value other than '1' is input, the processing is not performed.

■DB buffer clear request

The following shows the DB buffer clear request function.

Item	Description
Function	Clear processing of DB buffer is performed based on the DB buffer clear request data. This request is executed when the information linkage function is 'running'. When DB buffer clear requested is issued during the DB buffer resend processing, DB buffer is cleared after the units of jobs which are in resend processing have been resent.
Clear processing operation	When DB buffer clear request is ON (1), the clear processing of DB buffer is performed.*1 Normal: After the clear processing is completed, DB buffer clear request data is turned OFF (0). Error: Error log is output and DB buffer clear request data is turned OFF (0).

*1 The buffer clear processing is proceeded if the value of the DB buffer clear request data is changed during the DB buffer clear processing. The processing is performed only when '1' is input to DB buffer clear request. If the value other than '1' is input, the processing is not performed.

■DB buffer notification

The following shows the function to notify the status of DB buffer.

Notification item	Description
Status	Notifies the status of DB buffer (existence of buffer) to the specified device tag component or variable. ■Value to be notified 0: Not stored in DB buffer 1: Stored in DB buffer
Number of stored data	Notifies the number of units of data stored in a DB buffer to the specified device tag component or variable. ■Value to be notified Number of buffers stored in DB buffer When the number of DB buffer exceeds the maximum value of the notification destination data, the maximum values for each data type are stored.
DB Buffer Full	Notifies if DB buffer is full (DB buffer capacity is full) to the specified device tag or variable. DB buffering does not occur if the job in which the DB buffering is set is started while DB buffer is full. ■Value to be notified 0: When DB buffer has free space 1: When DB buffer does not have free space
Use Rate	Notifies the use rate of the DB buffer to the specified device tag or variable. ■Value to be notified DB buffer use rate (%) = Used amount/DB buffer size (Values after decimal point is rounded down. For a rate under 1%, it will be 1%.)

Access error notification function

The Access error notification function notifies the following errors when executing a job or accessing the server set as an access target server at DB buffer resend from MES interface module to a device tag component or global variable.

- When communication timeout occurred

Recovery from an error is notified when the recovery of the communication between MES interface module and the specified server is ascertained.

■Value to be notified

Error is detected: 1 (ON)

Recovery from error is detected: 0 (OFF)

Variable input/output function

The variable input/output function inputs/outputs data to/from the variable area in which data in MES interface module can be saved temporarily.

For the setting method of variables, refer to the following:

☞ Page 161 Variable settings

Variables can be used for the following purpose.

- Storing data which is in calculation temporarily.
- Sharing data with other jobs.
- Referring the current time and operating status in an MES interface module from a job.

For data types of variables, refer to the following:

📖 MELSEC iQ-R MES Interface Module User's Manual (Startup)

Types of variables

There are two types of variables: the system variable which retains system information of an MES interface module and the user variable which can be defined by users.

There are two types of user variables; local variable which has variable area for each job and global variable which can be used for other jobs since it has a common variable area for all jobs.

Item	Type name		
	System variable ^{*1}	User variable	
		Local variable	Global variable
Variable area	<ul style="list-style-type: none"> • System area (system variable area) • Buffer memory (except for global variable area) 	<ul style="list-style-type: none"> • Variable area for each job 	<ul style="list-style-type: none"> • Variable area which is common for all jobs • Buffer memory (global variable area)
Number of settings/jobs	No restrictions for each job (Restricted only for project)	No restrictions for each job (Restricted only for project)	Up to 1024 bytes
Number of settings/projects	— (Defined by system)	Up to 2048 bytes ^{*2}	Up to 8192 bytes
Initial value	📖 MELSEC iQ-R MES Interface Module User's Manual (Startup)	Cannot be specified by user ^{*3}	Cannot be specified by user ^{*3}

*1 For the list of system variables, refer to the following:

📖 MELSEC iQ-R MES Interface Module User's Manual (Startup)

*2 Since a local variable retains data from start to end of one job, the data sharing between jobs is not available. However, the definition of one local variable can be used in multiple jobs.

*3 Depending on the data type of the variable, a variable is initialized as follows:

"Integer", "Real number": 0

"Character string": "" (Null)

Writing data to global variable or system variable from multiple jobs

When using global variables or system variables, data can be read/written to a specific variable from all jobs. However, exclusive control against the data read/write from multiple jobs is not performed.

The atomicity of the data assignment for global variables at job execution is not guaranteed.

The following shows the example when an operation action is performed by parallel two jobs.

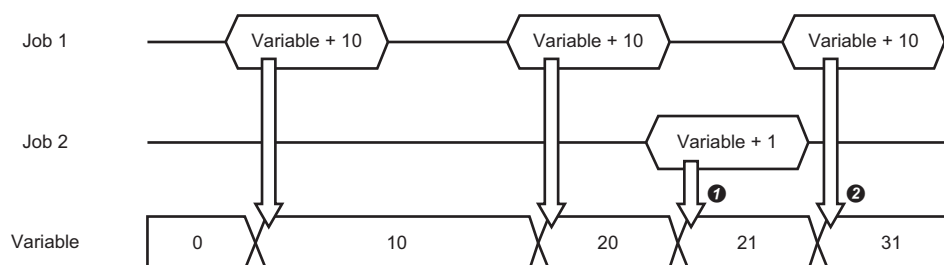

❶ The operation result of 'Job 1' is used since the variable area is common.

❷ The operation result of 'Job 2' is used since the variable area is common.

1.2 External Communication Client Function

Program execution function

The program execution function executes programs on an application server in the pre-processing performed at the start of a job (before the main-processing) and the post-processing performed at the end of the job (after the main-processing).

For the setting method of program execution, refer to the following:

☞ Page 130 External communication action settings

Use the Program execution function in the following situation:

- When creating data which is required for a job on the database in advance by executing a program with pre-processing
- When using data which is written to the database by a job by executing a program with post-processing

The details of function for program execution action are as follows:

Item	Description
Function	Executes the program (command) specified in MES interface module on the application server. Programs that can be executed from the command line on Windows® are applicable.
Function (Option)	■Wait for execution completion The next action is executed after the program execution processing is completed in the application server. "Return value notification", "Return value judgment", and "Return value mismatch" cannot be set without setting this option.
	■Return value notification Notifies the return value of the program execution to the specified data (such as device tag component).
	■Return value judgment Checks if the return value of the program execution is matched with the specified expected value (such as device tag component).
Exception	■Return value mismatch An exception for the case when the expected value (such as device tag component) is not matched with the return value of the program execution when "Return value judgment" option is specified.

1.3 Information Linkage Function

The information linkage function starts and controls jobs which link information between the target device such as a CPU module and target server such as a database server.

The following explains the functions of the information linkage function.

Function	Description	Setting method
Trigger condition monitoring function	Performs job start judgment and job start notification to job execution control.	☞ Page 115 Trigger conditions
Job execution control function	Performs operations from starting a job up to writing the execution result of the job.	☞ Page 113 Job settings
Trigger buffering function	Performs buffering when multiple job startup notifications are issued at the same time.	
One-shot execution function	Executes job once after receiving a request from MES Interface Function Configuration Tool.	☞ Page 183 One-shot execution
Data operation and processing function	Performs data operations and processing which is used for job.	☞ Page 132 Operation action settings
Data linkage function	Performs data linkage among target device, target server, and MES interface module.	☞ Page 138 Device tag settings ☞ Page 156 Access table/ procedure settings
Communication test function	Performs communication test for a target device or target server after receiving a request from MES Interface Function Configuration Tool.	☞ Page 92 Communication test function

Trigger condition monitoring function

The trigger condition monitoring function reads data to be used for a trigger condition, evaluates the trigger condition, and notifies the satisfaction of the trigger condition to the job execution control function.

Processing	Description
Data read to be used for trigger condition	Reads data to be used for the trigger condition in job units using the Device memory input/output function. The data to be used for jobs can also be read at this time. For details on data reading, refer to the following: ☞ Page 23 Device memory input/output function
Trigger judgment	Evaluates trigger condition which is to be a start condition of a job. When the trigger condition is satisfied, this function notifies the satisfaction of the trigger condition to the job execution control function.

Trigger judgment

A trigger condition is configured by combining an event and a condition. (☞ Page 49 Combination of conditions)

A trigger condition is evaluated according to a judgment result of the configuration of the trigger condition.

- Event: Indicates that an event occurs. When an event occurs, a trigger condition is satisfied.
- Condition: Indicates the state at a certain point in time. It is used as a precondition for trigger condition satisfaction.

The overview of the trigger condition and outline specifications of event/condition type are as follows:

Event/condition type	Description	Attribute
Condition (value monitoring) ^{*1}	The condition is satisfied (status = true) while the value of device tag component or variable satisfies the specified condition. Generates an event when the condition turns into the satisfied state from the not-satisfied state (from false to true) for using as an event.	Condition Event
Condition (period of time)	The condition is satisfied (status = true) from the specified start time to the specified end time.	Condition
Event (value changed) ^{*1}	Generates an event when the value of device tag component or variable is changed from the previous value.	Event
Event (fixed time)	Generates an event at the specified time.	Event
Event (fixed cycle)	Timer interval	Event
	Time interval	
Event (module monitoring)	MES interface module	Event
	Control CPU	

*1 A sequence program must be created so that a trigger condition is satisfied after 'MES interface function operation status' (X1) turns ON.

Condition (Value monitoring)

The condition (value monitoring) performs trigger judgment in each access interval set in "Read Data at Trigger Judgment." When comparing a monitoring target value and a comparison target value at trigger judgment, the condition starts to be satisfied when a judgment result is changed from false to true, and keeps being satisfied until the result is changed from true to false.

For using as an event, an event occurs when a judgment result is changed from false to true.

When a judgment result is true at the first trigger judgment, the condition starts to be satisfied or an event occurs.

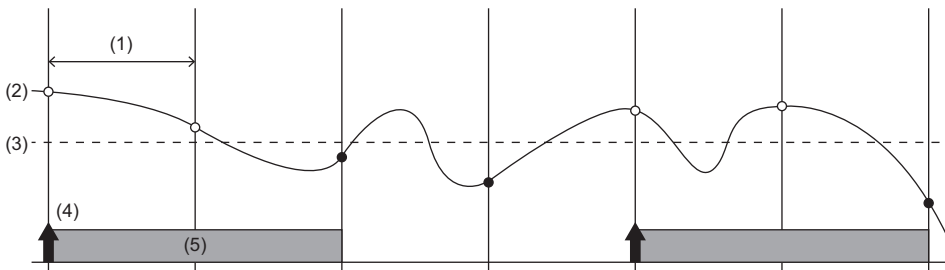

- : True
- : False
- (1) Access interval
- (2) Monitoring target value
- (3) Comparison target value
- (4) An event occurs
- (5) The condition is satisfied

The overview of the condition (value monitoring) is as follows:

- ① Trigger judgment is performed according to the access interval, monitoring target, comparison target, and condition.
- ② The condition is satisfied when the judgment result of the condition is true.
- ③ An event can also be occurred when the judgment result is changed to true.
- ④ If the judgment result is false, the condition will not be satisfied.

Precautions

If "=", "≥", or "≤" is used as a condition for the comparison between FLOAT [Single Precision] and FLOAT [Double Precision], the condition may not be satisfied because of the differences of their precision.

Condition (Period of time)

A condition (period of time) is satisfied during the period specified to the month and day, day of the week, and time (start time/end time). (The end time is not regarded as the condition to satisfy the condition.)

This function performs based on the time acquired from CPU No.1 on the own station.

The following table shows the operations depending on the specified period.

Specified period		Operation
Month and day, a day of the week		<p>The diagram shows a horizontal timeline with vertical dashed lines representing day boundaries. A single pulse is shown in each day cycle, labeled with *1.</p>
Start time, end time	Start time < end time	<p>The diagram shows a horizontal timeline with vertical dashed lines representing day boundaries. Within each day cycle, a pulse is shown between the start time (*2) and end time (*3). The condition is satisfied during this interval.</p>
	Start time > end time	<p>The diagram shows a horizontal timeline with vertical dashed lines representing day boundaries. Within each day cycle, a pulse is shown between the end time and start time. The condition is satisfied during this interval.</p>
	Start time = end time = XX:XX:XX	<p>The diagram shows a horizontal timeline with vertical dashed lines representing day boundaries. A single pulse is shown at a specific time point within each day cycle.</p>
	Start time = end time = 00:00:00	<p>The diagram shows a horizontal timeline with vertical dashed lines representing day boundaries. A pulse is shown at the beginning of each day cycle.</p>
	Start time = end time = every:00:00 or start time = end time = every:every:00	<p>The diagram shows a horizontal timeline with vertical dashed lines representing day boundaries. A series of pulses is shown at regular intervals (every 00:00) within each day cycle.</p>
	Start time = end time = every:XX:XX or start time = end time = every:every:XX	<p>The diagram shows a horizontal timeline with vertical dashed lines representing day boundaries. A series of pulses is shown at regular intervals (every XX:XX) within each day cycle.</p>

- *1 A day
- *2 Start time
- *3 The condition is satisfied.

Event (Value changed)

The event (value changed) performs trigger judgment in each access interval set in "Read Data at Trigger Judgment."
If the value is changed when comparing a monitoring target value and the previous one at trigger judgment, an event occurs.
An event does not occur at the first trigger judgment.

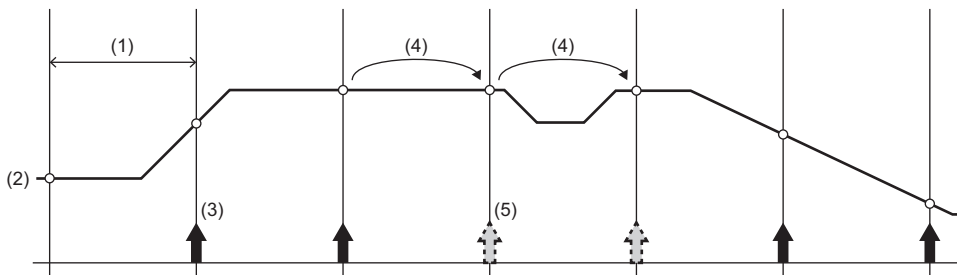

- (1) Access interval
- (2) Monitoring target value
- (3) An event occurs
- (4) The value is not changed
- (5) Since the value is not changed, an event does not occur

Event (Fixed time)

The event (fixed time) generates an event at the date and time specified to the month and day, day of the week, and time (occurrence time).

This function performs based on the time acquired from CPU No.1 on the own station.

Event (Fixed cycle)

The specifications of an event (fixed cycle) are as follows:

■Timer interval

① The fixed interval for each interval is regarded as an event.

The trigger condition is satisfied at start of MES interface module, at restart of the MES interface function, or at update of settings. After that, the trigger condition is satisfied at a fixed interval for each interval.

② The trigger condition monitoring function performs based on the internal timer in an MES interface module.

The trigger condition monitoring function performs based on the internal timer in an MES interface module without being affected by the time change of CPU No.1 on the own station.

■Time interval

① The fixed interval for each interval is regarded as an event.

② Since a round number^{*1} is used for the interval of fixed cycle (time interval) as an event, the value of the time interval that divides the time (24 hours/60 minutes/60 seconds) exactly can only be specified.

③ The 'reference time' which allows more arbitrary settings can be specified.

Example: The function operates on both odd time and even time when 2-hour interval is specified

④ The trigger condition monitoring function performs based on the time acquired from CPU No.1 on the own station.

*1 When the reference time is set '00:45:00' and the time interval is '15-minute-cycle', the timing will be as follows:

01:00:00', '01:15:00', ..., '00:15:00', '00:30:00'

Event (Module monitoring)

The specifications of an event (module monitoring) are as follows:

■MES interface module

- ❶ The function operates with the operating status of the module.
- ❷ "At Startup of MES Interface Module" and "At Restart/Update of Settings of the MES Interface Function" can be specified.
- ❸ Each of the setting can be specified individually, however, at least one of them is required to be specified.

■Control CPU

- ❶ The function performs based on an operating status notification from the control CPU.
- ❷ '→STOP', '→RUN', or '→PAUSE' can be specified as a status change.
- ❸ MES interface module monitors events in one second interval. If the switch status is changed for multiple times within one second, the event may not be detected.
- ❹ The module is monitored only when the MES interface function operates.

Combination of conditions

Configuration Type		Number of available events/ conditions	Available event/condition	Condition for trigger condition satisfaction
Single Event (SINGLE EVENT)		1	Other than below • Condition (Period of time)	A trigger condition is satisfied when a specified event occurs. When using the condition, at the time when the condition is satisfied is regarded as an event occurrence.
Multiple Events (MULTIPLE EVENT)		2		A trigger condition is satisfied when any of specified multiple events occurs. When using the condition, at the time when the condition is satisfied is regarded as an event occurrence.
Condition Combination Event	AND Combination (CONDITIONS(AND))	2	• Condition (Value monitoring)	The specified multiple conditions are combined. When the logical product (AND) or logical sum (OR) of the combined conditions is satisfied is regarded as an event occurrence, and the trigger condition is satisfied.
	OR Combination (CONDITIONS(OR))	2		
Precondition × Event		Precondition: 1	• Condition (Value monitoring) • Condition (Period of time) • Condition (Value monitoring) • Event (Value changed) • Event (Fixed time) • Event (Fixed cycle)	Specify a precondition and event. A trigger condition is satisfied when an event occurs while a precondition is satisfied.
		Event: 1		
Single handshake ^{*1*2}		—	—	A trigger condition is satisfied when a job start request turns ON. The job execution completion notification is turned ON after the job is completed.
Multiple handshake ^{*1*2}		—	—	A trigger condition is satisfied when all job start requests turn ON. The job execution completion notification is turned ON after the job is completed.

*1 A sequence program must be created so that a trigger condition is satisfied after 'MES interface function operation status' (X1) turns ON.

*2 For details on the handshakes, refer to the following:

☞ Page 51 Handshake

■ Outlines

Trigger condition is satisfied: ↑, Event: ↑, Condition: , Condition combination: , Job startup request: , Job completion notification: 

• Single event

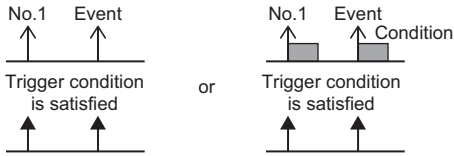

• Multiple events

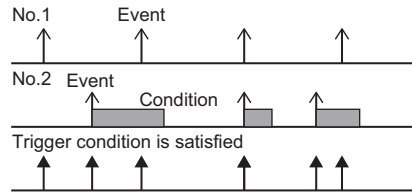

• Condition combination event (when the condition of AND combination is satisfied)

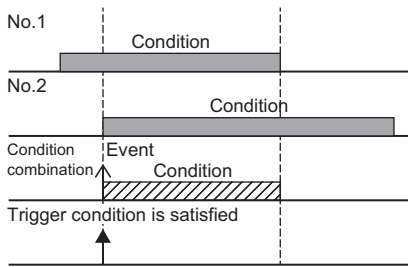

• Condition combination event (when the condition of OR combination is satisfied)

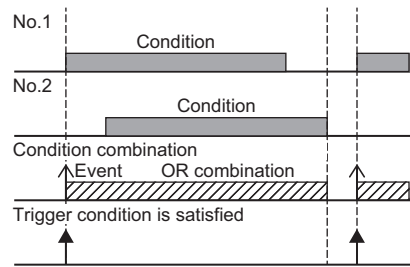

• Precondition × Event

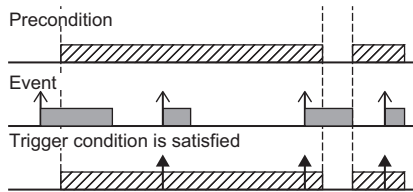

• Single handshake

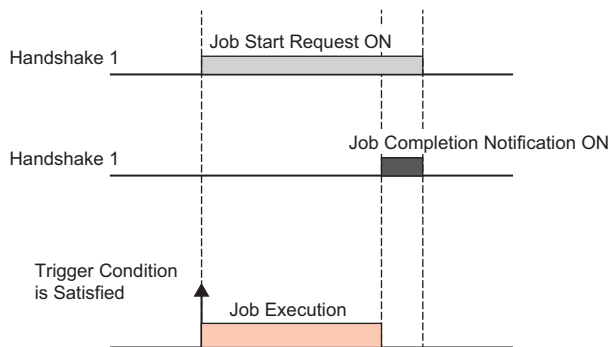

• Multiple handshake

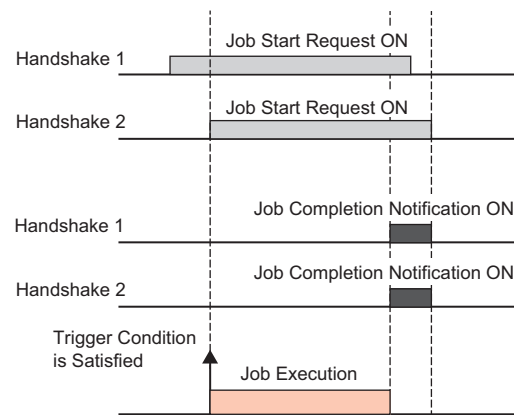

Handshake

The handshake operation is started by turning ON the device memory which has been set to 'Job start request' in the CPU module.

When the turning ON of 'Job start request' is detected in the MES interface module, the job operation is started.

After the job operation is completed, 'Job completion notification' is turned ON. When the turning OFF of 'Job start request' is detected in the CPU module, the 'Job completion notification' is turned OFF and the handshake is complete.

There are two types of handshakes: single handshake and multiple handshake.

■Single handshake

The overview of a single handshake is as follows:

- ① 'Job start request' is monitored at an access interval.
- ② The operation of a job is started by using data at the timing when an OFF to ON transition of 'Job start request' is detected.
- ③ Data of the job operation result is applied and 'Job completion notification' is turned ON when the operation of the job is completed.

If the main-processing fails, 'Job completion notification' does not turn ON. (To notify a programmable controller of the failure, set the settings in "Operation Settings at Main-Processing Failure". ( Page 119 Operation Setting at Main-Processing Failure/Interruption))

- ④ 'Job completion notification' is turned OFF at the timing when an ON to OFF transition of 'Job start request' is detected.
- Make sure to turn the Job start request OFF after an OFF to ON transition of the 'Job completion notification' is detected.

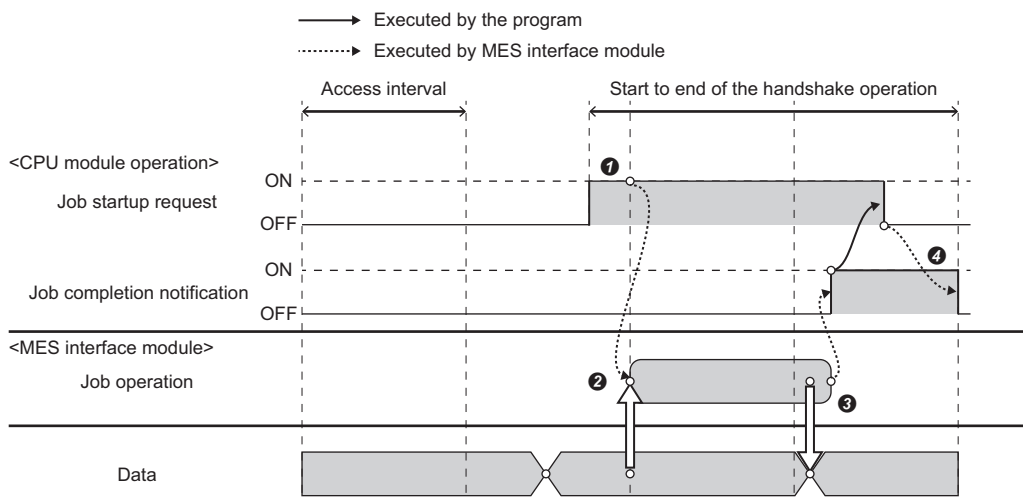

Sample program for using a single handshake

● Devices used in a program

Device name	Device	Application
MES interface module input signal	X1	MES interface function operation status
External input	X100	Processing request
Internal relay	M0	In process
	M100	Job start request
	M200	Job completion notification
	M201	Main-processing failure notification

● Program example

The following shows the program example which executes job when the processing request (X100) is turned ON from the CPU module.

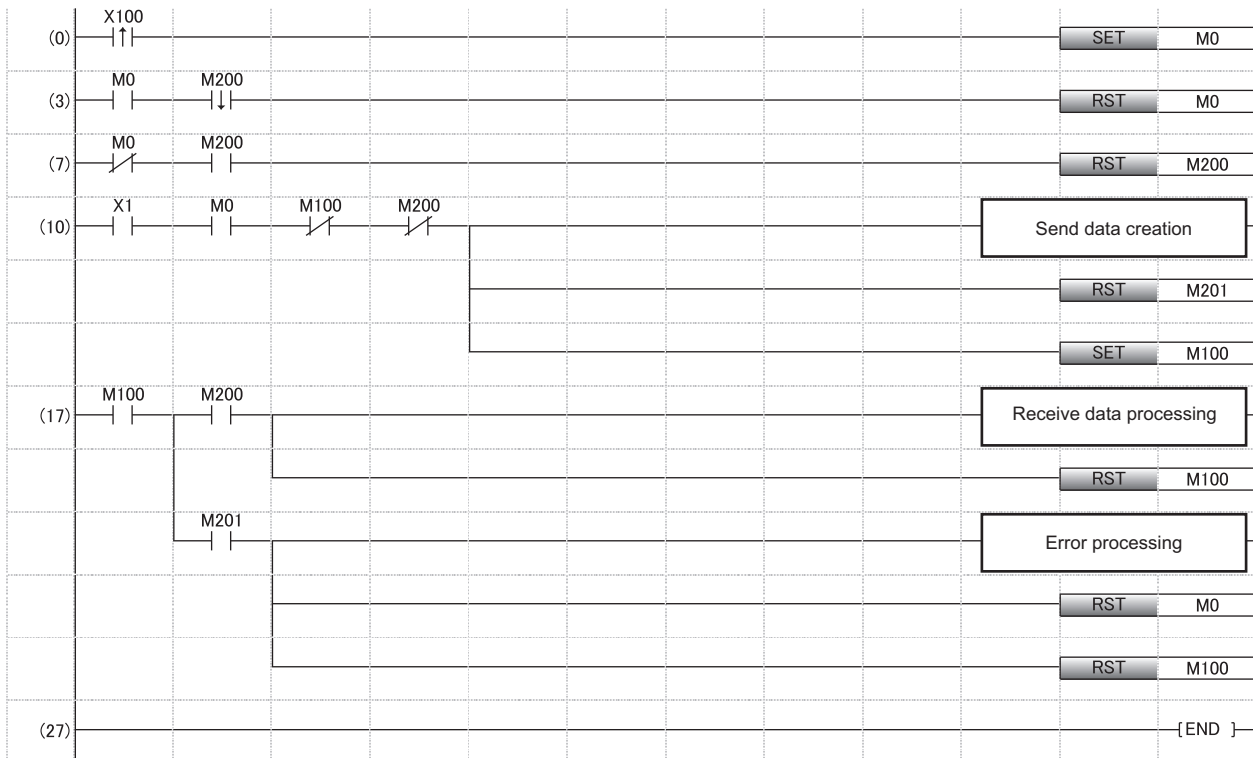

- (0) Sets the in-process flag at processing request.
- (3) Resets the in-process flag at normal completion.
- (7) Turns the job completion notification OFF
- (10) Job start processing
- (17) Processing at normal completion of job execution
Processing at main-processing failure

● Timing charts

The following shows the timing charts for the program example.

- At normal completion of job execution

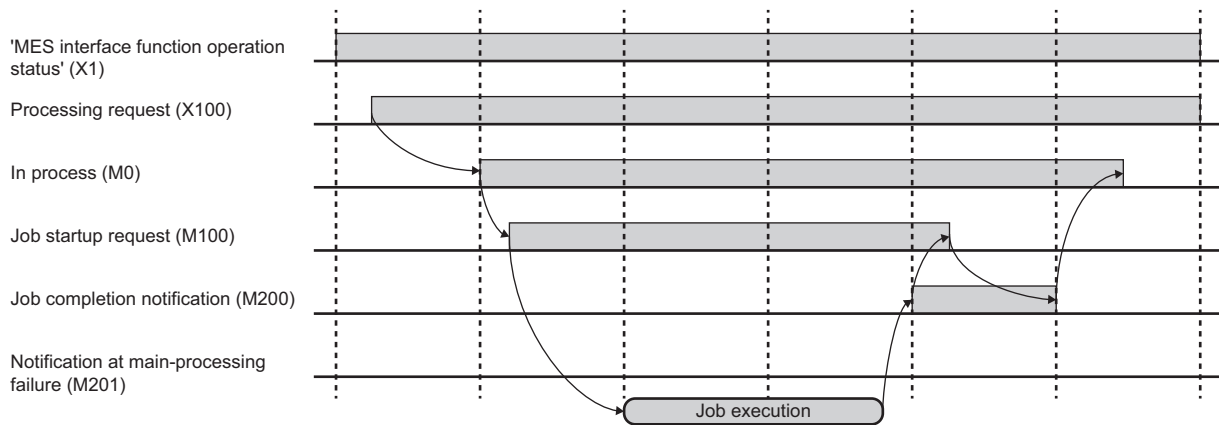

- At main-processing failure

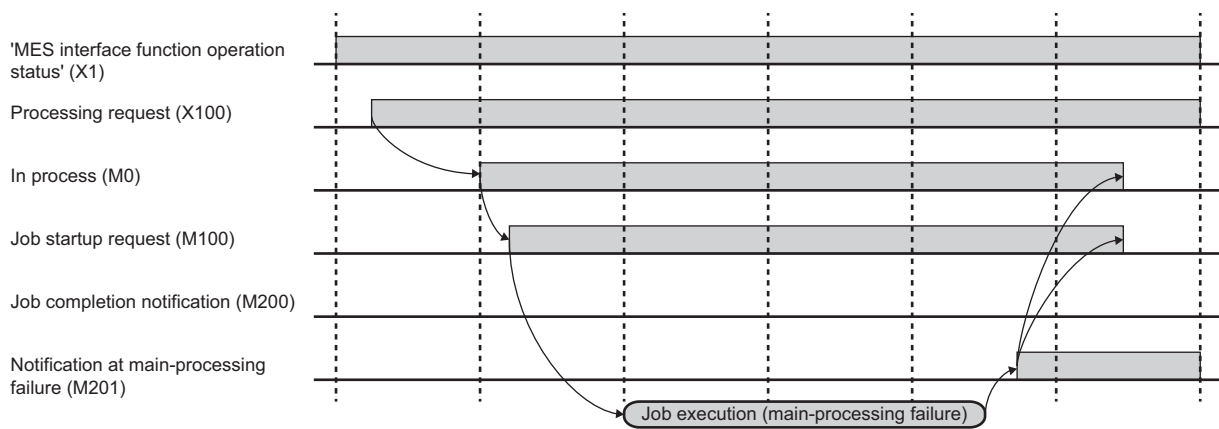

Multiple handshake

The overview of a multiple handshake is as follows:

- ① Each 'Job start request' is monitored at an access interval.
- ② The operation of a job is started by using data at the timing when an OFF to ON transition of each 'Job start request' is detected.
- ③ Data of the job operation result is applied and each 'Job completion notification' is turned ON when the operation of the job is completed.

If the main-processing fails, 'Job completion notification' does not turn ON. (To notify a programmable controller of the failure, set the settings in "Operation Settings at Main-Processing Failure". (☞ Page 119 Operation Setting at Main-Processing Failure/Interruption))

- ④ 'Job completion notification' is turned OFF at the timing when an ON to OFF transition of each 'Job start request' is detected.

Make sure to turn the Job start request OFF after an OFF to ON transition of the 'Job completion notification' is detected.

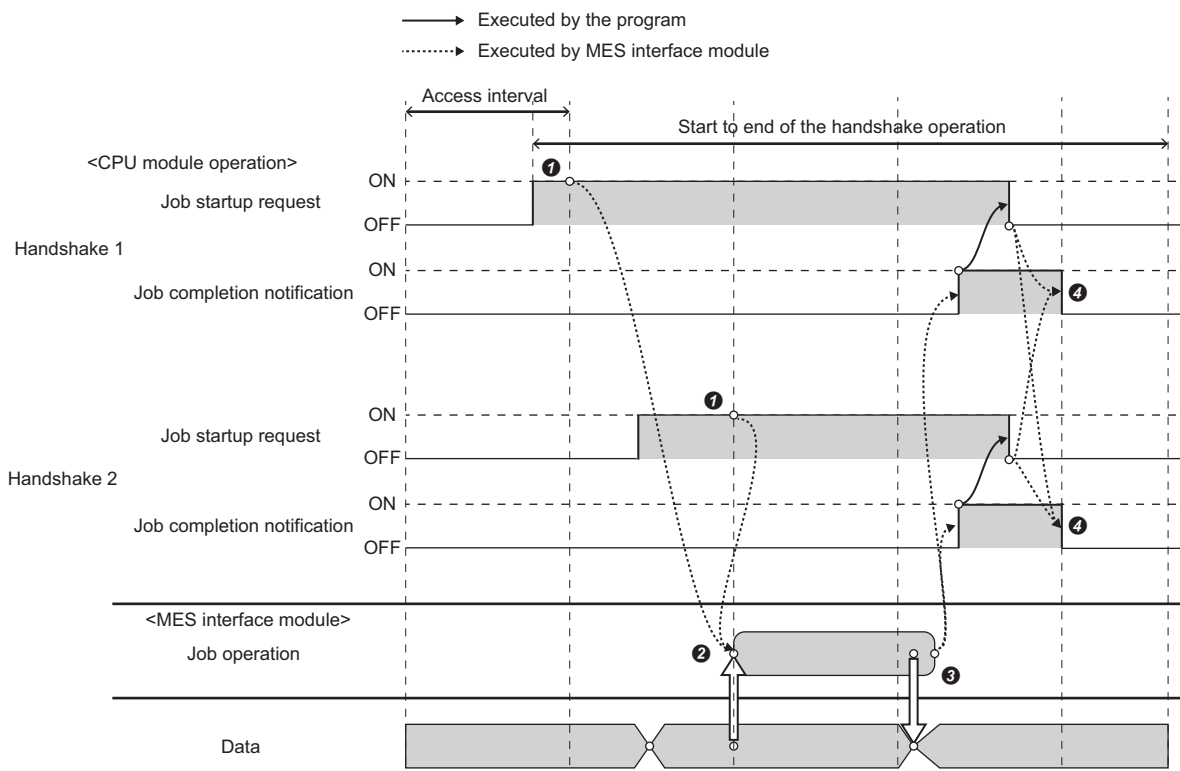

Point

If one 'Job start request' is turned OFF and ON while the other is ON after job execution is completed, the job is not executed.

Sample program for using a multiple handshake

● Devices used in a program

Device name	Device	Application
MES interface module input signal	X1	MES interface function operation status
Access target device 1 (own station)	External input	X100
	Internal relay	M0
		M100
		M200
M201		
Access target device 2 (other station)	External input	X110
	Internal relay	M10
		M110
		M210
		M211

● Program example

The following shows an example of a program in which a job runs when 'Processing request' (X100 and X110) is turned ON from a CPU module.

• Access target device 1

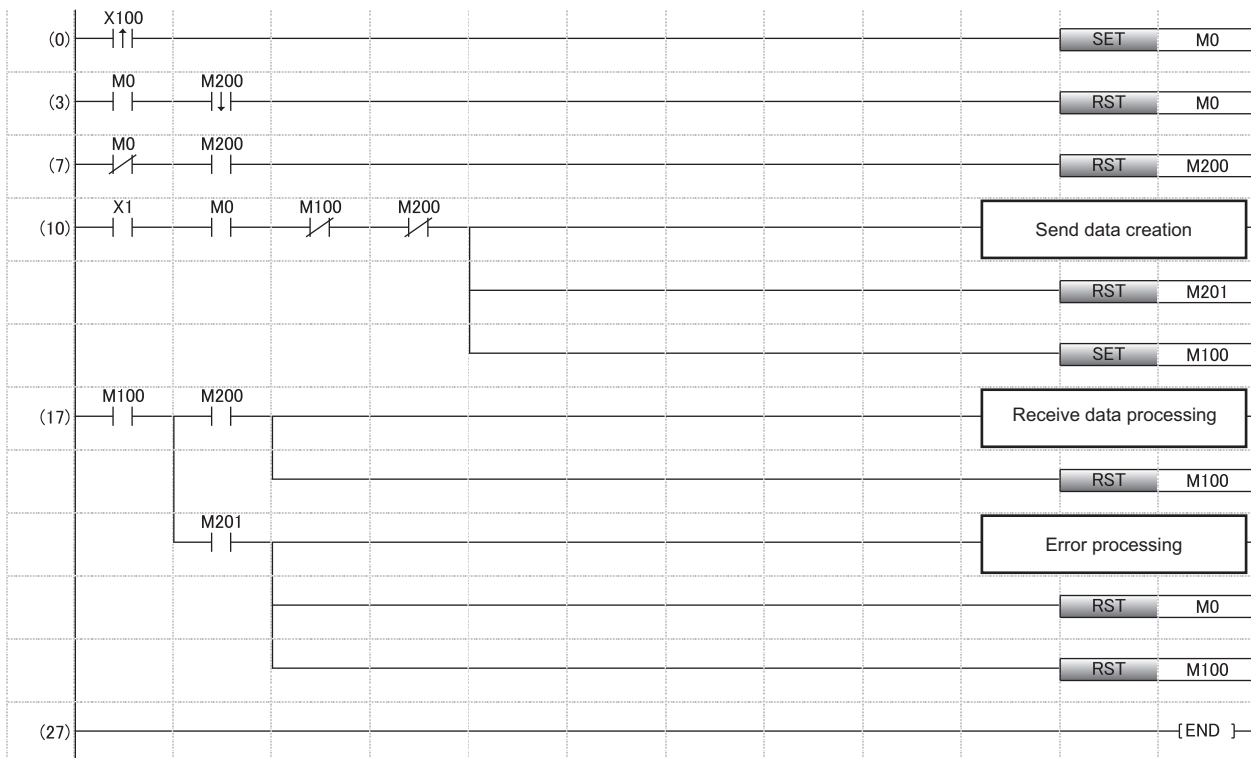

- (0) Sets the in-process flag at processing request.
- (3) Resets the in-process flag at normal completion.
- (7) Turns the job completion notification OFF
- (10) Job start processing
- (17) Processing at normal completion of job execution
Processing at main-processing failure

• Access target device 2

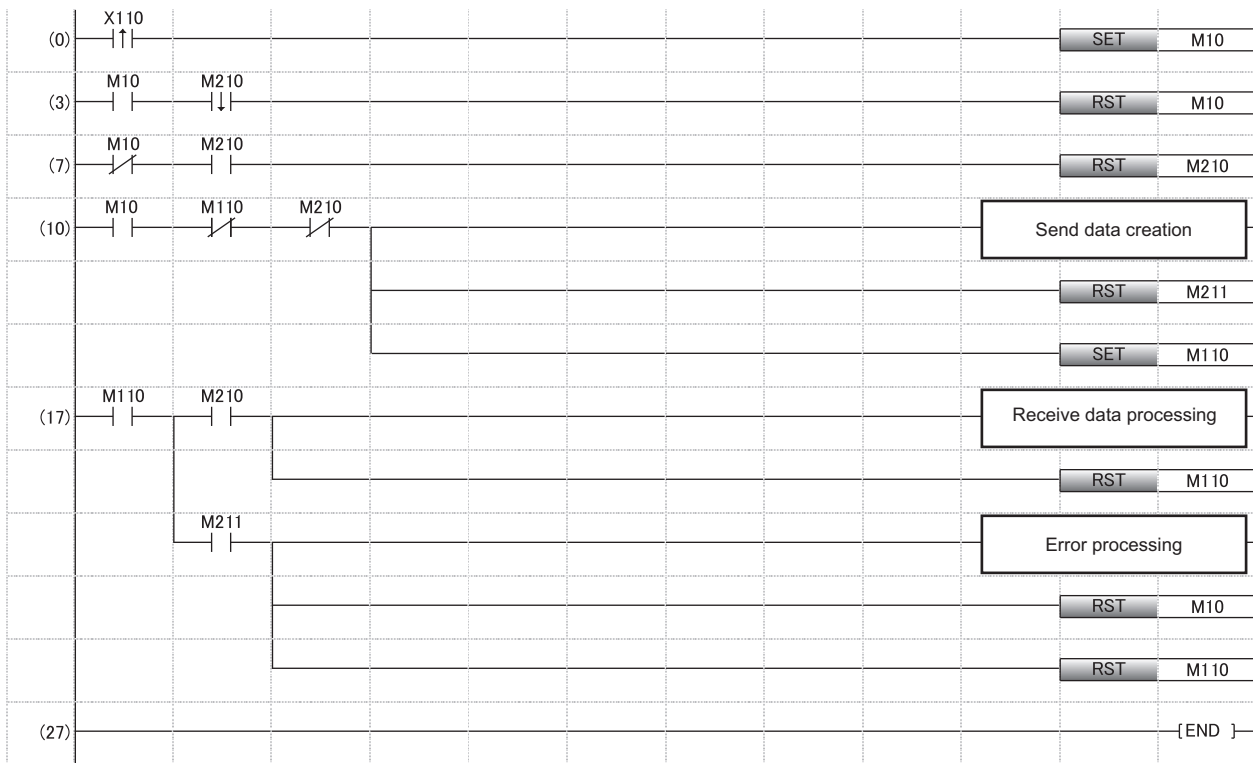

- (0) Sets the in-process flag at processing request.
- (3) Resets the in-process flag at normal completion.
- (7) Turns the job completion notification OFF
- (10) Job start processing
- (17) Processing at normal completion of job execution
Processing at main-processing failure

● Timing charts

The following shows the timing charts for the program example.

- At normal completion of job execution

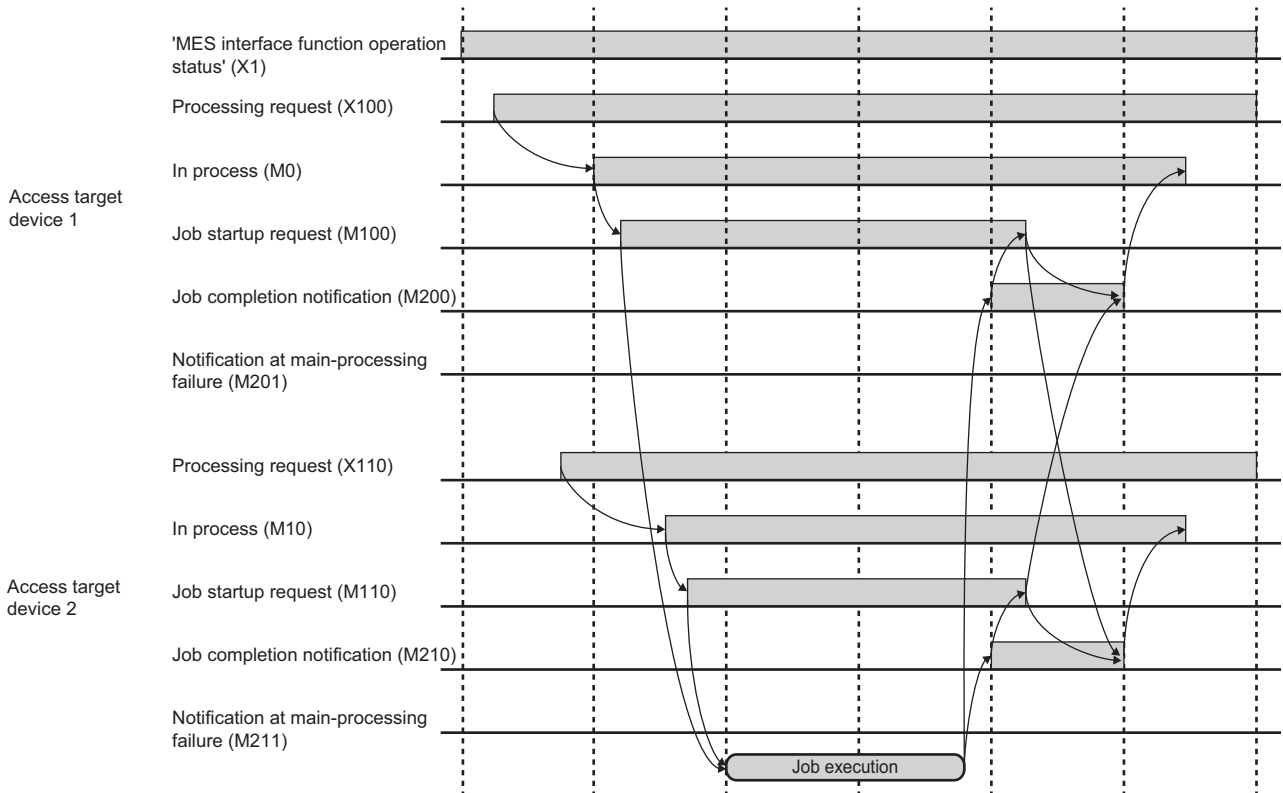

- At main-processing failure

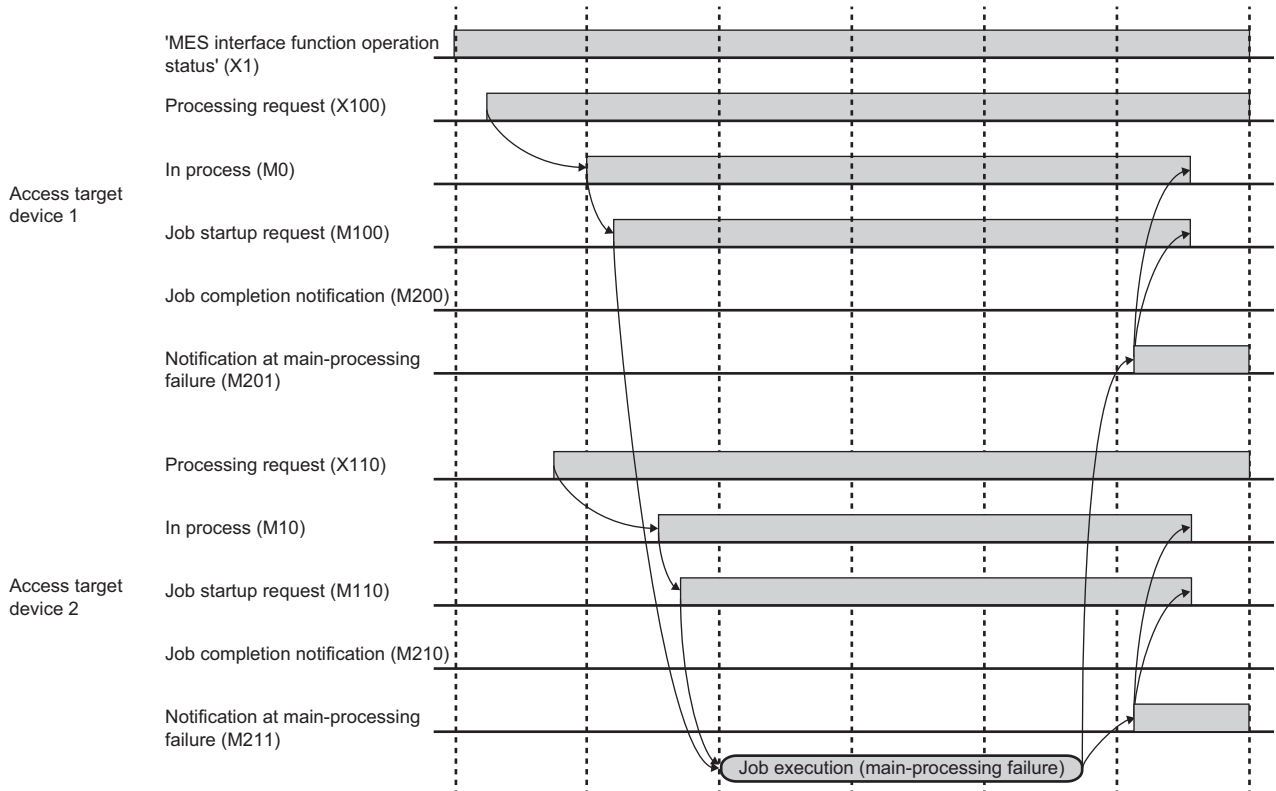

Specification for trigger conditions at time change

An MES interface module operates based on the time acquired from CPU No.1 on the own station; therefore, the apparent time skip range (1) and the apparent time duplication range (2) are generated depending on the timing of a time change. Operations of events and conditions to occur may change due to the time change.

The following two cases cause a time change.

- When the time of a CPU module is changed to the future time or the daylight saving time starts
- When the time of a CPU module is changed to the past time or the daylight saving time ends

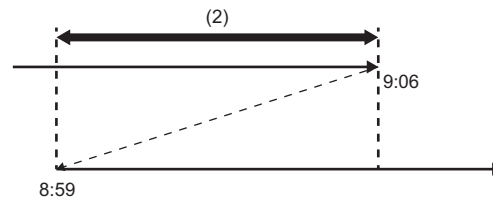
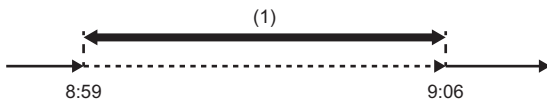

Operations of events

The following table shows the operation of an event which occurs within the apparent time skip range and the apparent time duplication range.

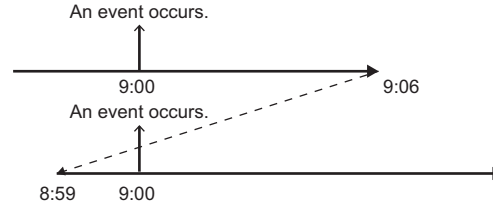
Within the apparent time skip range	Within the apparent time duplication range
<p>An event occurs at time change.*1*2 The time when an event occurs is a time after the time change.</p> <ul style="list-style-type: none"> • Example When setting to generate an event at 9:00, and the time is changed from 8:59 to 9:06 	<p>An event occurs twice.</p> <ul style="list-style-type: none"> • Example When setting to generate an event at 9:00, and the time is changed from 9:06 to 8:59 

*1 No event occurs in an RD81MES96 with firmware version '02' or earlier.

*2 When setting the event (fixed cycle) (time interval), if multiple events occur during the time change, the event is handled as one event.

The target event/condition types are as follows:

Configuration type	Event/condition type
Single event	<ul style="list-style-type: none"> • Event (Fixed time) • Event (Fixed cycle) (Time interval)
Multiple events	<ul style="list-style-type: none"> • Event (Fixed time) • Event (Fixed cycle) (Time interval)
Precondition × Event	<ul style="list-style-type: none"> • Event (Fixed time) • Event (Fixed cycle) (Time interval)

■ Operations of conditions

The following table shows the operation of a condition which occurs within the apparent time skip range and the apparent time duplication range.

Within the apparent time skip range	Within the apparent time duplication range
<p>A condition switches at time change. The time when a condition switches is a time after the time change. However, when the condition switches several times within the apparent time skip range, the condition may not switch after the time change.</p> <ul style="list-style-type: none"> • Example 1 When setting to turn the condition ON from 9:00 to 9:07 and the time is changed from 8:59 to 9:06 <ul style="list-style-type: none"> • Example 2 When setting to turn the condition ON from 9:00 to 9:05 and the time is changed from 8:59 to 9:06 	<p>A condition switches twice.</p> <ul style="list-style-type: none"> • Example 1 When setting to turn the condition ON from 8:58 to 9:00 and the time is changed from 9:06 to 8:59 <ul style="list-style-type: none"> • Example 2 When setting to turn the condition ON from 9:00 to 9:05 and the time is changed from 9:06 to 8:59

The target event/condition types are as follows:

Configuration Type	Event/condition type
Precondition × Event (Precondition)	• Condition (Period of time)

Job execution control function

The job execution control function determines the availability of the job startup based on the number of executable jobs and their execution status.

This function also reads data which is required for the execution of a job and writes the job execution result.

Processing	Description
Job startup	Upon the reception of the notification when the trigger condition is satisfied, the availability of the job execution is determined by the number of executable jobs and the execution status.
Data read to be used for job	Reads data required for executing job in job units using the Data input/output function. The data which is included in the data to be used for trigger condition is not read.
Exclusive control of database server used for job	Performs exclusive control of the database to be used for jobs to prevent that the multiple jobs which use the same database server are dead-locked.
Execution of action	Executes functions of MES interface module.
Writing of job execution result	Writes the execution result of the job to data using the Data input/output function.
Job verification function	Controls writing operation of the startup of job, execution of action, and execution result of job when executing job which is in verification before starting operation or in development.

Job startup

The specifications of the job startup are as follows:

- ① Up to three jobs can be executed simultaneously, however, the same jobs cannot be executed simultaneously.
- ② Normally, a notification is discarded when the notification, which indicates that the trigger condition of the same job is satisfied, is received while executing the job according to ①.
- ③ For ②, the trigger buffering function for executing jobs later can be used without discarding a notification.
- ④ The jobs which use the trigger buffering function cannot be executed simultaneously.
 - Behavior without using the trigger buffering function

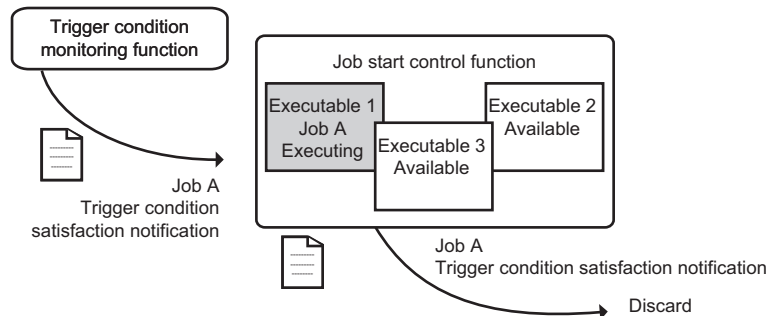

- Behavior using the trigger buffering function

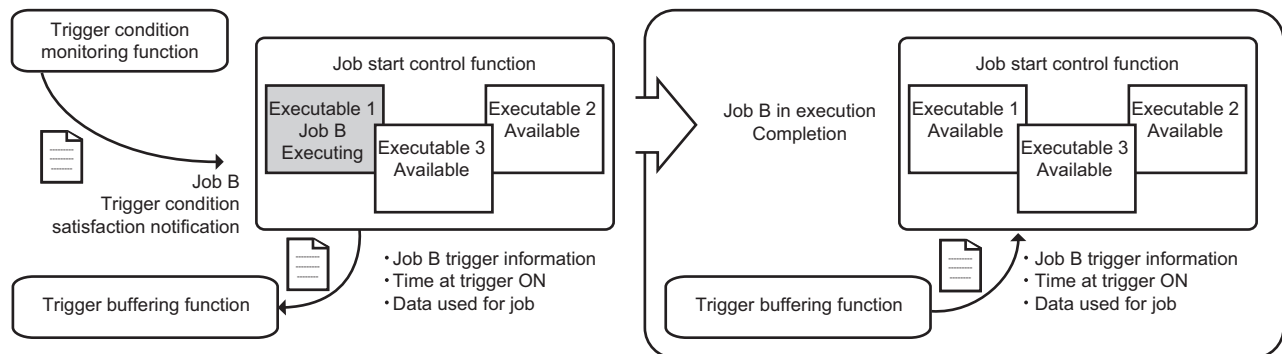

Exclusive control of database server used for job

Only one job can be accessed for one database (Target server settings).

When accessing the same database from multiple jobs simultaneously, the next job is suspended until the former job is completed.

Execution of action

The specifications of the action execution are as follows:

- ① Each function of MES interface module is regarded as an action. The action is executed in order set to job settings.
- ② The data linkage function provides information linkage among an MES interface module, access target device, and access target server by linking data used for each action.

Function	Description
DB communication action	To perform the DB input/output function.
External communication action	To perform the external communication client function.
Operation action	To perform the data operation and processing function.

Writing of job execution result

The specification for writing job execution result is as follows:

Write target	Write timing
Device tag	The updated data during the job execution is retained in the internal system, and the data is written at the completion of the execution.
Variable	Writes the result for each data update during job execution.

Job verification function

The following shows the list of the Job verification function and operations for each function.

Function	Description	Remarks	
Working history output	Working history	Outputs a log related to the job startup of the job execution function. When this function is enabled, the following logs are output. <ul style="list-style-type: none"> • Time at trigger ON • Start result of the target job: Success/Failure/Inhibition 	—
	Detailed log	Outputs logs related to the execution of the action and write of job execution result of the job execution control function. When this function is enabled, the following logs are output. <ul style="list-style-type: none"> • List of actions executed in each processing • Execution result of actions • Value of linked data by each action 	—
Data output inhibition	Device memory	Inhibits the job execution result of the job execution function from being written. When this function is enabled, writing all the data (all data to be specified in the job settings such as all actions/all notification settings and flag operations of handshake) of the job execution result is inhibited, and the data is not output to the target device.	<ul style="list-style-type: none"> • For the extended configuration, all the results of the specified job including pre-processing and post-processing are not reflected. • Only the device tag components to be set in the job settings are inhibited. Writing data to device tag components to be set in the settings other than the job settings are not inhibited.*1
	Database	Inhibits the action execution result of the job execution function from being output to the database. When this function is enabled, the communication such as Select or Insert is performed with the DB communication action, however, the reflection of the result of all the actions to the database is inhibited by rolling back the database without committing data.	<ul style="list-style-type: none"> • DB buffering is not performed during the inhibition. • The SQL statements, which have been buffered to the DB buffer before the inhibition, is resent during the inhibition.
Job execution inhibition	Inhibits the job start of the job execution function. While this function is enabled, the job is not started if the trigger condition is satisfied. When the working history can be output, the log of inhibition is output as a start result of the target job to the working history.	—	

*1 For the access other than job, refer to the following:

 Page 25 Access other than job

Job operation status

There are following five status for the job operation.

Status	Description
In execution inhibition	A job execution inhibition flag is set.
Disable	A trigger condition is not set.
Trigger condition monitoring	A trigger condition is being monitored.
Preparing for execution	Trigger condition is satisfied and action is not executed yet.
In execution	An action is being executed.

For the operation at job execution, refer to the following:

☞ Page 19 Data read/write timing for CPU modules at job operation

Considerations for the first connection with a database server

When selecting "Direct DB Connection" for "Access Type," the first connection to a database server is established in order. Therefore, if jobs accessing each database server are executed simultaneously and a communication error occurs in the first connection to a database server, the first connection to another database server is not established until the communication timeout time elapses.

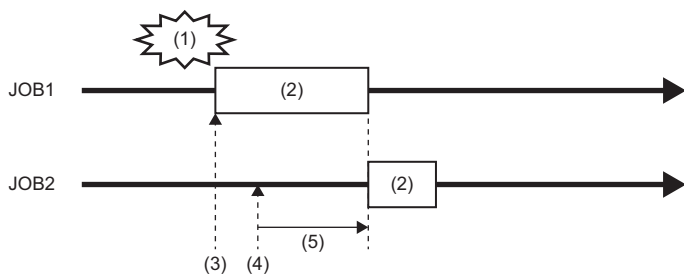

- (1) A communication error occurs.
- (2) Connection processing to a database server
- (3) First execution of JOB1
- (4) First execution of JOB2
- (5) Since the connection processing of JOB1 to a database server has not been completed, that of JOB2 starts after the communication timeout time elapses.

Trigger buffering function

The trigger buffering function buffers the following information required for job execution as trigger information to execute later when the job execution control function receives the trigger condition satisfaction notification of the same job which is in execution without discarding the notification.

- Read data of a device tag component
- Time at trigger monitoring
- Time at trigger ON
- Date and time character string

However, this function cannot be enabled for the job (including a job of which trigger type is handshake) which writes data to the CPU module, except for the specific function.*¹

*¹ The notification when a job execution is not performed normally (job cancellation notification/notification of exception) is available.

Behavior when the trigger buffering function is disabled (normal)

When a trigger condition for a job is satisfied again during execution of the job, the next job is not executed.

Ex.

When value monitoring is regarded as a condition

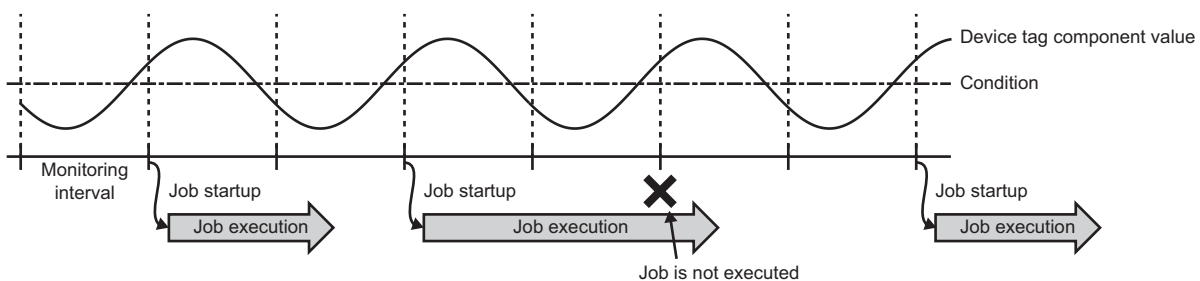

Behavior when the trigger buffering function is enabled

The trigger information is buffered when the latter trigger condition is satisfied. After the former trigger condition is satisfied, a job is executed according to the trigger information.

Ex.

When value monitoring is regarded as a condition

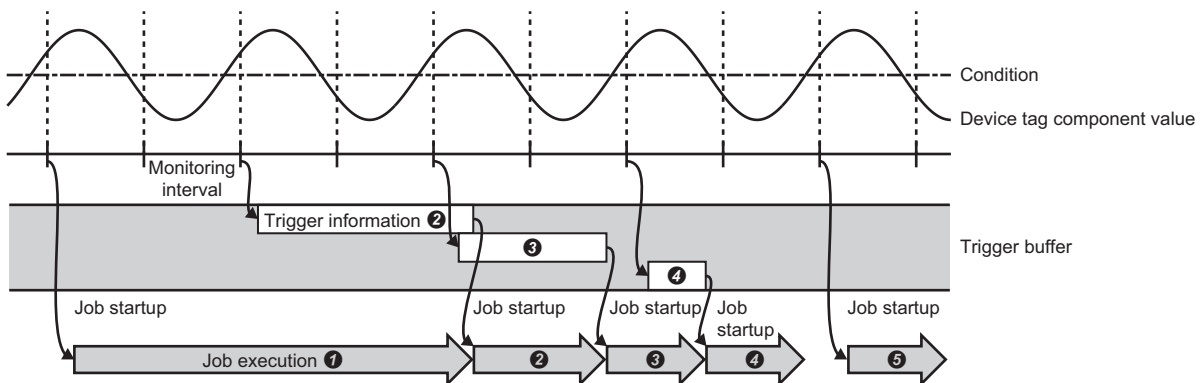

When the trigger buffering function is enabled, the data required for a job operation is always stored in the trigger buffer temporarily, then the job is executed depending on the load status.

■Normal (Trigger condition satisfaction interval > Processing time for job)

- When trigger condition is satisfied, the job data and its time are stored in the trigger buffer.
- Based on the information in the trigger buffer, a job is executed immediately.

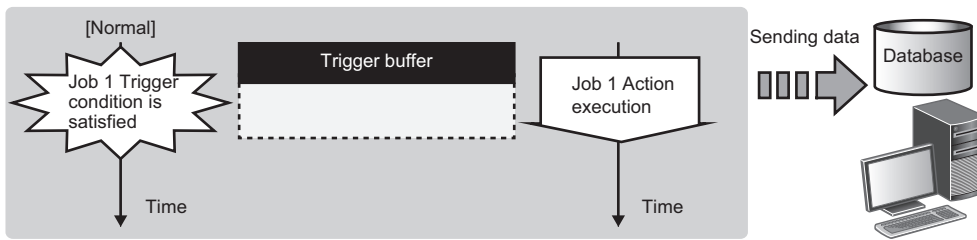

■At load concentration (Trigger condition satisfaction interval < Processing time for job)

- Every time when a trigger condition is satisfied, the job data and its time are stored one by one.
- Up to 192 job data are buffered even when the job processing is not completed in time.

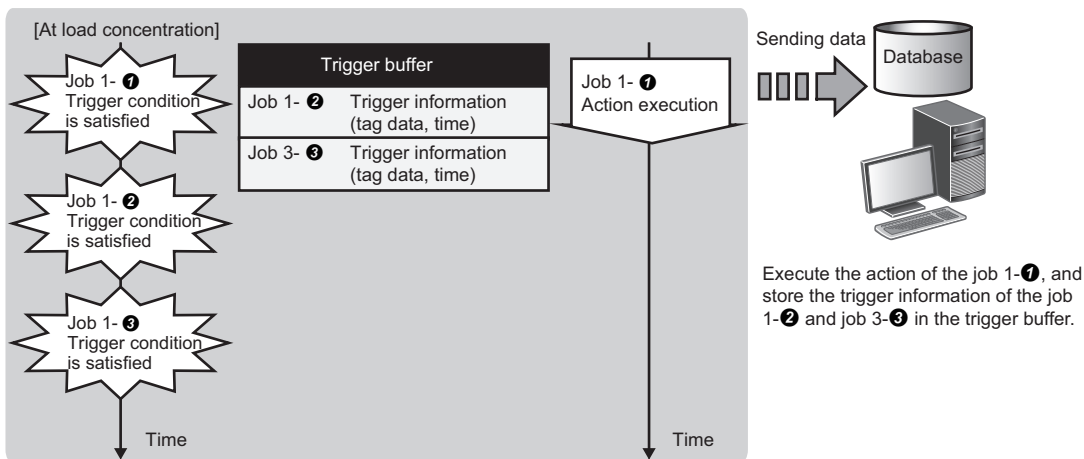

■At load reduction (Trigger condition satisfaction interval > Processing time for job)

- The information in the trigger buffer is read out sequentially, and the jobs are executed.
- Since the trigger buffer information which has been used for job execution is cleared, a new trigger buffering can be performed.

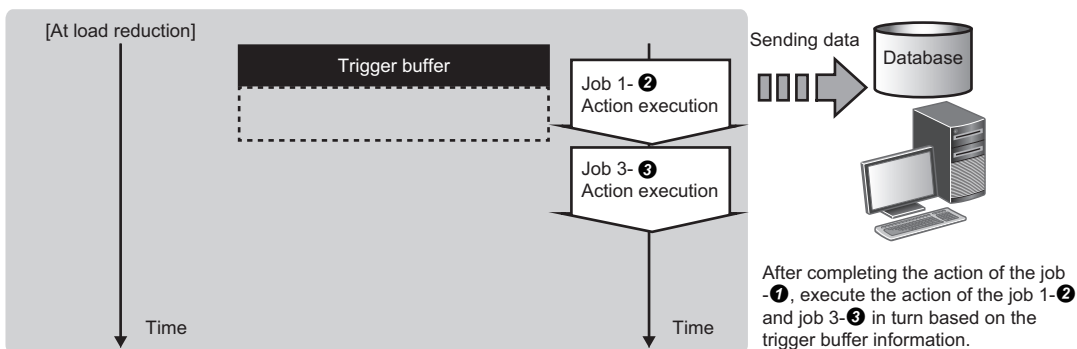

One-shot execution function

The one-shot execution function executes an arbitrary job in an arbitrary timing regardless of the operating status of an MES interface module.

The operation specification of the one-shot execution function is as follows:

1. The following operations can be performed by selecting a target job for one-shot execution (one-shot job) and selecting [Online] ⇒ [One-Shot Execution] in MES Interface Function Configuration Tool.
 - ① MES Interface Function Configuration Tool writes the settings required for the execution of one-shot job to the MES interface module.
 - ② MES Interface Function Configuration Tool notifies the execution request of the one-shot job to the MES interface module.

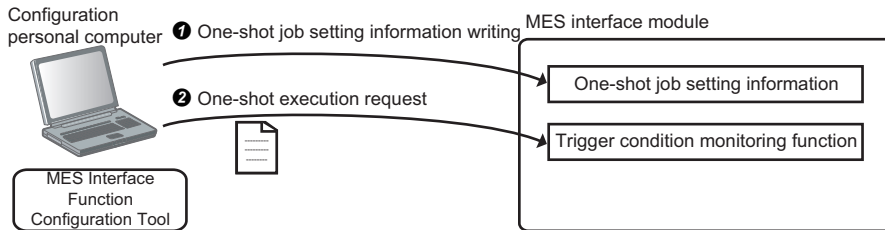

2. The MES interface module in which the notification has been received notifies the one-shot job execution request for the Job execution control function. After that, the job is executed based on the settings written in Operation 1-①.

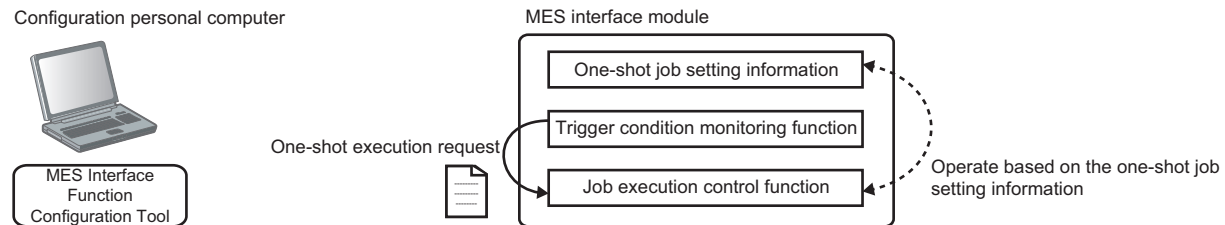

3. After the one-shot job is completed, MES interface module performs the following operations.

- ① The execution result of the one-shot job is saved as a detailed log.
- ② The settings written in Operation 1-① are deleted.
- ③ Completion of the one-shot job and detailed log of the Operation 3-① is notified to MES Interface Function Configuration Tool.

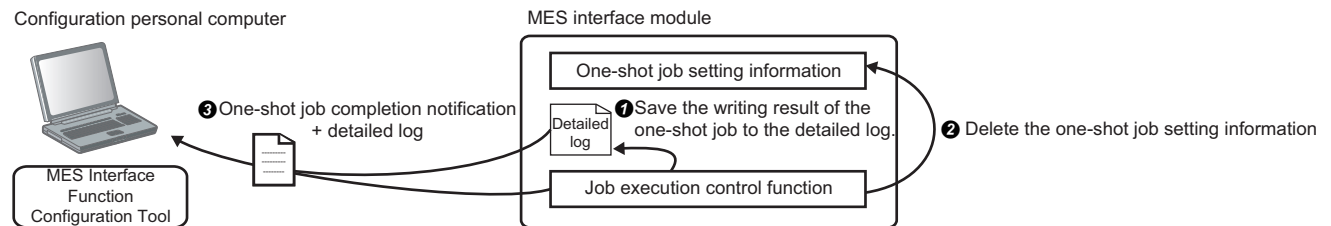

4. If canceling from MES Interface Function Configuration Tool during one-shot execution, or if the communication with the setting tool is disconnected, MES interface module will operate as follows:

- ① The one-shot job is canceled.
- ② The settings written in Operation 1-① and detailed log are deleted.
- ③ The one-shot execution is ended without notifying the completion of the one-shot job.

The detailed specification of the one-shot execution function is as follows:

Item		Specification	Remarks
Number of jobs which can be executed simultaneously		One job only.	—
Setting information of one-shot job	Available (enabled)	The following settings are available for one-shot execution. ■ Job settings for one-shot execution in MES Interface Function Configuration Tool ■ Settings related to job settings <ul style="list-style-type: none"> • Device tag settings • Target device settings • Access table/procedure settings • Target server settings • Variable settings 	A job is executed based on the setting information of one-shot job. If one-shot execution is executed for the same job, the job execution control function operates as different job.
	Not available (disabled)	The following settings are not available at the execution of one-shot job. ■ Trigger buffering setting <ul style="list-style-type: none"> • The setting will be "Disable". ■ DB buffering settings <ul style="list-style-type: none"> • The setting will be "Disable". ■ Verification settings <ul style="list-style-type: none"> • The working history will be "Not output". • The detailed log will be "Not output". • The job execution will not be inhibited. 	The detailed log saved in Operation 3-① is prepared for the response for MES Interface Function Configuration Tool, and the log is displayed regardless of the setting content of the verification setting.

Precautions

■One-shot execution while data is buffered to DB buffer

Buffering data is not deleted by executing a one-shot job.

However, when a resend request or clear request is issued in a one-shot job, the DB buffering function is activated based on each request.

Execute the one-shot job after checking the existence of resend request or clear request in the job.

■One-shot execution while trigger buffering is being executed

One-shot job is executed on a priority basis.

Buffering data is not deleted.

■Global variables

The global variables which are included in the setting for one-shot execution operate as global variables which can be used only at one-shot execution.

- The value of global variable which is in operation is not used.
- The value is not reflected to the global variables of the job which is in operation.

■Completion notification of handshake

When the event/condition type is handshake, the device tag component of the job completion notification is not turned ON.

■LED

The result is not reflected to the LED (ERR LED/DB COM LED/Dot matrix LED).

■Buffer memory

The value in the area which is related to job execution, such as a data access cycle information area, is not updated.

■Input signal (X)

The result is not output to an input signal (X) related to each error (X10 to X14) if an error occurred during one-shot execution.

■System variables

The result is not output to a system variable.

■One-shot execution time

One-shot execution may require time depending on the operating status of the job in the module or ambient conditions (such as network and database conditions) when the one-shot is executed.

Check the operating status of the job in the module or ambient conditions and execute the one-shot.

Data operation and processing function

The data operation and processing function performs an operation specified for the operator for values in the first and second items, and substitutes the values for the substitution item.

Use this function for one of the actions which are to be defined for pre-processing/main-processing/post-processing.

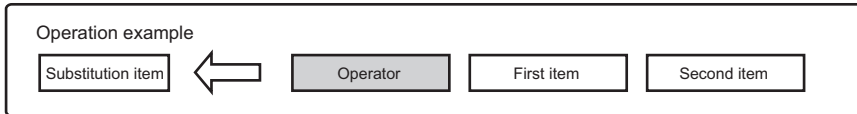

The combinations of data types that can be set for the data operation and processing function are as follows:

○: Available, ×: Not available

Substitution item		First item/second item				
		Device tag component		Variable	Constant	Macro
		Array tag setting is disabled	Array tag setting is enabled			
Device tag component* ¹	Array tag setting is disabled	○	×	○	○	○* ²
	Array tag setting is enabled	×	○* ³ ⁴	×	×	×
Variable* ⁵		○	×	○	○	○* ²
Constant		×	×	×	×	×
Macro		×	×	×	×	×

*1 Data write-protected tags cannot be set.

*2 Can be set only for "Date and Time Character String".

*3 Can be set only when using an RD81MES96N.

By enabling the array tag setting, data can be exchanged with an access target device in a batch.

*4 Cannot be set for the second item.

*5 Write-protected system variables cannot be set.

Specifications of operations

The list of operations is as follows:

Classification	Operator	Description
Substitution operation	ASSIGN	Substitutes data in the first item for the substitution item.
Arithmetic operation	+	Performs addition of numerical value data.
	-	Performs subtraction of numerical value data.
	×	Performs multiplication of numerical value data.
	÷	Performs division of numerical value data.
	%	Calculates remainder of numerical value data.
Character string operation	CONCAT	Combines character string data.
	LENGTH	Acquires the number of characters of the character string data.
	RIGHT	Reads out character string data from the end/rightmost of the character string data for the specified number of characters.
	LEFT	Reads out character string data from the first/leftmost of the character string data for the specified number of characters.
	UPPER	Converts lower-case characters included in character string data to upper-case characters.
	LOWER	Converts upper-case characters included in character string data to lower-case characters.
	RTRIM	Deletes blank characters at the end/rightmost of the character string data.
	LTRIM	Deletes blank characters at the first/leftmost of the character string data.
Bit operation	AND	Performs AND operation of integer data for each bit.
	OR	Performs OR operation of integer data for each bit.
	XOR	Performs XOR operation of integer data for each bit.
	RSHIFT	Shifts integer data to right for the number of specified bits.
	LSHIFT	Shifts integer data to left for the number of specified bits.
Type conversion	STR2INT	Converts character string data to integer data.
	STR2REAL	Converts character string data to real number data.
	INT2STR	Converts integer data to character string data.
	REAL2STR	Converts real number data to character string data.

Substitution operation

■ASSIGN

Item	Description
Function	Performs data assignment. • Substitution item = First item

- Available data type

Substitution item*1	First item*1	Second item
Integer or real number	Integer or real number	— (Not available)
Character string	Character string	— (Not available)

*1 For array tag components, set the same data type and size of array tag component for the substitution item and the first item. (If the data type is a string [Unicode®] or [SJIS], set the same number of characters.)

Arithmetic operation

■+ (Addition)

Item	Description
Function	Performs addition of numerical value data. • Substitution item = First item + Second item
Example	<p>■When the first item is 10 (integer) and the second item is 15 (integer)</p> <p>■When the first item is 10.5 (real number) and the second item is 0.75 (real number)</p> <p>• If an integer type is specified to the substitution item in an operation of which result is output as a real number type, the value after the decimal point is rounded off. (If an integer type is specified in the example above, the result will be '11').</p>

- Available data type

Substitution item	First item	Second item
Integer or real number	Integer	Integer
Integer or real number	Integer	Real number
Integer or real number	Real number	Integer
Integer or real number	Real number	Real number

■- (Subtraction)

Item	Description
Function	Performs subtraction of numerical value data. <ul style="list-style-type: none"> Substitution item = First item - Second item
Example	<p>■When the first item is 10 (integer) and the second item is 15 (integer)</p> <p>■When the first item is 10.5 (real number) and the second item is 0.75 (real number)</p> <p>• If an integer type is specified to the substitution item in an operation of which result is output as a real number type, the value after the decimal point is rounded off. (If an integer type is specified in the example above, the result will be '9').</p>

• Available data type

Substitution item	First item	Second item
Integer or real number	Integer	Integer
Integer or real number	Integer	Real number
Integer or real number	Real number	Integer
Integer or real number	Real number	Real number

■× (Multiplication)

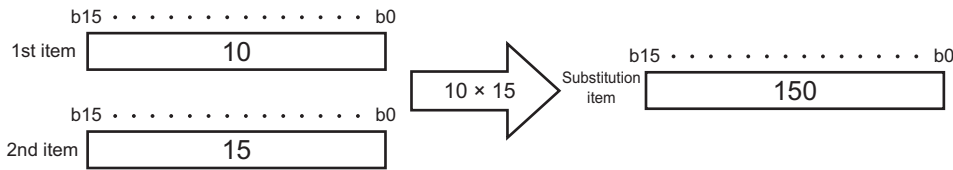
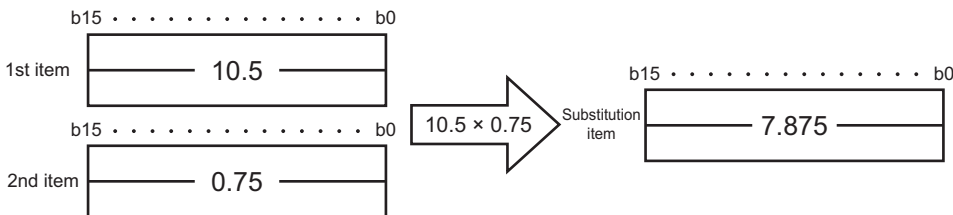
Item	Description
Function	Performs multiplication of numerical value data. • Substitution item = First item × Second item
Example	<p>■When the first item is 10 (integer) and the second item is 15 (integer)</p>  <p>■When the first item is 10.5 (real number) and the second item is 0.75 (real number)</p>  <p>• If an integer type is specified to the substitution item in an operation of which result is output as a real number type, the value after the decimal point is rounded off. (If an integer type is specified in the example above, the result will be '7').</p>

• Available data type

Substitution item	First item	Second item
Integer or real number	Integer	Integer
Integer or real number	Integer	Real number
Integer or real number	Real number	Integer
Integer or real number	Real number	Real number

■ ÷ (Division)

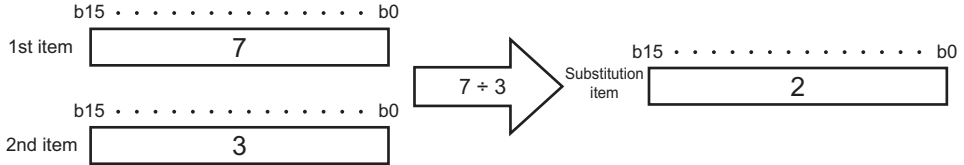
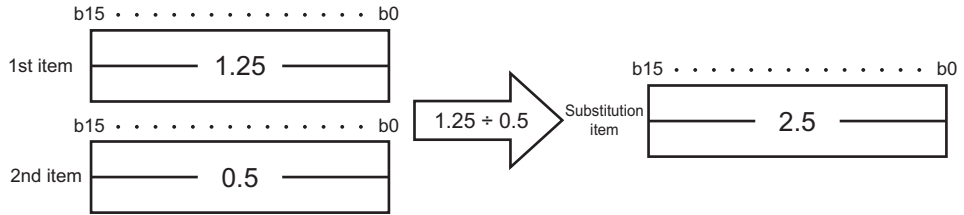
Item	Description
Function	<p>Performs division of numerical value data.</p> <ul style="list-style-type: none"> Substitution item = First item ÷ Second item <p>When an integer value is divided by an integer value, the decimal part of an algebraic quotient is rounded off (for 0 direction).</p> <ul style="list-style-type: none"> $5 \div 2 = 2.5 \rightarrow 2$ $5 \div (-2) = -2.5 \rightarrow -2$ $(-5) \div 2 = -2.5 \rightarrow -2$ $(-5) \div (-2) = 2.5 \rightarrow 2$ <p>If '0' is specified to the second item, 0 division error (error code: 1D81H) occurs.</p>
Example	<p>■ When the first item is 7 (integer) and the second item is 3 (integer)</p>  <p>■ When the first item is 1.25 (real number) and the second item is 0.5 (real number)</p>  <ul style="list-style-type: none"> If an integer value is indivisible by an integer value, the integer value after the decimal point substituted for the substitution item is rounded off. If an integer type is specified to the substitution item in an operation of which result is output as a real number type, the value after the decimal point is rounded off. (If an integer type is specified in the example above, the result will be '2').

• Available data type

Substitution item	First item	Second item
Integer or real number	Integer	Integer
Integer or real number	Integer	Real number
Integer or real number	Real number	Integer
Integer or real number	Real number	Real number

■ % (Remainder)

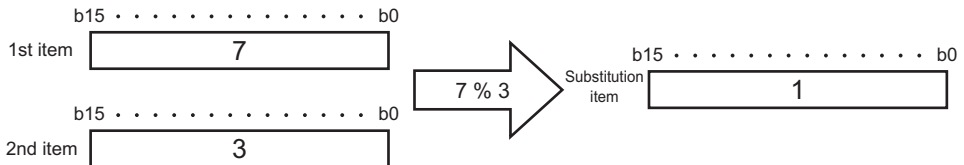
Item	Description
Function	<p>Calculates remainder of numerical value data.</p> <ul style="list-style-type: none"> Substitution item = First item % Second item <p>The sign of the remainder is the same as that of the first item.</p> <p>If '0' is specified to the second item, 0 division error (error code: 1D81H) occurs.</p>
Example	<p>■ When the first item is 7 (integer) and the second item is 3 (integer)</p> 

• Available data type

Substitution item	First item	Second item
Integer or real number	Integer	Integer

Character string operation

■ CONCAT

Item	Description
Function	Combines character string data. Combines a character string data in the second item to the end/rightmost of the character string data in the first item, and substitutes the result for the substitution item.
Example	<p>■When the first item is "ABC" (Unicode), the second item is "123" (Unicode), and the substitution item is Unicode</p> <p>The diagram illustrates the CONCAT operation. On the left, the 'First item' is a memory block with addresses b15 to b0 containing characters 'A', 'B', 'C', and a termination character '00H'. Below it, the 'Second item' is another memory block with addresses b15 to b0 containing characters '1', '2', '3', '00H', '4', and '5'. On the right, the 'Substitution item' is a memory block with addresses b15 to b0 containing characters 'A', 'B', 'C', '1', '2', '3', and '00H'. Two arrows point from the first and second items to the substitution item, indicating that their contents are copied into it.</p> <ul style="list-style-type: none"> • The characters in the first item including termination character is set to the substitution item, and then the characters in the second item including termination character is set to the substitution item. • The characters after the termination character are ignored. • If the termination character could not be found, the number of characters specified to the device tag component or variable are assigned. • If the number of characters set to the substitution item is smaller than that of characters in the substitution item, the value after the end characters will be undefined.

• Available data type

Substitution item	First item	Second item
Character string	Character string	Character string

■LENGTH

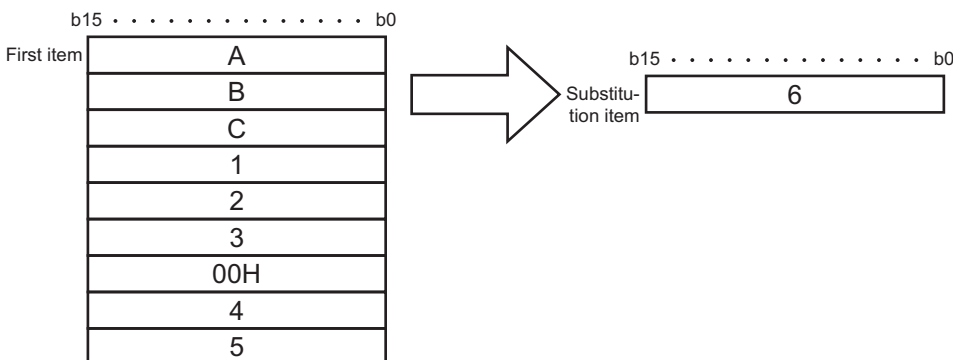
Item	Description
Function	Acquires the number of characters of the character string data. Acquires the number of characters in the character string data in the first item, and substitutes them for the substitution item.
Example	<p>■When the first item is "ABC123" (Unicode)</p>  <p>The diagram illustrates the function's operation. On the left, a vertical box labeled 'First item' contains the characters 'A', 'B', 'C', '1', '2', '3', '00H', '4', and '5' from top to bottom. Above this box, the bit range 'b15 b0' is indicated. An arrow points from this box to a horizontal box on the right labeled 'Substitution item' which contains the number '6'. Above this box, the bit range 'b15 b0' is also indicated.</p> <ul style="list-style-type: none"> • A termination character is not counted as a number of characters. • If the termination character could not be found, the number of characters specified to the device tag component or variable are assigned.

• Available data type

Substitution item	First item	Second item
Integer or real number	Character string	— (Not available)

RIGHT

Item	Description
Function	<p>Reads out character string data from the end/rightmost of the character string data for the specified number of characters.</p> <p>■When the second item is a positive number Reads out the number of character string data specified to the second item from the end/rightmost of the character string data in the first item, and substitutes the result for the substitution item. When the character string length (actual data length) in the first item is shorter than that of the second item, the data in the first item is substituted for the substitution item.</p> <p>■When the second item is a negative number Reads out the character string data, of which number of characters in the absolute value of the numerical value specified to the second item are deleted, from the first/leftmost of the character string data in the first item, and substitutes the result for the substitution item. If the character string length (actual data length) in the first item is shorter than the absolute value of numerical value in the second item, the character string data of which length is 0 is substituted for the substitution item.</p> <p>■When the second item is '0' Substitutes the character string data of which length is 0 for the substitution item.</p>
Example	<p>■When the first item is "ABC123" and the second item is 4 C123" is read out. (4 characters from right)</p> <p>■When the first item is "ABC123" and the second item is -4 23" is read out. (4 characters from the left are deleted.)</p> <ul style="list-style-type: none"> • A termination character is not included in the number of characters which is to be specified for the second item. • If the termination character could not be found, the number of characters specified to the device tag component or variable are assigned.

- Available data type

Substitution item	First item	Second item
Character string	Character string	Integer

LEFT

Item	Description
Function	<p>Reads out character string data from the first/leftmost of the character string data for the specified number of characters.</p> <p>■When the second item is a positive number Reads out the number of character string data specified to the second item from the first/leftmost of the character string data in the first item, and substitutes the result for the substitution item. When the character string length (actual data length) in the first item is shorter than that of the second item, the data in the first item is substituted for the substitution item.</p> <p>■When the second item is a negative number Reads out the character string data, of which number of characters in the absolute value of the numerical value specified to the second item are deleted, from the end/rightmost of the character string data in the first item, and substitutes the result for the substitution item. If the character string length (actual data length) in the first item is shorter than the absolute value of numerical value in the second item, the character string data of which length is 0 is substituted for the substitution item.</p> <p>■When the second item is '0' Substitutes the character string data of which length is 0 for the substitution item.</p>
Example	<p>■When the first item is "ABC123" and the second item is 4 "ABC1" is read out. (4 characters from right)</p> <p>■When the first item is "ABC123" and the second item is -4 "AB" is read out. (4 characters from the right are deleted.)</p> <ul style="list-style-type: none"> • A termination character is not included in the number of characters which is to be specified for the second item. • If the termination character could not be found, the number of characters specified to the device tag component or variable are assigned.

- Available data type

Substitution item	First item	Second item
Character string	Character string	Integer

■UPPER

Item	Description
Function	Converts lower-case characters included in character string data to upper-case characters. Converts the lower-case characters (U+0061 to U+007A) included in the character string data in the first item to the upper-case characters (U+0041 to U+005A), and substitutes them for the substitution item.
Example	<p>■When the first item is "AbcDef" (Unicode) Converted to "ABCDEF"</p> <ul style="list-style-type: none"> • The characters including a termination character in the first item are converted. The characters after the termination character are not converted and substituted. • If the termination character could not be found, the number of characters specified to the device tag component or variable are assigned.

- Available data type

Substitution item	First item	Second item
Character string	Character string	— (Not available)

■LOWER

Item	Description
Function	Converts upper-case characters included in character string data to lower-case characters. Converts the upper-case characters (U+0041 to U+005A) included in the character string data in the first item to the lower-case characters (U+0061 to U+007A), and substitutes them for the substitution item.
Example	<p>■When the first item is "AbcDef" (Unicode) Converted to "abcdef"</p> <ul style="list-style-type: none"> • The characters including a termination character in the first item are converted. The characters after the termination character are not converted and substituted. • If the termination character could not be found, the number of characters specified to the device tag component or variable are assigned.

- Available data type

Substitution item	First item	Second item
Character string	Character string	— (Not available)

■RTRIM

Item	Description
Function	Deletes blank characters at the end/rightmost of the character string data. Deletes the blank characters (U+0020) at the end/rightmost in the first item, and substitutes them for the substitution item.
Example	<p>■When the first item is "__12_3__" (" ": blank) Converted to "__12_3"</p> <ul style="list-style-type: none"> • The characters including a termination character in the first item are converted. The characters after the termination character are not converted and substituted. • If the termination character could not be found, the number of characters specified to the device tag component or variable are assigned.

- Available data type

Substitution item	First item	Second item
Character string	Character string	— (Not available)

■LTRIM

Item	Description
Function	Deletes blank characters at the first/leftmost of the character string data. Deletes the blank characters (U+0020) at the first/leftmost in the first item, and substitutes them for the substitution item.
Example	<p>■When the first item is "__12_3__" (" ": blank) Converted to "12_3__"</p> <ul style="list-style-type: none"> • The characters including a termination character in the first item are converted. The characters after the termination character are not converted and substituted. • If the termination character could not be found, the number of characters specified to the device tag component or variable are assigned.

- Available data type

Substitution item	First item	Second item
Character string	Character string	— (Not available)

Bit operation

■AND

Item	Description																																																													
Function	Performs AND operation of integer data for each bit. AND operation of integer data in the first item and second item for each bit are performed, and the result is substituted for the substitution item. The existence/difference of sign in the substitution item, first item, and second item are not considered.																																																													
Example	<p>■When the first item is Word [Signed], the second item is Word [Signed], and the substitution item is Word [Signed]</p> <p>1st item</p> <table border="1" style="margin-left: 40px;"> <tr> <td>b15</td> <td>1</td><td>1</td><td>1</td><td>1</td><td>1</td><td>1</td><td>1</td><td>1</td><td>0</td><td>0</td><td>0</td><td>0</td><td>0</td><td>1</td><td>1</td><td>1</td><td>1</td> <td>b1</td> <td>b0</td> </tr> </table> <p>2nd item</p> <table border="1" style="margin-left: 40px;"> <tr> <td>b15</td> <td>0</td><td>0</td><td>0</td><td>1</td><td>0</td><td>0</td><td>1</td><td>0</td><td>0</td><td>0</td><td>1</td><td>1</td><td>0</td><td>1</td><td>0</td><td>1</td><td>0</td><td>0</td> <td>b1</td> <td>b0</td> </tr> </table> <p style="text-align: center;">↓</p> <p>Substitution item</p> <table border="1" style="margin-left: 40px;"> <tr> <td>b15</td> <td>0</td><td>0</td><td>0</td><td>1</td><td>0</td><td>0</td><td>1</td><td>0</td><td>0</td><td>0</td><td>0</td><td>0</td><td>0</td><td>0</td><td>1</td><td>0</td><td>0</td> <td>b1</td> <td>b0</td> </tr> </table>	b15	1	1	1	1	1	1	1	1	0	0	0	0	0	1	1	1	1	b1	b0	b15	0	0	0	1	0	0	1	0	0	0	1	1	0	1	0	1	0	0	b1	b0	b15	0	0	0	1	0	0	1	0	0	0	0	0	0	0	1	0	0	b1	b0
b15	1	1	1	1	1	1	1	1	0	0	0	0	0	1	1	1	1	b1	b0																																											
b15	0	0	0	1	0	0	1	0	0	0	1	1	0	1	0	1	0	0	b1	b0																																										
b15	0	0	0	1	0	0	1	0	0	0	0	0	0	0	1	0	0	b1	b0																																											

- Available data type

Substitution item	First item	Second item
Integer*1	Integer**1*2*3	Integer**1*2*3

*1 "16-bit BCD" and "32-bit BCD" cannot be set.

*2 A data type the data size (bit length) of which differs from one in the substitution item cannot be set.

*3 For a constant, a value that cannot be represented by a data type the data size (bit length) of which is same as one in the substitution item cannot be set.

■OR

Item	Description																																																													
Function	Performs OR operation of integer data for each bit. OR operation of integer data in the first item and second item for each bit are performed, and the result is substituted for the substitution item. The existence/difference of sign in the substitution item, first item, and second item are not considered.																																																													
Example	<p>■When the first item is Word [Signed], the second item is Word [Signed], and the substitution item is Word [Signed]</p> <p>1st item</p> <table border="1" style="margin-left: 40px;"> <tr> <td>b15</td> <td>1</td><td>1</td><td>1</td><td>1</td><td>1</td><td>1</td><td>1</td><td>1</td><td>0</td><td>0</td><td>0</td><td>0</td><td>0</td><td>1</td><td>1</td><td>1</td><td>1</td> <td>b1</td> <td>b0</td> </tr> </table> <p>2nd item</p> <table border="1" style="margin-left: 40px;"> <tr> <td>b15</td> <td>0</td><td>0</td><td>0</td><td>1</td><td>0</td><td>0</td><td>1</td><td>0</td><td>0</td><td>0</td><td>1</td><td>1</td><td>0</td><td>1</td><td>0</td><td>1</td><td>0</td><td>0</td> <td>b1</td> <td>b0</td> </tr> </table> <p style="text-align: center;">↓</p> <p>Substitution item</p> <table border="1" style="margin-left: 40px;"> <tr> <td>b15</td> <td>1</td><td>1</td><td>1</td><td>1</td><td>1</td><td>1</td><td>1</td><td>1</td><td>0</td><td>0</td><td>1</td><td>1</td><td>1</td><td>1</td><td>1</td><td>1</td><td>1</td> <td>b1</td> <td>b0</td> </tr> </table>	b15	1	1	1	1	1	1	1	1	0	0	0	0	0	1	1	1	1	b1	b0	b15	0	0	0	1	0	0	1	0	0	0	1	1	0	1	0	1	0	0	b1	b0	b15	1	1	1	1	1	1	1	1	0	0	1	1	1	1	1	1	1	b1	b0
b15	1	1	1	1	1	1	1	1	0	0	0	0	0	1	1	1	1	b1	b0																																											
b15	0	0	0	1	0	0	1	0	0	0	1	1	0	1	0	1	0	0	b1	b0																																										
b15	1	1	1	1	1	1	1	1	0	0	1	1	1	1	1	1	1	b1	b0																																											

- Available data type

Substitution item	First item	Second item
Integer*1	Integer**1*2*3	Integer**1*2*3

*1 "16-bit BCD" and "32-bit BCD" cannot be set.

*2 A data type the data size (bit length) of which differs from one in the substitution item cannot be set.

*3 For a constant, a value that cannot be represented by a data type the data size (bit length) of which is same as one in the substitution item cannot be set.

XOR

Item	Description
Function	<p>Performs XOR operation of integer data for each bit.</p> <p>XOR operation of integer data in the first item and second item for each bit are performed, and the result is substituted for the substitution item.</p> <p>The existence/difference of sign in the substitution item, first item, and second item are not considered.</p>
Example	<p>■When the first item is Word [Signed], the second item is Word [Signed], and the substitution item is Word [Signed]</p>

• Available data type

Substitution item	First item	Second item
Integer ^{*1}	Integer ^{*1*2*3}	Integer ^{*1*2*3}

*1 "16-bit BCD" and "32-bit BCD" cannot be set.

*2 A data type the data size (bit length) of which differs from one in the substitution item cannot be set.

*3 For a constant, a value that cannot be represented by a data type the data size (bit length) of which is same as one in the substitution item cannot be set.

RSHIFT

Item	Description
Function	<p>Shifts integer data to right for the number of specified bits.</p> <p>The existence/difference of sign in the substitution item and first item are not considered.</p> <p>■When the second item is a positive number</p> <p>Shifts integer data in the first item to right for the number of bits specified to the second item, and substitutes the result for the substitution item.</p> <p>The blank bit position is filled with '0'.</p> <p>If the data size (bit length) in the first item is less than the numerical value in the second item, '0' is substituted for the substitution item.</p> <p>■When the second item is a negative number</p> <p>Shifts integer data in the first item to left for the number of bits of the absolute value of numerical value specified to the second item, and substitutes the result for the substitution item.</p> <p>The blank bit position is filled with '0'.</p> <p>If the data size (bit length) in the first item is less than the absolute value of numerical value in the second item, '0' is substituted for the substitution item.</p> <p>■When the second item is '0'</p> <p>Substitutes data in the first item for the substitution item.</p>
Example	<p>■When the first item is Word [Signed], the second item is '10', and the substitution item is Word [Signed]</p>

• Available data type

Substitution item	First item	Second item
Integer ^{*1}	Integer ^{*1*2*3}	Integer

*1 "16-bit BCD" and "32-bit BCD" cannot be set.

*2 A data type the data size (bit length) of which differs from one in the substitution item cannot be set.

*3 For a constant, a value that cannot be represented by a data type the data size (bit length) of which is same as one in the substitution item cannot be set.

■LSHIFT

Item	Description
Function	<p>Shifts integer data to left for the number of specified bits.</p> <p>The existence/difference of sign in the substitution item and first item are not considered.</p> <p>■When the second item is a positive number</p> <p>Shifts integer data in the first item to left for the number of bits specified to the second item, and substitutes the result for the substitution item.</p> <p>The blank bit position is filled with '0'.</p> <p>If the data size (bit length) in the first item is less than the numerical value in the second item, '0' is substituted for the substitution item.</p> <p>■When the second item is a negative number</p> <p>Shifts integer data in the first item to right for the number of bits of the absolute value of numerical value specified to the second item, and substitutes the result for the substitution item.</p> <p>The blank bit position is filled with '0'.</p> <p>If the data size (bit length) in the first item is less than the absolute value of numerical value in the second item, '0' is substituted for the substitution item.</p> <p>■When the second item is '0'</p> <p>Substitutes data in the first item for the substitution item.</p>
Example	<p>■When the first item is Word [Signed], the second item is '10', and the substitution item is Word [Signed]</p> <p>The diagram shows a 16-bit word (1st item) with bits b15 to b0: 1 1 1 1 1 1 1 1 0 0 0 0 1 1 1 1. A 10-bit shift is indicated by an arrow pointing to the 'Substitution item', which is a 16-bit word with bits b15 to b0: 0 0 1 1 1 1 0 0 0 0 0 0 0 0 0 0. The value is 0.</p>

• Available data type

Substitution item	First item	Second item
Integer ^{*1}	Integer ^{*1*2*3}	Integer

*1 "16-bit BCD" and "32-bit BCD" cannot be set.

*2 A data type the data size (bit length) of which differs from one in the substitution item cannot be set.

*3 For a constant, a value that cannot be represented by a data type the data size (bit length) of which is same as one in the substitution item cannot be set.

Type conversion

■STR2INT

1

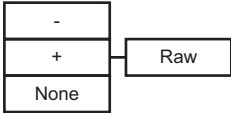
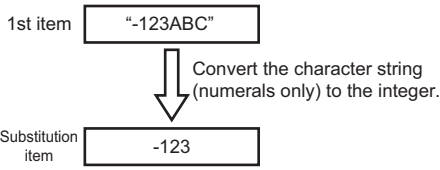
Item	Description
Function	<p>Converts character string data to integer data.</p> <p>Reads out the character string data that meets the notation specification from the first of the character string data in the first item as a conversion target.</p> <p>Converts the target data to the integer data, and substitutes the result for the substitution item.</p> <p>When the character string length of the conversion target is '0', '0' is substituted.</p>
Notation specification	<p>■Configuration of character string</p>  <p>■Usable characters -, +, 0, 1, 2, 3, 4, 5, 6, 7, 8, 9</p>
Example	<p>■First item: "-123ABC"</p>  <p>Converts the character string in the first item to numerical value, and sets it to the substitution item.</p> <ul style="list-style-type: none"> • If the character string other than sign and numerical values are included in the first item, the numerical value from the head of the data including the sign is selected and converted. • If the first character except for a sign is other than numerical value, the operation result will be '0'.

- Available data type

Substitution item	First item	Second item
Integer	Character string ^{*1}	— (Not available)

*1 Constants cannot be set.

STR2REAL

Item	Description
Function	<p>Converts character string data to real number data.</p> <p>Reads out the character string data that meets the notation specification from the first of the character string data in the first item as a conversion target.</p> <p>The mantissa part which exceeds 17 digits of the number of significant figures are not converted.</p> <p>Converts the target data to the real number data, and substitutes the result for the substitution item.</p> <p>When the character string length of the conversion target is '0', '0' is substituted.</p>
Notation specification	<p>■Configuration of character string</p> <p>■Usable characters -, +, e, E, .(decimal point), 0, 1, 2, 3, 4, 5, 6, 7, 8, 9</p>
Example	<p>■First item: "-1.23e+10"</p>

• Available data type

Substitution item	First item	Second item
Real number	Character string ^{*1}	— (Not available)

*1 Constants cannot be set.

■INT2STR

Item	Description
Function	Converts integer data to character string data. Converts the integer data in the first item to the character string data to meet the notation specification, and substitutes them for the substitution item.
Notation specification	<p>■Configuration of character string</p> <p>■Usable characters -, 0, 1, 2, 3, 4, 5, 6, 7, 8, 9</p>
Example	<p>■First item: 4235</p>

• Available data type

Substitution item	First item	Second item
Character string	Integer*1	— (Not available)

*1 Constants cannot be set.

■REAL2STR

Item	Description
Function	Converts real number data to character string data. Converts the real number data in the first item to the character string data to meet the notation specification, and substitutes them for the substitution item.
Notation specification	<p>■Configuration of character string</p> <p>■Usable characters -, E, .(decimal point), 0, 1, 2, 3, 4, 5, 6, 7, 8, 9</p> <p>■Number of digits in the mantissa part When the second item is low precision: 6 digits (excluding decimal point) When the second item is high precision and the first item is FLOAT [Single Precision]: 9 digits (excluding decimal point) When the second item is high precision and the first item is FLOAT [Double Precision]: 17 digits (excluding decimal point)</p>
Example	<p>■First item: 0.0000456</p>

• Available data type

Substitution item	First item	Second item
Character string	Real number ^{*1}	Precision specification flag Select "LOW" (low precision) or "HIGH" (high precision)

*1 Constants cannot be set.

Complex operations

By specifying local variables or global variables to the first item, second item, and substitution term, complex operations can be performed.

The available components for data operation and processing are as follows:

- Device tag component
- Local variable
- Global variable
- System variable*¹
- Constant*¹ (Value, character string, special constant (macro*²))

*¹ The system variables which are constant or read-only cannot be used for substitution item.

*² For details on macro, refer to the following:

📖 MELSEC iQ-R MES Interface Module User's Manual (Startup)

Since the global variable can be used between the different jobs, it can be used for various operations.

Ex.

Local variable A: Available in the same job

Global variable A: Available between the different jobs

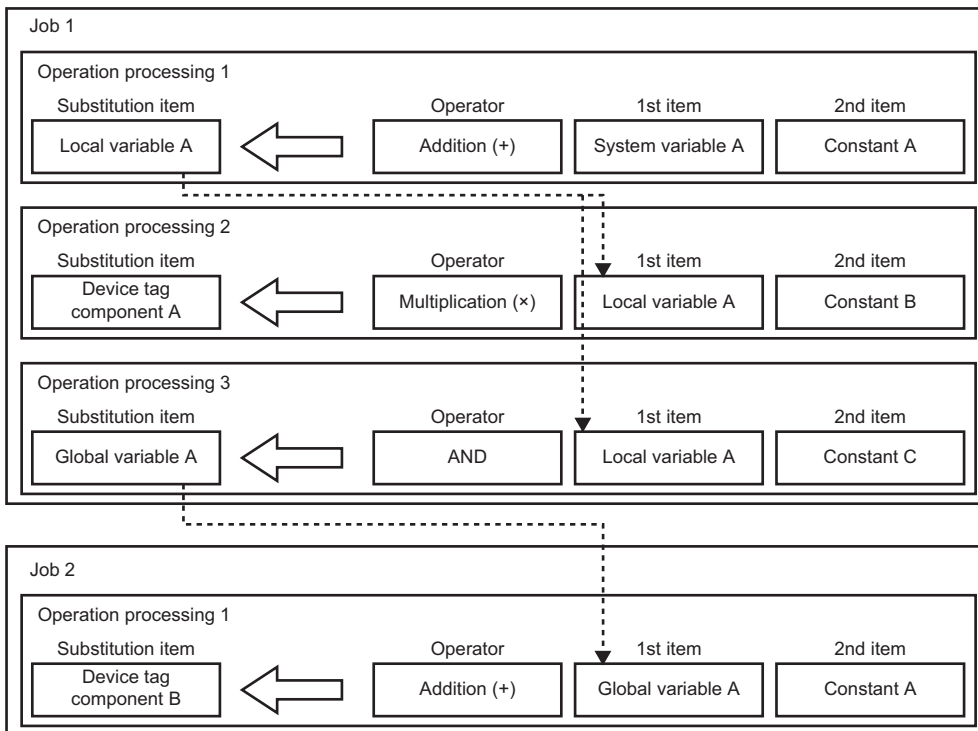

Data linkage function

Data assignment function

The data assignment function concatenates data to be input/output between the data input/output functions, and assigns the data to the specified direction.

This function also reports device data to be used for the operations in the CPU module by writing them to the database, and saves the data in the server or operation result to variables temporarily, then reflects data to the device data in the CPU module simultaneously.

Additionally, the variables specified by user can be used as an assignment data.

The availability of data assignment for data to be input/output between the data input/output functions is as follows:

○: Available, ×: Not available

Target	Source				
	Access field (SQL statement)	Access procedure argument (Output argument)	Other DB communication data External communication data	Device tag component Variable	Constant Macro
Access field (SQL statement)	×	×	×	○: DB communication action (Insert, Update)	
Access procedure argument (Input argument)	×	×	×	○: DB communication action (Stored Procedure)	
Other DB communication data External communication data	×	×	×	○: DB communication action	
Device tag component ^{*1*} Variable ^{*1*}	○: DB communication action (Select, Multiple Select)	○: DB communication action (Stored Procedure)	○: DB communication action ○: External communication action	○: Operation action ○: Notifications ^{*4}	
Constant Macro	×	×	×	×	

*1 The assignment for the device tag components and variables which are write-prohibited cannot be performed.

*2 Only multiple selection processing can be executed for the assignment for array tags.

*3 Only the same array tags can be assigned for array tags.

*4 The assignment processing of each notification is performed in accordance with the specifications of the Data assignment function.

■Availability of data assignment to device tag component or variable

○: Available, ×: Not available

Target		Source		
		Integer	Real number	Character string
Integer	Bit	○	○	× • Explicit conversion by operation is required.
	Other than Bit	○	○	
Real number		○	○	× • Explicit conversion by operation is required.
Character string		×	×	○ • Explicit conversion by operation is required.

■Availability of data assignment to access field (SQL statement)

○: Available, ×: Not available

Target		Source (Device tag component, variable, constant, macro)			
		Integer	Real number	Character string	Date and time
Access field (SQL statement)	Integer	○	○	×	×
	Real number [floating point]	○	○	×	×
	Real number [fixed point]*1	○	○	×	×
	Character string [Unicode(NCHAR)]	×	×	○	×
	Character string [Unicode(CHAR)]	×	×	○	×
	Date and time	×	×	○*2	○
	No data type specification	○	○*3	○*4	○

*1 Can be used only for an RD81MES96N.

*2 An SQL statement is created by adding required information such as a format specifier according to the database type regarding the character string as a value of date and time.

An SQL statement is created in accordance with the data type of an assignment source and sent to the database.

The operation when SQL statements cannot be processed in the database due to the difference of the data type between the data sent by the SQL statement and the data type of the DB field depends on the specification of database.

If an error occurred in the database, "Failed in SQL execution" error occurs in DB Connection Service, and "SQL execution error" occurs in MES interface module.

*3 For an RD81MES96N, an SQL statement is created as 'real number [floating point]' and sent to a database.

*4 Regardless of the data type of an assignment source, an SQL statement is created with the following data type and sent to a database.
Oracle, SQL Server, MySQL, and MariaDB: Character string [Unicode(NCHAR)]

Access and PostgreSQL: Character string [Unicode(CHAR)]

• Availability of narrowing-down condition (Where clause)

○: Available, ×: Not available

Comparison target		Compared value (Device tag component, variable, constant, macro)			
		Integer	Real number	Character string	Date and time
Access field (Narrowing-Down Conditions)	Integer	○	×	×	×
	Real number [floating point]	×	○	×	×
	Real number [fixed point]*1	×	○	×	×
	Character string [Unicode(NCHAR)]	×	×	○	×
	Character string [Unicode(CHAR)]	×	×	○	×
	Date and time	×	×	×	○
	No data type specification	○	○*2	○	○

*1 Can be used only for an RD81MES96N.

*2 For an RD81MES96N, an SQL statement is created as 'real number [floating point]' and sent to a database.

■Availability of data assignment from access field (SQL execution result)

○: Available, ×: Not available

Target		Source (Access field (SQL execution result))						
		Integer	Real number [floating point]	Real number [fixed point] ^{*1}	Character string [Unicode(NCHAR)]	Character string [Unicode(CHAR)]	Date and time	No data type specification
Device tag component, variable	Integer	○	○	○	×	×	×	○
	Real number	○	○	○	×	×	×	○
	Character string	×	×	×	○	○	○ ^{*2}	○

*1 Can be used only for an RD81MES96N.

*2 The acquired data can be assigned to character string data.

When the assignment source is 'date and time', the applicable time is in the range of '0001/01/01 00:00:00.000' to '9999/12/31 23:59:59.999'. If inapplicable date and time is specified for the source, it may not assigned properly.

- The data is acquired according to the data type of the access field (SQL execution result), and assigned to the assignment target.
- If the data type of the access field (SQL execution result) is not specified, data is acquired according to the data type of the assignment target and assigned.
- The assignment is performed in accordance with the data assignment specification for device tag components and variables. ( Page 86 Availability of data assignment to device tag component or variable)
- The operation when the actual data type of the DB field differ depends on the specification of the database.
- If an error occurred in the database, "Failed in SQL execution" error occurs in DB Connection Service, and "SQL execution error" occurs in MES interface module.

■Availability of data assignment for access procedure argument (input argument)

○: Available, ×: Not available

Target		Source (Device tag component, variable, constant, macro)			
		Integer	Real number	Character string	Date and time
Access procedure argument (Input argument)	Integer	○	○	×	×
	Real number	○	○	×	×
	Character string [Unicode]	○	○	×	×
	Date and time	×	×	×	○

- Data is assigned according to the data type of access procedure argument (input argument).
- The assignment is performed in accordance with the data assignment specification for device tag components and variables. (☞ Page 86 Availability of data assignment to device tag component or variable)
- The operation when the stored procedure cannot be called in the database due to the difference of the data type between the argument set when calling the stored procedure and the argument defined in the database depends on the specification of the database.
- If an error occurred in the database, "Failed in SQL execution" error occurs in DB Connection Service, and "SQL execution error" occurs in MES interface module.

■Availability of data assignment from access procedure argument (output argument)

○: Available, ×: Not available

Target		Source (Access procedure argument (output argument))			
		Integer	Real number	Character string [Unicode]	Date and time
Device tag component, variable	Integer	○	○	×	×
	Real number	○	○	×	×
	Character string	×	×	○	×

- The data of the access procedure argument (output argument) is acquired, and it is assigned to the assignment target.
- The assignment is performed in accordance with the data assignment specification for device tag components and variables. (☞ Page 86 Availability of data assignment to device tag component or variable)
However, for character string assignment, even if the character string length of an assignment source exceeds that of an assignment target, no error occurs and the character string for the number of characters in the assignment target is assigned. (When the database is Oracle, an error may occur in execution of a stored procedure.)
- The operation when the stored procedure cannot be called in the database due to the difference of the data type between the argument set when calling the stored procedure and the argument defined in the database depends on the specification of the database.
- If an error occurred in the database, "Failed in SQL execution" error occurs in DB Connection Service, and "SQL execution error" occurs in MES interface module.
- When assigning the character string constant which is defined or variable that stores the character string in the procedure, the blank is entered to the remaining positions if the character string length is longer than the assigned one according to the ODBC restriction. (Note that the blank is not added if the termination character is included in the character string.)

■ Data assignment for notifications, other DB communication data, and external communication data

- Assignment specifications of notifications

Item		Target, data type ^{*1}	Source, data type
Notifications	DB buffer	Resend request	—
		Clear request	
		Status notification	Device tag component, variable Data type: Integer
		DB buffer full notification	
		Number of stored buffer notification	
		Use rate notification	
Target server	Access error notification	Device tag component, variable Data type: Integer	—
Access field	Default value	—	Constant, macro ^{*2} Data type: Any
Value monitoring	Monitoring target	—	Device tag component, variable Data type: Any
	Comparison target	—	Device tag component, variable, constant, macro Data type: Any
Handshake	Job start request	—	Device tag component Data type: Bit
	Job completion notification	Device tag component Data type: Bit	—
External communication action	Expected value of return value	—	Device tag component, variable, constant Data type: Integer
DB communication action	Comparison target for narrowing-down condition	—	Device tag component, variable, constant, macro Data type: Any
Pre-processing	Processing failure notification	Device tag component, variable Data type: Any	Device tag component, variable, constant, macro Data type: Any
Main-processing	Processing failure notification		
Post-processing	Processing failure notification		
DB buffering	DB buffering notification	Device tag component, variable Data type: Any	Device tag component, variable, constant, macro Data type: Any
DB communication action	Exception occurrence notification		
External communication action	Exception occurrence notification		

*1 The device tag components and system variables which are write-protected cannot be used.

*2 Macros can be used only for string data types.

- Assignment specifications of other DB communication data and external communication data

Item		Target, data type ^{*1}	Source, data type
Other DB communication data	Stored procedure return value	Device tag component, variable Data type: Integer	—
	Number of inserted records (Insert)	Device tag component, variable Data type: Integer (other than Bit)	—
	Number of inserted records (Multiple Insert)		
	Number of deleted records		
	Number of updated records (newly inserted records)		
	Number of applicable records (Select)		
	Number of applicable records (Multiple Select)		
	Number of selected records		
Maximum number of records to be selected	—	Device tag component, variable, constant, macro Data type: Integer (other than Bit)	
External communication data	Program execution return value	Device tag component, variable Data type: Integer	—

*1 The device tag components and system variables which are write-protected cannot be used.

Communication test function

The communication test function performs a communication test between an MES interface module and an access target device or access target server after receiving a request from MES Interface Function Configuration Tool.

Before writing settings to an MES interface module, perform a communication test by using the access target device setting or access target server setting of a write target.

The detailed specification of the communication test function is as follows:

Item		Specification
Number of concurrent tests		Only one communication test can be performed.
Setting information	Target device communication test	Performs communication test using the target device setting of MES Interface Function Configuration Tool. The communication test does not affect the operating information linkage function.
	Target server communication test	Performs communication test using the target server setting of MES Interface Function Configuration Tool. The communication test does not affect the operating information linkage function.

Precautions

Depending on the operating status of jobs in a module or the status of peripherals (such as network and database), the communication test may take time.

Before performing communication test, check the operation status of jobs in a module and the status of peripherals.

Methods of communication test

The communication test can be performed with any of the following methods.

■To perform a communication test for a set access target

1. Select an access target to perform communication test on the target device setting list or target server setting list.
(☞ Page 134 Access target device setting list, Page 152 Target server setting list)
2. Select [Online] ⇒ [Communication test to Target Device]/[Communication test to Target Server].

■To perform a communication test for an access target being set

Click the [Communication Test] button in the "Target Device Setting" or "Target Server Setting" screen. (☞ Page 135 Access target device settings, Page 153 Access target server settings)

DB information browse function

The DB information browse function accesses a database from MES Interface Function Configuration Tool via an MES interface module, and acquires DB table names, DB field names, data types of DB fields, stored procedure names, and argument information of a stored procedure.

This function is performed when browsing the table information or stored procedure information with the communication action setting of the MES Interface Function Configuration Tool.

☞ Page 158 DB table information browse

☞ Page 158 DB field information browse

☞ Page 159 DB procedure information browse

Browse routes are as follows:

Browse route	Description	Reference
Via DB Connection Service	To access a database when selecting "Connection via Service" for "Access Type." Information is acquired by accessing a table of a database from an MES interface module via DB Connection Service.	Page 94 Via DB Connection Service
Direct access to a database	To access a database when selecting "Direct DB Connection" for "Access Type". Information is acquired by accessing a table of a database directly from an MES interface module.	Page 94 Direct access to a database

Point

- To acquire information of a database without using an MES interface module, refer to the following:
☞ Page 187 DB information browse function
- The advantages of acquiring information of a database via an MES interface module are as follows:
No need to connect a configuration personal computer to a database server.
Accessing a database server is available with the minimum number of devices.

Via DB Connection Service

The following shows the flow of acquiring information by accessing a table of a database from an MES interface module via DB Connection Service.

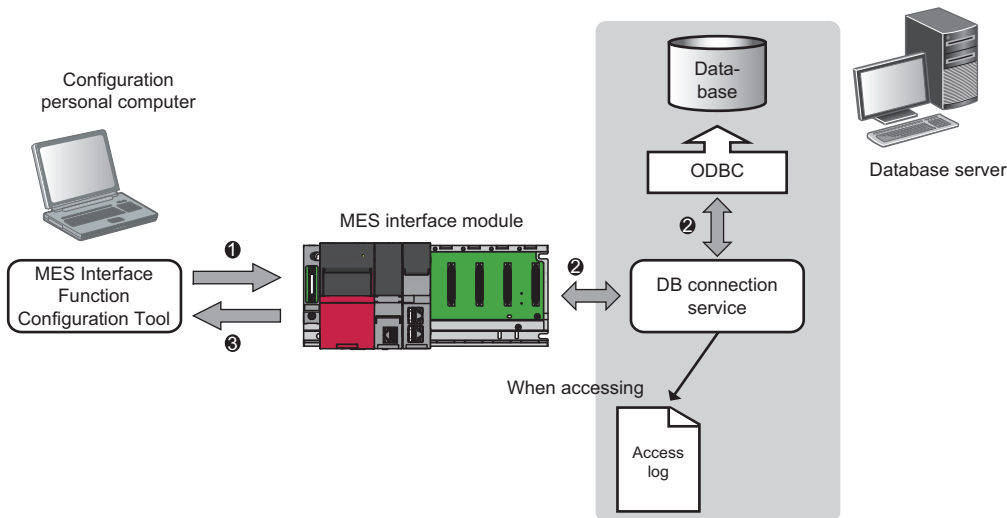

- ① When the [Browse DB Table Information], [Browse DB Field Information], or [Browse DB Procedure Information] button is clicked in MES Interface Function Configuration Tool, a request to browse table information or stored procedure information is received from the MES Interface Function Configuration Tool.
- ② The table information (table name, view name, and field name) or stored procedure information in a database is acquired via DB Connection Service.
- ③ It is returned to the MES Interface Function Configuration Tool.

Direct access to a database

The following shows the flow of acquiring information by accessing a table of a database directly from an MES interface module.

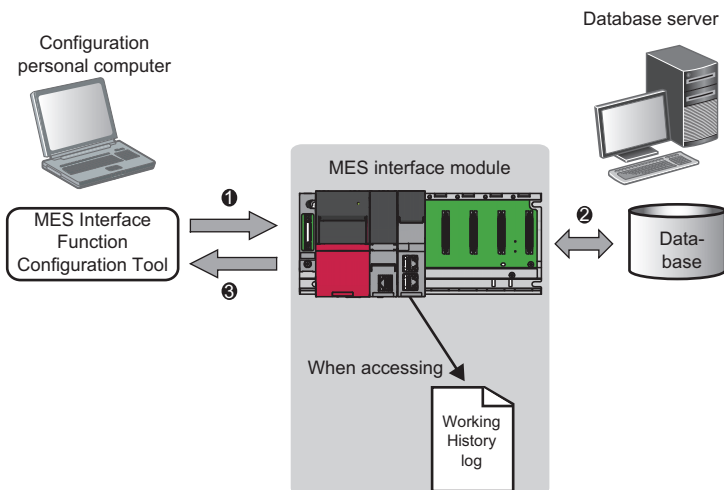

- ① When the [Browse DB Table Information], [Browse DB Field Information], or [Browse DB Procedure Information] button is clicked in MES Interface Function Configuration Tool, a request to browse table information or stored procedure information is received from the MES Interface Function Configuration Tool.
- ② The table information (table name, view name, and field name) or stored procedure information is acquired by directly accessing a database.
- ③ It is returned to the MES Interface Function Configuration Tool.

1.4 External Communication Server Function

REST server function

The REST server function performs job operations by receiving a request message from a user application (REST client) using HTTP interface.

It also supports the XML processing function of a MELSEC-Q series MES interface module.

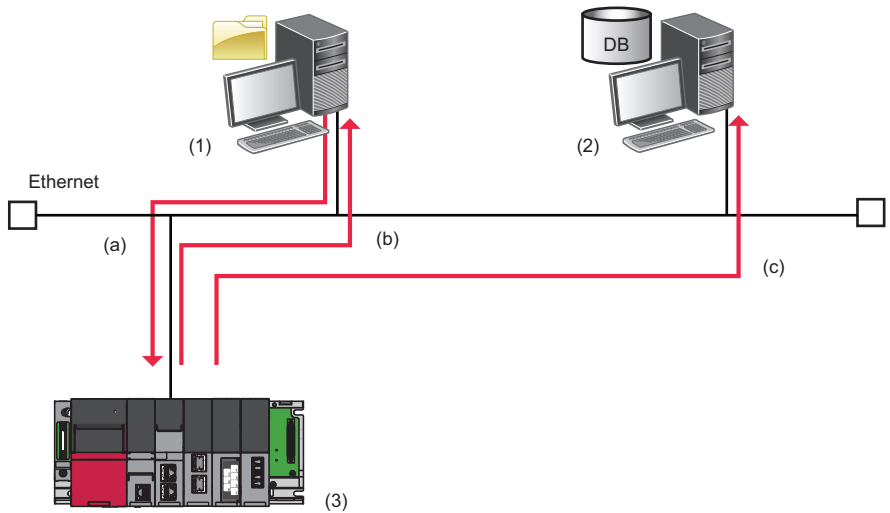

(1) User application (REST client)

(2) Database server

(3) MES interface module (REST server)

(a) A job execution request message is sent. (The MES interface module (REST server) receives a request from the user application (REST client).)

(b) A job execution reception response message is sent. (The processing reception result is returned to the user application (REST client).)

(c) A job is executed. (A job operation (example: one-shot execution) is performed for the received request.)

The REST server function allows to receive processing for the following requests from a user application (REST client).

Function	Description
One-shot execution	<ul style="list-style-type: none"> To execute a specified job only once for a setting item operated in an MES interface module regardless of the trigger condition and job status (enabled/disabled). If the specified job is being executed, the job is not executed again.
Validate	<ul style="list-style-type: none"> To put the job into the state in which the specified job is executed when trigger conditions are satisfied (job is enabled). This is the same operation to change the job execution inhibition to 'Disable' in MES Interface Function Configuration Tool.
Invalidate	<ul style="list-style-type: none"> To put the job into the state in which the specified job is not executed even if trigger conditions are satisfied (job is disabled). This is the same operation to change the job execution inhibition to 'Enable' in MES Interface Function Configuration Tool.
Acquisition of job information	<ul style="list-style-type: none"> To acquire information on a job running on an MES interface module.

For the API specification of the REST server function, refer to the following:

📖 Page 210 API SPECIFICATIONS (REST SERVER FUNCTION)

1.5 Security Function

The security function prevents information assets in an MES interface module from being leaked or falsified by illegal access from a third party.

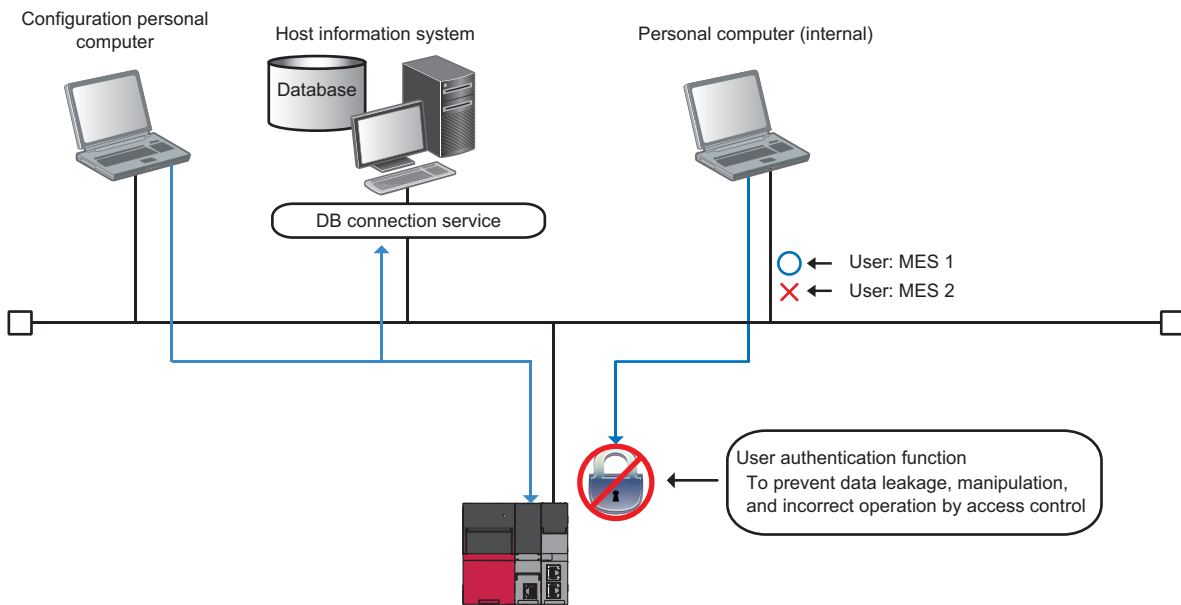

User authentication function

The user authentication function restricts access to an MES interface module from users other than specific ones by setting a user name and a password.

Item	Specification	Setting method
Number of users	Up to 16 users	☞ Page 163 Security settings
User name* ¹	Length: Up to 32 characters	
Password* ¹	Length: UP to 32 characters	
Default user	User name: RD81MES96 Password: MITSUBISHI	

*1 For the usable characters, refer to the following:

☞ Page 297 Usable Characters

The operation of user authentication differs depending on the parameter settings (user account setting forced change), security settings (user authentication), and specify connection destination (user authentication).

Parameter setting* ¹ (User account setting forced change)	Security setting* ² (User authentication)	Specify connection destination* ² (User authentication)	Authentication specification	Authentication result
Change to defaults.	Authenticate	Authenticate	A user name and password specified in the "Specify Connection Destination" screen are verified with the default ones.	Matched: Authenticated
		Not authenticate		Unmatched: Not authenticated
	Not authenticate	Authenticate		Matched: Authenticated
		Not authenticate		Unmatched: Not authenticated* ³
Do not change	Authenticate	Authenticate	A user name and password specified in the "Specify Connection Destination" screen are verified with ones registered in the security setting.	Matched: Authenticated
		Not authenticate		Unmatched: Not authenticated* ³
	Not authenticate	Authenticate	The use of user authentication registered in the security setting is verified with that specified in the "Specify Connection Destination" screen.	Unmatched: Not authenticated
		Not authenticate	Do not verify.	Authenticated (connectable)* ⁴

*1 Set it in an engineering tool. (☞ Page 206 PARAMETER SETTING)

*2 Set it in MES Interface Function Configuration Tool. (☞ Page 163 Security settings, ☞ Page 165 Connection destination specification)

*3 The verification result is always unmatched (not authenticated), because no user name or password is specified in the "Specify Connection Destination" screen.

*4 Connectable even when specifying a user name and password in the "Specify Connection Destination" screen.

1.6 Other Functions

SD memory card management function

The SD memory card management function consists of the following functions which are related to an SD memory card used for MES interface module.

Function	Description	Setting method
SD memory card diagnostics	To display the status of an SD memory card.	☞ Page 175 SD memory card diagnostics
SD memory card format	To format an SD memory card.	

SD memory card diagnostics

Information (items) that can be displayed with the SD memory card diagnostics is as follows:

Information (item)	Description
Capacity	The total capacity of an SD memory card is displayed.
Used amount	The used amount and use rate of an SD memory card are displayed.

SD memory card format

Formats an SD memory card.

After formatting, the volume label will be the model name of an MES interface module.

Additionally, the operating status of MES interface module will be in "STOP" state after formatting.

Self-diagnostics function

The self-diagnostics function is an internal function to check the hardware health of an MES interface module and diagnose whether the module operates properly.

There are two main functions for the self-diagnostics function.

- Automatic hardware test (☞ Page 228 Automatic hardware test)
- Hardware test for LED check (☞ Page 229 Hardware test for LED check)

Initialization function

The initialization function initializes a firmware update-prohibited password retained in an MES interface module.

Operating procedure

1. Select "Module Initialization Setting" in "Basic Settings" ⇒ "Various Operations Settings" ⇒ "Mode Settings" for an MES interface module in an engineering tool. (☞ Page 206 Basic Settings)
2. Set the CPU module to the STOP state, and write the parameters.
3. Reset the CPU module.

After it is reset, the initialization function is performed automatically. The LED display for initialization is as follows:

Status		RUN LED status	ERR LED status
Initialization completed	Normal completion	ON	OFF
	Abnormal completion	ON	ON

4. When the initialization is completed normally, return the mode setting changed in step 1 to "Online" and reset the CPU module.
5. When the initialization is completed abnormally, check if measures are taken to reduce noise of the programmable controller system, and perform the initialization again. If it is completed abnormally again, a hardware failure may occur in an MES interface module. Please contact your local Mitsubishi Electric sales office or representative.
Do not use an electric screwdriver when removing the module. Loose the module fixing screws completely to remove the module.

1.7 Data Structure

The data used in MES interface module can be used according to the data structure of the device memory in the CPU module or the table definition of the database.

Array tag can be used as a type of data structure.

Array tag specifications

Array tag is a data structure that the data with the same data type for the specified number of arrays are arranged. There are two arranging types, continuous array and block array.

Note that when defining an array tag, devices cannot be duplicated in the same device tag.

An array tag can be used for a DB communication action when selecting "Multiple Select" or "Multiple Insert."

The specifications of the array tag and their details are as follows:

Item	Specification	Remarks
Array size	2 to 40960	When selecting "Multiple Insert," 2 to 1000 can be set.
Data size	Up to 40960 points	<ul style="list-style-type: none"> ■Data size Data size of device tag component × Number of array elements
Array type	<ul style="list-style-type: none"> • Continuous array • Block array 	<ul style="list-style-type: none"> ■Device name specification method Continuous array: Different device type can be specified for elements. Block array: Same device type must be specified for elements.

Point

For using an array tag when selecting "Multiple Insert," refer to 'Point' in the following:

☞ Page 32 Multiple Insert

Detailed specifications

Array tag is configured by consecutive data of device tag components which have the same data type, however, the configuration of data array will differ depending on the array type and data type.

■Continuous array

For continuous array, arrange device tag components consecutively.

Ex.

Array size: 4

Device tag component A: Device memory D0 (Word [Signed])

Device tag component B: Device memory D100 (Double Word [Signed])

Device tag component C: Device memory ZR (Character string [Unicode] 4 characters)

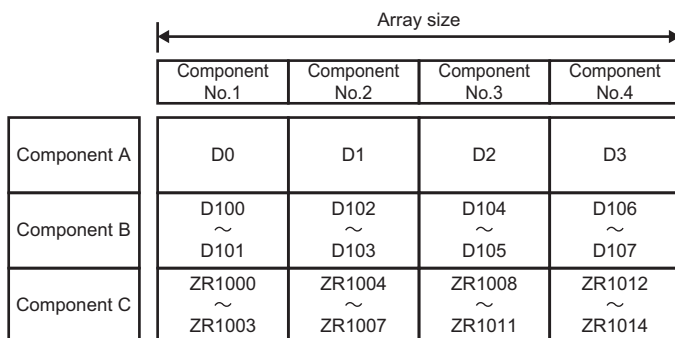

■Block array

For block array, arrange all the devices of device tag components which are defined in one device tag as one block.
The size used for one block can be changed in "Array Block Size".

Ex.

Array size: 4

Array block size: No specification (The array block size is 8 in this example.)

Device tag component A: Device memory D0 (Word [Signed])

Device tag component B: Device memory D1 (Double Word [Signed])

Device tag component C: Device memory D4 (Character string [Unicode] 4 characters)

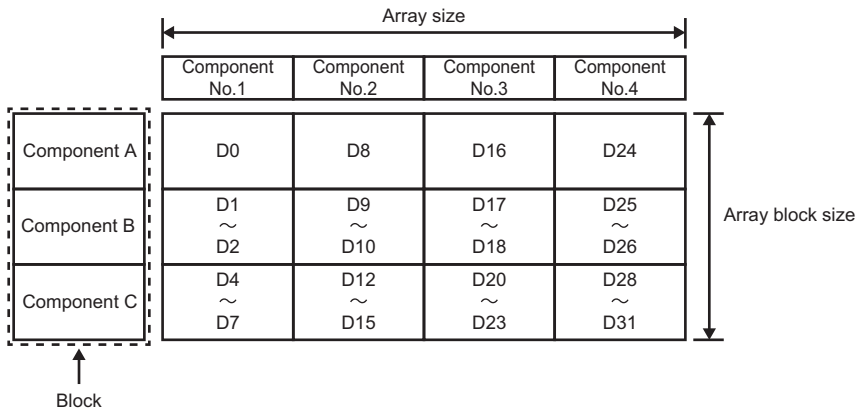

If the default value (or no specification) is set to "Array Block Size", it will be the smallest required size. A value smaller than the default cannot be set.

Usually, "Array Block Size" does not need to be changed because it is automatically adjusted to avoid the duplication of components.

Change the value in "Array Block Size" in the following cases:

- Setting an arbitrary number for the start device number of each block.
- Adding any array tag component in the future.

The example when adding components for the array tag of the block type array is as follows:

Ex.

Array size: 3

Device tag component A: Device memory D0 (Word [Signed])

Device tag component B: Device memory D1 (Double Word [Signed])

Device tag component C: Device memory D4 (Character string [Unicode] 4 characters)

Device tag component D to be added: Device memory D8 (Word [Signed])

● When '10' is set for "Array Block Size"

Device numbers are not changed even when the component D is added.

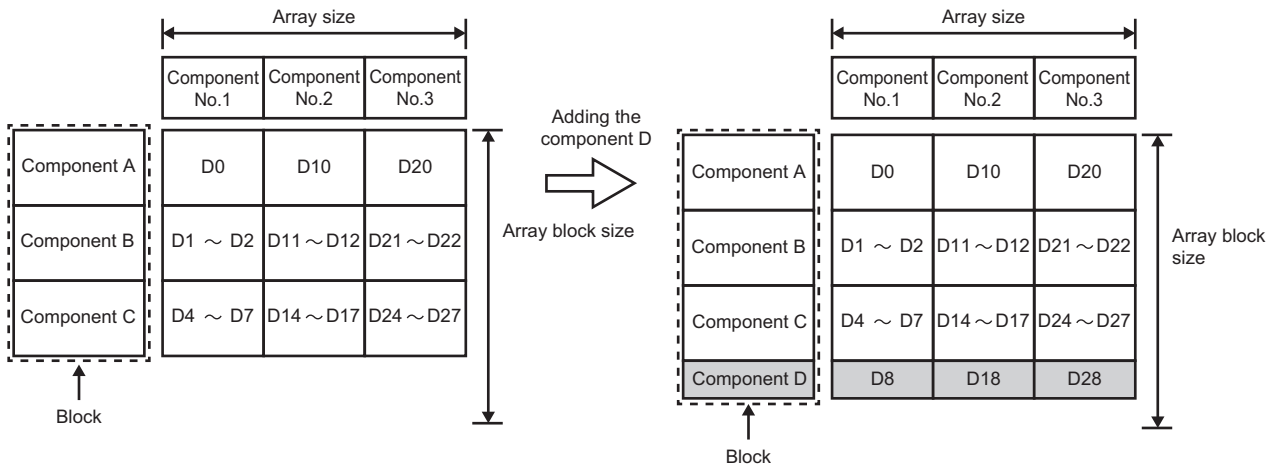

● When nothing is set for "Array Block Size"

If the component D is added, device numbers in and after the component No.2 are changed.

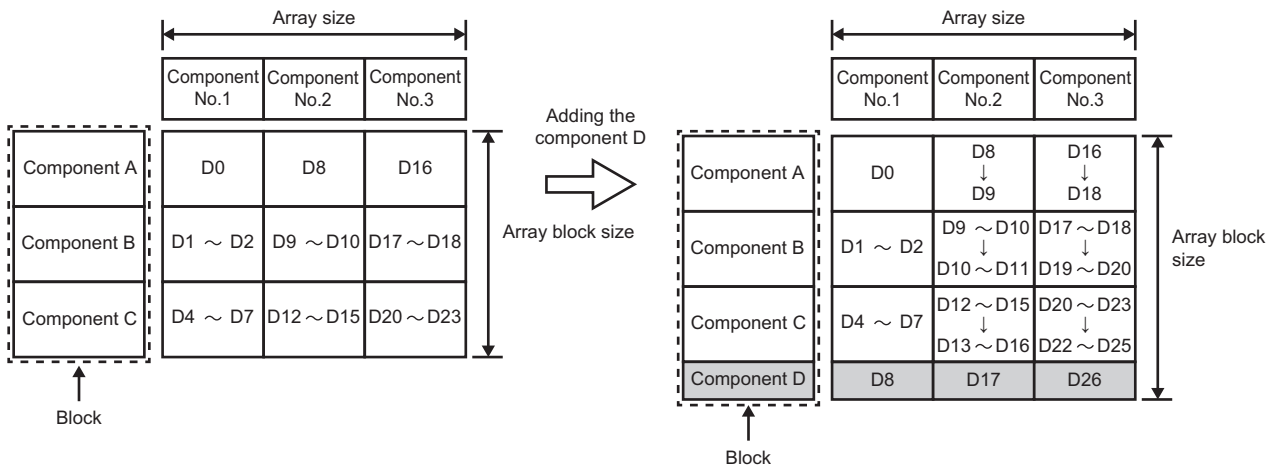

Data structure for each data type

The following data types have a sequence data structure.

- Bit
- Word [unsigned]/Bit string [16-bit]
- Double word [unsigned]/Bit string [32-bit]
- Word [signed]
- Double word [signed]
- Single-precision real number
- Double-precision real number
- Character string [Unicode]

Ex.

Array data of Word [Unsigned]/Bit String [16-bit] and Double Word [Signed] when device memory D0 is specified to the start of array

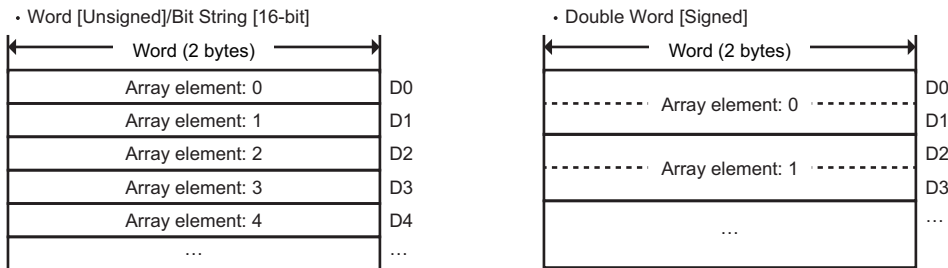

Ex.

Array data of bit when device memory M0 and M36 are specified to the start of array

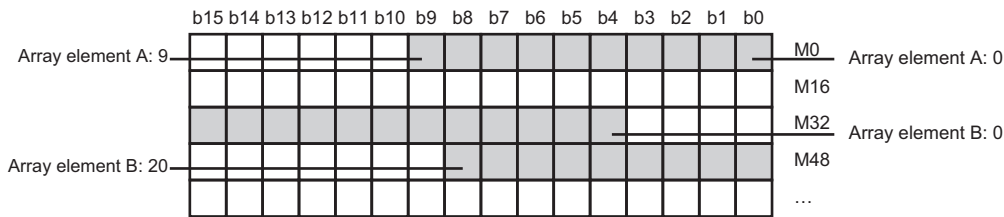

Ex.

Array data of which array element is Character string [Unicode] when device memory D0 is specified to the start of array

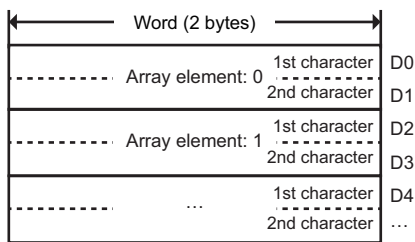

Arrays in which bit/digit specification of device memories is used

The configuration of data array differs for each array type.

■Continuous array

Digit specification of bit devices: Each device tag component is arranged continuously by the number of bits used.

Bit specification of word devices: Each device tag component is arranged continuously in bits. Bit number 'F' is followed by bit number '0' of the next device number.

Ex.

Array size: 17

Device tag component A: K1M0

Device tag component B: D0.0

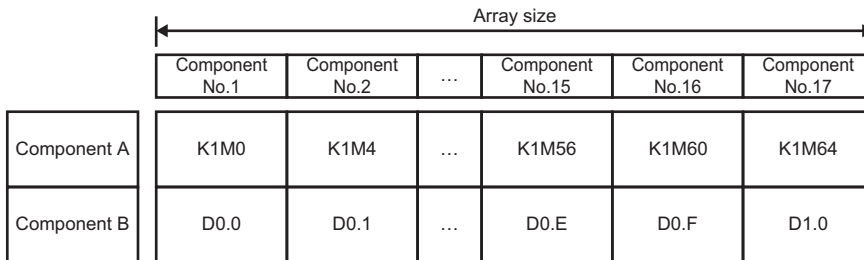

■Block array

Digit specification of bit devices: The block size is treated in bits and each device tag component is arranged as a block.

Ex.

Array size: 17

Array block size: 10

Device tag component A: K1M0

Device tag component B: M4

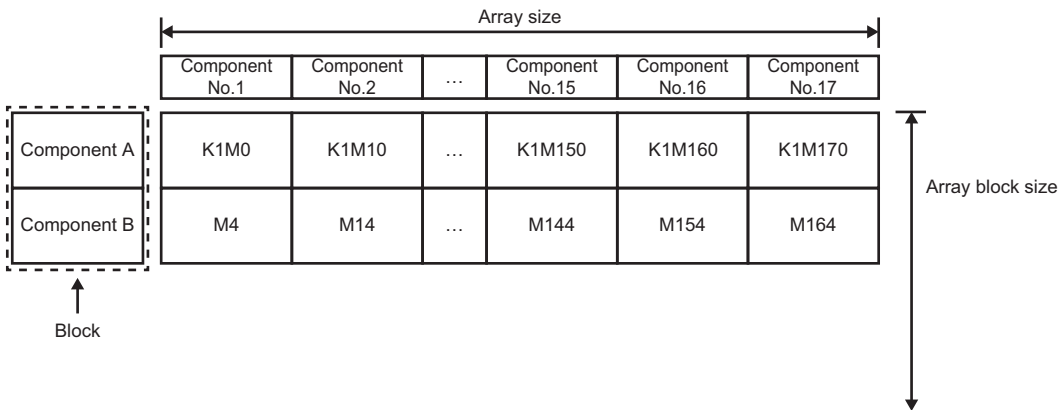

Bit specification of word devices: The block size is treated in words and each device tag component is arranged as a block.

Ex.

Array size: 17

Array block size: 2

Device tag component A: D0.0

Device tag component B: D1

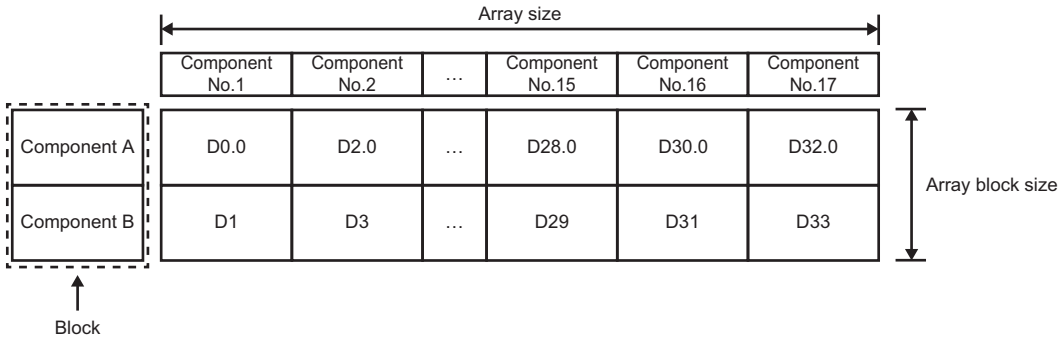

1.8 Internal Operation Check in MES interface module

In MES interface module, multiple operation settings can be configured for linkage.

However, the operation speed may differ between the operation when performing only one linkage operation setting and when performing other multiple linkage operation settings.

The following method is available to check the information related to the internal operations of MES interface module:

- Use buffer memory. ( Page 293 Cycle information (Un\G9472 to 12418))

2 MES Interface Function Configuration Tool

This chapter explains MES Interface Function Configuration Tool.

2.1 MES Interface Function Configuration Tool

2

MES Interface Function Configuration Tool is a tool to set various settings required for operating an MES interface module. Various operations can be performed, such as checking each status and working logs of an MES interface module and stopping and restarting it.

For the startup method and screen configuration for MES Interface Function Configuration Tool, refer to the following:

📖 MELSEC iQ-R MES Interface Module User's Manual (Startup)

2.2 Project File Handling

This section describes the details on handling project files.

The setting for the MES interface function for one MES interface module is treated as one project in MES Interface Function Configuration Tool.

Creating a new project

Create a new project.

When a new project is created, the project currently being edited is discarded.

Operating procedure

Select [Project] ⇒ [New].

Opening a project

Read a saved project.

Operating procedure

1. Select [Project] ⇒ [Open].
2. The "Open" screen appears.
Select a target file and click the [Open] button.

Saving a project

Save a project.

Overwriting and saving a project

Operating procedure

Select [Project] ⇒ [Save].

Precautions

When a same project file is opened, edited, and saved at the same time from multiple MES Interface Function Configuration Tools, the latest contents will be saved.

Saving a project under a new name

Operating procedure

1. Select [Project] ⇒ [Save As].
2. The "Save As" screen appears.
Specify a save location and file name, then click the [Save] button.

Importing a setting from a project

Select an arbitrary setting from a saved project and import it to the project setting that is currently being edited. Use when utilizing each setting of a saved project.

Operating procedure

1. Select [Project] ⇒ [Import] ⇒ [Project File].
2. The "Open" screen appears, then specify a project to import.
3. When selecting a project to import, the "Project File Import" screen appears.

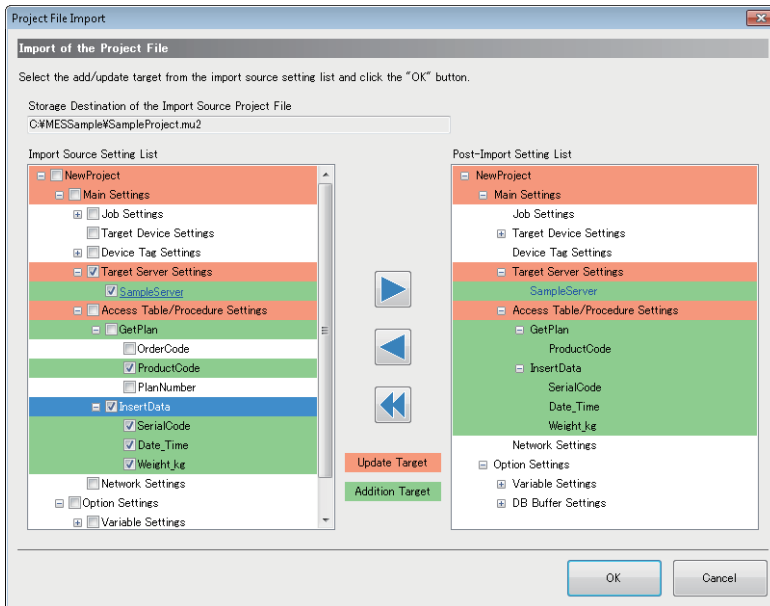

4. Select a setting for the import target from "Import Source Setting List." Click the [▶] button to reflect the setting to the "Post-Import Setting List." Click the [◀] button to clear the selected items in the "Post-Import Setting List." Click the [◀◀] button to clear all the items in the "Post-Import Setting List."
5. Click the [OK] button to import.

Point

- Items having reference relations with the selected items are displayed in blue.
- Items having reference relations with the checked items are displayed with an underline.

When importing a setting having a reference relation

When selecting an item to import and if the target refers to another item, the referred item is also selected automatically. When the item selected automatically refers to another item, the referred item is also selected automatically.

An error occurs when the reference relations of the project after the import are not maintained due to the import.

Opening a project file used recently

Select a project file used recently to open.

Operating procedure

Select [Project] ⇒ [Recently used Project file] ⇒ [(project path used recently)].

Opening CSV files

Open a CSV file (setting information file) and apply the contents of the CSV file to the project being edited.

For details on the CSV file (setting information file), refer to the following:

☞ Page 306 Setting information file

Operating procedure

1. Select [Project] ⇒ [Open CSV Files].
2. The "Browse For Folder" screen appears.
Select the folder where a CSV file is stored, and click the [OK] button.

Saving CSV files

Save the project being edited in a CSV file (setting information file).

For details on the CSV file (setting information file), refer to the following:

☞ Page 306 Setting information file

Operating procedure

1. Select [Project] ⇒ [Save CSV Files].
2. The "Browse For Folder" screen appears.
Select a folder to save the CSV file, and click the [OK] button.

2.3 Project Settings

Set the information on the project (project name, comments).

Window

Click the project root in the edit item tree.

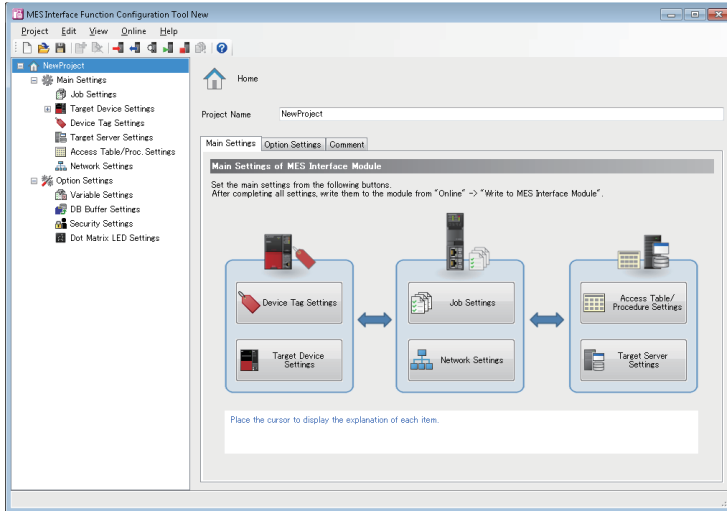

Displayed items

Item	Description	Reference	
Project Name	Set a project name.	—	
[Basic Settings] tab	[Device Tag Settings] button	Click this to open the device tag setting list.	Page 137 Device Tag Settings
	[Target Device Settings] button	Click this to open the target device setting list.	Page 134 Access Target Device Settings
	[Job Settings] button	Click this to open the job setting list.	Page 112 Job Settings
	[Network Settings] button	Click this to open the network settings.	Page 160 Network Settings
	[Access Table/Procedure Settings] button	Click this to open the access table and procedure setting list.	Page 155 Access Table/Procedure Settings
	[Target Server Settings] button	Click this to open the target server setting list.	Page 152 Target Server Settings
[Option Settings] tab	[Variable Settings] button	Click this to open the "Variable Settings" screen.	Page 161 Variable settings
	[Security Settings] button	Click this to open the "Security Settings" screen.	Page 163 Security settings
	[DB Buffer Settings] button	Click this to open the "DB Buffer Settings" screen.	Page 162 DB buffer settings
	[Dot Matrix LED Settings] button	Click this to open the "Dot Matrix LED Settings" screen.	Page 164 Dot matrix LED settings
[Comment] tab	Comment	Set the comment for a project.	—

2.4 Job Settings

Set the job settings for MES interface module.

Job setting list

The job settings in the project are listed.

Window

Click "Job Settings" in the edit item tree.

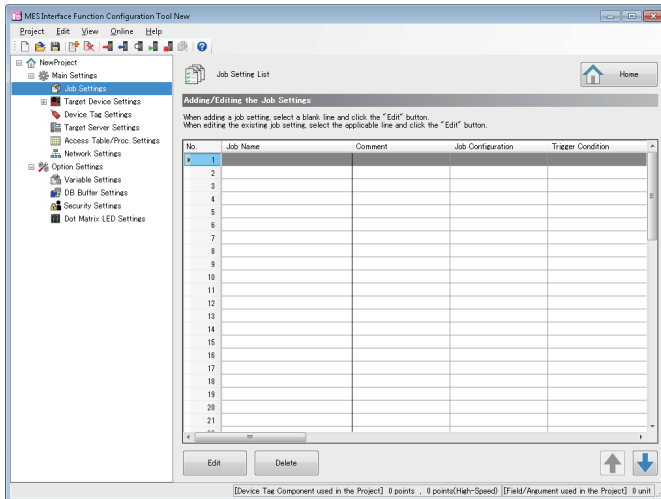

Displayed items

Item	Description	
Job Setting List	Job Name	The name of a job setting is displayed.
	Comment	A set comment is displayed.
	Job Configuration	The type of a job is displayed.
	Trigger Condition	The configuration type and event/condition type of a trigger condition are displayed.
	Trigger Buffering Setting	Whether the trigger buffering setting is enabled or disabled is displayed.
	Access Type	The access type of a job is displayed.
	Access Interval	The access interval to read data used at trigger judgment is displayed.
	Reading Target Data	A target for reading data is displayed.
	DB Buffering Setting	The setting content of DB buffering is displayed.
	DB Buffer Use Size	A size to be a criterion for DB buffering for a target job is displayed.
	Verification Settings	The setting content of a verification setting is displayed.
[Edit] button	Click this to open the "Job Setting" screen of a selected row.	
[Delete] button	Click this to delete the setting of a selected row.	

Job settings

The wizard for editing job settings is displayed.

Window

Click the [Edit] button in the "Job Setting List" screen.

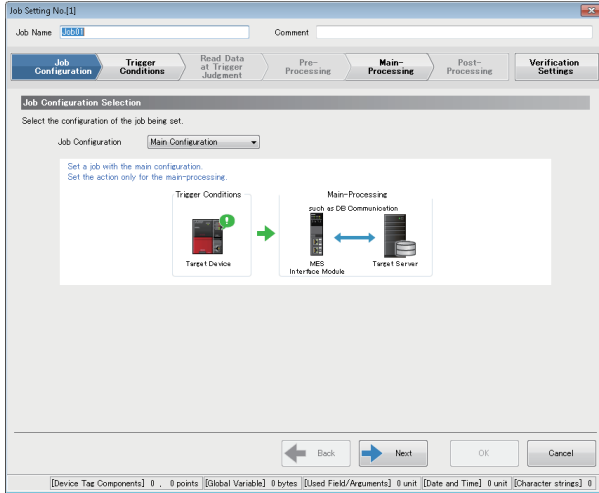

Displayed items

Item	Description	Reference
Job Name*1	Enter a job name.	—
Comment	Set a comment.	—
[Job Configuration] tab	Set the settings for job configuration.	Page 114 Job configuration
[Trigger Conditions] tab	Set the settings for trigger condition.	Page 115 Trigger conditions
[Read Data at Trigger Judgment] tab	Select a data reading method used for a trigger judgment.	Page 117 Read data at trigger judgment
[Pre-Processing] tab	Set the settings for pre-processing.	Page 118 Pre-processing
[Main-Processing] tab	Set the settings for main-processing.	Page 119 Main-processing
[Post-Processing] tab	Set the settings for post-processing.	Page 121 Post-processing
[Verification Settings] tab	For a job in verification, set the settings for verification control.	Page 122 Verification settings
[Back] button	Click this to move to the previous setting screen.	—
[Next] button	Click this to move to the next setting screen.	—
[OK] button	Click this to apply the set contents.	—

*1 A same name cannot be used for the job name.

Point

The setting screen can be switched by clicking the set tab directly.
A set tab has a check mark (☑).

Job configuration

Select a job configuration to be set by using wizard.

Window

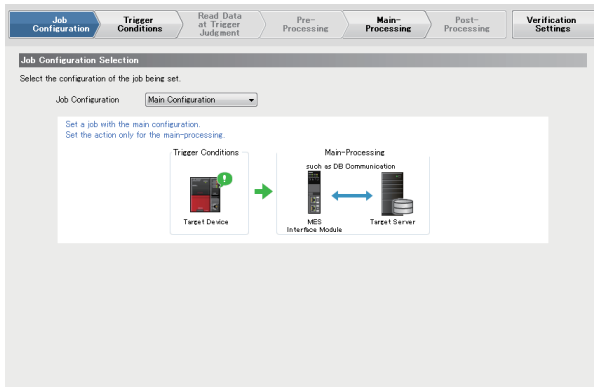

Displayed items

Item		Description
Job Configuration Selection	Job Configuration	Select the configuration of a set job.
Settings for No. of Pre-Processing and Post-Processing Actions ^{*1}	Pre-Processing	Select the checkbox to use the pre-processing.
	No. of Pre-Processing Actions	Specify the maximum number of settings for actions that are set in the pre-processing.
	Post-Processing	Select the checkbox to use the post-processing.
	No. of Post-Processing Actions	Specify the maximum number of settings for actions that are set in the post-processing.

*1 The setting can be set when "Extended Configuration" is selected for "Job Configuration."

Trigger conditions

Set the settings related to job startup of MES interface module.

Window

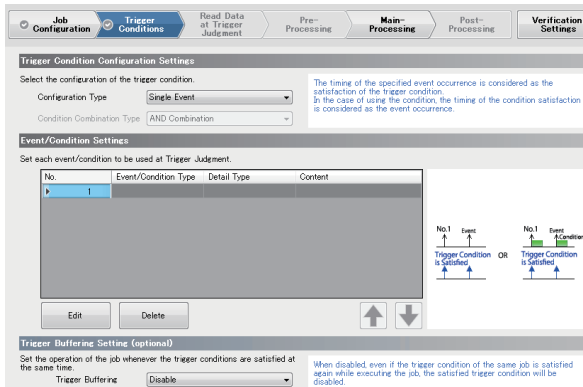

Displayed items

Item	Description	
Trigger Condition Configuration Settings	Configuration Type	Select the configuration type of a trigger condition.
	Condition Combination Type	Select a combination type when combining multiple conditions.
Event/condition setting list	Event/Condition Type ^{*1}	An event/condition type is displayed.
	Detail Type ^{*1}	A detail type is displayed.
	Content ^{*1}	The content according to the event/condition type and detail type is displayed.
	Job Startup Request ^{*2}	Set a device used for a job start request.
	(Data Type) ^{*2}	The data type of a device used for a job start request is displayed.
	Job Completion Notification ^{*2}	Set a device used for a job completion notification.
[Edit] button ^{*1}		Click this to open the "Condition Settings" screen of a selected row.
[Delete] button ^{*1}		Click this to delete the setting of a selected row.
Trigger Buffering Setting (optional)	Trigger Buffering ^{*3}	Select whether the trigger buffering is enabled or disabled.

*1 Does not appear when selecting "Single Handshake" or "Multiple Handshake" for "Configuration Type."

*2 Does not appear when selecting an item other than "Single Handshake" and "Multiple Handshake" for "Configuration Type."

*3 Cannot be set when selecting "Single Handshake" or "Multiple Handshake" for "Configuration Type."

Condition settings

The following shows the procedure for setting conditions to start a job when selecting an item other than "Single Handshake" and "Multiple Handshake" for "Configuration Type."

Operating procedure

1. Click the [Edit] button in the [Trigger Conditions] tab in the "Job Setting" screen to set the following items.

Item	Description	
Event/Condition Type Common Settings	Event/Condition Type	Select an event/condition type.
	Detail Type	Select the detail type of an event/condition.

2. Set the following items according to the event/condition type and detail type.

• Condition (Value Monitoring)

Item		Description
Event/Condition Type Individual Settings	Monitoring Target	Set target data for value monitoring.
	(Data Type)	The data type of a monitoring target is displayed.
	Condition	Set the comparison condition for value monitoring.
	Comparison Target	Set the comparison target data for value monitoring.
	(Data Type)	The data type of a comparison target is displayed.

• Condition (Period of Time)

Item		Description
Event/Condition Type Individual Settings	Month and Day	Set the month and day.
	Day of the Week	Set the day of the week.
	Start Time	Set the time.
	End Time	

• Event (Value Changed)

Item		Description
Event/Condition Type Individual Settings	Monitoring Target	Set the monitoring target data for the value changed.
	(Data Type)	The data type of a monitoring target is displayed.

• Event (Fixed Time)

Item		Description
Event/Condition Type Individual Settings	Month and Day	Set the month and day.
	Day of the Week	Set the day of the week.
	Occurrence Time	Set the time.

• Event (Fixed Cycle) (Timer Interval)

Item		Description
Event/Condition Type Individual Settings	Timer Interval	Set the timer interval. Setting range: 1 to 3600

• Event (Fixed Cycle) (Time Interval)

Item		Description
Event/Condition Type Individual Settings	Time Interval	Set the time interval in an interval and a unit.
	Reference Time	Set the reference time for the time interval in hours, minutes, and seconds.

• Event (Module Monitoring) (MES Interface Module)

Item		Description
Event/Condition Type Individual Settings	At Startup of MES Interface Module	Set whether to generate an event at startup of MES interface module.
	At Restart/Update of Settings of the MES Interface Function	Set whether to generate an event when restarting or updating the settings of the MES interface function.

• Event (Module Monitoring) (Control CPU)

Item		Description
Event/Condition Type Individual Settings	Control CPU Status Change	Select an event for the control CPU status change.

3. Click the [OK] button.

Read data at trigger judgment

Set a method, interval, and target to read data used for the trigger condition at trigger judgment.

It can be set when setting "Event/Condition Type" using a device tag in "Event/Condition Settings" in the [Trigger Conditions] tab.

Window

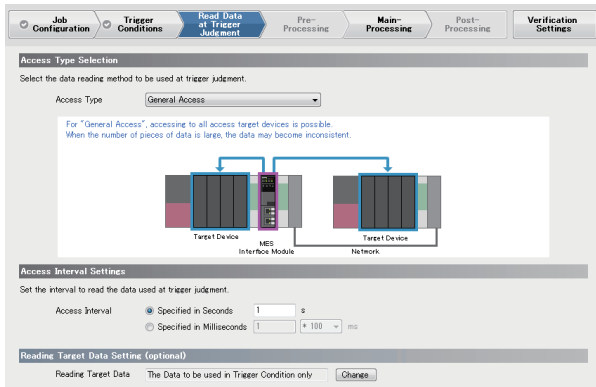

Displayed items

Item		Description
Access Type Selection	Access Type	Select an access type.
Access Interval Settings*1	Seconds Specification	Select this to monitor in seconds and specify the monitoring interval in seconds.
	Milliseconds Specification	Select this to monitor in milliseconds and specify the monitoring interval in milliseconds.
Reading Target Data Setting (optional)	Reading Target Data	The reading target data at trigger judgment is displayed.
	[Change] button	Click this to open the "Reading Target Data Setting" screen.

*1 Does not appear when selecting "High-Speed Access (Each Scan)" for "Access Type."

Reading target data setting

Set the reading target data at trigger judgment.

For the data reading at trigger judgment, refer to the following:

📖 Page 19 Data read/write timing for CPU modules at job operation

Operating procedure

1. Click the [Change] button in the [Read Data at Trigger Judgment] tab in the "Job Setting" screen.
2. Select an item for "Reading Target Data."
3. Click the [OK] button.

Pre-processing

Set the action to be executed as the pre-processing of a job.

Pre-processing can be set when selecting "Extended Configuration" for "Job Configuration" in the [Job Configuration] tab, and selecting "Use."

Window

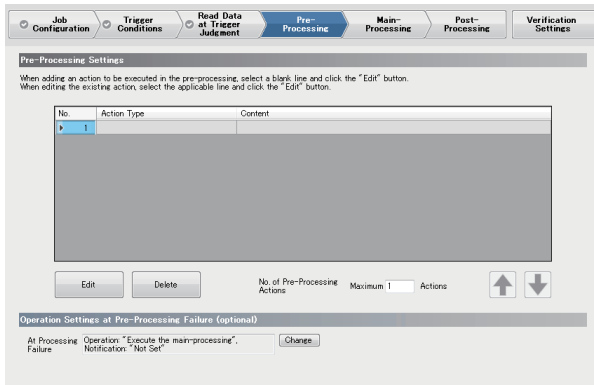

Displayed items

Item	Description	
Pre-Processing Settings	Action Type	The type of an action is displayed.
	Content	The outline content of each action is displayed according to the action type.
	[Edit] button	Click this to set the action of a selected row. 📄 Page 123 Action Settings
	[Delete] button	Click this to delete the setting of a selected row.
	No. of Pre-Processing Actions	Specify the maximum number of settings for the pre-processing action.
Operation Settings at Pre-Processing Failure (optional)	At Processing Failure	The setting content of an operation at pre-processing failure is displayed.
	[Change] button	Click this to open the "Operation Setting at Pre-Processing Failure" screen.

Operation setting at pre-processing failure

Set the job operation when the pre-processing is failed.

Operating procedure

1. Click the [Change] button in the [Pre-Processing] tab in the "Job Setting" screen to set the following items.

Item	Description	
Operation Settings at Pre-Processing Failure	Operation	Select a next job operation when the pre-processing is failed.
	Notification	Select the checkbox to report the pre-processing failure.
	Notification Destination	Specify data used for the notification destination.
	(Data Type)	The data type used for the notification destination is displayed.
	Notification Data	Specify data used as the notification data.
	(Data Type)	The data type used as the notification data is displayed.

2. Click the [OK] button.

Main-processing

Set an action to be executed as the main-processing of a job.

Window

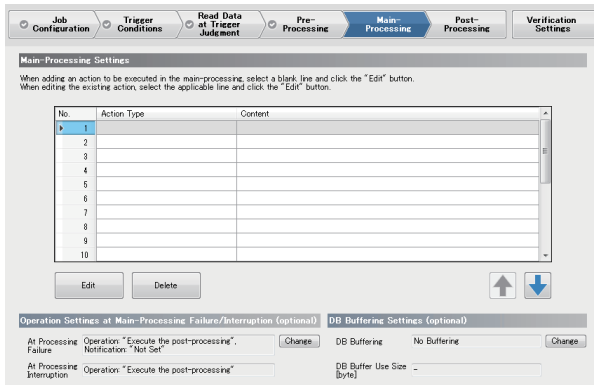

Displayed items

Item		Description
Main-Processing Settings	Action Type	The type of an action is displayed.
	Content	The outline content of each action is displayed according to the action type.
	[Edit] button	Click this to set the action of a selected row. 
	[Delete] button	Click this to delete the setting of a selected row.
Operation Settings at Main-Processing Failure/Interruption (optional)	At Processing Failure	The setting content when the main-processing fails (job cancellation).
	At Processing Interruption	The setting content when the main-processing is interrupted is displayed.
	[Change] button	Click this to open the "Operation Setting at Main-Processing Failure/Interruption" screen.
DB Buffering Settings (optional)	DB Buffering	The setting content (following operations) of the "DB Buffering Setting" screen is displayed.
	DB Buffer Use Size [Byte]	A size to be a criterion for DB buffering for a set job is displayed.
	[Change] button	Click this to open the "DB Buffering Setting" screen.

Operation Setting at Main-Processing Failure/Interruption

Set the job operation when the main-processing is failed or interrupted.

Operating procedure

1. Click the [Change] button under "Operation Settings at Main-Processing Failure/Interruption (optional)" in the [Main-Processing] tab in the "Job Setting" screen to set the following items.

Item		Description
Operation Settings at Main-Processing Failure	Operation	Select an operation when the main-processing is failed (job cancellation).
	Notification	Select the checkbox to report the main-processing failure (job cancellation).
	Notification Destination	Specify data used for the notification destination.
	(Data Type)	The data type used for the notification destination is displayed.
	Notification Data	Specify data used as the notification data.
Operation Setting at Main-Processing Interruption	(Data Type)	The data type used as the notification data is displayed.
	Operation	Select an operation when the main-processing is interrupted.

2. Click the [OK] button.

DB Buffering Settings

Set the DB buffering of the job being set.

Operating procedure

1. Click the [Change] button under "DB Buffering Settings (optional)" in the [Main-Processing] tab in the "Job Setting" screen to set the following items.

Item		Description
DB Buffering Setting	DB Buffering	Select whether the DB buffering is enabled or disabled, and a buffering area.
	[...] button	Click this to open the "DB Buffer Settings" screen.  Page 162 DB buffer settings
Job Operation Settings at DB Buffering	Operation	Select an operation when the DB buffering is performed in the main-processing.
	Notification	Select the checkbox to report that the DB buffering is performed in the main-processing.
	Notification Destination	Specify data used for the notification destination.
	(Data Type)	The data type used for the notification destination is displayed.
	Notification Data	Specify data used as the notification data.
(Data Type)	The data type used as the notification data is displayed.	

2. Click the [OK] button.

Post-processing

Set the action to be executed as the post-processing of a job.

Post-processing can be set when selecting "Extended Configuration" for "Job Configuration" in the [Job Configuration] tab, and selecting "Use."

Window

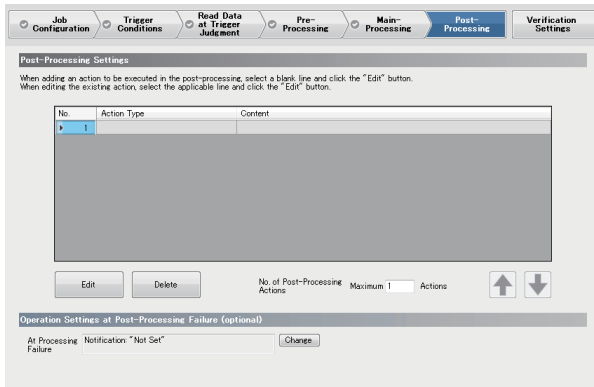

Displayed items

Item		Description
Post-Processing Settings	Action Type	The type of an action is displayed.
	Content	The outline content of each action is displayed according to the action type.
	[Edit] button	Click this to set the action of a selected row. 📄 Page 123 Action Settings
	[Delete] button	Click this to delete the setting of a selected row.
	No. of Post-Processing Actions	Specify the maximum number of settings for the post-processing action.
Operation Settings at Post-Processing Failure	At Processing Failure	The setting content of an operation at post-processing failure is displayed.
	[Change] button	Click this to open the "Operation Setting at Post-Processing Failure" screen.

Operation setting at post-processing failure

Set the job operation when the post-processing is failed.

Operating procedure

1. Click the [Change] button in the [Post-Processing] tab in the "Job Setting" screen to set the following items.

Item		Description
Operation Settings at Post-Processing Failure	Notification	Select the checkbox to report the post-processing failure.
	Notification Destination	Specify data used for the notification destination.
	(Data Type)	The data type used for the notification destination is displayed.
	Notification Data	Specify data used as the notification data.
	(Data Type)	The data type used as the notification data is displayed.

2. Click the [OK] button.

Verification settings

Set log output settings (working history, detailed log) and input/output simulation settings (device tag writing control, DB output control) for job verification.

Window

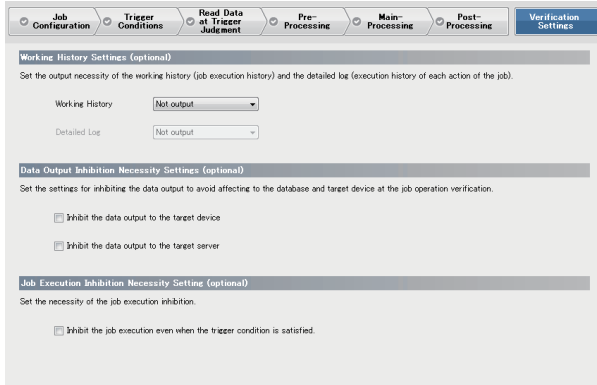

Displayed items

Item		Description
Working History Settings (optional)	Working History	Select whether to output or not output the working history.
	Detailed Log	Select whether to output or not output the detailed log.
Data Output Inhibition Necessity Settings (optional)	Inhibit the data output to the target device	Select the checkbox to inhibit the data output to avoid affecting to the target device at the job operation verification.
	Inhibit the data output to the target server	Select the checkbox to inhibit the data output to avoid affecting to the target server at the job operation verification.
Job Execution Inhibition Necessity Setting (optional)	Inhibit the job execution even when the trigger condition is satisfied.	Select the checkbox to inhibit the job execution even when the trigger condition is satisfied.

2.5 Action Settings

Set the settings for processing performed in a job.

Operating procedure

1. Click the [Edit] button in the [Pre-Processing] tab/[Main-Processing] tab/[Post-Processing] tab in the "Job Setting" screen.

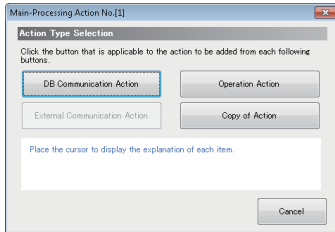

2. Select an action type to be added.

Action Type	Description	Reference
DB Communication Action ^{*1}	Set the action to input/output data in the target server.	Page 124 DB communication action setting
External Communication Action ^{*2}	Set the action to execute the program in the application server.	Page 130 External communication action settings
Operation Action	Set the action to perform four/remainder arithmetic operations based on the factors such as device tag or variable and constant.	Page 132 Operation action settings
Copy of Action	Copy and add the set action to utilize.	Page 133 Copying an action

*1 Cannot be selected for pre-processing and post-processing.

*2 Cannot be selected for main-processing.

3. Set the settings on the setting screen of each action.

DB communication action setting

Set the action to input/output data in the target server.

Window

Click the [DB Communication Action] button in the "Action Type Selection" screen.

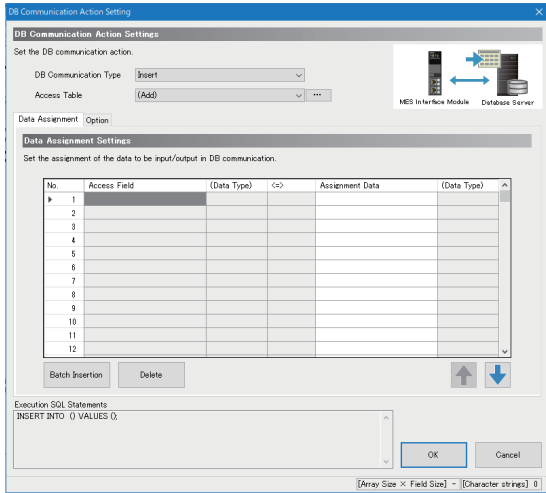

Displayed items

Item	Description	
DB Communication Action Settings	DB Communication Type	Select a DB communication type.
	Access Table (Access Procedure)	Select a target access table (access procedure) for DB communication.
	[...] button	Click this to open the "Access Table/Procedure Settings" screen of the corresponding access table (access procedure). ☞ Page 156 Access table/procedure settings
[Data Assignment] tab	Set the data assignment of MES interface module in the DB communication.	
[Narrowing-Down Conditions] tab	Set the narrowing-down of the target record in the DB communication.	
[Sorting Order] tab	Set the priority order of the corresponding record in select.	
[Option] tab	Set the optional function such as the number of target records notification in each DB communication type.	
[Exception] tab	Set the operation when an exception occurs in the DB communication.	
Execution SQL Statements (Execution Procedure)	The SQL statements ^{*1} executed in the current DB communication action and the procedure are displayed.	
[OK] button	Click this to apply the setting.	

*1 The execution SQL statements may not be displayed properly when using the following combination of modules and software. In that case, update MX MESInterface-R.
 MES interface module: RD81MES96 with firmware version '06' or later, or RD81MES96N
 MX MESInterface-R: '1.03D' or earlier

■[Data Assignment] tab

Item		Description
Data assignment setting list	Access Field (Access Procedure Argument)	An access field (access procedure argument) in a selected access table (access procedure) is displayed. When the database type of an access server specified in the selected access table is Oracle and the DB communication type is "Select" or "Multiple Select," the following access fields are added and displayed: ^{*1} <ul style="list-style-type: none"> • ROWNUM [Pseudocolumn] • ROWID [Pseudocolumn]
	(Data Type)	The data type of an access field (access parameter) is displayed. For ROWNUM [Pseudocolumn], "Integer" is displayed. For ROWID [Pseudocolumn], "Character String [Unicode(CHAR)]" is displayed.
	↔	The data assignment direction is displayed.
	Assignment Data	Set data to be assigned.
	(Data Type)	The data type to be assigned is displayed.
[Batch Insertion] button		Click this to open the "Batch Insertion" screen.
[Delete] button		Click this to delete the setting of a selected row.

*1 If 1023 access fields are used in the selected access table, only "ROWNUM [Pseudocolumn]" is added and displayed. If 1024 ones are used, no pseudocolumns are displayed.

■[Narrowing-Down Conditions] tab

Item		Description
Narrowing-down condition setting list	Combination	Set the combination method for each narrowing-down condition.
	Access Field	Set an access field used for the narrowing-down condition. When the database type of an access server specified in a selected access table is "Oracle," the following access fields can be selected: <ul style="list-style-type: none"> • ROWNUM [Pseudocolumn] • ROWID [Pseudocolumn]
	(Data Type)	The data type of an access field is displayed. <ul style="list-style-type: none"> • For an access field entered by a user, the set value is displayed. • For ROWNUM [Pseudocolumn], "Integer" is always displayed. • For ROWID [Pseudocolumn], "Character String [Unicode(CHAR)]" is always displayed.
	Condition	Set the condition type of the narrowing-down condition.
	Comparison Target	Set the data for the comparison target.
	(Data Type)	The data type of a comparison target is displayed.
[Batch Insertion] button		Click this to open the "Batch Insertion" screen.
[Delete] button		Click this to delete the setting of a selected row.

■[Sorting Order] tab

Item		Description
Sorting order setting list	Access Field	Set an access field used for the sorting order. When the database type of an access server specified in a selected access table is "Oracle," the following access fields can be selected: <ul style="list-style-type: none"> • ROWNUM [Pseudocolumn] • ROWID [Pseudocolumn]
	Order	Select a sorting order for applicable records.
[Delete] button		Click this to delete the setting of a selected row.

■[Option] tab

- DB Communication Type: Select

Item		Description
Notification Settings of the No. of Applicable Records	Notify the No. of applicable records	Select the checkbox to report the number of records that satisfies the narrowing-down condition.
	Notification Destination	Specify data used for the notification destination.
	(Data Type)	The data type used for the notification destination is displayed.
Operation Setting at Data Null Field Selection	Substitute the default value	Select the checkbox to store the default value of the access field if a value (NULL) is selected from a null field.

- DB Communication Type: Insert

Item		Description
Notification Settings of the No. of Inserted Records	Notify the No. of inserted records	Select the checkbox to report the number of inserted records.
	Notification Destination	Specify data used for the notification destination.
	(Data Type)	The data type used for the notification destination is displayed.

- DB Communication Type: Update

Item		Description
Notification Settings of the No. of Updated Records	Notify the No. of updated records	Select the checkbox to report the number of updated records.
	Notification Destination	Specify data used for the notification destination.
	(Data Type)	The data type used for the notification destination is displayed.

- DB Communication Type: Delete

Item		Description
Notification Settings of the No. of Deleted Records	Notify the No. of deleted records	Select the checkbox to report the number of deleted records.
	Notification Destination	Specify data used for the notification destination.
	(Data Type)	The data type used for the notification destination is displayed.

• DB Communication Type: Multiple Select

Item		Description
Notification Settings of the No. of Multiple Selected Records	Notify the record count	Select the checkbox to report the number of records that satisfies the narrowing-down condition and the number of selected records.
	Notification Destination	Specify data used for the notification destination.
	(Data Type)	The data type used for the notification destination is displayed.
Maximum No. of Records Settings	Set the Maximum No. of Records	Select the checkbox to set the maximum number of records to be selected.
	Setting Value	Specify data used for the setting value.
	(Data Type)	The data type used for the setting value is displayed.
Operation Setting at the No. of Selected Records Insufficient	Clear the unsubstituted assignment data to 0	Select the checkbox to clear the unsubstituted assignment data (up to the maximum number of records) to 0 if the number of selected records is less than the number of array tag components of the assignment data or the specified maximum number of records.
Operation Setting at Data Null Field Selection	Substitute the default value	Select the checkbox to store the default value of the access field if a value (NULL) is selected from a null field.

• DB Communication Type: Multiple Insert

Item		Description
Notification Settings of the No. of Inserted Records	Notify the No. of inserted records	Select the checkbox to report the number of inserted records.
	Notification Destination	Specify data used for the notification destination.
	(Data Type)	The data type used for the notification destination is displayed.
Settings of the No. of Inserted Records	Set the No. of inserted records	Select the checkbox to set the number of records to be inserted.
	Setting Value	Specify data used for the setting value.
	(Data Type)	The data type used for the setting value is displayed.

• DB Communication Type: Stored Procedure

Item		Description
Return Value Notification Settings	Notify the return value	Select the checkbox to report the return value.
	Notification Destination	Specify data used for the notification destination.
	(Data Type)	The data type used for the notification destination is displayed.

■[Exception] tab

Item		Description
No Applicable Record - Exception Settings (optional)	Exception Setting	The operation setting when an exception (no applicable record) occurs is displayed.
	[Change] button	Click this to open the "Exception Settings (No Applicable Record)" screen.
Multiple Applicable Records - Exception Settings (optional)	Exception Setting	The operation setting when an exception (multiple applicable records) occurs is displayed.
	[Change] button	Click this to open the "Exception Settings (Multiple Applicable Records)" screen.
Applicable Record Overflow - Exception Settings (optional)	Exception Setting	The operation setting when an exception (applicable record overflow) occurs is displayed.
	[Change] button	Click this to open the "Exception Settings (Applicable Records Overflow)" screen.

Batch insertion

Assign a device tag, variable, and constant.

Operating procedure

1. Click the [Batch Insertion] button in the [Data Assignment] tab/[Narrowing-Down Conditions] tab in the "DB Communication Action Setting" screen.
2. Select target data.
3. Click the [OK] button.

Exception Settings (No Applicable Record)

Set the operation and notification when an exception (no applicable record) occurs in the DB communication action.

Operating procedure

1. Click the [Change] button under "No Applicable Record - Exception Settings (optional)" in the [Exception] tab in the "DB Communication Action Setting" screen to set the following items.

Item		Description
No Applicable Record - Operation Selection	Exception Operation	Select an operation when an exception occurs.
No Applicable Record - Notification Settings	Notify the exception occurrence	Select the checkbox to report the exception occurrence.
	Notification Destination	Specify data used for the notification destination.
	(Data Type)	The data type used for the notification destination is displayed.
	Notification Data	Specify data used as the notification data.
(Data Type)	The data type used as the notification data is displayed.	
No Applicable Record - Select Option Setting	Clear the data set in "Assignment Data" to 0	Select the checkbox to clear the data set in the assignment data to 0.
No Applicable Record - Update Option Setting	Insert new records based on the narrowing-down settings	Select the checkbox to insert new records based on the narrowing-down settings.
No Applicable Record - Multiple Select Option Setting	Clear the data set in "Assignment Data" to 0	Select the checkbox to clear the data set in the assignment data to 0.

2. Click the [OK] button.

Exception Settings (Multiple Applicable Records)

Set the operation and notification when an exception (multiple applicable records) occurs in the DB communication action.

Operating procedure

1. Click the [Change] button under "Multiple Applicable Records - Exception Settings (optional)" in the [Exception] tab in the "DB Communication Action Setting" screen to set the following items.

Item		Description
Multiple Applicable Records - Operation Selection	Exception Operation	Select an operation when an exception occurs.
Multiple Applicable Records - Notification Settings	Notify the exception occurrence	Select the checkbox to report the exception occurrence.
	Notification Destination	Specify data used for the notification destination.
	(Data Type)	The data type used for the notification destination is displayed.
	Notification Data	Specify data used as the notification data.
(Data Type)	The data type used as the notification data is displayed.	
Multiple Applicable Records - Select Option Setting	Select First Record of Applicable Record	Select the checkbox to select the first record of applicable records.

2. Click the [OK] button.

Exception Settings (Applicable Records Overflow)

Set the operation and notification when an exception (applicable record overflow) occurs in the DB communication action.

Operating procedure

1. Click the [Change] button under "Applicable Record Overflow - Exception Settings (optional)" in the [Exception] tab in the "DB Communication Action Setting" screen to set the following items.

Item		Description
Applicable Record Overflow - Operation Selection	Exception Operation	Select an operation when an exception occurs.
Applicable Record Overflow - Notification Settings	Notify the exception occurrence	Select the checkbox to report the exception occurrence.
	Notification Destination	Specify data used for the notification destination.
	(Data Type)	The data type used for the notification destination is displayed.
	Notification Data	Specify data used as the notification data.
(Data Type)	The data type used as the notification data is displayed.	
Applicable Record Overflow - Multiple Select Option Setting	Select from the first record of applicable records	Select the checkbox to select from the first record of applicable records.

2. Click the [OK] button.

External communication action settings

Set the action to execute the program in the application server.

Window

Click the [External Communication Action] button in the "Action Type Selection" screen.

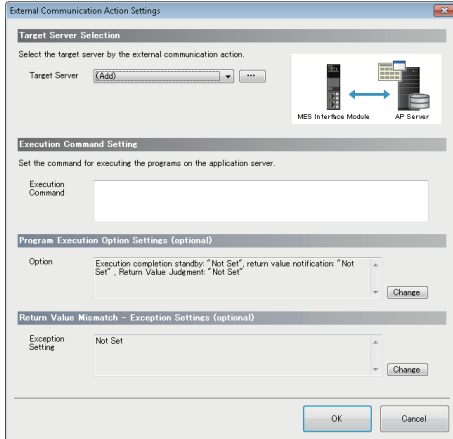

Displayed items

Item		Description
Target Server Selection	Target Server	Select a target server for an external communication action.
	[...] button	Click this to open the "Target Server Setting" screen of the corresponding access target server. Page 153 Access target server settings
Execution Command Setting	Execution Command	Set a command to execute in a program execution.
Program Execution Option Settings (optional)	Option	The setting content of the optional function such as execution completion standby is displayed.
	[Change] button	Click this to open the "Program Execution Option Setting" screen.
Return Value Mismatch - Exception Settings (optional)	Exception Setting	The setting content of an operation when a return value does not match an expected one is displayed.
	[Change] button	Click this to open the "Exception Settings (Return Value Mismatch)" screen.
[OK] button		Click this to apply the setting.

Program execution option settings

Set the optional function such as execution completion standby operation in the following operations of the program execution.

Operating procedure

1. Click the [Change] button under "Program Execution Option Settings (optional)" in the "External Communication Action Settings" screen to set the following items.

Item		Description
Program Execution Completion Standby Settings	Wait for the program execution completion	Select the checkbox to put the following operations on standby till the program execution completion.
Return Value Notification Settings	Notify the return value	Select the checkbox to report the return value of program execution.
	Notification Destination	Specify data used for the notification destination.
	(Data Type)	The data type used for the notification destination is displayed.
Return Value Judgment Settings	Judge the result of program execution based on the return value.	Select the checkbox to judge the result of program execution based on the return value.
	Expected Value	Specify data used for the return value judgment.
	(Data Type)	The data type used for the return value judgment is displayed.

2. Click the [OK] button.

Exception Settings (Return Value Mismatch)

Set the operation and notification when an exception (return value mismatch) occurs in the program execution.

Operating procedure

1. Click the [Change] button under "Return Value Mismatch - Exception Settings (optional)" in the "External Communication Action Settings" screen to set the following items.

Item		Description
Return Value Mismatch - Operation Selection	Exception Operation	Select an operation when an exception occurs.
	Return Value Mismatch - Notification Settings	Notify the exception occurrence
	Notification Destination	Specify data used for the notification destination.
	(Data Type)	The data type used for the notification destination is displayed.
	Notification Data	Specify data used as the notification data.
	(Data Type)	The data type used as the notification data is displayed.

2. Click the [OK] button.

Operation action settings

Set the action to perform four/remainder arithmetic operations based on the factors such as device tag or variable and constant.

Window

Click the [Operation Action] button in the "Action Type Selection" screen.

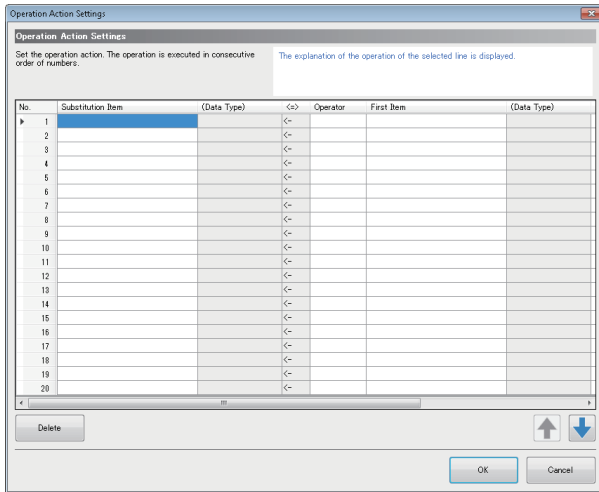

Displayed items

Item	Description	
Operation setting list	Substitution Item	Set data to substitute an operation result.
	(Data Type)	The type of data to substitute an operation result is displayed.
	Operator	Select an operator.
	First Item	Set data (first item) used for an operation.
	(Data Type)	The type of data (first item) used for an operation is displayed.
	Second Item	Set data (second item) used for an operation.
	(Data Type)	The type of data (second item) used for an operation is displayed.
[Delete] button	Click this to delete the data in a selected row.	
[OK] button	Click this to apply the setting.	

Copying an action

Copy and add the set action to utilize.

Window

Click the [Copy of Action] button in the "Action Type Selection" screen.

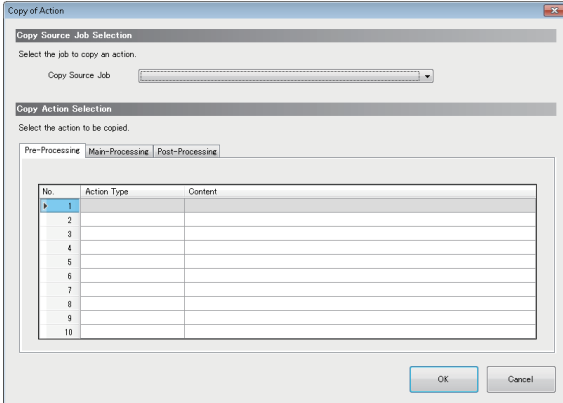

Displayed items

Item	Description	
Copy Source Job Selection	Copy Source Job	Select a job to copy an action.
Copy Action Selection*1	Action Type	The type of an action to be copied is displayed.
	Content	The content of an action to be copied is displayed.
[OK] button		Click this to copy a selected action.

*1 The display contents are same in the [Pre-Processing] tab, [Main-Processing] tab, and [Post-Processing] tab.

2.6 Access Target Device Settings

Set the target device accessed by an MES interface module.

Access target device setting list

Set the connection route to access a device existing in the own station or other stations from MES interface module.

The control CPU module is set for the target device name "ControlCPU" in the first item in the default setting.

The first item cannot be deleted or changed the settings. Only the target device name and comment can be changed.

Window

Click "Target Device Settings" in the edit item tree.

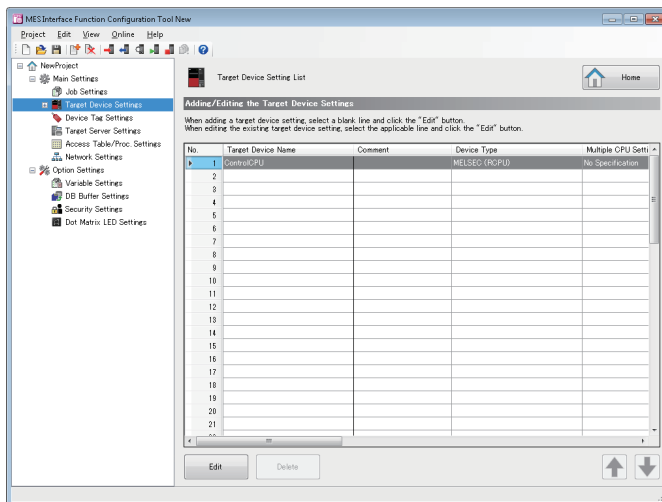

Displayed items

Item	Description	
Target Device Setting List	Target Device Name	The name of an access target device is displayed.
	Comment	A set comment is displayed.
	Device Type	The type of an access target device is displayed.
	Multiple CPU Setting	A CPU number when an access target device is in a multiple CPU system is displayed.
	Communication Route	Whether a communication route is set or not is displayed.
	Network Communication Route	The setting content of a network communication route is displayed.
	Co-Existence Network Route	The setting content of a co-existence network route is displayed.
	Import Setting	The path of a project specified as an import source when using the function to import global labels and common device comments is displayed.
[Edit] button	Click this to open the "Target Device Setting" screen of a selected row.	
[Delete] button	Click this to delete the setting of a selected row.	

Access target device settings

Set the connection route to a device accessed from MES interface module.

Window

Click the [Edit] button in the "Target Device Setting List" screen.

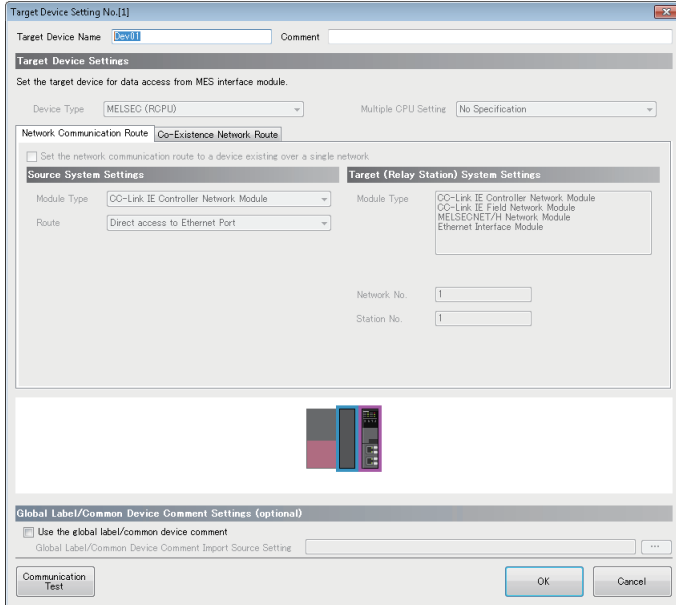

Displayed items

Item	Description	
Target Device Name* ¹	Set the name of an access target device.	
Comment	Set a comment.	
Target Device Settings	Device Type* ²	Set the type of an access target device.
	Multiple CPU Setting	Select a CPU number in a multiple CPU system.
[Communication Test] button	Click this to perform a communication test with the set access target device.	
Global Label/Common Device Comment Settings (optional)	Use the global label/common device comment	Select this to import global labels/common device comments to MES Interface Function Configuration Tool.
	Global Label/Common Device Comment Import Source Setting	The path of an engineering tool project specified as an import source is displayed. An import source project can be specified in the "Select the Global Label/Common Device Comment Import Source Project" screen displayed by clicking the [...] button.
[OK] button	Click this to apply the set contents.	

*1 A same name cannot be used for the target device name.

*2 If selecting "MELSEC (FXCPU)," the [Co-Existence Network Route] tab cannot be switched to.

■[Network Communication Route] tab

Item		Description
Set the network communication route to a device existing over a single network		Select the checkbox to set the route for accessing a device existing over a single network.
Source System Settings	Module Type ^{*1}	Set the module type for the source system.
	Route	Set the routed system when selecting "MES Interface Module (Ethernet Port)" for the module type.
	Station No.	Set the station number for the source system. Setting range: 1 to 120
	Start I/O No.	Set the start I/O No. when selecting "CC-Link System Master/Local Module" for the module type. Setting range: 0 to FE0H
Settings of System to be Routed	IP Address	Set the IP address of the Ethernet port (Ethernet Interface Module/CPU) on the system to be routed.
	Network No.	Set the network No. of the Ethernet interface module to be routed. Setting range: 1 to 239
	Station No.	Set the station No. of Ethernet Interface Module to be routed. Setting range: 1 to 120
	Module Type	Set the module type of the system to be routed.
Target (Relay Station) System Settings	Module Type	A module type that can be used in the access target (routed) system is displayed according to a module type selected in the source system. ^{*2}
	IP Address	Set the IP address of the target (relay station) system.
	Network No.	Set the network No. of the target system. Setting range: 1 to 239
	Station No.	Set the station No. of the target system. Setting range: 0 to 63 (for CC-Link System Master/Local Module), 0 to 120 (for other modules)

*1 If selecting "MES Interface Module (Ethernet Port)", the [Co-Existence Network Route] tab cannot be switched to.

*2 When all the following conditions are satisfied, select a module type that can be used in the target (relay station) system.

"MELSEC (FXCPU)" is selected for "Device Type."

"MES Interface Module (Ethernet Port)" is selected for "Module Type."

"Direct access to Ethernet Port" is selected for "Route."

■[Co-Existence Network Route] tab

Item		Description
Set the co-existence network route to a device existing over a different network		Select the checkbox to set the route for accessing a device existing over a different network.
Relay Station System Settings	Module Type	Set the module type that can be used in a co-existence network route depending on the module type set in the source system.
	Start I/O No.	Set the start I/O No. of CC-Link System Master/Local Module in the relay station system. Setting range: 0 to FE0H
Co-Existence Target System Settings	Module Type	A module type that can be used in the target system is displayed according to a module type selected in the relay station system.
	Network No.	Set the network No. of CC-Link IE Controller Network module, CC-Link IE Field Network module, MELSECNET/H network module, and Ethernet interface module for the access target. Setting range: 1 to 239
	Station No.	Set the station number of CC-Link IE Controller Network module, CC-Link IE Field Network module, MELSECNET/H network module, CC-Link System Master/Local Module, and Ethernet interface module for the target. Setting range: 0 to 63 (for CC-Link System Master/Local Module), 0 to 120 (for other modules)



When accessing an QCPU (Q mode) for which the MELSOFT connection extended setting was set, specify "Ethernet Interface Module".

2.7 Device Tag Settings

Set the device tag accessed by an MES interface module.

Device tag setting list

Set a group of device memory accessed from MES interface module as a tag.

Up to 64 device tags can be set.

Window

Click "Device Tag Settings" in the edit item tree.

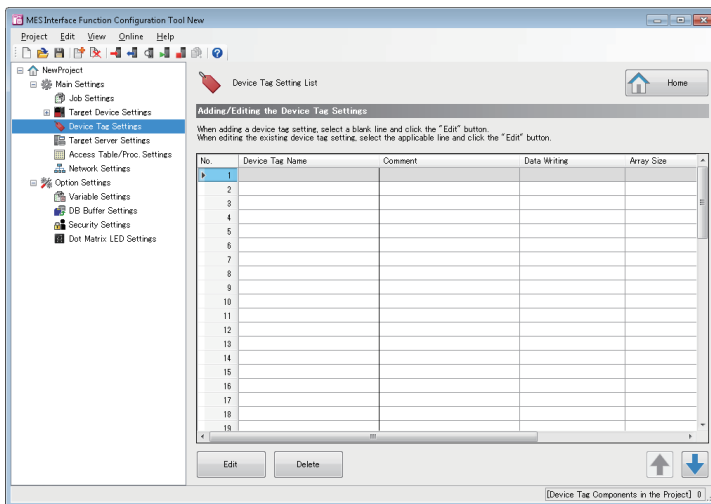

Displayed items

Item	Description	
Device Tag Setting List	Device Tag Name	The name of a device tag setting is displayed.
	Comment	A set comment is displayed.
	Data Writing	Whether a device tag can be written to or not is displayed.
	Array Size	The array size of an array tag setting is displayed.
	Array Type	The array type of an array tag setting is displayed.
[Edit] button	Click this to open the "Device Tag Settings" screen of a selected row.	
[Delete] button	Click this to delete the setting of a selected row.	

Device tag settings

Set the settings for the device memory accessed from MES interface module.

Global labels (including module labels) and common device comments set with an engineering tool can also be imported.

Page 142 Importing global labels/common device comments

Window

Click the [Edit] button in the "Device Tag Setting List" screen.

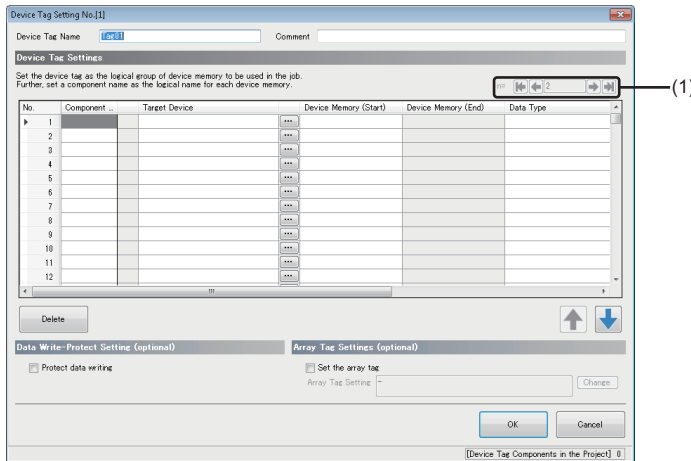

Displayed items

Item	Description	
Device Tag Name ^{*1}	Set a device tag name.	
Comment	Set a comment.	
(1) Setting the component number of an array	Set the component number of an array of the device memory displayed in "Device Memory [n]". <ul style="list-style-type: none"> : To set the minimum value (2).^{*2} : To subtract '1' from a set component number.^{*2} : To add '1' to a set component number.^{*3} : To set the maximum value (array size setting value).^{*3} 	
Device Tag Settings	Component Name	Set the name of a component to access. For related data (which is imported from a global label), the icon () that indicates the data is related data is displayed. ^{*4} Page 142 Importing global labels/common device comments
	Target Device	Select a device including a component to access.
	[...] button	Click this to open the "Target Device Setting" screen of the corresponding access target device. Page 135 Access target device settings
	Device Memory (Start)	Specify the start of a device memory to access. When applying bit or digit specification to a device memory, refer to the following: Page 139 Bit specification/digit specification of device memories
	Device Memory (End)	Displays the end device obtained by calculating the set start device and the data type and number of characters.
	Data Type	Set the data type of a device memory to access. Page 140 Setting availability of data types for each device
	Length	Set the number of characters when specifying a character string for the data type.
	Device Memory [n]	When an array tag setting is enabled, a device assigned to the component number of a set array is displayed. ^{*5} (Example) D2-D3
[Delete] button	Click this to delete the setting of a selected row.	
Data Write-Protect Setting (optional)	Protect data writing	Select the checkbox to protect data writing to the device tag being set.

Item	Description	
Array Tag Settings (optional)	Set the array tag	Select the checkbox to use a device tag as an array tag.
	Array Tag Setting	Displays the array size and array type.
	[Change] button	Click this to open the "Array Tag Settings" screen of a device tag being set.
[OK] button	Click this to apply the set contents.	

- *1 A same name cannot be used for the device tag name.
- *2 Cannot be clicked when a component number is the minimum value (2).
- *3 Cannot be clicked when a component number is the maximum value (array size setting value).
- *4 Even when an element name is modified, the relation is not released.
- *5 Nothing is displayed if a device number assigned to a component number is out of the range.

Bit specification/digit specification of device memories

Digit specification of bit devices and bit specification of word devices can be used as a method for specifying a device memory of a device tag component.

When using digit specification of bit devices or bit specification of word devices, an MES interface module operates as if word devices or bit devices were specified, respectively.

Digit specification of bit devices

By specifying a bit device and the number of digits, a series of continuous bit devices can be accessed as word devices.

- Specifications for digit specification of bit devices

Item	Specification	
Overall	Format	[Number of digits][Bit device] (Example 1) When specifying M0 to M19: K5M0 (Example 2) When specifying X0 to X3: K1X0
	Data type	<ul style="list-style-type: none"> • Word [unsigned]/Bit string [16-bit] • Double word [unsigned]/Bit string [32-bit] • 16bit BCD • 32bit BCD
	Range	The available range differs for each specified number of digits. ☞ Detailed specifications for each number of digits In addition, the smaller range between the available range of data types and that of digits applies.
	Array tag	Available
Device	Word device	Unavailable
	Double-word device	Unavailable
	Bit device	Available (Bit-specified word devices are unavailable.)
Number of digits	Range	K1 to K8

- Detailed specifications for each number of digits

○: Available, ×: Not available

Specified number of digits	Target number of points	Target device memory (Example) Device memory: X0	Data type			
			Word [unsigned]/ Bit string [16-bit]	Double word [unsigned]/ Bit string [32-bit]	16bit BCD	32bit BCD
K1	4	X0 to X3	○	×	○	×
K2	8	X0 to X7	○	×	○	×
K3	12	X0 to XB	○	×	○	×
K4	16	X0 to XF	○	×	○	×
K5	20	X0 to X13	×	○	×	○
K6	24	X0 to X17	×	○	×	○
K7	28	X0 to X1B	×	○	×	○
K8	32	X0 to X1F	×	○	×	○

■ Bit specification of word devices

By specifying a word device and bit number, only a specific bit device in the word device can be accessed.

- Specifications for bit specification of word devices

Item		Specification
Overall	Format	[Word device].[Bit number] (Example 1) When specifying bit 5 in D0: D0.5 (Example 2) When specifying bit 10 in D0: D0.A
	Data type	Bit
	Array tag	Available
Device	Word device	Available (Digit-specified bit devices are unavailable.)
	Double-word device	Unavailable
	Bit device	Unavailable
Bit number	Range	0 to F (hexadecimal)

Setting availability of data types for each device

○: Available, ×: Not available

Data type	Bit device	Digit-specified bit device	Word device	Bit-specified word device	Double-word device
Bit	○	×	×	○	×
Word [unsigned]/Bit string [16-bit]	×	○ (K1 to K4)	○	×	×
Double word [unsigned]/Bit string [32-bit]	×	○ (K5 to K8)	○	×	○
Word [signed]	×	×	○	×	×
Double word [signed]	×	×	○	×	○
16bit BCD	×	○ (K1 to K4)	○	×	×
32bit BCD	×	○ (K5 to K8)	○	×	○
Single-precision real number	×	×	○	×	○
Double-precision real number	×	×	○	×	○
Character string [Unicode]	×	×	○	×	○
Character string [ASCII/SJIS]	×	×	○	×	○

Point

A same device cannot be set in a same device tag. The device is regarded as the same in the following cases:

- D0.0 for bit specification and D0
- K8M0 (M0 to M31) for digit specification and M31

Array tag settings

Set the settings for using as an array tag in the device tag settings.

Operating procedure

1. Click the [Change] button in the "Device Tag Setting" screen to set the following items.

Item		Description
Array Tag Settings	Array Size	Specify an array size. Setting range: 2 to 40960 When using it in a DB communication action with "Multiple Insert" selected for "DB Communication Type," specify it within the range of 2 to 1000.
	Array Type	Select an array type.
	Specify the array block size	Select the checkbox to specify the array block size.
	Array Block Size	Specify an array block size. Setting range: 0 to 1073741824

2. Click the [OK] button.

Importing global labels/common device comments

Import global labels (including module labels) and common device comments set with an engineering tool to the project of MES Interface Function Configuration Tool.

Data imported from global labels is referred to as related data.

Related devices can be updated depending on the changes of global labels in an engineering tool project.

Data which can be imported is as follows:

○: Available, ×: Not available, —: No data

Item	Engineering tool
Common device comment	○
Each program device comment	×
Global label (Global)	○
Module label (M+Global)	○
Local label	×
System label	—

For global labels and device comments, refer to the following:

 GX Works3 Operating Manual

Considerations for importing data

■Importing global labels

- An engineering tool (GX Works3 Version 1.015R or later) must be installed to import global labels.
- Devices (data type) which cannot be used in MES Interface Function Configuration Tool and global labels whose devices/labels are not assigned are not imported. (However, these devices and labels are displayed in the import list.)
- When the global labels are set 32769 or more in one project, the global labels which exceed 32768 are not displayed in the list of global labels to be imported.
- Do not import global labels during the save process of an engineering tool project. If attempted, the engineering tool project may not be saved properly.
- When sorting is applied to any setting items in the "Device Tag Settings" screen, global labels cannot be imported.

■Importing common device comments

- An engineering tool (GX Works3 Version 1.015R or later) must be installed to import common device comments.
- When the common device comments are set 32769 or more in one project, the common device comments which exceed 32768 are not displayed in the list of common device comments to be imported.
- Do not import common device comments during the save process of an engineering tool project. If attempted, the engineering tool project may not be saved properly.
- When one or more comments are set for each device name to the imported common device comments, all the comments are displayed in the list.
- When common device comments are imported, the setting of each comment title is ignored.
(Example) Common device comments can be imported with MES Interface Function Configuration Tool regardless of its language (Japanese, English, etc.)
- When sorting is applied to any setting items in the "Device Tag Settings" screen, common device comments cannot be imported.

Importing global labels

Import global labels set with an engineering tool as data.

When the global labels created in an engineering tool are edited, they are updated in batch. It is therefore necessary to link the global labels.

Operating procedure

1. Right-click the device tag component list, and select [Import Global Label].



2. Select the import source project of global labels in the "Import Global Label (Select Project)" screen, and click the [OK] button.

☞ Page 143 "Import Global Label (Select Project)" screen

3. Select global labels to be imported in the "Import Global Label (Select Data)" screen, and click the [OK] button.

☞ Page 144 "Import Global Label (Select Data)" screen

■ "Import Global Label (Select Project)" screen

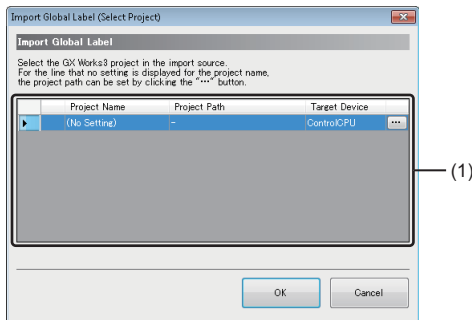

Item	Description
(1) Import source list	An engineering tool project and access target device which are set as import sources of global labels are displayed. If no project is set for the access target device, "(No Setting)" is displayed. Specify a project in the "Target Device Setting" screen displayed by clicking the [...] button. ☞ Page 135 Access target device settings
[OK] button	Click this to apply the setting and display the screen for specifying import target global labels. ☞ Page 144 "Import Global Label (Select Data)" screen

■ "Import Global Label (Select Data)" screen

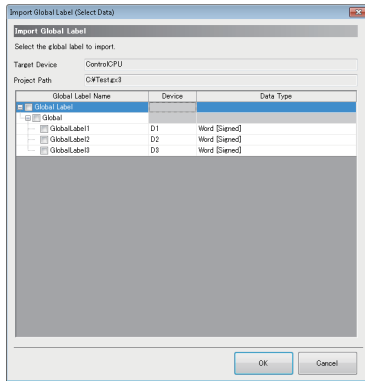

Item	Description
Target Device	Displays the target device selected in the "Import Global Label (Select Project)" screen.
Project Path	Displays the path of the project selected in the "Import Global Label (Select Project)" screen.
Global Label Name ^{*1}	Displays global label names (which have been set with an engineering tool). Select the global labels to be imported.
Device	Displays the start device of a global label.
Data Type	Displays the data type of a global label.
[OK] button	Imports the specified global labels and closes the screen.

*1 When an unusable character is used or a global label name exceeded the available length of device tag component, the label name is modified as follows:

If an unusable character is used for a global label, the character will be deleted.

If the character length of a global label exceeded the maximum number of displayable characters for a device tag component, the global label name will be displayed for the number of displayable characters from the end of the name.

For usable characters, refer to the following:

Page 297 Usable Characters

■ Global label name

- Simple type

The following table shows a display example when a global label is simple type, and a display example of device tag component name after importing data.

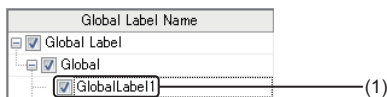

○: Available, ×: Not available

Type	Global label name	Import	Device tag component name after import
(1) Simple type	GlobalLabel1	○	GlobalLabel1

- Array

The following table shows a display example when a global label is array, and a display example of device tag component name after importing data.

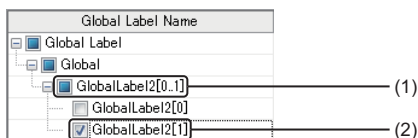

○: Available, ×: Not available

Type	Global label name	Import	Device tag component name after import
(1) Array data	GlobalLabel2[0..1]	×	—
(2) Array element	GlobalLabel2[1]	○	GlobalLabel2_1

- Structure

The following table shows a display example when a global label is structure, and a display example of device tag component name after importing data.

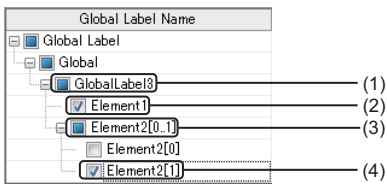

○: Available, ×: Not available

Type	Global label name	Import	Device tag component name after import
(1) Structure data	GlobalLabel3	×	—
(2) Structure element	Element1	○	GlobalLabel3_Element1
(3) Structure element [array]	Element2[0..1]	×	—
(4) Array element	Element2[1]	○	GlobalLabel3_Element2_1

- Structured array

The following table shows a display example when a global label is structured array, and a display example of device tag component name after importing data.

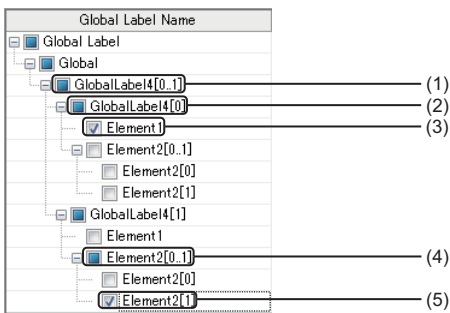

○: Available, ×: Not available

Type	Global label name	Import	Device tag component name after import
(1) Structured array data	GlobalLabel4[0..1]	×	—
(2) Structured array element	GlobalLabel4[0]	×	—
(3) Structure element	Element1	○	GlobalLabel4_0_Element1
(4) Structure element [array]	Element2[0..1]	×	—
(5) Array element	Element2[1]	○	GlobalLabel4_1_Element2_1

- Timer/Counter/Retentive timer

The following table shows a display example when a global label is timer, counter, or retentive timer, and a display example of device tag component name after importing data.

Global Label Name	Device	Data Type
Global Label		
Global		
TimerLabel	T1	Timer
Contact	TS1	Bit
Coil	TC1	Bit
Current Value	T1	Word [Signed]

○: Available, ×: Not available

Type		Global label name	Import	Device tag component name after import
Timer	—	TimerLabel	×	—
	Contact	Contact	○	TimerLabel_Contact
	Coil	Coil	○	TimerLabel_Coil
	Current Value	Current Value	○	TimerLabel_Current_Value
Counter	—	CounterLabel	×	—
	Contact	Contact	○	CounterLabel_Contact
	Coil	Coil	○	CounterLabel_Coil
	Current Value	Current Value	○	CounterLabel_Current_Value
Retentive Timer	—	RetentiveTimerLabel	×	—
	Contact	Contact	○	RetentiveTimerLabel_Contact
	Coil	Coil	○	RetentiveTimerLabel_Coil
	Current Value	Current Value	○	RetentiveTimerLabel_Current_Value

■Data type

The data type of global labels and the data type of device tag components after importing data are as follows.

○: Available, ×: Not available

Data type of global label	Availability	Data type of device tag component
Bit	○	Bit
Word [signed]	○	Word [signed]
Double word [signed]	○	Double word [signed]
Word [unsigned]/Bit string [16-bit]	○	Word [unsigned]/Bit string [16-bit]
Double word [unsigned]/Bit string [32-bit]	○	Double word [unsigned]/Bit string [32-bit]
Single-precision real number	○	Single-precision real number
Double-precision real number	○	Double-precision real number
String (n) ^{*1}	○	Character string [ASCII/SJIS]
String [Unicode] (n) ^{*1}	○	Character String [Unicode]
Timer	○	Contact: Bit
Counter	○	Coil: Bit
Retentive timer	○	Current value: Word [Signed]
Long timer	×	—
Long counter	×	—
Long retentive timer	×	—
Time	×	—
Pointer	×	—

*1 'n' indicates the number of characters. Global labels can be imported into an MES Interface Function Configuration Tool project only when 'n' is between 1 and 255.

Releasing relation to global labels

Release the relations between the global labels of an engineering tool and related data.

Operating procedure

1. Select the related data to release the relation in the device tag component list.
2. Right-click the selected data, and select [Release Relation to Global Label].

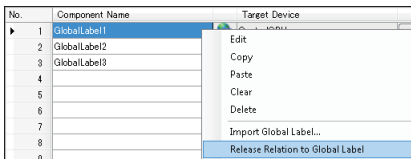

Point

The relation can also be released by performing one of the following operations in the "Target Device Setting" screen. (☞ Page 135 Access target device settings)

- Unselect the checkbox of "Use the global label/common device comment."
- Change the device type to one other than "MELSEC (RCPU)."

Precautions

To link the data whose relation was once released, import the global label again.

Updating related data of global labels

Update the data related to global labels of an engineering tool to the recent value.

If data cannot be updated, release the relation.

Operating procedure

1. Select [Edit] ⇒ [Update Data Related to Global Label].
2. Select an update target project in the "Update Data Related to Global Label (Select Project)" screen, and click the [OK] button.

☞ Page 148 "Update Data Related to Global Label (Select Project)" screen

3. Select update target global labels in the "Update Data Related to Global Label (Select Data)" screen, and click the [OK] button.

☞ Page 149 "Update Data Related to Global Label (Select Data)" screen

■"Update Data Related to Global Label (Select Project)" screen

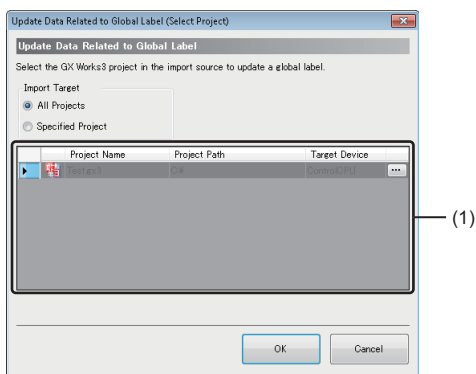

Item	Description
All Projects	Select this to update the related data of all projects.
Specified Project	Select this to update the related data of the specified project.
(1) Import source list	An engineering tool project and access target device which are set as import sources of global labels are displayed. If no project is set for the access target device, "(No Setting)" is displayed. Specify a project in the "Target Device Setting" screen displayed by clicking the [...] button. ☞ Page 135 Access target device settings
[OK] button	Click this to apply the setting and display the screen for specifying update target global labels. ☞ Page 149 "Update Data Related to Global Label (Select Data)" screen

■ "Update Data Related to Global Label (Select Data)" screen

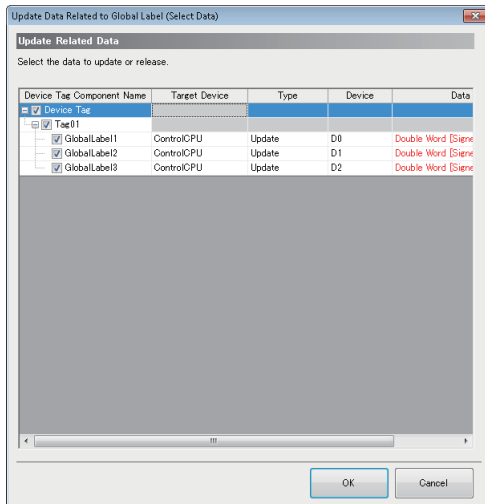

Item	Description
Device Tag Component Name	Displays a device tag component name. Select the related data to be updated.
Target Device	Displays a target device.
Type	Displays the update status. <ul style="list-style-type: none"> • "Update": When related data, devices, or data types are different from the previous data, the values are updated. • "Relation release": Relations are released when the related data cannot be found or updating causes inconsistency.*1
Device	Displays the start device after the update. When the start device is changed after the update, the device name is displayed in red.
Data Type	Displays the data type after the update. When the data type or size is changed after the update, the data name is displayed in red.
[OK] button	Click this to update specified related data or release the relation.

*1 The following cases apply:

- A file of an import source project does not exist.
- An applicable global label name does not exist in an import source project.
- A device, data type, or character string size that cannot be used for an MES interface module is specified.
- A device that cannot be combined with a data type is used.

Importing common device comments

Import common device comments set with an engineering tool as data.

Operating procedure

1. Right-click the device tag component list, and select [Import Common Device Comment].

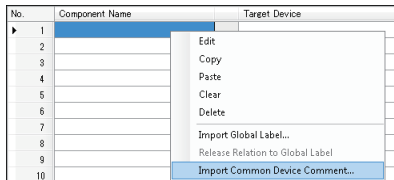

2. Select the import source project of common device comments in the "Import Common Device Comment (Select Project)" screen, and click the [OK] button.

☞ Page 150 "Import Common Device Comment (Select Project)" screen

3. Select common device comments to be imported in the "Import Common Device Comment (Select Data)" screen, and click the [OK] button.

☞ Page 151 "Import Common Device Comment (Select Data)" screen

■ "Import Common Device Comment (Select Project)" screen

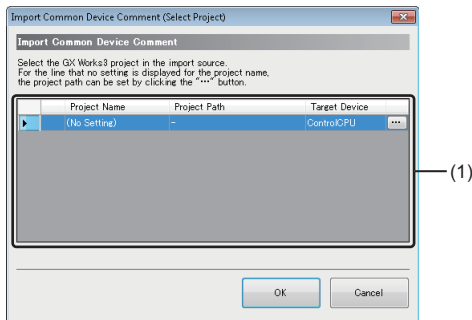

Item	Description
(1) Import source list	Displays an engineering tool project and target device which have been set as an import source of common device comments. If no project is set for the access target device, "(No Setting)" is displayed. Specify a project in the "Target Device Setting" screen displayed by clicking the [...] button. ☞ Page 135 Access target device settings
[OK] button	Click this to apply the setting and display the screen for specifying import target common device comments. ☞ Page 151 "Import Common Device Comment (Select Data)" screen

■ "Import Common Device Comment (Select Data)" screen

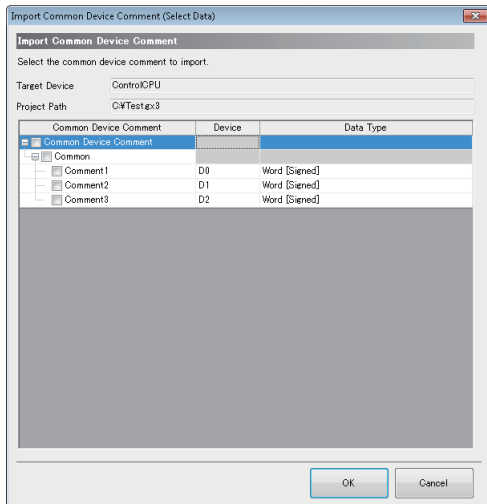

Item	Description
Target Device	Displays the target device selected in the "Import Common Device Comment (Select Project)" screen.
Project Path	Displays the path of the project selected in the "Import Common Device Comment (Select Project)" screen.
Common Device Comment* ¹	Displays common device comments (which have been set with an engineering tool). Select the common device comments to be imported.
Device	Displays devices that contain common device comments.
Data Type	Displays the data type of a device. <ul style="list-style-type: none"> • "Bit": Bit device • "Word [Signed]": Word device
[OK] button	Imports the specified common device comments and closes the screen.

*1 When an unusable character is used or a common device comment name exceeded the available length of device tag component, the comment name is modified as follows:

If an unusable character is used for a common device comment, the character will be deleted.

If the character length of a common device comment exceeded the maximum number of displayable characters for a device tag component name, the common device comment name will be displayed for the number of displayable characters from the end of the name.

For usable characters, refer to the following:

☞ Page 297 Usable Characters

2.8 Target Server Settings

Set the target server connected with an MES interface module.

Target server setting list

Set the settings for the server accessed from MES interface module.

Up to 16 servers can be set for target server.

Window

Click "Target Server Settings" in the edit item tree.

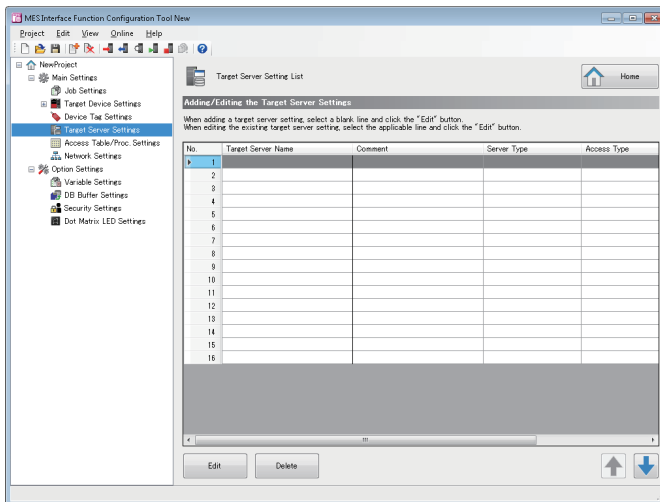

Displayed items

Item	Description	
Target Server Setting List	Target Server Name	Displays the target server setting name.
	Comment	A set comment is displayed.
	Server Type	Displays a server type.
	Access Type	Displays an access type.
	IP Address	Displays the IP address of the server.
[Edit] button	Click this to open the "Target Server Setting" screen of a selected row.	
[Delete] button	Click this to delete the setting of a selected row.	

Access target server settings

Set the settings for the server accessed from MES interface module.

Window

Click the [Edit] button in the "Target Server Setting List" screen.

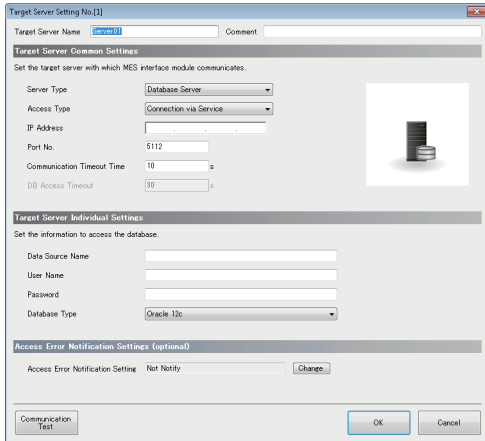

Displayed items

Item	Description	
Target Server Name* ¹	Set an access target server name.	
Comment	Set a comment.	
Target Server Common Settings	Server Type	Set the target server type.
	Access Type* ²	Set the access type of a database server.
	IP Address	Set the IP address of the server in which DB Connection Service is installed in decimal.
	Port No.	Set a port number of the server. Setting range: 1024 to 65535
	Communication Timeout Time* ^{3,4}	Set the timeout time until MES interface module detects a communication error when a communication error occurs on the network between MES interface module and the server. Setting range: 1 to 180 seconds
DB Access Timeout* ⁵	Set the timeout time when there is no response to a data writing or reading request from an MES interface module to a database. Setting range: 30 to 3600 seconds	
Target Server Individual Settings	Data Source Name* ⁶	Set the name of an ODBC data source to access.
	Service/Database Name* ⁵	Set the service name or database name of a database to access.
	User Name* ⁷	Set a user name to access a database or application server.
	Password	Set a password to access a database or application server.
Database Type* ⁸	Select a database server type.* ^{9,10}	
Access Error Notification Settings (optional)	Access Error Notification Setting	Displays whether or not to notify the current setting status for the access error status.
	[Change] button	Click this to open the "Access Error Notification Setting" screen.
[Communication Test] button	Click this to perform a communication test with the set access target server.	
[OK] button	Click this to apply the set contents.	

*1 A same name cannot be used for the target server name.

*2 Can be set when selecting "Database Server" for "Server Type."

*3 The communication timeout time is treated as timeout value when server is down or network is disconnected. In cases where abnormality can be detected before such occurrence, an error is detected without waiting for timeout time.

*4 If the communication timeout time is set longer, the MES interface function such as setting update, module stop, and SD memory card format may require time to stop.

*5 Can be set when selecting "Direct DB Connection" for "Access Type."

*6 Can be set when selecting "Connection via Service" for "Access Type."

*7 Case-sensitive when the database type is Oracle 11g, Oracle 12c, Oracle 18c, Oracle 19c, or Oracle 21c.

*8 In the communication test function, even if a database which is different than the actual connected database is set, the communication test may succeed.

*9 When using Access for Microsoft 365, select "Access 2019."

*10 When using a DB communication action with "Multiple Insert" selected for "DB Communication Type," a selectable database server differs for each software version of MX MESInterface-R storing MES Interface Function Configuration Tool.

Software version of MX MESInterface-R	Selectable database server
'1.13P' or earlier	SQL Server
'1.14Q' to '1.16S'	Oracle, SQL Server, MySQL, PostgreSQL
'1.17T' or later	Oracle, SQL Server, MySQL, PostgreSQL, MariaDB

Access error notification setting

Set whether or not to notify the access error status.

Operating procedure

1. Click the [Change] button in the "Target Server Setting" screen to set the following items.

Item	Description
Notify the access error status	Select the checkbox to report the access error status.
Notification	Notification Destination
	(Data Type)
	The data type used for the notification destination is displayed.

2. Click the [OK] button.

2.9 Access Table/Procedure Settings

Set the access table/procedure connected by MES interface module.

Access table/procedure setting list

Set the settings for the access table/procedure accessed from MES interface module.

Up to 1024 access tables/procedures can be registered.

2

Window

Click "Access Table/Proc. Settings" in the edit item tree.

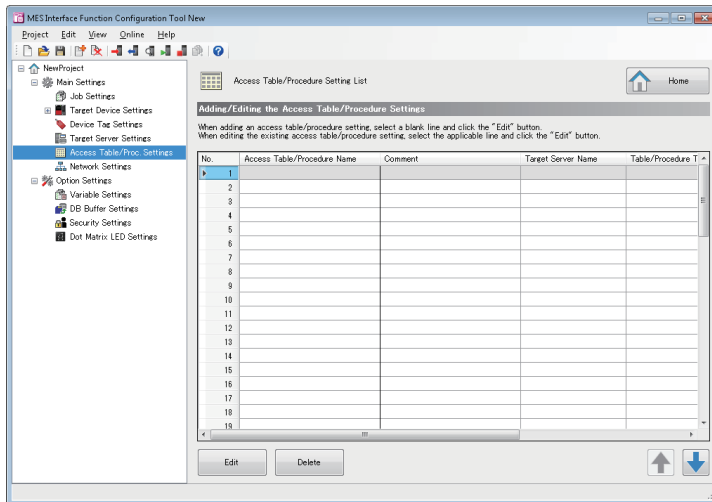

Displayed items

Item	Description	
Access Table/Procedure Setting List	Access Table/Procedure Name	Displays the setting name of the access table/procedure.
	Comment	A set comment is displayed.
	Target Server Name	Displays the setting name of the target server.
	Table/Procedure Type	Displays the set table/procedure type.
	DB Table/Procedure Name	Displays the set DB table/procedure name.
[Edit] button	Click this to open the "Access Table/Procedure Settings" screen of a selected row.	
[Delete] button	Click this to delete the setting of a selected row.	

Access table/procedure settings

Set a group of database field accessed from MES interface module as access table/procedure.

Window

Click the [Edit] button in the "Access Table/Procedure Setting List" screen.

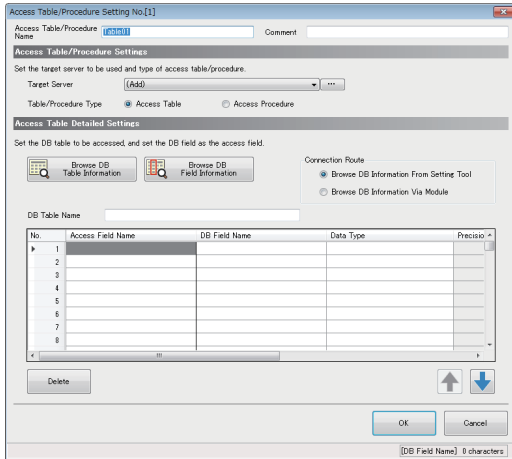

Displayed items

Item	Description	
Access Table/Procedure Name ^{*1}	Set an access table/procedure name.	
Comment	Set a comment.	
Access Table/Procedure Settings	Target Server	Select a target server.
	[...] button	Click this to open the "Target Server Setting" screen of the corresponding access target server. When selecting "(Add)" for "Target Server," a new "Target Server Setting" screen opens. Page 153 Access target server settings
	Table/Procedure Type	Select table or stored procedure to be set.
[OK] button	Click this to apply the set contents.	

*1 A same name cannot be used for the access table/procedure name.

■When selecting "Access Table"

Item	Description	
Access Table Detailed Settings	[Browse DB Table Information] button	Click this to open the "Browse DB Table Information" screen.
	[Browse DB Field Information] button	Click this to open the "Browse DB Field Information" screen.
	Connection Route ^{*1}	Select a browse route for DB table information browsing and DB field information browsing. <ul style="list-style-type: none"> Browse DB Information From Setting Tool: To browse DB information without using an MES interface module. It can be browsed without starting an MES interface module. (☞ Page 187 DB information browse function) Browse DB Information Via Module: To browse DB information via an MES interface module. (☞ Page 94 Via DB Connection Service)
	DB Table Name	Set a DB table name or view name to access.
Access field list	Access Field Name	Set an access field name used for data assignment in the "DB Communication Action" screen.
	DB Field Name	Set the field name of a database.
	Data Type	Set the data type acquired by selecting manually or browsing DB field arbitrarily.
	Precision Hold	Set whether to hold precision when the data is real number [floating point], real number [fixed point], or date and time. When enabled at the time of converting to SQL numeric character string, it converts such that there is no occurrence of real number rounding error. In addition, fractional seconds are added in the date and time. This setting is applied when used for the following access fields. <ul style="list-style-type: none"> Narrowing-down condition for Select Data assignment for Insert Data assignment and narrowing-down condition for Update Narrowing-down condition for Delete Narrowing-down condition for Multiple Select Data assignment for Multiple Insert
	Default Value Setting	Set the default value setting.
	Default Value	Set the default value of the access field.
[Delete] button	Click this to delete the setting of a selected row.	

*1 Cannot be selected when selecting "Direct DB Connection" for "Access Type." ("Browse DB Information Via Module" remains selected.)

■When selecting "Access Procedure"

Item	Description	
Access Procedure Detailed Settings	[Browse DB Procedure Information] button	Click this to open the "Browse DB Procedure Information" screen.
	Connection Route ^{*1}	Select a browse route for DB procedure information browsing. <ul style="list-style-type: none"> Browse DB Information From Setting Tool: To browse DB information without using an MES interface module. It can be browsed without starting an MES interface module. (☞ Page 187 DB information browse function) Browse DB Information Via Module: To browse DB information via an MES interface module. (☞ Page 94 Via DB Connection Service)
	DB Procedure Name	Set a DB procedure name used as the access procedure.
Access procedure list	Access Proc. Argument Name	Set the access procedure argument by selecting manually or selecting the DB procedure name acquired by browsing DB procedure information.
	Argument No.	Displays the DB procedure argument number.
	Data Type	Set the data type acquired by selecting manually or browsing DB procedure information.
	Assignment Direction ^{*2}	Set the assignment direction for the argument acquired by selecting manually or browsing DB procedure information.
[Delete] button	Click this to delete the setting of a selected row.	

*1 Cannot be set when selecting "Direct DB Connection" for "Access Type." ("Browse DB Information Via Module" remains selected.)

*2 In case of SQL Server, because there is no distinction between "OUT" and "INOUT", acquire as "INOUT".

However, when there is no input usage in the DB communication action (Stored Procedure), the assignment direction is recommended to set to "OUT" manually.

DB table information browse

Select the DB table name that can be used in the specified target server from the list.

Operating procedure

1. Click the [Browse DB Table Information] button in the "Access Table/Procedure Setting" screen.
2. Select a DB table name or view name to use from the list.

The DB table name is not displayed on the list in the following cases. If the target DB table name is not displayed, enter it manually.

- When the DB table name exceeds the maximum number of characters (32 characters (Unicode))
- When the number of DB tables exceeds the maximum number of items displayed (1024 tables)
- When unusable characters are included in the DB table name ( Page 297 Usable Characters)

Contents of the list can be updated by using the [Refresh] button.

3. Click the [OK] button.

Point

DB table information is acquired for each database type. (It is acquired from the following tables and views in databases to be accessed.)

Oracle: A table and view created by a user

SQL Server: A table and view in the schema set for "Default schema" of a user

Access: A table and view created by a user

MySQL: All tables and views

PostgreSQL: A table and view in the schema set for "Default schema"

MariaDB: All tables and views

DB field information browse

Select the field name of the specified DB table from the list.

Operating procedure

1. Click the [Browse DB Field Information] button in the "Access Table/Procedure Setting" screen.
2. Select a DB field name to use from the list.

The DB field name is not displayed on the list in the following cases. If the target DB field name is not displayed, enter it manually.

- When the DB field name exceeds the maximum number of characters (32 characters (Unicode))
- When the number of DB fields exceeds the maximum number of items displayed (1024 fields)
- When unusable characters are included in the DB field name ( Page 297 Usable Characters)
- When the data type is not supported by the DB field

Contents of the list can be updated by using the [Refresh] button.

3. Click the [OK] button.

Point

If an access field name is blank when applying the DB Field Information, a DB field name is applied. However, when unusable characters are included in the access field name, they are omitted. (If all the characters are omitted, a default name (Field0001, Field0002, ...) is set.)

DB procedure information browse

Select the DB procedure name that can be used in the specified target server from the list.

Operating procedure

1. Click the [Browse DB Procedure Information] button in the "Access Table/Procedure Setting" screen.
2. Select a DB procedure name to use from the list.

The DB procedure name is not displayed on the list in the following cases. If the target DB procedure name is not displayed, enter it manually.

- When the DB procedure name exceeds the maximum number of characters (32 characters (Unicode))
- When the number of DB procedures exceeds the maximum number of items displayed (1024 procedures)
- When the number of DB procedure arguments exceeds 256
- When unusable characters are included in the DB procedure name ( Page 297 Usable Characters)
- When multiple DB procedures with the same name exist (only one of them is displayed.)^{*1}

Contents of the list can be updated by using the [Refresh] button.

3. Click the [OK] button.

*1 If multiple DB procedures with the same name exist, the one with the highest number of arguments is displayed.

Point

- If unusable characters are included in the access procedure argument name when applying the DB procedure information, they are omitted. (If all the characters are omitted, a default name (Arg001, Arg002, ...) is set.)
- DB procedure information is acquired for each database type. (It is acquired from the following stored procedures in databases to be accessed.)
Oracle: All stored procedures
SQL Server: A stored procedure in the schema set for "Default schema" of a user
MySQL: All stored procedures
PostgreSQL: A stored procedure in the schema set for "Default schema"
MariaDB: All stored procedures

2.10 Network Settings

Set the settings required for network connections.

Window

Click "Network Settings" in the edit item tree.

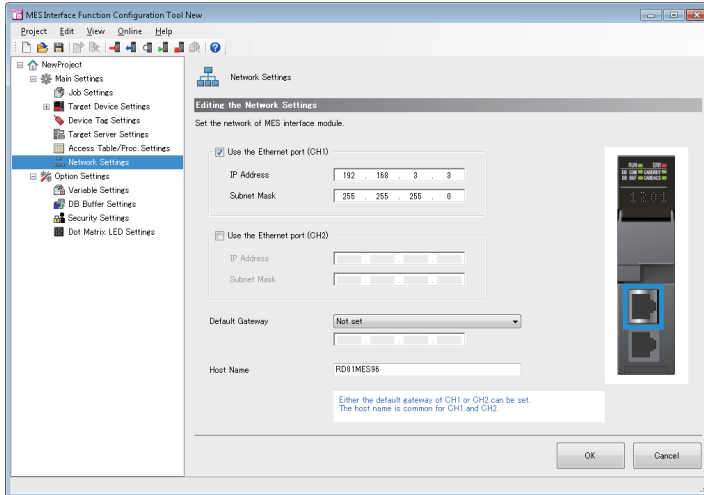

Displayed items

Item	Description	
Ethernet Port (CH1)	Use the Ethernet port (CH1)	Select the checkbox to use the Ethernet port (CH1). ^{*1}
	IP Address	Set the IP address (CH1) of an MES interface module in decimal. ^{*2}
	Subnet Mask	Set a subnet mask in decimal when using it.
Ethernet Port (CH2)	Use the Ethernet port (CH2)	Select the checkbox to use the Ethernet port (CH2). ^{*1}
	IP Address	Set the IP address (CH2) of an MES interface module in decimal. ^{*2}
	Subnet Mask	Set a subnet mask in decimal when using it.
Default Gateway	Select the necessity of default gateway, and set the IP address. ^{*3}	
Host Name	Set a host name.	
[OK] button	Click this to apply the set contents.	

*1 CH1 or CH2 must be set to use.

*2 A same IP address or an IP address of the same network cannot be set to both CH1 and CH2.

*3 Only one of CH1 or CH2 can be registered.

Communication with the same network as each CH is performed from each corresponding CH only.
(Even if a default gateway is set in other CH, communication is not performed from the other CH.)

2.11 Option Settings

Set the following items:

- Variable settings
- DB buffer settings
- Security settings
- Dot matrix LED settings

Variable settings

Set the settings for local variable and global variable.

Window

Click "Variable Settings" in the edit item tree.

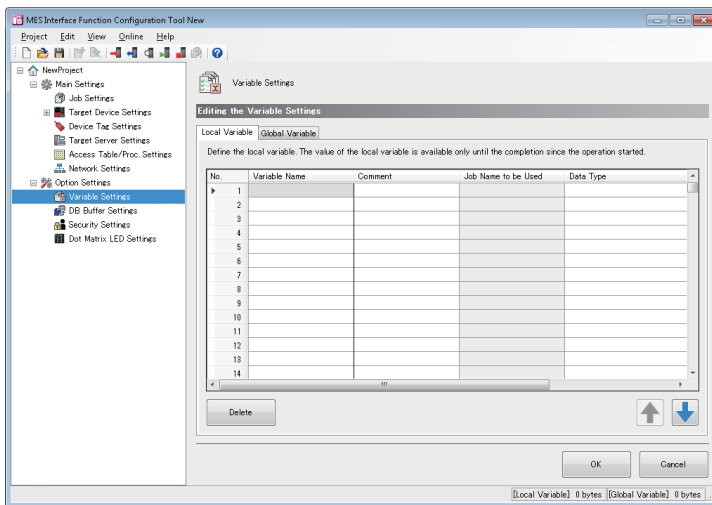

Displayed items

■[Local Variable] tab

Item	Description	
Local variable list	Variable Name	Set the variable name.
	Comment	Set a comment.
	Job Name to be Used	Displays the job name using the target local variable.
	Data Type	Set the data type of the local variable.
	Length	Set the number of characters when specifying "Character String [Unicode]" for the data type.
[Delete] button	Click this to delete the setting of a selected row.	
[OK] button	Click this to apply the set contents.	

■[Global Variable] tab

Item	Description	
Global variable list	Variable Name	Set the variable name.
	Comment	Set a comment.
	Data Type	Set the data type of the global variable.
	Length	Set the number of characters when specifying "Character String [Unicode]" for the data type.
[Delete] button	Click this to delete the setting of a selected row.	
[OK] button	Click this to apply the set contents.	

DB buffer settings

Set the settings required for using the DB buffering function in the job setting.

Window

Click "DB Buffer Settings" in the edit item tree.

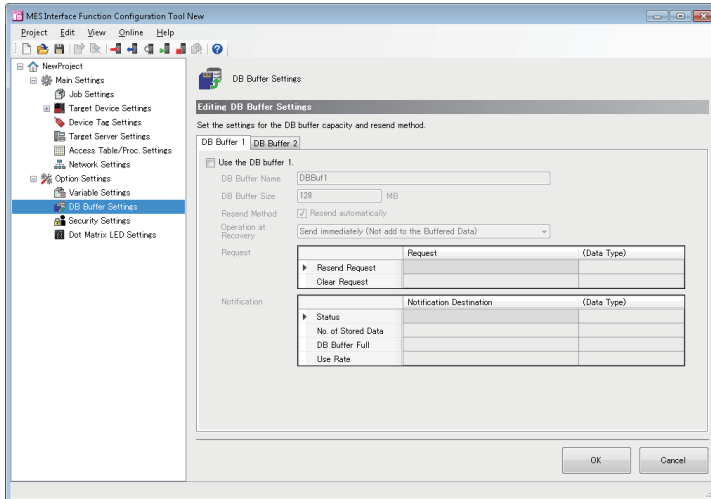

Displayed items

Item	Description	
Use the DB buffer 1 (Use the DB buffer 2)	Select the checkbox to use the DB buffer.	
DB Buffer Name	Set a DB buffer name.	
DB Buffer Size	Set the DB buffer capacity to use. Set the capacity used for the DB buffer in the SD memory card capacity within the following range. However, secure a sufficient free space in the SD memory card to set. ■RD81MES96N • Maximum capacity of the total DB buffer = SD memory card capacity - 420 MB ■RD81MES96 • Maximum capacity of the total DB buffer = SD memory card capacity - 370 MB	
Resend Mode	Select the checkbox to resend it automatically.	
Operation at Recovery	Set the order to send the buffered SQL statements. • Add to the Buffered Data • Send immediately (Not add to the Buffered Data)	
Request	—	Set a component to be requirement source for DB buffer processing for "Request." The data type of the component set in "Request" is displayed in "(Data Type)."
	Resend Request	Set the device tag component and global variable to request a resend processing for the stored DB buffer.
	Clear Request	Set the device tag component and global variable to request a clear processing for the DB buffer.
Notification	—	Set a component to be notification destination for the DB buffer diagnostics for "Notification Destination." The data type of the component set in "Notification Destination" is displayed in "(Data Type)."
	Status	Set the device tag component and global variable to store the status that the DB buffer is stored or not.
	No. of Stored Data	Set the device tag component and global variable to store the number of buffers currently stored.
	DB Buffer Full	Set the device tag component and global variable to store the status that the DB buffer is full or not.
	Use Rate	Set the device tag component and global variable to store the use rate (%) of DB buffer.
[OK] button	Click this to apply the set contents.	

Security settings

Set the account for user authentication to be confirmed when accessing MES interface module.
Up to 16 accounts can be registered.

Window

Click "Security Settings" in the edit item tree.

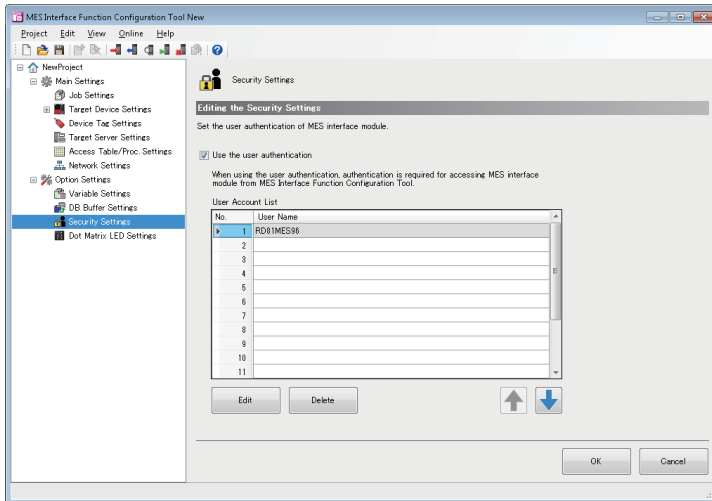

Displayed items

Item	Description
Use the user authentication	Select the checkbox to perform the authentication for online operations such as writing and reading settings.
User Account List	User Name
[Edit] button	Click this to open the "User Account" screen of a selected row.
[Delete] button	Click this to delete the setting of a selected row.
[OK] button	Click this to apply the set contents.

User account settings

The following shows the procedure for configuring detailed settings of a user account for user authentication confirmed when accessing an MES interface module.

Operating procedure

1. Click the [Edit] button in the "Security Settings" screen.
2. Enter a user name and password (case-sensitive).
3. Click the [OK] button.

Point

When changing the user name only, "New Password" and "New Password (Confirm Password)" field don't need to be entered.

Dot matrix LED settings

Set the settings related to Dot Matrix LED display in MES interface module.

Window

Click "Dot Matrix LED Settings" in the edit item tree.

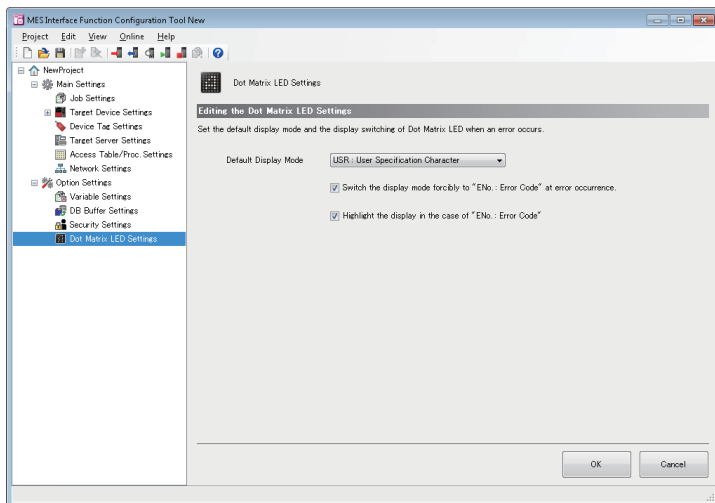

Displayed items

Item	Description
Default Display Mode	Select the contents to be displayed in the DOT Matrix LED.
Switch the display mode forcibly to "ENo.: Error Code" at error occurrence.	Select the checkbox to switch the display mode forcibly to "ENo.: Error Code" when an error occurs.
Highlight the display in the case of "ENo.: Error Code" ^{*1}	Select the checkbox to highlight the display when the display mode is "ENo.: Error Code."
[OK] button	Click this to apply the set contents.

*1 Reading may be difficult depending on the installation environment.
Do not highlight if reading is difficult

2.12 Online

Online operations can be performed to the MES interface module connected to the network.

Connection destination specification

Set and edit the connection destination information.
Perform the user authentication when connecting actually.

Window

Select [Online] ⇒ [Specify Connection Destination].

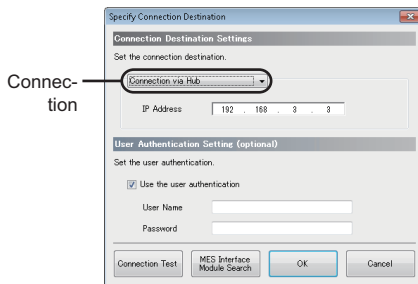

Displayed items

Item		Description
Connection Destination Settings	Connection method	Select the connection method.
	IP Address	Set the IP address for connection destination.
User Authentication Setting (optional)	Use the user authentication	Select the checkbox to perform the user authentication.
	User Name	Specify a user name for user authentication.
	Password	Specify a password for user authentication.
[Connection Test] button		Click this to perform a connection test with a set connection destination.
[MES Interface Module Search] button		Click this to search for an MES interface module on a network to which a configuration personal computer belongs.
[OK] button		Click this to apply the set contents.

MES interface module search

The following shows the procedure for searching for an MES interface module on a network to which a configuration personal computer belongs.

Operating procedure

1. Click the [MES Interface Module Search] button in the "Specify Connection Destination" screen.
2. Select a target MES interface module for connection in the list.
3. Click the [OK] button.

Precautions

In case of more than one MES interface module having same IP address are displayed, IP address is duplicated on the same network and multiple MES interface modules may exist. Modify IP address of each MES interface module.

The MES interface module search cannot be performed properly in the following configurations where multiple IP addresses are enabled in the configuration personal computer at the same time.

- When an IP address is assigned to each Ethernet port of the configuration personal computer with multiple Ethernet ports
- When a wireless LAN setting is enabled in addition to Ethernet port of the configuration personal computer
- When multiple IP addresses are assigned to one network device (Ethernet port) of the configuration personal computer

Online data operation

The following shows the operations to read, write, verify, and update a setting (project) in an MES interface module.

Reading from MES interface module

Read a setting in an MES interface module specified for "Specify Connection Destination."

Operating procedure

Select [Online] ⇒ [Read from MES Interface Module].

Writing from MES interface module

Write a setting to an SD memory card inserted in an MES interface module specified for "Specify Connection Destination."

Operating procedure

Select [Online] ⇒ [Write to MES Interface Module].

Verifying with MES interface module

Compare a setting in an MES interface module specified for "Specify Connection Destination" with one in a project being edited.

Note that the following items are excluded:

- Project Name
- Project Comment

Operating procedure

Select [Online] ⇒ [Verify with MES Interface Module].

Updating settings of MES interface module

Restart an MES interface module to update a setting to a written one.

Operating procedure

Select [Online] ⇒ [Update Setting of MES Interface Module].

Diagnostics

The diagnostics function diagnoses an MES interface module by displaying information in the MES interface module and checking diagnostic information such as the operating status and error status of the module.

In addition, remote operations such as error clear and module stop can be performed for an MES interface module.

Diagnostic function name	Description	Reference
Diagnostics	Displays the module status, error history, and product information of the module, and performs the remote operation for the module status.	Page 168 MES interface module diagnostics
Job Diagnostics	Displays the working history and detailed log of the module. Changes temporarily the verification settings of the job set in the module.	Page 170 Job diagnostics
Server Access Diagnostics	Displays the connection status of the target server set in the module.	Page 172 Server access diagnostics
Device Access Diagnostics	Displays the connection status of the target device set in the module.	Page 173 Device access diagnostics
DB Buffer Diagnostics	Displays the current use status of the DB buffer in the module and performs operations manually.	Page 174 DB buffer diagnostics
SD Memory Card Diagnostics	Displays the current use status of the SD memory card inserted in the module and formats the SD memory card.	Page 175 SD memory card diagnostics

MES interface module diagnostics

The following shows the screen for displaying the module status, error history, and product information of an MES interface module, and performing the remote operation for the module status.

Window

Select [Online] ⇒ [Diagnose MES Interface Module].

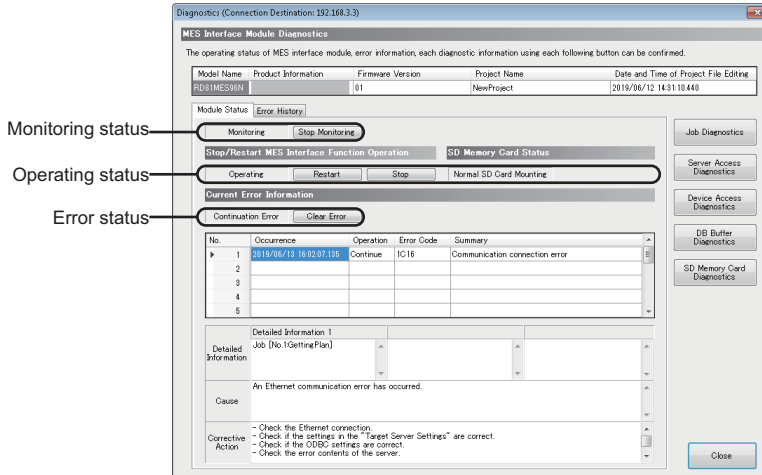

Displayed items

Item	Description
Model Name	Displays the model name of an MES interface module.
Product Information	Displays the product information of an MES interface module.
Firmware Version	Displays the firmware version of an MES interface module.
Project Name	Displays the project name of a project running in an MES interface module.
Date and Time of Project File Editing	Displays the date and time of editing a project running in an MES interface module.
[Module Status] tab	Displays the monitoring status, operating status, and error status of an MES interface module, and performs the remote operation of each status.
[Error History] tab	Displays the error history of an MES interface module.
[Job Diagnostics] button	Click this to open the "Job Diagnostics" screen.
[Server Access Diagnostics] button	Click this to open the "Server Access Diagnostics" screen.
[Device Access Diagnostics] button	Click this to open the "Device Access Diagnostics" screen.
[DB Buffer Diagnostics] button	Click this to open the "DB Buffer Diagnostics" screen.
[SD Memory Card Diagnostics] button	Click this to open the "SD Memory Card Diagnostics" screen.

■[Module Status] tab

Item		Description
Monitoring status	—	Displays the monitoring status.
	[Start Monitoring] button/[Stop Monitoring] button	Click this to start or stop monitoring.
Operating status	—	Displays the operating status of MES interface function and SD memory card status.
	[Restart] button/[Stop] button	Click either of these to restart or stop the operation of the MES interface function. When stopping the operation, the processing is performed as follows: <ul style="list-style-type: none"> • The trigger buffer is cleared. • A job being executed when the operation is stopped rolls back to the database, returns to the state before execution without writing to a device, and ends, if the main-processing is not completed. Note that variables and the operation of an external communication action do not return to the state before execution. When the main-processing is completed, a job performs the post-processing, writes to a device, and completes. <ul style="list-style-type: none"> • When the job stops while communicating with the database, and if there is no response even after waiting up till the communication time out time from the corresponding connection, then it changes to unconnected status (In such a case it is not an error).
Error status	—	Displays the error status of MES interface module.
	[Clear Error] button	Click this to clear the error status of an MES interface module.
Current error list* ¹	Occurrence	Displays the occurrence date and time.
	Operation	Displays the error status.
	Error Code	Displays the error code.
	Description	Displays an error outline.
Detailed Information	Detailed Information	Displays the detailed information of error.
	Cause	Displays the cause of error occurrence.
	Corrective Action	Displays the corrective action for clearing error.

*1 Up to 15 continuation errors and 1 stop error can be displayed.

When a new stop error occurs in the state where a stop error occurs, the information of the stop error is updated.

An error is not displayed in the following cases:

- An error that has already been displayed in the "Current error list" occurs again.
- A new continuation error occurs after a stop error occurs.
- A new continuation error occurs while 15 continuation errors are displayed.

■[Error History] tab

Item		Description
[Refresh] button		Click this to update the error history to the latest information.
[History Clear] button		Click this to clear the error history.
[Create File] button		Click this to open the "Create File of Error History" screen.
No. of History		Select the number of errors to display on the error history list.
Error history list	Occurrence	Displays the occurrence date and time.
	Operation	Displays the error status.
	Error Code	Displays the error code.
	Description	Displays an error outline.
Detailed Information	Detailed Information	Displays the detailed information of error.
	Cause	Displays the cause of error occurrence.
	Corrective Action	Displays the corrective action for clearing error.

■To save error histories

Error histories are saved in a CSV file (diagnose information file).

For details on a CSV file (diagnose information file), refer to the following:

☞ Page 335 Diagnose information file

Operating procedure

1. Click the [Create File] button in the [Error History] tab in the "Diagnostics" screen.
2. Specify a save location and file name in the "Create File of Error History" screen.
3. Click the [Save] button.

Job diagnostics

The following shows the screen for displaying the working history, failure history, and detailed log of an MES interface module. The verification settings of a job set in an MES interface module can be changed temporarily.

Window

Click the [Job Diagnostics] button in the "Diagnostics" screen.

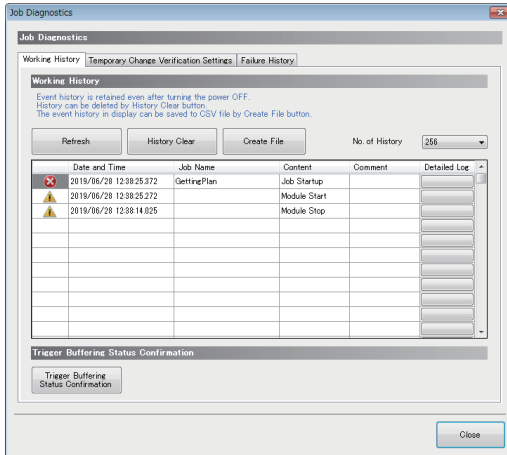

Displayed items

■[Working History] tab

Item	Description	
[Refresh] button	Click this to update the working history to the latest information.	
[History Clear] button	Click this to clear the working history.	
[Create File] button	Click this to open the "Create File of Event History" screen. ☞ Page 171 Saving working histories or failure histories	
No. of History	Select the number of histories to be displayed on the working history list.	
Working history list ^{*1*2}	Warning display	Displays an icon depending on the error type. : When the job execution result is processing failure and processing interruption. : When the job execution is being inhibited or for the operation history (stop or restart operations of the module) for MES interface module
	Date and Time	Displays a date and time.
	Job Name	Displays the executed job name.
	Content	Displays the working contents of the job and operations for the module.
	Comment	A set comment is displayed.
	Detailed Log ^{*3}	When the "Detailed Log" is set to "Output" in the verification settings, "Detailed Log" screen appears by clicking the [Display] button. ☞ Page 176 Detailed log (working history)
[Trigger Buffering Status Confirmation] button	Click this to open the "Trigger Buffering Status Confirmation" screen. ☞ Page 180 Trigger buffering status confirmation	

*1 When the "Detailed Log" is set to "Output" in the verification settings, it may not be displayed up to the maximum number of items displayed (256).

*2 If the trigger buffering count reaches to the maximum number (192 counts) when the trigger buffering condition of a job, of which the trigger buffering is enabled, is satisfied, the working history of the job will not be displayed.

*3 The detailed log may not be output when an error occurs at job execution.



■[Temporary Change Verification Settings] tab

Item		Description
[Refresh] button		Click this to update the verification setting information to the latest information.
Job to be Confirmed/Changed Select	Target Job	Select the target job to be confirmed and changed.
Confirmation and Change for Verification Settings	Current Setting Contents	Displays the verification settings on MES interface module.
	Change Item	Select the items to be changed.
	Setting Contents to be Changed	Displays the setting contents to be changed.
[Change] button		Requests a verification settings change to MES interface module.

■[Failure History] tab

A log^{*1} is displayed if an operation to a database server fails when "Direct DB Connection" is selected for "Access Type."

*1 A log that is output when the connection to or disconnection from a database fails, or when execution of an SQL statement or stored procedure fails

Item		Description
[Refresh] button		Click this to update the failure history to the latest information.
[History Clear] button		Clears the failure history.
[Create File] button		Click this to open the "Create File of Failure History" screen.  Page 171 Saving working histories or failure histories
No. of History		Select the number of items to display in the failure history list.
Failure history list	Date and Time	Displays a date and time.
	Job Name	Displays the executed job name.
	Action No.	Displays an executed action number.
	Detail Type	Displays the DB communication type of an executed DB communication action.
	Target Server	Displays the communication destination database server name of an executed DB communication action.
	Access Table/Procedure	Displays the target access table/procedure name of an executed DB communication action.
	Detailed Log	Click the [Display] button to open the "Detailed Log" screen.  Page 179 Detailed log (failure history)

■Saving working histories or failure histories

Working histories and failure histories are saved in a CSV file (diagnose information file).

For details on a CSV file (diagnose information file), refer to the following:

 Page 335 Diagnose information file

Operating procedure

1. Click the [Create File] button in the [Working History] tab or [Failure History] tab in the "Job Diagnostics" screen.
2. Specify a save location and file name in the "Create File of Event History" screen or "Create File of Failure History" screen.
3. Click the [Save] button.

Server access diagnostics



Display the connection status of the target server set in MES interface module.

Window

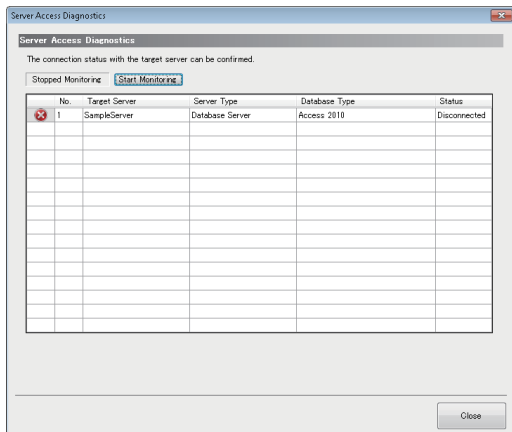
Click the [Server Access Diagnostics] button in the "Diagnostics" screen.



Displayed items

Item	Description	
[Start Monitoring] button/[Stop Monitoring] button	Switches start monitoring and stop monitoring.	
Server access connection status list	Warning display	Displays an icon depending on the error type.  : When disconnected  : When not connected
	Target Server	Displays the server name registered in the target server settings.
	Server Type	Displays the server type registered in the target server settings.
	Database Type	Displays the connected database when the server type is a database server.
	Status	Displays the result of connection to the server from MES interface module.

Device access diagnostics

Display the connection status of the target device set in MES interface module.



Window

Click the [Device Access Diagnostics] button in the "Diagnostics" screen.

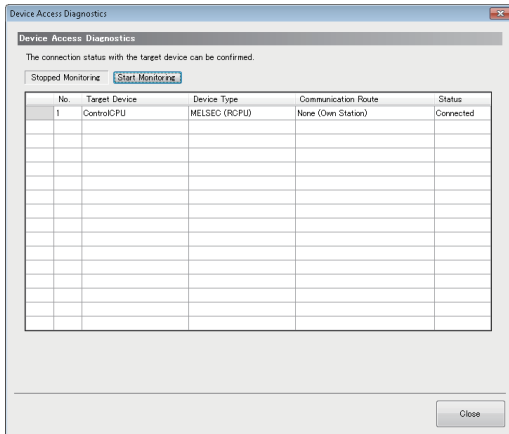
2



Displayed items

Item	Description	
[Start Monitoring] button/[Stop Monitoring] button	Switches start monitoring and stop monitoring.	
Device access connection status list	Warning display	Displays an icon depending on the error type.  : When disconnected  : When not connected
	Target Device	Displays the device name registered in the target device settings.
	Device Type	Displays the device type registered in the target device settings.
	Communication Route	Displays the network settings.
	Status	Displays the result of connection to the device from MES interface module.

DB buffer diagnostics



Display the current use status of the DB buffer in MES interface module and perform operations manually.

Window

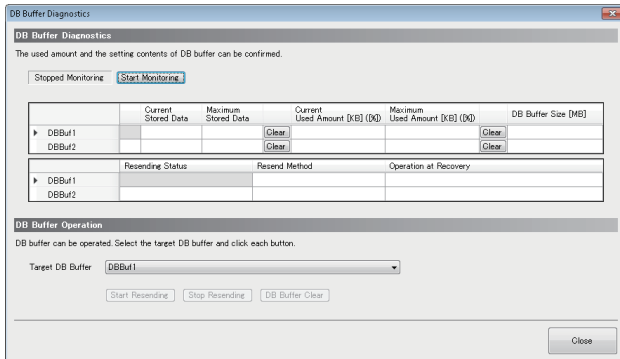
Click the [DB Buffer Diagnostics] button in the "Diagnostics" screen.



Displayed items

Item		Description
DB Buffer Diagnostics	[Start Monitoring] button/[Stop Monitoring] button	Switches start monitoring and stop monitoring.
	Warning display	Displays an icon depending on the error type.  : When the use rate is 100%  : When the use rate is 1% to 99%
	Current Stored Data	Displays the number of jobs that the DB buffering is currently being performed.
	Maximum Stored Data	Displays the maximum number of jobs that the DB buffering is performed after starting MES interface module.
	[Clear] button	Clears the maximum stored data.
	Current Used Amount [KB] (Use Rate [%])	Displays the current used amount and use rate of the DB buffering.
	Maximum Used Amount [KB] (Use Rate [%])	Displays the maximum used amount and use rate of the DB buffering after starting MES interface module.
	[Clear] button	Clears the maximum used amount.
	Resending Status	Displays the current resending status of DB buffer.
	Resend Mode	Displays the resend mode of DB buffer.
	Operation at Recovery	Displays the operation at recovery of DB buffer.
	DB Buffer Size [MB]	Displays the DB buffer size currently set.
DB Buffer Operation	Target DB Buffer	Select the target DB buffering area.
	[Start Resending] button	Starts the resend of the DB buffering data.
	[Stop Resending] button	Stops the resend of the DB buffering data.
	[DB Buffer Clear] button	Clears the DB buffer.

SD memory card diagnostics

Display the current use status of the SD memory card inserted in MES interface module and format the SD memory card.

Window

Click the [SD Memory Card Diagnostics] button in the "Diagnostics" screen.

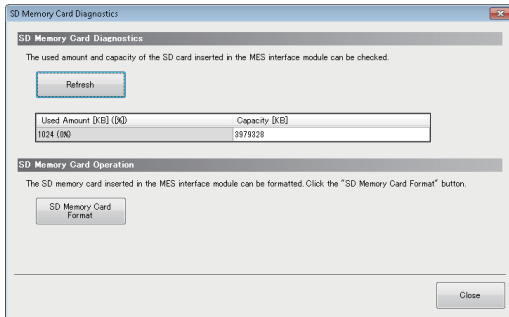

Displayed items

Item		Description
SD Memory Card Diagnostics	[Refresh] button	Click this to update the status of an SD memory card to the latest information.
	Used Amount [KB] ((%))	Displays the used amount and use rate of an SD memory card.
	Capacity [KB]	Displays the capacity of an SD memory card.
SD Memory Card Operation	[SD Memory Card Format] button	Click this to format an SD memory card.

Precautions

All the settings of MES interface module will be lost if the SD memory card is formatted since the settings are saved in the SD memory card.

Read the current setting as necessary, and write the setting after formatting the card.

If the power is OFF to ON or the CPU module is reset without writing the setting in the SD memory card, the IP address of MES interface module returns to the initial status (192.168.3.3).

Detailed log (working history)

Displays the execution result of the job for each action, processing flow, and data flow.

The detailed log can be displayed when selecting "Output" for the "Detailed Log" in the verification settings.

A detailed log is output for the job executed with one-shot execution regardless of the verification settings.

Window

Click the [Display] button in the [Working History] tab in the "Job Diagnostics" screen, or execute a one-shot job.

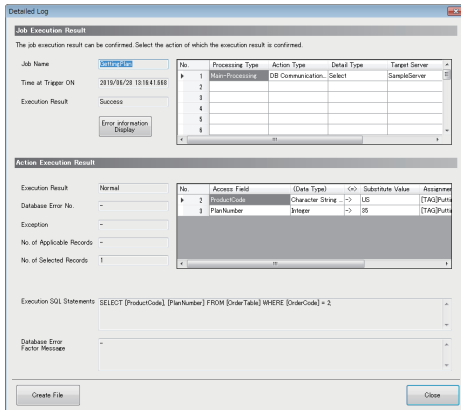

Displayed items

Item		Description
Job Execution Result	Job Name	Displays the job name that displays the detailed log.
	Time at Trigger ON	Displays the date and time when the trigger condition of the job is satisfied.
	Execution Result	Displays the execution result of the job.
	[Error Information Display] button	Displays the error information of the job that the one-shot is executed. [Error Information Display] button is displayed only for the detailed log at one-shot execution.
	Processing Type	Displays the processing type.
	Action Type	Displays the action type.
	Detail Type	Displays the detail type of action.
	Target Server	Displays the target server accessed in the action.
	Access Table/Procedure	Displays the access table/procedure accessed in the action.
[Create File] button		Click this to open the "Browse For Folder" screen. Page 178 Saving detailed logs

■DB communication action

- Type: For the type other than Stored Procedure

Item	Description	
Action Execution Result	Execution Result	Displays the execution result of a selected action.
	Database Error No.	An error number acquired from a database server is displayed when "Error" is displayed for "Execution Result" and "Direct DB Connection" is selected for "Access Type."
	Exception	Displays the contents of the exception that occurs.
	Applicable Record	Displays the number of selected records as a result of Select or Multiple Select. "-" is displayed when the notification is not set in the [Option] tab in the "DB Communication Action Setting" screen. (☞ Page 126 [Option] tab)
	Selected Record	Displays the number of selected records as a result of Select or Multiple Select. "-" is displayed when Multiple Select is executed and the notification is not set in the [Option] tab in the "DB Communication Action Setting" screen. (☞ Page 126 [Option] tab)
	Inserted Record	Displays the number of inserted records as a result of the optional function (Insert New Record (UPSERT)) for an exception in Insert, Multiple Insert, or Update.
	Updated Record	Displays the number of updated records as a result of Update.
	Deleted Record	Displays the number of deleted records as a result of Delete.
	Required Record	Displays the number of records requested in Multiple Select. The number of records to be displayed varies depending on the maximum number of records settings in the [Option] tab in the "DB Communication Action Setting" screen. (☞ Page 126 [Option] tab) • Set: The maximum number of records is displayed. • Not Set: The array size of a device tag for the assignment data is displayed.
	Access Field* ¹	Displays the access field.
	(Data Type)* ¹	Displays the data type of an access field.
	⇔* ¹	Displays the data assignment direction.
	Substitute Value* ^{1*2}	Displays the substituted value as a result of action.
	Assignment Data* ¹	Displays the assigned data.
	(Data Type)* ¹	Displays the data type of the assignment data.
	Execution SQL Statements	Displays the executed SQL statements* ³ .
Database error factor message	An error factor message acquired from a database server is displayed when "Error" is displayed for "Execution Result" and "Direct DB Connection" is selected for "Access Type."	

*1 When selecting "Multiple Select" or "Multiple Insert," only a result for data in the first record of the database is displayed.

*2 For the data types "FLOAT [Single Precision]" and "FLOAT [Double Precision]," up to 6 and 15 digits of the mantissa part, respectively, are displayed.

*3 The execution SQL statements may not be displayed properly when using the following combination of modules and software. In that case, update MX MESInterface-R.

MES interface module: RD81MES96 with firmware version '06' or later, or RD81MES96N

MX MESInterface-R: '1.03D' or earlier

- Type: Stored Procedure

Item	Description	
Action Execution Result	Execution Result	Displays the execution result of a selected action.
	Database Error No.	An error number acquired from a database server is displayed when "Error" is displayed for "Execution Result" and "Direct DB Connection" is selected for "Access Type."
	Return Value	Displays the return value of the executed procedure.
	Access Procedure Argument	Displays the access procedure argument.
	(Data Type)	Displays the data type of the access procedure argument.
	⇔	Displays the data assignment direction.
	Substitute Value* ¹	Displays the substituted value as a result of action.
	Assignment Data	Displays the assigned data.
	(Data Type)	Displays the data type of the assignment data.
	Execution Procedure	Displays the executed procedure.
	Database error factor message	An error factor message acquired from a database server is displayed when "Error" is displayed for "Execution Result" and "Direct DB Connection" is selected for "Access Type."

*1 For the data types "FLOAT [Single Precision]" and "FLOAT [Double Precision]," up to 6 and 15 digits of the mantissa part, respectively, are displayed.

External communication action

Item		Description
Action Execution Result	Execution Result	Displays the execution result of a selected action.
	Exception	Displays the contents of the exception that occurs.
	Return Value	Displays the return value of the executed program.
	Expected Value	Displays the expected value of the return value judgment.
	Execution Command	Displays the execution command required to the communication target.

Operation action

Item		Description
Action Execution Result	Execution Result	Displays the execution result of a selected action.*1
	Array Size	Displays the number of substituted arrays when an array tag is used in a selected action.
	Substitution Item*2*3	Setting row: The data that the operation result is substituted is displayed. Substitute value row: The value actually used is displayed.
	(Data Type)	Displays the data type of the data (substitution item) that the operation result is substituted.
	Operator	Displays the operator.
	First Item*2*3	Setting row: The data (first item) used for operation is displayed. Substitute value row: The value actually used is displayed.
	(Data Type)	Displays the data type of the data (first item) used for operation.
	Second Item*2*3	Setting row: The data (second item) used for operation is displayed. Substitute value row: The value actually used is displayed.
	(Data Type)	Displays the data type of the data (second item) used for operation.

*1 If an array tag is used in a selected action, only the operation result of the first component of an array is displayed and the operation results of the second one and the subsequent ones are not displayed.

*2 The setting contents and the substitute value are displayed, respectively, in the first row (setting row) and the second row (substitute value row) for each operation No.

No.	Substitution Item	(Data Type)	Operator	First Item	(Data Type)	Second Item
1	[LOCAL]Conversion	FLOAT[Single Pr...	/	[TAG]GettingData.Weight_g	Word [Unsigned].	[REAL]1000
	5.08000E-1			508		1000

← Setting row
← Substitute value row

*3 For the data types "FLOAT [Single Precision]" and "FLOAT [Double Precision]," up to 6 and 15 digits of the mantissa part, respectively, are displayed.

Saving detailed logs

Detailed logs are saved in a CSV file (diagnose information file).

For details on a CSV file (diagnose information file), refer to the following:

📄 Page 335 Diagnose information file

Operating procedure

1. Click the [Create File] button of the "Detailed Log" screen.
2. Specify a save location in the "Browse For Folder" screen.
3. Click the [OK] button.

Detailed log (failure history)

The following shows the screen for displaying details of a log which is output if an operation to a database server fails when "Direct DB Connection" is selected for "Access Type."

Window

Click the [Display] button in the [Failure History] tab in the "Job Diagnostics" screen.

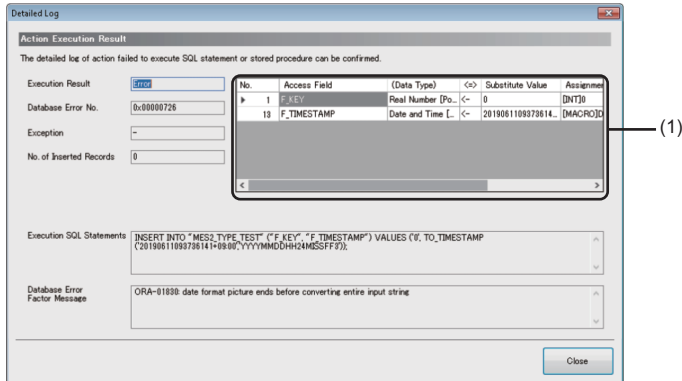

Displayed items

Item	Description
Execution Result	"Error" is displayed.
Database Error No.	An error number acquired from a database server is displayed.
Exception	"-" is displayed.
No. of Applicable Records	The number of selected records is displayed as a result of Select or Multiple Select. "-" is displayed when the notification is not set in the [Option] tab in the "DB Communication Action Setting" screen. (Page 126 [Option] tab)
No. of Selected Records	The number of selected records is displayed as a result of Select or Multiple Select. "-" is displayed when the notification is not set in the [Option] tab in the "DB Communication Action Setting" screen. (Page 126 [Option] tab)
No. of Inserted Records	The number of inserted records is displayed as a result of Insert or Multiple Insert.
No. of Updated Records	The number of updated records is displayed as a result of Update.
No. of Deleted Records	The number of deleted records is displayed as a result of Delete.
No. of Required Records	The number of records requested in Multiple Select is displayed. The number of records to be displayed varies depending on the maximum number of records settings in the [Option] tab in the "DB Communication Action Setting" screen. (Page 126 [Option] tab) <ul style="list-style-type: none"> Set: The maximum number of records is displayed. Not Set: The array size of a device tag for the assignment data is displayed.
Return Value	A return value of an executed procedure is displayed as a result of Stored Procedure. "-" is displayed when there is no return value or the notification of a return value is not set.
(1) Assignment result list	A result of assignment to an access field or access procedure argument is displayed.
Execution SQL Statements	An execution SQL statement or execution procedure of a DB communication action is displayed.
Database error factor message	An error factor message acquired from a database server is displayed.

Trigger buffering status confirmation

The following shows the screen for displaying the trigger buffering status in an MES interface module.

Window

Click the [Trigger Buffering Status Confirmation] button in the "Job Diagnostics" screen.

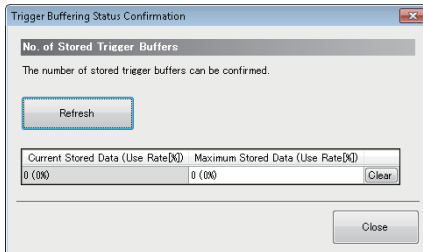

Displayed items

Item		Description
[Refresh] button		Click this to update the trigger buffering status to the latest information.
Trigger Buffering Status	Current Stored Data (Use Rate [%])	Displays the current number of stored trigger buffers and use rate.
	Maximum Stored Data (Use Rate [%])	Displays the maximum number of stored trigger buffers and use rate after starting MES interface module.
	[Clear] button	Clears the maximum stored data.

Management

Information in an MES interface module can be displayed and operations can be performed to it.

Firmware update management

The following shows the screen and procedure for displaying and changing the prohibition state of the firmware update set in an MES interface module.

2

Window

Select [Online] ⇒ [Manage MES Interface Module].

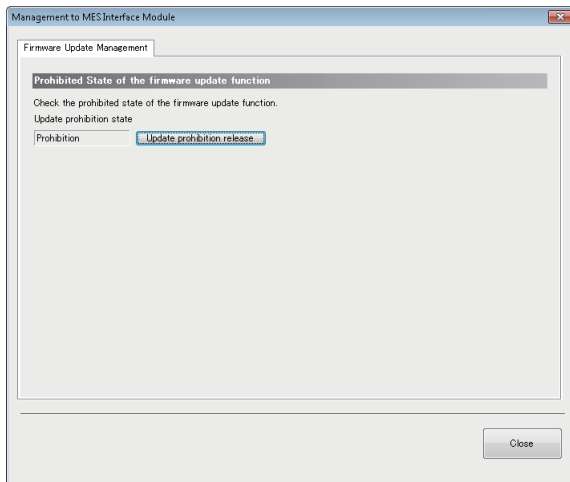

Displayed items

Item	Description
Update prohibition state	The prohibition state of the firmware update is displayed.
[Update prohibition] button ^{*1}	Click this to display the "Firmware Update Function Prohibition Operation" screen.
[Update prohibition release] button ^{*2}	☞ Page 181 Changing the prohibition state of the firmware update

*1 Appears when "Permission" is displayed for "Update prohibition state."

*2 Appears when "Prohibition" is displayed for "Update prohibition state."

■ Changing the prohibition state of the firmware update

Operating procedure

• For setting it to "Prohibition"

1. Set a password for "Prohibition release password" and "Prohibition release password (Confirm Password)" (8 to 16 characters).
2. Click the [OK] button.

• For setting it to "Permission"

1. Enter a password set for "Prohibition release password."
2. Click the [OK] button.

Point

If a prohibition release password is forgotten, initialize an MES interface module. "Update prohibition state" will be set to "Permission."

☞ Page 99 Initialization function

■Startup time after updating the firmware

The startup time of a product may differ depending on the firmware version, and a firmware update may affect system behavior.

To make a system program run on the startup of this product, configure an interlock using input/output signals.

For the input/output signals, refer to the following:

☞ Page 270 Input/Output Signals

One-shot execution

Request one-shot execution of a job specified for an MES interface module.

Operating procedure

Select [Online] ⇒ [One-Shot Execution].

2.13 Help

This section shows the help function for the following operations.

- Opening the user's manual
- Connection to MITSUBISHI ELECTRIC FA Global Website
- Version information

Opening the user's manual

The user's manual (operation help) can be opened by the following operation.

Operating procedure

Select [Help] ⇒ [MELSEC iQ-R MES Interface Module Help].

Connection to MITSUBISHI ELECTRIC FA Global Website

MITSUBISHI ELECTRIC FA Global Website can be opened in a web browser by the following operation.

Operating procedure

Select [Help] ⇒ [Connection to MITSUBISHI ELECTRIC FA Global Website].

Version information

The version information and user registration information of MES Interface Function Configuration Tool can be displayed by the following operation.

Operating procedure

Select [Help] ⇒ [Version Information].

3 DB CONNECTION SERVICE AND SETTING TOOL

This chapter explains DB Connection Service and DB Connection Service Setting Tool.

For the startup method and screen configuration for DB Connection Service Setting Tool, refer to the following:

📖 MELSEC iQ-R MES Interface Module User's Manual (Startup)

3.1 DB Connection Service Functions

The information linkage function of MES interface module can be used by installing DB Connection Service on the server.

Point

- DB Connection Service is required to be installed on all the database servers and application servers accessed from MES interface module.
- When using DB Connection Service on the database server, the ODBC setting for the database to be used is required to be set in advance. For the ODBC setting procedure, refer to the manuals and online help for the database software and operating system used.
- When using DB Connection Service on the application server, an account for user program execution is required to be created in advance.
- The setting for DB Connection Service can be changed in DB Connection Service Setting Tool. (📖 Page 189 Setting Items)

DB connection function

The DB connection function connects an MES interface module and the ODBC interface for database.

The following shows the operation on the database server.

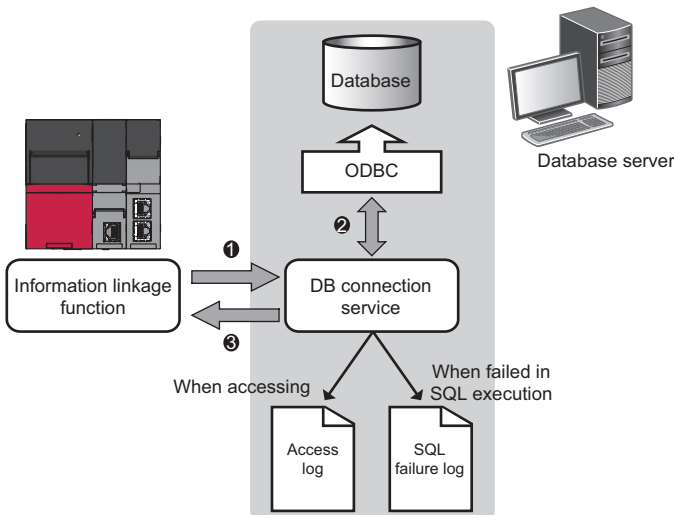

- 1 An SQL statement or stored procedure execution request is received from the information linkage function performing on MES interface mode.
- 2 The SQL statement or stored procedure is executed by accessing the database via ODBC interface.
- 3 The execution result is sent to MES interface module.

Program execution function

The program execution function executes a program on an application server upon request from an MES interface module. The following shows the operation on the application server.

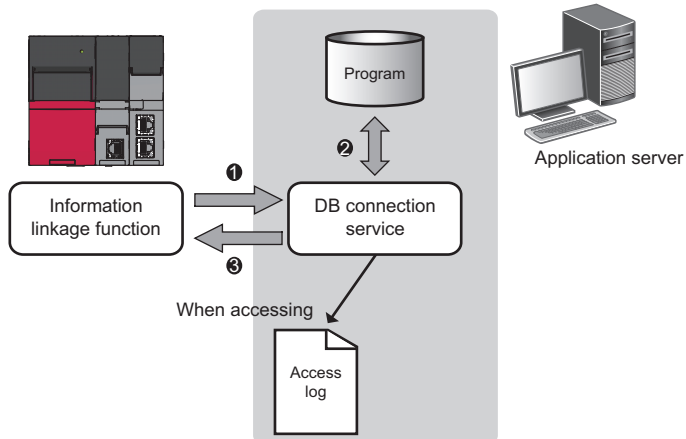

- 1 A program execution request is received from the information linkage function performing on MES interface module.
- 2 The program on the application server is executed.*1
- 3 The program execution result is sent to MES interface module.

*1 DB Connection Service Client (user session) executes programs.
DB Connection Service Client is automatically started at the time of user login.

DB information browse function

The DB information browse function sends the table information (table name, view name, and field name) or stored procedure information in a database to MES Interface Function Configuration Tool.

This function is performed when browsing the table information or stored procedure information with the communication action setting of the MES Interface Function Configuration Tool.

☞ Page 158 DB table information browse

☞ Page 158 DB field information browse

☞ Page 159 DB procedure information browse

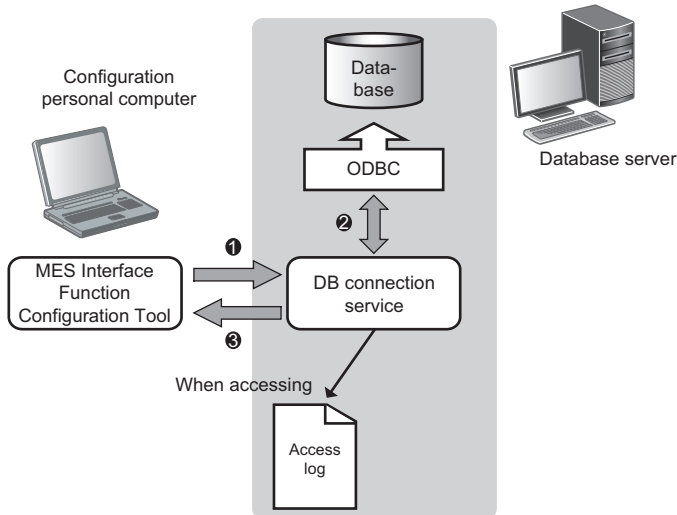

- 1 When the [Browse DB Table Information], [Browse DB Field Information], or [Browse DB Procedure Information] button is clicked in MES Interface Function Configuration Tool, a request to browse table information or stored procedure information is received from the MES Interface Function Configuration Tool.
- 2 The table information (table name, view name, and field name) or stored procedure information in a database is acquired.
- 3 It is returned to the MES Interface Function Configuration Tool.

Security function

The security function can specify the IP address of an MES interface module and a configuration personal computer that can connect to DB Connection Service to ensure the security of the server.

Batch specification using the mask bit length specification is possible.

If the security function is not used, any MES interface module and configuration personal computer can be connected to DB Connection Service.

Log output function

DB Connection Service outputs an access log and an SQL failure log.

Access log

The communication contents of an MES interface module, the configuration personal computer, and DB Connection Service are output to the access log.

For the access log specifications, refer to the following:

 Page 197 Access log

SQL failure log

The error contents are output to the SQL failure log when the SQL statement or stored procedure cannot be completed normally in the database due to the reason such as no table exists.

For the SQL failure log specifications, refer to the following:

 Page 201 SQL failure log

Log charset specification

A log file (access log, SQL failure log) is output in ASCII/SJIS or Unicode (UTF-8) depending on the log charset specification of DB Connection Service Setting Tool.

When the settings of the "Log charset" are changed, a new log is output by switching the output file, even if the "access log capacity" specified by the user is not achieved.

The file name at the time of switching the output file is changed in the same way as when the file capacity exceeds.

3.2 Setting Items

This section shows the screen for changing the setting contents for DB Connection Service.

The setting contents of DB Connection Service, which is currently in operation, are displayed during startup.

Operating procedure

1. Set the following items, then click the [Reflect settings] button.

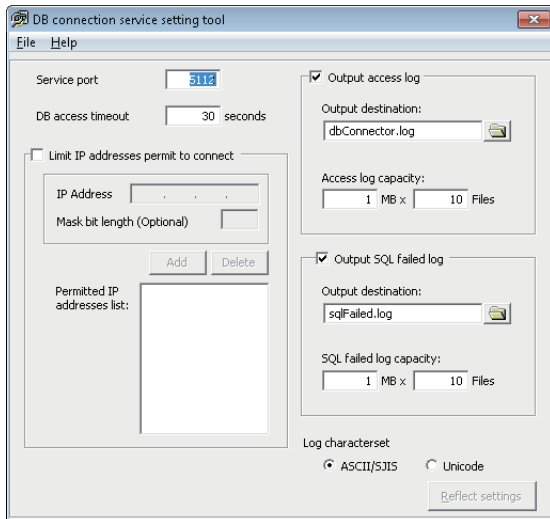

Item	Description
Service port (required)	Set the port number where DB Connection Service runs.
DB access timeout (required)	Set a DB access timeout time (unit: second) for the case when no response is returned to MES interface module after requesting the server to write/read the value to/from the database or execute a program.
Limit IP addresses permit to connect	Specify whether to set the connection-permitted IP address.
Output access log	Set whether to output the access log.
Output SQL failed log	Set whether to output the SQL failure log.
Log character set	Specify the character code of the log file (access log, SQL failure log) that is output by DB Connection Service in ASCII/SJIS or Unicode.

2. After applying the setting, check whether any errors occur in the event viewer of Windows.

Precautions

- Change the setting for DB Connection Service while a job that uses it is not running.

The status is as follows:

- The programmable controller is powered OFF.
- The MES interface function is stopped to perform with [Online] ⇔ [Remote operation] of MES Interface Function Configuration Tool. (Page 168 MES interface module diagnostics)

- When reflecting the settings while a job using DB Connection Service is running, the execution of the connected job is canceled and a communication error occurs.

For a job in which the DB buffering is enabled, any SQL statement is buffered in the DB buffer.

Service port (required)

Set the port number where DB Connection Service runs. *1*2

The set port number is used for communications with MES interface module and a configuration personal computer.

*1 Set the value in [Service port] same as the one set in [Port No.] of [Access Target Server Settings] of MES Interface Function Configuration Tool.

☞ Page 152 Target Server Settings

*2 Specify a port number that is not being used by any database or other applications. Usually, it does not need to be changed.

Setting data

Setting range: 1024 to 65535, Default: 5112

DB access timeout (required)

Set a DB access timeout time (unit: second) for the case when no response is returned to MES interface module or a configuration personal computer after requesting the server to write/read the value to/from the database or execute a program.

When a timeout occurs, the connection with MES interface module or a configuration personal computer is disconnected and job execution is canceled.

Set the setting values in "Connection time out time" for [Access Target Server Settings] in MES Interface Function Configuration Tool and "DB access timeout time" in DB Connection Service Setting Tool as follows:

- Setting value of connection timeout time \leq setting value of DB access timeout time

Setting data

Setting range: 1 to 3600, Default: 30

Limit IP addresses permit to connect

Specify whether to set the connection-permitted IP address.

By checking the "Limit IP addresses permit to connect" checkbox, connection is permitted only from MES interface module and the configuration personal computer with the set IP address.

At least one IP address needs to be set for connection-permitted IP address. Up to 64 IP addresses can be set for it.

When not checking the "Limit IP addresses permit to connect" checkbox, connection is permitted from any MES interface module and configuration personal computer.

When checking the "Limit IP addresses permit to connect" checkbox, set the IP addresses with connection permission.

Adding connection-permitted IP addresses

■To specify an individual IP address

Operating procedure

1. Set the following items, then click the [Add] button.

Item	Description
IP address	Set a connection-permitted IP address in decimal.
Mask bit length	(Blank)

2. The IP address is added to the "Permitted IP addresses list".

■When specifying IP addresses in batch

Operating procedure

1. Set the following items, then click the [Add] button.

Item	Description
IP address	Set a connection-permitted IP address in decimal.
Mask bit length	Set the enabled bit length of the set IP address. (Setting range: 1 to 32)

2. The IP address and mask bit length are added to the "Permitted IP addresses list".

Ex.

If the IP address is set to '192.168.0.64' and Mask bit length is set to '26', the range of the connection-permitted IP address are from '192.168.0.64' to '192.168.0.127' whose logical product is '192.168.0.64'.

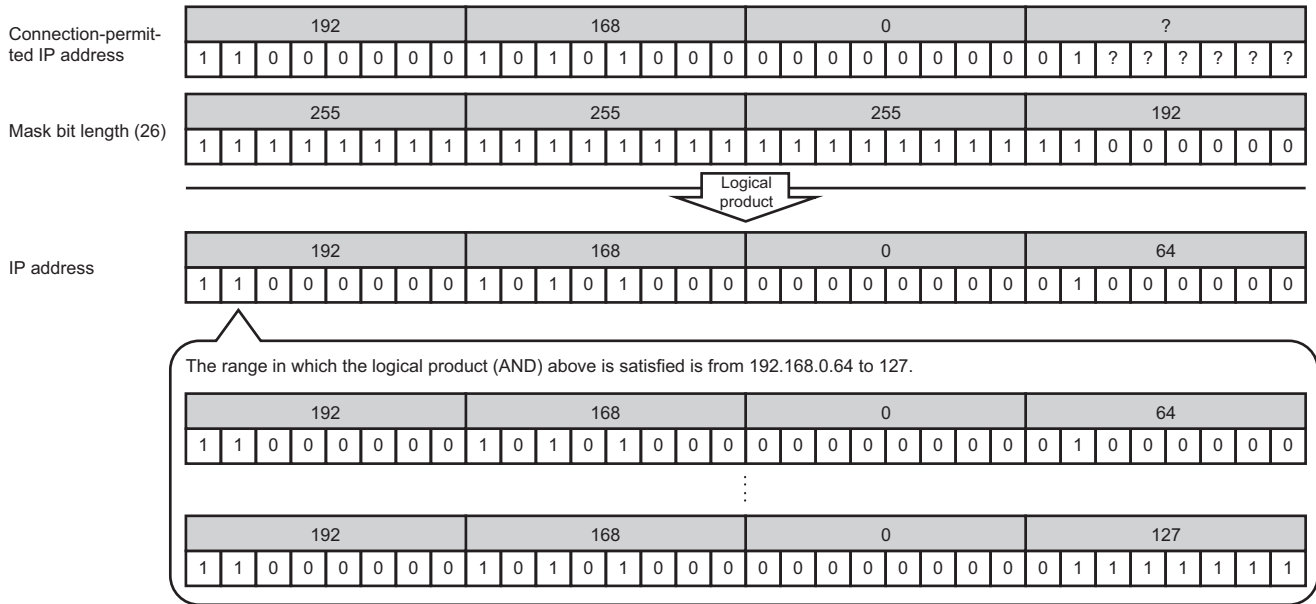

Deleting connection-permitted IP addresses

Select the IP address to be deleted from "Permitted IP addresses list", then click the [Delete] button.

Output access log

Set whether to output the access log.

When checking the "Output access log" checkbox, set the following items.

Item	Description
Output destination	Set the output destination of a log file.
Access log capacity	Set the capacity of an access log file and number of files.

Setting data

Default: Output

Output destination

Set the output destination of a log file.

If a file name only is specified, the log is output to a install folder.

If a read-only file is specified, the log is not output and "Access log output error" is output to the event viewer of Windows.

Setting data

Default: "dbConnector.log"

Access log capacity

Set the capacity of an access log file and number of files.

If the capacity for a file is exceeded, the log is copied to a file with a numbered file name and a new log file is created.

If the total number of files exceeds the one which is set, the file is deleted from the oldest one.

Setting data

Setting range: 1 to 10 MB × 2 to 100 files, Default: 1 MB × 10 files

Ex.

When the output destination is set to 'dbConnector.log' and the access log capacity is set to '1MB × 3 files'

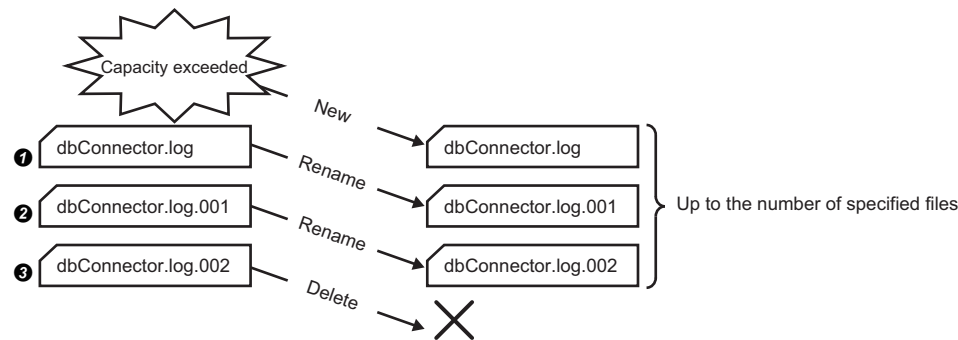

- ❶ When "dbConnector.log" exceeds 1M byte, it is renamed as "dbConnector.log.001". A new "dbConnector.log" is created and the logging restarts again.
- ❷ "dbConnector.log.001" is renamed as "dbConnector.log.002".
- ❸ "dbConnector.log.002" is deleted because the total number of files exceeds 3.

Output SQL failed log

Set whether to output the SQL failure log.

When checking the "Output SQL failed log" checkbox, set the following items.

Item	Description
Output destination	Set the output destination of a log file.
SQL failed log capacity	Set the file capacity for each SQL failure log and number of files.

Setting data

Default: Output

Output destination

Set the output destination of a log file.

If no output destination is set, the log is output to a install folder.

If a read-only file is specified, the log is not output and "SQL failure log output error" is output to the event viewer of Windows.

Setting data

Default: "sqlFailed.log"

SQL failed log capacity

Set the file capacity for each SQL failure log and number of files.

If the capacity for a file is exceeded, the log is copied to a file with a numbered file name and a new log file is created.

If the total number of files exceeds the one which is set, the file is deleted from the oldest one.

Setting data

Setting range: 1 to 10 MB × 2 to 100 files, Default: 1 MB × 10 files

Specify the log character set

Specify the character code of a log file (access log, SQL failure log) that is output by DB Connection Service in ASCII/SJIS or Unicode.

The specified character code is enabled after the settings are updated.

Setting data

Default: ASCII/SJIS

3.3 Importing/Exporting Files

Import/export a file.

Import

Import a saved file.

Operating procedure

1. Select [File] ⇒ [Import] from the menu.
2. The "Open" screen is displayed.

Set the following items, then click the [Open] button.

Item	Description
Look in	Select the location where the file is stored.
File name	Specify the name of the file to be imported.
Files of type	Select a type of the file to be imported. • DB connection service setting files (*.xml)

Precautions

When importing a file, use the one that was stored by the export function.
Do not edit any export file.

Export

Export the setting contents in DB Connection Service Setting Tool to a file.

Operating procedure

1. Select [File] ⇒ [Export] from the menu.
2. The "Save As" screen appears.

Set the following items, then click the [Save] button.

Item	Description
Save in	Select the location where the file is to be saved.
File name	Specify the name of the file to be saved.
Files of type	Select a type of the file to be saved. • DB connection service setting files (*.xml)

3.4 Help

The product information of DB Connection Service Setting Tool and MITSUBISHI ELECTRIC FA Global Website are displayed.

Product information

Operating procedure

1. Select [Help] ⇒ [Product information] from the menu.
2. The "Product information" screen of DB Connection Service Setting Tool appears.

Connection to MITSUBISHI ELECTRIC FA Global Website

Operating procedure

1. Select [Help] ⇒ [Connect to MITSUBISHI ELECTRIC FA Global Website] from the menu.
2. The MITSUBISHI ELECTRIC FA Global Website appears.

3.5 Output Log Specifications

This section shows the output log format for the access log and the SQL failure log.

- [Date] [Error code] Message Line feed

Item			Description	
Output character	[Date]	Year	1st to 4th bytes from the head of the line	4-digit integer for year (Numerals)
		Year - Month delimiter	5th byte from the head of the line	"/" (Slash: 2FH)
		Month	6th to 7th bytes from the head of the line	2-digit integer (01 to 12) (Numerals)
		Month - Day delimiter	8th byte from the head of the line	"/" (Slash: 2FH)
		Day	9th to 10th bytes from the head of the line	2-digit integer (01 to 31) (Numerals)
		Day - Hour delimiter	11th byte from the head of the line	" " (Space: 20H)
		Hour	12th to 13th bytes from the head of the line	2-digit integer (00 to 23) (Numerals)
		Hour - Minute delimiter	14th byte from the head of the line	":" (Colon: 3AH)
		Minute	15th to 16th bytes from the head of the line	2-digit integer (00 to 59) (Numerals)
		Minute - Second delimiter	17th byte from the head of the line	":" (Colon: 3AH)
		Second	18th to 19th bytes from the head of the line	2-digit integer (00 to 59) (Numerals)
		Second - Millisecond delimiter	20th byte from the head of the line	"." (Period: 2EH)
		Millisecond	21st to 23rd bytes from the head of the line	3-digit integer (000 to 999) (Numerals)
		Millisecond - Error code delimiter	24th byte from the head of the line	" " (Space: 20H)
	[Error code] ^{*1}	25th to 34th bytes from the head of the line	Alphanumeric characters of "0x" + 8-digit hexadecimal	
	Error code - Message delimiter	35th byte from the head of the line	" " (Space: 20H)	
	Message	36th or later byte from the head of the line	According to the specifications of each log	
	Line feed	End of the line	CR + LF (0DH, 0AH)	

*1 For error codes, refer to the following:

 Page 241 Error Code List

Access log

The communication contents of an MES interface module and DB Connection Service are output to an access log.

Restriction

For an access log to which a processing result (Success or Failed) is output, a numerical value inserted after 'Success' may not be normal if a trigger is set in the table.

(Example) Access log when selecting "Select"

2005/03/01 12:00:00.000 0x00000000 SID 0:SQL<SELECT * from TABLE;>:Success(-1)

The processing result is successful in this example, but it is output for the trigger instead of the number of selected records.

Service start/end

Start

Item	Description
Output log format	[Date] [Error code] Service Start
Example	2015/08/01 12:00:00.000 0x00000000 Service Start

End

Item	Description
Output log format	[Date] [Error code] Service Stop
Example	2015/08/01 12:00:00.000 0x00000000 Service Stop

Connection/disconnection from MES interface module

Connection

Item	Description
Output log format	[Date] [Error code] SID [Session ID]:MIFWS Connected:[Source IP]:[Target data source]:[Connection User Name]
Example	2015/08/01 12:00:00.000 0x00000000 SID 00000001:MIFWS Connected:192.168.3.3:DataSource:UserName

Disconnection

Item	Description
Output log format	[Date] [Error code] SID [Session ID]:MIFWS Disconnected:[Source IP]:[Target data source]:[Connection User Name]
Example	2015/08/01 12:00:00.000 0x00000000 SID 00000001:MIFWS Disconnected:192.168.3.3:DataSource:UserName

Connection/disconnection to a database

For details on [Database error number] and [Database error message] in the output log format in the case of failure, refer to the manual for each database.

Depending on the [Error code], the contents after 'Database Message' are not be output.

According to the error code, check the error contents and take corrective actions.

 Page 260 Access log of DB Connection Service

Connection

Item	Description
Output log format	When succeeded [Date] [Error code] SID [Session ID]:DB Connect:[Target data source]:[Connection User Name]:Success
	When failed [Date] [Error code] SID [Session ID]:DB Connect:[Target data source]:[Connection User Name]:Failed Database Message [Database error number] [Database error message]
Example	When succeeded 2015/08/01 12:00:00.000 0x00000000 SID 00000001:DB Connect:DataSource:UserName:Success
	When failed 2015/08/01 12:00:00.000 0x20400022 SID 00000001:DB Connect:DataSource:UserName:Failed Database Message 0x000003f9 [Oracle][ODBC][Ora]ORA-01017: invalid username/password;logon denied

■ Disconnection

Item		Description
Output log format	When succeeded	[Date] [Error code] SID [Session ID]:DB Disconnect:[Target data source]:[Connection User Name]:Success
	When failed	[Date] [Error code] SID [Session ID]:DB Disconnect:[Target data source]:[Connection User Name]:Failed Database Message [Database error number] [Database error message]
Example	When succeeded	2015/08/01 12:00:00.000 0x00000000 SID 00000001:DB Disconnect:DataSource:UserName:Success

SQL statement reception/processing results

For details on [Database error number] and [Database error message] in the output log format in the case of failure, refer to the manual for each database.

Depending on the [Error code], the contents after 'Database Message' are not be output.

According to the error code, check the error contents and take corrective actions.

☞ Page 260 Access log of DB Connection Service

■ SELECT

Item		Description
Output log format	When succeeded	[Date] [Error code] SID [Session ID]:SQL<[SQL statement]>:Success([No. of selected records])
	When failed	[Date] [Error code] SID [Session ID]:SQL<[SQL statement]>:Failed Database Message [Database error number] [Database error message]
Example	When succeeded	2015/08/01 12:00:00.000 0x00000000 SID 00000001:SQL<SELECT COL from TABLE;>:Success(1)
	When failed	2015/08/01 12:00:00.000 0x20600023 SID 00000001:SQL<SELECT COLL from TABLE;>:Failed Database Message 0x00000388 [Oracle][ODBC][Ora]ORA-00904: "COLL": invalid identifier

■ UPDATE

Item		Description
Output log format	When succeeded	[Date] [Error code] SID [Session ID]:SQL<[SQL statement]>:Success([No. of updated records])
	When failed	[Date] [Error code] SID [Session ID]:SQL<[SQL statement]>:Failed Database Message [Database error number] [Database error message]
Example	When succeeded	2015/08/01 12:00:00.000 0x00000000 SID 00000001:SQL<UPDATE TABLE SET COL = '1';>:Success(1)
	When failed	2015/08/01 12:00:00.000 0x20600023 SID 00000001:SQL<UPDATE TABLE SET COL = 'COL';>:Failed Database Message 0x000006ba [Oracle][ODBC][Ora]ORA-01722: invalid number

■ INSERT

Item		Description
Output log format	When succeeded	[Date] [Error code] SID [Session ID]:SQL<[SQL statement]>:Success([No. of inserted records])
	When failed	[Date] [Error code] SID [Session ID]:SQL<[SQL statement]>:Failed Database Message [Database error number] [Database error message]
Example	When succeeded	2015/08/01 12:00:00.000 0x00000000 SID 00000001:SQL<INSERT INTO TABLE (COL) VALUES ('1');>:Success(1)
	When failed	2015/08/01 12:00:00.000 0x20600023 SID 00000001:SQL<INSERT INTO TABLE (COL) VALUES ('1');>:Failed Database Message 0x000003ae [Oracle][ODBC][Ora]ORA-00942: table or view does not exist

■ COMMIT

Item		Description
Output log format	When succeeded	[Date] [Error code] SID [Session ID]:COMMIT:Success
	When failed	[Date] [Error code] SID [Session ID]:COMMIT:Failed Database Message [Database error number] [Database error message]
Example	When succeeded	2015/08/01 12:00:00.000 0x00000000 SID 00000001:COMMIT:Success

■ROLLBACK

Item		Description
Output log format	When succeeded	[Date] [Error code] SID [Session ID]:ROLLBACK:Success
	When failed	[Date] [Error code] SID [Session ID]:ROLLBACK:Failed Database Message [Database error number] [Database error message]
Example	When succeeded	2015/08/01 12:00:00.000 0x00000000 SID 00000001:ROLLBACK:Success

■GetNext (Request for the next record)

Item		Description
Output log format	When succeeded	[Date] [Error code] SID [Session ID]:GetNext:Success
	When failed	[Date] [Error code] SID [Session ID]:GetNext:Failed Database Message [Database error number] [Database error message]
Example	When succeeded	2015/08/01 12:00:00.000 0x00000000 SID 00000001:GetNext:Success

■DELETE

Item		Description
Output log format	When succeeded	[Date] [Error code] SID [Session ID]:SQL<[SQL statement]>:Success([No. of deleted records])
	When failed	[Date] [Error code] SID [Session ID]:SQL<[SQL statement]>:Failed Database Message [Database error number] [Database error message]
Example	When succeeded	2015/08/01 12:00:00.000 0x00000000 SID 00000001:SQL<DELETE FROM TABLE;>:Success(1)
	When failed	2015/08/01 12:00:00.000 0x20600023 SID 00000c60:SQL<DELETE FROM table1 ;>:Failed Database Message 0x000003ae [Oracle][ODBC][Ora]ORA-00942: table or view does not exist.

Stored procedure execution reception/processing results

Item		Description
Output log format	When succeeded	[Date] [Error code] SID [Session ID]:Procedure<[Procedure name]>([Value in argument 1][, Value in argument 2][, ...])>:Success([Return value])
	When failed	[Date] [Error code] SID [Session ID]:Procedure<[Procedure name]>([Value in argument 1][, Value in argument 2][, ...])>:Failed Database Message [Database error number] [Database error message]
Example	When succeeded	2015/08/01 12:00:00.000 0x00000000 SID 00000e14:Procedure<StoredProcedure1('10', '0', ..., '0')>:Success(0)
	When failed	2015/08/01 12:00:00.000 0x20f00007 SID 00000794:Procedure<StoredProcedure1>:Failed Database Message 0x00000afc [Microsoft][SQL Server Native Client 11.0][SQL Server] stored procedure 'StoredProcedure1' does not exist.

Program execution reception/processing results

Item		Description
Output log format	When succeeded	[Date] [Error code] ProgramExec:[Source IP]:<[Command line]>:Success([Return value])
	When failed	[Date] [Error code] ProgramExec:[Source IP]:<[Command line]>:Failed
Example	When succeeded	2015/08/01 12:00:00.000 0x00000000 ProgramExec:192.168.3.3:<sample.exe>:Success(0)

Table name/field name/stored procedure name browsing results

■Table name browsing

Item		Description
Output log format	When succeeded	[Date] [Error code] SID [Session ID]:Table Get:Success
	When failed	[Date] [Error code] SID [Session ID]:Table Get:Failed
Example	When succeeded	2015/08/01 12:00:00.000 0x00000000 SID 0:Table Get:Success
	When failed	2015/08/01 12:00:00.000 0x00000000 SID 0:Table Get:Failed

■Field name browsing

Item		Description
Output log format	When succeeded	[Date] [Error code] SID [Session ID]:Field Get:[Table name]:Success
	When failed	[Date] [Error code] SID [Session ID]:Field Get:[Table name]:Failed
Example	When succeeded	2015/08/01 12:00:00.000 0x00000000 SID 0:Field Get: TableName:Success
	When failed	2015/08/01 12:00:00.000 0x00000000 SID 0:Field Get: TableName:Failed

■Stored procedure name browsing

Item		Description
Output log format	When succeeded	[Date] [Error code] SID [Session ID]:Procedure Get:Success
	When failed	[Date] [Error code] SID [Session ID]:Procedure Get:Failed
Example	When succeeded	2015/08/01 12:00:00.000 0x00000000 SID 00000924:Procedure Get:Success
	When failed	2015/08/01 12:00:00.000 0x00000000 SID 00000924:Procedure Get:Failed

■Stored procedure argument information browsing

Item		Description
Output log format	When succeeded	[Date] [Error code] SID [Session ID]:ProcParam Get:[Stored procedure name]:Success
	When failed	[Date] [Error code] SID [Session ID]:ProcParam Get:[Stored procedure name]:Failed
Example	When succeeded	2015/08/01 12:00:00.000 0x00000000 SID 00000924:ProcParam Get:StoredProcedureName:Success
	When failed	2015/08/01 12:00:00.000 0x00000000 SID 00000924:ProcParam Get:StoredProcedureName:Failed

SQL failure log

If an error occurs when the SQL statement or stored procedure is executed in the database, the error contents are output to the SQL failure log.

For details on [Database error number] and [Database error message] in the output log format in the case of failure, refer to the manual for each database.

Depending on the [Error code], the contents after 'Database Message' are not be output.

According to the error code, check the error contents and take corrective actions.

 Page 264 SQL failure log of DB Connection Service

SQL statement execution failed

Item	Description
Output log format	[Date] [Error code] [Target data source]:[SQL statement] Database Message [Database error number] [Database error message]
Example	2015/08/01 12:00:00.000 0x00000000 DataSource:INSERT INTO TABLE (COL) VALUES (""); Database Message 0x00000388 [Oracle][ODBC][Ora]ORA-00904: "COL" :invalid identifier

Stored procedure execution failed

Item	Description
Output log format	[Date] [Error code] [Target data source]:[Procedure name] ([Value in argument 1][, Value in argument 2][, ...]) Database Message [Database error number] [Database error message]
Example	2015/08/01 12:00:00.000 0x20f00007 SQLSERVER:SampleProcedure ('003', 'MES') Database Message 0x00000afc [Microsoft][SQL Server Native Client 11.0][SQL Server] stored procedure 'SampleProcedure' does not exist.

4 Project File Conversion Tool

This chapter explains Project File Conversion Tool.

4.1 About Project File Conversion Tool

Project File Conversion Tool converts the settings for MELSEC-Q series MES interface module (project) to the settings to operate MELSEC iQ-R series MES interface module.

Startup method

Operating procedure

Click 'RMESIFCONV\MUPtoMU2.exe' under the execution file storage destination^{*1} of the MES Interface Function Configuration Tool.

*1 For 64-bit version operating system, it is installed in the following folder:
C:\Program Files(x86)\MELSOFT\RMESIF

Conversion procedure

The following shows the conversion procedure of a project file.

1. Specify a conversion source project file of a MELSEC-Q series MES interface module (*.mup) under "Conversion Source File."

A project file can be specified in the "Conversion Source File Specification" screen displayed by clicking the [...] button.

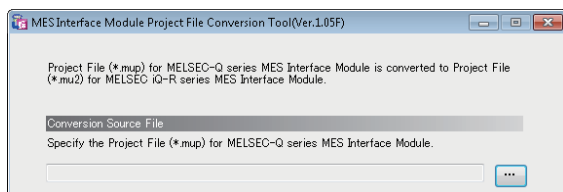

Point

- A project file name with 200 or less characters (including the path) can be converted.
- A project file (whose extension is 'mup') can be specified by dragging and dropping.

2. Specify a conversion target project file of a MELSEC iQ-R series MES interface module (*.mu2) under "Conversion Output File."

A conversion target file is automatically set when a conversion source file is set.

The name with the extension of the conversion source file changed to 'mu2' is set to the conversion target file.

The save destination of the conversion target file and conversion target file name can be changed in the "Conversion Output File Specification" screen displayed by clicking the [...] button.

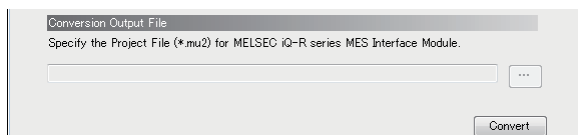

Point

- A project file name with 200 or less characters (including the path) can be converted.
- If the same mu2 file name as the specified conversion target file name, or conversion log files with the same name exists in the save destination of a conversion target file, the file name will be re-named as '(file name)_YYYYMMDDhhmmss.mu2'.
(The time the conversion has been started is added. YYYY: Year, MM: Month, DD: Day, hh: Hour, mm: Minute, ss: Second)

3. Click the [Convert] button.

Project conversion is started.

Note that the conversion may end with an error. For the conversion specifications of a project, refer to the following:

 Page 204 Project Conversion Specifications

Point

- A log file for the result of conversion using Project File Conversion Tool is output in the following situations: project conversion is started, project conversion is ended, and an error occurred. ( Page 203 Conversion log file)
- When the [Cancel] button displayed during the conversion is clicked, the conversion processing can be cancelled. (After the conversion is cancelled, a conversion target file and conversion log file are not output.)

Precautions

During the conversion processing of a project file, a conversion source file and conversion target file cannot be changed.

Conversion log file

A conversion log file is a file where the result of the conversion using Project File Conversion Tool is output.

The file is output when a project conversion is started, a project conversion is ended, and an error occurred.

Specifications

Item	Description
File name ^{*1}	(Conversion target file name).log
Output destination	Conversion target file output folder
Character code	UTF-8 (with BOM)
Output mode	Data is not overwritten. ^{*2}
Format	[Category] Processed year, month, date, hour, minutes, and seconds, Code, Message ^{*3} <ul style="list-style-type: none"> • Category: Info, Error, Warning (Moderate), or Warning (Minor)  Page 203 Category of each conversion message • Processed year, month, date, hour, minutes, and seconds: YYYY/MM/DD HH:MM:SS (If the month, date, hour, minute, and second are less than two digits, a zero will be inserted in front of each value. The time is represented in 24-hour format.) • Code: 8 digits (code corresponds to a message) • Message: A message that indicates conversion information, error, and warning

*1 The file is named as the name specified to "Conversion Output File". The extension '.mu2' is not included.

*2 If the same mu2 file name or the same conversion log file name exists in the output destination, the file name will be re-named as '(log file name)_YYYYMMDDhhmmss.log'.

*3 The display example is as follows:

[Info] 2017/05/15 10:55:06, 50000001, Started the Convert-Processing

■Category of each conversion message

Category	Description
Info	Any of the following information is displayed. <ul style="list-style-type: none"> • Project conversion processing is started. • Project conversion processing is ended.
Error	Any of the following information is displayed. <ul style="list-style-type: none"> • Project file read/write error occurred. • A project file cannot be converted because of the restrictions by the specification of a MELSEC iQ-R MES interface module.
Warning (Moderate)	Warning information is displayed when the setting value is replaced by Project File Conversion Tool without outputting as a conversion error.
Warning (Minor)	

4.2 Project Conversion Specifications

This section explains the specifications of conversion from a MELSEC-Q series MES interface module project file (*.mup) to a MELSEC iQ-R series MES interface module project file (*.mu2).

When a conversion error occurred

When the project file of a MELSEC-Q series MES interface module is set as in the following table, a conversion log file whose category is 'Error' or 'Info' is output and the conversion processing does not proceed. (📄 Page 203 Conversion log file)
Follow the corrective actions below, change the setting of the MELSEC-Q series MES interface module project file, and then convert the file again using Project File Conversion Tool.

Setting name	Description	Corrective action
Access target CPU settings	17 or more settings exist in the access target CPU setting.*1	Configure 16 or less settings for the access target CPU.
	Any of the following unsupported device exists in the MELSEC iQ-R series MES interface module. • PLC series: ACPU, QCPU (A mode), QnACPU	Change the PLC series other than the following: • ACPU • QCPU (A mode) • QnACPU
	The following unsupported network type exists in the MELSEC iQ-R series MES interface module. • Network: C24	Change the network type other than the following: • C24
Server service settings	17 or more settings exist in the server service setting.	Configure 16 or less settings for the server service setting.
	Invalid IP address exists in the MELSEC iQ-R series MES interface module.	Change the IP address to the available one.
	The data source name is blank.	Set a data source name.
	Any of the following unsupported database type exists in the MELSEC iQ-R series MES interface module. • Database type: Oracle8i, Oracle9i, MSDE2000, Access2000, Wonderware Historian	Change the database type other than the following: • Oracle8i • Oracle9i • MSDE2000 • Access2000 • Wonderware Historian
Device tag settings	A device tag component in which statistical processing is set exists.	Invalidate "Perform statistical processes" of the device tag.
	A device used in a device tag component is overlapped.	Change the device of the device tag component to prevent the overlap of the device.
Others	The setting after conversion conflicts with the restriction on MELSEC iQ-R series MES interface module.*2	Perform the following operations. ① Change the extension of the output file from '(file name).mu2.tmp' to 'mu2'. ② Open the file in MELSEC iQ-R series MES Interface Function Configuration Tool. ③ Change the settings by referring to the error contents of the conversion log, or information displayed on the status bar*3 of each setting screen of MES Interface Function Configuration Tool.

*1 When using Project File Conversion Tool stored in MX MESInterface-R with software version '1.10L' or later, no conversion error occurs.

*2 In this case, the conversion fails and data is output as a '(file name). mu2.tmp' file.

*3 Whether or not the setting value conflicts with the restriction can be checked by the color of the setting value. (The upper limit of the setting value is not displayed.)

Red: The setting value conflicts with restriction.

Situations where setting contents are changed

When the project file of a MELSEC-Q series MES interface module is set as in the following table, a conversion log file whose category is 'Warning (Moderate or Minor)' or 'Info' is output and the conversion processing is proceeded as follows. (Page 203 Conversion log file)

Setting name		Setting content	Change result		
Common items	Setting value	The value out of the range of MELSEC iQ-R series MES interface module is set.	The value is converted to the value within the upper limit and lower limit which are available in MELSEC iQ-R series MES interface module.		
System setting	DB buffering settings	Tag/Component	A data type unsupported by MELSEC iQ-R series MES interface module exists.	The setting is changed to none.	
Access target CPU settings	<ul style="list-style-type: none"> Network communication route Co-existence network communication route 	Network	When the following network type is set: <ul style="list-style-type: none"> CC IE Control NET/10(H) 	The network type is changed as follows: <ul style="list-style-type: none"> CC IE Control NET/10(H)→CC-Link IE Controller Network Module 	
Server service settings	Access error notification setting	Tag/Component	A data type unsupported by MELSEC iQ-R series MES interface module exists.	The setting is changed to none.	
	Database type		When any of the following database is set: <ul style="list-style-type: none"> SQL Server 2000/2005/2008/2012/2014/2016/2017/2019 Oracle 10g/11g/12c/18c/19c Access2003/2007/2010/2013/2016/2019 	The database type is changed as follows: <ul style="list-style-type: none"> SQL Server 2000/2005/2008/2012/2014/2016/2017/2019 → SQL Server 2012 Oracle 10g/11g/12c/18c/19c → Oracle 12c Access2003/2007/2010/2013/2016/2019 → Access 2013 	
Device tag settings	Head device		When the start device is any of the following: <ul style="list-style-type: none"> SS, SN, SC 	The device is changed as follows: <ul style="list-style-type: none"> SS→STS SN→STN SC→STC 	
	Sampling settings		—	Within the tag information used as a trigger condition in a job, the shortest sampling interval is converted as an access interval.	
Job settings	Communication action (other than stored procedure)	DB-tag link settings	After conversion, assignment data for an access field became inconsistent.	The assignment data is changed to none.	
	Communication action (stored procedure)	DB-tag link settings	After conversion, assignment data for an access field became inconsistent.	The communication action is changed to none.	
	Operation action		After conversion, the combination of 'substitution item', 'first item', and 'second item' became incorrect.	The operation row is changed to none.	
	Variable	—	—	—	All variables are converted to local variables. If the total size of local variables exceeds the upper limit (2048 byte), the variables beyond the upper limit are converted as global variables.
				The variable used in multiple area cannot be converted because the data type of the variable cannot be identified.	The variable is replaced with multiple variables. (The variable is converted to different variables with different data types.)*1
Trigger conditions	—		<ul style="list-style-type: none"> After conversion, the combination of 'Combination', 'Trigger' 1, and 'Trigger 2' became incorrect. After conversion, the data used for "Value monitoring startup" and "Handshake operation" became incorrect. 	The trigger condition is changed to none.	
			A setting item which cannot be set for MELSEC iQ-R series MES interface module is set.	The setting item is changed to the one which can be set for MELSEC iQ-R series MES interface module.	

*1 In order not to change the job setting before the conversion, before using the separated variables, add a type conversion processing of a variable to an operation action.

5 PARAMETER SETTING

Various operations can be set in the parameter setting of the engineering tool.

5.1 Parameter Setting Procedure

This section shows the procedure for setting parameters to use an MES interface module.

1. Add an MES interface module to an engineering tool.
 - ☞ "Parameter" ⇒ right-click "Module Information" ⇒ [Add New Module] on the Navigation window
2. Set two types of parameter settings, basic settings and refresh settings, by selecting in the tree in the screen displayed by the following operation.
 - ☞ [Navigation window] ⇒ [Parameter] ⇒ [Module Information] ⇒ [RD81MES96N] or [RD81MES96]
3. Write the settings to the CPU module with the engineering tool after the parameter setting is completed.
 - ☞ [Online] ⇒ [Write to PLC]
4. The settings are reflected by resetting the CPU module or turning the power OFF → ON.

5.2 Basic Settings

Set various operation settings of an MES interface module.

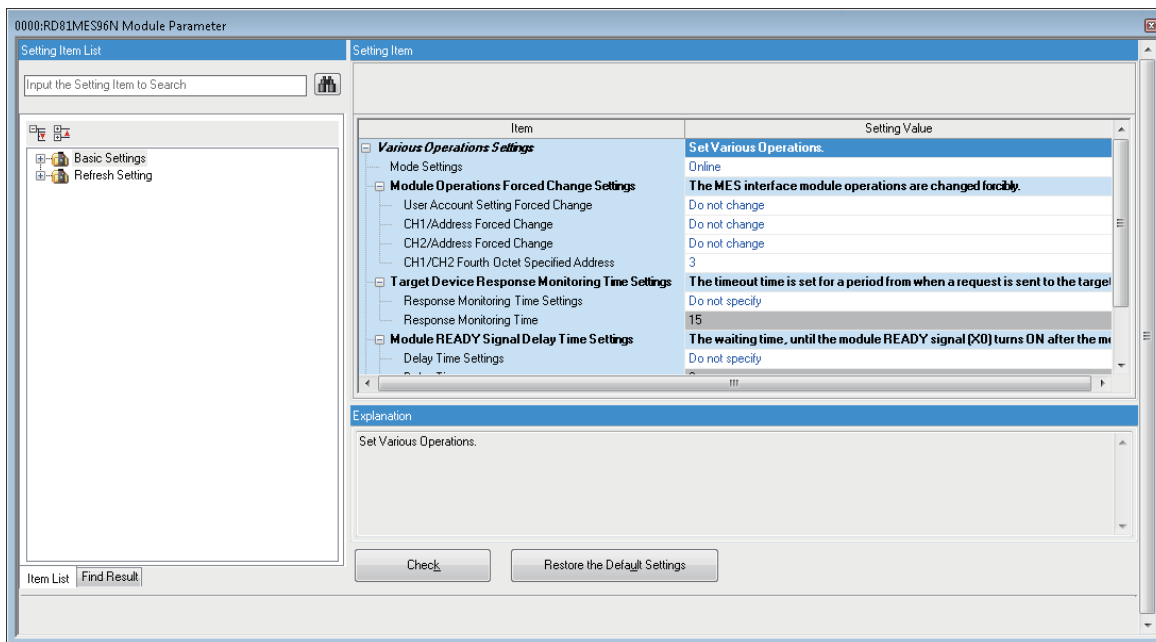

Various operation settings

Configure the various operation settings for an MES interface module.

Item	Description	Setting range	
Mode Settings ^{*1}	<p>The operation mode of the MES interface module is set.</p> <ul style="list-style-type: none"> • Online: It is a normal operation mode. • Online(Asynchronous Mode): The MES interface module and the CPU module start without synchronization. • Firmware update^{*2}: Update the firmware of MES interface module. • Module Initialization Setting^{*2}: Initializes the information held by the MES interface module. • Automatic hardware test: H/W such as ROM/RAM/Ethernet of the MES interface module is tested. • Hardware test for LED check: The LED of the MES interface module is tested. 	<ul style="list-style-type: none"> • Online • Online(Asynchronous Mode)^{*3} • Firmware update^{*2} • Module Initialization Setting^{*2} • Automatic hardware test • Hardware test for LED check (Default: Online)	
Module Operations Forced Change Settings	User Account Setting Forced Change ^{*4}	<p>Set whether or not to change the "User Account Setting" of the MES interface module forcibly.</p> <ul style="list-style-type: none"> • Do not change: Operate by using the setting contents specified in the "User Account Setting" of the MES Interface Function Configuration Tool. • Change to default: Operate by using default user account settings. 	<ul style="list-style-type: none"> • Do not change • Change to default (Default: Do not change)
	CH1/Address Forced Change	<p>Set whether or not to change the CH1 IP address and subnet mask of the MES interface module forcibly.</p> <ul style="list-style-type: none"> • Do not change: Operate by using the IP address and subnet mask specified in the "Network Settings" of the MES Interface Function Configuration Tool. • Change to 192.168.3.3: Operate by changing the IP address and subnet mask as follows: IP address = 192.168.3.3 Subnet mask = 255.255.255.0 • Change only fourth octet: Change the fourth octet of the IP address to the value entered in the "CH1/CH2 Fourth Octet Specified Address" and operate. • Change to 192.168.3.xxx: Operate by changing the IP address and subnet mask as follows: IP address (first octet to third octet) = 192.168.3 IP address (fourth octet) = Value entered in "CH1/CH2 Fourth Octet Specified Address" Subnet mask = 255.255.255.0 	<ul style="list-style-type: none"> • Do not change • Change to 192.168.3.3^{*5} • Change only fourth octet^{*6} • Change to 192.168.3.xxx^{*5} (Default: Do not change)
	CH2/Address Forced Change	<p>Set whether or not to change the CH2 IP address and subnet mask of the MES interface module forcibly.</p> <ul style="list-style-type: none"> • Do not change: Operate by using the IP address and subnet mask specified in the "Network Settings" of the MES Interface Function Configuration Tool. • Change to 192.168.4.3: Operate by changing the IP address and subnet mask as follows: IP address = 192.168.4.3 Subnet mask = 255.255.255.0 • Change only fourth octet: Change the fourth octet of the IP address to the value entered in the "CH1/CH2 Fourth Octet Specified Address" and operate. • Change to 192.168.4.xxx: Operate by changing the IP address and subnet mask as follows: IP address (first octet to third octet) = 192.168.4 IP address (fourth octet) = Value entered in "CH1/CH2 Fourth Octet Specified Address" Subnet mask = 255.255.255.0 	<ul style="list-style-type: none"> • Do not change • Change to 192.168.4.3^{*5} • Change only fourth octet^{*6} • Change to 192.168.4.xxx^{*5} (Default: Do not change)
	CH1/CH2 Fourth Octet Specified Address	<p>When "Change only fourth octet"/"Change to 192.168.3.xxx" is set by using "CH1/Address Forced Change" or "Change only fourth octet"/"Change to 192.168.4.xxx" is set by using "CH2/Address Forced Change", the entered value will be reflected in the fourth octet of IP address of CH1 or CH2.</p>	<ul style="list-style-type: none"> • 1 to 254 (Default: 3)
Target Device Response Monitoring Time Setting ^{*7*8}	Response Monitoring Time Settings	<p>Set whether or not to specify the timeout time (Second) from when the MES interface module sends a request to the target CPU until receiving the reply.</p> <ul style="list-style-type: none"> • Do not specify: The timeout time operates in 15 seconds. • Specify: The timeout time operates by using the value entered in the "Response monitoring time". 	<ul style="list-style-type: none"> • Do not specify • Specify (Default: Do not specify)
	Response Monitoring Time ^{*9}	<p>The value entered when "Specify" is set in "Response Monitoring Time Settings", becomes the timeout time from when a request is sent to the target CPU until receiving the reply.</p>	<ul style="list-style-type: none"> • 15 to 255 (Default: 15)

Item		Description	Setting range
Module READY Signal Delay Time Settings*7	Delay Time Settings	Set whether or not to specify waiting time until the 'Module READY signal' (X0) turns ON after the MES interface module is ready. Set the waiting time when accessing the target device in which communication route is established or started with delay. • Do not specify: Turn ON the 'Module READY signal' (X0) without waiting time. • Specify: Turn ON the 'Module READY signal' (X0) after the "Delay time" elapses.	• Do not specify • Specify (Default: Do not specify)
	Delay Time	Set the waiting time until the 'Module READY signal' (X0) turns ON.	0 to 255 (Default: 0)
For System	For System 1 to 3	Do not apply the settings as those are used for the system.	—

*1 For the difference between 'online' and 'online (asynchronous mode)', refer to the following:

 Page 208 Online and online (asynchronous mode)

*2 Can be set only when using an RD81MES96N.

*3 It is available in the following combination.

MES interface module: RD81MES96 with firmware version '08' or later, or RD81MES96N

GX Works3: software version '1.045X' or later

*4 When "Change to default" is set in the user account setting forced change, operation is performed as follows:

User name: RD81MES96

Password: MITSUBISHI

*5 The default gateway operates in unset state.

*6 The subnet mask and default gateway operate with the setting values of MES Interface Function Configuration Tool.

*7 If the parameter setting for MES interface module is not set in the engineering tool, operation is performed by default.

*8 If there is no response from the target device within the set time, a response timeout error (error code: 1824H) occurs.

*9 It may not time out at the specified time due to retry processing etc.

Online and online (asynchronous mode)

The following explains the difference between 'online' and 'online (asynchronous mode)'.

■Online

A CPU module and an MES interface module synchronize each other and complete their start processing, then start at the same time. (A CPU module stands by until an MES interface module completes its start processing.)

■Online (asynchronous mode)

A CPU module and an MES interface module start individually when their start processing is completed without waiting for the completion of the processing of the other module.

Precautions

The following shows the considerations for using 'online (asynchronous mode)'.

- Do not access the buffer memory of an MES interface module until the module starts after a CPU module starts. Otherwise, an indefinite value may be acquired and a sequence program may not run as intended.

When accessing the buffer memory, make sure that 'Module READY' (X0) is turned ON.

5.3 Refresh Settings

Set the refresh timing for the specified refresh target.

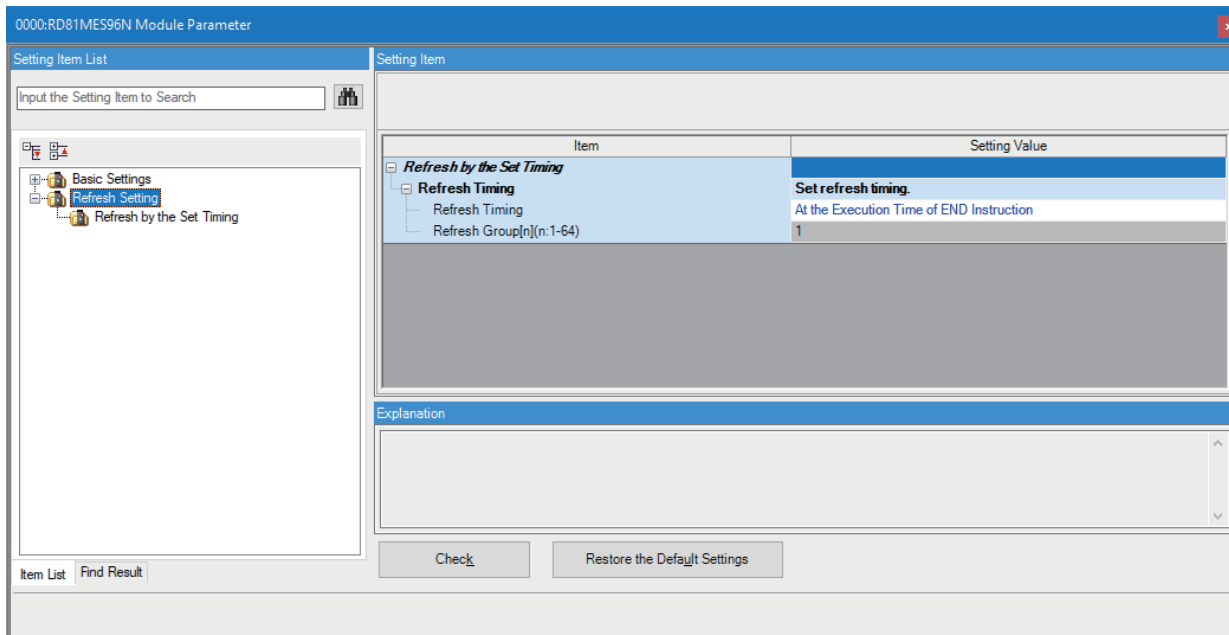

Setting value	Description
At the Execution Time of END Instruction	The setting is refreshed at the END processing in the CPU module.
At the Execution Time of Specified Program	The setting is refreshed when executing the program specified in "Group [n]".

6 API SPECIFICATIONS (REST SERVER FUNCTION)

This chapter explains the API specifications of the REST server function.

6.1 Resource List

The following resources are used for the REST server function.

URI	HTTP method	Description	Reference
/v1/job.json*1	POST	Job-related operations	Page 211 /v1/job.json(POST)
/v1/jobs.json*1	GET	Job information acquisition operation	Page 214 /v1/jobs.json(GET)
/MESXML.CGI	POST	XML processing function resource (which is fully compatible with MELSEC-Q series MES interface module)	Page 222 MESXML.CGI(POST)

*1 'v1' indicates the version information of API.

The common specifications for each resource are described in the following section.

☞ Page 210 Common specifications

Common specifications

Item	Description
URI request message size	Up to 128 KB When a message size exceeded 128 KB, an error code is returned to a response message. For error codes, refer to the following: ☞ Page 265 Error codes of REST server function response message
URI encoding	To use HTTP, the conversion (escape) by URI encoding is required for converting specific characters in an XML request message. For the URI encoding rules and URI encoding examples, refer to the following: ☞ Page 210 URI encoding rule, Page 210 URI encoding example

■URI encoding rule

Characters before conversion	Characters after conversion
[A-Z], [a-z], [0-9], '*', '-', '.', '@', '_'	Not converted
Space	'+' (plus sign)
Others	'%' + 2-digit hexadecimal character code

■URI encoding example

Characters before conversion	Characters after conversion
%	%25
&	%26
+	%2B
=	%3D
?	%3F

6.2 /v1/job.json(POST)

This resource is used to perform job-related operations of an MES interface module.

URI

- `http://(IP address of an MES interface module (Ethernet port))/v1/job.json?action=□&name=□`
- `http://(IP address of an MES interface module (Ethernet port))/v1/job.json?action=□&id=□`

Resource information

Resource information	Description
Request format	—
Response format	JSON (character code: UTF-8)
Authentication method	Basic authentication (A user can be authenticated with the account information which is specified in the security setting of MES Interface Function Configuration Tool.)

Request parameter

Name	Description
action	Specify an operation to be executed. <ul style="list-style-type: none">• oneshot: one-shot execution of a job• validate: validation of a job• invalidate: invalidation of a job
name	Specify a job name (1 to 32 characters (UTF-8)).
id	Specify a job ID (job number (1 to 64) in the job setting list).

6

Precautions

- Setting parameter is required for 'action'.
- Set a parameter for either 'name' or 'id'. If both of them are set or none of them are set, an error will occur.

Example

- URI example when requesting a one-shot execution for a job whose job name is 'JOB01'

`http://192.168.3.3/v1/job.json?action=oneshot&name=JOB01`

- URI example when requesting the validation of a job

`http://192.168.3.3/v1/job.json?action=validate&id=1`

Request format

Definition

Setting request body is not required.

Considerations for request

When "Handshake" is specified at the one-shot execution request, the device tag component of a job completion notification turns ON at the completion of the job execution regardless of the ON/OFF status of the device tag component of a job start request. In this condition, the job execution cannot be performed again. When the device tag component of a job completion notification is turned ON while a handshake operation is not performed in a ladder program, forcibly turn the device tag component OFF.

Response format

■ Definition

```
{
  "result": "□",
  "errcode": "□",
  "date": "□",
  "id": "□",
  "name": "□"
}
```

Name	Description
result	The reception result of a request message is returned. <ul style="list-style-type: none">• accepted: Succeeded• failed: Failed
errcode	An error code is returned when an error occurred. For error codes, refer to the following: <ul style="list-style-type: none">☞ Page 266 Common error code☞ Page 266 Error codes of /v1/job.json
date	The date (YYYY-MM-DD hh:mm:ss.fff OFFSET) when an operation has been accepted is returned. (Example) 2017-04-10 15:20:43.532 +09:00
id	The operation target job ID (job number (1 to 64) in the job setting list) is returned.
name	The operation target job name (1 to 32 characters (UTF-8)) is returned.

■ Example

- Response when succeeded

```
{
  "result": "accepted",
  "date": "2017-04-10 15:20:43.532 +09:00",
  "id": "1",
  "name": "JOB01"
}
```

- Response when failed

```
{
  "result": "failed",
  "errcode": "0x4118XXXX",
  "date": "2017-04-10 15:20:43.532 +09:00",
  "id": "1",
  "name": "JOB01"
}
```

Sample program

■Java language

The following shows a sample program (JobStart.java) written in Java[®] language.

```
import java.io.*;
import java.net.*;
import java.util.Base64;
import java.util.Base64.Encoder;
public class JobStart {
    public static void main(String[] args) {
        try {
            //Request URI creation
            String uri = "http://192.168.3.3/v1/job.json?";
            uri += "action=oneshot&name=Job01";
            System.err.println(uri); //Display URI
            //POST
            URL url = new URL(uri);
            URLConnection conn = url.openConnection();
            conn.setDoOutput(true);
            conn.setUseCaches(false);
            //BASIC authentication
            String account = "RD81MES96:MITSUBISHI";
            Encoder encoder = Base64.getEncoder();
            String enc_account = encoder.encodeToString(account.getBytes()); //Encoding to Base64
            conn.setRequestProperty("Authorization", "Basic " + enc_account);
            //Receive a response
            InputStream inputStream = conn.getInputStream();
            BufferedReader reader = new BufferedReader(new InputStreamReader(inputStream));
            String str;
            while ((str = reader.readLine()) != null) {
                System.out.println(str); //Receive contents display
            }
            reader.close();
        } catch (Exception e) {
            System.err.println("Error\n" + e);
        }
    }
}
```

6.3 /v1/jobs.json(GET)

This resource is used to acquire job information set in an MES interface module.

URI

- `http://(IP address of an MES interface module (Ethernet port))/v1/jobs.json`
- `http://(IP address of an MES interface module (Ethernet port))/v1/jobs.json?name=□`
- `http://(IP address of an MES interface module (Ethernet port))/v1/jobs.json?id=□`

Resource information

Refer to the following:

 Page 211 Resource information

Request parameter

Name	Description
name	Specify an operation target job name (1 to 32 characters (UTF-8)).
id	Specify an operation target job ID (job number (1 to 64) in the job setting list).

Precautions

- If both 'name' and 'id' are set, an error will occur.
- When neither 'name' nor 'id' is set, all job information is acquired.

■Example

- URI example when acquiring the job information of all jobs
`http://192.168.3.3/v1/jobs.json`
- URI example when acquiring the job information of a specific job
`http://192.168.3.3/v1/jobs.json?id=1`

Request format



■Definition

Setting request body is not required.

Response format

■ Definition

```
{
  "result": "□",
  "errcode": "□",
  "date": "□",
  "number_of_jobs": □,
  "jobs": [
    {
      "id": "□",
      "name": "□",
      "operating_status": □,
      "error_information": □,
      "error_code": "□",
      "job_execution_inhibition": □,
      "target_server_output_inhibition": □,
      "target_device_output_inhibition": □,
      "working_history_output": □,
      "detailed_log_output": □
    },
    ...
    {
      "id": "□",
      "name": "□",
      "operating_status": □,
      "error_information": □,
      "error_code": "□",
      "job_execution_inhibition": □,
      "target_server_output_inhibition": □,
      "target_device_output_inhibition": □,
      "working_history_output": □,
      "detailed_log_output": □
    }
  ]
}
```

Name	Description
result	The reception result of a request message is returned. <ul style="list-style-type: none">• accepted: Succeeded• failed: Failed
errcode	An error code is returned when an error occurred. For error codes, refer to the following:  Page 266 Common error code  Page 267 Error codes of /v1/jobs.json
date	The date (YYYY-MM-DD hh:mm:ss.fff OFFSET) when an operation has been accepted is returned. (Example) 2017-04-10 15:20:43.532 +09:00
number_of_jobs*1	The number of job information items (1 to 64) for an acquisition target is returned. If an error occurred, a notification may not be sent.

Name		Description
jobs	—	Job information is returned for the number of acquired data items.
	id	The job ID (job number (1 to 64) in the job setting list) is returned.
	name	A job name (1 to 32 characters (UTF-8)) is returned.
	operating_status	A job operating status is returned. <ul style="list-style-type: none"> • 0: In execution inhibition • 1: Monitoring trigger condition • 2: Preparing for execution • 3: Executing
	error_information	Error information at a job execution is returned. <ul style="list-style-type: none"> • true: Error • false: No error
	error_code	An error code at a job execution is returned. An error is returned only when an error occurred. For error codes, refer to the following: Page 241 Error codes for an MES interface module
	job_execution_inhibition	The job execution inhibition status is returned. <ul style="list-style-type: none"> • true: Inhibiting • false: Not inhibited
	target_server_output_inhibition	The target server output inhibition status of a job is returned. <ul style="list-style-type: none"> • true: Inhibiting • false: Not inhibited
	target_device_output_inhibition	The target device output inhibition status of a job is returned. <ul style="list-style-type: none"> • true: Inhibiting • false: Not inhibited
	working_history_output	The working history output status of a job is returned. <ul style="list-style-type: none"> • true: Output • false: Not output
	detailed_log_output	The detailed log output status of a job is returned. <ul style="list-style-type: none"> • true: Output • false: Not output

*1 When acquiring job information by specifying a job name or job ID, '1' is returned.

■ Example

- Response example when acquiring job information of all jobs

```
{
  "result": "accepted",
  "date": "2017-04-10 15:20:43.532 +09:00",
  "number_of_jobs": 2,
  "jobs": [
    {
      "id": "1",
      "name": "Job01",
      "operating_status": 1,
      "error_information": true,
      "error_code": "1C16H",
      "job_execution_inhibition": false,
      "target_server_output_inhibition": true,
      "target_device_output_inhibition": false,
      "working_history_output": true,
      "detailed_log_output": false
    },
    {
      "id": "2",
      "name": "Job02",
      "operating_status": 0,
      "error_information": false,
      "job_execution_inhibition": true,
      "target_server_output_inhibition": false,
      "target_device_output_inhibition": true,
      "working_history_output": false,
      "detailed_log_output": true
    }
  ]
}
```

- Response example when acquiring job information of a specific job

```
{
  "result": "accepted",
  "date": "2017-04-10 15:20:43.532 +09:00",
  "number_of_jobs": 1,
  "jobs": [
    {
      "id": "2",
      "name": "Job02",
      "operating_status": 0,
      "error_information": false,
      "job_execution_inhibition": true,
      "target_server_output_inhibition": false,
      "target_device_output_inhibition": true,
      "working_history_output": false,
      "detailed_log_output": true
    }
  ]
}
```

- Response example when no job is set

```
{
  "result": "accepted",
  "date": "2017-04-10 15:20:43.532 +09:00",
  "number_of_jobs": 0
}
```

- Response example when a request parameter is incorrect or module status is incorrect (module is initializing)

```
{
  "result": "failed",
  "errcode": "0x4118XXXX"
  "date": "2017-04-10 15:20:43.532 +09:00"
}
```

Sample program

■Java language

The following shows a sample program (JobValidate.java) written in Java language.

```
import java.io.*;
import java.lang.reflect.Field;
import java.net.*;
import java.util.*;
import java.util.Base64;
import java.util.Base64.Encoder;
public class JobValidate {
    public static void main(String[] args) {
        try {
            //Request URI creation
            String uri = "http://192.168.3.3/v1/jobs.json?";
            uri += "id=1";
            System.err.println(uri); //Display URI
            //GET
            URL url = new URL(uri);
            URLConnection conn = url.openConnection();
            conn.setUseCaches(false);
            //BASIC authentication
            String account = "RD81MES96.MITSUBISHI";
            Encoder encoder = Base64.getEncoder();
            String enc_account = encoder.encodeToString(account.getBytes()); //Encoding to Base64
            conn.setRequestProperty("Authorization", "Basic " + enc_account);
            //Receive a response
            InputStream inputStream = conn.getInputStream();
            BufferedReader reader = new BufferedReader(new InputStreamReader(inputStream));
            String str;
            String response = "";
            while ((str = reader.readLine()) != null) {
                System.out.println(str); //Receive contents display
                response += str;
            }
            reader.close();
            //Parse job information
            JobsResponse res = parseResponse(response);
            //Check the first job information. If the job execution is inhibited, disable the inhibition.
            if (res.result.equals("accepted") && res.jobs.get(0).job_execution_inhibition) {
                //Request URI creation
                uri = "http://192.168.3.3/v1/job.json?";
                uri += "action=validate&id=1";
                System.err.println(uri); //Display URI
                //POST
                url = new URL(uri);
                conn = url.openConnection();
                conn.setUseCaches(false);
                //BASIC authentication
                conn.setRequestProperty("Authorization", "Basic " + enc_account);
                //Receive a response
                inputStream = conn.getInputStream();
                reader = new BufferedReader(new InputStreamReader(inputStream));
                response = "";
                while ((str = reader.readLine()) != null) {
                    System.out.println(str); //Receive contents display
                }
                reader.close();
            }
        } catch (Exception e) {
            System.err.println("Error\n" + e);
        }
    }
}
```

```

//Parse job information
static JobsResponse parseResponse(String instr) throws Exception {
    JobsResponse response = new JobsResponse();
    Object current = response;
    List<JobInfo> jobs = null;
    Field key = null;
    for (String token : instr.substring(instr.indexOf('{') + 1, instr.lastIndexOf('}')).split(",|\\\"")) {
        token = token.trim();
        if (key == null && !token.startsWith("{") && !token.startsWith("[") && !token.equals("")) { //Get a field
            (key = current.getClass().getDeclaredField(token)).setAccessible(true);
        } else if (!token.equals(":") && !token.equals("")) {
            if (token.contains("{}")) { //Create job information and add it to the list
                if (jobs == null)
                    key.set(current, jobs = new ArrayList<JobInfo>());
                jobs.add((JobInfo) (current = new JobInfo()));
            } else { //Set a value with correct type
                if (key.getType() == int.class)
                    key.set(current, Integer.parseInt(token.replaceAll(":", "").trim()));
                else if (key.getType() == boolean.class)
                    key.set(current, Boolean.parseBoolean(token.replaceAll(":", "").trim()));
                else
                    key.set(current, token.replaceAll(":", "").trim());
            }
            key = null;
        }
    }
    return response;
}

// Response format of /v1/jobs.json(GET)
class JobsResponse {
    String result;
    String errcode;
    String date;
    int id;
    String name;
    int number_of_jobs;
    List<JobInfo> jobs;
}

// Response format of /v1/jobs.json(GET) (jobs hierarchy)
class JobInfo {
    int id;
    String name;
    int operating_status;
    boolean error_information;
    String error_code;
    boolean job_execution_inhibition;
    boolean target_server_output_inhibition;
    boolean target_device_output_inhibition;
    boolean working_history_output;
    boolean detailed_log_output;
}

```

■C# language

The following shows a sample program written in C# language.

```
using System;
using System.IO;
using System.Net;
using System.Runtime.Serialization.Json;
using System.Text;
//[Note]
//You need to add "System.Runtime.Serialization" in references of the project when you build this program.
namespace RestSample
{
    class JobValidate
    {
        static void Main(string[] args)
        {
            try
            {
                //Request URI creation
                Uri uri = new Uri("http://192.168.3.3/v1/jobs.json?id=1");
                Console.WriteLine(uri.AbsoluteUri); //Display URI
                //GET
                WebClient client = new WebClient();
                client.Encoding = Encoding.UTF8;
                //BASIC authentication
                client.Credentials = new NetworkCredential("RD81MES96", "MITSUBISHI");
                //Receive a response
                string str = client.DownloadString(uri);
                Console.WriteLine(str); //Receive contents display
                //Parse job information
                DataContractJsonSerializer serializer = new DataContractJsonSerializer(typeof(JobsResponse));
                MemoryStream stream = new MemoryStream(Encoding.UTF8.GetBytes(str));
                JobsResponse res = (JobsResponse)serializer.ReadObject(stream);
                stream.Close();
                //Check the first job information. If the job execution is inhibited, disable the inhibition.
                if (res.result.Equals("accepted") && res.jobs[0].job_execution_inhibition)
                {
                    //Request URI creation
                    uri = new Uri("http://192.168.3.3/v1/job.json?action=validate&id=1");
                    Console.WriteLine(uri.AbsoluteUri); //Display URI
                    //POST
                    client = new WebClient();
                    client.Credentials = new NetworkCredential("RD81MES96", "MITSUBISHI");
                    client.Encoding = Encoding.UTF8;
                    //Receive a response
                    str = client.UploadString(uri, "POST", string.Empty);
                    Console.WriteLine(str); //Receive contents display
                }
            }
            catch (Exception e)
            {
                Console.WriteLine("Error\n" + e.Message);
            }
        }
    }
}
// Response format of /v1/jobs.json(GET)
public class JobsResponse {
    public string result;
    public string errcode;
    public string date;
    public int number_of_jobs;
    public JobInfo[] jobs;
}
// Response format of /v1/jobs.json(GET) (jobs hierarchy)
```

```
public class JobInfo {  
    public string id;  
    public string name;  
    public int operating_status;  
    public bool error_information;  
    public string error_code;  
    public bool job_execution_inhibition;  
    public bool target_server_output_inhibition;  
    public bool target_device_output_inhibition;  
    public bool working_history_output;  
    public bool detailed_log_output;  
}  
}
```

6.4 MESXML.CGI(POST)

This resource is used to perform job-related operations of an MES interface module.

URI

http://(IP address of an MES interface module (Ethernet port))/MESXML.CGI

Resource information

Resource information	Description
Request format	XML (version: 1.0, character code: UTF-8)
Response format	XML (version: 1.0, character code: UTF-8)
Authentication method	Basic authentication (A user can be authenticated with the account information which is specified in the security setting of MES Interface Function Configuration Tool.)

Request parameter

No request parameter.

Request format

■Definition

```
<REQUEST type="□" jobname="□"/>
```

Element	Attribute	Description
REQUEST	—	Requests operations for the specified job. (Number of occurrences: one time, no parent element)
	type	Specify an operation to be executed. <ul style="list-style-type: none">• oneshot: One-shot execution of a job is requested.• validate: A job is validate.• invalidate: A job is invalidate.
	jobname	Specify a job name (1 to 32 characters).

■Example

- When requesting one-shot execution for a job whose job name is 'Pro01'

```
<?xml version="1.0" ?>
```

```
<REQUEST type="oneshot" jobname="Pro01"/>
```

■Considerations for request

When "Handshake" is specified at the one-shot execution request, the device tag component of a job completion notification turns ON at the completion of the job execution regardless of the ON/OFF status of the device tag component of a job start request. In this condition, the job execution cannot be performed again. When the device tag component of a job completion notification is turned ON while a handshake operation is not performed in a ladder program, forcibly turn the device tag component OFF.

Response format

■Definition

<RESPONSE status="□" code="□"/>

Element	Attribute	Description
RESPONSE	—	Returns the response of the operation for the specified job. (Number of occurrences: one time, no parent element)
	status	The reception result of a request message is returned. <ul style="list-style-type: none">• accepted: Succeeded• failed: Failed
	code	An error code is returned when an error occurred. For error codes, refer to the following:  Page 265 Error code list of MELSEC-Q series MES interface module-compatible API

■Example

- Response when succeeded

```
<?xml version="1.0" ?>
```

```
<RESPONSE status="accepted"/>
```

- Response when failed

```
<?xml version="1.0" ?>
```

```
<RESPONSE status="failed" code="0x4117XXXX"/>
```

Sample program

■Java language

The following shows a sample program (JobStart.java) written in Java language.

```
import java.io.*;
import java.net.*;
import java.util.Base64;
import java.util.Base64.Encoder;

public class JobStart {
    public static void main(String[] args) {
        try {
            //Request message creation
            String requestMessage = "<?xml version='1.0'?>";
            requestMessage += "<REQUEST type='oneshot' jobname='Job01'/>";
            System.err.println(requestMessage); //Send contents display
            //Conversion with URL encoding
            requestMessage = URLEncoder.encode(requestMessage, "UTF-8");
            //POST
            URL url = new URL("http://192.168.3.3/MESXML.cgi");
            URLConnection conn = url.openConnection();
            conn.setDoOutput(true);
            conn.setUseCaches(false);
            conn.setRequestProperty("Content-type", "text/xml");
            conn.setRequestProperty("Content-length", String.valueOf(requestMessage.length()));
            //BASIC authentication
            String account = "RD81MES96:MITSUBISHI";
            Encoder encoder = Base64.getEncoder();
            String enc_account = encoder.encodeToString(account.getBytes()); //Encoding to Base64
            conn.setRequestProperty("Authorization", "Basic " + enc_account);
            OutputStream outputStream = conn.getOutputStream();
            PrintStream printStream = new PrintStream(outputStream);
            printStream.print(requestMessage);
            printStream.close();
            //Receive a response
            InputStream inputStream = conn.getInputStream();
            BufferedReader reader = new BufferedReader(new InputStreamReader(inputStream));
            String str;
            while ((str = reader.readLine()) != null){
                System.out.println(str); //Receive contents display
            }
            System.out.flush();
            reader.close();
        } catch (Exception e) {
            System.err.println("Error\n" + e);
        }
    }
}
```

7 TROUBLESHOOTING

This chapter explains the errors which may occur when using an MES interface module and the troubleshooting.

7.1 Checking Method for Error Descriptions

Error descriptions can be checked by checking error descriptions of an MES interface module or a server.

Checking target	Checking method	Details
MES interface module	System monitor of an engineering tool	Error codes*1 can be checked by the system monitor of an engineering tool. ☞ Page 226 Checking the Module Status
	Buffer memory	Error codes*1 can be checked in the following buffer memory. ☞ Page 287 Module information (Un\G7168 to 7199) ☞ Page 294 Error log information (Un\G13056 to 13391)
	MES Interface Function Configuration Tool	Error codes*1 and failure histories in direct DB connection can be checked by using the diagnostic function. ☞ Page 168 MES interface module diagnostics
	Dot matrix LED	Error codes*1 can be checked with the dot matrix LED on the front of an MES interface module.
Project File Conversion Tool	Conversion log file	Error codes can be checked in the conversion log file which is output at conversion. ☞ Page 203 Conversion log file
Database server Application server	DB Connection Service log	Error descriptions can be checked in the following log of DB Connection Service. • Access log (☞ Page 192 Output access log) • SQL failure log (☞ Page 193 Output SQL failed log)
	Event log of Windows	Errors for DB Connection Service are output. They can be checked in the event viewer of Windows.

*1 Error code

If the same error occurs repeatedly, the error is output only for the first time. (Detailed information is also output only for the first occurrence of the error.)

When the same error occurs several times in different causes, take action to correct the error in the order of occurrence based on the error code and detailed information that were outputted at the first occurrence of the error.

By clearing the error (or resetting and turning the power OFF and ON) after taking the corrective action, error information is output when the same error occurs again.

Error type

There are two types of errors of an MES interface module as follows:

Error type	ERR LED	Module status	Corrective action
Module stop error	Flashing	The MES interface function stops.	Take action for the error according to the error code, and turn the 'ERR LED' OFF by any of the following operations: <ul style="list-style-type: none"> • Error clear request (Y10) • Select [Online] ⇨ [Diagnose MES Interface Module] ⇨ [Module Diagnostics] tab and click the [Error Clear] button on MES Interface Function Configuration Tool. • Power OFF → ON • Reset the CPU module
Module continuation error	ON	The MES interface function continues.	

7.2 Checking the Module Status

The module status can be checked in the "Module Diagnostics" screen of an engineering tool.

Function	Purpose	Reference
Error Information	To display the description of an error currently occurred. The history of errors detected and operations performed in an MES interface module can be checked by clicking the [Event History] button.	Page 226 Error information
Module Information List	To display the information on each status of an MES interface module.	Page 227 Module information list

In addition, the self-diagnostic tests that check the hardware of an MES interface module can be performed in an engineering tool. (☞ Page 228 Self-diagnostic tests)

Error information

The description of an error occurring and its corrective action can be checked in the [Error Information] tab.

Window

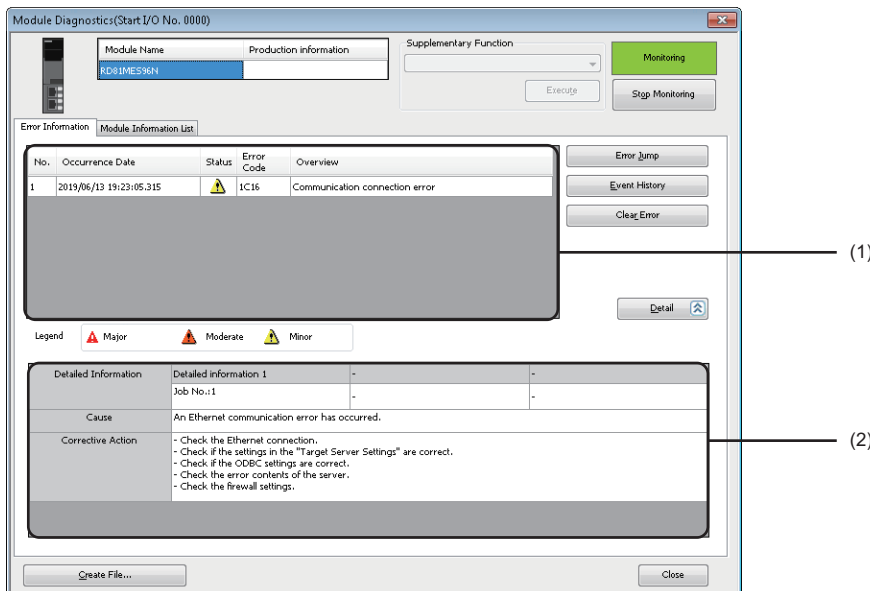

Displayed items

Item	Description	
(1) Error information list	Errors occurring are listed.	
(2) Error detailed information	—	Detailed information on an error selected in the error information list is displayed.
	Detailed Information	Detailed information of an error is displayed (up to three).
	Cause	An error cause is displayed.
	Corrective Action	A corrective action for an error is displayed.

Restriction

An error in an MES interface module cannot be cleared with the [Clear Error] button.

To clear an error, use the diagnostic function of MES Interface Function Configuration Tool. (☞ Page 168 MES interface module diagnostics)

Module information list

The LED information and switch information can be checked in the [Module Information List] tab.

During a self-diagnostic test, "Automatic hardware is being tested" or "Hardware test for LED check is being executed" is displayed in all the LED information and switch information.

If an error occurs, refer to the following section to take corrective action.

☞ Page 231 Troubleshooting by Symptom

Window

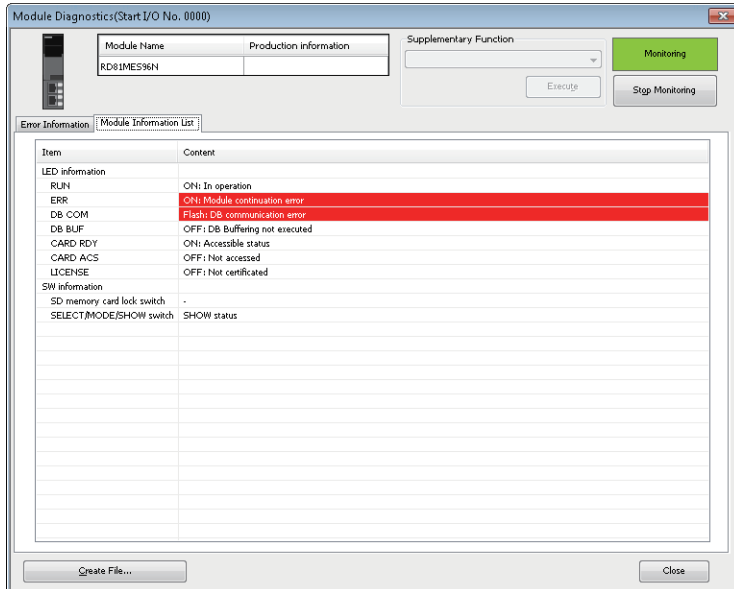

Displayed items

Item		Description
LED information	RUN	The operating status of a module is displayed.
	ERR	The error status of a module is displayed.
	DB COM	The connection status with a database is displayed.
	DB BUF	The execution status of DB buffering is displayed.
	CARD RDY	The status of an SD memory card is displayed.
	CARD ACS	The access status of an SD memory card is displayed.
	LICENSE ^{*1}	The certification status of a license is displayed.
Switch information	SD memory card lock switch	Information on the SD memory card lock switch is displayed.
	SELECT/MODE/SHOW switch	Information on the dot matrix LED display mode switch is displayed.

*1 Appears only when using an RD81MES96N.

Self-diagnostic tests

Automatic hardware test

The following explains the test on hardware such as ROM/RAM/Ethernet of an MES interface module.



The values in the buffer memory cannot be referenced in an engineering tool during the automatic hardware test.

Operating procedure

1. Select "Automatic hardware test" in "Basic Settings" ⇒ "Various Operations Settings" ⇒ "Mode Settings" for an MES interface module in an engineering tool.
2. Disconnect a cable if it is connected to a 1000BASE-T/100BASE-TX/10BASE-T interface.
3. Remove an SD memory card if it is inserted.
4. Set the CPU module to the STOP state, and write the parameters.
5. Reset the CPU module.

After it is reset, the automatic hardware test is performed automatically. The LED display for diagnosis is as follows:

Status		RUN LED status	ERR LED status	Dot matrix LED status
Diagnosing		ON	OFF	"H.T." (Flashing)
Complete diagnosing	Normal completion	ON	OFF	"OK" (ON)
	Abnormal completion	ON	ON	"ERR" (ON)

6. When the test is completed normally, return the mode setting changed in step 1 to "Online" and reset the CPU module.
7. When the test is completed abnormally, check if measures are taken to reduce noise of the system, and perform the test again. If it is completed abnormally again, a hardware failure may occur in the MES interface module. Please contact your local Mitsubishi Electric sales office or representative.

Do not use an electric screwdriver when removing the module. Loosen the module fixing screws completely to remove the module.

Hardware test for LED check

Turn the LED ON to perform the hardware diagnostics of MES interface module.



The values in the buffer memory cannot be referenced in an engineering tool during the hardware test for LED check.

Operating procedure

1. Select "Hardware test for LED check" in "Basic Settings" ⇒ "Various Operations Settings" ⇒ "Mode Settings" for an MES interface module in an engineering tool.
2. Set the CPU module to the STOP state, and write the parameters.
3. Reset the CPU module.
After it is reset, the hardware test for LED check is performed automatically. When the following contents are displayed, check them visually for any errors.

LED name	Display color	Display status
RUN	Green	ON
ERR	Red	ON
DB COM	Green	ON
DB BUF	Green	ON
CARD RDY	Green	ON
CARD ACS	Green	ON
LICENSE	Green	ON
Dot matrix LED	Orange	Page 230 Patterns for dot matrix LED check

4. When the test is completed normally, change the mode set in the step 1 back to "Online," and reset the CPU module.
5. When the test is completed abnormally (when any color or status is different from the one shown in the table above), check if measures are taken to reduce noise of the system, and perform the test again. If it is completed abnormally again, a hardware failure may occur in the MES interface module. Please contact your local Mitsubishi Electric sales office or representative.
Do not use an electric screwdriver when removing the module. Loosen the module fixing screws completely to remove the module.

■ Patterns for dot matrix LED check

Test patterns are turned ON in turn on the dot matrix LED. (Pattern 1 → Pattern 2 →...)

The pattern switches every one second.

□ ON ■ OFF

Pattern 1 (all ON)

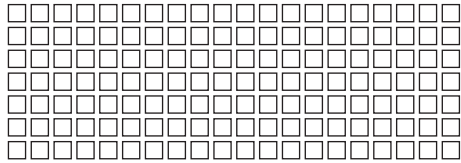

Pattern 3 (1st row is ON)

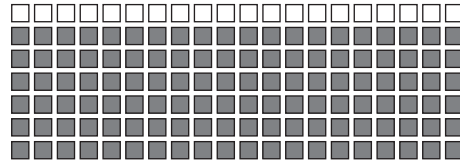

Pattern 2 (1st column is ON)

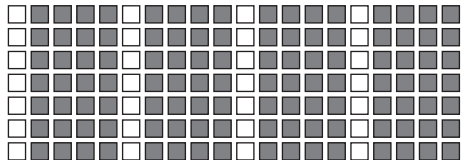

Pattern 3 (2nd row is ON)

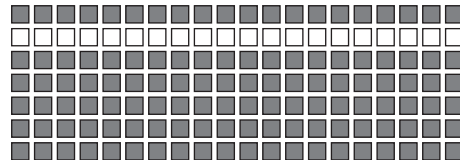

Pattern 2 (2nd column is ON)

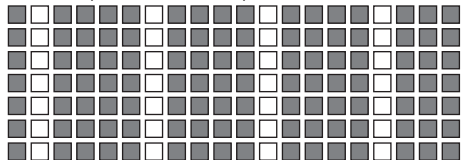

Pattern 3 (3rd row is ON)

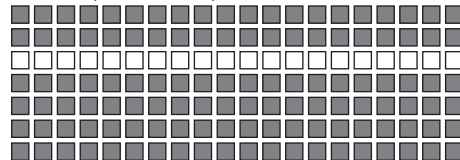

Pattern 2 (3rd column is ON)

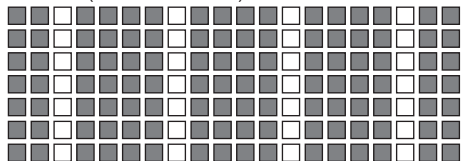

Pattern 3 (4th row is ON)

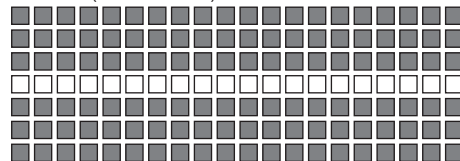

Pattern 2 (4th column is ON)

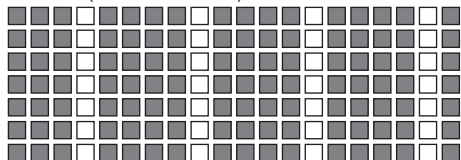

Pattern 3 (5th row is ON)

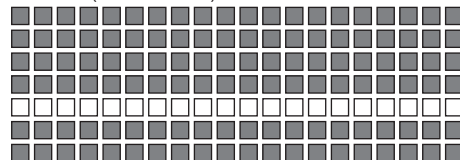

Pattern 2 (5th column is ON)

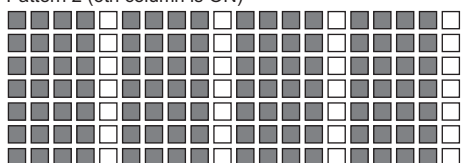

Pattern 3 (6th row is ON)

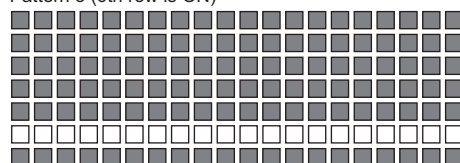

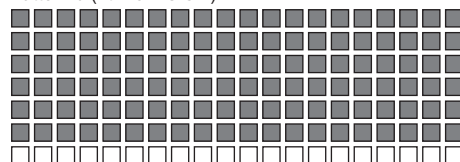

Pattern 3 (7th row is ON)



7.3 Troubleshooting by Symptom

Troubleshooting on MES Interface Function Configuration Tool

Symptom	Check point	Corrective action
Unable to connect MES Interface Function Configuration Tool to the MES interface module.	Is there any disconnection in the connection route?	Connect the cables properly.
	Is the IP address specified in the connection destination specification correct?	Review the IP address setting.
	Is the user authentication setting, user name, and password specified in the connection destination specification correct?	Review the user authentication setting, user name, and password setting.
	Is the IP address duplicated?	Review the IP address setting.
	Is there a firewall and/or a proxy server in the connection route?	Consult your network administrator about the firewall setting and/or the setting contents of the proxy server.
	Is the "Mode Settings" of RD81MES96 "Online"?	Change to "Online" in the "Mode Settings" with the engineering tool.
	Is there any problem on the personal computer?	Replace it with another computer.
	Is it connected directly using the Ethernet (CH2)?	<ul style="list-style-type: none"> Connect directly using the Ethernet (CH1). When using the Ethernet (CH2), use a hub.
	Is it connected to the Ethernet port which is not selected to use in the network settings?	<ul style="list-style-type: none"> Connect to the Ethernet port which is selected to use in the network settings. Enable the setting of the connected Ethernet port.
	Are multiple IP addresses enabled on the personal computer side at the same time?	<ul style="list-style-type: none"> When using direct connection, review the network settings so that multiple IP addresses are not enabled on the personal computer. Disable the wireless LAN.
	Is the direct connection specified for the connection destination?	<p>When using direct connection, take the following actions:</p> <ul style="list-style-type: none"> Connect the MES interface module (CH1) with the personal computer on a 1:1 basis. When using security software with a firewall function, refer to the manual for the software used and allow the communication with MES Interface Function Configuration Tool. If any software has been installed during a period when the symptom occurs, refer to the manual for the software and check if the communication with MES Interface Function Configuration Tool is not restricted.
	Is the IP address of the MES interface module to be connected displayed in two or more places in the "MES Interface Module Search" screen?	<ul style="list-style-type: none"> Check if there are several MES interface modules to which the same IP address is set on the same network, and review the IP address setting.
	Is the RUN LED of another MES interface module flashing by clicking the [Module Confirmation] button?	
Is the checkbox of "Use the user authentication" unselected in the connection destination specification at the first startup of an MES interface module?	<p>At the first startup of an MES interface module, select "Use the user authentication" in the connection destination specification, and enter the default user name and password to connect.</p> <p>For details, refer to 'PROCEDURE BEFORE OPERATION' in the following manual. (MELSEC iQ-R MES Interface Module User's Manual (Startup))</p>	
Does the following message appear? <ul style="list-style-type: none"> Attempted to access the module of which the version is not supported. Check the connection destination. 	Use MES Interface Function Configuration Tool stored in MX MESInterface-R with software version '1.10L' or later.	
MES Interface Function Configuration Tool does not start.	Have five MES Interface Function Configuration Tools already started?	Terminate the other MES Interface Function Configuration Tools and then start it. (Up to five MES Interface Function Configuration Tools can be started in a personal computer.)

Symptom	Check point	Corrective action
Unable to open the project file or import the project file.	Is an old version of MES Interface Function Configuration Tool used?	Use the latest version of MES Interface Function Configuration Tool.
	Is a file which has the extension other than '.mu2' specified?	Specify a file which has the '.mu2' extension.
	Is the specified project file corrupted?	Specify other project file.
Unable to read the data from MES interface module or diagnose MES interface module.	Is an old version of MES Interface Function Configuration Tool used?	Use the latest version of MES Interface Function Configuration Tool.
	Is the project file in the module corrupted?	<ul style="list-style-type: none"> • Replace the SD memory card with another one. • Format the SD memory card in the SD memory card diagnostics of MES Interface Function Configuration Tool.
Unable to write to an MES interface module or perform the one-shot execution.	Does the following message appear? <ul style="list-style-type: none"> • Failed to acquire the data. 	<ul style="list-style-type: none"> • Use an MES interface module with firmware version that supports importing global labels and common device comments. • Release relation to global labels.
Unable to search an MES interface module.	Is the PING successful?	<ul style="list-style-type: none"> • When using security software with a firewall function, refer to the manual for the software used and allow the communication with MES Interface Function Configuration Tool. • If any software has been installed during a period when the symptom occurs, refer to the manual for the software and check if the communication with MES Interface Function Configuration Tool is not restricted.
The information cannot be acquired by browsing DB procedure information.	Is "ONLY_FULL_GROUP_BY" enabled in the MySQL setting?	Disable "ONLY_FULL_GROUP_BY" in the MySQL setting.
The latest information cannot be acquired by clicking the [Refresh] button in each screen of the DB information browse function.	Is the transaction isolation level "REPEATABLE READ" when using MySQL or MariaDB as a database?	Change the transaction isolation level to "READ COMMITTED".
An empty folder of MESInterface remains in the start menu after uninstallation.	—	Delete MESInterface folder manually.
The name of the table or stored procedure registered in the database cannot be referenced using the DB information browse function.	<p>■Database is SQL Server Is the schema name set for "Default schema" of the user to access the database different from the one to which a table or a stored procedure to be referenced belongs?</p> <p>■Database is PostgreSQL Is the schema name set for "Default schema" of the database different from the one to which the table to be referenced belongs?</p>	<p>■Database is SQL Server Set the same name for "Default schema" of the user to access to the database as the one to which a table or a stored procedure to be referenced belongs.  Page 158 DB table information browse  Page 159 DB procedure information browse</p> <p>■Database is PostgreSQL Set the same name for "Default schema" of the database as the one to which a table or a stored procedure to be referenced belongs.  Page 158 DB table information browse</p>

Troubleshooting on DB Connection Service

Symptom	Check point	Corrective action
Unable to reflect the setting.	Was a user with an administrator authority used for the login?	Log in again with a user with an administrator authority.
Unable to export a file.	Is there no connection-permitted IP address?	<ul style="list-style-type: none"> • Unselect "Limit IP addresses permit to connect". • Add a connection-permitted IP address.
An access log output error is registered in the event viewer of Windows.	Is the file specified in the access log setting read-only?	Review the file specification.
	Is the access to the folder specified in the access log setting authorized?	Check the right of access to the folder.
	Is the capacity of the specified drive full?	Check the free space on the drive.
An SQL failure log output error is registered in the event viewer of Windows.	Is the file specified in the SQL failure log setting read-only?	Review the file specification.
	Is the access to the folder specified in the SQL failure log setting authorized?	Check the right of access to the folder.
	Is the capacity of the specified drive full?	Check the free space on the drive.
Unable to start DB Connection Service Setting Tool.	Has another DB Connection Service Setting Tool been already started?	Close the already started DB Connection Service Setting Tool. (Only one DB Connection Service Setting Tool can be activated at the same time.)
	Is the memory or the system resources on the personal computer sufficient?	<ul style="list-style-type: none"> • Increase the necessary memory on the personal computer. • Close other programs and restart DB Connection Service Setting Tool.
The screen of DB Connection Service Setting Tool is not displayed correctly.	Is the memory or the system resources on the personal computer sufficient?	<ul style="list-style-type: none"> • Increase the necessary memory on the personal computer. • Close other programs and restart DB Connection Service Setting Tool.
Unable to operate DB Connection Service Setting Tool.		
Forced to terminate DB Connection Service Setting Tool.		
"The DB Connector service failed to start due to the following error: The system cannot find the file specified." is registered in the event viewer of Windows.	Does the following file exist in the installing destination directory of DB Connection Service and DB Connection Service Setting Tool? • MESIF\DBCconnector.exe	Uninstall DB Connection Service and DB Connection Service Setting Tool and restart the personal computer before reinstallation.
	Is the personal computer restarted after uninstalling DB Connection Service and DB Connection Service Setting Tool?	
Oracle data source driver is not located although "odbcad32.exe" under SysWOW64 was executed on 64-bit version Windows.	Has the 32-bit version of Oracle Client been installed?	Install the 32-bit version of Oracle Client, and then execute "odbcad32.exe" again.
An empty folder of MESInterface remains in the start menu after uninstallation.	—	Delete MESInterface folder manually.
DB Connection Service ends with an error.	Has data been acquired from a DB field in which TIMESTAMP , TIMESTAMP WITH TIME ZONE , or DATE is specified for Oracle by using an action with "Select" selected, no data type set (blank) for the access field, and the data type for the assignment data set to a character string?	<ul style="list-style-type: none"> • Set the data type for the access field to "Date and Time [Without Time Zone]" for a DB field in which TIMESTAMP or DATE is specified for Oracle. • Set the data type for the access field to "Date and Time [With Time Zone]" for a DB field in which TIMESTAMP WITH TIME ZONE is specified for Oracle. • Set the number of characters in a character string for the assignment data larger than that of a character string to be acquired.
Data source for Access is not displayed in the [System DSN] tab in the "ODBC Data Source Administrator" screen even though it is set.	Is Click-to-Run (C2R) used as the installation method of Access?	When the installation method of Access is Click-to-Run (C2R), install a Microsoft Access database engine first, then start ODBC Data Source Administrator. Note that the bits of Microsoft Access database engine to be installed and Access to be used must be the same. Due to changes in Access specifications, whether a Microsoft Access database engine must be installed and its version may be changed. For details, contact Microsoft Corporation.

Troubleshooting on LED indication and I/O signals

Symptom	Check point	Corrective action
The RUN LED does not turn ON.	Is the module in preparation?	Wait for the startup of MES interface module to complete. (Depending on the system configuration, it may take several minutes until the RUN LED turns ON.)
	Is the 'Module READY' (X0) OFF?	There may be a watchdog timer error. Please contact your local Mitsubishi Electric sales office or representative.
	Is "Online(Asynchronous Mode)" selected for the mode setting of an RD81MES96 with firmware version '07' or earlier?	<ul style="list-style-type: none"> • Change the mode setting to "Online". (Page 207 Various operation settings) • Use an RD81MES96 with firmware version '08' or later, or RD81MES96N.
	Does the system configuration satisfy both of the following conditions? <ul style="list-style-type: none"> • The module is used with a recorder module (RD81RC96), camera recorder module (RD81RC96-CA), or MES interface module (RD81MES96N) in the system. • "Online (Asynchronous Mode)" is selected for the mode setting. 	Change the mode setting to "Online". (Page 207 Various operation settings)
The RUN LED is flashing.	Is the module selected as the target for online module change?	Turn ON the module selection cancel request flag (SM1615).
The RUN LED is OFF.	Is the module ready to be exchanged in the process of online module change?	Perform the online module change function. For details, refer to the following: (MELSEC iQ-R Online Module Change Manual)
The ERR LED is ON or flashing.	Is any of the input signals (X10 to X14) ON?	According to the error code obtained by the error detection shown on the left, identify the error cause and take corrective actions. (Page 241 Error Code List)
	Check the error code in the system monitor of engineering tool.	By the error code, identify the error and take corrective actions. (Page 241 Error Code List)
'Module READY' (X0) does not turn ON, or it takes time to turn ON.	Is the module in preparation?	Wait for the startup of MES interface module to complete. (Depending on the number of settings in the target device setting, it may take several minutes until the 'Module READY' (X0) turns ON.)
	Is an SD memory card containing unnecessary files used?	Format the SD memory card in the SD memory card diagnostics of MES Interface Function Configuration Tool, and write the setting to use.
	Is the module READY signal delay time set?	<ul style="list-style-type: none"> • Wait until the module READY signal delay time elapses. • Review whether the module READY signal delay time is appropriate.
	Is the RUN LED turned OFF?	There may be a watchdog timer error. Please contact your local Mitsubishi Electric sales office or representative.
The contents of the dot matrix LED display cannot be switched even though the dot matrix LED display mode switch (SELECT/MODE/SHOW switch) is operated.	Is the contents of SELECT/MODE/SHOW switch item blank in [Module Diagnostics] ⇔ [Module Information List] of the engineering tool?	The dot matrix LED display mode switch (SELECT/MODE/SHOW switch) may have a failure. Please contact your local Mitsubishi Electric sales office or representative.
A period, not specified characters, is indicated in the dot matrix LED.	Are unusable characters set to the user specification character of the dot matrix LED?	Set usable characters to the user specification character of the dot matrix LED. (MELSEC iQ-R MES Interface Module User's Manual (Startup))

Troubleshooting on network connection

Symptom	Check point	Corrective action
Unable to access the MES interface module.	Is an Ethernet cable connected to CH1 or CH2?	Connect an Ethernet cable to CH1 or CH2.
	Is there any disconnection in the connection route?	Connect the cables properly.
	Is the IP address duplicated in other devices on the network?	Review the IP address setting.
	Is there any problem with the network settings of the personal computer?	Check the network settings on the personal computer.
	Is it connected directly using the Ethernet (CH2)?	<ul style="list-style-type: none"> • Connect directly using the Ethernet (CH1). • When using the Ethernet (CH2), use a hub.
	Is it connected to the Ethernet port which is not selected to use in the network settings?	<ul style="list-style-type: none"> • Connect to the Ethernet port which is selected to use in the network settings. • Enable the setting of the connected Ethernet port.
	Are multiple IP addresses enabled on the personal computer side at the same time?	<ul style="list-style-type: none"> • When using direct connection, review the network settings so that multiple IP addresses are not enabled on the personal computer. • Disable the wireless LAN.
	Was an attempt made to connect directly via a hub?	When using direct connection, connect MES interface module (CH1) with the personal computer on a 1:1 basis.
	Is the IP address of the MES interface module to be connected displayed in two or more places in the "MES Interface Module Search" screen?	Check if there are several MES interface modules to which the same IP address is set on the same network, and review the IP address setting.
Is the RUN LED of another MES interface module flashing by clicking the [Module Confirmation] button?		

Troubleshooting on the target device communication

Symptom	Check point	Corrective action
Unable to communicate to the specified target device.	When the response timeout error (error code: 1824H) is notified, does the device to which the remote password setting is enabled on the communication route with the target device exist?	<ul style="list-style-type: none"> • Disable the remote password setting. • Unlock the remote password.
	When communicating to the target device via the Ethernet route, does the device to which the same IP address is set exist on the same network?	<ul style="list-style-type: none"> • Do not use the device to which the same IP address is set on the same network. • Set the IP address to devices without duplication.

Troubleshooting on the information linkage function

Symptom	Check point	Corrective action
Communication with the specified database server cannot be established.	Was the server restarted after installing the database?	Restart the server.
	Is the port number set for "Service port" of DB Connection Service Setting Tool same as the one set for "Port No." in [Target Server Settings] of MES Interface Function Configuration Tool?	Set the same value. (Communication is not available if different port numbers are set.)
	Is the port number specified for "Service port" of DB Connection Service Setting Tool being used for the database or any other applications?	Change the port number to another not being used for the database or any other applications.
	Is the ODBC setting of the database correct?	Review the ODBC setting of the database.
	Does the device to which the same IP address is set exist on the same network?	<ul style="list-style-type: none"> Do not use the device to which the same IP address is set on the same network. Set the IP address to devices without duplication.
	Is the authentication plugin "mysql_native_password" when the database is MySQL?	Specify "mysql_native_password" for the authentication plugin.
	Is there any problem with the authority of a user set for the database?	Check if the user set for the database have the access right.
	Is the connection from the IP address of an MES interface module permitted?	<ul style="list-style-type: none"> When the access type is direct DB connection, permit the connection from the IP address of the MES interface module in the network settings of the database. When the access type is connection via service, permit the connection from the IP address of the MES interface module in the security function of DB Connection Service.
The database is not updated.	Has an error occurred in [Diagnose MES Interface Module] ⇒ [Module Status] tab ⇒ "Current Error Information"?	If an error has occurred, identify the error cause and take corrective actions.
	Is "Data Output Inhibition (Target Server)" enabled in [Diagnose MES Interface Module] ⇒ [Job Diagnostics] ⇒ [Temporary Change Verification Settings] tab?	Disable "Data Output Inhibition (Target Server)".
	Has an error occurred in the access log of DB Connection Service?	If an error has occurred, identify the error cause and take corrective actions.
	Are the relevant records or table locked on the database when inserting, updating or deleting data?	Unlock them on the database and execute it. (If they are locked, the execution is delayed until they are unlocked.)
	Is the "Database Type" setting in the [Target Server Settings] of MES Interface Function Configuration Tool correct?	Set the database being used.
	Is the number of updated, inserted, or deleted records '0' in the access log of DB Connection Service?	<ul style="list-style-type: none"> Check if the narrowing-down condition is satisfied. Check if there is any missing field into which a value is to be inserted. Check if the unique constraint of the database (PRIMARY KEY constraint) is violated. Check if the value to be stored exceeds the number of characters defined for the field.
	Are "FLOAT [Single Precision]" and "FLOAT [Double Precision]" compared in the narrowing-down condition?	Set to compare real numbers having same precision.
	Is an SQL statement called from the processing (such as stored procedure) executed in the database?	When using SQL Server and calling an SQL statement from the processing (such as stored procedure) executed in the database, specify "SET NOCOUNT ON" before calling.

Symptom	Check point	Corrective action
Database values are not stored in the device memory of the target device.	Has an error occurred in [Diagnose MES Interface Module] ⇒ [Module Status] tab ⇒ "Current Error Information"?	If an error has occurred, identify the error cause and take corrective actions.
	Is a job history that is set to output the working history to [Diagnose MES Interface Module] ⇒ [Job Diagnostics] ⇒ [Working History] tab ⇒ "Working History" output when the trigger condition is satisfied?	When there is no history in the "Working History", refer to the symptom 'Job does not start up'.
	Is "Data Output Inhibition (Target Device)" enabled in [Diagnose MES Interface Module] ⇒ [Job Diagnostics] ⇒ [Temporary Change Verification Settings] tab?	<ul style="list-style-type: none"> Set to disable "Data Output Inhibition (Target Device)" in the job diagnostics to use. Unselect "Inhibit the data output to the target device" in the verification setting in the job setting, and write the setting to use.
	Has an error occurred in the access log of DB Connection Service?	If an error has occurred, identify the error cause and take corrective actions.
	Is the number of selected records indicated as '0' in the access log of DB Connection Service?	Check if the narrowing-down condition is satisfied.
	Was the relevant device value manipulated in the CPU module?	Do not manipulate the device value in the CPU module at the time of writing from the MES interface module.
	Is the number of databases set for the database server sufficient?	<ul style="list-style-type: none"> Review the set number of databases, or review the number of target server settings according to the set number of databases. One database connection must be used for one item of the target server setting.
	Are "FLOAT [Single Precision]" and "FLOAT [Double Precision]" compared in the narrowing-down condition?	Set to compare real numbers having same precision.
	Is an SQL statement called from the processing (such as stored procedure) executed in the database?	When using SQL Server and calling an SQL statement from the processing (such as stored procedure) executed in the database, specify "SET NOCOUNT ON" before calling.
	Is the transaction isolation level "REPEATABLE READ" when using MySQL or MariaDB as a database?	Change the transaction isolation level to "READ COMMITTED".
A job does not start.	Has an error occurred in [Diagnose MES Interface Module] ⇒ [Module Status] tab ⇒ "Current Error Information"?	If an error has occurred, identify the error cause and take corrective actions.
	Does the condition remain satisfied in the trigger condition?	Review the trigger condition. (A job starts when the condition turns into the satisfied state from the not-satisfied state.)
	When any one of the following is selected for the event/condition type, is the time for changing a value of monitoring target long enough for the access interval set in "Read Data at Trigger Judgment"? <ul style="list-style-type: none"> Condition (Value monitoring) Event (Value changed) Handshake 	<ul style="list-style-type: none"> Lengthen the time for changing the value of monitoring target device. (Latch it in the sequence program.) Decrease the access interval at read data at trigger judgment.
	Has a job start request for handshake 1 turned OFF and ON when "Single Handshake" is selected for "Configuration Type" in a trigger condition?	<ul style="list-style-type: none"> Decrease the access interval. Increase the time that the job start request is OFF. (An MES interface module cannot detect that the job start request has turned OFF.)
	Have job start requests for handshake 1 and handshake 2 turned OFF and ON when "Multiple Handshake" is selected for "Configuration Type" in a trigger condition?	
	Is the number of settings for jobs and/or data points large?	<ul style="list-style-type: none"> Lengthen the access interval. Reduce the number of settings for jobs and/or data points to be used. Change the reading target data to "The Data to be used in Trigger Condition only" at trigger judgment. (MES interface module may be overloaded.)
	Is the device tag component which is used for the trigger condition of the job read correctly?	If an error has occurred, identify the error cause and take corrective actions.

Symptom	Check point	Corrective action
A job does not start.	Is "Job Execution Inhibition" enabled in [Diagnose MES Interface Module] ⇒ [Job Diagnostics] ⇒ [Temporary Change Verification Settings] tab?	<ul style="list-style-type: none"> Set to disable "Job Execution Inhibition" in the job diagnostics to use. Unselect "Inhibit the job execution even when the trigger condition is satisfied" in the verification setting in the job setting, and write the setting to use.
	Is there any other job that is being executed?	<p>Terminate the job that is in execution, or use another target server setting item.</p> <p>(If a job uses the same target server setting item that is currently used for another job, the job is not executed until another job execution is completed.)</p>
	Has an error or job cancellation occurred during job execution?	If an error has occurred, identify the error cause and take corrective actions.
	Are "FLOAT [Single Precision]" and "FLOAT [Double Precision]" compared in the trigger condition setting (condition (value monitoring)) of the job?	Set to compare real numbers having same precision.
	Is an RD81MES96 (the firmware version is '02' or earlier) that does not support the daylight saving time used while the daylight saving time function of a CPU module is being used?	<p>Do not use the daylight saving time function of a CPU module when using an RD81MES96 with firmware version '02' or earlier.</p> <p>(This type of MES interface module does not support the function.)</p>
	When the access type is the high-speed access (interval specification), has the high-speed access interval overload count of the buffer memory been incremented?	<p>Lengthen the access interval more than the scan time. (Data access may have failed because the specified access interval is shorter than the scan time.)</p> <ul style="list-style-type: none"> Lengthen the access interval more than the scan time. Change the access type to the high-speed access (each scan). <p>(Data access may have failed because the specified access interval is shorter than the scan time.)</p>
	When the access type is the high-speed access (each scan), has the high-speed access interval overload count of the buffer memory incremented?	<ul style="list-style-type: none"> Lengthen the access interval. Use the constant scan of the CPU module. Reduce the number of settings for jobs and/or data points to be used. <p>(MES interface module may be overloaded.)</p>
	When the trigger buffering is disabled, was an attempt made to execute the same job again while executing the job?	<ul style="list-style-type: none"> Use the constant scan of the CPU module. Reduce the number of settings for jobs and/or data points to be used. <p>(MES interface module may not finish the processing yet due to the short scan time, or be overloaded.)</p>
Job execution is slow.	Is the processing load on the server personal computer increased?	Check if the processing load of an application software on the personal computer is excessively high.
	Is data volume in the database within the specified capacity of the personal computer?	Review the data volume in the database.
	Is the number of selected/updated records excessively large when selecting or updating?	Review the Select/Update/Delete conditions that apply appropriate records only.
	Is "Output" set for "Working History" under "Working History Settings" in the [Verification Settings] tab of the Job settings?	<p>Set "Not output" for "Working History".</p> <p>☞ Page 122 Verification settings</p>
	Is the service processing load on the CPU module to be accessed increased?	<ul style="list-style-type: none"> Review the service setting of the CPU module to be accessed. Use the constant scan of the CPU module to be accessed.

Symptom	Check point	Corrective action
Unable to acquire correct values from the database.	Does the data type of the access field specified in the access table setting match with that of the database field?	Specify a correct data type to the data type of the access field.
	Is an SQL statement called from the processing (such as stored procedure) executed in the database?	When using SQL Server and calling an SQL statement from the processing (such as stored procedure) executed in the database, specify "SET NOCOUNT ON" before calling.
	Are Unicode character strings acquired from the database?	When acquiring Unicode character strings from CHAR or VARCHAR2 data type field of Oracle, set NLS_LANG character setting of Oracle client to AL32UTF8.
	Does a value acquired from a database match either of the following values? • A value stored in a database by using a different access target server setting. • A value stored by using an application instead of an MES interface module.	Review the transaction isolation level setting of the database.
	Has the action of Stored Procedure been executed for PostgreSQL?	Update the version of ODBC driver according to PostgreSQL.
	Is the character code of argument character strings other than utf8, utf8mb3, or utf8mb4 used for a stored procedure in MySQL?	Use utf8, utf8mb3, or utf8mb4 as the character code of argument character strings for the stored procedure in MySQL.
	Are characters outside the ASCII range used for a stored procedure when using MySQL Standard Edition in connection via service?	<ul style="list-style-type: none"> • Use characters within the ASCII range. • Use direct DB connection.
Unable to store correct values in the database.	Is the character string stored in the database?	When storing the character string in NCHAR or NVARCHAR2 data type field of Oracle, set NLS_LANG character setting of Oracle client to AL32UTF8.
	Is the address of the device memory specified in the device tag setting correct? (When accessing the file register ZR and R, did the specified addresses exist?)	Review the device tag setting, and specify an existing address of the device memory. (If an address does not exist when accessing the file register ZR and R, incorrect values (such as FFFFH, -1, or 0) may be read.)
	Is a setting set to store the date and time type data to a database from an RD81MES96 (the firmware version is '02' or earlier) that does not support the daylight saving time while the daylight saving time function of a CPU module is being used?	Do not use the daylight saving time function of a CPU module when using an RD81MES96 with firmware version '02' or earlier. (This type of MES interface module does not support the function.)
	Has the action for which the value is not updated (Update) in MySQL or MariaDB been executed?	Click the [Details] button in the "MySQL Connector/ODBC Data Source Configuration" screen, and select the checkbox of "Return matched rows instead of affected rows" in the [Cursors/Results] tab.
	Is a character string assigned to the date and time type or compared without specifying the data type of the access field when using the direct DB connection method for Oracle?	<ul style="list-style-type: none"> • Specify "Date and Time [Without Time Zone]" or "Date and Time [With Time Zone]" for the data type of the access field. • For direct DB connection in Oracle, the format of a character string that can be specified by implicit conversion differs depending on the parameter setting (NLS_TIMESTAMP_FORMAT, etc.) of the database. Specify the format accordingly.
Although "Resend automatically" has been selected in the DB buffer setting, an SQL statement which was buffered is not resent after the communication is recovered.	Is any one of the following operation performed while the MES interface module is running? • Was the personal computer for database server restarted? • Was the ODBC setting of the database changed? • Has the user name or password of the database been changed?	<ul style="list-style-type: none"> • Perform any of the following operations: Update the settings from MES Interface Function Configuration Tool. Turn the power of the programmable controller OFF and ON. Reset the CPU module. • Use the latest version of DB Connection Service and Setting Tool.

Troubleshooting on an SD memory card

Symptom	Check point	Corrective action
Settings were erased while the power was OFF	Is there a problem with the type of SD memory card?	Replace the SD memory card with an available one. MELSEC iQ-R MES Interface Module User's Manual (Startup)
	Was the power turned OFF or the control CPU reset during writing to the SD memory card?	Format the SD memory card with MES Interface Function Configuration Tool again.
Unable to recognize the SD memory card.	Is the SD memory card inserted correctly?	Remove the SD memory card once, then insert it again.
	Was the power turned OFF or the control CPU reset during writing to the SD memory card?	Format the SD memory card with MES Interface Function Configuration Tool again.

Troubleshooting on the REST server function

Symptom	Check point	Corrective action
The REST server function does not work.	The operating status of MES interface function is "Running" in the [Online] ⇒ [Diagnose MES Interface Module] ⇒ [Module Status] tab.	When the operating status of the information linkage function is 'Stop', perform any of the following operation: <ul style="list-style-type: none"> Restart the operation of MES interface function Turn the power of the programmable controller OFF and ON Reset the CPU module

Troubleshooting on Project File Conversion Tool

Symptom	Check point	Corrective action
Conversion of a project file fails.	Check if the '(file name).mu2.tmp' file is output.	<p>If a '(file name).mu2.tmp' file is output, perform the following procedure.</p> <ol style="list-style-type: none"> Change the extension of the output file from '(file name).mu2.tmp' to 'mu2'. Open the file in MELSEC iQ-R series MES Interface Function Configuration Tool. Change the settings by referring to the error contents of the conversion log, or information displayed on the status bar of each setting screen of MES Interface Function Configuration Tool. <p>If a '(file name).mu2.tmp' file is not output, perform the following procedure.</p> <ol style="list-style-type: none"> Open the conversion source file with MELSEC-Q series MES Interface Function Configuration Tool. Change the setting by referring to the error log output when the conversion failed, and perform conversion again.
Unable to write a converted project file to an MES interface module.	<p>Does the following message appear?</p> <ul style="list-style-type: none"> Unable to write in the target MES interface module. The setting items which cannot be used are included. Review the following setting items. Is the device type of the target device other than "MELSEC (RCPU)" used? 	<ul style="list-style-type: none"> Select "MELSEC (RCPU)" for "Device Type" in the access target device setting. Use an RD81MES96 with firmware version '04' or later. Use an RD81MES96N. <p>(An RD81MES96 with firmware version '03' or earlier cannot access a QCPU (Q mode) or LCPU.)</p>
	<p>Does the following message appear?</p> <ul style="list-style-type: none"> Unable to write in the target MES interface module. The setting items which cannot be used are included. Review the following setting items. Is a setting set after access target device setting No.17? 	<ul style="list-style-type: none"> Do not set a setting in No.17 or later of the access target device setting. Use an RD81MES96N. <p>(For an RD81MES96, a setting cannot be set in No.17 or later of the access target device setting.)</p>

7.4 Error Code List

This section shows the error code lists.

Error codes for an MES interface module

If a system error occurs, please contact your local Mitsubishi Electric sales office or representative.

Error code	Error name	Error description	Corrective action
1800H	Unsupported device error	<ul style="list-style-type: none"> A device unsupported by MES interface module exists on the access route. 	<ul style="list-style-type: none"> Review the device on the access route.
1801H to 1802H	Incorrect target error	<ul style="list-style-type: none"> Incorrect setting values in the "Target Device Settings". 	<ul style="list-style-type: none"> Review the settings in the "Target Device Settings".
1803H	Incorrect target error	<ul style="list-style-type: none"> A non-existent device is set in the "Target Device Settings". A device/access route unsupported by MES interface module is set in the "Target Device Settings". 	<ul style="list-style-type: none"> Review the settings in the "Target Device Settings". Check if there is any problem on the route to the target device.
1804H	Incorrect target error	<ul style="list-style-type: none"> A non-existent device is set in the "Target Device Settings". A device unsupported by MES interface module is set in the "Target Device Settings". 	<ul style="list-style-type: none"> Review the settings in the "Target Device Settings".
1805H	Incorrect target error	<ul style="list-style-type: none"> A non-accessible device is set in the "Target Device Settings". 	<ul style="list-style-type: none"> Review the settings in the "Target Device Settings".
1806H	Device memory type error	<ul style="list-style-type: none"> A non-existent device memory type is specified. (Or the size of device memory exceeds the applicable range.) 	<ul style="list-style-type: none"> Review the device memory type entered in the "Device Tag Settings". When using an MES interface module (RD81MES96 the firmware version of which is '02' or earlier) that does not support an extended SRAM cassette 16MB (NZ2MC-16MBS), set the file register capacity within 5696 K words in CPU parameters of a CPU module.
1807H	Device memory No. error	<ul style="list-style-type: none"> A non-existent device memory No. is specified. 	<ul style="list-style-type: none"> Review the device memory No. entered in the "Device Tag Settings".
1808H	Target device communication error	<ul style="list-style-type: none"> An error has occurred when accessing the target device. 	<ul style="list-style-type: none"> Check if the settings in the "Target Device Settings" are correct. Check the status of the target device. Check if the route to the target device is correct. Check if there is any problem on the route to the target device.
1809H	Data reception error	<ul style="list-style-type: none"> Failed to receive the data. 	<ul style="list-style-type: none"> Review the device on the access route.
180AH	Size error	<ul style="list-style-type: none"> The size of device memory exceeds the applicable range. 	<ul style="list-style-type: none"> Review the device memory No. entered in the "Device Tag Settings".
180BH	Block error	<ul style="list-style-type: none"> The block No. of the specified extension file register is incorrect. 	<ul style="list-style-type: none"> Check the block No. (device memory type) of the extension file register.
180CH	Data reception error	<ul style="list-style-type: none"> Failed to receive the data. 	<ul style="list-style-type: none"> Review the device on the access route.
180DH	Write-protect error	<ul style="list-style-type: none"> The block No. of the specified extension file register overlaps with the write-protect area of the memory cassette. 	<ul style="list-style-type: none"> Check the block No. (device memory type) of the extension file register. Check the write-protect DIP switch on the memory cassette of the target device.
180EH	Device type mismatch error	<ul style="list-style-type: none"> The device type set in the "Target Device Settings" is different from the one of the actual target device. 	<ul style="list-style-type: none"> Review the settings in the "Target Device Settings".
180FH	Station No. specification error	<ul style="list-style-type: none"> Incorrect station No. is specified in the "Target Device Settings". 	<ul style="list-style-type: none"> Review the settings in the "Target Device Settings".
1810H	ROM operation error	<ul style="list-style-type: none"> The TC setting value was written to the CPU module during ROM operation. 	<ul style="list-style-type: none"> Change the TC setting value during RAM operation.
1811H	Incorrect target device settings error (Start I/O No.)	<ul style="list-style-type: none"> Incorrect start I/O No. is specified in the "Target Device Settings". 	<ul style="list-style-type: none"> Review the contents (start I/O No.) of the target device settings. Check the configuration of the target device (start I/O No.).
1812H to 1813H	Data reception error	<ul style="list-style-type: none"> Failed to receive the data. 	<ul style="list-style-type: none"> Review the device on the access route.

Error code	Error name	Error description	Corrective action
1814H	Incorrect target device settings error (IP address)	<ul style="list-style-type: none"> Incorrect IP address is specified in the "Target Device Settings". 	<ul style="list-style-type: none"> Review the contents (IP address) in the "Target Device Settings". Check the configuration of the target device (IP address).
1815H to 1816H	Target device communication reception data error	<ul style="list-style-type: none"> Incorrect data received from the target device. 	<ul style="list-style-type: none"> Review the settings in the "Target Device Settings". Check the status of the communication cable and the target module.
1817H	Unsupported device error	<ul style="list-style-type: none"> A device unsupported by MES interface module exists on the access route. 	<ul style="list-style-type: none"> Review the device on the access route.
1818H	Data reception error	<ul style="list-style-type: none"> Multiple responses were received at Ethernet direct communication. 	<ul style="list-style-type: none"> Check if the direct connection with the module is configured on a 1:1 basis.
1819H	Incorrect target device status error	<ul style="list-style-type: none"> Unable to set. The MES interface module is communicating with other devices at Ethernet direct communication. 	<ul style="list-style-type: none"> Check if the direct connection with the module is configured on a 1:1 basis.
181AH	Incorrect target device settings error (Station No./Network No.)	<ul style="list-style-type: none"> Incorrect Station No./Network No. are specified in the "Target Device Settings". 	<ul style="list-style-type: none"> Review the contents (Station No./Network No.) in the "Target Device Settings". Check the configuration of the target device (Station No./Network No.).
181BH	Target device communication connection error (IP address)	<ul style="list-style-type: none"> Incorrect IP address is specified in the "Target Device Settings". 	<ul style="list-style-type: none"> Review the contents (IP address) in the "Target Device Settings". Check the configuration of the target device (IP address).
181CH	Target device communication timeout error	<ul style="list-style-type: none"> No response from the target device. 	<ul style="list-style-type: none"> Check the status of the target device. Review the contents in the "Target Device Settings" Adjust the target device response monitoring time.
181DH to 181FH	Data send error	<ul style="list-style-type: none"> Failed to send the data. 	<ul style="list-style-type: none"> Review the device on the access route.
1820H to 1823H	Data reception error	<ul style="list-style-type: none"> Failed to receive the data. 	<ul style="list-style-type: none"> Review the device on the access route.
1824H	Response timeout error	<ul style="list-style-type: none"> No response from the target station. 	<ul style="list-style-type: none"> Review the settings in the "Target Device Settings". Check the status of the communication cable and the target module. Adjust the target device response monitoring time. Review the routing parameter of the devices on the access route. Review the control CPU of the network module on the network communication route to the target module. Review whether the target device is supported by MES interface module. Check the configuration of the target device.
1874H	Monitor condition dissatisfied error	<ul style="list-style-type: none"> Attempted to access the device which did not match the monitor condition. 	<ul style="list-style-type: none"> Review the monitor condition in the engineering tool.
18F0H	Target device communication error	<ul style="list-style-type: none"> Failed to communicate with target device. 	<ul style="list-style-type: none"> Check the source error code.
18FEH	Target device communication error	<ul style="list-style-type: none"> An error has occurred when accessing the target device. 	<ul style="list-style-type: none"> Check if the settings in the "Target Device Settings" are correct. Check the status of the target device. Check if the route to the target device is correct. Check if there is any problem on the route to the target device.
18FFH to 1900H	System error	—	—
1901H to 1903H	Target device communication error	<ul style="list-style-type: none"> Failed to communicate with target device. 	<ul style="list-style-type: none"> Check the source error code.
1904H	Errors detected in the CPU module	—	<ul style="list-style-type: none"> Check the source error code displayed on the error detailed information of the engineering tool, and check it in the user's manual of the CPU module.
1905H to 1906H	Target device communication error	<ul style="list-style-type: none"> Failed to communicate with target device. 	<ul style="list-style-type: none"> Check the source error code.

Error code	Error name	Error description	Corrective action
1907H	Errors detected in the serial communication module	—	<ul style="list-style-type: none"> Check the source error code displayed on the error detailed information of the engineering tool, and check it in the user's manual of the serial communication module.
1908H to 190AH	Target device communication error	<ul style="list-style-type: none"> Failed to communicate with target device. 	<ul style="list-style-type: none"> Check the source error code.
190BH	Errors detected in the CC-Link module	—	<ul style="list-style-type: none"> Check the source error code displayed on the error detailed information of the engineering tool, and check it in the user's manual of the CC-Link module.
190CH	Errors detected in the Ethernet-equipped module	—	<ul style="list-style-type: none"> Check the source error code displayed in the error detailed information of an engineering tool. Refer to the user's manual of the Ethernet-equipped module and check the errors displayed in the source error code.
190DH	Errors detected in the CC-Link IE Field Network module	—	<ul style="list-style-type: none"> Check the source error code displayed on the error detailed information of the engineering tool, and check it in the user's manual of the CC-Link IE Field Network module.
190EH	Errors detected in the CC-Link IE Controller Network module	—	<ul style="list-style-type: none"> Check the source error code displayed on the error detailed information of the engineering tool, and check it in the user's manual of the CC-Link IE Controller Network module.
190FH	Errors detected in the MELSECNET/H network module	—	<ul style="list-style-type: none"> Check the source error code displayed on the error detailed information of the engineering tool, and check it in the user's manual of the MELSECNET/H network module.
1910H	BCD type conversion error	<ul style="list-style-type: none"> The value that cannot be correctly represented in BCD type is stored in the device memory. 	<ul style="list-style-type: none"> Review the settings in the "Device Tag Settings". Check if the value stored in the device memory can be properly represented in BCD type.
1911H	Real number data error	<ul style="list-style-type: none"> Incorrect real number data of the device memory 	<ul style="list-style-type: none"> Review the settings in the "Device Tag Settings". Check if '-0', subnormal number, $\pm\infty$ or non-numeric value (NaN) is set in the device memory.
1912H	Number of characters overflow error	<ul style="list-style-type: none"> Unable to write. The number of characters in the character string [ASCII/SJIS] to be written exceeded that of the target device tag. 	<ul style="list-style-type: none"> Review the settings in the "Device Tag Settings".
1931H	Target device connection error	<ul style="list-style-type: none"> Unable to connect to the target device. 	<ul style="list-style-type: none"> Review the settings in the "Target Device Settings". Check the status of the communication cable and the target module. Review the device on the access route.
1940H	Sequence scan synchronization sampling function unsupported CPU error	<ul style="list-style-type: none"> The control CPU of MES interface module does not support the sequence scan synchronization sampling function. 	<ul style="list-style-type: none"> Replace with a CPU supporting the sequence scan synchronization sampling function. Change the setting from the high-speed access to the general access.
1941H	Number of sequence scan synchronization sampling function points exceeded error	<ul style="list-style-type: none"> The total number of access points for each module using the sequence scan synchronization sampling function in the same control CPU has exceeded the maximum number. (The number of access points is calculated by rounding up in 8 K points.) 	<ul style="list-style-type: none"> Review the settings of each module using the sequence scan synchronization sampling function in the control CPU so that the total number of access points is the maximum number or less.
1942H	System error	—	—
1943H	Target device communication error	<ul style="list-style-type: none"> An error has occurred when accessing the target device. 	<ul style="list-style-type: none"> Check if the settings in the "Target Device Settings" are correct. Check the status of the target device. Check if the route to the target device is correct. Check if there is any problem on the route to the target device.

Error code	Error name	Error description	Corrective action
1944H	Response timeout error	<ul style="list-style-type: none"> No response from the target station. 	<ul style="list-style-type: none"> Review the settings in the "Target Device Settings". Check the status of the target device. Adjust the target device response monitoring time. Review whether the target device is supported by MES interface module. Check the configuration of the target device.
1980H	BCD type conversion error	<ul style="list-style-type: none"> The value that cannot be correctly represented in BCD type is stored in the device memory. 	<ul style="list-style-type: none"> Review the settings in the "Device Tag Settings". Check if the value stored in the device memory can be properly represented in BCD type.
1981H	Real number data error	<ul style="list-style-type: none"> Incorrect real number data of the device memory 	<ul style="list-style-type: none"> Review the settings in the "Device Tag Settings". Check if '-0', subnormal number, $\pm\infty$ or non-numeric value (NaN) is set in the device memory.
1990H	System error	—	—
19C0H	Verification settings error	<ul style="list-style-type: none"> Incorrect settings in the "Verification Settings" 	<ul style="list-style-type: none"> Review the settings in the "Verification Settings".
19C1H	Working history write error	<ul style="list-style-type: none"> Failed to write the working history. 	<ul style="list-style-type: none"> Check the file access status (X3). Turn the power OFF → ON or reset the CPU module.
19E0H	CH1/CH2 fourth octet specification address setting error	<ul style="list-style-type: none"> The value set in the CH1/CH2 fourth octet specification address is out of the range. 	<ul style="list-style-type: none"> Check if a value from 1 to 254 is set in the CH1/CH2 fourth octet specification address.
1C00H	DB Connection Service communication error	<ul style="list-style-type: none"> An Ethernet communication error has occurred. 	<ul style="list-style-type: none"> Check the Ethernet connection. Check if the settings in the "Target Server Settings" are correct. Check if the ODBC settings are correct.
1C01H to 1C04H	DB buffer content error	<ul style="list-style-type: none"> Incorrect DB buffer contents (The SD memory card may be damaged.) 	<ul style="list-style-type: none"> Replace the SD memory card. Slide the write protect switch to unlock the SD memory card (remove the write-protect) when the switch is in the lock position (protecting data writing).
1C05H	DB buffer restoration	<ul style="list-style-type: none"> The partially incorrect DB buffer contents are restored. (The DB buffering information in the SD memory card may be partially corrupted.) 	<ul style="list-style-type: none"> Replace the SD memory card if the same error occurs again.
1C06H to 1C07H	DB buffer clear error	<ul style="list-style-type: none"> Failed to clear the DB buffer. (The SD memory card may be damaged) 	<ul style="list-style-type: none"> Replace the SD memory card. Slide the write protect switch to unlock the SD memory card (remove the write-protect) when the switch is in the lock position (protecting data writing).
1C08H to 1C0AH	DB buffer file open error	<ul style="list-style-type: none"> Incorrect DB buffer (The SD memory card may be damaged.) 	<ul style="list-style-type: none"> Replace the SD memory card. Slide the write protect switch to unlock the SD memory card (remove the write-protect) when the switch is in the lock position (protecting data writing).
1C0BH	DB buffer full error	<ul style="list-style-type: none"> Unable to buffer the data. The DB buffer is full. 	<ul style="list-style-type: none"> Check the network status. Secure the DB buffering capacity. Resend the DB buffer. Clear the DB buffer. Change and update the settings.
1C0CH to 1C0DH	DB buffer read error	<ul style="list-style-type: none"> Unable to read data normally in the DB buffer. 	<ul style="list-style-type: none"> Check the SD memory card. Replace the SD memory card if it is damaged. Slide the write protect switch to unlock the SD memory card (remove the write-protect) when the switch is in the lock position (protecting data writing).
1C0EH	DB buffer file close error	<ul style="list-style-type: none"> Incorrect DB buffer (The SD memory card may be damaged.) 	<ul style="list-style-type: none"> Check the SD memory card. Replace the SD memory card if it is damaged. Slide the write protect switch to unlock the SD memory card (remove the write-protect) when the switch is in the lock position (protecting data writing).

Error code	Error name	Error description	Corrective action
1C0FH to 1C11H	DB buffering data size error	<ul style="list-style-type: none"> Incorrect data size stored in the DB buffer (The SD memory card may be damaged.) 	<ul style="list-style-type: none"> Check the SD memory card. Replace the SD memory card if it is damaged. Slide the write protect switch to unlock the SD memory card (remove the write-protect) when the switch is in the lock position (protecting data writing).
1C12H to 1C13H	DB buffering write error	<ul style="list-style-type: none"> Failed to write data to the DB buffer. 	<ul style="list-style-type: none"> Secure a sufficient free space in the SD memory card, and reset the settings of the DB buffering capacity. Check if the SD memory card is damaged. Slide the write protect switch to unlock the SD memory card (remove the write-protect) when the switch is in the lock position (protecting data writing).
1C14H	Incorrect maximum number of records error	<ul style="list-style-type: none"> The value of the device tag specified for the maximum number of acquired records or variable value is set to '0' or less. 	<ul style="list-style-type: none"> The value of the device tag specified for the maximum number of acquired records or variable value is set to '1' or more.
1C15H	Communication start error	<ul style="list-style-type: none"> Failed to start the communication. An Ethernet communication error has occurred. 	<ul style="list-style-type: none"> Check the Ethernet connection. Check if the settings in the "Target Server Settings" are correct. Check if the ODBC settings are correct.
1C16H	Communication connection error	<ul style="list-style-type: none"> An Ethernet communication error has occurred. 	<ul style="list-style-type: none"> Check the Ethernet connection. Check if the settings in the "Target Server Settings" are correct. Check if the ODBC settings are correct. Check the error contents of the server. Check the firewall settings.
1C17H	Communication connection timeout	<ul style="list-style-type: none"> An Ethernet communication error has occurred. 	<ul style="list-style-type: none"> Check the Ethernet connection. Check if the settings in the "Target Server Settings" are correct. Check if the ODBC settings are correct. Check the error contents (log of DB Connection Service/Event log of Windows) of the server. Consult your network administrator about the firewall settings.
1C18H	Communication message send error	<ul style="list-style-type: none"> An Ethernet communication error has occurred. 	<ul style="list-style-type: none"> Check the Ethernet connection. Check if the settings in the "Target Server Settings" are correct. Check if the ODBC settings are correct.
1C19H	Communication message send timeout	<ul style="list-style-type: none"> An Ethernet communication error has occurred. 	<ul style="list-style-type: none"> Check the Ethernet connection. Check if the settings in the "Target Server Settings" are correct. Check if the ODBC settings are correct.
1C1AH	Communication message reception error	<ul style="list-style-type: none"> An Ethernet communication error has occurred. 	<ul style="list-style-type: none"> Check the Ethernet connection. Check if the settings in the "Target Server Settings" are correct. Check if the ODBC settings are correct. Check if the database has been restarted. Check if the unique constraint of the database (PRIMARY KEY constraint) is violated. Check if the MES interface module is not running before starting the database. ■Also check the following when the database is Access. <ul style="list-style-type: none"> Check if 128 or more fields are updated in one action. Check the sent SQL statement and the database contents. Check if the settings of the table and field are correct. Check if reserved words of the database are used for the table and field. Check if multiple accesses have been made to one file at the same time (such as the accesses from multiple MES interface modules).

Error code	Error name	Error description	Corrective action
1C1BH	Communication message reception timeout error	<ul style="list-style-type: none"> An Ethernet communication error has occurred. 	<ul style="list-style-type: none"> Check the Ethernet connection. Check if the settings in the "Target Server Settings" are correct. Check if the ODBC settings are correct.
1C1CH	DB transaction status error	<ul style="list-style-type: none"> Incorrect DB transaction status 	<ul style="list-style-type: none"> Check the transaction status of the database.
1C1DH	DB transaction start status error	<ul style="list-style-type: none"> Incorrect DB transaction start status 	<ul style="list-style-type: none"> Check the transaction status of the database.
1C1EH	DB transaction end status error	<ul style="list-style-type: none"> Incorrect DB transaction end status 	<ul style="list-style-type: none"> Check the transaction status of the database.
1C1FH	Database connection error	<ul style="list-style-type: none"> An Ethernet communication error has occurred. 	<ul style="list-style-type: none"> Check the Ethernet connection. Check if the settings in the "Target Server Settings" are correct. Check if the ODBC settings are correct.
1C20H	Communication message reception error	<ul style="list-style-type: none"> An Ethernet communication error has occurred. 	<ul style="list-style-type: none"> Check the Ethernet connection. Check if the settings in the "Target Server Settings" are correct. Check if the ODBC settings are correct.
1C21H	Communication message reception content error	<ul style="list-style-type: none"> An Ethernet communication error has occurred. 	<ul style="list-style-type: none"> Check the Ethernet connection. Check if the settings in the "Target Server Settings" are correct. Check if the ODBC settings are correct.
1C22H	DB access (or program execution) completion wait timeout	<ul style="list-style-type: none"> No response from the database at database access, or no response from the program at program execution. (An Ethernet communication error has occurred.) 	<ul style="list-style-type: none"> Check the Ethernet connection. Check if the settings in the "Target Server Settings" are correct. Check if the ODBC settings are correct. Check if the database is running normally. Check if the program specified for program execution has been completed. Increase the DB access timeout time in DB Connection Service Setting Tool. Check if the processing overload of the server is high. Check if data amount in the database exceeds the capacity of the computer. Check if the number of selected/updated records is extremely large when selecting or updating. ■Also check the following when the database is MySQL. <ul style="list-style-type: none"> Check if surrogate characters are used in the sent SQL statement.
1C23H	SELECT execution error	<ul style="list-style-type: none"> Failed to execute SELECT. 	<ul style="list-style-type: none"> Check the sent SQL statement and the database contents. Check if the settings of the table and field are correct. Check if reserved words of the database are used for the table and field. ■Also check the following when the database is Access. <ul style="list-style-type: none"> Check if multiple accesses have been made to one file at the same time (such as the accesses from multiple MES interface modules).
1C24H	COMMIT execution error	<ul style="list-style-type: none"> Failed to execute COMMIT. 	<ul style="list-style-type: none"> Check the sent SQL statement and the database contents. Check if the settings of the table and field are correct. Check if reserved words of the database are used for the table and field.
1C25H	ROLLBACK execution error	<ul style="list-style-type: none"> Failed to execute ROLLBACK. 	<ul style="list-style-type: none"> Check the sent SQL statement and the database contents. Check if the settings of the table and field are correct. Check if reserved words of the database are used for the table and field.

Error code	Error name	Error description	Corrective action
1C26H	DB update error	<ul style="list-style-type: none"> Failed in the update processing of the DB. 	<ul style="list-style-type: none"> Check the sent SQL statement and the database contents. Check if the settings of the table and field are correct. Check if reserved words of the database are used for the table and field. ■Also check the following when the database is Access. <ul style="list-style-type: none"> Check if 128 or more fields are updated in one action. Check if multiple accesses have been made to one file at the same time (such as the accesses from multiple MES interface modules).
1C27H	SQL execution error	<ul style="list-style-type: none"> An error has occurred in SQL execution. 	<ul style="list-style-type: none"> Check the sent SQL statement and the database contents. Check if the settings of the table and field are correct. Check if reserved words of the database are used for the table and field. Check if the unique constraint of the database (PRIMARY KEY constraint) is violated. ■Also check the following when the database is Access. <ul style="list-style-type: none"> Check if multiple accesses have been made to one file at the same time (such as the accesses from multiple MES interface modules).
1C28H	ODBC connection error at SQL execution	<ul style="list-style-type: none"> An error has occurred when connecting the ODBC in the SQL execution. 	<ul style="list-style-type: none"> Check the sent SQL statement and the database contents. Check if the settings of the table and field are correct. Check if reserved words of the database are used for the table and field.
1C29H	Program execution completion wait timeout error	<ul style="list-style-type: none"> No response from the program at program execution. 	<ul style="list-style-type: none"> Increase the DB access timeout time in DB Connection Service Setting Tool. Terminate running programs before logoff. Check if the program specified with the program execution function is executable with the specified account.
1C2AH	Number of characters overflow error (DB communication action)	<ul style="list-style-type: none"> Unable to write. The number of characters of "Notification Data" in the "Exception Settings" exceeds that of the "Notification Destination". 	<ul style="list-style-type: none"> Review the settings of the "Notification Destination" in the "Exception Settings".
1C2BH	Overflow error (DB communication action)	<ul style="list-style-type: none"> Unable to write. The value of "Notification Data" in the "Exception Settings" is out of range of the "Notification Destination" 	<ul style="list-style-type: none"> Review the settings of the "Notification Destination" in the "Exception Settings".
1C2CH	Number of characters overflow error (DB communication action)	<ul style="list-style-type: none"> Unable to write. The number of characters of the acquired character string in "Select" or "Multiple Select" exceeds that of "Assignment Data". 	<ul style="list-style-type: none"> Review the settings in the "Assignment Data" in the "Data Assignment Settings".
1C2DH	Overflow error (DB communication action)	<ul style="list-style-type: none"> Unable to write. The value acquired in "Select", "Multiple Select", or "Stored Procedure" is out of the range of that of "Assignment Data". 	<ul style="list-style-type: none"> Review the settings in the "Assignment Data" in the "Data Assignment Settings".
1C2EH	System error	—	—
1C2FH	DB Connection Service communication error	<ul style="list-style-type: none"> An Ethernet communication error has occurred at DB buffer resend. 	<ul style="list-style-type: none"> Check the Ethernet connection. Check if the settings in the "Target Server Settings" are correct. Check if the ODBC settings are correct.
1C30H	Communication start error	<ul style="list-style-type: none"> Failed to start the communication. An Ethernet communication error has occurred at DB buffer resend. 	<ul style="list-style-type: none"> Check the Ethernet connection. Check if the settings in the "Target Server Settings" are correct. Check if the ODBC settings are correct.
1C31H	Communication connection error	<ul style="list-style-type: none"> An Ethernet communication error has occurred at DB buffer resend. 	<ul style="list-style-type: none"> Check the Ethernet connection. Check if the settings in the "Target Server Settings" are correct. Check if the ODBC settings are correct. Check the error contents of the server. Check the firewall settings.

Error code	Error name	Error description	Corrective action
1C32H	Communication connection timeout error	<ul style="list-style-type: none"> An Ethernet communication error has occurred at DB buffer resend. 	<ul style="list-style-type: none"> Check the Ethernet connection. Check if the settings in the "Target Server Settings" are correct. Check if the ODBC settings are correct. Check the error contents (log of DB Connection Service/Event log of Windows) of the server. Consult your network administrator about the firewall settings.
1C33H	Communication message send error	<ul style="list-style-type: none"> An Ethernet communication error has occurred at DB buffer resend. 	<ul style="list-style-type: none"> Check the Ethernet connection. Check if the settings in the "Target Server Settings" are correct. Check if the ODBC settings are correct.
1C34H	Communication message send timeout	<ul style="list-style-type: none"> An Ethernet communication error has occurred at DB buffer resend. 	<ul style="list-style-type: none"> Check the Ethernet connection. Check if the settings in the "Target Server Settings" are correct. Check if the ODBC settings are correct.
1C35H	Communication message reception error	<ul style="list-style-type: none"> An Ethernet communication error has occurred at DB buffer resend. 	<ul style="list-style-type: none"> Check the Ethernet connection. Check if the settings in the "Target Server Settings" are correct. Check if the ODBC settings are correct. Check if the database has been restarted. ■Also check the following when the database is Access. <ul style="list-style-type: none"> Check if 128 or more fields are updated in one action. Check the sent SQL statement and the database contents. Check if the settings of the table and field are correct. Check if reserved words of the database are used for the table and field.
1C36H	Communication message reception timeout error	<ul style="list-style-type: none"> An Ethernet communication error has occurred at DB buffer resend. 	<ul style="list-style-type: none"> Check the Ethernet connection. Check if the settings in the "Target Server Settings" are correct. Check if the ODBC settings are correct.
1C37H	Database connection error	<ul style="list-style-type: none"> An Ethernet communication error has occurred at DB buffer resend. 	<ul style="list-style-type: none"> Check the Ethernet connection. Check if the settings in the "Target Server Settings" are correct. Check if the ODBC settings are correct.
1C38H	Communication message reception error	<ul style="list-style-type: none"> An Ethernet communication error has occurred at DB buffer resend. 	<ul style="list-style-type: none"> Check the Ethernet connection. Check if the settings in the "Target Server Settings" are correct. Check if the ODBC settings are correct.
1C39H	Communication message reception content error	<ul style="list-style-type: none"> An Ethernet communication error has occurred at DB buffer resend. 	<ul style="list-style-type: none"> Check the Ethernet connection. Check if the settings in the "Target Server Settings" are correct. Check if the ODBC settings are correct.
1C3AH	DB access completion wait timeout error (At DB buffer resend)	<ul style="list-style-type: none"> No response from the database at database access (DB buffer resend). (An Ethernet communication error has occurred.) 	<ul style="list-style-type: none"> Check the Ethernet connection. Check if the settings in the "Target Server Settings" are correct. Check if the ODBC settings are correct. Check if the database is running normally. Increase the DB access timeout time in DB Connection Service Setting Tool. Check if the processing overload of the server is high. Check if data amount in the database exceeds the capacity of the computer. Check if the number of selected/updated records is extremely large when selecting or updating.

Error code	Error name	Error description	Corrective action
1C3BH	DB update error	<ul style="list-style-type: none"> Failed in the update processing of the DB at DB buffer resend. 	<ul style="list-style-type: none"> Check the sent SQL statement and the database contents. Check if the settings of the table and field are correct. Check if reserved words of the database are used for the table and field. ■Also check the following when the database is Access. <ul style="list-style-type: none"> Check if 128 or more fields are updated in one action. Check if multiple accesses have been made to one file at the same time (such as the accesses from multiple MES interface modules).
1C3CH	SQL execution error	<ul style="list-style-type: none"> An error has occurred in SQL execution at DB buffer resend. 	<ul style="list-style-type: none"> Check the sent SQL statement and the database contents. Check if the settings of the table and field are correct. Check if reserved words of the database are used for the table and field. Check if the unique constraint of the database (PRIMARY KEY constraint) is violated. ■Also check the following when the database is Access. <ul style="list-style-type: none"> Check if multiple accesses have been made to one file at the same time (such as the accesses from multiple MES interface modules).
1C3DH	ODBC connection error at SQL execution	<ul style="list-style-type: none"> An error has occurred when connecting ODBC in SQL execution at DB buffer resend. 	<ul style="list-style-type: none"> Check the sent SQL statement and the database contents. Check if the settings of the table and field are correct. Check if reserved words of the database are used for the table and field.
1C3EH	COMMIT execution error	<ul style="list-style-type: none"> Failed to execute COMMIT at DB buffer resend. 	<ul style="list-style-type: none"> Check the sent SQL statement and the database contents. Check if the settings of the table and field are correct. Check if reserved words of the database are used for the table and field.
1C3FH	ROLLBACK execution error	<ul style="list-style-type: none"> Failed to execute ROLLBACK at DB buffer resend. 	<ul style="list-style-type: none"> Check the sent SQL statement and the database contents. Check if the settings of the table and field are correct. Check if reserved words of the database are used for the table and field.
1C40H	DB buffering error	<ul style="list-style-type: none"> Failed to write DB buffer. 	<ul style="list-style-type: none"> Check if the SD memory card is damaged. Check if the DB buffer size of the DB buffer settings is appropriate. Check if the SD memory card had been used in other applications. Slide the write protect switch to unlock the SD memory card (remove the write-protect) when the switch is in the lock position (protecting data writing).
1C41H to 1C44H	System error	—	—
1C45H	Overflow error (DB communication action)	<ul style="list-style-type: none"> Unable to write. The number of acquired records is out of the range of the value of "Notification Destination" in the "Option Settings". 	<ul style="list-style-type: none"> Review the settings in the "Notification Destination" in the "Option Settings".
1C46H	Data type inconsistency error	<ul style="list-style-type: none"> Failed to execute the DB communication action. Unexpected data type was set. 	<ul style="list-style-type: none"> Set the correct data type with the MES Interface Function Configuration Tool.
1C47H to 1C48H	Forced cancellation of the communication	<ul style="list-style-type: none"> Canceled the communication of the job in execution forcibly. MES interface module was stopped. 	<ul style="list-style-type: none"> Restart MES interface module.

Error code	Error name	Error description	Corrective action
1C49H to 1C4AH	Stored procedure execution error	<ul style="list-style-type: none"> An error has occurred in the stored procedure execution. 	<ul style="list-style-type: none"> Check the sent stored procedure information and the database contents. Check if the settings of the stored procedure are correct. Check if reserved words are used for the stored procedure names and argument.
1C4BH	System error	—	—
1C4CH	DB buffer notification error	<ul style="list-style-type: none"> Failed to update the value of the notification destination (status, number of stored data, DB buffer full, use rate) when storing the data to the DB buffer. 	<ul style="list-style-type: none"> Check if the device set in the target device setting can be connected.
1C4DH	DB buffer notification error	<ul style="list-style-type: none"> Failed to update the value of the notification destination (status, number of stored data, DB buffer full, use rate) when clearing the data of the DB buffer. 	<ul style="list-style-type: none"> Check if the device set in the target device setting can be connected.
1C4EH	DB buffer notification error	<ul style="list-style-type: none"> Failed to update the value of the notification destination (status, number of stored data, DB buffer full, use rate) when updating settings. 	<ul style="list-style-type: none"> Check if the device set in the target device setting can be connected.
1C4FH	DB buffer notification error	<ul style="list-style-type: none"> Failed to update the value of the resend request when stopping the data resend of the DB buffer. 	<ul style="list-style-type: none"> Check if the device set in the target device setting can be connected.
1C50H	DB buffer notification error	<ul style="list-style-type: none"> Failed to update the value of the notification destination (status, number of stored data, DB buffer full, use rate) when stopping the module. 	<ul style="list-style-type: none"> Check if the device set in the target device setting can be connected.
1C51H	Access error notification error	<ul style="list-style-type: none"> Failed to update the value of the notification destination (access error notification) when failing to connect to the server. 	<ul style="list-style-type: none"> Check if the device set in the target device setting can be connected.
1C52H	Access error notification error	<ul style="list-style-type: none"> Failed to update the value of the notification destination (access error notification) when updating the settings. 	<ul style="list-style-type: none"> Check if the device set in the target device setting can be connected.
1C53H	Target server authentication error	<ul style="list-style-type: none"> Failed to connect to the target server due to incorrect user name or password. 	<ul style="list-style-type: none"> Check the user name/password set in the "Target Server Settings". Check if the ODBC settings are correct.
1C54H	Assignment data unset error	<ul style="list-style-type: none"> Unable to execute. No assignment data is set in the "Data Assignment Settings" of the DB communication action (Select/Multiple Select). 	<ul style="list-style-type: none"> Review whether the assignment data is set in the "Data Assignment Settings" in the DB communication action (Select/Multiple Select).
1C55H	Access procedure argument overflow error	<ul style="list-style-type: none"> Unable to execute the "Stored Procedure". The value of "Assignment Data" is out of the range of that of "Access Procedure Argument". 	<ul style="list-style-type: none"> Review the element in the "Assignment Data" in the "Data Assignment Settings".
1C56H	Incorrect maximum number of records error	<ul style="list-style-type: none"> The value specified in the maximum number of records to be acquired is greater than the array size. 	<ul style="list-style-type: none"> For the value specified in the maximum number of records to be acquired, set it less than the array size.
1C57H	DB connection service version error	<ul style="list-style-type: none"> Function incompatible with DB Connection Service version of connection target is used. 	<ul style="list-style-type: none"> Install the latest version of DB Connection Service to a database server or application server of the connection target.
1C58H	Incorrect number of inserted records error	<ul style="list-style-type: none"> The value of the device tag specified for the number of inserted records or variable value is set to '0' or less. 	<ul style="list-style-type: none"> The value of the device tag specified for the number of inserted records or variable value is set to '1' or more.
1C59H	Incorrect number of inserted records error	<ul style="list-style-type: none"> The value specified in the number of records to be inserted is greater than the array size. 	<ul style="list-style-type: none"> For the value specified in the number of records to be inserted set it less than the array size.
1D00H	Program execution function error	<ul style="list-style-type: none"> Failed to create an event at program execution. 	<ul style="list-style-type: none"> Check if the program specified with the program execution function is executable with the specified account.
1D01H	Program execution function error	<ul style="list-style-type: none"> Failed to create a thread at program execution. 	<ul style="list-style-type: none"> Check if the program specified with the program execution function is executable with the specified account.
1D02H	Program file specified with program execution function error	<ul style="list-style-type: none"> The execution file of the program specified with the program execution function does not exist. 	<ul style="list-style-type: none"> Check if the program specified with the program execution function is executable with the specified account. Check if the execution file of the program specified with the program execution function exists.

Error code	Error name	Error description	Corrective action
1D03H	Multiple program files specified with program execution function error	<ul style="list-style-type: none"> Multiple execution files of the program specified with the program execution function exist. 	<ul style="list-style-type: none"> Check if the program specified with the program execution function is executable with the specified account. Check if multiple execution files of the program specified with the program execution function exist.
1D04H	Program execution function error	<ul style="list-style-type: none"> Failed to acquire the user identification information in the application server. 	<ul style="list-style-type: none"> Check if the program specified with the program execution function is executable with the specified account.
1D05H	Program execution function error	<ul style="list-style-type: none"> Incorrect program start parameter 	<ul style="list-style-type: none"> Check if the program specified with the program execution function is executable with the specified account. Check if the start parameter specified with the program execution function are correct.
1D06H	Program execution function error	<ul style="list-style-type: none"> Failed to log on to the application server. 	<ul style="list-style-type: none"> Check if the program specified with the program execution function is executable with the specified account. Logon at least once after creating the account that is specified for the program execution function. A user with an empty password cannot be specified. Set a password for the specified user.
1D07H	Program execution function error	<ul style="list-style-type: none"> Failed to acquire the user identification information in the application server. 	<ul style="list-style-type: none"> Check if the program specified with the program execution function is executable with the specified account.
1D08H	Program execution function error	<ul style="list-style-type: none"> Unable to find the profile of the user specified in the application server. 	<ul style="list-style-type: none"> Check if the program specified with the program execution function is executable with the specified account.
1D09H	Program execution function error	<ul style="list-style-type: none"> Failed to add a privilege for the program execution in the application server. 	<ul style="list-style-type: none"> Check if the program specified with the program execution function is executable with the specified account.
1D0AH	Program execution function error	<ul style="list-style-type: none"> Failed to load the user profile in the application server. 	<ul style="list-style-type: none"> Check if the program specified with the program execution function is executable with the specified account.
1D0BH	Program execution function error	<ul style="list-style-type: none"> Failed to add the access rights for the screen display in the application server. 	<ul style="list-style-type: none"> Check if the program specified with the program execution function is executable with the specified account.
1D0CH	Program execution function error	<ul style="list-style-type: none"> Failed to startup the program in the application server. 	<ul style="list-style-type: none"> Check if the program specified with the program execution function is executable with the specified account.
1D0DH	Program execution function error	<ul style="list-style-type: none"> Failed to search a loaded user file. 	<ul style="list-style-type: none"> Check if the program specified with the program execution function is executable with the specified account.
1D0EH	Program execution function error	<ul style="list-style-type: none"> Failed to terminate the exclusion control in the application server. 	<ul style="list-style-type: none"> Check if the program specified with the program execution function is executable with the specified account.
1D0FH	Overflow error (External communication action)	<ul style="list-style-type: none"> Unable to write. The program execution result return value is out of the range of that of "Notification Destination" in "Return Value Notification Settings". 	<ul style="list-style-type: none"> Review the settings of "Notification Destination" of "Return Value Notification Settings".
1D10H	Number of characters over error (External communication action)	<ul style="list-style-type: none"> Unable to write. The number of characters of "Notification Data" in the "Exception Settings (return value mismatched)" exceeds that of the "Notification Destination". 	<ul style="list-style-type: none"> Review the settings in the "Notification Destination" in the "Exception Settings (Return Value Mismatch)".
1D11H	Overflow error (External communication action)	<ul style="list-style-type: none"> Unable to write. The value of "Notification Data" in "Exception Settings (return value mismatched)" is out of the range of that of "Notification Destination". 	<ul style="list-style-type: none"> Review the settings in the "Notification Destination" in the "Exception Settings (Return Value Mismatch)".

Error code	Error name	Error description	Corrective action
1D12H	Detailed log sampling error	<ul style="list-style-type: none"> Failed to sample detailed log. 	<ul style="list-style-type: none"> Insert the SD memory card. Check if the DB buffer size of the DB buffer settings is appropriate. Check if the SD memory card had been used in other applications. Slide the write protect switch to unlock the SD memory card (remove the write-protect) when the switch is in the lock position (protecting data writing).
1D80H	Overflow error (Operation action)	<ul style="list-style-type: none"> Unable to write. The value obtained by the operation is out of the range of that of "Substitution Item". 	<ul style="list-style-type: none"> Review the settings of "Substitution Item".
1D81H	0 division error	<ul style="list-style-type: none"> 0 division (÷, %) was executed in the operation action. 	<ul style="list-style-type: none"> Set the second item so that the 0 division does not occur.
1D82H	Overflow error (Operation action)	<ul style="list-style-type: none"> Unable to write. The value obtained by the operation is out of the range of that of "Substitution Item". 	<ul style="list-style-type: none"> Review the settings of "Substitution Item".
1D83H	Number of characters overflow error (Operation action)	<ul style="list-style-type: none"> Unable to write. The value obtained by operation exceeds the number of characters of "Substitution Item". 	<ul style="list-style-type: none"> Review the settings of "Substitution Item".
1D84H to 1D85H	System error	—	—
1D86H	Overflow error (Operation action)	<ul style="list-style-type: none"> Unable to write. The value obtained by the operation is out of the range of that of "Substitution Item". 	<ul style="list-style-type: none"> Review the settings of "Substitution Item".
1D87H	Number of characters overflow error (Operation action)	<ul style="list-style-type: none"> Unable to write. The value obtained by operation exceeds the number of characters of "Substitution Item". 	<ul style="list-style-type: none"> Review the settings of "Substitution Item".
1D88H to 1D89H	System error	—	—
1D8AH	Detailed log sampling error	<ul style="list-style-type: none"> Failed to sample detailed log. 	<ul style="list-style-type: none"> Insert the SD memory card. Check if the DB buffer size of the DB buffer settings is appropriate. Check if the SD memory card had been used in other applications. Slide the write protect switch to unlock the SD memory card (remove the write-protect) when the switch is in the lock position (protecting data writing).
1E00H	Overflow error (Job settings)	<ul style="list-style-type: none"> Unable to write. The value of "Operation Setting at Pre-Processing/Main-Processing/Post-Processing Failure" or "DB Buffer Settings" is out of the range of that of "Notification Destination". 	<ul style="list-style-type: none"> Review the settings in "Operation Setting at Pre-Processing/Main-Processing/Post-Processing Failure" or "Notification Destination" in "DB Buffering Settings".
1E01H	Number of characters over error (Job settings)	<ul style="list-style-type: none"> Unable to write. The number of characters of "Operation Settings at Pre-processing/Main-processing/Post-processing failure" or "DB Buffer Settings" exceeds that of the "Notification Destination". 	<ul style="list-style-type: none"> Review the settings in "Operation Setting at Pre-Processing/Main-Processing/Post-Processing Failure" or "Notification Destination" in "DB Buffering Settings".
1E02H to 1E05H	System error	—	—
1E06H	Dot Matrix LED display mode error	<ul style="list-style-type: none"> The specified dot matrix LED display mode is out of range. 	<ul style="list-style-type: none"> Review the value specified in the system variable S_MATRIXLED_MODE.
1E07H	Character string acquisition error (device memory)	<ul style="list-style-type: none"> Unable to read. The value of device memory cannot be recognized as a character string. 	<ul style="list-style-type: none"> Set the value in the database of the acquisition source to be recognized as a character.
1E08H	Character string acquisition error (database)	<ul style="list-style-type: none"> Unable to read. The value acquired from the database cannot be recognized as a character string. 	<ul style="list-style-type: none"> Set the value in the database of the acquisition source to be recognized as a character.
1F00H	Setting file read error	<ul style="list-style-type: none"> The SD memory card is not inserted or failed to read the setting file. (The setting file is corrupted.) 	<ul style="list-style-type: none"> Insert the SD memory card. Retry the writing of the settings with MES Interface Function Configuration Tool. Slide the write protect switch to unlock the SD memory card (remove the write-protect) when the switch is in the lock position (protecting data writing).

Error code	Error name	Error description	Corrective action
1F01H	Log file write error	<ul style="list-style-type: none"> Failed to write the log file. 	<ul style="list-style-type: none"> Check the SD memory card. Replace the SD memory card if it is damaged. Check if the DB buffer size of the DB buffer settings is appropriate. Check if the SD memory card had been used in other applications. Slide the write protect switch to unlock the SD memory card (remove the write-protect) when the switch is in the lock position (protecting data writing).
1F05H	One-shot duplication execution error	<ul style="list-style-type: none"> Executed another one-shot execution during one-shot execution. 	<ul style="list-style-type: none"> Execute after the one-shot execution processing is completed.
1F08H	One-shot duplication execution error	<ul style="list-style-type: none"> Executed another one-shot execution during one-shot execution. 	<ul style="list-style-type: none"> Execute after the one-shot execution processing is completed.
1F09H to 1F0BH	System error	—	—
1F20H	Log output error	<ul style="list-style-type: none"> The SD memory card is not inserted or failed to write the log file. 	<ul style="list-style-type: none"> Insert the SD memory card. Replace the SD memory card. Slide the write protect switch to unlock the SD memory card (remove the write-protect) when the switch is in the lock position (protecting data writing).
1F21H	Log information error	The log information is corrupted. Restored by deleting the previous information.	—
1F43H	Setting file write error	<ul style="list-style-type: none"> Failed to write the setting file. 	<ul style="list-style-type: none"> Retry the writing of the settings with MES Interface Function Configuration Tool.
2121H	SD memory card error	<ul style="list-style-type: none"> An error has been detected in the SD memory card. 	<ul style="list-style-type: none"> Format the SD memory card. Reinsert the SD memory card. Check the SD memory card. Replace the SD memory card if it is damaged.
2440H	Module major error	<ul style="list-style-type: none"> The control CPU setting of the system parameters is different from the one of other CPUs in the multiple CPU system. An error has been detected in the I/O module or intelligent function module during the initial processing. 	<ul style="list-style-type: none"> Review the system parameters in the CPU No. 2 or later one, and match the number with those of the smallest numbered CPU module. A hardware failure may occur in the module. Please consult your local Mitsubishi representative.
2450H	Module major error	<ul style="list-style-type: none"> A major error has been detected from the I/O module or intelligent function module. 	<ul style="list-style-type: none"> Check the connection status of the extension cable. Check if the I/O module or intelligent function module is mounted correctly. Reset the CPU module and switch it to RUN. If the same error is displayed again, a hardware failure may occur in the module. Please consult your local Mitsubishi representative.
24C0H to 24C1H	System bus error	<ul style="list-style-type: none"> An error has been detected on the system bus. 	<ul style="list-style-type: none"> Take measures to reduce noise. Reset the CPU module and switch it to RUN. If the same error is displayed again, a hardware failure may occur in the CPU module, I/O module, intelligent function module, base unit, or extension cable. Please consult your local Mitsubishi representative.
24C2H	System bus error	<ul style="list-style-type: none"> An error has been detected on the system bus. 	<ul style="list-style-type: none"> Check the connection status of the extension cable. Take measures to reduce noise. Reset the CPU module and switch it to RUN. If the same error is displayed again, a hardware failure may occur in the CPU module, I/O module, intelligent function module, base unit, or extension cable. Please consult your local Mitsubishi representative.
24C3H	System bus error	<ul style="list-style-type: none"> An error has been detected on the system bus. 	<ul style="list-style-type: none"> Take measures to reduce noise. Reset the CPU module and switch it to RUN. If the same error is displayed again, a hardware failure may occur in the CPU module, I/O module, intelligent function module, base unit, or extension cable. Please consult your local Mitsubishi representative.

Error code	Error name	Error description	Corrective action
24C4H to 24C5H	System bus error	<ul style="list-style-type: none"> An error has been detected on the system bus. 	<ul style="list-style-type: none"> Take measures to reduce noise. Reset the CPU module and switch it to RUN. If the same error is displayed again, a hardware failure may occur in the I/O module, intelligent function module, base unit, or extension cable. Please consult your local Mitsubishi representative.
24C6H	System bus error	<ul style="list-style-type: none"> An error has been detected on the system bus. 	<ul style="list-style-type: none"> Take measures to reduce noise. Reset the CPU module and switch it to RUN. If the same error is displayed again, a hardware failure may occur in the CPU module or extension cable. Please consult your local Mitsubishi representative.
24C8H	System bus error	<ul style="list-style-type: none"> An error has been detected on the system bus. 	<ul style="list-style-type: none"> Take measures to reduce noise. Reset the CPU module and switch it to RUN. If the same error is displayed again, a hardware failure may occur in the I/O module, intelligent function module, or extension cable. Please consult your local Mitsubishi representative.
24E0H	System bus error	<ul style="list-style-type: none"> An error has been detected on the system bus. 	<ul style="list-style-type: none"> Take measures to reduce noise. Reset the CPU module and switch it to RUN. If the same error is displayed again, a hardware failure may occur in the CPU module or base unit. Please consult your local Mitsubishi representative.
3010H	Target device communication error	<ul style="list-style-type: none"> An error has occurred when accessing the target device. 	<p>Check the following points and reset or turn OFF and ON again the power of the CPU module on the own station and the target device in which problem has generated.</p> <ul style="list-style-type: none"> Check if the settings in the "Target Device Settings" are correct. Check the status of the target device. Check if the route to the target device is correct. Check if there is any problem on the route to the target device.
3030H	Target device setting error	<ul style="list-style-type: none"> Incorrect settings in the "Target Device Settings" 	<ul style="list-style-type: none"> Review the settings in the "Target Device Settings".
3040H	Setting update error	<ul style="list-style-type: none"> Failed to update the settings. 	<p>Review the following settings.</p> <ul style="list-style-type: none"> Device Tag Settings Job Settings (Trigger Condition) Target Device Settings
3050H	Specified device memory error	<ul style="list-style-type: none"> Incorrect representation of the specified device memory in the "Device Tag Settings". An unusable device memory was specified. 	<ul style="list-style-type: none"> Review the device memory in the "Device Tag Settings".
3051H to 3055H	System error	—	—
3060H	System error	—	—
3070H	System error	—	—
3080H	System error	—	—
30A0H	Setting update error	<ul style="list-style-type: none"> Failed to update the settings due to incorrect default display mode of the dot matrix LED. 	<ul style="list-style-type: none"> Review the default display mode of the dot matrix LED.
30A1H	System error	—	—
30B0H	SD memory card removal error	<ul style="list-style-type: none"> The SD memory card was removed without stopping the file access. 	<ul style="list-style-type: none"> Insert the SD memory card and update the settings.
30B1H	Format error	<ul style="list-style-type: none"> Failed to format the SD memory card. 	<ul style="list-style-type: none"> Check if the SD memory card is inserted firmly. Check if an error has occurred in the SD memory card. Slide the write protect switch to unlock the SD memory card (remove the write-protect) when the switch is in the lock position (protecting data writing).
30B2H	Mount error	<ul style="list-style-type: none"> Failed to insert the SD memory card. 	<ul style="list-style-type: none"> Check if the SD memory card is inserted firmly. Replace the SD memory card. Slide the write protect switch to unlock the SD memory card (remove the write-protect) when the switch is in the lock position (protecting data writing).

Error code	Error name	Error description	Corrective action
30B3H	SD memory card is not inserted	<ul style="list-style-type: none"> MES interface module started without inserting the SD memory card. 	<ul style="list-style-type: none"> Check if the SD memory card is inserted firmly. Insert the SD memory card.
30B4H	System error	—	—
30C0H	System error	—	—
30D0H	Setting update timeout error	<ul style="list-style-type: none"> A timeout has occurred while updating the settings due to the overload of MES interface module. 	<ul style="list-style-type: none"> Update the settings again. Reset the CPU module.
30D1H to 30D2H	System error	—	—
30D3H	Target device communication error	<ul style="list-style-type: none"> An error has occurred when accessing the target device. 	<p>Check the following points and reset or turn OFF and ON again the power of the CPU module on the own station and the target device in which problem has generated.</p> <ul style="list-style-type: none"> Check if the settings in the "Target Device Settings" are correct. Check the status of the target device. Check if the route to the target device is correct. Check if there is any problem on the route to the target device.
30E0H	System error	—	—
3600H to 3614H	System error	—	—
3615H	SD memory card access error	<ul style="list-style-type: none"> Failed to access the SD memory card. 	<ul style="list-style-type: none"> Check the SD memory card. Replace the SD memory card if it is damaged. Check if the DB buffer size of the DB buffer settings is appropriate. Check if the SD memory card had been used in other applications. Slide the write protect switch to unlock the SD memory card (remove the write-protect) when the switch is in the lock position (protecting data writing).
3700H to 3704H	System error	—	—
3780H to 3781H	System error	—	—
3782H to 3786H	System error	—	—
3800H to 3805H	System error	—	—
3880H	System error	—	—
3881H	SD memory card access error	<ul style="list-style-type: none"> Failed to access the SD memory card. 	<ul style="list-style-type: none"> Check the SD memory card. Replace the SD memory card if it is damaged. Check if the DB buffer size of the DB buffer settings is appropriate. Check if the SD memory card had been used in other applications. Slide the write protect switch to unlock the SD memory card (remove the write-protect) when the switch is in the lock position (protecting data writing). Check if the connectable SD memory card is used.
3882H	SD memory card error	Unable to operate in this module. The settings for a new version of MES interface module is written in the SD memory card.	<ul style="list-style-type: none"> Format the SD memory card and retry the writing of the settings with MES Interface Function Configuration Tool.
3900H to 3903H	System error	—	—
3920H	System error	—	—
3921H	SD memory card access error	<ul style="list-style-type: none"> Failed to access the SD memory card. 	<ul style="list-style-type: none"> Check the SD memory card. Replace the SD memory card if it is damaged. Check if the DB buffer size of the DB buffer settings is appropriate. Check if the SD memory card had been used in other applications. Slide the write protect switch to unlock the SD memory card (remove the write-protect) when the switch is in the lock position (protecting data writing).
3940H	System error	—	—
3944H to 3948H	System error	—	—

Error code	Error name	Error description	Corrective action
3960H	System error	—	—
3970H	System error	—	—
3C00H to 3C03H	Hardware failure	<ul style="list-style-type: none"> • A hardware failure has been detected. 	<ul style="list-style-type: none"> • Take measures to reduce noise. • Reset the CPU module and switch it to RUN. If the same error is displayed again, a hardware failure may occur in MES interface module. Please consult your local Mitsubishi representative.
3C0FH	Hardware failure	<ul style="list-style-type: none"> • A hardware failure has been detected. 	<ul style="list-style-type: none"> • Take measures to reduce noise. • Reset the CPU module and switch it to RUN. If the same error is displayed again, a hardware failure may occur in MES interface module. Please consult your local Mitsubishi representative.
3C22H	Memory error	<ul style="list-style-type: none"> • An error has been detected in the memory. 	<ul style="list-style-type: none"> • Take measures to reduce noise. • Reset the CPU module and switch it to RUN. If the same error is displayed again, a hardware failure may occur in MES interface module. Please consult your local Mitsubishi representative.
3C2FH	Memory error	<ul style="list-style-type: none"> • An error has been detected in the memory. 	<ul style="list-style-type: none"> • Take measures to reduce noise. • Reset the CPU module and switch it to RUN. If the same error is displayed again, a hardware failure may occur in MES interface module. Please consult your local Mitsubishi representative.
3C32H	Memory error	<ul style="list-style-type: none"> • An error has been detected in the memory. 	<ul style="list-style-type: none"> • Take measures to reduce noise. • Reset the CPU module and switch it to RUN. If the same error is displayed again, a hardware failure may occur in MES interface module. Please consult your local Mitsubishi representative.
3F01H to 3F05H	Memory error	<ul style="list-style-type: none"> • An error has been detected in the memory. 	<ul style="list-style-type: none"> • Take measures to reduce noise. • Reset the CPU module and switch it to RUN. If the same error is displayed again, a hardware failure may occur in MES interface module. Please consult your local Mitsubishi representative.

Error codes for DB Connection Service

The DB Connection Service outputs errors to the Windows Event Log, access log, and SQL failure log.

And, DB Connection Service Client also outputs errors to Windows Event Log.

If a system error occurs, please contact your local Mitsubishi Electric sales office or representative.

Event log of Windows

■Event log output warning list of DB Connection Service (source name: DBConnector)

Error code	Error description and cause	Corrective action
1	There is no setting file. Start the service using the default setting.	Set the settings again with DB Connection Service Setting Tool.

■Event log output error list of DB Connection Service (source name: DBConnector)

Error code	Error description and cause	Corrective action
1	Unable to start the service due to insufficient memory.	<ul style="list-style-type: none"> • Terminate any unnecessary applications. • Add more memory to the personal computer.
2	Unable to start the service due to insufficient resources.	
3	System error	—
4		
5	Failed to read the setting file. The service is stopped.	<ul style="list-style-type: none"> • Refer to the actions of error codes 101 to 129. • Actions are displayed with error codes 101 to 129.
6	Failed to initialize the log file. The service is stopped.	<ul style="list-style-type: none"> • Refer to the actions of error codes 401 to 403, and 501 to 503. • Actions are displayed with error codes 401 to 403, and 501 to 503.
7	System error	—
8		
9	The service port has already been opened. The service is stopped.	<ul style="list-style-type: none"> • Change the service port with DB Connection Service Setting Tool.
10	System error	—
11		
101	The computer ran out of memory while reading the setting file.	<ul style="list-style-type: none"> • Terminate any unnecessary applications. • Add more memory to the personal computer.
102	The setting file path is too long.	<ul style="list-style-type: none"> • Reinstall DB Connection Service to the directory whose path name is shorter.
103	The setting file name indicates the directory.	<ul style="list-style-type: none"> • Reinstall DB Connection Service.
104	The setting file could not be opened.	
105	Description of the setting file is not correct.	<ul style="list-style-type: none"> • Terminate other applications, and set the setting again with DB Connection Service Setting Tool.

Error code	Error description and cause	Corrective action	
106	Parameter specification of the setting file is not correct.	<ul style="list-style-type: none"> • Set the settings again with DB Connection Service Setting Tool. 	
107	The version of the setting file is not correct.		
108	The service port setting is not correct.		
109	The service port setting is out of range.		
110	The DB access timeout time setting is not correct.		
111	The DB access timeout time setting is out of range.		
112	There are too many connection-permitted IP address settings.		
113	Description of the connection-permitted IP address setting is not correct.		
114	The mask bit length setting of the connection-permitted IP address is not correct.		
115	The mask bit length setting of the connection-permitted IP address is out of range.		
116	The access log setting is not correct.		
117	The setting of the access log file name is not correct.		
118	The access log file name is too long.		
119	The maximum file size setting for the access log is not correct.		
120	The maximum file size setting for the access log is out of range.		
121	The maximum number of access log files is not set correctly.		
122	The maximum number of access log files is out of range.		
123	The SQL failure log setting is not correct.		
124	The setting of the SQL failure log file name is not correct.		
125	The SQL failure log file name is too long.		
126	The maximum file size setting for the SQL failure log is not correct.		
127	The maximum file size setting for the SQL failure log is out of range.		
128	The maximum number of SQL failure log files is not set correctly.		
129	The maximum number of SQL failure log files is out of range.		
401	The computer ran out of memory when initializing the access log file.		<ul style="list-style-type: none"> • Terminate any unnecessary applications. • Add more memory to the personal computer.
402	The computer ran out of resources when initializing the access log file.		
403	The full path name of the access log file is too long.		<ul style="list-style-type: none"> • Shorten the path to the access log file with DB Connection Service Setting Tool.
404	The access log file could not be opened.		<ul style="list-style-type: none"> • If no directory exists for storing the access log file, create it. • When the attribution of the access log file is set to read-only, cancel the setting. • If read/write is disabled for the access log file, enable it in the security setting. • When the access log file name represents a directory, rename or delete the directory. • When the access log file has been open in another application, terminate the application. • check if the disk device has any failure.
405	The log could not be written to the access log file.		<ul style="list-style-type: none"> • When the disk capacity is full, ensure a free disk capacity. • When the access log file has been open in another application, terminate the application. • check if the disk device has any failure.
406	Failed to delete the old access log file.	<ul style="list-style-type: none"> • When the attribution of the oldest access log file is set to read-only, cancel the setting. • If read/write is disabled for the oldest access log file, enable it in the security setting. • When the oldest access log file has been open in another application, terminate the application. • check if the disk device has any failure. 	

Error code	Error description and cause	Corrective action
407	Failed to rename the access log file.	<ul style="list-style-type: none"> When the attribution of the access log file and the old access log file is set to read-only, cancel the setting. If read/write is disabled for the access log file and the old access log file, enable it in the security setting. When the new and old access log files have been open in another application, terminate the application. check if the disk device has any failure.
501	The computer ran out of memory when initializing the SQL failure log file.	<ul style="list-style-type: none"> Terminate any unnecessary applications. Add more memory to the personal computer.
502	The computer ran out of resources when initializing the SQL failure log file.	
503	The full path name of the SQL failure log file is too long.	<ul style="list-style-type: none"> Shorten the path to the SQL failure log file with DB Connection Service Setting Tool.
504	The SQL failure log file could not be opened.	<ul style="list-style-type: none"> If no directory exists for storing the SQL failure log file, create it. When the attribution of the SQL failure log file is set to read-only, cancel the setting. If read/write is disabled for the SQL failure log file, enable it in the security setting. When the SQL failure log file name represents a directory, rename or delete the directory. When the SQL failure log file has been open in another application, terminate the application. check if the disk device has any failure.
505	The log could not be written to the SQL failure log file.	<ul style="list-style-type: none"> When the disk capacity is full, ensure a free disk capacity. When the SQL failure log file has been open in another application, terminate the application. check if the disk device has any failure.
506	Failed to delete the old SQL failure log file.	<ul style="list-style-type: none"> When the attribution of the oldest SQL failure log file is set to read-only, cancel the setting. If read/write is disabled for the oldest SQL failure log file, enable it in the security setting. When the oldest SQL failure log file has been open in another application, terminate the application. check if the disk device has any failure.
507	Failed to rename the SQL failure log file.	<ul style="list-style-type: none"> When the attribution of the SQL failure log file and the old SQL failure log file is set to read-only, cancel the setting. If read/write is disabled for the SQL failure log file and the old SQL failure log file, enable it in the security setting. When the SQL failure log file and the old SQL failure log file have been open in another application, terminate the application. check if the disk device has any failure.

■Event log output error list of DB Connection Service Client (source name: DBCnctClient)

Error code	Error description and cause	Corrective action
50	Unable to start DB Connection Service Client.	<ul style="list-style-type: none"> Terminate any unnecessary applications. Add more memory to the personal computer.
51		
52		
53		

Access log of DB Connection Service

Error code	Error description and cause	Corrective action
0x20100001 ^{*1}	(Service Not Start.) Failed to start the service due to insufficient memory.	<ul style="list-style-type: none"> • Terminate any unnecessary applications. • Add more memory to the personal computer.
0x20100002 ^{*1}	(Service Not Start.) Failed to start the service due to insufficient resources.	
0x20100010	System error	—
0x20100011 ^{*1}	(Service Not Start.) Failed to start the service due to failure of the service port initialization.	<ul style="list-style-type: none"> • If firewall software has been installed, set the specified service port operational.
0x20100012 ^{*1}	(Service Not Start.) Another application has opened the service port.	<ul style="list-style-type: none"> • Terminate the application that has opened the service port. • Set another service port with DB Connection Service Setting Tool.
0x20100013	System error	—
0x20200001 ^{*1}	(Not Initialize a service for each client: [IP address]) Failed to initialize a service for each client due to insufficient memory.	<ul style="list-style-type: none"> • Terminate any unnecessary applications. • Add more memory to the personal computer.
0x20200003	System error	—
0x20200010 ^{*1}	(Deny network connection request from [IP address]) Rejected the connection request from the non-permitted IP address.	<ul style="list-style-type: none"> • Add the IP address to the connection-permitted IP address using DB Connection Service Setting Tool.
0x20300001	(SID [Session ID]: Request Receive Error: [IP address]) Failed to receive data due to insufficient memory.	<ul style="list-style-type: none"> • Terminate any unnecessary applications. • Add more memory to the personal computer. • Check if it is connected to the network. • Check if the gateway and/or hub is operating. • Check if the power of the module is not turned OFF. • Check if the source IP address belongs to the MES interface module or the configuration personal computer. • Check the version of the MES interface module or MES Interface Function Configuration Tool. • Check if it is connected to the network. • Check if the gateway and/or hub is operating. • Check if the power of the MES interface module is not turned OFF.
0x20300010	(SID [Session ID]: Request Receive Error: [IP address]) Connection disconnected during request reception.	
0x20300011	(SID [Session ID]: Request Receive Error: [IP address]) Timed out during request reception.	
0x20300012	(SID [Session ID]: Request Receive Error: [IP address]) Detected failure of the MES interface module or the configuration personal computer while waiting for or receiving a request.	
0x20300013	(SID [Session ID]: Request Receive Error: [IP address]) Receive I/O error	
0x20300014	(SID [Session ID]: Request Receive Error: [IP address]) Buffer overrun (Request length exceeded)	
0x20300015	(SID [Session ID]: Request Receive Error: [IP address]) Received an incorrect request.	
0x20310010	(SID [Session ID]: Response Transmit Error: [IP address]) Failed to transmit a response due to disconnection.	
0x20310011	(SID [Session ID]: Response Transmit Error: [IP address]) Timed out during response transmission	
0x20310012	(SID [Session ID]: Response Transmit Error: [IP address]) Detected failure of the MES interface module or the configuration personal computer during response transmission.	
0x20310013	(SID [Session ID]: Response Transmit Error: [IP address]) Send I/O error	
0x20400001	(SID [Session ID]: DB Connect: [Data source]: [User]: Failed) Failed in DB connection due to insufficient memory.	<ul style="list-style-type: none"> • Terminate any unnecessary applications. • Add more memory to the personal computer.
0x20400002 ^{*1}	(SID [Session ID]: DB Connect: [Data source]: [User]: Failed) Failed in DB connection due to insufficient resources.	
0x20400010	(SID [Session ID]: DB Connect: [Data source]: [User]: Failed) Incorrect DB connection request	<ul style="list-style-type: none"> • Check if the source IP address belongs to the MES interface module or the configuration personal computer. • Check the version of the MES interface module or MES Interface Function Configuration Tool.
0x20400011	System error	—
0x20400012	System error	
0x20400020 ^{*1}	(SID [Session ID]: DB Connect: [Data source]: [User]: Failed) Failed to create a DB handle.	<ul style="list-style-type: none"> • Terminate any unnecessary applications. • Add more memory to the personal computer.
0x20400021	System error	—

Error code	Error description and cause	Corrective action
0x20400022*1	(SID [Session ID]: DB Connect: [Data source]: [User]: Failed) Failed in DB connection.	<ul style="list-style-type: none"> Set correct data source name, user name, and password in the "Target Server Settings" of MES Interface Function Configuration Tool. Start the "ODBC Data Source Administrator" and set the ODBC setting. (□□ MELSEC iQ-R MES Interface Module User's Manual (Startup))
0x20400023	System error	—
0x20500011		
0x20500012		
0x20500020 to 0x20500022		
0x20600001	(SID [Session ID]: SQL<...>: Failed) (SID [Session ID]: COMMIT: Failed) (SID [Session ID]: ROLLBACK: Failed) (SID [Session ID]: GetNext: Failed) (SID [Session ID]: Reset: Failed) Failed in SQL execution due to insufficient memory.	<ul style="list-style-type: none"> Terminate any unnecessary applications. Add more memory to the personal computer.
0x20600002*1	(SID [Session ID]: SQL<...>: Failed) (SID [Session ID]: COMMIT: Failed) (SID [Session ID]: ROLLBACK: Failed) (SID [Session ID]: GetNext: Failed) (SID [Session ID]: Reset: Failed) Failed in SQL execution due to insufficient resources.	
0x20600010	(SID [Session ID]: SQL<...>: Failed) (SID [Session ID]: COMMIT: Failed) (SID [Session ID]: ROLLBACK: Failed) (SID [Session ID]: GetNext: Failed) (SID [Session ID]: Reset: Failed) Incorrect SQL execution request	<ul style="list-style-type: none"> Check if the source IP address belongs to the MES interface module or the configuration personal computer. Check the version of the MES interface module or MES Interface Function Configuration Tool.
0x20600011	System error	—
0x20600012		
0x20600020	(SID [Session ID]: SQL<...>: Failed) (SID [Session ID]: COMMIT: Failed) (SID [Session ID]: ROLLBACK: Failed) (SID [Session ID]: GetNext: Failed) (SID [Session ID]: Reset: Failed) DB Connection Service does not support the SQL instruction to be executed.	<ul style="list-style-type: none"> Check if the source IP address belongs to the MES interface module or the configuration personal computer. Check the version of the MES interface module or MES Interface Function Configuration Tool.
0x20600021*1	(SID [Session ID]: SQL<...>: Failed) (SID [Session ID]: COMMIT: Failed) (SID [Session ID]: ROLLBACK: Failed) (SID [Session ID]: GetNext: Failed) (SID [Session ID]: Reset: Failed) Failed in preparation before SQL execution.	<ul style="list-style-type: none"> Set a correct database type in the "Target Server Settings" with MES Interface Function Configuration Tool. Set a correct table name in the "DB Communication Action Setting" with MES Interface Function Configuration Tool.
0x20600022*1	(SID [Session ID]: SQL<...>: Failed) (SID [Session ID]: COMMIT: Failed) (SID [Session ID]: ROLLBACK: Failed) (SID [Session ID]: GetNext: Failed) (SID [Session ID]: Reset: Failed) Failed to obtain the number of fields in the record that is to be obtained by the SQL execution.	
0x20600023*1	(SID [Session ID]: SQL<...>: Failed) (SID [Session ID]: COMMIT: Failed) (SID [Session ID]: ROLLBACK: Failed) (SID [Session ID]: GetNext: Failed) (SID [Session ID]: Reset: Failed) Failed in SQL execution.	<ul style="list-style-type: none"> Set a correct database type in the "Target Server Settings" with MES Interface Function Configuration Tool. Set a correct access table, access field, and each setting tab in the "DB Communication Action Setting" with MES Interface Function Configuration Tool. Also, set a correct data type for the data stored in the access field. Check if the unique constraint of the database (PRIMARY KEY constraint) is violated. Check if reserved words of the database are set for access table names and access field names.
0x20600024	System error	—

Error code	Error description and cause	Corrective action
0x20600025	(SID [Session ID]: SQL<...>: Failed) (SID [Session ID]: COMMIT: Failed) (SID [Session ID]: ROLLBACK: Failed) (SID [Session ID]: GetNext: Failed) (SID [Session ID]: Reset: Failed) No record was updated, inserted, or deleted by the SQL execution.	<ul style="list-style-type: none"> Set each setting tab in the "DB Communication Action Setting" with MES Interface Function Configuration Tool. Check if the database has been filled with registered data.
0x20600026 to 0x2060002A	System error	—
0x2060002B	(SID [Session ID]: *** Transmitting Commit Success Response Failed. ***) Failed to transmit the COMMIT success response.	<ul style="list-style-type: none"> Check if it is connected to the network. Check if the gateway and/or hub is operating. Check if the power of the MES interface module is not turned OFF.
0x20700001	(ProgramExec: [IP address]: <...>: Failed) Failed in program execution due to insufficient memory.	<ul style="list-style-type: none"> Terminate any unnecessary applications. Add more memory to the personal computer.
0x20700002	(ProgramExec: [IP address]: <...>: Failed) Failed in program execution due to insufficient resources.	
0x20700003	System error	—
0x20700010	(ProgramExec: [IP address]: <...>: Failed) Incorrect program execution request	<ul style="list-style-type: none"> Check if the source IP address belongs to the MES interface module.
0x20700011	System error	—
0x20700012		
0x20700020	(ProgramExec: [IP address]: <...>: Failed) Failed to log on in program execution	<ul style="list-style-type: none"> Set a correct user name and password in the "Target Server Settings" with MES Interface Function Configuration Tool. Check if the user account is invalid or not by the administrative tool of Windows. Check if the setting is forcing the user to enter password at next logon by the administrative tool of Windows. Check if the user password is expired or not by the administrative tool of Windows.
0x20700021	(ProgramExec: [IP address]: <...>: Failed) Failed to load user profile during program execution	<ul style="list-style-type: none"> No user profile for Windows may have been created. With the user name and password set in the "Target Server Settings" of MES Interface Function Configuration Tool, log on Windows once, and re-execute it. The load applied to the computer may have been too high. Check the execution conditions of other applications.
0x20700022	System error	—
0x20700023	(ProgramExec: [IP address]: <...>: Failed) Failed to generate process during program execution	<ul style="list-style-type: none"> Check if the application to be executed in program execution exists or not. Check if the name of the application to be executed in program execution is a directory. Make a proper security setting for the application to be executed in program execution.
0x20700024	(ProgramExec: [IP address]: <...>: Failed) The wait for process completion timed out or was interrupted during program execution.	<ul style="list-style-type: none"> Increase the DB access timeout time in DB Connection Service Setting Tool. Terminate the application executed by program execution before logoff.
0x20800010	(SID [Session ID]: TCPOpen Request Error: [IP address]) Incorrect TCPOpen request	<ul style="list-style-type: none"> Check if the source IP address belongs to the MES interface module or the configuration personal computer. Check the version of the MES interface module or MES Interface Function Configuration Tool.
0x20800011	System error	—
0x20800012		
0x20B00001		
0x20B00002		
0x20B00003	Failed to acquire table names from the database	<ul style="list-style-type: none"> Set a correct database type in the "Target Server Settings" with MES Interface Function Configuration Tool. Check if there is any problem in the connection route.
0x20B00004	Failed to acquire the information which is necessary for table name acquisition when acquiring table names from the database	<ul style="list-style-type: none"> Set a correct database type in the "Target Server Settings" with MES Interface Function Configuration Tool.
0x20B00005	System error	—
0x20B00006		

Error code	Error description and cause	Corrective action
0x20B00008	Failed to acquire the version of the database when acquiring table names from the database	• Set a correct database type in the "Target Server Settings" with MES Interface Function Configuration Tool.
0x20B00009	Failed to prepare before the SQL execution when acquiring table names from the database	
0x20B0000A	Failed to execute SQL when acquiring table names from the database	• Set a correct database type in the "Target Server Settings" with MES Interface Function Configuration Tool. • Check if there is any problem in the connection route.
0x20B0000B to 0x20B0000D	System error	—
0x20B0000E	The database type set in the "Target Server Settings" is different from the actual database type.	• Set a correct database type in the "Target Server Settings" with MES Interface Function Configuration Tool.
0x20B0000F	System error	—
0x20C00001		
0x20C00002		
0x20C00003	Failed to acquire field names from the database	• Set a correct database type in the "Target Server Settings" with MES Interface Function Configuration Tool. • Check if there is any problem in the connection route.
0x20C00004	Failed to acquire the information which is necessary for field name acquisition when acquiring field names from the database	• Set a correct database type in the "Target Server Settings" with MES Interface Function Configuration Tool.
0x20C00005 to 0x20C00007	System error	—
0x20C00008	Failed to acquire the version of the database when acquiring field names from the database	• Set a correct database type in the "Target Server Settings" with MES Interface Function Configuration Tool.
0x20C00009 0x20C0000A	Failed to execute SQL when acquiring field names from the database	• Set a correct database type in the "Target Server Settings" with MES Interface Function Configuration Tool. • Check if there is any problem in the connection route.
0x20C0000B to 0x20C0000D	System error	—
0x20C0000E	The database type set in the "Target Server Settings" is different from the actual database type.	• Set a correct database type in the "Target Server Settings" with MES Interface Function Configuration Tool.
0x20C0000F	System error	—
0x2FE00010		

*1 [Database error number] and [Database error message] are output to the space after Database Message in the access log of DB Connection Service.

For the output log format, refer to the following:

 Page 197 Access log

SQL failure log of DB Connection Service

Error code	Error description and cause	Corrective action
0x20600001	Failed in SQL execution due to insufficient memory.	<ul style="list-style-type: none"> • Terminate any unnecessary applications. • Add more memory to the personal computer.
0x20600002* ¹	Failed in SQL execution due to insufficient resources.	
0x20600020	DB Connection Service does not support the SQL instruction to be executed.	<ul style="list-style-type: none"> • Check if the source IP address belongs to the MES interface module or the configuration personal computer. • Check the version of the MES interface module or MES Interface Function Configuration Tool.
0x20600021* ¹	Failed in preparation before SQL execution.	<ul style="list-style-type: none"> • Set a correct database type in the "Target Server Settings" with MES Interface Function Configuration Tool.
0x20600022* ¹	Failed to obtain the number of fields in the record that is to be obtained by the SQL execution.	<ul style="list-style-type: none"> • Set a correct table name in the "DB Communication Action Setting" with MES Interface Function Configuration Tool.
0x20600023* ¹	Failed in SQL execution.	<ul style="list-style-type: none"> • Set a correct database type in the "Target Server Settings" with MES Interface Function Configuration Tool. • Set a correct access table, access field, and each setting tab in the "DB Communication Action Setting" with MES Interface Function Configuration Tool. Also, set a correct data type for the data stored in the access field. • Check if the unique constraint of the database (PRIMARY KEY constraint) is violated. • Check if reserved words of the database are set for access table names and access field names.
0x20600024	System error	—
0x20600025	No record was updated, inserted, or deleted by the SQL execution.	<ul style="list-style-type: none"> • Set each setting tab in the "DB Communication Action Setting" with MES Interface Function Configuration Tool. • Check if the database has been filled with registered data.
0x20600026 to 0x20600028	System error	—
0x2060002B	(Data source name: *** Transmitting Commit Success Response Failed. ***) Failed to transmit the COMMIT success response.	<ul style="list-style-type: none"> • Check if it is connected to the network. • Check if the gateway and/or hub is operating. • Check if the power of the MES interface module is not turned OFF.

*1 [Database error number] and [Database error message] are output to the space after Database Message in the SQL failure log of DB Connection Service.

For the output log format, refer to the following:

 Page 201 SQL failure log

Error codes of REST server function response message

The following shows the error codes (code or errcode) of response messages of the REST server function.

Error code list of MELSEC-Q series MES interface module-compatible API

Error code	Error name	Error description	Corrective action
0x41170101	System error	—	• Please consult your local Mitsubishi representative.
0x41170103	REST server function reception message length error	The length of an REST server function reception request message is invalid.	• Read the sent XML message.
0x41171101	REST server function reception request message read error	REST server function reception request message is incorrect. • The format of XML is incorrect.	• Read the sent XML message.
0x41171111	REST server function reception request message route overlap error	REST server function reception request message route is overlapped. • Two or more <REQUEST> tags exist.	• Read the sent XML message.
0x41171201	REST server function reception request message route error	An incorrect route for an REST server function reception request message exists. • Any tag other than <REQUEST> exists.	• Read the sent XML message.
0x41171205	REST server function reception request message attribute error	The attribute in the received REST server function reception request message is incorrect. Failed to identify the message type is oneshot, validate, or invalidate. • Attribute "type" does not exist. • Attribute "type" value is incorrect. • Attribute "jobname" does not exist. • XML declaration is incorrect.	• Read the sent XML message.
0x41171301	REST server function reception request message job name error	The job name in an REST server function reception request message is incorrect. • The job of the specified job name does not exist.	• Read the sent XML message.
0x41173101	Job execution error	Failed in one-shot execution of the job which is requested by the REST server function.	• Check if the job is "In execution" or "Preparing for execution". • Check if the MES interface module is in operation.
0x41173103	System error	—	• Please consult your local Mitsubishi representative.
0x41173105	System error	—	• Please consult your local Mitsubishi representative.
0x41173106	MES Interface Function Configuration Tool version error	The function does not work because the setting file has been written from MES Interface Function Configuration Tool which does not support the REST server function.	• Write the setting file from the MES Interface Function Configuration Tool which is stored to MX MESInterface-R whose software version is '1.05F' or later.
0x411731A1 to 0x411731A3	System error	—	• Please consult your local Mitsubishi representative.

Error code list of API added to MELSEC iQ-R series MES interface module

Common error code

Error code	Error name	Error description	Corrective action
0x41180001	MES Interface Function Configuration Tool version error	The function does not work because the setting file has been written from MES Interface Function Configuration Tool which does not support the REST server function.	<ul style="list-style-type: none"> Write the setting file from the MES Interface Function Configuration Tool which is stored to MX MESInterface-R whose software version is '1.05F' or later.
0x41180002	Module status incorrect error	The module cannot operate because the MES interface function operation status is stopped or stopping.	<ul style="list-style-type: none"> Check if the MES interface module is in operation.
0x41180003	Module status incorrect error	The module cannot operate because the MES interface function operation status is initializing.	<ul style="list-style-type: none"> Check if the MES interface module is in operation.
0x41180004	Module status incorrect error	The module cannot operate because the MES interface function operation status is stopped or stopping.	<ul style="list-style-type: none"> Check if the MES interface module is in operation.
0x41180005	URI reading error	The URI of the request message is incorrect. <ul style="list-style-type: none"> The format of URI is incorrect. 	<ul style="list-style-type: none"> Check the content of the sent URI.

Error codes of /v1/job.json

Error code	Error name	Error description	Corrective action
0x41180101	Job ID error	The URI parameter of the request message is incorrect. <ul style="list-style-type: none"> The job of the specified job ID does not exist. 	<ul style="list-style-type: none"> Check the content of the sent URI parameter.
0x41180102	Trigger buffer full error	Failed in one-shot execution of the job which is requested by the REST server function because the trigger buffer is full.	<ul style="list-style-type: none"> Reduce the job execution frequency.
0x41180103	URI parameter item name incorrect error	The URI parameter item name of the request message is incorrect. <ul style="list-style-type: none"> The parameter item name other than "action", "id", and "name" is set. 	<ul style="list-style-type: none"> Check the content of the sent URI parameter.
0x41180104	URI parameter value incorrect error	The URI parameter value of the request message is incorrect. <ul style="list-style-type: none"> The value of the parameter item name "action" is incorrect. The value of the parameter item name "id" is incorrect. The value of the parameter item name "name" is incorrect. 	<ul style="list-style-type: none"> Check the content of the sent URI parameter.
0x41180105	URI parameter overlap error	The URI parameter item name of the request message is overlapped. <ul style="list-style-type: none"> The parameter item name "action" is overlapped. The parameter item name "id" is overlapped. The parameter item name "name" is overlapped. The parameter item names, "id" and "name" are both set. 	<ul style="list-style-type: none"> Check the content of the sent URI parameter.
0x41180106	URI parameter insufficient error	The URI parameter item name of the request message is insufficient. <ul style="list-style-type: none"> The parameter item name "action" does not exist. Neither "id" nor "name" exists. 	<ul style="list-style-type: none"> Check the content of the sent URI parameter.
0x41180107	Job name error	The URI parameter of the request message is incorrect. <ul style="list-style-type: none"> The job of the specified job name does not exist. 	<ul style="list-style-type: none"> Check the content of the sent URI parameter.
0x41180108	Job execution error	Failed in one-shot execution of the job which is requested by the REST server function.	<ul style="list-style-type: none"> Check if the job is "In execution" or "Preparing for execution".
0x41180109	Module status incorrect error	The module cannot operate because the MES interface function operation status is stopped or stopping.	<ul style="list-style-type: none"> Check if the MES interface module is in operation.
0x411801A1 to 0x411801A7	System error	—	<ul style="list-style-type: none"> Please consult your local Mitsubishi representative.

■Error codes of /v1/jobs.json

Error code	Error name	Error description	Corrective action
0x41180201	Job ID error	The URI parameter of the request message is incorrect. • The job of the specified job ID does not exist.	• Check the content of the sent URI parameter.
0x41180202	URI parameter item name incorrect error	The URI parameter item name of the request message is incorrect. • The parameter item name other than "id" or "name" is set.	• Check the content of the sent URI parameter.
0x41180203	URI parameter value incorrect error	The URI parameter value of the request message is incorrect. • The value of the parameter item name "id" is incorrect. • The value of the parameter item name "name" is incorrect.	• Check the content of the sent URI parameter.
0x41180204	URI parameter overlap error	The URI parameter item name of the request message is overlapped. • The parameter item name "id" is overlapped. • The parameter item name "name" is overlapped. • The parameter item names, "id" and "name" are both set.	• Check the content of the sent URI parameter.
0x41180205	Job name error	The URI parameter of the request message is incorrect. • The job of the specified job name does not exist.	• Check the content of the sent URI parameter.
0x411802A1 to 0x411802A6	System error	—	• Please consult your local Mitsubishi representative.

7.5 Event Code List

This section shows the event code list.

Event code	Event type	Overview	Cause
20400	Operation	Firmware update completed successfully (intelligent function module)	The firmware of the Intelligent Function Module was successfully updated.
20401	Operation	Firmware update failed (Intelligent Function Module)	The firmware update of the Intelligent Function Module failed.

APPENDIX

Appendix 1 Module Labels

This section shows the module labels used to set the input/output signals and buffer memory of an MES interface module.

Module label configuration

The name of a module label is defined in the following configurations:

"Instance name"_"Module number"."Label name"

"Instance name"_"Module number"."Label name"_D

Ex.

MES96_1.bSts_ModuleREADY

■ Instance name

The instance name of an MES interface module is 'MES96'.

■ Module number

A module number is a number starting from 1, which is added to identify a module that has the same instance name.

■ Label name

This is a module unique label name.

■ _D

This indicates that the module label is for direct access. Without this symbol means a label for refresh. There are some differences between refresh and direct access as shown below.

Type	Description	Access timing
Refresh	Values written to/read from a module label are applied to a module in a batch at the time of refresh. This shortens the program execution time.	At the time of refresh
Direct access	Values written to/read from a module label are immediately applied to a module. Although the program execution time is longer than refresh, the responsiveness will be increased.	At the time of writing to/ reading from a module label

A

Appendix 2 Input/Output Signals

This section explains the input/output signals of an MES interface module.

The following shows an example of assigning input/output signals when the start input/output number of an MES interface module is '0.'

Device X indicates an input signal from MES interface module to a CPU module.

Device Y indicates an output signal from a CPU module to MES interface module.

Precautions

As for input/output signals to a CPU module, do not output (turn ON) 'Use prohibited' signals.

Doing so may cause malfunction of a programmable controller system.

Input/output signal list

The following shows the input/output signal list of an MES interface module.

For details on the input/output signals, refer to the following:

☞ Page 271 Input signal details

☞ Page 274 Output signal details

Input signals

Device No.	Signal name
X0	Module READY
X1	MES interface function operation status
X2	Use prohibited
X3	File access status
X4 to XF	Use prohibited
X10	Module stop error status
X11	Module continuation error status
X12	Job execution error
X13	Target server error
X14	Target device error
X15 to X1F	Use prohibited

Output signals

Device No.	Signal name
Y0	Use prohibited
Y1	MES interface function operation restart request
Y2	MES interface function operation stop request
Y3	File access stop request
Y4	File access stop cancel request
Y5 to YF	Use prohibited
Y10	Error clear request
Y11 to Y1F	Use prohibited

Input signal details

The following shows the details on the input signals from an MES interface module to a CPU module.

Module READY (X0)

This signal turns ON when MES interface module becomes ready after the programmable controller is powered ON from OFF or the CPU module is reset.

This signal turns OFF when a watch dog timer error occurred.

Do not access the buffer memory and perform online operations from MES Interface Function Configuration Tool until the MES interface module is in READY status.



MES interface function operation status (X1)

● This signal turns ON when the MES interface function is in operation.

This indicates that the processing of the MES interface function is executable.

● This signal turns OFF when the MES interface function is stopped.

The MES interface function stops in the following cases:

- The period after the programmable controller is powered ON from OFF or the CPU module is reset until the MES interface function is started
- When "Stop" is selected in the module operation of MES Interface Function Configuration Tool ( Page 169 [Module Status] tab)
- When a module stop error occurs in the MES interface module ( Page 231 Troubleshooting on MES Interface Function Configuration Tool)
- During updating the settings
- MES interface function operation stop request is received and the MES interface function is in stop status
- While file access is stopped ( MELSEC iQ-R MES Interface Module User's Manual (Startup))

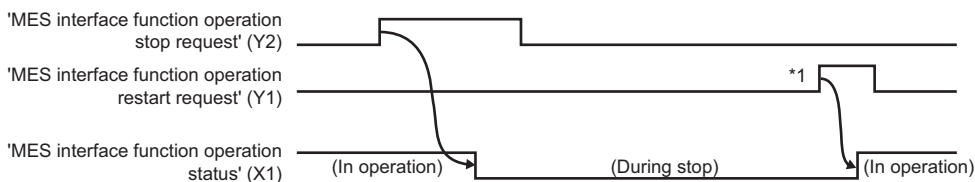

*1 If an SD memory card is reinserted (if it is unmounted once or more than once), the operation does not start. Restart the operation of the MES interface function in the "Diagnostics" screen or by updating the setting.



File access status (X3)

- This signal turns ON while file access is stopped.

An SD memory card can be inserted/removed while file access is stopped.

While file access is stopped, the following operations are not available.

- Read from/write to an SD memory card
- MES interface function
- Reading, writing, verification, setting update, and each diagnostic except "SD Memory Card Diagnostics" from MES Interface Function Configuration Tool

- This signal turns OFF during file access operation.

By powering the programmable controller ON from OFF or resetting the CPU module, the file access will be in operation.

However, this signal turns OFF during initialization upon powering ON from OFF.

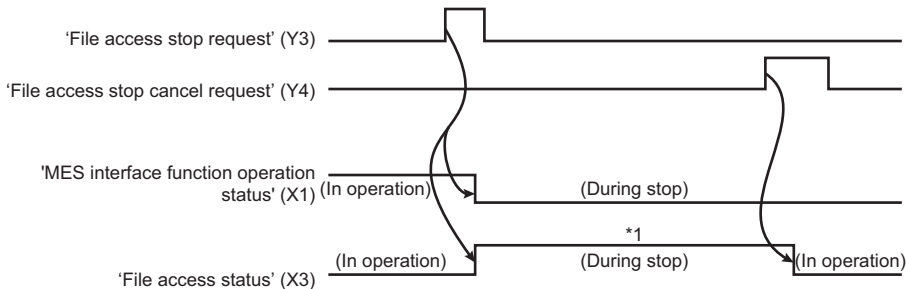

*1 The following operations are available.

- Replacement of an SD memory card
- Power OFF of a programmable controller

For the considerations when handling an SD memory card while file access is stopped, refer to the following:

📖 MELSEC iQ-R MES Interface Module User's Manual (Startup)

Module stop error status (X10)

This signal turns ON while a module stop error occurs (ERR LED is flashing).

When any of the following errors occurs while 'Module stop error status' (X10) or 'Module continuation error status' (X11) is ON, any one of the following (or multiple) turns ON.

- Job execution error (X12)
- Target server error (X13)
- Target device error (X14)

Module continuation error status (X11)

This signal turns ON while a module continuation error occurs (ERR LED is ON).

It turns OFF when 'Error clear request' (Y10) is turned ON.

Job execution error (X12)

This signal turns ON when an error related to job execution occurs.

When this signal is ON, an error code is stored to the error log area (Un\G13056 to 13391).

The signal turns OFF in the following cases.

- 'Error clear request' (Y10) is turned ON.
- The setting is updated or error is cleared from MES Interface Function Configuration Tool.
- All the jobs were executed successfully.

Target server error (X13)

This signal turns ON when an error such as a communication error occurs while accessing a database.

When this signal is ON, an error code is stored to the access target status (server) area (Un\G8704 to 8959).

The signal turns OFF in the following cases.

- 'Error clear request' (Y10) is turned ON.
- The setting is updated or error is cleared from MES Interface Function Configuration Tool.
- An error such as a communication error has been cleared in DB access of all the target servers.

Target device error (X14)

This signal turns ON when an error occurs while communicating with or accessing an access target device.

When this signal is ON, an error code is stored to the access target status (device) area (Un\G8448 to 8703).

The signal turns OFF in the following cases.

- 'Error clear request' (Y10) is turned ON.
- The setting is updated or error is cleared from MES Interface Function Configuration Tool.
- A communication error or an access error has been cleared in all the target devices.

Output signal details

The following shows the details on the output signals from MES interface module to a CPU module.

MES interface function operation restart request (Y1)

The operation of the MES interface function is started in accordance with the settings stored in the module.

If an SD memory card is reinserted (if it is unmounted once or more than once), the operation does not start.

Restart the operation of the MES interface function in the "Diagnostics" screen or by updating the setting.

When 'MES interface function operation status' (X1) is ON, 'MES interface function operation stop request' (Y2) needs to be executed first.

A request is not accepted in the following cases at the timing when an MES interface module monitors the output signals.

- 'MES interface function operation stop request' (Y2) is being executed (Y2 is ON).
- This signal turns ON at the same time as 'MES interface function operation stop request' (Y2).

The request is not accepted before the MES interface function starts operation. (It is not accepted if 'MES interface function operation status' (X1) has never turned ON after turning the power ON.)

MES interface function operation stop request (Y2)

This signal sets the MES interface function operation to a stop state.

A request is not accepted in the following cases at the timing when an MES interface module monitors the output signals.

- 'MES interface function operation restart request' (Y1) is being executed (Y1 is ON).
- This signal turns ON at the same time as 'MES interface function operation restart request' (Y1).

File access stop request (Y3)

This signal sets the file access to a stop state.

For ON/OFF timing, refer to the following:

 Page 272 File access status (X3)

For the considerations when handling an SD memory card while file access is stopped, refer to the following:

 MELSEC iQ-R MES Interface Module User's Manual (Startup)

File access stop cancel request (Y4)

This signal cancels the stop state of the file access.

For ON/OFF timing, refer to the following:

 Page 272 File access status (X3)

Point

If a file access is stopped by mistake due to 'File access stop request (Y3)', the file access can be started again.

Error clear request (Y10)

By turning this signal ON while a module continuation error (ERR. LED: ON) occurs, both the ERR. LED and X11 to X14 are turned OFF.

It clears the latest error area (Un\G7168 to 7199).

The latest error code displayed on the system monitor of engineering tool is cleared.

Appendix 3 Buffer Memory

This section explains the buffer memory of an MES interface module.

Precautions

- Do not write any data to the "system area" of the buffer memory. Doing so may cause malfunction of the programmable controller system.
- The character code of character string to be stored in buffer memory is ASCII. When you want to store a code other than ASCII, the character codes are listed in buffer memory list.

Buffer memory list

The following table shows the buffer memory list of an MES interface module.

R: Read-only, W: Write-only, R/W: Readable/Writable

Address Dec (Hex)	Application	Name and description		Initial value	R/W
0 (0H)	Module information	LED information	RUN LED status 0: OFF, 1: ON, 2: Flashing	0	R
1 (1H)			ERR LED status 0: OFF, 1: ON, 2: Flashing	0	R
2 (2H)			DB COM LED status 0: OFF, 1: ON, 2: Flashing	0	R
3 (3H)			DB BUF LED status 0: OFF, 1: ON, 2: Flashing	0	R
4 (4H)			CARD RDY LED status 0: OFF, 1: ON, 2: Flashing	0	R
5 (5H)			CARD ACS LED status 0: OFF, 1: ON, 2: Flashing	0	R
6 (6H)			LICENSE LED status ^{*1} 0: OFF, 1: ON, 2: Flashing	0	R
7 (7H)			System area	—	—
8 (8H)			Dot matrix LED display mode 0: User specification character 1: Error code 2: CH1 IP address 3: CH2 IP address 4: DB buffer 1 use rate 5: DB buffer 2 use rate	0	R
9 to 24 (9H to 18H)			Dot matrix LED display character string ^{*2}	0	R
25 (19H)	Parameter information	Parameter 1 • System area (b0 to b7) • Response monitoring time (b8 to b15)	0	R	
26 (1AH)		Parameter 2 • User account setting forced change (b0) 0: Not change, 1: Change to default • CH1/address forced change (b1 to b3) 000b: Not change 001b: Change to 192.168.3.3 010b: Change only fourth octet 011b: Change to 192.168.3.xxx • CH2/address forced change (b4 to b6) 000b: Not change 001b: Change to 192.168.4.3 010b: Change only fourth octet 011b: Change to 192.168.4.xxx • System area (b7) • CH1/CH2 fourth octet specified address (b8 to b15)	0	R	
27 (1BH)		Parameter 3 • Delay time (b0 to b7) • Response monitoring time settings (b14) 0: Not specify 1: Specify • Delay time settings (b15) 0: Not specify 1: Specify	0	R	
28 to 29 (1CH to 1DH)		System area	—	—	

Address Dec (Hex)	Application	Name and description		Initial value	R/W	
30 (1EH)	Module information	MES interface function operation status 0: Initializing, 1: Running, 2: Stopping, 3: Stop		0	R	
31 (1FH)		Module error status 0: No error, 1: Continuation error, 2: Stop error		0	R	
32 to 63 (20H to 3FH)		Project information	Project name (32 characters) (Stored in character string format) (UTF-16)		0	R
64 to 73 (40H to 49H)			Date and time of project file writing (Store "YYYY/MM/DD hh/mm/ss" in character string format)		0	R
74 to 83 (4AH to 53H)			Date and time of project file editing (Character string format is same as date and time project file editing)		0	R
84 (54H)		System area		—	—	
85 (55H)		Module READY signal delay time		0	R	
86 to 511 (56H to 1FFH)	System area		—	—		
512 (200H)	Network information	Ethernet port CH1 current value	Valid flag 0: Not use, 1: Use	0	R	
513 (201H)		Ethernet port CH2 current value	Valid flag 0: Not use, 1: Use	0	R	
514 (202H)		Ethernet port CH1 setting value	Valid flag 0: Not use, 1: Use	0	R	
515 (203H)		Ethernet port CH2 setting value	Valid flag 0: Not use, 1: Use	0	R	
516 to 525 (204H to 20DH)		System area		—	—	
526 to 533 (20EH to 215H)		Ethernet port CH1 current value	IP address (character string)		0	R
534 to 535 (216H to 217H)			IP address		0	R
536 to 537 (218H to 219H)			Subnet mask		0	R
538 to 539 (21AH to 21BH)			Default gateway		0	R
540 to 557 (21CH to 22DH)			System area		—	—
558 to 589 (22EH to 24DH)		Ethernet port CH2 current value	Same as CH1			
590 to 653 (24EH to 28DH)		System area		—	—	
654 to 661 (28EH to 295H)		Ethernet port CH1 setting value	IP address (character string)		0	R
662 to 663 (296H to 297H)			IP address		0	R
664 to 665 (298H to 299H)			Subnet mask		0	R
666 to 667 (29AH to 29BH)			Default gateway		0	R
668 to 685 (29CH to 2ADH)			System area		—	—
686 to 717 (2AEH to 2CDH)		Ethernet port CH2 setting value	Same as CH1			
718 to 1037 (2CEH to 40DH)		System area		—	—	
1038 to 5375 (40EH to 14FFH)	System area		—	—		



Address Dec (Hex)	Application	Name and description			Initial value	R/W		
5376 (1500H)	DB buffer information	DB buffer 1 detailed information	DB buffer stored action information *3	Number of action information notifications		0	R	
5377 to 5384 (1501H to 1508H)				Stored action information 1	Time at trigger ON	0	R	
5385 (1509H)					Job setting number	0	R	
5386 (150AH)					Action setting number	0	R	
5387 (150BH)					Target server setting number	0	R	
5388 (150CH)					DB communication type	0	R	
5389 to 5420 (150DH to 152CH)					SQL statement (stored in character string format) (UTF-16)	0	R	
5421 to 6080 (152DH to 17C0H)				Stored action information 2 to 16	Same as stored action information 1	0	R	
6081 to 6143 (17C1H to 17FFH)				System area			—	—
6144 to 6911 (1800H to 1AFFH)				DB buffer 2 detailed information	Same as DB buffer 1 detailed information			
6912 to 7167 (1B00H to 1BFFH)	System area			—	—			
7168 (1C00H)	Module information	Module error information	Error code		0	R		
7169 (1C01H)			System area		—	—		
7170 to 7177 (1C02H to 1C09H)			Error occurrence date and time		0	R		
7178 to 7199 (1C0AH to 1C1FH)			System area		—	—		
7200 to 7423 (1C20H to 1CFFH)	System area			—	—			

Address Dec (Hex)	Application	Name and description		Initial value	R/W
7424 (1D00H)	DB buffer information	DB buffer 1 information (0 is fixed when the valid flag is disabled (0).)	Valid flag 0: Not use, 1: Use	0	R
7425 (1D01H)			Resend mode 0: Auto-resending at recovery, 2: Manual resending	0	R
7426 (1D02H)			Operation at recovery 0: Add to the buffered data 1: Send immediately (Not add to the buffered data)	0	R
7427 to 7428 (1D03H to 1D04H)			Size Unit: Byte	0	R
7429 to 7430 (1D05H to 1D06H)			Number of stored data (current value)	0	R
7431 to 7432 (1D07H to 1D08H)			Number of stored data (maximum value)	0	R
7433 to 7434 (1D09H to 1D0AH)			Used amount (current value) Unit: Byte	0	R
7435 to 7436 (1D0BH to 1D0CH)			Used amount (maximum value) Unit: Byte	0	R
7437 (1D0DH)			Use rate (current value) Unit: %	0	R
7438 (1D0EH)			Use rate (maximum value) Unit: %	0	R
7439 (1D0FH)			Resending status 0: Not sent, 1: Resending	0	R
7440 to 7447 (1D10H to 1D17H)			System area	—	—
7448 to 7471 (1D18H to 1D2FH)		DB buffer 2 information	Same as DB buffer 1 information		—
7472 to 7935 (1D30H to 1EFFH)	System area			—	—
7936 (1F00H)	SD memory card information	Mounting status 0: Initializing SD memory card status 1: Normal SD memory card mounting 2: Stopped file access 3: Invalid SD card mounting 4: Formatting SD memory card 5: Not inserted		0	R
7937 to 7939 (1F01H to 1F03H)		System area		—	—
7940 to 7941 (1F04H to 1F05H)		Capacity Unit: KB		0	R
7942 to 7943 (1F06H to 1F07H)		Free space Unit: KB		0	R
7944 to 7945 (1F08H to 1F09H)		Used amount Unit: KB		0	R
7946 (1F0AH)		Use rate Unit: %		0	R
7947 to 7999 (1F0BH to 1F3FH)		System area		—	—
8000 to 8447 (1F40H to 20FFH)	System area			—	—



Address Dec (Hex)	Application	Name and description		Initial value	R/W
8448 to 8451 (2100H to 2103H)	Target device information	Target device 1 to 64 information*4	Valid flag 0: Not set, 1: Set	0	R
8452 to 8455 (2104H to 2107H)			System area	—	—
8456 to 8463 (2108H to 210FH)			Connection status 0: Not connected, 1: Connected, 2: Disconnected	0	R
8464 to 8471 (2110H to 2117H)			System area	—	—
8472 to 8475 (2118H to 211BH)			Error information 0: No error, 1: Error	0	R
8476 to 8479 (211CH to 211FH)			System area	—	—
8480 to 8543 (2120H to 215FH)			Error code	0	R
8544 to 8703 (2160H to 21FFH)		System area	—	—	
8704 (2200H)	Target server information	Target server 1 to 16 information	Valid flag 0: Not set, 1: Set	0	R
8705 (2201H)			System area	—	—
8706 to 8707 (2202H to 2203H)			Connection status 0: Not connected, 1: Connected, 2: Disconnected	0	R
8708 to 8709 (2204H to 2205H)			System area	—	—
8710 (2206H)			Error information 0: No error, 1: Error	0	R
8711 (2207H)			System area	—	—
8712 to 8727 (2208H to 2217H)			Error code	0	R
8728 to 8743 (2218H to 2227H)			System area	—	—
8744 to 8959 (2228H to 22FFH)			System area	—	—

Address Dec (Hex)	Application	Name and description		Initial value	R/W
8960 to 8963 (2300H to 2303H)	Job information	Job 1 to 64 information	Valid flag (0 to 63 bit correspond to job 1 to 64, respectively.) 0: Not set, 1: Set	0	R
8964 to 8967 (2304H to 2307H)			System area	—	—
8968 to 8975 (2308H to 230FH)			Operating status 0: Inhibiting execution or invalid 1: Monitoring trigger condition 2: Preparing for execution 3: Executing	0	R
8976 to 8983 (2310H to 2317H)			System area	—	—
8984 to 8987 (2138H to 231BH)			Error information 0: No error, 1: Error	0	R
8988 to 8991 (231CH to 231FH)			System area	—	—
8992 to 9055 (2320H to 235FH)			Error code (Job 1 to 64)	0	R
9056 to 9119 (2360H to 239FH)			System area	—	—
9120 to 9123 (23A0H to 23A3H)			Job execution inhibition status 0: Not inhibited, 1: Inhibiting	0	R
9124 to 9127 (23A4H to 23A7H)			System area	—	—
9128 to 9131 (23A8H to 23ABH)			Target server output inhibition status 0: Not inhibited, 1: Inhibiting	0	R
9132 to 9135 (23ACH to 23AFH)			System area	—	—
9136 to 9139 (23B0H to 23B3H)			Target device output inhibition status 0: Not inhibited, 1: Inhibiting	0	R
9140 to 9143 (23B4H to 23B7H)			System area	—	—
9144 to 9151 (23B8H to 23BFH)			Working history output status (lower bit) 0: Not output, 1: Output Detailed log output status (upper bit) 0: Not output, 1: Output	0	R
9152 to 9159 (23C0H to 23C7H)			System area	—	—
9160 to 9211 (23C8H to 23FBH)			System area	—	—
9212 to 9471 (23FCH to 24FFH)			System area	—	—



Address Dec (Hex)	Application	Name and description	Initial value	R/W	
9472 to 10495 (2500H to 28FFH)	Cycle information	System area	—	—	
10496 to 10497 (2900H to 2901H)		Target device 1 access time	Input processing time (current value) at trigger judgment	0	R
10498 to 10499 (2902H to 2903H)			Input processing time (maximum value) at trigger judgment	0	R
10500 to 10501 (2904H to 2905H)			Input processing time (current value) before action execution	0	R
10502 to 10503 (2906H to 2907H)			Input processing time (maximum value) before action execution	0	R
10504 to 11007 (2908H to 2AFFH)		Access time for target device 2 to 64 ⁴	Same as the access time of the target device 1		
11008 to 12159 (2B00H to 2F7FH)		System area	—	—	
12160 (2F80H)		Number of trigger buffer data	0	R	
12161 (2F81H)		Trigger buffer overload count	0	R	
12162 to 12225 (2F82H to 2FC1H)		Trigger buffer overload count for job 1 to 64	0	R	
12226 to 12289 (2FC2H to 3001H)	System area	—	—		
12290 (3002H)	High-speed access interval overload count	0	R		
12291 to 12354 (3003H to 3042H)	High-speed access interval overload count for job 1 to 64	0	R		
12355 to 12418 (3043H to 3082H)	System area	—	—		
12419 to 13055 (3083H to 32FFH)	System area	—	—		
13056 (3300H)	Error log information	Error count	0	R	
13057 (3301H)		Latest error log number	0	R	
13058 (3302H)		Error log 1	Error code	0	R
13059 (3303H)			System area	—	—
13060 to 13067 (3304H to 330BH)			Error occurrence date and time	0	R
13068 to 13217 (330CH to 33A1H)		Error log 2 to 16	Same as the error log 1		
13218 to 13391 (33A2H to 344FH)		System area	—	—	

Address Dec (Hex)	Application	Name and description			Initial value	R/W		
13392 (3450H)	Firmware update history information ^{*1}	Firmware update completion with/without an error			0	R		
13393 to 13401 (3451H to 3459H)		System area			—	—		
13402 (345AH)		Latest firmware update information	History information	Execution time (year)	0	R		
13403 (345BH)				Execution time (month)	0	R		
13404 (345CH)				Execution time (day)	0	R		
13405 (345DH)				Execution time (hour)	0	R		
13406 (345EH)				Execution time (minute)	0	R		
13407 (345FH)				Execution time (second)	0	R		
13408 (3460H)				Execution time (day of the week)	0	R		
13409 (3461H)				Firmware version after update	0	R		
13410 (3462H)				Firmware version before update	0	R		
13411 (3463H)				Latest firmware update result		Firmware update target	0	R
13412 (3464H)						Firmware update result	0	R
13413 (3465H)		Previous firmware update information	History information	Execution time (year)	0	R		
13414 (3466H)				Execution time (month)	0	R		
13415 (3467H)				Execution time (day)	0	R		
13416 (3468H)				Execution time (hour)	0	R		
13417 (3469H)				Execution time (minute)	0	R		
13418 (346AH)				Execution time (second)	0	R		
13419 (346BH)				Execution time (day of the week)	0	R		
13420 (346CH)				Firmware version after update	0	R		
13421 (346DH)				Firmware version before update	0	R		
13422 (346EH)				Previous firmware update result		Firmware update target	0	R
13423 (346FH)						Firmware update result	0	R

*1 Stored only when using an RD81MES96N.

*2 The displayed characters are updated when switched. (Scrolling the displayed characters will not be considered as switching display characters.)

*3 The latest 16 pieces of information are stored in ascending order.

*4 Information on target device 17 to 64 is stored only when using an RD81MES96N.



Buffer memory details

The following explains the buffer memory details of an MES interface module.

Module information (Un\G0 to 85)

The LED information, parameter information, MES interface function operating status, module error status, project information, and module READY signal delay time of an MES interface module are stored in this area.

For the stored values, refer to the following:

☞ Page 276 Buffer memory list

For the specifications, refer to the following:

Item	Reference
LED information	☞ MELSEC iQ-R MES Interface Module User's Manual (Startup)
Parameter information	Page 206 PARAMETER SETTING

■LED information (Un\G0 to 24)

The LED status, dot matrix LED display mode, and dot matrix LED display character string (ASCII format (within the range from 0x0020 to 0x007E)) are stored.

■Parameter information (Un\G25 to 29)

The parameter setting status is stored.

■MES interface function operation status (Un\G30)

The operating status of MES interface function is stored.

■Module error status (Un\G31)

The error status of MES interface module is stored.

■Project information (Un\G32 to 83)

The project setting information which is currently operated in MES interface module is stored.

Buffer memory name	Address	Description
Project name	Un\G32 to 63	The project name is stored.
Date and time of project file writing	Un\G64 to 73	The date and time when a project is written from MES Interface Function Configuration Tool are stored.
Date and time of project file editing	Un\G74 to 83	The date and time when project file is edited are stored.

■Module READY signal delay time (Un\G85)

The module READY signal delay time is stored.

Network information (Un\G512 to 1037)

The connection status of an MES interface module to a network is stored in this area.

■Common setting (Un\G512 to 517)

Common settings for Ethernet port are stored.

Buffer memory name	Address	Description
Ethernet port CH1 current value valid flag	Un\G512	The setting status (use/ not use) of current Ethernet port (CH1) is stored. 0: Not use 1: Use
Ethernet port CH2 current value valid flag	Un\G513	The setting status (use/ not use) of current Ethernet port (CH2) is stored. The setting value is same as 'Ethernet port CH1 current value valid flag' (Un\G512).
Ethernet port CH1 setting value valid flag	Un\G514	The setting status (value set by MES Interface Function Configuration Tool) of Ethernet port (CH1) is stored. 0: Not use 1: Use
Ethernet port CH2 setting value valid flag	Un\G515	The setting status (value set by MES Interface Function Configuration Tool) of Ethernet port (CH2) is stored. The setting value is same as 'Ethernet port CH1 setting value valid flag' (Un\G514).

■Ethernet port CH1 current value (Un\G526 to 557)

The current IP address information of Ethernet port (CH1) is stored.

Buffer memory name	Address	Description
IP address (character string)	Un\G526 to 533	IP address is stored in character string. The character string to be stored is set by left justifying. (Example) "192.168.3.3"
IP address	Un\G534 to 535	IP address is stored in double word (32 bit value).
Subnet mask	Un\G536 to 537	Subnet mask is stored in double word (32 bit value).
Default gateway	Un\G538 to 539	Default gateway address is stored in double word (32 bit value). When the default gateway is not set, 0 is stored.

■Ethernet port CH2 current value (Un\G558 to 589)

The current IP address information of Ethernet port (CH2) is stored.

Each item is same as 'Ethernet port CH1 current value' (Un\G526 to 557).

■Ethernet port CH1 setting value (Un\G654 to 685)

The IP address information of the setting value of Ethernet port (CH1) (value set by MES Interface Function Configuration Tool) is stored.

Each item is same as 'Ethernet port CH1 current value' (Un\G526 to 557).

■Ethernet port CH2 setting value (Un\G686 to 717)

The IP address information of the setting value of Ethernet port (CH2) (value set by MES Interface Function Configuration Tool) is stored.

Each item is same as 'Ethernet port CH1 current value' (Un\G526 to 557).

DB buffer information (Un\G5376 to 6911)

The details of information stored in the DB buffer is stored in this area.

■DB buffer 1 detailed information (Un\G5376 to 6143)

The detail of information stored in DB buffer 1 is stored.

DB buffer stored action information (Un\G5376 to 6080)

The action information of a job stored in the DB buffer is stored.

The latest 16 pieces of job information are stored in order of DB buffering by each action.

- Number of action information notifications (Un\G5376)

Within the stored action information 1 to 16, the number of DB buffer stored action information items is stored.

- Stored action information 1 (Un\G5377 to 5420)

The following job information stored in the DB buffer is stored for each action.

Buffer memory name	Address	Description																																																															
Time at trigger ON	Un\G5377 to 5384	<p>The trigger condition satisfied date and time of the job in which DB buffering is performed is stored.</p> <p>When the power of the module is turned OFF, the information of date and time when trigger condition is satisfied is not saved. If the power of the module is turned ON while DB buffering is performed for job information to an SD memory card, the initial value '0' will be stored.</p> <table border="1" style="margin-left: 40px;"> <thead> <tr> <th></th> <th>b15</th> <th>...</th> <th>b8</th> <th>b7</th> <th>...</th> <th>b0</th> </tr> </thead> <tbody> <tr> <td>Un\G5377</td> <td colspan="3">Unused</td> <td colspan="3">UTC offset^{*1}</td> </tr> <tr> <td>Un\G5378</td> <td colspan="3">Month (01H to 12H)</td> <td colspan="3">Year (00H to 99H) lower 2 digits</td> </tr> <tr> <td>Un\G5379</td> <td colspan="3">Hour (00H to 23H)</td> <td colspan="3">Day (01H to 31H)</td> </tr> <tr> <td>Un\G5380</td> <td colspan="3">Second (00H to 59H)</td> <td colspan="3">Minute (00H to 59H)</td> </tr> <tr> <td>Un\G5381</td> <td colspan="3">Year (00H to 99H) upper 2 digits</td> <td colspan="3">Day of the week (00H to 06H)^{*2}</td> </tr> <tr> <td>Un\G5382</td> <td colspan="3">Lower milliseconds (00H to 99H)^{*3}</td> <td colspan="3">Upper milliseconds (00H to 09H)^{*4}</td> </tr> <tr> <td>Un\G5383</td> <td colspan="3">System area</td> <td colspan="3">System area</td> </tr> <tr> <td>Un\G5384</td> <td colspan="3">System area</td> <td colspan="3">System area</td> </tr> </tbody> </table>		b15	...	b8	b7	...	b0	Un\G5377	Unused			UTC offset ^{*1}			Un\G5378	Month (01H to 12H)			Year (00H to 99H) lower 2 digits			Un\G5379	Hour (00H to 23H)			Day (01H to 31H)			Un\G5380	Second (00H to 59H)			Minute (00H to 59H)			Un\G5381	Year (00H to 99H) upper 2 digits			Day of the week (00H to 06H) ^{*2}			Un\G5382	Lower milliseconds (00H to 99H) ^{*3}			Upper milliseconds (00H to 09H) ^{*4}			Un\G5383	System area			System area			Un\G5384	System area			System area		
	b15	...	b8	b7	...	b0																																																											
Un\G5377	Unused			UTC offset ^{*1}																																																													
Un\G5378	Month (01H to 12H)			Year (00H to 99H) lower 2 digits																																																													
Un\G5379	Hour (00H to 23H)			Day (01H to 31H)																																																													
Un\G5380	Second (00H to 59H)			Minute (00H to 59H)																																																													
Un\G5381	Year (00H to 99H) upper 2 digits			Day of the week (00H to 06H) ^{*2}																																																													
Un\G5382	Lower milliseconds (00H to 99H) ^{*3}			Upper milliseconds (00H to 09H) ^{*4}																																																													
Un\G5383	System area			System area																																																													
Un\G5384	System area			System area																																																													
Job setting number	Un\G5385	The job setting number of the job in which DB buffering is performed is stored.																																																															
Action setting number	Un\G5386	<p>The action setting number of the DB communication action in which DB buffering is performed is stored.</p> <p>When DB buffering is performed in an RD81MES96 with firmware version '06' or earlier, the value is fixed to '0.'</p>																																																															
Target server setting number	Un\G5387	The target server setting number of the DB communication action in which DB buffering is performed is stored.																																																															
DB communication type	Un\G5388	<p>The DB communication type of the DB communication action in which DB buffering is performed is stored.</p> <p>1: Insert 2: Update 3: Delete 4: Stored Procedure</p>																																																															
SQL statement	Un\G5389 to 5420	The first 32 characters (character code: UTF-16) of the SQL statement in the DB communication action in which DB buffering is performed is stored.																																																															

*1 UTC offset

-48 to 52: -12 hours to +13 hours (unit: 15 minutes)

*2 0: Sunday, 1: Monday, 2: Tuesday, 3: Wednesday, 4: Thursday, 5: Friday, 6: Saturday

*3 Lower milliseconds: Tens digit, ones digit

*4 Upper milliseconds: Hundreds digit

- Stored action information 2 to 16 (Un\G5421 to 6080)

Each item is same as 'Stored action information 1' (Un\G5377 to 5420).

■DB buffer 2 detailed information (Un\G6144 to 6911)

The detailed information stored in BD buffer 2 is stored.

Each item is same as 'DB buffer 1 detailed information' (Un\G5376 to 6143).

Module information (Un\G7168 to 7199)

The latest error information of an MES interface module is stored in this area.

■Error code (Un\G7168)

An error code which indicates the error contents is stored. (☞ Page 241 Error Code List)

■Error occurrence date and time (Un\G7170 to 7177)

The time when the error occurred is stored in BCD code.

	b15	...	b8	b7	...	b0
Un\G7170	Unused			UTC offset ^{*1}		
Un\G7171	Month (01H to 12H)			Year (00H to 99H) lower 2 digits		
Un\G7172	Hour (00H to 23H)			Day (01H to 31H)		
Un\G7173	Second (00H to 59H)			Minute (00H to 59H)		
Un\G7174	Year (00H to 99H) upper 2 digits			Day of the week (00H to 06H) ^{*2}		
Un\G7175	Lower milliseconds (00H to 99H) ^{*3}			Upper milliseconds (00H to 09H) ^{*4}		
Un\G7176	System area			System area		
Un\G7177	System area			System area		

*1 UTC offset

-48 to 52: -12 hours to +13 hours (Unit: 15 minutes)

*2 0: Sunday, 1: Monday, 2: Tuesday, 3: Wednesday, 4: Thursday, 5: Friday, 6: Saturday

*3 Lower milliseconds: Tens digit, ones digit

*4 Upper milliseconds: Hundreds digit

DB buffer information (Un\G7424 to 7471)

The status of the DB buffering function is stored in this area.

■DB buffer 1 information (Un\G7424 to 7447)

The status of DB buffer 1 is stored.

When the 'Valid flag' (Un\G7424) is disabled (0), each following item is fixed to 0.

Buffer memory name	Address	Description
Valid flag	Un\G7424	The setting status of DB buffer 1 is stored. 0: Not use (not set) 1: Use (set)
Resend mode	Un\G7425	The resend mode set in the "DB Buffer Settings" is stored. 0: Auto-resending at recovery 2: Manual resending
Operation at recovery	Un\G7426	The operation at recovery set in the "DB Buffer Settings" is stored. 0: Add to the buffered data 1: Send immediately (Not add to the buffered data)
Size	Un\G7427 to 7428	The DB buffer size set in the "DB buffer settings" is stored. (Unit: Byte)
Number of stored data (current value)	Un\G7429 to 7430	The current number of units of DB buffered data is stored. (Unit: case)
Number of stored data (maximum value)	Un\G7431 to 7432	The maximum number of units of DB buffered data up to the present time after turning the power ON is stored. (Unit: case)
Used amount (current value)	Un\G7433 to 7434	The capacity using the current DB buffer is stored. (Unit: Byte)
Used amount (maximum value)	Un\G7435 to 7436	The maximum used amount of DB buffer up to the present time after powering ON is stored. (Unit: Byte)
Use rate (current value)	Un\G7437	The use rate of the current DB buffer is stored. (Unit: %)
Use rate (maximum value)	Un\G7438	The maximum use rate of DB buffer up to the present time after powering ON is stored. (Unit: Byte)
Resending status	Un\G7439	The resend status of the current DB buffer is stored. 0: Resending (DB buffer is being resent.) 1: Not sent (DB buffer is not resent.)

■DB buffer 2 information (Un\G7448 to 7471)

The status of DB buffering 2 is stored.

Each item is same as 'DB buffer 1 information' (Un\G7424 to 7447).

SD memory card information (Un\G7936 to 7999)

The status of an SD memory card inserted in an MES interface module is stored in this area.

■Mounting status (Un\G7936)

The status of SD memory card is stored.

- 0: Initializing SD memory card status
- 1: Normal SD memory card mounting
- 2: Stopped file access
- 3: Invalid SD card mounting
- 4: Formatting SD memory card
- 5: Not inserted

■Capacity (Un\G7940 to 7941)

The capacity of an SD memory card is stored. (Unit: KB)

■Free space (Un\G7942 to 7943)

The free space of an SD memory card is stored. (Unit: KB)

■Used amount (Un\G7944 to 7945)

The used amount of SD memory card is stored. (Unit: KB)

■Use rate (Un\G7946)

The use rate of SD memory card is stored. (Unit: %)

Target device information (Un\G8448 to 8703)

The setting status of a target device is stored in this area.

Valid flag (Un\G8448 to 8451)

The setting status of "Target Device Settings" is stored.

The corresponding bit of the setting No. of the set target device is turned ON.

0: Not set

1: Set

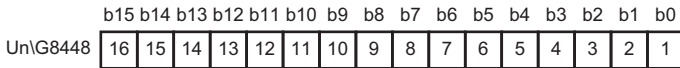

⋮

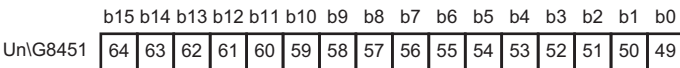

Connection status (Un\G8456 to 8463)

The connection status of an access target device is stored.

Depending on the connection status, values are stored in the corresponding bit of the setting No. of the target device as follows:

00b: Not connected (including the case in which 'Valid flag' (Un\G8448 to 8451) is not set (0).)

01b: Connected

10b: Disconnected

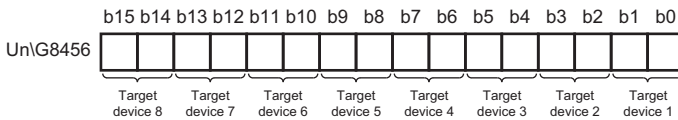

⋮

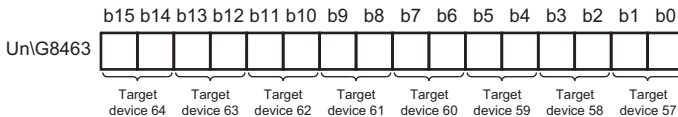

Error information (Un\G8472 to 8475)

The error information of the target device is stored.

The corresponding bit of the setting No. of the target device where an error has occurred is turned ON.

0: No error

1: Error

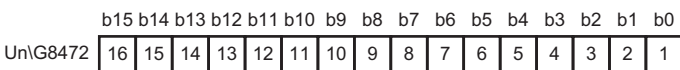

⋮

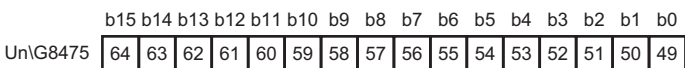

Error code (Un\G8480 to 8543)

An error code which indicates the error contents is stored to the corresponding area of the setting No. of the target device in which an error occurs.

Ex.

When an error occurs in the target device set in the target device setting No.16

· Bit 15 of the 'error information' (Un\G8472) is turned ON.

· An error code is stored in 'Error code 16' (Un\G8495).

Target server information (Un\G8704 to 8959)

The setting status of a target server is stored in this area.

Valid flag (Un\G8704)

The setting status of the "Target Server Settings" is stored.

The corresponding bit of the setting No. of the set target server is turned ON.

0: Not set

1: Set

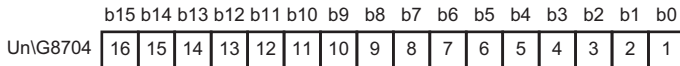

Connection status (Un\G8706 to 8707)

Connection status of the target server is stored.

Depending on the connection status, values are stored in the corresponding bit of the setting No. of the target server as follows:

00b: Not connected (including the case in which 'Valid flag' (Un\G8704) is not set (0).)

01b: Connected

10b: Disconnected

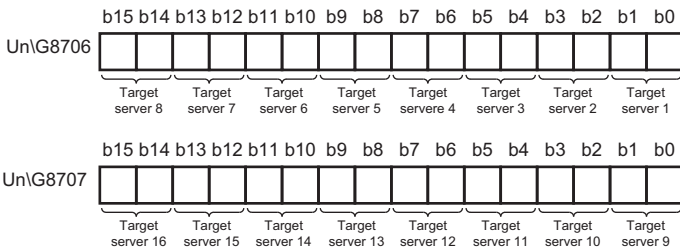

Error information (Un\G8710)

Error information of the target server is stored.

The corresponding bit of the setting No. of the target server where an error has occurred is turned ON.

0: No error

1: Error

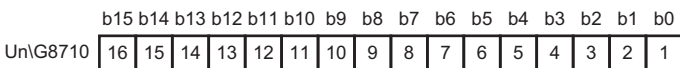

Error code (Un\G8712 to 8727)

An error code which indicates the error contents is stored to the corresponding area of the setting No. of the target server in which an error occurs.

Ex.

When an error occurs in the target server set in the target server setting No.16

· Bit 15 of 'Error information' (Un\G8710) is turned ON.

· An error code is stored in 'Error code 16' (Un\G8727).

Job information (Un\G8960 to 9211)

The job status information is stored in this area.

Valid flag (Un\G8960 to 8963)

The setting status of the "Job Settings" is stored.

The corresponding bit of the setting No. of the set job is turned ON.

0: Not set

1: Set

	b15	b14	b13	b12	b11	b10	b9	b8	b7	b6	b5	b4	b3	b2	b1	b0
Un\G8960	16	15	14	13	12	11	10	9	8	7	6	5	4	3	2	1
Un\G8961	32	31	30	29	28	27	26	25	24	23	22	21	20	19	18	17
Un\G8962	48	47	46	45	44	43	42	41	40	39	38	37	36	35	34	33
Un\G8963	64	63	62	61	60	59	58	57	56	55	54	53	52	51	50	49

Operating status (Un\G8968 to 8975)

Status of job operation is stored.

Depending on the operating status, values are stored in the corresponding bit of the setting No. of the job as follows:

00b: Inhibiting execution or invalid (trigger condition is not set)

01b: Monitoring trigger condition

10b: Preparing for execution

11b: Executing

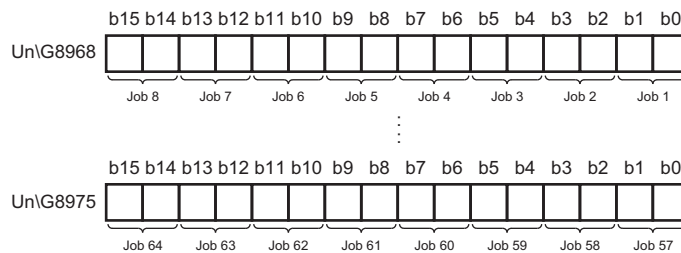

Error information (Un\G8984 to 8987)

The error information at job execution is stored.

The corresponding bit of the setting No. of the job where an error has occurred is turned ON.

0: No error

1: Error

	b15	b14	b13	b12	b11	b10	b9	b8	b7	b6	b5	b4	b3	b2	b1	b0
Un\G8984	16	15	14	13	12	11	10	9	8	7	6	5	4	3	2	1
Un\G8985	32	31	30	29	28	27	26	25	24	23	22	21	20	19	18	17
Un\G8986	48	47	46	45	44	43	42	41	40	39	38	37	36	35	34	33
Un\G8987	64	63	62	61	60	59	58	57	56	55	54	53	52	51	50	49

■Error code (Un\G8992 to 9055)

An error code which indicates the error contents is stored to the corresponding area of the setting No. of the target server in which a job execution error occurs.

Ex.

When an error occurs in the job execution set in the job setting No.64

- Bit 15 of 'Error information' (Un\G8987) is turned ON.
- An error code is stored in 'Error code 64' (Un\G9055).

■Job execution inhibition status (Un\G9120 to 9123)

Status of job execution inhibition is stored.

0: Not inhibited

1: Inhibiting

	b15	b14	b13	b12	b11	b10	b9	b8	b7	b6	b5	b4	b3	b2	b1	b0
Un\G9120	16	15	14	13	12	11	10	9	8	7	6	5	4	3	2	1
Un\G9121	32	31	30	29	28	27	26	25	24	23	22	21	20	19	18	17
Un\G9122	48	47	46	45	44	43	42	41	40	39	38	37	36	35	34	33
Un\G9123	64	63	62	61	60	59	58	57	56	55	54	53	52	51	50	49

■Target server output inhibition status (Un\G9128 to 9131)

The target server output inhibition status is stored.

0: Not inhibited

1: Inhibiting

	b15	b14	b13	b12	b11	b10	b9	b8	b7	b6	b5	b4	b3	b2	b1	b0
Un\G9128	16	15	14	13	12	11	10	9	8	7	6	5	4	3	2	1
Un\G9129	32	31	30	29	28	27	26	25	24	23	22	21	20	19	18	17
Un\G9130	48	47	46	45	44	43	42	41	40	39	38	37	36	35	34	33
Un\G9131	64	63	62	61	60	59	58	57	56	55	54	53	52	51	50	49

■Target device output inhibition status (Un\G9136 to 9139)

The target device output inhibition status is stored.

0: Not inhibited

1: Inhibiting

	b15	b14	b13	b12	b11	b10	b9	b8	b7	b6	b5	b4	b3	b2	b1	b0
Un\G9136	16	15	14	13	12	11	10	9	8	7	6	5	4	3	2	1
Un\G9137	32	31	30	29	28	27	26	25	24	23	22	21	20	19	18	17
Un\G9138	48	47	46	45	44	43	42	41	40	39	38	37	36	35	34	33
Un\G9139	64	63	62	61	60	59	58	57	56	55	54	53	52	51	50	49

■Working history/detailed log output status (Un\G9144 to 9151)

The output statuses of working history and detailed log are stored.

- Working history output status (lower bit)

0: Output

1: Not output

- Detailed log output status (upper bit)

0: Output

1: Not output

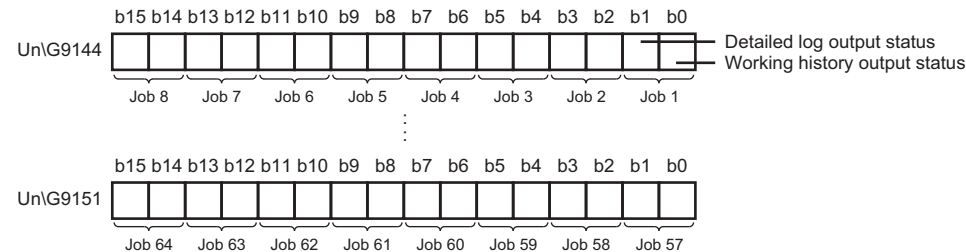

Cycle information (Un\G9472 to 12418)

The cycle information (elapsed time of data access) of data access actually operated by an MES interface module is stored in this area.

■Access time for target device 1 to 64 (Un\G10496 to 11007)

The time information required for reading data for each target device is stored.

- Input processing time at trigger judgment

The processing time (current and maximum) required for acquiring data used for the trigger condition for each target device is stored in milliseconds.

- Input processing time before action execution.

The processing time (current and maximum) required for acquiring data used for actions other than the trigger condition for each target device is stored in milliseconds.

■Information linkage function area (Un\G12160 to 12418)

Information on the information linkage function is stored.

Buffer memory name	Address	Description
Number of trigger buffer data	Un\G12160	The number of current trigger buffer data is stored.
Trigger buffer overload count	Un\G12161	The trigger buffer overload count up to the present time after powering ON, updating settings, and resetting is stored. If the count exceeds the maximum value, the maximum value (65535) is stored.
Trigger buffer overload count for job 1 to 64	Un\G12162 to 12225	The accumulated trigger buffer overload count for each job up to the present time after powering ON, updating settings, and resetting is stored. If the count exceeds the maximum value, the maximum value (65535) is stored.
High-speed access interval overload count	Un\G12290	When the access type is high-speed access (interval specification) or high-speed access (each scan), the total count that the data has not been acquired is stored. The timing to increment the count is as follows: <ul style="list-style-type: none"> • High-speed access (interval specification) When the data has never been acquired within the access interval*1 • High-speed access (each scan) When the data has not been acquired at the END processing If the count exceeds the maximum value, the maximum value (65535) is stored. When the access type is general access, '0' is stored.
High-speed access interval overload count for job 1 to 64	Un\G12291 to 12354	When the access type is high-speed access (interval specification) or high-speed access (each scan), the total count that the data has not been acquired is stored for each job. The timing to increment the count is same as 'High-speed access interval overload count' (Un\G12290). If the count exceeds the maximum value, the maximum value (65535) is stored. When the access type is general access, '0' is stored.

*1 The count may be incremented when any of the following operations are performed.

The state of a CPU module is switched from STOP to RUN.

Parameters (system parameter, CPU parameter, and module parameter) are written to a CPU module.

When the access type is high-speed access (interval specification), examples of incrementing values in 'High-speed access interval overload count' (Un\G12290) and 'High-speed access interval overload count for job 1 to 64' (Un\G12291 to 12354) are as follows:

Ex.

When the sequence scan time is longer than the access interval temporarily

Even when the sequence scan time is longer than the access interval temporarily, the data is acquired after the sequence scan is completed. The number of access intervals that could not acquire data is added to the high-speed access interval overload count as an accumulated value and stored. (Two are incremented in the following case.)

↔: Sequence scan time

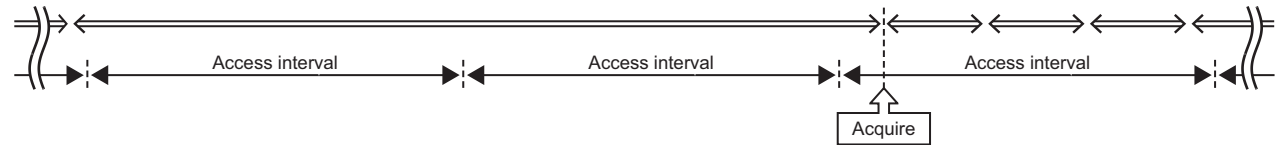

Ex.

When the data fails to be acquired due to overload etc. in MES interface module

The number of access intervals that could not acquire data is added to the high-speed access interval overload count as an accumulated value and stored when succeeded in acquiring the data. (One is incremented in the following case.)

↔: Sequence scan time, ○: Succeeded in acquisition, ×: Failed in acquisition

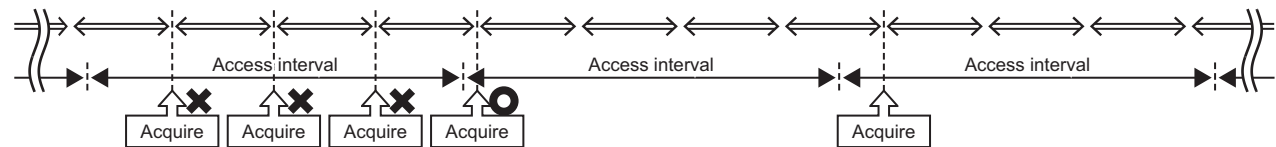

Error log information (Un\G13056 to 13391)

The history of an error occurred in an MES interface module is stored in this area.

■Error count (Un\G13056)

The accumulated count registered in the error log area is stored.

If the count exceeds the maximum value, the maximum value (65535) is stored.

■Latest error log number (Un\G13057)

The error log number in which the latest error log is registered is stored.*1

0: No error (No error log registered)

1 or more: Error log number in which the latest error log is registered

*1 The pointer value of '16' indicates that the latest error log has been registered in the error log area of 16.

■Error log 1 to 16 (Un\G13058 to 13217)

The error history is stored.

Error log area is comprised of 16 error logs with the same data configuration (continuation error: up to 15, stop error: up to 1).

When a new stop error occurs in the state where a stop error is stored, the information of the stop error is updated.

An error log is not stored in the following cases.

- When an error that has already been stored in the error log area occurs again
- When a new continuation error occurs after a stop error occurs
- When a new continuation error occurs in the state where 15 continuation errors are stored

Buffer memory name	Description
Error code	An error code which indicates the error contents is stored. (Page 241 Error Code List)
Error occurrence date and time	The time when the error occurred is stored in BCD code. (Page 287 Error occurrence date and time (Un\G7170 to 7177))

Firmware update history information (Un\G13392 to 13423)

The firmware update history of an MES interface module is stored in this area.

Name		Address	Description
Firmware update completion with/without an error		Un\G13392	The error occurrence state on the firmware update function is stored. <ul style="list-style-type: none"> • 0: Update completed without an error (including successful completion) • 1: Update completed with an error '1' is stored when a value of 'Firmware update result' (Un\G13412) is within 100 to 300H.
System area		Un\G13393 to 13401	Use prohibited
Latest firmware update information	History information	Execution time (year)	Un\G13402 The value of the year (four digits) when the firmware update was executed is stored as a BIN code.
		Execution time (month)	Un\G13403 The value of the month when the firmware update was executed is stored as a BIN code.
		Execution time (day)	Un\G13404 The value of the day when the firmware update was executed is stored as a BIN code.
		Execution time (hour)	Un\G13405 The value of the hour when the firmware update was executed is stored as a BIN code.
		Execution time (minute)	Un\G13406 The value of the minutes when the firmware update was executed is stored as a BIN code.
		Execution time (second)	Un\G13407 The value of the seconds when the firmware update was executed is stored as a BIN code.
		Execution time (day of the week)	Un\G13408 The value of the day of the week when the firmware update was executed is stored as a BIN code. (0: Sunday, 1: Monday, 2: Tuesday, 3: Wednesday, 4: Thursday, 5: Friday, 6: Saturday)
		Firmware version after update	Un\G13409 The firmware version after update is stored. (When the update is completed with an error, '0' is stored.)
		Firmware version before update	Un\G13410 The firmware version before update is stored.
Latest firmware update result		Firmware update target	Un\G13411 The start input/output number of the module where the firmware update was executed is stored.
		Firmware update result	Un\G13412 The execution result of the firmware update is stored. <ul style="list-style-type: none"> • 1H: Normal end • 100H: Flash ROM error • 200H: Model mismatched • 201H: File invalid • 203H: Firmware update prohibition state • 300H: Firmware data error
Previous firmware update information	History information	Execution time (year)	Un\G13413 The value of the year (four digits) when the firmware update was executed is stored as a BIN code.
		Execution time (month)	Un\G13414 The value of the month when the firmware update was executed is stored as a BIN code.
		Execution time (day)	Un\G13415 The value of the day when the firmware update was executed is stored as a BIN code.
		Execution time (hour)	Un\G13416 The value of the hour when the firmware update was executed is stored as a BIN code.
		Execution time (minute)	Un\G13417 The value of the minutes when the firmware update was executed is stored as a BIN code.
		Execution time (second)	Un\G13418 The value of the seconds when the firmware update was executed is stored as a BIN code.
		Execution time (day of the week)	Un\G13419 The value of the day of the week when the firmware update was executed is stored as a BIN code. (0: Sunday, 1: Monday, 2: Tuesday, 3: Wednesday, 4: Thursday, 5: Friday, 6: Saturday)
		Firmware version after update	Un\G13420 The firmware version after update is stored. (When the update is completed with an error, '0' is stored.)
		Firmware version before update	Un\G13421 The firmware version before update is stored.

Name		Address	Description
Previous firmware update result	Firmware update target	Un\G13422	The start input/output number of the module where the firmware update was executed is stored.
	Firmware update result	Un\G13423	The execution result of the firmware update is stored. <ul style="list-style-type: none"> • 1H: Normal end • 100H: Flash ROM error • 200H: Model mismatched • 201H: File invalid • 203H: Firmware update prohibition state • 300H: Firmware data error

Appendix 4 Usable Characters

This section explains the usable characters.

○: Usable, ×: Unusable

Classification ^{*1}	①	②	③	④	⑤	⑥	⑦	⑧	⑨	⑩
	0 to 9	A to Z	a to z	- (U+002D)	\ (U+005C)	_ (U+005F)	Symbols except ④ to ⑥	CR+LF (Line feed) (U+005F+U-000A)	DEL and control characters except ⑧	Others (U+0080 or later)
Item name	○ ^{*2}	○	○	×	×	○ ^{*3}	×	×	×	○
Access information ^{*4}	○	○	○	○	○	○	○ ^{*5}	×	×	×
Firmware update	○	○	○	○	○	○	○	×	×	×
Comment	○	○	○	○	○	○	○	○ ^{*6}	×	○
Host name	○ ^{*2}	○	×	○ ^{*2*8}	×	×	×	×	×	×
Execution command	○	○	○	○	○	○	○	×	×	○

*1 Classification details are as follows.

Classification	Item
Item name	<ul style="list-style-type: none"> • Project name • Target device name • Component name • Access table name • Access field name • Access procedure name • Access procedure argument name • DB table name • DB field name • DB procedure name • Global variable name • Local variable name • Job name • Device tag name • Target server name • DB buffer name
Access information	<ul style="list-style-type: none"> • Account user name • Account password name • Server user name • Server password • User name (specify connection destination) • Password (specify connection destination) • Data source name
Firmware update	<ul style="list-style-type: none"> • Prohibition release password
Comment	<ul style="list-style-type: none"> • Comment (job, target device, device tag, target server, access table, access procedure, local variable, global variable) • Comment (project)
Host name	<ul style="list-style-type: none"> • Host name
Execution command	<ul style="list-style-type: none"> • Execution command (program execution)

*2 Cannot be used at the beginning.

*3 Cannot be used at the beginning except in the DB table name, DB field name, and DB procedure name.

*4 Includes user name, password, and data source name.

*5 "." (U+003A) cannot be used for account user name.

*6 Can be used for project only.

*7 Lower-case characters are converted to upper-case characters.

*8 Cannot be used at the end.



Appendix 5 Processing Time

This section shows the measurement results for the processing time required for DB communication actions of an MES interface module.

Note that the processing time required for a DB communication action may increase depending on any of the following factors:

- Usage environment (personal computer, network, and SD memory card)
- Sequence scan time
- Access status from a personal computer, HMI, or other intelligent function module to a CPU module
- Access from a personal computer by using MES Interface Function Configuration Tool
- Settings of MES interface module

Processing time required for a DB communication action (when "Single Handshake" is selected in a trigger condition (general access))

Measurement conditions		
Item		Description
Server	CPU	Intel® Core™ i7 3.6 GHz
	Memory	16 GB
	Operating system	Windows Server 2012 R2 (Standard) (64-bit version)
	Database software	<ul style="list-style-type: none"> • Oracle 12c (Standard Edition) • SQL Server 2017(Standard Edition)
Access target CPU	CPU module	R120CPU (Control CPU)
	Network	No other station specified (Own station)
	Sequence scan time	5 ms (constant scan)
Device tag setting	Number of tags	<ul style="list-style-type: none"> • For trigger condition: 1 tag ■For send/receive data (when Select, Update, or Insert is selected) <ul style="list-style-type: none"> • 1 tag (for 16, 64, 256, 1024 fields) • 4 tags (for 4096 fields) ■For send/receive data (when Multiple Select is selected) <ul style="list-style-type: none"> • 1 tag
	Data type	<ul style="list-style-type: none"> • For trigger condition: Bit • For send/receive data: Word [Unsigned]
	Number of components	<ul style="list-style-type: none"> • For trigger condition: 2 ■For send/receive data (when Select, Update, or Insert is selected) <ul style="list-style-type: none"> • Same as the number of fields ■For send/receive data (when Multiple Select is selected) <ul style="list-style-type: none"> • 16 data: 4 components • 64 data: 8 components • 256 data: 16 components • 1024 data: 32 components • 4096 data: 64 components • 16384 data: 128 components • 40000 data: 200 components
	Number of arrays	<ul style="list-style-type: none"> ■When Multiple Select is selected <ul style="list-style-type: none"> • 16 data: 4 • 64 data: 8 • 256 data: 16 • 1024 data: 32 • 4096 data: 64 • 16384 data: 128 • 40000 data: 200
Job setting	Trigger condition	<ul style="list-style-type: none"> • Single handshake
	Read data at trigger judgment	<ul style="list-style-type: none"> • Access type: General access • Access interval: 1 × 100 ms • Reading target data: data to be used in trigger condition only
	Number of jobs	<ul style="list-style-type: none"> • 1 job
	Number of actions	<ul style="list-style-type: none"> ■When Select, Update, or Insert is selected <ul style="list-style-type: none"> • 1 action (for 16, 64, 256 fields) • 2 actions (for 1024 fields) • 5 actions (for 4096 fields) ■When Multiple Select is selected <ul style="list-style-type: none"> • 1 action
	Narrowing-down condition	None
	Sorting order	None
Measurement method	Measurement interval	From job startup request ON to job completion notification OFF
	Number of measurements	Average value of 20 measurement results



Measurement results

■When the database software is Oracle

- Select, Update, or Insert

The following table shows the results when selecting "Select," "Update," or "Insert" for "DB Communication Type" in the "DB Communication Action Setting" screen.

MES interface module	Access type	DB communication type	Number of fields				
			16	64	256	1024	4096
RD81MES96N	Connection via service	Select	230 ms	230 ms	320 ms	670 ms	2100 ms
		Update Insert	230 ms	230 ms	240 ms	340 ms	900 ms
	Direct DB connection	Select	240 ms	240 ms	420 ms	770 ms	2210 ms
		Update Insert	230 ms	230 ms	240 ms	340 ms	900 ms
RD81MES96	Connection via service	Select	230 ms	230 ms	320 ms	670 ms	2100 ms
		Update Insert	230 ms	230 ms	240 ms	340 ms	900 ms

- Multiple Select

The following table shows the results when selecting "Multiple Select" for "DB Communication Type" in the "DB Communication Action Setting" screen.

MES interface module	Access type	DB communication type	Number of units of data						
			16	64	256	1024	4096	16384	40000
RD81MES96N	Connection via service	Multiple Select	230 ms	230 ms	320 ms	600 ms	1600 ms	5640 ms	13500 ms
	Direct DB connection	Multiple Select	230 ms	330 ms	460 ms	910 ms	2170 ms	7710 ms	18120 ms
RD81MES96	Connection via service	Multiple Select	230 ms	230 ms	320 ms	600 ms	1600 ms	5640 ms	13500 ms

■When the database software is SQL Server

- Select, Update, or Insert

The following table shows the results when selecting "Select," "Update," or "Insert" for "DB Communication Type" in the "DB Communication Action Setting" screen.

MES interface module	Access type	DB communication type	Number of fields				
			16	64	256	1024	4096
RD81MES96N	Connection via service	Select	250 ms	250 ms	340 ms	580 ms	1880 ms
		Update Insert	230 ms	230 ms	240 ms	340 ms	780 ms
	Direct DB connection	Select	240 ms	240 ms	420 ms	770 ms	2160 ms
		Update Insert	230 ms	230 ms	240 ms	340 ms	900 ms

- Multiple Select, Multiple Insert

The following table shows the results when selecting "Multiple Select" or "Multiple Insert" for "DB Communication Type" in the "DB Communication Action Setting" screen.

MES interface module	Access type	DB communication type	Number of units of data						
			16	64	256	1024	4096	16384	40000
RD81MES96N	Connection via service	Multiple Select	230 ms	230 ms	420 ms	750 ms	1640 ms	5510 ms	12920 ms
		Multiple Insert	240 ms	240 ms	240 ms	260 ms	500 ms	1100 ms	2380 ms
	Direct DB connection	Multiple Select	290 ms	400 ms	420 ms	470 ms	1690 ms	5200 ms	11790 ms
		Multiple Insert	240 ms	240 ms	240 ms	240 ms	480 ms	1080 ms	2400 ms

Processing time required for a DB communication action (when "Single Handshake" is selected in a trigger condition (high-speed access))

Measurement conditions		
Item		Description
Server	CPU	Intel Core i7 3.6 GHz
	Memory	16 GB
	Operating system	Windows Server 2012 R2 (Standard) (64-bit version)
	Database software	<ul style="list-style-type: none"> • Oracle 12c (Standard Edition) • SQL Server 2017(Standard Edition)
Access target CPU	CPU module	R120CPU (Control CPU)
	Network	No other station specified (Own station)
	Sequence scan time	5 ms (constant scan)
Device tag setting	Number of tags	<ul style="list-style-type: none"> • For trigger condition: 1 tag ■ For send/receive data (when Select, Update, or Insert is selected) • 1 tag (for 16, 64, 256, 1024 fields) • 4 tags (for 4096 fields)
	Data type	<ul style="list-style-type: none"> • For trigger condition: Bit • For send/receive data: Word [Unsigned]
	Number of components	<ul style="list-style-type: none"> • For trigger condition: 2 ■ For send/receive data (when Select, Update, or Insert is selected) • Same as the number of fields
Job setting	Trigger condition	<ul style="list-style-type: none"> • Single handshake
	Read data at trigger judgment	<ul style="list-style-type: none"> • Access type: High-speed access (each scan) • Reading target data: all of the data to be used in the job
	Number of jobs	<ul style="list-style-type: none"> • 1 job
	Number of actions	<ul style="list-style-type: none"> ■ When Select, Update, or Insert is selected • 1 action (for 16, 64, 256 fields) • 2 actions (for 1024 fields) • 5 actions (for 4096 fields)
	Narrowing-down condition	None
	Sorting order	None
Measurement method	Measurement interval	From job startup request ON to job completion notification OFF
	Number of measurements	Average value of 20 measurement results



Measurement results

■When the database software is Oracle

- Select, Update, or Insert

The following table shows the results when selecting "Select," "Update," or "Insert" for "DB Communication Type" in the "DB Communication Action Setting" screen.

MES interface module	Access type	DB communication type	Number of fields				
			16	64	256	1024	4096
RD81MES96N	Connection via service	Select	90 ms	90 ms	180 ms	530 ms	1960 ms
		Update Insert	60 ms	60 ms	90 ms	190 ms	600 ms
	Direct DB connection	Select	130 ms	130 ms	210 ms	580 ms	2080 ms
		Update Insert	60 ms	70 ms	100 ms	190 ms	600 ms
RD81MES96	Connection via service	Select	90 ms	90 ms	180 ms	530 ms	1960 ms
		Update Insert	60 ms	60 ms	90 ms	190 ms	600 ms

■When the database software is SQL Server

- Select, Update, or Insert

The following table shows the results when selecting "Select," "Update," or "Insert" for "DB Communication Type" in the "DB Communication Action Setting" screen.

MES interface module	Access type	DB communication type	Number of fields				
			16	64	256	1024	4096
RD81MES96N	Connection via service	Select	100 ms	110 ms	200 ms	470 ms	1680 ms
		Update Insert	100 ms	100 ms	120 ms	170 ms	400 ms
	Direct DB connection	Select	150 ms	150 ms	230 ms	530 ms	2040 ms
		Update Insert	60 ms	70 ms	100 ms	190 ms	560 ms

- Multiple Insert

The following table shows the results when selecting "Multiple Insert" for "DB Communication Type" in the "DB Communication Action Setting" screen.

MES interface module	Access type	DB communication type	Number of units of data						
			16	64	256	1024	4096	16384	40000
RD81MES96N	Connection via service	Multiple Insert	60 ms	60 ms	60 ms	80 ms	120 ms	240 ms	2390 ms
	Direct DB connection	Multiple Insert	50 ms	50 ms	60 ms	60 ms	90 ms	240 ms	2400 ms

Processing time required for a DB communication action (when "Condition (Value Monitoring)" is selected in a trigger condition (high-speed access))

Measurement conditions		
Item		Description
Server	CPU	Intel Core i7 3.6 GHz
	Memory	16 GB
	Operating system	Windows Server 2012 R2 (Standard) (64-bit version)
	Database software	<ul style="list-style-type: none"> • Oracle 12c (Standard Edition) • SQL Server 2017(Standard Edition)
Access target CPU	CPU module	R120CPU (Control CPU)
	Network	No other station specified (Own station)
	Sequence scan time	5 ms (constant scan)
Device tag setting	Number of tags	<ul style="list-style-type: none"> • For trigger condition: 1 tag ■For send/receive data (when Select, Update, or Insert is selected) • 1 tag (for 16, 64, 256, 1024 fields) • 4 tags (for 4096 fields)
	Data type	<ul style="list-style-type: none"> • For trigger condition: Bit • For send/receive data: Word [Unsigned]
	Number of components	<ul style="list-style-type: none"> • For trigger condition: 2 ■For send/receive data (when Select, Update, or Insert is selected) • Same as the number of fields
Job setting	Trigger condition	<ul style="list-style-type: none"> • Condition (Value monitoring)
	Read data at trigger judgment	<ul style="list-style-type: none"> • Access type: High-speed access (each scan) • Reading target data: all of the data to be used in the job
	Number of jobs	<ul style="list-style-type: none"> • 1 job
	Number of actions	<ul style="list-style-type: none"> ■When Select, Update, or Insert is selected • 1 action (for 16, 64, 256 fields) • 2 actions (for 1024 fields) • 5 actions (for 4096 fields)
	Narrowing-down condition	None
	Sorting order	None
Measurement method	Measurement interval	<p>Until the job operation status of the buffer memory is changed from "In execution" to "Trigger condition monitoring" after a trigger condition is satisfied (☞ Page 291 Operating status (Un\G8968 to 8975))</p> <p>For a sample program for controlling jobs in an MES interface module using the operating status of a job in the buffer memory, refer to the following:</p> <p>☞ Page 304 Sample program for controlling jobs in an MES interface module using the operating status of a job in the buffer memory</p>
	Number of measurements	Average value of 20 measurement results



■ Sample program for controlling jobs in an MES interface module using the operating status of a job in the buffer memory

● Devices used in the program

Device name	Device	Application
MES interface module input signal	X1	MES interface function operation status
External input	X100	Processing request
Internal relay	M0	In process
	M100	Job start request
MES interface module buffer memory	U0\G8968.0	Operating status of the job No.1 in the job setting list.
	U0\G8968.1	
	U0\G8984.0	Error information when the job No.1 in the job setting list is executed.

● Program example

The following shows the program example which executes job when the processing request (X100) is turned ON from the CPU module.

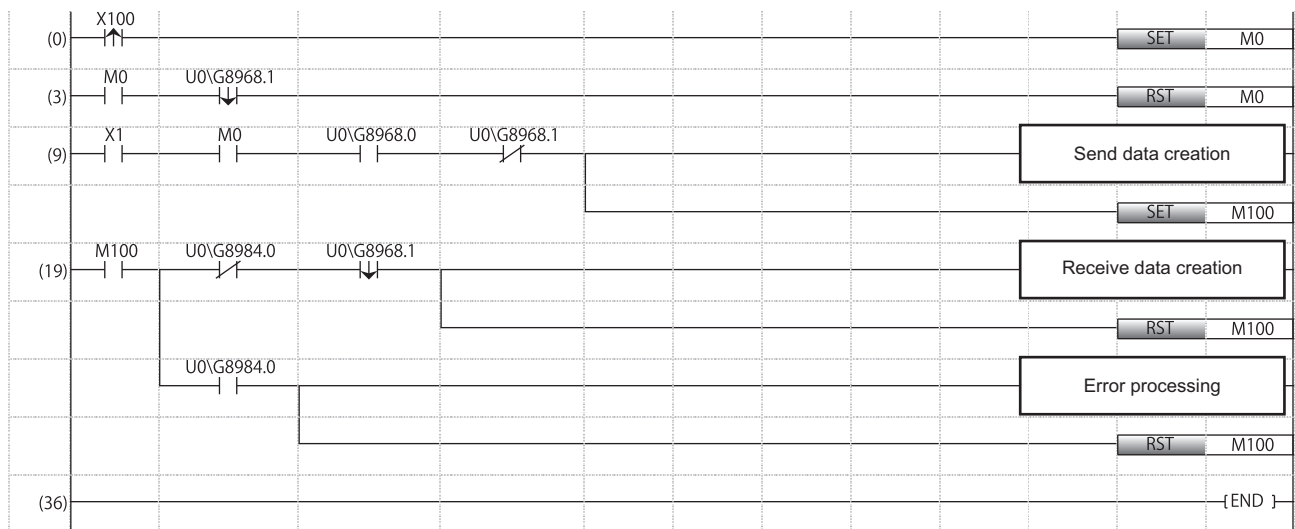

- (0) Sets the in-process flag at processing request.
- (3) Resets the in-process flag at job completion.
- (9) Job start processing
- (19) Processing at job-execution completion
Processing at job-execution failure

Measurement results

■When the database software is Oracle

- Select, Update, or Insert

The following table shows the results when selecting "Select," "Update," or "Insert" for "DB Communication Type" in the "DB Communication Action Setting" screen.

MES interface module	Access type	DB communication type	Number of fields				
			16	64	256	1024	4096
RD81MES96N	Connection via service	Select	23 ms	41 ms	116 ms	422 ms	1654 ms
		Update Insert	18 ms	24 ms	40 ms	106 ms	380 ms
	Direct DB connection	Select	72 ms	88 ms	152 ms	462 ms	1769 ms
		Update Insert	24 ms	25 ms	40 ms	106 ms	380 ms
RD81MES96	Connection via service	Select	23 ms	41 ms	116 ms	422 ms	1654 ms
		Update Insert	18 ms	24 ms	40 ms	106 ms	380 ms

■When the database software is SQL Server

- Select, Update, or Insert

The following table shows the results when selecting "Select," "Update," or "Insert" for "DB Communication Type" in the "DB Communication Action Setting" screen.

MES interface module	Access type	DB communication type	Number of fields				
			16	64	256	1024	4096
RD81MES96N	Connection via service	Select	35 ms	55 ms	120 ms	360 ms	1430 ms
		Update	50 ms	50 ms	60 ms	80 ms	235 ms
		Insert	45 ms	50 ms	60 ms	95 ms	235 ms
	Direct DB connection	Select	85 ms	100 ms	165 ms	440 ms	1740 ms
		Update	25 ms	30 ms	40 ms	100 ms	330 ms
		Insert	25 ms	30 ms	45 ms	100 ms	345 ms

- Multiple Insert

The following table shows the results when selecting "Multiple Insert" for "DB Communication Type" in the "DB Communication Action Setting" screen.

MES interface module	Access type	DB communication type	Number of units of data						
			16	64	256	1024	4096	16384	40000
RD81MES96N	Connection via service	Multiple Insert	35 ms	40 ms	40 ms	45 ms	100 ms	185 ms	415 ms
	Direct DB connection	Multiple Insert	20 ms	25 ms	30 ms	30 ms	60 ms	190 ms	430 ms

Appendix 6 CSV File Import/Export Specifications

Setting information file

Setting information files are stored in the following folders.

Folder/file configuration

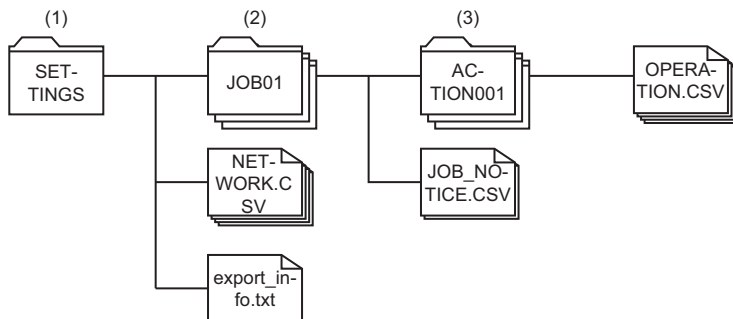

Folder type	Folder name	File name*1	Description
(1) User-specified folder*2	(Set by user)	PROJECT.CSV	Project name, comments, CSV format version
		TARGET_DEVICE.CSV	Access target device setting
		DEVICE_TAG.CSV	Device tag setting
		DEVICE_TAG_COMPONENT.CSV	Device tag setting/device tag component setting
		LOCAL_VARIABLE.CSV	Variable setting/local variable setting
		GLOBAL_VARIABLE.CSV	Variable setting/global variable setting
		TARGET_SERVER.CSV*3	Access target server setting
		ACCESS_TABLE.CSV	Access table/procedure setting
		ACCESS_FIELD.CSV	Access field/argument setting
		JOB.CSV	Job setting
		NETWORK.CSV	Network setting
		DB_BUFFER.CSV	DB buffer setting
		SECURITY.CSV	Security setting
		USER.CSV*4	Security setting/user account setting
DOT_MATRIX_LED.CSV	Dot matrix LED setting		
export_info.txt*5	Information such as date and time when a CSV file is saved		
(2) Job folder	JOB [job number] (Example) JOB01	JOB_NOTICE.CSV	Job setting/notification settings
		TRIGGER_CONDITION.CSV	Job setting/trigger condition setting
(3) Action folder	ACTION[Processing type]*6[Action number] (Example) ACTION001	OPERATION.CSV*7	Operation action
		DB_COMMUNICATION.CSV*7	DB communication action
		DB_ASSIGNMENT.CSV*7	DB communication action/data assignment setting
		DB_NARROWING_DOWN.CSV*7	DB communication action/narrowing-down condition setting
		DB_SORTING_ORDER.CSV*7	DB communication action/sort setting
EXTERNAL_COMMUNICATION.CSV*7	External communication action		

*1 No case sensitive

*2 A folder to specify when performing the following operations.

Save CSV files

Open CSV files

*3 When saving a CSV file, user name and password are not output.

*4 When saving a CSV file, a user account No., user name, and password are not output.

*5 This file is not used to open a CSV file.

*6 The processing type is displayed with the following values:

0: Pre-processing, 1: Main-processing, 2: Post-processing

*7 When saving a CSV file, a CSV file which is corresponding to the action type being used is output.

When a CSV file with multiple action types exists in an action folder, the CSV file cannot be opened.

CSV format version

The appropriate version of CSV format should be used for the software version of MX MESInterface-R used. If the file of a CSV format version which is not supported by the software version of MX MESInterface-R is imported/exported, appropriate operation may not be obtained.

The availability of the CSV format file function for each software version of MX MESInterface-R is as follows.

Software version	CSV format version	Changed content	Remarks
'1.03D' or earlier	—	—	The CSV format file function is unsupported.
'1.04E'	1	First edition of the CSV file format	The CSV format file function is added.
'1.05F'	2	Global labels and common device comments can be imported.	—
"1.10L"	3	<ul style="list-style-type: none"> • Direct DB connection is supported. • Multiple handshake is supported. • FX5CPUs and FXCPUs can be connected. 	RD81MES96Ns are supported.

Output of a log file

When a CSV file could not be opened, a log file which includes error information is output.

The output specification of a log file is as follows:

Rule	Description
Character code	UTF-8 (with BOM)
Line feed code	CRLF
Output destination	A file is output under the user-specified folder.
File name	csv_open_YYYYMMDD_hhmmssfff.log

Format

■Format specification

Item name	Description	
Delimiter	Comma (,)	
Character code	UTF-8 (with BOM)	
Line feed code	CRLF (0x0D, 0x0A)	
Upper-case/lower-case characters	Case sensitive	
Special characters	Line feed	When a line feed is included in a setting value, the whole data is enclosed with double quotes (").
	Comma	When a comma (,) is included in a setting value, the whole setting value is enclosed with double quotes (").
	Double quotation	A double quote (") in a setting value is expressed with double double quotes (""), and the whole setting value is enclosed with double quotes (").
Comment line	The line starts with (//) is ignored when opening a CSV file. Maximum number of comment rows = 1 (number of title rows) + maximum number of setting rows	

■Description of format

(1)	VARIABLE NO	VARIABLE NAME	COMMENT	DATA TYPE	LENGTH
(2)	1	VarL0001	Production Trigger	BIT	
(2)	2	VarL0002	Production Volume	UWORD	
(3)	//Variable No	Variable Name	Comment	Data Type	Size

Component	Description
(1) Title row	The titles of setting items are displayed.
(2) Setting row	Setting values are displayed.
(3) Comment row	<p>Comments are displayed.</p> <p>When a CSV file is imported and opened with MES Interface Function Configuration Tool, only the content of setting rows is applied to the setting tool.</p> <p>The comment row is not output when opening a CSV file with comments and saving the CSV file with MES Interface Function Configuration Tool.</p>

Details of files

■PROJECT.CSV

Column title	Description	Setting value	Description of setting value	Remarks	CSV format version
PROJECT NAME	Project name	{1 to 32 characters}	Project name	—	1
COMMENT	Comment	{0 to 400 characters}	Comment	—	1
CSV FORMAT VERSION	CSV format version	{1 to 255}	CSV format version	—	1

■TARGET_DEVICE.CSV

Column title	Description	Setting value	Description of setting value	Remarks	CSV format version
TARGET DEVICE NO	Target device No.	{1 to 64}	Target device No.	—	1
TARGET DEVICE NAME	Target device name	{1 to 32 characters}	Target device name	—	1
COMMENT	Comment	{0 to 100 characters}	Comment	—	1
DEVICE TYPE	Device type	RCPU	MELSEC (RCPU)	—	1
		QCPU	MELSEC (QCPU (Q mode))	—	
		LCPU	MELSEC (LCPU)	—	
		FX5CPU	MELSEC (FX5CPU)	—	
		FXCPU	MELSEC (FXCPU)	—	
MULTIPLE CPU	Multiple CPU setting	NO	No specification	—	1
		CPU1	CPU No.1	—	
		CPU2	CPU No.2	—	
		CPU3	CPU No.3	—	
		CPU4	CPU No.4	—	
SINGLE NETWORK	Set the network communication route to a device existing over a single network	DISABLE	Disable	—	1
		ENABLE	Enable	—	
SOURCE MODULE TYPE	Source system - Module type	CCIECONT	CC-Link IE Controller Network module	Use when "Set the network communication route to a device existing over a single network" is enabled.	1
		CCIEFIELD	CC-Link IE Field Network module		
		MELSECNETH	MELSECNET/H network module		
		CCLINK	CC-Link System Master/Local Module		
		ETHERNET	Ethernet interface module		
		MESIF	MES interface module (Ethernet port)		
SOURCE ROUTE	Source system - Route	DIRECT_ETHERNET	Direct access to Ethernet Port	Use when the Source system - Module type is "MES Interface Module (Ethernet Port)".	1
		DIRECT_CPU	Direct access to CPU Module (Ethernet Port)		
		VIA_ETHERNET	Via Ethernet Interface Module of Other System		
		VIA_CPU	Via CPU Module (Ethernet Port) of Other System		
SOURCE START IO NUM	Source system - Start I/O No.	{0 to FE0}	Source system - Start I/O No.	Use when the Source system -Module type is "CC-Link System Master/Local Module".	1

Column title	Description	Setting value	Description of setting value	Remarks	CSV format version
SOURCE STATION NUM	Source system - Station No.	{1 to 120}	Source system - Station No.	Use when either of the following settings is configured: <ul style="list-style-type: none"> Source system - Route is "Direct access to Ethernet Port." Source system - Route is "Via Ethernet Interface Module of Other System" and the device type is one other than "MELSEC (FXCPU)." 	1
ROUTED IP ADDRESS	System to be routed - IP address	{IP address}	System to be routed - IP address	Use when the Source system - Route is "Via Ethernet Interface Module of Other System" or "Via CPU Module (Ethernet Port) of Other System".	1
ROUTED MODULE TYPE	System to be routed - Module type	CCIECONT	CC-Link IE Controller Network module	Use when the Source system - Route is "Via CPU Module (Ethernet Port) of Other System".	1
		CCIEFIELD	CC-Link IE Field Network module		
		MELSECNETH	MELSECNET/H network module		
		ETHERNET	Ethernet interface module		
ROUTED NETWORK NUM	System to be routed - Network No.	{1 to 239}	System to be routed - Network No.	Use when the Source system - Route is "Via Ethernet Interface Module of Other System".	1
ROUTED STATION NUM	System to be routed - Station No.	{1 to 120}	System to be routed - Station No.	Use when the Source system - Route is "Via Ethernet Interface Module of Other System".	1
TARGET MODULE TYPE	Target system - Module type	ETHERNET_ADAP	Ethernet interface block (-ADP)	Use when the device type is "MELSEC (FXCPU)" and the Source system - Route is "Direct access to Ethernet Port".	3
		ETHERNET_L	Ethernet interface block (-L)		
TARGET IP ADDRESS	Target (relay station) system - IP address	{IP address}	Target (relay station) system - IP address	Use when the Source system - Route is "Direct access to Ethernet Port" or "Direct access to CPU Module (Ethernet Port)".	1



Column title	Description	Setting value	Description of setting value	Remarks	CSV format version
TARGET NETWORK NUM	Target (relay station) system - Network No.	{1 to 239}	Target (relay station) system - Network No.	Use when any of the following settings is configured: <ul style="list-style-type: none"> • Source system - Module type is other than "CC-Link System Master/Local Module" • Source system - Module type is "MES interface module (Ethernet port)" and Source system - Route is "Direct access to CPU Module (Ethernet Port)" • The device type is one other than "MELSEC (FXCPU)." 	1
TARGET STATION NUM	Target (relay station) system - Station No.	{0 to 120}	Target (relay station) system - Station No.	Use when any of the following settings is configured: <ul style="list-style-type: none"> • Source system - Module type is other than "CC-Link System Master/Local Module" • Source system - Module type is "MES interface module (Ethernet port)" and Source system - Route is "Direct access to CPU Module (Ethernet Port)" • The device type is one other than "MELSEC (FXCPU)." 	1
DIFFERENT NETWORK	Set the co-existence network route to a device existing over a different network	DISABLE	Disable	—	1
		ENABLE	Enable		
RELAY MODULE TYPE	Relay station system - Module type	CCIECONT	CC-Link IE Controller Network module	Use when "Set the co-existence network route to a device existing over a different network" is enabled.	1
		CCIEFIELD	CC-Link IE Field Network module		
		MELSECNETH	MELSECNET/H network module		
		CCLINK	CC-Link System Master/Local Module		
		ETHERNET	Ethernet interface module		
RELAY START IO NUM	Relay station system - Start I/O No.	{0 to FE0}	Relay station system - Start I/O No.	Use when "Set the co-existence network route to a device existing over a different network" is enabled and the Source system - Module type is other than "CC-Link System Master/Local Module".	1

Column title	Description	Setting value	Description of setting value	Remarks	CSV format version
CO-EX NETWORK NUM	Co-existence target system - Network No.	{1 to 239}	Co-existence target system - Network No.	Use when "Set the co-existence network route to a device existing over a different network" is enabled and the Source system - Module type is other than "CC-Link System Master/Local Module".	1
CO-EX STATION NUM	Co-existence target system - Station No.	{0 to 120}	Co-existence target system - Station No.	Use when "Set the co-existence network route to a device existing over a different network" is enabled.	1
GLOBAL LABEL SETTING	Use the global label/common device comment	DISABLE	Disable	Use when "Device Type" is "MELSEC(RCPU)".	2
		ENABLE	Enable		
GLOBAL LABEL PATH SETTING	Import source setting of global labels and common device comments	{1 to 200 characters}	A project path of global labels and common device comments import source project file	Use when "Use the global label/common device comment" is enabled.	2

■DEVICE_TAG.CSV

Column title	Description	Setting value	Description of setting value	Remarks	CSV format version
TAG NO	Device tag No.	{1 to 64}	Device tag No.	—	1
TAG NAME	Device tag name	{1 to 32 characters}	Device tag name	—	1
COMMENT	Comment	{0 to 100 characters}	Comment	—	1
PROTECT DATA WRITING	Protect data writing	DISABLE	Disable	—	1
		ENABLE	Enable		
ARRAY TAG SETTING	Set the array tag	DISABLE	Disable	—	1
		ENABLE	Enable		
ARRAY SIZE	Array size	{2 to 40960}	Array size	Use when "Set the array tag" is enabled.	1
ARRAY TYPE	Array type	CONTINUOUS	Continuous array	Use when "Set the array tag" is enabled.	1
		BLOCK	Block array		
SPECIFY BLOCK SIZE	Specify the array block size	DISABLE	Disable	Use when the array type is "Block array".	1
		ENABLE	Enable		
ARRAY BLOCK SIZE	Array block size	{0 to 1073741824}	Array block size	Use when "Specify the array block size" is enabled.	1



■DEVICE_TAG_COMPONENT.CSV

Column title	Description	Setting value	Description of setting value	Remarks	CSV format version
TAG NO	Device tag No.	{1 to 64}	Device tag No.	—	1
COMPONENT NO	Device tag component No.	{1 to 1024}	Device tag component No.	—	1
COMPONENT NAME	Component name	{1 to 32 characters}	Component name	—	1
TARGET DEVICE NO	Target device No.	{1 to 64}	Target device No.	—	1
DEVICE MEMORY	Device memory (start)	{Device memory name}	Device memory (start)	—	1
DATA TYPE	Data type	BIT	Bit	—	1
		UWORD	Word [Unsigned]/Bit String [16-bit]		
		UDWORD	Double Word [Unsigned]/Bit String [32-bit]		
		WORD	Word [Signed]		
		DWORD	Double Word [Signed]		
		SINGLE	FLOAT [Single Precision]		
		DOUBLE	FLOAT [Double Precision]		
		16BCD	16bit BCD		
		32BCD	32bit BCD		
		UNICODE	Character string [Unicode]		
SJIS	Character string [ASCII/SJIS]				
LENGTH	Length	{1 to 255}	Length	Use when the data type is "Character string [Unicode]" or "Character string [SJIS]".	1
GLOBAL LABEL	Global label name	{0 to 400 characters}	Global label name	—	2

■LOCAL_VARIABLE.CSV

Column title	Description	Setting value	Description of setting value	Remarks	CSV format version
VARIABLE NO	Local variable No.	{1 to 1024}	Local variable No.	—	1
VARIABLE NAME	Local variable name	{1 to 32 characters}	Local variable name	—	1
COMMENT	Comment	{0 to 100 characters}	Comment	—	1
DATA TYPE	Data type	BIT	Bit	—	1
		UWORD	Word [Unsigned]/Bit String [16-bit]		
		UDWORD	Double Word [Unsigned]/Bit String [32-bit]		
		WORD	Word [Signed]		
		DWORD	Double Word [Signed]		
		SINGLE	FLOAT [Single Precision]		
		DOUBLE	FLOAT [Double Precision]		
		UNICODE	Character string [Unicode]		
LENGTH	Length	{1 to 255}	Length	Use when the data type is "Character string [Unicode]".	1

■GLOBAL_VARIABLE.CSV

Column title	Description	Setting value	Description of setting value	Remarks	CSV format version
VARIABLE NO	Global variable No.	{1 to 4096}	Global variable No.	—	1
VARIABLE NAME	Global variable name	{1 to 32 characters}	Global variable name	—	1
COMMENT	Comment	{0 to 100 characters}	Comment	—	1
DATA TYPE	Data type	BIT	Bit	—	1
		UWORD	Word [Unsigned]/Bit String [16-bit]	—	
		UDWORD	Double Word [Unsigned]/Bit String [32-bit]	—	
		WORD	Word [Signed]	—	
		DWORD	Double Word [Signed]	—	
		SINGLE	FLOAT [Single Precision]	—	
		DOUBLE	FLOAT [Double Precision]	—	
UNICODE	Character string [Unicode]	—	—		
LENGTH	Length	{1 to 255}	Length	Use when the data type is "Character string [Unicode]".	1

■TARGET_SERVER.CSV

Column title	Description	Setting value	Description of setting value	Remarks	CSV format version
TARGET SERVER NO	Target server No.	{1 to 16}	Target server No.	—	1
TARGET SERVER NAME	Target server name	{1 to 32 characters}	Target server name	—	1
COMMENT	Comment	{0 to 100 characters}	Comment	—	1
SERVER TYPE	Server type	DATABASE	Database server	—	1
		APPLICATION	Application server		
ACCESS TYPE	Access type	VIA_SERVICE	Connection via service	—	3
		DIRECT_DB	Direct DB connection		
IP ADDRESS	IP address	{IP address}	IP address	—	1
PORT NUM	Port No.	{1024 to 65535}	Port No.	—	1
COMMUNICATION TIMEOUT	Communication timeout time	{1 to 180}	Communication timeout time	—	1
DB ACCESS TIMEOUT	DB access timeout	{30 to 3600}	DB access timeout	Use when the access type is "Direct DB Connection".	3
DATA SOURCE NAME	Data source name	{1 to 32 characters}	Data source name	<ul style="list-style-type: none"> Use when the server type is "Database Server". When the access type is "Direct DB Connection", the content set for "Service/Database Name" is output. 	1
USER NAME	User name	{0 to 32 characters}	User name	This item is not output.	1
PASSWORD	Password	{0 to 32 characters}	Password	This item is not output.	1

Column title	Description	Setting value	Description of setting value	Remarks	CSV format version
DATABASE TYPE	Database type	ORACLE11G	Oracle 11g	Use when the server type is "Database Server".	1
		ORACLE12C	Oracle 12c		
		ORACLE18C	Oracle 18c		
		ORACLE19C	Oracle 19c		
		ORACLE21C	Oracle 21c		
		SQLSERVER2008 R2	SQL Server 2008 R2		
		SQLSERVER2012	SQL Server 2012		
		SQLSERVER2014	SQL Server 2014		
		SQLSERVER2016	SQL Server 2016		
		SQLSERVER2017	SQL Server 2017		
		SQLSERVER2019	SQL Server 2019		
		SQLSERVER2022	SQL Server 2022		
		ACCESS2010	Access 2010		
		ACCESS2013	Access 2013		
		ACCESS2016	Access 2016		
		ACCESS2019	Access 2019		
		ACCESS2021	Access 2021		
		MYSQL	MySQL		
		POSTGRESQL	PostgreSQL		
MARIADB	MariaDB				
NOTIFY ACCESS ERROR	Notify the access error status	DISABLE	Disable	—	1
		ENABLE	Enable		
NOTICE DST	Notification destination	TAG{01 to 64}- {0001 to 1024}	Device tag	Use when "Notify the access error status" is enabled.	1
		GLOBAL{0001 to 4096}	Global variable		

■ACCESS_TABLE.CSV

Column title	Description	Setting value	Description of setting value	Remarks	CSV format version
ACCESS TABLE NO	Access table/procedure No.	{1 to 64}	Access table/procedure No.	—	1
ACCESS TABLE NAME	Access table/procedure name	{1 to 32 characters}	Access table/procedure name	—	1
COMMENT	Comment	{0 to 100 characters}	Comment	—	1
TARGET SERVER NO	Target server No.	{1 to 16}	Target server No.	—	1
TABLE PROC TYPE	Table/procedure type	TABLE	Access table	—	1
		PROCEDURE	Access procedure		
DB TABLE NAME	DB table/procedure name	{1 to 32 characters}	DB table/procedure name	—	1

■ACCESS_FIELD.CSV

Column title	Description	Setting value	Description of setting value	Remarks	CSV format version	
ACCESS TABLE NO	Access table/procedure No.	{1 to 64}	Access table/procedure No.	—	1	
ACCESS FIELD NO	Access field/procedure argument No.	{1 to 1024}	Access field/procedure argument No.	—	1	
ACCESS FIELD NAME	Access field/procedure argument name	{1 to 32 characters}	Access field/procedure argument name	—	1	
DB FIELD NAME	DB field name/DB procedure argument number	{1 to 32 characters}	DB field name/DB procedure argument number	—	1	
DATA TYPE	Data type	(Blank)	Not set	—	1	
		INTEGER	Integer			
		REAL	<ul style="list-style-type: none"> ■When the table/procedure type of an access table is "Access Table" <ul style="list-style-type: none"> • Real number [point] ■When the table/procedure type of an access table is "Access Procedure" <ul style="list-style-type: none"> • Real number 			
		DECIMAL	Real number [fixed point]			
		NCHAR	<ul style="list-style-type: none"> ■When the table/procedure type of an access table is "Access Table" <ul style="list-style-type: none"> • Character String [Unicode(NCHAR)] ■When the table/procedure type of an access table is "Access Procedure" <ul style="list-style-type: none"> • Character string [Unicode] 			
		CHAR	Character String [Unicode(CHAR)]			
		DATETIME	Date and time [without time zone]			
		DATETIME_TZ	Date and time [with time zone]			
		INTEGER[SMALLINT]	Integer (when the smallint type is specified in a database)			Use when the database is PostgreSQL and the table/procedure type of an access table is "Access Procedure".
		INTEGER[INTEGER]	Integer (when the integer type is specified in a database)			
		INTEGER[BIGINT]	Integer (when the bigint type is specified in a database)			
		REAL[NUMERIC]	Real number (when the numeric type is specified in a database)			
		REAL[REAL]	Real number (when the real type is specified in a database)			
		REAL[DOUBLE_PRECISION]	Real number (when the double precision type is specified in a database)			
		CHAR[CHARACTER]	Character string (when the character type is specified in a database)			
CHAR[CHARACTER_VARYING]	Character string (when the character varying type is specified in a database)					
DATETIME[TIMESTAMP]	Date and time (when the timestamp type is specified in a database)					
PRECISION HOLD	Precision hold	DISABLE	Disable	—	1	
		ENABLE	Enable			

Column title	Description	Setting value	Description of setting value	Remarks	CSV format version
DEFAULT VALUE SETTING	Default value setting	DISABLE	Disable	—	1
		ENABLE	Enable		
DEFAULT VALUE	Default value	[DATESTRING]{0 to 64 characters}	Date and time character string	Use when the default value setting is enabled.	1
		[INT]{Integer}	Constant (Integer)		
		[REAL]{Real number}	Constant (Real number)		
		[STRING]{0 to 255 characters}	Constant (Character string [Unicode])		
DIRECTION	Assignment direction	IN	IN	Use when the table/ procedure type of an access table is "Access Procedure".	1
		OUT	OUT		
		INOUT	INOUT		

■JOB.CSV

Column title	Description	Setting value	Description of setting value	Remarks	CSV format version
JOB NO	Job No.	{1 to 64}	Job No.	—	1
JOB NAME	Job name	{1 to 32 characters}	Job name	—	1
COMMENT	Comment	{0 to 100 characters}	Comment	—	1
JOB CONFIGURATION	Job configuration	MAIN	Main configuration	—	1
		EXTEND	Extended configuration		
PRE ACTION NUM	Number of pre-processing actions	{0 to 10}	Number of pre-processing actions	0 indicates disabled.	1
POST ACTION NUM	Number of post-processing actions	{0 to 10}	Number of post-processing actions	0 indicates disabled.	1
TRIGGER CONFIGURATION	Configuration type of a trigger condition	SINGLE	<ul style="list-style-type: none"> • Single event • Single handshake • Multiple handshake 	—	1
		MULTIPLE	Multiple events		
		COMBINATION	Condition combination event		
		PRECONDITION	Precondition × Event		
TRIGGER COMBINATION	Condition combination type of a trigger condition	AND	AND combination	—	1
		OR	OR combination		
TRIGGER BUFFERING	Trigger buffering	DISABLE	Disable	—	1
		ENABLE	Enable		
ACCESS TYPE	Access type of read data at trigger judgment	GENERAL	General access	—	1
		HISPEED_INTERVAL	High-speed access (interval specification)		
		HISPEED_EACH_SCAN	High-speed access (each scan)		
ACCESS INTERVAL	Access interval at read data at trigger judgment	{1 to 3600}	Access interval at read data at trigger judgment	Use when the access type of read data at trigger judgment is other than "High-speed access (each scan)". <ul style="list-style-type: none"> ■When the unit is seconds <ul style="list-style-type: none"> • 1 to 3600 s ■When the unit is milliseconds <ul style="list-style-type: none"> • 1 to 9 × 1 ms • 1 to 9 × 10 ms • 1 to 9 × 100 ms 	1
ACCESS INTERVAL UNIT	Access interval at read data at trigger judgment - Unit	SECOND	Second	Use when the access type of read data at trigger judgment is other than "High-speed access (each scan)".	1
		MILLISECOND	Millisecond		
READING TARGET	Reading target data	TRIGGER_DATA	The Data to be used in Trigger Condition only	—	1
		ALL_DATA	All of the Data to be used in the Job		
PRE FAIL OPERATION	Operation at pre-processing failure	MAIN_PROCESSING	Execute main-processing	Use when the number of pre-processing actions is more than 1.	1
		POST_PROCESSING	Execute the post-processing		
		END_JOB	End the job		
MAIN FAIL OPERATION	Operation at main-processing failure	POST_PROCESSING	Execute the post-processing	—	1
		END_JOB	End the job		

Column title	Description	Setting value	Description of setting value	Remarks	CSV format version
MAIN ABORT OPERATION	Operation at main-processing interruption	POST_PROCESSING	Execute the post-processing	Use when the job configuration is "Extended configuration".	1
		END_JOB	End the job		
DB BUFFERING SETTING	DB buffering	DISABLE	No buffering	—	1
		BUFFER1	Buffering to DBBuf1		
		BUFFER2	Buffering to DBBuf2		
DB BUFFERING OPERATION	Operation at DB buffering	POST_PROCESSING	Execute the post-processing	Use when DB buffering is other than "No buffering".	1
		END_JOB	Not execute the post-processing		
WORKING HISTORY	Working history output	DISABLE	Disable	—	1
		ENABLE	Enable		
DETAILED LOG	Detailed log output	DISABLE	Disable	—	1
		ENABLE	Enable		
INHIBIT OUTPUT DEVICE	Inhibit the data output to the target device	DISABLE	Disable	—	1
		ENABLE	Enable		
INHIBIT OUTPUT SERVER	Inhibit the data output to the target server	DISABLE	Disable	—	1
		ENABLE	Enable		
INHIBIT JOB EXECUTION	Inhibit the job execution even when the trigger condition is satisfied.	DISABLE	Disable	—	1
		ENABLE	Enable		

■NETWORK.CSV

Column title	Description	Setting value	Description of setting value	Remarks	CSV format version
USE CH1	Use the Ethernet port (CH1)	DISABLE	Disable	—	1
		ENABLE	Enable		
CH1 IP ADDRESS	CH1 IP address	{IP address}	CH1 IP address	Use when "Use the Ethernet port (CH1)" is enabled.	1
CH1 SUBNET MASK	CH1 subnet mask	{IP address}	CH1 subnet mask	Use when "Use the Ethernet port (CH1)" is enabled.	1
USE CH2	Use the Ethernet port (CH2)	DISABLE	Disable	—	1
		ENABLE	Enable		
CH2 IP ADDRESS	CH2 IP address	{IP address}	CH2 IP address	Use when "Use the Ethernet port (CH2)" is enabled.	1
CH2 SUBNET MASK	CH2 subnet mask	{IP address}	CH2 subnet mask	Use when "Use the Ethernet port (CH2)" is enabled.	1
GATEWAY SETTING	Default gateway setting	NOTSET	Not set	—	1
		CH1	Set to CH1		
		CH2	Set to CH2		
DEFAULT GATEWAY	Default gateway	{IP address}	Default gateway	—	1
HOST NAME	Host name	{1 to 24 characters}	Host name	—	1

■DB_BUFFER.CSV

Column title	Description	Setting value	Description of setting value	Remarks	CSV format version
DB BUFFER NO	DB buffer No.	{1 to 2}	DB buffer No.	—	1
USE DB BUFFER	Use the DB buffer	DISABLE	Disable	—	1
		ENABLE	Enable		
DB BUFFER NAME	DB buffer name	{1 to 32 characters}	DB buffer name	Use when "Use the DB buffer" is enabled.	1
DB BUFFER SIZE	DB buffer size	{64 to 1024}	DB buffer size	Use when "Use the DB buffer" is enabled.	1
RESEND AUTO	Resend automatically	DISABLE	Disable	Use when "Use the DB buffer" is enabled.	1
		ENABLE	Enable		
OPERATION RECOVERY	Operation at recovery	ADD_TO_BUFFER D_DATA	Add to the Buffered Data	Use when "Use the DB buffer" is enabled.	1
		SEND_IMMEDIATELY	Send immediately (Not add to the Buffered Data)		
RESEND REQUEST	Resend request	(Blank)	Not set	Use when "Use the DB buffer" is enabled.	1
		TAG{01 to 64}- {0001 to 1024}	Device tag		
		GLOBAL{0001 to 4096}	Global variable		
CLEAR REQUEST	Clear request	(Blank)	Not set	Use when "Use the DB buffer" is enabled.	1
		TAG{01 to 64}- {0001 to 1024}	Device tag		
		GLOBAL{0001 to 4096}	Global variable		
STATUS NOTICE DST	Notification destination of status	(Blank)	Not set	Use when "Use the DB buffer" is enabled.	1
		TAG{01 to 64}- {0001 to 1024}	Device tag		
		GLOBAL{0001 to 4096}	Global variable		
NUM NOTICE DST	Notification destination of the number of stored data	(Blank)	Not set	Use when "Use the DB buffer" is enabled.	1
		TAG{01 to 64}- {0001 to 1024}	Device tag		
		GLOBAL{0001 to 4096}	Global variable		
FULL NOTICE DST	Notification destination of DB buffer full	(Blank)	Not set	Use when "Use the DB buffer" is enabled.	1
		TAG{01 to 64}- {0001 to 1024}	Device tag		
		GLOBAL{0001 to 4096}	Global variable		
USE RATE NOTICE DST	Notification destination of use rate	(Blank)	Not set	Use when "Use the DB buffer" is enabled.	1
		TAG{01 to 64}- {0001 to 1024}	Device tag		
		GLOBAL{0001 to 4096}	Global variable		

■SECURITY.CSV

Column title	Description	Setting value	Description of setting value	Remarks	CSV format version
USE USER AUTH	Use the user authentication	DISABLE	Disable	—	1
		ENABLE	Enable		

■USER.CSV

Column title	Description	Setting value	Description of setting value	Remarks	CSV format version
ACCOUNT NO	User account No.	{1 to 16}	User account No.	This item is not output.	1
USER NAME	User name	{6 to 32 characters}	User name	This item is not output.	1
PASSWORD	Password	{6 to 32 characters}	Password	This item is not output.	1

■DOT_MATRIX_LED.CSV

Column title	Description	Setting value	Description of setting value	Remarks	CSV format version
DEFAULT MODE	Default display mode	USR	USR: User-specified character	—	1
		ENO	ENo.: Error code		
		IP1	IP1: CH1 IP address		
		IP2	IP2: CH2 IP address		
		BUF1	BUF1: DB buffer 1 use rate		
		BUF2	BUF2: DB buffer 2 use rate		
SWITCH FORCIBLY	Switch the display mode forcibly to "ENo.: Error Code" at error occurrence.	DISABLE	Disable	—	1
		ENABLE	Enable		
HIGHLIGHT DISPLAY	Highlight the display in the case of "ENo.: Error Code"	DISABLE	Disable	—	1
		ENABLE	Enable		

■export_info.txt

Item name	Description
PROJECT NAME	Project name
EXPORT DATE	Export date and time
TOOL VERSION	Software version of MES Interface Function Configuration Tool

■JOB_NOTICE.CSV

Column title	Description	Setting value	Description of setting value	Remarks	CSV format version
NOTICE TYPE	Notification type	PRE_FAIL1	At pre-processing failure 1	When saving a CSV file, all the data of types are output.	1
		PRE_FAIL2	At pre-processing failure 2		
		MAIN_FAIL1	At main-processing failure 1		
		MAIN_FAIL2	At main-processing failure 2		
		DB_BUFFERING	At DB buffering		
		POST_FAIL1	At post-processing failure 1		
		POST_FAIL2	At post-processing failure 2		
NOTICE SETTING	Availability of notifications	DISABLE	Disable	When two same kind of notification settings (PRE_FAIL1 and PRE_FAIL2, for example) exist, the both notifications are enabled if either of these settings is set to ENABLE.	1
		ENABLE	Enable		
NOTICE DST	Notification destination	TAG{01 to 64}- {0001 to 1024}	Device tag	—	1
		LOCAL{0001 to 1024}	Local variable		
		GLOBAL{0001 to 4096}	Global variable		
		S_MATRIXLED_DISPLAY	Dot matrix LED display		
		S_MATRIXLED_MODE	Dot matrix LED display mode		
NOTICE DATA	Notification data	TAG{01 to 64}- {0001 to 1024}	Device tag	—	1
		LOCAL{0001 to 1024}	Local variable		
		GLOBAL{0001 to 4096}	Global variable		
		S_SERVER_STATUSES{01 to 16}	Connection status of the target server		
		S_DEVICE_STATUSES{01 to 16}	Connection status of the target device		
		S_MATRIXLED_DISPLAY	Dot matrix LED display		
		S_MATRIXLED_MODE	Dot matrix LED display mode		
		FAILURE_ACTION	Failure action No.		
		[DATESTRING]{0 to 64 characters}	Date and time character string		
		[INT]{Integer}	Constant (Integer)		
		[REAL]{Real number}	Constant (Real number)		
		[STRING]{0 to 255 characters}	Constant (Character string [Unicode])		

■ TRIGGER_CONDITION.CSV

Column title	Description	Setting value	Description of setting value	Remarks	CSV format version
TRIGGER NO	Event/condition No.	{1 to 2}	Event/condition No.	When the condition is "Precondition × Event", PRECONDITION is output to the row of precondition and EVENT is output to the row of event.	1
		PRECONDITION	Precondition		
		EVENT	Event		
EVENT CONDITION TYPE	Event/condition type	VALUE_MONITORING	Condition (Value monitoring)	—	1
		VALUE_CHANGED	Event (Value changed)		
		PERIOD_OF_TIME	Condition (Period of time)		
		FIXED_TIME	Event (Fixed time)		
		FIXED_CYCLE	Event (Fixed cycle)		
		MODULE_MONITORING	Event (Module monitoring)		
		HANDSHAKE	Single handshake		
		MULTIPLE_HANDSHAKE	Multiple handshake		
DETAIL TYPE	Detail type	TIMER_INTERVAL	Timer interval	Use when the event/condition type is "Event (Fixed cycle)" or "Event (Module Monitoring)".	1
		TIME_INTERVAL	Time interval		
		MESIF_MODULE	MES interface module		
		CONTROL_CPU	Control CPU		
MONITORING TARGET	Value monitoring/value changed monitoring - Target	TAG{01 to 64}- {0001 to 1024}	Device tag	Use when the event/condition type is "Condition (Value monitoring)" or "Event (Value changed)".	1
		GLOBAL{0001 to 4096}	Global variable		
CONDITION	Value monitoring - Condition	EQUAL	=	Use when the event/condition type is "Condition (Value monitoring)".	1
		NOT_EQUAL	≠		
		HIGHER_THAN	>		
		LOWER_THAN	<		
		HIGHER_THAN_EQUAL	≥		
		LOWER_THAN_EQUAL	≤		
COMPARISON TARGET	Value monitoring - Comparison target	TAG{01 to 64}- {0001 to 1024}	Device tag	Use when the event/condition type is "Condition (Value monitoring)".	1
		GLOBAL{0001 to 4096}	Global variable		
		[INT]{Integer}	Constant (Integer)		
		[REAL]{Real number}	Constant (Real number)		
		[STRING]{0 to 255 characters}	Constant (Character string [Unicode])		
MONTH	Month and day - Month	EVERY	Every	Use when the event/condition type is "Condition (Period of time)" or "Event (Fixed time)".	1
		{1 to 12}	Month		
DAY	Month and day - Day	EVERY	Every	Use when the event/condition type is "Condition (Period of time)" or "Event (Fixed time)".	1
		LAST	Last		
		{1 to 31}	Day		

Column title	Description	Setting value	Description of setting value	Remarks	CSV format version
WEEK	Day of the week - Week	EVERY	Every	Use when the event/condition type is "Condition (Period of time)" or "Event (Fixed time)".	1
		LAST	Last		
		{1 to 4}	Week		
MON-SUN	Day of the week - Monday to Sunday	{0000000 to 1111111}	The first value indicates Monday and the last value indicates Sunday. Additionally, 0 indicates disabled and 1 indicates enabled.	Use when the event/condition type is "Condition (Period of time)" or "Event (Fixed time)".	1
START TIME	Start/occurrence time	00:00:00 to 23:59:59	The time is expressed as hh:mm:ss. When "Every" is specified, "" is displayed.	Use when the Event/condition type is "Condition (Period of time)" or "Event (Fixed time)".	1
END TIME	End time	00:00:00 to 23:59:59	The time is expressed as hh:mm:ss. When "Every" is specified, "" is displayed.	Use when the event/condition type is "Condition (Period of time)".	1
TIMER INTERVAL	Fixed cycle - Timer interval	{1 to 3600}	Fixed cycle - Timer interval	Use only when the event/condition type is "Event (Fixed Cycle)" and the detail type is "Timer Interval".	1
TIME INTERVAL	Fixed cycle - Time interval	1, 2, 3, 4, 5, 6, 8, 10, 12, 15, 20, 24, 30, 60	Fixed cycle - Time interval	Use only when the event/condition type is "Event (Fixed Cycle)" and the detail type is "Time Interval".	1
TIME INTERVAL UNIT	Fixed cycle - Time interval - Unit	SECOND	Second	Use only when the event/condition type is "Event (Fixed Cycle)" and the detail type is "Time Interval".	1
		MINUTE	Minute		
		HOUR	Hour		
REFERENCE TIME	Fixed cycle - Time interval - Reference time	00:00:00 to 23:59:59	The time is expressed as hh:mm:ss.	Use only when the event/condition type is "Event (Fixed Cycle)" and the detail type is "Time Interval".	1
MESIF MODULE STARTUP	At Startup of MES Interface Module	DISABLE	Disable	Use only when the event/condition type is "Event (Module Monitoring)" and the detail type is "MES Interface Module".	1
		ENABLE	Enable		
MESIF FUNC RESTART	At Restart/Update of Settings of the MES Interface Function	DISABLE	Disable	Use only when the event/condition type is "Event (Module Monitoring)" and the detail type is "MES Interface Module".	1
		ENABLE	Enable		
CONTROL CPU STATUS	Control CPU Status Change	STOP	→STOP	Use only when the event/condition type is "Event (Module Monitoring)" and the detail type is "Control CPU".	1
		RUN	→RUN		
		PAUSE	→PAUSE		
REQUEST SRC	Handshake - Job startup request	TAG{01 to 64}-{0001 to 1024}	Device tag	Use only when the configuration type of a trigger condition is "Single Handshake" or "Multiple Handshake".	1



Column title	Description	Setting value	Description of setting value	Remarks	CSV format version
NOTICE DST	Handshake - Job completion notification	TAG{01 to 64}- {0001 to 1024}	Device tag	Use only when the configuration type of a trigger condition is "Single Handshake" or "Multiple Handshake".	1
REQUEST SRC2	Handshake 2 - Job startup request	TAG{01 to 64}- {0001 to 1024}	Device tag	Use only when the configuration type of a trigger condition is "Multiple Handshake".	3
NOTICE DST2	Handshake 2 - Job completion notification	TAG{01 to 64}- {0001 to 1024}	Device tag	Use only when the configuration type of a trigger condition is "Multiple Handshake".	3

■ OPERATION.CSV

Column title	Description	Setting value	Description of setting value	Remarks	CSV format version
OPERATION NO	Operation No.	{1 to 20}	Operation No.	—	1
SUBSTITUTION ITEM	Substitution item	TAG{01 to 64}- {0001 to 1024}	Device tag	—	1
		LOCAL{0001 to 1024}	Local variable		
		GLOBAL{0001 to 4096}	Global variable		
		S_MATRIXLED_DISP	Dot matrix LED display		
		S_MATRIXLED_MODE	Dot matrix LED display mode		
OPERATOR	Operator	ASSIGN	Substitutes data for the substitution item.	—	1
		+	+		
		-	-		
		*	×		
		/	÷		
		%	%		
		CONCAT	Combines data.		
		LENGTH	Acquires the number of characters.		
		RIGHT	Reads data from the end/rightmost of the data.		
		LEFT	Reads data from the first/leftmost of the data.		
		UPPER	Converts lower-case characters to upper-case characters.		
		LOWER	Converts upper-case characters to lower-case characters.		
		RTRIM	Deletes blank characters at the end/rightmost of the data.		
		LTRIM	Deletes blank characters at the end/leftmost of the data.		
		AND	AND		
		OR	OR		
		XOR	XOR		
		RSHIFT	Shifts data to right.		
		LSHIFT	Shifts data to left.		
		STR2INT	Character string → Integer		
STR2REAL	Character string → Real number				
INT2STR	Integer → Character string				
REAL2STR	Real number → Character string				

Column title	Description	Setting value	Description of setting value	Remarks	CSV format version
FIRST ITEM	First item	TAG{01 to 64}- {0001 to 1024}	Device tag	—	1
		LOCAL{0001 to 1024}	Local variable		
		GLOBAL{0001 to 4096}	Global variable		
		S_SERVER_STAT US{01 to 16}	Connection status of the target server		
		S_DEVICE_STATU S{01 to 16}	Connection status of the target device		
		S_MATRIXLED_DI SP	Dot matrix LED display		
		S_MATRIXLED_M ODE	Dot matrix LED display mode		
		[DATESTRING]{0 to 64 characters}	Date and time character string		
		[INT]{Integer}	Constant (Integer)		
		[REAL]{Real number}	Constant (Real number)		
		[STRING]{0 to 255 characters}	Constant (Character string [Unicode])		
SECOND ITEM	Second item	TAG{01 to 64}- {0001 to 1024}	Device tag	Use for the operator whose second item can be entered. For low precision and high precision, use when the operator is "Real number → Character string".	1
		LOCAL{0001 to 1024}	Local variable		
		GLOBAL{0001 to 4096}	Global variable		
		S_SERVER_STAT US{01 to 16}	Connection status of the target server		
		S_DEVICE_STATU S{01 to 16}	Connection status of the target device		
		S_MATRIXLED_DI SP	Dot matrix LED display		
		S_MATRIXLED_M ODE	Dot matrix LED display mode		
		[DATESTRING]{0 to 64 characters}	Date and time character string		
		[INT]{Integer}	Constant (Integer)		
		[REAL]{Real number}	Constant (Real number)		
		[STRING]{0 to 255 characters}	Constant (Character string [Unicode])		
		[PRECISION]LOW	Low precision		
		[PRECISION]HIGH	High precision		

■DB_COMMUNICATION.CSV

Column title	Description	Setting value	Description of setting value	Remarks	CSV format version
DB COMMUNICATION TYPE	DB communication type	SELECT	Select	—	1
		INSERT	Insert		
		UPDATE	Update		
		DELETE	Delete		
		MULTI-SELECT	Multiple Select		
		MULTI-INSERT	Multiple Insert		
		STORED_PROCEDURE	Stored Procedure		
ACCESS TABLE NO	Access table No.	{1 to 64}	Access table No.	—	1
RECORD NUM NOTICE	Notify the record count	DISABLE	Disable	Use when the DB communication type is any of the following: <ul style="list-style-type: none"> • Select • Insert • Update • Delete • Multiple Select • Multiple Insert 	1
		ENABLE	Enable		
RECORD NUM DST	Notification destination of the number of records <ul style="list-style-type: none"> • No. of Applicable Records (SELECT) • No. of Inserted Records (INSERT) • No. of Updated Records (UPDATE) • No. of Deleted Records (DELETE) • No. of Applicable Records (Multi-SELECT) • No. of Inserted Records (Multi-INSERT) 	TAG{01 to 64}-{0001 to 1024}	Device tag	Use when the DB communication type is any of the following: <ul style="list-style-type: none"> • Select • Insert • Update • Delete • Multiple Select • Multiple Insert 	1
		LOCAL{0001 to 1024}	Local variable		
		GLOBAL{0001 to 4096}	Global variable		
SELECTED RECORD NUM DST	Notification destination of the number of selected records <ul style="list-style-type: none"> • Number of selected records (Multi-SELECT) 	TAG{01 to 64}-{0001 to 1024}	Device tag	Use when the DB communication type is any of the following: <ul style="list-style-type: none"> • Multiple Select 	1
		LOCAL{0001 to 1024}	Local variable		
		GLOBAL{0001 to 4096}	Global variable		
SET MAX RECORD NUM	Set the Maximum No. of Records ^{*1}	DISABLE	Disable	Use when the DB communication type is any of the following: <ul style="list-style-type: none"> • Multiple Select • Multiple Insert 	1
		ENABLE	Enable		
MAX RECORD NUM	Maximum number of records ^{*1} - Setting value	TAG{01 to 64}-{0001 to 1024}	Device tag	Use when the DB communication type is any of the following: <ul style="list-style-type: none"> • Multiple Select • Multiple Insert 	1
		LOCAL{0001 to 1024}	Local variable		
		GLOBAL{0001 to 4096}	Global variable		
		[INT]{Integer}	Constant (Integer)		
M-SELECT ZERO CLEAR	Clear the unsubstituted assignment data to 0	DISABLE	Disable	Use when the DB communication type is any of the following: <ul style="list-style-type: none"> • Multiple Select 	1
		ENABLE	Enable		
SET DEFAULT VALUE	Substitute the default value	DISABLE	Disable	Use when the DB communication type is any of the following: <ul style="list-style-type: none"> • Select • Multiple Select 	1
		ENABLE	Enable		

Column title	Description	Setting value	Description of setting value	Remarks	CSV format version
RETURN VALUE NOTICE	Notify the return value	DISABLE	Disable	Use when the DB communication type is any of the following: <ul style="list-style-type: none"> • Stored Procedure 	1
		ENABLE	Enable		
RETURN VALUE DST	Return value - Notification destination	TAG{01 to 64}-{0001 to 1024}	Device tag	Use when the DB communication type is any of the following: <ul style="list-style-type: none"> • Stored Procedure 	1
		LOCAL{0001 to 1024}	Local variable		
		GLOBAL{0001 to 4096}	Global variable		
NO RECORD OPERATION	No applicable record - Exception operation	EXECUTE	Execute the next action regarding the exception as normal.	Use when the DB communication type is any of the following: <ul style="list-style-type: none"> • Select • Update • Delete • Multiple Select 	1
		CANCEL	Cancel the processing (job cancellation) regarding the exception as an error.		
		INTERRUPT	The processing is interrupted without executing the next action.		
NO RECORD NOTICE	No applicable record - Notify the exception occurrence	DISABLE	Disable	Use when the DB communication type is any of the following: <ul style="list-style-type: none"> • Select • Update • Delete • Multiple Select 	1
		ENABLE	Enable		
NO RECORD NOTICE DST	No applicable record - Notification destination	TAG{01 to 64}-{0001 to 1024}	Device tag	Use when the DB communication type is any of the following: <ul style="list-style-type: none"> • Select • Update • Delete • Multiple Select 	1
		GLOBAL{0001 to 4096}	Global variable		
		S_MATRIXLED_DISPLAY	Dot matrix LED display		
		S_MATRIXLED_MODE	Dot matrix LED display mode		
NO RECORD NOTICE DATA	No applicable record - Notification data	TAG{01 to 64}-{0001 to 1024}	Device tag	Use when the DB communication type is any of the following: <ul style="list-style-type: none"> • Select • Update • Delete • Multiple Select 	1
		LOCAL{0001 to 1024}	Local variable		
		GLOBAL{0001 to 4096}	Global variable		
		S_SERVER_STATUS{01 to 16}	Connection status of the target server		
		S_DEVICE_STATUSES{01 to 16}	Connection status of the target device		
		S_MATRIXLED_DISPLAY	Dot matrix LED display		
		S_MATRIXLED_MODE	Dot matrix LED display mode		
		[DATESTRING]{0 to 64 characters}	Date and time character string		
		[INT]{Integer}	Constant (Integer)		
		[REAL]{Real number}	Constant (Real number)		
		[STRING]{0 to 255 characters}	Constant (Character string [Unicode])		
NO RECORD ZERO CLEAR	No applicable record - Clear the data set in "Assignment Data" to 0	DISABLE	Disable	Use when the DB communication type is any of the following: <ul style="list-style-type: none"> • Select • Multiple Select 	1
		ENABLE	Enable		

Column title	Description	Setting value	Description of setting value	Remarks	CSV format version
M-RECORDS OPERATION	Multiple applicable records - Exception operation	EXECUTE	Execute the next action regarding the exception as normal.	Use when the DB communication type is any of the following: • Select • Update • Delete	1
		CANCEL	Cancel the processing (job cancellation) regarding the exception as an error.		
		INTERRUPT	The processing is interrupted without executing the next action.		
M-RECORDS NOTICE	Multiple applicable records - Exception notify the exception occurrence	DISABLE	Disable	Use when the DB communication type is any of the following: • Select • Update • Delete	1
		ENABLE	Enable		
M-RECORDS NOTICE DST	Multiple applicable records - Notification destination	TAG{01 to 64}-{0001 to 1024}	Device tag	Use when the DB communication type is any of the following: • Select • Update • Delete	1
		GLOBAL{0001 to 4096}	Global variable		
		S_MATRIXLED_DISPLAY	Dot matrix LED display		
		S_MATRIXLED_MODE	Dot matrix LED display mode		
M-RECORDS NOTICE DATA	Multiple applicable records - Notification data	TAG{01 to 64}-{0001 to 1024}	Device tag	Use when the DB communication type is any of the following: • Select • Update • Delete	1
		LOCAL{0001 to 1024}	Local variable		
		GLOBAL{0001 to 4096}	Global variable		
		S_SERVER_STATUS{01 to 16}	Connection status of the target server		
		S_DEVICE_STATUS{01 to 16}	Connection status of the target device		
		S_MATRIXLED_DISPLAY	Dot matrix LED display		
		S_MATRIXLED_MODE	Dot matrix LED display mode		
		[DATESTRING]{0 to 64 characters}	Date and time character string		
		[INT]{Integer}	Constant (Integer)		
		[REAL]{Real number}	Constant (Real number)		
		[STRING]{0 to 255 characters}	Constant (Character string [Unicode])		
OVERFLOW OPERATION	Applicable record overflow - Exception operation	EXECUTE	Execute the next action regarding the exception as normal.	Use when the DB communication type is any of the following: • Multiple Select	1
		CANCEL	Cancel the processing (job cancellation) regarding the exception as an error.		
		INTERRUPT	The processing is interrupted without executing the next action.		
OVERFLOW NOTICE	Applicable record overflow - Notify the exception occurrence	DISABLE	Disable	Use when the DB communication type is any of the following: • Multiple Select	1
		ENABLE	Enable		



Column title	Description	Setting value	Description of setting value	Remarks	CSV format version
OVERFLOW NOTICE DST	Applicable record overflow - Notification destination	TAG{01 to 64}- {0001 to 1024}	Device tag	Use when the DB communication type is any of the following: • Multiple Select	1
		GLOBAL{0001 to 4096}	Global variable		
		S_MATRIXLED_DISPLAY	Dot matrix LED display		
		S_MATRIXLED_MODE	Dot matrix LED display mode		
OVERFLOW NOTICE DATA	Applicable record overflow - Notification data	TAG{01 to 64}- {0001 to 1024}	Device tag	Use when the DB communication type is any of the following: • Multiple Select	1
		LOCAL{0001 to 1024}	Local variable		
		GLOBAL{0001 to 4096}	Global variable		
		S_SERVER_STATUS{01 to 16}	Connection status of the target server		
		S_DEVICE_STATUSES{01 to 16}	Connection status of the target device		
		S_MATRIXLED_DISPLAY	Dot matrix LED display		
		S_MATRIXLED_MODE	Dot matrix LED display mode		
		[DATESTRING]{0 to 64 characters}	Date and time character string		
		[INT]{Integer}	Constant (Integer)		
		[REAL]{Real number}	Constant (Real number)		
		[STRING]{0 to 255 characters}	Constant (Character string [Unicode])		
SELECT FROM FIRST	Multiple applicable records - Select first record of applicable record/select from the first record of applicable records	DISABLE	Disable	Use when the DB communication type is any of the following: • Select • Multiple Select	1
		ENABLE	Enable		
INSERT NEW RECORD	No applicable record - Insert new records based on the narrowing-down settings	DISABLE	Disable	Use when the DB communication type is any of the following: • Update	1
		ENABLE	Enable		

*1 Refers to the number of inserted records when selecting "Multiple Insert."

■DB_ASSIGNMENT.CSV

Column title	Description	Setting value	Description of setting value	Remarks	CSV format version
ASSIGNMENT NO	Data assignment No.	{1 to 1024}	Data assignment No.	—	1
ACCESS FIELD NO	Access field No.	{1 to 1024}	Access field No.	—	1
		10001	ROWNUM [Pseudocolumn]		
		10002	ROWID [Pseudocolumn]		
ASSIGNMENT DATA	Assignment data	(Blank)	Not set	—	1
		TAG{01 to 64}- {0001 to 1024}	Device tag		
		LOCAL{0001 to 1024}	Local variable		
		GLOBAL{0001 to 4096}	Global variable		
		S_SERVER_STAT US{01 to 16}	Connection status of the target server		
		S_DEVICE_STATU S{01 to 16}	Connection status of the target device		
		S_MATRIXLED_DI SP	Dot matrix LED display		
		S_MATRIXLED_M ODE	Dot matrix LED display mode		
		TRIGGER_MONIT OR_DATETIME	Time at trigger monitoring		
		TRIGGER_ON_DA TETIME	Time at trigger ON		
		JOB_START_DAT ETIME	Job execution start date and time		
		SERVER_DATETI ME	Server date and time		
		[DATESTRING]{0 to 64 characters}	Date and time character string		
		[INT]{Integer}	Constant (Integer)		
		[REAL]{Real number}	Constant (Real number)		
[STRING]{0 to 255 characters}	Constant (Character string [Unicode])				

■DB_NARROWING_DOWN.CSV

Column title	Description	Setting value	Description of setting value	Remarks	CSV format version
NARROWING DOWN NO	Narrowing-down conditions number	{1 to 8}	Narrowing-down conditions number	—	1
COMBINATION	CONCAT	AND	AND	For the narrowing-down condition No.1, 'NONE' is output.	1
		OR	OR		
		NONE	None		
ACCESS FIELD NO	Access field No.	{1 to 1024}	Access field No.	—	1
CONDITION	Condition	EQUAL	=		1
		NOT_EQUAL	≠		
		HIGHER_THAN	>		
		LOWER_THAN	<		
		HIGHER_THAN_EQUAL	≥		
		LOWER_THAN_EQUAL	≤		
COMPARISON TARGET	Comparison target	TAG{01 to 64}- {0001 to 1024}	Device tag	—	1
		LOCAL{0001 to 1024}	Local variable		
		GLOBAL{0001 to 4096}	Global variable		
		TRIGGER_MONIT OR_DATETIME	Time at trigger monitoring		
		TRIGGER_ON_DA TETIME	Time at trigger ON		
		JOB_START_DAT ETIME	Job execution start date and time		
		SERVER_DATETI ME	Server date and time		
		[DATESTRING]{0 to 64 characters}	Date and time character string		
		[INT]{Integer}	Constant (Integer)		
		[REAL]{Real number}	Constant (Real number)		
		[STRING]{0 to 255 characters}	Constant (Character string [Unicode])		

■DB_SORTING_ORDER.CSV

Column title	Description	Setting value	Description of setting value	Remarks	CSV format version
SORTING ORDER NO	Sorting order No.	{1 to 8}	Sorting order No.	—	1
ACCESS FIELD NO	Access field No.	{1 to 1024}	Access field No.	—	1
ORDER	Order	ASC	Ascending order	—	1
		DESC	Descending order		

EXTERNAL_COMMUNICATION.CSV

Column title	Description	Setting value	Description of setting value	Remarks	CSV format version
TARGET SERVER NO	Target server No.	{1 to 16}	Target server No.	—	1
EXECUTION COMMAND	Execution command	{1 to 127 characters}	Execution command	—	1
WAIT COMPLETION	Wait for the program execution completion	DISABLE	Disable	—	1
		ENABLE	Enable		
NOTIFY RETURN VALUE	Notify the return value	DISABLE	Disable	Use when "Wait for the program execution completion" is enabled.	1
		ENABLE	Enable		
RETURN VALUE	Notification destination of return value	TAG{01 to 64}-{0001 to 1024}	Device tag	Use when "Notify the return value" is enabled.	1
		LOCAL{0001 to 1024}	Local variable		
		GLOBAL{0001 to 4096}	Global variable		
JUDGE RESULT	Judge the result of program execution based on the return value.	DISABLE	Disable	Use when "Wait for the program execution completion" is enabled.	1
		ENABLE	Enable		
EXPECTED VALUE	Expected value	TAG{01 to 64}-{0001 to 1024}	Device tag	Use when "Judge the result of program execution based on the return value" is enabled.	1
		LOCAL{0001 to 1024}	Local variable		
		GLOBAL{0001 to 4096}	Global variable		
		[INT]{Integer}	Constant (Integer)		
MISMATCH OPERATION	Return value mismatch - Exception operation	EXECUTE	Execute the next action regarding the exception as normal.	Use when "Judge the result of program execution based on the return value" is enabled.	1
		CANCEL	Cancel the processing regarding the exception as an error.		
MISMATCH NOTICE	Notify the exception occurrence	DISABLE	Disable	Use when "Judge the result of program execution based on the return value" is enabled.	1
		ENABLE	Enable		
MISMATCH NOTICE DST	Return value mismatch - Notification destination	TAG{01 to 64}-{0001 to 1024}	Device tag	Use when "Notify the exception occurrence" is enabled.	1
		GLOBAL{0001 to 4096}	Global variable		
		S_MATRIXLED_DISPLAY	Dot matrix LED display		
		S_MATRIXLED_MODE	Dot matrix LED display mode		

Column title	Description	Setting value	Description of setting value	Remarks	CSV format version
MISMATCH NOTICE DATA	Return value mismatch - Notification data	TAG{01 to 64}- {0001 to 1024}	Device tag	Use when "Notify the exception occurrence" is enabled.	1
		LOCAL{0001 to 1024}	Local variable		
		GLOBAL{0001 to 4096}	Global variable		
		S_SERVER_STAT US{01 to 16}	Connection status of the target server		
		S_DEVICE_STATU S{01 to 16}	Connection status of the target device		
		S_MATRIXLED_DI SP	Dot matrix LED display		
		S_MATRIXLED_M ODE	Dot matrix LED display mode		
		[DATESTRING]{0 to 64 characters}	Date and time character string		
		[INT]{Integer}	Constant (Integer)		
		[REAL]{Real number}	Constant (Real number)		
		[STRING]{0 to 255 characters}	Constant (Character string [Unicode])		

Diagnose information file

A diagnose information file is stored in the following folder.

However, the files which include the information of error history and operating history are not stored in the folder.

Folder/file configuration

- Detailed log

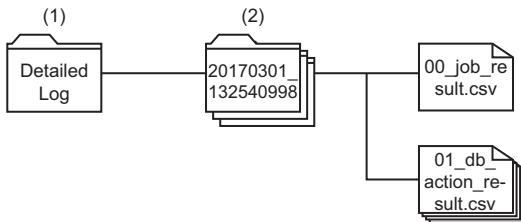

- Error history

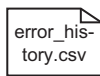

- Working history



- Failure history

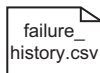

Folder type	Folder name	File name*1	Description
(1) User-specified folder	{User-specified folder name}	—	A folder where a detailed log folder is stored.
(2) Detailed log folder	{Year/month/day}_{Time}*2*3	00_job_result.csv	Job execution result in the detailed log
		nn_db_action_result.csv*4	Action execution result in the detailed log (DB communication action)
		nn_op_action_result.csv*4	Action execution result in the detailed log (operation action)
		nn_ex_action_result.csv*4	Action execution result in the detailed log (external communication action)
—	—	{User-specified name}.csv	Error history
—	—	{User-specified name}.csv	Working history
—	—	{User-specified name}.csv	Failure history

*1 A file name is not case sensitive.

*2 The folder name indicates the date and time when the trigger condition is satisfied.

*3 When folder names are overlapped, a sequential number is added to the end of the folder name.
Example: 20170301_132540998_2

*4 nn: Action number of job execution result



Format

■Format specification

Item name	Description	
Delimiter	Comma (,)	
Character code	UTF-8 (with BOM)	
Line feed code	CRLF (0x0D, 0x0A)	
Upper-case/lower-case characters	Case sensitive	
Special characters	Line feed	When a line feed is included in data, the line feed is converted to a space.
	Comma	When a comma (,) is included in data, the whole data is enclosed with double quotes ("").
	Double quotation	A double quote (") in a setting value is expressed with double double quotes (""), and the whole setting value is enclosed with double quotes (").

■Description of format

	(1)	(2)			
	[Job Name]	Job01	...		
	[Time at Trigger ON]	2017/03/01 10:03:55.386	...		
	[Excution Rusult]	Processing Failure	...		
(3)	[No.]	[Processing Type]	[Action Type]	...	[Execution Result]
(4)	1	Pre-Processing	Operation Action	...	Normal
	2	Main-Processing	DB Communication Action	...	Exception (Normal)
	3	Post-Processing	External Communication Action	...	Error

Component	Description	
Fixed items	—	The items are output only once at the head of a file.
	(1) Item column	Indicates the names of fixed items.
	(2) Data column	Indicates the data of fixed items.
Repeated items	—	The cells are output repeatedly under the fixed items.
	(3) Title row	The row indicates the names of repeated items.
	(4) Data rows	The rows indicate the data of repeated items.

Details of files

■Error history

- Fixed items

There is no fixed items for error history.

- Repeated items



Item name	Output content	Remarks
No.	A number is output.	—
Occurrence	The occurrence date and time are output.	
Operation	An operation is output.	
Error code	An error code is output.	
Summary	A summary is output.	
Detailed information 1	Detailed information 1 is output.	A line feed is replaced with a space.
Detailed information 2	Detailed information 2 is output.	
Detailed information 3	Detailed information 3 is output.	
Cause	An error cause is output.	
Corrective action	Corrective actions are output.	

■Working history

- Fixed items

There is no fixed items for error history.

- Repeated items

Item name	Output content	Remarks
Status	The icon type of working history is displayed. <ul style="list-style-type: none"> • None: No icon. • Warning:  • Error:  	—
Date and time	Date and time are output.	
Job name	The executed job name is output.	
Description	The operation of a job or the operation for a module is output.	
Comment	The comment set in the job settings is output.	

■Failure history

- Fixed items

There is no fixed items for failure history.

- Repeated items

Item name	Output content	Remarks
Date and time	Date and time are output.	—
Job name	A job name is output.	
Action No.	An action number is output.	
Detail type	A detail type is output.	
Target server	An access target server is output.	
Access table/procedure	An access table or access procedure is output.	
Execution SQL statements/execution procedure	An execution SQL statement or execution procedure is output.	
Database error number	A database error number is output.	
Database error factor message	A database error factor message is output.	

■ Job execution result

- Fixed items

Item name	Output content	Remarks
Job name	A job name is output.	—
Time at trigger ON	The date and time when trigger condition is satisfied are output.	
Execution result	The execution result of a job is output.	

- Repeated items

Item name	Output content	Remarks
No.	An action number is output.	—
Processing type	A processing type is output.	
Action type	An action type is output.	
Detail type	A detail type is output.	
Target server	An access target server is output.	
Access table/procedure	An access table or access procedure is output.	
Execution result	The execution result of an action is output.	

■ Action execution result (DB communication action)

- Fixed items

Item name	Output content	Remarks
Execution result	The execution result of an action is output.	—
Exception	The exception at action execution is output.	
No. of Required Records	The number of required records is output.	A value is output when the DB communication type is "Multiple Select". Other than that, "-" is output.
No. of Applicable Records	The number of applicable records is output.	A value is output when the DB communication type is "Select" or "Multiple Select". Other than that, "-" is output.
No. of Selected Records	The number of selected records is output.	
No. of Inserted Records	The number of inserted records is output.	A value is output only when selecting "Insert" or "Multiple Insert" for "DB Communication Type"; otherwise, "-" is output.
No. of Updated Records	The number of updated records is output.	A value is output when the DB communication type is "Update". Other than that, "-" is output.
No. of Deleted Records	The number of deleted records is output.	A value is output when the DB communication type is "Delete". Other than that, "-" is output.
Execution SQL statements/execution procedure	An execution SQL statement or execution procedure is output.	—
Database error number	A database error number is output.	
Database error factor message	A database error factor message is output.	

- Repeated items

Item name	Output content	Remarks
No.	A data assignment number is output.	—
Access field/procedure argument	An access field or access procedure argument is output.	
(Data type)	An access field or procedure argument is output.	
↔	A data assignment direction is output.	
Substitute value	A substitute value is output.	
Assignment data	Assignment data is output.	
(Data type)	The data type of assignment data is output.	

■ Action execution result (operation action)

- Fixed items

Item name	Output content	Remarks
Execution result	The execution result of an action is output.	—

- Repeated items

Item name	Output content	Remarks
No.	A calculation number is output.	—
Substitution item	A substitution item is output.	
(Data type)	The data type of a substitution item is output.	
Operator	An operator is output.	
First item	The first item is output.	
(Data type)	The data type of the first item is output.	
Second item	The second item is output.	
(Data type)	The data type of the second item is output.	
Array size	The number of substituted arrays is output.	

■ Action execution result (External communication action)

- Fixed items

Item name	Output content	Remarks
Execution result	The execution result of an action is output.	—
Exception	The exception at action execution is output.	
Return value	A return value is output.	
Expected value	An expected value is output.	
Execution command	An execution command is output.	

- Repeated items

There is no repeated items for action execution results (external communication actions).

Appendix 7 Data Collection Method for CPU Modules that cannot be Accessed Directly

This section explains the method for collecting data from CPU modules that cannot be accessed directly (hereafter, explained with the motion CPU).

Performing refresh by using CPU buffer in a multiple CPU system

By performing refresh between the RCPU and motion CPU in the multiple CPU system, device data in the motion CPU can be read to the RCPU.

Device data in the motion CPU can be handled by adding the device data read to the RCPU to the device tag setting.

Settings required for auto refresh

Set the number of points sent by each CPU module and a device to store data in the "Refresh Setting between Multiple CPUs" of the engineering tool.

🔗 'Parameter' ⇒ "(CPU module)" ⇒ "CPU Parameter" ⇒ "Refresh Setting between Multiple CPUs" on the Navigation window

For the refresh setting, refer to the following:

📖 MELSEC iQ-R CPU Module User's Manual (Application)

Acquisition example of device data in the motion CPU

■ System configuration

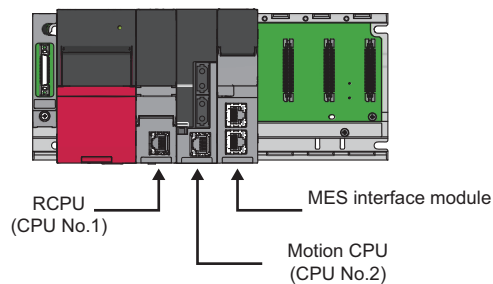

■ Refresh setting for the RCPU (CPU No.1)

Set a device and the number of send points on the RCPU to store data in the CPU buffer memory in "Refresh Setting (At the END)" of the RCPU.

Ex.

CPU buffer memory → D256 to D511 of RCPU (256 points)

Setting No.	Points	Device	
		Start	End
□ No. 1 (Send)			
□ No. 2 (Receive)			
□ Total	256/522240 Points		
1	256	D256	
2			D511
3			

Refresh setting for the motion CPU (CPU No.2)

Set a device to be stored in the CPU buffer memory and the number of send points in "Refresh (END) Setting" of the motion CPU.

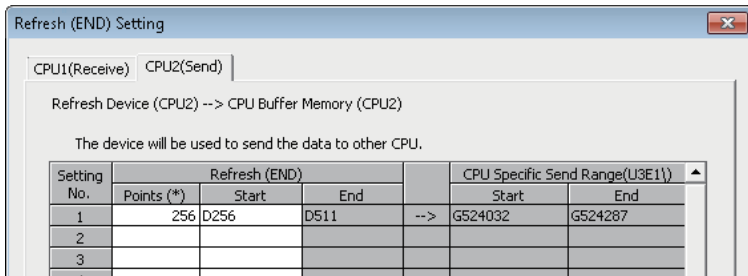

Device tag setting in MES interface module

Register the RCP (CPU No. 1) devices (devices set for refreshing) in the device tag.

Ex.

Register D256 to D511 of RCP (CPU No.1) in Tag01

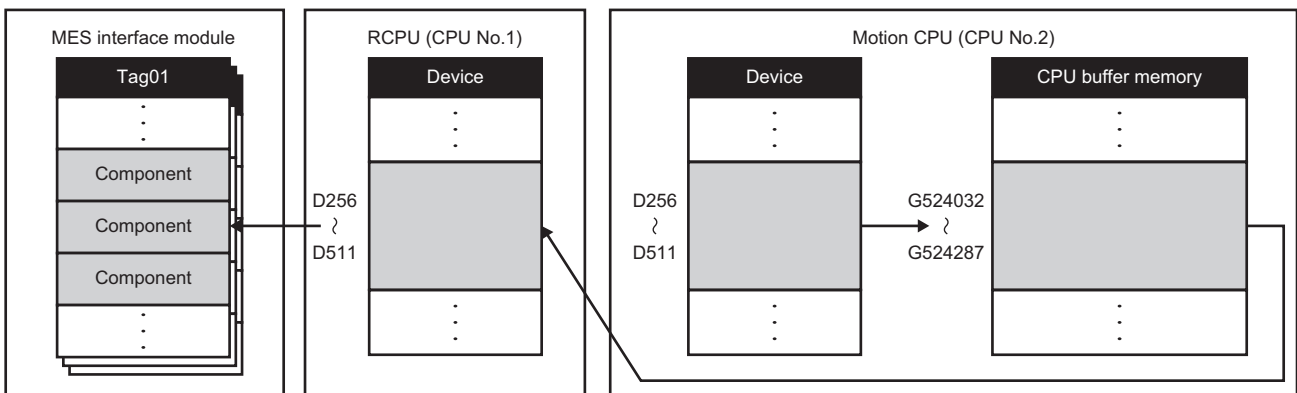

Appendix 8 Warning Messages in Windows

Overview of warning messages

When using an operating system with the user account control function, a warning message appears if performing the following as an administrator.

- Installation/uninstallation of MX MESInterface-R
- Starting DB Connection Service Setting Tool

Methods for disabling warning messages

This sections explains the methods to disable warning messages.

The following two methods are available for preventing warning messages.

- Disabling the user account control function
- Method for permitting programs without any warning message

Precautions

The user account control (UAC) is provided to protect the system from being destroyed (e.g. prevention of start-up of a program which will execute an unintended operation).

Before taking either of the methods described below, understand that the security function offered by UAC will be disabled and consider the risk.

Disabling the user account control function

The following shows the procedure for disabling the user account control function.

1. Select [System and Security] ⇒ [Change User Account Control settings] in the control panel of Windows.
2. Set the slide bar "Never notify" and click the [OK] button.

Method for permitting programs without any warning message

The following shows the procedure for permitting programs without any warning message.

1. Select [System and Security] ⇒ [Administrative Tools] ⇒ [Local Security Policy]^{*1} in the control panel of Windows.
2. Select [Local Policies] ⇒ [Security Options] ⇒ [User Account Control: Behavior of the elevation prompt for administrators in Admin Approval Mode] in the "Local Security Policy" screen.
3. Select "Elevate without prompting" in the [Local Security Setting] tab, and click the [OK] button.

*1 When the user account control is enabled, the "User Account Control" screen appears. Click the [Continue] or [Yes] button.

Appendix 9 Considerations When Handling "(Blank)" DB Fields

This section shows the considerations for handling a DB field for which "(Blank)" was set.

Inserting "(Blank)" or updating data to "(Blank)"

The method to specify "(Blank)" for assignment data, and a value that is to be stored to the database after "(Blank)" is inserted or data is updated to "(Blank)" are as follows.

Data type of DB field	Method to specify "(Blank)" for assignment data	Value to be stored to a database					
		Oracle	SQL Server	Access	MySQL	PostgreSQL	MariaDB
Character string	Set a device tag component whose value is '0'	NULL	Blank character	Blank character	Blank character	Blank character	Blank character
	No settings	NULL	NULL ^{*1}	NULL ^{*1}	NULL ^{*1}	NULL ^{*1}	NULL ^{*1}
Numerical value, date and time	No settings	NULL ^{*1}	NULL ^{*1}	NULL ^{*1}	NULL ^{*1}	NULL ^{*1}	NULL ^{*1}

*1 It cannot be specified for a narrow-down condition of SELECT, UPDATE, DELETE, and Multi-SELECT.

Setting "(Blank)" for a narrow-down condition of SELECT, UPDATE, DELETE, and Multi-SELECT

The method to specify "(Blank)" for a comparison target as a narrow-down condition, and a value to be specified for an SQL statement are as follows.

Data type of DB field	Method to specify "(Blank)" for a comparison target as a narrow-down condition	SQL statement (comparison condition is '=')					
		Oracle	SQL Server	Access	MySQL	PostgreSQL	MariaDB
Character string	Set a device tag component whose value is '0'	IS NULL	= N"	= N"	= N"	= N"	= N"
	Select [Constant] ⇨ [Character String (Unicode)] instead of setting a value.						
Numerical value, date and time	Not available	—	—	—	—	—	—



Appendix 10 Replacing an RD81MES96 with an RD81MES96N

This section shows the procedures for replacing an RD81MES96 with an RD81MES96N.

Replacement procedure

The following shows the replacement procedure for an RD81MES96N.

Operating procedure

1. Open a project file of the control CPU of an RD81MES96 in an engineering tool.
If a project file of the control CPU is not saved, read it in the engineering tool.
2. Double-click "Parameter" ⇨ "System Parameter" in the Navigation window.
3. Select "I/O Assignment Setting" in the [I/O Assignment] tab.
4. Click the [...] button.

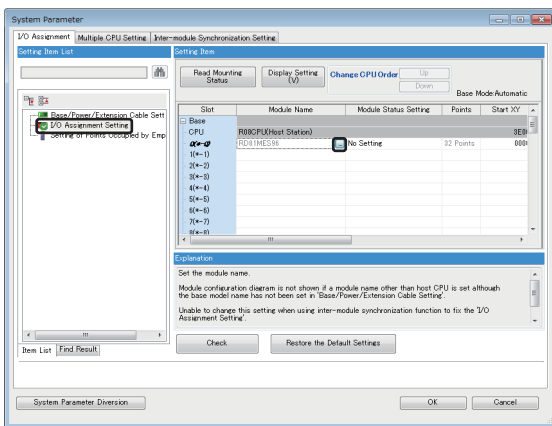

5. Select "RD81MES96N" for "Module Name," and click the [OK] button.

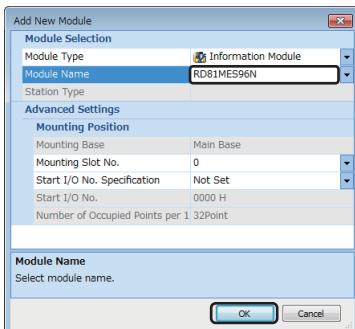

6. Click the [Yes] button.

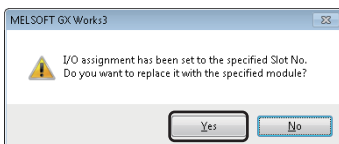

7. Click the [OK] button.

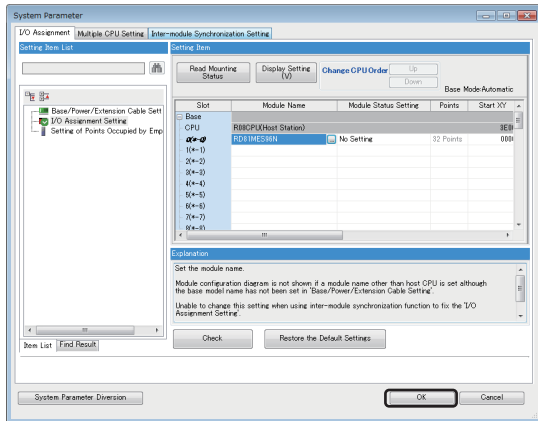

8. Double-click "Parameter" ⇒ "Module Information" ⇒ "RD81MES96N" in the Navigation window.

9. Select "Basic Settings", and set each setting item same as one set for "RD81MES96".

10. Select "Refresh Setting", and set each setting item same as one set for "RD81MES96".

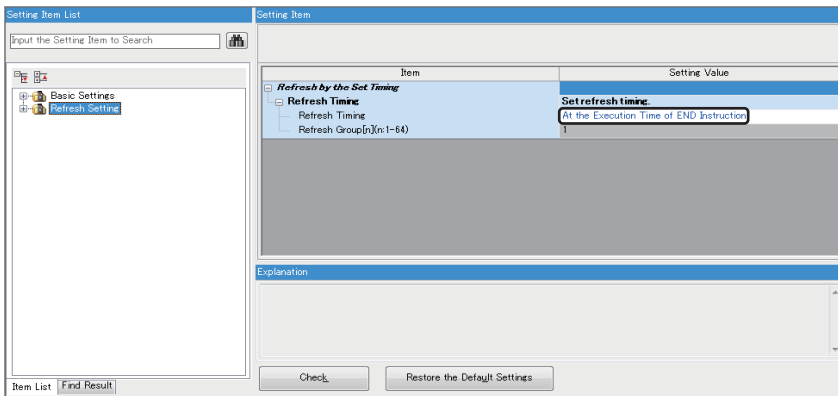

11. Double-click "Parameter" ⇒ "Module Information" in the Navigation window, and right-click "Unset: RD81MES96" then select [Delete Data].

12. Write the settings to the control CPU in the engineering tool after setting the parameters.

[Online] ⇒ [Write to PLC]

13. Open a project file of an RD81MES96 in MES Interface Function Configuration Tool.

If a project file of an RD81MES96 is not saved, read it in MES Interface Function Configuration Tool.

14. Write the project file to the RD81MES96N in MES Interface Function Configuration Tool.

15. Perform either of the following operations:

- Turn the power of the programmable controller OFF and ON.
- Reset the CPU module.



Replacement procedure when a failure occurs in an RD81MES96

The following shows the procedure for replacing an RD81MES96 with an RD81MES96N when a failure occurs.

Operating procedure

1. Open a project file of the control CPU of an RD81MES96 in an engineering tool.
If a project file of the control CPU is not saved, read it in the engineering tool.
2. Double-click "Parameter" ⇨ "System Parameter" in the Navigation window.
3. Select "I/O Assignment Setting" in the [I/O Assignment] tab.
4. Click the [...] button.

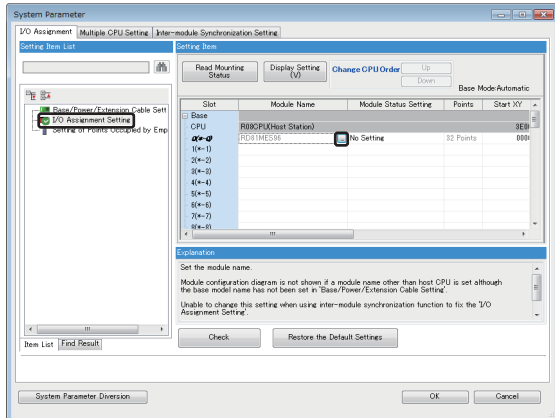

5. Select "RD81MES96N" for "Module Name," and click the [OK] button.

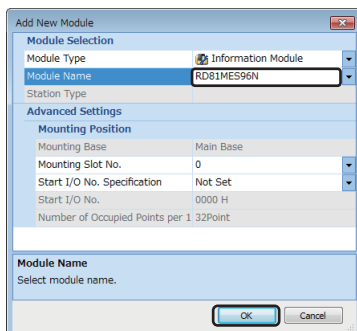

6. Click the [Yes] button.

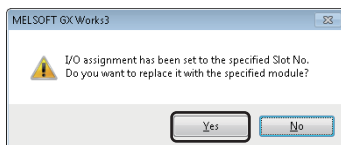

7. Click the [OK] button.

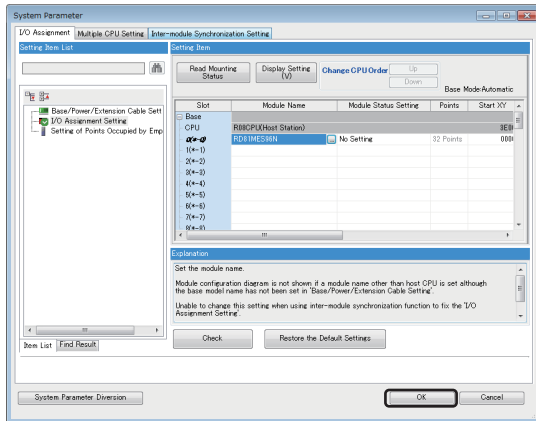

8. Double-click "Parameter" ⇒ "Module Information" ⇒ "RD81MES96N" in the Navigation window.

9. Select "Basic Settings", and set each setting item same as one set for "RD81MES96".

10. Select "Refresh Setting", and set each setting item same as one set for "RD81MES96".

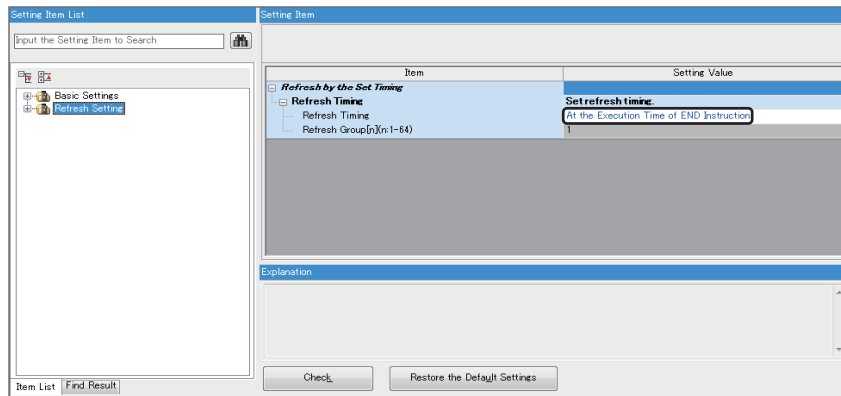

11. Double-click "Parameter" ⇒ "Module Information" in the Navigation window, and right-click "Unset: RD81MES96" then select [Delete Data].

12. Write the settings to the control CPU in the engineering tool after setting the parameters.

[Online] ⇒ [Write to PLC]

13. Turn the power of the control CPU OFF.

14. Remove the SD memory card from the RD81MES96.

15. Remove the RD81MES96 from the base unit, and mount an RD81MES96N.

16. Insert the SD memory card removed in step 14 into the RD81MES96N.

17. Turn the power of the control CPU ON.



Considerations

For RD81MES96N settings, use any of the following versions of MES Interface Function Configuration Tool and an engineering tool.

- MES Interface Function Configuration Tool stored in MX MESInterface-R with version '1.10L' or later
- GX Works3 with version '1.060N' or later

Appendix 11 Software Licenses

This section describes the licenses for software used for an RD81MES96N.

Microsoft JDBC Driver 7.2 for SQL Server

MICROSOFT SOFTWARE LICENSE TERMS

MICROSOFT JDBC DRIVER 7.2 FOR SQL SERVER

These license terms are an agreement between Microsoft Corporation (or based on where you live, one of its affiliates) and you. Please read them. They apply to the software named above, which includes the media on which you received it, if any. The terms also apply to any Microsoft

- updates,
- supplements,
- Internet-based services, and
- support services

for this software, unless other terms accompany those items. If so, those terms apply.

BY USING THE SOFTWARE, YOU ACCEPT THESE TERMS. IF YOU DO NOT ACCEPT THEM, DO NOT USE THE SOFTWARE.

If you comply with these license terms, you have the rights below.

1. INSTALLATION AND USE RIGHTS.

a. Installation and Use.

i. You may install and use any number of copies of the software on your devices.

b. Third Party Programs. The software may include third party programs that Microsoft, not the third party, licenses to you under this agreement. Notices, if any, for the third party program are included for your information only.

2. ADDITIONAL LICENSING REQUIREMENTS AND/OR USE RIGHTS.

a. Distributable Code.

i. Right to Use and Distribute. You are permitted to distribute the software in programs you develop if you comply with the terms below:

* You may copy and distribute the object code form of the software ("Distributable Code") in programs you develop. You may not modify the software.

* You may permit distributors of your programs to copy and distribute the Distributable Code as part of those programs.

ii. Distribution Requirements. For any Distributable Code you distribute, you must

* add significant primary functionality to it in your programs;

* require distributors and external end users to agree to terms that protect it at least as much as this agreement;

* display your valid copyright notice on your programs; and

* indemnify, defend, and hold harmless Microsoft from any claims, including attorneys' fees, related to the distribution or use of your programs.

iii. Distribution Restrictions. You may not

* alter any copyright, trademark or patent notice in the Distributable Code;

* use Microsoft's trademarks in your programs' names or in a way that suggests your programs come from or are endorsed by Microsoft;

* include Distributable Code in malicious, deceptive or unlawful programs; or

* modify or distribute the source code of any Distributable Code so that any part of it becomes subject to an Excluded License. An Excluded License is one that requires, as a condition of use, modification or distribution, that

* the code be disclosed or distributed in source code form; or

* others have the right to modify it.

3. SCOPE OF LICENSE. The software is licensed, not sold. This agreement only gives you some rights to use the software. Microsoft reserves all other rights. Unless applicable law gives you more rights despite this limitation, you may use the software only as expressly permitted in this agreement. In doing so, you must comply with any technical limitations in the software that only allow you to use it in certain ways. You may not

- work around any technical limitations in the software;
- reverse engineer, decompile or disassemble the software, except and only to the extent that applicable law expressly permits, despite this limitation;
- make more copies of the software than specified in this agreement or allowed by applicable law, despite this limitation;
- publish the software for others to copy;
- rent, lease or lend the software;
- transfer the software or this agreement to any third party; or
- use the software for commercial software hosting services.

4. EXPORT RESTRICTIONS. The software is subject to United States export laws and regulations. You must comply with all domestic and international export laws and regulations that apply to the software. These laws include restrictions on destinations, end users and end use. For additional information, see www.microsoft.com/exporting.

5. SUPPORT SERVICES. Because this software is "as is," we may not provide support services for it.

6. ENTIRE AGREEMENT. This agreement, and the terms for supplements, updates, Internet-based services and support services that you use, are the entire agreement for the software and support services.

7. APPLICABLE LAW.

a. United States. If you acquired the software in the United States, Washington state law governs the interpretation of this agreement and applies to claims for breach of it, regardless of conflict of laws principles. The laws of the state where you live govern all other claims, including claims under state consumer protection laws, unfair competition laws, and in tort.

b. Outside the United States. If you acquired the software in any other country, the laws of that country apply.

8. LEGAL EFFECT. This agreement describes certain legal rights. You may have other rights under the laws of your country. You may also have rights with respect to the party from whom you acquired the software. This agreement does not change your rights under the laws of your country if the laws of your country do not permit it to do so.

9. DISCLAIMER OF WARRANTY. THE SOFTWARE IS LICENSED "AS-IS." YOU BEAR THE RISK OF USING IT. MICROSOFT GIVES NO EXPRESS WARRANTIES, GUARANTEES OR CONDITIONS. YOU MAY HAVE ADDITIONAL CONSUMER RIGHTS UNDER YOUR LOCAL LAWS WHICH THIS AGREEMENT CANNOT CHANGE. TO THE EXTENT PERMITTED UNDER YOUR LOCAL LAWS, MICROSOFT EXCLUDES THE IMPLIED WARRANTIES OF MERCHANTABILITY, FITNESS FOR A PARTICULAR PURPOSE AND NON-INFRINGEMENT.

10. LIMITATION ON AND EXCLUSION OF REMEDIES AND DAMAGES. YOU CAN RECOVER FROM MICROSOFT AND ITS SUPPLIERS ONLY DIRECT DAMAGES UP TO U.S. \$5.00. YOU CANNOT RECOVER ANY OTHER DAMAGES, INCLUDING CONSEQUENTIAL, LOST PROFITS, SPECIAL, INDIRECT OR INCIDENTAL DAMAGES.

This limitation applies to

- anything related to the software, services, content (including code) on third party Internet sites, or third party programs, and
- claims for breach of contract, breach of warranty, guarantee or condition, strict liability, negligence, or other tort to the extent permitted by applicable law.

It also applies even if Microsoft knew or should have known about the possibility of the damages. The above limitation or exclusion may not apply to you because your country may not allow the exclusion or limitation of incidental, consequential or other damages.

Please note: As this software is distributed in Quebec, Canada, some of the clauses in this agreement are provided below in French.

Remarque : Ce logiciel étant distribué au Québec, Canada, certaines des clauses dans ce contrat sont fournies ci-dessous en français.

EXONÉRATION DE GARANTIE. Le logiciel visé par une licence est offert « tel quel ». Toute utilisation de ce logiciel est à votre seule risque et péril. Microsoft n'accorde aucune autre garantie expresse. Vous pouvez bénéficier de droits additionnels en vertu du droit local sur la protection des consommateurs, que ce contrat ne peut modifier. La ou elles sont permises par le droit locale, les garanties implicites de qualité marchande, d'adéquation à un usage particulier et d'absence de contrefaçon sont exclues.

LIMITATION DES DOMMAGES-INTÉRÊTS ET EXCLUSION DE RESPONSABILITÉ POUR LES DOMMAGES. Vous pouvez obtenir de Microsoft et de ses fournisseurs une indemnisation en cas de dommages directs uniquement à hauteur de 5,00 \$ US. Vous ne pouvez prétendre à aucune indemnisation pour les autres dommages, y compris les dommages spéciaux, indirects ou accessoires et pertes de bénéfices.

Cette limitation concerne :

- tout ce qui est relié au logiciel, aux services ou au contenu (y compris le code) figurant sur des sites Internet tiers ou dans des programmes tiers ; et
- les réclamations au titre de violation de contrat ou de garantie, ou au titre de responsabilité stricte, de négligence ou d'une autre faute dans la limite autorisée par la loi en vigueur.

Elle s'applique également, même si Microsoft connaissait ou devrait connaître l'éventualité d'un tel dommage. Si votre pays n'autorise pas l'exclusion ou la limitation de responsabilité pour les dommages indirects, accessoires ou de quelque nature que ce soit, il se peut que la limitation ou l'exclusion ci-dessus ne s'appliquera pas à votre égard.

EFFET JURIDIQUE. Le présent contrat décrit certains droits juridiques. Vous pourriez avoir d'autres droits prévus par les lois de votre pays. Le présent contrat ne modifie pas les droits que vous confèrent les lois de votre pays si celles-ci ne le permettent pas.

MariaDB Connector/J

GNU LESSER GENERAL PUBLIC LICENSE

Version 2.1, February 1999

Copyright (C) 1991, 1999 Free Software Foundation, Inc.
51 Franklin Street, Fifth Floor, Boston, MA 02110-1301 USA
Everyone is permitted to copy and distribute verbatim copies
of this license document, but changing it is not allowed.

[This is the first released version of the Lesser GPL. It also counts
as the successor of the GNU Library Public License, version 2, hence
the version number 2.1.]

Preamble

The licenses for most software are designed to take away your freedom to share and change it. By contrast, the GNU General Public Licenses are intended to guarantee your freedom to share and change free software--to make sure the software is free for all its users.

This license, the Lesser General Public License, applies to some specially designated software packages--typically libraries--of the Free Software Foundation and other authors who decide to use it. You can use it too, but we suggest you first think carefully about whether this license or the ordinary General Public License is the better strategy to use in any particular case, based on the explanations below.

When we speak of free software, we are referring to freedom of use, not price. Our General Public Licenses are designed to make sure that you have the freedom to distribute copies of free software (and charge for this service if you wish); that you receive source code or can get it if you want it; that you can change the software and use pieces of it in new free programs; and that you are informed that you can do these things.

To protect your rights, we need to make restrictions that forbid distributors to deny you these rights or to ask you to surrender these rights. These restrictions translate to certain responsibilities for you if you distribute copies of the library or if you modify it.

For example, if you distribute copies of the library, whether gratis or for a fee, you must give the recipients all the rights that we gave you. You must make sure that they, too, receive or can get the source code. If you link other code with the library, you must provide complete object files to the recipients, so that they can relink them with the library after making changes to the library and recompiling it. And you must show them these terms so they know their rights.

We protect your rights with a two-step method: (1) we copyright the library, and (2) we offer you this license, which gives you legal permission to copy, distribute and/or modify the library.

To protect each distributor, we want to make it very clear that there is no warranty for the free library. Also, if the library is modified by someone else and passed on, the recipients should know that what they have is not the original version, so that the original author's reputation will not be affected by problems that might be introduced by others.

Finally, software patents pose a constant threat to the existence of any free program. We wish to make sure that a company cannot effectively restrict the users of a free program by obtaining a restrictive license from a patent holder. Therefore, we insist that any patent license obtained for a version of the library must be consistent with the full freedom of use specified in this license.

Most GNU software, including some libraries, is covered by the ordinary GNU General Public License. This license, the GNU Lesser General Public License, applies to certain designated libraries, and is quite different from the ordinary General Public License. We use this license for certain libraries in order to permit linking those libraries into non-free programs.

When a program is linked with a library, whether statically or using a shared library, the combination of the two is legally speaking a combined work, a derivative of the original library. The ordinary General Public License therefore permits such linking only if the entire combination fits its criteria of freedom. The Lesser General Public License permits more lax criteria for linking other code with the library.

We call this license the "Lesser" General Public License because it does Less to protect the user's freedom than the ordinary General Public License. It also provides other free software developers Less of an advantage over competing non-free programs. These disadvantages are the reason we use the ordinary General Public License for many libraries. However, the Lesser license provides advantages in certain special circumstances.

For example, on rare occasions, there may be a special need to encourage the widest possible use of a certain library, so that it becomes a de-facto standard. To achieve this, non-free programs must be allowed to use the library. A more frequent case is that a free library does the same job as widely used non-free libraries. In this case, there is little to gain by limiting the free library to free software only, so we use the Lesser General Public License.

In other cases, permission to use a particular library in non-free programs enables a greater number of people to use a large body of free software. For example, permission to use the GNU C Library in non-free programs enables many more people to use the whole GNU operating system, as well as its variant, the GNU/Linux operating system.

Although the Lesser General Public License is Less protective of the users' freedom, it does ensure that the user of a program that is linked with the Library has the freedom and the wherewithal to run that program using a modified version of the Library.

The precise terms and conditions for copying, distribution and modification follow. Pay close attention to the difference between a "work based on the library" and a "work that uses the library". The former contains code derived from the library, whereas the latter must be combined with the library in order to run.

TERMS AND CONDITIONS FOR COPYING, DISTRIBUTION AND MODIFICATION

0. This License Agreement applies to any software library or other program which contains a notice placed by the copyright holder or other authorized party saying it may be distributed under the terms of this Lesser General Public License (also called "this License"). Each licensee is addressed as "you".

A "library" means a collection of software functions and/or data prepared so as to be conveniently linked with application programs (which use some of those functions and data) to form executables.

The "Library", below, refers to any such software library or work which has been distributed under these terms. A "work based on the Library" means either the Library or any derivative work under copyright law: that is to say, a work containing the Library or a portion of it, either verbatim or with modifications and/or translated straightforwardly into another language. (Hereinafter, translation is included without limitation in the term "modification".)

"Source code" for a work means the preferred form of the work for making modifications to it. For a library, complete source code means all the source code for all modules it contains, plus any associated interface definition files, plus the scripts used to control compilation and installation of the library.

Activities other than copying, distribution and modification are not covered by this License; they are outside its scope. The act of running a program using the Library is not restricted, and output from such a program is covered only if its contents constitute a work based on the Library (independent of the use of the Library in a tool for writing it). Whether that is true depends on what the Library does and what the program that uses the Library does.

1. You may copy and distribute verbatim copies of the Library's complete source code as you receive it, in any medium, provided that you conspicuously and appropriately publish on each copy an appropriate copyright notice and disclaimer of warranty; keep intact all the notices that refer to this License and to the absence of any warranty; and distribute a copy of this License along with the Library.

You may charge a fee for the physical act of transferring a copy, and you may at your option offer warranty protection in exchange for a fee.

2. You may modify your copy or copies of the Library or any portion of it, thus forming a work based on the Library, and copy and distribute such modifications or work under the terms of Section 1 above, provided that you also meet all of these conditions:

- a) The modified work must itself be a software library.
- b) You must cause the files modified to carry prominent notices stating that you changed the files and the date of any change.
- c) You must cause the whole of the work to be licensed at no charge to all third parties under the terms of this License.
- d) If a facility in the modified Library refers to a function or a table of data to be supplied by an application program that uses the facility, other than as an argument passed when the facility is invoked, then you must make a good faith effort to ensure that, in the event an application does not supply such function or table, the facility still operates, and performs whatever part of its purpose remains meaningful.

(For example, a function in a library to compute square roots has a purpose that is entirely well-defined independent of the application. Therefore, Subsection 2d requires that any application-supplied function or table used by this function must be optional: if the application does not supply it, the square root function must still compute square roots.)

These requirements apply to the modified work as a whole. If identifiable sections of that work are not derived from the Library, and can be reasonably considered independent and separate works in themselves, then this License, and its terms, do not apply to those sections when you distribute them as separate works. But when you distribute the same sections as part of a whole which is a work based on the Library, the distribution of the whole must be on the terms of this License, whose permissions for other licensees extend to the entire whole, and thus to each and every part regardless of who wrote it.

Thus, it is not the intent of this section to claim rights or contest your rights to work written entirely by you; rather, the intent is to exercise the right to control the distribution of derivative or collective works based on the Library.

In addition, mere aggregation of another work not based on the Library with the Library (or with a work based on the Library) on a volume of a storage or distribution medium does not bring the other work under the scope of this License.

3. You may opt to apply the terms of the ordinary GNU General Public License instead of this License to a given copy of the Library. To do this, you must alter all the notices that refer to this License, so that they refer to the ordinary GNU General Public License, version 2, instead of to this License. (If a newer version than version 2 of the ordinary GNU General Public License has appeared, then you can specify that version instead if you wish.) Do not make any other change in these notices.

Once this change is made in a given copy, it is irreversible for that copy, so the ordinary GNU General Public License applies to all subsequent copies and derivative works made from that copy.

This option is useful when you wish to copy part of the code of the Library into a program that is not a library.

4. You may copy and distribute the Library (or a portion or derivative of it, under Section 2) in object code or executable form under the terms of Sections 1 and 2 above provided that you accompany it with the complete corresponding machine-readable source code, which must be distributed under the terms of Sections 1 and 2 above on a medium customarily used for software interchange.

If distribution of object code is made by offering access to copy from a designated place, then offering equivalent access to copy the source code from the same place satisfies the requirement to distribute the source code, even though third parties are not compelled to copy the source along with the object code.

5. A program that contains no derivative of any portion of the Library, but is designed to work with the Library by being compiled or linked with it, is called a "work that uses the Library". Such a work, in isolation, is not a derivative work of the Library, and therefore falls outside the scope of this License.

However, linking a "work that uses the Library" with the Library creates an executable that is a derivative of the Library (because it contains portions of the Library), rather than a "work that uses the library". The executable is therefore covered by this License. Section 6 states terms for distribution of such executables.

When a "work that uses the Library" uses material from a header file that is part of the Library, the object code for the work may be a derivative work of the Library even though the source code is not. Whether this is true is especially significant if the work can be linked without the Library, or if the work is itself a library. The threshold for this to be true is not precisely defined by law.

If such an object file uses only numerical parameters, data structure layouts and accessors, and small macros and small inline functions (ten lines or less in length), then the use of the object file is unrestricted, regardless of whether it is legally a derivative work. (Executables containing this object code plus portions of the Library will still fall under Section 6.)

Otherwise, if the work is a derivative of the Library, you may distribute the object code for the work under the terms of Section 6. Any executables containing that work also fall under Section 6, whether or not they are linked directly with the Library itself.

6. As an exception to the Sections above, you may also combine or link a "work that uses the Library" with the Library to produce a work containing portions of the Library, and distribute that work under terms of your choice, provided that the terms permit modification of the work for the customer's own use and reverse engineering for debugging such modifications.

You must give prominent notice with each copy of the work that the Library is used in it and that the Library and its use are covered by this License. You must supply a copy of this License. If the work during execution displays copyright notices, you must include the copyright notice for the Library among them, as well as a reference directing the user to the copy of this License. Also, you must do one of these things:

- a) Accompany the work with the complete corresponding machine-readable source code for the Library including whatever changes were used in the work (which must be distributed under Sections 1 and 2 above); and, if the work is an executable linked with the Library, with the complete machine-readable "work that uses the Library", as object code and/or source code, so that the user can modify the Library and then relink to produce a modified executable containing the modified Library. (It is understood that the user who changes the contents of definitions files in the Library will not necessarily be able to recompile the application to use the modified definitions.)
- b) Use a suitable shared library mechanism for linking with the Library. A suitable mechanism is one that (1) uses at run time a copy of the library already present on the user's computer system, rather than copying library functions into the executable, and (2) will operate properly with a modified version of the library, if the user installs one, as long as the modified version is interface-compatible with the version that the work was made with.
- c) Accompany the work with a written offer, valid for at least three years, to give the same user the materials specified in Subsection 6a, above, for a charge no more than the cost of performing this distribution.
- d) If distribution of the work is made by offering access to copy from a designated place, offer equivalent access to copy the above specified materials from the same place.
- e) Verify that the user has already received a copy of these materials or that you have already sent this user a copy.

For an executable, the required form of the "work that uses the Library" must include any data and utility programs needed for reproducing the executable from it. However, as a special exception, the materials to be distributed need not include anything that is normally distributed (in either source or binary form) with the major components (compiler, kernel, and so on) of the operating system on which the executable runs, unless that component itself accompanies the executable.

It may happen that this requirement contradicts the license restrictions of other proprietary libraries that do not normally accompany the operating system. Such a contradiction means you cannot use both them and the Library together in an executable that you distribute.

7. You may place library facilities that are a work based on the Library side-by-side in a single library together with other library facilities not covered by this License, and distribute such a combined library, provided that the separate distribution of the work based on the Library and of the other library facilities is otherwise permitted, and provided that you do these two things:

- a) Accompany the combined library with a copy of the same work based on the Library, uncombined with any other library facilities. This must be distributed under the terms of the Sections above.
- b) Give prominent notice with the combined library of the fact that part of it is a work based on the Library, and explaining where to find the accompanying uncombined form of the same work.

8. You may not copy, modify, sublicense, link with, or distribute the Library except as expressly provided under this License. Any attempt otherwise to copy, modify, sublicense, link with, or distribute the Library is void, and will automatically terminate your rights under this License. However, parties who have received copies, or rights, from you under this License will not have their licenses terminated so long as such parties remain in full compliance.

9. You are not required to accept this License, since you have not signed it. However, nothing else grants you permission to modify or distribute the Library or its derivative works. These actions are prohibited by law if you do not accept this License. Therefore, by modifying or distributing the Library (or any work based on the Library), you indicate your acceptance of this License to do so, and all its terms and conditions for copying, distributing or modifying the Library or works based on it.

10. Each time you redistribute the Library (or any work based on the Library), the recipient automatically receives a license from the original licensor to copy, distribute, link with or modify the Library subject to these terms and conditions. You may not impose any further restrictions on the recipients' exercise of the rights granted herein. You are not responsible for enforcing compliance by third parties with this License.

11. If, as a consequence of a court judgment or allegation of patent infringement or for any other reason (not limited to patent issues), conditions are imposed on you (whether by court order, agreement or otherwise) that contradict the conditions of this License, they do not excuse you from the conditions of this License. If you cannot distribute so as to satisfy simultaneously your obligations under this License and any other pertinent obligations, then as a consequence you may not distribute the Library at all. For example, if a patent license would not permit royalty-free redistribution of the Library by all those who receive copies directly or indirectly through you, then the only way you could satisfy both it and this License would be to refrain entirely from distribution of the Library.

If any portion of this section is held invalid or unenforceable under any particular circumstance, the balance of the section is intended to apply, and the section as a whole is intended to apply in other circumstances.

It is not the purpose of this section to induce you to infringe any patents or other property right claims or to contest validity of any such claims; this section has the sole purpose of protecting the integrity of the free software distribution system which is implemented by public license practices. Many people have made generous contributions to the wide range of software distributed through that system in reliance on consistent application of that system; it is up to the author/donor to decide if he or she is willing to distribute software through any other system and a licensee cannot impose that choice.

This section is intended to make thoroughly clear what is believed to be a consequence of the rest of this License.

12. If the distribution and/or use of the Library is restricted in certain countries either by patents or by copyrighted interfaces, the original copyright holder who places the Library under this License may add an explicit geographical distribution limitation excluding those countries, so that distribution is permitted only in or among countries not thus excluded. In such case, this License incorporates the limitation as if written in the body of this License.

13. The Free Software Foundation may publish revised and/or new versions of the Lesser General Public License from time to time. Such new versions will be similar in spirit to the present version, but may differ in detail to address new problems or concerns.

Each version is given a distinguishing version number. If the Library specifies a version number of this License which applies to it and "any later version", you have the option of following the terms and conditions either of that version or of any later version published by the Free Software Foundation. If the Library does not specify a license version number, you may choose any version ever published by the Free Software Foundation.

14. If you wish to incorporate parts of the Library into other free programs whose distribution conditions are incompatible with these, write to the author to ask for permission. For software which is copyrighted by the Free Software Foundation, write to the Free Software Foundation; we sometimes make exceptions for this. Our decision will be guided by the two goals of preserving the free status of all derivatives of our free software and of promoting the sharing and reuse of software generally.

NO WARRANTY

15. BECAUSE THE LIBRARY IS LICENSED FREE OF CHARGE, THERE IS NO WARRANTY FOR THE LIBRARY, TO THE EXTENT PERMITTED BY APPLICABLE LAW. EXCEPT WHEN OTHERWISE STATED IN WRITING THE COPYRIGHT HOLDERS AND/OR OTHER PARTIES PROVIDE THE LIBRARY "AS IS" WITHOUT WARRANTY OF ANY KIND, EITHER EXPRESSED OR IMPLIED, INCLUDING, BUT NOT LIMITED TO, THE IMPLIED WARRANTIES OF MERCHANTABILITY AND FITNESS FOR A PARTICULAR PURPOSE. THE ENTIRE RISK AS TO THE QUALITY AND PERFORMANCE OF THE LIBRARY IS WITH YOU. SHOULD THE LIBRARY PROVE DEFECTIVE, YOU ASSUME THE COST OF ALL NECESSARY SERVICING, REPAIR OR CORRECTION.

16. IN NO EVENT UNLESS REQUIRED BY APPLICABLE LAW OR AGREED TO IN WRITING WILL ANY COPYRIGHT HOLDER, OR ANY OTHER PARTY WHO MAY MODIFY AND/OR REDISTRIBUTE THE LIBRARY AS PERMITTED ABOVE, BE LIABLE TO YOU FOR DAMAGES, INCLUDING ANY GENERAL, SPECIAL, INCIDENTAL OR CONSEQUENTIAL DAMAGES ARISING OUT OF THE USE OR INABILITY TO USE THE LIBRARY (INCLUDING BUT NOT LIMITED TO LOSS OF DATA OR DATA BEING RENDERED INACCURATE OR LOSSES SUSTAINED BY YOU OR THIRD PARTIES OR A FAILURE OF THE LIBRARY TO OPERATE WITH ANY OTHER SOFTWARE), EVEN IF SUCH HOLDER OR OTHER PARTY HAS BEEN ADVISED OF THE POSSIBILITY OF SUCH DAMAGES.

END OF TERMS AND CONDITIONS

How to Apply These Terms to Your New Libraries

If you develop a new library, and you want it to be of the greatest possible use to the public, we recommend making it free software that everyone can redistribute and change. You can do so by permitting redistribution under these terms (or, alternatively, under the terms of the ordinary General Public License).

To apply these terms, attach the following notices to the library. It is safest to attach them to the start of each source file to most effectively convey the exclusion of warranty; and each file should have at least the "copyright" line and a pointer to where the full notice is found.

one line to give the library's name and an idea of what it does.
Copyright (C) year name of author

This library is free software; you can redistribute it and/or modify it under the terms of the GNU Lesser General Public License as published by the Free Software Foundation; either version 2.1 of the License, or (at your option) any later version.

This library is distributed in the hope that it will be useful,
but WITHOUT ANY WARRANTY; without even the implied warranty of
MERCHANTABILITY or FITNESS FOR A PARTICULAR PURPOSE. See the GNU
Lesser General Public License for more details.

You should have received a copy of the GNU Lesser General Public
License along with this library; if not, write to the Free Software
Foundation, Inc., 51 Franklin Street, Fifth Floor, Boston, MA 02110-1301 USA

Also add information on how to contact you by electronic and paper mail.

You should also get your employer (if you work as a programmer) or your school, if any, to sign a "copyright disclaimer" for the library, if necessary. Here is a sample; alter the names:

Yoyodyne, Inc., hereby disclaims all copyright interest in
the library 'Frob' (a library for tweaking knobs) written
by James Random Hacker.

signature of Ty Coon, 1 April 1990
Ty Coon, President of Vice

That's all there is to it!

PostgreSQL JDBC Driver

Copyright (c) 1997, PostgreSQL Global Development Group
All rights reserved.

Redistribution and use in source and binary forms, with or without modification, are permitted provided that the following conditions are met:

1. Redistributions of source code must retain the above copyright notice, this list of conditions and the following disclaimer.
2. Redistributions in binary form must reproduce the above copyright notice, this list of conditions and the following disclaimer in the documentation and/or other materials provided with the distribution.

THIS SOFTWARE IS PROVIDED BY THE COPYRIGHT HOLDERS AND CONTRIBUTORS "AS IS" AND ANY EXPRESS OR IMPLIED WARRANTIES, INCLUDING, BUT NOT LIMITED TO, THE IMPLIED WARRANTIES OF MERCHANTABILITY AND FITNESS FOR A PARTICULAR PURPOSE ARE DISCLAIMED. IN NO EVENT SHALL THE COPYRIGHT OWNER OR CONTRIBUTORS BE LIABLE FOR ANY DIRECT, INDIRECT, INCIDENTAL, SPECIAL, EXEMPLARY, OR CONSEQUENTIAL DAMAGES (INCLUDING, BUT NOT LIMITED TO, PROCUREMENT OF SUBSTITUTE GOODS OR SERVICES; LOSS OF USE, DATA, OR PROFITS; OR BUSINESS INTERRUPTION) HOWEVER CAUSED AND ON ANY THEORY OF LIABILITY, WHETHER IN CONTRACT, STRICT LIABILITY, OR TORT (INCLUDING NEGLIGENCE OR OTHERWISE) ARISING IN ANY WAY OUT OF THE USE OF THIS SOFTWARE, EVEN IF ADVISED OF THE POSSIBILITY OF SUCH DAMAGE.

Oracle Database JDBC Driver

Oracle Technology Network License Agreement

Oracle is willing to authorize Your access to software associated with this License Agreement ("Agreement") only upon the condition that You accept that this Agreement governs Your use of the software. By selecting the "Accept License Agreement" button or box (or the equivalent) or installing or using the Programs You indicate Your acceptance of this Agreement and Your agreement, as an authorized representative of Your company or organization (if being acquired for use by an entity) or as an individual, to comply with the license terms that apply to the software that You wish to download and access. If You are not willing to be bound by this Agreement, do not select the "Accept License Agreement" button or box (or the equivalent) and do not download or access the software.

Definitions

"Oracle" refers to Oracle America, Inc. "You" and "Your" refers to (a) a company or organization (each an "Entity") accessing the Programs, if use of the Programs will be on behalf of such Entity; or (b) an individual accessing the Programs, if use of the Programs will not be on behalf of an Entity. "Contractors" refers to Your agents and contractors (including, without limitation, outsourcers). "Program(s)" refers to Oracle software provided by Oracle pursuant to this Agreement and any updates, error corrections, and/or Program Documentation provided by Oracle. "Program Documentation" refers to Program user manuals and Program installation manuals, if any. If available, Program Documentation may be delivered with the Programs and/or may be accessed from www.oracle.com/documentation. "Associated Product" refers to the Oracle product(s), if any, and as identified in the Programs documentation or on the Programs download site, with which the Programs are intended to enable or enhance interoperability with Your application(s). "Separate Terms" refers to separate license terms that are specified in the Program Documentation, readmes or notice files and that apply to Separately Licensed Third Party Technology. "Separately Licensed Third Party Technology" refers to third party technology that is licensed under Separate Terms and not under the terms of this Agreement.

License Rights and Restrictions

Oracle grants You a nonexclusive, nontransferable, limited license to, subject to the restrictions stated in this Agreement, (a) internally use the Programs solely for the purposes of developing, testing, prototyping and demonstrating Your applications, and running the Programs for Your own internal business operations; and (b) redistribute unmodified Programs and Programs Documentation pursuant to the Programs Redistribution section below. You may allow Your Contractor(s) to use the Programs, provided they are acting on Your behalf to exercise license rights granted in this Agreement and further provided that You are responsible for their compliance with this Agreement in such use. You will have a written agreement with Your Contractor(s) that strictly limits their right to use the Programs and that otherwise protects Oracle's intellectual property rights to the same extent as this Agreement. You may make copies of the Programs to the extent reasonably necessary to exercise the license rights granted in this Agreement. You may make one copy of the Programs for backup purposes.

Further, You may not:

- remove or modify any Program markings or any notice of Oracle's or a licensor's proprietary rights;
- use the Programs to provide third party training unless Oracle expressly authorizes such use on the Program's download page;
- assign this Agreement or distribute, give, or transfer the Programs or an interest in them to any third party, except as expressly permitted in this Agreement (the foregoing shall not be construed to limit the rights You may otherwise have with respect to Separately Licensed Third Party Technology);
- cause or permit reverse engineering (unless required by law for interoperability), disassembly or decompilation of the Programs; and
- disclose results of any Program benchmark tests without Oracle's prior consent.

The Programs may contain source code that, unless expressly licensed in this Agreement for other purposes (for example, licensed under an open source license), is provided solely for reference purposes pursuant to the terms of this Agreement and may not be modified.

All rights not expressly granted in this Agreement are reserved by Oracle. If You want to use the Programs or Your application for any purpose other than as expressly permitted under this Agreement, You must obtain from Oracle or an Oracle reseller a valid Programs license under a separate agreement permitting such use. However, You acknowledge that the Programs may not be intended for production use and/or Oracle may not make a version of the Programs available for production or other purposes; any development or other work You undertake with the Programs is at Your sole risk.

Programs Redistribution

We grant You a nonexclusive, nontransferable right to copy and distribute unmodified Programs and Programs Documentation as part of and included in Your application that is intended to interoperate with the Associated Product, if any, provided that You do not charge Your end users any additional fees for the use of the Programs. Prior to distributing the Programs and Programs Documentation, You shall require Your end users to execute an agreement binding them to terms, with respect to the Programs and Programs Documentation, materially consistent and no less restrictive than those contained in this section and the sections of this Agreement entitled "License Rights and Restrictions" (except that the redistribution right granted to You shall not be included; Your end users may not distribute Programs and Programs Documentation to any third parties), "Ownership," "Export Controls," "Disclaimer of Warranties; Limitation of Liability," "No Technical Support" (with respect to Oracle support; You may provide Your own support for Programs at Your discretion), "Audit; Termination (except that Oracle's audit right shall not be included)," "Relationship Between the Parties," and "U.S. Government End Users." You must also include a provision stating that Your end users shall have no right to distribute the Programs and Programs Documentation, and a provision specifying us as a third party beneficiary of the agreement. You are responsible for obtaining these agreements with Your end users.

You agree to: (a) defend and indemnify us against all claims and damages caused by Your distribution of the Programs and Programs Documentation in breach of this Agreement and/or failure to include the required contractual provisions in Your end user agreement as stated above; (b) keep executed end user agreements and records of end user information including name, address, date of distribution and identity of Programs distributed; (c) allow us to inspect Your end user agreements and records upon request; and, (d) enforce the terms of Your end user agreements so as to effect a timely cure of any end user breach, and to notify us of any breach of the terms.

Ownership

Oracle or its licensors retain all ownership and intellectual property rights to the Programs.

Third-Party Technology

The Programs may contain or require the use of third party technology that is provided with the Programs. Oracle may provide certain notices to You in Program Documentation, readmes or notice files in connection with such third party technology. Third party technology will be licensed to You either under the terms of this Agreement or, if specified in the Program Documentation, readmes or notice files, under Separate Terms. Your rights to use Separately Licensed Third Party Technology under Separate Terms are not restricted in any way by this Agreement. However, for clarity, notwithstanding the existence of a notice, third party technology that is not Separately Licensed Third Party Technology shall be deemed part of the Programs and is licensed to You under the terms of this Agreement.

Source Code for Open Source Software

For software that You receive from Oracle in binary form that is licensed under an open source license that gives You the right to receive the source code for that binary, You can obtain a copy of the applicable source code from <https://oss.oracle.com/sources/> or <http://www.oracle.com/goto/opensourcecode>. If the source code for such software was not provided to You with the binary, You can also receive a copy of the source code on physical media by submitting a written request pursuant to the instructions in the "Written Offer for Source Code" section of the latter website.

Export Controls

Export laws and regulations of the United States and any other relevant local export laws and regulations apply to the Programs . You agree that such export control laws govern Your use of the Programs (including technical data) and any services deliverables provided under this agreement, and You agree to comply with all such export laws and regulations (including "deemed export" and "deemed re-export" regulations). You agree that no data, information, program and/or materials resulting from Programs or services (or direct products thereof) will be exported, directly or indirectly, in violation of these laws, or will be used for any purpose prohibited by these laws including, without limitation, nuclear, chemical, or biological weapons proliferation, or development of missile technology. Accordingly, You confirm:

- You will not download, provide, make available or otherwise export or re-export the Programs, directly or indirectly, to countries prohibited by applicable laws and regulations nor to citizens, nationals or residents of those countries.
- You are not listed on the United States Department of Treasury lists of Specially Designated Nationals and Blocked Persons, Specially Designated Terrorists, and Specially Designated Narcotic Traffickers, nor are You listed on the United States Department of Commerce Table of Denial Orders.
- You will not download or otherwise export or re-export the Programs, directly or indirectly, to persons on the above mentioned lists.
- You will not use the Programs for, and will not allow the Programs to be used for, any purposes prohibited by applicable law, including, without limitation, for the development, design, manufacture or production of nuclear, chemical or biological weapons of mass destruction.

Information Collection

The Programs' installation and/or auto-update processes, if any, may transmit a limited amount of data to Oracle or its service provider about those processes to help Oracle understand and optimize them. Oracle does not associate the data with personally identifiable information. Refer to Oracle's Privacy Policy at www.oracle.com/privacy.

Disclaimer of Warranties; Limitation of Liability

THE PROGRAMS ARE PROVIDED "AS IS" WITHOUT WARRANTY OF ANY KIND. ORACLE FURTHER DISCLAIMS ALL WARRANTIES, EXPRESS AND IMPLIED, INCLUDING WITHOUT LIMITATION, ANY IMPLIED WARRANTIES OF MERCHANTABILITY, FITNESS FOR A PARTICULAR PURPOSE, OR NONINFRINGEMENT .

IN NO EVENT WILL ORACLE BE LIABLE FOR ANY INDIRECT, INCIDENTAL, SPECIAL, PUNITIVE OR CONSEQUENTIAL DAMAGES, OR DAMAGES FOR LOSS OF PROFITS, REVENUE, DATA OR DATA USE, INCURRED BY YOU OR ANY THIRD PARTY, WHETHER IN AN ACTION IN CONTRACT OR TORT, EVEN IF ORACLE HAS BEEN ADVISED OF THE POSSIBILITY OF SUCH DAMAGES. ORACLE'S ENTIRE LIABILITY FOR DAMAGES UNDER THIS AGREEMENT SHALL IN NO EVENT EXCEED ONE THOUSAND DOLLARS (U.S. \$1,000) .

No Technical Support

Unless Oracle support for the Programs, if any, is expressly included in a separate, current support agreement between You and Oracle, Oracle's technical support organization will not provide technical support, phone support, or updates to You for the Programs provided under this Agreement.

Audit; Termination

Oracle may audit Your use of the Programs. You may terminate this Agreement by destroying all copies of the Programs. This Agreement shall automatically terminate without notice if You fail to comply with any of the terms of this Agreement, in which case You shall promptly destroy all copies of the Programs.

U.S. Government End Users

Programs and/or Programs Documentation delivered to U.S. Government end users are "commercial computer software" pursuant to the applicable Federal Acquisition Regulation and agency-specific supplemental regulations. As such, use, duplication, disclosure, modification, and adaptation of the Programs and/or Programs Documentation shall be subject to the license terms and license restrictions set forth in this Agreement. No other rights are granted to the U.S. Government.

Relationship Between the Parties

Oracle is an independent contractor and we agree that no partnership, joint venture, or agency relationship exists between us. We each will be responsible for paying our own employees, including employment related taxes and insurance.. Nothing in this agreement shall be construed to limit either party's right to independently develop or distribute software that is functionally similar to the other party's products, so long as proprietary information of the other party is not included in such software.

Entire Agreement; Governing Law

You agree that this Agreement is the complete agreement for the Programs and this Agreement supersedes all prior or contemporaneous agreements or representations, including any clickwrap, shrinkwrap or similar licenses, or license agreements for prior versions of the Programs. This Agreement may not be modified and the rights and restrictions may not be altered or waived except in a writing signed by authorized representatives of You and of Oracle. If any term of this Agreement is found to be invalid or unenforceable, the remaining provisions will remain effective.

This Agreement is governed by the substantive and procedural laws of the State of California, USA, and You and Oracle agree to submit to the exclusive jurisdiction of, and venue in, the courts of San Francisco or Santa Clara counties in California in any dispute arising out of or relating to this Agreement.

Notices

Should you have any questions concerning this License Agreement, or if you desire to contact Oracle for any reason, please write:

Oracle America, Inc.
500 Oracle Parkway
Redwood City, CA 94065

Oracle Employees: Under no circumstances are Oracle Employees authorized to download software for the purpose of distributing it to customers. Oracle products are available to employees for internal use or demonstration purposes only. In keeping with Oracle's trade compliance obligations under U.S. and applicable multilateral law, failure to comply with this policy could result in disciplinary action up to and including termination.

Last updated: 30 November 2016

Sentinel Fit 1.4

■Open SSL

LICENSE ISSUES

=====

The OpenSSL toolkit stays under a dual license, i.e. both the conditions of the OpenSSL License and the original SSLeay license apply to the toolkit.

See below for the actual license texts. Actually both licenses are BSD-style Open Source licenses. In case of any license issues related to OpenSSL please contact opensslcore@openssl.org.

OpenSSL License

=====
Copyright (c) 1998-2016 The OpenSSL Project. All rights reserved.

Redistribution and use in source and binary forms, with or without modification, are permitted provided that the following conditions are met:

1. Redistributions of source code must retain the above copyright notice, this list of conditions and the following disclaimer.
2. Redistributions in binary form must reproduce the above copyright notice, this list of conditions and the following disclaimer in the documentation and/or other materials provided with the distribution.
3. All advertising materials mentioning features or use of this software must display the following acknowledgment:

"This product includes software developed by the OpenSSL Project for use in the OpenSSL Toolkit. (<http://www.openssl.org/>)"

4. The names "OpenSSL Toolkit" and "OpenSSL Project" must not be used to endorse or promote products derived from this software without prior written permission. For written permission, please contact openssl-core@openssl.org.

5. Products derived from this software may not be called "OpenSSL" nor may "OpenSSL" appear in their names without prior written permission of the OpenSSL Project.

6. Redistributions of any form whatsoever must retain the following acknowledgment:

"This product includes software developed by the OpenSSL Project for use in the OpenSSL Toolkit (<http://www.openssl.org/>)"

THIS SOFTWARE IS PROVIDED BY THE OpenSSL PROJECT ``AS IS'' AND ANY EXPRESSED OR IMPLIED WARRANTIES, INCLUDING, BUT NOT LIMITED TO, THE IMPLIED WARRANTIES OF MERCHANTABILITY AND FITNESS FOR A PARTICULAR PURPOSE ARE DISCLAIMED. IN NO EVENT SHALL THE OpenSSL PROJECT OR ITS CONTRIBUTORS BE LIABLE FOR ANY DIRECT, INDIRECT, INCIDENTAL, SPECIAL, EXEMPLARY, OR CONSEQUENTIAL DAMAGES (INCLUDING, BUT NOT LIMITED TO, PROCUREMENT

■Expat

The MIT License (MIT)

Copyright (c) 1998, 1999, 2000 Thai Open Source Software Center Ltd and Clark Cooper

Copyright (c) 2001, 2002, 2003, 2004, 2005, 2006 Expat maintainers.

Permission is hereby granted, free of charge, to any person obtaining a copy of this software and associated documentation files (the "Software"), to deal in the Software without restriction, including without limitation the rights to use, copy, modify, merge, publish, distribute, sublicense, and/or sell copies of the Software, and to permit persons to whom the Software is furnished to do so, subject to the following conditions:

The above copyright notice and this permission notice shall be included in all copies or substantial portions of the Software.

THE SOFTWARE IS PROVIDED "AS IS", WITHOUT WARRANTY OF ANY KIND, EXPRESS OR IMPLIED, INCLUDING BUT NOT LIMITED TO THE WARRANTIES OF MERCHANTABILITY, FITNESS FOR A PARTICULAR PURPOSE AND NONINFRINGEMENT. IN NO EVENT SHALL THE AUTHORS OR COPYRIGHT HOLDERS BE LIABLE FOR ANY CLAIM, DAMAGES OR OTHER LIABILITY, WHETHER IN AN ACTION OF CONTRACT, TORT OR OTHERWISE, ARISING FROM, OUT OF OR IN CONNECTION WITH THE SOFTWARE OR THE USE OR OTHER DEALINGS IN THE SOFTWARE.

■Lbase 64 (for Lua)

The MIT License (MIT)

Copyright (c) 23 March 2010 Luiz Henrique de Figueiredo lh@tecgraf.puc-rio.br

Permission is hereby granted, free of charge, to any person obtaining a copy of this software and associated documentation files (the "Software"), to deal in the Software without restriction, including without limitation the rights to use, copy, modify, merge, publish, distribute, sublicense, and/or sell copies of the Software, and to permit persons to whom the Software is furnished to do so, subject to the following conditions:

The above copyright notice and this permission notice shall be included in all copies or substantial portions of the Software.

THE SOFTWARE IS PROVIDED "AS IS", WITHOUT WARRANTY OF ANY KIND, EXPRESS OR IMPLIED, INCLUDING BUT NOT LIMITED TO THE WARRANTIES OF MERCHANTABILITY, FITNESS FOR A PARTICULAR PURPOSE AND NONINFRINGEMENT. IN NO EVENT SHALL THE AUTHORS OR COPYRIGHT HOLDERS BE LIABLE FOR ANY CLAIM, DAMAGES OR OTHER LIABILITY, WHETHER IN AN ACTION OF CONTRACT, TORT OR OTHERWISE, ARISING FROM, OUT OF OR IN CONNECTION WITH THE SOFTWARE OR THE USE OR OTHER DEALINGS IN THE SOFTWARE.

■Lpeg

Copyright © 2007-2015 Lua.org, PUC-Rio.

Permission is hereby granted, free of charge, to any person obtaining a copy of this software and associated documentation files (the "Software"), to deal in the Software without restriction, including without limitation the rights to use, copy, modify, merge, publish, distribute, sublicense, and/or sell copies of the Software, and to permit persons to whom the Software is furnished to do so, subject to the following conditions:

The above copyright notice and this permission notice shall be included in all copies or substantial portions of the Software.

THE SOFTWARE IS PROVIDED "AS IS", WITHOUT WARRANTY OF ANY KIND, EXPRESS OR IMPLIED, INCLUDING BUT NOT LIMITED TO THE WARRANTIES OF MERCHANTABILITY, FITNESS FOR A PARTICULAR PURPOSE AND NONINFRINGEMENT. IN NO EVENT SHALL THE AUTHORS OR COPYRIGHT HOLDERS BE LIABLE FOR ANY CLAIM, DAMAGES OR OTHER LIABILITY, WHETHER IN AN ACTION OF CONTRACT, TORT OR OTHERWISE, ARISING FROM, OUT OF OR IN CONNECTION WITH THE SOFTWARE OR THE USE OR OTHER DEALINGS IN THE SOFTWARE.

■Lua-epat

Copyright © 1994-2015 Lua.org, PUC-Rio.

Permission is hereby granted, free of charge, to any person obtaining a copy of this software and associated documentation files (the "Software"), to deal in the Software without restriction, including without limitation the rights to use, copy, modify, merge, publish, distribute, sublicense, and/or sell copies of the Software, and to permit persons to whom the Software is furnished to do so, subject to the following conditions:

The above copyright notice and this permission notice shall be included in all copies or substantial portions of the Software.

THE SOFTWARE IS PROVIDED "AS IS", WITHOUT WARRANTY OF ANY KIND, EXPRESS OR IMPLIED, INCLUDING BUT NOT LIMITED TO THE WARRANTIES OF MERCHANTABILITY, FITNESS FOR A PARTICULAR PURPOSE AND NONINFRINGEMENT. IN NO EVENT SHALL THE AUTHORS OR COPYRIGHT HOLDERS BE LIABLE FOR ANY CLAIM, DAMAGES OR OTHER LIABILITY, WHETHER IN AN ACTION OF CONTRACT, TORT OR OTHERWISE, ARISING FROM, OUT OF OR IN CONNECTION WITH THE SOFTWARE OR THE USE OR OTHER DEALINGS IN THE SOFTWARE.

■Luafilesystem

Copyright © 1994-2015 Lua.org, PUC-Rio.

Permission is hereby granted, free of charge, to any person obtaining a copy of this software and associated documentation files (the "Software"), to deal in the Software without restriction, including without limitation the rights to use, copy, modify, merge, publish, distribute, sublicense, and/or sell copies of the Software, and to permit persons to whom the Software is furnished to do so, subject to the following conditions:

The above copyright notice and this permission notice shall be included in all copies or substantial portions of the Software.

THE SOFTWARE IS PROVIDED "AS IS", WITHOUT WARRANTY OF ANY KIND, EXPRESS OR IMPLIED, INCLUDING BUT NOT LIMITED TO THE WARRANTIES OF MERCHANTABILITY, FITNESS FOR A PARTICULAR PURPOSE AND NONINFRINGEMENT. IN NO EVENT SHALL THE AUTHORS OR COPYRIGHT HOLDERS BE LIABLE FOR ANY CLAIM, DAMAGES OR OTHER LIABILITY, WHETHER IN AN ACTION OF CONTRACT, TORT OR OTHERWISE, ARISING FROM, OUT OF OR IN CONNECTION WITH THE SOFTWARE OR THE USE OR OTHER DEALINGS IN THE SOFTWARE.

■ Sproto

The MIT License (MIT)

Copyright (c) 2014 codingnow.com

Permission is hereby granted, free of charge, to any person obtaining a copy of this software and associated documentation files (the "Software"), to deal in the Software without restriction, including without limitation the rights to use, copy, modify, merge, publish, distribute, sublicense, and/or sell copies of the Software, and to permit persons to whom the Software is furnished to do so, subject to the following conditions:

The above copyright notice and this permission notice shall be included in all copies or substantial portions of the Software.

THE SOFTWARE IS PROVIDED "AS IS", WITHOUT WARRANTY OF ANY KIND, EXPRESS OR IMPLIED, INCLUDING BUT NOT LIMITED TO THE WARRANTIES OF MERCHANTABILITY, FITNESS FOR A PARTICULAR PURPOSE AND NONINFRINGEMENT. IN NO EVENT SHALL THE AUTHORS OR COPYRIGHT HOLDERS BE LIABLE FOR ANY CLAIM, DAMAGES OR OTHER LIABILITY, WHETHER IN AN ACTION OF CONTRACT, TORT OR OTHERWISE, ARISING FROM, OUT OF OR IN CONNECTION WITH THE SOFTWARE OR THE USE OR OTHER DEALINGS IN THE SOFTWARE.

■ Lua-jit

The MIT License (MIT)

Copyright (C) 2005-2014 Mike Pall. All rights reserved.

Permission is hereby granted, free of charge, to any person obtaining a copy of this software and associated documentation files (the "Software"), to deal in the Software without restriction, including without limitation the rights to use, copy, modify, merge, publish, distribute, sublicense, and/or sell copies of the Software, and to permit persons to whom the Software is furnished to do so, subject to the following conditions:

The above copyright notice and this permission notice shall be included in all copies or substantial portions of the Software.

THE SOFTWARE IS PROVIDED "AS IS", WITHOUT WARRANTY OF ANY KIND, EXPRESS OR IMPLIED, INCLUDING BUT NOT LIMITED TO THE WARRANTIES OF MERCHANTABILITY, FITNESS FOR A PARTICULAR PURPOSE AND NONINFRINGEMENT. IN NO EVENT SHALL THE AUTHORS OR COPYRIGHT HOLDERS BE LIABLE FOR ANY CLAIM, DAMAGES OR OTHER LIABILITY, WHETHER IN AN ACTION OF CONTRACT, TORT OR OTHERWISE, ARISING FROM, OUT OF OR IN CONNECTION WITH THE SOFTWARE OR THE USE OR OTHER DEALINGS IN THE SOFTWARE.

■ mbed TLS

Copyright (C) 2006-2015, ARM Limited, All Rights Reserved

Licensed under the Apache License, Version 2.0 (the "License"); you may not use this file except in compliance with the License.

You may obtain a copy of the License at <http://www.apache.org/licenses/LICENSE-2.0>

Unless required by applicable law or agreed to in writing, software distributed under the License is distributed on an "AS IS" BASIS, WITHOUT WARRANTIES OR CONDITIONS OF ANY KIND, either express or implied.

See the License for the specific language governing permissions and limitations under the License.

Appendix 12 Added and Changed Functions

This section shows the added and changed functions of MES interface modules (RD81MES96 and RD81MES96N) and MX MESInterface-R.

Added/changed contents	Firmware version		Software version	Reference		
	RD81MES96	RD81MES96N				
Daylight saving time is supported.	'03' or later	'01' or later	—	Page 58 Specification for trigger conditions at time change		
MELSEC iQ-R CPU modules are supported. <ul style="list-style-type: none"> Programmable controller CPU (CC-Link IE built-in) Process CPU C Controller module 				MELSEC iQ-R MES Interface Module User's Manual (Startup)		
Online module change				MELSEC iQ-R Online Module Change Manual		
MELSEC-Q CPU modules (including C Controller modules) and MELSEC-L CPU modules are supported.				'1.01B' or later	MELSEC iQ-R MES Interface Module User's Manual (Startup)	
High-speed access is supported.					Page 23 Access type	
One-shot execution can be canceled while being executed.					Page 65 One-shot execution function	
MELSEC iQ-R CPU modules are supported. <ul style="list-style-type: none"> Safety CPU 	'05' or later	—	MELSEC iQ-R MES Interface Module User's Manual (Startup)			
Open source databases are supported. <ul style="list-style-type: none"> MySQL PostgreSQL 				'1.02C' or later	MELSEC iQ-R MES Interface Module User's Manual (Startup)	
An access route is added. <ul style="list-style-type: none"> MELSECNET/H network 						
A macro is added. <ul style="list-style-type: none"> Time at trigger monitoring 						
An event/condition type is added. <ul style="list-style-type: none"> Event (Value changed) 						Page 48 Event (Value changed)
Windows 10 is supported.	—	—	'1.03D' or later	MELSEC iQ-R MES Interface Module User's Manual (Startup)		
Import/Export of data from/to a CSV file is supported.				'1.04E' or later	MELSEC iQ-R MES Interface Module User's Manual (Startup)	
The 64-bit version of DB Connection Service and DB Connection Service Setting Tool are supported.						Page 306 CSV File Import/Export Specifications
Windows Server 2016 is supported.						
Accessible DBs are added. <ul style="list-style-type: none"> SQL Server 2016 Access 2016 	'06' or later	'01' or later	—	MELSEC iQ-R MES Interface Module User's Manual (Startup)		
The data types of access fields are added. <ul style="list-style-type: none"> Character String [Unicode(NCHAR)] Character String [Unicode(CHAR)] 						
A field where data is not stored can be searched in DB communication actions (SELECT, UPDATE, DELETE, Multi-SELECT) for Oracle database.						
The communication test function that checks communication with an access target device/access target server is added.					Page 92 Communication test function	

Added/changed contents	Firmware version		Software version	Reference				
	RD81MES96	RD81MES96N						
Global labels and common device comments can be imported.	'06' or later	'01' or later	'1.05F' or later	Page 142 Importing global labels/common device comments				
The project file conversion function is supported.	—	—		Page 202 Project File Conversion Tool				
The REST server function is supported.	'07' or later	'01' or later		Page 95 REST server function				
MELSEC iQ-R CPU modules are supported. • R00CPU, R01CPU, R02CPU			IMELSEC iQ-R MES Interface Module User's Manual (Startup)					
Online (asynchronous mode) is supported.	'08' or later	—	—	Page 207 Various operation settings				
An accessible DB is added. • SQL Server 2017			'1.07H' or later	IMELSEC iQ-R MES Interface Module User's Manual (Startup)				
When the automatic resend setting is enabled in the DB buffer settings, an SQL statement which has been buffered is resent after the communication is recovered.	—	—	—	Page 35 DB buffering function Page 162 DB buffer settings Page 236 Troubleshooting on the information linkage function				
An accessible DB is added. • Oracle 18c	'09' or later	'01' or later	'1.10L' or later	IMELSEC iQ-R MES Interface Module User's Manual (Startup)				
RD81MES96Ns are supported.					Not supported			
MELSEC-F CPU modules and MELSEC iQ-F CPU modules are supported.								
Long devices are supported. • Long timer • Long retentive timer • Long counter • Long index register • Refresh data register								
The number of access target devices are increased. • 16→64								
Direct DB connection is supported.								
DB information can be browsed via a module.								
Device tags the array tag settings of which are enabled in an operation action can be used.								
A trigger condition is added. • Multiple handshake						Page 54 Multiple handshake		
The data type of an access field is changed. • Real number → Real number [floating point], real number [fixed point]						IMELSEC iQ-R MES Interface Module User's Manual (Startup)		
The firmware update function is supported.						—	Page 181 Firmware update management IMELSEC iQ-R Module Configuration Manual	
The maximum number of points that can be accessed during high-speed access is changed. • 8192 points → 32768 points					'03' or later	'1.11M' or later	—	IMELSEC iQ-R MES Interface Module User's Manual (Startup)
A new item is added for a DB communication action. • Multiple Insert								Page 26 DB record input/output function
The maximum length of a character string that can be used in a job is changed. • 2048 characters → 90000 characters	IMELSEC iQ-R MES Interface Module User's Manual (Startup)							

Added/changed contents	Firmware version		Software version	Reference
	RD81MES96	RD81MES96N		
DBs are added for a DB communication action with "Multiple Insert" selected. • Oracle • MySQL • PostgreSQL	Not supported	'08' or later	'1.14Q' or later	Page 32 Multiple Insert
A macro is added in the data assignment for a DB communication action with "Multiple Insert" selected. • Date and time				—
Bit specification and digit specification of devices are supported.				Page 104 Arrays in which bit/digit specification of device memories is used Page 138 Device tag settings IMELSEC iQ-R MES Interface Module User's Manual (Startup)
Accessible DBs are added. • Oracle 19c • SQL Server 2019 • Access 2019	Not supported	'11' or later	'1.17T' or later	IMELSEC iQ-R MES Interface Module User's Manual (Startup)
DBs are added for a DB communication action with "Stored Procedure" selected. • MySQL • PostgreSQL				Page 33 Stored Procedure
An accessible DB is added. • MariaDB				IMELSEC iQ-R MES Interface Module User's Manual (Startup)
Windows 11 is supported. Windows Server 2022 is supported.	—	—	'1.19V' or later	IMELSEC iQ-R MES Interface Module User's Manual (Startup)
Accessible DBs are added. • Oracle 21c • SQL Server 2022 • Access 2021	Not supported	'13' or later	—	Page 26 DB record input/output function
Oracle pseudocolumns are supported. • ROWNUM • ROWID				Page 94 Direct access to a database
Views are supported for the DB information browse function. (When browsing DB information in a server with "Direct DB Connection" selected for the access type in the access target server setting)				Page 94 Via DB Connection Service
Views are supported for the DB information browse function. (When browsing DB information in a server with "Connection via Service" selected for the access type in the access target server setting)	—	—	—	Page 94 Via DB Connection Service

MEMO

A

INDEX

A

Access log 188,192,197
Account 163
Action 17,18,123
Array tag 100
Array tag setting 141
Automatic hardware test 228

B

Block array 101

C

Clear request 41,162
Communication timeout time 153
Condition (period of time). 47,116
Condition (value monitoring). 46,116
Continuous array 100

D

DB buffer diagnostics 174
DB buffering function. 35
DB buffering setting. 120
Delete 29,126
Detailed log 61,122,176,179
Device access diagnostics 173
Device tag 17,137

E

Error history 169
Event (fixed cycle). 48,116
Event (fixed time) 48,116
Event (module monitoring). 49,116
Event (value changed). 48,116
Exception setting (applicable records overflow)
. 129
Exception setting (multiple applicable records)
. 128
Exception setting (no applicable record) 128
Exception Setting (return value mismatch). 131

F

Failure history 171
Firmware update management 181

H

Hardware test for LED check 229

I

Insert. 28,126

J

Job 17,18,20,60,112
Job cancellation 18

Job diagnostics 170

M

Module status. 169
Multiple Insert. 32,127
Multiple Select 30,127

N

Narrowing-down condition 33,126

R

Reading. 166

S

SD memory card diagnostics 175
Select 27,126
Server access diagnostics 172
Sorting order 34,126
SQL failure log 188,193,201
SQL statement 124
Stored Procedure 33,127

T

Trigger buffering 63,115,180

U

Update 29,126
Updating setting 166

V

Verifying 166

W

Working history 61,122,170
Writing. 166

MEMO

REVISIONS

*The manual number is given on the bottom left of the back cover.

Revision date	*Manual number	Description
December 2015	SH(NA)-081423ENG-A	First edition
July 2016	SH(NA)-081423ENG-B	■Added or modified parts TERMS, Section 1.1, Section 1.3, Section 2.3, Section 2.4, Section 2.6, Section 2.12, Section 5.3, Section 5.4, Appendix 3, Appendix 8
September 2016	SH(NA)-081423ENG-C	■Added or modified part Appendix 8
March 2017	SH(NA)-081423ENG-D	■Added function Communication test function ■Added or modified parts SAFETY PRECAUTIONS, Section 1.3, Section 2.2, Section 2.4, Section 2.5, Section 2.6, Section 2.8, Section 2.12, Section 5.4, Appendix 6, Appendix 9
October 2017	SH(NA)-081423ENG-E	■Added functions REST server function, project file conversion function ■Added or modified parts Section 1.4, Section 2.6, Section 2.7, Chapter 4, Chapter 6, Section 7.1, Section 7.3, Section 7.4, Appendix 3, Appendix 6, Appendix 9
April 2018	SH(NA)-081423ENG-F	■Added or modified parts Section 5.2, Section 7.3, Appendix 9
May 2018	SH(NA)-081423ENG-G	■Added or modified parts Section 7.3, Section 7.4, Appendix 9, Appendix 10
August 2018	SH(NA)-081423ENG-H	■Added or modified parts Section 2.9, Section 4.2, Section 7.3, Appendix 5, Appendix 6, Appendix 10
October 2019	SH(NA)-081423ENG-I	■Added or modified parts TERMS, Section 1.3, Section 1.6, Section 2.4, Section 2.6, Section 2.7, Section 2.8, Section 2.9, Section 2.11, Section 2.12, Section 4.2, Section 5.2, Section 7.1, Section 7.2, Section 7.3, Appendix 3, Appendix 4, Appendix 5, Appendix 6, Appendix 10, Appendix 11, Appendix 12
April 2020	SH(NA)-081423ENG-J	■Added or modified part Section 1.1, Section 1.3, Section 1.6, Section 2.5, Section 2.7, Section 2.8, Section 2.9, Section 2.12, Section 7.4, Appendix 5, Appendix 6, Appendix 12
June 2020	SH(NA)-081423ENG-K	■Added or modified part Section 7.3
October 2020	SH(NA)-081423ENG-L	■Added or modified parts SAFETY PRECAUTIONS, CONDITIONS OF USE FOR THE PRODUCT, Section 7.4
March 2022	SH(NA)-081423ENG-M	■Added or modified parts DISCONTINUED MODEL, Section 1.1, Section 1.7, Section 2.7, Section 2.8, Section 4.2, Appendix 6, Appendix 12
February 2023	SH(NA)-081423ENG-N	■Added or modified parts INTRODUCTION, Section 1.1, Section 1.3, Section 2.8, Section 2.9, Section 7.3, Appendix 6, Appendix 9, Appendix 12, COPYRIGHTS
November 2023	SH(NA)-081423ENG-O	■Added or modified parts Section 1.1, Section 1.3, Section 2.5, Section 2.8, Section 2.9, Section 2.12, Section 3.1, Section 7.3, Section 7.4, Appendix 6, Appendix 12

Japanese manual number: SH-081421-R

This manual confers no industrial property rights or any rights of any other kind, nor does it confer any patent licenses. Mitsubishi Electric Corporation cannot be held responsible for any problems involving industrial property rights which may occur as a result of using the contents noted in this manual.

© 2015 MITSUBISHI ELECTRIC CORPORATION

WARRANTY

Please confirm the following product warranty details before using this product.

1. Gratis Warranty Term and Gratis Warranty Range

If any faults or defects (hereinafter "Failure") found to be the responsibility of Mitsubishi occurs during use of the product within the gratis warranty term, the product shall be repaired at no cost via the sales representative or Mitsubishi Service Company.

However, if repairs are required onsite at domestic or overseas location, expenses to send an engineer will be solely at the customer's discretion. Mitsubishi shall not be held responsible for any re-commissioning, maintenance, or testing on-site that involves replacement of the failed module.

[Gratis Warranty Term]

The gratis warranty term of the product shall be for one year after the date of purchase or delivery to a designated place. Note that after manufacture and shipment from Mitsubishi, the maximum distribution period shall be six (6) months, and the longest gratis warranty term after manufacturing shall be eighteen (18) months. The gratis warranty term of repair parts shall not exceed the gratis warranty term before repairs.

[Gratis Warranty Range]

- (1) The range shall be limited to normal use within the usage state, usage methods and usage environment, etc., which follow the conditions and precautions, etc., given in the instruction manual, user's manual and caution labels on the product.
- (2) Even within the gratis warranty term, repairs shall be charged for in the following cases.
 1. Failure occurring from inappropriate storage or handling, carelessness or negligence by the user. Failure caused by the user's hardware or software design.
 2. Failure caused by unapproved modifications, etc., to the product by the user.
 3. When the Mitsubishi product is assembled into a user's device, Failure that could have been avoided if functions or structures, judged as necessary in the legal safety measures the user's device is subject to or as necessary by industry standards, had been provided.
 4. Failure that could have been avoided if consumable parts (battery, backlight, fuse, etc.) designated in the instruction manual had been correctly serviced or replaced.
 5. Failure caused by external irresistible forces such as fires or abnormal voltages, and Failure caused by force majeure such as earthquakes, lightning, wind and water damage.
 6. Failure caused by reasons unpredictable by scientific technology standards at time of shipment from Mitsubishi.
 7. Any other failure found not to be the responsibility of Mitsubishi or that admitted not to be so by the user.

2. Onerous repair term after discontinuation of production

- (1) Mitsubishi shall accept onerous product repairs for seven (7) years after production of the product is discontinued. Discontinuation of production shall be notified with Mitsubishi Technical Bulletins, etc.
- (2) Product supply (including repair parts) is not available after production is discontinued.

3. Overseas service

Overseas, repairs shall be accepted by Mitsubishi's local overseas FA Center. Note that the repair conditions at each FA Center may differ.

4. Exclusion of loss in opportunity and secondary loss from warranty liability

Regardless of the gratis warranty term, Mitsubishi shall not be liable for compensation to:

- (1) Damages caused by any cause found not to be the responsibility of Mitsubishi.
- (2) Loss in opportunity, lost profits incurred to the user by Failures of Mitsubishi products.
- (3) Special damages and secondary damages whether foreseeable or not, compensation for accidents, and compensation for damages to products other than Mitsubishi products.
- (4) Replacement by the user, maintenance of on-site equipment, start-up test run and other tasks.

5. Changes in product specifications

The specifications given in the catalogs, manuals or technical documents are subject to change without prior notice.

TRADEMARKS

Intel is either registered trademarks or trademarks of Intel Corporation in the United States and/or other countries.

MariaDB is either a registered trademark or a trademark of MariaDB Corporation Ab.

Microsoft, Microsoft Access, and Windows are trademarks of the Microsoft group of companies.

MySQL is either a registered trademark or a trademark of MySQL AB.

Oracle and Java are registered trademarks of Oracle and/or its affiliates.

Unicode is either a registered trademark or a trademark of Unicode, Inc. in the United States and other countries.

The company names, system names and product names mentioned in this manual are either registered trademarks or trademarks of their respective companies.

In some cases, trademark symbols such as [™] or [®] are not specified in this manual.

COPYRIGHTS

For the open source software used in this product, refer to the following:

 [Page 349 Software Licenses](#)

SH(NA)-081423ENG-O(2311)KWIX

MODEL: R-MES-U-OU-E

MODEL CODE: 13JX24

MITSUBISHI ELECTRIC CORPORATION

HEAD OFFICE: TOKYO BLDG., 2-7-3, MARUNOUCHI, CHIYODA-KU, TOKYO 100-8310, JAPAN
NAGOYA WORKS: 1-14, YADA-MINAMI 5-CHOME, HIGASHI-KU, NAGOYA 461-8670, JAPAN

When exported from Japan, this manual does not require application to the
Ministry of Economy, Trade and Industry for service transaction permission.

Specifications subject to change without notice.