



Programmable Controller

**MELSEC iQ-R**  
series

## MELSEC iQ-R I/O Module (With Diagnostic Functions) User's Manual (Application)

---

-RX40NC6B  
-RY40PT5B





# SAFETY PRECAUTIONS



---

(Read these precautions before using this product.)

Before using this product, please read this manual and the relevant manuals carefully and pay full attention to safety to handle the product correctly.

The precautions given in this manual are concerned with this product only. For the safety precautions of the programmable controller system, refer to the MELSEC iQ-R Module Configuration Manual.

In this manual, the safety precautions are classified into two levels: "  WARNING" and "  CAUTION".

 <b>WARNING</b>	Indicates that incorrect handling may cause hazardous conditions, resulting in death or severe injury.
 <b>CAUTION</b>	Indicates that incorrect handling may cause hazardous conditions, resulting in minor or moderate injury or property damage.

Under some circumstances, failure to observe the precautions given under "  CAUTION" may lead to serious consequences.

Observe the precautions of both levels because they are important for personal and system safety.

Make sure that the end users read this manual and then keep the manual in a safe place for future reference.

## [Design Precautions]

---

### **WARNING**

- Configure safety circuits external to the programmable controller to ensure that the entire system operates safely even when a fault occurs in the external power supply or the programmable controller. Failure to do so may result in an accident due to an incorrect output or malfunction.
    - (1) Emergency stop circuits, protection circuits, and protective interlock circuits for conflicting operations (such as forward/reverse rotations or upper/lower limit positioning) must be configured external to the programmable controller.
    - (2) When the programmable controller detects an abnormal condition, it stops the operation and all outputs are:
      - Turned off if the overcurrent or overvoltage protection of the power supply module is activated.
      - Held or turned off according to the parameter setting if the self-diagnostic function of the CPU module detects an error such as a watchdog timer error.
    - (3) All outputs may be turned on if an error occurs in a part, such as an I/O control part, where the CPU module cannot detect any error. To ensure safety operation in such a case, provide a safety mechanism or a fail-safe circuit external to the programmable controller. For a fail-safe circuit example, refer to "General Safety Requirements" in the MELSEC iQ-R Module Configuration Manual.
    - (4) Outputs may remain on or off due to a failure of a component such as a relay and transistor in an output circuit. Configure an external circuit for monitoring output signals that could cause a serious accident.
  - In an output circuit, when a load current exceeding the rated current or an overcurrent caused by a load short-circuit flows for a long time, it may cause smoke and fire. To prevent this, configure an external safety circuit, such as a fuse.
  - Configure a circuit so that the external power supply is turned off first and then the programmable controller. If the programmable controller is turned off first, an accident may occur due to an incorrect output or malfunction.
  - For the operating status of each station after a communication failure, refer to manuals for the network used. For the manuals, please consult your local Mitsubishi representative. Incorrect output or malfunction due to a communication failure may result in an accident.
  - When connecting an external device with a CPU module or intelligent function module to modify data of a running programmable controller, configure an interlock circuit in the program to ensure that the entire system will always operate safely. For other forms of control (such as program modification, parameter change, forced output, or operating status change) of a running programmable controller, read the relevant manuals carefully and ensure that the operation is safe before proceeding. Improper operation may damage machines or cause accidents. When a Safety CPU is used, data cannot be modified while the Safety CPU is in SAFETY MODE.
  - Especially, when a remote programmable controller is controlled by an external device, immediate action cannot be taken if a problem occurs in the programmable controller due to a communication failure. To prevent this, configure an interlock circuit in the program, and determine corrective actions to be taken between the external device and CPU module in case of a communication failure.
  - Do not write any data to the "system area" and "write prohibited area" of the buffer memory in the module. Also, do not use any "use prohibited" signals as an output signal from the CPU module to each module. Doing so may cause malfunction of the programmable controller system. For the "system area", "write prohibited area", and the "use prohibited" signals, refer to the user's manual for the module used. For areas used for safety communications, they are protected from being written by users, and thus safety communications failure caused by data writing does not occur.
-

## [Design Precautions]

---

### **WARNING**

- If a communication cable is disconnected, the network may be unstable, resulting in a communication failure of multiple stations. Configure an interlock circuit in the program to ensure that the entire system will always operate safely even if communications fail. Incorrect output or malfunction due to a communication failure may result in an accident. When safety communications are used, an interlock by the safety station interlock function protects the system from an incorrect output or malfunction.

#### [Precaution for using the I/O module with diagnostic functions in normal mode]

- Configure a circuit so that the programmable controller is turned on first and then the external power supply. If the external power supply is turned on first, an accident may occur due to an incorrect output or malfunction.

#### [Precautions for using the I/O module with diagnostic functions in SIL2 mode]

- When the I/O module with diagnostic functions detects a fault in the external power supply or programmable controller, it turns off outputs. Configure an external circuit to ensure that the power source of a hazard is shut off by turning off the outputs. Failure to do so may result in an accident.
  - When a load current exceeding the rated current or an overcurrent caused by a load short-circuit flows, the output module with diagnostic functions detects an error and turns off all outputs. Note that if the overcurrent state continues for a long time, it may cause smoke and fire. To prevent this, configure an external safety circuit, such as a fuse.
  - Configure protection circuits, such as a fuse and breaker, external to the output module with diagnostic functions.
  - When a communication failure occurs with CC-Link IE Field Network, the I/O module with diagnostic functions turns off outputs. However, the program does not automatically turn off outputs. Create a program that turns off outputs when a CC-Link IE Field Network error is detected. If CC-Link IE Field Network is restored with outputs on, connected machines may suddenly operate, resulting in an accident.
  - Create an interlock circuit which uses reset buttons so that the system does not restart automatically after executing safety functions and turning off outputs.
-

## [Design Precautions]

---

### CAUTION

- Do not install the control lines or communication cables together with the main circuit lines or power cables. Doing so may result in malfunction due to electromagnetic interference. Keep a distance of 100mm or more between those cables.
  - During control of an inductive load such as a lamp, heater, or solenoid valve, a large current (approximately ten times greater than normal) may flow when the output is turned from off to on. Therefore, use a module that has a sufficient current rating.
  - After the CPU module is powered on or is reset, the time taken to enter the RUN status varies depending on the system configuration, parameter settings, and/or program size. Design circuits so that the entire system will always operate safely, regardless of the time.
  - Do not power off the programmable controller or reset the CPU module while the settings are being written. Doing so will make the data in the flash ROM and SD memory card undefined. The values need to be set in the buffer memory and written to the flash ROM and SD memory card again. Doing so also may cause malfunction or failure of the module.
  - When changing the operating status of the CPU module from external devices (such as the remote RUN/STOP functions), select "Do Not Open by Program" for "Opening Method" of "Module Parameter". If "Open by Program" is selected, an execution of the remote STOP function causes the communication line to close. Consequently, the CPU module cannot reopen the line, and external devices cannot execute the remote RUN function.
-

## [Security Precautions]

---

### **WARNING**

- To maintain the security (confidentiality, integrity, and availability) of the programmable controller and the system against unauthorized access, denial-of-service (DoS) attacks, computer viruses, and other cyberattacks from external devices via the network, take appropriate measures such as firewalls, virtual private networks (VPNs), and antivirus solutions.
- 

## [Installation Precautions]

---

### **WARNING**

- Shut off the external power supply (all phases) used in the system before mounting or removing the module. Failure to do so may result in electric shock or cause the module to fail or malfunction.
- 

## [Installation Precautions]

---

### **CAUTION**

- Use the programmable controller in an environment that meets the general specifications in the Safety Guidelines included with the base unit. Failure to do so may result in electric shock, fire, malfunction, or damage to or deterioration of the product.
  - To mount a module, place the concave part(s) located at the bottom onto the guide(s) of the base unit, and push in the module until the hook(s) located at the top snaps into place. Incorrect interconnection may cause malfunction, failure, or drop of the module.
  - To mount a module with no module fixing hook, place the concave part(s) located at the bottom onto the guide(s) of the base unit, push in the module, and fix it with screw(s). Incorrect interconnection may cause malfunction, failure, or drop of the module.
  - When using the programmable controller in an environment of frequent vibrations, fix the module with a screw.
  - Tighten the screws within the specified torque range. Undertightening can cause drop of the component or wire, short circuit, or malfunction. Overtightening can damage the screw and/or module, resulting in drop, short circuit, or malfunction. For the specified torque range, refer to the MELSEC iQ-R Module Configuration Manual.
  - When using an extension cable, connect it to the extension cable connector of the base unit securely. Check the connection for looseness. Poor contact may cause malfunction.
  - When using an SD memory card, fully insert it into the SD memory card slot. Check that it is inserted completely. Poor contact may cause malfunction.
  - Securely insert an extended SRAM cassette or a battery-less option cassette into the cassette connector of the CPU module. After insertion, close the cassette cover and check that the cassette is inserted completely. Poor contact may cause malfunction.
  - Do not directly touch any conductive parts and electronic components of the module, SD memory card, extended SRAM cassette, battery-less option cassette, or connector. Doing so can cause malfunction or failure of the module.
-

## [Wiring Precautions]

---

### **WARNING**

---

- Shut off the external power supply (all phases) used in the system before installation and wiring. Failure to do so may result in electric shock or cause the module to fail or malfunction.
  - After installation and wiring, attach a blank cover module (RG60) to each empty slot and an included extension connector protective cover to the unused extension cable connector before powering on the system for operation. Failure to do so may result in electric shock.
-



## [Wiring Precautions]

---

### CAUTION

- Individually ground the FG and LG terminals of the programmable controller with a ground resistance of 100 ohms or less. Failure to do so may result in electric shock or malfunction.
  - Use applicable solderless terminals and tighten them within the specified torque range. If any spade solderless terminal is used, it may be disconnected when the terminal screw comes loose, resulting in failure.
  - Check the rated voltage and signal layout before wiring to the module, and connect the cables correctly. Connecting a power supply with a different voltage rating or incorrect wiring may cause fire or failure.
  - Connectors for external devices must be crimped or pressed with the tool specified by the manufacturer, or must be correctly soldered. Incomplete connections may cause short circuit, fire, or malfunction.
  - Securely connect the connector to the module. Poor contact may cause malfunction.
  - Do not install the control lines or communication cables together with the main circuit lines or power cables. Doing so may result in malfunction due to noise. Keep a distance of 100mm or more between those cables.
  - Place the cables in a duct or clamp them. If not, dangling cables may swing or inadvertently be pulled, resulting in malfunction or damage to modules or cables.  
In addition, the weight of the cables may put stress on modules in an environment of strong vibrations and shocks.  
Do not clamp the extension cables with the jacket stripped. Doing so may change the characteristics of the cables, resulting in malfunction.
  - Check the interface type and correctly connect the cable. Incorrect wiring (connecting the cable to an incorrect interface) may cause failure of the module and external device.
  - Tighten the terminal screws or connector screws within the specified torque range. Undertightening can cause drop of the screw, short circuit, fire, or malfunction. Overtightening can damage the screw and/or module, resulting in drop, short circuit, fire, or malfunction.
  - When disconnecting the cable from the module, do not pull the cable by the cable part. For the cable with connector, hold the connector part of the cable. For the cable connected to the terminal block, loosen the terminal screw. Pulling the cable connected to the module may result in malfunction or damage to the module or cable.
  - Prevent foreign matter such as dust or wire chips from entering the module. Such foreign matter can cause a fire, failure, or malfunction.
  - A protective film is attached to the top of the module to prevent foreign matter, such as wire chips, from entering the module during wiring. Do not remove the film during wiring. Remove it for heat dissipation before system operation.
  - Programmable controllers must be installed in control panels. Connect the main power supply to the power supply module in the control panel through a relay terminal block. Wiring and replacement of a power supply module must be performed by qualified maintenance personnel with knowledge of protection against electric shock. For wiring, refer to the MELSEC iQ-R Module Configuration Manual.
  - For Ethernet cables to be used in the system, select the ones that meet the specifications in the user's manual for the module used. If not, normal data transmission is not guaranteed.
-

## [Startup and Maintenance Precautions]

---

### **WARNING**

---

- Do not touch any terminal while power is on. Doing so will cause electric shock or malfunction.
  - Correctly connect the battery connector. Do not charge, disassemble, heat, short-circuit, solder, or throw the battery into the fire. Also, do not expose it to liquid or strong shock. Doing so will cause the battery to produce heat, explode, ignite, or leak, resulting in injury and fire.
  - Shut off the external power supply (all phases) used in the system before cleaning the module or retightening the terminal screws, connector screws, or module fixing screws. Failure to do so may result in electric shock.
-

## [Startup and Maintenance Precautions]

---

### CAUTION

- When connecting an external device with a CPU module or intelligent function module to modify data of a running programmable controller, configure an interlock circuit in the program to ensure that the entire system will always operate safely. For other forms of control (such as program modification, parameter change, forced output, or operating status change) of a running programmable controller, read the relevant manuals carefully and ensure that the operation is safe before proceeding. Improper operation may damage machines or cause accidents.
  - Especially, when a remote programmable controller is controlled by an external device, immediate action cannot be taken if a problem occurs in the programmable controller due to a communication failure. To prevent this, configure an interlock circuit in the program, and determine corrective actions to be taken between the external device and CPU module in case of a communication failure.
  - Do not disassemble or modify the modules. Doing so may cause failure, malfunction, injury, or a fire.
  - Use any radio communication device such as a cellular phone or PHS (Personal Handy-phone System) more than 25cm away in all directions from the programmable controller. Failure to do so may cause malfunction.
  - Shut off the external power supply (all phases) used in the system before mounting or removing the module. Failure to do so may cause the module to fail or malfunction.
  - Tighten the screws within the specified torque range. Undertightening can cause drop of the component or wire, short circuit, or malfunction. Overtightening can damage the screw and/or module, resulting in drop, short circuit, or malfunction.
  - After the first use of the product, do not perform each of the following operations more than 50 times (IEC 61131-2/JIS B 3502 compliant). Exceeding the limit may cause malfunction.
    - Mounting/removing the module to/from the base unit
    - Inserting/removing the extended SRAM cassette or battery-less option cassette to/from the CPU module
    - Mounting/removing the terminal block to/from the module
  - After the first use of the product, do not insert/remove the SD memory card to/from the CPU module more than 500 times. Exceeding the limit may cause malfunction.
  - Do not touch the metal terminals on the back side of the SD memory card. Doing so may cause malfunction or failure of the module.
  - Do not touch the integrated circuits on the circuit board of an extended SRAM cassette or a battery-less option cassette. Doing so may cause malfunction or failure of the module.
  - Do not drop or apply shock to the battery to be installed in the module. Doing so may damage the battery, causing the battery fluid to leak inside the battery. If the battery is dropped or any shock is applied to it, dispose of it without using.
-

## [Startup and Maintenance Precautions]

---

### CAUTION

- Startup and maintenance of a control panel must be performed by qualified maintenance personnel with knowledge of protection against electric shock. Lock the control panel so that only qualified maintenance personnel can operate it.
  - Before handling the module, touch a conducting object such as a grounded metal to discharge the static electricity from the human body. Failure to do so may cause the module to fail or malfunction.
- 

## [Operating Precautions]

---

### CAUTION

- When changing data and operating status, and modifying program of the running programmable controller from an external device such as a personal computer connected to an intelligent function module, read relevant manuals carefully and ensure the safety before operation. Incorrect change or modification may cause system malfunction, damage to the machines, or accidents.
  - Do not power off the programmable controller or reset the CPU module while the setting values in the buffer memory are being written to the flash ROM in the module. Doing so will make the data in the flash ROM and SD memory card undefined. The values need to be set in the buffer memory and written to the flash ROM and SD memory card again. Doing so can cause malfunction or failure of the module.
- 

## [Disposal Precautions]

---

### CAUTION

- When disposing of this product, treat it as industrial waste.
  - When disposing of batteries, separate them from other wastes according to the local regulations. For details on battery regulations in EU member states, refer to the MELSEC iQ-R Module Configuration Manual.
- 

## [Transportation Precautions]

---

### CAUTION

- When transporting lithium batteries, follow the transportation regulations. For details on the regulated models, refer to the MELSEC iQ-R Module Configuration Manual.
  - The halogens (such as fluorine, chlorine, bromine, and iodine), which are contained in a fumigant used for disinfection and pest control of wood packaging materials, may cause failure of the product. Prevent the entry of fumigant residues into the product or consider other methods (such as heat treatment) instead of fumigation. The disinfection and pest control measures must be applied to unprocessed raw wood.
-

# CONDITIONS OF USE FOR THE PRODUCT

---

- (1) MELSEC programmable controller ("the PRODUCT") shall be used in conditions;
  - i) where any problem, fault or failure occurring in the PRODUCT, if any, shall not lead to any major or serious accident; and
  - ii) where the backup and fail-safe function are systematically or automatically provided outside of the PRODUCT for the case of any problem, fault or failure occurring in the PRODUCT.
- (2) The PRODUCT has been designed and manufactured for the purpose of being used in general industries. MITSUBISHI ELECTRIC SHALL HAVE NO RESPONSIBILITY OR LIABILITY (INCLUDING, BUT NOT LIMITED TO ANY AND ALL RESPONSIBILITY OR LIABILITY BASED ON CONTRACT, WARRANTY, TORT, PRODUCT LIABILITY) FOR ANY INJURY OR DEATH TO PERSONS OR LOSS OR DAMAGE TO PROPERTY CAUSED BY THE PRODUCT THAT ARE OPERATED OR USED IN APPLICATION NOT INTENDED OR EXCLUDED BY INSTRUCTIONS, PRECAUTIONS, OR WARNING CONTAINED IN MITSUBISHI ELECTRIC USER'S, INSTRUCTION AND/OR SAFETY MANUALS, TECHNICAL BULLETINS AND GUIDELINES FOR the PRODUCT.

("Prohibited Application")

Prohibited Applications include, but not limited to, the use of the PRODUCT in;
  - Nuclear Power Plants and any other power plants operated by Power companies, and/or any other cases in which the public could be affected if any problem or fault occurs in the PRODUCT.
  - Railway companies or Public service purposes, and/or any other cases in which establishment of a special quality assurance system is required by the Purchaser or End User.
  - Aircraft or Aerospace, Medical applications, Train equipment, transport equipment such as Elevator and Escalator, Incineration and Fuel devices, Vehicles, Manned transportation, Equipment for Recreation and Amusement, and Safety devices, handling of Nuclear or Hazardous Materials or Chemicals, Mining and Drilling, and/or other applications where there is a significant risk of injury to the public or property.Notwithstanding the above restrictions, Mitsubishi Electric may in its sole discretion, authorize use of the PRODUCT in one or more of the Prohibited Applications, provided that the usage of the PRODUCT is limited only for the specific applications agreed to by Mitsubishi Electric and provided further that no special quality assurance or fail-safe, redundant or other safety features which exceed the general specifications of the PRODUCTS are required. For details, please contact the Mitsubishi Electric representative in your region.
- (3) Mitsubishi Electric shall have no responsibility or liability for any problems involving programmable controller trouble and system trouble caused by DoS attacks, unauthorized access, computer viruses, and other cyberattacks.
  - When SIL2 mode is set
- (1) Although Mitsubishi Electric has declared Product's compliance with the international safety standards IEC61508, IEC61511, this fact does not guarantee that Product will be free from any malfunction or failure. The user of this Product shall comply with any and all applicable safety standard, regulation or law and take appropriate safety measures for the system in which the Product is installed or used and shall take the second or third safety measures other than the Product. Mitsubishi Electric is not liable for damages that could have been prevented by compliance with any applicable safety standard, regulation or law.
- (2) Mitsubishi Electric prohibits the use of Products with or in any application involving, and Mitsubishi Electric shall not be liable for a default, a liability for defect warranty, a quality assurance, negligence or other tort and a product liability in these applications.
  - (a) power plants,
  - (b) trains, railway systems, airplanes, airline operations, other transportation systems,
  - (c) hospitals, medical care, dialysis and life support facilities or equipment,
  - (d) amusement equipments,
  - (e) incineration and fuel devices,
  - (f) handling of nuclear or hazardous materials or chemicals,
  - (g) mining and drilling,
  - (h) and other applications where the level of risk to human life, health or property are elevated.
- (3) Mitsubishi Electric shall have no responsibility or liability for any problems involving programmable controller trouble and system trouble caused by DoS attacks, unauthorized access, computer viruses, and other cyberattacks.

# INTRODUCTION

---

Thank you for purchasing the Mitsubishi Electric MELSEC iQ-R series programmable controllers.

This manual describes the functions, parameter settings, troubleshooting, I/O signals, and buffer memory of the relevant products listed below.

Before using this product, please read this manual and the relevant manuals carefully and develop familiarity with the functions and performance of the MELSEC iQ-R series programmable controller to handle the product correctly.

When applying the program examples provided in this manual to an actual system, ensure the applicability and confirm that it will not cause system control problems.

Please make sure that the end users read this manual.

## Relevant products

---

RX40NC6B, RY40PT5B



# COMPLIANCE WITH EMC AND LOW VOLTAGE DIRECTIVES

---

## Method of ensuring compliance

---

To ensure that Mitsubishi Electric programmable controllers maintain EMC and Low Voltage Directives when incorporated into other machinery or equipment, certain measures may be necessary. Please refer to one of the following manuals.

-  MELSEC iQ-R Module Configuration Manual
-  Safety Guidelines (This manual is included with the base unit.)

The CE mark on the side of the programmable controller indicates compliance with EMC and Low Voltage Directives.

## Additional measures

---

No additional measures are necessary for the compliance of this product with EMC and Low Voltage Directives.

# CONTENTS

SAFETY PRECAUTIONS .....	1
CONDITIONS OF USE FOR THE PRODUCT .....	11
INTRODUCTION .....	12
COMPLIANCE WITH EMC AND LOW VOLTAGE DIRECTIVES .....	12
RELEVANT MANUALS .....	17
TERMS .....	18
GENERIC TERMS AND ABBREVIATIONS .....	18

## PART 1 NORMAL MODE

<b>CHAPTER 1 FUNCTIONS</b> .....	<b>20</b>
<b>1.1 Input Function</b> .....	<b>20</b>
Input response time setting function .....	21
Input HOLD/CLEAR function .....	22
Input delay function .....	24
Number of input ON times integration function .....	27
Event time stamp function .....	30
<b>1.2 Output Function</b> .....	<b>33</b>
Setting of output mode at error .....	33
Output delay function .....	34
Number of output ON times integration function .....	36
<b>1.3 Common Functions of the I/O Module with Diagnostic Functions</b> .....	<b>39</b>
Interrupt function .....	39
LED indication setting on error condition .....	42
<b>1.4 Diagnostic Function</b> .....	<b>43</b>
Input disconnection detection function .....	43
Output disconnection detection function .....	46
Short-circuit detection function .....	49
Error history function .....	51
<b>1.5 Event History Function</b> .....	<b>54</b>
<b>CHAPTER 2 PARAMETER SETTINGS</b> .....	<b>55</b>
<b>2.1 Basic Settings</b> .....	<b>55</b>
<b>2.2 Application Settings</b> .....	<b>56</b>
<b>2.3 Interrupt Settings</b> .....	<b>57</b>
<b>2.4 Refresh Settings</b> .....	<b>58</b>
Refresh processing time .....	59
<b>CHAPTER 3 TROUBLESHOOTING</b> .....	<b>60</b>
<b>3.1 Troubleshooting with the LEDs</b> .....	<b>60</b>
When the RUN LED turns off .....	60
When the ERR LED turns on .....	60
When the ALM LED turns on .....	60
When an I/O LED does not change .....	60
<b>3.2 Checking the Module Status</b> .....	<b>61</b>
<b>3.3 Troubleshooting by Symptom</b> .....	<b>64</b>
When the I/O module with diagnostic functions does not start up .....	64

When the ON/OFF state of an external input cannot be read . . . . .	64
When a disconnection in the input wiring cannot be detected. . . . .	65
When a disconnection in the input wiring cannot be detected correctly . . . . .	65
When a disconnection was detected in the input wiring . . . . .	65
When the ON/OFF state of an external output cannot be changed . . . . .	66
When a disconnection or short-circuit in the output wiring cannot be detected. . . . .	66
When a disconnection or short-circuit in the output wiring cannot be detected correctly . . . . .	66
When a disconnection or short-circuit was detected in the output wiring . . . . .	66
When a load momentarily turns on before the completion of the initial processing . . . . .	67
<b>3.4 List of Error Codes . . . . .</b>	<b>68</b>
<b>3.5 List of Alarm Codes. . . . .</b>	<b>70</b>

---

## **APPENDICES (NORMAL MODE) 71**

<b>Appendix 1 Module Label . . . . .</b>	<b>71</b>
<b>Appendix 2 I/O Signals . . . . .</b>	<b>73</b>
List of I/O signals. . . . .	73
Details on input signals . . . . .	75
Details on output signals . . . . .	77
<b>Appendix 3 Buffer Memory . . . . .</b>	<b>79</b>
List of buffer memory addresses . . . . .	79
Details of buffer memory addresses . . . . .	90
<b>Appendix 4 Optional Item . . . . .</b>	<b>117</b>
Spring clamp terminal block . . . . .	117
<b>Appendix 5 Disabling the Safety Module. . . . .</b>	<b>118</b>
<b>Appendix 6 Using the Module in the Redundant System with Redundant Extension Base Unit . . . . .</b>	<b>119</b>
Restrictions on functions and specifications . . . . .	119
Precautions . . . . .	119
<b>Appendix 7 Added or Modified Function . . . . .</b>	<b>120</b>

---

## **PART 2 SIL2 MODE**

---

### **CHAPTER 4 OVERVIEW 122**

---

### **CHAPTER 5 PART NAMES 124**

---

### **CHAPTER 6 SPECIFICATIONS 126**

6.1 Performance Specifications . . . . .	126
6.2 Function List . . . . .	130

---

### **CHAPTER 7 PROCEDURES BEFORE OPERATION 131**

---

### **CHAPTER 8 SYSTEM CONFIGURATION 137**

8.1 Redundant Master Station . . . . .	137
8.2 Redundant Line . . . . .	139
8.3 Firmware Version for SIL2 Mode . . . . .	141

---

### **CHAPTER 9 INSTALLATION AND WIRING 142**

9.1 Before Using the I/O Module with Diagnostic Functions. . . . .	142
9.2 Wiring . . . . .	142
9.3 Wiring Examples . . . . .	145



<b>CHAPTER 10 FUNCTIONS</b>	<b>149</b>
<b>10.1 SIL2 Mode</b>	<b>150</b>
<b>10.2 Safety Input Function</b>	<b>160</b>
Input double wiring function	160
Input response time setting function	162
Input HOLD function	163
External input monitor function	164
<b>10.3 Safety Output Function</b>	<b>165</b>
Output double wiring function	165
Output HOLD function	167
<b>10.4 Input Diagnostic Function</b>	<b>168</b>
Double input discrepancy detection function	168
Input dark test function	175
<b>10.5 Output Diagnostic Function</b>	<b>177</b>
Output dark test function	177
Output read-back function	179
<b>10.6 Protection Function</b>	<b>180</b>
<b>10.7 Common Functions of the I/O Module with Diagnostic Functions</b>	<b>181</b>
LED indication setting on error condition	181
<b>10.8 Error History Function</b>	<b>182</b>
<b>10.9 Event History Function</b>	<b>183</b>
<b>CHAPTER 11 PARAMETER SETTINGS</b>	<b>185</b>
<b>11.1 Basic Settings</b>	<b>185</b>
<b>11.2 Application Settings</b>	<b>186</b>
<b>11.3 Refresh Settings</b>	<b>187</b>
<b>CHAPTER 12 MAINTENANCE AND INSPECTION</b>	<b>188</b>
<b>CHAPTER 13 TROUBLESHOOTING</b>	<b>190</b>
<b>13.1 Troubleshooting with the LEDs</b>	<b>190</b>
<b>13.2 Checking the Module Status</b>	<b>191</b>
<b>13.3 Troubleshooting by Symptom</b>	<b>193</b>
When the I/O module with diagnostic functions does not start up	193
When the RUN LED is off	193
When the ERR LED is flashing or turns on	193
When the S MODE LED is flashing or off	194
When the ALM LED is flashing	195
When an I/O LED does not change	195
When a module parameter error is displayed in the "Module Diagnostics" window	195
When the ON/OFF state of an external input cannot be read	195
When the ON/OFF state of an external output cannot be changed	196
When an external output ON signal intermittently turns off	196
When a load momentarily turns on before establishment of the safety connection	197
<b>13.4 Troubleshooting While Proceeding Procedures Before Operation</b>	<b>198</b>
When the module parameter write to the remote head module fails	198
Troubleshooting on the "Safety Communication Setting" window	198
Troubleshooting on the "Safety Module Operation" window	198
<b>13.5 List of Error Codes</b>	<b>200</b>

<b>APPENDICES (SIL2 MODE)</b>	<b>202</b>
<b>Appendix 8 Safety I/O Signals</b> .....	<b>202</b>
List of safety I/O signals .....	202
Safety input signal details .....	204
Safety output signal details .....	204
<b>Appendix 9 I/O Signals</b> .....	<b>205</b>
List of I/O signals .....	205
Details on input signals .....	206
Details on output signals .....	208
<b>Appendix 10 Buffer Memory</b> .....	<b>209</b>
List of buffer memory areas .....	209
Details of buffer memory areas .....	212
<b>Appendix 11 Calculation Method of Safety Response Time (Maximum Value)</b> .....	<b>216</b>
<b>Appendix 12 External Dimensions</b> .....	<b>217</b>
<b>INDEX</b>	<b>218</b>
REVISIONS .....	220
WARRANTY .....	221
TRADEMARKS .....	224

# RELEVANT MANUALS

Manual name [manual number]	Description	Available form
MELSEC iQ-R I/O Module (With Diagnostic Functions) User's Manual (Application) [SH-081621ENG] (this manual)	Functions, parameter settings, troubleshooting, I/O signals, and buffer memory of the I/O module with diagnostic functions	Print book e-Manual PDF
MELSEC iQ-R Module Configuration Manual [SH-081262ENG]	Common information on the hardware configuration of all modules, overview of each system configuration, and specifications of the power supply module, base unit, SD memory card, and battery	Print book e-Manual PDF
MELSEC iQ-R I/O Module (With Diagnostic Functions) User's Manual (Startup) [SH-081619ENG]	Specifications, procedures before operation, installation, and wiring of the I/O module with diagnostic functions	Print book e-Manual PDF
MELSEC iQ-R I/O Module Function Block Reference [BCN-P5999-0376]	FBs of the MELSEC iQ-R series I/O modules	e-Manual PDF
GX Works3 Operating Manual [SH-081215ENG]	System configuration, parameter settings, and online operations of GX Works3	e-Manual PDF
MELSEC iQ-R Online Module Change Manual [SH-081501ENG]	The online module change, which allows a module to be changed without stopping the system for MELSEC iQ-R series programmable controllers	Print book e-Manual PDF
Before Using the Product [BCN-P5999-0209]	Compatible models, specifications, and installation procedure of the Q6TE-18SN spring clamp terminal block	Print book PDF

This manual does not include detailed information on the following:

- General specifications
- Applicable combinations of CPU modules and the other modules, and the number of mountable modules
- Installation

For details, refer to the following.

 MELSEC iQ-R Module Configuration Manual

## Point

e-Manual refers to the Mitsubishi Electric FA electronic book manuals that can be browsed using a dedicated tool.

e-Manual has the following features:

- Required information can be cross-searched in multiple manuals.
- Other manuals can be accessed from the links in the manual.
- The hardware specifications of each part can be found from the product figures.
- Pages that users often browse can be bookmarked.
- Sample programs can be copied to an engineering tool.

# TERMS

Unless otherwise specified, this manual uses the following terms.

Term	Description
Engineering tool	A tool used for setting up programmable controllers, programming, debugging, and maintenance
Redundant system with redundant extension base unit	A redundant system that is configured using extension base unit(s)
SIL2 mode	An operation mode of the I/O module and the intelligent function module to perform safety input and output at the SIL2 level.

# GENERIC TERMS AND ABBREVIATIONS

Unless otherwise specified, this manual uses the following generic terms and abbreviations.

Generic term/abbreviation	Description
CPU module	A generic term for the MELSEC iQ-R series CPU modules
I/O module with diagnostic functions	The abbreviation for the MELSEC iQ-R series I/O module with diagnostic functions
Normal mode	An abbreviation for the mode to be set for performing normal I/O operation
Power supply module	A generic term for MELSEC iQ-R series power supply modules
Remote head module	The abbreviation for the RJ72GF15-T2 CC-Link IE Field Network remote head module

This part consists of the following chapters. These chapters describe the details on using the I/O module with diagnostic functions in normal mode.

1 FUNCTIONS

---

2 PARAMETER SETTINGS

---

3 TROUBLESHOOTING

---

APPENDICES (NORMAL MODE)

---

# 1 FUNCTIONS

## 1.1 Input Function

This function takes in the ON/OFF state of external inputs.

However, when the input response time setting function or input delay function is enabled, the ON/OFF state of the input signals in the module (X0 to XF) and the ON/OFF state of the actual external inputs (X00 to X0F) may not match.

The following figure shows the processing procedure of the input function.

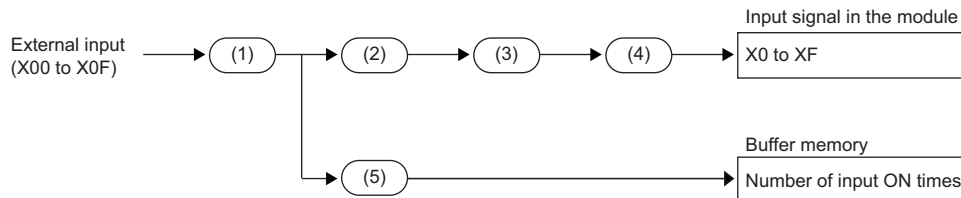

No.	Processing
(1)	Input response time setting function
(2)	Input delay function <ul style="list-style-type: none"> <li>• OFF delay</li> <li>• ON delay</li> <li>• Pulse stretch</li> </ul>
(3)	Input HOLD/CLEAR function
(4)	Event time stamp function
(5)	Number of input ON times integration function

## Input response time setting function

This function allows changing the input response times of the input module with diagnostic functions for each input. The input module with diagnostic functions takes in external inputs with the set input response times.

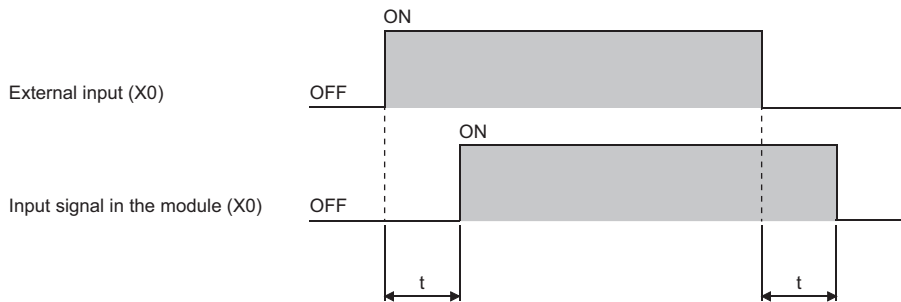

t: Input response time

### Setting procedure

Set the following item from "Basic setting".

- "Input response time setting" (  Page 95 Input response time setting)

 [Navigation window] ⇒ [Parameter] ⇒ [Module Information] ⇒ Target module ⇒ [Module Parameter] ⇒ [Basic setting]

### Input response time and pulse width to be ignored as noise

The input module with diagnostic functions may take in noise and others as input because of the setting of an input response time.

The following table lists the minimum pulse widths that can be taken in as input. The pulse width to be ignored as noise should be less than the following minimum values:

Set an input response time with due consideration for the following values and use environment.

Input response time setting value	Minimum pulse width that can be taken in as input (Reference value)
1ms	1.0ms
5ms	5.0ms
10ms	10.0ms
20ms	20.0ms
70ms	70.0ms

# Input HOLD/CLEAR function

This function allows setting whether to hold or clear the input status just before an error (alarm, minor error, or moderate error) when the error is detected in the input module with diagnostic functions.

Depending on whether "Input HOLD/CLEAR function enable/disable" is enabled or disabled, the input module with diagnostic functions operates differently when an error is detected.

Input HOLD/CLEAR function enable/disable	Enable (default)		Disable
	CLEAR	HOLD (default)	CLEAR/HOLD (default)
Input status just before an error	OFF	OFF	OFF
	ON	OFF*1	ON

\*1 When a moderate error is detected, the input status remains on.

The following table lists the target inputs to be held or cleared for each type of detected errors.

Detected error	Target input to be held or cleared
Alarm*2	Only the input with an alarm
Minor error, moderate error*3	All inputs

\*2 When an alarm is detected, 'Alarm flag' (X11) turns on.

\*3 When a minor error or moderate error is detected, 'Error flag' (X10) turns on.

- When 'Alarm flag' (X11) turns on, the input is held or cleared. When 'Alarm flag' (X11) turns off, the HOLD/CLEAR state is cleared.
- When 'Error flag' (X10) turns on, the input is held or cleared. When 'Error flag' (X10) turns off, the HOLD/CLEAR state is cleared.
- When both 'Alarm flag' (X11) and 'Error flag' (X10) turn on, the HOLD/CLEAR state is cleared when both the flags turn off. When only one of them turns off, the HOLD/CLEAR state is not cleared.

## Ex.

Operation of when "Input HOLD/CLEAR function setting" is set to "CLEAR"

- When the external input remains on

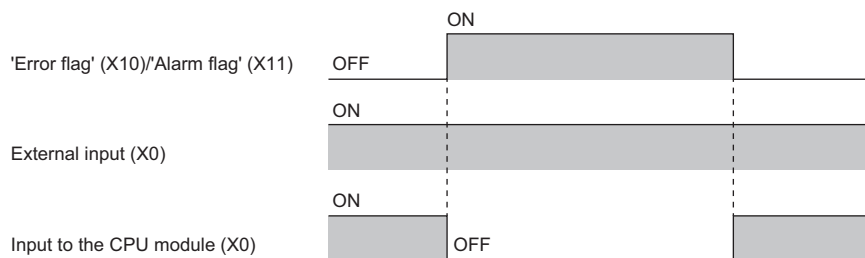

- When the external input turns off

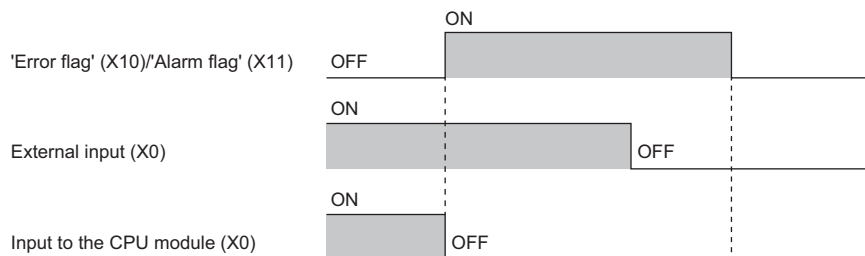



**Ex.**

Operation of when "Input HOLD/CLEAR function setting" is set to "HOLD"

- When the external input remains on

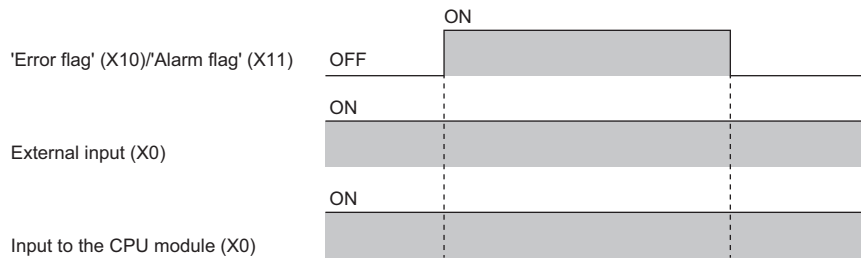

- When the external input turns off

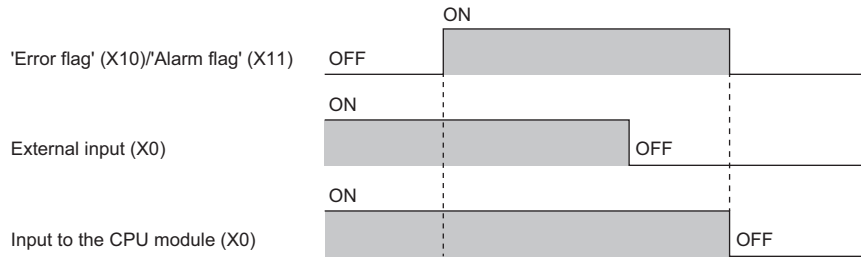

## Setting procedure

Set the following items from "Basic setting".

- "Input HOLD/CLEAR function enable/disable" ( Page 95 Input HOLD/CLEAR function enable/disable)
- "Input HOLD/CLEAR function setting" ( Page 96 Input HOLD/CLEAR setting)

[Navigation window] ⇒ [Parameter] ⇒ [Module Information] ⇒ Target module ⇒ [Module Parameter] ⇒ [Basic setting]

# Input delay function

This function allows changing the status of an X signal in the module after a certain time (input delay time) elapsed when the status of the external input changes.

The input delay function has the following three functions.

- OFF delay
- ON delay
- Pulse stretch

## Point

- The input delay time does not include the external input response time.
- The input delay time is set in the range of 1 to 150000 (in increments of 400 $\mu$ s, 400 $\mu$ s to 60s).
- The accuracy of the input delay time is from 0 to 400 $\mu$ s.
- When the inter-module synchronization function is used, the input delay function cannot be used together. (The settings for the input delay function are ignored.)
- The OFF delay, ON delay, and pulse stretch can be enabled only individually.

## OFF delay

When an external input turns off, this function turns off the X signal after a certain time (input delay time) elapsed.

When the input delay time is set to a value larger than the scan time while the OFF delay is used, the program can recognize that the external input turns on even if its ON time is short.

Even when the external input device is replaced, the program can be used as it is only by changing the setting value of the input delay time.

### Operation of the OFF delay

The following figure shows an operation example of the OFF delay.

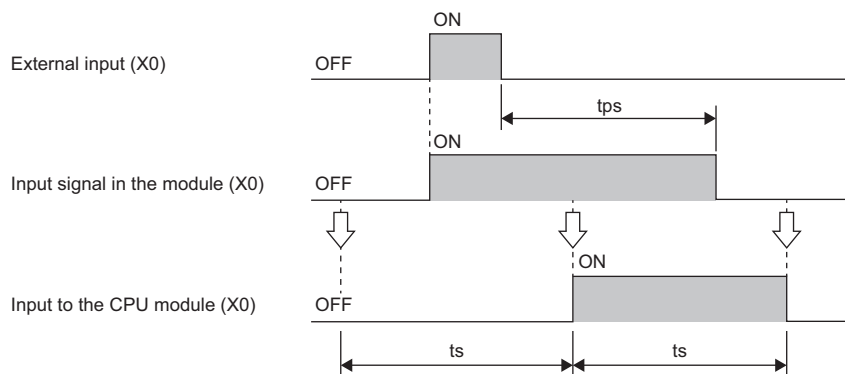

tps: Input delay time

ts: Scan time

↓: END processing of the CPU module

## ON delay

When an external input turns on, this function turns on the X signal after a certain time (input delay time) elapsed.

When the input delay time is set to a value larger than the scan time while the ON delay is used, the program can recognize that the external input turns off even if its OFF time is short.

Even when the external input device is replaced, the program can be used as it is only by changing the setting value of the input delay time.

### ■ Operation of the ON delay

The following figure shows an operation example of the ON delay.

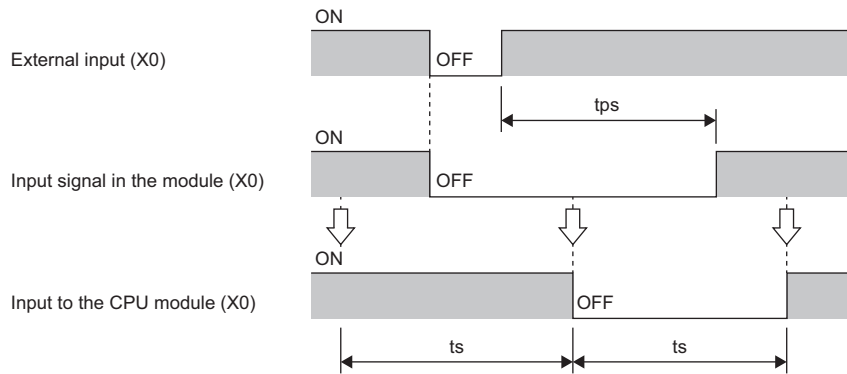

tps: Input delay time

ts: Scan time

⇩: END processing of the CPU module

## Pulse stretch

When a status change of an external input is detected, this function can hold the signal status before the change for a certain time (input delay time) from the change. (When a status change of an external input is detected, the external input is not taken in until a certain time has elapsed from the change.)

After a certain time has elapsed, taking in the external input starts.

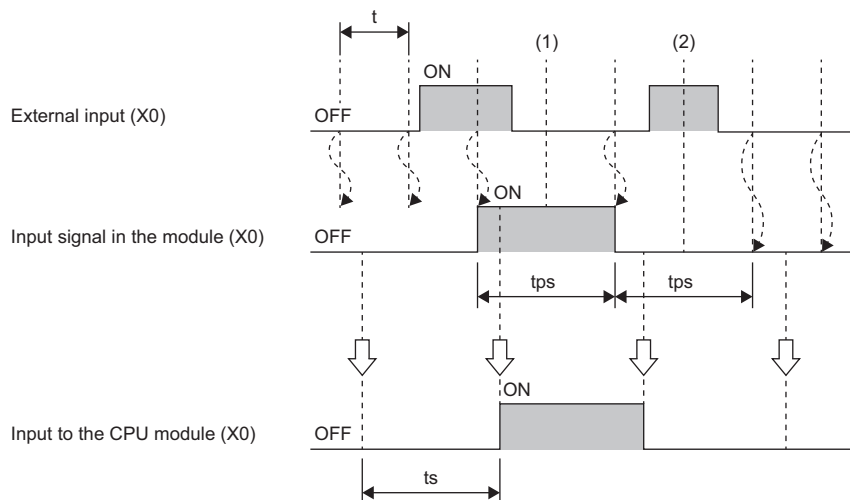

t: Control cycle (200 $\mu$ s)

$t_{ps}$ : Input delay time

$t_s$ : Scan time

↓: END processing of the CPU module

(1): Because the signal is ignored until a certain time ( $t_{ps}$ ) has elapsed after the status of the external input changes, the OFF state is not recognized.

(2): Because the signal is ignored until a certain time ( $t_{ps}$ ) has elapsed after the status of the external input changes, the ON state is not recognized.

## Setting procedure

Set the following items from "Application setting".

- "Input delay function enable/disable" (☞ Page 96 Input delay function enable/disable)
- "Input delay type setting" (☞ Page 97 Input delay type setting)
- "Input delay time setting" (☞ Page 97 Input delay time setting)

☞ [Navigation window] ⇒ [Parameter] ⇒ [Module Information] ⇒ Target module ⇒ [Module Parameter] ⇒ [Application setting]

## Number of input ON times integration function

This function counts the number of times that an external input turns on.

When the number of input ON times alarm detection count has been set and the number of input ON times reaches the set value, an alarm occurs.

### Number of input ON times integration

The input module with diagnostic functions counts the number of times that an external input turns on in the range from 0 to 4294967295.

When the number of input ON times exceeds the maximum value, the count stops. To continue the count, clear the number of input ON times with 'Number of input ON times value clear request' (Un\G3584). (The count starts from 0.)

The number of input ON times is counted for each external input. Only for the input for which "Input ON Number Count Function enable/disable" is set to "Enable", the number of input ON times is counted.

The number of input ON times is stored in 'Number of input ON times' (Un\G2848 to Un\G2879).

#### Point

- When the input delay function is enabled, the number of input ON times is counted at the timing when the delayed input turns on.
- The number of input ON times is recorded in the non-volatile memory of the input module with diagnostic functions every second and at power-off. The number of input ON times recorded in the non-volatile memory is restored in 'Number of input ON times' (Un\G2848 to Un\G2879) when the power is turned on or the CPU module is reset. Therefore, the number of input ON times is held even if the power is turned off or the CPU module is reset.

### ■ Operation of the number of input ON times integration function

The following figure shows an operation example of the number of input ON times integration function.

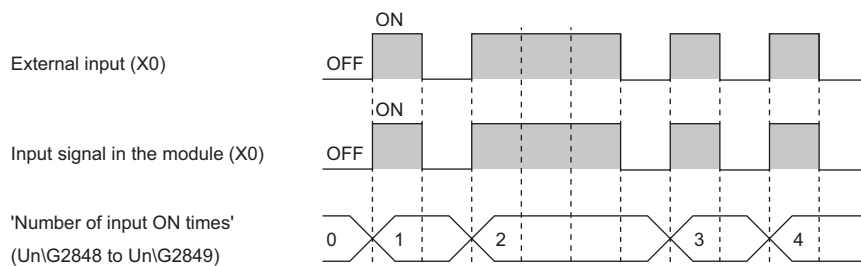

## Number of input ON times alarm detection notification

To use the number of input ON times alarm detection notification, set "Number of input ON times alarm detect setting" to "To detect" and set "Number of input ON times alarm detect count setting".

When the number of input ON times reaches the number of input ON times alarm detection count (set value), an alarm (Number of input ON times alarm detection count reached) occurs.

The details of the alarm can be checked in the module diagnostics window of the engineering tool.

The alarm occurrence can be checked with the ALM LED.

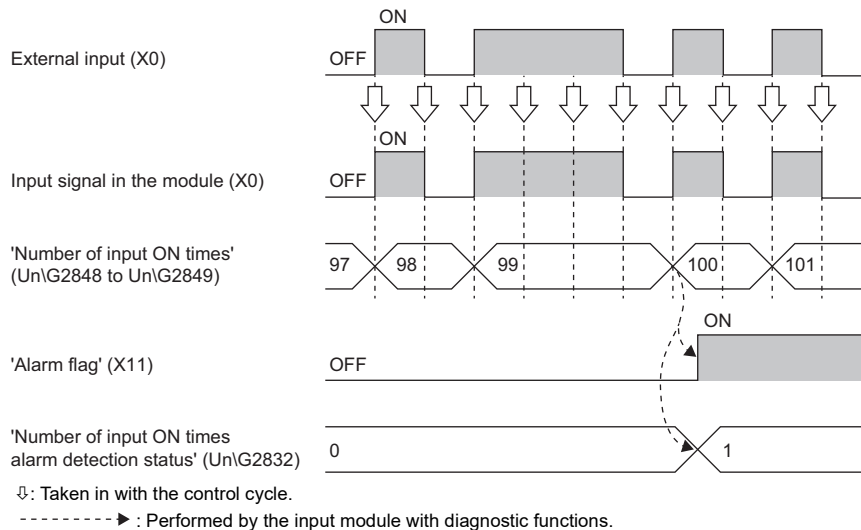

### Point

In the following cases, an alarm occurs immediately.

- When the number of input ON times has already reached the number of input ON times alarm detection count at power-on
- When a value equal to or less than the current number of input ON times is set as the number of input ON times alarm detection count

## Clearing an alarm

Although the number of input ON times is cleared to 0, an alarm is not cleared. To clear the alarm, turn on and off 'Alarm clear request' (Y11) after clearing 'Number of input ON times' (UnG2848 to UnG2879).

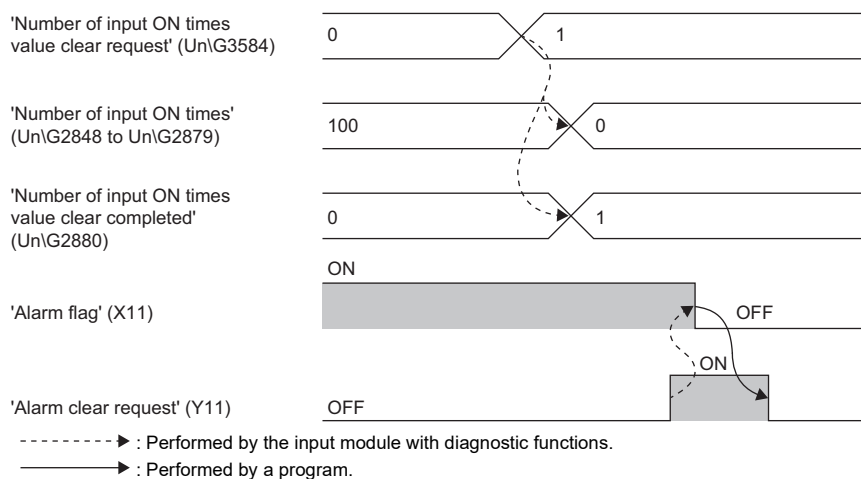

## Clearing the number of input ON times

The number of input ON times can be cleared with 'Number of input ON times value clear request' (Un\G3584).

Each bit of 'Number of input ON times value clear request' (Un\G3584) corresponds to each input.

When the bit corresponding to the input to be cleared is changed from 0 (Not requested) to 1 (Requested), the value of 'Number of input ON times' (Un\G2848 to Un\G2879) is cleared and 1 (Completed) is stored in 'Number of input ON times value clear completed' (Un\G2880).

Even if 1 (Completed) is stored in 'Number of input ON times value clear completed' (Un\G2880), the bit of 'Number of input ON times value clear request' (Un\G3584) is not automatically changed to 0 (Not requested). Set 0 (Not requested) in 'Number of input ON times value clear request' (Un\G3584) with a program.

When 0 (Not requested) is stored in 'Number of input ON times value clear request' (Un\G3584), the bit of 'Number of input ON times value clear completed' (Un\G2880) is changed to 0 (Not completed).

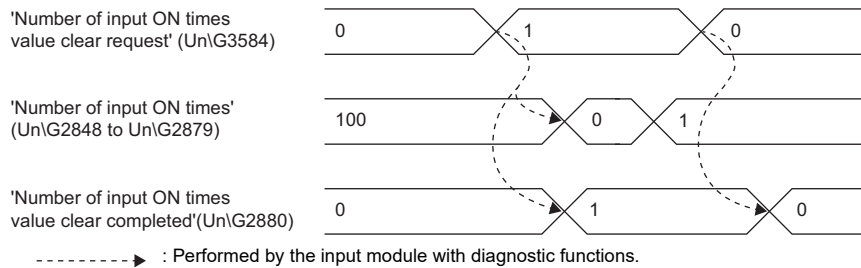

For each bit of 'Number of input ON times value clear request' (Un\G3584) and the input to be cleared, refer to the following.

☞ Page 113 Number of input ON times value clear request

## Setting procedure

Set the following items from "Application setting".

- "Input ON Number Count Function enable/disable" (☞ Page 98 Number of input ON times integration function enable/disable)
- "Number of input ON times alarm detect count setting" (☞ Page 99 Number of input ON times alarm detection count setting)
- "Number of input ON times alarm detect setting" (☞ Page 98 Number of input ON times alarm detection setting)

🔗 [Navigation window] ⇨ [Parameter] ⇨ [Module Information] ⇨ Target module ⇨ [Module Parameter] ⇨ [Application setting]

# Event time stamp function

This function records the time data when an input status changes.

When this function is used, the events in the entire system can be recorded in the correct order of occurrence based on the time data and time stamp value recorded individually by the input module with diagnostic functions. This record helps investigate a cause when a trouble occurs.

Up to 128 event time stamp data sets can be recorded in a module.

The event time stamp data recorded in the input module with diagnostic functions can be read to the CPU module and saved to an SD memory card using function blocks (FB). (To use function blocks (FB), set "Target" to "Module Label" in "Refresh settings".)

Module labels and function blocks (FB) cannot be used when the input module with diagnostic functions is used with a remote head module.

To read the event time stamp data, use the REMFR instruction.

However, when the scan time of the CPU module is long, all the time stamp data set of the events which have occurred may not be read.

## Starting collecting event time stamp data

To start collecting the event time stamp data, set the parameter for using the event time stamp function and turn on and off 'Operating condition setting request' (Y12).

The event time stamp data is collected at the interval of 200µs.

When the status of an external input changes, the time data at the change, the set condition (rise or fall), and the terminal number of the changed input are stored in Event time stamp data (UnG4608 to UnG5375).

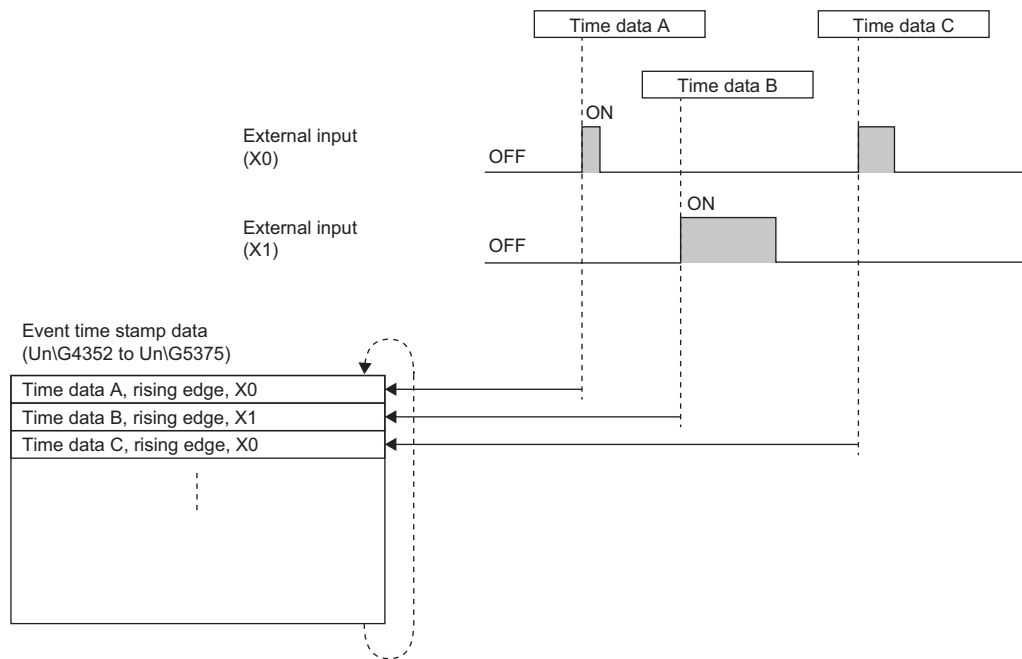

## Accuracy

The accuracy of the time data of the event time stamp data is 1ms.

### Point

The accuracy of when the module is mounted on a slave station of CC-Link IE Field Network is 730ms at a maximum.



## Event time stamp data

Collected event time stamp data is stored in Event time stamp data (Un\G4608 to Un\G5375).

After Event time stamp data (Un\G4608 to Un\G5375) becomes full, the data is overwritten from the first data area.

Event time stamp data

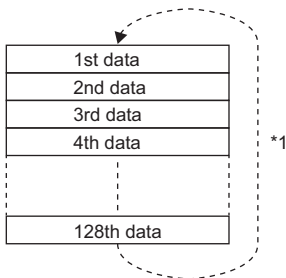

\*1 After 128 data sets are stored, the data is overwritten from the first data area.

## Reading and saving event time stamp data

Event time stamp data can be read to the CPU module and saved to an SD memory card in the CSV file format.

To read the event time stamp data to the CPU module or save it to an SD memory card in the CSV file format, use function blocks (FB).

I/O:0010	Event type	Input terminal	Store State
DATE:2015/06/30 10:10:30.123	1	X01	0
DATE:2015/06/30 10:20:30.456	0	X0F	0
DATE:2015/06/30 11:15:30.789	1	X02	0
DATE:2015/07/01 14:15:30.012	0	X1C	0
DATE:2015/07/02 16:15:30.345	1	X03	0

(1) Header row  
(2) Data row  
(3) Data column

### Point

- To use function blocks (FB), set "Target" to "Module Label" in "Refresh settings".
- Module labels and function blocks (FB) cannot be used when the input module with diagnostic functions is used with a remote head module. To read the event time stamp data, use the REMFR instruction.

## Setting for not-refreshed data

Whether to overwrite the event time stamp data which have not been read can be set for when an external input status changes 128 times or more before the CPU module refreshes the event time stamp data.



- When the event time stamp data is not overwritten (default), the 128 data sets which have not been read are held and the subsequent data sets are discarded.
- When the event time stamp data is overwritten, the data is overwritten with the 129th data set or later from the oldest one even if the data to be overwritten has not been read.

In the following cases, 1 (Discarded/Overwritten) is stored in 'Event time stamp storage status' (Un\G4354).

- When "Data setting which the refresh is not completed yet" has been set to "Don't overwrite" and the data is discarded
- When "Data setting which the refresh is not completed yet" has been set to "Overwrite" and not-refreshed event time stamp data is overwritten.

## Setting procedure

Set the following items from "Application setting".

- "Event time stamp function enable/disable" (  Page 99 Event time stamp function enable/disable)
- "Event time stamp condition setting" (  Page 100 Event time stamp condition setting)
- "Data setting which the refresh is not completed yet" (  Page 100 Setting for not-refreshed data)

 [Navigation window] ⇨ [Parameter] ⇨ [Module Information] ⇨ Target module ⇨ [Module Parameter] ⇨ [Application setting]

## 1.2 Output Function

This function outputs the output data specified by the CPU module to the external device without any change.

However, when the output delay function is enabled, the ON/OFF state of Y signals (Y0 to YF) and the ON/OFF state of the external outputs (Y0 to YF) may not match.

The following figure shows the processing procedure of the output function.

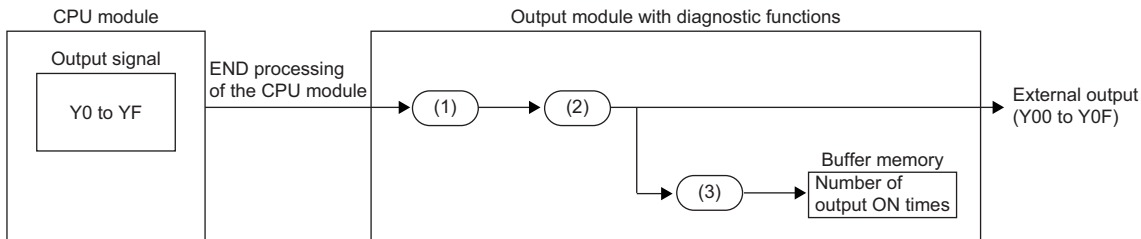

No.	Processing
(1)	Output delay function • OFF delay • ON delay
(2)	Setting of output mode at error
(3)	Number of output ON times integration function

### Setting of output mode at error

This function allows setting whether to hold or clear the output status just before a CPU stop error when the error has occurred.

#### Setting procedure

Set the following item from "Basic setting".

- "In-Error Output Mode Setting" (☞ Page 92 Setting of output mode at error)

☞ [Navigation window] ⇒ [Parameter] ⇒ [Module Information] ⇒ Target module ⇒ [Module Parameter] ⇒ [Basic setting]

# Output delay function

When the status of an output signal from the CPU module is changed, this function changes the status of the external output after a certain time (output delay time) elapsed.

The output delay function has the following two functions.

- OFF delay
- ON delay

## Point

- The output delay time does not include the response time of the hardware.
- The output delay time is set in the range of 1 to 150000 (in increments of 400 $\mu$ s, 400 $\mu$ s to 60s).
- The accuracy of the output delay time is from 0 to 400 $\mu$ s.
- When the inter-module synchronization function is used, the output delay function cannot be used together. (The settings for the output delay function are ignored.)
- The OFF delay and ON delay can be enabled only individually.

## OFF delay

When an output signal from the CPU module is turned off, this function turns off the external output after a certain time (output delay time) elapsed.

The ON state of an external output can be held for a certain time by using the OFF delay even if the output signal from the CPU module is turned off.

### ■ Operation of the OFF delay

The following figure shows an operation example of the OFF delay.

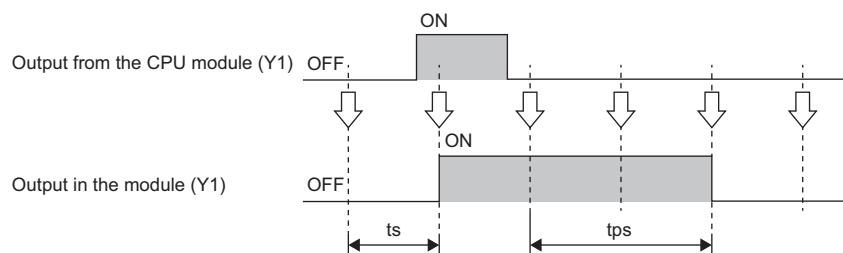

- tps: Output delay time  
ts: Scan time  
↓: END processing of the CPU module

## ON delay

When an output signal from the CPU module is turned on, this function turns on the external output after a certain time (output delay time) elapsed.

The OFF state of an external output can be held for a certain time by using the ON delay even if the output signal from the CPU module is turned on.

### ■Operation of the ON delay

The following figure shows an operation example of the ON delay.

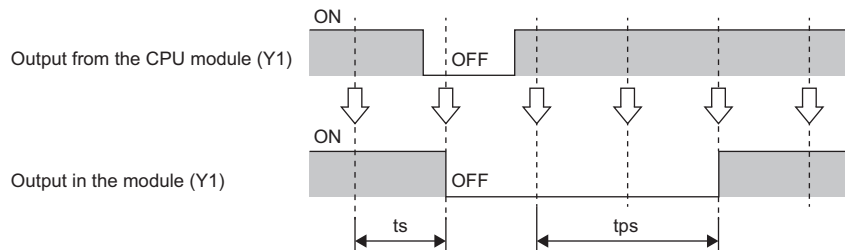

tps: Output delay time  
 ts: Scan time  
 ↓: END processing of the CPU module

## Setting procedure

Set the following items from "Application setting".

- "Output delay function enable/disable" (☞ Page 102 Output delay function enable/disable)
- "Output delay type setting" (☞ Page 102 Output delay type setting)
- "Output delay time setting" (☞ Page 103 Output delay time setting)

☞ [Navigation window] ⇒ [Parameter] ⇒ [Module Information] ⇒ Target module ⇒ [Module Parameter] ⇒ [Application setting]

# Number of output ON times integration function

This function counts the number of times that an output from the CPU module turns on.

When the number of output ON times alarm detection count has been set and the number of output ON times reaches the set value, an alarm occurs.

This function helps predict the life of external connected devices.

## Number of output ON times integration

The output module with diagnostic functions counts the number of times that an output turns on in the range from 0 to 4294967295.

When the number of output ON times exceeds the maximum value, the count stops. To continue the count, clear the number of output ON times with 'Number of output ON times value clear request' (Un\G3840). (The count starts from 0.)

The number of output ON times is counted for each external output. Only for the output for which "Output ON number count function enable/disable" is set to "Enable", the number of output ON times is counted.

The number of output ON times is stored in 'Number of output ON times' (Un\G3136 to Un\G3167).

### Point

- The number of output ON times is recorded in the non-volatile memory of the output module with diagnostic functions every second and at power-off. The number of output ON times recorded in the non-volatile memory is restored in 'Number of output ON times' (Un\G3136 to Un\G3167) when the power is turned on or the CPU module is reset. Therefore, the number of output ON times is held even if the power is turned off or the CPU module is reset.

## Operation of the number of output ON times integration function

The following figure shows an operation example of the number of output ON times integration function.

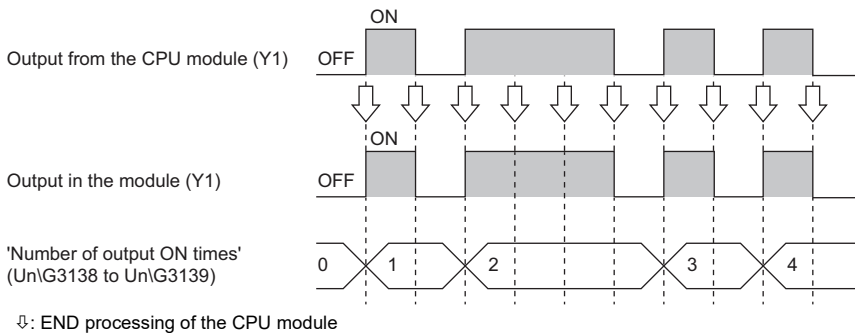

## Number of output ON times alarm detection notification

To use the number of output ON times alarm detection notification, set "Number of output ON times alarm detect setting" to "To detect" and set "Number of output ON times alarm detect count setting".

When the number of output ON times reaches the number of output ON times alarm detection count (set value), an alarm (Number of output ON times alarm detection count reached) occurs.

The details of the alarm can be checked in the module diagnostics window of the engineering tool.

The alarm occurrence can be checked with the ALM LED.

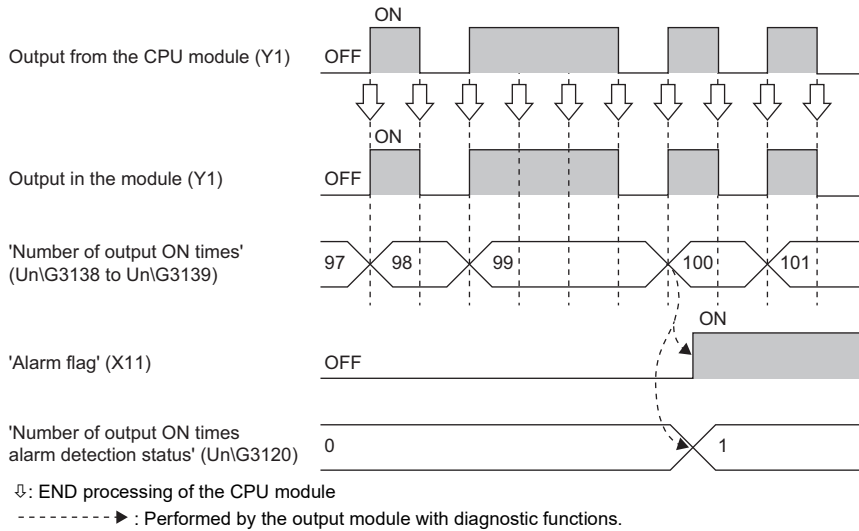

### Point

In the following cases, an alarm occurs immediately.

- When the number of output ON times has already reached the number of output ON times alarm detection count at power-on
- When a value equal to or less than the current number of output ON times is set as the number of output ON times alarm detection count

### Clearing an alarm

Although 'Number of output ON times' (Un\G3136 to Un\G3167) is cleared to 0, an alarm is not cleared. To clear the alarm, turn on and off 'Alarm clear request' (Y11) after clearing 'Number of output ON times' (Un\G3136 to Un\G3167).

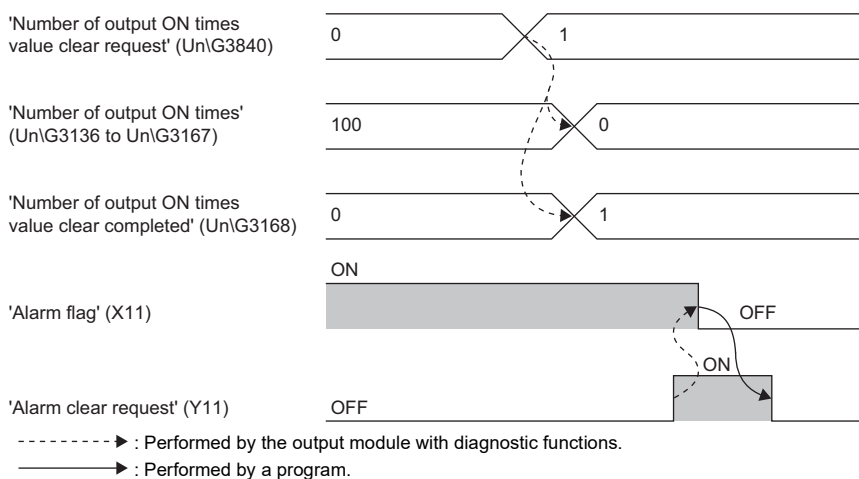

## Clearing the number of output ON times

The number of output ON times can be cleared with 'Number of output ON times value clear request' (Un\G3840).

Each bit of 'Number of output ON times value clear request' (Un\G3840) corresponds to each output.

When the bit corresponding to the output to be cleared is changed from 0 (Not requested) to 1 (Requested), the value of 'Number of output ON times' (Un\G3136 to Un\G3167) is cleared and 1 (Completed) is stored in 'Number of output ON times value clear completed' (Un\G3168).

Even if 1 (Completed) is stored in 'Number of output ON times value clear completed' (Un\G3168), the bit of 'Number of output ON times value clear request' (Un\G3840) is not automatically changed to 0 (Not requested). Set 0 (Not requested) in 'Number of output ON times value clear request' (Un\G3840) with a program.

When 0 (Not requested) is stored in 'Number of output ON times value clear request' (Un\G3840), the bit of 'Number of output ON times value clear completed' (Un\G3168) is changed to 0 (Not completed).

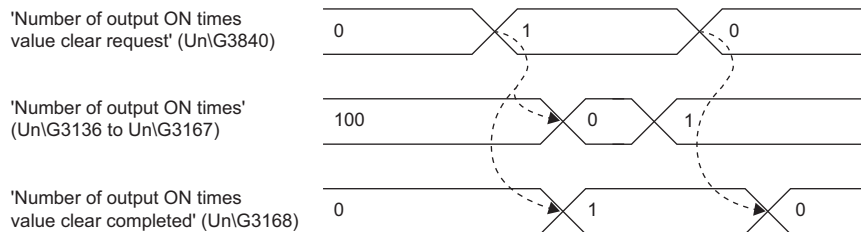

For each bit of 'Number of output ON times value clear request' (Un\G3840) and the output to be cleared, refer to the following.

Page 113 Number of output ON times value clear request

## Setting procedure

Set the following items from "Application setting".

- "Output ON number count function enable/disable" ( Page 103 Number of output ON times integration function enable/disable)
- "Number of output ON times alarm detect setting" ( Page 104 Number of output ON times alarm detection setting)
- "Number of output ON times alarm detect count setting" ( Page 104 Number of output ON times alarm detection count setting)

[Navigation window] ⇒ [Parameter] ⇒ [Module Information] ⇒ Target module ⇒ [Module Parameter] ⇒ [Application setting]



# 1.3 Common Functions of the I/O Module with Diagnostic Functions

This section describes the functions common to the input module with diagnostic functions and the output module with diagnostic functions.

## Interrupt function

When an interrupt factor is detected, this function generates an interrupt to the CPU module.

With this function, an interrupt program can be started when an error or other event occurs.

Up to 16 interrupt pointers can be used in the I/O module with diagnostic functions for each module.

### Setting procedure

Set the following items in "Interrupt setting".

- "Interrupt condition target setting"
- "Interrupt condition target input output terminal setting range"
- "Interrupt pointer"

 [Navigation window] ⇒ [Parameter] ⇒ [Module Information] ⇒ Target module ⇒ [Module Parameter] ⇒ [Interrupt setting]

Item	Description
Interrupt condition target setting [n] <sup>*1</sup>	Select a target factor of interrupt detection.
Interrupt condition target input output terminal setting range [n] <sup>*1</sup>	Set the target I/O terminal number so that if an interrupt factor is detected on the set terminal, an interrupt is performed.
Interrupt pointer	Specify the number of an interrupt pointer which is started when an interrupt factor is detected.

\*1 n indicates the interrupt setting number. (n: 1 to 16)

#### ■ Interrupt condition target setting [n]

Select a target factor of interrupt detection.

- Input module with diagnostic functions

Item	Target condition	Detection timing
Interrupt condition target setting [n] <sup>*1</sup>	Disable (default value)	Interrupt detection is not performed.
	Error flag	The rise (OFF to ON) of 'Error flag' (X10) is detected.
	Alarm flag	The rise (OFF to ON) of 'Alarm flag' (X11) is detected.
	Disconnection detection state	The rise (0 (Normal) to 1 (Disconnection detected)) of Input disconnection detection status is detected.
	Number of input ON times alarm detect status	The rise (0 (Normal) to 1 (Alarm detection count reached)) of Number of input ON times alarm detection status is detected.
	Input signal (Rising)	The rise (OFF to ON) of Input signal (X0 to XF) is detected.
	Input signal (Falling)	The fall (ON to OFF) of Input signal (X0 to XF) is detected.
	Input signal (Rising and Falling)	The rise (OFF to ON) and fall (ON to OFF) of Input signal (X0 to XF) are detected.

\*1 n indicates the interrupt setting number. (n: 1 to 16)

- Output module with diagnostic functions

Item	Target condition	Detection timing
Interrupt condition target setting [n] <sup>*2</sup>	Disable (default value)	Interrupt detection is not performed.
	Error flag	The rise (OFF to ON) of 'Error flag' (X10) is detected.
	Alarm flag	The rise (OFF to ON) of 'Alarm flag' (X11) is detected.
	Disconnection detection state	The rise (0 (Normal) to 1 (Disconnection detected)) of Output disconnection detection status is detected.
	Output Short-circuit detection state	The rise (0 (Normal) to 1 (Short circuit detected)) of Output short-circuit detection status is detected.
	Number of output ON times alarm detect status	The rise (0 (Normal) to 1 (Alarm detection count reached)) of Number of output ON times alarm detection status is detected.

\*2 n indicates the interrupt setting number. (n: 1 to 16)

## ■ Interrupt condition target input output terminal setting range [n]

Set the target I/O terminal number so that if an interrupt factor is detected on the set terminal, an interrupt is performed.

- Input module with diagnostic functions

Item	Setting range
Interrupt condition target input output terminal setting range [n] <sup>*1</sup>	X00
	X01
	X02
	X03
	X04
	X05
	X06
	X07
	X08
	X09
	X0A
	X0B
	X0C
	X0D
	X0E
	X0F
	All input terminal designation <sup>*2</sup>

\*1 n indicates the interrupt setting number. (n: 1 to 16)

\*2 X00 to X0F are set as the interrupt condition target input terminals.

- Output module with diagnostic functions

Item	Setting range
Interrupt condition target input output terminal setting range [n] <sup>*3</sup>	Y00
	Y01
	Y02
	Y03
	Y04
	Y05
	Y06
	Y07
	Y08
	Y09
	Y0A
	Y0B
	Y0C
	Y0D
	Y0E
	Y0F
	All output terminal designation <sup>*4</sup>

\*3 n indicates the interrupt setting number. (n: 1 to 16)

\*4 Y00 to Y0F are set as the interrupt condition target output terminals.

## ■ Interrupt pointer

Specify the number of an interrupt pointer which is started when an interrupt factor is detected. For details on the interrupt pointers, refer to the following.

 MELSEC iQ-R CPU Module User's Manual (Application)

## Setting example

**Ex.**

To execute an interrupt program when a disconnection is detected at X0 of the input module with diagnostic functions

- Parameter setting

Set "Interrupt setting" of the module parameters as shown below.

No.	Interrupt condition target setting	Interrupt condition target input output terminal setting range	Interrupt pointer
1	Disconnection detection state	X00	I50

- Label setting

Classification	Label name	Description	Device								
Module label	RCPU.stSM.bAlways_ON	Always ON	SM400								
	RCPU.stSM.bAfter_RUN1_Scan_ON	ON only for a scan after RUN	SM402								
	RX40NC6B_1.unInterruptFactorMask_D[0]	Interrupt factor mask [1]	U0\G3344								
	RX40NC6B_1.unInterruptFactorResetRequest_D[0]	Interrupt factor reset request [1]	U0\G3328								
Defined labels	Define global labels as shown below.										
	<table border="1"> <thead> <tr> <th>Label Name</th> <th>Data Type</th> <th>Class</th> <th>Assign (Device/Label)</th> </tr> </thead> <tbody> <tr> <td>1 G_bDisconnectDetection</td> <td>Bit</td> <td>VAR_GLOBAL</td> <td>F0</td> </tr> </tbody> </table>			Label Name	Data Type	Class	Assign (Device/Label)	1 G_bDisconnectDetection	Bit	VAR_GLOBAL	F0
Label Name	Data Type	Class	Assign (Device/Label)								
1 G_bDisconnectDetection	Bit	VAR_GLOBAL	F0								

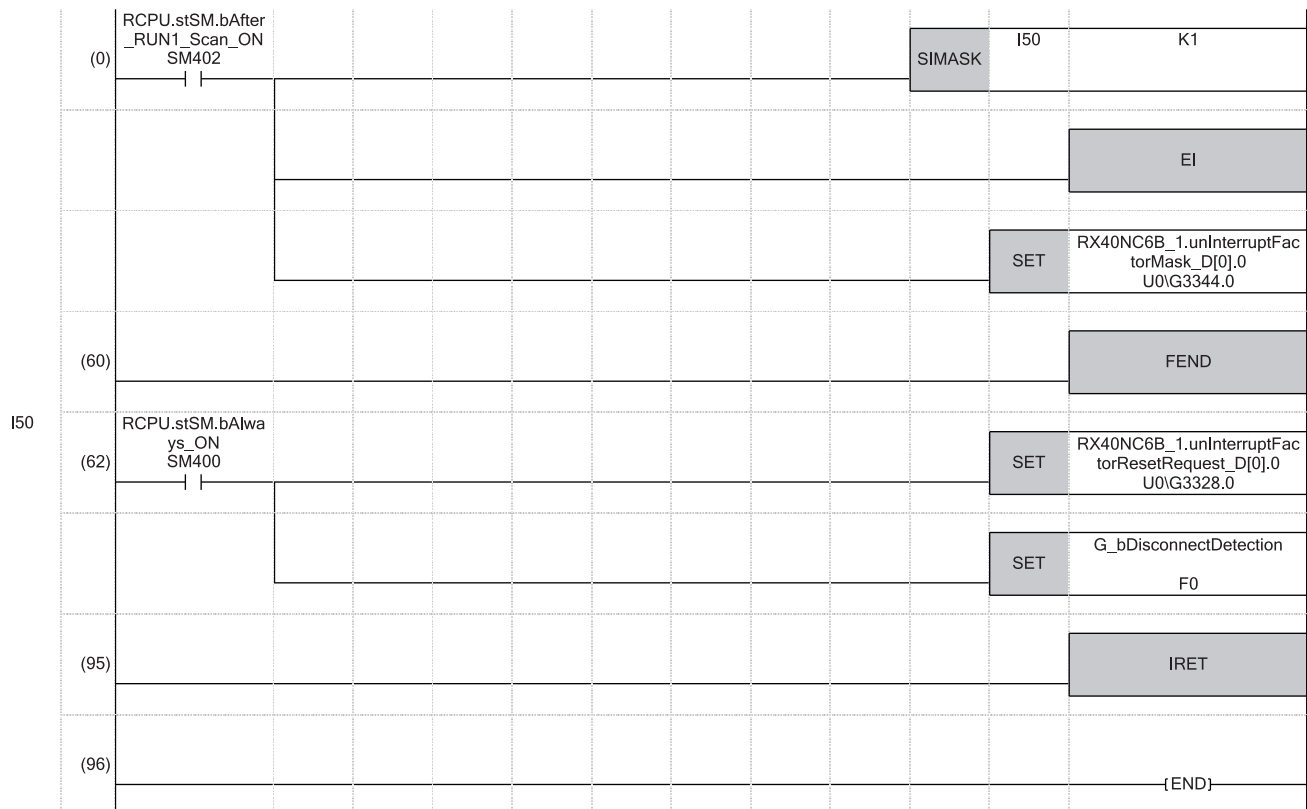

- (0) Only the interrupt pointer I50 can be executed.
- (62) "Interrupt factor reset request [1]" (U0\G3328) is turned on. The processing at disconnection detection is performed.

# LED indication setting on error condition

This function enables setting the indication of the I/O status indicator LED for when an error occurs. The following figure shows the LED status on normal and abnormal conditions.

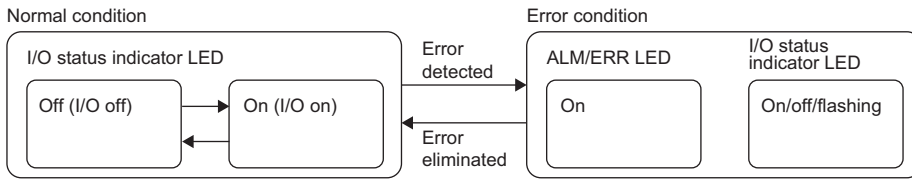

## LED indication on error condition

The ERR/ALM LED turns on when an error is detected.

The indication of the I/O status indicator LED can be set in "LED display setting when error occurred" for when an error is detected.

### ■Hide abnormal occurrence points

The ON/OFF state of an I/O is indicated.

When the ERR/ALM LED is on, check the I/O with an error with the error history/alarm history.

### ■Always display abnormal occurrence points

Only the LEDs of I/Os with an error turn on. The LEDs of I/Os without error are off. (The ON/OFF state of input/output cannot be indicated.)

The indications of the ERR/ALM LED and I/O status indicator LED enable identifying the input/output with an error.

### ■Switching display of input status and alarm (1 second intervals)

The LED indication is switched between "Hide abnormal occurrence points" and "Always display abnormal occurrence points" at the interval of a second.

Check the I/O with an error with the error history or alarm history.

## Setting procedure

Set the following item from "Basic setting".

- "LED display setting when error occurred" (  Page 92 LED indication setting on error condition)

 [Navigation window] ⇒ [Parameter] ⇒ [Module Information] ⇒ Target module ⇒ [Module Parameter] ⇒ [Basic setting]

# 1.4 Diagnostic Function

## Input disconnection detection function

This function detects disconnections in input wiring.

When the input current is 20ms or higher, or 0.3mA/point or lower, a disconnection (no connection) is detected.

When the leakage current of the input device is 0.3mA/point or lower, connect a bleeder resistor (resistance value as a guide: approximately 56kΩ) in parallel near the input device.

When the external power supply is not supplied, the input disconnection detection function does not operate properly.

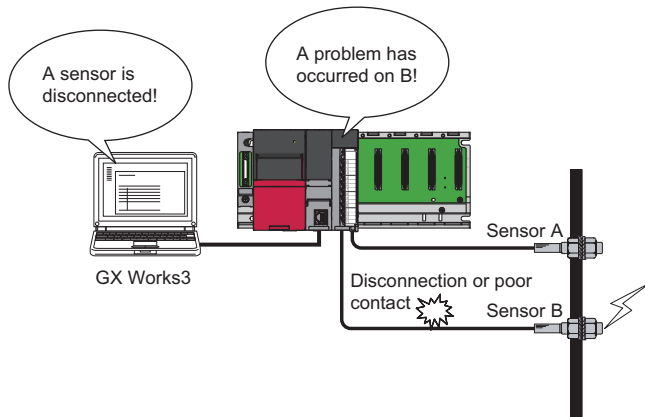

### Operation of when an error is detected

When a disconnection occurs or no wiring is connected at an input terminal where "Input disconnection detection setting" is set to "To detect", this function judges this state as a disconnection and 1 (Disconnection detected) is stored in 'Input disconnection detection status' (Un\G2816).

When a disconnection is detected in the input module with diagnostic functions, an alarm (Input disconnection detection) occurs. At this time, the input status depends on the value in "Input HOLD/CLEAR function setting".

The details of the alarm can be checked in the module diagnostics window of the engineering tool.

When a disconnection is detected, the ALM LED on the front side of the module turns on.

## Operation of when a connection is recovered from a disconnection

The operation of when the cause of a disconnection is eliminated and the connection with the external device is recovered differs depending on the setting in "Input disconnection detection automatic clear enable/disable".

### ■When "Input disconnection detection automatic clear enable/disable" is set to "Disable"

The following shows the operation of when 'Alarm clear request' (Y11) is turned on and off.

- The value of 'Input disconnection detection status' (Un\G2816) changes from 1 (Disconnection detected) to 0 (Normal).
- 'Alarm flag' (X11) turns off.
- The ALM LED turns off.

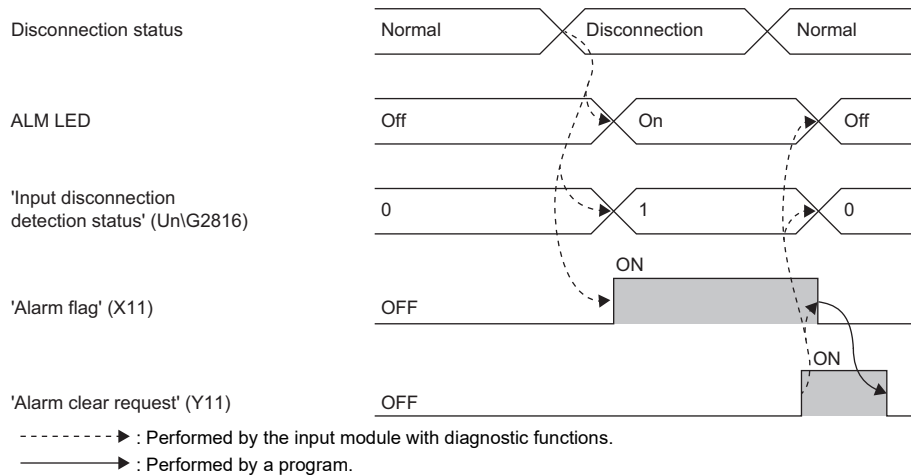

### ■When "Input disconnection detection automatic clear enable/disable" is set to "Enable"

The following shows the operation of when the connection is recovered from disconnection.

- The value of 'Input disconnection detection status' (Un\G2816) changes from 1 (Disconnection detected) to 0 (Normal).
- 'Alarm flag' (X11) turns off.
- The ALM LED turns off.

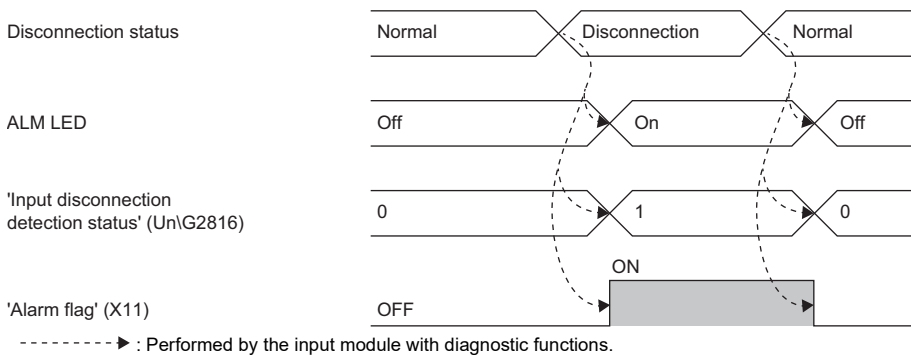

## Setting procedure

Set the following items from "Application setting".

- "Input disconnection detection setting" (📖 Page 101 Input disconnection detection setting)
- "Input disconnection detection automatic clear enable/disable" (📖 Page 101 Input disconnection detection automatic clear enable/disable)

🔍 [Navigation window] ⇒ [Parameter] ⇒ [Module Information] ⇒ Target module ⇒ [Module Parameter] ⇒ [Application setting]

## List of detectable conditions

The following shows the devices at which disconnection (no connection) can be detected and the detectable conditions for the sensor power supply.

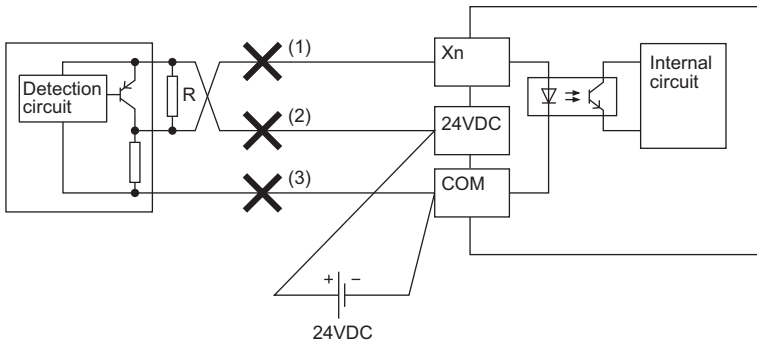

R: Bleeder resistor

◎: Detectable, ○: Detectable depending on the condition, ×: Undetectable

Connected device	Condition	Disconnection (no connection)		
		(1)	(2)	(3)
2-wire type input device	Leakage current is over 0.3mA.	◎	◎	—
	Leakage current is 0.3mA or lower.	○*1	○*1	—
3-wire type input device	Standby current is over 0.3mA.	◎	◎	×
	Standby current is 0.3mA or lower.	○*1	○*1	×

\*1 Connect a bleeder resistor (resistance value as a guide: approximately 56kΩ) in parallel near the input device.

## Output disconnection detection function

This function allows checking whether the load is disconnected or not when the output is off.

The minimum load current (at output ON) of when the disconnection detection function is used is 20ms or 3mA/point. If a load lower than 20ms, or lower than 3mA/point is used, a disconnection may be detected erroneously at output OFF.

When the external power supply is not supplied, the disconnection detection function does not operate properly.

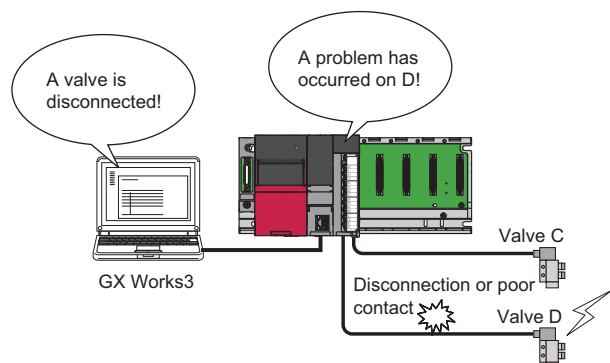

### Operation of when an error is detected

When a disconnection occurs or no wiring is connected at an output terminal where "Output disconnection detection setting" is set to "Not detected", this function judges this state as a disconnection and 1 (Disconnection detected) is stored in 'Output disconnection detection status'.

When a disconnection is detected in the output module with diagnostic functions, an alarm (Output disconnection detection) occurs.

The details of the alarm can be checked in the module diagnostics window of the engineering tool.

When a disconnection is detected, the ALM LED turns on.

#### Point

When an inductive load is used, the module may not judge the wiring status correctly.

Refer to the following manual to take appropriate measure against the back EMF or configure the setting of "Output disconnection detection disable time setting" using the engineering tool.

MELSEC iQ-R I/O Module (With Diagnostic Functions) User's Manual (Startup)



## Operation of when a connection is recovered from a disconnection

The operation of when the cause of a disconnection is eliminated and the connection with the external device is recovered differs depending on the setting in "Output disconnection detection automatic clear enable/disable".

### ■When "Output disconnection detection automatic clear enable/disable" is set to "Disable"

The following shows the operation of when 'Alarm clear request' (Y11) is turned on and off.

- The value of 'Output disconnection detection status' (Un\G3072) changes from 1 (Disconnection detected) to 0 (Normal).
- 'Alarm flag' (X11) turns off.
- The ALM LED turns off.

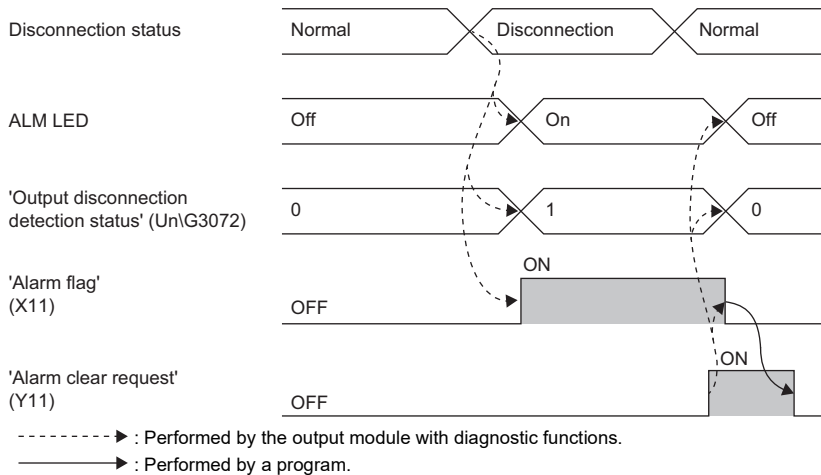

### ■When "Output disconnection detection automatic clear enable/disable" is set to "Enable"

The following shows the operation of when the connection is recovered from disconnection.

- The value of 'Output disconnection detection status' (Un\G3072) changes from 1 (Disconnection detected) to 0 (Normal).
- 'Alarm flag' (X11) turns off.
- The ALM LED turns off.

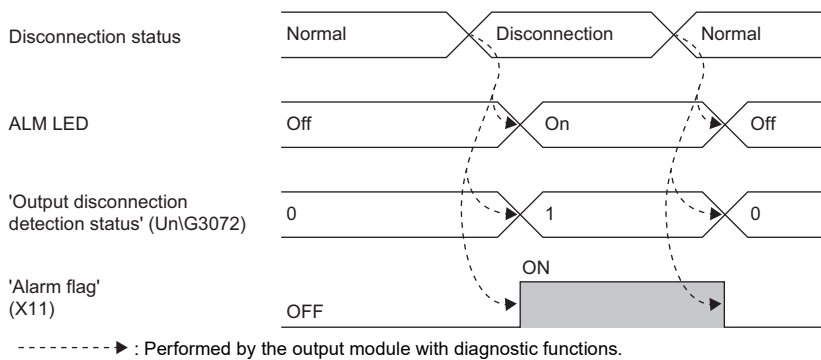

## Setting procedure

Set the following items from "Application setting".

- "Output disconnection detection setting" (☞ Page 105 Output disconnection detection setting)
- "Output disconnection detection disable time setting" (☞ Page 107 Output disconnection detection disable time setting)
- "Output disconnection detection automatic clear enable/disable" (☞ Page 105 Output disconnection detection automatic clear enable/disable)

☞ [Navigation window] ⇒ [Parameter] ⇒ [Module Information] ⇒ Target module ⇒ [Module Parameter] ⇒ [Application setting]

## ■Output disconnection detection disable time setting

With this setting, the time where disconnection detection is disabled after an output is turned off can be selected. The influence of back EMF immediately after an output is turned off can be eliminated and incorrect detections by the disconnection detection function can be reduced. Select a setting range from the table below depending on the connected device and application.

Item	Setting range
Output disconnection detection disable time setting	0ms
	100ms (default value)
	200ms
	300ms

## List of detectable conditions

The following shows the places at which disconnection (no connection) and short circuit (ground fault) can be detected and the detectable conditions for the sensor power supply.

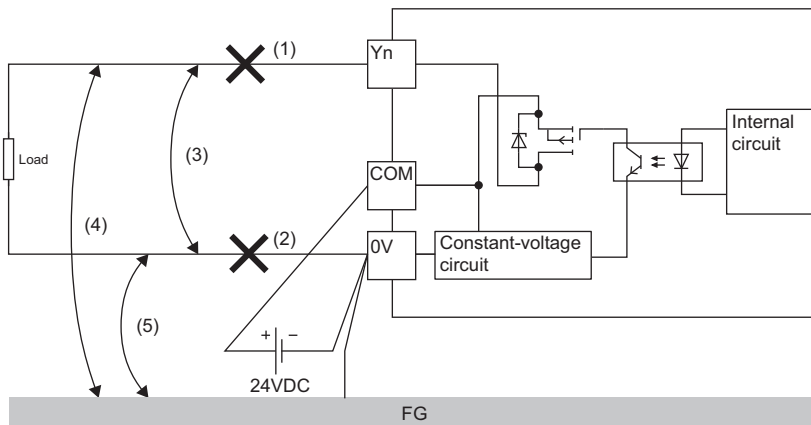

○: Detectable depending on the condition, ×: Undetectable

Connected device	Disconnection (no connection)		Short circuit (ground fault)		
	(1)	(2)	(3)	(4)	(5)
2-wire type input device	○ <sup>*1</sup>	○ <sup>*1</sup>	○ <sup>*2</sup>	○ <sup>*2*3</sup>	×

\*1 A disconnection can be detected only when the output is off. However, when an output device whose load current is 3mA or lower is connected, a disconnection may be detected even if no wiring is disconnected.

\*2 A short circuit can be detected only when the output is on. When the output current is 0.5A/point or higher, a short circuit is detected.

\*3 The negative common (0V) of the external power supply must be connected to the device frame.

# Short-circuit detection function

This function detects an overcurrent of outputs and limits the output current.

When the output current is 20ms or higher, or 0.5A/point or higher, a short circuit is detected.

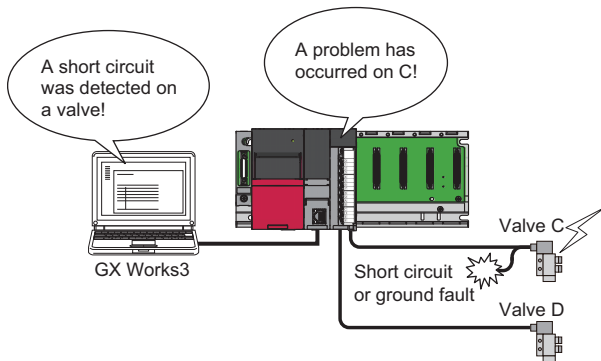

## Operation of when an error is detected

When a short circuit occurs on the output terminal for which "Output short-circuit detection setting" is set to "To detect", 'Output short-circuit detection status' is set to 1 (Short circuit detected).

When the output module with diagnostic functions detects a short circuit, an alarm (Output short-circuit detection) occurs.

The output terminal with a short circuit stops the output.

The alarm status due to an output short-circuit detection can be checked in the module diagnostics window of the engineering tool.

When a short circuit is detected, the ALM LED turns on.

## Operation of when the connection is recovered from a short circuit

The operation of when the cause of a short circuit is eliminated and the connection with the external device is recovered differs depending on the setting in "Short Circuit Auto Clear enable/disable".

### ■When "Short Circuit Auto Clear enable/disable" is set to "Disable"

The following shows the operation of when 'Alarm clear request' (Y11) is turned on and off.

- The value of 'Output short-circuit detection status' (Un\G3088) changes from 1 (Short circuit detected) to 0 (Normal).
- 'Alarm flag' (X11) turns off.
- The ALM LED turns off.

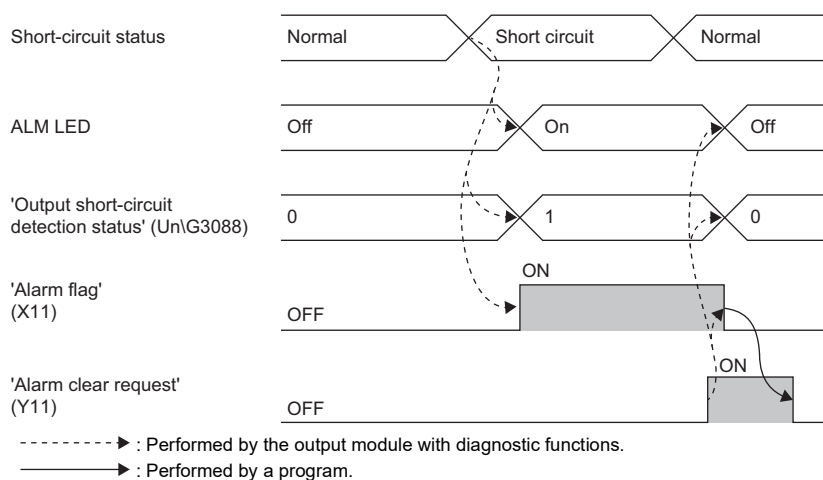

## ■When "Short Circuit Auto Clear enable/disable" is set to "Enable"

The following shows the operation of when the connection is recovered from the short circuit.

- The value of 'Output short-circuit detection status' (Un\G3088) changes from 1 (Short circuit detected) to 0 (Normal).
- 'Alarm flag' (X11) turns off.
- The ALM LED turns off.

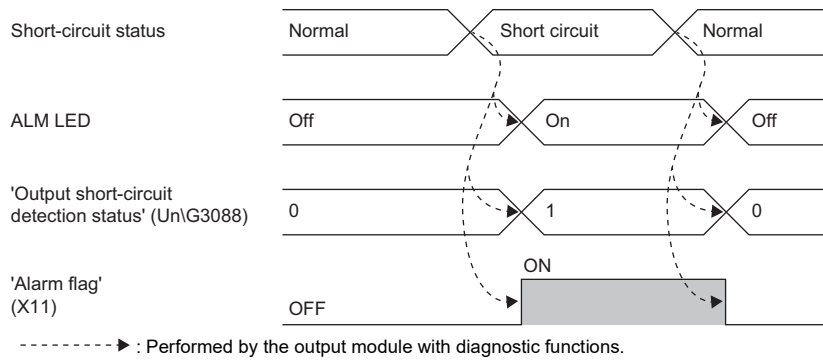

## Setting procedure

Set the following items from "Application setting".

- "Output short-circuit detection setting" ( Page 106 Output short-circuit detection setting)
- "Short Circuit Auto Clear enable/disable" ( Page 106 Output short-circuit detection automatic clear enable/disable)

[Navigation window] ⇒ [Parameter] ⇒ [Module Information] ⇒ Target module ⇒ [Module Parameter] ⇒ [Application setting]

## List of detectable conditions

For the places at which output short circuit can be detected and the detectable conditions, refer to the following.

Page 48 List of detectable conditions

## Error history function

This function stores errors and alarms, which have occurred in the I/O module with diagnostic functions, in the buffer memory as histories.

Up to 16 histories can be stored for both errors and alarms.

### Operation

When an error occurs, the error code and error time are stored sequentially from 'Error history No.1' (Un\G16 to Un\G21).

When an alarm occurs, the alarm code and alarm time are stored sequentially from 'Alarm history No.1' (Un\G272 to Un\G277).

- Assignment of an error history

	b15	to	b8 b7	to	b0
Un\G16	Error code				
Un\G17	First two digits of the year		Last two digits of the year		
Un\G18	Month		Day		
Un\G19	Hour		Minute		
Un\G20	Second		Day of the week		
Un\G21	Millisecond (higher-order digits)		Millisecond (lower-order digits)		
Un\G22	System area				
⋮					
Un\G23					

- Assignment of an alarm history

	b15	to	b8 b7	to	b0
Un\G272	Alarm code				
Un\G273	First two digits of the year		Last two digits of the year		
Un\G274	Month		Day		
Un\G275	Hour		Minute		
Un\G276	Second		Day of the week		
Un\G277	Millisecond (higher-order digits)		Millisecond (lower-order digits)		
Un\G278	System area				
⋮					
Un\G279					

#### Ex.

Storage example of an error history

Item	Description	Example <sup>*1</sup>
Error code	The error code is stored.	1900H
First/Last two digits of the year	The error time is stored in the BCD code.	2016H
Month/Day		527H
Hour/Minute		1234H
Second		56H
Day of the week		The following values are stored in the BCD code for each day of the week. Sunday: 0, Monday: 1, Tuesday: 2, Wednesday: 3 Thursday: 4, Friday: 5, Saturday: 6
Millisecond (upper)	The error time is stored in the BCD code.	7H
Millisecond (lower)		89H
System area	—	—

\*1 The value stored when the input response time setting error (error code: 1900H) occurs at 12:34:56.789 on Friday, May 27, 2016  
The start address of the error history in which the latest error is stored can be checked with 'Latest address of error history' (Un\G0).

The start address of the alarm history in which the latest alarm is stored can be checked with 'Latest address of alarm history' (Un\G256).

**Ex.**

When the 3rd error occurs

When the 3rd error is stored in the error history No.3, 32 is stored in 'Latest address of error history' (Un\G0).

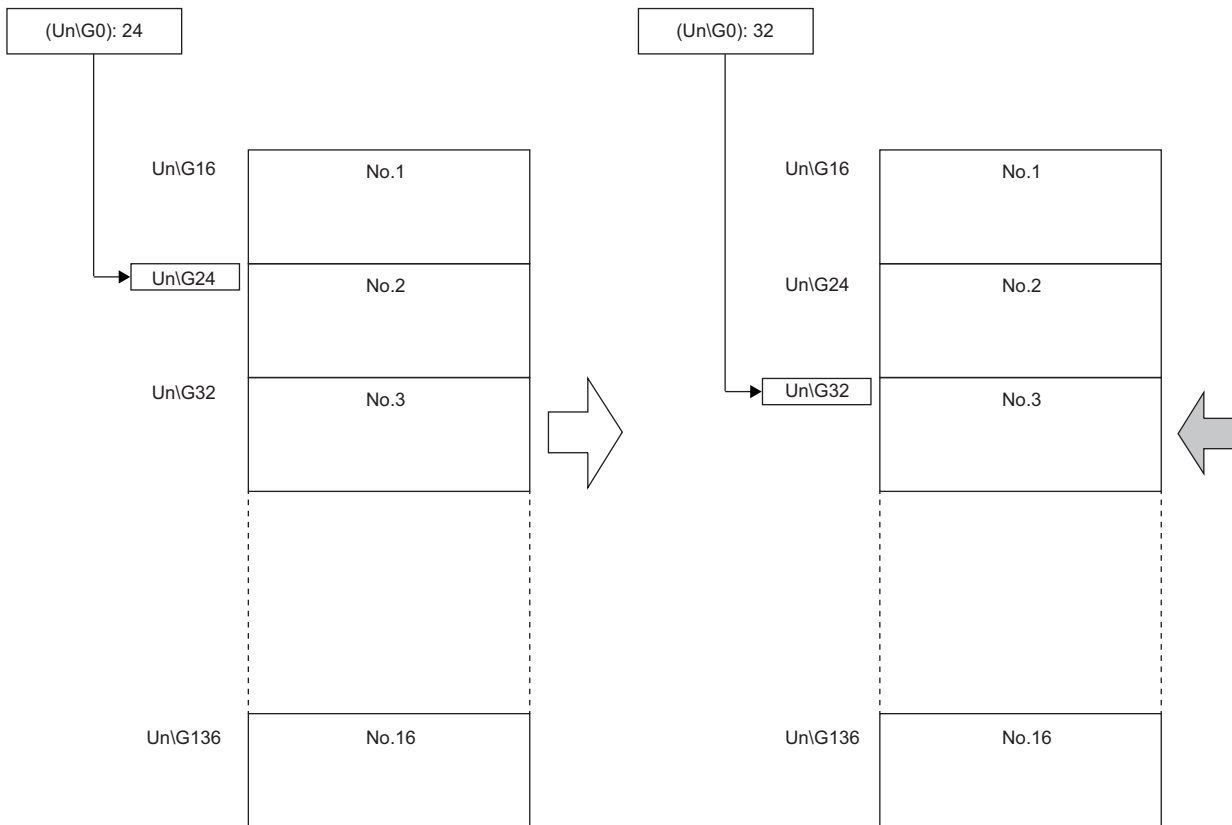

**Ex.**

When the 17th error occurs

The 17th error is stored in 'Error history No.1' (Un\G16 to Un\G21), and 16 is stored in 'Latest address of error history' (Un\G0).

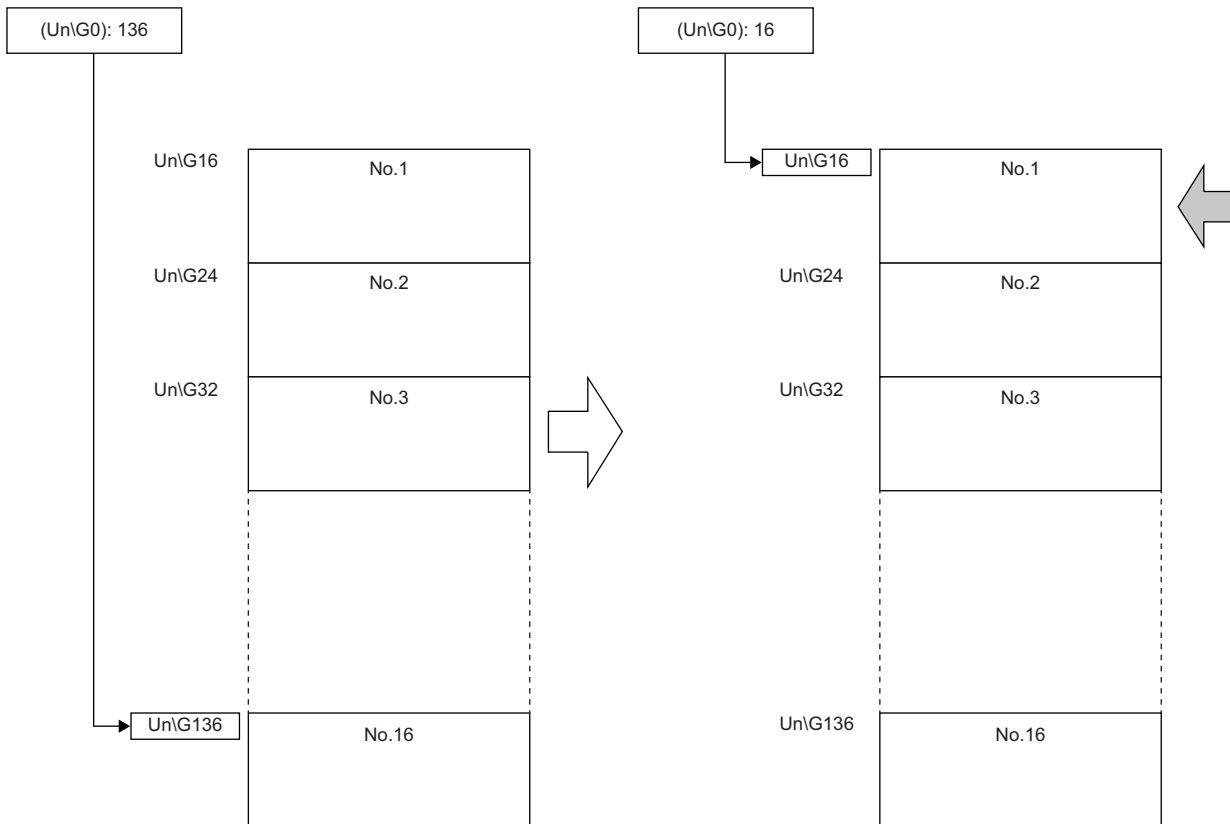
**Point**

- When the storage areas of the error history become full, the histories are overwritten sequentially from 'Error history No.1' (Un\G16 to Un\G21) and error histories are continued to be recorded. The histories before overwritten are deleted.
- The same processing is performed when alarms occur.
- The recorded error histories are cleared when the power supply of the I/O module with diagnostic functions is turned off or the CPU module is reset.

# 1.5 Event History Function

This function collects errors and alarms that occurred in the I/O module with diagnostic functions and executed operations as event information in the CPU module.

In the CPU module, event information that occurred in the I/O module with diagnostic functions is collected and held in the data memory in the CPU module or an SD memory card.

The event information collected in the CPU module can be displayed using the engineering tool and the occurrence history can be checked in chronological order.

Event type	Classification	Description
System	Error	Self-diagnostics errors detected in each module
	Alarm	Alarms detected in each module
	Information	The operation by the normal detection of the system that is not classified as Error or Alarm, or the operation performed automatically by the system.
Security	Alarm	The operation which is judged as unauthorized access to each module
	Information	The operations which is not judged as unlock of a password or unauthorized access
Operation	Alarm	Among operations performed on modules, delete operation (data clear) that is not judged as an error by self-diagnostics but likely to change the behavior
	Information	Operations performed by users including operations which changes system behavior, such as error clear, and operations which changes the structure

## Setting procedure

Set the event history function in the event history setting window of the engineering tool. For the setting procedure, refer to the following.

 MELSEC iQ-R CPU Module User's Manual (Application)

## Display of the event history

Display the event history from the menu of the engineering tool. For details on the operating procedure and display description, refer to the following.

 GX Works3 Operating Manual

## Event history list

The following table shows an event that occurs in the I/O module with diagnostic functions when the event type is "Operation".

Event code	Event classification	Event name	Description	Additional information
00A12	Alarm	Failure of disabling safety module	Disabling the safety module function failed.	—
20100	Information	Error release (error clear)	An error clear request was executed.	—



# 2 PARAMETER SETTINGS

This chapter describes how to set the parameters of the I/O module with diagnostic functions. Setting parameters with the engineering tool here eliminates the need to program them.

## 2.1 Basic Settings

### Setting procedure

Open "Basic setting" of the engineering tool.

1. Start Module Parameter.

[Navigation window] ⇒ [Parameter] ⇒ [Module Information] ⇒ Target module ⇒ [Module Parameter] ⇒ [Basic setting]

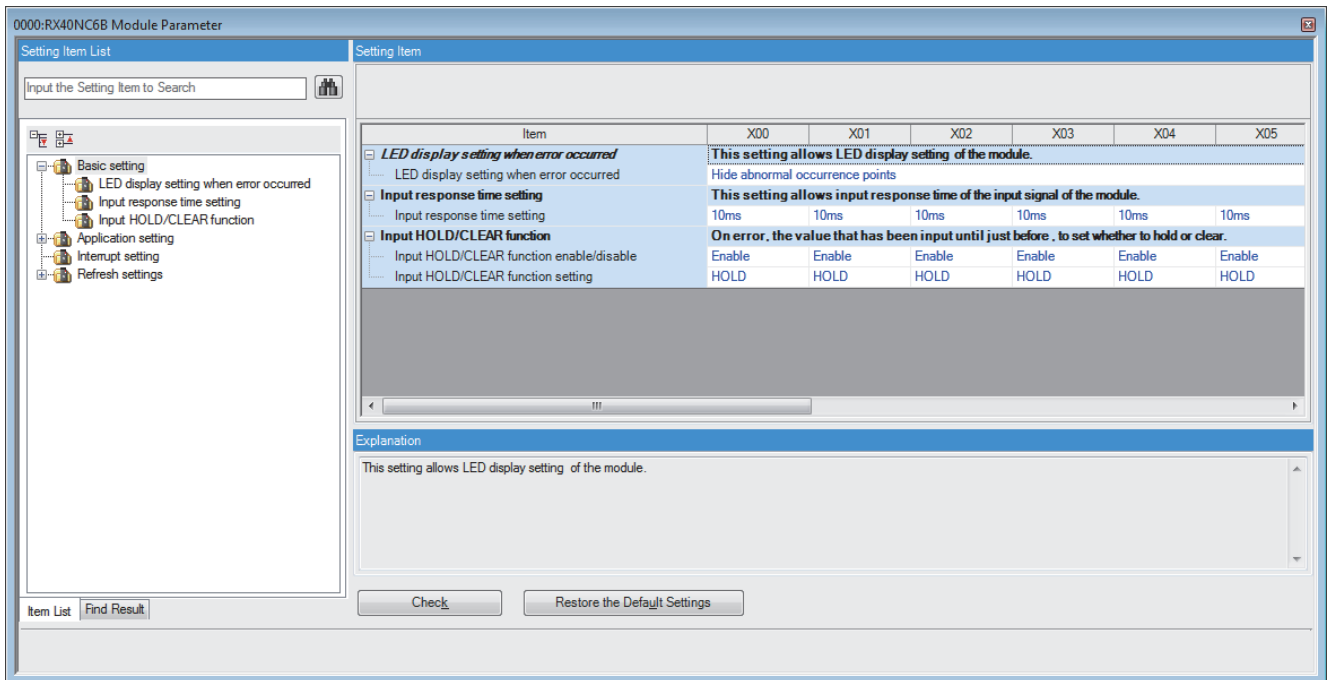

2. Double-click on the item to be changed and enter a setting value.

- Item where a value is selected from a drop-down list

Click the [▼] button of the item to be set to display a drop-down list. Select an item.

- Item where a value is entered into a text box

Double-click on the item to be set and enter a numerical value.

## 2.2 Application Settings

### Setting procedure

Open "Application setting" of the engineering tool.

#### 1. Start Module Parameter.

[Navigation window] ⇒ [Parameter] ⇒ [Module Information] ⇒ Target module ⇒ [Module Parameter] ⇒ [Application setting]

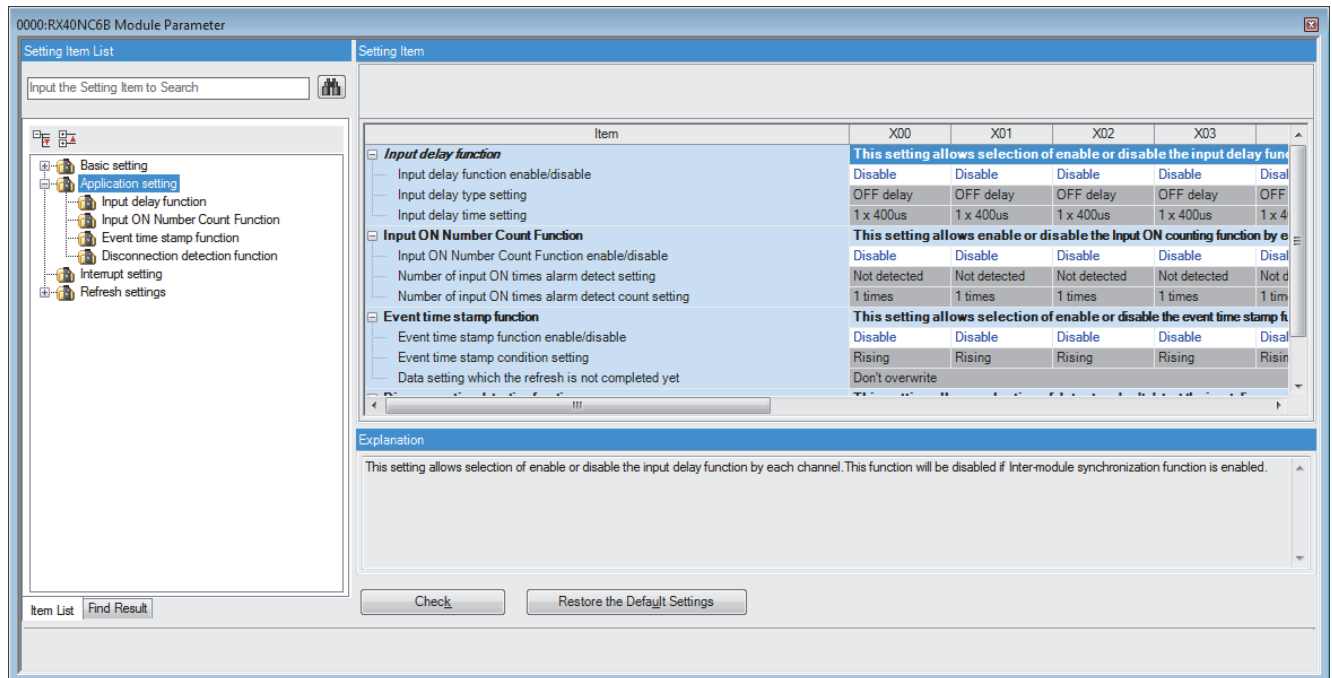

#### 2. Double-click on the item to be changed and enter a setting value.

- Item where a value is selected from a drop-down list

Click the [▼] button of the item to be set to display a drop-down list. Select an item.

- Item where a value is entered into a text box

Double-click on the item to be set and enter a numerical value.

## 2.3 Interrupt Settings

### Setting procedure

Open "Interrupt setting" of the engineering tool.

1. Start Module Parameter.

[Navigation window] ⇒ [Parameter] ⇒ [Module Information] ⇒ Target module ⇒ [Module Parameter] ⇒ [Interrupt setting]

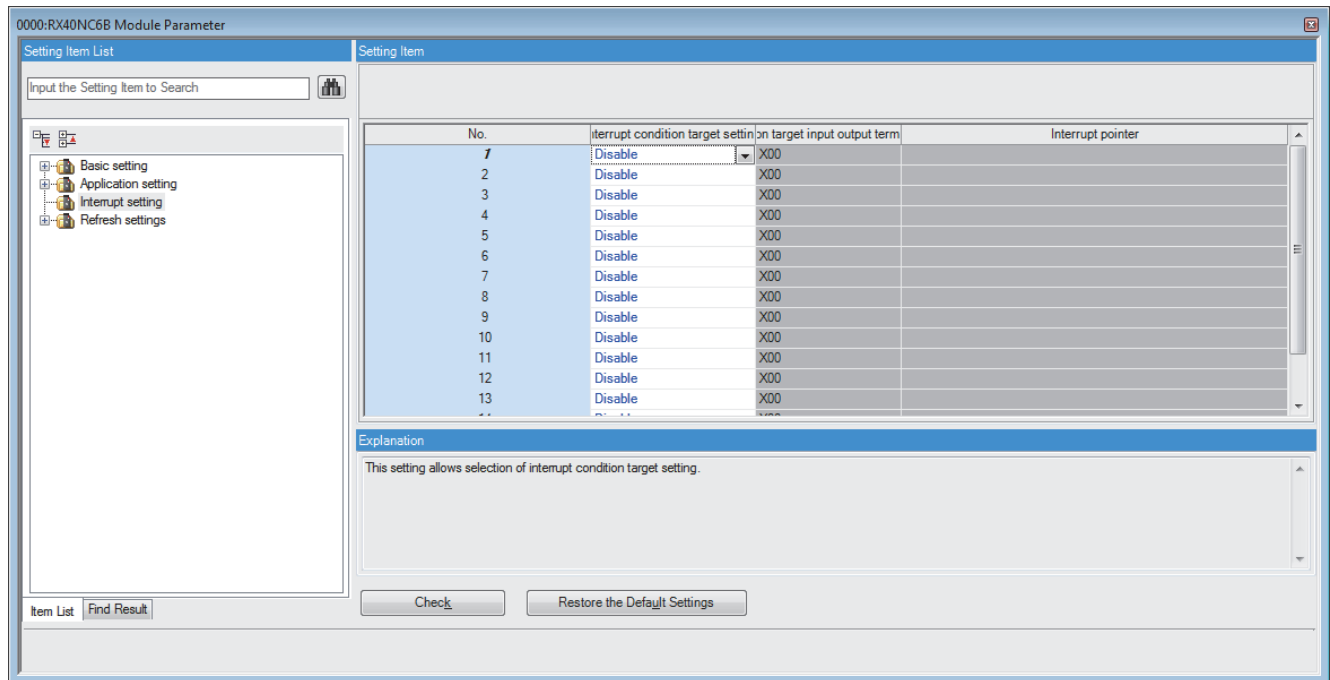

2. Click the item of interrupt setting number (No.1 to 16) to be changed to enter the setting value.

- Item where a value is selected from a drop-down list

Click the [▼] button of the item to be set to display a drop-down list. Select an item.

- Item where a value is entered into a text box

Double-click on the item to be set and enter a numerical value.

## 2.4 Refresh Settings

### Setting procedure

Set the buffer memory area of the I/O module with diagnostic functions to be refreshed.

This refresh setting eliminates the need for reading/writing data by programming.

#### 1. Start Module Parameter.

 [Navigation window] ⇒ [Parameter] ⇒ [Module Information] ⇒ Target module ⇒ [Module Parameter] ⇒ [Refresh settings]

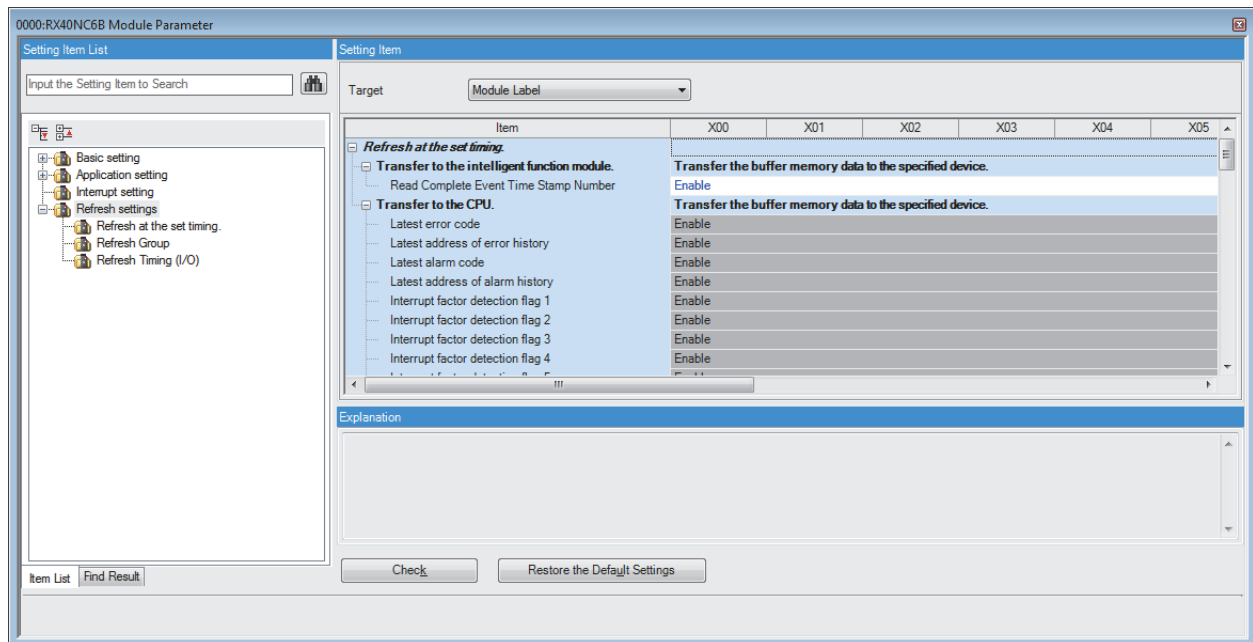

#### 2. Click "Target" and set a refresh destination.

- When "Module Label" is set in "Target"

Set whether to enable or disable the refresh by setting "Read Complete Event Time Stamp Number" to Enable or Disable.

- When "Refresh Data Register (RD)" is set in "Target"

Setting a start device in "Start Device Name" automatically sets the transfer destinations of all the items.

- When "Device" is set in "Target"

Double-click the item to be set to enter the refresh target device.

#### 3. Click "Refresh Group" and set the timing of the auto refresh.

Set "At the Execution Time of END Instruction" or "At the Execution Time of Specified Program" in "Refresh Group".

When "At the Execution Time of Specified Program" is set, double-click on "Group [n] (n: 1-64)" and set a value of 1 to 64.

#### Point

- When the refresh is enabled, the values of the refresh target are enabled at the refresh timing set with the engineering tool. At this time, the buffer memory areas are overwritten with the values of the refresh target. To change the values of the refresh target buffer memory areas, create a program so that the values of module labels or devices of the refresh source are changed.
- To read the event time stamp data to the CPU module using function blocks (FB), set "Target" to "Module Label".

## Refresh processing time

A refresh processing time [ $\mu\text{s}$ ] is a constituent of the scan time of the CPU module. For details on the scan time, refer to the following.

 MELSEC iQ-R CPU Module User's Manual (Application)

The refresh processing time [ $\mu\text{s}$ ], which is taken for refresh, is given by:

- Refresh processing time [ $\mu\text{s}$ ] = Refresh read time (time for transferring refresh data to the CPU module) + Refresh write time (time for transferring refresh data to the I/O module with diagnostic functions)

The refresh read time and refresh write time vary depending on the settings of "Target".

### When "Target" is "Module Label" or "Refresh Data Register (RD)"

The following table shows the refresh read time and refresh write time with an R□CPU used.

Model	Classification	When using the refresh settings
RX40NC6B	Refresh read time	24.71 $\mu\text{s}$
	Refresh write time	9.69 $\mu\text{s}$
RY40PT5B	Refresh read time	22.78 $\mu\text{s}$

### When "Target" is "Device"

Calculate the refresh read time and refresh write time according to the number of items and the number of their transfer data (in units of word) that are set to be refreshed. For the calculation method, refer to the following.

 MELSEC iQ-R CPU Module User's Manual (Application)

# 3 TROUBLESHOOTING

## 3.1 Troubleshooting with the LEDs

### When the RUN LED turns off

Check item	Action
Check whether power is supplied.	Check that the supply voltage to the power supply module is within the rated range.
Check whether the capacity of the power supply module is enough.	Calculate the current consumption of mounted modules, such as the CPU module, I/O modules, and intelligent function modules, to check that the power capacity is enough.
Check whether the module is mounted properly.	Check the mounting state of the module.
Cases other than the above	Reset the CPU module and check that the RUN LED turns on. If the RUN LED still remains off, the possible cause is a failure of the module. Please consult your local Mitsubishi representative.

### When the ERR LED turns on

Check item	Action
Check whether any errors have occurred.	Check 'Latest error code' (Un\G2560), and take actions described in the list of error codes.  Page 68 List of Error Codes

### When the ALM LED turns on

Check item	Action
Check whether any alarms have occurred.	Check 'Latest alarm code' (Un\G2564), and take actions described in the list of alarm codes.  Page 70 List of Alarm Codes

### When an I/O LED does not change

Check item	Action
Check whether "Switching display of input status and alarm (1 second intervals)" or "Always display abnormal occurrence points" is set in "LED display setting when error occurred" of the input module with diagnostic functions. Check whether "Switching display of output status and alarm (1 second intervals)" or "Always display abnormal occurrence points" is set in "LED display setting when error occurred" of the output module with diagnostic functions.	Check the current setting of "LED display setting when error occurred".

## 3.2 Checking the Module Status

The following functions are available in the "Module Diagnostics" window for the I/O module with diagnostic functions.

Function	Application
Error Information	This function displays errors that have occurred. Clicking the [Event History] button displays the history of errors and alarms detected in the I/O module with diagnostic functions and errors detected and operations executed in the other modules.
Module Information List	This function displays each status information of the I/O module with diagnostic functions.

3

### Error Information

Check errors that have occurred and actions against them.

[Diagnostics] ⇒ [System Monitor] ⇒ Right-click the target module. ⇒ "Module Diagnostics"

Item	Description
Cause	Displays the details of the cause of each error.
Corrective Action	Displays actions against the error.

To check alarm codes, error history, and alarm history, use the "Event History" window of the engineering tool.

 [Diagnostics] ⇒ [System Monitor] ⇒ [Event History] button

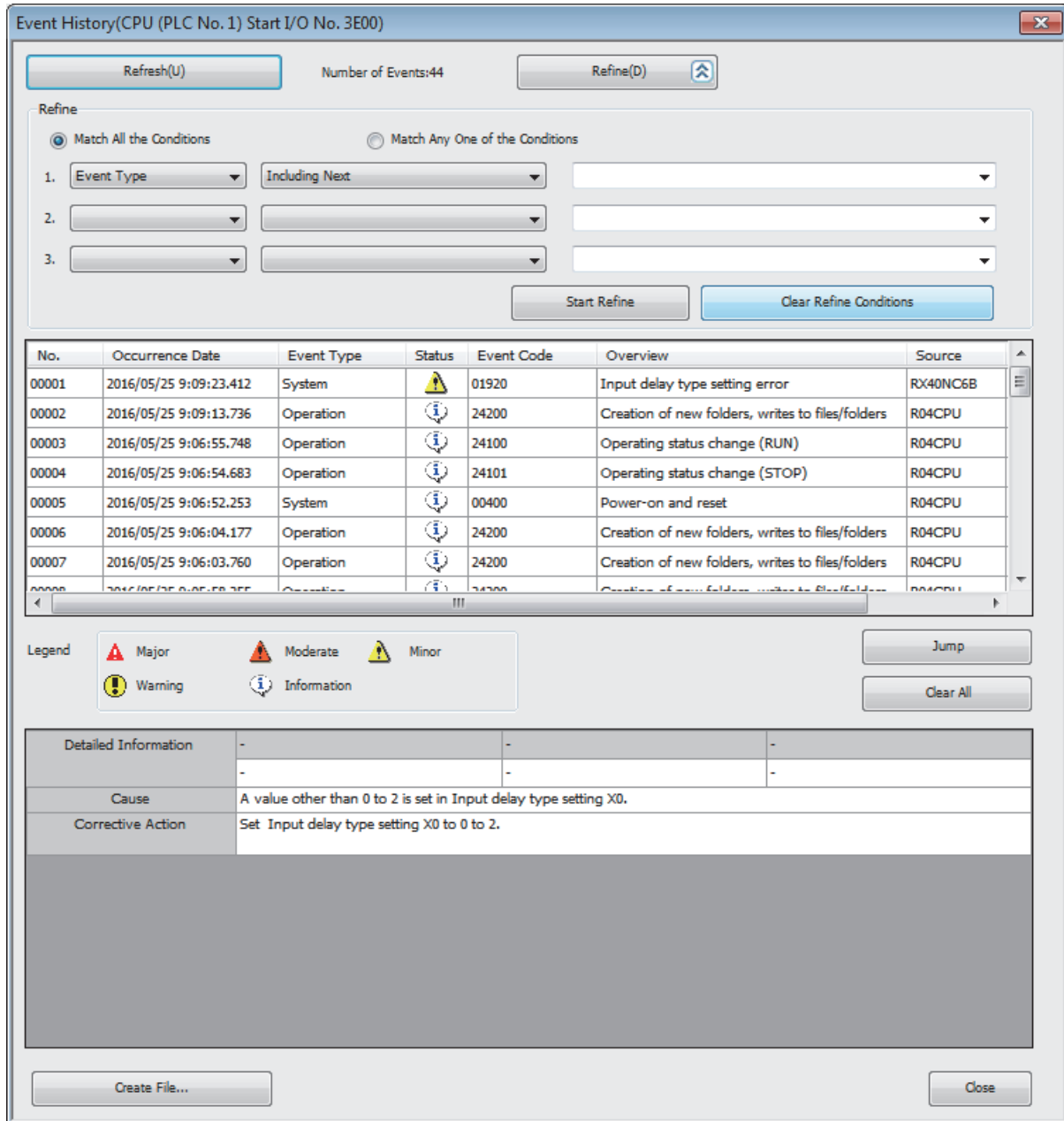

Event History(CPU (PLC No. 1) Start I/O No. 3E00)

Refresh(U)      Number of Events:44      Refine(D)

Refine









Match All the Conditions       Match Any One of the Conditions

1. Event Type      Including Next      [ ]



2. [ ]      [ ]      [ ]



3. [ ]      [ ]      [ ]

Start Refine      Clear Refine Conditions

No.	Occurrence Date	Event Type	Status	Event Code	Overview	Source
00001	2016/05/25 9:09:23.412	System		01920	Input delay type setting error	RX40NC6B
00002	2016/05/25 9:09:13.736	Operation		24200	Creation of new folders, writes to files/folders	R04CPU
00003	2016/05/25 9:06:55.748	Operation		24100	Operating status change (RUN)	R04CPU
00004	2016/05/25 9:06:54.683	Operation		24101	Operating status change (STOP)	R04CPU
00005	2016/05/25 9:06:52.253	System		00400	Power-on and reset	R04CPU
00006	2016/05/25 9:06:04.177	Operation		24200	Creation of new folders, writes to files/folders	R04CPU
00007	2016/05/25 9:06:03.760	Operation		24200	Creation of new folders, writes to files/folders	R04CPU
00008	2016/05/25 9:05:58.355	Operation		24200	Creation of new folders, writes to files/folders	R04CPU

Legend

 Major       Moderate       Minor

 Warning       Information

Jump      Clear All

Detailed Information	-	-	-
Cause	A value other than 0 to 2 is set in Input delay type setting X0.		
Corrective Action	Set Input delay type setting X0 to 0 to 2.		

Create File...      Close



## Module Information List

In the "Module Information List" tab, each status information of the I/O module with diagnostic functions can be checked.

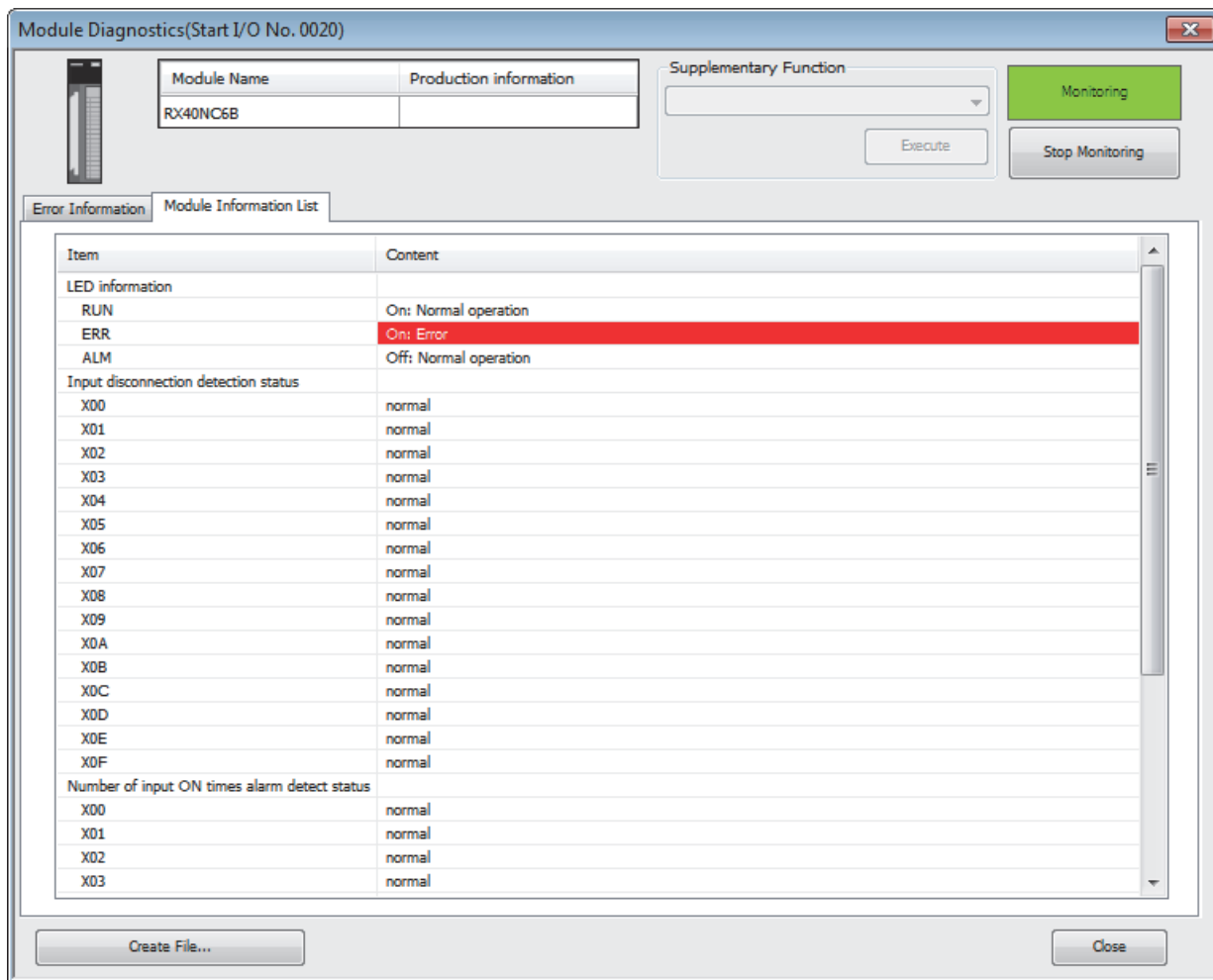

Item	Description
LED information	Displays the status of each LED of the I/O module with diagnostic functions.
Input disconnection detection status	Displays the status of input disconnection detection for each input.
Number of input ON times alarm detect status	Displays the number of input ON times alarm detection status for each input.

## 3.3 Troubleshooting by Symptom

### When the I/O module with diagnostic functions does not start up

Check item	Action
Check whether five seconds have elapsed after power-off of the power supply module.	When applying the input power source to the power supply module again, do so five seconds or more after the shut-off of the power.

### When the ON/OFF state of an external input cannot be read

Check item	Action
Check whether a disconnection is detected.	<p>If the RUN LED and ALM LED are on, a disconnection in the input wiring may have been detected. Check 'Latest alarm code' (UnG2564) to check whether a disconnection has been detected.</p> <p>If a disconnection has been detected, take the action for the input disconnection detection (alarm code: 88□H) described in the following.</p> <p>☞ Page 70 List of Alarm Codes</p>
Check whether the I/O status indicator LED (X0 to XF) of the input module with diagnostic functions turns on when the external input device is on.	<p>When the LED does not turn on, the input wiring has problems. Check whether the input wiring has been disconnected or short-circuited and the voltage of the input signal is proper, and review the wiring.</p> <p>For the rated input voltage, refer to the performance specifications described in the following.</p> <p>📖 MELSEC iQ-R I/O Module (With Diagnostic Functions) User's Manual (Startup)</p>
Check whether the input delay function has been properly used.	<p>When the input delay function is enabled, input signals will turn on or off according to the set input delay type when the delay time has elapsed after the external devices turn on or off. Disable the input delay function, or review the delay time.</p> <p>For details on the input delay function, refer to the following.</p> <p>☞ Page 24 Input delay function</p>
Check whether the system parameter "Inter-module Synchronous Setting" is correct.	<ul style="list-style-type: none"> <li>• If "Use Inter-module Synchronous Function in System" is set to "Not Use", change the setting to "Use".</li> <li>• If an expected value has not been set in "Fixed Scan Interval Setting of Inter-module Synchronization", set a correct cycle.</li> </ul>
Check whether the module has been selected as the synchronization target module.	If the input module with diagnostic functions has not been selected as the synchronization target module, select it as the target module.
Check whether the external power supply is supplied.	<p>Check that the voltage of the external power supply is within the rated range. For the external power supply, refer to the performance specifications described in the following.</p> <p>📖 MELSEC iQ-R I/O Module (With Diagnostic Functions) User's Manual (Startup)</p>

#### Point

If the ON/OFF state of the external input still cannot be read even after the actions described above are taken, the possible cause is a failure of the input module with diagnostic functions. Please consult your local Mitsubishi representative.

## When a disconnection in the input wiring cannot be detected

Check item	Action
Check whether the I/O status indicator LED (X0 to XF) of the input module with diagnostic functions turns on when the external input device is on.	When the LED does not turn on, the input wiring has problems. Check whether the input wiring has been disconnected or short-circuited and the voltage of the input signal is proper, and review the wiring. For the rated input voltage, refer to the performance specifications described in the following.  MELSEC iQ-R I/O Module (With Diagnostic Functions) User's Manual (Startup)
Check whether "Input disconnection detection setting" has been set to "To detect".	If "Input disconnection detection setting" of the target input has been set to "Not detected", set "To detect".
Check whether a resistor for disconnection detection has been connected.	When the leakage current of the input device is 0.3mA/point or lower, connect a bleeder resistor (resistance value as a guide: approximately 56kΩ) in parallel near the input device.
Check whether the disconnection (no connection) detection current satisfies the specifications.	Check whether the disconnection (no connection) detection current is 0.3mA per point or less.

### Point

If a disconnection in the input wiring still cannot be detected even after the actions described above are taken, the possible cause is a failure of the input module with diagnostic functions. Please consult your local Mitsubishi representative.

## When a disconnection in the input wiring cannot be detected correctly

Check item	Action
Check whether the wiring is influenced by noise.	Check the wiring status.
Check whether a wireless communication device such as a cellular phone or PHS (Personal Handy-phone System) is close to the programmable controller.	Use any wireless communication device such as a cellular phone or PHS (Personal Handy-phone System) more than 25cm away in all directions from the programmable controller.

## When a disconnection was detected in the input wiring

Check item	Action
Check whether the input wiring has any problems.	Check that the voltage of the input signal is proper, and review the wiring.
Check whether the external power supply is supplied.	Check that the supply voltage to the module is within the rated range.
Check whether the wiring is influenced by noise.	Check the wiring status.

## When the ON/OFF state of an external output cannot be changed

Check item	Action
Check whether the corresponding I/O status indicator LED (Y0 to YF) of the output module with diagnostic functions turns on when 'Output signal 0 to F' (Y0 to YF) is turned on.	When the LED turns on, the output wiring has problems. Review the output wiring. Check whether the output wiring has been disconnected or short-circuited, and review the wiring.
Check whether the output delay function has been properly used.	When the output delay function is enabled, output signals will turn on or off according to the set output delay type when the delay time has elapsed after the external output signal turn on or off. Disable the output delay function, or review the delay time. For details on the output delay function, refer to the following.  Page 34 Output delay function
Check whether the system parameter "Inter-module Synchronous Setting" is correct.	<ul style="list-style-type: none"> <li>• If "Use Inter-module Synchronous Function in System" is set to "Not Use", change the setting to "Use".</li> <li>• If an expected value has not been set in "Fixed Scan Interval Setting of Inter-module Synchronization", set a correct cycle.</li> </ul>
Check whether the module has been selected as the synchronization target module.	If the output module with diagnostic functions has not been selected as the synchronization target module, select it as the target module.

### Point

If the ON/OFF state of the external output still cannot be changed even after the actions described above are taken, the possible cause is a failure of the output module with diagnostic functions. Please consult your local Mitsubishi representative.

## When a disconnection or short-circuit in the output wiring cannot be detected

Check item	Action
Check whether the corresponding I/O status indicator LED (Y0 to YF) of the output module with diagnostic functions turns on when 'Output signal 0 to F' (Y0 to YF) is turned on.	When the LED turns on, the output wiring has problems. Review the output wiring. Check whether the output wiring has been disconnected or short-circuited, and review the wiring.
Check whether "Output disconnection detection setting Y□" and "Output short-circuit detection setting Y□" have been set to "To detect".	If the parameter settings of the output point have been set to "Not detected", set "To detect".

### Point

If a disconnection or short-circuit in the output wiring still cannot be detected even after the actions described above are taken, the possible cause is a failure of the output module with diagnostic functions. Please consult your local Mitsubishi representative.

## When a disconnection or short-circuit in the output wiring cannot be detected correctly

Check item	Action
Check whether the wiring is influenced by noise.	Check the wiring status.
Check whether a wireless communication device such as a cellular phone or PHS (Personal Handy-phone System) is close to the programmable controller.	Use any wireless communication device such as a cellular phone or PHS (Personal Handy-phone System) more than 25cm away in all directions from the programmable controller.

## When a disconnection or short-circuit was detected in the output wiring

Check item	Action
Check whether the output wiring has any problems.	Check whether the output wiring is disconnected or short-circuited, and review the wiring.
Check whether the external power supply is supplied.	Check that the supply voltage to the module is within the rated range.
Check whether the wiring is influenced by noise.	Check the wiring status.

# When a load momentarily turns on before the completion of the initial processing

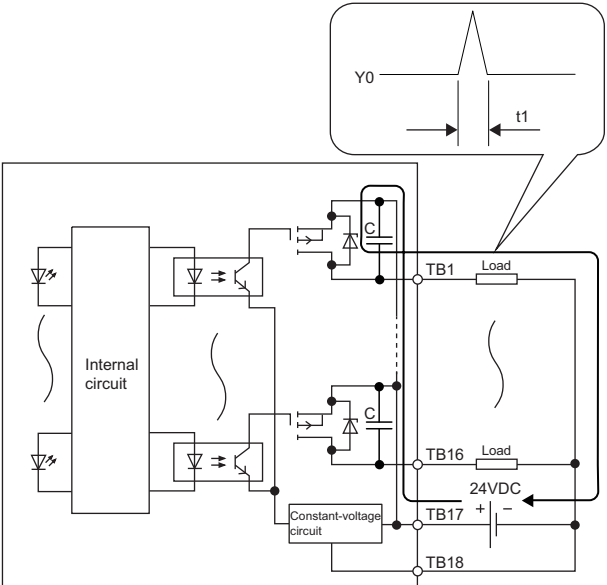
Check item	Action
<p>Check whether output momentarily turns on in the following condition:            Depending on the capacity (C) between the drain and source of a MOSFET, the load current may flow as shown in the figure below, and thus the load may momentarily turn on before the completion of the initial processing of the output module with diagnostic functions (before the RUN LED of the output module with diagnostic functions turns on).</p>  <p>t1: Output turns on for approx. 200μs.</p>	<p>Use a load or device with the response speed of 1ms or longer.</p>

## 3.4 List of Error Codes

If an error occurs during operation, the I/O module with diagnostic functions stores the corresponding error code in the buffer memory area 'Latest error code' (Un\G2560). Additionally, 'Error flag' (X10) turns on. Turning on 'Error clear request' (Y10) clears the error code in 'Latest error code' (Un\G2560) and 'Error flag' (X10) turns off.

Error codes of the I/O module with diagnostic functions are classified into minor errors and moderate errors.

- Minor error: Errors that occur due to an incorrect setting in programs or parameters (1000Hs)
- Moderate error: Errors including hardware failures or errors at execution of the inter-module synchronization function (2000Hs, 3000Hs)

The following table lists error codes to be stored.

□ in an error code: Indicates the number of an I/O terminal in which the error has occurred. In accordance with X0 to XF (input module) or Y0 to YF (output module), a numerical value of 0 to F is assigned.

△ in an error code: Refer to the error description and cause.

Error code	Error name	Error description and cause	Action
181△H	Interrupt condition target setting range error	<p>■Input module with diagnostic functions A value other than 0 to 3 and 7 to 10 has been set in Interrupt condition target setting [n].</p> <p>■Output module with diagnostic functions A value other than 0 to 4 and 7 has been set in Interrupt condition target setting [n].</p> <p>△ indicates the interrupt setting corresponding to the error, as follows. 0: Setting 1 to F: Setting 16</p>	<p>■Input module with diagnostic functions Set a value of 0 to 3 and 7 to 10 in Interrupt condition target setting [n]. For Interrupt condition target setting [n], refer to the following. ☞ Page 93 Interrupt condition target setting [n]</p> <p>■Output module with diagnostic functions Set a value of 0 to 4 and 7 in Interrupt condition target setting [n]. For Interrupt condition target setting [n], refer to the following. ☞ Page 93 Interrupt condition target setting [n]</p>
182△H	Interrupt condition target I/O terminal setting range error	<p>A value other than 0 to 16 has been set in Interrupt condition target I/O terminal setting [n]. △ indicates the interrupt setting corresponding to the error, as follows. 0: Setting 1 to F: Setting 16</p>	<p>Set a value of 0 to 16 in Interrupt condition target I/O terminal setting [n]. For Interrupt condition target I/O terminal setting [n], refer to the following. ☞ Page 94 Interrupt condition target I/O terminal setting [n]</p>
190□H	Input response time setting error	<p>A value other than 9H to DH has been set in Input response time setting.</p>	<p>Set a value of 9H to DH in Input response time setting. For details on Input response time setting, refer to the following. ☞ Page 95 Input response time setting</p>
192□H	Input delay type setting error	<p>A value other than 0 to 2 has been set in Input delay type setting.</p>	<p>Set a value of 0 to 2 in Input delay type setting. For details on Input delay type setting, refer to the following. ☞ Page 97 Input delay type setting</p>
194□H	Input delay time setting error	<p>A value other than 1 to 150000 has been set in Input delay time setting.</p>	<p>Set a value of 1 to 150000 in Input delay time setting.</p>
196□H	Number of input ON times alarm detection count setting error	<p>A value other than 1 to 4294967295 has been set in Number of input ON times alarm detection count setting.</p>	<p>Set a value of 1 to 4294967295 in Number of input ON times alarm detection count setting.</p>
198□H	Event time stamp condition setting error	<p>A value other than 0 to 2 has been set in Event time stamp condition setting.</p>	<p>Set a value of 0 to 2 in Event time stamp condition setting. For details on Event time stamp condition setting, refer to the following. ☞ Page 100 Event time stamp condition setting</p>
1A2□H	Output delay type setting error	<p>A value other than 0 and 1 has been set in Output delay type setting.</p>	<p>Set a value 0 or 1 in Output delay type setting. For details on Output delay type setting, refer to the following. ☞ Page 102 Output delay type setting</p>
1A4□H	Output delay time setting error	<p>A value other than 1 to 150000 has been set in Output delay time setting.</p>	<p>Set a value of 1 to 150000 in Output delay time setting.</p>
1A6□H	Number of output ON times alarm detection count setting error	<p>A value other than 1 to 4294967295 has been set in Number of output ON times alarm detection count setting.</p>	<p>Set a value of 1 to 4294967295 in Number of output ON times alarm detection count setting.</p>

Error code	Error name	Error description and cause	Action
1B00H	LED indication setting on error condition error	A value other than 0 to 2 has been set in LED indication setting on error condition.	Set a value of 0 to 2 in LED indication setting on error condition. For details on LED indication setting on error condition, refer to the following. ☞ Page 92 LED indication setting on error condition
1EA0H	Synchronization cycle setting too short error	A value of 0.20ms or less has been set in "Fixed Scan Interval Setting of Inter-module Synchronization", which is a system parameter.	Set a value of 0.222ms or more in "Fixed Scan Interval Setting of Inter-module Synchronization", which is a system parameter.
3001H	Hardware error	A hardware error has been detected.	The possible cause is noise or a hardware failure. If measures to reduce noise do not eliminate this error, the possible cause is a failure of the module. Please consult your local Mitsubishi representative.
3040H	Start-up in normal mode with safety validated	The module whose function as the safety module was enabled was started up in normal mode.	To use the module in normal mode, disable the safety module function. For the procedure how to disable the safety module function, refer to the following. ☞ Page 118 Disabling the Safety Module

## 3.5 List of Alarm Codes

If an alarm occurs during operation, the I/O module with diagnostic functions stores the corresponding alarm code in the buffer memory area 'Latest alarm code' (Un\G2564).

If an alarm has occurred, take actions against the alarm, such as reviewing connected devices, wiring, and voltage and replacing connected external devices. After the alarm cause is eliminated, turn on 'Alarm clear request' (Y11) to clear the alarm code in 'Latest alarm code' (Un\G2564). If the alarm occurs again, the possible cause is a failure of the module. Please consult your local Mitsubishi representative.

The following table lists alarm codes to be stored.

□ in an alarm code: Indicates the number of an I/O terminal in which the alarm has occurred. In accordance with X0 to XF (input module) or Y0 to YF (output module), a numerical value of 0 to F is assigned.

Alarm code	Alarm name	Alarm description and cause	Action
80□H	Number of input ON times alarm detection count reached	The number of input ON times has reached the number of input ON times alarm detection count.	Set the corresponding bit of Number of input ON times value clear request to 1 (Requested) to clear the number of input ON times.
88□H	Input disconnection detection	A disconnection has been detected.	After a connection is recovered, turn on and off 'Alarm clear request' (Y11). The value 0 (Normal) is set in all Input disconnection detection status, 'Alarm flag' (X11) turns off, and the alarm code in Latest alarm code is cleared.
90□H	Number of output ON times alarm detection count reached	The number of output ON times has reached the number of output ON times alarm detection count.	Set the corresponding bit of Number of output ON times value clear request to 1 (Requested) to clear the number of output ON times.
98□H	Output disconnection detection	A disconnection has been detected.	After a connection is recovered, turn on and off 'Alarm clear request' (Y11). The value 0 (Normal) is set in all Output disconnection detection status, 'Alarm flag' (X11) turns off, and the alarm code in Latest alarm code is cleared.
A0□H	Output short-circuit detection	A short-circuit has been detected.	After the recovery from the short-circuit, turn on and off 'Alarm clear request' (Y11). The value 0 (Normal) is set in all Output short-circuit detection status, 'Alarm flag' (X11) turns off, and the alarm code in Latest alarm code is cleared.



# APPENDICES (NORMAL MODE)

## Appendix 1 Module Label

The functions of the I/O module with diagnostic functions can be set with module labels.

### Module labels of I/O signals

The module label name of an I/O signal is defined with the following structure:

"Module name"\_"Module number".b"Label name" or "Module name"\_"Module number".b"Label name"\_D

Ex.

RX40NC6B\_1.bErrorFlag\_D

#### ■Module name

The character string of a module model name is given.

#### ■Module number

A number starting from 1 is added to identify modules that have the same module name.

#### ■Label name

The label identifier unique to a module is given.

#### ■\_D

This string indicates that the module label is for the direct access input (DX) or direct access output (DY). A module label without the string is for the input (X) or output (Y) of the refresh processing.

### Module labels of buffer memory areas

The module label name of a buffer memory area is defined with the following structure:

"Module name"\_"Module number"."Data type"."Data format"."Label name"\_D

Ex.

RX40NC6B\_1.stnSetting\_uInputResponseTimeSetting\_X00\_D

#### ■Module name

The character string of a module model name is given.

#### ■Module number

A number starting from 1 is added to identify modules that have the same module name.

#### ■Data type

The data type to sort a buffer memory area is given. Each data type is as follows:

Data type	Description
stnMonitor	Monitor
stnControl	Control
stnSetting	Setting

## ■Data format

The string that represents the data size of a buffer memory area is given. Each data format is as follows:

Data format	Description
u	Word [Unsigned]/Bit string [16-bit]
w	Word [Signed]
d	Double word [Signed]

## ■Label name

The label identifier unique to a module is given.

## ■\_D

This string indicates that the module label is for the direct access. A module label without the string is for the auto refresh. The following table shows the differences between the auto refresh and direct access.

Type	Description	Access timing	Example
Auto refresh	Values that are read from or written to the module label are reflected in the module collectively at the auto refresh. The run time of the program can be reduced. To use the auto refresh, set "Target" to "Module Label" in "Refresh settings" of "Module Parameter".	At auto refresh	RX40NC6B_1.stnSetting_ulInputResponseTimeSetting_X00
Direct access	Values that are read from or written to the module label are reflected in the module instantly. Compared with the auto refresh, the run time of the program becomes longer. However, the responsiveness is high.	At reading/writing from/to the module label	RX40NC6B_1.stnSetting_ulInputResponseTimeSetting_X00_D

# Appendix 2 I/O Signals

## List of I/O signals

The following tables list the I/O signals of the I/O module with diagnostic functions.

For details on the I/O signals, refer to the following.

☞ Page 75 Details on input signals

☞ Page 77 Details on output signals

### Point

- The following tables show the I/O numbers (X/Y) of when 0 is set as the start I/O number of the I/O module with diagnostic functions.
- Do not use the "use prohibited" signals in the following tables since they are used by the system. If users use (turn on) the signals, the functions of the I/O module with diagnostic functions cannot be guaranteed.

### Input module with diagnostic functions

#### ■ Input signal

Device number	Signal name
X0	External input X00
X1	External input X01
X2	External input X02
X3	External input X03
X4	External input X04
X5	External input X05
X6	External input X06
X7	External input X07
X8	External input X08
X9	External input X09
XA	External input X0A
XB	External input X0B
XC	External input X0C
XD	External input X0D
XE	External input X0E
XF	External input X0F
X10	Error flag
X11	Alarm flag
X12	Operating condition setting completed flag
X13 to X1E	Use prohibited
X1F	Module READY

#### ■ Output signal

Device number	Signal name
Y0 to YF	Use prohibited
Y10	Error clear request
Y11	Alarm clear request
Y12	Operating condition setting request
Y13 to Y1F	Use prohibited

## Output module with diagnostic functions

### ■Input signal

Device number	Signal name
X0 to XF	Use prohibited
X10	Error flag
X11	Alarm flag
X12	Operating condition setting completed flag
X13 to X1E	Use prohibited
X1F	Module READY

### ■Output signal

Device number	Signal name
Y0	External output Y00
Y1	External output Y01
Y2	External output Y02
Y3	External output Y03
Y4	External output Y04
Y5	External output Y05
Y6	External output Y06
Y7	External output Y07
Y8	External output Y08
Y9	External output Y09
YA	External output Y0A
YB	External output Y0B
YC	External output Y0C
YD	External output Y0D
YE	External output Y0E
YF	External output Y0F
Y10	Error clear request
Y11	Alarm clear request
Y12	Operating condition setting request
Y13 to Y1F	Use prohibited

# Details on input signals

This section describes the details on the input signals for the I/O module with diagnostic functions that are assigned to the CPU module.

This section describes the I/O numbers (X/Y) of when 0 is set as the start I/O number of the I/O module with diagnostic functions.

## Input signal

These signals indicate the ON/OFF state of external inputs.

However, when the input response time setting function or input delay function is enabled, the ON/OFF state of 'Input signal' (X0) and the ON/OFF state of the actual external input (X00) may not match.

### ■Device number

The following table shows the device numbers of these input signals.

Signal name	External input															
	X00	X01	X02	X03	X04	X05	X06	X07	X08	X09	X0A	X0B	X0C	X0D	X0E	X0F
Input signal	X0	X1	X2	X3	X4	X5	X6	X0	X8	X9	XA	XB	XC	XD	XE	XF

## Error flag

'Error flag' (X10) turns on when an error occurs.

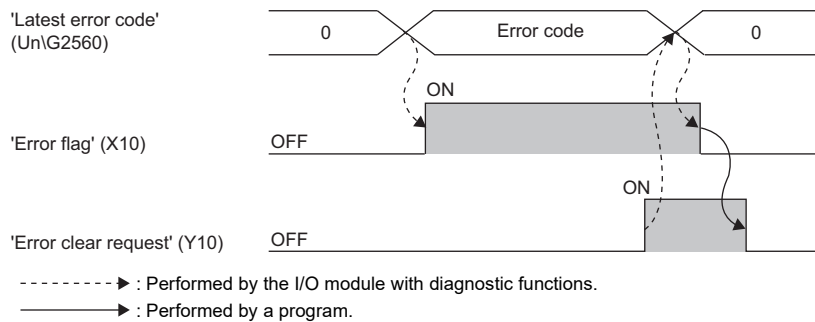

### ■Device number

The following table shows the device number of this input signal.

Signal name	External input/output
	X/Y00 to X/Y0F
Error flag	X10



## Alarm flag

'Alarm flag' (X11) turns on when an alarm occurs.

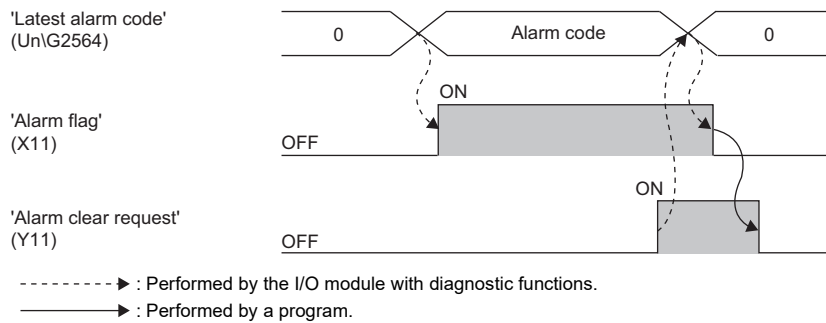

### Device number

The following table shows the device number of this input signal.

Signal name	External input/output
	X/Y00 to X/Y0F
Alarm flag	X11

## Operating condition setting completed flag

This signal is used as an interlock condition to turn on and off 'Operating condition setting request' (Y12) when the value of a buffer memory area is changed.

For the buffer memory areas that require 'Operating condition setting request' (Y12) to be turned on and off to enable new values, refer to the following.

☞ Page 79 List of buffer memory addresses

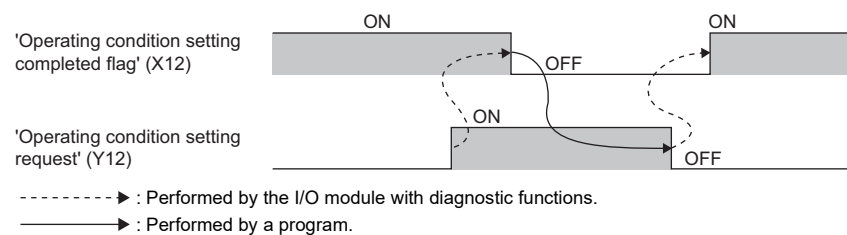

### Device number

The following table shows the device number of this input signal.

Signal name	External input/output
	X/Y00 to X/Y0F
Operating condition setting completed flag	X12

## Module READY

This signal is used as an interlock condition to read/write data from/to the CPU module.

When the initial processing of the I/O module with diagnostic functions is completed after the CPU module is powered on or is reset, Module READY turns off.

When a watchdog timer error occurs, Module READY turns on.

### Device number

The following table shows the device number of this input signal.

Signal name	External input/output
	X/Y00 to X/Y0F
Module READY	X1F

# Details on output signals

This section describes the details on the output signals for the I/O module with diagnostic functions that are assigned to the CPU module.

This section describes the I/O numbers (X/Y) of when 0 is set as the start I/O number of the I/O module with diagnostic functions.



This section describes the I/O signals of when 0 is set as the I/O terminal number.

## Output signal

These signals indicate the ON/OFF state of external outputs.

However, when the output delay function is enabled, the ON/OFF state of 'Output signal' (Y0) and the ON/OFF state of the external output (Y00) may not match.

### ■Device number

The following table shows the device numbers of these output signals.

Signal name	External output															
	Y00	Y01	Y02	Y03	Y04	Y05	Y06	Y07	Y08	Y09	Y0A	Y0B	Y0C	Y0D	Y0E	Y0F
Output signal	Y0	Y1	Y2	Y3	Y4	Y5	Y6	Y7	Y8	Y9	YA	YB	YC	YD	YE	YF

## Error clear request

Turn on and off this signal to clear 'Error flag' (X10) and 'Latest error code' (Un\G2560). For the timing to turn on and off this signal, refer to the following.

Page 75 Error flag

### ■Device number

The following table shows the device number of this output signal.

Signal name	External input/output
	X/Y00 to X/Y0F
Error clear request	Y10

## Alarm clear request

Turn on and off this signal to clear 'Alarm flag' (X11) and 'Latest alarm code' (Un\G2564). For the timing to turn on and off this signal, refer to the following.

Page 76 Alarm flag

### ■Device number

The following table shows the device number of this output signal.

Signal name	External input/output
	X/Y00 to X/Y0F
Alarm clear request	Y11



## Operating condition setting request

Turn on and off this signal to enable the settings of the I/O module with diagnostic functions.

For the timing to turn on and off this signal, refer to the following.

☞ Page 76 Operating condition setting completed flag

For the buffer memory areas whose settings are to be enabled, refer to the following.

☞ Page 79 List of buffer memory addresses

### ■Device number

The following table shows the device number of this output signal.

Signal name	External input/output
	X/Y00 to X/Y0F
Operating condition setting request	Y12



# Appendix 3 Buffer Memory

## List of buffer memory addresses

The following tables list the buffer memory addresses of the I/O module with diagnostic functions. For details on the buffer memory addresses, refer to the following.

 Page 90 Details of buffer memory addresses

The buffer memory areas of the I/O module with diagnostic functions are classified into the following data types.

Data type	Description	
Setting data	Description	Set this data according to connected devices and the system applications.
	Read/Write attribute	Data can be read/written from/to this area.
	Setting method	Set this data using the engineering tool or a program.
	Setting timing	After the change of a value, the set value is enabled by turning on and off 'Operating condition setting request' (Y12).
Control data	Description	Use this data to control the I/O module with diagnostic functions.
	Read/Write attribute	Data can be read/written from/to this area.
	Setting method	Set this data using the engineering tool or a program.
	Setting timing	A set value is enabled as soon as the value is changed.
Monitor data	Description	Use this data to monitor the status of the I/O module with diagnostic functions.
	Read/Write attribute	Reading data is only allowed. Writing data is not allowed.
	Setting method	—
	Setting timing	—

### Point

Among the buffer memory areas, do not write data in the system areas or the areas whose data types are monitor data. Writing data into these areas can cause a malfunction of the module.

A

## For the input module with diagnostic functions

### ■Error history areas (Un\G0 to Un\G255)

Address (decimal)	Address (hexadecimal)	Name	Default value	Data type	Auto refresh			
0	0H	Latest address of error history	0	Monitor	○			
1 to 15	1H to FH	System area	—	—	—			
16	10H	Error history No.1	0	Monitor	×			
17	11H					Error time	First two digits of the year	Last two digits of the year
18	12H						Month	Day
19	13H					Hour	Minute	
20	14H					Second	Day of the week	
21	15H					Millisecond		
22, 23	16H, 17H	System area	—	—	—			
24 to 29	18H to 1DH	Error history No.2	Same as Error history No.1	0	Monitor	×		
30, 31	1EH, 1FH	System area	—	—	—			
32 to 37	20H to 25H	Error history No.3	Same as Error history No.1	0	Monitor	×		
38, 39	26H, 27H	System area	—	—	—			
40 to 45	28H to 2DH	Error history No.4	Same as Error history No.1	0	Monitor	×		
46, 47	2EH, 2FH	System area	—	—	—			
48 to 53	30H to 35H	Error history No.5	Same as Error history No.1	0	Monitor	×		
54, 55	36H, 37H	System area	—	—	—			
56 to 61	38H to 3DH	Error history No.6	Same as Error history No.1	0	Monitor	×		
62, 63	3EH, 3FH	System area	—	—	—			
64 to 69	40H to 45H	Error history No.7	Same as Error history No.1	0	Monitor	×		
70, 71	46H, 47H	System area	—	—	—			
72 to 77	48H to 4DH	Error history No.8	Same as Error history No.1	0	Monitor	×		
78, 79	4EH, 4FH	System area	—	—	—			
80 to 85	50H to 55H	Error history No.9	Same as Error history No.1	0	Monitor	×		
86, 87	56H, 57H	System area	—	—	—			
88 to 93	58H to 5DH	Error history No.10	Same as Error history No.1	0	Monitor	×		
94, 95	5EH, 5FH	System area	—	—	—			
96 to 101	60H to 65H	Error history No.11	Same as Error history No.1	0	Monitor	×		
102, 103	66H, 67H	System area	—	—	—			
104 to 109	68H to 6DH	Error history No.12	Same as Error history No.1	0	Monitor	×		
110, 111	6EH, 6FH	System area	—	—	—			
112 to 117	70H to 75H	Error history No.13	Same as Error history No.1	0	Monitor	×		
118, 119	76H, 77H	System area	—	—	—			
120 to 125	78H to 7DH	Error history No.14	Same as Error history No.1	0	Monitor	×		
126, 127	7EH, 7FH	System area	—	—	—			
128 to 133	80H to 85H	Error history No.15	Same as Error history No.1	0	Monitor	×		
134, 135	86H, 87H	System area	—	—	—			
136 to 141	88H to 8DH	Error history No.16	Same as Error history No.1	0	Monitor	×		
142 to 255	8EH to FFH	System area	—	—	—			

## ■Alarm history areas (Un\G256 to Un\G511)

Address (decimal)	Address (hexadecimal)	Name	Default value	Data type	Auto refresh		
256	100H	Latest address of alarm history	0	Monitor	○		
257 to 271	101H to 10FH	System area	—	—	—		
272	110H	Alarm history No.1	0	Monitor	×		
273	111H	Alarm code					
274	112H	Alarm time				First two digits of the year	Last two digits of the year
275	113H					Month	Day
276	114H					Hour	Minute
277	115H					Second	Day of the week
		Millisecond					
278, 279	116H, 117H	System area	—	—	—		
280 to 285	118H to 11DH	Alarm history No.2	Same as Alarm history No.1	0	Monitor	×	
286, 287	11EH, 11FH	System area	—	—	—		
288 to 293	120H to 125H	Alarm history No.3	Same as Alarm history No.1	0	Monitor	×	
294, 295	126H, 127H	System area	—	—	—		
296 to 301	128H to 12DH	Alarm history No.4	Same as Alarm history No.1	0	Monitor	×	
302, 303	12EH, 12FH	System area	—	—	—		
304 to 309	130H to 135H	Alarm history No.5	Same as Alarm history No.1	0	Monitor	×	
310, 311	136H, 137H	System area	—	—	—		
312 to 317	138H to 13DH	Alarm history No.6	Same as Alarm history No.1	0	Monitor	×	
318, 319	13EH, 13FH	System area	—	—	—		
320 to 325	140H to 145H	Alarm history No.7	Same as Alarm history No.1	0	Monitor	×	
326, 327	146H, 147H	System area	—	—	—		
328 to 333	148H to 14DH	Alarm history No.8	Same as Alarm history No.1	0	Monitor	×	
334, 335	14EH, 14FH	System area	—	—	—		
336 to 341	150H to 155H	Alarm history No.9	Same as Alarm history No.1	0	Monitor	×	
342, 343	156H, 157H	System area	—	—	—		
344 to 349	158H to 15DH	Alarm history No.10	Same as Alarm history No.1	0	Monitor	×	
350, 351	15EH, 15FH	System area	—	—	—		
352 to 357	160H to 165H	Alarm history No.11	Same as Alarm history No.1	0	Monitor	×	
358, 359	166H, 167H	System area	—	—	—		
360 to 365	168H to 16DH	Alarm history No.12	Same as Alarm history No.1	0	Monitor	×	
366, 367	16EH, 16FH	System area	—	—	—		
368 to 373	170H to 175H	Alarm history No.13	Same as Alarm history No.1	0	Monitor	×	
374, 375	176H, 177H	System area	—	—	—		
376 to 381	178H to 17DH	Alarm history No.14	Same as Alarm history No.1	0	Monitor	×	
382, 383	17EH, 17FH	System area	—	—	—		
384 to 389	180H to 185H	Alarm history No.15	Same as Alarm history No.1	0	Monitor	×	
390, 391	186H, 187H	System area	—	—	—		
392 to 397	188H to 18DH	Alarm history No.16	Same as Alarm history No.1	0	Monitor	×	
398 to 511	18EH to 1FFH	System area	—	—	—		

## Parameters (Un\G512 to Un\G2559)

Address (decimal)	Address (hexadecimal)	Name	Default value	Data type	Auto refresh
512 to 527	200H to 20FH	System area	—	—	—
528	210H	LED indication setting on error condition	0	Setting	×
529 to 559	211H to 22FH	System area	—	—	—
560 to 575	230H to 23FH	Interrupt condition target setting [n] <sup>*1</sup>	0	Setting	×
576 to 591	240H to 24FH	System area	—	—	—
592 to 607	250H to 25FH	Interrupt condition target I/O terminal setting [n] <sup>*1</sup>	0	Setting	×
608 to 1023	260H to 3FFH	System area	—	—	—
1024	400H	Input response time setting X00	BH	Setting	×
1025	401H	Input response time setting X01	BH	Setting	×
1026	402H	Input response time setting X02	BH	Setting	×
1027	403H	Input response time setting X03	BH	Setting	×
1028	404H	Input response time setting X04	BH	Setting	×
1029	405H	Input response time setting X05	BH	Setting	×
1030	406H	Input response time setting X06	BH	Setting	×
1031	407H	Input response time setting X07	BH	Setting	×
1032	408H	Input response time setting X08	BH	Setting	×
1033	409H	Input response time setting X09	BH	Setting	×
1034	40AH	Input response time setting X0A	BH	Setting	×
1035	40BH	Input response time setting X0B	BH	Setting	×
1036	40CH	Input response time setting X0C	BH	Setting	×
1037	40DH	Input response time setting X0D	BH	Setting	×
1038	40EH	Input response time setting X0E	BH	Setting	×
1039	40FH	Input response time setting X0F	BH	Setting	×
1040	410H	Input HOLD/CLEAR function enable/disable	FFFFH	Setting	×
1041 to 1043	411H to 413H	System area	—	—	—
1044	414H	Input HOLD/CLEAR setting	FFFFH	Setting	×
1045 to 1055	415H to 41FH	System area	—	—	—
1056	420H	Input delay function enable/disable	0000H	Setting	×
1057 to 1059	421H to 423H	System area	—	—	—
1060	424H	Input delay type setting X00	0	Setting	×
1061	425H	Input delay type setting X01	0	Setting	×
1062	426H	Input delay type setting X02	0	Setting	×
1063	427H	Input delay type setting X03	0	Setting	×
1064	428H	Input delay type setting X04	0	Setting	×
1065	429H	Input delay type setting X05	0	Setting	×
1066	42AH	Input delay type setting X06	0	Setting	×
1067	42BH	Input delay type setting X07	0	Setting	×
1068	42CH	Input delay type setting X08	0	Setting	×
1069	42DH	Input delay type setting X09	0	Setting	×
1070	42EH	Input delay type setting X0A	0	Setting	×
1071	42FH	Input delay type setting X0B	0	Setting	×
1072	430H	Input delay type setting X0C	0	Setting	×
1073	431H	Input delay type setting X0D	0	Setting	×
1074	432H	Input delay type setting X0E	0	Setting	×
1075	433H	Input delay type setting X0F	0	Setting	×
1076 to 1087	434H to 43FH	System area	—	—	—
1088, 1089	440H, 441H	Input delay time setting X00	1	Setting	×
1090, 1091	442H, 443H	Input delay time setting X01	1	Setting	×
1092, 1093	444H, 445H	Input delay time setting X02	1	Setting	×
1094, 1095	446H, 447H	Input delay time setting X03	1	Setting	×
1096, 1097	448H, 449H	Input delay time setting X04	1	Setting	×

Address (decimal)	Address (hexadecimal)	Name	Default value	Data type	Auto refresh
1098, 1099	44AH, 44BH	Input delay time setting X05	1	Setting	×
1100, 1101	44CH, 44DH	Input delay time setting X06	1	Setting	×
1102, 1103	44EH, 44FH	Input delay time setting X07	1	Setting	×
1104, 1105	450H, 451H	Input delay time setting X08	1	Setting	×
1106, 1107	452H, 453H	Input delay time setting X09	1	Setting	×
1108, 1109	454H, 455H	Input delay time setting X0A	1	Setting	×
1110, 1111	456H, 457H	Input delay time setting X0B	1	Setting	×
1112, 1113	458H, 459H	Input delay time setting X0C	1	Setting	×
1114, 1115	45AH, 45BH	Input delay time setting X0D	1	Setting	×
1116, 1117	45CH, 45DH	Input delay time setting X0E	1	Setting	×
1118, 1119	45EH, 45FH	Input delay time setting X0F	1	Setting	×
1200	4B0H	Number of input ON times integration function enable/disable	0000H	Setting	×
1201 to 1203	4B1H to 4B3H	System area	—	—	—
1204	4B4H	Number of input ON times alarm detection setting	0000H	Setting	×
1205 to 1207	4B5H to 4B7H	System area	—	—	—
1208, 1209	4B8H, 4B9H	Number of input ON times alarm detection count setting X00	1	Setting	×
1210, 1211	4BAH, 4BBH	Number of input ON times alarm detection count setting X01	1	Setting	×
1212, 1213	4BCH, 4BDH	Number of input ON times alarm detection count setting X02	1	Setting	×
1214, 1215	4BEH, 4BFH	Number of input ON times alarm detection count setting X03	1	Setting	×
1216, 1217	4C0H, 4C1H	Number of input ON times alarm detection count setting X04	1	Setting	×
1218, 1219	4C2H, 4C3H	Number of input ON times alarm detection count setting X05	1	Setting	×
1220, 1221	4C4H, 4C5H	Number of input ON times alarm detection count setting X06	1	Setting	×
1222, 1223	4C6H, 4C7H	Number of input ON times alarm detection count setting X07	1	Setting	×
1224, 1225	4C8H, 4C9H	Number of input ON times alarm detection count setting X08	1	Setting	×
1226, 1227	4CAH, 4CBH	Number of input ON times alarm detection count setting X09	1	Setting	×
1228, 1229	4CCH, 4CDH	Number of input ON times alarm detection count setting X0A	1	Setting	×
1230, 1231	4CEH, 4CFH	Number of input ON times alarm detection count setting X0B	1	Setting	×
1232, 1233	4D0H, 4D1H	Number of input ON times alarm detection count setting X0C	1	Setting	×
1234, 1235	4D2H, 4D3H	Number of input ON times alarm detection count setting X0D	1	Setting	×
1236, 1237	4D4H, 4D5H	Number of input ON times alarm detection count setting X0E	1	Setting	×
1238, 1239	4D6H, 4D7H	Number of input ON times alarm detection count setting X0F	1	Setting	×
1240 to 1247	4D8H to 4DFH	System area	—	—	—
1248	4E0H	Event time stamp function enable/disable	0000H	Setting	×
1249 to 1251	4E1H to 4E3H	System area	—	—	—
1252	4E4H	Event time stamp condition setting X00	0	Setting	×
1253	4E5H	Event time stamp condition setting X01	0	Setting	×
1254	4E6H	Event time stamp condition setting X02	0	Setting	×
1255	4E7H	Event time stamp condition setting X03	0	Setting	×
1256	4E8H	Event time stamp condition setting X04	0	Setting	×
1257	4E9H	Event time stamp condition setting X05	0	Setting	×
1258	4EAH	Event time stamp condition setting X06	0	Setting	×
1259	4EBH	Event time stamp condition setting X07	0	Setting	×
1260	4ECH	Event time stamp condition setting X08	0	Setting	×
1261	4EDH	Event time stamp condition setting X09	0	Setting	×
1262	4EEH	Event time stamp condition setting X0A	0	Setting	×
1263	4EFH	Event time stamp condition setting X0B	0	Setting	×
1264	4F0H	Event time stamp condition setting X0C	0	Setting	×
1265	4F1H	Event time stamp condition setting X0D	0	Setting	×
1266	4F2H	Event time stamp condition setting X0E	0	Setting	×
1267	4F3H	Event time stamp condition setting X0F	0	Setting	×
1268 to 1279	4F4H to 4FFH	System area	—	—	—
1280	500H	Setting for not-refreshed data	0000H	Setting	×



Address (decimal)	Address (hexadecimal)	Name	Default value	Data type	Auto refresh
1281 to 1311	501H to 51FH	System area	—	—	—
1312	520H	Input disconnection detection setting	0000H	Setting	×
1313 to 1315	521H to 523H	System area	—	—	—
1316	524H	Input disconnection detection automatic clear enable/disable	1	Setting	×
1317 to 2559	525H to 9FFH	System area	—	—	—

\*1 [n] in the table indicates the interrupt setting number. (n = 1 to 16)

### ■Monitor areas (Un\G2560 to Un\G3327)

Address (decimal)	Address (hexadecimal)	Name	Default value	Data type	Auto refresh
2560	A00H	Latest error code	0	Monitor	○
2561 to 2563	A01H to A03H	System area	—	—	—
2564	A04H	Latest alarm code	0	Monitor	○
2565 to 2591	A05H to A1FH	System area	—	—	—
2592 to 2607	A20H to A2FH	Interrupt factor detection flag [n] <sup>*1</sup>	0	Monitor	○
2608 to 2815	A30H to AFFH	System area	—	—	—
2816	B00H	Input disconnection detection status	0000H	Monitor	○
2817 to 2831	B01H to B0FH	System area	—	—	—
2832	B10H	Number of input ON times alarm detection status	0000H	Monitor	○
2833 to 2847	B11H to B1FH	System area	—	—	—
2848, 2849	B20H, B21H	Number of input ON times X00	0	Monitor	○
2850, 2851	B22H, B23H	Number of input ON times X01	0	Monitor	○
2852, 2853	B24H, B25H	Number of input ON times X02	0	Monitor	○
2854, 2855	B26H, B27H	Number of input ON times X03	0	Monitor	○
2856, 2857	B28H, B29H	Number of input ON times X04	0	Monitor	○
2858, 2859	B2AH, B2BH	Number of input ON times X05	0	Monitor	○
2860, 2861	B2CH, B2DH	Number of input ON times X06	0	Monitor	○
2862, 2863	B2EH, B2FH	Number of input ON times X07	0	Monitor	○
2864, 2865	B30H, B31H	Number of input ON times X08	0	Monitor	○
2866, 2867	B32H, B33H	Number of input ON times X09	0	Monitor	○
2868, 2869	B34H, B35H	Number of input ON times X0A	0	Monitor	○
2870, 2871	B36H, B37H	Number of input ON times X0B	0	Monitor	○
2872, 2873	B38H, B39H	Number of input ON times X0C	0	Monitor	○
2874, 2875	B3AH, B3BH	Number of input ON times X0D	0	Monitor	○
2876, 2877	B3CH, B3DH	Number of input ON times X0E	0	Monitor	○
2878, 2879	B3EH, B3FH	Number of input ON times X0F	0	Monitor	○
2880	B40H	Number of input ON times value clear completed	0000H	Monitor	○
2881 to 3327	B41H to CFFH	System area	—	—	—

\*1 [n] in the table indicates the interrupt setting number. (n = 1 to 16)

### ■Control areas (Un\G3328 to Un\G4351)

Address (decimal)	Address (hexadecimal)	Name	Default value	Data type	Auto refresh
3328 to 3343	D00H to D0FH	Interrupt factor reset request [n] <sup>*1</sup>	0	Control	×
3344 to 3359	D10H to D1FH	Interrupt factor mask [n] <sup>*1</sup>	0	Control	×
3360 to 3583	D20H to DFFH	System area	—	—	—
3584	E00H	Number of input ON times value clear request	0000H	Control	×
3585 to 4351	E01H to 10FFH	System area	—	—	—

\*1 [n] in the table indicates the interrupt setting number. (n = 1 to 16)

## ■Event time stamp areas (Un\G4352 to Un\G5375)

Address (decimal)	Address (hexadecimal)	Name	Default value	Data type	Auto refresh		
4352	1100H	Event time stamp number for next storage <sup>*1</sup>	0000H	Monitor	○		
4353	1101H	Event time stamp number for CPU read <sup>*1</sup>	0000H	Monitor	○		
4354	1102H	Event time stamp storage status <sup>*1</sup>	0000H	Monitor	○		
4355	1103H	System area	—	—	—		
4356	1104H	Event time stamp data 1 for refresh <sup>*1</sup>	0000H	Monitor	○		
						First two digits of the year	Last two digits of the year
4357	1105H					Month	Day
4358	1106H					Hour	Minute
4359	1107H					Second	Day of the week
4360	1108H					Millisecond	
4361	1109H	Event type	I/O terminal				
4362 to 4367	110AH to 110FH	Event time stamp data 2 for refresh <sup>*1</sup>	Same as Event time stamp data 1 for refresh	0000H	Monitor	○	
4368 to 4373	1110H to 1115H	Event time stamp data 3 for refresh <sup>*1</sup>	Same as Event time stamp data 1 for refresh	0000H	Monitor	○	
4374 to 4379	1116H to 111BH	Event time stamp data 4 for refresh <sup>*1</sup>	Same as Event time stamp data 1 for refresh	0000H	Monitor	○	
4380 to 4385	111CH to 1121H	Event time stamp data 5 for refresh <sup>*1</sup>	Same as Event time stamp data 1 for refresh	0000H	Monitor	○	
4386 to 4391	1122H to 1127H	Event time stamp data 6 for refresh <sup>*1</sup>	Same as Event time stamp data 1 for refresh	0000H	Monitor	○	
4392 to 4397	1128H to 112DH	Event time stamp data 7 for refresh <sup>*1</sup>	Same as Event time stamp data 1 for refresh	0000H	Monitor	○	
4398 to 4403	112EH to 1133H	Event time stamp data 8 for refresh <sup>*1</sup>	Same as Event time stamp data 1 for refresh	0000H	Monitor	○	
4404 to 4415	1134H to 113FH	System area	—	—	—		
4416	1140H	Event time stamp number of read completion <sup>*1</sup>	0000H	Monitor	○		
4417 to 4607	1141H to 11FFH	System area	—	—	—		
4608 to 4613	1200H to 1205H	Event time stamp data 1	Same as Event time stamp data 1 for refresh	0000H	Monitor	×	
4614 to 4619	1206H to 120BH	Event time stamp data 2	Same as Event time stamp data 1 for refresh	0000H	Monitor	×	
4620 to 5363	120CH to 14F3H	Event time stamp data 3 to Event time stamp data 126	0000H	Monitor	×		
5364 to 5369	14F4H to 14F9H	Event time stamp data 127	Same as Event time stamp data 1 for refresh	0000H	Monitor	×	
5370 to 5375	14FAH to 14FFH	Event time stamp data 128	Same as Event time stamp data 1 for refresh	0000H	Monitor	×	

\*1 Used for reading event time stamp data to the CPU module using function blocks. To read the event time stamp data to the CPU module using function blocks, set the items of the refresh settings.

## ■Command area for module invalidation, Validation status area (Un\G5376 to Un\G65535)

Address (decimal)	Address (hexadecimal)	Name	Default value	Data type	Auto refresh
5376	1500H	Command area for module invalidation	0000H	Setting	×
5377	1501H	Validation status area	0000H	Monitor	×
5378 to 65535	1502H to FFFFH	System area	—	—	—

A

## For the output module with diagnostic functions

### ■Error history areas (Un\G0 to Un\G255)

Same as the input module with diagnostic functions

☞ Page 80 Error history areas (Un\G0 to Un\G255)

### ■Alarm history areas (Un\G256 to Un\G511)

Same as the input module with diagnostic functions

☞ Page 81 Alarm history areas (Un\G256 to Un\G511)

### ■Parameter areas (Un\G512 to Un\G2559)

Address (decimal)	Address (hexadecimal)	Name	Default value	Data type	Auto refresh
512	200H	Setting of output mode at error	FFFFH	Setting	×
513 to 527	201H to 20FH	System area	—	—	—
528	210H	LED indication setting on error condition	0	Setting	×
529 to 559	211H to 22FH	System area	—	—	—
560 to 575	230H to 23FH	Interrupt condition target setting [n] <sup>*1</sup>	0	Setting	×
576 to 591	240H to 24FH	System area	—	—	—
592 to 607	250H to 25FH	Interrupt condition target I/O terminal setting [n] <sup>*1</sup>	0	Setting	×
608 to 1807	260H to 70FH	System area	—	—	—
1808	710H	Output delay function enable/disable	0000H	Setting	×
1809 to 1811	711H to 713H	System area	—	—	—
1812	714H	Output delay type setting Y00	0	Setting	×
1813	715H	Output delay type setting Y01	0	Setting	×
1814	716H	Output delay type setting Y02	0	Setting	×
1815	717H	Output delay type setting Y03	0	Setting	×
1816	718H	Output delay type setting Y04	0	Setting	×
1817	719H	Output delay type setting Y05	0	Setting	×
1818	71AH	Output delay type setting Y06	0	Setting	×
1819	71BH	Output delay type setting Y07	0	Setting	×
1820	71CH	Output delay type setting Y08	0	Setting	×
1821	71DH	Output delay type setting Y09	0	Setting	×
1822	71EH	Output delay type setting Y0A	0	Setting	×
1823	71FH	Output delay type setting Y0B	0	Setting	×
1824	720H	Output delay type setting Y0C	0	Setting	×
1825	721H	Output delay type setting Y0D	0	Setting	×
1826	722H	Output delay type setting Y0E	0	Setting	×
1827	723H	Output delay type setting Y0F	0	Setting	×
1828 to 1839	724H to 72FH	System area	—	—	—
1840, 1841	730H, 731H	Output delay time setting Y00	1	Setting	×
1842, 1843	732H, 733H	Output delay time setting Y01	1	Setting	×
1844, 1845	734H, 735H	Output delay time setting Y02	1	Setting	×
1846, 1847	736H, 737H	Output delay time setting Y03	1	Setting	×
1848, 1849	738H, 739H	Output delay time setting Y04	1	Setting	×
1850, 1851	73AH, 73BH	Output delay time setting Y05	1	Setting	×
1852, 1853	73CH, 73DH	Output delay time setting Y06	1	Setting	×
1854, 1855	73EH, 73FH	Output delay time setting Y07	1	Setting	×
1856, 1857	740H, 741H	Output delay time setting Y08	1	Setting	×
1858, 1859	742H, 743H	Output delay time setting Y09	1	Setting	×
1860, 1861	744H, 745H	Output delay time setting Y0A	1	Setting	×
1862, 1863	746H, 747H	Output delay time setting Y0B	1	Setting	×
1864, 1865	748H, 749H	Output delay time setting Y0C	1	Setting	×
1866, 1867	74AH, 74BH	Output delay time setting Y0D	1	Setting	×
1868, 1869	74CH, 74DH	Output delay time setting Y0E	1	Setting	×



Address (decimal)	Address (hexadecimal)	Name	Default value	Data type	Auto refresh
1870, 1871	74EH, 74FH	Output delay time setting Y0F	1	Setting	×
1872 to 1903	750H to 76FH	System area	—	—	—
1904	770H	Number of output ON times integration function enable/disable	0000H	Setting	×
1905 to 1907	771H to 773H	System area	—	—	—
1908	774H	Number of output ON times alarm detection setting	0000H	Setting	×
1909 to 1911	775H to 777H	System area	—	—	—
1912, 1913	778H, 779H	Number of output ON times alarm detection count setting Y00	1	Setting	×
1914, 1915	77AH, 77BH	Number of output ON times alarm detection count setting Y01	1	Setting	×
1916, 1917	77CH, 77DH	Number of output ON times alarm detection count setting Y02	1	Setting	×
1918, 1919	77EH, 77FH	Number of output ON times alarm detection count setting Y03	1	Setting	×
1920, 1921	780H, 781H	Number of output ON times alarm detection count setting Y04	1	Setting	×
1922, 1923	782H, 783H	Number of output ON times alarm detection count setting Y05	1	Setting	×
1924, 1925	784H, 785H	Number of output ON times alarm detection count setting Y06	1	Setting	×
1926, 1927	786H, 787H	Number of output ON times alarm detection count setting Y07	1	Setting	×
1928, 1929	788H, 789H	Number of output ON times alarm detection count setting Y08	1	Setting	×
1930, 1931	78AH, 78BH	Number of output ON times alarm detection count setting Y09	1	Setting	×
1932, 1933	78CH, 78DH	Number of output ON times alarm detection count setting Y0A	1	Setting	×
1934, 1935	78EH, 78FH	Number of output ON times alarm detection count setting Y0B	1	Setting	×
1936, 1937	790H, 791H	Number of output ON times alarm detection count setting Y0C	1	Setting	×
1938, 1939	792H, 793H	Number of output ON times alarm detection count setting Y0D	1	Setting	×
1940, 1941	794H, 795H	Number of output ON times alarm detection count setting Y0E	1	Setting	×
1942, 1943	796H, 797H	Number of output ON times alarm detection count setting Y0F	1	Setting	×
1944 to 1951	798H to 79FH	System area	—	—	—
1952	7A0H	Output disconnection detection setting	0000H	Setting	×
1953 to 1955	7A1H to 7A3H	System area	—	—	—
1956	7A4H	Output disconnection detection automatic clear enable/disable	0001H	Setting	×
1957 to 1967	7A5H to 7AFH	System area	—	—	—
1968	7B0H	Output short-circuit detection setting	0000H	Setting	×
1969 to 1971	7B1H to 7B3H	System area	—	—	—
1972	7B4H	Output short-circuit detection automatic clear enable/disable	0001H	Setting	×
1973 to 1987	7B5H to 7C3H	System area	—	—	—
1988	7C4H	Output disconnection detection disable time setting	0001H	Setting	×
1989 to 2559	7C5H to 9FFH	System area	—	—	—

\*1 [n] in the table indicates the interrupt setting number. (n = 1 to 16)

## ■Monitor areas (Un\G2560 to Un\G3327)

Address (decimal)	Address (hexadecimal)	Name	Default value	Data type	Auto refresh
2560	A00H	Latest error code	0	Monitor	○
2561 to 2563	A01H to A03H	System area	—	—	—
2564	A04H	Latest alarm code	0	Monitor	○
2565 to 2591	A05H to A1FH	System area	—	—	—
2592 to 2607	A20H to A2FH	Interrupt factor detection flag [n] <sup>*1</sup>	0	Monitor	○
2608 to 3071	A30H to BFFH	System area	—	—	—
3072	C00H	Output disconnection detection status	0000H	Monitor	○
3073 to 3087	C01H to C0FH	System area	—	—	—
3088	C10H	Output short-circuit detection status	0000H	Monitor	○
3089 to 3119	C11H to C2FH	System area	—	—	—
3120	C30H	Number of output ON times alarm detection status	0000H	Monitor	○
3121 to 3135	C31H to C3FH	System area	—	—	—
3136, 3137	C40H, C41H	Number of output ON times Y00	0	Monitor	○
3138, 3139	C42H, C43H	Number of output ON times Y01	0	Monitor	○
3140, 3141	C44H, C45H	Number of output ON times Y02	0	Monitor	○
3142, 3143	C46H, C47H	Number of output ON times Y03	0	Monitor	○
3144, 3145	C48H, C49H	Number of output ON times Y04	0	Monitor	○
3146, 3147	C4AH, C4BH	Number of output ON times Y05	0	Monitor	○
3148, 3149	C4CH, C4DH	Number of output ON times Y06	0	Monitor	○
3150, 3151	C4EH, C4FH	Number of output ON times Y07	0	Monitor	○
3152, 3153	C50H, C51H	Number of output ON times Y08	0	Monitor	○
3154, 3155	C52H, C53H	Number of output ON times Y09	0	Monitor	○
3156, 3157	C54H, C55H	Number of output ON times Y0A	0	Monitor	○
3158, 3159	C56H, C57H	Number of output ON times Y0B	0	Monitor	○
3160, 3161	C58H, C59H	Number of output ON times Y0C	0	Monitor	○
3162, 3163	C5AH, C5BH	Number of output ON times Y0D	0	Monitor	○
3164, 3165	C5CH, C5DH	Number of output ON times Y0E	0	Monitor	○
3166, 3167	C5EH, C5FH	Number of output ON times Y0F	0	Monitor	○
3168	C60H	Number of output ON times value clear completed	0000H	Monitor	○
3169 to 3327	C61H to CFFH	System area	—	—	—

\*1 [n] in the table indicates the interrupt setting number. (n = 1 to 16)

## ■Control areas (Un\G3328 to Un\G4351)

Address (decimal)	Address (hexadecimal)	Name	Default value	Data type	Auto refresh
3328 to 3343	D00H to D0FH	Interrupt factor reset request [n] <sup>*1</sup>	0	Control	×
3344 to 3359	D10H to D1FH	Interrupt factor mask [n] <sup>*1</sup>	0	Control	×
3360 to 3839	D20H to EFFH	System area	—	—	—
3840	F00H	Number of output ON times value clear request	0000H	Control	×
3841 to 4351	F01H to 10FFH	System area	—	—	—

\*1 [n] in the table indicates the interrupt setting number. (n = 1 to 16)

## ■System areas (Un\G4352 to Un\G5375)

Address (decimal)	Address (hexadecimal)	Name	Default value	Data type	Auto refresh
4352 to 5375	1100H to 14FFH	System area	—	—	—

**■Command area for module invalidation, Validation status area (Un\G5376 to Un\G65535)**

Address (decimal)	Address (hexadecimal)	Name	Default value	Data type	Auto refresh
5376	1500H	Command area for module invalidation	0000H	Setting	×
5377	1501H	Validation status area	0000H	Monitor	×
5378 to 65535	1502H to FFFFH	System area	—	—	—

# Details of buffer memory addresses

This section describes the details of buffer memory addresses of the I/O module with diagnostic functions.

## Latest address of error history

This area shows the buffer memory address where the latest error history is stored.

### ■ Buffer memory address

The following table shows the buffer memory address of this area.

Buffer memory name	X/Y0 to X/YF
Latest address of error history	0

## Error history No.

Up to 16 errors that have occurred in the module are registered.

**Ex.**

For Error history No.1

	b15	to	b8 b7	to	b0
Un\G16	Error code				
Un\G17	First two digits of the year		Last two digits of the year		
Un\G18	Month		Day		
Un\G19	Hour		Minute		
Un\G20	Second		Day of the week		
Un\G21	Millisecond (higher-order digits)		Millisecond (lower-order digits)		
Un\G22	System area				
⋮					
Un\G23					

Item	Description	Example <sup>*1</sup>
Error code	The error code is stored.	1900H
First/Last two digits of the year	The error time is stored in the BCD code.	2016H
Month/Day		527H
Hour/Minute		1234H
Second		56H
Day of the week		The following values are stored in the BCD code for each day of the week. Sunday: 0, Monday: 1, Tuesday: 2, Wednesday: 3 Thursday: 4, Friday: 5, Saturday: 6
Millisecond (upper)	The error time is stored in the BCD code.	7H
Millisecond (lower)		89H
System area	—	—

\*1 The value stored when the input response time setting error (error code: 1900H) occurs at 12:34:56.789 on Friday, May 27, 2016

### ■ Buffer memory address

The following table shows the buffer memory address of this area.

Buffer memory name	Error history No.1 to Error history No.16
Error history No.	16 to 143

## Latest address of alarm history

This area shows the buffer memory address where the latest alarm history is stored.

### ■ Buffer memory address

The following table shows the buffer memory address of this area.

Buffer memory name	X/Y0 to X/YF
Latest address of alarm history	256

## Alarm history No.

Up to 16 alarms that have occurred in the module are registered.

**Ex.**

For Alarm history No.1

	b15	to	b8 b7	to	b0
Un\G272	Alarm code				
Un\G273	First two digits of the year		Last two digits of the year		
Un\G274	Month		Day		
Un\G275	Hour		Minute		
Un\G276	Second		Day of the week		
Un\G277	Millisecond (higher-order digits)		Millisecond (lower-order digits)		
Un\G278	System area				
⋮					
Un\G279					

Item	Description	Example*1
Alarm code	The alarm code is stored.	800H
First/Last two digits of the year	The error time is stored in the BCD code.	2016H
Month/Day		527H
Hour/Minute		1234H
Second		56H
Day of the week	The following values are stored in the BCD code for each day of the week. Sunday: 0, Monday: 1, Tuesday: 2, Wednesday: 3 Thursday: 4, Friday: 5, Saturday: 6	5H
Millisecond (upper)	The error time is stored in the BCD code.	7H
Millisecond (lower)		89H
System area	—	—

\*1 The value stored when the number of input ON times alarm detection count reached (alarm code: 800H) occurs at 12:34:56.789 on Friday, May 27, 2016

### ■ Buffer memory address

The following table shows the buffer memory address of this area.

Buffer memory name	Alarm history No.1 to Alarm history No.16
Alarm history No.	272 to 399

A

## Setting of output mode at error

Set the output mode for when an error occurs for each output.

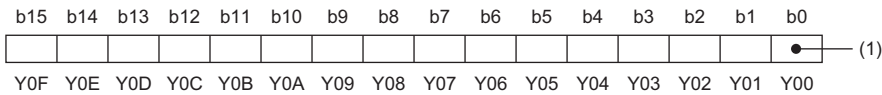

(1) 0: CLEAR, 1: HOLD

### ■Buffer memory address

The following table shows the buffer memory address of this area.

Buffer memory name	Y0 to YF
Setting of output mode at error	512

### ■Enabling the setting

Turn on and off 'Operating condition setting request' (Y12) to enable the setting.

### ■Default value

The default value is set to 1 (HOLD) for all the outputs.

## LED indication setting on error condition

Set the LED indication method for when an error occurs for each module.

Setting value	Description
0	I/O with an error not indicated
1	I/O status and error indication switching (at the interval of a second)
2	I/O with an error always indicated

When a value other than the above is set, the LED indication setting on error condition error (error code: 1B00H) occurs.

### ■Buffer memory address

The following table shows the buffer memory address of this area.

Buffer memory name	X/Y0 to X/YF
LED indication setting on error condition	528

### ■Enabling the setting

Turn on and off 'Operating condition setting request' (Y12) to enable the setting.

### ■Default value

The default value is set to 0 (I/O with an error not indicated).

## Interrupt condition target setting [n]

Set the factor to be detected for interrupt operation.

- Input module with diagnostic functions

Setting value	Description
0	Disable
1	'Error flag' (X10)
2	'Alarm flag' (X11)
3	Input disconnection detection status
7	Number of input ON times alarm detection status
8	Input signal (rise) <sup>*1</sup>
9	Input signal (fall) <sup>*1</sup>
10	Input signal (rise + fall) <sup>*1</sup>

\*1 When the input response time setting function or input delay function is enabled, the status of an input signal may be different from the status of the actual external input signal (X00 to X0F).

- Output module with diagnostic functions

Setting value	Description
0	Disable
1	'Error flag' (X10)
2	'Alarm flag' (X11)
3	Output disconnection detection status
4	Output short-circuit detection status
7	Number of output ON times alarm detection status

When a value other than the above is set, the interrupt condition target setting range error (error code: 181△H) occurs.

△ indicates the interrupt setting number. (△ = 1 to 16)

When an input signal (X), output signal (Y), or buffer memory area set in 'Interrupt condition target setting [n]' (Un\G560 to Un\G575) is turned on, an interrupt request is sent to the CPU module.

n indicates the interrupt setting number. (n = 1 to 16)

### ■Buffer memory address

The following table shows the buffer memory address of this area.

Buffer memory name	1	2	3	4	5	6	7	8	9	10	11	12	13	14	15	16
Interrupt condition target setting [n]	560	561	562	563	564	565	566	567	568	569	570	571	572	573	574	575

### ■Enabling the setting

Turn on and off 'Operating condition setting request' (Y12) to enable the setting.

### ■Default value

The default value is set to 0 for all the areas.

## Interrupt condition target I/O terminal setting [n]

Set the target I/O terminal number for the interrupt detection. Setting 16 specifies all the I/O terminals and an interrupt is issued when the condition is detected in any of the I/O terminals.

- Input module with diagnostic functions

Setting value	Description
0 to 15	X00 to X0F
16	All input terminals specified

- Output module with diagnostic functions

Setting value	Description
0 to 15	Y00 to Y0F
16	All output terminals specified

When a value other than the above is set, the interrupt condition target I/O terminal setting range error (error code: 182△H) occurs.

△ indicates the interrupt setting number. (△ = 1 to 16)

### ■Buffer memory address

The following table shows the buffer memory address of this area.

Buffer memory name	1	2	3	4	5	6	7	8	9	10	11	12	13	14	15	16
Interrupt condition target I/O terminal setting [n]	592	593	594	595	596	597	598	599	600	601	602	603	604	605	606	607

### ■Enabling the setting

Turn on and off 'Operating condition setting request' (Y12) to enable the setting.

### ■Default value

The default value is set to 0 for all the areas.



## Input response time setting

Set the input response time of input signals for each input signal.

Setting value	Description
9H	1ms
AH	5ms
BH	10ms
CH	20ms
DH	70ms

When a value other than the above is set, the input response time setting error (error code: 190□H) occurs. □ indicates the number of an I/O terminal in which the error has occurred. (□ = 0 to F)

### ■Buffer memory address

The following table shows the buffer memory address of this area.

Buffer memory name	X00	X01	X02	X03	X04	X05	X06	X07	X08	X09	X0A	X0B	X0C	X0D	X0E	X0F
Input response time setting	1024	1025	1026	1027	1028	1029	1030	1031	1032	1033	1034	1035	1036	1037	1038	1039

### ■Enabling the setting

Turn on and off 'Operating condition setting request' (Y12) to enable the setting.

### ■Default value

The default value is set to BH (10ms) for all the signals.

## Input HOLD/CLEAR function enable/disable

Set whether to enable or disable the input HOLD/CLEAR for each input.

b15	b14	b13	b12	b11	b10	b9	b8	b7	b6	b5	b4	b3	b2	b1	b0
<input type="checkbox"/>	<input type="checkbox"/>	<input type="checkbox"/>	<input type="checkbox"/>	<input type="checkbox"/>	<input type="checkbox"/>	<input type="checkbox"/>	<input type="checkbox"/>	<input type="checkbox"/>	<input type="checkbox"/>	<input type="checkbox"/>	<input type="checkbox"/>	<input type="checkbox"/>	<input type="checkbox"/>	<input type="checkbox"/>	<input checked="" type="checkbox"/>
X0F	X0E	X0D	X0C	X0B	X0A	X09	X08	X07	X06	X05	X04	X03	X02	X01	X00

(1) 0: Disable, 1: Enable

### ■Buffer memory address

The following table shows the buffer memory address of this area.

Buffer memory name	X00 to X0F
Input HOLD/CLEAR function enable/disable	1040

### ■Enabling the setting

Turn on and off 'Operating condition setting request' (Y12) to enable the setting.

### ■Default value

The default value is set to 1 (Enable) for all the inputs.

## Input HOLD/CLEAR setting

Set whether to hold or clear inputs for each input.

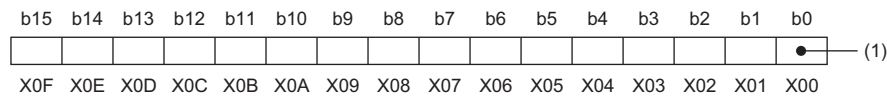

(1) 0: CLEAR, 1: HOLD

### ■Buffer memory address

The following table shows the buffer memory address of this area.

Buffer memory name	X0 to XF
Input HOLD/CLEAR setting	1044

### ■Enabling the setting

Turn on and off 'Operating condition setting request' (Y12) to enable the setting.

### ■Default value

The default value is set to 1 (HOLD) for all the inputs.

## Input delay function enable/disable

Set whether to enable or disable the input delay function for each input. This setting is disabled when the synchronization function is used.

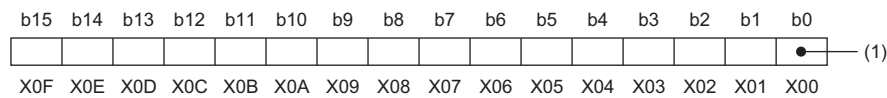

(1) 0: Disable, 1: Enable

### ■Buffer memory address

The following table shows the buffer memory address of this area.

Buffer memory name	X0 to XF
Input delay function enable/disable	1056

### ■Enabling the setting

Turn on and off 'Operating condition setting request' (Y12) to enable the setting.

### ■Default value

The default value is set to 0 (Disable) for all the inputs.

## Input delay type setting

Set the input delay type for each input.

Setting value	Description
0	OFF delay
1	ON delay
2	Pulse stretch

When a value other than the above is set, the input delay type setting error (error code: 192□H) occurs. □ indicates the number of an I/O terminal in which the error has occurred. (□ = 0 to F)

### ■Buffer memory address

The following table shows the buffer memory address of this area.

Buffer memory name	X00	X01	X02	X03	X04	X05	X06	X07	X08	X09	X0A	X0B	X0C	X0D	X0E	X0F
Input delay type setting	1060	1061	1062	1063	1064	1065	1066	1067	1068	1069	1070	1071	1072	1073	1074	1075

### ■Enabling the setting

Turn on and off 'Operating condition setting request' (Y12) to enable the setting.

### ■Default value

The default value is set to 0 (OFF delay) for all the inputs.

## Input delay time setting

Set the input delay time for each input.

### ■Buffer memory address

The following table shows the buffer memory address of this area.

Buffer memory name	X00	X01	X02	X03	X04	X05	X06	X07	X08	X09	X0A	X0B	X0C	X0D	X0E	X0F
Input delay time setting	1088 1089	1090 1091	1092 1093	1094 1095	1096 1097	1098 1099	1100 1101	1102 1103	1104 1105	1106 1107	1108 1109	1110 1111	1112 1113	1114 1115	1116 1117	1118 1119

### ■Setting range

- The available range is 1 to 150000 (400μs to 60s). (Set the range in increments of 400μs.)
- The input delay time setting error (error code: 194□H) occurs in the input terminal where a value out of the setting range has been set. □ indicates the number of an I/O terminal in which the error has occurred. (□ = 0 to F)

### ■Enabling the setting

Turn on and off 'Operating condition setting request' (Y12) to enable the setting.

### ■Default value

The default value is set to 1 (400μs) for all the inputs.

## Number of input ON times integration function enable/disable

Set whether to enable or disable the number of input ON times integration function for each input.

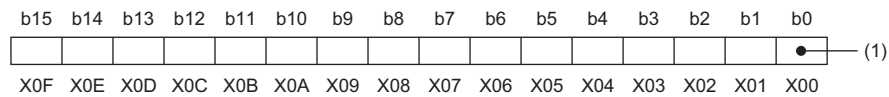

(1) 0: Disable, 1: Enable

### ■Buffer memory address

The following table shows the buffer memory address of this area.

Buffer memory name	X0 to XF
Number of input ON times integration function enable/disable	1200

### ■Enabling the setting

Turn on and off 'Operating condition setting request' (Y12) to enable the setting.

### ■Default value

The default value is set to 0 (Disable) for all the inputs.

## Number of input ON times alarm detection setting

Set whether to detect an alarm for the number of input ON times for each input.

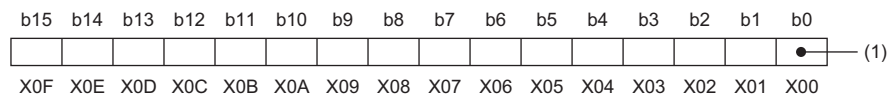

(1) 0: Not detect, 1: Detect

### ■Buffer memory address

The following table shows the buffer memory address of this area.

Buffer memory name	X0 to XF
Number of input ON times alarm detection setting	1204

### ■Enabling the setting

Turn on and off 'Operating condition setting request' (Y12) to enable the setting.

### ■Default value

The default value is set to 0 (Not detect) for all the inputs.

## Number of input ON times alarm detection count setting

Set the number of input ON times alarm detection count for each input.

### ■Buffer memory address

The following table shows the buffer memory address of this area.

Buffer memory name	X00	X01	X02	X03	X04	X05	X06	X07	X08	X09	X0A	X0B	X0C	X0D	X0E	X0F
Number of input ON times	1208	1210	1212	1214	1216	1218	1220	1222	1224	1226	1228	1230	1232	1234	1236	1238
alarm detection count setting	1209	1211	1213	1215	1217	1219	1221	1223	1225	1227	1229	1231	1233	1235	1237	1239

### ■Setting range

- The available range is 1 to 4294967295.
- The number of input ON times alarm detection count setting error (error code: 196□H) occurs in the input terminal where a value out of the setting range has been set. □ indicates the number of an I/O terminal in which the error has occurred. (□ = 0H to FH)

### ■Enabling the setting

Turn on and off 'Operating condition setting request' (Y12) to enable the setting.

### ■Default value

The default value is set to 1 for all the inputs.

## Event time stamp function enable/disable

Set whether to enable or disable the event time stamp function for each input.

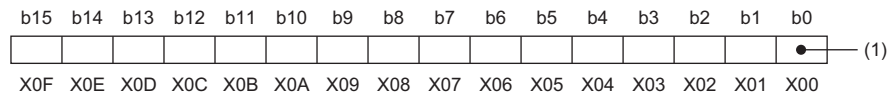

(1) 0: Disable, 1: Enable

### ■Buffer memory address

The following table shows the buffer memory address of this area.

Buffer memory name	X0 to XF
Event time stamp function enable/disable	1248

### ■Enabling the setting

Turn on and off 'Operating condition setting request' (Y12) to enable the setting.

### ■Default value

The default value is set to 0 (Disable) for all the inputs.

## Event time stamp condition setting

Set the event time stamp condition for each input.

Setting value	Description
0	Rise
1	Fall
2	Rise + Fall

When a value other than the above is set, the event time stamp condition setting error (error code: 198□H) occurs. □ indicates the number of an I/O terminal in which the error has occurred. (□ = 0H to FH)

### ■Buffer memory address

The following table shows the buffer memory address of this area.

Buffer memory name	X00	X01	X02	X03	X04	X05	X06	X07	X08	X09	X0A	X0B	X0C	X0D	X0E	X0F
Event time stamp condition setting	1252	1253	1254	1255	1256	1257	1258	1259	1260	1261	1262	1263	1264	1265	1266	1267

### ■Enabling the setting

Turn on and off 'Operating condition setting request' (Y12) to enable the setting.

### ■Default value

The default value is set to 0 (Rise) for all the inputs.

## Setting for not-refreshed data

Set whether to overwrite older data with new event data for when 128 or more non-refreshed event time stamp data sets exist.

Setting value	Description
0	Not overwrite
1	Overwrite

### ■Buffer memory address

The following table shows the buffer memory address of this area.

Buffer memory name	X0 to XF
Setting for not-refreshed data	1280

### ■Enabling the setting

Turn on and off 'Operating condition setting request' (Y12) to enable the setting.

### ■Default value

The default value is set to 0 (Not overwrite) for all the inputs.

## Input disconnection detection setting

Set whether to detect input disconnections for each input.

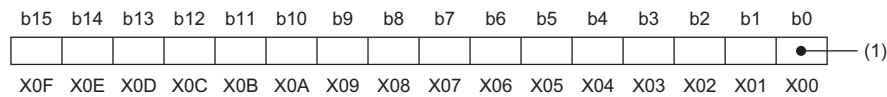

(1) 0: Not detect, 1: Detect

### ■Buffer memory address

The following table shows the buffer memory address of this area.

Buffer memory name	X0 to XF
Input disconnection detection setting	1312

### ■Enabling the setting

Turn on and off 'Operating condition setting request' (Y12) to enable the setting.

### ■Default value

The default value is set to 0 (Not detect) for all the inputs.

## Input disconnection detection automatic clear enable/disable

Set whether to enable or disable the automatic clear of disconnection detection for the input disconnection detection function.

Setting value	Description
0	Disable
1	Enable

When a numerical value other than the above is set, the set value is regarded as 1 (Enable).

### ■Buffer memory address

The following table shows the buffer memory address of this area.

Buffer memory name	X0 to XF
Input disconnection detection automatic clear enable/disable	1316

### ■Enabling the setting

Turn on and off 'Operating condition setting request' (Y12) to enable the setting.

### ■Default value

The default value is set to 1 (Enable).

## Output delay function enable/disable

Set whether to enable or disable the output delay for each output. This setting is disabled when the synchronization function is used.

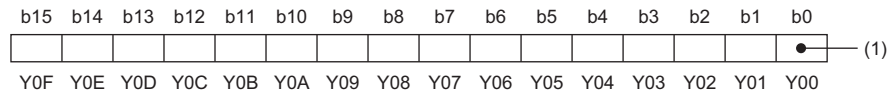

(1) 0: Disable, 1: Enable

### ■ Buffer memory address

The following table shows the buffer memory address of this area.

Buffer memory name	Y0 to YF
Output delay function enable/disable	1808

### ■ Enabling the setting

Turn on and off 'Operating condition setting request' (Y12) to enable the setting.

### ■ Default value

The default value is set to 0 (Disable) for all the outputs.

## Output delay type setting

Set the output delay type for each output.

Setting value	Description
0	OFF delay
1	ON delay

When a value other than the above is set, the output delay type setting error (error code: 1A2□H) occurs. □ indicates the number of an I/O terminal in which the error has occurred. (□ = 0H to FH)

### ■ Buffer memory address

The following table shows the buffer memory address of this area.

Buffer memory name	Y00	Y01	Y02	Y03	Y04	Y05	Y06	Y07	Y08	Y09	Y0A	Y0B	Y0C	Y0D	Y0E	Y0F
Output delay type setting	1812	1813	1814	1815	1816	1817	1818	1819	1820	1821	1822	1823	1824	1825	1826	1827

### ■ Enabling the setting

Turn on and off 'Operating condition setting request' (Y12) to enable the setting.

### ■ Default value

The default value is set to 0 (OFF delay) for all the outputs.



## Output delay time setting

Set the output delay time for each output.

### ■Buffer memory address

The following table shows the buffer memory address of this area.

Buffer memory name	Y00	Y01	Y02	Y03	Y04	Y05	Y06	Y07	Y08	Y09	Y0A	Y0B	Y0C	Y0D	Y0E	Y0F
Output delay time setting	1840	1842	1844	1846	1848	1850	1852	1854	1856	1858	1860	1862	1864	1866	1868	1870
	1841	1843	1845	1847	1849	1851	1853	1855	1857	1859	1861	1863	1865	1867	1869	1871

### ■Setting range

- The available range is 1 to 150000 (400μs to 60s). (Set the range in increments of 400μs.)
- The output delay time setting error (error code: 1A4□H) occurs in the output terminal where a value out of the setting range has been set. □ indicates the number of an I/O terminal in which the error has occurred. (□ = 0H to FH)

### ■Enabling the setting

Turn on and off 'Operating condition setting request' (Y12) to enable the setting.

### ■Default value

The default value is set to 1 (400μs) for all the inputs.

## Number of output ON times integration function enable/disable

Set whether to enable or disable the number of output ON times integration function for each output.

b15	b14	b13	b12	b11	b10	b9	b8	b7	b6	b5	b4	b3	b2	b1	b0
<input type="checkbox"/>	<input type="checkbox"/>	<input type="checkbox"/>	<input type="checkbox"/>	<input type="checkbox"/>	<input type="checkbox"/>	<input type="checkbox"/>	<input type="checkbox"/>	<input type="checkbox"/>	<input type="checkbox"/>	<input type="checkbox"/>	<input type="checkbox"/>	<input type="checkbox"/>	<input type="checkbox"/>	<input type="checkbox"/>	<input checked="" type="checkbox"/>
Y0F	Y0E	Y0D	Y0C	Y0B	Y0A	Y09	Y08	Y07	Y06	Y05	Y04	Y03	Y02	Y01	Y00

(1) 0: Disable, 1: Enable

### ■Buffer memory address

The following table shows the buffer memory address of this area.

Buffer memory name	Y0 to YF
Number of output ON times integration function enable/disable	1904

### ■Enabling the setting

Turn on and off 'Operating condition setting request' (Y12) to enable the setting.

### ■Default value

The default value is set to 0 (Disable) for all the outputs.

## Number of output ON times alarm detection setting

Set whether to detect an alarm for the number of output ON times for each output.

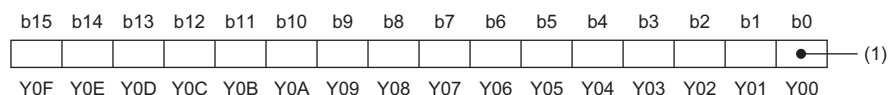

(1) 0: Not detect, 1: Detect

### ■Buffer memory address

The following table shows the buffer memory address of this area.

Buffer memory name	Y0 to YF
Number of output ON times alarm detection setting	1908

### ■Enabling the setting

Turn on and off 'Operating condition setting request' (Y12) to enable the setting.

### ■Default value

The default value is set to 0 (Not detect) for all the outputs.

## Number of output ON times alarm detection count setting

Set the number of output ON times alarm detection count for each output.

### ■Buffer memory address

The following table shows the buffer memory address of this area.

Buffer memory name	Y00	Y01	Y02	Y03	Y04	Y05	Y06	Y07	Y08	Y09	Y0A	Y0B	Y0C	Y0D	Y0E	Y0F
Number of output ON times alarm detection count setting	1912	1914	1916	1918	1920	1922	1924	1926	1928	1930	1932	1934	1936	1938	1940	1942
	1913	1915	1917	1919	1921	1923	1925	1927	1929	1931	1933	1935	1937	1939	1941	1943

### ■Setting range

- The available range is 1 to 4294967295.
- The number of output ON times alarm detection count setting error (error code: 1A6□H) occurs in the output terminal where a value out of the setting range has been set. □ indicates the number of an I/O terminal in which the error has occurred. (□ = 0H to FH)

### ■Enabling the setting

Turn on and off 'Operating condition setting request' (Y12) to enable the setting.

### ■Default value

The default value is set to 1 for all the inputs.

## Output disconnection detection setting

Set whether to detect output disconnections for each output.

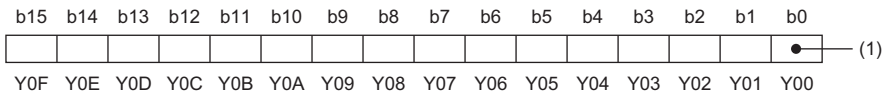

(1) 0: Not detect, 1: Detect

### ■ Buffer memory address

The following table shows the buffer memory address of this area.

Buffer memory name	Y0 to YF
Output disconnection detection setting	1952

### ■ Enabling the setting

Turn on and off 'Operating condition setting request' (Y12) to enable the setting.

### ■ Default value

The default value is set to 0 (Not detect) for all the outputs.

## Output disconnection detection automatic clear enable/disable

Set whether to enable or disable the automatic clear of disconnection detection for the output disconnection detection function.

Setting value	Description
0	Disable
1	Enable

When a numerical value other than the above is set, the set value is regarded as 1 (Enable).

### ■ Buffer memory address

The following table shows the buffer memory address of this area.

Buffer memory name	Y0 to YF
Output disconnection detection automatic clear enable/disable	1956

### ■ Enabling the setting

Turn on and off 'Operating condition setting request' (Y12) to enable the setting.

### ■ Default value

The default value is set to 1 (Enable).

## Output short-circuit detection setting

Set whether to detect an output short-circuit for each output.

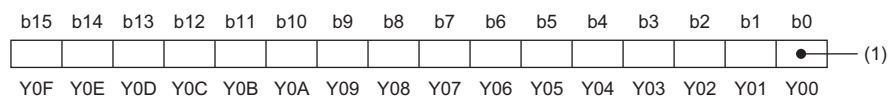

(1) 0: Not detect, 1: Detect

### ■Buffer memory address

The following table shows the buffer memory address of this area.

Buffer memory name	Y0 to YF
Output short-circuit detection setting	1968

### ■Enabling the setting

Turn on and off 'Operating condition setting request' (Y12) to enable the setting.

### ■Default value

The default value is set to 0 (Not detect) for all the outputs.

## Output short-circuit detection automatic clear enable/disable

Set whether to enable or disable the automatic clear of short-circuit detection for the output short circuit detection function.

Setting value	Description
0	Disable
1	Enable

When a numerical value other than the above is set, the set value is regarded as 1 (Enable).

### ■Buffer memory address

The following table shows the buffer memory address of this area.

Buffer memory name	Y00 to Y0F
Output short-circuit detection automatic clear enable/disable	1972

### ■Enabling the setting

Turn on and off 'Operating condition setting request' (Y12) to enable the setting.

### ■Default value

The default value is set to 1 (Enable).

## Output disconnection detection disable time setting

Set an output disconnection detection disable time for each module.

Setting value	Description
0	0ms
1	100ms
2	200ms
3	300ms

When a numerical value other than the above is set, the set value is regarded as 1 (100ms).

### ■Buffer memory address

The following table shows the buffer memory address of this area.

Buffer memory name	Y0 to YF
Output disconnection detection disable time setting	1988

### ■Enabling the setting

Turn on and off 'Operating condition setting request' (Y12) to enable the setting.

### ■Default value

The default value is set to 1 (100ms).

## Latest error code

The latest error code detected in the I/O module with diagnostic functions is stored. For details, refer to the following.

☞ Page 68 List of Error Codes

### ■Buffer memory address

The following table shows the buffer memory address of this area.

Buffer memory name	X/Y0 to X/YF
Latest error code	2560

### ■How to clear an error

Turn on and off 'Error clear request' (Y10).

## Latest alarm code

The latest alarm code detected in the I/O module with diagnostic functions is stored. For details, refer to the following.

☞ Page 70 List of Alarm Codes

### ■Buffer memory address

The following table shows the buffer memory address of this area.

Buffer memory name	X/Y0 to X/YF
Latest alarm code	2564

### ■How to clear an alarm

Turn on and off 'Alarm clear request' (Y11).

## Interrupt factor detection flag [n]

The detection status of an interrupt factor is stored.

Monitor value	Description
0	No interrupt factor
1	Interrupt factor

When an interrupt factor occurs, an interrupt request is sent to the CPU module at the same time as 1 (Interrupt factor) is stored in 'Interrupt factor detection flag [n]' (Un\G2592 to Un\G2607).

If the same interrupt factor occurs while 1 (Interrupt factor) is stored in 'Interrupt factor detection flag [n]' (Un\G2592 to Un\G2607), the interrupt request is not sent. If a different interrupt factor occurs, the interrupt request is sent.

n indicates the interrupt setting number. (n = 1 to 16)

### ■Buffer memory address

The following table shows the buffer memory address of this area.

Buffer memory name	1	2	3	4	5	6	7	8	9	10	11	12	13	14	15	16
Interrupt factor detection flag [n]	2592	2593	2594	2595	2596	2597	2598	2599	2600	2601	2602	2603	2604	2605	2606	2607

## Input disconnection detection status

When 'Input disconnection detection setting' (Un\G1312) is set to 1 (Detect), the input disconnection detection status is stored.

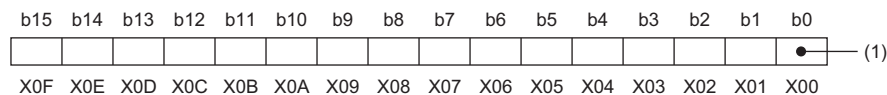

(1) 0: Normal, 1: Disconnection detected

### ■Buffer memory address

The following table shows the buffer memory address of this area.

Buffer memory name	X0 to XF
Input disconnection detection status	2816

## Number of input ON times alarm detection status

When 'Number of input ON times integration function enable/disable' (Un\G1200) is set to 1 (Enable) and 'Number of input ON times alarm detection setting' (Un\G1204) is set to 1 (Detect), whether the number of input ON times reaches the number of input ON times alarm detection count is stored.

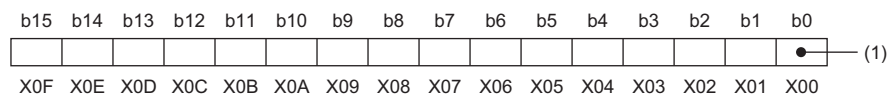

(1) 0: Normal, 1: Alarm detection count reached

### ■Buffer memory address

The following table shows the buffer memory address of this area.

Buffer memory name	X0 to XF
Number of input ON times alarm detection status	2832

## Number of input ON times

When 'Number of input ON times integration function enable/disable' (Un\G1200) is set to 1 (Enable), the number of times that the status of an input is changed from off to on is stored.

### ■Buffer memory address

The following table shows the buffer memory address of this area.

Buffer memory name	X00	X01	X02	X03	X04	X05	X06	X07	X08	X09	X0A	X0B	X0C	X0D	X0E	X0F
Number of input ON times	2848	2850	2852	2854	2856	2858	2860	2862	2864	2866	2868	2870	2872	2874	2876	2878
	2849	2851	2853	2855	2857	2859	2861	2863	2865	2867	2869	2871	2873	2875	2877	2879

## Number of input ON times value clear completed

This area shows whether the number of input ON times held in the module is cleared.

When 'Number of input ON times value clear request' (Un\G3584) is set to 1 (Requested), 1 (Completed) is stored in this area after the number of input ON times is cleared. The value returns to 0 (Not completed) when 'Number of input ON times value clear request' (Un\G3584) is set to 0 (Not requested).

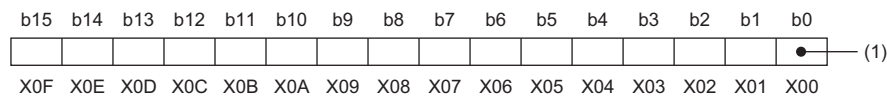

(1) 0: Not completed, 1: Completed

### ■Buffer memory address

The following table shows the buffer memory address of this area.

Buffer memory name	X0 to XF
Number of input ON times value clear completed	2880

## Output disconnection detection status

When 'Output disconnection detection setting' (Un\G1952) is set to 1 (Detect), the output disconnection detection status is stored.

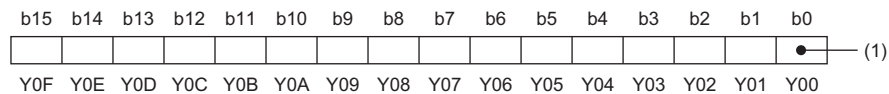

(1) 0: Normal, 1: Disconnection detected

### ■ Buffer memory address

The following table shows the buffer memory address of this area.

Buffer memory name	Y0 to YF
Output disconnection detection status	3072

## Output short-circuit detection status

When 'Output short-circuit detection setting' (Un\G1968) is set to 1 (Detect), the output short-circuit detection status is stored.

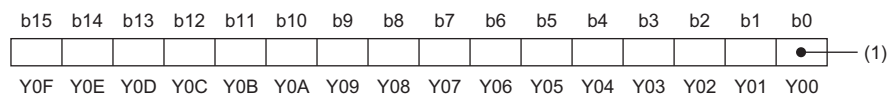

(1) 0: Normal, 1: Short-circuit detected

### ■ Buffer memory address

The following table shows the buffer memory address of this area.

Buffer memory name	Y0 to YF
Output short-circuit detection status	3088





## Interrupt factor reset request [n]

Set this area to send an interrupt factor reset request.

Setting value	Description
0	No reset request
1	Reset request

When 'Interrupt factor reset request [n]' (Un\G3328 to Un\G3343) corresponding to a generated interrupt factor has been set to 1 (Reset request), the interrupt factor corresponding to the specified interrupt is reset. After that, the value of 'Interrupt factor reset request [n]' (Un\G3328 to Un\G3343) changes to 0 (No reset request). A setting value of 2 or larger is regarded as 1 (Reset request).

n indicates the interrupt setting number. (n = 1 to 16)

### ■Buffer memory address

The following table shows the buffer memory address of this area.

Buffer memory name	1	2	3	4	5	6	7	8	9	10	11	12	13	14	15	16
Interrupt factor reset request [n]	3328	3329	3330	3331	3332	3333	3334	3335	3336	3337	3338	3339	3340	3341	3342	3343

### ■Default value

The default value is set to 0 (No reset request) for all the areas.

## Interrupt factor mask [n]

Set the mask for an interrupt factor to be used.

Setting value	Description
0	Mask (Interrupt not used)
1	Clear mask (Interrupt used)

When the value of 'Interrupt factor mask [n]' (Un\G3344 to Un\G3359) has been changed to 1 (Clear mask (Interrupt used)) and an interrupt factor occurs, an interrupt request is sent to the CPU module. A setting value of 2 or larger is regarded as 1 (Clear mask (Interrupt used)).

n indicates the interrupt setting number. (n = 1 to 16)

### ■Buffer memory address

The following table shows the buffer memory address of this area.

Buffer memory name	1	2	3	4	5	6	7	8	9	10	11	12	13	14	15	16
Interrupt factor mask [n]	3344	3345	3346	3347	3348	3349	3350	3351	3352	3353	3354	3355	3356	3357	3358	3359

### ■Default value

The default value is set to 0 (Mask (Interrupt not used)) for all the areas.

## Number of input ON times value clear request

When 'Number of input ON times value clear request' (Un\G3584) is set to 1 (Requested), the number of input ON times is cleared.

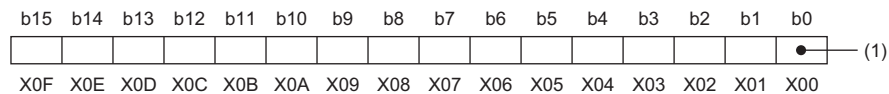

(1) 0: Not requested, 1: Requested

### ■ Buffer memory address

The following table shows the buffer memory address of this area.

Buffer memory name	X0 to XF
Number of input ON times value clear request	3584

### ■ Default value

The default value is set to 0 (Not requested) for all the inputs.

## Number of output ON times value clear request

When 'Number of output ON times value clear request' (Un\G3840) is set to 1 (Requested), the number of output ON times is cleared.

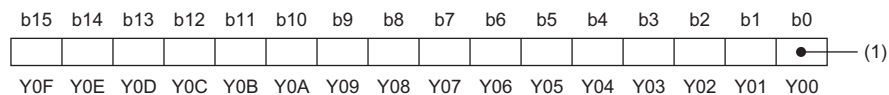

(1) 0: Not requested, 1: Requested

### ■ Buffer memory address

The following table shows the buffer memory address of this area.

Buffer memory name	Y0 to YF
Number of output ON times value clear request	3840

### ■ Default value

The default value is set to 0 (Not requested) for all the outputs.

## Event time stamp number for next storage

When an event occurs and the event time stamp data area is updated, the next number for storing the event time stamp data is stored.

### ■Buffer memory address

The following table shows the buffer memory address of this area.

Buffer memory name	X0 to XF
Event time stamp number for next storage	4352

## Event time stamp number for CPU read

The number of event time stamp that has been read to the CPU module is stored.

### ■Buffer memory address

The following table shows the buffer memory address of this area.

Buffer memory name	X0 to XF
Event time stamp number for CPU read	4353

## Event time stamp storage status

In the following cases, 1 (Discarded/Overwritten) is stored.

- When "Data setting which the refresh is not completed yet" has been set to "Don't overwrite" and the data is discarded
- When "Data setting which the refresh is not completed yet" has been set to "Overwrite" and not-refreshed event time stamp data is overwritten.

### ■Buffer memory address

The following table shows the buffer memory address of this area.

Buffer memory name	X0 to XF
Event time stamp storage status	4354

## Event time stamp data for refresh

Out of data stored in 'Event time stamp data' (Un\G4608 to Un\G5375), up to the eight events are stored in this area. This buffer memory area is used for reading event time stamp data to the CPU module using function blocks (FB). To use function blocks (FB), set "Target" to "Module Label" in "Refresh settings".

**Ex.**

For Event time stamp data 1 for refresh

	b15	to	b8 b7	to	b0
Un\G4356	First two digits of the year		Last two digits of the year		
Un\G4357	Month		Day		
Un\G4358	Hour		Minute		
Un\G4359	Second		Day of the week		
Un\G4360	Millisecond (higher-order digits)		Millisecond (lower-order digits)		
Un\G4361	Event type		I/O terminal		

Item	Description	Example <sup>*1</sup>
First/Last two digits of the year	The time of an event occurrence is stored in the BCD code.	2016H
Month/Day		527H
Hour/Minute		1234H
Second		56H
Day of the week	The following values are stored in the BCD code for each day of the week. Sunday: 0, Monday: 1, Tuesday: 2, Wednesday: 3 Thursday: 4, Friday: 5, Saturday: 6	5H
Millisecond (upper)	The time of an event occurrence is stored in the BCD code.	7H
Millisecond (lower)		89H
Event type	The type of the event that has occurred is stored. • Rise of signal: 0H • Fall of signal: 1H	1H
I/O terminal	The I/O terminal number where an event has occurred is stored.	1H

\*1 The value stored when a fall of the signal is detected on I/O terminal 1 at 12:34:56.789 on Friday, May 27, 2016.

### ■Buffer memory address

The following table shows the buffer memory address of this area.

Buffer memory name	Data 1 to Data 8
Event time stamp data for refresh	4356 to 4403

## Event time stamp number of read completion

The number of event time stamp that has been read to the CPU module is stored.

### ■Buffer memory address

The following table shows the buffer memory address of this area.

Buffer memory name	X0 to XF
Event time stamp number of read completion	4416

## Event time stamp data

When an event has occurred, data of up to 128 events are stored in this area.

The data to be stored in this area has the same structure and contents of data stored in 'Event time stamp data for refresh' (Un\G4356 to Un\G4403).

### ■Buffer memory address

The following table shows the buffer memory address of this area.

Buffer memory name	Data 1 to Data 128
Event time stamp data	4608 to 5375

## Command area for module invalidation

For the I/O module with diagnostic functions with its safety module function enabled, set this area to 1234H to disable the safety module function in normal mode.

### ■Buffer memory address

The following table shows the buffer memory address of this area.

Buffer memory name	X/Y0 to X/YF
Command area for module invalidation	5376

### ■Enabling the setting

Turn on and off 'Operating condition setting request' (Y12) to enable the setting.



If this area is set to a value other than 1234H and 'Operating condition setting request' (Y12) is turned on and off, the safety module function is not disabled.

### ■Default value

The default value is set to 0000H.

### ■Procedure for disabling the safety module

For details, refer to the following.

Page 118 Disabling the Safety Module

## Validation status area

Whether the safety module function is enabled or disabled is stored.

Stored value	Description	Remarks
0	Disable	Indicates that the safety module function of the I/O module with diagnostic functions is disabled.
1	Enable	Indicates that the safety module function of the I/O module with diagnostic functions is enabled.

If the I/O module with diagnostic functions is started up in normal mode while the stored value of this area is Enable (1), an error (start-up in normal mode with safety validated (error code: 3040H)) occurs.

### ■Buffer memory address

The following table shows the buffer memory address of this area.

Buffer memory name	X/Y0 to X/YF
Validation status area	5377

# Appendix 4 Optional Item

---

## Spring clamp terminal block

---

The spring clamp terminal block Q6TE-18SN for the Q series can be connected for use.

For details on the Q6TE-18SN, refer to the following.

 Before Using the Product (BCN-P5999-0209)

# Appendix 5 Disabling the Safety Module

For the I/O module with diagnostic functions whose function as the safety module for SIL2 mode was enabled in the other system, to use this module in normal mode, disabling its safety module function is required. If the I/O module with diagnostic functions is started up in normal mode with the safety module function enabled, an error (start-up in normal mode with safety validated (error code: 3040H)) occurs. The module does not operate normally until its safety module function becomes disabled.

## Safety module validity status check

Whether the safety module function is enabled or not can be checked with Validation status area (Un\G5377).

- The I/O module with diagnostic functions does not operate normally in normal mode while Enable (1) is stored in Validation status area (Un\G5377). In such a case, disabling the safety module function is required. Note that for the I/O module with diagnostic functions operating in normal mode, its safety module function cannot be disabled through "Safety Module Operation" of GX Works3.
- The I/O module with diagnostic functions operates normally in normal mode when Disable (0) is stored in Validation status area (Un\G5377). In this case, disabling the safety module function is not required.

## Procedure for disabling the safety module

1. Set Command area for module invalidation (Un\G5376) to 1234H and turn on and off 'Operating condition setting request' (Y12). This operation disables the safety module function of the I/O module with diagnostic functions.
2. To check whether the safety module function becomes disabled or not, refer to the table below.

Disabling the safety module	Description
Succeeded	<ul style="list-style-type: none"> <li>• Disable (0) is stored in Validation status area (Un\G5377).</li> <li>• The ALM LED flashes (400ms cycle). (I/O module with diagnostic functions waiting for restart)</li> </ul>
Failed	<ul style="list-style-type: none"> <li>• Enable (1) remains in Validation status area (Un\G5377).</li> <li>• The ALM LED does not flash (400ms cycle).</li> <li>• A code (failure of disabling safety module (event code: 00A12H)) is registered with the event history. (☞ Page 54 Event History Function)</li> </ul>

- If disabling the safety module fails, check that a set value in Command area for module invalidation (Un\G5376) is correct, and once again, turn on and off 'Operating condition setting request' (Y12) and check whether the safety module function is disabled.
  - When 'Operating condition setting request' (Y12) is turned on, 'Operating condition setting completed flag' (X12) turns off regardless of the result (succeed or fail) of disabling the safety module function.
3. After checking that the disabling has succeeded, reset the CPU module, or turn off and on the programmable controller's power to restart the I/O module with diagnostic functions.
  4. Check that the ALM LED is off. (The I/O module with diagnostic functions is operating normally in normal mode.) If the ALM LED is on, it indicates that an alarm occurred, even though the I/O module with diagnostic functions is operating in normal mode. Check 'Latest alarm code' (Un\G2564), and take actions described in the list of alarm codes. (☞ Page 70 List of Alarm Codes)



# Appendix 6 Using the Module in the Redundant System with Redundant Extension Base Unit

This chapter describes restrictions and precautions for using the I/O module with diagnostic functions that is mounted on the extension base unit in the redundant system.

## Restrictions on functions and specifications

### Functions

Function	Restriction
Interrupt function	The interrupt program cannot be executed.
Inter-module synchronization function	Cannot be used. When the function is used, proper operation cannot be guaranteed.

### Module FB

Name	Restriction
M+RX40NC6B_SaveEventTime	Cannot be used. When the FB is used, proper operation cannot be guaranteed.

## Precautions

### Using the module in the redundant system

When using the module in the redundant system, refer to the following manual and observe the precautions on programming for when using the Process CPU (redundant mode).

📖 MELSEC iQ-R CPU Module User's Manual (Application)

A

# Appendix 7 Added or Modified Function

---

This section describes the function added to or modified for the I/O module with diagnostic functions.

Addition/modification	Firmware version	Reference
SIL2 mode	"02" or later	Page 122 OVERVIEW

This part consists of the following chapters. These chapters describe the details on using the I/O module with diagnostic functions in SIL2 mode.

4 OVERVIEW

---

5 PART NAMES

---

6 SPECIFICATIONS

---

7 PROCEDURES BEFORE OPERATION

---

8 SYSTEM CONFIGURATION

---

9 INSTALLATION AND WIRING

---

10 FUNCTIONS

---

11 PARAMETER SETTINGS

---

12 MAINTENANCE AND INSPECTION

---

13 TROUBLESHOOTING

---

APPENDICES (SIL2 MODE)

---

# 4 OVERVIEW

---

The I/O module with diagnostic functions has SIL2 mode. When the customer builds safety applications up to IEC 61508: 2010 SIL2 or IEC 61511: 2015 SIL2, the I/O module with diagnostic functions set to SIL2 mode can be used.

The I/O module with diagnostic functions set to SIL2 mode can be used to build safety functions for general industrial machinery.



# 5 PART NAMES

This chapter describes the part names of the I/O module with diagnostic functions.

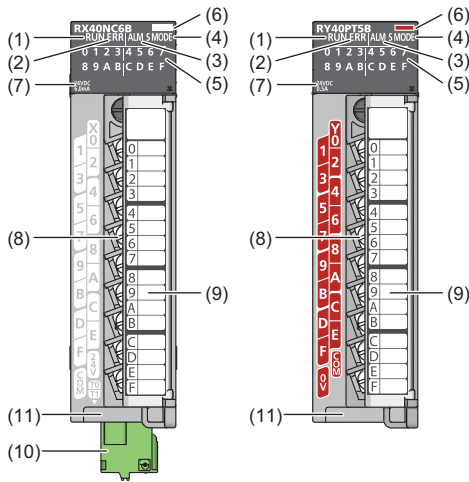

No.	Name	Description
(1)	RUN LED	Displays the operating status. On: Operating Off: When 5V power supply was disconnected or a watchdog timer error occurred
(2)	ERR LED	This part is combined with an I/O status indicator LED to display the error occurrence status at each I/O terminal. <sup>*1</sup> On: An error occurred (minor error). Flashing: An error occurred (moderate error). Off: Normal operation
(3)	ALM LED	Depending on "LED display settings during an error", displays the wait-for-restart state after the safety module is enabled or the error occurrence state. • When "Do not display I/O error" is set Flashing (400ms cycle): Wait-for-restart Off: Normal operation • When "Always display I/O error" or "Display I/O status and error switching (1 second interval)" is set A minor error occurrence can be checked. ☞ Page 181 LED indication setting on error condition
(4)	S MODE LED <sup>*2</sup>	Displays the module operating status (related to SIL2 mode). On: Safety I/O in operation Flashing (1s cycle): Safety I/O stopped Flashing (400ms cycle): Executing the module position check <sup>*3</sup> Off: Operating in normal mode
(5)	I/O status indicator LED	Depending on "LED display settings during an error", displays the I/O status or error occurrence status of each I/O terminal. • When "Do not display I/O error" is set On: I/O signal turned on Off: I/O signal turned off • When "Always display I/O error" or "Display I/O status and error switching (1 second interval)" is set The I/O where a minor error occurred can be identified. ☞ Page 181 LED indication setting on error condition
(6)	Module identification lamp	Light gray: Input Dark orange: Output
(7)	Rating indication	Displays the rated voltage and the input or output current.
(8)	Terminal block	18-point screw terminal block. For details on its terminal layout, refer to the following. ☞ Page 126 Performance Specifications
(9)	Terminal block cover	Cover to protect from electric shocks when the power is turned on
(10)	Terminal block for test pulse output <sup>*2</sup>	Terminal block used for test pulse output. For details, refer to the following. ☞ Page 143 Wiring the terminal block for test pulse output
(11)	Production information marking	Displays the production information (16 digits) about the module.

\*1 For details, refer to the following.

☞ Page 200 List of Error Codes

\*2 The LED and terminal block are added to the module with production information (first four digits) of "0202" or later.

\*3 For details, refer to the following.

☞ Page 155 Safety module operation



# 6 SPECIFICATIONS

This chapter describes the performance specifications and function list of the I/O module with diagnostic functions in SIL2 mode.

## 6.1 Performance Specifications

This section describes the performance specifications of the I/O module with diagnostic functions in SIL2 mode.

### Input module with diagnostic functions

Item	Specifications	
Number of input points	16	
Rated input voltage	24VDC (Ripple ratio: Within 5%) (Allowable voltage range: 20.4 to 28.8VDC)	
Rated input current	6.0mA TYP. (at 24VDC)	
ON voltage/ON current	14V or higher/3.5mA or higher	
OFF voltage/OFF current	6V or lower/1mA or lower	
Input resistance	Approx. 4.0kΩ	
Input response time	 Page 127 Input response time	
Control cycle time	2ms	
External power supply*1	Voltage	24VDC (Ripple ratio: Within 5%) (Allowable voltage range: 20.4 to 28.8VDC)
	Current	130mA (at 24VDC)
Withstand voltage	510VACrms for one minute	
Isolation resistance	10MΩ or more with isolation resistance tester	
Noise immunity	Simulator noise 500Vp-p, noise width 1μs, noise frequency 25 to 60Hz (noise simulator condition)	
Protection degree	IP2X	
Wiring method for common	16 points/common (common terminal: TB18)	
Number of occupied I/O points	32 points (I/O assignment: Input 32 points)	
External interface	18-point screw terminal block (M3×6 screw), test pulse terminal block  Page 142 Wiring	
Internal current consumption (5VDC)	450mA (TYP. all points ON)	
Weight	0.25kg	

- \*1 Use an external power supply satisfying the following conditions.
- An external power supply has the overvoltage protection function.
  - The output voltage does not exceed 35VDC when a single fault occurs.

#### Restriction

Immediately after power-off of the power supply module, if the input power source is applied to the power supply module again, the input module with diagnostic functions may not start up. When applying the input power source to the power supply module again, wait five seconds or more after the shut-off of the power, and apply the power again.



### ■Circuit configuration

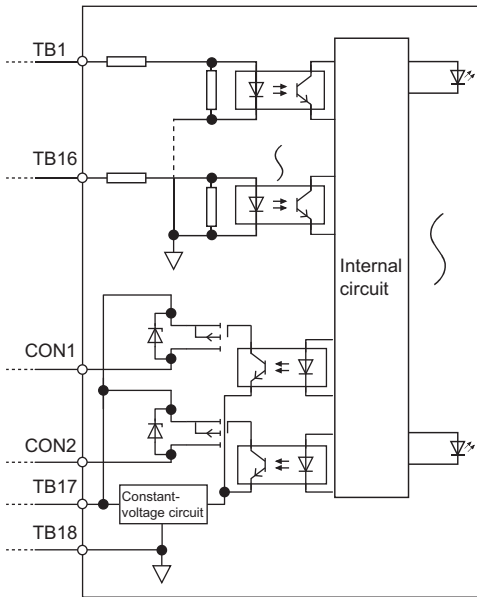

### ■Terminal layout

Viewed from the front of the module

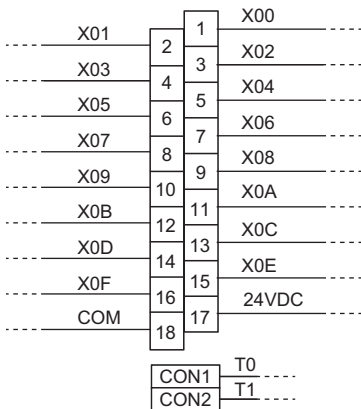

The names X00 to X0F, T0, and T1 are signal names.  
 The numbers 1 to 18 indicate terminal numbers in the 18-point terminal block.  
 CON1 and CON2 indicate terminal numbers of the terminal block for test pulse output.

### ■Input response time

Timing	Setting value				
	1ms	5ms	10ms <sup>*1</sup>	20ms	70ms
OFF→ON (MAX)	1ms	5ms	10ms	20ms	70ms
ON→OFF (MAX)	1ms	5ms	10ms	20ms	70ms

\*1 The default value for the input response time is set to 10ms.

### ■Safety input response time for SIL2 mode

The safety input response time for SIL2 mode refers to the time taken until safety data is received by the head module after signal input from an input device. The time is defined by the following formula.

$$\bullet \text{ Safety input response time} = \text{Transmission interval monitoring time}^{*1} + \text{Control cycle time} \times 2 + \text{Input response time}^{*2}$$

\*1 Set it in "Transmission interval monitoring time" of "Basic setting". (Page 185 Basic Settings)

\*2 Set it in "Input response time" of "Basic setting". (Page 185 Basic Settings)

For a response time including network delay, refer to the following.

📖 MELSEC iQ-R CC-Link IE Field Network User's Manual (Application)

## Output module with diagnostic functions

Item		Specifications
Number of output points		16
Rated load voltage		24VDC (Allowable voltage range: 20.4 to 28.8VDC)
Maximum load current		0.5A/point, 5A/common
Maximum inrush current		Current is to be limited by the overload protection function.
Leakage current at OFF		0.3mA or lower
Maximum voltage drop at ON		1.0VDC (TYP.) 0.5A
Output response time	OFF→ON	0.5ms or less
	ON→OFF	1.5ms or less
Control cycle time		2ms
Surge suppressor		Zener diode
Fuse		None
External power supply*1	Voltage	24VDC (Ripple ratio: Within 5%) (Allowable voltage range: 20.4 to 28.8VDC)
	Current	87mA (at 24VDC)
Withstand voltage		510VACrms for one minute
Isolation resistance		10MΩ or more with isolation resistance tester
Noise immunity		Simulator noise 500Vp-p, noise width 1μs, noise frequency 25 to 60Hz (noise simulator condition)
Protection degree		IP2X
Wiring method for common		16 points/common (common terminal: TB18)
Number of occupied I/O points		32 points (I/O assignment: Output 32 points)
Protection function	Overload protection	Limited current when detecting overcurrent: 1.0A or higher/point Activated to each point. (☞ Page 180 Protection Function)
	Overheat protection	Activated to each point. (☞ Page 180 Protection Function)
External interface		18-point screw terminal block (M3×6 screw) ☞ Page 142 Wiring
Internal current consumption (5VDC)		190mA (TYP. all points ON)
Weight		0.24kg

- \*1 Use an external power supply satisfying the following conditions.
- An external power supply has the overvoltage protection function.
  - The output voltage does not exceed 35VDC when a single fault occurs.

### Restriction

- Immediately after power-off of the power supply module, if the input power source is applied to the power supply module again, the output module with diagnostic functions may not start up. When applying the input power source to the power supply module again, wait five seconds or more after the shut-off of the power, and apply the power again.
- For the output module with diagnostic functions, connect a device with the response speed of 1ms or longer. Connecting a device with the response speed shorter than 1ms can cause a malfunction of the device.

### ■Circuit configuration

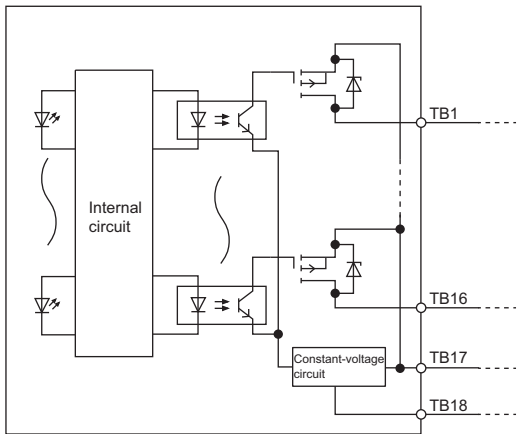

### ■Terminal layout

Viewed from the front of the module

Y01	1	Y00
Y03	2	Y02
Y05	3	Y04
Y07	4	Y06
Y09	5	Y08
Y0B	6	Y0A
Y0D	7	Y0C
Y0F	8	Y0E
0V	9	COM
	10	
	11	
	12	
	13	
	14	
	15	
	16	
	17	
	18	

The names Y00 to Y0F are single names.  
The numbers 1 to 18 indicate terminal numbers.

### ■Safety output response time for SIL2 mode

The safety output response time for SIL2 mode refers to the time taken until the safety data is output to an output device after it is transferred from the head module. The time is defined by the following formula.

- Safety output response time = Control cycle time × 5 + Output response time

For a response time including network delay, refer to the following.

📖 MELSEC iQ-R CC-Link IE Field Network User's Manual (Application)

## 6.2 Function List

The following table lists the functions of the I/O module with diagnostic functions in SIL2 mode.

Item		Description	Reference
Safety input function	Input double wiring function	Turns input wiring into double wiring.	Page 160 Input double wiring function
	Input response time setting function	Reduces noise in input signals.	Page 162 Input response time setting function
	Input HOLD function	Holds input values when safety refresh data reception is interrupted.	Page 163 Input HOLD function
	External input monitor function	With External input monitor signal (Un\G1024, Un\G1028), the ON/OFF state of an external input terminal can be checked on a per-point basis.	Page 164 External input monitor function
Safety output function	Output double wiring function	Turns output wiring into double wiring.	Page 165 Output double wiring function
	Output HOLD function	Holds output values when safety refresh data reception is interrupted.	Page 167 Output HOLD function
Input diagnostic function	Double input discrepancy detection function	Identifies failures by monitoring the discrepancy state of doubled input signals.	Page 168 Double input discrepancy detection function
	Input dark test function	Outputs test pulses to turn off the inputs that are on and diagnoses contacts including external devices for failure.	Page 175 Input dark test function
Output diagnostic function	Output dark test function	Outputs test pulses to turn off the outputs that are on and diagnoses contacts including external devices for failure.	Page 177 Output dark test function
	Output read-back function	Reads back the output results for diagnosis to see if the output signals are output correctly.	Page 179 Output read-back function
Protection function		Prevents trouble such as an overvoltage and overcurrent from affecting other modules in the system.	Page 180 Protection Function
Common function of the I/O module with diagnostic functions	LED indication setting on error condition	This function helps set the indication of the I/O status indicator LED when a minor error occurs. The error occurrence status of each I/O terminal can be displayed in the corresponding I/O status indicator LED.	Page 181 LED indication setting on error condition
Error history function		For the errors that occurred in the I/O module with diagnostic functions, a maximum of 16 error histories can be checked using the engineering tool.	Page 182 Error History Function
Event history function		Collects errors that occurred in the I/O module with diagnostic functions and executed operations as event information in the remote head module.	Page 183 Event History Function

### Restriction

The following functions are not available for the I/O module with diagnostic functions in SIL2 mode.

- Online module change function
- Inter-module synchronization function

# 7 PROCEDURES BEFORE OPERATION

This chapter describes procedures before operation for using the I/O module with diagnostic functions in SIL2 mode.

## Installation procedure

### 1. Installing the battery

Install the battery on the SIL2 Process CPU in both systems. (📖 MELSEC iQ-R CPU Module User's Manual (Startup))

### 2. Installing an extended SRAM cassette and SD memory card

As necessary, install an extended SRAM cassette and SD memory card on the SIL2 Process CPU in both systems. (📖 MELSEC iQ-R CPU Module User's Manual (Startup))

Do not perform power-off or reset or remove the SD memory card while accessing the SD memory card. (📖 MELSEC iQ-R CPU Module User's Manual (Application))

### 3. Installing the modules

Install each module on the base unit. (👉 Page 137 SYSTEM CONFIGURATION)

## Wiring procedure

### 1. Wiring

Wire each module and external device.

Wiring location	Reference
Wiring the power supply	<ul style="list-style-type: none"><li>• 📖 MELSEC iQ-R Module Configuration Manual</li></ul>
Wiring the redundant function module	<ul style="list-style-type: none"><li>• 👉 Page 137 SYSTEM CONFIGURATION</li><li>• 📖 MELSEC iQ-R CPU Module User's Manual (Application)</li></ul>
Wiring from the master/local module to the remote head module	<ul style="list-style-type: none"><li>• 👉 Page 137 SYSTEM CONFIGURATION</li><li>• 📖 MELSEC iQ-R Ethernet/CC-Link IE User's Manual (Startup)</li><li>• 📖 MELSEC iQ-R CC-Link IE Field Network Remote Head Module User's Manual (Startup)</li></ul>
Wiring the I/O module with diagnostic functions	<ul style="list-style-type: none"><li>• 👉 Page 137 SYSTEM CONFIGURATION</li><li>• 👉 Page 142 INSTALLATION AND WIRING</li></ul>

2. Check the following items and then power on the external power supply to the I/O module with diagnostic functions. If the power of the system is turned on before the power-on of the external power supply, an error occurs in the I/O module with diagnostic functions.

- The power supply is wired correctly.
- The power supply voltage satisfies the specifications.

## Procedure on the remote head module side

### 1. Powering on the system

Check the following items and then power on the system.

- The power supply is wired correctly.
- The power supply voltage satisfies the specifications.
- The remote head module is in STOP state.

### 2. Creating a project

Start the engineering tool and create a project. (👉 Page 150 Creating a new project (remote head module side))

### 3. Connecting the personal computer and remote head module



Connect the personal computer with the engineering tool installed, and the remote head module. (📖 MELSEC iQ-R CC-Link IE Field Network Remote Head Module User's Manual (Startup))

### 4. Initializing the remote head module

Use the engineering tool to initialize the remote head module. (📖 MELSEC iQ-R CC-Link IE Field Network Remote Head Module User's Manual (Startup))

## 5. Setting parameters on the remote head module side

Set the system parameters, CPU parameters, and module parameters of each module.

- System parameter and CPU parameter setting (  Page 150 Creating a new project (remote head module side), Page 150 Setting parameters on the remote head module side)
- Module parameter setting of each module (  Page 150 Setting parameters on the remote head module side)

## 6. Write to the remote head module

Write the configured parameters to the remote head module using the engineering tool. (  MELSEC iQ-R CC-Link IE Field Network Remote Head Module User's Manual (Startup))

## 7. Resetting the remote head module

Use any of the following methods to restart the system on the remote head module side.

- Turning off and on the power
- Resetting the remote head module (  MELSEC iQ-R CC-Link IE Field Network Remote Head Module User's Manual (Startup))

## Procedure on the SIL2 Process CPU side

### 1. Powering on the system

In both systems, check the following items and then power on the system.

- The power supply is wired correctly.
- The power supply voltage satisfies the specifications.
- The SIL2 Process CPU is in STOP state.

Power on the system and ensure that the following LEDs turn on.

- Power supply module: POWER LED
- SIL2 Process CPU: READY LED
- SIL2 function module: READY LED
- Redundant function module: RUN LED
- Master/local module: RUN LED

Although the LED status of each module is as follows after this first step, proceed to the next step.

- SIL2 Process CPU: ERROR LED flashing
- SIL2 function module: ERROR LED flashing
- Redundant function module: ERR LED On
- Master/local module: ERR LED On

### 2. Creating a project

Start the engineering tool and create a project. (  Page 151 Creating a new project (SIL2 Process CPU side))

### 3. Connecting the personal computer and SIL2 Process CPU

On the personal computer on which the engineering tool is installed, start the engineering tool. (  Page 151 Creating a new project (SIL2 Process CPU side))

#### 4. Initializing the SIL2 Process CPU

Use the engineering tool to initialize the SIL2 Process CPU. (📖 MELSEC iQ-R CPU Module User's Manual (Startup))  
Initialize one SIL2 Process CPU and then connect the other SIL2 Process CPU to the personal computer.  
Then, initialize the SIL2 Process CPU in the same way. (📖 MELSEC iQ-R CPU Module User's Manual (Application))

#### 5. Parameter setting on the SIL2 Process CPU side

Set the system parameters, CPU parameters, and module parameters of each module. (👉 Page 151 Creating a new project (SIL2 Process CPU side), 👉 Page 152 Parameter setting on the SIL2 Process CPU side)

#### Point

---

Load the actual system configuration into the module configuration diagram on the engineering tool to set the system parameters.

---

#### 6. Safety communication setting

Configure the safety communication setting. (👉 Page 153 Safety communication setting)

#### 7. Writing the system A/B setting

Configure the system A/B setting using the engineering tool. (👉 Page 154 Writing the system A/B setting, 📖 MELSEC iQ-R CPU Module User's Manual (Application))

#### 8. Setting user information

Set user information in the SIL2 Process CPU in both systems and projects. (📖 GX Works3 Operating Manual)

#### 9. Creating programs

Create a safety program and standard program.

#### 10. Writing to the programmable controller

Write the configured parameters and created programs to the both systems using the engineering tool. (👉 Page 154 Writing the system A/B setting, 📖 MELSEC iQ-R CPU Module User's Manual (Application))

#### 11. Resetting the SIL2 Process CPU

Use any of the following methods to restart both systems.

- Turning off and on the power
- Resetting the SIL2 Process CPU

## 12. Checking LEDs on the SIL2 Process CPU side

Check that the LED status of each module is as follows. The CARD READY LED turns on or off depending on whether the SD memory card is installed.

- Control system

R08PSFCPU	R6PSFM	R6RFM	RJ71GF11-T2
READY	READY	RUN	RUN
ERROR	ERROR	ERR	ERR
PROGRAM RUN	PROGRAM RUN	SYS [A	MST
USER	SAFETY COM RUN	[B	D LINK
BATTERY	SAFETY COM ERR	[CTRL	SD/RD
CARD READY	TEST	[SBY	L ERR
CARD ACCESS		[BACKUP	
FUNCTION		[SEPARATE	
		MEMORY COPY	
		LINK	
		L ERR	

- Standby system\*1

R08PSFCPU	R6PSFM	R6RFM	RJ71GF11-T2
READY	READY	RUN	RUN
ERROR	ERROR	ERR	ERR
PROGRAM RUN	PROGRAM RUN	SYS [A	MST
USER	SAFETY COM RUN	[B	D LINK
BATTERY	SAFETY COM ERR	[CTRL	SD/RD
CARD READY	TEST	[SBY	L ERR
CARD ACCESS		[BACKUP	
FUNCTION		[SEPARATE	
		MEMORY COPY	
		LINK	
		L ERR	

\*1 For the redundant master station system, the MST LED of the standby system master/local module flashes.

The following LEDs turn on when an error occurs. Use the engineering tool to check details of the error and remove the error cause.

- SIL2 Process CPU: ERROR LED (📖 MELSEC iQ-R CPU Module User's Manual (Startup))
- SIL2 function module: ERROR LED (📖 MELSEC iQ-R CPU Module User's Manual (Application))
- Redundant function module: ERR LED, L ERR LED (📖 MELSEC iQ-R CPU Module User's Manual (Application))
- Master/local module: ERR LED, L ERR LED (📖 MELSEC iQ-R Ethernet/CC-Link IE User's Manual (Startup))

## Enabling modules

### 1. Safety module operation

Check that the system is powered on the SIL2 Process CPU side and the remote head module side, and use "Safety Module Operation" of the engineering tool to enable the modules set to SIL2 mode. (👉 Page 155 Safety module operation)

### 2. Powering off the system

After enabling the modules, power off the system on the SIL2 Process CPU side and the remote head module side.

### 3. Restarting the system

Set the RUN/STOP/RESET switch for the SIL2 Process CPU and remote head module in both systems to RUN, and turn the power of both systems on.



## Operation check procedure

### 1. Checking

Check the status of each module used in the system and program behaviors.

- Check each module to see whether an error occurred.
- Check that the LED status of each module is as follows.
- Control system

R08PSFCPU	R6PSFM	R6RFM	RJ71GF11-T2
READY <input checked="" type="checkbox"/>	READY <input checked="" type="checkbox"/>	RUN <input checked="" type="checkbox"/> ERR	RUN <input checked="" type="checkbox"/> ERR
ERROR <input type="checkbox"/>	ERROR <input type="checkbox"/>	SYS [A <input checked="" type="checkbox"/> CTRL <input type="checkbox"/>	MST <input type="checkbox"/>
PROGRAM RUN <input checked="" type="checkbox"/>	PROGRAM RUN <input checked="" type="checkbox"/>	[B <input checked="" type="checkbox"/> SBY <input type="checkbox"/>	D LINK <input checked="" type="checkbox"/>
USER <input type="checkbox"/>	SAFETY COM RUN <input checked="" type="checkbox"/>	[BACKUP <input type="checkbox"/>	SD/RD <input checked="" type="checkbox"/>
BATTERY <input type="checkbox"/>	SAFETY COM ERR <input type="checkbox"/>	[SEPARATE <input type="checkbox"/>	L ERR <input type="checkbox"/>
CARD READY <input type="checkbox"/>	TEST <input type="checkbox"/>	MEMORY COPY <input type="checkbox"/>	
CARD ACCESS <input type="checkbox"/>		LINK <input checked="" type="checkbox"/>	
FUNCTION <input type="checkbox"/>		L ERR <input type="checkbox"/>	

- Standby system\*1

R08PSFCPU	R6PSFM	R6RFM	RJ71GF11-T2
READY <input checked="" type="checkbox"/>	READY <input checked="" type="checkbox"/>	RUN <input checked="" type="checkbox"/> ERR	RUN <input checked="" type="checkbox"/> ERR
ERROR <input type="checkbox"/>	ERROR <input type="checkbox"/>	SYS [A <input type="checkbox"/> CTRL <input type="checkbox"/>	MST <input type="checkbox"/>
PROGRAM RUN <input type="checkbox"/>	PROGRAM RUN <input type="checkbox"/>	[B <input type="checkbox"/> SBY <input type="checkbox"/>	D LINK <input checked="" type="checkbox"/>
USER <input type="checkbox"/>	SAFETY COM RUN <input type="checkbox"/>	[BACKUP <input type="checkbox"/>	SD/RD <input checked="" type="checkbox"/>
BATTERY <input type="checkbox"/>	SAFETY COM ERR <input type="checkbox"/>	[SEPARATE <input type="checkbox"/>	L ERR <input type="checkbox"/>
CARD READY <input type="checkbox"/>	TEST <input type="checkbox"/>	MEMORY COPY <input type="checkbox"/>	
CARD ACCESS <input type="checkbox"/>		LINK <input checked="" type="checkbox"/>	
FUNCTION <input type="checkbox"/>		L ERR <input type="checkbox"/>	

- Remote head module side\*2

RJ72GF15-T2	RJ72GF15-T2	RX40NC6B	RX40NC6B
RUN <input checked="" type="checkbox"/> ERR	RUN <input checked="" type="checkbox"/> ERR	RUN ERR   ALM S MODE	RUN ERR   ALM S MODE
BUS RUN <input checked="" type="checkbox"/> D LINK <input checked="" type="checkbox"/>	BUS RUN <input checked="" type="checkbox"/> D LINK <input checked="" type="checkbox"/>	0 1 2 3 4 5 6 7	0 1 2 3 4 5 6 7
[CTRL <input checked="" type="checkbox"/> SD/RD <input checked="" type="checkbox"/>	[CTRL <input checked="" type="checkbox"/> SD/RD <input checked="" type="checkbox"/>	8 9 A B C D E F	8 9 A B C D E F
[SBY <input checked="" type="checkbox"/> L ERR	[SBY <input checked="" type="checkbox"/> L ERR	24VDC 6.0mA	24VDC 6.0mA
CC-Link IE Field		CC-Link IE Field	

\*1 For the redundant master station system, the MST LED of the standby system master/local module flashes.

\*2 Because the remote head module is not in a redundancy configuration for the redundant master station system, the following LEDs are always turned off.

• CTRL LED • SBY LED

- Check whether an error occurred in CC-Link IE Field Network diagnostics. (MELSEC iQ-R CC-Link IE Field Network User's Manual (Application))
- Check that the safety program and standard program behave normally.

### 2. Switching the safety operation mode

For normal operation as a safety control system via the SIL2 Process CPU, switch the safety operation mode to SAFETY MODE. Before switching the safety operation mode, set the SIL2 Process CPU to STOP state. (Page 159 Switching the safety operation mode, MELSEC iQ-R CPU Module User's Manual (Application))

#### Point

When the SIL2 Process CPU is in STOP state, a continuation error of operating status mismatch is detected in the standby system.

### 3. Program execution

Power off the SIL2 Process CPU and remote head module in both systems. Then, set the RUN/STOP/RESET switch for the SIL2 Process CPU and remote head module in both systems to RUN, and turn the power of both systems on. Check that the SIL2 Process CPU PROGRAM RUN LED for the control system turns on.

#### **Point**

---

If the RUN/STOP/RESET switch is set to RUN in power-on state, a continuation error of operating status mismatch is detected in the standby system.

---

### 4. Program monitoring

Use the engineering tool to check that programs run normally.

# 8 SYSTEM CONFIGURATION

This chapter describes the system configurations for using the I/O module with diagnostic functions in SIL2 mode. For application in SIL2 mode, a redundant system must be configured based on a redundant master station or redundant line. In such a case, mount the I/O module with diagnostic functions to a remote head module.

## Display of I/O module with diagnostic functions

For using the I/O module with diagnostic functions in SIL2 mode, two modules must be used as a pair as shown below. Configure the settings of modules using GX Works3 so that a module near the remote head module is handled as Main and another as Sub. On the screen of GX Works3, the modules are displayed as listed in the table below.

Module		Model name displayed on GX Works3
Input module with diagnostic functions	RX40NC6B(Main)	RX40NC6B(S2M)
	RX40NC6B(Sub)	RX40NC6B(S2S)
Output module with diagnostic functions	RY40PT5B(Main)	RY40PT5B(S2M)
	RY40PT5B(Sub)	RY40PT5B(S2S)

## 8.1 Redundant Master Station

The following diagram shows the system configuration with a redundant master station.

- System configuration diagram

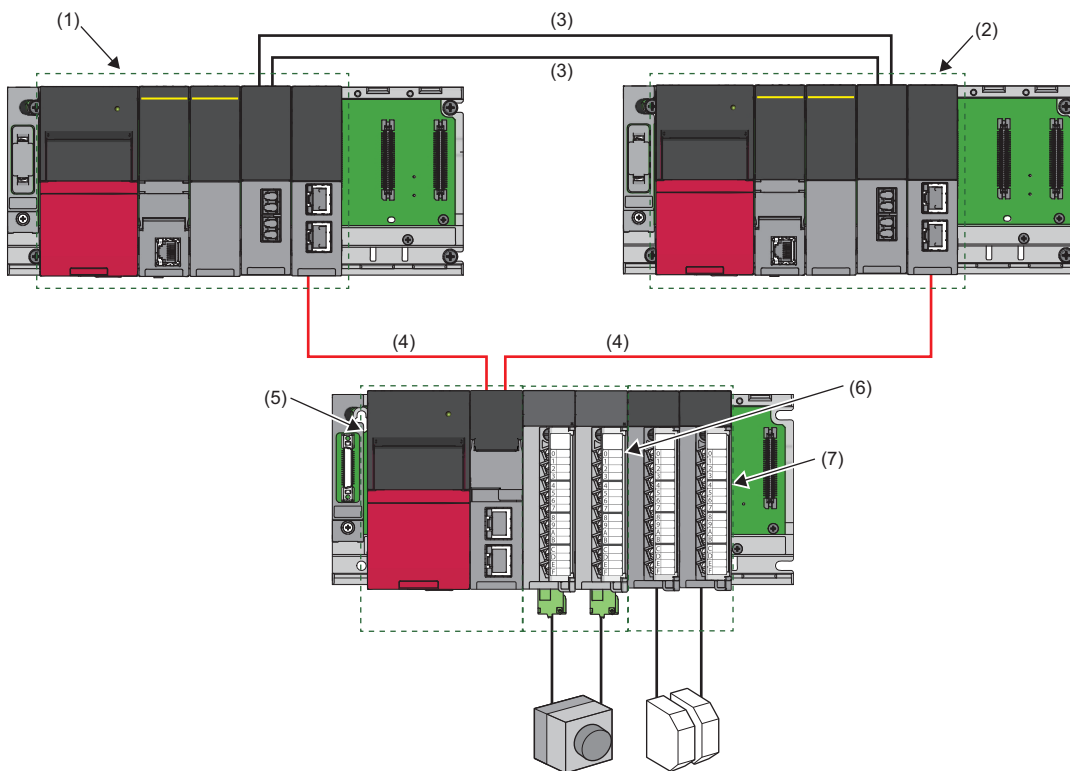

• List of components

No.	Name	Description
(1)	System A system	<p>Composed of the following modules:</p> <ul style="list-style-type: none"> <li>• RnPSFCPU</li> <li>• R6PSFM</li> <li>• R6RFM</li> <li>• RJ71GF11-T2</li> </ul> <p>■Precautions</p> <ul style="list-style-type: none"> <li>• Each module has restrictions on use in a system on the system configuration diagram. For details, refer to the User's Manual (Application) for each module.</li> <li>• Mount the above modules on the same base unit. Mount the modules so that they are arranged in the following order: RnPSFCPU → R6PSFM → R6RFM → RJ71GF11-T2, starting from the right side of the power supply module.</li> </ul>
(2)	System B system	<p>Composed of the following modules:</p> <ul style="list-style-type: none"> <li>• RnPSFCPU</li> <li>• R6PSFM</li> <li>• R6RFM</li> <li>• RJ71GF11-T2</li> </ul> <p>■Precautions</p> <ul style="list-style-type: none"> <li>• Each module has restrictions on use in a system on the system configuration diagram. For details, refer to the User's Manual (Application) for each module.</li> <li>• Mount the above modules on the same base unit. Mount the modules so that they are arranged in the following order: RnPSFCPU → R6PSFM → R6RFM → RJ71GF11-T2, starting from the right side of the power supply module.</li> </ul>
(3)	Tracking cable	Use cables designed for use by the R6RFM. (📖 MELSEC iQ-R CPU Module User's Manual (Startup))
(4)	CC-Link IE Field Network supporting cable	Use cables supporting CC-Link IE Field Network. (📖 MELSEC iQ-R Ethernet/CC-Link IE User's Manual (Startup))
(5)	Remote head module	Use the RJ72GF15-T2. Note that the module has restrictions on use in a system on the system configuration diagram. For details, refer to the MELSEC iQ-R CC-Link IE Field Network Remote Head Module User's Manual (Application).
(6)	RX40NC6B SIL2 mode set	<p>Composed of the following modules:</p> <ul style="list-style-type: none"> <li>• RX40NC6B(Main)</li> <li>• RX40NC6B(Sub)</li> </ul> <p>■Precautions</p> <ul style="list-style-type: none"> <li>• When using the RX40NC6B in SIL2 mode, there is a restriction on the version. For details, refer to Page 141 Firmware Version for SIL2 Mode.</li> <li>• Mount the above modules on the same base unit. Mount the modules so that they are arranged in the following order: RX40NC6B(Main) → RX40NC6B(Sub), starting from the right side of the remote head module.</li> </ul>
(7)	RY40PT5B SIL2 mode set	<p>Composed of the following modules:</p> <ul style="list-style-type: none"> <li>• RY40PT5B(Main)</li> <li>• RY40PT5B(Sub)</li> </ul> <p>■Precautions</p> <ul style="list-style-type: none"> <li>• When using the RY40PT5B in SIL2 mode, there is a restriction on the version. For details, refer to Page 141 Firmware Version for SIL2 Mode.</li> <li>• Mount the above modules on the same base unit. Mount the modules so that they are arranged in the following order: RY40PT5B(Main) → RY40PT5B(Sub), starting from the right side of the remote head module.</li> </ul>

## 8.2 Redundant Line

The following diagram shows the system configuration with a redundant line.

- System configuration diagram

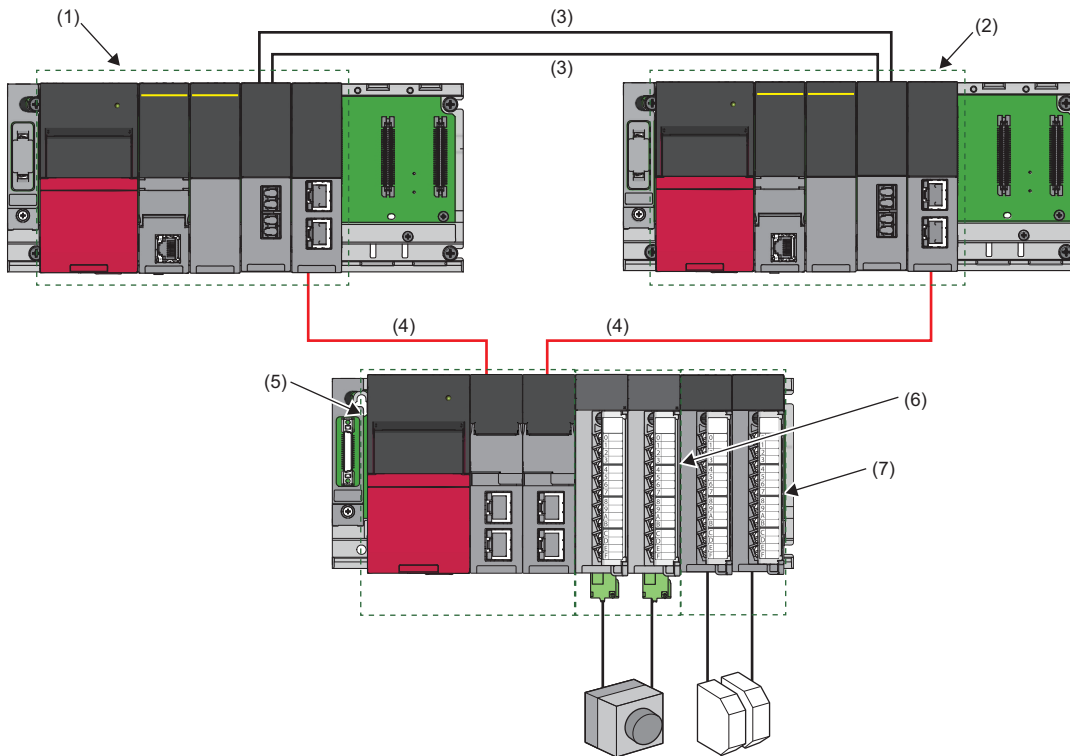

• List of components

No.	Name	Description
(1)	System A system	<p>Composed of the following modules:</p> <ul style="list-style-type: none"> <li>• RnPSFCPU</li> <li>• R6PSFM</li> <li>• R6RFM</li> <li>• RJ71GF11-T2</li> </ul> <p>■Precautions</p> <ul style="list-style-type: none"> <li>• Each module has restrictions on use in a system on the system configuration diagram. For details, refer to the User's Manual (Application) for each module.</li> <li>• Mount the above modules on the same base unit. Mount the modules so that they are arranged in the following order: RnPSFCPU → R6PSFM → R6RFM → RJ71GF11-T2, starting from the right side of the power supply module.</li> </ul>
(2)	System B system	<p>Composed of the following modules:</p> <ul style="list-style-type: none"> <li>• RnPSFCPU</li> <li>• R6PSFM</li> <li>• R6RFM</li> <li>• RJ71GF11-T2</li> </ul> <p>■Precautions</p> <ul style="list-style-type: none"> <li>• Each module has restrictions on use in a system on the system configuration diagram. For details, refer to the User's Manual (Application) for each module.</li> <li>• Mount the above modules on the same base unit. Mount the modules so that they are arranged in the following order: RnPSFCPU → R6PSFM → R6RFM → RJ71GF11-T2, starting from the right side of the power supply module.</li> </ul>
(3)	Tracking cable	Use cables designed for use by the R6RFM. (📖 MELSEC iQ-R CPU Module User's Manual (Startup))
(4)	CC-Link IE Field Network supporting cable	Use cables supporting CC-Link IE Field Network. (📖 MELSEC iQ-R Ethernet/CC-Link IE User's Manual (Startup))
(5)	Remote head module	Use two sets of the RJ72GF15-T2 to build a redundant configuration. Note that the module has restrictions on use in a system on the system configuration diagram. For details, refer to the MELSEC iQ-R CC-Link IE Field Network Remote Head Module User's Manual (Application).
(6)	RX40NC6B SIL2 mode set	<p>Composed of the following modules:</p> <ul style="list-style-type: none"> <li>• RX40NC6B(Main)</li> <li>• RX40NC6B(Sub)</li> </ul> <p>■Precautions</p> <ul style="list-style-type: none"> <li>• When using the RX40NC6B in SIL2 mode, there is a restriction on the version. For details, refer to Page 141 Firmware Version for SIL2 Mode.</li> <li>• Mount the above modules on the same base unit. Mount the modules so that they are arranged in the following order: RX40NC6B(Main) → RX40NC6B(Sub), starting from the right side of the remote head module.</li> </ul>
(7)	RY40PT5B SIL2 mode set	<p>Composed of the following modules:</p> <ul style="list-style-type: none"> <li>• RY40PT5B(Main)</li> <li>• RY40PT5B(Sub)</li> </ul> <p>■Precautions</p> <ul style="list-style-type: none"> <li>• When using the RY40PT5B in SIL2 mode, there is a restriction on the version. For details, refer to Page 141 Firmware Version for SIL2 Mode.</li> <li>• Mount the above modules on the same base unit. Mount the modules so that they are arranged in the following order: RY40PT5B(Main) → RY40PT5B(Sub), starting from the right side of the remote head module.</li> </ul>

## 8.3 Firmware Version for SIL2 Mode

---

For application in SIL2 mode, use the I/O module with diagnostic functions with the following condition.

- Use a module whose firmware version is 02 or later.

For details on how to check the firmware version, refer to MELSEC iQ-R Module Configuration Manual.

# 9 INSTALLATION AND WIRING

This chapter describes the installation and wiring of the I/O module with diagnostic functions.

## 9.1 Before Using the I/O Module with Diagnostic Functions

### Precautions for using the output module with diagnostic functions

#### ■Momentarily turning on of output at establishment of the safety connection

Output may momentarily turn on before establishment of the safety connection of the output module with diagnostic functions (before the S MODE LED of the output module with diagnostic functions turns on). For the output module with diagnostic functions, use a load or device with the response speed of 1ms or longer.

## 9.2 Wiring

This section describes the wiring of the I/O module with diagnostic functions.

### Precautions

- For terminal block wiring, be sure to use a solderless terminal whose thickness is 0.8mm or less. Connect up to two solderless terminals to one terminal section.
- A solderless terminal with an insulation sleeve cannot be used in a terminal block. To prevent a short-circuit when a screw in a terminal block becomes loose, we recommend putting a mark tube or insulation tube on the wire connection section of a solderless terminal.
- Use the following for a wire connecting to a terminal block.

Applicable wire size	Material	Temperature rating
0.3 to 0.75mm <sup>2</sup> (22 to 18 AWG) (stranded wire) Outside diameter: 2.8mm or less*1	Copper wire	75°C or more

- For a solderless terminal, use R1.25-3, which is UL listed.
- Tighten screws in a terminal block within the following torque ranges.

Screw location	Tightening torque range
Terminal block screw (M3 screw)	0.42 to 0.58N·m
Terminal block mounting screw (M3.5 screw)	0.66 to 0.89N·m

\*1 When 0.75mm<sup>2</sup> or bigger cables are used, the horizontal overhang will become so large that cables interfere with the terminal blocks or connectors of adjacent modules, eventually giving stress to the modules. Therefore, use 0.75mm<sup>2</sup> or smaller cables. When the type of terminal block is changed to a spring clamp terminal block (Q6TE-18SN), 0.3 to 1.5mm<sup>2</sup> (22 to 16 AWG) cables can be used. To use cables bigger than the above, manage by using FA goods manufactured by Mitsubishi Electric Engineering Co., Ltd. (such as FA-TB161AC+ FA-CBL20D).

- The output module with diagnostic functions only monitors the output status of the module's output terminals. To monitor the output status of connected devices, implement another monitoring function in the system.

### Terminal block wiring, installation, and disconnection procedures

For details on the wiring, installation, and disconnection procedures, refer to the following:

📖 MELSEC iQ-R Module Configuration Manual



## Wiring the terminal block for test pulse output

### ■ Tightening torque

Tighten terminal block mounting screws within the following torque range. If screws are tightened excessively, the module's case may be damaged.

Screw location	Tightening torque range
Terminal block mounting screw (M2.5 screw)	0.2 to 0.3N·m

### ■ Cable to be used

The following table shows the cable to be connected to the terminal block for test pulse output.

Wire diameter	Type	Material	Temperature rating
24 to 12 AWG	Stranded wire	Copper wire	75°C or more

### ■ Mounting and removing a terminal block

To remove a terminal block, loosen the terminal block mounting screws with a flathead screwdriver, and then pull out the terminal block.

To mount a terminal block, insert it into the module, and mount it securely with the terminal block mounting screws.

If the terminal block fails to be fixed securely, it may cause drop, short-circuit, or malfunction.

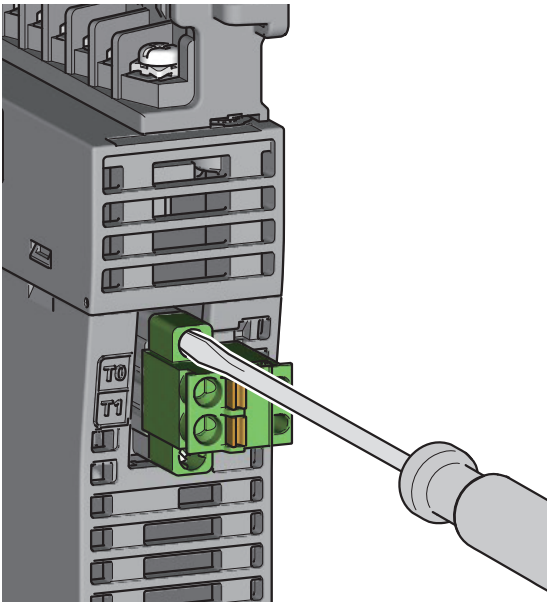

## ■ Mounting a cable

Insert a cable with a bar solderless terminal into the insertion slot and push the cable in. After pushing the cable in, pull it lightly to check that it is clamped securely in place.

## ■ Removing a cable

Using a flathead screwdriver, push in the open/close button for the cable to be removed. With the open/close button pushed in, pull the cable out.

## ■ Precautions

- Use a bar solderless terminal for terminal block wiring. If a stripped cable is inserted into the insertion slot (1) without using a bar solderless terminal, it cannot be clamped securely.
- To attach a bar solderless terminal to a cable, use a crimping tool.
- Before inserting a bar solderless terminal, check the shape of the insertion slot (1) and the shape of the bar solderless terminal, and insert the terminal in the correct orientation. When a bar solderless terminal bigger in size than the insertion slot (1) is inserted, it may cause damage to the terminal block.

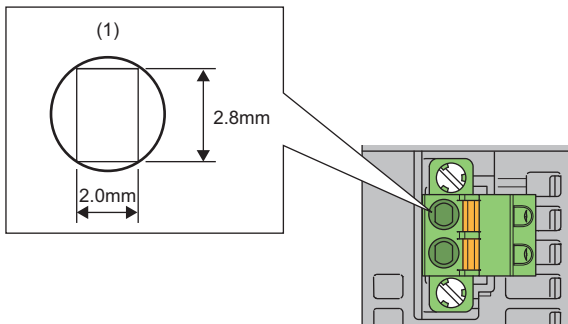

## ■ Cable terminal processing procedure

Strip the coating approx. 10mm from the end of the cable, and attach a bar solderless terminal to the stripped part. If the wire strip length is too large, the conductor part may extend over the front of the terminal block, which may cause an electric shock or short-circuit between terminals adjacent to each other. If the wire strip length is too small, the cable may have a poor contact with the spring clamp terminal block.

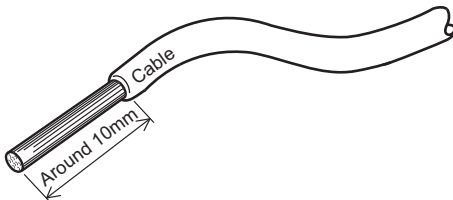

## ■ List of bar solderless terminal reference products

The following table lists bar solderless terminal reference products.

Product	Model	Applicable wire size	Bar solderless terminal tool	Company
Bar solderless terminal	AI 0.25-10YE	0.25mm <sup>2</sup>	CRIMPFOX6	PHOENIX CONTACT GmbH & Co. KG
	AI 0.34-10TQ	0.34mm <sup>2</sup>		
	AI 0.5-10WH	0.5mm <sup>2</sup>		
	AI 0.75-10GY	0.75mm <sup>2</sup>		
	AI 1-10RD	1.0mm <sup>2</sup>		
	AI 1.5-10BK	1.5mm <sup>2</sup>		
	AI 2.5-10BU	2.5mm <sup>2</sup>		

# 9.3 Wiring Examples

This section shows examples of wiring of parts such as an emergency stop switch and start/stop/reset switch.

## Double wiring (using test pulse outputs)

With two input modules with diagnostic functions, an emergency stop switch is wired as follows:

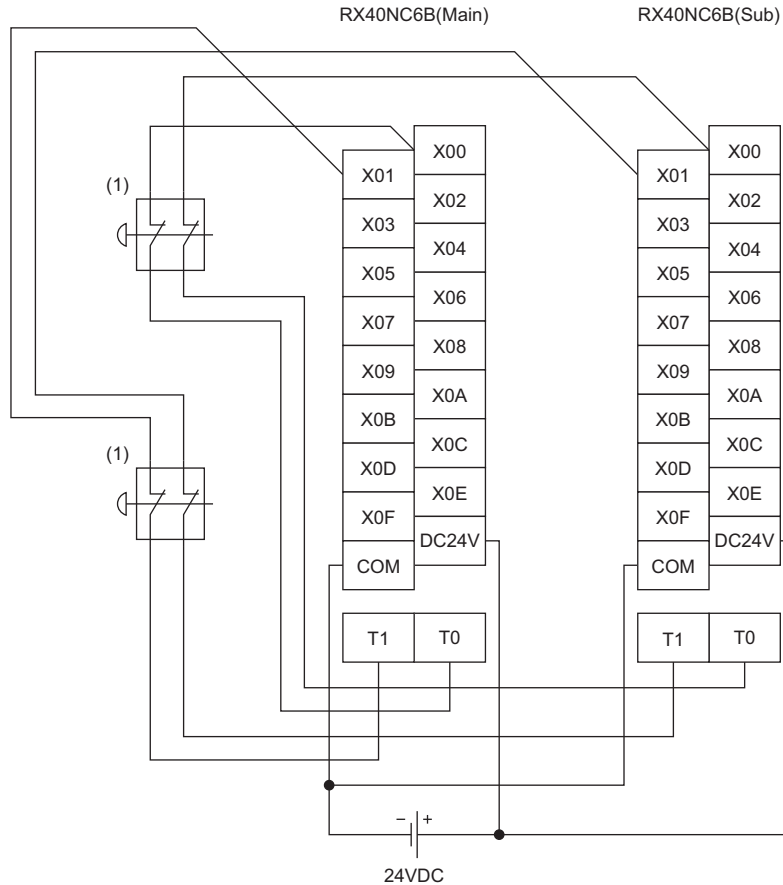

(1) Connect an emergency stop switch that has two normally closed contacts based on direct opening action, between X00 to X0F (input) terminals and T0 and T1 (test pulse output) terminals.

### Input double wiring

Apply input double wiring in either of the following combinations.

- For the RX40NC6B (Main) and the RX40NC6B (Sub), wire even-numbered input terminals with T0 test pulse output terminals.
- For the RX40NC6B (Main) and the RX40NC6B (Sub), wire odd-numbered input terminals with T1 test pulse output terminals.

RX40NC6B(Main)		RX40NC6B(Sub)	
Input terminal	Test pulse output terminal	Input terminal	Test pulse output terminal
X00	T0	X00	T0
X01	T1	X01	T1
to		to	
X0E	T0	X0E	T0
X0F	T1	X0F	T1

## Safety (door) switch wiring

With two input modules with diagnostic functions, a safety (door) switch is wired as follows:

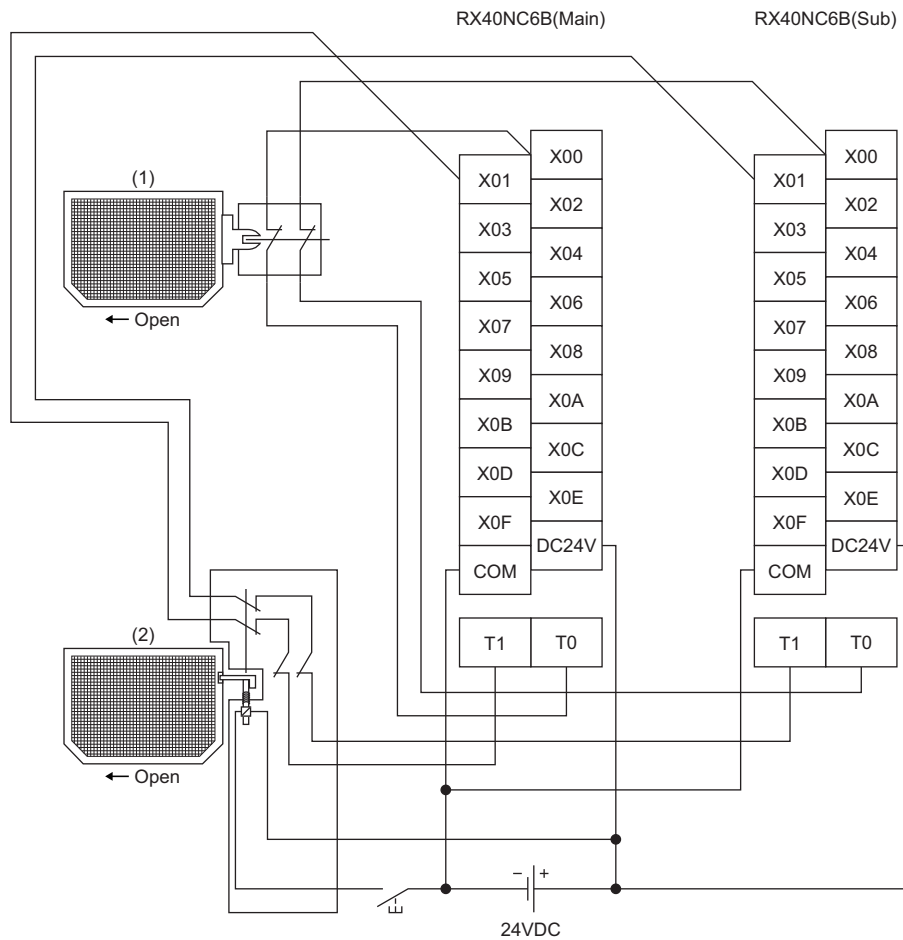

- (1) This is a door switch with two normally closed contacts based on direct opening action. Connect this door switch between X00 to X0F (input) terminals and T0 (test pulse output) terminals.
- (2) This is a spring lock type door switch with two normally closed contacts based on direct opening action. Connect this door switch between X00 to X0F (input) terminals and T1 (test pulse output) terminals and 24VDC terminals.

### Input double wiring

Apply input double wiring in either of the following combinations.

- For the RX40NC6B (Main) and the RX40NC6B (Sub), wire even-numbered input terminals with T0 test pulse output terminals.
- For the RX40NC6B (Main) and the RX40NC6B (Sub), wire odd-numbered input terminals with T1 test pulse output terminals.

RX40NC6B(Main)		RX40NC6B(Sub)	
Input terminal	Test pulse output terminal	Input terminal	Test pulse output terminal
X00	T0	X00	T0
X01	T1	X01	T1
to		to	
X0E	T0	X0E	T0
X0F	T1	X0F	T1

## Light curtain and laser scanner wiring

With two input modules with diagnostic functions, a light curtain and laser scanner are wired as follows:

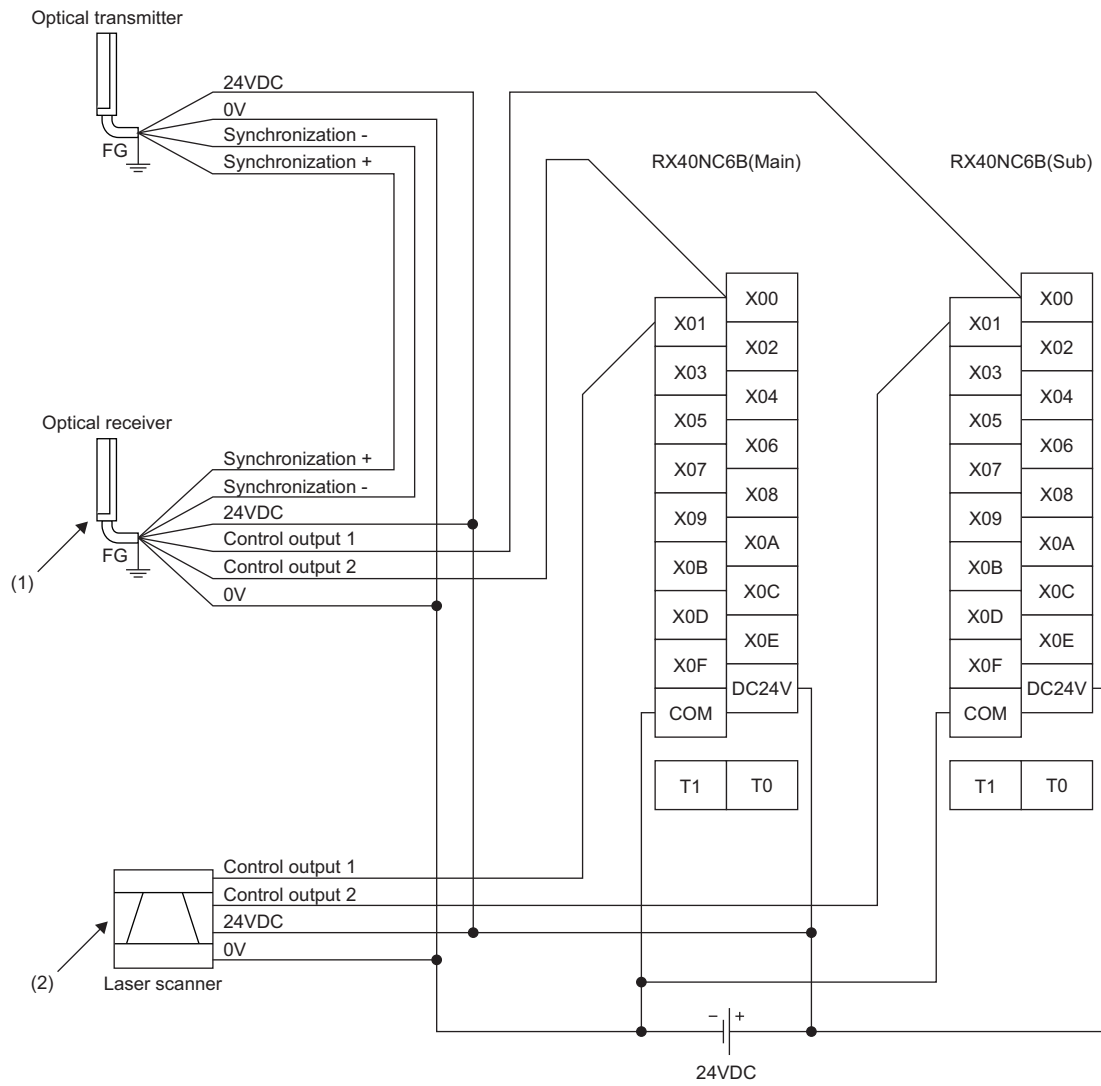

- (1) Connect light curtain control output 1 and control output 2 to X00 to X0F (input) terminals.
- (2) Connect laser scanner control output 1 and control output 2 to X00 to X0F (input) terminals.

## Electromagnetic contactor wiring

With an input module with diagnostic functions and output module with diagnostic functions, electromagnetic contactors are wired as follows:

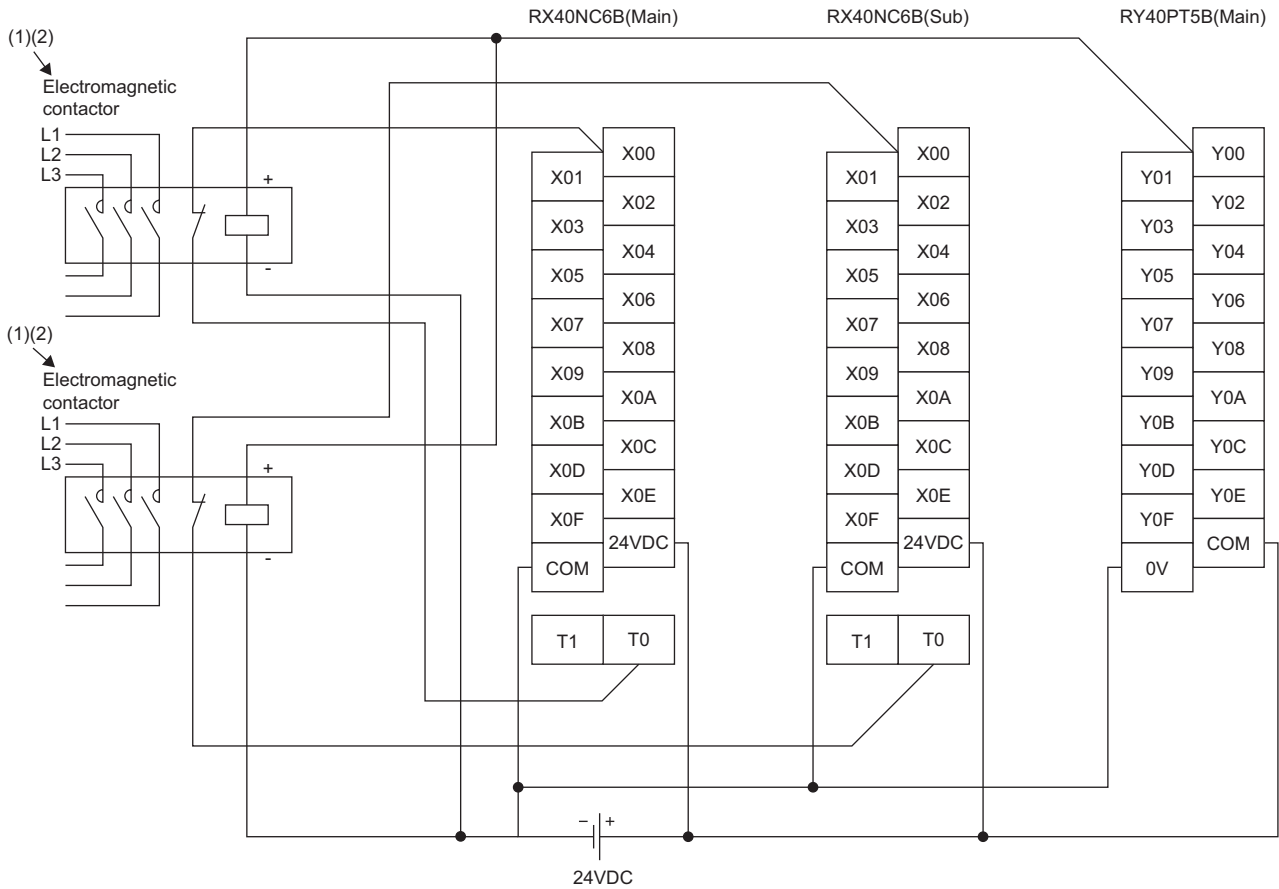

- (1) Connect contactor safety separation contacts (for turning off sub-normally-closed-contacts when main contacts are welded) between X00 to X0F (input) terminals and T0 and T1 (test output) terminals.
- (2) Connect the positive sides of contactors to Y00 to Y0F (output) terminals, and connect the negative sides of contactors to 0V terminals.

# 10 FUNCTIONS

This chapter describes the details of the functions that can be used in the I/O module with diagnostic functions in SIL2 mode and their setting procedures.

For details on safety I/O signals, I/O signals, and buffer memory areas, refer to the following.

- ☞ Page 202 Safety I/O Signals
- ☞ Page 205 I/O Signals
- ☞ Page 209 Buffer Memory

**Point** 

The numerical value corresponding to the I/O terminal number of the terminal where an error occurred is put in the □ of the relevant error code described in this chapter. For details on numerical values, refer to the following.

- ☞ Page 200 List of Error Codes

## Application in SIL2 mode

With the use of the I/O module with diagnostic functions in SIL2 mode, safe inputs and outputs are provided by using two modules (two sets of the RX40NC6B or the RY40PT5B) and a safety program. Safety communications are carried out between the Main I/O module with diagnostic functions and the SIL2 Process CPU to send and receive data. Safety communications are possible only through the paths with an arrow described as safety connections in the following figure.

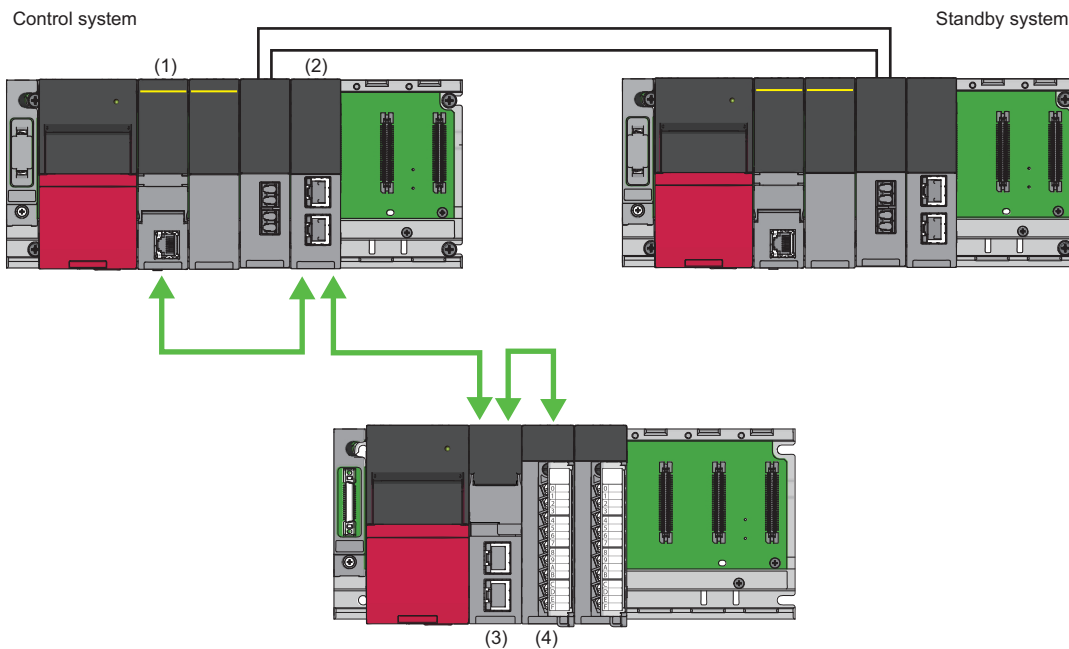

←→ Safety connection (each arrow direction indicates the direction in which a safety connection is possible)

- (1) SIL2 Process CPU
- (2) Master/local module
- (3) Remote head module
- (4) I/O module with diagnostic functions

# 10.1 SIL2 Mode

This section describes the settings necessary for operating the I/O module with diagnostic functions in SIL2 mode. Page 137 SYSTEM CONFIGURATION With the system shown in Page 137 SYSTEM CONFIGURATION configured, the following settings must be configured for each module and system.

## Creating a new project (remote head module side)

Create a new project with the remote head module, and add necessary modules.

1. Create a project with the remote head module. According to the system configuration, specify RJ72GF15-T2 or RJ72GF15-T2 (LR).
2. Depending on the system configuration, add "RX40NC6B(S2M)", "RX40NC6B(S2S)", "RY40PT5B(S2M)", and "RY40PT5B(S2S)".

## Setting parameters on the remote head module side

With the created project, set the parameters.

1. Configure "Network Required Setting" in "CPU Parameter" for the remote head module.
2. Set the module parameters for "RX40NC6B(S2M)", "RX40NC6B(S2S)", "RY40PT5B(S2M)", and "RY40PT5B(S2S)". For details on each parameter, refer to each function.
3. Write the set parameters into the remote head module of the intelligent device station, and reset the remote head module, or turn off and on the power.
4. Save the project.

### Point

The project on the remote head module side is used for setting safety communications in a project on the SIL2 Process CPU side.



## Creating a new project (SIL2 Process CPU side)

Create a new project with the SIL2 Process CPU, and add necessary modules.

1. Create a project with the SIL2 Process CPU.

 [Project] ⇒ [New]

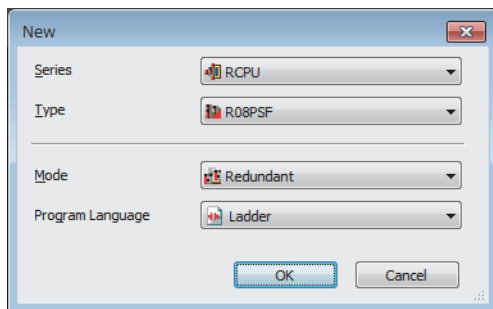

2. Add the user "Administrators" to the project and save the project.
3. Initialize the SIL2 Process CPU (built-in memory and user information) in both systems.
4. Depending on the system configuration, add R6PSFM and R6RFM.

 [Navigation window] ⇒ [Module Configuration] ⇒ [Element Selection window] ⇒ [CPU Extension]

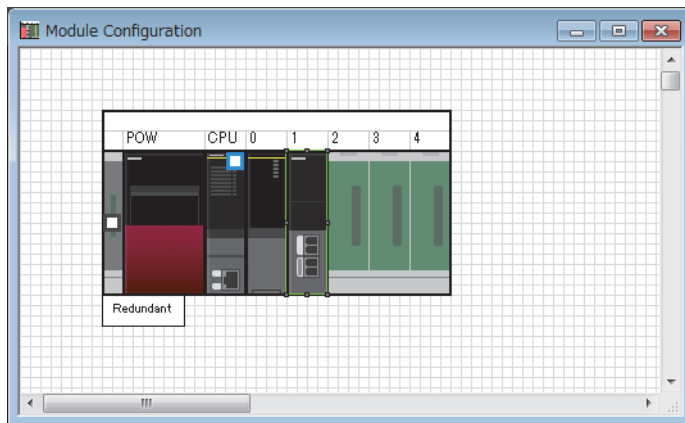

5. Depending on the system configuration, add RJ71GF11-T2(MR) or RJ71GF11-T2(LR) as the master station.

 [Navigation window] ⇒ [Parameter] ⇒ [Module Information] ⇒ Right-click ⇒ [Add New Module]

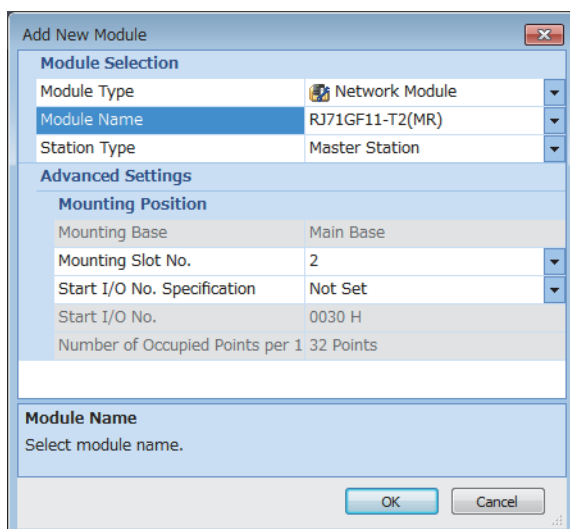

## Parameter setting on the SIL2 Process CPU side

With the created project, set the parameters.

1. Set "CPU Parameter" according to the system configuration.

For details on the items and setting method, refer to MELSEC iQ-R CPU Module User's Manual (Application).

2. Set "Required Settings" in "Module Parameter" for the master/local module.

[Navigation window] ⇒ [Parameter] ⇒ [Module Information] ⇒ Target module ⇒ [Module Parameter] ⇒ [Required Settings]

3. Using "Network Configuration Settings" in "Module Parameter" for the master/local module, set the intelligent device station. For the intelligent device station, set RJ72GF15-T2 or RJ72GF15-T2 (LR) depending on the system configuration.

[Navigation window] ⇒ [Parameter] ⇒ [Module Information] ⇒ Target module ⇒ [Module Parameter] ⇒ [Basic Settings] ⇒ [Network Configuration Settings]

No.	Model Name	STA#	Station Type	RX/RV Setting			RWw/RWv Setting			Reserved/Error	Invalid Station/System	Switching Monitoring Target Station	Pairing
				Points	Start	End	Points	Start	End				
0	Host Station	0	Master Station										
1	Host Station	1	Sub-Master Station							No Setting			No Pairs
2	RJ72GF15-T2	3	Intelligent Device Station	16	0000	000F	8	0000	0007	No Setting			

4. Save the project.

## Safety communication setting

Set safety communications using the project on the remote head module side. For details on safety communications, refer to the MELSEC iQ-R CC-Link IE Field Network User's Manual (Application).

1. Open a project on the SIL2 Process CPU side.
2. Set "To Use or Not to Use the Safety Communication Setting" in "Module Parameter" for the master/local module to "Use".
3. Double-click "Safety Communication Setting" in "Module Parameter" for the master/local module, and display the "Safety Communication Setting" window.

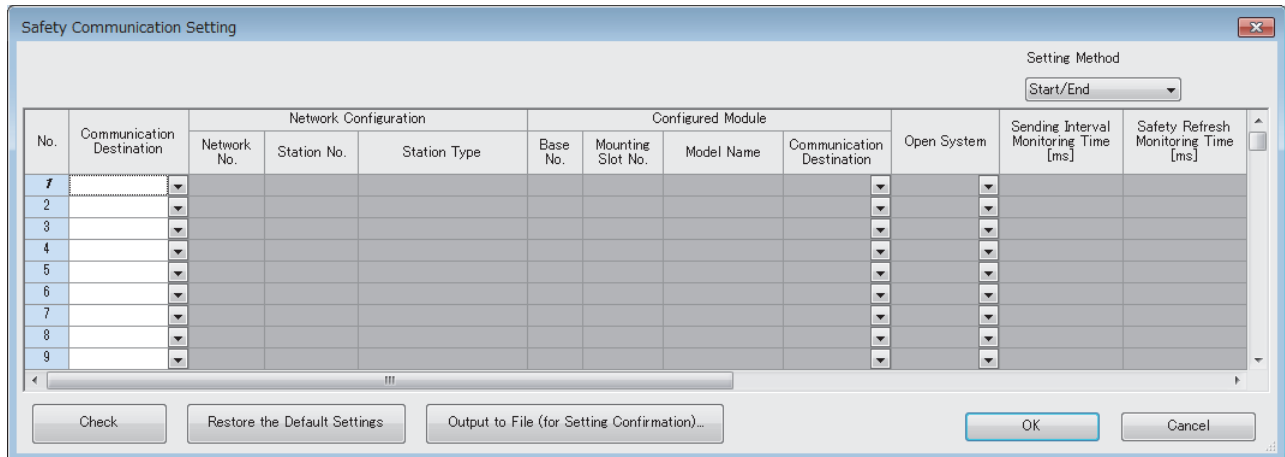

4. Select "Local Network" for "Communication Destination", and display the "Select the target module for the Safety Communication Setting" window.

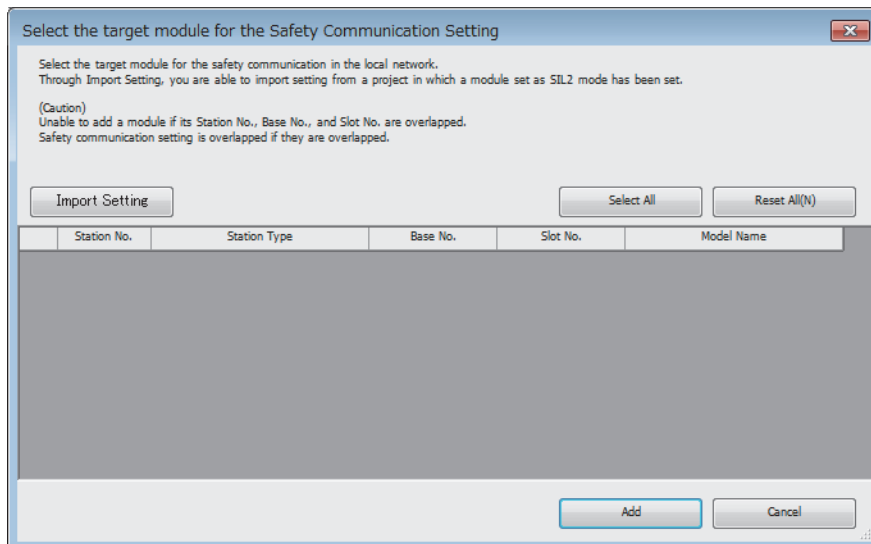

5. Click the [Import Setting] button, and select the SIL2 system (remote head module side) project.

- Select the check box for the safety communication setting target module, and click the [Add] button.

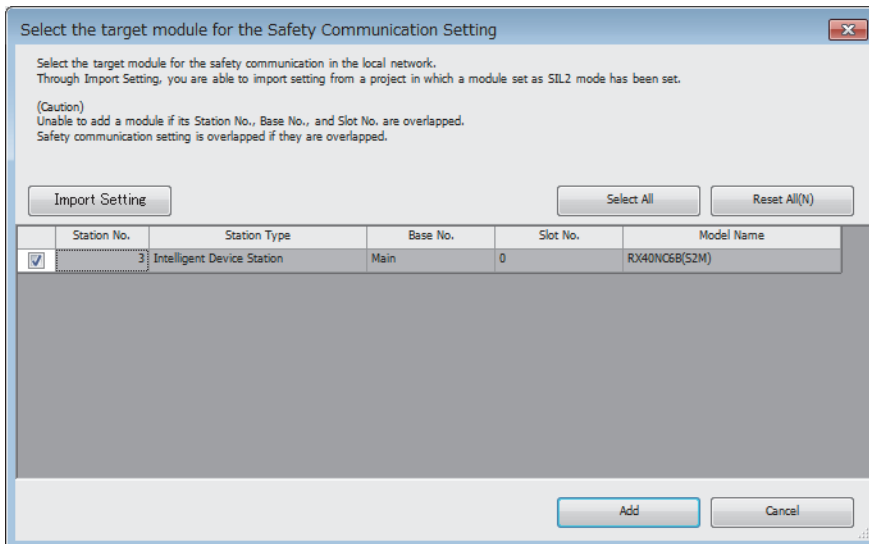

- In the "Safety Communication Setting" window, set safety communications for the added module.

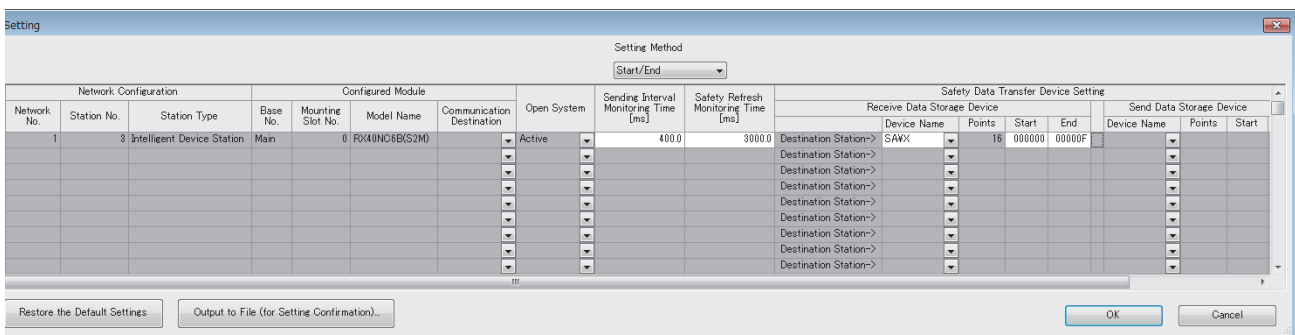

Item	Description
Sending Interval Monitoring Time [ms]	Refer to the following manual and set a value appropriate to your system. <a href="#">MELSEC iQ-R CC-Link IE Field Network User's Manual (Application)</a>
Safety Refresh Monitoring Time [ms]	
Receive Data Storage Device	For the RX40NC6B, select "SAIX" for "Device Name" to set the device for 16 points. For the RY40PT5B, this setting is not required.
Send Data Storage Device	For the RY40PT5B, select "SAIY" for "Device Name" to set the device for 16 points. For the RX40NC6B, this setting is not required.

- Write the set parameters into the SIL2 Process CPU and reset the SIL2 Process CPU or turn off and on the power.

## Writing the system A/B setting

Set system A/B to the SIL2 Process CPU in both systems. For details on the setting method, refer to the MELSEC iQ-R CPU Module User's Manual (Application). After the setting, both systems need to be restarted.

## Setting user information

Set user information to set up access restrictions on the SIL2 Process CPU in both systems and projects. For details on the setting method, refer to the GX Works3 Operating Manual.

The set user information must be written into the SIL2 Process CPU in both systems.

## Creating programs

Create a safety program and standard program.

## Safety module operation

With "Safety Module Operation" in the engineering tool, enable the RX40NC6B (Main) or the RY40PT5B (Main) so that it can be used in SIL2 mode.

**Point**

When performing the safety module operation, observe the following.

- Ensure that the engineering tool is directly connected to the SIL2 Process CPU in the control system (specify "No Specification" for the engineering tool connection destination setting) before starting "Safety Module Operation". Do not connect the engineering tool directly to the SIL2 Process CPU in the standby system. Depending on the system configuration, performing the safety module operation with the engineering tool directly connected to the SIL2 Process CPU in the standby system may cause a timeout. A time that triggers a timeout is Set time in "Check at Communication Time" (second) × 3. (The default value for "Check at Communication Time" is 30 seconds.) For details on "Check at Communication Time", refer to the GX Works3 Operating Manual.
- Ensure that the safety operation mode is set to TEST MODE for the SIL2 Process CPU before performing the safety module operation. For details on TEST MODE, refer to the MELSEC iQ-R CPU Module User's Manual (Application).

1. Open a project on the SIL2 Process CPU side.
2. Start the "Safety Module Operation" window.

 [Online] ⇒ [Safety PLC Operation] ⇒ [Safety Module Operation]

3. Select the master/local module in the network where safety module operation is performed. The module (RX40NC6B (Main) or RY40PT5B (Main)) to be enabled is displayed.
4. Select the check box for the RX40NC6B (Main) or the RY40PT5B (Main) to be enabled, and click the [Update] button. The current enabled/disabled status of the safety module is displayed for "Module Status".

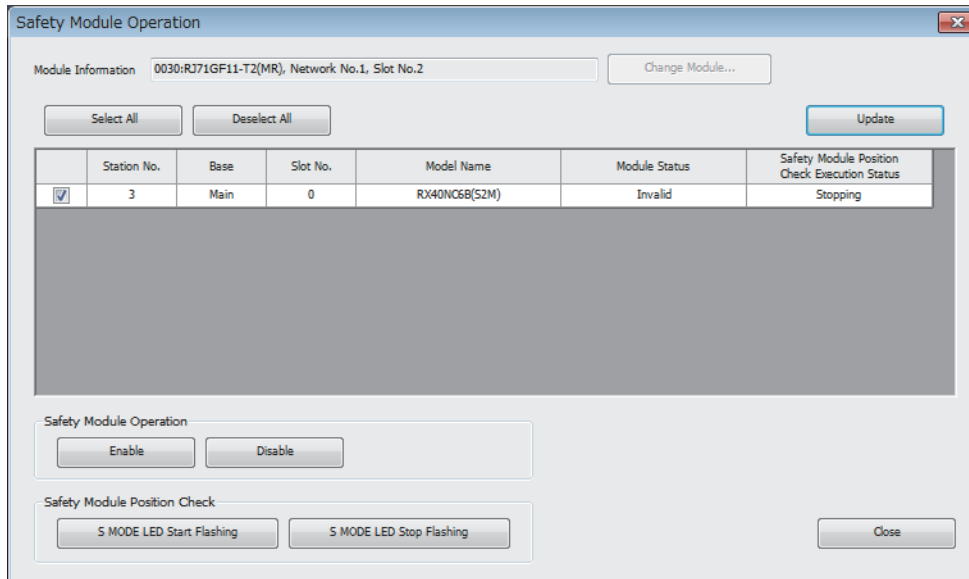

Module Status	Description
—	The information is not acquired.
Valid	The safety module is enabled and the configured parameters are valid.
Invalid	The safety module is not enabled and the configured parameters are not valid.
Valid (Reset Wait)	The safety module has just been enabled. In this state, the I/O module with diagnostic functions needs to be reset, and the module status will be enabled after the reset. At this time, the ALM LED flashes every 0.4 seconds.
Invalid (Reset Wait)	The module has just been disabled. In this state, the I/O module with diagnostic functions needs to be reset, and the module status will be disabled after the reset. At this time, the ALM LED flashes every 0.4 seconds.
Timeout	A timeout occurred because no response was returned from the target module. Check the settings or status of the target module. <ul style="list-style-type: none"> <li>• Is the module is set to SIL2 mode?</li> <li>• Has an error occurred?</li> </ul>

- Select the check box for the RX40NC6B (Main) or the RY40PT5B (Main) to be enabled, and click the [S MODE LED Start Flashing] button. Check that the S MODE LED for the I/O modules with diagnostic functions (Main and Sub) to be enabled is flashing (0.4s cycle). This operation makes it possible to check that there is no error in the operation target module before enabling it. In this case, the position checking status is displayed for "Safety Module Position Check Execution Status".

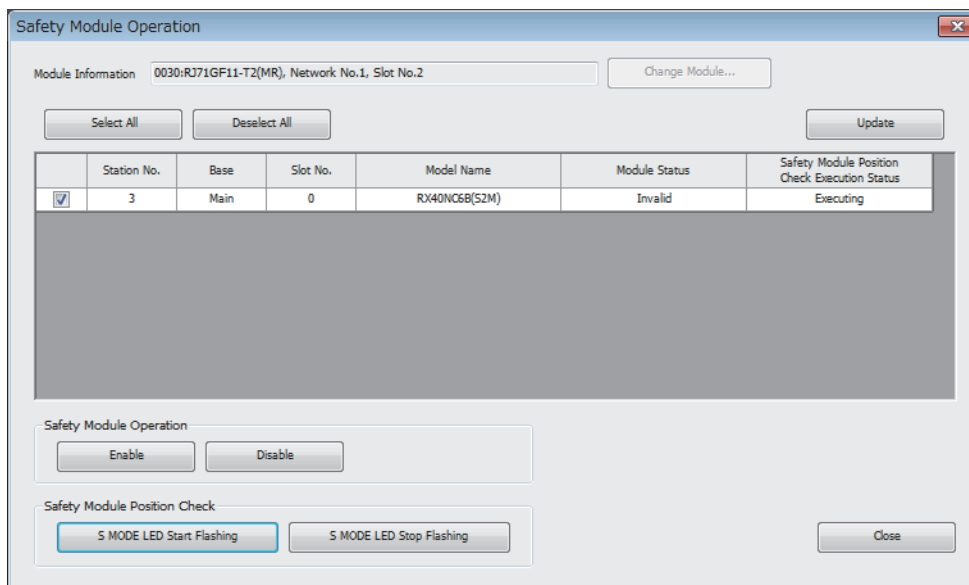

Safety Module Position Check Execution Status	Description
—	The information is not acquired.
Executing	The safety module position check is in process.
Stopping	The safety module position check is not executed.
Timeout	A timeout occurred because no response was returned from the target module. Check the settings or status of the target module. <ul style="list-style-type: none"> <li>• Is the module is set to SIL2 mode?</li> <li>• Has an error occurred?</li> </ul>

- After checking that the S MODE LED for the I/O module with diagnostic functions (Main and Sub) is flashing (0.4s cycle), click the [S MODE LED Stop Flashing] button to make the S MODE LED stop flashing.

7. Click the [Enable] button. In this case, the current enabled/disabled status of the safety module is displayed for "Module Status".

Module Status	Description
—	The information is not acquired.
Valid (Reset Wait)	The safety module has just been enabled. In this state, the I/O module with diagnostic functions needs to be reset, and the module status will be enabled after the reset. At this time, the ALM LED flashes every 0.4 seconds.
Verification Failed	The module parameters are different between the SIL2 Process CPU project and the remote head module project. Ensure that the module parameters are consistent.
Enabling Failed (Module Error)	The safety module failed to be enabled. Check wiring or other items and retry it. If this error persists, the module may be in failure.
Enabling Failed (Data Error)	
Timeout	A timeout occurred because no response was returned from the target module. Check the settings or status of the target module. <ul style="list-style-type: none"> <li>• Is the module is set to SIL2 mode?</li> <li>• Has an error occurred?</li> </ul>

8. Check that "Valid (Reset Wait)" is displayed for "Module Status". The enabling or disabling operation can be reflected in the I/O module with diagnostic functions by resetting the remote head module or turning off and on the power.
9. Reset the remote head module or turn off and on the power, and click the [Update] button.
10. Check that "Valid" is displayed for "Module Status".

### Point

- If a module that is already enabled is attempted to be enabled, the status does not change to "Valid (Reset Wait)" while the status is in "Valid".
- When changing a module parameter of the I/O module with diagnostic functions, enabling the safety module is required again.

## ■Disabling the safety module

Modules enabled by "Safety Module Operation" need to be disabled when using them in normal mode.

To disable the modules, follow the procedure below.

1. In the "Safety Module Operation" window, select the check box for the RX40NC6B (Main) or the RY40PT5B (Main) to be disabled, and click the [Disable] button. In this case, the current enabled/disabled status of the safety module is displayed for "Module Status".

Module Status	Description
—	The information is not acquired.
Invalid (Reset Wait)	The module has just been disabled. In this state, the I/O module with diagnostic functions needs to be reset, and the module status will be disabled after the reset. At this time, the ALM LED flashes every 0.4 seconds.
Enabling Failed (Module Error)	The safety module failed to be enabled. Check wiring or other items and retry it. If this error persists, the module may be in failure.
Enabling Failed (Data Error)	
Timeout	A timeout occurred because no response was returned from the target module. Check the settings or status of the target module. <ul style="list-style-type: none"> <li>• Is the module is set to SIL2 mode?</li> <li>• Has an error occurred?</li> </ul>

2. Check that "Invalid (Reset Wait)" is displayed for "Module Status" in the "Safety Module Operation" window. The enabling or disabling operation can be reflected in the RX40NC6B (Main) or the RY40PT5B (Main) by resetting the remote head module or turning off and on the power.

## Operation check

Check the status of each module used in the system and program behaviors. For details on the check procedure, refer to the following.

☞ Page 131 PROCEDURES BEFORE OPERATION

1. Power off the SIL2 Process CPU and remote head module in both systems.
2. Set the RUN/STOP/RESET switch for the SIL2 Process CPU and remote head module in both systems to RUN, and turn the power of both systems on.
3. Check each module to see if an error did not occur.
4. Check the LED on/off status of each module.
  - Control system

R08PSFCPU	R6PSFM	R6RFM	RJ71GF11-T2
READY <input checked="" type="checkbox"/> ERROR <input type="checkbox"/> PROGRAM RUN <input checked="" type="checkbox"/> USER <input type="checkbox"/> BATTERY <input type="checkbox"/> CARD READY <input type="checkbox"/> CARD ACCESS <input type="checkbox"/> FUNCTION <input type="checkbox"/>	READY <input checked="" type="checkbox"/> ERROR <input type="checkbox"/> PROGRAM RUN <input checked="" type="checkbox"/> SAFETY COM RUN <input checked="" type="checkbox"/> SAFETY COM ERR <input type="checkbox"/> TEST <input type="checkbox"/>	RUN <input checked="" type="checkbox"/> ERR <input type="checkbox"/> SYS [A <input checked="" type="checkbox"/> CTRL <input type="checkbox"/> [B <input checked="" type="checkbox"/> SBY <input type="checkbox"/> [ BACKUP <input checked="" type="checkbox"/> [ SEPARATE <input type="checkbox"/> MEMORY COPY <input type="checkbox"/> LINK <input checked="" type="checkbox"/> L ERR <input type="checkbox"/>	RUN <input checked="" type="checkbox"/> ERR <input type="checkbox"/> MST <input checked="" type="checkbox"/> D LINK <input checked="" type="checkbox"/> SD/RD <input checked="" type="checkbox"/> L ERR <input type="checkbox"/>

• Standby system

R08PSFCPU	R6PSFM	R6RFM	RJ71GF11-T2
READY <input checked="" type="checkbox"/> ERROR <input type="checkbox"/> PROGRAM RUN <input checked="" type="checkbox"/> USER <input type="checkbox"/> BATTERY <input type="checkbox"/> CARD READY <input type="checkbox"/> CARD ACCESS <input type="checkbox"/> FUNCTION <input type="checkbox"/>	READY <input checked="" type="checkbox"/> ERROR <input type="checkbox"/> PROGRAM RUN <input checked="" type="checkbox"/> SAFETY COM RUN <input checked="" type="checkbox"/> SAFETY COM ERR <input type="checkbox"/> TEST <input type="checkbox"/>	RUN <input checked="" type="checkbox"/> ERR <input type="checkbox"/> SYS [A <input checked="" type="checkbox"/> CTRL <input type="checkbox"/> [B <input checked="" type="checkbox"/> SBY <input type="checkbox"/> [ BACKUP <input checked="" type="checkbox"/> [ SEPARATE <input type="checkbox"/> MEMORY COPY <input type="checkbox"/> LINK <input checked="" type="checkbox"/> L ERR <input type="checkbox"/>	RUN <input checked="" type="checkbox"/> ERR <input type="checkbox"/> MST <input checked="" type="checkbox"/> D LINK <input checked="" type="checkbox"/> SD/RD <input checked="" type="checkbox"/> L ERR <input type="checkbox"/>



• Remote head module side\*1

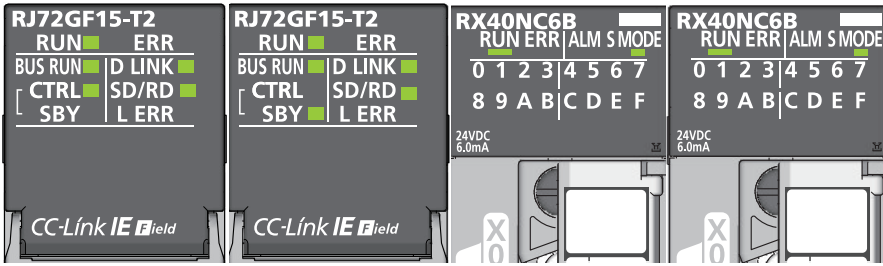

\*1 Because the remote head module is not in a redundancy configuration for the redundant master station system, the following LEDs are always turned off.

- CTRL LED ·SBY LED

**5.** Check that no error occurred in CC-Link IE Field Network diagnostics.

(📖 MELSEC iQ-R CC-Link IE Field Network User's Manual (Application))

**6.** Check the behaviors of the safety program and standard program.

### Switching the safety operation mode

For normal operation as an SIL2 system, switch the safety operation mode.

- 1.** Power off the SIL2 Process CPU in both systems.
- 2.** Set the RUN/STOP/RESET switch for the SIL2 Process CPU in both systems to STOP, and turn on the power.
- 3.** With "Switch Safety Operation Mode" in the engineering tool, switch to the safety mode.  
🔗 [Online] ⇒ [Safety PLC Operation] ⇒ [Switch Safety Operation Mode]
- 4.** Power off the SIL2 Process CPU and remote head module in both systems.
- 5.** Set the RUN/STOP/RESET switch for the SIL2 Process CPU and remote head module in both systems to RUN, and turn the power of both systems on.
- 6.** Ensure that the TEST LED for the R6PSFM is off.

# 10.2 Safety Input Function

## Input double wiring function

This function turns input wiring into double wiring. With double wiring, input signals on each side are verified so that when one side fails, safety inputs can be turned off.

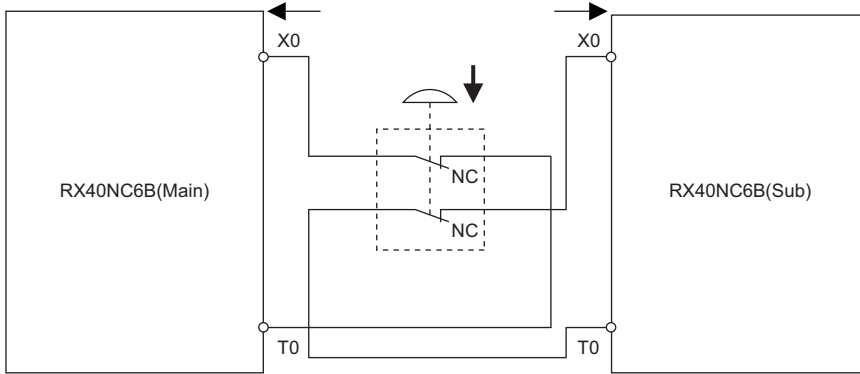

### Double wiring combination

For double wiring, perform wiring on a terminal with the same terminal number in both the RX40NC6B (Main) and the RX40NC6B (Sub).

**Ex.**

For example, to perform double wiring on the terminal with terminal number X00 in the RX40NC6B (Main), the terminal with terminal number X00 in the RX40NC6B (Sub) is used.

### Diagnostic functions to detect input errors

An input error can be detected with the following diagnostic functions.

Diagnostic function	Diagnostics	Reference
Double input discrepancy detection function	Detects the discrepancy state of double input signals.	Page 168 Double input discrepancy detection function
Input dark test function	Outputs test pulses to turn off the inputs that are on and diagnoses contacts including external devices for failure.	Page 175 Input dark test function

## Double input combination

The input module with diagnostic functions evaluates an input signal's logic and reflects the result in the relevant safety input (SAIX). When double inputs are made with different signals, a double input discrepancy detection state arises. The following table shows the correspondences between double input signal statuses and safety inputs (SAIX).

Input terminal status		Safety input (SAIX□)	Double input evaluation result
X□ in the RX40NC6B (Main)	X□ in the RX40NC6B (Sub)		
OFF	OFF	OFF	OFF (Normal)
OFF	ON	OFF	OFF (Mismatch)
ON	OFF	OFF	OFF (Mismatch)
ON	ON	ON	ON (Normal)

### ■ Status of safety input SAIX0, with double wiring applied to X00 in the RX40NC6B (Main) and X00 in the RX40NC6B (Sub)

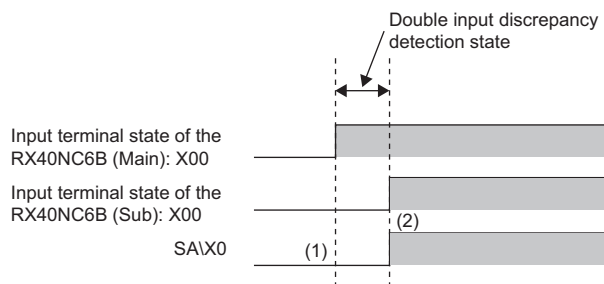

- (1) Even when X00 in the RX40NC6B (Main) becomes ON, because X00 in the RX40NC6B (Sub) is OFF, ON is not reflected in SAIX0.  
 (2) When double wiring is ON (X00 in the RX40NC6B (Main) and X00 in the RX40NC6B (Sub) are both ON), SAIX0 becomes ON.

## Setting procedure

With "Wiring input selection", set the terminal to perform double wiring on.

[Navigation window] ⇒ [Parameter] ⇒ [Module Information] ⇒ Model ⇒ [Module Parameter] ⇒ [Basic setting] ⇒ "Wiring input selection"

### Point

- When "Not used" is selected for "Wiring input selection", input data is always OFF.
- For an unused input terminal, set "Not used" for "Wiring input selection".

# Input response time setting function

This function helps change the input response time of the input module with diagnostic functions on a per-point basis. The input module with diagnostic functions takes in external inputs with the set input response times.

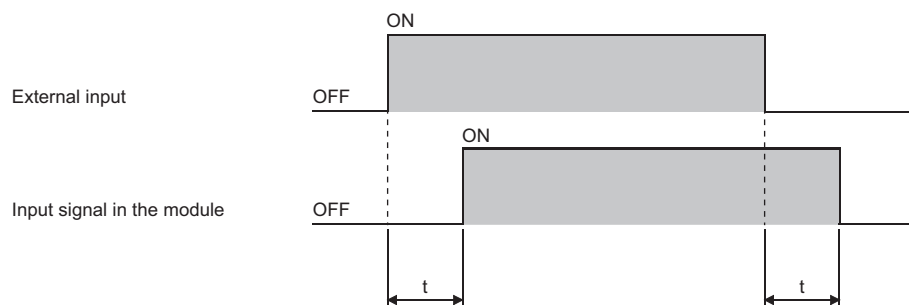

t: Input response time

## Setting procedure

Set the time with "Input response time".

[Navigation window] ⇒ [Parameter] ⇒ [Module Information] ⇒ Target module ⇒ [Module Parameter] ⇒ [Basic setting] ⇒ "Input response time"

## Input response time and pulse width of noise that can be removed

The input module with diagnostic functions may take in noise and others as an input depending on the setting of an input response time.

The following table lists the minimum widths of pulses that can be taken in as inputs. The pulse widths of noise that can be removed are smaller than the minimum values in the following table.

Set an input response time with due consideration of the following values and use environment.

Input response time setting value	Minimum width of pulse that can be taken in as input (Reference value)
1ms	1.0ms
5ms	5.0ms
10ms	10.0ms
20ms	20.0ms
70ms	70.0ms

## When noise occurred

If noise of 200μs or longer occurs, the time required for taking in an external input may become same as or longer than the input response time because of the filter processing in the module.

## Correlation between an input response time and input dark test parameters

An input response time must be set to satisfy the following conditions.

Input response time > Input dark test pulse output time<sup>\*1</sup>

<sup>\*1</sup> Input dark test pulse output time = Input dark test pulse OFF time × ((Number of pulse output for input dark test × 2) - 1)

For details on an input dark test, refer to the following.

Page 175 Input dark test function

# Input HOLD function

---

This function holds input values when safety refresh data reception is interrupted.

## Input HOLD occurrence

When detecting an interruption of safety refresh data reception, the input module with diagnostic functions holds the inputs immediately before that interruption.

## Input HOLD release

After an input HOLD occurs (safety refresh data reception is interrupted), when safety refresh data is received normally within the time set with "Safety I/O Hold Time" in "CPU Parameter", the input HOLD will be released.

## Safety I/O HOLD time exceeded error

When the time of holding inputs exceeds the time set with "Safety I/O Hold Time" in "CPU Parameter", a safety I/O HOLD time exceeded error (error code: 1500H) will occur. And, all input values become OFF.

## External input monitor function

---

With External input monitor signal (Un\G1024, Un\G1028), the ON/OFF state of an external input terminal can be checked on a per-point basis. Because external input signals can be monitored regardless of the double input combinations for the input double wiring function, the cause can be investigated easily when a double input discrepancy occurs.

For details on External input monitor signal (Un\G1024, Un\G1028), refer to the following.

 Page 213 External input monitor signal

### **Restriction**

---

Do not use the stored value for External input monitor signal (Un\G1024, Un\G1028) for safety control.

---

# 10.3 Safety Output Function

## Output double wiring function

This function turns output wiring into double wiring. With double wiring, output signals on each side are verified so that when one side fails, safety outputs can be turned off.

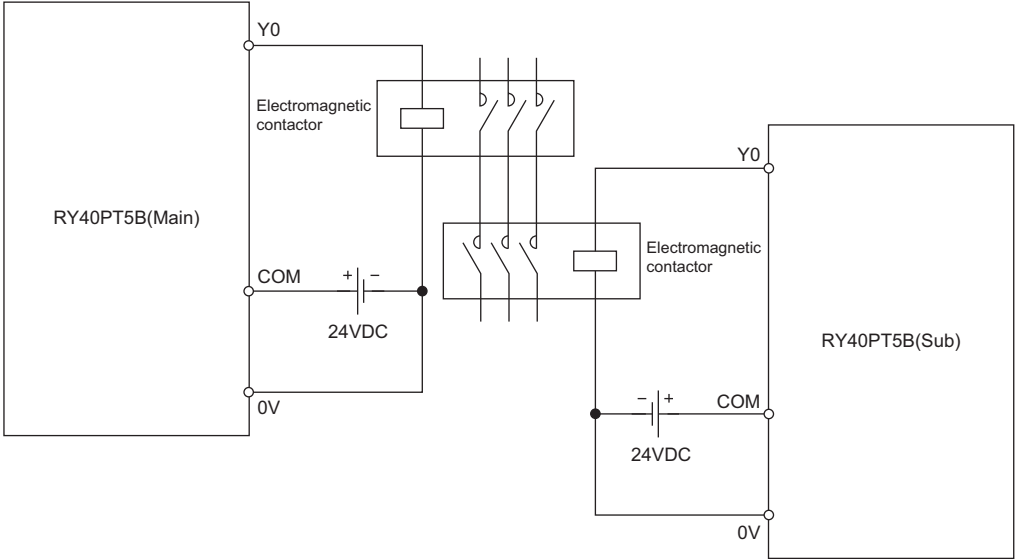

### Double wiring combination

For double wiring, perform wiring on a terminal with the same terminal number in both the RY40PT5B (Main) and the RY40PT5B (Sub).

**Ex.**

For example, to perform double wiring on the terminal with terminal number Y00 in the RY40PT5B (Main), the terminal with terminal number Y00 in the RY40PT5B (Sub) is used.

### Diagnostic functions to detect output errors

An output error can be detected with the following diagnostic functions.

Diagnostic function	Diagnostics	Reference
Output dark test function	Outputs test pulses to turn off the outputs that are on and diagnoses contacts including external devices for failure.	Page 177 Output dark test function
Output read-back function	Reads back the output results for diagnosis to see if the output signals are output correctly.	Page 179 Output read-back function

### Double output combination

When the safety output (SA\Y□) is ON, a double output turns on the corresponding output terminals in both the RY40PT5B (Main) and the RY40PT5B (Sub).

Safety output (SA\Y□)	Output terminal status	
	Y□ in the RY40PT5B (Main)	Y□ in the RY40PT5B (Sub)
OFF	OFF	OFF
ON	ON	ON

## Setting procedure

With "Wiring output selection", set the terminal to perform double wiring on.

 [Navigation window] ⇒ [Parameter] ⇒ [Module Information] ⇒ Model ⇒ [Module Parameter] ⇒ [Basic setting] ⇒ "Wiring output selection"

### Point

- When "Not used" is selected for "Wiring output selection", the applicable output terminals are always OFF.
- For an unused output terminal, set "Not used" for "Wiring output selection".



# Output HOLD function

---

This function holds output values when safety refresh data reception is interrupted.

## Output HOLD occurrence

When detecting an interruption of safety refresh data reception, the output module with diagnostic functions holds the outputs immediately before that interruption.

## Output HOLD release

After an output HOLD occurs (safety refresh data reception is interrupted), when safety refresh data is received normally within the time set with "Safety I/O Hold Time" in "CPU Parameter", the output HOLD will be released.

## Safety I/O HOLD time exceeded error

When the time of holding outputs exceeds the time set with "Safety I/O Hold Time" in "CPU Parameter", a safety I/O HOLD time exceeded error (error code: 1500H) will occur. And, all output values become OFF.

# 10.4 Input Diagnostic Function

## Double input discrepancy detection function

This function identifies failures by monitoring the discrepancy state of double safety inputs (SAIX).

### Double input discrepancy detection

#### ■Double input discrepancy detection (input discrepancy detection time specified)

In the "Application setting" window, when "Redundant input discrepancy detection settings" is set to "Enabled" and "Redundant input discrepancy detection type" is set to "Discrepancy detection time specified", if the double input discrepancy state continues for the specified time or longer, a double input discrepancy detection error will occur as an input error. For the double input discrepancy detection time, refer to the following.

☞ Page 172 Double input discrepancy detection time

The following shows an overview of double input discrepancy detection (input discrepancy detection time specified) operation for double wiring inputs (X00 in the RX40NC6B (Main) and X00 in the RX40NC6B (Sub)).

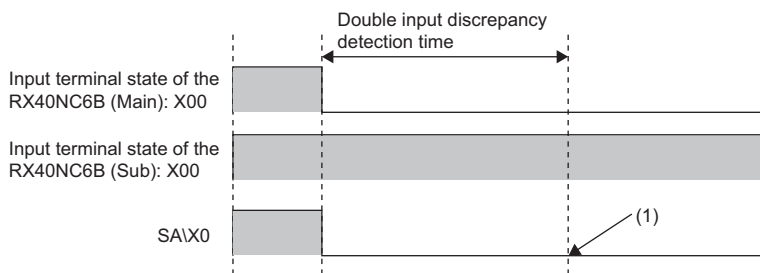

(1) After the double input discrepancy detection time elapses, a double input discrepancy detection error occurs.

#### ■Operation when an error is detected (input discrepancy detection time specified)

When the double input discrepancy state continues for the specified time or longer, a double input discrepancy detection error (error code: 1400H) will occur. In addition, the input point where a double input discrepancy was detected becomes OFF. For the input point where a double input discrepancy was detected, check it with Double input discrepancy detection state (Un\G1036) because a bit of the corresponding input point in this buffer memory area becomes ON.

### ■ Double input discrepancy detection (input discrepancy detection time not specified)

In the "Application setting" window, when "Redundant input discrepancy detection settings" is set to "Enabled" and "Redundant input discrepancy detection type" is set to "Discrepancy detection time not specified", even if the double input discrepancy state continues, a double input discrepancy detection error will not occur. When input signals on both modules become ON and the ON state continues for 500ms, a double input discrepancy detection error will occur as an input error. The following shows an overview of double input discrepancy detection (input discrepancy detection time not specified) operation for double wiring inputs (X00 in the RX40NC6B (Main) and X00 in the RX40NC6B (Sub)) when a double input discrepancy detection error occurs and when it does not occur each.

- When a double input discrepancy detection error does not occur

After the input terminals turn into the state of ON/ON, when the discrepancy state (ON/OFF or OFF/ON) continues for longer than 500ms, a double input discrepancy will be detected and a double input discrepancy detection state will arise. A double input discrepancy detection error (error code: 1400H) will not occur. Then, when the OFF/OFF state of the input terminals is detected, the double input discrepancy detection state will be eliminated.

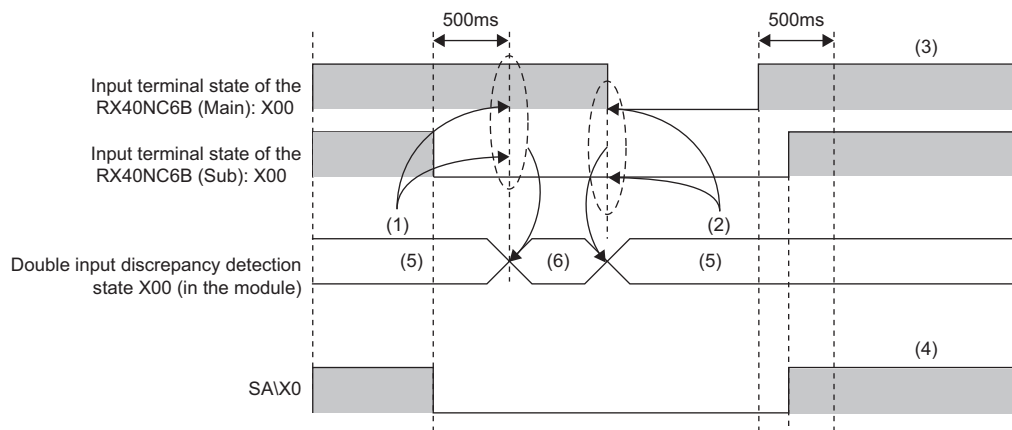

- (1) Detects a double input discrepancy.  
 (2) When X00 in the RX40NC6B (Main) and X00 in the RX40NC6B (Sub) become OFF/OFF, the double input discrepancy detection state will be eliminated.  
 (3) When the time difference for returning to the ON/ON state of X00 in the RX40NC6B (Main) and the RX40NC6B (Sub) is within 500ms, SAIX0 will also become ON.  
 (4) A double input discrepancy detection error does not occur.  
 (5) No discrepancy  
 (6) Discrepancy occurred

- When a double input discrepancy detection error occurs

After the input terminals turn into the state of ON/ON, when the discrepancy state (ON/OFF or OFF/ON) continues for longer than 500ms, a double input discrepancy will be detected and a double input discrepancy detection state will arise. A double input discrepancy detection error (error code: 1400H) will not occur. In the double input discrepancy detection state, if the input terminals return to the ON/ON state and that state continues for longer than 500ms, a double input discrepancy detection error (error code: 1400H) will occur.

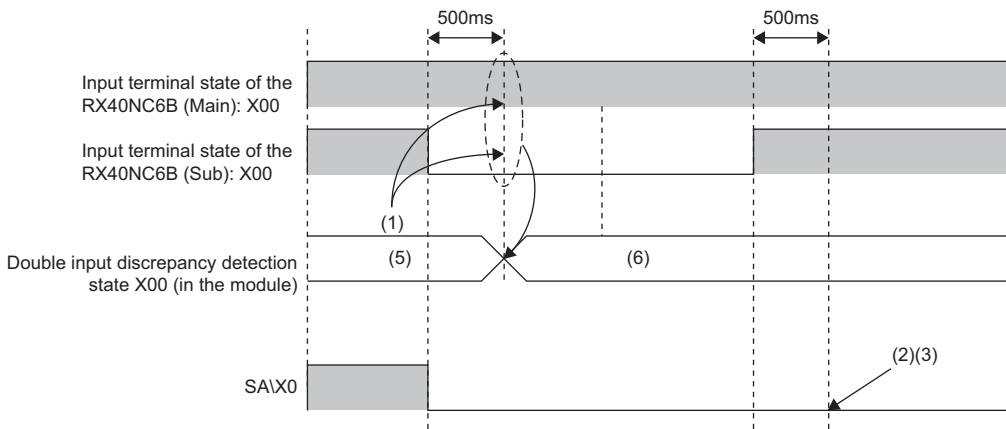

- (1) Detects a double input discrepancy.
- (2) A double input discrepancy detection error occurs.
- (3) SAIX0 continues to be OFF.
- (5) No discrepancy
- (6) Discrepancy occurred

### ■ Operation when an error is detected (input discrepancy detection time not specified)

In the double input discrepancy detection state, if the input terminals return to the ON/ON state and that state continues for longer than 500ms, a double input discrepancy detection error (error code: 1400H) will occur. In addition, the input point where a double input discrepancy was detected becomes OFF.

For the input point where a double input discrepancy was detected, check it with Double input discrepancy detection state (Un\G1036) because a bit of the corresponding input point in this buffer memory area becomes ON.

## ■Application example of the double input discrepancy detection (input discrepancy detection time not specified)

Use this function when the double input discrepancy detection time cannot be uniformly determined. With this function, a double input discrepancy detection error occurs not immediately after the discrepancy is detected, but only when a certain condition is satisfied.

The following shows an example of when the double input discrepancy detection (input discrepancy detection time not specified) is applied to the double sensors of a switch for the door that is manually opened and closed.

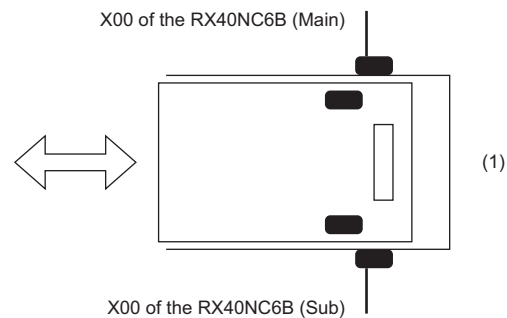

(1) The door is ajar.

When the door is ajar, open it all the way and close it again. You can check that both door sensors become OFF by doing so. This also helps distinguish a discrepancy caused by failure from the one caused by the door ajar. The door can be used continuously without a double input discrepancy detection error.

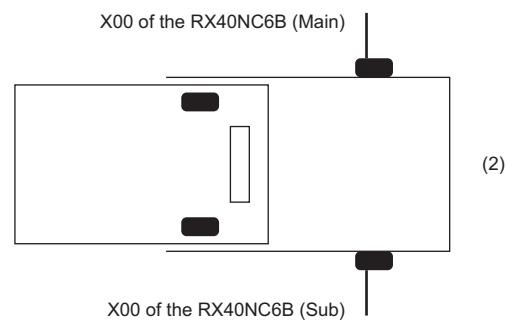

(2) The door is fully open.

When this function is used with the double input discrepancy auto recovery function, even if a double input discrepancy detection error occurs by closing the door ajar, the error will be eliminated by opening it fully. For details on the double input discrepancy auto recovery function, refer to the following.

☞ Page 173 Double input discrepancy auto recovery function

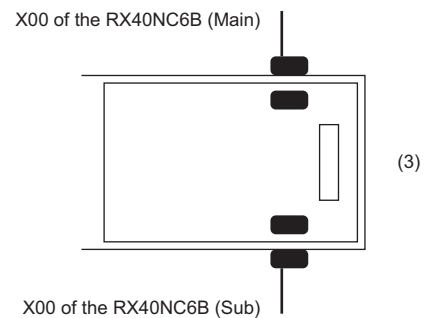

(3) The door is closed again.

## ■Setting procedure

Perform this setting with "Redundant input discrepancy detection settings" and "Redundant input discrepancy detection type".

 [Navigation window] ⇒ [Parameter] ⇒ [Module Information] ⇒ Model ⇒ [Module Parameter] ⇒ "Application setting" ⇒ "Redundant input discrepancy detection settings" and "Redundant input discrepancy detection type"

### Point

- When it is not desirable that a double input discrepancy be detected during system maintenance such as system startup and inspection, set "Disabled" for "Redundant input discrepancy detection settings".
- When "Disabled" is selected for "Redundant input discrepancy detection settings", settings for "Redundant input discrepancy detection type" will be ignored.

## Double input discrepancy detection time

When the double input discrepancy detection time is set, even if a double input discrepancy occurs, an error will not occur within the set detection time. The following table shows the relationships between double input evaluations and double input discrepancy detection times.

Input terminal status		Elapsed time after discrepancy state start	Safety input (SAIX□)	Double input evaluation result
X□ in the RX40NC6B (Main)	X□ in the RX40NC6B (Sub)			
OFF	OFF	—	OFF	OFF (Normal)
OFF	ON	< Double input discrepancy detection time	OFF	OFF (Mismatch)
OFF	ON	≥ Double input discrepancy detection time	OFF	Double input discrepancy detection error
ON	OFF	< Double input discrepancy detection time	OFF	OFF (Mismatch)
ON	OFF	≥ Double input discrepancy detection time	OFF	Double input discrepancy detection error
ON	ON	—	ON	ON (Normal)

## ■Setting procedure

Set the time with "Redundant input discrepancy detection time".

 [Navigation window] ⇒ [Parameter] ⇒ [Module Information] ⇒ Model ⇒ [Module Parameter] ⇒ [Application setting] ⇒ "Redundant input discrepancy detection time"

### Point

- A double input discrepancy error is detected for signals after noise removal filtering based on the input response time. For that reason, the time from when a discrepancy occurs between actual signals until a double input discrepancy detection error occurs is equal to the input response time + double input discrepancy detection time.
- The "Redundant input discrepancy detection time" setting is effective only for input signals with "Redundant input discrepancy detection settings" set to "Enabled" and "Redundant input discrepancy detection type" set to "Discrepancy detection time specified". For input signals with values other than the above set, the value set for "Redundant input discrepancy detection time" will be ignored.

## ■ Guidelines on double input discrepancy detection time

Condition	Guidelines on double input discrepancy detection time
For a mechanical switch	Set the time around 100ms.
For a sensor input	Set the time around 20ms.
When double input synchronization time can be defined	For input equipment with specifications for synchronization time open to the public, set a value determined by considering the safety factor for misdetections. In addition, with 200% or larger safety factor in mind, set a value that prevents misdetections according to the input device. Example: When the synchronization time is 1s, with 200% safety factor, set the double input discrepancy detection time to 2s.
When double input synchronization time cannot be defined	For a device such as a door switch that manually opens and closes the door, when synchronization time cannot be defined, set the maximum time or set "Redundant input discrepancy detection settings" to "Disabled". Even if "Disabled" is set, when an input signal on one side becomes OFF, the system itself stops. Therefore, safety can be assured by periodically inspecting the input module with diagnostic functions at sufficiently short intervals.
For performing the input dark test function	For double input discrepancy detection time, set the sufficiently longer time than the input dark test pulse OFF time of the input dark test function. If not, a test pulse (OFF pulse) for the input dark test function may be mistakenly detected as double input discrepancy.

## Double input discrepancy auto recovery function

When a double input discrepancy detection error occurs and the cause of that error is eliminated, this function can automatically restore the normal state. By enabling this function, it is possible to make the reset operation for the input module with diagnostic functions that aims to reset an error no longer necessary. When this function is enabled, if a double input discrepancy is detected, a double input discrepancy detection error (error code: 1400H) will occur.

### ■ Auto recovery timing

To release a double input discrepancy detection error, actual input signals on both sides need to be turned OFF. The following shows a timing in which a double input discrepancy detection error is automatically recovered.

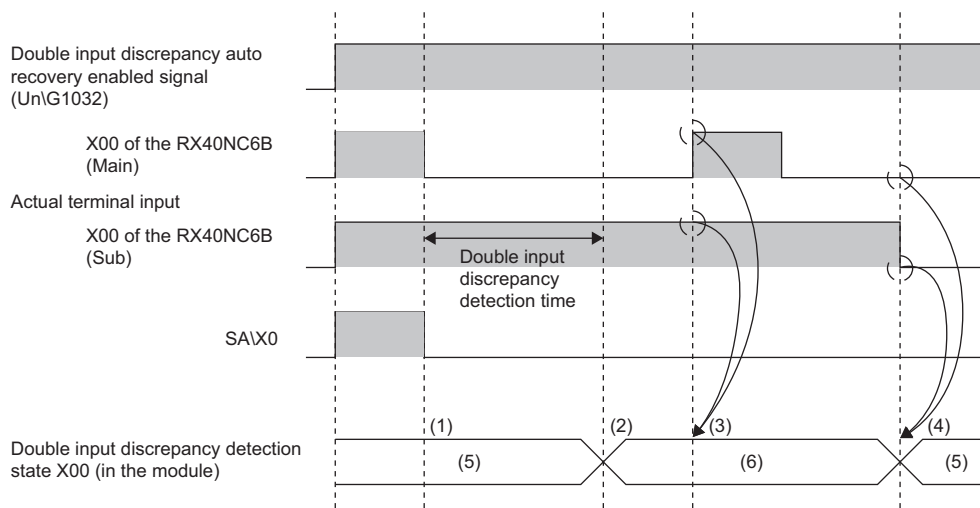

- (1) SAIX0 becomes OFF when a discrepancy is detected.
- (2) A double input discrepancy detection error (error code: 1400H) occurs.
- (3) Even when both X00 in the RX40NC6B (Main) and X00 in the RX40NC6B (Sub) become ON, auto recovery is not performed.
- (4) When both X00 in the RX40NC6B (Main) and X00 in the RX40NC6B (Sub) become OFF, auto recovery is performed.
- (5) No discrepancy
- (6) Discrepancy occurred

## ■Double input discrepancy auto recovery enabled signal

When "Auto recovery settings after discrepancy error" is set to "Enable", 1 is stored in Double input discrepancy auto recovery enabled signal (Un\G1032). For details on Double input discrepancy auto recovery enabled signal (Un\G1032), refer to the following.

 Page 214 Double input discrepancy auto recovery enabled signal

### **Point**

---

Double input discrepancy auto recovery enabled signal (Un\G1032) is a buffer memory area for monitoring. Do not use it for safety programs.

---

## ■Setting procedure

Set with "Auto recovery settings after discrepancy error".

 [Navigation window] ⇒ [Parameter] ⇒ [Module Information] ⇒ Model ⇒ [Module Parameter] ⇒ [Application setting] ⇒ "Auto recovery settings after discrepancy error"

### **Point**

---

The "Auto recovery settings after discrepancy error" setting is effective only for input signals with "Redundant input discrepancy detection settings" set to "Enabled" and "Redundant input discrepancy detection type" set to "Discrepancy detection time specified". For input signals with values other than the above set, the value set for "Auto recovery settings after discrepancy error" will be ignored.

---

## Double input discrepancy detection state monitoring signal

Regardless of the setting of "Auto recovery settings after discrepancy error", the double input discrepancy detection state can be monitored with Double input discrepancy detection state (Un\G1036). For details on Double input discrepancy detection state (Un\G1036), refer to the following.

 Page 214 Double input discrepancy detection state

### **Point**

---

Double input discrepancy detection state (Un\G1036) is a buffer memory area for monitoring. Do not use it for safety programs.

---



## Input dark test function

This function outputs test pulses to turn off external input signal (X00 to X0F) that are ON and diagnoses contacts including external devices for failure. Such a fault as adhesion, short-circuit, and failure in a circuit can be detected. Also, the test pulse OFF time or the number of pulses to be output that are used for one diagnosis process can be set according to the usage environment.

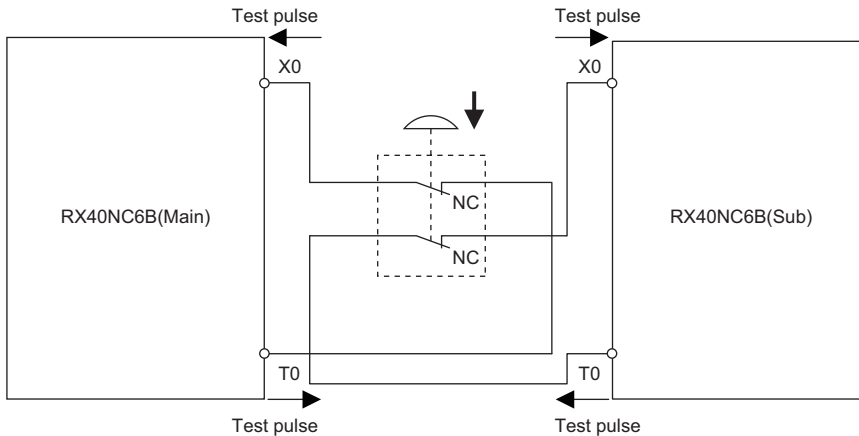

To execute the input dark test function, use test pulse output terminals (T0, T1) and connect input equipment. Use the input terminals and test pulse output terminals of the input module with diagnostic functions in the following combinations.

- For the RX40NC6B (Main) and the RX40NC6B (Sub), wire even-numbered input terminals with T0 test pulse output terminals.
- For the RX40NC6B (Main) and the RX40NC6B (Sub), wire odd-numbered input terminals with T1 test pulse output terminals.

RX40NC6B(Main)		RX40NC6B(Sub)	
Input terminal	Test pulse output terminal	Input terminal	Test pulse output terminal
X00	T0	X00	T0
X01	T1	X01	T1
to		to	
X0E	T0	X0E	T0
X0F	T1	X0F	T1

When a connection is made to test pulse output terminals in an incorrect combination, it is judged that a disconnection occurred and an input dark test error (error code: 1401H) will occur.

### Operation when an error is detected

When an error is detected during input dark test diagnostics, an input dark test error (error code: 1401H) will occur. In addition, the input point where an input dark test error was detected turns off.

For the input point where an input dark test error was detected, check it with Input dark test error detection state (Un\G1040) because a bit of the corresponding input point in this buffer memory area turns on.

## Setting procedure

Set the parameters for the input dark test function with "Application setting".

### Point

There is a correlation between an input response time and input dark test parameter values. To set parameters, set values that satisfy their correlation. For details, refer to the following.

 Page 162 Correlation between an input response time and input dark test parameters

1. With "Input dark test execution setting", set whether to conduct an input dark test on a per-point basis.  
 [Navigation window] ⇒ [Parameter] ⇒ [Module Information] ⇒ Model ⇒ [Module Parameter] ⇒ [Application setting] ⇒ "Input dark test function"
2. With "Input dark test pulse OFF time", set the width of an OFF pulse to be output by a test pulse output terminal on a per-module basis.
3. With "Number of pulses output for input dark test", set the number of OFF pulses during input dark test diagnostics on a per-module basis.

### Point

- For input terminals with "Wiring input selection" set to "Not used", the settings for "Input dark test execution setting" are ignored and test pulse output is disabled.
- Adjust the input dark test pulse OFF time and the number of input dark test pulse outputs according to the installation environment and wiring length.

# 10.5 Output Diagnostic Function

## Output dark test function

This function outputs test pulses to turn off external output signal (Y00 to Y0F) that are ON and diagnoses internal circuits for failure. Such a fault as adhesion, wire breaks, and failure in a circuit can be detected. Also, the test pulse OFF time or the number of pulses to be output that are used for one diagnosis process can be set according to the usage environment.

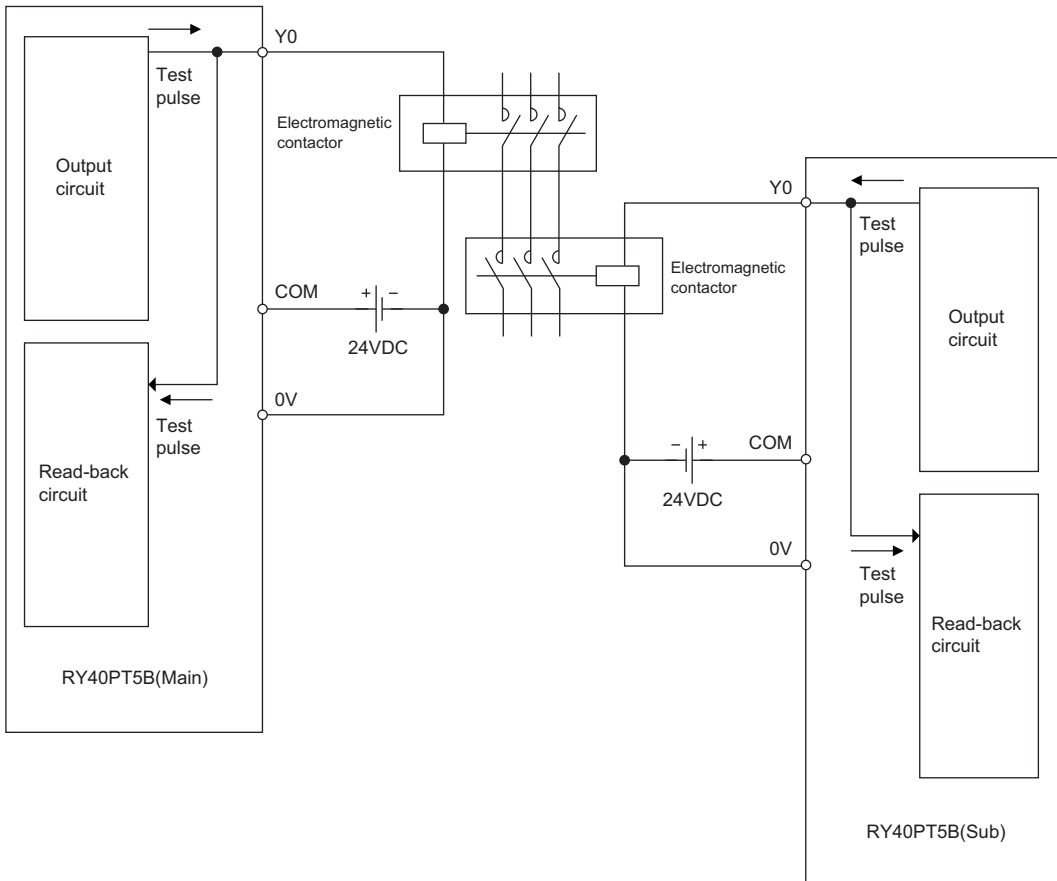

### Operation when an error is detected

When an error is detected during output dark test diagnostics, an output dark test error (error code: 2003H) state will arise and all outputs will be turned OFF.

For the output point where an output dark test error was detected, check it with Output dark test error detection state (Un\G1540) because a bit of the corresponding output point in this buffer memory area turns on.

## Setting procedure

Set the parameters for the output dark test function with "Application setting".

1. With "Output dark test execution setting", set whether to conduct an output dark test on a per-point basis.  
 [Navigation window] ⇒ [Parameter] ⇒ [Module Information] ⇒ Model ⇒ [Module Parameter] ⇒ [Application setting] ⇒ "Output dark test function"
2. With "Output dark test pulse OFF time", set the width of an OFF pulse to be output by a test pulse output terminal on a per-point basis.
3. With "Number of pulses output for output dark test", set the number of OFF pulses during output dark test diagnostics on a per-module basis.

### Point

- For output terminals with "Wiring output selection" set to "Not used", the settings for "Output dark test execution setting" are ignored and test pulse output is disabled.
- Adjust the output dark test pulse OFF time and the number of output dark test pulse outputs according to the installation environment and wiring length.

## Output read-back function

This function reads back the output results for diagnosis to see if the external output signals (Y00 to Y0F) are turned ON or OFF correctly. By performing diagnostics to see if the output terminal state and the safety device output data match, the function detects an error in the module's output operation. Note that this function can be used without setting parameters. The minimum load current (at output ON) of when the output read-back function is used is 3mA/point. If the load current is below this, the output read-back function may not operate normally.

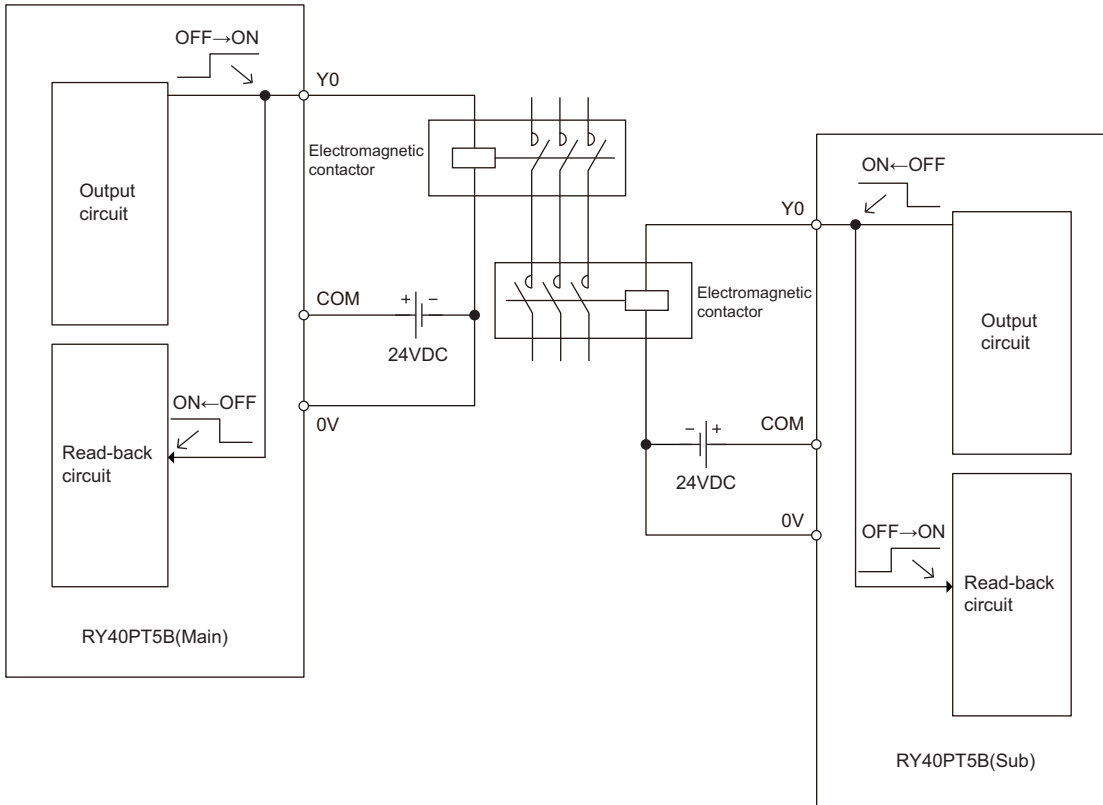

### Operation when an error is detected

When an error is detected during output read-back diagnostics, an output read-back error (error code: 2002H) will occur and all outputs will be turned OFF.

For the output point where an output read-back error was detected, check it with Output read-back error detection state (Un\G1536) because a bit of the corresponding output point in this buffer memory area turns on.

#### Point

The maximum output voltage in output OFF state is 1V. Note that if the voltage exceeds 1V due to a short-circuit or hardware failure, the connected device may still be in ON state even though the module output is off because no error is detected when the voltage is lower than 5V.

# 10.6 Protection Function

The following table lists protection functions.

Function name	Purpose	Description
Module power supply overvoltage protection	Protects against ignition and burnout originated from the I/O module with diagnostic functions due to an overvoltage on the primary side.	Activated when an overvoltage occurs in the module power supply.
Module power supply overcurrent protection	Protects against ignition and burnout originated from the I/O module with diagnostic functions due to an overcurrent on the primary side.	Activated when an overcurrent occurs in the module power supply.
Overload protection	Protects against ignition and burnout originated from the I/O module with diagnostic functions due to an overcurrent or overheating attributable to a short-circuit in the output circuit.	Activated when a current exceeding the rated value flows. In addition, an output read-back error (error code: 2002H) will occur. Returns to the normal state when the remote head module is reset or the power is turned off and on after the load goes down to the level of the rated load.
Overheat protection	Protects against ignition and burnout originated from the output module with diagnostic functions due to an overheat condition attributable to overcurrent in the output circuit.	When a high heat is detected inside the module, the outputs are turned off. In addition, an output read-back error (error code: 2002H) will occur. Returns to the normal state when the remote head module is reset or the power is turned off and on after the heat decreases to a certain level.

The following table lists the modules to be protected by each protection function.

Function name	Protection target	
	Input module with diagnostic functions	Output module with diagnostic functions
Module power supply overvoltage protection	○	○
Module power supply overcurrent protection	○	○
Overload protection	—	○
Overheat protection	—	○

**Point** 

- The protection functions protect the module's internal circuits, not intended to protect external devices.
- When an overload (overvoltage, overcurrent) occurs, the temperature inside the module may rise, which may deteriorate output elements or discolor the case or printed circuit board. When a load error occurs, turn off the related outputs immediately and eliminate the cause.

# 10.7 Common Functions of the I/O Module with Diagnostic Functions

## LED indication setting on error condition

This function helps set the indication of the I/O status indicator LED when a minor error occurs. The following figure shows the LED status in normal and abnormal conditions.

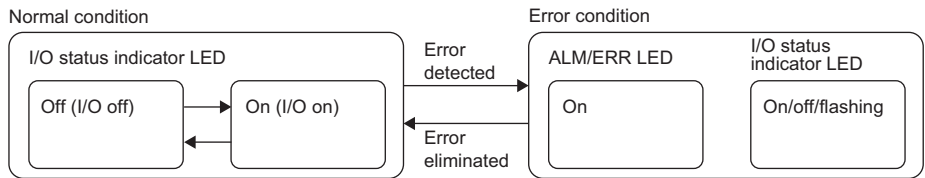

### LED indication on error condition

The ERR LED turns on when a minor error is detected.

The indication of the I/O status indicator LED when a minor error is detected can be set in "LED display settings during an error".

#### ■Do not display I/O error

The ON/OFF state of an I/O is indicated.

When the ERR LED is on, check with the error history to identify the I/O where an error occurred.

#### ■Always display I/O error

Only the LED of an I/O with an error turns on. The LED of an I/O without error is off. (The ON/OFF state of input/output cannot be indicated.)

The indications of the ALM LED, ERR LED and I/O status indicator LED help identify the input/output with an error.

#### ■Display I/O status and error switching (1 second interval)

The LED indication is switched between "Do not display I/O error" and "Always display I/O error" at the interval of a second. Check for the I/O with an error with the error history.

### Setting procedure

Set the following item from "Basic setting".

[Navigation window] ⇒ [Parameter] ⇒ [Module Information] ⇒ Target module ⇒ [Module Parameter] ⇒ [Basic setting] ⇒ "LED display settings during an error"

#### Restriction

When "LED display settings during an error" is set to "Display I/O status and error switching (1 second interval)", an item displayed in the "Module Diagnostics" window is partly restricted. For details, refer to the following.

Page 192 Module Information List

# 10.8 Error History Function

For the errors that occurred in the I/O module with diagnostic functions, a maximum of 16 error histories can be checked using the engineering tool.

[Diagnostics] ⇒ [System Monitor] ⇒ Right-click the target module. ⇒ [Module Diagnostics]

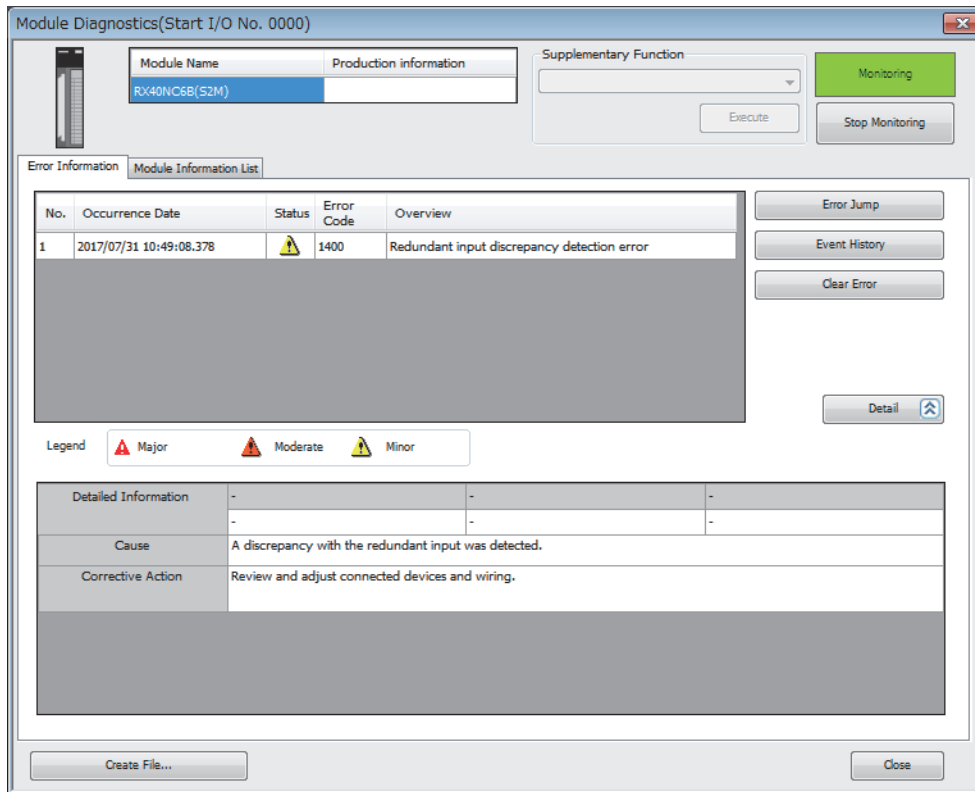

### Point

When the number of error histories exceeds 16, the histories are overwritten sequentially from the first one, and error histories are continued to be recorded. The histories before being overwritten are deleted.

## How to clear error histories using the error history function

Error histories can be cleared by either of the following methods.

- Turn the programmable controller's power off.
- Reset the remote head module.



# 10.9 Event History Function

This function collects errors that occurred in the I/O module with diagnostic functions and executed operations as event information in the remote head module.

Information of an event that occurred in the I/O module with diagnostic functions is collected by the remote head module and held inside the data memory in the remote head module.

Event information collected by the remote head module can be displayed using the engineering tool, and occurrence histories can be checked in chronological order.

Event type	Classification	Description
System	Error	Self-diagnostics error detected in each module
	Alarm	Alarm detected in each module
	Information	Operation normally detected by the system not classified as an error or alarm, or operation performed automatically by the system.
Security	Alarm	The operation which is judged as unauthorized access to each module
	Information	Operation that could not be judged as a successful unlock of a password or unauthorized access
Operation	Alarm	Among operations performed on modules, delete operation (data clear) that is not judged as an error by self-diagnostics but likely to change the behavior
	Information	Operations performed by users including operations which changes system behavior, such as error clear, and operations which changes the structure

## Setting procedure

Set the event history function in the event history setting window of the engineering tool. For the setting procedure, refer to the following.

 MELSEC iQ-R CPU Module User's Manual (Application)

## Display of the event history

Display the event history from the menu of the engineering tool. For details on the operating procedure and display description, refer to the following.

 GX Works3 Operating Manual

## Event history list

The following table shows an event that occurs in the I/O module with diagnostic functions.

Event code	Event classification	Event name	Description	Additional information
00150	Information	Safety communication start	Safety communications were started.	—
00151	Information	Safety communication stop	Safety communications were stopped.	—
00A00 <sup>*1</sup>	Alarm	Safety communication error	A safety communication error was detected.	—
00A02 <sup>*1</sup>	Alarm	Response monitoring timeout with safety communication connection being established	A response timeout occurred while a safety communication connection was being established.	—
00A03 <sup>*1</sup>	Alarm	Response monitoring timeout during safety communication refresh	A response timeout occurred during safety communication refresh.	—
00A04 <sup>*1</sup>	Alarm	Response monitoring timeout during safety communication error processing	A timeout occurred during the safety communication error response.	—
00A05 <sup>*1</sup>	Alarm	Safety communication reception interval monitoring timeout	No response was returned within the specified safety refresh monitoring time.	—
00A06 <sup>*1</sup>	Alarm	Safety communication receive data delay detection	Consecutive receive data is not complete.	—
00A07 <sup>*1</sup>	Alarm	Safety communication receive data loss detection	A loss of consecutive receive data was detected.	—
00A08 <sup>*1</sup>	Alarm	Application data error	A safety communication data frame error was detected.	—
00A10	Alarm	Safety module validation match failure	An error was detected at the verification of safety parameter.	—
00A11	Alarm	Failure of enabling safety module	Enabling the safety parameter failed.	—
00A12	Alarm	Failure of disabling safety module	Disabling the safety parameter failed.	—
20100	Information	Error release (error clear)	An error clear request was executed.	—

\*1 Although this event may occur on the switching of systems incorporating SIL2 Process CPUs, an input value or output value is held within a period where the input HOLD function or output HOLD function is effective (the time set with "Safety I/O Hold Time" in "CPU Parameter").

# 11 PARAMETER SETTINGS

This chapter describes how to set the parameters of the I/O module with diagnostic functions.

## 11.1 Basic Settings

### Setting procedure

Open "Basic setting" of the engineering tool.

#### 1. Start Module Parameter.

[Navigation window] ⇒ [Parameter] ⇒ [Module Information] ⇒ Target module ⇒ [Module Parameter] ⇒ [Basic setting]

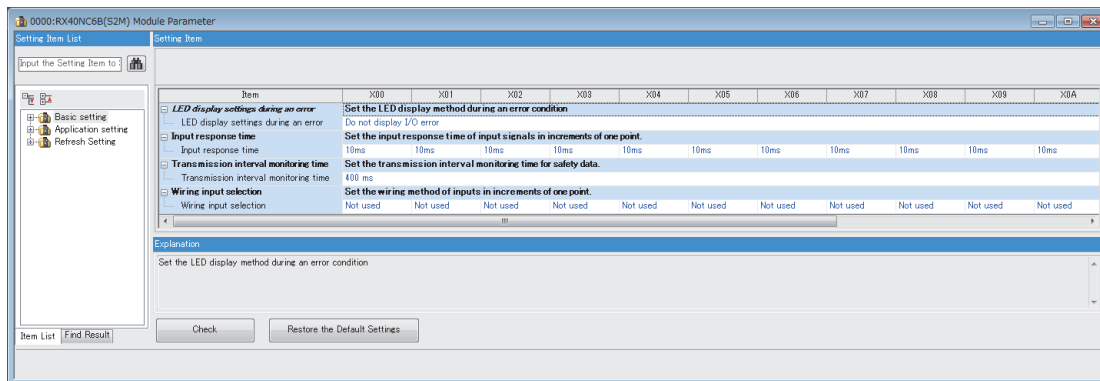

#### 2. Double-click on the item to be changed and enter a setting value.

- Item where a value is selected from a drop-down list

Click the [▼] button of the item to be set to display a drop-down list. Select an item.

- Item where a value is entered into a text box

Double-click on the item to be set and enter a numerical value.

### Transmission interval monitoring time

"Transmission interval monitoring time" of the I/O module with diagnostic functions is the time used for monitoring where the master station detects an error on safety communications (data transmission from the I/O module with diagnostic functions to the master station). If the interval of safety communications from the I/O module with diagnostic functions exceeds the time set in "Transmission interval monitoring time", the master station detects it as disconnection.

For "Transmission interval monitoring time", set the time satisfying both of the following conditions.

- $TM \geq S2cyc \times 3$
- $TM \geq (SCmst \times 2) + (LS \times 2)$

TM: Transmission interval monitoring time of the I/O module with diagnostic functions

S2cyc: Control cycle time (📖 Page 126 Performance Specifications)

SCmst: Safety cycle time of the master station (📖 MELSEC iQ-R CPU Module User's Manual (Application))

LS: Link scan time (📖 MELSEC iQ-R CC-Link IE Field Network User's Manual (Application))

# 11.2 Application Settings

## Setting procedure

Open "Application setting" of the engineering tool.

### 1. Start Module Parameter.

[Navigation window] ⇒ [Parameter] ⇒ [Module Information] ⇒ Target module ⇒ [Module Parameter] ⇒ [Application setting]

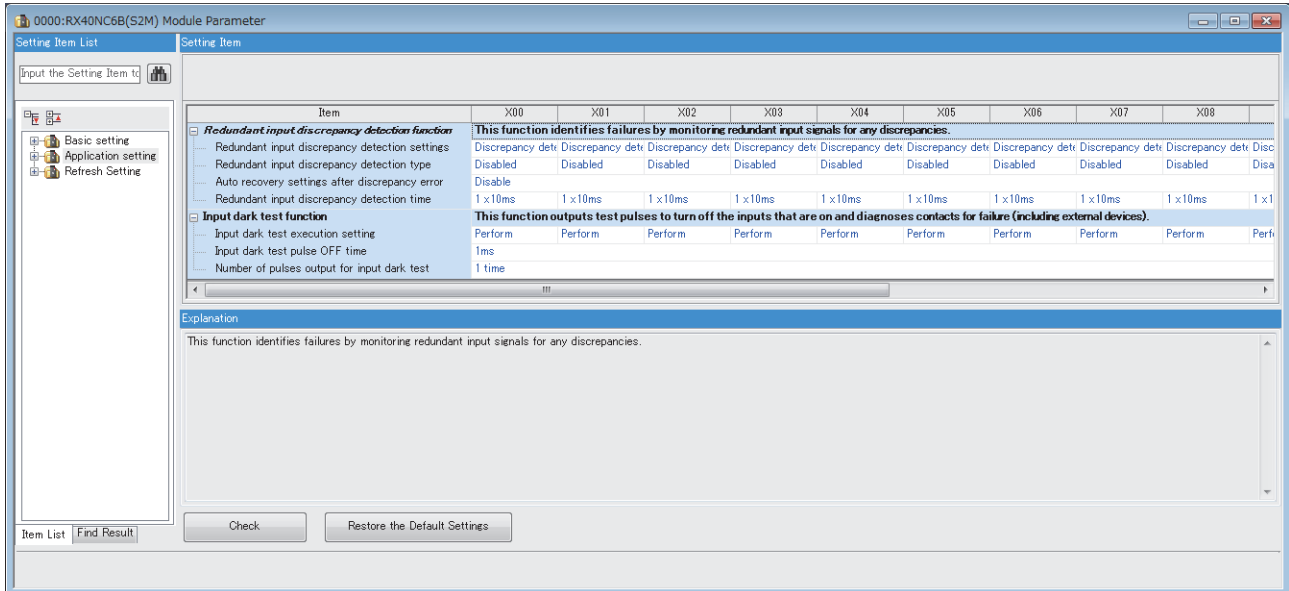

### 2. Double-click on the item to be changed and enter a setting value.

- Item where a value is selected from a drop-down list

Click the [▼] button of the item to be set to display a drop-down list. Select an item.

- Item where a value is entered into a text box

Double-click on the item to be set and enter a numerical value.

## 11.3 Refresh Settings

---

Module parameter refresh settings are not available for the I/O module with diagnostic functions that is set to SIL2 mode.

# 12 MAINTENANCE AND INSPECTION

---

This chapter describes inspection to be performed for using the I/O module with diagnostic functions in SIL2 mode.

## Periodic inspection

Perform the following inspection one or two times in 6 months to a year. Perform it as well after equipment is transferred or modified, or wiring is changed.

- Apply 6V to all input terminals of the input module with diagnostic functions and check that an input does not turn on.

For other inspection items, refer to the following.

 MELSEC iQ-R Module Configuration Manual

# MEMO

---

# 13 TROUBLESHOOTING

This chapter describes the details of errors that may occur when using the I/O module with diagnostic functions and troubleshooting.

## 13.1 Troubleshooting with the LEDs

By checking the LED indicator status, primary diagnostics without the engineering tool can be performed to narrow down the range of causes of error occurrences.

The status of the I/O module with diagnostic functions can be checked with RUN LED, ERR LED, ALM LED, and S MODE LED. The following table shows the correspondences between the LEDs and the statuses of the I/O module with diagnostic functions.

Name	Description
RUN LED	Displays the module operating status. On: Normal operation Off: When 5V power supply was disconnected or a watchdog timer error occurred
ERR LED	Displays the error occurrence status of the module.*1 On: An error occurred (minor error). Flashing: An error occurred (moderate error). Off: Normal operation
ALM LED	Depending on "LED display settings during an error", displays the wait-for-restart state after the safety module is enabled or the error occurrence state. When "Do not display I/O error" is set Flashing (400ms cycle): Wait-for-restart Off: Normal operation • When "Always display I/O error" or "Display I/O status and error switching (1 second interval)" is set A minor error occurrence can be checked.  Page 181 LED indication setting on error condition
S MODE LED	Displays the module operating status (related to SIL2 mode). On: Safety I/O in operation Flashing (1s cycle): Safety I/O stopped Flashing (400ms cycle): Executing the module position check*2 Off: Operating in normal mode

\*1 For details, refer to the following.

 Page 200 List of Error Codes

\*2 For details, refer to the following.

 Page 155 Safety module operation



# 13.2 Checking the Module Status

The following functions are available in the "Module Diagnostics" window for the I/O module with diagnostic functions.

Function	Application
Error Information	Displays the details of the currently occurring error. Click the [Event History] button to check the histories of errors that occurred on the network as well as histories of errors detected in modules and executed operations.
Module Information List	Displays status information of the I/O module with diagnostic functions.

## Error Information

This function is used for checking the currently occurring error and the action to take.

 [Diagnostics] ⇒ [System Monitor] ⇒ Right-click the target module. ⇒ "Module Diagnostics"

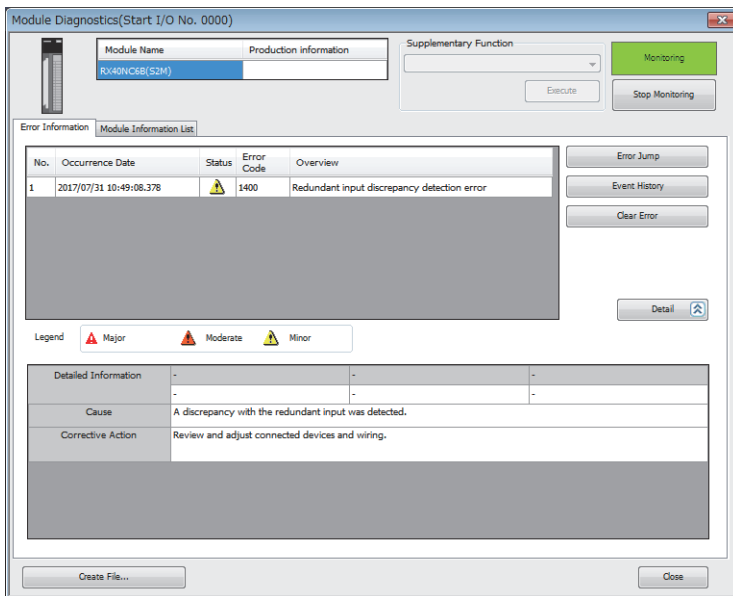

Item	Description
Status	Major: Error because of which the module stops, such as hardware or memory failure
	Moderate: Error because of which the module stops, such as a parameter error related to module operation
	Minor: Error after which the module continues its operation, such as communication failure.
Detailed Information	Displays a maximum of three pieces of detailed information about each error.
Cause	Displays the details of the cause of each error.
Corrective Action	Displays the action against the error.

## Module Information List

Status information of the I/O module with diagnostic functions can be checked by selecting the "Module Information List" tab.

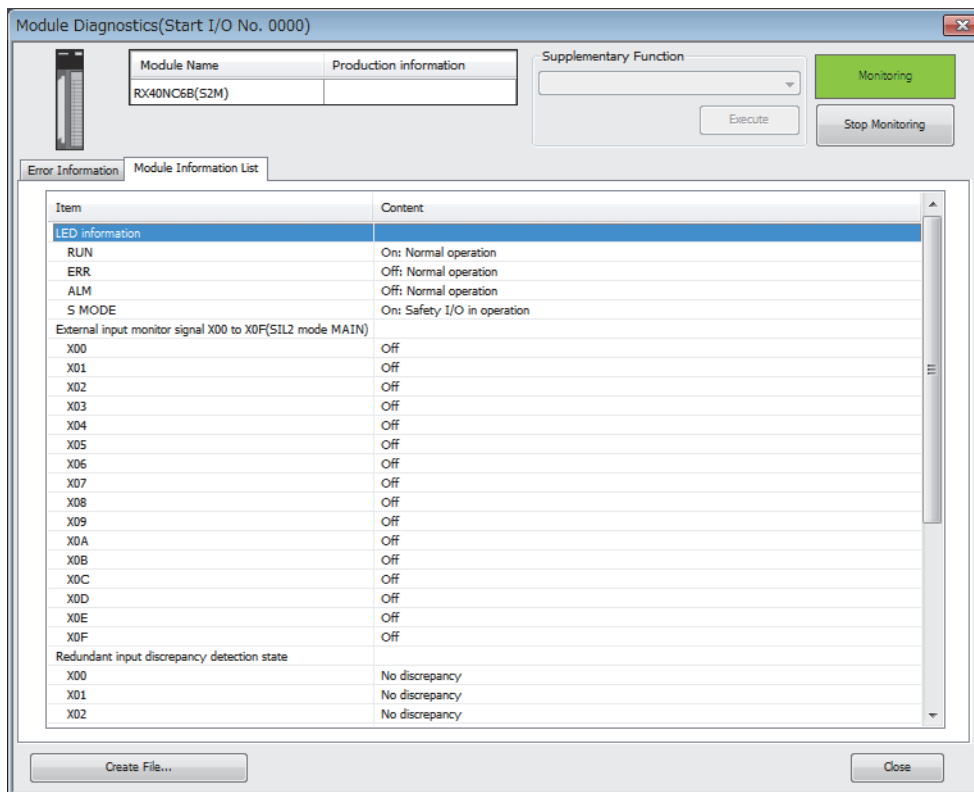

Item	Description
LED information	Displays the status of each LED of the I/O module with diagnostic functions.
External input monitor signal X00 to X0F (SIL2 mode MAIN) External input monitor signal X00 to X0F (SIL2 mode Sub)	Displays the status of external input for each input.
Redundant input discrepancy detection state	Displays the double input discrepancy detection state for each input.
Auto recovery settings after discrepancy error	Displays the setting status of double input discrepancy auto recovery setting.

### Restriction

If a minor error occurs when "LED display settings during an error" of "Basic setting" is set to "Display I/O status and error switching (1 second interval)", "On" and "Off" are alternatively displayed for "ALM" of "LED information". (The duration of display may differ between "On" and "Off", because "ALM" area reflects the status of the I/O module with diagnostic functions during communications with the I/O module.) In addition, "On" and "Off" are output in CSV format by clicking "Create File".

For this reason, when checking LED status on the "Module Diagnostics" window, do not set "LED display settings during an error" of "Basic setting" to "Display I/O status and error switching (1 second interval)".

## 13.3 Troubleshooting by Symptom

### When the I/O module with diagnostic functions does not start up

Check item	Action
Check whether five seconds have elapsed after power-off of the power supply module.	When applying the input power source to the power supply module again, do so five seconds or more after the shut-off of the power.

### When the RUN LED is off

Check item	Action
Check whether power is supplied.	Check that the supply voltage to the power supply module is within the rated range.
Check whether the capacity of the power supply module is enough.	Calculate the current consumption of the mounted modules, such as the remote head module, I/O modules, and intelligent function modules, to check that the power capacity is enough.
Check whether the modules are mounted properly.	Check the mounting state of each module.
Cases other than the above	Reset the remote head module and check that the RUN LED turns on. If the RUN LED still remains off, the possible cause is a module failure. Please consult your local Mitsubishi representative.

### When the ERR LED is flashing or turns on

#### When the LED is flashing

Check item	Action
Check whether a moderate error has occurred.	Check the error code in the "Module Diagnostics" window and take the action described in the list of error codes. <a href="#">Page 200 List of Error Codes</a>

#### When the LED turns on

Check item	Action
Check whether a minor error has occurred.	Check the error code in the "Module Diagnostics" window and take the action described in the list of error codes. <a href="#">Page 200 List of Error Codes</a>

# When the S MODE LED is flashing or off

## When the S MODE LED is flashing (1s cycle)

Check item	Action
Check whether the status is "Safety station interlock status".	Monitor the 'safety station interlock status on a per-safety connection basis (1st module)' (SA\SD1232 to SA\SD1239) <sup>*1</sup> , and check the interlock status of the I/O module with diagnostic functions. When the interlock state is "Interlocked", operate the 'safety station interlock release request on a per-safety connection basis (1st module)' (SA\SD1240 to SA\SD1247) <sup>*1</sup> that corresponds to the I/O module with diagnostic functions to release the interlock state of the I/O module with diagnostic functions. For details on the safety special register, refer to the following. MELSEC iQ-R CPU Module User's Manual (Application)
Check whether the I/O module with diagnostic functions is in safety module disabled state.	Enable the safety module for the I/O module with diagnostic functions. If enabling the safety module fails, follow the steps below again starting from "Safety communication setting". Page 132 Procedure on the SIL2 Process CPU side
Check whether the remote head module is in STOP state.	Check the RUN/STOP/RESET switch for the remote head module and if it is set to STOP, change it to RUN.
Check whether the wiring between the master station and the remote head module is correct.	Check the wiring between the master station and the remote head module.
Check whether a momentary power failure has occurred in the remote head module. (Check whether a power shutoff (error code: 1000H) has occurred in the remote head module. ( MELSEC iQ-R CC-Link IE Field Network Remote Head Module User's Manual (Application)))	When a momentary power failure has occurred in the remote head module, if a value of the transmission interval monitoring time for the master station or the I/O module with diagnostic functions is smaller than the value described in the precaution about a momentary power failure of the remote head module, safety communications may stop. Take the following actions if necessary. <ul style="list-style-type: none"> <li>• Take measures against a momentary power failure. ( MELSEC iQ-R Module Configuration Manual)</li> <li>• Check "Transmission interval monitoring time" of the I/O module with diagnostic functions. ( Page 185 Basic Settings)</li> <li>• Check "Sending Interval Monitoring Time" of the master station. ( MELSEC iQ-R CC-Link IE Field Network User's Manual (Application))</li> </ul> For the precaution about a momentary power failure of the remote head module, refer to the following. MELSEC iQ-R CC-Link IE Field Network Remote Head Module User's Manual (Application)

\*1 For details on the 2nd module and later safety special register, refer to the following.  
 MELSEC iQ-R CPU Module User's Manual (Application)

### Point

Changing the module parameter of the I/O module with diagnostic functions and writing it to the remote head module causes a change in the safety parameter, and thus the I/O module with diagnostic functions automatically shifts to the safety module disabled state. To set the I/O module with diagnostic functions to the safety module enabled state again, it is required to perform [Import Setting] to the changed project of the remote head module by using "Safety Communication Setting" of the CPU module project, and then to enable the safety module.

## When the S MODE LED is flashing (400ms cycle)

Check item	Action
Check whether the module position check has been executed.	With "Safety Module Operation" in the engineering tool, select the relevant module and click [S MODE LED Stop Flashing] button.

## When the S MODE LED is off

Check item	Action
Check whether the operation mode is set to SIL2 mode.	Check with the GX Works3 system parameter to see if the operation mode of the I/O module with diagnostic functions is SIL2 mode. If not, switch to the I/O module with diagnostic functions in SIL2 mode in the module configuration window.

## When the ALM LED is flashing

Check item	Action
Check whether the system was restarted after the activation of the safety module.	When the safety module is enabled, restart the system.

## When an I/O LED does not change

Check item	Action
Check whether "Display I/O status and error switching (1 second interval)" or "Always display I/O error" is set in "LED display settings during an error" of the input module with diagnostic functions. Check whether "Display I/O status and error switching (1 second interval)" or "Always display I/O error" is set in "LED display settings during an error" of the output module with diagnostic functions.	Check the current setting of "LED display settings during an error".

## When a module parameter error is displayed in the "Module Diagnostics" window

Check item	Action
Check whether the module configuration is correct.	Check that the module configuration is the same as the one set with the engineering tool.
Check whether a module incompatible with the SIL2 mode is not used.	Check that modules whose firmware version are compatible with the SIL2 mode are used. Incompatible modules do not operate normally in SIL2 mode. For details, refer to the following. ☞ Page 141 Firmware Version for SIL2 Mode



## When the ON/OFF state of an external input cannot be read

Check the following items in order of No.

No.	Check item	Action
1	Check whether the S MODE LED is on.	If the S MODE LED is not on, take action by referring to the following. ☞ Page 194 When the S MODE LED is flashing or off
2	When the external input signal is on, check whether the corresponding input LED is on.	If the LED is not on, check again the wiring between the external input device and the module's external input terminal. Also check that the voltage of the module's external power supply is within the rated input voltage range.
3	Check whether the read safety device is correct.	If a safety device different from the safety device assigned by the refresh device setting is referred to, the safety device cannot be read correctly. Check the refresh device setting, and make necessary corrections to make the program content consistent. (☞ MELSEC iQ-R CPU Module User's Manual (Application))
4	Check whether "Wiring input selection" is set to "Not used".	When "Not used" is set for "Wiring input selection", the relevant safety input is always OFF. Change the "Wiring input selection" setting according to the actual wiring.
5	Check whether two signals of double input wiring match.	When "Wiring input selection" is set to "Redundant (NC/NC)", as long as the levels of two paired input signals do not match, a state of the safety input level being different from the actual input signal level continues. Check whether the external input device is faulty or whether the wiring between the device and the external input terminal is correct.

## When the ON/OFF state of an external output cannot be changed

Check the following items in order of No.

No.	Check item	Action
1	Check whether the S MODE LED is on.	If the S MODE LED is not on, take action by referring to the following.  Page 194 When the S MODE LED is flashing or off
2	When the safety output is turned on, check whether the corresponding output LED is on.	If the LED is on, there is a problem in the wiring between the external output terminal and the external output device. Check the wiring again for any wire break or short-circuit.
3	Check whether the safety device to which output data is set is correct.	If data is set to a safety device different from the safety device assigned by the refresh device setting, a safety output cannot be made correctly. Check the refresh device setting, and make necessary corrections to make the program content consistent. (  MELSEC iQ-R CPU Module User's Manual (Application))
4	Check whether "Wiring output selection" is set to "Not used".	When "Not used" is set for "Wiring output selection", the relevant safety output is always OFF. Change the "Wiring output selection" setting according to the actual wiring.
5	Check whether the PROGRAM RUN LED of the SIL2 Process CPU is on.	If the PROGRAM RUN LED of the SIL2 Process CPU is not on, the SIL2 Process CPU may be in STOP state and the program may not be operating. Check the RUN/STOP/RESET switch for the SIL2 Process CPU and if it is set to STOP, change it to RUN.

## When an external output ON signal intermittently turns off

Check item	Action
Check whether an output dark test has been conducted.	Check the specifications of the safety device to be used, and review the settings for "Output dark test pulse OFF time" and "Number of pulses output for output dark test".

### Point

If operation is not performed normally even after the actions described above are taken, the possible cause is a module failure. Please consult your local Mitsubishi representative.

# When a load momentarily turns on before establishment of the safety connection

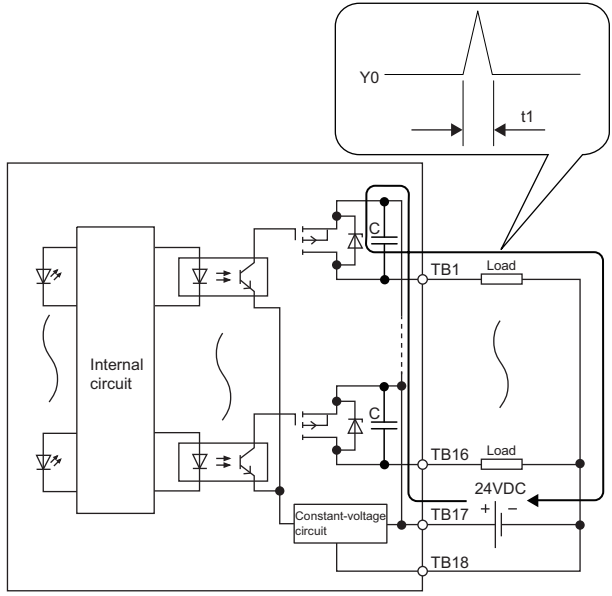
Check item	Action
<p>Check whether a load momentarily turns on in the following condition:            Depending on the capacity (C) between the drain and source of a MOSFET, the load current may flow as shown in the figure below, and thus the load may momentarily turn on before establishment of the safety connection of the output module with diagnostic functions (before the S MODE LED of the output module with diagnostic functions turns on).</p>  <p>t1: Output turns on for approx. 200μs.</p>	<p>Use a load or device with the response speed of 1ms or longer.</p>

# 13.4 Troubleshooting While Proceeding Procedures Before Operation

## When the module parameter write to the remote head module fails

Refer to the following.

 MELSEC iQ-R CC-Link IE Field Network Remote Head Module User's Manual (Application)

## Troubleshooting on the "Safety Communication Setting" window

### When [Import Setting] cannot be performed to the project of the remote head module

Check item	Action
Check whether the module configuration of the remote head module project targeted for [Import Setting] operation is correct.	Review the module configuration of the remote head module project targeted for [Import Setting] operation.



## Troubleshooting on the "Safety Module Operation" window

### When the "Safety Module Operation" window cannot be opened

Check item	Action
Check whether "To Use or Not to Use the Safety Communication Setting" is set to "Use" in the project of the SIL2 Process CPU.	Check "To Use or Not to Use the Safety Communication Setting" in the project of the SIL2 Process CPU and if "Not Use" is set, change it to "Use". In addition, follow the steps below again starting from "Safety communication setting".  Page 131 Procedure on the remote head module side

### When "Verification Failed" is displayed for "Module Status"

Check the following items in order of No.

No.	Check item	Action
1	Check whether the project was written to the remote head module.	Follow the steps below again starting from "Write to the remote head module".  Page 131 Procedure on the remote head module side
2	Check whether the remote head module was reset after the write of the project to the remote head module.	The project is not valid unless the remote head module is reset after the write of the project to the remote head module. Follow the steps below again starting from "Resetting the remote head module".  Page 131 Procedure on the remote head module side
3	Check whether [Import Setting] was performed to the project written to the remote head module, by using "Safety Communication Setting" of the SIL2 Process CPU project.	Save the project that was written to the remote head module. In addition, follow the steps below again starting from "Safety communication setting".  Page 132 Procedure on the SIL2 Process CPU side
4	Check whether the module to be enabled is correct.	Press the [S MODE LED Start Flashing] button while selecting the module to be enabled on the "Safety Module Operation" window. Check that the S MODE LED for the module to be enabled is flashing (400ms cycle).

#### Point



When changing a module parameter of the I/O module with diagnostic functions, perform the necessary operation again starting from the write of project to the remote head module.

The setting of module parameter of the I/O module with diagnostic functions that was written to the project of the remote head module is not reflected unless the [Import Setting] operation targeted for the remote head module project is completed by using "Safety Communication Setting" of the SIL2 Process CPU project. Thus, if the safety module operation is performed after a module parameter of the I/O module with diagnostic functions is changed in the project of the remote head module without subsequent operation of [Import Setting] to the remote head module project, "Verification Failed" is displayed for "Module Status".



## When "Timeout" is displayed for "Module Status"

Check the following items in order of No.

No.	Check item	Action
1	Check whether LEDs of the I/O module with diagnostic functions are in the following states. <ul style="list-style-type: none"> <li>The ERR LED is flashing.</li> <li>The S MODE LED is flashing (1s cycle).</li> </ul>	A moderate error occurred in the I/O module with diagnostic functions. The safety module operation cannot be performed for the I/O module with diagnostic functions with a moderate error. Check the error code in the "Module Diagnostics" window and take the action described in the list of error codes.  Page 200 List of Error Codes
2	Check whether the safety module operation was performed with the personal computer connected to the SIL2 Process CPU in the standby system.	If the CPU redundant system with remote I/O modules is configured based on a redundant line, the safety module operation cannot be performed from the SIL2 Process CPU in the standby system. Perform the safety module operation again from the personal computer on which GX Works3 is open and to which the SIL2 Process CPU in the control system is connected.
3	Check whether the S MODE LED of the I/O module with diagnostic functions is off.	<ul style="list-style-type: none"> <li>Check that the firmware version of the I/O module with diagnostic functions is 02 or later.</li> <li>The I/O module with diagnostic functions is set to normal mode. Set the parameters for SIL2 mode by following the steps below again starting from "Setting parameters on the remote head module side".</li> </ul>  Page 131 Procedure on the remote head module side

### Point

If the safety module operation is performed while communications with the I/O module with diagnostic functions are disabled, the time taken until "Timeout" is displayed for "Module Status" is set time in "Check at Communication Time" (second) × 3. (The default value for "Check at Communication Time" is 30 seconds.) For details on "Check at Communication Time", refer to the GX Works3 Operating Manual.

## When "Enabling Failed (Module Error)" is displayed for "Module Status"

Check item	Action
Check whether "Enabling Failed (Module Error)" is displayed for "Module Status".	If this symptom persists even after the module is attempted to be enabled again, please consult your local Mitsubishi representative.

## When "Enabling Failed (Data Error)" is displayed for "Module Status"

Check item	Action
Check whether measures have been properly taken against noise.	If measures to reduce noise do not eliminate this symptom, the possible cause is a module failure. Please consult your local Mitsubishi representative.

## When "—" is displayed for "Module Status"

Check the following items in order of No.

No.	Check item	Action
1	Check whether the I/O module with diagnostic functions is mounted properly.	Check that the I/O module with diagnostic functions is mounted properly.
2	Check whether there are no problems on connections from the personal computer where GX Works3 is installed to the remote head module.	Review "Specify Connection Destination".
3	Check whether there are no problems on the power supply of the remote head module.	Check the power supply module.

# 13.5 List of Error Codes

When an error occurs while the I/O module with diagnostic functions is running, its error code can be checked in the module diagnostics window of GX Works3. Additionally, Error flag (X10) turns on when an error occurs.

Error codes of the I/O module with diagnostic functions are classified into minor errors and moderate errors.

- Minor error: Error that occurs due to an incorrect setting in programs or parameters (Number in the 1000s + H). Depending on the error type, a portion that stops operation differs.
- Moderate error: Hardware failure, self-diagnostics error, or error detected by safety output diagnostics (Number in the 2000s or in the 3000s + H). The entire module stops operation.

A minor error can be cleared by turning on and off Error clear request (Y10) after removing the error cause.

A moderate error can be cleared by resetting the remote head module or turning off and on the power after removing the error cause. If a moderate error occurs, the module remains in safety stop state until the remote head module is reset or the power is turned off and on.

The following table lists error codes to be stored.

□ in an error code: Indicates the number of an I/O terminal in which the error has occurred. In accordance with X0 to XF (input module) or Y0 to YF (output module), a numerical value of 0 to F is assigned.

Error code	Error name	Error description and cause	Action
1100H	Transmission interval monitoring time range error	A value other than 6 to 3000 is set in "Transmission interval monitoring time".	Set "Transmission interval monitoring time" within the range from 6 to 3000.
1110H	LED indication setting on error condition range error	A value other than 0 to 2 is set in "LED indication setting on error condition".	Set "LED indication setting on error condition" within the range from 0 to 2.
112□H	Wiring selection of input range error	A value other than 0 to 1 is set in "Wiring selection of input X□".	Set "Wiring selection of input X□" within the range from 0 to 1.
113□H	Input response time range error	A value other than 0 to 4 is set in "Input response time X□".	<ul style="list-style-type: none"> <li>• Set "Input response time X□" within the range from 0 to 4.</li> <li>• Set "Input response time X□" to a longer time than the input dark test pulse output time.</li> </ul> Input dark test pulse output time = Input dark test pulse OFF time × ((Number of pulse output for input dark test × 2) - 1)
1140H	Double input discrepancy auto recovery setting range error	A value other than 0 to 1 is set in "Double input discrepancy auto recovery setting".	Set "Double input discrepancy auto recovery setting" within the range from 0 to 1.
115□H	Double input discrepancy detection time range error	A value other than 1 to 6000 is set in "Double input discrepancy detection time X□".	Set "Double input discrepancy detection time X□" within the range from 1 to 6000.
1160H	Input dark test pulse OFF time range error	A value other than 0 to 2 is set in "Input dark test pulse OFF time".	Set "Input dark test pulse OFF time" within the range from 0 to 2.
1170H	Number of pulse output for input dark test range error	A value other than 0 to 2 is set in "Number of pulse output for input dark test".	Set "Number of pulse output for input dark test" within the range from 0 to 2.
118□H	Wiring selection of output range error	A value other than 0 to 1 is set in "Wiring selection of output Y□".	Set "Wiring selection of output Y□" within the range from 0 to 1.
119□H	Output dark test pulse OFF time range error	A value other than 0 to 2 is set in "Output dark test pulse OFF time Y□".	Set "Output dark test pulse OFF time Y□" within the range from 0 to 2.
11A0H	Number of pulse output for output dark test range error	A value other than 0 to 2 is set in "Number of pulse output for output dark test".	Set "Number of pulse output for output dark test" within the range from 0 to 2.
1400H	Double input discrepancy detection error	The discrepancy of double input was detected.	<ul style="list-style-type: none"> <li>• Set "Not used" for "Wiring input selection" of an unused input terminal.</li> <li>• Check for a terminal with the error using Double input discrepancy detection state (Un\G1036), and review and adjust connected devices and wiring. (☞ Page 214 Double input discrepancy detection state)</li> </ul>
1401H	Input dark test error	During an input dark test, test pulses were not detected.	<ul style="list-style-type: none"> <li>• Set "Not used" for "Wiring input selection" of an unused input terminal.</li> <li>• Check for a terminal with the error using Input dark test error detection state (Un\G1040), and review and adjust connected devices and wiring. (☞ Page 215 Input dark test error detection state)</li> </ul>

Error code	Error name	Error description and cause	Action
1500H	Safety I/O HOLD time exceeded error	Duration of I/O HOLD state exceeded the set time.	<ul style="list-style-type: none"> <li>• Check that no error occurred on the switching of systems incorporating SIL2 Process CPUs.</li> <li>• Check whether an error occurred in communications with a SIL2 Process CPU.</li> </ul>
2002H	Output read-back error	The discrepancy between an output read-back value and an output value was detected.	<ul style="list-style-type: none"> <li>• Set "Not used" for "Wiring output selection" of an unused output terminal.</li> <li>• Check for a terminal with the error using Output read-back error detection state (Un\G1536), and review and adjust connected devices and wiring. (☞ Page 215 Output read-back error detection state)</li> <li>• If the same error occurs again, there may be an influence from noise or a hardware error. Please consult your local Mitsubishi representative.</li> </ul>
2003H	Output dark test error	During an output dark test, test pulses were not detected.	<ul style="list-style-type: none"> <li>• Set "Not used" for "Wiring output selection" of an unused output terminal.</li> <li>• Check for a terminal with the error using Output dark test error detection state (Un\G1540), and review and adjust connected devices and wiring. (☞ Page 215 Output dark test error detection state)</li> <li>• If the same error occurs again, there may be an influence from noise or a hardware error. Please consult your local Mitsubishi representative.</li> </ul>
3001H	Hardware error	A hardware error was detected.	There may be an influence from noise or a hardware error. If the same error occurs again even after measures have been taken against noise, the module may be in failure. Please consult your local Mitsubishi representative.
3010H	External power supply error	An error was detected on the external power supply.	<ul style="list-style-type: none"> <li>• Review and adjust connected devices, wiring, and voltage.</li> <li>• Power on the external power supply at the same timing of power-on of the module power supply.</li> <li>• If the same error occurs again, the possible cause is a module failure. Please consult your local Mitsubishi representative.</li> </ul>
3020H	Safety mutual monitoring error	An error was detected in the counterpart device of mutual monitoring.	A moderate error was detected in the counterpart device of mutual monitoring. Check the error code on the counterpart device side, and take an action according to the error code.
3050H	Safety parameter error	An error of safety parameter was detected at the startup of the system.	The possible cause is a failure of safety parameter write. Write the safety parameter to the module again with GX Works3. If the same error occurs again, the possible cause is a module failure. Please consult your local Mitsubishi representative.
3060H	Module configuration error	An error was detected in the module configuration.	<ul style="list-style-type: none"> <li>• Check that the mounting position of each module is correct.</li> <li>• The I/O module with diagnostic functions not supporting SIL2 mode may be mounted as a pair. Mount the I/O module that supports SIL2 mode.</li> <li>• If the same error occurs again, the possible cause is a module failure. Please consult your local Mitsubishi representative.</li> </ul>

# APPENDICES (SIL2 MODE)

## Appendix 8 Safety I/O Signals

### List of safety I/O signals

This section shows a list of safety I/O signals for the I/O module with diagnostic functions in SIL2 mode.

For details on the safety I/O signals, refer to the following.

☞ Page 204 Safety input signal details

☞ Page 204 Safety output signal details

#### Point

- The safety I/O numbers (SA\X/SA\Y) listed in the following tables are the safety I/O numbers when 0 is set as the start number with the safety data transfer device setting in the safety communication setting window.
- Do not use the "use prohibited" signals in the following tables since they are used by the system. If users use (turn on) the signals, the functions of the I/O module with diagnostic functions cannot be guaranteed.

### Input module with diagnostic functions

#### ■ Safety input signal

Device number	Signal name
SA\X0	Safety input signal X0
SA\X1	Safety input signal X1
SA\X2	Safety input signal X2
SA\X3	Safety input signal X3
SA\X4	Safety input signal X4
SA\X5	Safety input signal X5
SA\X6	Safety input signal X6
SA\X7	Safety input signal X7
SA\X8	Safety input signal X8
SA\X9	Safety input signal X9
SA\XA	Safety input signal XA
SA\XB	Safety input signal XB
SA\XC	Safety input signal XC
SA\XD	Safety input signal XD
SA\XE	Safety input signal XE
SA\XF	Safety input signal XF

#### ■ Safety output signal

Device number	Signal name
SA\Y0 to SA\YF	Use prohibited

## Output module with diagnostic functions

### ■ Safety input signal

Device number	Signal name
SAIX0 to SAIXF	Use prohibited

### ■ Safety output signal

Device number	Signal name
SAIY0	Safety output signal Y0
SAIY1	Safety output signal Y1
SAIY2	Safety output signal Y2
SAIY3	Safety output signal Y3
SAIY4	Safety output signal Y4
SAIY5	Safety output signal Y5
SAIY6	Safety output signal Y6
SAIY7	Safety output signal Y7
SAIY8	Safety output signal Y8
SAIY9	Safety output signal Y9
SAIYA	Safety output signal YA
SAIYB	Safety output signal YB
SAIYC	Safety output signal YC
SAIYD	Safety output signal YD
SAIYE	Safety output signal YE
SAIYF	Safety output signal YF

## Safety input signal details

This section describes the details on the safety input signals for the I/O module with diagnostic functions in SIL2 mode that are assigned to the CPU module.

The safety I/O numbers (SA\X/SA\Y) described in this section are the safety I/O numbers when 0 is set as the start number with the safety data transfer device setting in the safety communication setting window.

### Safety input signal

This input signal is used for safety control. The signal shows the ON/OFF state of an external input (X00 to X0F) of the input module with diagnostic functions.

However, when the double wiring function or input response time setting function is enabled, the ON/OFF state of the safety input signal (SA\X0) and the ON/OFF state of the actual external input (X00) may not match.

#### ■Device number

This number shows the device number of the safety input signal.

Signal name	External input															
	X00	X01	X02	X03	X04	X05	X06	X07	X08	X09	X0A	X0B	X0C	X0D	X0E	X0F
Safety input signal	SA\X 0	SA\X 1	SA\X 2	SA\X 3	SA\X 4	SA\X 5	SA\X 6	SA\X 0	SA\X 8	SA\X 9	SA\X A	SA\X B	SA\X C	SA\X D	SA\X E	SA\X F

## Safety output signal details

This section describes the details on the safety output signals for the I/O module with diagnostic functions in SIL2 mode that are assigned to the CPU module.

The safety I/O numbers (SA\X/SA\Y) described in this section are the safety I/O numbers when 0 is set as the start number with the safety data transfer device setting in the safety communication setting window.

### Safety output signal

This output signal is used for safety control. The signal shows the ON/OFF state of an output to an external terminal (Y00 to Y0F) of the output module with diagnostic functions.

However, when the double wiring function is enabled, the ON/OFF state of the safety output signal (SA\Y0) and the ON/OFF state of the external output (Y00) may not match.

#### ■Device number

This number shows the device number of the safety output signal.

Signal name	External output															
	Y00	Y01	Y02	Y03	Y04	Y05	Y06	Y07	Y08	Y09	Y0A	Y0B	Y0C	Y0D	Y0E	Y0F
Safety output signal	SA\Y 0	SA\Y 1	SA\Y 2	SA\Y 3	SA\Y 4	SA\Y 5	SA\Y 6	SA\Y 0	SA\Y 8	SA\Y 9	SA\Y A	SA\Y B	SA\Y C	SA\Y D	SA\Y E	SA\Y F

# Appendix 9 I/O Signals

## List of I/O signals

This section describes a list of I/O signals for the I/O module with diagnostic functions in SIL2 mode.

For details on the I/O signals, refer to the following.

☞ Page 206 Details on input signals

☞ Page 208 Details on output signals

### Point

- The following tables show the I/O signals (X/Y) when 0 is set as the start I/O number of the I/O module with diagnostic functions.
- Do not use the "use prohibited" signals in the following tables since they are used by the system. If users use (turn on) the signals, the functions of the I/O module with diagnostic functions cannot be guaranteed.

### Input signal

Device number	Signal name
X0 to XF	Use prohibited
X10	Error flag
X11 to X1E	Use prohibited
X1F	Module READY

### Output signal

Device number	Signal name
Y0 to YF	Use prohibited
Y10	Error clear request
Y11 to Y1F	Use prohibited

A

# Details on input signals

This section describes the details on the input signals for the I/O module with diagnostic functions that are assigned to the CPU module.

This section describes the I/O numbers (X/Y) when 0 is set as the start I/O number of the I/O module with diagnostic functions.

## Error flag

Error flag (X10) turns on when an error occurs.

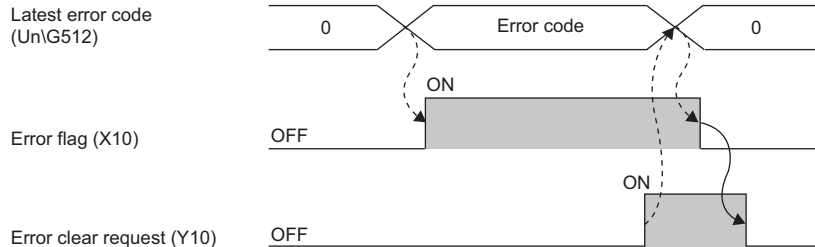

-----> : Performed by the I/O module with diagnostic functions.  
 —————> : Performed by a program.

### Device number

This number shows the device number of the input signal.

Signal name	External input/output
	X/Y00 to X/Y0F
Error flag	X10



## Module READY

This signal is used as an interlock condition to read/write data from/to the CPU module.

When the initial processing of the I/O module with diagnostic functions is completed after the CPU module is powered on or is reset, Module READY (X1F) turns off.

When a watchdog timer error occurs, Module READY (X1F) turns on.

### ■Device number

This number shows the device number of the input signal.

Signal name	External input/output
	X/Y00 to X/Y0F
Module READY	X1F

## Details on output signals

---

This section describes the details on the output signals for the I/O module with diagnostic functions that are assigned to the CPU module.

This section describes the I/O numbers (X/Y) when 0 is set as the start I/O number of the I/O module with diagnostic functions.

### Error clear request

---

Turn on and off this signal to clear Error flag (X10). For the timing to turn on and off this signal, refer to the following.

 Page 206 Error flag

#### ■ Device number

This number shows the device number of the output signal.

Signal name	External input/output
	X/Y00 to X/Y0F
Error clear request	Y10

#### Point

To control Error clear request (Y10) from the safety program, control it by operating a standard program using standard/safety common labels.

---

# Appendix 10 Buffer Memory

---

## List of buffer memory areas

---

The following tables list the buffer memory areas of the I/O module with diagnostic functions. For details on the buffer memory areas, refer to the following.

 Page 212 Details of buffer memory areas

The buffer memory areas of the I/O module with diagnostic functions are intended only for monitor data (data used for referring to the status of the I/O module with diagnostic functions). Reading data is only allowed. Writing data is not allowed.

---

### **Point**

Do not write data into buffer memory areas. Writing data into these areas can cause a module malfunction.

---

## Error history areas (Un\G0 to Un\G255)

Address (decimal)	Address (hexadecimal)	Name	Default value			
0	0H	Latest address of error history	0			
1 to 15	1H to FH	System area	—			
16	10H	Error history No.1	0			
17	11H			Error time	Error code	
18	12H					First two digits of the year
19	13H				Month	Day
20	14H				Hour	Minute
21	15H				Second	Day of the week
					Millisecond	
22, 23	16H, 17H	System area	—			
24 to 29	18H to 1DH	Error history No.2	Same as Error history No.1			
30, 31	1EH, 1FH	System area	—			
32 to 37	20H to 25H	Error history No.3	Same as Error history No.1			
38, 39	26H, 27H	System area	—			
40 to 45	28H to 2DH	Error history No.4	Same as Error history No.1			
46, 47	2EH, 2FH	System area	—			
48 to 53	30H to 35H	Error history No.5	Same as Error history No.1			
54, 55	36H, 37H	System area	—			
56 to 61	38H to 3DH	Error history No.6	Same as Error history No.1			
62, 63	3EH, 3FH	System area	—			
64 to 69	40H to 45H	Error history No.7	Same as Error history No.1			
70, 71	46H, 47H	System area	—			
72 to 77	48H to 4DH	Error history No.8	Same as Error history No.1			
78, 79	4EH, 4FH	System area	—			
80 to 85	50H to 55H	Error history No.9	Same as Error history No.1			
86, 87	56H, 57H	System area	—			
88 to 93	58H to 5DH	Error history No.10	Same as Error history No.1			
94, 95	5EH, 5FH	System area	—			
96 to 101	60H to 65H	Error history No.11	Same as Error history No.1			
102, 103	66H, 67H	System area	—			
104 to 109	68H to 6DH	Error history No.12	Same as Error history No.1			
110, 111	6EH, 6FH	System area	—			
112 to 117	70H to 75H	Error history No.13	Same as Error history No.1			
118, 119	76H, 77H	System area	—			
120 to 125	78H to 7DH	Error history No.14	Same as Error history No.1			
126, 127	7EH, 7FH	System area	—			
128 to 133	80H to 85H	Error history No.15	Same as Error history No.1			
134, 135	86H, 87H	System area	—			
136 to 141	88H to 8DH	Error history No.16	Same as Error history No.1			
142 to 255	8EH to FFH	System area	—			

## System areas (Un\G256 to Un\G511)

Address (decimal)	Address (hexadecimal)	Name	Default value
256 to 511	100H to 1FFH	System area	—

## Monitor areas (Un\G512 to Un\G2047)

### ■ Input module with diagnostic functions

Address (decimal)	Address (hexadecimal)	Name	Default value
512	200H	Latest error code	0
513 to 523	201H to 20BH	System area	—
524	20CH	Safety module validation status	0001H
525 to 1023	20DH to 3FFH	System area	—
1024	400H	External input monitor signal X00 to X0F (SIL2 mode Main)	0000H
1025 to 1027	401H to 403H	System area	—
1028	404H	External input monitor signal X00 to X0F (SIL2 mode Sub)	0000H
1029 to 1031	405H to 407H	System area	—
1032	408H	Double input discrepancy auto recovery enabled signal	0000H
1033 to 1035	409H to 40BH	System area	—
1036	40CH	Double input discrepancy detection state	0000H
1037 to 1039	40DH to 40FH	System area	—
1040	410H	Input dark test error detection state	0000H
1041 to 2047	411H to 7FFH	System area	—

### ■ Output module with diagnostic functions

Address (decimal)	Address (hexadecimal)	Name	Default value
512	200H	Latest error code	0
513 to 523	201H to 20BH	System area	—
524	20CH	Safety module validation status	0001H
525 to 1535	20DH to 5FFH	System area	—
1536	600H	Output read-back error detection state	0000H
1537 to 1539	601H to 603H	System area	—
1540	604H	Output dark test error detection state	0000H
1541 to 2047	605H to 7FFH	System area	—

## System areas (Un\G2048 to Un\G65535)

Address (decimal)	Address (hexadecimal)	Name	Default value
2048 to 65535	800H to FFFFH	System area	—

## Details of buffer memory areas

This section describes the details of buffer memory areas of the I/O module with diagnostic functions.

### Latest address of error history

This area shows the buffer memory address where the latest error history is stored.

#### ■Buffer memory address

The following table shows the buffer memory address of this area.

Buffer memory name	X/Y00 to X/Y0F
Latest address of error history	0

### Error history No.

Up to 16 errors that have occurred in the module are registered.

**Ex.**

For Error history No.1

	b15	to	b8 b7	to	b0
Un\G16	Error code				
Un\G17	First two digits of the year		Last two digits of the year		
Un\G18	Month		Day		
Un\G19	Hour		Minute		
Un\G20	Second		Day of the week		
Un\G21	Millisecond (higher-order digits)		Millisecond (lower-order digits)		
Un\G22	System area				
⋮					
Un\G23					

Item	Description	Example <sup>*1</sup>
Error code	The error code is stored.	1900H
First/Last two digits of the year	Stored in the BCD code.	2016H
Month/Day		527H
Hour/Minute		1234H
Second		56H
Day of the week		The following values are stored in the BCD code for each day of the week. Sunday: 0, Monday: 1, Tuesday: 2, Wednesday: 3 Thursday: 4, Friday: 5, Saturday: 6
Millisecond (upper)	Stored in the BCD code.	7H
Millisecond (lower)		89H
System area	—	—

\*1 The value stored when the input response time setting error (error code: 1900H) occurs at 12:34:56.789 on Friday, May 27, 2016

#### ■Buffer memory address

The following table shows the buffer memory address of this area.

Buffer memory name	Error history No.1 to Error history No.16
Error history No.	16 to 143

## Latest error code

The latest error code detected in the I/O module with diagnostic functions is stored. For details, refer to the following.

☞ Page 200 List of Error Codes

### ■Buffer memory address

The following table shows the buffer memory address of this area.

Buffer memory name	X/Y00 to X/Y0F
Latest error code	512

### ■How to clear an error

Turn on and off Error clear request (Y10).

## Safety module validation status

Whether the safety module function is enabled in SIL2 mode is stored.

Stored value	Description
0001H	Disabled state
0002H	Disabled state (reset waiting)
0003H	Enabled state
0004H	Enabled state (reset waiting)

For how to enable the safety module function, refer to the following.

☞ Page 155 Safety module operation

### ■Buffer memory address

The following table shows the buffer memory address of this area.

Buffer memory name	X/Y00 to X/Y0F
Safety module validation status	524

## External input monitor signal

The ON/OFF state of an external input terminal can be checked on a per-point basis. By monitoring this area when a double input discrepancy occurs, troubleshooting becomes easy.

Also, the reference area varies depending on which status of the external input terminal of the RX40NC6B (Main) or the RX40NC6B (Sub) needs to be monitored.

**Ex.**

In this example, 0 is set as the start I/O number of the RX40NC6B (Main) and 2 is set as the start I/O number of the RX40NC6B (Sub).

Buffer memory address	RX40NC6B (Main)	RX40NC6B (Sub)
Un\G1024	The ON/OFF status of the RX40NC6B (Main) can be checked with External input monitor signal X00 to X0F (SIL2 mode Main) (U0\G1024).	External input monitor signal X00 to X0F (SIL2 mode Main) (U2\G1024) are fixed to 0.
Un\G1028	External input monitor signal X00 to X0F (SIL2 mode Sub) (U0\G1028) are fixed to 0.	The ON/OFF status of the RX40NC6B (Sub) can be checked with External input monitor signal X00 to X0F (SIL2 mode Sub) (U2\G1028).

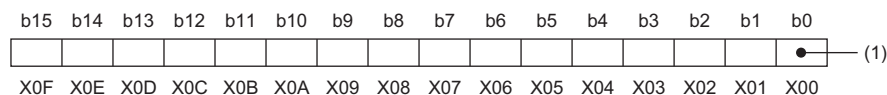

(1) 0: OFF, 1: ON

Bits of external input terminals for which "Wiring input selection" is set to "Not used" are fixed to 0.

A

### ■Buffer memory address

The following table shows the buffer memory addresses of these areas.

Buffer memory name	X00 to X0F
External input monitor signal X00 to X0F (SIL2 mode Main)	1024
External input monitor signal X00 to X0F (SIL2 mode Sub)	1028

### Double input discrepancy auto recovery enabled signal

The setting status of "Auto recovery settings after discrepancy error" can be checked in this area. When "Auto recovery settings after discrepancy error" is set to "Enable", 1 is stored.

"Auto recovery settings after discrepancy error"	Stored value
"Disable"	0
"Enable"	1

### ■Buffer memory address

The following table shows the buffer memory address of this area.

Buffer memory name	X00 to X0F
Double input discrepancy auto recovery enabled signal	1032

### Double input discrepancy detection state

The double input discrepancy detection state is stored regardless of the setting of "Auto recovery settings after discrepancy error". This signal turns on when a double input discrepancy occurs in the relevant input signal pair.

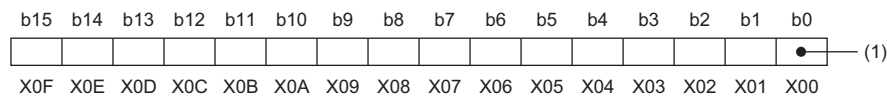

### ■Buffer memory address

The following table shows the buffer memory address of this area.

Buffer memory name	X00 to X0F
Double input discrepancy detection state	1036

### ■Clearing Double input discrepancy detection state

This area will not be cleared even if the double input discrepancy detection state is eliminated. Turn on and off Error clear request (Y10) to clear this area.





# Appendix 11 Calculation Method of Safety Response Time (Maximum Value)

The safety response time is the maximum time taken from when the safety input of the RX40NC6B (intelligent device station (safety station)) turns off until the safety output of the RY40PT5B (intelligent device station (safety station)) turns off (the time including an error detection).

This maximum time is calculated by the following formula.

Intelligent device station (safety station) on the input side → Master station (safety station) → Intelligent device station (safety station) on the output side

$$(SCmst \times 3) + (S2cycin \times 2 + S2cycout \times 2.5) + (RMin + RMout) + SRin + SRout + (nin \times 2) + (nout \times 2)$$

Symbol	Description
SCmst	Safety cycle time of the master station (safety station) <sup>*1</sup>
S2cycin	Control cycle time of the input side (RX40NC6B (Main)) <sup>*2</sup>
S2cycout	Control cycle time of the output side (RY40PT5B (Main)) <sup>*2</sup>
RMin	Safety refresh monitoring time of the input side connection of the master station (safety station) <sup>*3</sup> + Safety I/O HOLD time <sup>*5</sup>
RMout	Safety refresh monitoring time of the output side connection of the master station (safety station) + Safety I/O HOLD time <sup>*5</sup>
SRin	Safety input response time for SIL2 mode <sup>*2</sup>
SRout	Safety output response time for SIL2 mode <sup>*2</sup>
nin	$RMin - (TMmstin \div 2) - TMrmtin + c$
nout	$RMout - TMmstout - (TMrmtout \div 2) + a$
a	$TMmstout - b$ (This value is valid only when a station set to Active is the RJ71GF11-T2. Otherwise plug 0.)
b	A smallest multiple of Safety cycle time value which is greater than the calculation result of $TMmstout$ divided by 2.
c	$TMrmtin - d$ (This value is valid only when a station set to Passive is the RJ71GF11-T2, or when a station set to Passive is the RJ72GF15-T2 that is connected with the RX40NC6B and RY40PT5B. Otherwise plug 0.)
d	A smallest multiple of Safety cycle time value (Control cycle time of the RX40NC6B (Main)) which is greater than the calculation result of $TMrmtin$ divided by 2. <sup>*4</sup>
TMmstin	Transmission interval monitoring time of the input side connection of the master station (safety station)
TMmstout	Transmission interval monitoring time of the output side connection of the master station (safety station)
TMrmtin	Transmission interval monitoring time of the input side (RX40NC6B (Main))
TMrmtout	Transmission interval monitoring time of the output side (RY40PT5B (Main))

\*1 For Safety cycle time, refer to the following.

 MELSEC iQ-R CPU Module User's Manual (Application)

\*2 For details, refer to the following.

 Page 126 Performance Specifications

\*3 For details, refer to the following.

 MELSEC iQ-R CC-Link IE Field Network User's Manual (Application)

\*4 A sample calculation of b and d:

When Transmission interval monitoring time is 24ms and Safety cycle time is 10ms, the result is 20; the smallest multiple of 10 which is greater than the value of 12 (obtained from  $24 \div 2$ ).

\*5 For Safety I/O HOLD time, refer to the following.

 MELSEC iQ-R CPU Module User's Manual (Application)

# Appendix 12 External Dimensions

The following figures show the external dimensions of the I/O module with diagnostic functions.

## Input module with diagnostic functions

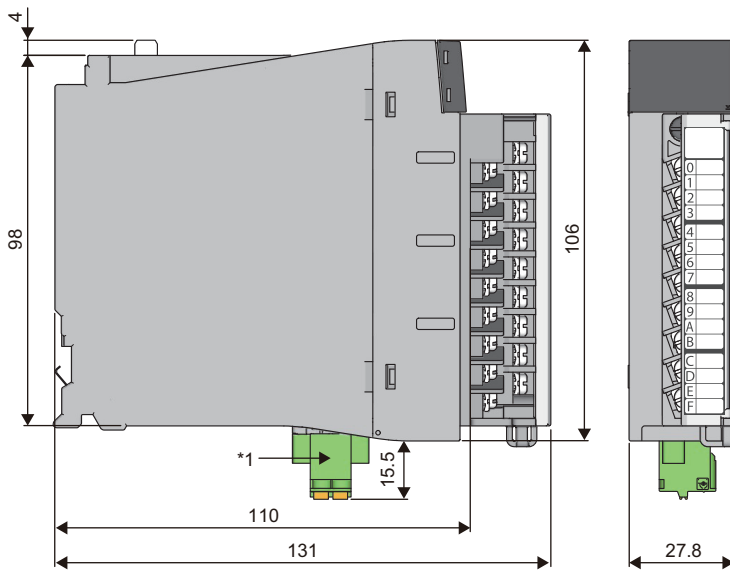

(Unit: mm)

\*1 The terminal block for test pulse output is added to the module with production information (first four digits) of "0202" or later.

## Output module with diagnostic functions

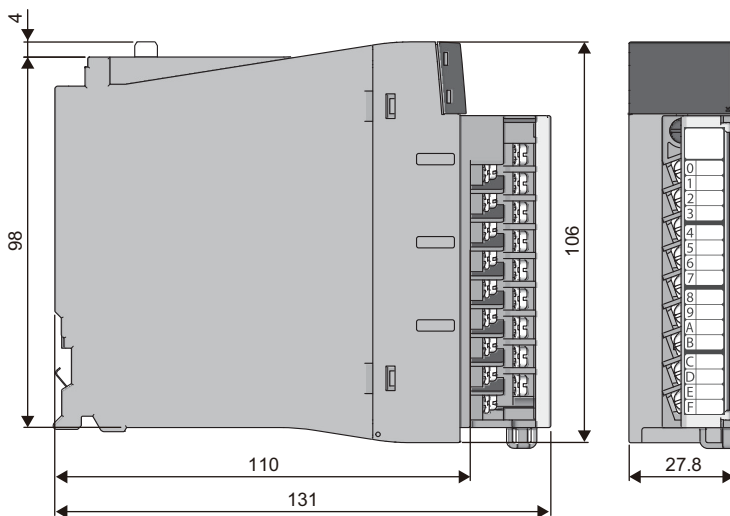

(Unit: mm)

A

# INDEX

---

## A

---

Alarm clear request . . . . .	77
Alarm flag . . . . .	76
Alarm history No. . . . .	91
ALM LED . . . . .	124

## C

---

Clearing the number of input ON times . . . . .	29
Clearing the number of output ON times . . . . .	38

## D

---

Disabling the safety module . . . . .	118
Display of the event history . . . . .	54
Double input discrepancy auto recovery function . . . . .	173

## E

---

ERR LED . . . . .	124
Error clear request . . . . .	77,208
Error flag . . . . .	75,206
Error history No. . . . .	90,212
Error information . . . . .	61
Event time stamp condition setting . . . . .	100
Event time stamp data . . . . .	31,115
Event time stamp data for refresh . . . . .	115
Event time stamp function enable/disable . . . . .	99
Event time stamp number for CPU read . . . . .	114
Event time stamp number for next storage . . . . .	114
Event time stamp number of read completion . . . . .	115
Event time stamp storage status . . . . .	114

## I

---

I/O status indicator LED . . . . .	124
Input dark test error detection state . . . . .	215
Input dark test function . . . . .	175
Input delay function enable/disable . . . . .	96
Input delay time setting . . . . .	97
Input delay type setting . . . . .	97
Input disconnection detection automatic clear enable/disable . . . . .	101
Input disconnection detection setting . . . . .	101
Input disconnection detection status . . . . .	108
Input HOLD/CLEAR function enable/disable . . . . .	95
Input response time and pulse width of noise that can be removed . . . . .	162
Input response time and pulse width to be ignored as noise . . . . .	21
Input response time setting . . . . .	95
Input response time setting function . . . . .	162
Input signal . . . . .	75
Interrupt condition target I/O terminal setting . . . . .	94
Interrupt condition target setting . . . . .	93
Interrupt factor detection flag . . . . .	108
Interrupt factor mask . . . . .	112
Interrupt factor reset request . . . . .	112

## L

---

Latest address of alarm history . . . . .	91
Latest address of error history . . . . .	90,212
Latest alarm code . . . . .	107
Latest error code . . . . .	107,213
LED indication on error condition . . . . .	42,181
LED indication setting on error condition . . . . .	92
List of detectable conditions . . . . .	45,48,50

## M

---

Module information list . . . . .	63
Module power supply overcurrent protection . . . . .	180
Module power supply overvoltage protection . . . . .	180
Module READY . . . . .	76,207

## N

---

Number of input ON times . . . . .	109
Number of input ON times alarm detection count setting . . . . .	99
Number of input ON times alarm detection notification . . . . .	28
Number of input ON times alarm detection setting . . . . .	98
Number of input ON times alarm detection status . . . . .	108
Number of input ON times integration . . . . .	27
Number of input ON times integration function enable/disable . . . . .	98
Number of input ON times value clear completed . . . . .	109
Number of input ON times value clear request . . . . .	113
Number of output ON times . . . . .	111
Number of output ON times alarm detection count setting . . . . .	104
Number of output ON times alarm detection notification . . . . .	37
Number of output ON times alarm detection setting . . . . .	104
Number of output ON times alarm detection status . . . . .	111
Number of output ON times integration . . . . .	36
Number of output ON times integration function enable/disable . . . . .	103
Number of output ON times value clear completed . . . . .	111
Number of output ON times value clear request . . . . .	113

## O

---

OFF delay . . . . .	24,34
ON delay . . . . .	25,35
Operating condition setting completed flag . . . . .	76
Operating condition setting request . . . . .	78
Operation of when a connection is recovered from a disconnection . . . . .	44,47
Operation of when the connection is recovered from a short circuit . . . . .	49
Output dark test error detection state . . . . .	215
Output dark test function . . . . .	177

Output delay function enable/disable . . . . .	102
Output delay time setting . . . . .	103
Output delay type setting . . . . .	102
Output disconnection detection automatic clear enable/disable . . . . .	105
Output disconnection detection disable time setting . . . . .	107
Output disconnection detection setting . . . . .	105
Output disconnection detection status . . . . .	110
Output read-back error detection state . . . . .	215
Output read-back function . . . . .	179
Output short-circuit detection automatic clear enable/disable . . . . .	106
Output short-circuit detection setting . . . . .	106
Output short-circuit detection status . . . . .	110
Output signal . . . . .	77
Overload protection . . . . .	180

## P

---

Protection function . . . . .	180
Pulse stretch . . . . .	26

## R

---

Reading and saving event time stamp data . . . . .	31
Refresh processing time . . . . .	59
RUN LED . . . . .	124

## S

---

S MODE LED . . . . .	124
Safety input signal . . . . .	204
Safety output signal . . . . .	204
Setting for not-refreshed data . . . . .	32,100
Setting of output mode at error . . . . .	92
Starting collecting event time stamp data . . . . .	30



# REVISIONS

\*The manual number is given on the bottom left of the back cover.

Revision date	*Manual number	Description
May 2016	SH(NA)-081621ENG-A	First edition
December 2017	SH(NA)-081621ENG-B	■Added or modified parts SAFETY PRECAUTIONS, INTRODUCTION, RELEVANT MANUALS, TERMS, Section 1.1, 1.2, 1.3, 1.4, 3.1, Appendix 2, 3, PART2
October 2020	SH(NA)-081621ENG-C	■Added or modified parts SAFETY PRECAUTIONS, CONDITIONS OF USE FOR THE PRODUCT, RELEVANT MANUALS, TERMS, GENERIC TERMS AND ABBREVIATIONS, Section 1.1, 1.4, Appendix 6
November 2022	SH(NA)-081621ENG-D	■Added or modified parts CONDITIONS OF USE FOR THE PRODUCT, Chapter 4, WARRANTY

Japanese manual number: SH-081620-D

This manual confers no industrial property rights or any rights of any other kind, nor does it confer any patent licenses. Mitsubishi Electric Corporation cannot be held responsible for any problems involving industrial property rights which may occur as a result of using the contents noted in this manual.

© 2016 MITSUBISHI ELECTRIC CORPORATION

# WARRANTY

---

Please confirm the following product warranty details before using this product.

## **1. Gratis Warranty Term and Gratis Warranty Range**

If any faults or defects (hereinafter "Failure") found to be the responsibility of Mitsubishi occurs during use of the product within the gratis warranty term, the product shall be repaired at no cost via the sales representative or Mitsubishi Service Company.

However, if repairs are required onsite at domestic or overseas location, expenses to send an engineer will be solely at the customer's discretion. Mitsubishi shall not be held responsible for any re-commissioning, maintenance, or testing on-site that involves replacement of the failed module.

[Gratis Warranty Term]

The gratis warranty term of the product shall be for one year after the date of purchase or delivery to a designated place. Note that after manufacture and shipment from Mitsubishi, the maximum distribution period shall be six (6) months, and the longest gratis warranty term after manufacturing shall be eighteen (18) months. The gratis warranty term of repair parts shall not exceed the gratis warranty term before repairs.

[Gratis Warranty Range]

- (1) The range shall be limited to normal use within the usage state, usage methods and usage environment, etc., which follow the conditions and precautions, etc., given in the instruction manual, user's manual and caution labels on the product.
- (2) Even within the gratis warranty term, repairs shall be charged for in the following cases.
  1. Failure occurring from inappropriate storage or handling, carelessness or negligence by the user. Failure caused by the user's hardware or software design.
  2. Failure caused by unapproved modifications, etc., to the product by the user.
  3. When the Mitsubishi product is assembled into a user's device, Failure that could have been avoided if functions or structures, judged as necessary in the legal safety measures the user's device is subject to or as necessary by industry standards, had been provided.
  4. Failure that could have been avoided if consumable parts (battery, backlight, fuse, etc.) designated in the instruction manual had been correctly serviced or replaced.
  5. Failure caused by external irresistible forces such as fires or abnormal voltages, and Failure caused by force majeure such as earthquakes, lightning, wind and water damage.
  6. Failure caused by reasons unpredictable by scientific technology standards at time of shipment from Mitsubishi.
  7. Any other failure found not to be the responsibility of Mitsubishi or that admitted not to be so by the user.

## **2. Onerous repair term after discontinuation of production**

- (1) Mitsubishi shall accept onerous product repairs for seven (7) years after production of the product is discontinued. Discontinuation of production shall be notified with Mitsubishi Technical Bulletins, etc.
- (2) Product supply (including repair parts) is not available after production is discontinued.

## **3. Overseas service**

Overseas, repairs shall be accepted by Mitsubishi's local overseas FA Center. Note that the repair conditions at each FA Center may differ.

## **4. Exclusion of loss in opportunity and secondary loss from warranty liability**

Regardless of the gratis warranty term, Mitsubishi shall not be liable for compensation to:

- (1) Damages caused by any cause found not to be the responsibility of Mitsubishi.
- (2) Loss in opportunity, lost profits incurred to the user by Failures of Mitsubishi products.
- (3) Special damages and secondary damages whether foreseeable or not, compensation for accidents, and compensation for damages to products other than Mitsubishi products.
- (4) Replacement by the user, maintenance of on-site equipment, start-up test run and other tasks.

## **5. Changes in product specifications**

The specifications given in the catalogs, manuals or technical documents are subject to change without prior notice.

When SIL2 mode is set

Please confirm the following product warranty details before using this product.

### **1. Limited Warranty and Product Support.**

- a. Mitsubishi Electric Company ("MELCO") warrants that for a period of eighteen (18) months after date of delivery from the point of manufacture or one year from date of Customer's purchase, whichever is less, Mitsubishi programmable logic controllers (the "Products") will be free from defects in material and workmanship.
- b. At MELCO's option, for those Products MELCO determines are not as warranted, MELCO shall either repair or replace them or issue a credit or return the purchase price paid for them.
- c. For this warranty to apply:
  - (1) Customer shall give MELCO (i) notice of a warranty claim to MELCO and the authorized dealer or distributor from whom the Products were purchased, (ii) the notice shall describe in reasonable details the warranty problem, (iii) the notice shall be provided promptly and in no event later than thirty (30) days after the Customer knows or has reason to believe that Products are not as warranted, and (iv) in any event, the notice must be given within the warranty period;
  - (2) Customer shall cooperate with MELCO and MELCO's representatives in MELCO's investigation of the warranty claim, including preserving evidence of the claim and its causes, meaningfully responding to MELCO's questions and investigation of the problem, grant MELCO access to witnesses, personnel, documents, physical evidence and records concerning the warranty problem, and allow MELCO to examine and test the Products in question offsite or at the premises where they are installed or used; and
  - (3) If MELCO requests, Customer shall remove Products it claims are defective and ship them to MELCO or MELCO's authorized representative for examination and, if found defective, for repair or replacement. The costs of removal, shipment to and from MELCO's designated examination point, and reinstallation of repaired or replaced Products shall be at Customer's expense.
  - (4) If Customer requests and MELCO agrees to effect repairs onsite at any domestic or overseas location, the Customer will pay for the costs of sending repair personnel and shipping parts. MELCO is not responsible for any re-commissioning, maintenance, or testing on-site that involves repairs or replacing of the Products.
- d. Repairs of Products located outside of Japan are accepted by MELCO's local authorized service facility centers ("FA Centers"). Terms and conditions on which each FA Center offers repair services for Products that are out of warranty or not covered by MELCO's limited warranty may vary.
- e. Subject to availability of spare parts, MELCO will offer Product repair services for (7) years after each Product model or line is discontinued, at MELCO's or its FA Centers' rates and charges and standard terms in effect at the time of repair. MELCO usually produces and retains sufficient spare parts for repairs of its Products for a period of seven (7) years after production is discontinued.
- f. MELCO generally announces discontinuation of Products through MELCO's Technical Bulletins. Products discontinued and repair parts for them may not be available after their production is discontinued.

### **2. Limits of Warranties.**

- a. MELCO does not warrant or guarantee the design, specify, manufacture, construction or installation of the materials, construction criteria, functionality, use, properties or other characteristics of the equipment, systems, or production lines into which the Products may be incorporated, including any safety, fail-safe and shut down systems using the Products.
- b. MELCO is not responsible for determining the suitability of the Products for their intended purpose and use, including determining if the Products provide appropriate safety margins and redundancies for the applications, equipment or systems into which they are incorporated.
- c. Customer acknowledges that qualified and experienced personnel are required to determine the suitability, application, design, construction and proper installation and integration of the Products. MELCO does not supply such personnel.
- d. MELCO is not responsible for designing and conducting tests to determine that the Product functions appropriately and meets application standards and requirements as installed or incorporated into the end-user's equipment, production lines or systems.
- e. MELCO does not warrant any Product:
  - (1) repaired or altered by persons other than MELCO or its authorized engineers or FA Centers;
  - (2) subjected to negligence, carelessness, accident, misuse, or damage;
  - (3) improperly stored, handled, installed or maintained;
  - (4) integrated or used in connection with improperly designed, incompatible or defective hardware or software;
  - (5) that fails because consumable parts such as batteries, backlights, or fuses were not tested, serviced or replaced;
  - (6) operated or used with equipment, production lines or systems that do not meet applicable and commensurate legal, safety and industry-accepted standards;
  - (7) operated or used in abnormal applications;
  - (8) installed, operated or used in contravention of instructions, precautions or warnings contained in MELCO's user, instruction and/or safety manuals, technical bulletins and guidelines for the Products;
  - (9) used with obsolete technologies or technologies not fully tested and widely accepted and in use at the time of the Product's manufacture;
  - (10) subjected to excessive heat or moisture, abnormal voltages, shock, excessive vibration, physical damage or other improper environment; or
  - (11) damaged or malfunctioning due to Acts of God, fires, acts of vandals, criminals or terrorists, communication or power failures, or any other cause or failure that results from circumstances beyond MELCO's control.
- f. All Product information and specifications contained on MELCO's website and in catalogs, manuals, or technical information materials provided by MELCO are subject to change without prior notice.



- g. The Product information and statements contained on MELCO's website and in catalogs, manuals, technical bulletins or other materials provided by MELCO are provided as a guide for Customer's use. They do not constitute warranties and are not incorporated in the contract of sale for the Products.
- h. These terms and conditions constitute the entire agreement between Customer and MELCO with respect to warranties, remedies and damages and supersede any other understandings, whether written or oral, between the parties. Customer expressly acknowledges that any representations or statements made by MELCO or others concerning the Products outside these terms are not part of the basis of the bargain between the parties and are not factored into the pricing of the Products.
- i. THE WARRANTIES AND REMEDIES SET FORTH IN THESE TERMS ARE THE EXCLUSIVE AND ONLY WARRANTIES AND REMEDIES THAT APPLY TO THE PRODUCTS.
- j. MELCO DISCLAIMS THE IMPLIED WARRANTIES OF MERCHANTABILITY AND FITNESS FOR A PARTICULAR PURPOSE.

### **3. Limits on Damages.**

- a. MELCO'S MAXIMUM CUMULATIVE LIABILITY BASED ON ANY CLAIMS FOR BREACH OF WARRANTY OR CONTRACT, NEGLIGENCE, STRICT TORT LIABILITY OR OTHER THEORIES OF RECOVERY REGARDING THE SALE, REPAIR, REPLACEMENT, DELIVERY, PERFORMANCE, CONDITION, SUITABILITY, COMPLIANCE, OR OTHER ASPECTS OF THE PRODUCTS OR THEIR SALE, INSTALLATION OR USE SHALL BE LIMITED TO THE PRICE PAID FOR PRODUCTS NOT AS WARRANTED.
- b. Although MELCO has declared Product's compliance with the international safety standards IEC61508, IEC61511, this fact does not guarantee that Product will be free from any malfunction or failure. The user of this Product shall comply with any and all applicable safety standard, regulation or law and take appropriate safety measures for the system in which the Product is installed or used and shall take the second or third safety measures other than the Product. MELCO is not liable for damages that could have been prevented by compliance with any applicable safety standard, regulation or law.
- c. MELCO prohibits the use of Products with or in any application involving power plants, trains, railway systems, airplanes, airline operations, other transportation systems, amusement equipments, hospitals, medical care, dialysis and life support facilities or equipment, incineration and fuel devices, handling of nuclear or hazardous materials or chemicals, mining and drilling, and other applications where the level of risk to human life, health or property are elevated.
- d. MELCO SHALL NOT BE LIABLE FOR SPECIAL, INCIDENTAL, CONSEQUENTIAL, INDIRECT OR PUNITIVE DAMAGES, FOR LOSS OF PROFITS, SALES, OR REVENUE, FOR INCREASED LABOR OR OVERHEAD COSTS, FOR DOWNTIME OR LOSS OF PRODUCTION, FOR COST OVERRUNS, OR FOR ENVIRONMENTAL OR POLLUTION DAMAGES OR CLEAN-UP COSTS, WHETHER THE LOSS IS BASED ON CLAIMS FOR BREACH OF CONTRACT OR WARRANTY, VIOLATION OF STATUTE, NEGLIGENCE OR OTHER TORT, STRICT LIABILITY OR OTHERWISE.
- e. In the event that any damages which are asserted against MELCO arising out of or relating to the Products or defects in them, consist of personal injury, wrongful death and/or physical property damages as well as damages of a pecuniary nature, the disclaimers and limitations contained in these terms shall apply to all three types of damages to the fullest extent permitted by law. If, however, the personal injury, wrongful death and/or physical property damages cannot be disclaimed or limited by law or public policy to the extent provided by these terms, then in any such event the disclaimer of and limitations on pecuniary or economic consequential and incidental damages shall nevertheless be enforceable to the fullest extent allowed by law.
- f. In no event shall any cause of action arising out of breach of warranty or otherwise concerning the Products be brought by Customer more than one year after the cause of action accrues.
- g. Each of the limitations on remedies and damages set forth in these terms is separate and independently enforceable, notwithstanding the unenforceability or failure of essential purpose of any warranty, undertaking, damage limitation, other provision of these terms or other terms comprising the contract of sale between Customer and MELCO.

### **4. Delivery/Force Majeure.**

- a. Any delivery date for the Products acknowledged by MELCO is an estimated and not a promised date. MELCO will make all reasonable efforts to meet the delivery schedule set forth in Customer's order or the purchase contract but shall not be liable for failure to do so.
- b. Products stored at the request of Customer or because Customer refuses or delays shipment shall be at the risk and expense of Customer.
- c. MELCO shall not be liable for any damage to or loss of the Products or any delay in or failure to deliver, service, repair or replace the Products arising from shortage of raw materials, failure of suppliers to make timely delivery, labor difficulties of any kind, earthquake, fire, windstorm, flood, theft, criminal or terrorist acts, war, embargoes, governmental acts or rulings, loss or damage or delays in carriage, acts of God, vandals or any other circumstances reasonably beyond MELCO's control.

### **5. Choice of Law/Jurisdiction.**

These terms and any agreement or contract between Customer and MELCO shall be governed by the laws of the State of New York without regard to conflicts of laws. To the extent any action or dispute is not arbitrated, the parties consent to the exclusive jurisdiction and venue of the federal and state courts located in the Southern District of the State of New York. Any judgment there obtained may be enforced in any court of competent jurisdiction.

### **6. Arbitration.**

Any controversy or claim arising out of, or relating to or in connection with the Products, their sale or use or these terms, shall be settled by arbitration conducted in accordance with the Center for Public Resources (CPR) Rules for Non-Administered Arbitration of International Disputes, by a sole arbitrator chosen from the CPR's panels of distinguished neutrals. Judgment upon the award rendered by the Arbitrator shall be final and binding and may be entered by any court having jurisdiction thereof. The place of the arbitration shall be New York City, New York. The language of the arbitration shall be English. The neutral organization designated to perform the functions specified in Rule 6 and Rules 7.7(b), 7.8 and 7.9 shall be the CPR.

# TRADEMARKS

---

The company names, system names and product names mentioned in this manual are either registered trademarks or trademarks of their respective companies.

In some cases, trademark symbols such as <sup>™</sup> or <sup>®</sup> are not specified in this manual.



SH(NA)-081621ENG-D(2211)MEE

MODEL: R-DFIO-U-OU-E

MODEL CODE: 13JX51

## **MITSUBISHI ELECTRIC CORPORATION**

HEAD OFFICE : TOKYO BUILDING, 2-7-3 MARUNOUCHI, CHIYODA-KU, TOKYO 100-8310, JAPAN  
NAGOYA WORKS : 1-14, YADA-MINAMI 5-CHOME, HIGASHI-KU, NAGOYA, JAPAN

When exported from Japan, this manual does not require application to the  
Ministry of Economy, Trade and Industry for service transaction permission.

Specifications subject to change without notice.