



Programmable Controller

MELSEC iQ-R
series

MELSEC iQ-R C Intelligent Function Module User's Manual (Application)

-RD55UP06-V
-RD55UP12-V



SAFETY PRECAUTIONS

(Read these precautions before using this product.)

Before using this product, please read this manual and the relevant manuals carefully, and pay full attention to safety to handle the product correctly.

The precautions given in this manual are concerned with this product only. For the safety precautions of the programmable controller system, refer to the user's manual for the CPU module used.

In this manual, the safety precautions are classified into two levels: "⚠️ WARNING" and "⚠️ CAUTION".

 WARNING	Indicates that incorrect handling may cause hazardous conditions, resulting in death or severe injury.
 CAUTION	Indicates that incorrect handling may cause hazardous conditions, resulting in minor or moderate injury or property damage.

Under some circumstances, failure to observe the precautions given under "⚠️ CAUTION" may lead to serious consequences.

Observe the precautions of both levels because they are important for personal and system safety.

Make sure that the end users read this manual and then keep the manual in a safe place for future reference.

[Design Precautions]

WARNING

- Configure safety circuits external to the programmable controller to ensure that the entire system operates safely even when a fault occurs in the external power supply or the programmable controller. Failure to do so may result in an accident due to an incorrect output or malfunction.
 - (1) Emergency stop circuits, protection circuits, and protective interlock circuits for conflicting operations (such as forward/reverse rotations or upper/lower limit positioning) must be configured external to the programmable controller.
 - (2) When the programmable controller detects an abnormal condition, it stops the operation and all outputs are:
 - Turned off if the overcurrent or overvoltage protection of the power supply module is activated.
 - Held or turned off according to the parameter setting if the self-diagnostic function of the CPU module detects an error such as a watchdog timer error.
 - (3) All outputs may be turned on if an error occurs in a part, such as an I/O control part, where the CPU module cannot detect any error. To ensure safety operation in such a case, provide a safety mechanism or a fail-safe circuit external to the programmable controller. For a fail-safe circuit example, refer to the MELSEC iQ-R Module Configuration Manual.
 - (4) Outputs may remain on or off due to a failure of a component such as a relay and transistor in an output circuit. Configure an external circuit for monitoring output signals that could cause a serious accident.
 - In an output circuit, when a load current exceeding the rated current or an overcurrent caused by a load short-circuit flows for a long time, it may cause smoke and fire. To prevent this, configure an external safety circuit, such as a fuse.
 - Configure a circuit so that the programmable controller is turned on first and then the external power supply. If the external power supply is turned on first, an accident may occur due to an incorrect output or malfunction.
 - Configure a circuit so that the external power supply is turned off first and then the programmable controller. If the programmable controller is turned off first, an accident may occur due to an incorrect output or malfunction.
 - For the operating status of each station after a communication failure, refer to manuals for the network used. For the manuals, please consult your local Mitsubishi representative. Incorrect output or malfunction due to a communication failure may result in an accident.
 - When connecting an external device with a CPU module or intelligent function module to modify data of a running programmable controller, configure an interlock circuit in the program to ensure that the entire system will always operate safely. For other forms of control (such as program modification, parameter change, forced output, or operating status change) of a running programmable controller, read the relevant manuals carefully and ensure that the operation is safe before proceeding. Improper operation may damage machines or cause accidents. When a Safety CPU is used, data cannot be modified while the Safety CPU is in SAFETY MODE.
 - Especially, when a remote programmable controller is controlled by an external device, immediate action cannot be taken if a problem occurs in the programmable controller due to a communication failure. To prevent this, configure an interlock circuit in the program, and determine corrective actions to be taken between the external device and CPU module in case of a communication failure.
-

[Design Precautions]

WARNING

- Do not write any data to the "system area" and "write-protect area" of the buffer memory in the module. Also, do not use any "use prohibited" signals as an output signal from the CPU module to each module. Doing so may cause malfunction of the programmable controller system. For the "system area", "write-protect area", and the "use prohibited" signals, refer to the user's manual for the module used. For areas used for safety communications, they are protected from being written by users, and thus safety communications failure caused by data writing does not occur.
 - If a communication cable is disconnected, the network may be unstable, resulting in a communication failure of multiple stations. Configure an interlock circuit in the program to ensure that the entire system will always operate safely even if communications fail. Incorrect output or malfunction due to a communication failure may result in an accident. When safety communications are used, an interlock by the safety station interlock function protects the system from an incorrect output or malfunction.
-

[Design Precautions]

CAUTION

- Do not install the control lines or communication cables together with the main circuit lines or power cables. Doing so may result in malfunction due to electromagnetic interference. Keep a distance of 100mm or more between those cables.
 - During control of an inductive load such as a lamp, heater, or solenoid valve, a large current (approximately ten times greater than normal) may flow when the output is turned from off to on. Therefore, use a module that has a sufficient current rating.
 - After the CPU module is powered on or is reset, the time taken to enter the RUN status varies depending on the system configuration, parameter settings, and/or program size. Design circuits so that the entire system will always operate safely, regardless of the time.
 - Do not power off the programmable controller or reset the CPU module while the settings are being written. Doing so will make the data in the flash ROM and SD memory card undefined. The values need to be set in the buffer memory and written to the flash ROM and SD memory card again. Doing so also may cause malfunction or failure of the module.
 - When changing the operating status of the CPU module from external devices (such as the remote RUN/STOP functions), select "Do Not Open by Program" for "Opening Method" of "Module Parameter". If "Open by Program" is selected, an execution of the remote STOP function causes the communication line to close. Consequently, the CPU module cannot reopen the line, and external devices cannot execute the remote RUN function.
-

[Security Precautions]

WARNING

- To maintain the security (confidentiality, integrity, and availability) of the programmable controller and the system against unauthorized access, denial-of-service (DoS) attacks, computer viruses, and other cyberattacks from external devices via the network, take appropriate measures such as firewalls, virtual private networks (VPNs), and antivirus solutions.
-

[Installation Precautions]

WARNING

- Shut off the external power supply (all phases) used in the system before mounting or removing the module. Failure to do so may result in electric shock or cause the module to fail or malfunction.
-

[Installation Precautions]

CAUTION

- Use the programmable controller in an environment that meets the general specifications in the MELSEC iQ-R Module Configuration Manual. Failure to do so may result in electric shock, fire, malfunction, or damage to or deterioration of the product.
 - To mount a module, place the concave part(s) located at the bottom onto the guide(s) of the base unit, and push in the module until the hook(s) located at the top snaps into place. Incorrect interconnection may cause malfunction, failure, or drop of the module.
 - To mount a module with no module fixing hook, place the concave part(s) located at the bottom onto the guide(s) of the base unit, push in the module, and fix it with screw(s). Incorrect interconnection may cause malfunction, failure, or drop of the module.
 - When using the programmable controller in an environment of frequent vibrations, fix the module with a screw.
 - Tighten the screws within the specified torque range. Undertightening can cause drop of the component or wire, short circuit, or malfunction. Overtightening can damage the screw and/or module, resulting in drop, short circuit, or malfunction. For the specified torque range, refer to the MELSEC iQ-R Module Configuration Manual.
 - When using an extension cable, connect it to the extension cable connector of the base unit securely. Check the connection for looseness. Poor contact may cause malfunction.
 - When using an SD memory card, fully insert it into the SD memory card slot. Check that it is inserted completely. Poor contact may cause malfunction.
 - Securely insert an extended SRAM cassette into the cassette connector of the CPU module. After insertion, close the cassette cover and check that the cassette is inserted completely. Poor contact may cause malfunction.
 - Beware that the module could be very hot while power is on and immediately after power-off.
 - Do not directly touch any conductive parts and electronic components of the module, SD memory card, extended SRAM cassette, or connector. Doing so can cause malfunction or failure of the module.
-

[Wiring Precautions]

WARNING

- Shut off the external power supply (all phases) used in the system before installation and wiring. Failure to do so may result in electric shock or cause the module to fail or malfunction.
- After installation and wiring, attach a blank cover module (RG60) to each empty slot before powering on the system for operation. Also, attach an extension connector protective cover^{*1} to each unused extension cable connector as necessary. Directly touching any conductive parts of the connectors while power is on may result in electric shock.

*1 For details, please consult your local Mitsubishi Electric representative.

[Wiring Precautions]

CAUTION

- Individually ground the FG and LG terminals of the programmable controller with a ground resistance of 100 ohms or less. Failure to do so may result in electric shock or malfunction.
 - Use applicable solderless terminals and tighten them within the specified torque range. If any spade solderless terminal is used, it may be disconnected when the terminal screw comes loose, resulting in failure.
 - Check the rated voltage and signal layout before wiring to the module, and connect the cables correctly. Connecting a power supply with a different voltage rating or incorrect wiring may cause fire or failure.
 - Connectors for external devices must be crimped or pressed with the tool specified by the manufacturer, or must be correctly soldered. Incomplete connections may cause short circuit, fire, or malfunction.
 - Securely connect the connector to the module. Poor contact may cause malfunction.
 - Do not install the control lines or communication cables together with the main circuit lines or power cables. Doing so may result in malfunction due to noise. Keep a distance of 100mm or more between those cables.
 - Place the cables in a duct or clamp them. If not, dangling cables may swing or inadvertently be pulled, resulting in malfunction or damage to modules or cables. In addition, the weight of the cables may put stress on modules in an environment of strong vibrations and shocks. Do not clamp the extension cables with the jacket stripped. Doing so may change the characteristics of the cables, resulting in malfunction.
 - Check the interface type and correctly connect the cable. Incorrect wiring (connecting the cable to an incorrect interface) may cause failure of the module and external device.
 - Tighten the terminal screws or connector screws within the specified torque range. Undertightening can cause drop of the screw, short circuit, fire, or malfunction. Overtightening can damage the screw and/or module, resulting in drop, short circuit, fire, or malfunction.
 - When disconnecting the cable from the module, do not pull the cable by the cable part. For the cable with connector, hold the connector part of the cable. For the cable connected to the terminal block, loosen the terminal screw. Pulling the cable connected to the module may result in malfunction or damage to the module or cable.
 - Prevent foreign matter such as dust or wire chips from entering the module. Such foreign matter can cause a fire, failure, or malfunction.
-

[Wiring Precautions]

CAUTION

- When a protective film is attached to the top of the module, remove it before system operation. If not, inadequate heat dissipation of the module may cause a fire, failure, or malfunction.
 - Programmable controllers must be installed in control panels. Connect the main power supply to the power supply module in the control panel through a relay terminal block. Wiring and replacement of a power supply module must be performed by qualified maintenance personnel with knowledge of protection against electric shock. For wiring, refer to the MELSEC iQ-R Module Configuration Manual.
 - For Ethernet cables to be used in the system, select the ones that meet the specifications in the user's manual for the module used. If not, normal data transmission is not guaranteed.
-

[Startup and Maintenance Precautions]

WARNING

- Do not touch any terminal while power is on. Doing so will cause electric shock or malfunction.
 - Correctly connect the battery connector. Do not charge, disassemble, heat, short-circuit, solder, or throw the battery into the fire. Also, do not expose it to liquid or strong shock. Doing so will cause the battery to produce heat, explode, ignite, or leak, resulting in injury and fire.
 - Shut off the external power supply (all phases) used in the system before cleaning the module or retightening the terminal screws, connector screws, or module fixing screws. Failure to do so may result in electric shock.
-

[Startup and Maintenance Precautions]

CAUTION

- When connecting an external device with a CPU module or intelligent function module to modify data of a running programmable controller, configure an interlock circuit in the program to ensure that the entire system will always operate safely. For other forms of control (such as program modification, parameter change, forced output, or operating status change) of a running programmable controller, read the relevant manuals carefully and ensure that the operation is safe before proceeding. Improper operation may damage machines or cause accidents.
 - Especially, when a remote programmable controller is controlled by an external device, immediate action cannot be taken if a problem occurs in the programmable controller due to a communication failure. To prevent this, configure an interlock circuit in the program, and determine corrective actions to be taken between the external device and CPU module in case of a communication failure.
 - Do not disassemble or modify the modules. Doing so may cause failure, malfunction, injury, or a fire.
 - Use any radio communication device such as a cellular phone or PHS (Personal Handy-phone System) more than 25cm away in all directions from the programmable controller. Failure to do so may cause malfunction.
 - Shut off the external power supply (all phases) used in the system before mounting or removing the module. Failure to do so may cause the module to fail or malfunction.
 - Tighten the screws within the specified torque range. Undertightening can cause drop of the component or wire, short circuit, or malfunction. Overtightening can damage the screw and/or module, resulting in drop, short circuit, or malfunction.
 - After the first use of the product, do not perform each of the following operations more than 50 times (IEC 61131-2/JIS B 3502 compliant). Exceeding the limit may cause malfunction.
 - Mounting/removing the module to/from the base unit
 - Inserting/removing the extended SRAM cassette or battery-less option cassette to/from the CPU module
 - Mounting/removing the terminal block to/from the module
 - Connecting/disconnecting the extension cable to/from the base unit
 - After the first use of the product, do not insert/remove the SD memory card to/from the CPU module more than 500 times. Exceeding the limit may cause malfunction.
 - Do not touch the metal terminals on the back side of the SD memory card. Doing so may cause malfunction or failure of the module.
 - Do not touch the integrated circuits on the circuit board of an extended SRAM cassette. Doing so may cause malfunction or failure of the module.
 - Do not drop or apply shock to the battery to be installed in the module. Doing so may damage the battery, causing the battery fluid to leak inside the battery. If the battery is dropped or any shock is applied to it, dispose of it without using.
 - Startup and maintenance of a control panel must be performed by qualified maintenance personnel with knowledge of protection against electric shock. Lock the control panel so that only qualified maintenance personnel can operate it.
-

[Startup and Maintenance Precautions]

CAUTION

- Before handling the module, touch a conducting object such as a grounded metal to discharge the static electricity from the human body. Wearing a grounded antistatic wrist strap is recommended. Failure to discharge the static electricity may cause the module to fail or malfunction.
 - After unpacking, eliminate static electricity from the module to prevent electrostatic discharge from affecting the module. If an electrostatically charged module comes in contact with a grounded metal object, a sudden electrostatic discharge of the module may cause failure.
For details on how to eliminate static electricity from the module, refer to the following.
Antistatic Precautions Before Using MELSEC iQ-R Series Products (FA-A-0368)
 - Use a clean and dry cloth to wipe off dirt on the module.
-

[Operating Precautions]

CAUTION

- When changing data and operating status, and modifying program of the running programmable controller from an external device such as a personal computer connected to an intelligent function module, read relevant manuals carefully and ensure the safety before operation. Incorrect change or modification may cause system malfunction, damage to the machines, or accidents.
 - Do not power off the programmable controller or reset the CPU module while the setting values in the buffer memory are being written to the flash ROM in the module. Doing so will make the data in the flash ROM undefined. The values need to be set in the buffer memory and written to the flash ROM again. Doing so can cause malfunction or failure of the module.
 - Before using the Shell command, check the specifications of the command. For the specifications, refer to the manual of VxWorks. If the command is not properly executed, the system failure/stop (watchdog timer) may occur and the entire programmable controller system may stop.
-

[Disposal Precautions]

CAUTION

- When disposing of this product, treat it as industrial waste.
 - When disposing of batteries, separate them from other wastes according to the local regulations. For details on battery regulations in EU member states, refer to the MELSEC iQ-R Module Configuration Manual.
-

[Transportation Precautions]

CAUTION

- When transporting lithium batteries, follow the transportation regulations. For details on the regulated models, refer to the MELSEC iQ-R Module Configuration Manual.
 - The halogens (such as fluorine, chlorine, bromine, and iodine), which are contained in a fumigant used for disinfection and pest control of wood packaging materials, may cause failure of the product. Prevent the entry of fumigant residues into the product or consider other methods (such as heat treatment) instead of fumigation. The disinfection and pest control measures must be applied to unprocessed raw wood.
-

CONDITIONS OF USE FOR THE PRODUCT

- (1) MELSEC programmable controller ("the PRODUCT") shall be used in conditions;
- i) where any problem, fault or failure occurring in the PRODUCT, if any, shall not lead to any major or serious accident; and
 - ii) where the backup and fail-safe function are systematically or automatically provided outside of the PRODUCT for the case of any problem, fault or failure occurring in the PRODUCT.
- (2) The PRODUCT has been designed and manufactured for the purpose of being used in general industries. MITSUBISHI ELECTRIC SHALL HAVE NO RESPONSIBILITY OR LIABILITY (INCLUDING, BUT NOT LIMITED TO ANY AND ALL RESPONSIBILITY OR LIABILITY BASED ON CONTRACT, WARRANTY, TORT, PRODUCT LIABILITY) FOR ANY INJURY OR DEATH TO PERSONS OR LOSS OR DAMAGE TO PROPERTY CAUSED BY the PRODUCT THAT ARE OPERATED OR USED IN APPLICATION NOT INTENDED OR EXCLUDED BY INSTRUCTIONS, PRECAUTIONS, OR WARNING CONTAINED IN MITSUBISHI ELECTRIC USER'S, INSTRUCTION AND/OR SAFETY MANUALS, TECHNICAL BULLETINS AND GUIDELINES FOR the PRODUCT.
- ("Prohibited Application")
- Prohibited Applications include, but not limited to, the use of the PRODUCT in;
- Nuclear Power Plants and any other power plants operated by Power companies, and/or any other cases in which the public could be affected if any problem or fault occurs in the PRODUCT.
 - Railway companies or Public service purposes, and/or any other cases in which establishment of a special quality assurance system is required by the Purchaser or End User.
 - Aircraft or Aerospace, Medical applications, Train equipment, transport equipment such as Elevator and Escalator, Incineration and Fuel devices, Vehicles, Manned transportation, Equipment for Recreation and Amusement, and Safety devices, handling of Nuclear or Hazardous Materials or Chemicals, Mining and Drilling, and/or other applications where there is a significant risk of injury to the public or property.
- Notwithstanding the above restrictions, Mitsubishi Electric may in its sole discretion, authorize use of the PRODUCT in one or more of the Prohibited Applications, provided that the usage of the PRODUCT is limited only for the specific applications agreed to by Mitsubishi Electric and provided further that no special quality assurance or fail-safe, redundant or other safety features which exceed the general specifications of the PRODUCTS are required. For details, please contact the Mitsubishi Electric representative in your region.
- (3) Mitsubishi Electric shall have no responsibility or liability for any problems involving programmable controller trouble and system trouble caused by DoS attacks, unauthorized access, computer viruses, and other cyberattacks.

CONSIDERATIONS FOR USE

Considerations for the Wind River Systems product

C intelligent function modules have an embedded real-time operating system, VxWorks, manufactured by Wind River Systems, Inc. in the United States. We, Mitsubishi, make no warranty for the Wind River Systems product and will not be liable for any problems and damages caused by the Wind River Systems product during use of a C intelligent function module. For the problems or specifications of the Wind River Systems product, refer to the corresponding manual or consult Wind River Systems, Inc.

Contact information is available on the following website.

- Wind River Systems, Inc.: www.windriver.com

Considerations for the sampling function

The data sampling in each sequence scan of the sampling function is not supported by CPU modules on other stations via a network.

INTRODUCTION

Thank you for purchasing the Mitsubishi MELSEC iQ-R series programmable controllers.

This manual describes the performance specifications, procedure before operation, wiring, and operation examples to use the module listed below.

Before using this product, please read this manual and the relevant manuals carefully and develop familiarity with the performance of the MELSEC iQ-R series programmable controller to handle the product correctly.

When applying the program examples provided in this manual to an actual system, ensure the applicability and confirm that it will not cause system control problems.

Please make sure that the end users read this manual.

Relevant product

RD55UP06-V, RD55UP12-V

CONTENTS

SAFETY PRECAUTIONS	1
CONDITIONS OF USE FOR THE PRODUCT	9
CONSIDERATIONS FOR USE	10
INTRODUCTION	10
RELEVANT MANUALS	13
TERMS	14
GENERIC TERMS AND ABBREVIATIONS	14
CHAPTER 1 FUNCTION	15
1.1 Program Related Function	15
Device access function	15
Label communication function	16
User program execution function from CPU module	17
Interrupt function to a CPU module	18
Interrupt function to a C intelligent function module	19
Data analysis function	21
Data analysis or statistical analysis using a CPU module	22
1.2 Ethernet Communication Function	23
FTP function	23
Telnet function	25
1.3 RAS Function	27
Program monitoring (WDT) function	27
Error history function	28
Event history function	28
Self-diagnostic function	28
Initialization function	29
1.4 Security Function	30
Individual identification information read function	30
File access restriction function	31
Service/account setting function	33
Lockout	35
IP filter function	36
1.5 Time Synchronization Function	37
1.6 Sampling Function	39
1.7 SD Memory Card Boot Function	46
1.8 FIRMWARE UPDATE FUNCTION	47
CHAPTER 2 PARAMETER SETTING	48
2.1 Parameter Setting Procedure	48
2.2 Basic Setting	49
RD55UP06-V	49
RD55UP12-V	51
2.3 Application Setting	54
2.4 Interrupt Setting	56
2.5 Refresh Setting	57
CHAPTER 3 TROUBLESHOOTING	58
3.1 Checking Method for Error Descriptions	58

3.2	Error Type	58
3.3	Checking Module Status	59
	Error information	59
	Module information list	60
3.4	Self-diagnostic Tests	61
3.5	Troubleshooting by Symptom	63
	RUN LED does not turn ON	63
	RUN LED continues flashing (low-speed)	63
	Ethernet communication cannot be established between personal computer and C intelligent function module	64
	File access fails	65
	Connection with peripherals fails	65
	File read/write (download or upload) fails	65
	An error occurs during user program execution	66
	Communication cannot be established with an Ethernet device	66
	An error occurs in communication processing on other modules	66
	A C intelligent function module dedicated instruction is not executed	66
3.6	Error Code List	67
3.7	Event List	76

APPENDIX **77**

Appendix 1	Module Label	77
Appendix 2	Input/Output Signals	78
	Input/Output signals list	78
	Input signal details	80
	Output signal details	81
Appendix 3	Buffer Memory	82
	Buffer memory list	82
	Buffer memory details	85
Appendix 4	Dedicated Instructions	93
	Dedicated instruction list	93
Appendix 5	VxWorks Component List	94
Appendix 6	Added and Changed Functions	102

INDEX **104**

REVISIONS	106
WARRANTY	107
TRADEMARKS	108

RELEVANT MANUALS

Manual name [manual number]	Description	Available form
MELSEC iQ-R C Intelligent Function Module User's Manual (Application) [SH-081567ENG] (this manual)	Functions, input/output signals, buffer memory, parameter setting, and troubleshooting of a C intelligent function module	Print book e-Manual PDF
MELSEC iQ-R C Intelligent Function Module User's Manual (Startup) [SH-081566ENG]	Specifications, procedure before operation, wiring, and operation examples of a C intelligent function module	Print book e-Manual PDF
MELSEC iQ-R Module Configuration Manual [SH-081222ENG]	The combination of the MELSEC iQ-R series modules, common information on the installation/wiring in the system, and specifications of the power supply module, base unit, SD memory card, and battery	e-Manual PDF
MELSEC iQ-R C Intelligent Function Module Programming Manual [SH-081568ENG]	Programming specifications and dedicated function libraries of a C intelligent function module	e-Manual PDF
MELSEC iQ-R C Controller Module/C Intelligent Function Module Programming Manual (Data Analysis) [SH-081756ENG]	Programming specifications and dedicated function libraries for analyzing the data of a C Controller module and a C intelligent function module	e-Manual PDF
MELSEC iQ-R C Intelligent Function Module Function Block Reference [BCN-P5999-1037]	Specifications, functions, and input/output labels of function blocks for a C intelligent function module	e-Manual PDF
MELSEC iQ-R Programming Manual (Module Dedicated Instructions) [SH-081976ENG]	Dedicated instructions for the intelligent function modules	e-Manual PDF
GX Works3 Operating Manual [SH-081215ENG]	System configurations, parameter settings, and operation methods for the online function in GX Works3	e-Manual PDF
CW Configurator Operating Manual [SH-081382ENG]	System configuration, parameter settings, and operation method for the online function in CW Configurator	e-Manual PDF
CW Workbench/CW-Sim Operating Manual [SH-081373ENG]	System configuration, specifications, functions, and troubleshooting of CW Workbench/CW-Sim	e-Manual PDF

Point

e-Manual refers to the Mitsubishi Electric FA electronic book manuals that can be browsed using a dedicated tool.

e-Manual has the following features:

- Required information can be cross-searched in multiple manuals.
- Other manuals can be accessed from the links in the manual.
- Hardware specifications of each part can be found from the product figures.
- Pages that users often browse can be bookmarked.

TERMS

Unless otherwise specified, this manual uses the following terms.

Term	Description
Data analysis function	A dedicated function library offered by a C Controller module and a C intelligent function module. It is used for data analysis processing.
Intelligent function module	A module that has functions other than an input or output, such as an A/D converter module and D/A converter module
MELSEC iQ-R series data link function	A dedicated function library offered by a C intelligent function module. It is used to access an own station or modules on the network.

GENERIC TERMS AND ABBREVIATIONS

Unless otherwise specified, this manual uses the following generic terms and abbreviations.

Generic term/abbreviation	Description
CW Configurator	A generic product name for SWnDND-RCCPU ('n' indicates its version.)
CW Workbench	An abbreviation for a C Controller module and C intelligent function module engineering tool, CW Workbench
CW-Sim	An abbreviation for VxWorks simulator that can operate and debug C Controller module programs and C intelligent function module programs on a personal computer with CW Workbench installed, without connecting to an actual device (target)
C intelligent function module	A generic term for MELSEC iQ-R series C intelligent function modules
C intelligent function module dedicated function	A dedicated function library offered by a C intelligent function module. It is used to control a C intelligent function module.
C Controller module	A generic term for MELSEC iQ-R series C Controller modules
GX Works3	A generic product name for SWnDND-GXW3 ('n' indicates its version.)
VxWorks	A product name for a real-time operating system manufactured by Wind River Systems, Inc.
Engineering tool	Another term for the software package for the MELSEC programmable controllers. It indicates GX Works3 and CW Configurator in this manual.
Dedicated function library	A generic term for C intelligent function module dedicated functions, MELSEC iQ-R series data link functions, data analysis functions, and statistical analysis functions
Target device	A personal computer or another CPU module to connect for data communication
Statistical analysis function	A dedicated function library offered by a C Controller module and a C intelligent function module. It is used for statistical analysis processing.

1 FUNCTION

This chapter shows the details of the functions of a C intelligent function module.

1.1 Program Related Function

Device access function

Data can be read from/written to devices and buffer memory of a C intelligent function module or a CPU module by using a dedicated function library.

For accessible modules and routes, refer to the following:

📖 MELSEC iQ-R C Intelligent Function Module Programming Manual

Point

Data can be read from/written to devices and buffer memory of a C intelligent function module by using a peripheral device (engineering tool).

Function list

The following table shows the functions used for accessing devices.

Function name	Description
CITL_FromBuf	To read data from the buffer memory of a C intelligent function module.
CITL_ToBuf	To write data to the buffer memory of a C intelligent function module.
CITL_X_In_Bit	To read an input signal (X) in bit (1-point) units.
CITL_X_In_Word	To read an input signal (X) in word (16-point) units.
CITL_X_In_Word_ISR	
CITL_X_Out_Bit	To write to an input signal (X) in bit (1-point) units.
CITL_X_Out_Word	To write to an input signal (X) in word (16-point) units.
CITL_X_Out_Word_ISR	
CITL_Y_In_Bit	To read an output signal (Y) in bit (1-point) units.
CITL_Y_In_Word	To read an output signal (Y) in word (16-point) units.
CITL_Y_In_Word_ISR	
mdrDevRst	To reset (turns OFF) bit devices.*1
mdrDevSet	To set (turns ON) bit devices.*1
mdrRandR	To read devices randomly.*1
mdrRandW	To write devices randomly.*1
mdrReceive	To read devices in batch.
mdrSend	To write devices in batch.

*1 CPU buffer memory cannot be accessed.

Label communication function

Data can be read from/written to labels stored in a CPU module.

Label communication flow

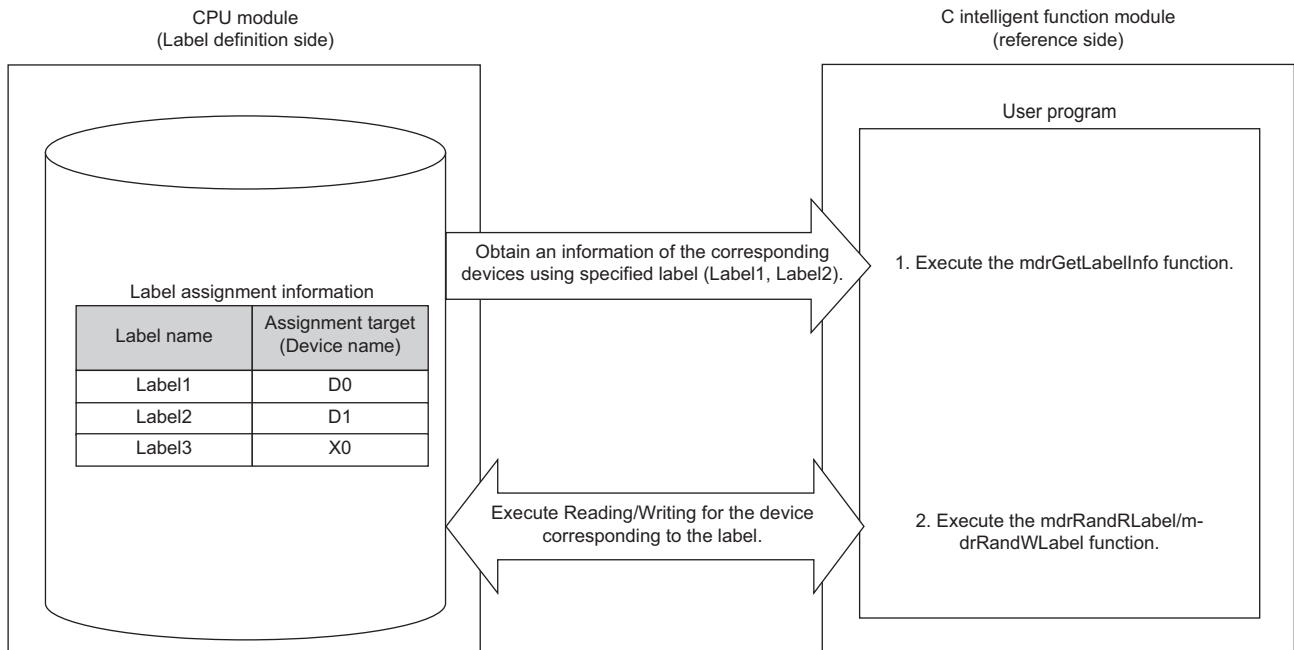

1. Acquire label assignment information (device information) of the specified label with the MELSEC iQ-R series data link function (mdrGetLabelInfo).
2. Read/write data from/to a device based on the acquired label assignment information (device information) by using each MELSEC iQ-R series data link function (mdrRandRLabel/mdrRandWLabel).

Point

- In the label communication, a CPU module can be accessed without changing a user program by acquiring label assignment information again even if the label assignment information of the CPU module is changed.
- The label assignment information (device information) acquired by using the MELSEC iQ-R series data link function (mdrGetLabelInfo) does not need to be acquired for each MELSEC iQ-R series data link function (mdrRandRLabel/mdrRandWLabel) execution. However, if the label assignment information (device information) stored in a CPU module is changed, acquire it again by using the MELSEC iQ-R series data link function (mdrGetLabelInfo). (Otherwise, an error response is returned.)

Function list

The following table shows the functions used for label communication.

Function name	Description
mdrGetLabelInfo	To acquire device information corresponding to label names.
mdrRandRLabel	To read devices corresponding to labels randomly.
mdrRandWLabel	To write devices corresponding to labels randomly.

Accessible CPU modules

The following table shows the accessible CPU modules.

Product name	Model name
Programmable controller CPU	R00CPU, R01CPU, R02CPU, R04CPU, R08CPU, R16CPU, R32CPU, R120CPU
Process CPU	R08PCPU, R16PCPU, R32PCPU, R120PCPU

Label types which can be referred to

The following table shows the label types that can be referred to from a C intelligent function module.

○: Available, ×: Not available, —: Not applicable

Label type	"Access from External Device" is selected or not selected.	Availability*1
Global label	Selected	○
	Unselected	×
Local label	—	
System label		

*1 The availability of the label differs depending on the device type assigned to the label.

For the device type, refer to the following:

 MELSEC iQ-R C Intelligent Function Module Programming Manual

Point

For referring to a label, select "Access from External Device" in GX Works3.

( GX Works3 Operating Manual)

User program execution function from CPU module

A routine (user program) registered with the C intelligent function module dedicated function (CITL_EntryDedicatedInstFunc) can be executed in a CPU module by using the dedicated instruction (G(P).CEXECUTE).

Function list

The following table shows the function used for executing a routine (user program) from a CPU module.

Function name	Description
CITL_EntryDedicatedInstFunc	To register a routine to be executed using the dedicated instruction (G(P).CEXECUTE).

■ Execution procedure

This section explains the procedure for executing the user program.

1. Register a routine (user program) to be executed by C intelligent function module dedicated function (CITL_EntryDedicatedInstFunc).
2. Execute the dedicated function (G(P).CEXECUTE) on the CPU module.
3. A registered routine (user program) is executed.

Dedicated instructions

For the dedicated instructions, refer to the following:

 Page 93 Dedicated Instructions

Interrupt function to a CPU module

When the interrupt condition set to an input signal (X) is satisfied, a C intelligent function module issues an interrupt request for a CPU module. An interrupt program of the CPU module can be activated by the interrupt request.

Function list

The following table shows the functions used for interrupting a CPU module.

Function name	Description
CITL_X_Out_Bit	To write to an input signal (X) in bit (1-point) units.
CITL_X_Out_Word	To write to an input signal (X) in word (16-point) units.
CITL_X_Out_Word_ISR	

Interrupt procedure

Interrupt requests to the CPU module are executed by interrupt conditions set in the module parameter.

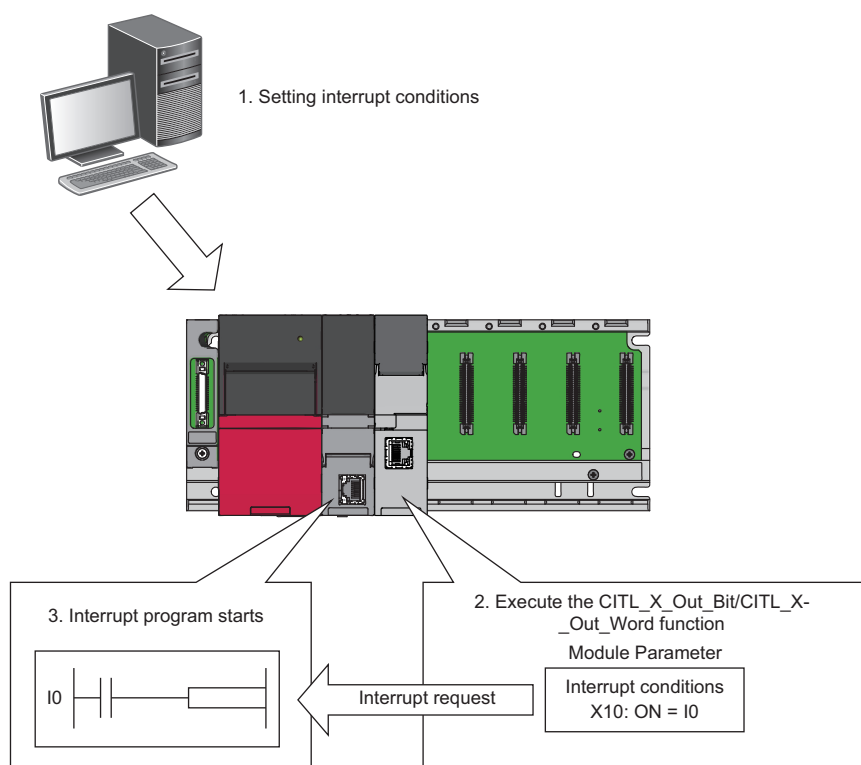

1. Set interrupt conditions in the C intelligent function module using an engineering tool. (Page 56 Interrupt Setting)
2. When an interrupt condition is set at the time of C intelligent function module dedicated function execution (CITL_X_Out_Bit/CITL_X_Out_Word), an interrupt request for the CPU module is executed.
3. Interrupt program of the CPU module is started by the interrupt request.

Point

When "Leading Edge/Trailing Edge" is set in the "Interrupt Condition Setting", the first interrupt factor which occurs during an interrupt program execution is recorded and the second or later ones are ignored. When 'trailing edge → leading edge' occurs during an interrupt program execution by leading edge, the second or later interrupt programs are not executed. Therefore, ensure a sufficient interval between input ON and OFF. (Same for 'trailing edge → leading edge → trailing edge')

Interrupt function to a C intelligent function module

When the output signal (Y) of the C intelligent function module is ON, the routine (user program) registered with the C intelligent function module dedicated function (CITL_EntryYInt) can be executed as an interrupt routine (interrupt program). A user program in a state of waiting for an output signal (Y) interrupt event notification can be restarted by using the C intelligent function module dedicated function (CITL_WaitYEvent).

Function list

The following table shows the functions used for interrupting a C intelligent function module.

Function name	Description
CITL_DisableYInt	To disable the routine registered with the CITL_EntryYInt function.
CITL_DisableYInt_ISR	
CITL_EnableYInt	To enable the routine registered with the CITL_EntryYInt function.
CITL_EnableYInt_ISR	
CITL_EntryYInt	To register a routine to be called when an output signal (Y) interrupt occurs.
CITL_WaitYEvent	To wait for the output signal (Y) interrupt event notification.

Interrupt procedure

■Executing interrupt routines

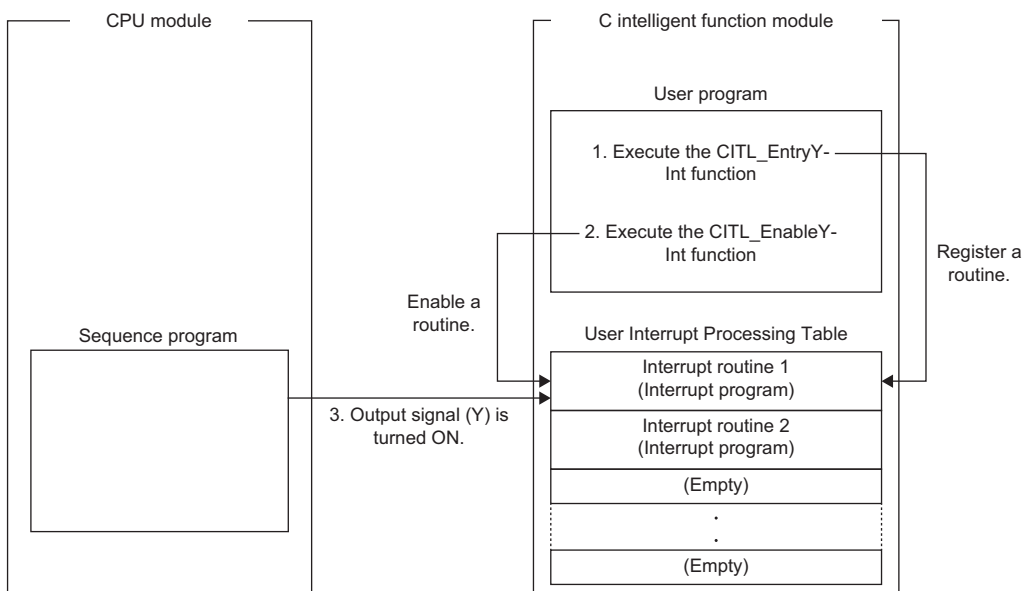

1. By using the C intelligent function module dedicated function (CITL_EntryYInt), register a routine (user program) to be called as an interrupt routine (interrupt program) when an output signal (Y) of a C intelligent function module turns ON.
2. Enable the registered interrupt routine (interrupt program) by using the C intelligent function module dedicated function (CITL_EnableYInt). If it is disabled, the interrupt routine (interrupt program) will not be executed.
3. When the output signal (Y) of a C intelligent function module turns ON, the interrupt routine (interrupt program) is executed.

Point

When an interrupt request is issued to the routine disabled with the C intelligent function module dedicated function (CITL_DisableYInt), the interrupt request is ignored.

■Restarting user programs

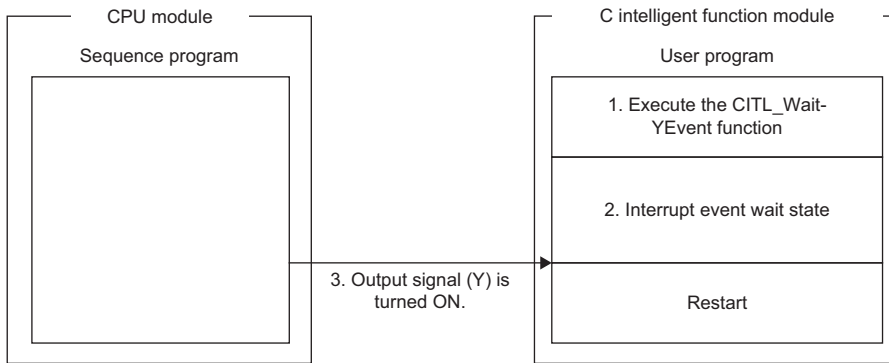

1. Execute the C intelligent function module dedicated function (CITL_WaitYEvent) while executing a user program.
2. The user program is placed into a state of waiting for an output signal (Y) interrupt event notification.
3. When the output signal (Y) of a C intelligent function module is turned ON, the user program is restarted.

Precautions

The following shows the considerations when using C intelligent function module dedicated function (CITL_WaitYEvent).

■When an interrupt event has already been notified

When an interrupt event has already been notified at the time of executing the C intelligent function module dedicated function (CITL_WaitYEvent), a user program restarts from a state of waiting for an interrupt event at the same time as the execution of the function.

In addition, when multiple interrupt events have been notified to the same interrupt event number at the time of executing the C intelligent function module dedicated function (CITL_WaitYEvent), a user program performs processing as a single interrupt event notification.

■When using the function in multiple user programs

Do not specify a same interrupt event (output signal (Y) number) in multiple user programs.

Otherwise, a user program to which a specified interrupt event (output signal (Y) number) is notified will be undefined.

Data analysis function

This function performs data analysis processing such as fast Fourier transform, digital filter operation, calculation of a cross point between a wave and a specified value, and calculation of a standard deviation.

This function enables the detection of machining errors by monitoring current wave and the preventive maintenance of devices by analyzing vibrations.

For data analysis functions and statistical analysis functions, refer to the following:

📖 MELSEC iQ-R C Controller Module/C Intelligent Function Module Programming Manual (Data Analysis)

Function list

The following table shows the functions used for the data analysis function.

■ Data analysis function

Function name	Description
DANL_SetOpCondition	To set operating conditions for data analysis.
DANL_GetOpCondition	To acquire operating conditions for data analysis.
DANL_DigitalFilter	To perform digital filter operation for the specified wave.
DANL_EnvelopeCalculation	To calculate the envelope of the specified wave.
DANL_FFTSpectrum	To perform spectrum calculation using fast Fourier transform (FFT) for the specified wave.
DANL_FindCrossPoint	To calculate the number of cross points of the specified wave and a reference value for the number of cross points specified to the maximum number of cross points.
DANL_Peak	To calculate the peak values (maximum and minimum) of the specified wave.
DANL_RMS	To calculate an RMS (root mean square) of the specified wave.
DANL_BoundCompareTest	To compare the specified wave and a check value to check an upper/lower limit.
DANL_AryBoundCompareTest	To compare the specified wave and a check value to check an upper/lower limit of the wave.

■ Statistical analysis function

Function name	Description
DANL_LeastSquare	To calculate a coefficient and a constant of a polynomial, and a multiple correlation coefficient by using a least-squares method for the specified array.
DANL_MovingAverage	To calculate a moving average of the specified array.
DANL_StandardDeviation	To calculate a standard deviation of the specified array.
DANL_Variance	To calculate a variance of the specified array.
DANL_MTUnit	To determine a unit space that is used in the MT method based on the specified normal data.
DANL_MTMahalanobisDistance	To calculate a Mahalanobis distance of the specified input data.
DANL_MultipleRegression	To calculate a coefficient, constant, and regression statistics for multiple regression analysis.

Data analysis or statistical analysis using a CPU module

Using a dedicated instruction or a module FB, analysis processing can be performed on a C intelligent function module.

Dedicated instructions

For the dedicated instructions, refer to the following:

☞ Page 93 Dedicated Instructions

Module FBs

For the module FBs, refer to the following:

📖 MELSEC iQ-R C Intelligent Function Module Function Block Reference

Processing flow for analyzing data

The following shows the processing flow for analyzing data when a dedicated instruction or a module FB is executed on a CPU module.

1. A dedicated instruction or a module FB is executed on a CPU module.
2. An analysis processing is performed on the C intelligent function module.
3. After the completion of the process, the C intelligent function module returns the result to the CPU module.

1.2 Ethernet Communication Function

FTP function

The server function of FTP(File Transfer Protocol), which is a protocol used to transfer files with target devices, is supported. The target device with FTP client function can access the files in the C intelligent function module.

File operation

The following operations can be performed for a file in a C intelligent function module from a target device with the FTP client function.

■Reading file (Download)

Use this when storing a file in a C intelligent function module on the target device side.

■Writing files (Upload)

Use this when registering a file stored on the target device side to a C intelligent function module.

■Browsing and deleting files and folders

Use this when browsing and deleting a file and folder in a C intelligent function module from the target device side.

Using FTP function

For using the FTP function, the service/account needs to be set.

 Page 33 Service/account setting function

Point

Users for file transfer function can be restricted by using user information (account settings).

■Account setting

This shows account settings set prior to the shipment (Initial settings).

- Login name: target
- Password: password

To prevent unauthorized access, change the password when using the FTP function.

Precautions

■Specifications of FTP client

- For the specifications of the FTP client installed on the target device, refer to the manual of the target device.
- Do not use an FTP access function with the Windows standard explorer. Doing so may cause that the file update time on the explorer does not match the time of the control CPU module, or that the file is displayed in the previous state even after it is overwritten.

■Operation while accessing file

Do not perform any of the following operations while accessing the file. The file may get damaged.

- Reset the CPU module, or turn the power OFF.
- Insert/remove an SD memory card.

■Reconnection after timeout

If a timeout error occurred during file transfer, the TCP connection will be closed (disconnected).

Log in to the C intelligent function module again with the FTP client before restarting the file transfer.

■File transmission time

The file transfer processing time will differ depending on the following causes.

- Load rate of Ethernet line (line congestion)
- Number of connections to be used simultaneously (processing of other connections)
- System Configuration

■Number of simultaneous connections

- Up to 10 target devices (FTP client) can log in to a C intelligent function module. If connecting from the 11th FTP client in the state where 10 target devices have logged in, an error will occur without establishing the connection.
- If UDP communication is performed during file transfer with FTP, an error such as timeout may occur. Either communicate after the file transfer or communicate with TCP.

■Writing files

- Files with the read-only attribute and files that are locked from other devices/functions cannot be written. Doing so may cause a write error.
- The write files cannot be transferred if the SD memory card is write-protected. Doing so may cause a write error.

■Deleting files

Determine the timing for deleting the files for the entire system including the C intelligent function module and peripheral devices.

■If the password has been forgotten

Initialize the C intelligent function module. Password before the shipment (Initial settings) will be changed. ( Page 29 Initialization function)

Telnet function

This function executes the Shell command with a Telnet tool in a personal computer without using CW Workbench for a TCP/IP network. This allows simple remote debugging (such as task information display and memory dumping) of a C intelligent function module.

Using Telnet function

For using the Telnet function, the service/account needs to be set.

 Page 33 Service/account setting function

■Account setting

This shows account settings set prior to the shipment (Initial settings).

- Login name: target
- Password: password

To prevent unauthorized access, change the password when using the Telnet function.

Precautions

■Available Shell commands

Shell commands of CW Workbench can be used. For details on the shell commands, refer to the manual of VxWorks.



■Number of connections

The same C intelligent function module cannot be connected by using multiple Telnet tools. Connect a Telnet tool to a C intelligent function module on a 1:1 basis. When connecting another Telnet tool, make sure to close (disconnect) the Telnet tool being connected.

■Shell command

Shell commands entered from the Telnet tool operate on task of priority 1.

Note the following when executing the command. System errors/stop (such as watchdog timer error) may occur in a C intelligent function module.

- Make sure to check the command specifications before executing commands which occupy the CPU processing.
- For rebooting VxWorks, reset the CPU module, or turn the power OFF and ON. Do not reboot VxWorks by executing the command (reboot) of VxWorks or pressing  + .
- Before executing a command in which arguments are included, make sure to check the command specifications/argument specifications. (When executed without specifying those arguments, with the result that 0 is specified to an argument.) Do not execute the close command with no argument specified. By doing so, a resource that is reserved in the VxWorks system will be closed. When a command that shows the status of the module, such as the show command, is executed, the module will be in the interrupt-disabled state for a long period of time, and any processing called from an interrupt routine is not executed. As a result, an interrupt which occurs at the fixed interval may be delayed.

■Message display on Shell

A message issued by VxWorks during Telnet connection may be displayed on Shell. For the message of VxWorks, refer to the manual and help of VxWorks.

■Timeout

When the line is disconnected during Telnet connection, it will take 30 seconds before Telnet connection (TCP) times out on the C intelligent function module side. Telnet cannot be reconnected until it times out.

Timeout time can be changed by the command provided by VxWorks.

```
ipcom_sysvar_set("iptcp.KeepIdle","XX",1);
ipcom_sysvar_set("iptcp.KeepIntvl","YY",1);
ipcom_sysvar_set("iptcp.KeepCnt","ZZ",1);
ipcom_ipd_kill("iptelnets");
ipcom_ipd_start("iptelnets")
```

Timeout time = iptcp.KeepIdle value + (iptcp.KeepIntvl value × iptcp.KeepCnt value)

- iptcp.KeepIdle: Time from when the line is disconnected to the first retry
- iptcp.KeepIntvl: Interval between retries
- iptcp.KeepCnt: Number of retries
- XX, YY: Specify the time (in seconds). (When '0' is specified, no timeout will occur.)
- ZZ: Specify the number of retries.

The following shows the procedure to change the timeout time of a C intelligent function module in operation.

1. Establish a Telnet connection to a C intelligent function module with a Telnet tool.
2. Execute the commands given above from the Shell command of the Telnet tool and change the timeout time.
3. Reboot the Telnet server.
4. Close (disconnect) the Telnet connection.
5. Establish a Telnet connection to a C intelligent function module with a Telnet tool again.

To change the Telnet connection (TCP) timeout time while starting the C intelligent function module, follow the procedure below.

1. Describe the commands given above in the script file (STARTUP.CMD).
2. Turn the power of the CPU module ON.

■If the Telnet password has been forgotten

Initialize the C intelligent function module. Password before the shipment (Initial settings) will be changed. ( Page 29 Initialization function)

1.3 RAS Function

Program monitoring (WDT) function

This function monitors and detects errors on hardware and a user program by using the watchdog timer (WDT), an internal timer of a C intelligent function module.

Program monitoring (WDT) type

■System watchdog timer

A timer to monitor the system of a C intelligent function module.
Use this to detect an error in hardware and system software.

■User watchdog timer

A timer to monitor a user program.
Use this to detect an error in a user program.

Monitoring time setting and reset

■System watchdog timer

The monitoring time of the system watchdog timer is 2000 ms (fixed value).
The system of a C intelligent function module resets it every cycle (2000 ms).

■User watchdog timer

Set a monitoring time for the user watchdog timer within the range of 100 ms to 10000 ms (in 10 ms units) by using the C intelligent function module dedicated function (CITL_StartWDT).
Monitoring starts by executing the C intelligent function module dedicated function (CITL_StartWDT), and the monitoring time is reset by executing the C intelligent function module dedicated function (CITL_ResetWDT).

Timeout of watchdog timer

When the watchdog timer times out, an error indicating that the monitoring time set in the watchdog timer setting has been exceeded (watchdog timer error) occurs. If a system watchdog timer error occurs, the RUN LED turns OFF and the ERR LED turns ON. If a user watchdog timer error occurs, the ERR LED starts flashing.

■System watchdog timer

In case of failure of a C intelligent function module hardware and interrupt program execution, timeout will occur as the system processing has been suspended for a long time.

■User watchdog timer

If a user program cannot complete processing within the time specified by using the C intelligent function module dedicated function (CITL_StartWDT), and also cannot reset by using the C intelligent function module dedicated function (CITL_ResetWDT), a timeout will occur.

Precautions

When using the following functions, a user watchdog timer error occurs easily since the CPU utilization by a system task with high priority increases.

- Shell command
- Connection with CW Workbench and Wind River Workbench
- Mounting and unmounting an SD memory card
- File access
- Ethernet communication
- NFS server communication

Error history function

Errors occurred in a C intelligent function module are stored in maximum 16 buffer memory as a history. If a major/moderate error occurs, even if new errors have occurred, the history is not updated.

Event history function

Errors occurred and operations performed in a C intelligent function module are sampled in a CPU module as event information.

Event information occurred in a C intelligent function module is sampled and retained in the data memory or an SD memory card in a CPU module.

Event information sampled in a CPU module can be displayed in an engineering tool, and the occurrence history can be checked chronologically.

Setting method

The event history function can be set in the event history setting screen of an engineering tool.

For the setting method, refer to the following:

 MELSEC iQ-R CPU Module User's Manual (Application)

■Checking an event history

An event history can be checked in an engineering tool.

For details on the operating procedures and how to read the displayed information, refer to the following:



 GX Works3 Operating Manual

 CW Configurator Operating Manual

Self-diagnostic function

Self-diagnostics test is performed to check the hardware of a C intelligent function module.

Self-diagnostics test is as follows.

- Automatic Hardware Test ( Page 61 Automatic hardware test)
- Hardware test for LED check ( Page 62 Hardware test for LED check)

Initialization function

Initialization and script of the C intelligent function module can be stopped.



When the initialization is in progress, the value of buffer memory cannot be checked by an engineering tool.

Types of initialization

■ Stop script setting

Execution of a script file (STARTUP.CMD), which is registered in standard ROM, is stopped. *1

*1 Registration will be cancelled by renaming the script file name with "STARTUP.BAK".

■ Module initialization setting

The service/account setting is initialized (restored to the factory default state) by initializing the standard ROM.

Initialization

1. Select "Stop Script File Setting" or "Module Initialization Setting" in "Basic Settings" ⇒ "Various Operations Settings" ⇒ "Mode Settings" for a C intelligent function module in an engineering tool. (📖 Page 49 Basic Setting)
2. Set the CPU module to the STOP state, and write the parameters.
3. Reset the CPU module.

After it is reset, the initialization function is performed automatically. The LED display for initialization is as follows:

Status		RUN LED status	ERR LED status
Initialization in progress		Flashing (low-speed)	OFF
Initialization complete	Normal completion	ON	OFF
	Abnormal completion	ON	ON

4. When the initialization is completed normally, return the mode setting changed in step 1 to "Online" and reset the CPU module.
5. When the initialization is completed abnormally, check if measures are taken to reduce noise of the programmable controller system, and perform the initialization again. If it is completed abnormally again, a hardware failure may occur in the C intelligent function module. Please contact your local Mitsubishi Electric sales office or representative.
Do not use an electric screwdriver when removing the module. Loosen the module fixing screws completely to remove the module.

1.4 Security Function

This function prevents assets stored in a C intelligent function module from being stolen, falsified, operated incorrectly, and executed improperly due to unauthorized access from a third party.

Point

The security function is one of the methods for preventing unauthorized access (such as program or data corruption) from an external device. However, this function does not prevent unauthorized access completely. Incorporate measures other than this function if the programmable controller system's safety must be maintained against unauthorized access from an external device. Mitsubishi Electric Corporation cannot be held responsible for any system problems that may occur from unauthorized access.

Examples of measures for unauthorized access are shown below.

- Install a firewall.
 - Install a personal computer as a relay station, and control the relay of send/receive data with an application program.
 - Install an external device for which the access rights can be controlled as a relay station. (For details on the external devices for which access rights can be controlled, consult the network provider or equipment dealer.)
-

Individual identification information read function

The individual identification information of a C intelligent function module can be read with the C intelligent function module dedicated function (CITL_GetIDInfo). By implementing an activation function with a user program, a user program, which does not run in C intelligent function modules with other individual identification information, can be created.

For C intelligent function module dedicated functions, refer to the following:

 MELSEC iQ-R C Intelligent Function Module Programming Manual

File access restriction function

A file attribute can be set for the files stored in the following types of memory. By setting a file attribute, access to a target file can be restricted, and falsification by an unauthorized user and data leakage to outside can be prevented.

- Standard ROM
- SD memory card

Point

- When an SD memory card is inserted to a peripheral device other than a C intelligent function module (such as a personal computer), files to which the access restriction is set can be operated. If the access restriction is set for the file in the SD memory card, take appropriate measures so that the SD memory card cannot be removed from the C intelligent function module at will.
- Access restrictions cannot be set for the folder.

File access restriction function setting

Change a file attribute handled in a C intelligent function module by using the `attrib()` command. A security password is required to change a file attribute.

For details on the `attrib()` command, refer to the manual of VxWorks.

■Setting file attribute

Set a file attribute to a file to be restricted by using the `attrib()` command.

The file attributes that can be handled in a C intelligent function module are as follows.

Attribute	Description
S	System file attribute
R	Read-only attribute *1
H	Hidden file attribute *2

*1 This attribute is not supported by the file access restriction function. However, if it is set, file deletion and file write can be prohibited.

*2 When the file is opened by specifying the file name, file operations can be performed. In order to prohibit the file operations, ensure to set the system file attribute.

■Checking file attribute

A file attribute which is set can be checked by using the `attrib()` command.

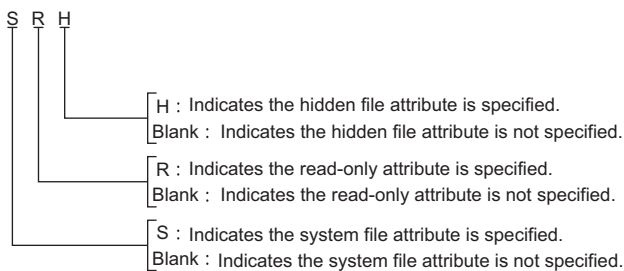

Checking file access restriction status

File access restriction status can be checked by executing the Shell command or the C intelligent function module dedicated function (CITL_GetFileSecurity).

Point

File access restriction status cannot be checked by using the script file (STARTUP.CMD).

Canceling/re-setting file access restriction

Change the file access restriction status by using the Shell command, the script file (STARTUP.CMD), or a user program. The security password set with an engineering tool is required.

■ Changing system file attribute

For operating a file with a system file attribute attached, cancel the file access restriction temporarily with the C intelligent function module dedicated function (CITL_ChangeFileSecurity). The canceled setting can be set again by setting the file access restriction with the C intelligent function module dedicated function (CITL_ChangeFileSecurity) or resetting the C intelligent function module.

Point

- When accessing a file to which a system file attribute is attached in the script file "STARTUP.CMD", cancel the access restriction in the script file (STARTUP.CMD). Again, add the system file attribute to the script file (STARTUP.CMD) in order to prevent the leakage of the password.
- Do not use the files with the system file attribute attached in the script file (STARTUP.CMD) in an SD memory card in order to prevent the leakage of password.

Precautions

■ When maintaining the safety against unauthorized access from external parties

To maintain the safety of a programmable controller system against unauthorized access from external parties, take appropriate measures. Note the following when setting a security password to prevent the leakage of the security password.

- Avoid settings with only simple alphanumeric characters.
- Set a complex password with symbols.

■ Settable characters for a security password

Characters that can be set are single byte alphanumeric characters and symbols. (Security password is case-sensitive.)

■ If the security password has been forgotten

Initialize the C intelligent function module. (☞ Page 29 Initialization function)

Service/account setting function

Set the services, account, and security password for a C intelligent function module.

By restricting the services and setting an account, unauthorized access from other users can be prevented.

Security password is required to change the service/account setting.

Window

1. [Tool] ⇒ [Module Tool List] ⇒ [Information Module] ⇒ [Service/account setting]

Select a target module.

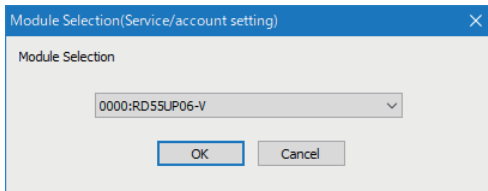

2. Enter a security password.

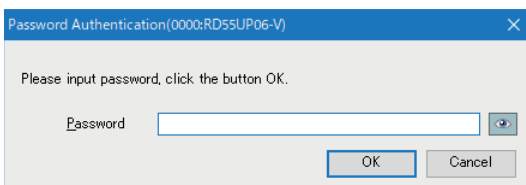

The "Service/account setting" screen appears.

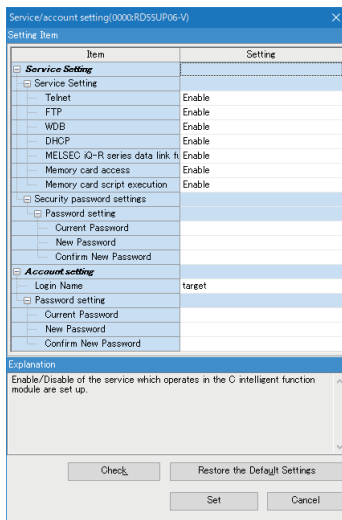

Displayed items

Item		Description	Setting range
Service Setting	Telnet	A service to use a Telnet.	<ul style="list-style-type: none"> • Enable • Disable (Default: Enable)
	FTP	A service to use an FTP.	
	WDB	A service to connect CW Workbench.	
	DHCP* ¹	A service to use a function which assigns the network settings automatically.	
	MELSEC iQ-R series data link function	A service to use MELSEC iQ-R series data link functions.	
	Memory card access	A service to access the memory card.	
	Memory card script execution	A service to use the script file stored in the memory card.	
Security password settings	Password setting* ²	Set a security password.	8 to 16 characters (Default: password)
Account setting	Login Name	Set the account log in name.	1 to 12 characters (single byte alphanumeric characters) (Default: target)
	Password setting* ²	Set the account password.	8 to 32 characters (Default: password)

*1 If it is disabled, a function which assigns the network settings automatically cannot be used.

To use the function, use VxWorks standard API functions.

For details on the VxWorks standard API functions, refer to the manual for VxWorks with the following version.

·VxWorks Version 6.9

If a function which assigns the network settings automatically is used, the IP address set in the parameter will be disabled.

*2 If the password setting is not entered (blank), it does not change from the current password.

Application method of the service/account setting

Settings in the service/account setting can be applied by the following operations:

■Service setting

1. Click the [Set] button in the "service/account setting" screen.
2. Turn the power OFF and ON, or reset the CPU module.

■Security password settings

Click the [Set] button in the "service/account setting" screen.

■Account setting

1. Click the [Set] button in the "service/account setting" screen.
2. Turn the power OFF and ON, or reset the CPU module.

Precautions

If a C intelligent function module is initialized, the service/account setting is restored to the factory default setting. (Page 29 Initialization function)

Usable character string for password setting

The following table shows the usable characters in the password setting.

Item	Description
Character	ASCII character string (Alphanumeric characters and special characters)* ¹ Usable special characters for password setting is as follows.* ² · ` , ~ , ! , @ , # , \$, % , ^ , & , * , (,) , _ , + , = , - , { , } , , \ , : , ; , ' , < , > , ? , , , . , / , [,] , space

*1 The password is case-sensitive.

*2 Special characters (|, ,, space) cannot be used in the password setting of the account settings.

Lockout

If the password authentication failed for several times, the password authentication will be denied (locked out) for a period of time. This prevents a brute force attack from unauthorized users.

Lockout time

The lockout time is as follows:

Number of password input error ^{*1}	Lockout time
1st time to 5th time	0 minute
6th time	1 minute
7th time	5 minutes
8th time	15 minutes
9th time or later	60 minutes

*1 Once the correct password is entered, the number of password input error will be cleared.

IP filter function

Access from an illegal IP address is prevented by identifying the IP address of communication target.

There are two IP filter functions.

Allow function: Allows access only from the specified IP addresses.

Deny function: Denies access only from the specified IP addresses.

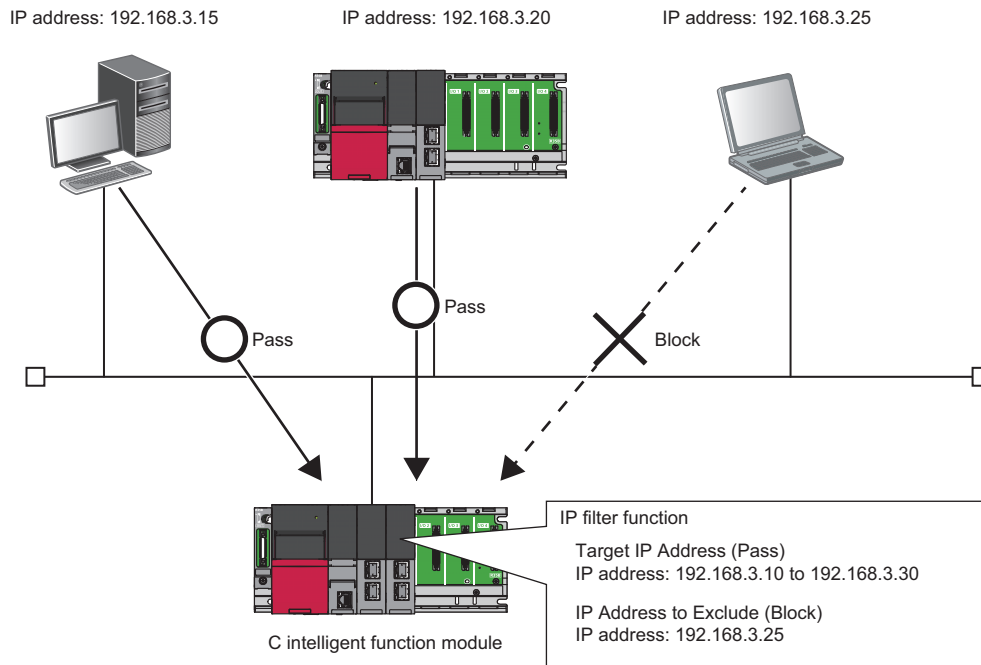

Setting method

1. Set the IP address to be allowed or denied in [Application Setting] ⇒ [Security] ⇒ "IP Filter Setting" in the module parameter of the C intelligent function module in the parameter setting of an engineering tool. (Page 54 Application Setting)
2. Set the CPU module to the STOP state, and write the parameters.
3. Reset the CPU module.

Precautions

If there is a proxy server on the LAN, block the IP address of the proxy server. Otherwise, the access from the personal computers that can access the proxy server cannot be prevented.

1.5 Time Synchronization Function

The time synchronization function synchronizes the time in a C intelligent function module with the CPU module time (in multiple CPU system, CPU No. 1).

Time synchronization timing

Timing of time synchronization is as follows.

- When the power is turned OFF and ON
- When the CPU module is reset
- Every 500 ms^{*1}
- When the C intelligent function module dedicated function (CITL_SyncTime) is executed

*1 The operating status of time synchronization can be set with the C intelligent function module dedicated function (CITL_SetSyncTimeStatus).

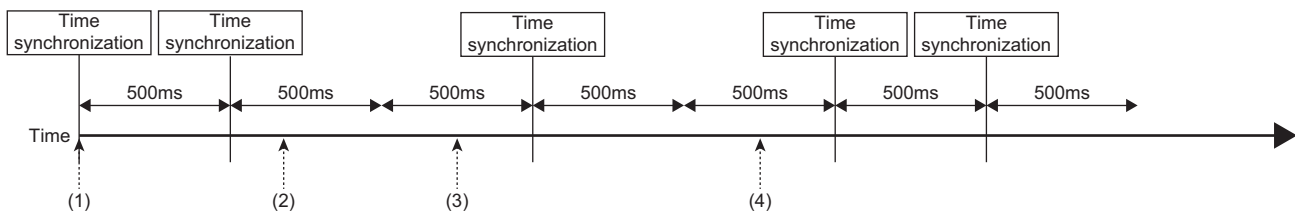

(1) The power is turned OFF and ON, or the CPU module is reset.

(2) The C intelligent function module dedicated function (CITL_SetSyncTimeStatus) is executed. (Synchronization is stopped.)

(3) When the C intelligent function module dedicated function (CITL_SyncTime) is executed.

(4) The C intelligent function module dedicated function (CITL_SetSyncTimeStatus) is executed. (Synchronization is started.)

Daylight saving time

If daylight saving time is set in the CPU module, the clock will be set ahead by 1 hour when the daylight saving time starts, and it will be set back to the original time when the daylight saving time ends.

The following shows an example of daylight saving setting time.

Ex.

If the daylight saving time starts from 02:00

The clock will be set ahead by 1 hour at the start time.

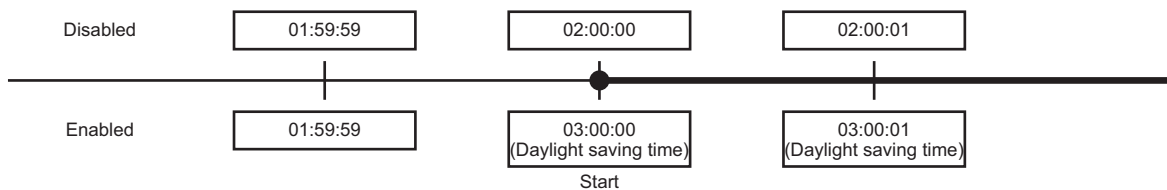

Ex.

If the daylight saving time ends at 02:00

The clock will be set back to the original time at the end time.

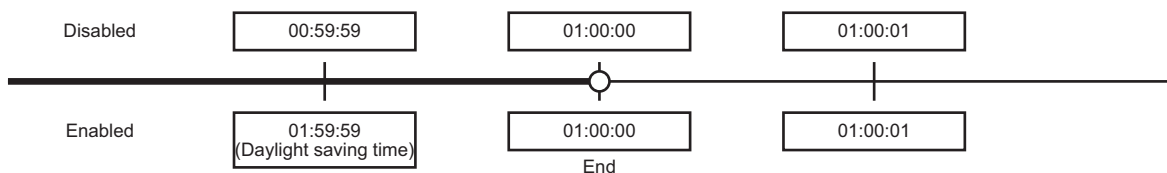

Operation for time synchronization

When a time synchronization process is executed to the CPU module, the time in a C intelligent function module is changed. Therefore, the time in the C intelligent function module may change significantly.

Since there is inaccuracy in the clock element in CPU module and C intelligent function module, the time may be moved slightly forward or backward when the time is synchronized.

Precautions

- Before using the C intelligent function module, set the clock data of CPU module. For the time data settings, refer to the manual of the CPU module used.
- There is inaccuracy in the clock data of the CPU module used by C intelligent function module. For the time data accuracy, refer to the user's manual of the CPU module used.
- When a C intelligent function module acquires the clock data in a CPU module, a maximum of one second of delay occurs as the transfer time.
- A time zone is not required to be set for the time synchronization function of a C intelligent function module because the clock data follows the time zone set in a CPU module. When specifying a time zone, set with a CPU module.

1.6 Sampling Function

This function samples target data from a CPU module.

Point

- To sample data in each sequence scan, a CPU module supporting the sequence scan synchronization sampling function is required.
- Data sampling in each sequence scan of a C intelligent function module is a best effort function. Since the processing time varies depending on the setting and the status of other devices, this function may not perform at the set sampling interval. Run the system by fully verifying the processing time of each function when constructing it.

Data sampling in sequence scan

This function samples target data by synchronizing with a sequence scan from a control CPU module by using the sequence scan synchronization sampling function of a control CPU module.

It also transfers device values to a C intelligent function module at the END processing of each scan in a control CPU module, then stores them in the temporary area in the module. The device values stored in the temporary area can be acquired with a C intelligent function module dedicated function.

Point

For the sequence scan synchronization sampling function, refer to the following:

📖 MELSEC iQ-R CPU Module User's Manual (Application)

■Timing of data sampling in each sequence scan

Target data is sampled for each sequence scan time of a CPU module.

When a CPU module is stopped, target data is not sampled.

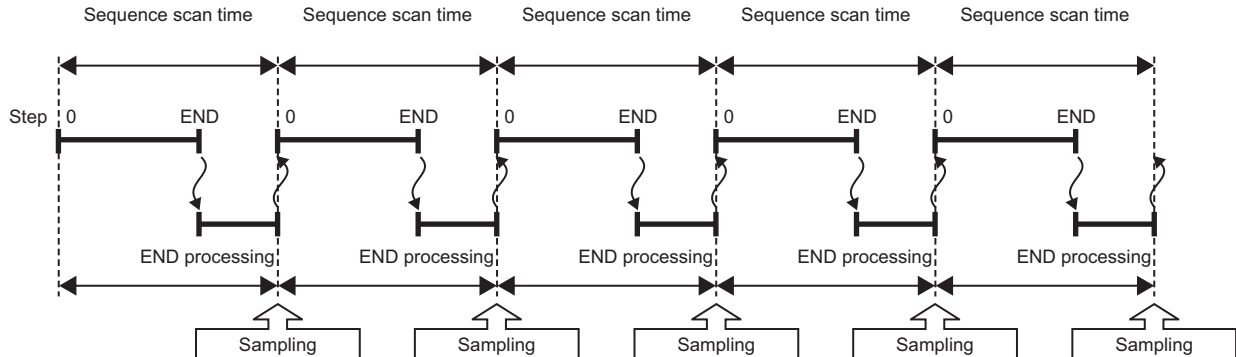

At the time of data sampling in each sequence scan, scan time increases due to transfer from a CPU module to a C intelligent function module.

For the influence on the sequence scan time, refer to the following:

📖 MELSEC iQ-R CPU Module User's Manual (Application)

■Temporary area at the time of data sampling

When executing the C intelligent function module dedicated function (CITL_SetCollectData), the temporary area is reserved in the memory with the following formula.

- Temporary area size: Number of retainable records × (Header information size + (Number of sampled points × 2 bytes))

The size of the temporary area varies depending on the number of sampling points and the number of retainable records.*1

*1 A record refers to data to be sampled in one sequence scan.

When executing the C intelligent function module dedicated function (CITL_SetCollectData) again, the temporary area for the previous settings is released, and the one calculated with new settings is reserved. To release the temporary area only, specify NULL for the storage destination for data set in the data sampling in each sequence scan setting (piSetData) of the C intelligent function module dedicated function (CITL_SetCollectData).

■Data sampling measurement time

The following shows the sequence scan time in which data can be sampled in each sequence scan.

However, since measurement time varies depending on the following external factors, the values in the following table are only a guide when using the sampling function.

- Sequence scan time
- Network status
- Operating status of a user program
- Access status to a CPU module from a peripheral device and another intelligent function module

Item	Number of device points							
	16	64	256	1024	4096	8192	16384	32768
Sampling rate [ms]	0.5	0.5	0.5	1	3	5	9	18

Data sampling flow

The following shows the flow of data sampling in each sequence scan.

■Function list

The following table shows the functions used for data sampling in each sequence scan.

Function name	Description
CITL_GetCollectData	To acquire data sampled in data sampling in each sequence scan.
CITL_SetCollectData	To set data to be sampled in data sampling in each sequence scan.
CITL_StartCollectData	To start data sampling in each sequence scan.
CITL_StopCollectData	To stop data sampling in each sequence scan.
CITL_WaitCollectDataRecvEvent	To wait for data to be sampled in data sampling in each sequence scan.

■Sampling data by polling

Target data is acquired from the temporary area of a C intelligent function module at a cycle set by a user.

However, if the execution cycle of the C intelligent function module dedicated function (CITL_GetCollectData) is too long, data may be missing. Create a user program by reference to the sampling timing specified with the dedicated function. (Page 42 Free space in the temporary area)

1. Set target data to be sampled with the C intelligent function module dedicated function (CITL_SetCollectData).
2. Start data sampling in each sequence scan with the C intelligent function module dedicated function (CITL_StartCollectData).
3. Acquire the target data from the temporary area of a C intelligent function module with the C intelligent function module dedicated function (CITL_GetCollectData).
4. To acquire the next target data, execute the C intelligent function module dedicated function (CITL_GetCollectData) again.

■Sampling data by waiting for data to be sampled

Target data is acquired from the temporary area of a C intelligent function module at the timing when data for the specified number of records is stored in the temporary area with the C intelligent function module dedicated function (CITL_WaitCollectDataRecvEvent).

1. Set target data with the C intelligent function module dedicated function (CITL_SetCollectData).
2. Start data sampling in each sequence scan with the C intelligent function module dedicated function (CITL_StartCollectData).
3. Wait for data for the specified number of records to be sampled with the C intelligent function module dedicated function (CITL_WaitCollectDataRecvEvent).
4. Acquire the target data from the temporary area of a C intelligent function module with the C intelligent function module dedicated function (CITL_GetCollectData).
5. To acquire the next target data, execute the C intelligent function module dedicated function (CITL_WaitCollectDataRecvEvent) again, and acquire the target data with the C intelligent function module dedicated function (CITL_GetCollectData).

■Changing target data (re-registration)

To change target data for data sampling in each sequence scan, data sampling needs to be stopped once. Change target data after stopping data sampling.

1. Stop data sampling with the C intelligent function module dedicated function (CITL_StopCollectData).
2. Set target data with the C intelligent function module dedicated function (CITL_SetCollectData).

■Ending data sampling

To end data sampling in each sequence scan, data sampling needs to be stopped once. End data sampling after stopping data sampling.

1. Stop data sampling with the C intelligent function module dedicated function (CITL_StopCollectData).
2. Specify NULL for the storage destination for data set in the data sampling in each sequence scan setting (plSetData) of the C intelligent function module dedicated function (CITL_SetCollectData).

Precautions

If CPU parameters of a control CPU module are changed during data sampling in each sequence scan, data sampling is stopped. Since the assignment of devices may be changed due to the change of CPU parameters, set target data with the C intelligent function module dedicated function (CITL_SetCollectData) again when restarting data sampling.

Sampling timing of target data

To sample target data without missing, the free space needs to be created in the temporary area by executing the C intelligent function module dedicated function (CITL_GetCollectData) and acquiring sampled data stored in the temporary area. For the execution interval of the C intelligent function module dedicated function (CITL_GetCollectData), set an interval optimal to the system within a value obtained by dividing 'the time when the space in the temporary area is full' by 2.

Point

When the number of retainable records is extremely small, the space in the temporary area may be full even if the execution timing of the C intelligent function module dedicated function (CITL_GetCollectData) is set to the maximum value. Create a user program to periodically execute the C intelligent function module dedicated function (CITL_GetCollectData) before the space in the temporary area is full.

Free space in the temporary area

The temporary area of a C intelligent function module is reserved in the memory when executing the C intelligent function module dedicated function (CITL_SetCollectData), and the space will be full at the time calculated with the following formula. When the space in the temporary area is full, data will not be sampled after that and data will be missing.

- Time: Number of retainable records × Sequence scan time

Data missing

Data missing is that the sampled data is not continuous.

Data is missing in the following cases:

Item	Description
Sampling failure	<ul style="list-style-type: none">• Data sampling in each sequence scan fails because it cannot catch up with the sampling interval• The temporary area of a C intelligent function module is full with stored data
Module operation	<ul style="list-style-type: none">• The operating status of a control CPU module is switched from STOP to RUN at the time of data sampling in each sequence scan

Checking data missing

Data missing can be checked by the following methods:

- Buffer memory (data missing status)^{*1}
- Header information (index and data missing status)

^{*1} When executing the C intelligent function module dedicated function (CITL_StopCollectData), the data missing status in the buffer memory is initialized.

Data structure of target data

The following shows the data structure of target data.

(1)			(2)		
1	2017/1/1 12:00:00.0000	0	1	~	3
2	2017/1/1 12:00:00.0100	0	3	~	6
3	2017/1/1 12:00:00.0200	0	5	~	9
⋮			⋮		
m	2017/1/1 12:01:45.5200	0	n	~	n

Item		Description	
(1)	Header information	Index	Indicates the sequential serial number of sampled data. (0 to 4294967295) A numerical value counted up in ascending order starting from 1 is output. When it exceeds the upper limit 4294967295, it counts up again from 0. When data is missing, an index is assigned again from a record after data is missing. (It counts up again from 1.)
		Date and time	Indicates the time of a C intelligent function module when data is sampled.
		Data missing status	Indicates the data missing status. Data is missing between a record in which the data is missing and the previous record. • 0: Data is not missing • 1: Data is missing
(2)	Target data	Sampled data (start)	Target data sampled in data sampling in each sequence scan
		Sampled data (end)	

■Header information

Data is output continuously in order from an index, a date and time, and the data missing status to the header information. For header information, data to be output can be specified with the C intelligent function module dedicated function (CITL_SetCollectData).

■Record size

The size of a record to be acquired can be checked with the C intelligent function module dedicated function (CITL_SetCollectData).

1 record size is the total size of header information and target data.

Item	Description
Header information	The size of header information is the total of a data size to be output. The calculating formula when outputting an index, a date and time, and the data missing status is as follows: • Header information size = Index (2 words) + Date and time (4 words) + Data missing status (1 word)
Target data	The size of target data can be calculated with the following formula. (Word) • Target data size = Number of bit devices + Number of word devices + (Number of double word devices × 2)

Target data

The following shows the data that can be sampled at the time of data sampling in each sequence scan.

■Data type

Target data can be sampled as a data type in the following table:

Data type	Number of device points
Bit	1 point
Word	1 point
Double word	2 points

■Number of settings

Target data can be set up to 32768 points.

Note that the number of points that can be sampled for one control CPU module must not be exceeded.

 MELSEC iQ-R CPU Module User's Manual (Application)

Precautions

When multiple intelligent function modules use the sequence scan synchronization sampling function, note the total number of points for target data. If it exceeds the number of points that can be sampled, an error may occur in registration processing of an intelligent function module registered later.

■Device list

The file registers for each local device and program in which the program name is specified cannot be accessed.
Bit specified devices and digit specified devices cannot be specified.

Item	Description	
Device	Special relay (SM)	
	Special register (SD)	
	Input relay (X)	
	Output relay (Y)	
	Internal relay (M)	
	Latch relay (L)	
	Annunciator (F)	
	Edge relay (V)	
	Link relay (B)	
	Data register (D)	
	Link register (W)	
	Timer	Contact (TS)
		Coil (TC)
		Current value (T/TN) ^{*1}
	Long timer	Contact (LTS)
		Coil (LTC)
		Current value (LT/LTN) ^{*1}
	Counter	Contact (CS)
		Coil (CC)
		Current value (C/CN) ^{*1}
	Long counter	Contact (LCS)
		Coil (LCC)
		Current value (LC/LCN) ^{*1}
	Retentive timer	Contact (STS)
		Coil (STC)
		Current value (ST/STN) ^{*1}
	Long retentive timer	Contact (LSTS)
		Coil (LSTC)
		Current value (LST/LSTN) ^{*1}
	Link special relay (SB)	
	Link special register (SW)	
Index register (Z)		
Long index register (LZ)		
File register	(R) ^{*2}	
	(ZR) ^{*2}	
Refresh data register (RD)		

*1 Either of the device names can be specified.

*2 When accessing out of the range of the file register (R/ZR) area, the value of -1(FFFFH) is read.

1.7 SD Memory Card Boot Function

This function starts Linux stored in an SD memory card.

Startup method

To start Linux, insert an SD memory card where an Linux image is written into the SD memory card slot of a C intelligent function module, then turn the power OFF and ON.

Contact information on Linux operations, refer to the following:

 C Controller/C Intelligent Function Module Consolidated Catalog (L08165E)

1.8 FIRMWARE UPDATE FUNCTION

Acquire a firmware update file from the Mitsubishi Electric FA website to update the version of the firmware. For the module models that support this function, precautions that are common to those modules, and update procedure, refer to the following:

📖 MELSEC iQ-R Module Configuration Manual

Restriction

Before using the firmware update function, check the firmware version of a C intelligent function module.
(📖 Page 102 Added and Changed Functions)

Precautions

The following shows the considerations for a C intelligent function module when using the firmware update function.

■ Startup time of a C intelligent function module

The startup time of a C intelligent function module may vary depending on the firmware version.

To make a system program run on the startup of a C intelligent function module, configure an interlock using input/output signals. (📖 Page 78 Input/Output Signals)

2 PARAMETER SETTING

Set various operations in parameters with an engineering tool.

2.1 Parameter Setting Procedure

The parameter setting procedure when C intelligent function module is used is shown below.

1. Add a C intelligent function module to an engineering tool.

 [Navigation window] ⇒ [Parameter] ⇒ right-click [Module Information] ⇒ [Add New Module]

2. Set four types of parameter settings, basic settings, application settings, interrupt settings, and refresh settings, in the screen displayed by the following operation:

 [Navigation window] ⇒ [Parameter] ⇒ [Module Information] ⇒ Target module

3. Write the settings to a CPU module in the engineering tool.

 [Online] ⇒ [Write to PLC]

4. Apply the settings by resetting the CPU module, or turning the power OFF and ON.

2.2 Basic Setting

Set mode settings and own node settings.

RD55UP06-V

2

Window

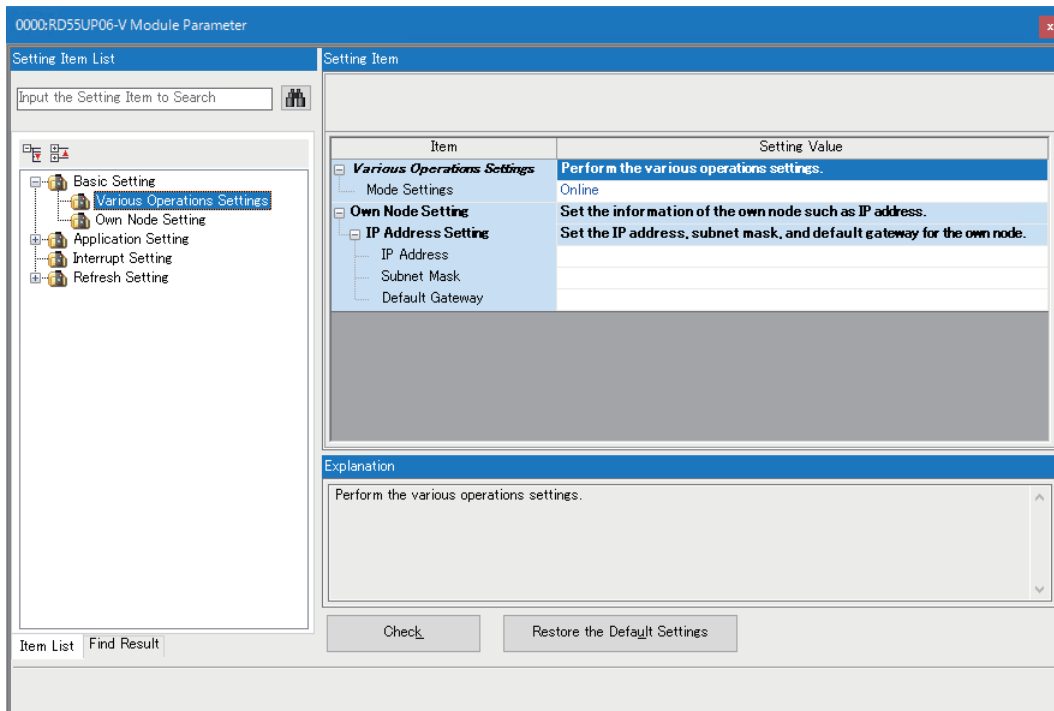

Displayed items

Item	Description	Setting range
Mode Settings	<p>Set the operation mode of C intelligent function module.</p> <ul style="list-style-type: none"> • Online: Normal operation mode. • Stop Script File Setting: The registered script file stops being executed. • Module Initialization Setting: The standard ROM is formatted. • Automatic H/W Test: H/W such as ROM/RAM/Ethernet of the C intelligent function module is tested. • LED H/W Test: The LED of the C intelligent function module is tested. • Firmware update: Update the firmware of C Intelligent Function Module. 	<ul style="list-style-type: none"> • Online • Stop Script File Setting • Module Initialization Setting • Automatic H/W Test • LED H/W Test • Firmware update (Default: Online)
Own Node Setting	<p>IP Address Setting</p> <p>Set the IP address, subnet mask, and default gateway for the own node. The "IP Address Setting" screen appears by double-clicking a cell of IP address setting.</p>	<p>Page 50 IP Address Setting</p>

IP Address Setting

Set the IP address of the own node.

Item	Description	Setting range
IP Address	<p>Set the IP address of the own node.</p> <p>Ensure that the own node and the external device to be communicated with have the same class and subnet address.</p> <p>Set the IP address in the range of class A/B/C.</p> <p>If IP address is not set, the module operates 192.168.3.3.</p> <p>Please note the following points to set the IP Address and the Subnet Mask setting.</p> <ul style="list-style-type: none"> • All zeros or all ones cannot be set as the bits in the host address portion of the IP address. • All zeros or all ones cannot be set as the bits in the network address portion of the IP address. 	<ul style="list-style-type: none"> • Empty (no setting) • 0.0.0.5 to 223.255.255.254 (Default: empty)
Subnet Mask	<p>Set the subnet mask of the own node.</p> <p>Set to determine how many bits of the IP address are used as the network address, which is used to identify the network.</p> <p>For example, set '255.255.255.0' to assign the upper 24 bits of IP address to the subnet mask.</p>	<ul style="list-style-type: none"> • Empty • 192.0.0.0 to 255.255.255.252 (Default: empty)
Default Gateway	<p>Set the IP address of the default gateway (the device which the own node passes through to access a device of another network).</p> <p>Please set subnet address of default gateway so that it is the same with the one of host station.</p>	<ul style="list-style-type: none"> • Empty • 0.0.0.1 to 223.255.255.254 (Default: empty)

RD55UP12-V

Window

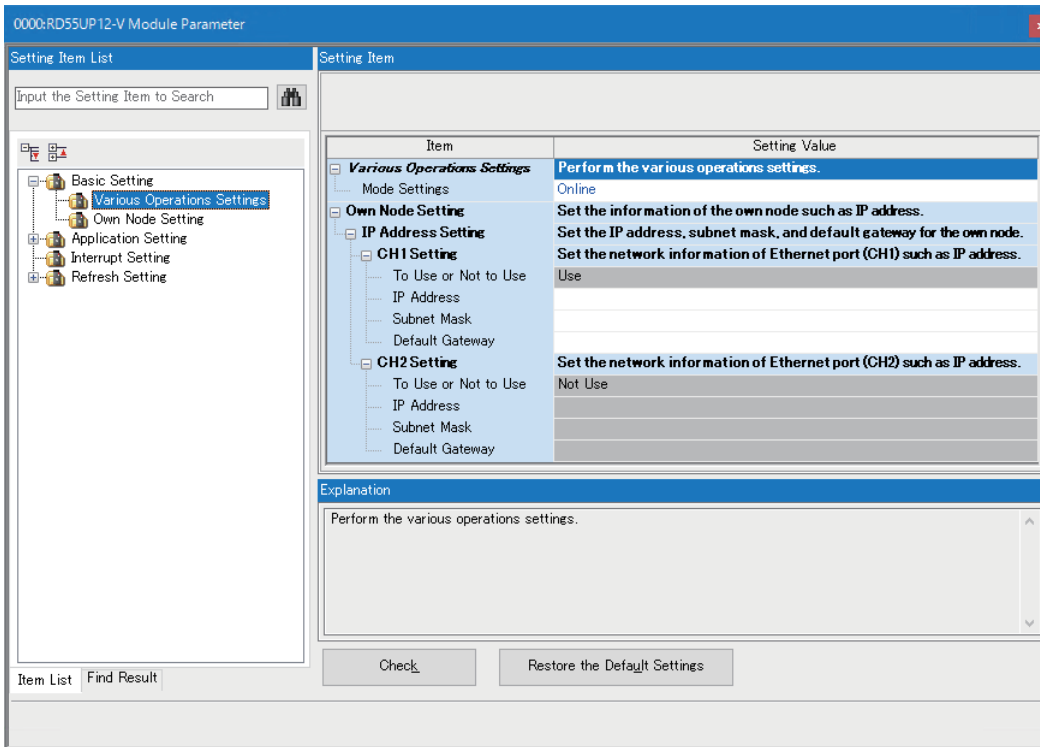

Displayed items

Item	Description	Setting range
Mode Settings	Set the operation mode of C intelligent function module. <ul style="list-style-type: none"> • Online: Normal operation mode. • Stop Script File Setting: The registered script file stops being executed. • Module Initialization Setting: The standard ROM is formatted. • Automatic H/W Test: H/W such as ROM/RAM/Ethernet of the C intelligent function module is tested. • LED H/W Test: The LED of the C intelligent function module is tested. • Firmware update: Update the firmware of C Intelligent Function Module. 	<ul style="list-style-type: none"> • Online • Stop Script File Setting • Module Initialization Setting • Automatic H/W Test • LED H/W Test • Firmware update (Default: Online)
Own Node Setting	IP Address Setting Set the IP address, subnet mask, and default gateway for the own node. The "IP Address Setting" screen appears by double-clicking a cell of IP address setting.	Page 52 IP Address Setting

IP Address Setting

Set the IP address of the own node.

CH1 Setting

To Use or Not to Use: Use

IP Address

Subnet Mask

Default Gateway

CH2 Setting

To Use or Not to Use: Not Use

IP Address

Subnet Mask

Default Gateway

Set the IP address of the own node CH1.
Ensure that the own node CH1 and the external device to be communicated with have the same class and subnet address.
Set the IP address in the range of class A/B/C.
Please set it to belong to a different network from own node CH2.
[Setting range]
- Empty (no setting)
- 0.0.0.5 to 223.255.255.254
You must set "Use" at least CH1 or CH2.

Please note the following points to set the IP Address and the Subnet Mask setting.

- All zeros or all ones cannot be set as the bits in the host address portion of the IP address.
- All zeros or all ones cannot be set as the bits in the network address portion of the IP address.
- You cannot input when the CH1 setting is "Not Use".

Check Restore the Default Settings OK Cancel

Item	Description	Setting range	
CH1 Setting	To Use or Not to Use	Set whether to use the Ethernet port (CH1). You must set "Use" at least CH1 or CH2.	
	Use	<ul style="list-style-type: none"> • Not Use • Use (Default: Use)	
	IP Address	Set the IP address of the own node CH1. Ensure that the own node CH1 and the external device to be communicated with have the same class and subnet address. Set the IP address in the range of class A/B/C. Please set it to belong to a different network from own node CH2. You must set "Use" at least CH1 or CH2. Please note the following points to set the IP Address and the Subnet Mask setting. <ul style="list-style-type: none"> • All zeros or all ones cannot be set as the bits in the host address portion of the IP address. • All zeros or all ones cannot be set as the bits in the network address portion of the IP address. • You cannot input when the CH1 setting is "Not Use". 	<ul style="list-style-type: none"> • Empty (no setting) • 0.0.0.5 to 223.255.255.254 (Default: empty)
	Subnet Mask	Set the subnet mask of the own node CH1. Set to determine how many bits of the IP address are used as the network address, which is used to identify the network. For example, set '255.255.255.0' to assign the upper 24 bits of IP address to the subnet mask. Please set it to belong to a different network from own node CH2. <ul style="list-style-type: none"> • You cannot input when the CH1 setting is "Not Use". 	<ul style="list-style-type: none"> • Empty • 192.0.0.0 to 255.255.255.252 (Default: empty)
Default Gateway	Set the IP address of the default gateway (the device which the own node(CH1) passes through to access a device of another network). Please set subnet address of default gateway so that it is the same with the one of host station. <ul style="list-style-type: none"> • You cannot input when the CH1 setting is "Not Use". 	<ul style="list-style-type: none"> • Empty • 0.0.0.1 to 223.255.255.254 (Default: empty)	

Item		Description	Setting range
CH2 Setting	To Use or Not to Use	Set whether to use the Ethernet port (CH2). You must set "Use" at least CH1 or CH2.	<ul style="list-style-type: none"> • Not Use • Use (Default: Not Use)
	IP Address	Set the IP address of the own node CH2. Ensure that the own node CH2 and the external device to be communicated with have the same class and subnet address. Set the IP address in the range of class A/B/C. Please set it to belong to a different network from own node CH1. An error will occur when IP address is not set. You must set "Use" at least CH1 or CH2. Please note the following points to set the IP Address and the Subnet Mask setting. <ul style="list-style-type: none"> • All zeros or all ones cannot be set as the bits in the host address portion of the IP address. • All zeros or all ones cannot be set as the bits in the network address portion of the IP address. • You cannot input when the CH2 setting is "Not Use". 	0.0.0.5 to 223.255.255.254 (Default: empty)
	Subnet Mask	Set the subnet mask of the own node CH2. Set to determine how many bits of the IP address are used as the network address, which is used to identify the network. For example, set '255.255.255.0' to assign the upper 24 bits of IP address to the subnet mask. Please set it to belong to a different network from own node CH1. <ul style="list-style-type: none"> • You cannot input when the CH2 setting is "Not Use". 	192.0.0.0 to 255.255.255.252 (Default: empty)
	Default Gateway	Set the IP address of the default gateway (the device which the own node(CH2) passes through to access a device of another network). Please set subnet address of default gateway so that it is the same with the one of host station. <ul style="list-style-type: none"> • You cannot input when the CH2 setting is "Not Use". 	<ul style="list-style-type: none"> • Empty • 0.0.0.1 to 223.255.255.254 (Default: empty)

Precautions

- When using both CH1 and CH2, set different values to their IP addresses and subnet masks.
- Setting both CH1 and CH2 to "Not Use" is not possible. Make sure that either CH1 or CH2 is set to "Use."

2.3 Application Setting

Set the target IP address.

Window

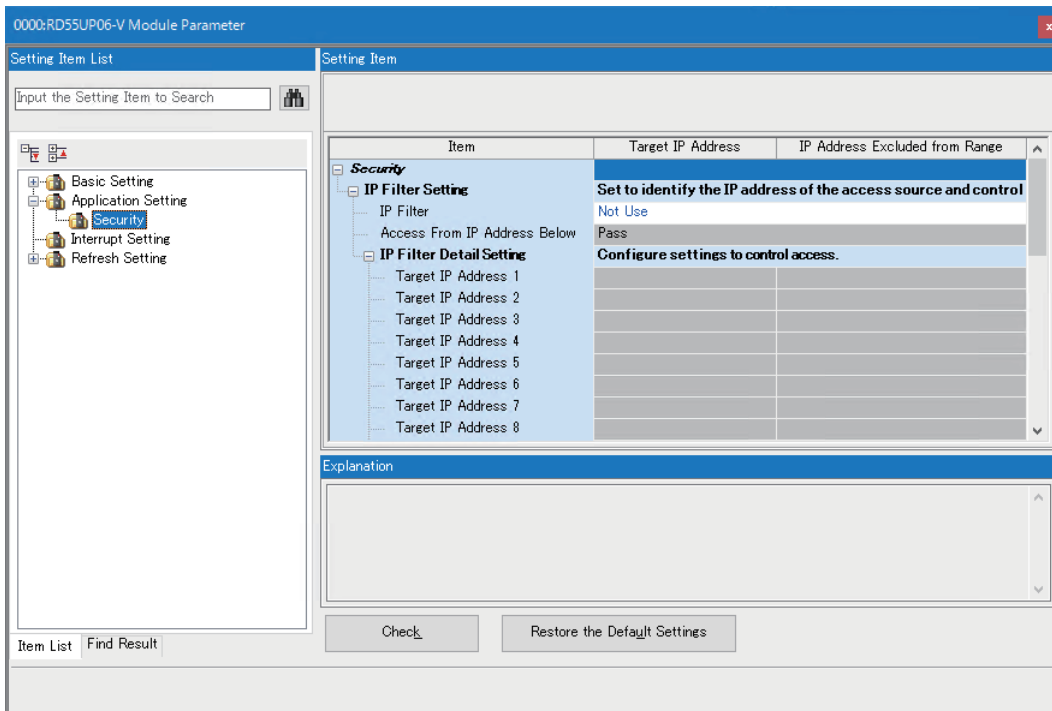

Displayed items

Item	Description	Setting range
IP Filter Setting	IP Filter	Set whether to enable the IP filter function.
	Access From IP Address Below	Set whether to allow/deny the access from the specified IP addresses.
	IP Filter Detail Setting	Set the IP addresses to be allowed or denied. Please do not include the loopback address (127.0.0.1) in the target IP address. The "IP Filter Detail Setting" screen appears by double-clicking a cell of IP filter detailed setting.
		<ul style="list-style-type: none"> • Not Use • Use (Default: Not Use)
		<ul style="list-style-type: none"> • Pass • Block
		Page 55 IP Filter Detail Setting

IP Filter Detail Setting

Set the target IP address and IP address to be excluded.

Window

2

IP Filter Detail Setting

Target IP Address

. . . - . . .

No.	IP Address Excluded from Range
1	. . .
2	. . .
3	. . .
4	. . .
5	. . .
6	. . .
7	. . .
8	. . .
9	. . .
10	. . .

Set the IP address to be allowed or denied.
To set a single IP address, enter the IP address in this field and leave the right field blank.

Check Restore the Default Settings OK Cancel

Displayed items

Item	Description	Setting range
Target IP Address	Set the IP address to be allowed or denied. To set a single IP address, enter the IP address in the left field and leave the right field blank.	0.0.0.1 to 223.255.255.254 (Default: empty)
IP Address Excluded from Range ^{*1}	Set the IP addresses to be excluded from the set range.	0.0.0.1 to 223.255.255.254 (Default: empty)

*1 Can be specified in GX Works3 or CW Configurator.

2.4 Interrupt Setting

Set interrupt operation settings, interrupt conditions, and interrupt pointer.

Window

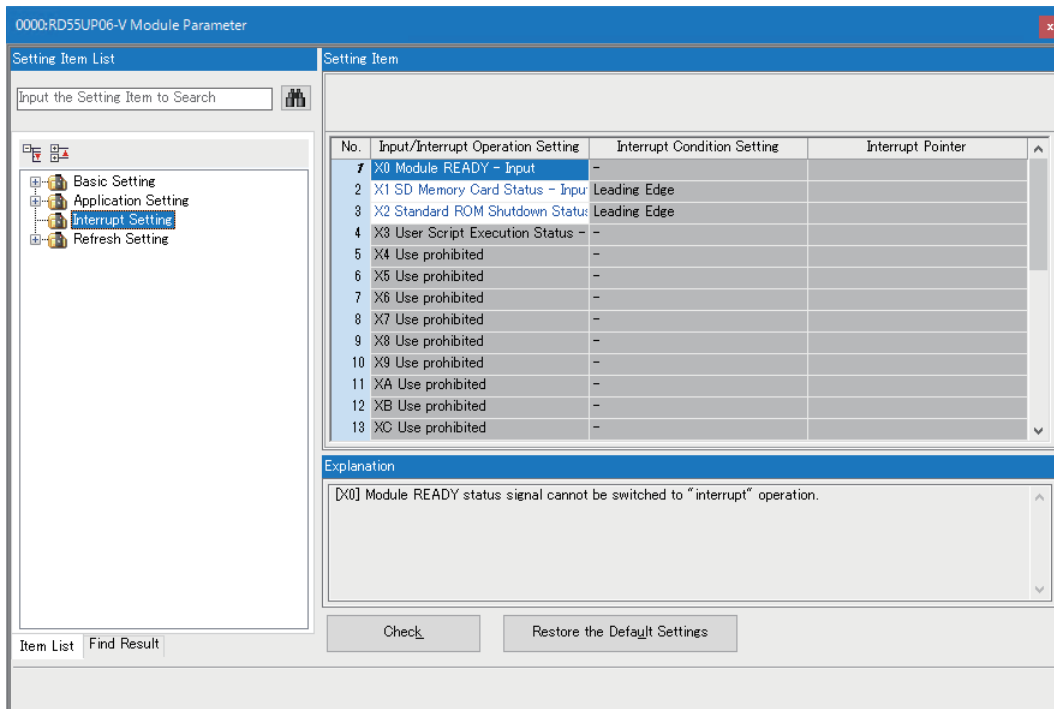

Displayed items

Item	Description	Setting range
Input/Interrupt Operation Setting	Set whether to operate in input or interrupt.	<ul style="list-style-type: none"> Input Interrupt (Default: Input)
Interrupt Condition Setting	Set conditions for interrupt occurrence factor. This setting is enabled when "Interrupt" is selected for "Input/Interrupt Operation Setting."	<ul style="list-style-type: none"> Leading Edge Trailing Edge Leading Edge/Trailing Edge (Default: Leading Edge)
Interrupt Pointer	Specify the interrupt pointer number which is activated when the interrupt factor is detected. Example: Set 'I50' to specify interrupt pointer I50.	I0 to I15, I50 to I1023 (Default: empty)

■Interrupt pointer

Specify an interrupt pointer that operates when interrupt factor is detected.

For details on interrupt pointers, refer to the following:

📖 MELSEC iQ-R CPU Module User's Manual (Application)

2.5 Refresh Setting

Set the refresh timing as per specified refresh target.

Window

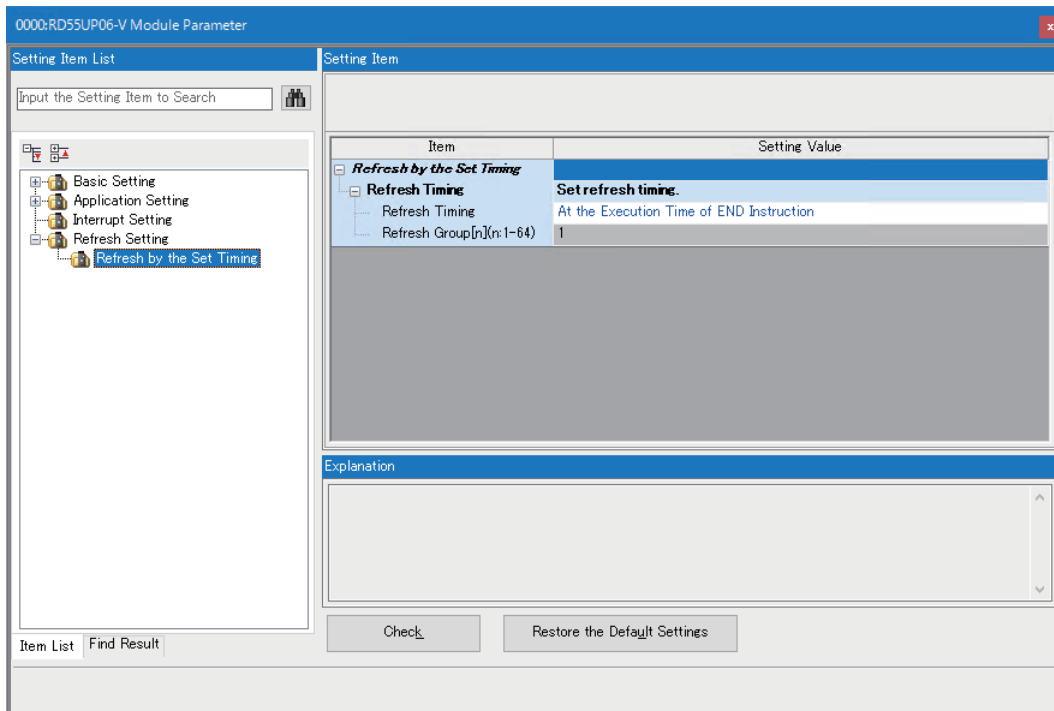

Displayed items

Item	Description	Setting range
Refresh Timing	Set refresh timing.	<ul style="list-style-type: none"> At the Execution Time of END Instruction At the Execution Time of Specified Program (Default: At the Execution Time of END Instruction)
Refresh Group[n](n: 1-64)	Specify the refresh group of the program. Please set it through Program Setting of CPU Parameter.	1 to 64

Refresh timing

■At the Execution Time of END Instruction

The setting is refreshed at the END processing in the CPU module.

■At the Execution Time of Specified Program

The setting is refreshed when a program specified in "Refresh Group[n](n: 1-64)" is executed.

3 TROUBLESHOOTING

This chapter explains the errors which may occur when using an C intelligent function module and the troubleshooting.

3.1 Checking Method for Error Descriptions

The following are the methods to check error descriptions.

Checking method	Description
System monitor of an engineering tool	Error codes can be checked by the system monitor of an engineering tool.
Buffer memory	Error codes can be checked in the following buffer memory. ☞ Page 87 Current error area (Un\G140 to 147) ☞ Page 88 Error log area (Un\G150 to 311)
Check with a C intelligent function module dedicated function	Error codes can be checked with the C intelligent function module dedicated function (CITL_GetErrInfo).

Point

- If multiple errors occur at the same time, take corrective action for the errors in chronological order.
- If a user program is incorrect, the accurate error code may not be output. If the error is not cleared even after taking corrective action, review the user program.

3.2 Error Type

There are two types of errors of a C intelligent function module as follows:

Error Type	Lighting status of ERR LED	Module Status	Corrective action
Module minor error	ON	Input signal (X) and buffer memory output continues.	After taking corrective actions according to the error code content, turn the ERR LED OFF by any of the following operations. <ul style="list-style-type: none">• Turning ON the error clear request (YF)• Cleaning error from an engineering tool• Clearing error with C intelligent function module dedicated function (CITL_ClearError)• Resetting the CPU module, or turning the power OFF and ON
Module major error or moderate error	Flashing	Input signal (X) and buffer memory output stops.	

3.3 Checking Module Status

The module status can be checked in the "Module Diagnostics" screen of an engineering tool.

Function	Purpose	Reference
Error Information	To display the description of an error currently occurred. The history of an error detected in a C intelligent function module and an executed operation can be checked by clicking the [Event History] button.	Page 59 Error information
Module Information List	To display the information on each status of a C intelligent function module.	Page 60 Module information list

Error information

The description of an error occurring and its corrective action can be checked in the [Error Information] tab.

Window

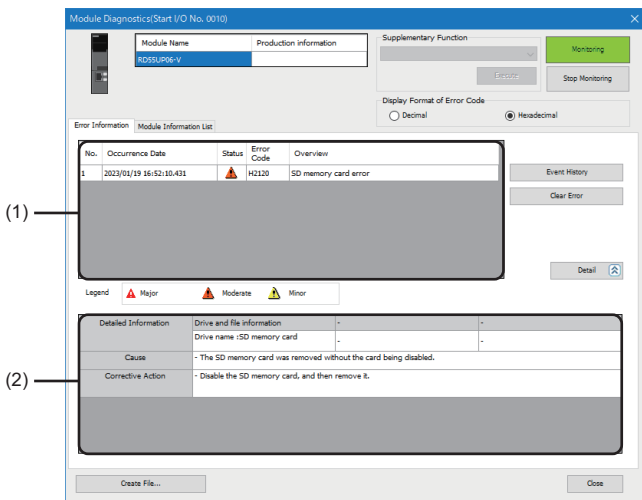

Displayed items

Item	Description	
(1) Error information list	Errors occurring are listed.	
(2) Error detailed information	—	Detailed information on an error selected in the error information list is displayed.
	Detailed Information	Detailed information on an error is displayed (up to three).
	Cause	An error cause is displayed.
	Corrective Action	A corrective action for an error is displayed.

Module information list

Errors occurring are listed.

During a self-diagnostic test, "Automatic hardware is being tested" or "Hardware test for LED check is being executed" is displayed in all the LED information and switch information.

If an error occurs, refer to the following section to take corrective action.

☞ Page 63 Troubleshooting by Symptom

Window

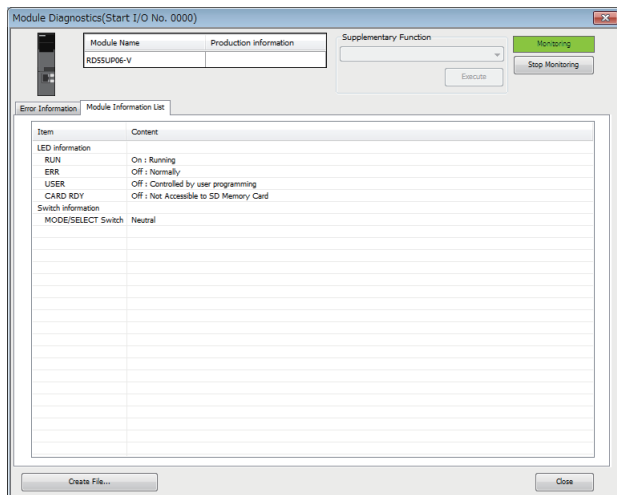

Displayed items

Item		Description
LED information	RUN	The operating status of a module is displayed.
	ERR	The error status of a module is displayed.
	USER	The control status of the USER LED of a module is displayed.
	CARD RDY	The status of an SD memory card is displayed.
Switch information	MODE/SELECT switch	Information on the MODE/SELECT switch is displayed.

3.4 Self-diagnostic Tests

Automatic hardware test

Tests related to the hardware such as ROM, RAM, and Ethernet of a C intelligent function module can be performed.

Restriction

- The values in the buffer memory cannot be referenced in an engineering tool during the automatic hardware test.
- During the automatic hardware test, do not change the operating status of a CPU module. Otherwise, the module major error (2442H) occurs in the CPU module.

Operating procedure

1. Select "Automatic hardware test" in "Basic Settings" ⇒ "Various Operations Settings" ⇒ "Mode Settings" for a C intelligent function module in an engineering tool.
2. Disconnect a cable if it is connected to a 1000BASE-T/100BASE-TX/10BASE-T interface.
3. Remove an SD memory card if it is inserted.
4. Set the CPU module to the STOP state, and write the parameters.
5. Reset the CPU module.
After it is reset, the automatic hardware test is performed automatically. The LED display for the automatic hardware test is as follows:

Status		RUN LED status	ERR LED status
Automatic hardware test is in process.		Flashing (low-speed)	OFF
Automatic hardware test is complete.	Normal completion	ON	OFF
	Abnormal completion	ON	ON

6. When the test is completed normally, return the mode setting changed in step 1 to "Online" and reset the CPU module.
7. When the test is completed abnormally, check if measures are taken to reduce noise of the programmable controller system, and perform the test again. If it is completed abnormally again, a hardware failure may occur in the C intelligent function module. Please contact your local Mitsubishi Electric sales office or representative.
Do not use an electric screwdriver when removing the module. Loose the module fixing screws completely to remove the module.

Hardware test for LED check

The following explains the LED hardware diagnostic of a C intelligent function module. For the diagnostic, the LED of a C intelligent function module needs to be turned ON.



The values in the buffer memory cannot be referenced in an engineering tool during the hardware test for LED check.

Operating procedure

1. Select "Hardware test for LED check" in "Basic Settings" ⇒ "Various Operations Settings" ⇒ "Mode Settings" for a C intelligent function module in an engineering tool.
2. Set the CPU module to the STOP state, and write the parameters.
3. Reset the CPU module.
After it is reset, the hardware test for LED check is performed automatically. When the following contents are displayed, check them visually for any errors.

LED name	Lighting color	Lighting status
RUN	Green	ON
ERR	Red	ON
CARD RDY	Green	ON
USER	Green	ON

4. When the test is completed normally, change the mode set in the step 1 back to "Online," and reset the CPU module.
5. When the test is completed abnormally, check if measures are taken to reduce noise of the programmable controller system, and perform the test again. If it is completed abnormally again, a hardware failure may occur in the C intelligent function module. Please contact your local Mitsubishi Electric sales office or representative.
Do not use an electric screwdriver when removing the module. Loose the module fixing screws completely to remove the module.

3.5 Troubleshooting by Symptom

If any of the functions of a C intelligent function module does not operate properly, perform troubleshooting by checking the following items. If the ERR LED is flashing, clear the error using an engineering tool.

RUN LED does not turn ON

Check the following items.

Check item	Corrective action
Is ERR LED ON?	System watchdog timer error occurred. <ul style="list-style-type: none">• Check if user tasks with higher priority occupy the system.• Take corrective actions against the occurrence of any system watchdog timer error (3C00H). (Page 67 Error Code List)
Is ERR LED flashing?	The hardware failure has occurred. Take corrective actions according to the events registered in the event history.
Is the power turned OFF, or is the CPU module reset while accessing files?	Reset the CPU module, or turn the power OFF and ON to start the C intelligent function module.

RUN LED continues flashing (low-speed)

Check the following items.

Flashing status (low-speed) of RUN LED is displayed during execution of script file (STARTUP.CMD).

After taking corrective actions corresponding to the 'Check item' given below, correct the script file and the user program that is activated from the script file.

Check item	Corrective action
Is the script file stored to the standard ROM?	<ul style="list-style-type: none">• Store the unprocessed script file in an SD memory card and restart the C intelligent function module.• Initialize the C intelligent function module.
Cannot the script file in the standard ROM be overwritten?	<ul style="list-style-type: none">• Store the unprocessed script file in an SD memory card and restart the C intelligent function module.• Check free space of the standard ROM.• Initialize the C intelligent function module.

Ethernet communication cannot be established between personal computer and C intelligent function module

Issue PING command from the personal computer to the C intelligent function module, and check the response.

If the response is incorrect

Check the following items.

Check item	Corrective action
Is an Ethernet cable connected to the Ethernet port?	Connect the Ethernet cable.
Are the IP address segments of the personal computer and the C intelligent function module different?	Set the same segments to both the personal computer and C intelligent function module. <ul style="list-style-type: none">• If it is relayed through the LAN of another segment via the gateway, contact the network administrator of the connected LAN.
Do the duplicate IP addresses with the personal computer and the C intelligent function module exist in the connected LAN?	Contact the LAN network administrator to eliminate the duplication of the IP address.
Do the IP address respond properly after the C intelligent function module is replaced?	Reset all terminals of the network to which the C intelligent function module is connected.
Is the IP address outside range specified?	Consider the following contents and set correct IP address. <ul style="list-style-type: none">• The IP address starts with a number from 1 to 233, excluding 127.• No space is included in the IP address.• The IP address is specified with single byte numbers only.
Is the network in the overloaded conditions?	Disconnect the other Ethernet devices, and establish the connection only with the C intelligent function module.
Is this blocked by IP filter function?	Access IP filter function from release or different IP address.
If using an RD55UP12-V, is the channel to be used set to "Not Use" in the IP address settings?	Change the setting for the channel to "Use," and set its IP address, subnet mask, and default gateway.

If the response is normal

In conjunction with the symptoms occurred, perform troubleshooting.

■CW Workbench connection fails

Check the following items.

Check item	Corrective action
Is "Target Server Options" of CW Workbench set properly?	Set "Target Server Options" of CW Workbench properly.

■Telnet connection fails

Check the following items.

Check item	Corrective action
Is the log in name and password correct?	Enter correct log in name and password. If the password is not known, reset log in name and password by initializing C intelligent function module.
Is the message "Sorry, session limit reached" displayed?	Terminate the Telnet connection from another personal computer and take any of the following actions: <ul style="list-style-type: none">• Reconnect after the Telnet connection timeout time has elapsed.• Turn the power OFF and ON, or reset the CPU module.

■FTP connection fails

Check the following items.

Check item	Corrective action
Is the log in name and password correct?	Enter correct log in name and password. If the password is not known, reset log in name and password by initializing C intelligent function module.
Are there 11 or more FTP connections to one C intelligent function module?	Make an adjustment so that the number of FTP connections becomes 10 or less.
An FTP connection can be established normally from the Windows® command prompt.	Change FTP client tool, which can connect successfully.

File access fails

Check the following items.

Check item	Corrective action
Is the CARD RDY LED turned OFF when the read/write target is an SD memory card?	Insert or re-insert SD memory card.
Is the SD memory card write-protected when write target is the SD memory card?	Cancel the write protection of the SD memory card.
Is there free space in the write target drive?	Secure a free space in the write target drive. Change the write target to another drive.
Is the user program that uses the write target file running?	Stop the user program that is using the write target file.
Has a file system error occurred in an SD memory card?	Restore the file system in the SD memory card.
Is the network in the overloaded conditions?	Disconnect the other Ethernet devices, and establish the connection only with the C intelligent function module.

SD memory card file system diagnostics and recovery

In SD memory card diagnostics, use `chkdsk` command.

While using `chkdsk` command, execute the following tools in a format such that the task is always restarted by `sp` command.

- CW Workbench Shell
- Telnet

For `chkdsk` command details, refer to VxWorks manual.

Precautions

An error such as the stored files are deleted when the file system is recovered may occur. Back up the program files and data before file system recovery and write those program files and data after the file system recovery.

Connection with peripherals fails

Check the following items.

Check item	Corrective action
Is the network in the overloaded conditions?	Disconnect the other Ethernet devices, and establish the connection only with the C intelligent function module.

File read/write (download or upload) fails

Check the following items.

Check item	Corrective action
Is the transfer mode of FTP correct?	Change the transfer mode of FTP to an appropriate mode.
Do the folder and file to be accessed via FTP include any invalid characters in their names?	Change the names so that they consist only of valid characters.

An error occurs during user program execution

Check the following items.

Check item	Solution
Has an error occurred in executable file (*.out) loading?	<ul style="list-style-type: none"> • Select "ARMARCH7gnu_SMP" on the [Build Support and Specs] tab in "Build Properties". • Download the files first which has all the symbols necessary for a file to be loaded. • Add "-mlong-calls" to the box next to the [Tool Flags] button in "Build Properties". For details on how to add the option, check the 'Considerations for creating a user program' in the following manual. (MELSEC iQ-R C Intelligent Function Module User's Manual (Startup))
Is the event registered in the event history?	Take corrective actions according to the registered events.
Has an error occurred in a C intelligent function module dedicated function, MELSEC iQ-R series data link function, data analysis function, or statistical analysis function?	Take appropriate actions in accordance with the error code at the time of function execution.
Has an error occurred in VxWorks standard API functions?	Refer to the manual of VxWorks. If the error persists, consult Wind River Systems, Inc.
Is the stack size of the task that runs the user program sufficient?	Increase the task stack size.
Does the pointer used in the user program refers to an invalid address?	Make correction to make the pointer refer to a valid address.
Is the memory area specified by the size reserved?	Secure the memory area.
Is the VX_FP_TASK option specified for the task that performs floating-point operations?	Specify the VX_FP_TASK option in the task performing floating-point operations. For details on the specification method, check the 'Considerations for creating a user program' in the following manual. (MELSEC iQ-R C Intelligent Function Module User's Manual (Startup))
Is the VxWorks message displayed when an error occurs?	Consult the Wind River Systems, Inc.

Communication cannot be established with an Ethernet device

Check the following items.

Check item	Corrective action
Is the Ethernet device communicating by specifying 1 to 1023, 61440 to 65534 to the port number of the C intelligent function module?	Use 1024 to 4999, 5010 to 61439 for the port number. The port number 1 to 1023 is the number for reserved in general (WELL KNOWN PORT NUMBERS), and the port number 61440 to 65534 is the number to be used for other communication devices.

An error occurs in communication processing on other modules

Check the following items.

Check item	Corrective action
Is the MELSEC iQ-R series data link function used to access from multiple modules or a built-in Ethernet port of the CPU module in the system where communication processing such as device access to the CPU module is performed frequently?	<ul style="list-style-type: none"> • When executing a MELSEC iQ-R series data link function in multiple tasks, do not execute the function at the same time by exclusion control, or execute the function in one task. • Lengthen the execution interval of the MELSEC iQ-R series data link function to avoid errors in communication processing.

A C intelligent function module dedicated instruction is not executed

Check the following items.

Check item	Corrective action
Is the dedicated instruction executed again before the completion of the dedicated function being processed?	After the completion of the dedicated function being processed, execute the dedicated instruction again.

3.6 Error Code List

The following table shows the codes for errors occurred in a C intelligent function module.

Error code	Error name	Description	Corrective Action
1800H	User function not registered	G(P).CEXECUTE was executed without registering a routine by CRTL_EntryDedicatedInstFunc function.	Execute CRTL_EntryDedicatedInstFunc function and register a routine before G(P).CEXECUTE executing.
1801H	ROM write count error	The number of writes to the ROM exceeded 100,000 times. (Number of writes > 100,000)	Replace the C intelligent function module.
1805H	Program error	The request data length of G(P).CEXECUTE is out of range.	Check the request data length of G(P).CEXECUTE.
1806H	Program error	The response data length of G(P).CEXECUTE is out of range.	Check the response data length of G(P).CEXECUTE.
1807H	IP Filter error	IP filter function is not working properly. Setting the target IP address is duplicated.	Please set so as not to overlap the target IP address.
1808H	The number of data points out of range error	The specified value of the specified number of data points is out of the range.	Check if a value within the settable range is stored for the number of data points.
1809H	Sampling cycle out of range error	The specified value of the specified sampling cycle is out of the range.	Specify 1 to 1,000,000 for sampling cycle.
180AH	Filter type out of range error	The specified filter type is out of the range.	Specify 0 to 3 for frequency response filter type.
180BH	Cutoff frequency 1 out of range	The specified value of the cutoff frequency 1 is out of the range.	Cutoff frequency 1 is set to 0 or less, or the sampling frequency / 2 or more is set. Please reconsider the set value.
180CH	Cutoff frequency 2 out of range	The specified value of the cutoff frequency 2 is out of the range.	Cutoff frequency 2 is set to 0 or less, sampling frequency / 2 or more, or cutoff frequency 1 or less. Please reconsider the set value.
180DH	Digital filter type out of range error	The specified value of the digital filter type is out of the range.	Specify 0 to 2 for digital filter type.
180EH	Degree out of range error	The specified value of the degree is out of the range.	Check if a value within the settable range is stored for the degree.
180FH	Ripple out of range error	The specified value of the ripple is out of the range.	Specify 0.015625 to 1.0 for Ripple.
1810H	Digital filter operation error	The specified value of degree is larger than the number of data.	Check if the value of degree is less than the number of data.
1811H	The start address of storage destination of input data out of range error	<ul style="list-style-type: none"> The specified value for the start address of input data storage destination is out of the range. The specified value of the start address of input data storage destination + number of data points to be stored to the buffer memory, which was specified for the start address of input data storage destination, is out of the range. 	<ul style="list-style-type: none"> Check if a value within the settable range is stored for the start address of input data storage destination. Check the value of the specified start address of input data storage destination + number of data points to be stored to the buffer memory, which was specified for the start address of input data storage destination.
1812H	The start address of output data out of range error	<ul style="list-style-type: none"> The specified value of start address of output data is out of the range. The specified value of the start address of output data + number of data points stored in the buffer memory specified for the start address of output data is out of the range. 	<ul style="list-style-type: none"> Check if a value within the settable range is stored for the start address of output data. Check the specified value of the start address of output data + number of data points stored in the buffer memory specified for the start address of output data.
1813H	Selected waveform data type out of range error	The specified value of selected waveform data type is out of the range.	Check if a value within the settable range is stored for the waveform data type selection.
1814H	The number of sampling points out of range error	The specified value of the specified number of sampling points is out of the range.	Specify 64, 128, 256, 512, 1024, 2048, 4096, 8192, 16384, 32768 for the number of sampling points.
1815H	Setting value of the window function out of range error	The specified value of window function is out of the range.	Specify 0 to 3 for the value of the window function.
1816H	Setting value of an output spectrum format out of range error	The specified value of the output spectrum format is out of the range.	Specify 0 to 2 for the output spectrum format.
1817H	FFT operation error	Unavailable data for FFT operation is specified.	Check if the data that can be calculated by FFT is specified.

Error code	Error name	Description	Corrective Action
1819H	Intersection recognition pattern out of range	The specified value of the intersection recognition pattern is out of range.	For the intersection recognition pattern, set E-3.40282347+38 to E-1.17549435-38, 0, E1.17549435-38 to E3.40282347+38.
181AH	Maximum number of intersections out of range	The specified value of maximum number of intersections is out of range.	For the maximum number of intersections, set -1, 1 to the number of data points.
181BH	The number of consecutive exceeded points out of range error	The specified value of number of consecutive exceeded points is out of the range.	Specify 1 to 100 as the number of consecutive exceeded points.
181CH	Check value specification error	The specified check value is the lower limit value > the upper limit value.	Specify check value so that the lower limit value ≤ the upper limit value.
181DH	The lower limit value out of range error	The specified lower limit value is out of the range.	Specify E-3.40282347+38 to E-1.17549435-38, 0, E1.17549435-38 to E3.40282347+38 for the lower limit value.
181EH	The upper limit value out of range error	The specified upper limit value is out of the range.	Specify E-3.40282347+38 to E-1.17549435-38, 0, E1.17549435-38 to E3.40282347+38 for the upper limit value.
181FH	The number of significant digits of a fractional value out of range error	The specified significant digits of a fractional value is out of the range.	Specify 0 to 14 for significant digits of a fractional value.
1820H	The start address of check value (the lower limit value) out of range error	The start address of check value (the lower limit value) is out of the range.	Specify 16,384 to 2,097,151 for the start address of check value (the lower limit value).
1821H	The start address of check value (the upper limit value) out of range error	The start address of check value (the upper limit value) is out of the range.	Specify 16,384 to 2,097,151 for the start address of check value (the upper limit value).
1822H	The start address of an X coordinate data out of range error	<ul style="list-style-type: none"> The specified value of the start address of X coordinate data is out of the range. The specified value of the start address of X coordinate data + number of data points to be stored to the buffer memory, which was specified for the start address of X coordinate data, is out of the range. 	<ul style="list-style-type: none"> Specify 16,384 to 2,097,151 for the start address of X coordinate data. Check the value specified for the start address of X coordinate data + number of data points to be stored to the buffer memory, which was specified for the start address of X coordinate data.
1823H	The start address of a Y coordinate data out of range error	<ul style="list-style-type: none"> The specified value of the start address of Y coordinate data is out of the range. The specified value of the start address of Y coordinate data + number of data points to be stored to the buffer memory, which was specified for the start address of Y coordinate data, is out of the range. 	<ul style="list-style-type: none"> Specify 16,384 to 2,097,151 for the start address of Y coordinate data. Check the value specified for the start address of Y coordinate data + number of data points to be stored to the buffer memory, which was specified for the start address of Y coordinate data.
1824H	Moving average number out of range error	The specified value of moving average number is out of the range.	Specify 1 to 90,000 for moving average number.
1826H	The option of calculating a correlation matrix of unit space out range error	The specified value of selected waveform data type is out of the range.	Specify 0 to 1 for presence / absence of correlation matrix output in unit space.
1827H	The option of calculating an SN ratio out range error	The specified value of option of calculating an SN ratio type is out of the range.	Specify 0 to 1 for presence / absence of SN ratio output.
1828H	The number of normal data out of range error	The specified value of the number of normal data is out of the range.	Specify 2 to 300 for the number of normal data.
1829H	The sample size of normal data out of range error	The specified value of the number of samples of normal data is out of the range.	Specify 2 to 3,000 for the sample size of normal data.
182AH	The start address of output destination of normal data MD out of range error	<ul style="list-style-type: none"> The specified value of start address of output destination of normal data MD is out of the range. The specified value of start address of output destination of normal data MD + storage destination size of normal data MD (bytes) is out of the range. 	<ul style="list-style-type: none"> Specify 16,384 to 2,097,150 for the start address of output destination of normal data MD. Check the specified value of start address of output destination of normal data MD + storage destination size of normal data MD (bytes).
182BH	The start address of output destination of average out of range error	<ul style="list-style-type: none"> The specified value of start address of output destination of average is out of the range. The specified value of start address of output destination of average + storage destination size of average (bytes) is out of the range. 	<ul style="list-style-type: none"> Specify 16,384 to 2,097,150 for the start address of output destination of average. Check the specified value of the start address of average data output destination + average data output result storage destination size (bytes).

Error code	Error name	Description	Corrective Action
182CH	The start address of output destination of standard deviation out of range error	<ul style="list-style-type: none"> The specified value of start address of output destination of standard deviation is out of the range. The specified value of start address of output destination of standard deviation + storage destination size of standard deviation (bytes) is out of the range. 	<ul style="list-style-type: none"> Specify 16,384 to 2,097,150 for the start address of output destination of standard deviation. Check the specified value of the start address of standard deviation output destination + standard deviation output result storage destination size (bytes).
182DH	The start address of output destination of inverse matrix out of range error	<ul style="list-style-type: none"> The specified value of start address of output destination of inverse matrix is out of the range. The specified value of start address of output destination of inverse matrix + storage destination size of inverse matrix (bytes) is out of the range. 	<ul style="list-style-type: none"> Specify 16,384 to 2,097,150 for the start address of output destination of inverse matrix. Check the specified value of the start address of inverse matrix output destination + inverse matrix output result storage destination size (bytes).
182EH	The start address of output destination of correlation matrix out of range error	<ul style="list-style-type: none"> The specified value of start address of output destination of correlation matrix is out of the range. The specified value of start address of output destination of correlation matrix + storage destination size of correlation matrix (bytes) is out of the range. 	<ul style="list-style-type: none"> Specify 16,384 to 2,097,150 for the start address of output destination of correlation matrix. Check the specified value of the start address of correlation matrix output destination + correlation matrix output result storage destination size (bytes).
182FH	Contribution level out of range error	The value of the specified contribution level is out of the range.	Specify 0 to 1 for contribution level.
1830H	SN ratio out of range error	The specified value of SN ratio is out of the range.	Specify 0 to 1 for SN ratio.
1831H	The number of input data items out of range error	The specified value of number of input data items is out of the range.	Specify 2 to 300 for number of input data items.
1832H	The number of samples of input data out of range error	The specified value of number of samples of input data is out of the range.	Specify 1 to 3,000 for number of samples of input data.
1833H	The start address of storage destination of average out of range error	<ul style="list-style-type: none"> The specified value of start address of storage destination of average is out of the range. The specified value of the start address of average data output destination + average data output result storage destination size (bytes) is out of the range. 	<ul style="list-style-type: none"> Specify 16,384 to 2,097,150 for the start address of storage destination of average. Check the specified value of the start address of average data output destination + average data output result storage destination size (bytes).
1834H	The start address of storage destination of standard deviation out of range error	<ul style="list-style-type: none"> The specified value of start address of storage destination of standard deviation is out of the range. The specified value of the start address of standard deviation output destination + standard deviation output result storage destination size (bytes) is out of the range. 	<ul style="list-style-type: none"> Specify 16,384 to 2,097,150 for the start address of storage destination of standard deviation. Check the specified value of the start address of standard deviation output destination + standard deviation output result storage destination size (bytes).
1835H	The start address of storage destination of inverse matrix out of range error	<ul style="list-style-type: none"> The specified value of start address of storage destination of inverse matrix is out of the range. The specified value of the start address of inverse matrix output destination + inverse matrix output result storage destination size (bytes) is out of the range. 	<ul style="list-style-type: none"> Specify 16,384 to 2,097,150 for the start address of storage destination of inverse matrix. Check the specified value of the start address of inverse matrix output destination + inverse matrix output result storage destination size (bytes).
1836H	The start address of storage destination of input data MD out of range error	<ul style="list-style-type: none"> The specified value of start address of storage destination of input data MD is out of the range. The specified value of start address of storage destination of input data MD + storage destination size of input data MD (bytes) is out of the range. 	<ul style="list-style-type: none"> Specify 16,384 to 2,097,150 for the start address of storage destination of input data MD. Check the specified value of the start address of input data MD output destination + input data MD output result storage destination size (bytes).
1837H	The start address of output destination of contribution level out of range error	<ul style="list-style-type: none"> The specified value of start address of output destination of degree of contribution is out of the range. The specified value of start address of contribution level output destination + contribution level output result storage destination size (bytes) is out of the range. 	<ul style="list-style-type: none"> Specify 16,384 to 2,097,150 for the start address of output destination of degree of contribution. Check the specified value of the start address of contribution level output destination + contribution level output result storage destination size (byte).
1838H	X coordinate storage destination size out of range error	The specified value of X coordinate storage destination size is out of the range.	Specify the value of the number of data points × number of data items × number of bytes of the type specified in waveform data type selection or more for X coordinate storage destination size (byte).

Error code	Error name	Description	Corrective Action
1839H	Y coordinate storage destination size out of range error	The specified value of Y coordinate storage destination size is out of the range.	Specify the value of the number of data points × number of bytes of the type specified in waveform data type selection or more for Y coordinate storage destination size (byte).
183AH	The number of data items out of range error	The specified value of number of data items is out of the range.	Specify 1 to 64 for the number of data items.
183BH	Calculation necessity of constant b out of range error	The specified value of calculation necessity of constant b is out of range.	Specify 0 or 1 for the calculation necessity of constant b.
183CH	Calculation necessity of regression statistics out of range error	The specified value of calculation necessity of regression statistics is out of the range.	Specify 0 or 1 for value of calculation necessity of regression statistics.
183DH	The storage destination size of coefficient m out of range error	The specified value of storage destination size of coefficient m is out of the range.	Specify the value of the number of data items × single-precision real number of bytes or more for the storage destination size of coefficient m (byte).
183EH	The storage destination size of coefficient m standard error out of range error	The specified value of storage destination size of coefficient m standard error is out of the range.	Specify the value the number of data items or more for storage destination size of coefficient m standard error (byte).
183FH	The data type of selected spectrum data out of range error	The specified value of data type of selected spectrum data is out of the range.	Specify 0 to 2 for data type of selected spectrum data.
1840H	Least squares method operation error	Unavailable data for the least squares method is specified.	<ul style="list-style-type: none"> • Check if the variance of input data (X coordinate array and Y coordinate array) is not 0. • An overflow may have occurred during calculation. Check the input data.
1841H	Multicollinearity error	Unable to calculate due to a multicollinearity error.	Delete the data which is strongly correlated each other. Delete the data first, then execute the dedicated instruction again.
1842H	Inverse correlation matrix error	The value of the inverse matrix of the correlation matrix of unit space is all 0.	Check the inverse matrix of the correlation matrix of the unit space which was specified for the start address of storage destination of inverse matrix.
1843H	Input data storage destination size error	The specified value of input data storage destination size (bytes) is out of range.	Specify the value of number of input data items × number of data samples × number of bytes of type specified in waveform data type selection or more for input data storage destination size (bytes).
1844H	Average data storage destination size error	The specified value of average data output result storage destination size (bytes) is out of range.	Specify the value of number of normal data items or input data items × single-precision real number of bytes or more for average data output result storage destination size (bytes).
1845H	Standard deviation data storage destination size error	The specified value of standard deviation data storage destination size (bytes) is out of range.	Specify the value of number of normal data items or input data items × single-precision real number of bytes or more for standard deviation output result storage destination (bytes).
1846H	Inverse matrix data storage destination size error	The specified value of inverse matrix data storage destination size (bytes) is out of range.	Specify the square of the number of normal data items or input data items × single-precision real number of bytes for the inverse matrix output result size (bytes).
1847H	Normal Data MD data storage destination size error	The specified value of normal data MD output result storage destination size (bytes) is out of range.	Specify the number of normal data samples or number of input data samples × single-precision real number of bytes for normal data MD output result storage destination size (bytes).
1848H	Correlation matrix data output result storage destination size error	The specified value of the correlation matrix output result storage destination size (bytes) is out of range.	Specify a value greater than or equal to the square of the value set for the normal data items × number of bytes required for a single-precision real number for the correlation matrix output result storage destination size (bytes).
1849H to 1974H	Standard deviation error	Calculation is impossible because standard deviation of item n is 0. (n = 1, 2, 3...)	All contents of item n are the same value. Delete the contents of item n, review the data, then execute the dedicated instruction again. (n = 1, 2, 3...)
1976H	Contribution level result storage destination size error	The specified value of contribution level output result storage destination size (byte) is out of range.	Specify the number of items of input data × number of samples of input data × single-precision real number of bytes or more for the contribution level output result storage destination size (byte).

Error code	Error name	Description	Corrective Action
1977H	The start address of output destination of coefficient m out of range error	<ul style="list-style-type: none"> The specified value of start address of storage destination of coefficient m is out of range. The specified value of the start address of coefficient m storage destination + coefficient m storage destination size (byte) is out of the range. 	<ul style="list-style-type: none"> Specify 16,384 to 2,097,150 for the start address of storage destination of coefficient m. Check the value of the start address of coefficient m storage destination + coefficient m storage destination size (byte).
1978H	The start address of output destination of coefficient m standard error out of range error	<ul style="list-style-type: none"> The specified value of start address of storage destination of coefficient m standard error is out of range. The specified value of the start address of coefficient m standard error storage destination + coefficient m standard error storage destination size (byte) is out of range. 	<ul style="list-style-type: none"> Specify 16,384 to 2,097,150 for the start address of storage destination of coefficient m standard error. Check the specified value of the start address of coefficient m standard error storage destination + coefficient m standard error storage destination size (byte).
1979H	The start address of storage destination of SN ratio (larger-is-better response) of input data MD out of range error	The specified value of start address of storage destination of SN ratio (larger-is-better response) of input data MD is out of range.	Specify 16,384 to 2,097,150 for the start address of output result storage destination of SN ratio (larger-is better response) of input data MD.
197AH	The start address of storage destination of SN ratio (larger-is-better response) of normal data MD out of range error	The specified value of start address of storage destination of SN ratio (larger-is-better response) of normal data MD is out of range.	Specify 16,384 to 2,097,150 for the start address of storage destination of SN ratio (larger-is-better response) of normal data MD.
197BH	The start address of output result storage destination of multiple correlation coefficient out of range error	The specified value of start address of output result storage destination of multiple correlation coefficient is out of range.	Specify 16,384 to 2,097,150 for the start address of output result storage destination of multiple correlation coefficient.
197CH	The start address of storage destination of a constant term (b) out of range error	The specified value of start address of storage destination of a constant term (b) is out of range.	Specify 16,384 to 2,097,150 for the start address of storage destination of a constant term (b).
197DH	The start address of storage destination of standard error of a constant term (b) out of range error	The specified value of start address of storage destination of standard error of a constant term (b) is out of range.	Specify 16,384 to 2,097,150 for the start address of storage destination of standard error of a constant term (b).
197EH	The start address of storage destination of coefficient of determination out of range error	The specified value of start address of storage destination of coefficient of determination is out of range.	Specify 16,384 to 2,097,150 for the start address of storage destination of coefficient of determination.
197FH	The start address of storage destination of standard error of estimated value of (y) out of range error	The specified value of start address of storage destination of standard error of estimated value of (y) is out of range.	Specify 16,384 to 2,097,150 for the start address of storage destination of standard error of estimated value of (y).
1980H	The start address of storage destination of F-statistic out of range error	The specified value of start address of storage destination of F-statistic is out of range.	Specify 16,384 to 2,097,150 for the start address of storage destination of F-statistic.
1981H	The start address of storage destination of degrees of freedom out of range error	The specified value of start address of storage destination of degrees of freedom is out of range.	Specify 16,384 to 2,097,150 for the start address of storage destination of degrees of freedom.
1982H	The start address of storage destination of regression sum of squares out of range error	The specified value of start address of storage destination of regression sum of squares is out of range.	Specify 16,384 to 2,097,150 for the start address of storage destination of regression sum of squares.
1983H	The start address of storage destination of residual sum of squares out of range error	The specified value of start address of storage destination of residual sum of squares is out of range.	Specify 16,384 to 2,097,150 for the start address of storage destination of residual sum of squares.
1984H	The start address of output destination of average of normal data MD out of range error	The specified value of start address of storage destination of average of normal data MD is out of range.	Specify 16,384 to 2,097,150 for the start address of storage destination of average of normal data MD.
1985H	Overflow error	An overflow occurred during computation.	Review the input data.
1986H	Unit space determination error	The number of samples of normal data is set to a value smaller than the number of items of normal data.	Specify the number of samples of normal data to be equal to or larger than the number of items of normal data.
1987H	Multiple regression determination error	Divided by zero during operation.	Since there is a possibility that data with Multicollinearity may be input, check value of input data.

Error code	Error name	Description	Corrective Action
1988H	Memory reservation error	Memory could not be reserved, or there are too many tasks using the following functions. <ul style="list-style-type: none"> • C Controller module dedicated function • C intelligent function module dedicated function • MELSEC data link function • MELSEC iQ-R series data link function • Data analysis function 	<ul style="list-style-type: none"> • The memory may be insufficient. End another running task or reduce the access size. • Check if the C Controller module or the C intelligent function module is running normally. • Reset the C Controller module or the C intelligent function module. • Reduce the number of tasks using the target function, and retry. • Review the size or number specified to the arguments of the user program.
1989H	OS startup error	An error was detected during OS startup.	<ul style="list-style-type: none"> • If you are using a SD memory card image provided by a third party, please contact the third party. • Initialize the C intelligent function module.
2120H	SD memory card error	The SD memory card was removed without the card being unmounted.	Unmount the SD memory card, and then remove it.
2121H	SD memory card error	An error has been detected in the SD memory card.	Re-insert the SD memory card. If the same error code is displayed again, the possible cause is a hardware failure of the SD memory card. Replace the SD memory card.
2440H	Module major error	An error has been detected during the initial communication with the control CPU module.	<ul style="list-style-type: none"> • Take measures to reduce noise. • Reset the programmable controller system. If the same error code is displayed again, the possible cause is a hardware failure of the C intelligent function module. Please contact your local Mitsubishi Electric sales office or representative.
2450H	Module major error	<ul style="list-style-type: none"> • A major error has been detected in the C intelligent function module. • A module in the programmable controller system is not mounted properly or was removed during operation. 	<ul style="list-style-type: none"> • Take measures to reduce noise. • Check the connection status of the extension cable. • Check the detailed information (system configuration information) by performing module diagnostics using an engineering tool, and check the module corresponding to the displayed slot number. • Reset the programmable controller system. If the same error code is displayed again, the possible cause is a hardware failure in the system. Please contact your local Mitsubishi Electric sales office or representative.
24C0H to 24C1H	System bus error	An error has been detected on the system bus.	<ul style="list-style-type: none"> • Take measures to reduce noise. • Reset the programmable controller system. If the same error code is displayed again, the possible cause is a hardware failure in the system. Please contact your local Mitsubishi Electric sales office or representative.
24C2H	System bus error	<ul style="list-style-type: none"> • The I/O module or intelligent function module is not mounted properly or was removed during operation. • An error has been detected on the system bus. 	<ul style="list-style-type: none"> • Check the detailed information (system configuration information), and check the module corresponding to the displayed slot number. • Check the connection status of the extension cable. • Take measures to reduce noise. • Reset the programmable controller system. If the same error code is displayed again, the possible cause is a hardware failure in the system. Please contact your local Mitsubishi Electric sales office or representative.
24C3H to 24C6H	System bus error	An error has been detected on the system bus.	<ul style="list-style-type: none"> • Take measures to reduce noise. • Reset the programmable controller system. If the same error code is displayed again, the possible cause is a hardware failure in the system. Please contact your local Mitsubishi Electric sales office or representative.

Error code	Error name	Description	Corrective Action
24C8H	System bus error	An error has been detected on the system bus.	<ul style="list-style-type: none"> Take measures to reduce noise. Reset the programmable controller system. If the same error code is displayed again, the possible cause is a hardware failure in the system. Please contact your local Mitsubishi Electric sales office or representative.
24E0H	System bus error	An error has been detected on the system bus.	<ul style="list-style-type: none"> Take measures to reduce noise. Reset the programmable controller system. If the same error code is displayed again, the possible cause is a hardware failure in the system. Please contact your local Mitsubishi Electric sales office or representative.
300CH	User WDT error	<p>The user watchdog timer controlled by the system has detected an error because CITL_ResetWDT was not executed within the monitoring time of the user watchdog, or an error has occurred in the user program.</p> <ul style="list-style-type: none"> The user WDT monitoring time is too short. A task of high CPU utilization is running. A program that will cause an error in the memory, stack, etc. was executed. Debugging has been performed with CW Workbench connected. The command was executed from Shell for debugging. The following functions that increase the CPU utilization by system tasks are used. <p>(1) Mounting/unmounting the SD memory card (2) Ethernet communication (3) NFS server communication</p>	<ul style="list-style-type: none"> Reset the programmable controller system. Decrease the CPU utilization of the task, or disable the task operation. Check the user program. Restart the CPU module with CW Workbench connection disconnected. Check the command executed from Shell. Taking into account the system task CPU utilization, sufficiently prolong the user WDT monitoring time. <p>If an error still occurs, check the mounted modules, and replace a defective module.</p>
300EH	Program error	The command in the script file cannot be executed. (The syntax is incorrect, no command exists, or the script file is corrupted.)	<ul style="list-style-type: none"> Confirm no error in the syntax and the presence of a command. Check if the power has been turned OFF, the CPU module has been reset, or the SD memory card has been removed while accessing the file. If the script file is stored in the SD memory card, diagnose and recover the SD memory card. If the same error occurs again, the possible cause is a hardware failure of the SD memory card. Replace it with another one. If the script file is stored in the standard ROM, initialize the standard ROM.
3C00H	System WDT error	<p>The system watchdog timer controlled by the system detected an error, or an error occurred in the system software.</p> <ul style="list-style-type: none"> A task of high CPU utilization is running. A program that will cause an error in the memory, stack, etc. was executed. An operation that increase the CPU utilization by the system task (writing parameter) was executed. The station on which the station-based block data assurance is enabled on the network has been accessed when the stop error occurred. CPU module drives recklessly or it breaks down. (Malfunction by noise etc. and Hardware error) 	<ul style="list-style-type: none"> Reset the programmable controller system. Decrease the CPU utilization of the task, or disable the task operation. Check the user program. Review the user program to prevent the station on which the station-based block data assurance is enabled from being accessed when the stop error occurred. Take measures to reduce noise. Check that the CPU module is securely installed in the base unit and the ambient environment is within the general specification range. <p>If the same error code is still displayed again, the possible cause is a hardware failure of the C intelligent function module. Please contact your local Mitsubishi Electric sales office or representative.</p>
3C01H	Hardware failure	A hardware failure has been detected.	<ul style="list-style-type: none"> Take measures to reduce noise. Reset the programmable controller system. If the same error code is displayed again, the possible cause is a hardware failure of the C intelligent function module. Please contact your local Mitsubishi Electric sales office or representative.

Error code	Error name	Description	Corrective Action
3C02H	Hardware failure	<ul style="list-style-type: none"> A hardware failure has been detected. Specifies the invalid argument to the C intelligent function module dedicated function for ISR. 	<ul style="list-style-type: none"> Take measures to reduce noise. Reset the programmable controller system. If the same error code is displayed again, the possible cause is a hardware failure of the C intelligent function module. Please contact your local Mitsubishi Electric sales office or representative. Please review the arguments of the C intelligent function module dedicated function for ISR.
3C03H	Hardware failure	A hardware failure has been detected.	<ul style="list-style-type: none"> Take measures to reduce noise. Reset the programmable controller system. If the same error code is displayed again, the possible cause is a hardware failure of the C intelligent function module. Please contact your local Mitsubishi Electric sales office or representative.
3C0FH	Hardware failure	A hardware failure has been detected.	<ul style="list-style-type: none"> Take measures to reduce noise. Reset the programmable controller system. If the same error code is displayed again, the possible cause is a hardware failure of the C intelligent function module. Please contact your local Mitsubishi Electric sales office or representative.
3C22H	Memory error	An error has been detected in the memory.	<ul style="list-style-type: none"> Take measures to reduce noise. Initialize the C intelligent function module. If the same error code is displayed again, the possible cause is a hardware failure of the C intelligent function module. Please contact your local Mitsubishi Electric sales office or representative.
3C2FH	Memory error	An error has been detected in the memory.	<ul style="list-style-type: none"> Take measures to reduce noise. Initialize the C intelligent function module. If the same error code is displayed again, the possible cause is a hardware failure of the C intelligent function module. Please contact your local Mitsubishi Electric sales office or representative.
3E11H	Memory error	An error has been detected in the memory.	<ul style="list-style-type: none"> Take measures to reduce noise. Initialize the C intelligent function module. If the same error code is displayed again, the possible cause is a hardware failure of the C intelligent function module. Please contact your local Mitsubishi Electric sales office or representative.
3E19H to 3E1DH	Memory error	An error has been detected in the memory.	<ul style="list-style-type: none"> Take measures to reduce noise. Initialize the C intelligent function module. If the same error code is displayed again, the possible cause is a hardware failure of the C intelligent function module. Please contact your local Mitsubishi Electric sales office or representative.
3E1FH to 3E21H	Memory error	An error has been detected in the memory.	<ul style="list-style-type: none"> Take measures to reduce noise. Initialize the C intelligent function module. If the same error code is displayed again, the possible cause is a hardware failure of the C intelligent function module. Please contact your local Mitsubishi Electric sales office or representative.
3E23H to 3E24H	Memory error	An error has been detected in the memory.	<ul style="list-style-type: none"> Take measures to reduce noise. Initialize the C intelligent function module. If the same error code is displayed again, the possible cause is a hardware failure of the C intelligent function module. Please contact your local Mitsubishi Electric sales office or representative.

Error code	Error name	Description	Corrective Action
3E26H to 3E2CH	Memory error	An error has been detected in the memory.	<ul style="list-style-type: none"> • Take measures to reduce noise. • Initialize the C intelligent function module. If the same error code is displayed again, the possible cause is a hardware failure of the C intelligent function module. Please contact your local Mitsubishi Electric sales office or representative.

3.7 Event List

The following shows an event occurred by the C intelligent function module.

Item	Description
Event Code	Indicates the ID number of each event.
Event type	Indicates the type of each event. <ul style="list-style-type: none"> • Security • Operation
Event category	Indicates the category of each event.
Event Detection	Indicates the description of detected events.
Detailed Information 1 to 3	Indicates the details of each detected event.

Event list

Event Code	Event type	Event category	Event Detection		Detailed Information 1	Detailed Information 2	Detailed Information 3
10300	Security	Information	Access acceptance from IP address prohibited with the IP Filter Settings	Access from an IP address for which access is prohibited with the IP Filter Settings was accepted.	—	Disconnected IP address information (1) IP address format <ul style="list-style-type: none"> • IPv4 (2) Sender IP address (3) To IP address of IP packet	—
20100	Operation	Information	Clear error	Error clear was performed.	—	—	—
20300	Operation	Information	SD memory card enabled	The SD memory card was enabled.	—	—	—
20301	Operation	Information	SD memory card disabled	The SD memory card is ready for removal (unusable).	—	—	—
20400	Operation	Information	Firmware update completed successfully (intelligent function module)	The firmware of the Intelligent Function Module was successfully updated.	Firmware update information for Intelligent Function Module	—	—
20401	Operation	Information	Firmware update failed (Intelligent Function Module)	The firmware update of the Intelligent Function Module failed.	Firmware update information for Intelligent Function Module	—	—
25000	Operation	Information	Registration from the user program	The event information (event log) was registered in the event history from the C intelligent function module dedicated function.	Detailed code (Detailed code specified by CITL_RegistEventLog function)	Detailed information (Detailed information specified by CITL_RegistEventLog function)	—

APPENDIX

Appendix 1 Module Label

The I/O signal, buffer memory of the C intelligent function module can be set using the module label.

Module label configuration

The name of a module label is defined in the following configurations:

"Instance name"_"Module number"."Label name"

"Instance name"_"Module number"."Label name"_D

Ex.

UP06_1.bIn_ModuleReady

■ Instance name

The instance name of a C intelligent function module (RD55UP06-V) is 'UP06.'^{*1}

*1 For an RD55UP12-V, the instance name is 'UP12.'

■ Module number

A module number is a number starting from 1, which is added to identify a module that has the same instance name.

■ Label name

This is a module unique label name.

■ _D

This indicates that the module label is for direct access. Without this symbol means a label for refresh. There are some differences between refresh and direct access as shown below.

Type	Description	Access timing
Refresh	Values written to/read from a module label are reflected to the module in batch at the time of refresh. This shortens program execution time.	At the time of refresh
Direct access	Values written to/read from a module label are immediately applied to a module. Although the program execution time is longer than refresh, the responsiveness will be increased.	At the time of writing to/ reading from a module label

A

Appendix 2 Input/Output Signals

This section explains the I/O signals of a C intelligent function module.

The following shows the example of I/O signal assignment when the start I/O number of a C intelligent function module is '0'.

Device X is the input signal from a C intelligent function module to a CPU module.

Device Y is the input signal from a CPU module to a C intelligent function module.

Precautions

Do not use "Use prohibited" (ON) the signal as an I/O signal to CPU module. When output against "Use prohibited" signal, malfunction of the programmable controller system may occur.

Input/Output signals list

I/O signals of the C intelligent function module are as follows.

Input signals	
Device number	Signal name
X0	Module READY • ON: Module preparation completed. • OFF: Preparing module or watchdog timer error occurring status
X1	SD memory card status • ON: Mounting • OFF: Unmounting
X2	Standard ROM shutdown state • ON: Shutdown completed. • OFF: Shutdown not completed.
X3	User script execution status • ON: Execution completed • OFF: Execution not completed.
X4 to XE	Use prohibited
XF	ERR LED status • ON: ON or flashing • OFF: OFF
X10	Area available for user 0
X11	Area available for user 1
X12	Area available for user 2
X13	Area available for user 3
X14	Area available for user 4
X15	Area available for user 5
X16	Area available for user 6
X17	Area available for user 7
X18	Area available for user 8
X19	Area available for user 9
X1A	Area available for user 10
X1B	Area available for user 11
X1C	Area available for user 12
X1D	Area available for user 13
X1E	Area available for user 14
X1F	Area available for user 15

Output signals

Device number	Signal name
Y0 to YE	Use prohibited
YF	Error clear request <ul style="list-style-type: none">• ON: Error clear request• OFF: —
Y10	Area available for user 0
Y11	Area available for user 1
Y12	Area available for user 2
Y13	Area available for user 3
Y14	Area available for user 4
Y15	Area available for user 5
Y16	Area available for user 6
Y17	Area available for user 7
Y18	Area available for user 8
Y19	Area available for user 9
Y1A	Area available for user 10
Y1B	Area available for user 11
Y1C	Area available for user 12
Y1D	Area available for user 13
Y1E	Area available for user 14
Y1F	Area available for user 15

Input signal details

The details of each input signal are as follows.

Module READY (X0)

Turns ON when the C intelligent function module becomes ready (before executing script file "STARTUP.CMD") after turning the power OFF and ON, or resetting the CPU module. This signal turns OFF when a watch dog timer error occurred.

SD memory card status (X1)

Turns ON/OFF by mounting status of the SD memory card.

- Turns ON when the SD memory card is mounted.
- Turns OFF when the SD memory card is unmounted.

Standard ROM shutdown state (X2)

Turns ON when the standard ROM is in shutdown state.

User script execution status (X3)

Turns ON when the script file "STARTUP.CMD" execution status is complete.

ERR LED status (XF)

Turns ON/OFF by lighting status of ERR LED.

- Turns ON when ERR LED is ON (A continuation error or watchdog timer error occurred) or flashing (major to moderate error occurred in the module).
- When the ERR LED is ON, it becomes OFF if the 'Error clear request' (YF) turns ON.

Area available for user 0 to 15 (X10 to X1F)

The area is available for users for reading/writing.

Output signal details

The details of each output signal are as follows.

An output signal is enabled when the signal is changed from OFF to ON.

Point

A system does not turn an output signal ON and OFF. To enable an output signal again, turn the output signal ON and OFF, and ON again.

Error clear request (YF)

The following will be performed if an error clear request is turned ON when a module error is occurring.

- ERR LED is turned OFF.
- ERR LED status (XF) is OFF.
- Most recent error code is cleared.
- Error log area is cleared (excluding the error count).

Area available for user 0 to 15 (Y10 to Y1F)

The area is available for users for reading/writing.

Appendix 3 Buffer Memory

This chapter explains the buffer memory of the C intelligent function module.

Precautions

Do not write data in the "System area" of the buffer memory.

If data is written to any of the system areas, the programmable controller system may malfunction.

Buffer memory list

The following table lists the buffer memories of the C intelligent function module.

R: Read-only, W: Write-only, R/W: Readable/Writable

Address Decimal (hexadecimal)	Application	Name	Initial value	R/W
0 (0H)	Module status area	RUN LED status	0	R
1 (1H)		ERR LED status	0	R
2 (2H)		CARD RDY LED status	0	R
3 (3H)		USER LED status	0	R
4 to 19 (4H to 13H)		System area	—	—
20 (14H)		Module operating status	0	R
21 to 46 (15H to 2EH)	System area	—	—	
47 to 54 (2FH to 36H)	Network connection status area (Ethernet port CH1)	IP address (string notation)	192.168.3.3	R
55 to 56 (37H to 38H)		IP address	C0A80303H	R
57 to 58 (39H to 3AH)		Subnet mask	FFFFFF00H	R
59 to 60 (3BH to 3CH)		Default gateway	0	R
61 to 69 (3DH to 45H)	System area	—	—	
70 (46H)	Common settings status area (Ethernet port CH1)	Set whether to use the Ethernet port (CH1) ^{*1}	0	R
71 to 72 (47H to 48H)		IP address	0	R
73 to 74 (49H to 4AH)		Subnet Mask	0	R
75 to 76 (4BH to 4CH)		Default gateway	0	R
77 to 80 (4DH to 50H)	System area	—	—	
81 to 88 (51H to 58H)	Network connection status area (Ethernet port CH2) ^{*1}	IP address (string notation)	—	R
89 to 90 (59H to 5AH)		IP address	0	R
91 to 92 (5BH to 5CH)		Subnet mask	0	R
93 to 94 (5DH to 5EH)		Default gateway	0	R
95 to 103 (5FH to 67H)	System area	—	—	

Address Decimal (hexadecimal)	Application	Name	Initial value	R/W	
104 (68H)	Common settings status area (Ethernet port CH2) ^{*1}	Set whether to use the Ethernet port (CH2)	1	R	
105 to 106 (69H to 6AH)		IP address	0	R	
107 to 108 (6BH to 6CH)		Subnet mask	0	R	
109 to 110 (6DH to 6EH)		Default gateway	0	R	
111 to 139 (6FH to 8BH)	System area		—	—	
140 (8CH)	Current error area	Error code	0	R	
141 (8DH)		System area	—	—	
142 to 147 (8EH to 93H)		Time	0	R	
148 to 149 (94H to 95H)	System area		—	—	
150 (96H)	Error log area	Error count	0	R	
151 (97H)		Error log write pointer	0	R	
152 (98H)		Error log area 1	Error code	0	R
153 (99H)			System area	—	—
154 to 159 (9AH to 9FH)			Time	0	R
160 to 161 (A0H to A1H)			System area	—	—
162 to 311 (A2H to 137H)			Error log 2 to 16	0	R
312 to 799 (138H to 31FH)	System area		—	—	
800 (320H)	Data sampling status area	Data missing status	0	R	
801 (321H)		Data sampling status	0	R	
802 to 803 (322H to 323H)	System area		—	—	



Address Decimal (hexadecimal)	Application	Name	Initial value	R/W		
900 (384H)	Firmware update history storage area	Firmware update completion with/without an error	0	R		
901 to 909 (385H to 38DH)		System area				
910 (38EH)		Information on latest firmware update	Log information	Execution time (year)	0	R
911 (38FH)				Execution time (month)	0	R
912 (390H)				Execution time (day)	0	R
913 (391H)				Execution time (hour)	0	R
914 (392H)				Execution time (minute)	0	R
915 (393H)				Execution time (second)	0	R
916 (394H)				Execution time (day of the week)	0	R
917 (395H)				Firmware version after update	0	R
918 (396H)				Firmware version before update	0	R
919 (397H)				Latest firmware update result		Firmware update target
920 (398H)				Firmware update result	0	R
921 (399H)		Information on previous firmware update	Log information	Execution time (year)	0	R
922 (39AH)				Execution time (month)	0	R
923 (39BH)				Execution time (day)	0	R
924 (39CH)				Execution time (hour)	0	R
925 (39DH)				Execution time (minute)	0	R
926 (39EH)				Execution time (second)	0	R
927 (39FH)				Execution time (day of the week)	0	R
928 (3A0H)				Firmware version after update	0	R
929 (3A1H)				Firmware version before update	0	R
930 (3A2H)				Previous firmware update result		Firmware update target
931 (3A3H)				Firmware update result	0	R
932 to 16383 (3A4H to 3FFFH)		System area				
16384 to 2097151 (4000H to 1FFFFFH)		User area		0	R/W	

*1 This will be a system area for an RD55UP06-V.

Buffer memory details

This section explains the details of the buffer memory of the C intelligent function module.

Module status area (Un\G0 to 20)

The status of each LED and operation of a C intelligent function module can be checked.

Buffer memory name	Address	Description
RUN LED status	Un\G0	0: OFF, 1: ON, 2: Flashing
ERR LED status	Un\G1	0: OFF, 1: ON, 2: Flashing
CARD RDY LED status	Un\G2	0: OFF, 1: ON
USER LED status	Un\G3	0: OFF, 1: ON, 2: Flashing
Module operating status	Un\G20	0: Initializing, 1: Running, 3: Stop *1

*1 Status in which nothing can be written to input signal (X) and buffer memory.

Network connection status area (Ethernet port CH1) (Un\G47 to 60)

The network connection status of a C intelligent function module (Ethernet port CH1) can be checked in this area.

Name	Address	Description	
		RD55UP06-V	RD55UP12-V
IP address (string notation)	Un\G47 to 54	IP address is stored in character string.*1 The initial value is '192.168.3.3.'	
IP address	Un\G55 to 56	IP address is stored in double word (32 bit value).*2 The initial value is C0A80303H.	
Subnet mask	Un\G57 to 58	IP subnet mask is stored in double word (32 bit value).*2 The initial value is FFFFFFF00H (255.255.255.0).	
Default gateway	Un\G59 to 60	Default gateway address is stored in double word (32 bit value).*2	

*1 If "Not Use" is selected in "Use or Not to Use" for CH1 of an RD55UP12-V, a string is not stored.

*2 If "Not Use" is selected in "Use or Not to Use" for CH1 of an RD55UP12-V, '0' is stored in all addresses in this area.

Common settings status area (Ethernet port CH1) (Un\G70 to 76)

The network setting status of the common setting (Ethernet port CH1) can be checked in this area.

Name	Address	Description	
		RD55UP06-V	RD55UP12-V
Set whether to use the Ethernet port (CH1)	Un\G70	System area	<ul style="list-style-type: none"> • 0: Use • 1: Not Use The initial value is '0' (Use).
IP address	Un\G71 to 72	IP address is stored in double word (32 bit value).	
Subnet Mask	Un\G73 to 74		
Default gateway	Un\G75 to 76		



Network connection status area (Ethernet port CH2) (Un\G81 to 94)

The network connection status of a C intelligent function module (Ethernet port CH2) can be checked in this area.

Name	Address	Description	
		RD55UP06-V	RD55UP12-V
IP address (string notation)	Un\G81 to 88	System area	IP address is stored in character string.* ¹
IP address	Un\G89 to 90		Default gateway address is stored in double word (32 bit value). ²
Subnet mask	Un\G91 to 92		
Default gateway	Un\G93 to 94		

*1 If "Not Use" is selected in "Use or Not to Use" for CH2 of an RD55UP12-V, a string is not stored.

*2 If "Not Use" is selected in "Use or Not to Use" for CH2 of an RD55UP12-V, '0' is stored in all addresses in this area.

Common settings status area (Ethernet port CH2) (Un\G104 to 110)

The network setting status of the common setting (Ethernet port CH2) can be checked in this area.

Name	Address	Description	
		RD55UP06-V	RD55UP12-V
Set whether to use the Ethernet port (CH2)	Un\G104	System area	<ul style="list-style-type: none"> • 0: Use • 1: Not Use The initial value is '1' (Not Use).
IP address	Un\G105 to 106		Default gateway address is stored in double word (32 bit value).
Subnet mask	Un\G107 to 108		
Default gateway	Un\G109 to 110		

Current error area (Un\G140 to 147)

The most recent error code which is currently occurring can be checked in this area.

Name	Address	Description
Error code	Un\G140	The error code is stored.
System area	Un\G141	Use prohibited
Time	Un\G142	b0 to 7: Time zone and summer time flag b8 to 15: System area
	Un\G143	b0 to 7: Last two digits of the year b8 to 15: Month (01 to 12)
	Un\G144	b0 to 7: Day (01 to 31) b8 to 15: Hour (00 to 23)
	Un\G145	b0 to 7: Minute (00 to 59) b8 to 15: Second (00 to 59)
	Un\G146	b0 to 7: Day of the week (0: Sun, 1: Mon, 2: Tue, 3: Wed, 4: Thu, 5: Fri, 6: Sat) b8 to 15: First two digits of the year
	Un\G147	b0 to 7: First two digits of the millisecond b8 to 15: Last two digits of the millisecond

■Error code (Un\G140)

The error code is stored.

■Time (Un\G142 to 147)

The time when the error occurred is stored as a BCD code.

	b15	...	b8	b7	...	b0
Un\G142	System area			Time zone and summer time flag*1		
Un\G143	Month (01H to 12H)			Year (00H to 99H) last 2 digits		
Un\G144	Hour (00H to 23H)			Day (01H to 31H)		
Un\G145	Second (00H to 59H)			Minute (00H to 59H)		
Un\G146	Year (00H to 99H) first 2 digits			Day of the week (00H to 6H)		
Un\G147	Lower milliseconds (00H to 99H)			Upper milliseconds (00H to 09H)		

*1 Time zone and Summer time flag details are as follows.

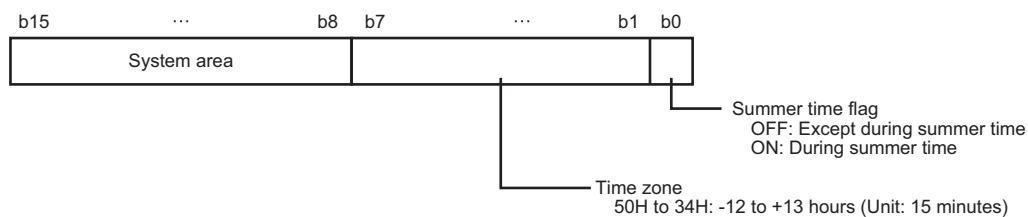

A

Point

The current error area information can be checked with the following diagnostics screens.

- System monitor of an engineering tool

The current error area can be cleared with the following methods.

- Turn the power OFF and ON, or reset the CPU module.
- Clear the errors from an engineering tool.
- Execute the C intelligent function module dedicated function (CITL_ClearError)
- Turn ON the error clear request (YF).

Error log area (Un\G150 to 311)

The history of errors which have occurred on the C intelligent function module can be checked in this area.

Name	Address	Description	
Error count	Un\G150	This is the cumulative number of errors registered in the error log area.	
Error log write pointer	Un\G151	This is the error log number registered to the most recent error log.	
Error log 1	Error code	Un\G152	The error code is stored.
	System area	Un\G153	Use prohibited
	Time	Un\G154	b0 to 7: Time zone and summer time flag b8 to 15: System area
		Un\G155	b0 to 7: Last two digits of the year b8 to 15: Month (01 to 12)
		Un\G156	b0 to 7: Day (01 to 31) b8 to 15: Hour (00 to 23)
		Un\G157	b0 to 7: Minute (00 to 59) b8 to 15: Second (00 to 59)
		Un\G158	b0 to 7: Day of the week (0: Sun, 1: Mon, 2: Tue, 3: Wed, 4: Thu, 5: Fri, 6: Sat) b8 to 15: First two digits of the year
		Un\G159	b0 to 7: First two digits of the millisecond b8 to 15: Last two digits of the millisecond
		System area	Un\G160
	Un\G161		
Error log 2 to 16	Un\G162 to 311	Details are the same as error log 1.	

■Error count (Un\G150)

Cumulative number registered in error log area is stored.

When the maximum value is exceeded, the value is fixed to 65535 (maximum).

■Error log write pointer (Un\G151)

The error log No. (in which the latest error is registered) is stored.*¹

- 0: No error (No error log registered)
- 1 or more: Error log No. registering the latest error log

*¹ When the pointer value is '16', it indicates that the latest error has been registered into the error log area of 16.

The registered errors will become minor errors (maximum 15) and moderate/major errors (1).

If a new minor error occurs when a maximum of 15 minor errors have been indicated, the newly occurred minor error will not be registered. And, if the error with the same error code is already registered, the date and time of occurrence and the detailed information of the relevant error is not updated. Even if a new error occurs after the occurrence of moderate/major errors, the new error will not be registered.

■Error log 1 to 16 (Un\G152 to 311)

Stores the history of the errors that have occurred in the C intelligent function module.

Error log area is comprised of 16 error logs with the same data configuration.

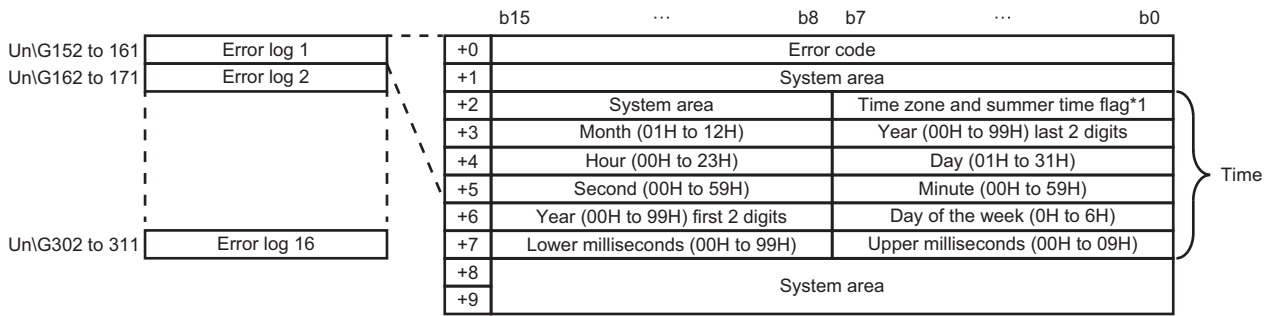

*1 Time zone and Summer time flag details are as follows.

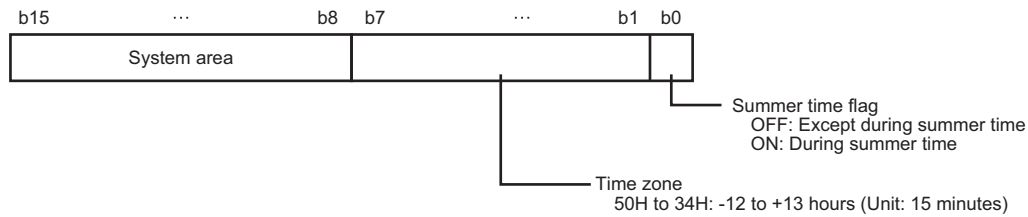

- Error code: The error code is stored.
- Time: The time when the error occurred is stored in BCD code.

Point

The error log area information can be checked with the following diagnostics screens.

- Error information in the module diagnostic screen of an engineering tool
- C intelligent function module dedicated function (CITL_GetErrInfo)

The current error area can be cleared with the following methods.

- Turn the power OFF and ON, or reset the CPU module. (The error log area except for the error count will be cleared.)
- Clear the errors from an engineering tool. (The error log area except for the error count will be cleared.)
- Execute the C intelligent function module dedicated function (CITL_ClearError). (The error log area except for the error count will be cleared.)
- Turn ON the error clear request (YF). (The entire error log area will be cleared.)

Data sampling status area (Un\G800 to 801)

The status of data sampling in each sequence scan by using the sampling function is stored.

Name	Address	Description
Data missing status	Un\G800	The data missing status is stored. <ul style="list-style-type: none"> • 0: Data is not missing • 1: Data is missing
Data sampling status	Un\G801	The execution status of data sampling in each sequence scan is stored. <ul style="list-style-type: none"> • 0: Data sampling is stopped • 1: Data sampling is being performed

Firmware update history storage area (Un\G900 to Un\G931)

The history of firmware update performed by the firmware update function is stored.

Name		Address	Description
Firmware update completion with/without an error		Un\G900	The error occurrence state on the firmware update function is stored. <ul style="list-style-type: none"> • 0: Update completed without an error (including successful completion) • 1: Update completed with an error '1' is stored when a value of the firmware update result (Un\G920) is within 100H to 300H.
System area		Un\G901 to 909	Use prohibited
Information on latest firmware update	Log information	Execution time (year)	Un\G910 The value of the year (four digits) when the firmware update was executed is stored as a BIN code.
		Execution time (month)	Un\G911 The value of the month when the firmware update was executed is stored as a BIN code.
		Execution time (day)	Un\G912 The value of the day when the firmware update was executed is stored as a BIN code.
		Execution time (hour)	Un\G913 The value of the hour when the firmware update was executed is stored as a BIN code.
		Execution time (minute)	Un\G914 The value of the minutes when the firmware update was executed is stored as a BIN code.
		Execution time (second)	Un\G915 The value of the seconds when the firmware update was executed is stored as a BIN code.
		Execution time (day of the week)	Un\G916 The value of the day of the week when the firmware update was executed is stored as a BIN code. (0: Sunday, 1: Monday, 2: Tuesday, 3: Wednesday, 4: Thursday, 5: Friday, 6: Saturday)
		Firmware version after update	Un\G917 The firmware version after update is stored. (When the update is completed with an error, '0' is stored.)
		Firmware version before update	Un\G918 The firmware version before update is stored.
Latest firmware update result		Firmware update target	Un\G919 The start input/output number of the module where the firmware update was executed is stored.
		Firmware update result	Un\G920 The execution result of the firmware update is stored. <ul style="list-style-type: none"> • 1H: Normal end • 100H: Flash ROM error • 200H: Model mismatched • 201H: File invalid • 203H: Firmware update prohibited state • 300H: Firmware data error
Information on previous firmware update	Log information	Execution time (year)	Un\G921 The value of the year (four digits) when the firmware update was executed is stored as a BIN code.
		Execution time (month)	Un\G922 The value of the month when the firmware update was executed is stored as a BIN code.
		Execution time (day)	Un\G923 The value of the day when the firmware update was executed is stored as a BIN code.
		Execution time (hour)	Un\G924 The value of the hour when the firmware update was executed is stored as a BIN code.
		Execution time (minute)	Un\G925 The value of the minutes when the firmware update was executed is stored as a BIN code.
		Execution time (second)	Un\G926 The value of the seconds when the firmware update was executed is stored as a BIN code.
		Execution time (day of the week)	Un\G927 The value of the day of the week when the firmware update was executed is stored as a BIN code. (0: Sunday, 1: Monday, 2: Tuesday, 3: Wednesday, 4: Thursday, 5: Friday, 6: Saturday)
		Firmware version after update	Un\G928 The firmware version after update is stored. (When the update is completed with an error, '0' is stored.)
		Firmware version before update	Un\G929 The firmware version before update is stored.

Name		Address	Description
Previous firmware update result	Firmware update target	Un\G930	The start input/output number of the module where the firmware update was executed is stored.
	Firmware update result	Un\G931	The execution result of the firmware update is stored. <ul style="list-style-type: none"> • 1H: Normal end • 100H: Flash ROM error • 200H: Model mismatched • 201H: File invalid • 203H: Firmware update prohibited state • 300H: Firmware data error

User area (Un\G16384 to 2097151)

The area is available for users for reading/writing using a C intelligent function module dedicated function.

Name	Address	Description
User area	Un\G16384 to 2097151	The area is available for users for reading/writing using a C intelligent function module dedicated function.

Appendix 4 Dedicated Instructions

Dedicated instructions are used to simplify programming when using intelligent function module functions.

For details, refer to the following:

📖 MELSEC iQ-R Programming Manual (Module Dedicated Instructions)

Dedicated instruction list

Application	Dedicated Instruction	Function Overview
User Program Execution	CEXECUTE	To execute a routine registered with the C intelligent function module dedicated function (CITL_EntryDedicatedInstFunc).
Data analysis	DIGIFLTR	To perform digital filter operation for the specified wave.
	ENVCALC	To calculate the envelope of the specified wave.
	FFTSPECT	To perform spectrum calculation using fast Fourier transform (FFT) for the specified wave.
Statistical analysis	LEASTSQ	To calculate a coefficient and a constant of a polynomial, and a multiple correlation coefficient by using a least-squares method for the specified array.
	MTUNIT	To determine a unit space that is used in the MT method based on the specified normal data.
	MTMD	To calculate a Mahalanobis distance of the specified input data.
	MULTIRG	To calculate a coefficient, constant, and regression statistics for multiple regression analysis.

Precautions

Do not change data (control data, request data, etc.) designated by a dedicated instruction until the execution of that instruction is completed.

Appendix 5 VxWorks Component List

This section shows the VxWorks components implemented in a C intelligent function module.

Description	Component List (prjParams.h)
_thread variables support	INCLUDE_TLS
Address Space Allocator Show Routines	INCLUDE_ADR_SPACE_SHOW
address space shell commands	INCLUDE_ADR_SPACE_SHELL_CMD
AIM MMU Show Routines	INCLUDE_AIM_MMU_SHOW
Altera Dw EMAC Enhanced Network Driver	INCLUDE_ALT_SOC_GEN5_DW_END
Altera QSPI support	INCLUDE_ALT_SOC_GEN5_QSPI
Altera SoC Gen 5 DesignWare I2C support	INCLUDE_ALT_SOC_GEN5_DW_I2C
Altera Soc Gen 5 Fpga Maneager support	DRV_ALT_SOC_GEN5_FPGA_MGR
Altera SoC Gen 5 timer driver	INCLUDE_ALT_SOC_GEN5_TIMER
ANSI assert	INCLUDE_ANSI_ASSERT
ANSI ctype	INCLUDE_ANSI_CTYPE
ANSI errno to erro string conversion function	INCLUDE_ANSI_STRERROR
ANSI locale	INCLUDE_ANSI_LOCALE
ANSI math	INCLUDE_ANSI_MATH
ANSI stdio	INCLUDE_ANSI_STDIO
ANSI stdio extensions	INCLUDE_ANSI_STDIO_EXTRA
ANSI stdlib	INCLUDE_ANSI_STDLIB
ANSI string	INCLUDE_ANSI_STRING
ANSI string duplication function	INCLUDE_ANSI_STRDUP
ANSI time	INCLUDE_ANSI_TIME
application initialization	INCLUDE_USER_APPL
ARM Generic Interrupt Controller driver	DRV_ARM_GIC
arp utility wrapper	INCLUDE_IPWRAP_ARP
arpLib	INCLUDE_ARP_API
asynchronous IO show routine	INCLUDE_POSIX_AIO_SHOW
atomic operators support	INCLUDE_ATOMIC_OPERATORS
Attach END to IPv4	INCLUDE_IPATTACH
AUX clock	INCLUDE_AUX_CLK
Basic IO system	INCLUDE_IO_BASIC
basic memory allocator	INCLUDE_MEM_MGR_BASIC
basic MMU	INCLUDE_MMU_BASIC
basic network support	INCLUDE_NETWORK
binary semaphore creation routine	INCLUDE_SEM_BINARY_CREATE
binary semaphores	INCLUDE_SEM_BINARY
Boot parameter process	INCLUDE_NET_BOOT
BSP Memory Configuration	INCLUDE_MEMORY_CONFIG
buil-in symbol table	INCLUDE_STANDALONE_SYM_TBL
c line interpreter	INCLUDE_SHELL_INTERP_C
C++ compiler support routines	INCLUDE_CPLUS_LANG
C++ core runtime	INCLUDE_CPLUS
C++ iostreams and other standard library facilities	INCLUDE_CPLUS_IOSTREAMS
C++ symbol demangler	INCLUDE_CPLUS_DEMANGLER
cache support	INCLUDE_CACHE_SUPPORT
cfiamdmt	INCLUDE_MTD_CFIAMD
class show routine	INCLUDE_CLASS_SHOW
command line interpreter	INCLUDE_SHELL_INTERP_CMD
Common network infrastructure	INCLUDE_COMMON_NET
Commonly used legacy mbuf routines	INCLUDE_MBUF_UTIL1
coprocessor	INCLUDE_COPROCESSOR

Description	Component List (prjParams.h)
coprocessor show routine	INCLUDE_COPROCESSOR_SHOW
Core NFS client	INCLUDE_CORE_NFS_CLIENT
counting semaphore creation routine	INCLUDE_SEM_COUNTING_CREATE
counting semaphores	INCLUDE_SEM_COUNTING
CRYPTO	INCLUDE_IPCRYPTO
debug shell commands	INCLUDE_DEBUG_SHELL_CMD
debugging facilities	INCLUDE_DEBUG
Default SMP scheduler policy	INCLUDE_SMP_SCHED_DEFAULT_POLICY
Device Manager	INCLUDE_DEVICE_MANAGER
DHCP Client	INCLUDE_IPDHCP
DNS Client	INCLUDE_IPDNS
DOS File System Consistency Checker	INCLUDE_DOSFS_CHKDSK
DOS File System FAT12/16/32 Handler	INCLUDE_DOSFS_FAT
DOS File System Old Directory Format Handler	INCLUDE_DOSFS_DIR_FIXED
DOS File System VFAT Directory Handler	INCLUDE_DOSFS_DIR_VFAT
DOS File System Volume Fomatter Module	INCLUDE_DOSFS_FMT
DOS filesystem backward-compatibility	INCLUDE_DOSFS
Dos FS BIO buffer size	INCLUDE_DOSFS_VOL_BIO_BUFFER_SIZE
DOS FS Show Routines	INCLUDE_DOSFS_SHOW
dosfs File System Main Module (dosFs2)	INCLUDE_DOSFS_MAIN
doubly linked lists	INCLUDE_DLL
ED&R Policy Hooks	INCLUDE_EDR_POLICY_HOOKS
ED&R shell commands	INCLUDE_EDR_SHELL_CMD
ED&R show routines	INCLUDE_EDR_SHOW
enable caches	INCLUDE_CACHE_ENABLE
enable guard pages for kernel task stacks	INCLUDE_PROTECT_TASK_STACK
enable non-executable kernel task stacks	INCLUDE_TASK_STACK_NO_EXEC
END driver polled statistics support	INCLUDE_END_POLLED_STATS
END interface support	INCLUDE_END
END: common Enhanced Network Device support	INCLUDE_END_COMMON
error status table	INCLUDE_STAT_SYM_TBL
Ethernet interface support	INCLUDE_ETHERNET
Ethernet Interface support	INCLUDE_IPCOM_USE_ETHERNET
Event Reporting Framework	INCLUDE_ERF
exception handling	INCLUDE_EXC_HANDLING
exception show routines	INCLUDE_EXC_SHOW
exception task	INCLUDE_EXC_TASK
Extended Block Device	INCLUDE_XBD
extended object library	INCLUDE_OBJ_OPEN
Fast, non-deterministic ISR callable spin locks	INCLUDE_SPINLOCK_ISR_ND
File System and Disk Utilities	INCLUDE_DISK_UTIL
File System Event Utilities	INCLUDE_FS_EVENT_UTIL
File System IO	INCLUDE_IO_FILE_SYSTEM
File System Monitor	INCLUDE_FS_MONITOR
file system shell commands	INCLUDE_DISK_UTIL_SHELL_CMD
file upload path initialization	INCLUDE_WVUPLOAD_FILE
Firewall	INCLUDE_IPFIREWALL
floating point show routine	INCLUDE_HW_FP_SHOW
formatted IO	INCLUDE_FORMATTED_IO
formatted output routines	INCLUDE_FORMATTED_OUT_BASIC
fpp formatting for printf	INCLUDE_FLOATING_POINT
ftllite	INCLUDE_TL_FTL
FTP client	INCLUDE_FTP

Description	Component List (prjParams.h)
FTP Server	INCLUDE_IPFTPS
full featured memory allocator	INCLUDE_MEM_MGR_FULL
General BSP macros	INCLUDE_BSP_MACROS
Generic PHY driver	INCLUDE_GENERICPHY
get name info	INCLUDE_GETNAMEINFO
get serv by name	INCLUDE_GETSERVBYNAME
get servse by port	INCLUDE_GETSERVBYPORT
getaddrinfo wrapper	INCLUDE_IPWRAP_GETADDRINFO
gethostbyaddr wrapper	INCLUDE_IPWRAP_GETHOSTBYADDR
gethostbyname wrapper	INCLUDE_IPWRAP_GETHOSTBYNAME
getifaddrs wrapper	INCLUDE_IPWRAP_GETIFADDRS
getnameinfo wrapper	INCLUDE_IPWRAP_GETNAMEINFO
getopt function	INCLUDE_GETOPT
getservbyname wrapper	INCLUDE_IPWRAP_GETSERVBYNAME
getservbyport wrapper	INCLUDE_IPWRAP_GETSERVBYPORT
Global configurations	INCLUDE_IPAIP_GLOBAL_CONFIGS
GNU compiler support routines	INCLUDE_GNU_INTRINSICS
GTF support	INCLUDE_GTF
gtf_timer_start	INCLUDE_GTF_TIMER_START
handle show routines	INCLUDE_HANDLE_SHOW
hardware fpp support	INCLUDE_HW_FP
hash library	INCLUDE_HASH
high resolution timestamping	INCLUDE_TIMESTAMP
Highly Reliable File System	INCLUDE_HRFS
host table	INCLUDE_HOST_TBL
host table sysctl support	INCLUDE_HOST_TBL_SYSCTL
Host/target breakpoint synchronization	INCLUDE_WDB_BP_SYNC
host/target modules and symbols synchronization	INCLUDE_WDB_MDL_SYM_SYNC
HRFS Default Write Mode	INCLUDE_HRFS_DEFAULT_WRITE_MODE
HRFS File System Consistency Checker	INCLUDE_HRFS_CHKDSK
HRFS Format	INCLUDE_HRFS_FORMAT
I2C generic device vxBus driver	DRV_I2C_GENERIC_DEV
ifconfig	INCLUDE_IFCONFIG
ifconfig wrapper	INCLUDE_IPWRAP_IFCONFIG
ifLib wrapper	INCLUDE_IPWRAP_IFLIB
ifname wrapper	INCLUDE_IPWRAP_IFNAME
ifShow wrapper	INCLUDE_IPWRAP_IFSHOW
inetLib	INCLUDE_INETLIB
inetLib wrapper	INCLUDE_IPWRAP_INETLIB
Init pre-kernel memory allocation globally	INIT_HWMEMPOOL_GLOBAL
initialize system symbol table	INCLUDE_SYM_TBL_INIT
Intel PRO/1000 VxBus Enhanced Network Driver	INCLUDE_GEI825XX_VXB_END
Inter-Integrated Circuit Bus	INCLUDE_I2C_BUS
IO system	INCLUDE_IO_SYSTEM
IP v4	INCLUDE_IPV4
IPCOM arp commands	INCLUDE_IPARP_CMD
IPCOM Firewall commands	INCLUDE_IPFIREWALL_CMD
IPCOM ifconfig commands	INCLUDE_IPIFCONFIG_CMD
IPCOM ipd commands	INCLUDE_IPD_CMD
IPCOM netstat commands	INCLUDE_IPNETSTAT_CMD
IPCOM ping commands	INCLUDE_IPPING_CMD
IPCOM radius client commands	INCLUDE_IPRADIUS_CMD
IPCOM route commands	INCLUDE_IPROUTE_CMD

Description	Component List (prjParams.h)
IPCOM shell command interface	INCLUDE_IPCOM_SHELL_CMD
IPCOM sysctl commands	INCLUDE_IPSYSCTL_CMD
IPCOM sysvar commands	INCLUDE_IPCOM_SYSVAR_CMD
IPCOM uses native VxWorks file system	INCLUDE_IPCOM_FS_NATIVE
IPNET	INCLUDE_IPNET
IPNet loopback configuration	INCLUDE_IPNET_LOOPBACK_CONFIG
IPNet Stack	INCLUDE_IPNET_STACK
IPNet sysctl integration	INCLUDE_IPNET_SYSCTL
ipProto wrapper	INCLUDE_IPWRAP_IPPROTO
IPv4	INCLUDE_IPCOM_USE_INET
IPv4 AutoIP	INCLUDE_IPAIP
IPv4 Multicast routing	INCLUDE_IPNET_USE_MCAST_ROUTING
ISR deferral	INCLUDE_ISR_DEFER
Job Queue support	INCLUDE_JOB_QUEUE
job task	INCLUDE_JOB_TASK
kernel	INCLUDE_KERNEL
kernel shell startup script	INCLUDE_STARTUP_SCRIPT
link BufPool	INCLUDE_LINKBUFPOOL
linked list library	INCLUDE_LSTLIB
Loopback Interface support	INCLUDE_IPNET_USE_LOOPBACK
M_BLK ethernet/802.3 header build and parse	INCLUDE_END_ETHER_HDR
mapped files shell commands	INCLUDE_MAPPED_FILES_SHOW_SHELL_CMD
memory allocator info routines	INCLUDE_MEM_MGR_INFO
Memory mapping	INCLUDE_MMAP
memory show routine	INCLUDE_MEM_SHOW
message logging	INCLUDE_LOGGING
message queue info routines	INCLUDE_MSG_Q_INFO
message queue show routine	INCLUDE_MSG_Q_SHOW
message queues	INCLUDE_MSG_Q
message queues creation and deletion library	INCLUDE_MSG_Q_CREATE_DELETE
MIB2 ICMP Management APIs	INCLUDE_MIB2_ICMP
MIB2 IF Counter Instrumentation	INCLUDE_MIB2_IF
MIB2 TCP Management APIs	INCLUDE_MIB2_TCP
MIB2 UDP Management APIs	INCLUDE_MIB2_UDP
MII bus controller module	INCLUDE_MII_BUS
Miscellaneous IO	INCLUDE_IO_MISC
MMU global map	INCLUDE_MMU_GLOBAL_MAP
module manager	INCLUDE_MODULE_MANAGER
mutex semaphore creation routine	INCLUDE_SEM_MUTEX_CREATE
mutex semaphores	INCLUDE_SEM_MUTEX
MUX common support (all protocol and device styles)	INCLUDE_MUX_COMMON
MUX mux2Bind() service (default)	INCLUDE_MUX2
MUX mux2Bind() service / END-style device	INCLUDE_MUX2_OVER_END
MUX muxTkBind() service	INCLUDE_MUXTK
MUX muxTkBind() service / END-style device	INCLUDE_MUXTK_OVER_END
MUX private support for M_BLK/Ipcom_pkt conversion	INCLUDE_VXMUX_MBLK
MUX support	INCLUDE_MUX
NAT	INCLUDE_IPNET_USE_NAT
netBufLib	INCLUDE_NETBUFLIB
netBufLib show routines	INCLUDE_NETPOOLSHOW
netBufPool	INCLUDE_NETBUFPOOL
NetDrv for remote IO	INCLUDE_NET_DRV
Netlink socket	INCLUDE_IPNET_USE_NETLINKSOCK

Description	Component List (prjParams.h)
netstat wrapper	INCLUDE_IPWRAP_NETSTAT
network boot device configuration	INCLUDE_NET_BOOT_CONFIG
Network Daemon Support	INCLUDE_NET_DAEMON
network device netmask setup	INCLUDE_NETMASK_GET
Network host show routines	INCLUDE_NET_HOST_SHOW
network init	INCLUDE_NET_INIT
network remote I/O access	INCLUDE_NET_REM_IO
Network Stack Memory Pool Configuration	INCLUDE_NET_POOL
NETWORK SYSCTL	INCLUDE_NET_SYSCTL
NFS client All	INCLUDE_NFS_CLIENT_ALL
NFS server	INCLUDE_CORE_NFS_SERVER
NFS server All	INCLUDE_NFS_SERVER_ALL
NFS server V2	INCLUDE_NFS2_SERVER
NFS server V3	INCLUDE_NFS3_SERVER
NFS v2 client	INCLUDE_NFS2_CLIENT
NFS v3 client	INCLUDE_NFS3_CLIENT
nullBufPool	INCLUDE_VXMUX_NULLBUFPOOL
object information	INCLUDE_OBJ_INFO
object management	INCLUDE_OBJ_LIB
object management ownership	INCLUDE_OBJ_OWNERSHIP
object show routines	INCLUDE_OBJECT_SHOW
oldRouteLib wrapper	INCLUDE_IPWRAP_OLDROUTELIB
persistent error log	INCLUDE_EDR_ERRLOG
persistent memory	INCLUDE_EDR_PM
PING client	INCLUDE_PING
ping wrapper	INCLUDE_IPWRAP_PING
pipes	INCLUDE_PIPES
pool allocation library	INCLUDE_POOL
POSIX advisory file locking	INCLUDE_POSIX_ADVISORY_FILE_LOCKING
POSIX AIO driver	INCLUDE_POSIX_AIO_SYSDRV
POSIX asynchronous IO	INCLUDE_POSIX_AIO
POSIX clocks	INCLUDE_POSIX_CLOCKS
POSIX directory utilities	INCLUDE_POSIX_DIRLIB
POSIX ftruncate	INCLUDE_POSIX_FTRUNC
POSIX IO	INCLUDE_IO_POSIX
POSIX message queue show routine	INCLUDE_POSIX_MQ_SHOW
POSIX message queues	INCLUDE_POSIX_MQ
POSIX mman	INCLUDE_POSIX_MEM
POSIX process scheduling	INCLUDE_POSIX_SCHED
POSIX semaphore	INCLUDE_POSIX_SEM
POSIX semaphore show routine	INCLUDE_POSIX_SEM_SHOW
POSIX Shared Memory Objects	INCLUDE_POSIX_SHM
POSIX signal	INCLUDE_POSIX_SIGNALS
POSIX thread CPU-time clock	INCLUDE_POSIX_THREAD_CPUTIME
POSIX threads	INCLUDE_POSIX_PTHREADS
Posix timer show component	INCLUDE_POSIX_TIMER_SHOW
POSIX timers	INCLUDE_POSIX_TIMERS
POSIX TRACE	INCLUDE_POSIX_TRACE
Pre-Kernel Memory Allocation	INCLUDE_HWMEM_ALLOC
Processor Local Bus	INCLUDE_PLB_BUS
ProxyARP	INCLUDE_IPPROXYARP
Pseudo terminal driver	INCLUDE_PTYDRV
public hostname setup	INCLUDE_NET_HOST_SETUP

Description	Component List (prjParams.h)
Radius Authentication Support	INCLUDE_IPCOM_USE_AUTH_RADIUS
Radius client	INCLUDE_IPRADIUS
RAM Disk	INCLUDE_RAM_DISK
raw filesystem	INCLUDE_RAWFS
rBuff library	INCLUDE_RBUFF
rBuff show routine	INCLUDE_RBUFF_SHOW
read the bootline	INCLUDE_BOOT_LINE_INIT
reader/write semaphores	INCLUDE_SEM_READ_WRITE
reader/write semaphores creation routine	INCLUDE_SEM_READ_WRITE_CREATE
Remote Command	INCLUDE_REMLIB
Remote Command sysctl support	INCLUDE_REMLIB_SYSCTL
Removable IO	INCLUDE_IO_REMOVABLE
ring buffers	INCLUDE_RNG_BUF
route	INCLUDE_ROUTECMD
route wrapper	INCLUDE_IPWRAP_ROUTECMD
Routing socket support	INCLUDE_IPNET_USE_ROUTE SOCK
RPC	INCLUDE_RPC
run static initializers	INCLUDE_CTORS_DTORS
select	INCLUDE_SELECT
semaphore deletion routines	INCLUDE_SEM_DELETE
semaphore exchange routine	INCLUDE_SEM_EXCHANGE
semaphore info routines	INCLUDE_SEM_INFO
semaphore show routine	INCLUDE_SEM_SHOW
Serial line connection commands	INCLUDE_TIP_CMD
Shared Data Show	INCLUDE_SHARED_DATA_SHOW
shared data show shell commands	INCLUDE_SHARED_DATA_SHOW_SHELL_CMD
shared library commands	INCLUDE_SHL_SHELL_CMD
Shared Library Show	INCLUDE_SHL_SHOW
shell banner	INCLUDE_SHELL_BANNER
show routine component	INCLUDE_SHOW_ROUTINES
Show routines for memory mapped objects	INCLUDE_MAPPED_FILES_SHOW
sigevent notification library	INCLUDE_SIGEVENT
signals	INCLUDE_SIGNALS
SIO	INCLUDE_SIO
Sio Channel Utilities	INCLUDE_SIO_UTILS
SNTP Client (API)	INCLUDE_IPSNTPC_API
SNTP Client (daemon)*1	INCLUDE_IPSNTPC*1
SNTP common configurations	INCLUDE_IPSNTP_COMMON
sntpTimeGet wrapper	INCLUDE_IPWRAP_SNPCTIMEGET
Socket API	INCLUDE_SOCKETLIB
Socket API System Call support	INCLUDE_SC_SOCKETLIB
Socket backend	INCLUDE_IPNET_USE_SOCKET_COMPAT
Socket support	INCLUDE_IPNET_SOCKET
software fpp support	INCLUDE_SW_FP
spinLock	INCLUDE_SPINLOCK
spy	INCLUDE_SPY
Spy CPU activity commands	INCLUDE_SPY_SHELL_CMD
Stack/Application Logging Utility	INCLUDE_APPL_LOG_UTIL
stdio	INCLUDE_STDIO
stdio show routine	INCLUDE_STDIO_SHOW
Support for reboot hooks	INCLUDE_REBOOT_HOOKS
symbol shell commands	INCLUDE_SYM_SHELL_CMD
symbol table show routine	INCLUDE_SYM_TBL_SHOW



Description	Component List (prjParams.h)
SYSCTL	INCLUDE_SYSCTL
SYSCTL CLI	INCLUDE_SYSCTL_CLI
sysctl System Call	INCLUDE_SC_SYSCTL
System Address Space Allocator	INCLUDE_ADR_SPACE_LIB
System Call Hook Support	INCLUDE_SYSCALL_HOOKS
System clock	INCLUDE_SYSCLK_INIT
system debug flag	INCLUDE_EDR_SYSDBG_FLAG
system debug flag	INCLUDE_SYSDBG_FLAG
System Viewer class instrumentation	INCLUDE_WINDVIEW_CLASS
System Viewer library	INCLUDE_WINDVIEW
system-defined timestamping	INCLUDE_SYS_TIMESTAMP
target loader	INCLUDE_LOADER
target loader shell command	INCLUDE_MODULE_SHELL_CMD
target symbol table	INCLUDE_SYM_TBL
target unloader	INCLUDE_UNLOADER
target-resident kernel shell	INCLUDE_SHELL
task create hooks	INCLUDE_TASK_CREATE_HOOKS
task hook show routine	INCLUDE_TASK_HOOKS_SHOW
task hooks	INCLUDE_TASK_HOOKS
task info routines	INCLUDE_TASK_INFO
task list management	INCLUDE_TASK_LIST
task shell commands	INCLUDE_TASK_SHELL_CMD
task show routine	INCLUDE_TASK_SHOW
task switch hooks	INCLUDE_TASK_SWITCH_HOOKS
task utility routines	INCLUDE_TASK_UTIL
TCP	INCLUDE_IPTCP
TELNET Server	INCLUDE_IPTELNETS
TELNET/FTP password protection	INCLUDE_SECURITY
terminal driver	INCLUDE_TTY_DEV
terminal driver support	INCLUDE_TYLIB
TFTP Client	INCLUDE_IPTFTP
TFTP client APIs	INCLUDE_TFTP_CLIENT
TFTP common configurations	INCLUDE_IPTFTP_COMMON
timex	INCLUDE_TIMEX
tip serial line connection utility	INCLUDE_TIP
Transactional Block Layer	INCLUDE_XBD_TRANS
trueFFS Flash File System	INCLUDE_TFFS
trueFFS Show Routines	INCLUDE_TFFS_SHOW
TSFS upload path initialization	INCLUDE_WVUPLOAD_TSFSSOCK
UART support for ns16550-compatible devices	DRV_SIO_NS16550
unix compatible environment variables	INCLUDE_ENV_VARS
unloader shell command	INCLUDE_UNLOADER_SHELL_CMD
Use Authentication	INCLUDE_IPCOM_USE_AUTH
Vector Floating Point	INCLUDE_VFP
vi-like editing mode	INCLUDE_SHELL_VI_MODE
VIO driver	INCLUDE_WDB_VIO
virtual memory show shell commands	INCLUDE_VM_SHOW_SHELL_CMD
Virtual Root File Sytem	INCLUDE_VRFS
VLAN Pseudo Interface support	INCLUDE_IPNET_USE_VLAN
VM library show routine	INCLUDE_VM_SHOW
vxBus Aux Clk Support	INCLUDE_VXB_AUX_CLK
VxBus Device Table	VXBUS_TABLE_CONFIG
vxBus Driver DMA System	INCLUDE_DMA_SYS

Description	Component List (prjParams.h)
vxBus Driver Parameter System	INCLUDE_PARAM_SYS
VxBus Interrupt Controller Library	INCLUDE_INTCTLR_LIB
vxBus subsystem	INCLUDE_VXBUS
vxBus subsystem show routines	INCLUDE_VXBUS_SHOW
vxBus Sys Clk Support	INCLUDE_VXB_SYS_CLK
vxBus Timer Support	INCLUDE_TIMER_SYS
VxBus Timestamp Support	INCLUDE_VXB_TIMESTAMP
vxIpiLib	INCLUDE_VXIPI
vxMemProbe initializer for exception handler support	INCLUDE_VXMEMPROBE_INIT
VxWorks debug library	INCLUDE_VXDBG
VxWorks events	INCLUDE_VXEVENTS
VxWorks IPCOM	INCLUDE_IPCOM
watchdog timer show routine	INCLUDE_WATCHDOGS_SHOW
watchdog timers	INCLUDE_WATCHDOGS
watchdog timers creation and deletion library	INCLUDE_WATCHDOGS_CREATE_DELETE
WDB agent	INCLUDE_WDB
WDB banner	INCLUDE_WDB_BANNER
WDB breakpoints	INCLUDE_WDB_BP
WDB call functions	INCLUDE_WDB_FUNC_CALL
WDB callouts	INCLUDE_WDB_DIRECT_CALL
WDB dynamic enabled	INCLUDE_WDB_DPRINTF
WDB eventpoints	INCLUDE_WDB_EVENTPOINTS
WDB events	INCLUDE_WDB_EVENTS
WDB exception notification	INCLUDE_WDB_EXC_NOTIFY
WDB gopher	INCLUDE_WDB_GOPHER
WDB is always enabled	INCLUDE_WDB_ALWAYS_ENABLED
WDB memory access	INCLUDE_WDB_MEM
WDB network connection	INCLUDE_WDB_COMM_NETWORK
WDB post kernel initialization	INCLUDE_WDB_POST_KERNEL_INIT
WDB register access	INCLUDE_WDB_REG
WDB target server file system	INCLUDE_WDB_TSFS
WDB task breakpoints	INCLUDE_WDB_TASK_BP
WDB task creation	INCLUDE_WDB_START_NOTIFY
WDB task debugging	INCLUDE_WDB_TASK
WDB task exit notification	INCLUDE_WDB_EXIT_NOTIFY
WDB task hooks	INCLUDE_WDB_TASK_HOOKS
WDB task registers	INCLUDE_WDB_TASK_REG
WDB tasks	INCLUDE_WDB_CTXT
WDB user event	INCLUDE_WDB_USER_EVENT
WDB virtual I/O library	INCLUDE_WDB_VIO_LIB
write-project program text	INCLUDE_PROTECT_TEXT
XBD Block Device	INCLUDE_XBD_BLK_DEV
XBD Disk Partition Handler	INCLUDE_XBD_PART_LIB
XBD Ram Drive	INCLUDE_XBD_RAMDRV
XDR	INCLUDE_XDR

*1 It is disabled for an RD55UP06-V and RD55UP12-V with the firmware version '08' or later.

Appendix 6 Added and Changed Functions

This section shows the added and changed functions of a C intelligent function module.

Added/changed contents	Firmware version		Reference
	RD55UP06-V	RD55UP12-V	
Data sampling in each sequence scan is supported.	"03"	"01"	☞ Page 39 Sampling Function
The data analysis function is supported.	"05"		☞ Page 21 Data analysis function
Data analysis or statistical analysis using a CPU module	"07"		☞ Page 22 Data analysis or statistical analysis using a CPU module
The firmware update function is supported.			☞ MELSEC iQ-R Module Configuration Manual
Dedicated instructions for data analysis are supported.			☞ MELSEC iQ-R Programming Manual (Module Dedicated Instructions)
Module FBs are supported.			☞ MELSEC iQ-R C Intelligent Function Module Function Block Reference
The SD memory card boot function is supported.	"08"*1	☞ Page 46 SD Memory Card Boot Function	

*1 It is available for an RD55UP06-V with a serial number of which the first two digits are '08' or higher.

MEMO

A

INDEX

A

Account setting 23,25,34
attrib() command. 31

D

Dedicated function library. 15
Dedicated instruction. 17

F

File attribute 31
FTP 23
FTP client. 23,24

I

Initialization 29
Interrupt condition 18
Interrupt routine 19

S

Security password. 31,32,33
System watchdog timer 27

T

Telnet 25

U

User watchdog timer 27

MEMO

REVISIONS

*The manual number is given on the bottom left of the back cover.

Revision date	*Manual number	Description
December 2015	SH(NA)-081567ENG-A	First edition
June 2016	SH(NA)-081567ENG-B	■Added or modified part Section 1.4
January 2017	SH(NA)-081567ENG-C	■Added or modified parts SAFETY PRECAUTIONS, Section 1.5, Section 1.6, Appendix 3, Appendix 6
April 2017	SH(NA)-081567ENG-D	■Added or modified parts RELEVANT MANUALS, TERMS, Section 1.1, Section 3.5, Appendix 6
October 2017	SH(NA)-081567ENG-E	■Added or modified part Section 1.6
December 2017	SH(NA)-081567ENG-F	■Added or modified parts TERMS, Section 1.1, Section 3.5
September 2018	SH(NA)-081567ENG-G	■Added or modified parts TERMS, Section 1.1, Section 3.6, Section 3.7, Appendix 3, Appendix 4, Appendix 6
October 2019	SH(NA)-081567ENG-H	■Added or modified parts Section 3.6, Appendix 5
July 2020	SH(NA)-081567ENG-I	■Added or modified parts SAFETY PRECAUTIONS, CONDITIONS OF USE FOR THE PRODUCT, INTRODUCTION, RELEVANT MANUALS, Section 1.4, Section 1.6, Section 1.7, Section 2.1, Section 2.2, Section 2.3, Section 2.5, Section 3.5, Section 3.6, Appendix 1, Appendix 3, Appendix 5, Appendix 6
December 2020	SH(NA)-081567ENG-J	■Added or modified parts Section 1.4, Section 2.2, Section 2.3
March 2023	SH(NA)-081567ENG-K	■Added or modified part Section 1.8, Section 3.6

Japanese manual number: SH-081564-K

This manual confers no industrial property rights or any rights of any other kind, nor does it confer any patent licenses. Mitsubishi Electric Corporation cannot be held responsible for any problems involving industrial property rights which may occur as a result of using the contents noted in this manual.

© 2015 MITSUBISHI ELECTRIC CORPORATION

WARRANTY

Please confirm the following product warranty details before using this product.

1. Gratis Warranty Term and Gratis Warranty Range

If any faults or defects (hereinafter "Failure") found to be the responsibility of Mitsubishi occurs during use of the product within the gratis warranty term, the product shall be repaired at no cost via the sales representative or Mitsubishi Service Company.

However, if repairs are required onsite at domestic or overseas location, expenses to send an engineer will be solely at the customer's discretion. Mitsubishi shall not be held responsible for any re-commissioning, maintenance, or testing on-site that involves replacement of the failed module.

[Gratis Warranty Term]

The gratis warranty term of the product shall be for one year after the date of purchase or delivery to a designated place. Note that after manufacture and shipment from Mitsubishi, the maximum distribution period shall be six (6) months, and the longest gratis warranty term after manufacturing shall be eighteen (18) months. The gratis warranty term of repair parts shall not exceed the gratis warranty term before repairs.

[Gratis Warranty Range]

- (1) The range shall be limited to normal use within the usage state, usage methods and usage environment, etc., which follow the conditions and precautions, etc., given in the instruction manual, user's manual and caution labels on the product.
- (2) Even within the gratis warranty term, repairs shall be charged for in the following cases.
 1. Failure occurring from inappropriate storage or handling, carelessness or negligence by the user. Failure caused by the user's hardware or software design.
 2. Failure caused by unapproved modifications, etc., to the product by the user.
 3. When the Mitsubishi product is assembled into a user's device, Failure that could have been avoided if functions or structures, judged as necessary in the legal safety measures the user's device is subject to or as necessary by industry standards, had been provided.
 4. Failure that could have been avoided if consumable parts (battery, backlight, fuse, etc.) designated in the instruction manual had been correctly serviced or replaced.
 5. Failure caused by external irresistible forces such as fires or abnormal voltages, and Failure caused by force majeure such as earthquakes, lightning, wind and water damage.
 6. Failure caused by reasons unpredictable by scientific technology standards at time of shipment from Mitsubishi.
 7. Any other failure found not to be the responsibility of Mitsubishi or that admitted not to be so by the user.

2. Onerous repair term after discontinuation of production

- (1) Mitsubishi shall accept onerous product repairs for seven (7) years after production of the product is discontinued. Discontinuation of production shall be notified with Mitsubishi Technical Bulletins, etc.
- (2) Product supply (including repair parts) is not available after production is discontinued.

3. Overseas service

Overseas, repairs shall be accepted by Mitsubishi's local overseas FA Center. Note that the repair conditions at each FA Center may differ.

4. Exclusion of loss in opportunity and secondary loss from warranty liability

Regardless of the gratis warranty term, Mitsubishi shall not be liable for compensation to:

- (1) Damages caused by any cause found not to be the responsibility of Mitsubishi.
- (2) Loss in opportunity, lost profits incurred to the user by Failures of Mitsubishi products.
- (3) Special damages and secondary damages whether foreseeable or not, compensation for accidents, and compensation for damages to products other than Mitsubishi products.
- (4) Replacement by the user, maintenance of on-site equipment, start-up test run and other tasks.

5. Changes in product specifications

The specifications given in the catalogs, manuals or technical documents are subject to change without prior notice.

TRADEMARKS

Windows is a trademark of the Microsoft group of companies.

Arm is a registered trademark of Arm Limited (or its subsidiaries) in the US and/or elsewhere.

VxWorks and Wind River are either registered trademarks or trademarks of Wind River Systems, Inc.

The company names, system names and product names mentioned in this manual are either registered trademarks or trademarks of their respective companies.

In some cases, trademark symbols such as [™] or [®] are not specified in this manual.

SH(NA)-081567ENG-K(2303)KWIX

MODEL: RD55UP06-V-U-OU-E

MODEL CODE: 13JX43

MITSUBISHI ELECTRIC CORPORATION

HEAD OFFICE: TOKYO BLDG., 2-7-3, MARUNOUCHI, CHIYODA-KU, TOKYO 100-8310, JAPAN
NAGOYA WORKS: 1-14, YADA-MINAMI 5-CHOME, HIGASHI-KU, NAGOYA 461-8670, JAPAN

When exported from Japan, this manual does not require application to the
Ministry of Economy, Trade and Industry for service transaction permission.

Specifications subject to change without notice.