

Programmable Controller

**MELSEC iQ-R**  
series

# MELSEC iQ-R Motion Controller User's Manual

---

-R16MTCPU  
-R32MTCPU  
-R64MTCPU





# SAFETY PRECAUTIONS



---

(Read these precautions before using this product.)

Before using this product, please read this manual and the relevant manuals carefully and pay full attention to safety to handle the product correctly.

The precautions given in this manual are concerned with this product only. Refer to MELSEC iQ-R Module Configuration Manual for a description of the PLC system safety precautions.

In this manual, the safety precautions are classified into two levels: "  WARNING" and "  CAUTION".

 <b>WARNING</b>	Indicates that incorrect handling may cause hazardous conditions, resulting in death or severe injury.
 <b>CAUTION</b>	Indicates that incorrect handling may cause hazardous conditions, resulting in minor or moderate injury or property damage.

Under some circumstances, failure to observe the precautions given under "  CAUTION" may lead to serious consequences.

Observe the precautions of both levels because they are important for personal and system safety.

Make sure that the end users read this manual and then keep the manual in a safe place for future reference.

## [Design Precautions]

---

### **WARNING**

- Configure safety circuits external to the programmable controller to ensure that the entire system operates safely even when a fault occurs in the external power supply or the programmable controller. Failure to do so may result in an accident due to an incorrect output or malfunction.
    - (1) Emergency stop circuits, protection circuits, and protective interlock circuits for conflicting operations (such as forward/reverse rotations or upper/lower limit positioning) must be configured external to the programmable controller.
    - (2) When the programmable controller detects an abnormal condition, it stops the operation and all outputs are:
      - Turned off if the overcurrent or overvoltage protection of the power supply module is activated.
      - Held or turned off according to the parameter setting if the self-diagnostic function of the CPU module detects an error such as a watchdog timer error.
    - (3) All outputs may be turned on if an error occurs in a part, such as an I/O control part, where the CPU module cannot detect any error. To ensure safety operation in such a case, provide a safety mechanism or a fail-safe circuit external to the programmable controller. For a fail-safe circuit example, refer to "General Safety Requirements" in the MELSEC iQ-R Module Configuration Manual.
    - (4) Outputs may remain on or off due to a failure of a component such as a relay and transistor in an output circuit. Configure an external circuit for monitoring output signals that could cause a serious accident.
  - In an output circuit, when a load current exceeding the rated current or an overcurrent caused by a load short-circuit flows for a long time, it may cause smoke and fire. To prevent this, configure an external safety circuit, such as a fuse.
  - Configure a circuit so that the programmable controller is turned on first and then the external power supply. If the external power supply is turned on first, an accident may occur due to an incorrect output or malfunction.
-

## [Design Precautions]

---

### **WARNING**

- Configure a circuit so that the external power supply is turned off first and then the programmable controller. If the programmable controller is turned off first, an accident may occur due to an incorrect output or malfunction.
  - For the operating status of each station after a communication failure, refer to manuals for the network used. For the manuals, please consult your local Mitsubishi representative. Incorrect output or malfunction due to a communication failure may result in an accident.
  - When connecting an external device with a CPU module or intelligent function module to modify data of a running programmable controller, configure an interlock circuit in the program to ensure that the entire system will always operate safely. For other forms of control (such as program modification, parameter change, forced output, or operating status change) of a running programmable controller, read the relevant manuals carefully and ensure that the operation is safe before proceeding. Improper operation may damage machines or cause accidents. When a Safety CPU is used, data cannot be modified while the Safety CPU is in SAFETY MODE.
  - Especially, when a remote programmable controller is controlled by an external device, immediate action cannot be taken if a problem occurs in the programmable controller due to a communication failure. To prevent this, configure an interlock circuit in the program, and determine corrective actions to be taken between the external device and CPU module in case of a communication failure.
  - Do not write any data to the "system area" and "write-protect area" of the buffer memory in the module. Also, do not use any "use prohibited" signals as an output signal from the CPU module to each module. Doing so may cause malfunction of the programmable controller system. For the "system area", "write-protect area", and the "use prohibited" signals, refer to the user's manual for the module used. For areas used for safety communications, they are protected from being written by users, and thus safety communications failure caused by data writing does not occur.
  - If a communication cable is disconnected, the network may be unstable, resulting in a communication failure of multiple stations. Configure an interlock circuit in the program to ensure that the entire system will always operate safely even if communications fail. Failure to do so may result in an accident due to an incorrect output or malfunction. When safety communications are used, an interlock by the safety station interlock function protects the system from an incorrect output or malfunction.
  - Configure safety circuits external to the programmable controller to ensure that the entire system operates safely even when a fault occurs in the external power supply or the programmable controller. Failure to do so may result in an accident due to an incorrect output or malfunction.
  - If safety standards (ex., robot safety rules, etc.,) apply to the system using the module, servo amplifier and servo motor, make sure that the safety standards are satisfied.
  - Construct a safety circuit externally of the module or servo amplifier if the abnormal operation of the module or servo amplifier differs from the safety directive operation in the system.
  - Do not remove the SSCNETⅢ cable while turning on the control circuit power supply of modules and servo amplifier. Do not see directly the light generated from SSCNETⅢ connector of the module or servo amplifier and the end of SSCNETⅢ cable. When the light gets into eyes, you may feel something wrong with eyes. (The light source of SSCNETⅢ complies with class 1 defined in JISC6802 or IEC60825-1.)
-

## [Design Precautions]

---

### **CAUTION**

- Do not install the control lines or communication cables together with the main circuit lines or power cables. Doing so may result in malfunction due to electromagnetic interference. Keep a distance of 100mm or more between those cables.
  - During control of an inductive load such as a lamp, heater, or solenoid valve, a large current (approximately ten times greater than normal) may flow when the output is turned from off to on. Therefore, use a module that has a sufficient current rating.
  - After the CPU module is powered on or is reset, the time taken to enter the RUN status varies depending on the system configuration, parameter settings, and/or program size. Design circuits so that the entire system will always operate safely, regardless of the time.
  - Do not power off the programmable controller or reset the CPU module while the settings are being written. Doing so will make the data in the flash ROM and SD memory card undefined. The values need to be set in the buffer memory and written to the flash ROM and SD memory card again. Doing so also may cause malfunction or failure of the module.
  - When changing the operating status of the CPU module from external devices (such as the remote RUN/STOP functions), select "Do Not Open by Program" for "Opening Method" of "Module Parameter". If "Open by Program" is selected, an execution of the remote STOP function causes the communication line to close. Consequently, the CPU module cannot reopen the line, and external devices cannot execute the remote RUN function.
- 

## [Security Precautions]

---

### **WARNING**

- To maintain the security (confidentiality, integrity, and availability) of the programmable controller and the system against unauthorized access, denial-of-service (DoS) attacks, computer viruses, and other cyberattacks from external devices via the network, take appropriate measures such as firewalls, virtual private networks (VPNs), and antivirus solutions.
- 

## [Installation Precautions]

---

### **WARNING**

- Shut off the external power supply (all phases) used in the system before mounting or removing the module. Failure to do so may result in electric shock or cause the module to fail or malfunction.
-

## [Installation Precautions]

---

### CAUTION

- Use the programmable controller in an environment that meets the general specifications in the Safety Guidelines (IB-0800525). Failure to do so may result in electric shock, fire, malfunction, or damage to or deterioration of the product.
  - To mount a module, place the concave part(s) located at the bottom onto the guide(s) of the base unit, and push in the module until the hook(s) located at the top snaps into place. Incorrect interconnection may cause malfunction, failure, or drop of the module.
  - To mount a module with no module fixing hook, place the concave part(s) located at the bottom onto the guide(s) of the base unit, push in the module, and fix it with screw(s). Incorrect interconnection may cause malfunction, failure, or drop of the module.
  - When using the programmable controller in an environment of frequent vibrations, fix the module with a screw.
  - Tighten the screws within the specified torque range. Undertightening can cause drop of the component or wire, short circuit, or malfunction. Overtightening can damage the screw and/or module, resulting in drop, short circuit, or malfunction. For the specified torque range, refer to the MELSEC iQ-R Module Configuration Manual.
  - When using an extension cable, connect it to the extension cable connector of the base unit securely. Check the connection for looseness. Poor contact may cause malfunction.
  - When using an SD memory card, fully insert it into the SD memory card slot. Check that it is inserted completely. Poor contact may cause malfunction.
  - Securely insert an extended SRAM cassette or a battery-less option cassette into the cassette connector of the CPU module. After insertion, close the cassette cover and check that the cassette is inserted completely. Poor contact may cause malfunction.
  - Beware that the module could be very hot while power is on and immediately after power-off.
  - Do not directly touch any conductive parts and electronic components of the module, SD memory card, extended SRAM cassette, battery-less option cassette, or connector. Doing so can cause malfunction or failure of the module.
- 

## [Wiring Precautions]

---

### WARNING

- Shut off the external power supply (all phases) used in the system before installation and wiring. Failure to do so may result in electric shock or cause the module to fail or malfunction.
- After installation and wiring, attach a blank cover module (RG60) to each empty slot before powering on the system for operation. Also, attach an extension connector protective cover<sup>\*1</sup> to each unused extension cable connector as necessary. Directly touching any conductive parts of the connectors while power is on may result in electric shock.

\*1 For details, please consult your local Mitsubishi Electric representative.

---

## [Wiring Precautions]

---

### CAUTION

- Individually ground the FG and LG terminals of the programmable controller with a ground resistance of 100 ohms or less. Failure to do so may result in electric shock or malfunction.
  - Use applicable solderless terminals and tighten them within the specified torque range. If any spade solderless terminal is used, it may be disconnected when the terminal screw comes loose, resulting in failure.
  - Check the rated voltage and signal layout before wiring to the module, and connect the cables correctly. Connecting a power supply with a different voltage rating or incorrect wiring may cause fire or failure.
  - Connectors for external devices must be crimped or pressed with the tool specified by the manufacturer, or must be correctly soldered. Incomplete connections may cause short circuit, fire, or malfunction.
  - Securely connect the connector to the module. Poor contact may cause malfunction.
  - Do not install the control lines or communication cables together with the main circuit lines or power cables. Doing so may result in malfunction due to noise. Keep a distance of 100mm or more between those cables.
  - Place the cables in a duct or clamp them. If not, dangling cables may swing or inadvertently be pulled, resulting in malfunction or damage to modules or cables.  
In addition, the weight of the cables may put stress on modules in an environment of strong vibrations and shocks.  
Do not clamp the extension cables with the jacket stripped. Doing so may change the characteristics of the cables, resulting in malfunction.
  - Check the interface type and correctly connect the cable. Incorrect wiring (connecting the cable to an incorrect interface) may cause failure of the module and external device.
  - Tighten the terminal screws or connector screws within the specified torque range. Undertightening can cause drop of the screw, short circuit, fire, or malfunction. Overtightening can damage the screw and/or module, resulting in drop, short circuit, fire, or malfunction.
  - When disconnecting the cable from the module, do not pull the cable by the cable part. For the cable with connector, hold the connector part of the cable. For the cable connected to the terminal block, loosen the terminal screw. Pulling the cable connected to the module may result in malfunction or damage to the module or cable.
  - Prevent foreign matter such as dust or wire chips from entering the module. Such foreign matter can cause a fire, failure, or malfunction.
  - When a protective film is attached to the top of the module, remove it before system operation. If not, inadequate heat dissipation of the module may cause a fire, failure, or malfunction.
  - Programmable controllers must be installed in control panels. Connect the main power supply to the power supply module in the control panel through a relay terminal block. Wiring and replacement of a power supply module must be performed by qualified maintenance personnel with knowledge of protection against electric shock. For wiring, refer to the MELSEC iQ-R Module Configuration Manual.
  - For Ethernet cables to be used in the system, select the ones that meet the specifications in the user's manual for the module used. If not, normal data transmission is not guaranteed.
-

## [Startup and Maintenance Precautions]

---

### **WARNING**

- Do not touch any terminal while power is on. Doing so will cause electric shock or malfunction.
  - Correctly connect the battery connector. Do not charge, disassemble, heat, short-circuit, solder, or throw the battery into the fire. Also, do not expose it to liquid or strong shock. Doing so will cause the battery to produce heat, explode, ignite, or leak, resulting in injury and fire.
  - Shut off the external power supply (all phases) used in the system before cleaning the module or retightening the terminal screws, connector screws, or module fixing screws. Failure to do so may result in electric shock.
- 

## [Startup and Maintenance Precautions]

---

### **CAUTION**

- When connecting an external device with a CPU module or intelligent function module to modify data of a running programmable controller, configure an interlock circuit in the program to ensure that the entire system will always operate safely. For other forms of control (such as program modification, parameter change, forced output, or operating status change) of a running programmable controller, read the relevant manuals carefully and ensure that the operation is safe before proceeding. Improper operation may damage machines or cause accidents.
  - Especially, when a remote programmable controller is controlled by an external device, immediate action cannot be taken if a problem occurs in the programmable controller due to a communication failure. To prevent this, configure an interlock circuit in the program, and determine corrective actions to be taken between the external device and CPU module in case of a communication failure.
  - Do not disassemble or modify the modules. Doing so may cause failure, malfunction, injury, or a fire.
  - Use any radio communication device such as a cellular phone or PHS (Personal Handy-phone System) more than 25cm away in all directions from the programmable controller. Failure to do so may cause malfunction.
  - Shut off the external power supply (all phases) used in the system before mounting or removing the module. Failure to do so may cause the module to fail or malfunction.
  - Tighten the screws within the specified torque range. Undertightening can cause drop of the component or wire, short circuit, or malfunction. Overtightening can damage the screw and/or module, resulting in drop, short circuit, or malfunction.
  - After the first use of the product, do not perform each of the following operations more than 50 times (IEC 61131-2/JIS B 3502 compliant).  
Exceeding the limit may cause malfunction.
    - Mounting/removing the module to/from the base unit
    - Inserting/removing the extended SRAM cassette or battery-less option cassette to/from the CPU module
    - Mounting/removing the terminal block to/from the module
    - Connecting/disconnecting the extension cable to/from the base unit
  - After the first use of the product, do not insert/remove the SD memory card to/from the CPU module more than 500 times. Exceeding the limit may cause malfunction.
  - Do not touch the metal terminals on the back side of the SD memory card. Doing so may cause malfunction or failure of the module.
  - Do not touch the integrated circuits on the circuit board of an extended SRAM cassette or a battery-less option cassette. Doing so may cause malfunction or failure of the module.
-



## [Startup and Maintenance Precautions]

---

### CAUTION

- Do not drop or apply shock to the battery to be installed in the module. Doing so may damage the battery, causing the battery fluid to leak inside the battery. If the battery is dropped or any shock is applied to it, dispose of it without using.
  - Startup and maintenance of a control panel must be performed by qualified maintenance personnel with knowledge of protection against electric shock. Lock the control panel so that only qualified maintenance personnel can operate it.
  - Before handling the module, touch a conducting object such as a grounded metal to discharge the static electricity from the human body. Wearing a grounded antistatic wrist strap is recommended. Failure to discharge the static electricity may cause the module to fail or malfunction.
  - After unpacking, eliminate static electricity from the module to prevent electrostatic discharge from affecting the module. If an electrostatically charged module comes in contact with a grounded metal object, a sudden electrostatic discharge of the module may cause failure.  
For details on how to eliminate static electricity from the module, refer to the following.  
Antistatic Precautions Before Using MELSEC iQ-R Series Products (FA-A-0368)
  - Use a clean and dry cloth to wipe off dirt on the module.
  - Before testing the operation, set a low speed value for the speed limit parameter so that the operation can be stopped immediately upon occurrence of a hazardous condition.
  - Confirm and adjust the program and each parameter before operation. Unpredictable movements may occur depending on the machine.
  - When using the absolute position system function, on starting up, and when the module or absolute position motor has been replaced, always perform a home position return.
  - Before starting the operation, confirm the brake function.
  - Do not perform a megger test (insulation resistance measurement) during inspection.
  - After maintenance and inspections are completed, confirm that the position detection of the absolute position detection function is correct.
  - Lock the control panel and prevent access to those who are not certified to handle or install electric equipment.
- 

## [Operating Precautions]

---

### CAUTION

- When changing data and operating status, and modifying program of the running programmable controller from an external device such as a personal computer connected to an intelligent function module, read relevant manuals carefully and ensure the safety before operation. Incorrect change or modification may cause system malfunction, damage to the machines, or accidents.
  - Do not power off the programmable controller or reset the CPU module while the setting values in the buffer memory are being written to the flash ROM in the module. Doing so will make the data in the flash ROM and SD memory card undefined. The values need to be set in the buffer memory and written to the flash ROM and SD memory card again. Doing so also may cause malfunction or failure of the module.
  - Note that when the reference axis speed is specified for interpolation operation, the speed of the partner axis (2nd, 3rd, or 4th axis) may exceed the speed limit value.
  - Do not go near the machine during test operations or during operations such as teaching. Doing so may lead to injuries.
-

## [Disposal Precautions]

---

### **CAUTION**

---

- When disposing of this product, treat it as industrial waste.
  - When disposing of batteries, separate them from other wastes according to the local regulations. For details on battery regulations in EU member states, refer to the MELSEC iQ-R Module Configuration Manual.
- 

## [Transportation Precautions]

---

### **CAUTION**

---

- When transporting lithium batteries, follow the transportation regulations. For details on the regulated models, refer to the MELSEC iQ-R Module Configuration Manual.
  - The halogens (such as fluorine, chlorine, bromine, and iodine), which are contained in a fumigant used for disinfection and pest control of wood packaging materials, may cause failure of the product. Prevent the entry of fumigant residues into the product or consider other methods (such as heat treatment) instead of fumigation. The disinfection and pest control measures must be applied to unprocessed raw wood.
-

# CONDITIONS OF USE FOR THE PRODUCT

---

- (1) MELSEC programmable controller ("the PRODUCT") shall be used in conditions;
- i) where any problem, fault or failure occurring in the PRODUCT, if any, shall not lead to any major or serious accident; and
  - ii) where the backup and fail-safe function are systematically or automatically provided outside of the PRODUCT for the case of any problem, fault or failure occurring in the PRODUCT.
- (2) The PRODUCT has been designed and manufactured for the purpose of being used in general industries. MITSUBISHI ELECTRIC SHALL HAVE NO RESPONSIBILITY OR LIABILITY (INCLUDING, BUT NOT LIMITED TO ANY AND ALL RESPONSIBILITY OR LIABILITY BASED ON CONTRACT, WARRANTY, TORT, PRODUCT LIABILITY) FOR ANY INJURY OR DEATH TO PERSONS OR LOSS OR DAMAGE TO PROPERTY CAUSED BY THE PRODUCT THAT ARE OPERATED OR USED IN APPLICATION NOT INTENDED OR EXCLUDED BY INSTRUCTIONS, PRECAUTIONS, OR WARNING CONTAINED IN MITSUBISHI ELECTRIC USER'S, INSTRUCTION AND/OR SAFETY MANUALS, TECHNICAL BULLETINS AND GUIDELINES FOR the PRODUCT.
- ("Prohibited Application")
- Prohibited Applications include, but not limited to, the use of the PRODUCT in;
- Nuclear Power Plants and any other power plants operated by Power companies, and/or any other cases in which the public could be affected if any problem or fault occurs in the PRODUCT.
  - Railway companies or Public service purposes, and/or any other cases in which establishment of a special quality assurance system is required by the Purchaser or End User.
  - Aircraft or Aerospace, Medical applications, Train equipment, transport equipment such as Elevator and Escalator, Incineration and Fuel devices, Vehicles, Manned transportation, Equipment for Recreation and Amusement, and Safety devices, handling of Nuclear or Hazardous Materials or Chemicals, Mining and Drilling, and/or other applications where there is a significant risk of injury to the public or property.
- Notwithstanding the above restrictions, Mitsubishi Electric may in its sole discretion, authorize use of the PRODUCT in one or more of the Prohibited Applications, provided that the usage of the PRODUCT is limited only for the specific applications agreed to by Mitsubishi Electric and provided further that no special quality assurance or fail-safe, redundant or other safety features which exceed the general specifications of the PRODUCTS are required. For details, please contact the Mitsubishi Electric representative in your region.
- (3) Mitsubishi Electric shall have no responsibility or liability for any problems involving programmable controller trouble and system trouble caused by DoS attacks, unauthorized access, computer viruses, and other cyberattacks.

## INTRODUCTION

---

Thank you for purchasing the Mitsubishi Electric MELSEC iQ-R series programmable controllers.

This manual describes the system configuration, specifications, installation, wiring, maintenance and inspection, and troubleshooting of the relevant products listed below.

Before using this product, please read this manual and the relevant manuals carefully and develop familiarity with the functions and performance of the MELSEC iQ-R series programmable controller to handle the product correctly.

When applying the program examples provided in this manual to an actual system, ensure the applicability and confirm that it will not cause system control problems.

Please make sure that the end users read this manual.

### Relevant products

---

R16MTCPU, R32MTCPU, R64MTCPU

# COMPLIANCE WITH EMC AND LOW VOLTAGE DIRECTIVES

---

## Method of ensuring compliance

To ensure that Mitsubishi programmable controllers maintain EMC and Low Voltage Directives when incorporated into other machinery or equipment, certain measures may be necessary. Please refer to one of the following manuals.

 MELSEC iQ-R Module Configuration Manual (SH-081262ENG)

 Safety Guidelines (This manual is included with the base unit.) (IB-0800525)

The CE mark on the side of the programmable controller indicates compliance with EMC and Low Voltage Directives.

## Additional measures

To ensure that this product maintains EMC and Low Voltage Directives, please refer to the following manual.

 MELSEC iQ-R Motion Controller User's Manual (IB-0300235)

# CONTENTS

SAFETY PRECAUTIONS	1
CONDITIONS OF USE FOR THE PRODUCT	9
INTRODUCTION	9
COMPLIANCE WITH EMC AND LOW VOLTAGE DIRECTIVES	10
RELEVANT MANUALS	13
TERMS	14
MANUAL PAGE ORGANISATION	15
DISCONTINUED MODELS	15
<b>CHAPTER 1 SYSTEM CONFIGURATION</b>	<b>16</b>
<b>1.1 Motion System Configuration</b>	<b>16</b>
Equipment configuration in system	16
Peripheral device configuration	17
R64MTCPU/R32MTCPU/R16MTCPU system overall configuration	18
Function explanation of the Motion CPU modules	19
Restrictions on Motion systems	19
<b>1.2 System Configuration Equipment</b>	<b>23</b>
Configuration equipment list	23
Software packages	28
<b>1.3 Checking Production Information and Operating System Software Version</b>	<b>29</b>
Checking production information	29
Checking operating system software version	30
<b>1.4 Restrictions by the Software Version</b>	<b>31</b>
<b>1.5 Engineering Software Version</b>	<b>33</b>
<b>1.6 Restrictions by the Hardware Version</b>	<b>33</b>
<b>CHAPTER 2 EQUIPMENT SPECIFICATIONS</b>	<b>34</b>
<b>2.1 General Specifications</b>	<b>34</b>
<b>2.2 Motion CPU Module</b>	<b>35</b>
Name of parts	35
LED display	37
Rotary switch setting and operation mode	39
Specifications	42
<b>2.3 Serial Absolute Synchronous Encoder</b>	<b>45</b>
Specifications	45
<b>2.4 SSCNETIII Cables</b>	<b>46</b>
Specifications	46
Connection between the Motion CPU module and servo amplifiers	47
Setting of the axis No. and switch of servo amplifier	48
Precautions for SSCNETIII cables	52
<b>CHAPTER 3 INSTALLATION AND WIRING</b>	<b>55</b>
<b>3.1 Mounting Environment</b>	<b>55</b>
<b>3.2 Module Installation</b>	<b>55</b>
Mounting position	55
Installation of the base unit	55
Installation and removal of module	55
<b>3.3 Installation and Removal of SD Memory Card</b>	<b>56</b>

3.4	<b>Mounting of Serial Absolute Synchronous Encoder</b> .....	<b>58</b>
3.5	<b>Wiring</b> .....	<b>59</b>
	Power supply circuit .....	59
	Safety circuit .....	59
<b>CHAPTER 4 START-UP PROCEDURES</b> .....		<b>61</b>
4.1	<b>Start-up Adjustment Procedure</b> .....	<b>61</b>
<b>CHAPTER 5 INSPECTION AND MAINTENANCE</b> .....		<b>64</b>
5.1	<b>Daily Inspection</b> .....	<b>64</b>
5.2	<b>Periodic Inspection</b> .....	<b>65</b>
5.3	<b>Life</b> .....	<b>66</b>
<b>CHAPTER 6 TROUBLESHOOTING</b> .....		<b>67</b>
6.1	<b>Troubleshooting Basics</b> .....	<b>67</b>
6.2	<b>Troubleshooting Procedure</b> .....	<b>68</b>
6.3	<b>Checking LED Display</b> .....	<b>69</b>
	Checking LED display of the Motion CPU module .....	69
6.4	<b>Checking with Engineering Tools</b> .....	<b>70</b>
6.5	<b>Troubleshooting by Circumstance</b> .....	<b>71</b>
	When the READY LED of the Motion CPU module has turned OFF .....	71
	When an error is displayed or flickering in the dot matrix LED .....	72
	When cannot write to Motion CPU .....	72
	When cannot read from Motion CPU .....	73
	When cannot install to Motion CPU .....	73
	When the servo amplifier does not start .....	73
<b>CHAPTER 7 EMC DIRECTIVES</b> .....		<b>74</b>
7.1	<b>Requirements for Compliance with the EMC Directive</b> .....	<b>74</b>
	Standards relevant to the EMC directive .....	75
	Installation instructions for EMC directive .....	76
	Parts of measure against noise .....	78
	Measure against noise .....	79
<b>APPENDICES</b> .....		<b>80</b>
<b>Appendix 1 Cables</b> .....		<b>80</b>
	SSCNETIII cables .....	80
	Serial absolute synchronous encoder cable .....	83
	SSCNETIII cables (SC-J3BUS□M-C) manufactured by Mitsubishi Electric System & Service .....	85
<b>Appendix 2 Exterior Dimensions</b> .....		<b>86</b>
	Motion CPU module .....	86
	Connector .....	88
	Serial absolute synchronous encoder (Q171ENC-W8) .....	89
REVISIONS .....		90
WARRANTY .....		91
INFORMATION AND SERVICES .....		92
TRADEMARKS .....		92

# RELEVANT MANUALS

Manual Name [Manual Number]	Description	Available form
MELSEC iQ-R Motion Controller User's Manual [IB-0300235] (This manual)	This manual explains specifications of the Motion CPU modules, SSCNETIII cables, synchronous encoder, troubleshooting, etc.	Print book e-Manual PDF
MELSEC iQ-R Motion Controller Programming Manual (Common) [IB-0300237]	This manual explains the Multiple CPU system configuration, performance specifications, common parameters, auxiliary/applied functions, error lists, etc.	Print book e-Manual PDF
MELSEC iQ-R Motion Controller Programming Manual (Program Design) [IB-0300239]	This manual explains the functions, programming, debugging for Motion SFC, etc.	Print book e-Manual PDF
MELSEC iQ-R Motion Controller Programming Manual (Positioning Control) [IB-0300241]	This manual explains the servo parameters, positioning instructions, device lists, etc.	Print book e-Manual PDF
MELSEC iQ-R Motion Controller Programming Manual (Advanced Synchronous Control) [IB-0300243]	This manual explains the dedicated instructions to use synchronous control by synchronous control parameters, device lists, etc.	Print book e-Manual PDF
MELSEC iQ-R Motion Controller Programming Manual (Machine Control) [IB-0300309]	This manual explains the dedicated instructions to use machine control by machine control parameters, machine positioning data, device lists, etc.	Print book e-Manual PDF
MELSEC iQ-R Motion Controller Programming Manual (G-Code Control) [IB-0300371]	This manual explains the dedicated instructions to use G-code control by G-code control parameters and G-code programs.	Print book e-Manual PDF



e-Manual refers to the Mitsubishi FA electronic book manuals that can be browsed using a dedicated tool.

e-Manual has the following features:

- Required information can be cross-searched in multiple manuals.
- Other manuals can be accessed from the links in the manual.
- The hardware specifications of each part can be found from the product figures.
- Pages that users often browse can be bookmarked.

# TERMS

Unless otherwise specified, this manual uses the following terms.

Term	Description
R64MTCPU/R32MTCPU/R16MTCPU or Motion CPU (module)	Abbreviation for MELSEC iQ-R series Motion controller
MR-J5(W)-□B	Servo amplifier model MR-J5-□B/MR-J5W-□B
MR-J4(W)-□B	Servo amplifier model MR-J4-□B/MR-J4W-□B
MR-J3(W)-□B	Servo amplifier model MR-J3-□B/MR-J3W-□B
MR-JE-□B	Servo amplifier model MR-JE-□B/MR-JE-□BF
AMP or Servo amplifier	General name for "Servo amplifier model MR-J5-□B/MR-J5W-□B/MR-J4-□B/MR-J4W-□B/MR-J3-□B/MR-J3W-□B/MR-JE-□B/MR-JE-□BF"
RnCPU, PLC CPU or PLC CPU module	Abbreviation for MELSEC iQ-R series CPU module
Multiple CPU system or Motion system	Abbreviation for "Multiple PLC system of the R series"
CPU <sub>n</sub>	Abbreviation for "CPU No.n (n = 1 to 4) of the CPU module for the Multiple CPU system"
Operating system software	General name for "SW10DNC-RMTFW"
Engineering tool	General name for MT Developer2/GX Works3/GX LogViewer
MT Works2	General product name for the Motion controller engineering software "SW1DND-MTW2"
MT Developer2	Abbreviation for the programming software included in the "MT Works2" Motion controller engineering software
GX Works3	General product name for the MELSEC PLC software package "SW1DND-GXW3"
GX LogViewer	Product name for the logging data display and analysis tool "SW1DNN-VIEWER"
Serial absolute synchronous encoder or Q171ENC-W8	Abbreviation for "Serial absolute synchronous encoder (Q171ENC-W8)"
SSCNETⅢ/H* <sup>1</sup>	High speed synchronous network between Motion controller and servo amplifier
SSCNETⅢ* <sup>1</sup>	
SSCNETⅢ(/H)	General name for SSCNETⅢ/H, SSCNETⅢ
Absolute position system	General name for "system using the servo motor and servo amplifier for absolute position"
Intelligent function module	General name for module that has a function other than input or output such as A/D converter module and D/A converter module.
SSCNETⅢ/H head module* <sup>1</sup>	Abbreviation for "MELSEC-L series SSCNETⅢ/H head module (LJ72MS15)"
Optical hub unit or MR-MV200	Abbreviation for SSCNETⅢ/H Compatible Optical Hub Unit (MR-MV200)
Sensing module	General name for SSCNETⅢ/H compatible sensing module MR-MT2000 series
Sensing SSCNETⅢ/H head module* <sup>1</sup> or MR-MT2010	Abbreviation for SSCNETⅢ/H head module (MR-MT2010)
Sensing extension module	General name for I/O module (MR-MT2100), pulse I/O module (MR-MT2200), analog I/O module (MR-MT2300), encoder I/F module (MR-MT2400)
Sensing I/O module or MR-MT2100	Abbreviation for I/O module (MR-MT2100)
Sensing pulse I/O module or MR-MT2200	Abbreviation for pulse I/O module (MR-MT2200)
Sensing analog I/O module or MR-MT2300	Abbreviation for analog I/O module (MR-MT2300)
Sensing encoder I/F module or MR-MT2400	Abbreviation for encoder I/F module (MR-MT2400)

\*1 SSCNET: Servo System Controller NETwork



# MANUAL PAGE ORGANISATION

## Representation of device No. used in this manual

The "R" and "Q" beside the device No. of positioning dedicated signals such as "[Rq.1140] Stop command (R: M34480+32n/ Q: M3200+20n)" indicate the device No. for the device assignment methods shown below. When "R" and "Q" are not beside the device No., the device No. is the same for both device assignment methods.

Symbol	Device assignment method
R	MELSEC iQ-R Motion device assignment
Q	Q series Motion compatible device assignment

## DISCONTINUED MODELS

The following models are described in this manual, but are no longer produced.

For the onerous repair term after discontinuation of production, refer to "WARRANTY" ( WARRANTY).

Model	Production discontinuation
MR-J3-□B	May 2019
MR-J3W-□B	May 2019
MR-J3-□B-RJ006	May 2019
MR-J3-□B-RJ004	May 2019
MR-J3-□B-RJ080W	May 2019
MR-J3-□BS	May 2019

# 1 SYSTEM CONFIGURATION

This section describes the Motion controller system configuration, precautions on use of system and configured equipment.

## 1.1 Motion System Configuration

### Equipment configuration in system

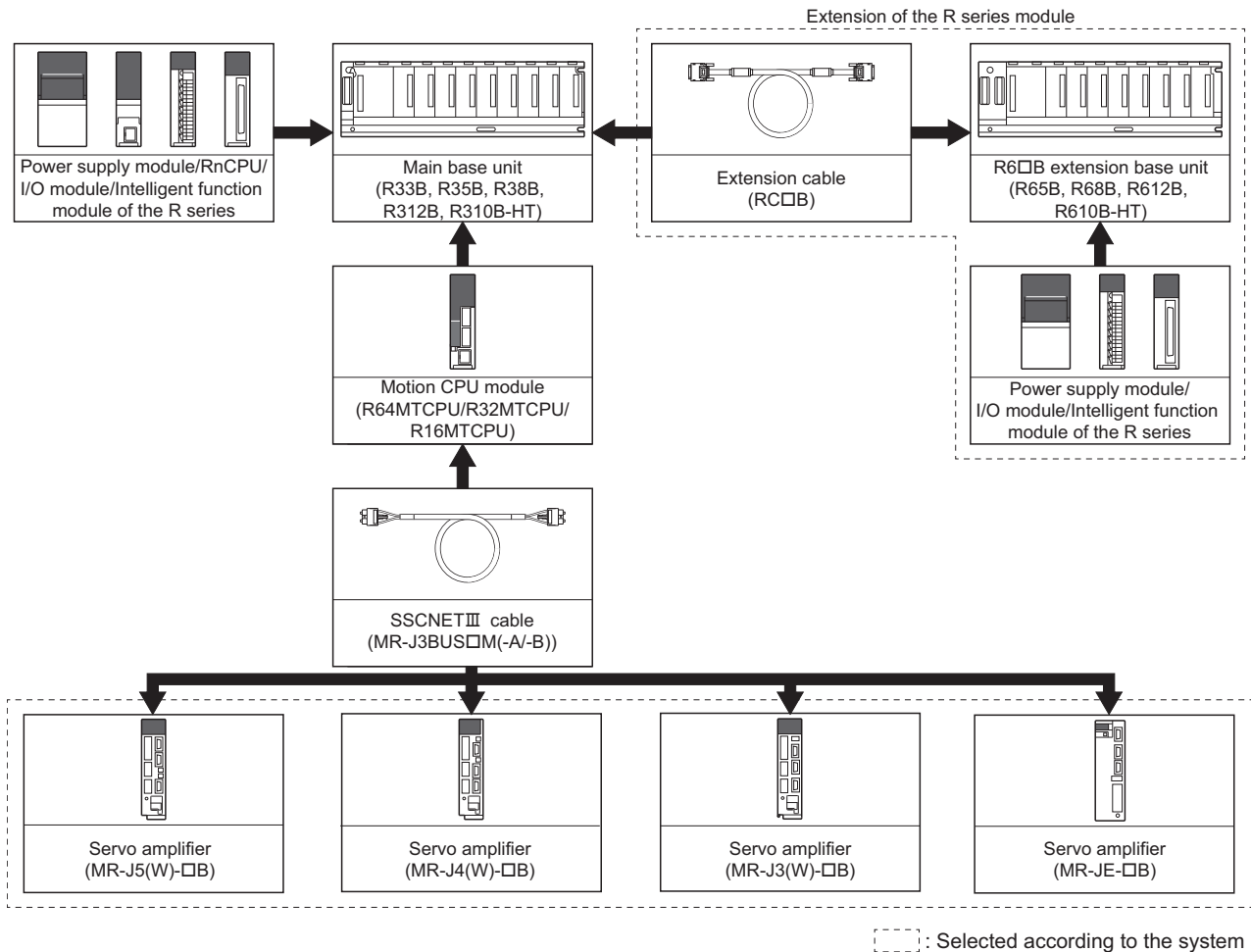

# Peripheral device configuration

## Ethernet configuration

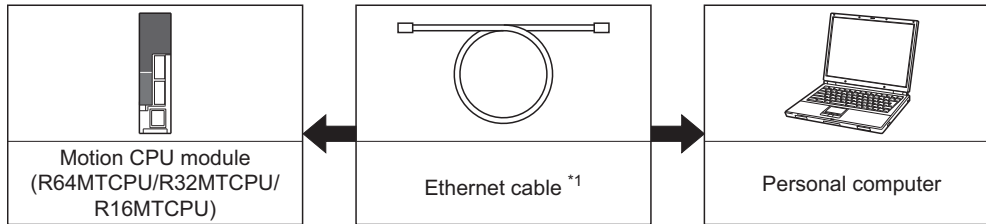

\*1 Corresponding Ethernet cables

Part name	Connection type	Cable type	Ethernet standard	Specification
Ethernet cable	Connection with HUB	Straight cable	10BASE-T	Compliant with Ethernet standards, category 5 or higher. • Shielded twisted pair cable (STP cable)
			100BASE-TX	
	Direct connection	Straight cable Crossover cable	10BASE-T	
			100BASE-TX	

### ■ Selection criteria of cable

- Category: 5 or higher
- Diameter of lead: AWG26 or higher
- Shield: Copper braid shield and drain wire or copper braid shield and aluminium layered type shield



## Function explanation of the Motion CPU modules

- The following servo amplifiers can be controlled in Motion CPU module.

Motion CPU	Servo amplifier control
R64MTCPU	Up to 64 axes per 2 lines (up to 32 axes per 1 line)
R32MTCPU	Up to 32 axes per 2 lines (up to 16 axes per 1 line)
R16MTCPU	Up to 16 axes per 1 line

- It is possible to set the program which synchronized with the motion operation cycle and executed at fixed cycle (Min. 0.222ms).
- It is possible to execute a download of servo parameters to servo amplifier, servo ON/OFF to servo amplifier and position commands, etc. by connecting between the Motion CPU module and servo amplifier with SSCNETIII cable.
- I/O modules and intelligent function modules (excluding some modules) can be controlled with the Motion CPU module. (☞ Page 26 PLC module which can be controlled by Motion CPU)
- Data exchange between CPU modules is possible by CPU buffer memory in the Multiple CPU system.
- Wiring is reduced by issuing the external signal (upper/lower stroke limit signal, proximity dog signal) via the servo amplifier.
- Battery is not required for the Motion CPU.

## Restrictions on Motion systems

### Combination of Multiple CPU system

- Motion CPU module cannot be used as standalone module. Be sure to install the MELSEC iQ-R series PLC CPU module to CPU No.1. Refer to the following for the configurations in a Multiple CPU system with the PLC CPU module as CPU No.1.  
 MELSEC iQ-R Module Configuration Manual
- Up to four modules of MELSEC iQ-R series PLC CPU modules/Motion CPU modules can be installed from the CPU slot (the slot on the right side of power supply module) to the I/O slot 6 of the main base unit. CPU modules are called CPU No.1 to CPU No.4 from the left sequentially. There is no restriction on the installation order of CPU No.2 to No.4. For CPU module other than CPU No.1, CPU reservation setting (allocating a CPU No. without actually installing a CPU module) can be made.
- It takes about 10 seconds to startup (a state where it can be controlled) the Motion CPU. After startup, each CPU requires time for initializing. For a system that begins executing programs without waiting for the startup of other CPUs, change the Multiple CPU synchronous startup setting.

### Motion CPU module restrictions

- The Motion CPU module only controls MELSEC iQ-R series modules. It cannot control MELSEC Q series modules.
- To execute the forced stop input, use a device set in the forced stop input setting ([Motion CPU Common Parameter] ⇒ [Basic Setting])
- Refer to the following for details of installing Motion CPU module to a DIN rail.  
 MELSEC iQ-R Module Configuration Manual
- Use the Graphic Operation Terminal (GOT) that supports Motion CPU (R64MTCPU/R32MTCPU/R16MTCPU).

## SSCNET communication restrictions

- Set "SSCNETⅢ/H" or "SSCNETⅢ" for every line in the SSCNET setting ([Motion CPU Common Parameter] ⇒ [Servo Network Setting]) to communicate with the servo amplifiers and SSCNETⅢ(H) compatible devices. The following shows the servo amplifiers and SSCNETⅢ(H) compatible devices that can be used when "SSCNETⅢ/H" and "SSCNETⅢ" are set.

○: Usable, ×: Unusable

Servo amplifier/SSCNETⅢ(H) compatible devices		SSCNET setting	
		SSCNETⅢ/H	SSCNETⅢ
Servo amplifier	MR-J5(W)-□B	○	×
	MR-J4(W)-□B	○	○*1
	MR-J3(W)-□B	×	○
	MR-JE-□B	○	×
Inverter	FR-A800 series	○	○
	FR-A700 series	×	○
Sensing module	MR-MT2000 series	○	×
SSCNETⅢ/H head module	LJ72MS15	○	×
VCI series/VPH series servo driver manufactured by CKD Nikki Denso Co., Ltd		○	○
Stepping motor module AlphaStep/5-phase manufactured by ORIENTAL MOTOR Co., Ltd		○	×
IAI electric actuator controller manufactured by IAI Corporation		○	×

\*1 Operated in J3 compatibility mode

### Point

It is possible to use different servo amplifiers on the same SSCNETⅢ/H line, but when high accuracy synchronization on the load side is needed for multiple axes such as for interpolation control or synchronous control, build a system using servo amplifiers of the same servo series.

- The maximum No. of control axes per line for the Motion CPU (R64MTCPU/R32MTCPU/R16MTCPU) are shown below by the communication type set in SSCNET setting. Settings that exceed the maximum No. of control axes per line cannot be made.

Motion CPU	Communication type	
	SSCNETⅢ/H	SSCNETⅢ
R64MTCPU	32 axes	16 axes
R32MTCPU	16 axes	
R16MTCPU	16 axes	

- The following are restrictions for the communication type depending on the operation cycle.

—: No restriction

Operation cycle	Communication type	
	SSCNETIII/H	SSCNETIII
0.222ms	<ul style="list-style-type: none"> <li>• Maximum 12 control axes per line.*<sup>1</sup></li> <li>• MR-J4W3-□B (software version A2 or earlier) cannot be used.*<sup>2</sup></li> <li>• 1 station per line can be set with the SSCNETIII/H head module or sensing module.*<sup>3</sup></li> <li>• MR-JE-□B and AlphaStep/5-phase cannot be used.*<sup>4</sup></li> <li>• Up to 2 axes per IAI electric actuator controller can be set.*<sup>6</sup></li> </ul>	<ul style="list-style-type: none"> <li>• The maximum number of control axes per line is 4 control axes.*<sup>1</sup></li> <li>• Set the axis select rotary switch of the servo amplifier to "0 to 3". If the axis select rotary switch of servo amplifier is set to "4 to F", the servo amplifiers are not recognized.</li> <li>• MR-J4W3-□B (software version A2 or earlier) cannot be used.*<sup>2</sup></li> <li>• MR-J3W-□B cannot be used.</li> <li>• FR-A700 series, VCI series, and VPH series cannot be used.*<sup>5</sup></li> </ul>
0.444ms	<ul style="list-style-type: none"> <li>• Maximum 24 control axes per line.*<sup>1</sup></li> <li>• Up to 2 stations per line can be set with the SSCNETIII/H head module and/or the sensing module.*<sup>3</sup></li> <li>• Up to 4 axes per IAI electric actuator controller can be set.*<sup>6</sup></li> </ul>	<ul style="list-style-type: none"> <li>• The maximum number of control axes per line is 8 axes.*<sup>1</sup></li> <li>• Set the axis select rotary switch of the servo amplifier to "0 to 7". If the axis select rotary switch of servo amplifier is set to "8 to F", the servo amplifiers are not recognized.</li> </ul>
0.888ms or more	<ul style="list-style-type: none"> <li>• Up to 4 stations per line can be set with the SSCNETIII/H head module and/or the sensing module.*<sup>3</sup></li> </ul>	—

\*1 When the number of control axes per line setting exceeds the maximum number of control axes per line, operation is carried out at the following operation cycles.

Maximum number of control axes per line		Operation cycle
SSCNETIII/H	SSCNETIII	
13 to 24 axes	5 to 8 axes	0.444ms
25 axes or more	9 axes or more	0.888ms

\*2 MR-J4W3-□B (Software version "A3" or later) supports operation cycle 0.222ms. However, when using operation cycle 0.222ms, some functions are restricted. Refer to the following for details.

 Servo amplifier Instruction Manual

\*3 When using the sensing module in axis mode, there are no restrictions on the number of stations for the sensing module.

\*4 When MR-JE-□B or AlphaStep/5-phase are present, operation is carried out at 0.444ms operation cycle.

\*5 When FR-A700 series, VCI series, or VPH series are present, operation is carried out at 0.444ms operation cycle.

\*6 When the setting exceeds the number of control axes per controller, a minor error (error code: 1C83H) occurs.

Set the operation cycle as follows according to the number of control axes per controller.

Number of control axes per controller	Operation cycle
1 to 2 axes	0.222ms or more
3 to 4 axes	0.444ms or more
5 axes or more	0.888ms or more

- When using MR-J5W-□B or MR-J4W-□B, if there is at least one axis which has not been set in servo network setting, all axes of the applicable servo amplifier cannot be connected, and all servo amplifiers after the applicable servo amplifier cannot be connected. Set "Not used" to the applicable axis with a dip switch for the axis which is not used by MR-J5W-□B or MR-J4W-□B.

- When using a multi-axis servo amplifier (MR-J4W-□B), there is a restriction on the number of connectable SSCNETⅢ/H compatible devices (servo amplifier (MR-J4(W)-□B), SSCNETⅢ/H head module, other drivers, etc.) between the Motion CPU and the multi-axis servo amplifier. The number of connectable SSCNETⅢ/H compatible devices are shown below. When more than the number of connectable units are connected, a warning (error code: 0C82H) occurs. While communication with MR-J4W-□B is still possible when the warning occurs, communication becomes unstable, therefore the unit configuration should be reviewed. Furthermore, when an optical hub unit is used, the number of connectable units is reduced. Refer to the following for details of when an optical hub unit is connected.

📖 MELSEC iQ-R Motion Controller Programming Manual (Common)

There are no restrictions when using MR-J5W-□B.

Servo amplifier		Number of connectable SSCNETⅢ/H compatible devices between the Motion CPU and the servo amplifier	
MR-J5-□B		No restriction	
MR-J5W2-□B	1 axis set	No restriction	
	2 axes set		
MR-J5W3-□B	1 axis set		
	2 axes set		
	3 axes set		
MR-J4-□B			
MR-J4W2-□B	1 axis set		14 units or less
	2 axes set		
MR-J4W3-□B	1 axis set		No restriction
	2 axes set		14 units or less
	3 axes set		13 units or less
MR-JE-□B			No restriction

Ex.

When 2 axes are set to a multi-axis servo amplifier (MR-J4W2-□B)

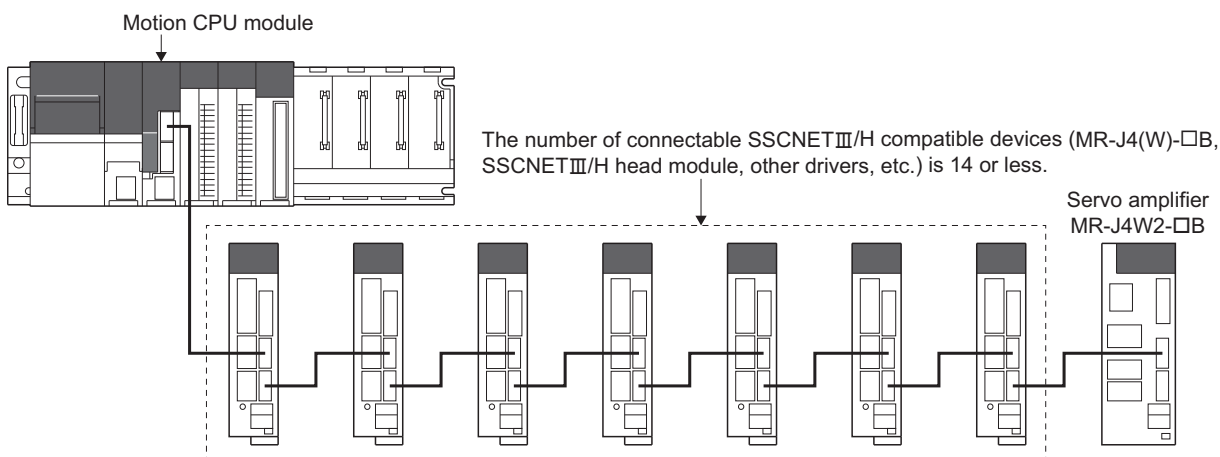



# 1.2 System Configuration Equipment

## Configuration equipment list

Motion controller related module				
Part name	Model name <sup>*1</sup>	Description	Current consumption 5VDC[A]	Remark
Motion CPU module	R64MTCPU	Up to 64 axes control, Operation cycle 0.222[ms] or more, Built-in Ethernet	1.20	
	R32MTCPU	Up to 32 axes control, Operation cycle 0.222[ms] or more, Built-in Ethernet	1.20	
	R16MTCPU	Up to 16 axes control, Operation cycle 0.222[ms] or more, Built-in Ethernet	1.20	
PLC CPU module <sup>*2</sup>	R00CPU	Program capacity 10k steps, LD instruction processing speed 31.3ns, Built-in Ethernet port	0.67	
	R01CPU	Program capacity 15k steps, LD instruction processing speed 31.3ns, Built-in Ethernet port	0.67	
	R02CPU	Program capacity 20k steps, LD instruction processing speed 3.92ns, Built-in Ethernet port	0.67	
	R04CPU	Program capacity 40k steps, LD instruction processing speed 0.98ns, Built-in Ethernet port	0.67	
	R08CPU	Program capacity 80k steps, LD instruction processing speed 0.98ns, Built-in Ethernet port	0.67	
	R16CPU	Program capacity 160k steps, LD instruction processing speed 0.98ns, Built-in Ethernet port	0.67	
	R32CPU	Program capacity 320k steps, LD instruction processing speed 0.98ns, Built-in Ethernet port	0.67	
	R120CPU	Program capacity 1200k steps, LD instruction processing speed 0.98ns, Built-in Ethernet port	0.67	
	R04ENCPU	Program capacity 40k steps, LD instruction processing speed 0.98ns, Built-in Ethernet port, Built-in CC-Link IE	1.49	
	R08ENCPU	Program capacity 80k steps, LD instruction processing speed 0.98ns, Built-in Ethernet port, Built-in CC-Link IE	1.49	
	R16ENCPU	Program capacity 160k steps, LD instruction processing speed 0.98ns, Built-in Ethernet port, Built-in CC-Link IE	1.49	
	R32ENCPU	Program capacity 320k steps, LD instruction processing speed 0.98ns, Built-in Ethernet port, Built-in CC-Link IE	1.49	
	R120ENCPU	Program capacity 1200k steps, LD instruction processing speed 0.98ns, Built-in Ethernet port, Built-in CC-Link IE	1.49	
Process CPU module <sup>*2</sup>	R08PCPU	Program capacity 80k steps, LD instruction processing speed 0.98ns, Built-in Ethernet port	0.76	
	R16PCPU	Program capacity 160k steps, LD instruction processing speed 0.98ns, Built-in Ethernet port	0.76	
	R32PCPU	Program capacity 320k steps, LD instruction processing speed 0.98ns, Built-in Ethernet port	0.76	
	R120PCPU	Program capacity 1200k steps, LD instruction processing speed 0.98ns, Built-in Ethernet port	0.76	
Safety CPU module <sup>*2</sup>	R08SFCPU	Program capacity 80k steps (40k steps for a safety program), LD instruction processing speed 0.98ns, Built-in Ethernet port	0.76	
	R16SFCPU	Program capacity 160k steps (40k steps for a safety program), LD instruction processing speed 0.98ns, Built-in Ethernet port	0.76	
	R32SFCPU	Program capacity 320k steps (40k steps for a safety program), LD instruction processing speed 0.98ns, Built-in Ethernet port	0.76	
	R120SFCPU	Program capacity 1200k steps (40k steps for a safety program), LD instruction processing speed 0.98ns, Built-in Ethernet port	0.76	
C Controller module <sup>*2</sup>	R12CCPU-V	Endian format: Little endian, OS: VxWorks® Version 6.9	1.26	

Part name	Model name <sup>*1</sup>	Description	Current consumption 5VDC[A]	Remark
Power supply module <sup>*3</sup>	R61P	100 to 240VAC input, 5VDC 6.5A output	—	
	R62P	100 to 240VAC input, 5VDC 3.5A/24VDC 0.6A output		
	R63P	24VDC input, 5VDC 6.5A output		
	R64P	100 to 240VAC input, 5VDC 9A output		
	R69P	24VDC input, 5VDC 9A output		
Main base unit <sup>*2</sup>	R33B	Number of I/O modules: 3 slots	0.46	
	R35B	Number of I/O modules: 5 slots	0.58	
	R38B	Number of I/O modules: 8 slots	0.71	
	R312B	Number of I/O modules: 12 slots	0.88	
	R310B-HT	Number of I/O modules: 10 slots, extended temperature range	0.82	
Extension base unit <sup>*2</sup>	R65B	Number of I/O modules: 5 slots	0.70	
	R68B	Number of I/O modules: 8 slots	0.81	
	R612B	Number of I/O modules: 12 slots	0.92	
	R610B-HT	Number of I/O modules: 10 slots, extended temperature range	0.85	
Extension cable	RC06B	Length 0.6m(1.97ft.)	—	
	RC12B	Length 1.2m(3.94ft.)		
	RC30B	Length 3m(9.84ft.)		
	RC50B	Length 5m(16.40ft.)		
	RC100B <sup>*4</sup>	Length 10m(32.81ft.)		
DIN rail installation adaptor	R6DIN1	DIN rail installation adaptor For connection of R33B/R35B/R38B/R312B/R310B-HT/R65B/R68B/R612B/R610B-HT	—	
Serial absolute synchronous encoder	Q171ENC-W8	Resolution: 4194304pulse/rev Permitted axial loads Radial load: Up to 19.6N, Thrust load: Up to 9.8N Permitted speed: 3600r/min	0.25	
Serial absolute synchronous encoder cable	Q170ENCBL□M-A	Serial absolute synchronous encoder Q171ENC-W8 ↔ MR-J4-□B-RJ 2m(6.56ft.), 5m(16.40ft.), 10m(32.81ft.), 20m(65.62ft.), 30m(98.43ft.), 50m(164.04ft.)	—	
Connector set for serial absolute synchronous encoder cable	MR-J3CN2	MR-J4-□B-RJ side connector Plug: 36210-0100PL Shell: 36310-3200-008 Q171ENC-W8 side connector Plug: D/MS3106B22-14S Cable clamp: D/MS3057-12A	—	
SD memory card	NZ1MEM-2GBSD	SD memory card 2G bytes	—	
	NZ1MEM-4GBSD	SDHC memory card 4G bytes	—	
	NZ1MEM-8GBSD	SDHC memory card 8G bytes	—	
	NZ1MEM-16GBSD	SDHC memory card 16G bytes	—	

Part name	Model name*1	Description	Current consumption 5VDC[A]	Remark
SSCNETIII cable	MR-J3BUS□M	<ul style="list-style-type: none"> <li>• R64MTCPU/R32MTCPU/R16MTCPU ↔ MR-J5(W)-□B, MR-J5(W)-□B ↔ MR-J5(W)-□B, MR-J5(W)-□B ↔ LJ72MS15</li> <li>• R64MTCPU/R32MTCPU/R16MTCPU ↔ MR-J4(W)-□B, MR-J4(W)-□B ↔ MR-J4(W)-□B, MR-J4(W)-□B ↔ LJ72MS15</li> <li>• R64MTCPU/R32MTCPU/R16MTCPU ↔ MR-J3(W)-□B, MR-J3(W)-□B ↔ MR-J3(W)-□B</li> <li>• R64MTCPU/R32MTCPU/R16MTCPU ↔ MR-JE-□B, MR-JE-□B ↔ MR-JE-□B, MR-JE-□B ↔ LJ72MS15</li> <li>• Standard cord for inside panel 0.15m(0.49ft.), 0.3m(0.98ft.), 0.5m(1.64ft.), 1m(3.28ft.), 3m(9.84ft.)</li> </ul>	—	
	MR-J3BUS□M-A	<ul style="list-style-type: none"> <li>• R64MTCPU/R32MTCPU/R16MTCPU ↔ MR-J5(W)-□B, MR-J5(W)-□B ↔ MR-J5(W)-□B, MR-J5(W)-□B ↔ LJ72MS15</li> <li>• R64MTCPU/R32MTCPU/R16MTCPU ↔ MR-J4(W)-□B, MR-J4(W)-□B ↔ MR-J4(W)-□B, MR-J4(W)-□B ↔ LJ72MS15</li> <li>• R64MTCPU/R32MTCPU/R16MTCPU ↔ MR-J3(W)-□B, MR-J3(W)-□B ↔ MR-J3(W)-□B</li> <li>• R64MTCPU/R32MTCPU/R16MTCPU ↔ MR-JE-□B, MR-JE-□B ↔ MR-JE-□B, MR-JE-□B ↔ LJ72MS15</li> <li>• Standard cable for outside panel 5m(16.40ft.), 10m(32.81ft.), 20m(65.62ft.)</li> </ul>	—	
	MR-J3BUS□M-B *5	<ul style="list-style-type: none"> <li>• R64MTCPU/R32MTCPU/R16MTCPU ↔ MR-J5(W)-□B, MR-J5(W)-□B ↔ MR-J5(W)-□B, MR-J5(W)-□B ↔ LJ72MS15</li> <li>• R64MTCPU/R32MTCPU/R16MTCPU ↔ MR-J4(W)-□B, MR-J4(W)-□B ↔ MR-J4(W)-□B, MR-J4(W)-□B ↔ LJ72MS15</li> <li>• R64MTCPU/R32MTCPU/R16MTCPU ↔ MR-J3(W)-□B, MR-J3(W)-□B ↔ MR-J3(W)-□B</li> <li>• R64MTCPU/R32MTCPU/R16MTCPU ↔ MR-JE-□B, MR-JE-□B ↔ MR-JE-□B, MR-JE-□B ↔ LJ72MS15</li> <li>• Long distance cable 30m(98.43ft.), 40m(131.23ft.), 50m(164.04ft.)</li> </ul>	—	

\*1 □=Cable length

(015: 0.15m(0.49ft.), 03: 0.3m(0.98ft.), 05: 0.5m(1.64ft.), 1: 1m(3.28ft.), 2: 2m(6.56ft.), 3: 3m(9.84ft.), 5: 5m(16.40ft.), 10: 10m(32.81ft.), 20: 20m(65.62ft.), 25: 25m(82.02ft.), 30: 30m(98.43ft.), 40: 40m(131.23ft.), 50:50m(164.04ft.)

\*2 5VDC internal current consumption of shared equipment with PLC might be changed. Be sure to refer to the MELSEC iQ-R series PLC Manuals.

\*3 Be sure to use the power supply module within the range of power supply capacity.

\*4 The ten-meter extension cable (RC100B) can only be used with a base unit having the 10m mark on it. Refer to the following for details of the 10m mark.

 MELSEC iQ-R Module Configuration Manual

\*5 Please contact your nearest Mitsubishi sales representative for the cable of less than 30m(98.43ft.).

## PLC module which can be controlled by Motion CPU

Part name*1	Model name	Description	Current consumption*2 5VDC[A]	Remark
Input module	RX10	AC input, input 16 points	0.11	Refer to the MELSEC iQ-R series manuals for each module.
	RX40C7	DC input, plus common/minus common shared type, input 16 points	0.11	
	RX41C4	DC input, plus common/minus common shared type, input 32 points	0.15	
	RX42C4	DC input, plus common/minus common shared type, input 64 points	0.18	
	RX40PC6H	DC input, plus common type, input 16 points	0.10	
	RX40NC6H	DC input, minus common type, input 16 points	0.10	
	RX41C6HS	DC input, plus common/minus common shared type, input 32 points	0.15	
	RX61C6HS	DC input, plus common/minus common shared type, input 32 points	0.15	
Output module	RY10R2	Contact output, output 16 points	0.45	
	RY40NT5P	Transistor output, sink type, output 16 points	0.14	
	RY41NT2P	Transistor output, sink type, output 32 points	0.18	
	RY41NT2H	Transistor output, sink type, output 32 points	0.42	
	RY42NT2P	Transistor output, sink type, output 64 points	0.25	
	RY40PT5P	Transistor output, source type, output 16 points	0.13	
	RY41PT1P	Transistor output, source type, output 32 points	0.19	
	RY41PT2H	Transistor output, source type, output 32 points	0.41	
Input/Output composite module	RH42C4NT2P	DC input, plus common/ minus common shared type, input 32 points, transistor output, sink type, output 32 points	0.22	
Analogue input module	R60AD4	Voltage/current input, 4ch	0.22	
	R60ADV8	Voltage input, 8ch	0.23	
	R60ADI8	Current input, 8ch	0.22	
	R60AD8-G	Voltage/current input, 8ch, channel isolated	0.33	
	R60AD16-G	Voltage/current input, 16ch, channel isolated	0.52	
	R60ADH4	Voltage/current output, 4ch	0.73	
Analogue output module	R60DA4	Voltage/current output, 4ch	0.16	
	R60DAV8	Voltage output, 8ch	0.16	
	R60DAI8	Current output, 8ch	0.16	
	R60DA8-G	Voltage/current output, 8ch, channel isolated	0.18	
	R60DA16-G	Voltage/current output, 16ch, channel isolated	0.25	
High-speed counter module	RD62P2	DC input, sink output type, 2ch	0.11	
	RD62P2E	DC input, source type, 2ch	0.20	
	RD62D2	Differential input, sink output type, 2ch	0.17	
Temperature input module	R60TD8-G	Thermocouple (B, R, S, K, E, J, T, N) input, 8ch, channel isolated	0.36	
	R60RD8-G	RTD (Pt100, JPt100, Ni100, Pt50) input, 8ch, channel isolated	0.35	
Laser displacement sensor control module	R60MH112	Resolution of under 0.25μm	0.14	
	R60MH112NA	Resolution of 0.25μm or more	0.14	
Blank cover module	RG60	Blank cover for use with main base unit/extension base unit I/O slots	—	





\*1 Refer to the following manual for details of modules that can be controlled with a Motion CPU.

 MELSEC iQ-R Module Configuration Manual

\*2 5VDC internal current consumption of shared equipment with PLC might be changed. Be sure to refer to the manuals for each module.

## SSCNETIII(/H) compatible devices

### ■SSCNETIII/H compatible devices

Part name	Model name	Description	Remarks
MR-J5 series servo amplifier	MR-J5-□B		Refer to the  servo amplifier (MR-J5(W)-□B) user's manuals.
	MR-J5-□B-RJ		
	MR-J5W2-□B	For 2-axis type	
	MR-J5W3-□B	For 3-axis type	
MR-J4 series servo amplifier	MR-J4-□B		Refer to the  servo amplifier (MR-J4(W)-□B) instruction manuals.
	MR-J4-□B-RJ		
	MR-J4-□B-LL		
	MR-J4W2-□B	For 2-axis type	
	MR-J4W3-□B	For 3-axis type	
MR-JE series servo amplifier	MR-JE-□B		Refer to the  servo amplifier (MR-JE-□B) instruction manuals.
	MR-JE-□BF		
Sensing module	MR-MT2010	Sensing SSCNETIII/H head module	Refer to the  sensing module instruction manuals.
	MR-MT2100	Sensing I/O module	
	MR-MT2200	Sensing pulse I/O module	
	MR-MT2300	Sensing analog I/O module	
	MR-MT2400	Sensing encoder I/F module	
SSCNETIII/H head module	LJ72MS15	Maximum link points: Input 64 bytes, Output 64 bytes Transmission cycle: 0.222ms, 0.444ms, 0.888ms	Refer to the  MELSEC-L series PLC manuals.
Optical hub unit	MR-MV200	3 branches, 1 unit, 24VDC power supply connector is attached	

### ■SSCNETIII compatible devices

Part name	Model name	Description	Remarks
MR-J3 series servo amplifier	MR-J3-□B		Refer to the  servo amplifier (MR-J3(W)-□B) instruction manuals.
	MR-J3W-□B	For 2-axis type	
	MR-J3-□B-RJ006	For fully closed control	
	MR-J3-□B-RJ004	For linear servo motor	
	MR-J3-□B-RJ080W	For direct drive motor	
	MR-J3-□B Safety	For drive safety servo	

# Software packages

## Operating system software

Motion CPU	Model name
R64MTCPU	SW10DNC-RMTFW
R32MTCPU	
R16MTCPU	

\*1 The operating system software is installed at the time of product purchases.

## Engineering software

### ■ Motion controller engineering software

Part name	Model name
MELSOFT MT Works2 • MT Developer2 <sup>*1</sup> • MR Configurator2 <sup>*2</sup>	SW1DND-MTW2-E

\*1 Included in Motion controller engineering software "MELSOFT MT Works2".

\*2 The servo setup software "MR Configurator2" is included with MELSOFT MT Works2.

### ■ PLC engineering software

Part name	Model name
MELSOFT GX Works3	SW1DND-GXW3-E

### ■ Logging data display and analysis tool

Part name	Model name
MELSOFT GX LogViewer	SW1DNN-VIEWER-M

# 1.3 Checking Production Information and Operating System Software Version

This section explains checking for the production information of Motion CPU module and the operating system software version.

## Checking production information

### Checking with the Motion CPU module

#### ■Rating plate

The rating plate is situated on the side face of the Motion CPU module. The SERIAL line displays the Motion CPU module production information.

#### ■Production information marking

The production information of the Motion CPU module is found on the production information marking on the front of the Motion CPU module.

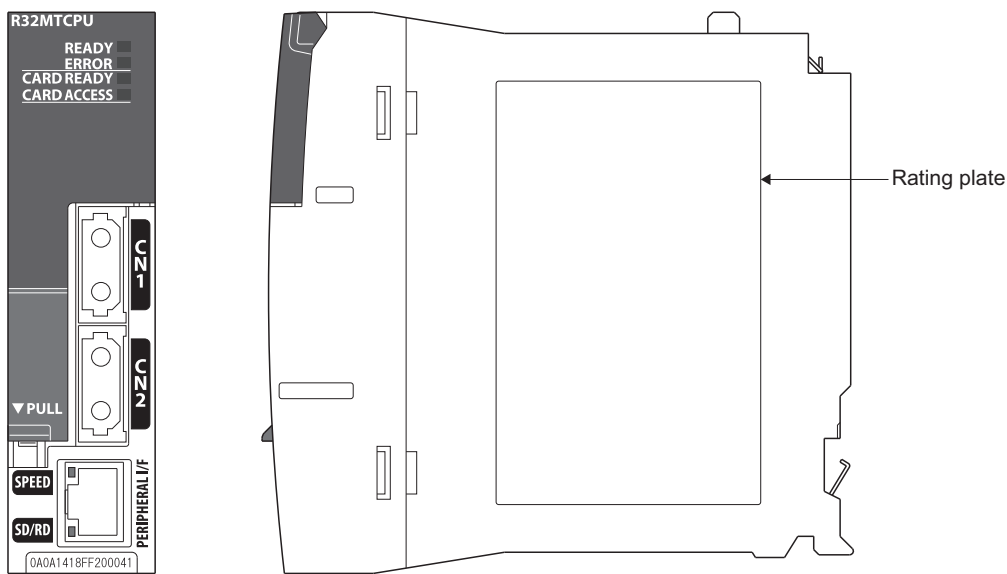

Production information

#### ■Checking with GX Works3

The production information can be checked on the system monitor screen in GX Works3. (☞ Page 30 Checking with GX Works3)

#### ■Checking with MT Developer2

Production information can be checked with MT Developer2 in the CPU information. (☞ Page 30 Checking with MT Developer2)

# Checking operating system software version

The operating system software version can be checked with MT Developer2 or GX Works3.

## Checking with GX Works3

Check on the product information list screen.

[Diagnostics] ⇒ [System monitor] ⇒ [Product Information List] button

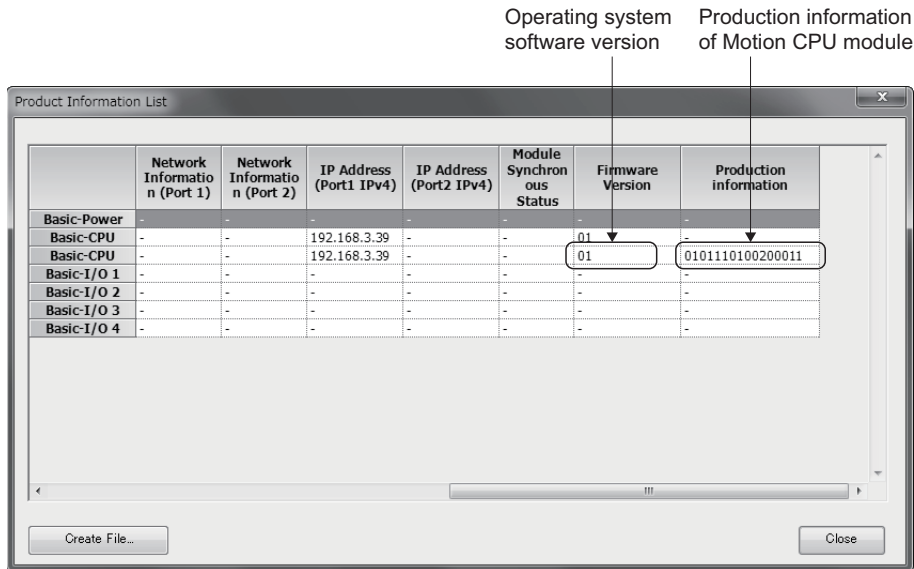

## Checking with MT Developer2

### ■ Installation screen

Check on the installation screen.

### ■ CPU information screen

Check on the CPU information screen.

[Help] ⇒ [CPU information]

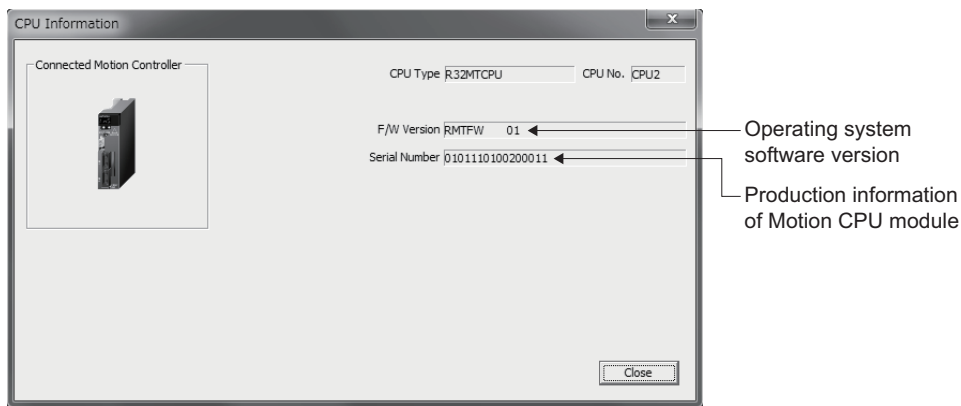

### ■ Device

Check with the special register "Operating system software version (SD740 to SD747)". Refer to the following for details on special registers.

📖 MELSEC iQ-R Motion Controller Programming Manual (Common)



# 1.4 Restrictions by the Software Version

There are restrictions in the function that can be used by the version of the operating system software and engineering software. The combination of each version and a function is shown below.

—: There is no restriction by the version.

Function	Operating system software version*1	Engineering software version				Section of reference
		MELSOFT MT Works2		GX Works3	GX LogViewer	
		MT Developer2	MR Configurator2			
Label access from external device	02	1.105K	—	—	—	*2
File transmission at boot	03	1.111R	—	—	—	*2
Event history	03	1.111R	—	—	—	*2
ABS direction in degrees	03	1.111R	—	—	—	*4
Clutch smoothing slippage method(Linear: Input value follow up)	03	1.111R	—	—	—	*4
Pressure control	03	1.111R	1.37P	—	—	*4
Optional data monitor (transient command)	03	1.111R	—	—	—	*2
Optical hub unit connection	03	1.111R	—	—	—	*2
Multiple CPU advanced synchronous control	03	1.111R	—	—	—	*5
Extension of the number of vision system connections	03	1.111R	—	—	—	*2
Motion dedicated PLC instructions (M(P).CHGA, M(P).CHGAS, M(P).CHGV, M(P).CHGVS, M(P).CHGT)	—	—	—	1.007H	—	*3
Motion dedicated PLC instructions (M(P).BITWR, D(P).BITWR)	03	—	—	1.007H	—	*3
Add-on function	03	1.111R	—	—	—	*2
Add-on dedicated function (MCFUN)	03	1.111R	—	—	—	*3
Servo amplifier (MR-J4-□B-LL) compatible	03	1.111R	1.37P	—	—	—
Vibration suppression command filter	04	1.115V	—	—	—	*4
Override function	04	1.115V	—	—	—	*4
Test mode expansion	04	1.115V	1.41T	—	—	*2
SD memory card compatible label function	04	1.115V	—	—	—	*2
Parameter change function	05	—	—	—	—	*2
Stepping motor module AlphaStep/5-phase manufactured by ORIENTAL MOTOR Co., Ltd.	05	1.118Y	—	—	—	*2
Home position return of driver home position return method	05	1.118Y	—	—	—	*4
Device assignment method	07	1.120A	—	—	—	*2
Machine control	07	1.120A	—	—	—	*6
Motion dedicated function (MCNST)	07	1.120A	—	—	—	*3
Multiple CPU advanced synchronous control (192 axis synchronization) <sup>7</sup>	07	1.120A	—	—	—	*5
Servo driver VPH series manufactured by CKD Nikki Denso Co., Ltd.	07	1.120A	—	—	—	*2
Inverter FR-A800 series	07	1.120A	—	—	—	*2
Override function compatible in machine control	08	1.120A	—	—	—	*4
Sequential coordinate command control for machine control	08	1.120A	—	—	—	*6
Data set method 3 home position return	08	1.125F	—	—	—	*4
Indirect specification expansion for Motion SFC program	08	1.125F	—	—	—	*3
IAI electric actuator controller manufactured by IAI Corporation	08	1.125F	—	—	—	*2
Compatible with cam conversion data	08	1.125F	—	—	—	—
Motion dedicated PLC instructions (M(P).MCNST/ D(P).MCNST)	07	—	—	1.025B	—	*3
Sensing module connection	09	1.128J	1.55H	—	—	*2
Expansion of the number of Motion SFC multi active steps	09	1.128J	—	—	—	*3

Function	Operating system software version *1	Engineering software version				Section of reference
		MELSOFT MT Works2		GX Works3	GX LogViewer	
		MT Developer2	MR Configurator2			
Improvement of absolute positioning operation for servo driver VCI/VPH series manufactured by CKD Nikki Denso Co., Ltd., and stepping motor module AlphaStep/5-phase manufactured by ORIENTAL MOTOR Co., Ltd.	09	—	—	—	—	*2
Expansion of the number of positioning points for the Motion dedicated function (MCNST)	10	1.120A	—	—	—	*6
Expansion of the number of Motion SFC programs and servo programs	10	1.130L	—	—	—	*3*4
Synchronous encoder via sensing module	10	1.130L	1.55H	—	—	*5
Mixed operation cycle function	10	1.130L	—	—	—	*2
RnENCPU Multiple CPU system compatible	10	1.118Y	—	1.032J	—	—
Actual coordinate value (world coordinate system) monitor for machine control	11	1.135R	—	—	—	*6
Virtual servo amplifier function	12	1.137T	—	—	—	*2
G-code control*8	14	1.140W	—	—	—	*9
Add-on library license authentication	14	1.140W	—	—	—	*2
RnCPU (R00CPU, R01CPU, R02CPU) Multiple CPU system compatible	—	1.140W	—	1.040S	—	—
WAIT-ON/OFF for machine control	15	1.145B	—	—	—	*6
Point arrival notification for machine control	15	1.145B	—	—	—	*6
G-code control (Ver.0103) compatible*8	15	1.145B	—	—	—	*9
G-code control (Ver.0104) compatible*8	16	1.150G	—	—	—	*9
RnSFCPU Multiple CPU system compatible	—	1.155M	—	1.055H	—	—
Cancel of the servo program function	20	1.160S	—	—	—	*4
Servo amplifier (MR-J5(W)-□B) compatible	24	1.175H	1.134Q	—	—	—
Servo system recorder function	24	1.175H	—	—	1.130L	*2
Co-recording function	25	1.180N	—	1.090U	—	*2
Acceleration/deceleration time and command torque time constant 1 word setting function	26	1.185T	—	—	—	*2
Tool coordinate specification in machine control machine program operation and machine JOG operation compatible	26	1.120A	—	—	—	*6
Servo amplifier (MR-JE-□B) compatible	27	1.187V	1.146C	—	—	—

\*1 The operating system software version can be confirmed in MT Developer2, or GX Works3. (Page 30 Checking operating system software version)

\*2 MELSEC iQ-R Motion Controller Programming Manual (Common)

\*3 MELSEC iQ-R Motion Controller Programming Manual (Program Design)

\*4 MELSEC iQ-R Motion Controller Programming Manual (Positioning Control)

\*5 MELSEC iQ-R Motion Controller Programming Manual (Advanced Synchronous Control)

\*6 MELSEC iQ-R Motion Controller Programming Manual (Machine Control)

\*7 Because the device assignment of status device settings are changed, the device assignment must be reviewed when updating the operating system software to version "07" or later from version "05" or earlier

\*8 Requires add-on library "SW10DND-GCD□".

\*9 MELSEC iQ-R Motion Controller Programming Manual (G-Code Control)

## 1.5 Engineering Software Version

The operating system software and engineering software versions that support Motion CPU are shown below.

Motion CPU	Operating system software	MELSOFT MT Works2 (MT Developer2)	GX Works3	GX LogViewer
R16MTCPU	01 or later	1.100E or later	1.000A or later	1.130L or later
R32MTCPU				
R64MTCPU	07 or later	1.120A or later	1.019V or later	

## 1.6 Restrictions by the Hardware Version

There are restrictions in the function that can be used by the version of the operating system software and hardware.

The combination of each version and a function is shown below.

Function	Operating system software version <sup>*1</sup>	The third and fourth digit from the left of production information <sup>*2</sup>			Section of reference
		R16MTCPU	R32MTCPU	R64MTCPU	
Running the servo system recorder function and digital oscilloscope simultaneously	24	17	17	14	<sup>*3</sup>

<sup>\*1</sup> The operating system software version can be confirmed in MT Developer2, or GX Works3. (☞ Page 30 Checking operating system software version)

<sup>\*2</sup> Refer to the checking production information for details of production information. (☞ Page 29 Checking production information)

<sup>\*3</sup>  MELSEC iQ-R Motion Controller Programming Manual (Common)

# 2 EQUIPMENT SPECIFICATIONS

## 2.1 General Specifications

General specifications of the Motion controller are shown below.

Item	Specification					
Operating ambient temperature	0 to 55°C (32 to 131°F)(When an extended temperature range base unit is not used)					
	0 to 60°C (32 to 140°F) <sup>*1</sup> (When an extended temperature range base unit is used)					
Storage ambient temperature	-25 to 75°C (-13 to 167°F)					
Operating ambient humidity	5 to 95%RH, non-condensing					
Storage ambient humidity	5 to 95%RH, non-condensing					
Vibration resistance	Compliant with JIS B 3502 and IEC 61131-2	—	Frequency	Constant acceleration	Half amplitude	Sweep count
		Under intermittent vibration	5 to 8.4Hz	—	3.5mm(0.14inch)	10 times each in X, Y, Z directions
			8.4 to 150Hz	9.8m/s <sup>2</sup>	—	
		Under continuous vibration	5 to 8.4Hz	—	1.75mm(0.07inch)	—
8.4 to 150Hz	4.9m/s <sup>2</sup>		—			
Shock resistance	Compliant with JIS B 3502 and IEC 61131-2 (147m/s <sup>2</sup> , 3 times each in X, Y, and Z directions)					
Operating ambience	No corrosive gases <sup>*2</sup> , flammable gases, less conductive dust					
Operating altitude <sup>*3</sup>	0 to 2000m(0 to 6561.68ft.)					
Mounting location	Inside control panel					
Overvoltage category <sup>*4</sup>	II or less					
Pollution level <sup>*5</sup>	2 or less					
Equipment class	Class I					

- \*1 All modules mounted on the extended temperature range base unit offer the same performance as that for an operating ambient temperature of 0 to 55°C (32 to 131°F), even though they are used in an operating ambient temperature of 0 to 60°C (32 to 140°F). When using the modules in the environment of the temperature exceeding 60°C (140°F), please consult your local Mitsubishi representative.
- \*2 Use the special coated products which comply with the IEC 60721-3-3 3:1994 in the environment with the corrosive gases. For details on the special coated products, please consult your local Mitsubishi representative.
- \*3 Do not use or store the Motion controller under pressure higher than the atmospheric pressure of altitude 0m. Doing so can cause an operation failure. When using the Motion controller under pressure, please contact with our sales representative.
- \*4 This indicates the section of the power supply to which the equipment is assumed to be connected between the public electrical power distribution network and the machinery within premises. CategoryII applies to equipment for which electrical power is supplied from fixed facilities. The surge voltage withstand level for up to the rated voltage of 300V is 2500V.
- \*5 This index indicates the degree to which conductive material is generated in terms of the environment in which the equipment is used. Pollution level 2 is when only non-conductive pollution occurs. A temporary conductivity caused by condensing must be expected occasionally.

### CAUTION

- The Motion controller must be stored and used under the conditions listed in the table of specifications above.
- When not using the module for a long time, disconnect the power line from the Motion controller or servo amplifier.
- Place the Motion controller and servo amplifier in static electricity preventing vinyl bags and store.
- When storing for a long time, please contact with our sales representative. Also, execute a trial operation.

# 2.2 Motion CPU Module

## Name of parts

This section explains the names of the parts of the Motion CPU module.

With front cover open

Front face of R16MTCPU

Front face of R32MTCPU

Front face of R64MTCPU

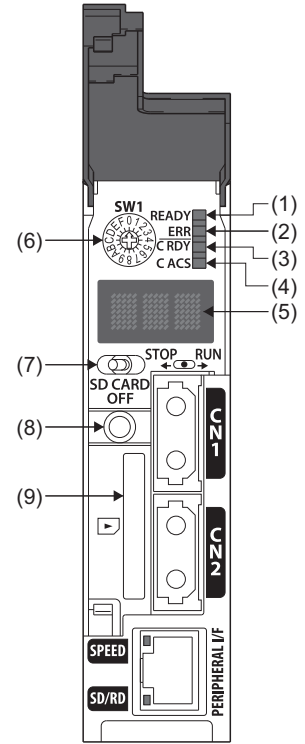
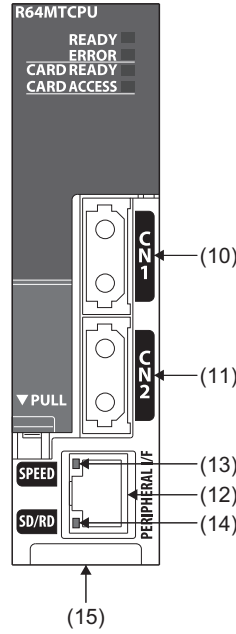
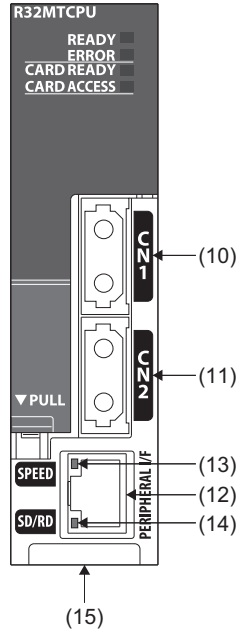
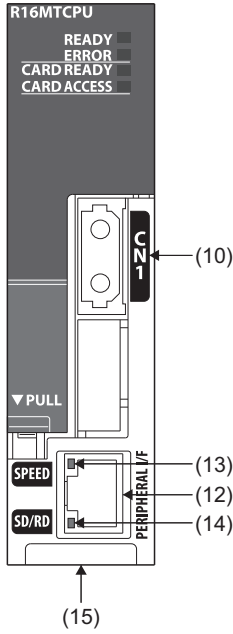

Side face

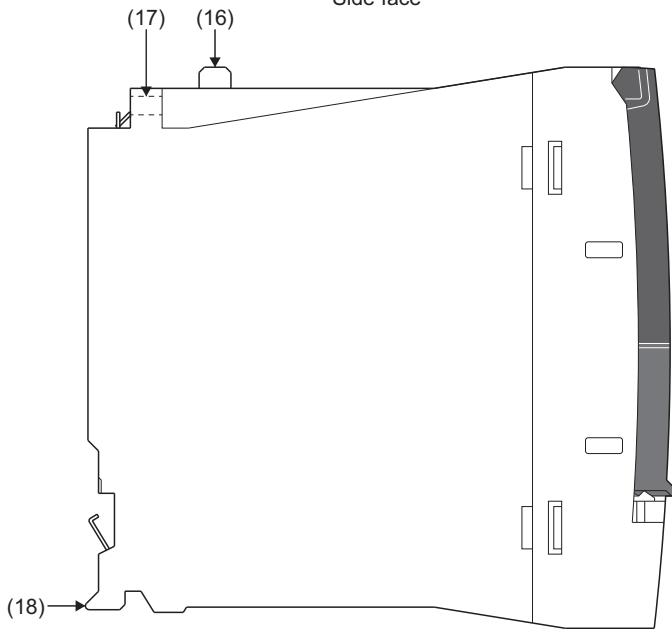

No.	Name	Details
(1)	READY LED	Indicates the operating status of the Motion CPU. ON: Operating normally Flickering: Initializing OFF: Hardware error (☞ Page 37 READY/ERROR LED display)
(2)	ERROR LED	Indicates an error occurrence in the Motion CPU module. ON, flickering: Hardware error, or error occurrence (☞ Page 37 READY/ERROR LED display) OFF: Operating normally
(3)	CARD READY LED	Indicates whether SD memory card is usable or not. ON: SD memory card is usable Flickering: Preparing OFF: No SD memory card inserted
(4)	CARD ACCESS LED	Indicates the access status of SD memory card. ON: Accessing SD memory card OFF: Not accessing SD memory card
(5)	Dot matrix LED	Indicates the operating status and error information. (☞ Page 37 Dot matrix LED display)
(6)	Mode select rotary switch	<ul style="list-style-type: none"> <li>• Set the operation mode. (Normal mode, Installation mode, etc.)</li> <li>• Each switch setting is 0 to F. (Factory default: 0) (☞ Page 39 Rotary switch setting)</li> </ul>
(7)	RUN/STOP switch	Move RUN/STOP to change the operating state of the Motion CPU module. RUN: Program is started. STOP: Program is stopped.
(8)	SD memory card access control switch	Switch for stopping card access when removing the SD memory card.
(9)	SD memory card slot	Slot for inserting the SD memory card.
(10)	SSCNETIII CN1 connector *1	Connector to connect the servo amplifier of line 1.
(11)	SSCNETIII CN2 connector *1*2	Connector to connect the servo amplifier of line 2.
(12)	PERIPHERAL I/F connector	For communication I/F with peripheral devices.
(13)	SPEED LED	ON: Communicating at 100Mbps OFF: Communicating at 10Mbps, or not connected.
(14)	SD/RD LED	Flickering: Communicating data OFF: Not communicating data
(15)	Production information marking	Displays the production information described on the rating plate.
(16)	Module fixing hook	Hook used to fix the module to the base unit.
(17)	Module fixing screw hole	Screw hole used to fix to the base unit. (M3×12 screws supplied by user)
(18)	Module fixing projection	Projection used to fix to the base unit.

\*1 Put the SSCNETIII cable in the duct or fix the cable at the closest part to the Motion CPU module with bundle material in order to prevent SSCNETIII cable from putting its own weight on SSCNETIII connector.

\*2 R64MTCPU/R32MTCPU only

# LED display









## READY/ERROR LED display

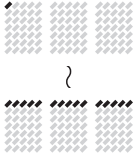









The Motion CPU operating status is shown below by the READY LED and ERROR LED combination.

LED display status		Operating status
READY	ERROR	
OFF	OFF	Power supply OFF
Flickering	OFF	Initializing
ON	OFF	Operating normally
OFF	ON or flickering	Major error occurrence
ON	Flickering	Moderate error occurrence
ON	ON	Minor error occurrence



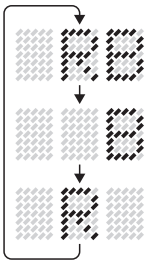

## Dot matrix LED display

The LED displays/flashes in the combination with errors.

Item	Dot matrix LED	Details	
Normal mode	Start	Progress display 	It takes about 10 seconds to initialize (RUN/STOP display). After startup, each CPU requires time for initializing. Check the rotary switch setting, and execute the Multiple CPU system power cycle if the operation stops at initializing for several minutes. If the Motion controller continues to stop at initializing, it may be Motion controller's hardware fault. Explain the error symptom (LED display) and get advice from our sales representative for the modules with failure.
		"E□□" is displayed 	Hardware error or software error during initializing. □ indicates the error code. Explain the error symptom (LED display) and get advice from our sales representative for the modules with failure.
		"Source > Destination" is displayed (Left: When files are transmitted from the SD memory card to the standard ROM) 	Executes file transmission at boot. The following are used to indicate the source, destination, delete target. R: Standard ROM S: SD memory card
		"× delete target" is displayed (Left: When files on the standard ROM are deleted) 	
STOP	"STP" is displayed 	Stopped the program with the "[Rq.1120] PLC ready flag (R: M30000/Q: M2000)" OFF.	
RUN	"RUN" is displayed 	Executed the program with the "[Rq.1120] PLC ready flag (R: M30000/Q: M2000)" ON.	
Test mode RUN	"TES" is displayed 	Mode to test Motion CPU operation.	
Amplifier-less operation mode	Displays "NAP" and "Mode" alternately.(Left: When mode is "RUN") 	Mode to operate without connecting servo amplifiers. The mode displayed is the mode that the Motion CPU is operating. ("STP", "RUN", "TES")	

Item		Dot matrix LED		Details
Normal mode	Digital oscilloscope RUN		Displays "LOG" and "Mode" alternately.(Left: When mode is "RUN")	Displays the status of the digital oscilloscope wait for trigger. The mode displayed is the mode that the Motion CPU is operating. ("STP", "RUN", "TES")
			Displays "TRG" and "Mode" alternately.(Left: When mode is "RUN")	Displays the status after the digital oscilloscope trigger issue. The mode displayed is the mode that the Motion CPU is operating. ("STP", "RUN", "TES")
Ethernet information display mode		Refer to Ethernet information display mode for details of the dot matrix LED display. (Page 40 Ethernet information display mode)		Displays information of IP address, subnet mask, default router address, MAC address, link status.
Installation mode		"INS" is displayed	Mode to install the operating system software.	
		Displays "INS" → "SDC" alternately.	Displays the status of the operating system software installation from the SD memory card.	
		"FIN" is displayed	Displays when the operating system software installation from the SD memory card is completed normally.	
		"ERR" is displayed (Left: When there is a "SD memory card access error")	Displays when there was an error in operating system software installation from the SD memory card. □ indicates the following errors. 0: SD memory card access error 1: Install file error 2: Built-in ROM access error 3: License key file error	
Built-in memory clear		"CLR" is displayed	Mode to clear the built-in memory (standard ROM, backup RAM). After displaying for 3 seconds, the display switches to the target memory.	
		Target memory is displayed.	The target memory for built-in memory clear is displayed. The following are the displays for the target memory. RB: Standard ROM and backup RAM B: Backup RAM R: Standard ROM • Switch the memory displayed by pushing the SD memory card access control switch.	
		Displays "CLR" → "Target memory" alternately. (Left: When target memory is "standard ROM and backup RAM")	Displays the status of the built-in memory clear.	
		"FIN" is displayed	Displays when built-in memory clear is completed normally.	
		"ERR" is displayed	Displays when an error occurred during built-in memory clear.	

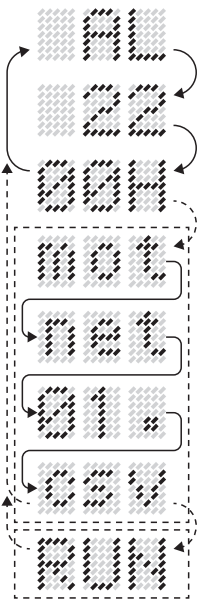

Item		Dot matrix LED	Details
Operating system software	Not installed		"A00" is flickering It becomes the status of installation mode when the operating system software is not installed.
	File error		"A01" is flickering Displays when there is a file error in the operating system software that was installed.
WDT error			"W□□" is displayed Hardware error or software error. □ displays the error code of "Motion CPU WDT error cause (SD512)".
Self-diagnostic error (Major/Moderate/Minor error)		 <p>"AL" flickers 3 times ↓ 4-digits error code is displayed in two sequential displays of 2-digits each. (Left: error code [2200H]) ↓ Scrolled display of the file name. (Left: When file name is "motnet01.csv") ↓ When a continuous error occurred, the mode is displayed. (Left: When mode is "RUN")</p>	Displays when a self-diagnostic error occurs (major/moderate/minor error). <ul style="list-style-type: none"> <li>• Displays the applicable file name when a parameter, or file error is detected.</li> <li>• The mode that the Motion CPU is operating. ("STP", "RUN", "TES") is displayed only for a continuous error.</li> </ul> Refer to the following for details of error codes and file names.  MELSEC iQ-R Motion controller Programming Manual (Common)

**Point** 

- When an error is displayed on the dot matrix LED, confirm the error code etc. using MT Developer2.
- Refer to the Motion CPU error batch monitor or the following for error details.  
 MELSEC iQ-R Motion Controller Programming Manual (Common)

## Rotary switch setting and operation mode

### Rotary switch setting

Rotary switch	Setting *1	Mode	Description
	0	Normal mode	Normal operation mode
	8	Ethernet information display mode	Displays IP address, MAC address, and Ethernet link status.
	A	Installation mode	Installed the operating system software using MT Developer2.
	C	Built-in memory clear	Initializes the built-in memory of the standard ROM and backup RAM.

\*1 Do not set other than the above setting.

### CAUTION

- Be sure to turn OFF the Multiple system power supply before the rotary switch setting change.

## Operation mode

### ■Normal mode

The Motion CPU module operates based on the parameters, user programs stored in the standard ROM or the SD memory card.

### ■Ethernet information display mode

Displays Ethernet related information. Displays in the order of IP address, subnet mask, default router address, MAC address, and link status.

During Ethernet information display mode, communication with MT Developer2, execution of Motion SFC programs, and axis control cannot be performed.

The following is an example of a display in Ethernet information display mode.

Ex.

IP address: 192.168.3.39

Subnet mask pattern: 255.255.255.0

Default router IP address: 192.168.3.1

MAC address: 38-E0-8E-01-23-45

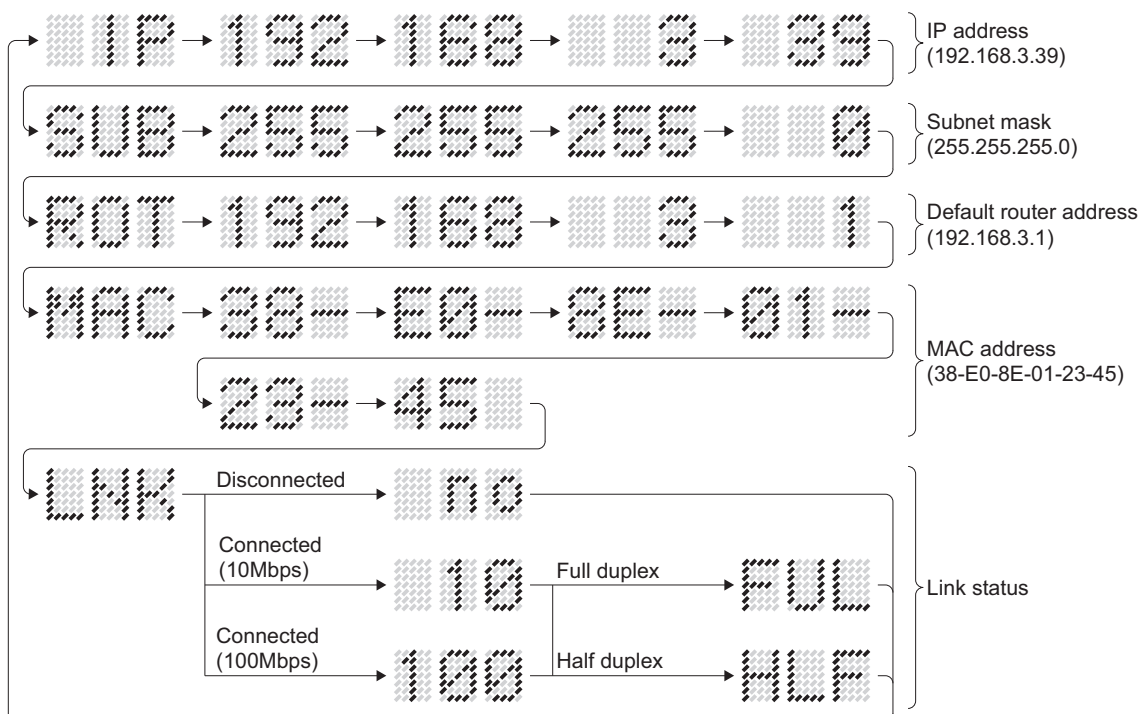

### Point

When the Ethernet parameters are not written in the Motion CPU, the addresses are displayed as follows.

- IP address: 192.168.3.39
- IP address: 0.0.0.0
- Default router IP address: 0.0.0.0

### ■Installation mode

Mode for installing the operating system software. Only communication with MT Developer2 is possible. Execution of Motion SFC programs, and axis control cannot be performed.

## ■ Built-in memory clear

Clears the contents of the standard ROM and backup RAM of the Motion CPU. During built-in memory clear, communication with MT Developer2, execution of Motion SFC programs, and axis control cannot be performed. The procedure for built-in memory clear is shown below.

1. Set the rotary switch to "C".
2. Turn ON the Multiple CPU system power supply.
3. The READY LED turns ON, and the dot matrix LED displays "CLR". After 3 seconds, the dot matrix LED display switches to the target memory.
4. Pushing the SD memory card access control switch changes the dot matrix display as shown below. Select the memory for built-in memory clear.



RB:Clear the standard ROM and backup RAM  
 B:Clear the backup RAM  
 R :Clear the standard ROM

5. By holding the SD memory card access control switch for longer than 3 seconds, "CLR" → "Memory selected in Step 4." is displayed alternately, and clear processing begins.
6. When built-in memory clear is complete, "FIN" is displayed on the dot matrix LED.
7. Turn OFF the Multiple CPU system power supply.
8. Set the rotary switch to "0" to switch to normal mode.

### Point

- Do not turn OFF the Multiple system power supply while the clear is processing.
- If Multiple CPU system power supply is turned OFF during clearing of standard ROM, accessing the standard ROM may no longer be possible. Execute a drive format from MT Developer2, or perform a built-in memory clear again.
- When an error is detected during the processing of a built-in memory clear, "ERR" is displayed on the dot matrix LED, and the ERROR LED flickers. Perform a built-in memory clear again.
- The contents cleared in the standard ROM are every program, parameter, event history, and data for digital oscilloscope. Refer to the following for details of each file.  
 📖 MELSEC iQ-R Motion Controller Programming Manual (Common)
- The contents cleared in the backup RAM are latch device data, absolute positioning data, current value history, and scroll monitor.

# Specifications

This section describes the Motion CPU specifications.

## Module specifications

Item		R64MTCPU	R32MTCPU	R16MTCPU	
Number of control axes		Up to 64 axes	Up to 32 axes	Up to 16 axes	
SSCNET communication *1	Communication type	SSCNETⅢ/H, SSCNETⅢ			
	Number of lines	2 lines *2		1 line *2	
	Distance between stations (maximum) [m(ft.)]	SSCNETⅢ/H	100(328.08)		
		SSCNETⅢ	50(164.04)		
	Combined cable length (maximum) [m(ft.)]*3	SSCNETⅢ/H	3200(10498.69)	1600(5249.34)	
		SSCNETⅢ	800(2624.67)		
	Number of sensing module connection stations	Up to 8 stations (Up to 4 stations/line)			Up to 4 stations
Number of SSCNETⅢ/H head module connection stations					
Number of optical hub unit connections		Up to 32 units (Up to 16 units/line)		Up to 16 units	
PERIPHERAL I/F (Ethernet)	Data transmission speed	100Mbps/10Mbps			
	Communication mode	Full-duplex/Half-duplex *4			
	Transmission method	Base band			
	Cable length (maximum) [m(ft.)]	30(98.43)			
Memory card slot		SD/SDHC memory card compatible			
Memory capacity	Standard ROM	12M bytes			
	SD memory card	Memory card capacity (Up to 32G bytes)			
Number of stages of extension base		Up to 7 stages			
Internal current consumption (5VDC) [A]		1.20			
Mass [kg]		0.28			
Exterior dimensions [mm(inch)]		106.0(4.17)(H)×27.8(1.09)(W)×110.0(4.33)(D)			

\*1 Servo amplifiers for SSCNET cannot be used.

\*2 SSCNETⅢ and SSCNETⅢ/H cannot be combined within the same line. For R64MTCPU/R32MTCPU, SSCNETⅢ and SSCNETⅢ/H can be set for each line.

\*3 When using the optical hub unit, the maximum combined cable length depends on the system configuration.

\*4 For half-duplex transmission, response time may be longer depending on the external device. When connecting with an external device via a switching HUB, set to full-duplex transmission.

## Motion control specifications

Item	R64MTCPU	R32MTCPU	R16MTCPU
Number of control axes	Up to 64 axes	Up to 32 axes	Up to 16 axes
Operation cycle (default)	0.222ms/ 1 to 2 axes 0.444ms/ 3 to 8 axes 0.888ms/ 9 to 20 axes 1.777ms/21 to 38 axes 3.555ms/39 to 64 axes	0.222ms/ 1 to 2 axes 0.444ms/ 3 to 8 axes 0.888ms/ 9 to 20 axes 1.777ms/21 to 32 axes	0.222ms/ 1 to 2 axes 0.444ms/ 3 to 8 axes 0.888ms/ 9 to 16 axes
Interpolation functions	Linear interpolation (Up to 4 axes), Circular interpolation (2 axes), Helical interpolation (3 axes)		
Control modes	PTP(Point to Point) control, Speed control, Speed-position switching control, Fixed-pitch feed, Continuous trajectory control, Position follow-up control, Speed control with fixed position stop, High-speed oscillation control, Speed-torque control, Pressure control <sup>*1</sup> , Advanced synchronous control, Machine control, G-code control		
Acceleration/deceleration control	Trapezoidal acceleration/deceleration, S-curve acceleration/deceleration, Advanced S-curve acceleration/deceleration		
Compensation	Backlash compensation, Electronic gear, Phase compensation		
Programming language	Motion SFC, Dedicated instruction		
Program capacity	Servo program	64k steps <sup>*2</sup>	
	Motion SFC program	8192k bytes <sup>*3</sup>	
Number of programs	Servo program	8192 (K0 to 8191) <sup>*4</sup>	
	Motion SFC program	512 (No.0 to 511) <sup>*5</sup>	
Number of positioning points	6400 points (Positioning data can be designated indirectly)		
Peripheral I/F	PERIPHERAL I/F		
Home position return function	Proximity dog method (2 types), Count method (3 types), Data set method (3 types), Dog cradle method, Stopper method (2 types), Limit switch combined method, Scale home position signal detection method, Dogless home position signal reference method, Driver home position return method		
	Home position return re-try function provided, home position shift function provided		
JOG operation function	Provided		
Manual pulse generator operation function	Possible to connect 3 modules (High-speed counter module use)		
Synchronous encoder operation function	Possible to connect 12 modules (Via module (High-speed counter module use) + Via servo amplifier <sup>*6</sup> + Via device + Multiple CPU advanced synchronous control + Via sensing module)		
M-code function	M-code output function provided, M-code completion wait function provided		
Limit switch output function	Number of output points 64 points × 2 settings Output timing compensation Watch data: Motion control data/Word device		
ROM operation function	Provided		
Multiple CPU advanced synchronous control	Provided		
External input signal	External input signals (FLS/RLS/DOG) of servo amplifier, Bit device		
Forced stop	Motion controller forced stop (Device), Forced stop terminal of servo amplifier		
Number of I/O points	Total 4096 points		
Mark detection function	Mark detection mode setting	Continuous detection mode, Specified number of detection mode, Ring buffer mode	
	Mark detection signal	High-speed input request signal (bit device, input signal of servo amplifier (DI1 to DI3), input signal of sensing module)	
	Mark detection setting	64 settings	
Clock function	Provided		
Security function	Provided		
All clear function	Provided		
Remote operation	Remote RUN/STOP		
File management function	Available for program and parameter data, cam data, label data, sampling data etc.		
Optional data monitor function	SSCNETⅢ/H	Up to 14 data/axis (Communication data: Up to 6 points/axis)	
	SSCNETⅢ	Up to 14 data/axis (Communication data: Up to 3 points/axis)	
Digital oscilloscope function	Motion buffering method (Real-time waveform can be displayed) Sampling data: Word 16CH, Bit 16CH Offline sampling		
Absolute position system	Made compatible by setting battery to servo amplifier. (No battery required when a servo motor with a batteryless absolute position encoder is used) (Possible to select the absolute data method or incremental method for each axis)		

Item	R64MTCPU	R32MTCPU	R16MTCPU
Driver communication function <sup>*7</sup>	Provided		
File transmission at boot function	Provided		
Parameter change function	Provided		
Mixed operation cycle function	Provided		
Event history function	Provided		
Add-on function	Provided		
Override function	Provided		
Vibration suppression command filter	Provided		
Servo system recorder function	Provided		

\*1 Servo amplifier(MR-J4-□B-LL) only.

\*2 For operating system software version "09" or earlier, 32k steps.

\*3 For operating system software version "09" or earlier, 4096k bytes.

\*4 For operating system software version "09" or earlier, 4096 (K0 to 4095).

\*5 For operating system software version "09" or earlier, 256 (No.0 to 255).

\*6 Servo amplifier(MR-J5(W)-□B/MR-J4(W)-□B) only.

Refer to the following for details of devices that can be used as a synchronous encoder axis.

 MELSEC iQ-R Motion Controller Programming Manual (Advanced Synchronous Control)

\*7 Servo amplifier(MR-J5-□B/MR-J4-□B/MR-J3-□B) only.

## 2.3 Serial Absolute Synchronous Encoder

### Specifications

This section describes the specifications of serial absolute synchronous encoder.

Item	Specifications
Model name	Q171ENC-W8*1
Ambient temperature	-5 to 55°C(23 to 131°F)
Resolution	4194304pulse/rev
Transmission method	Serial communications
Direction of increasing addresses	CCW (viewed from end of shaft)
Protective construction	Dustproof/Waterproof (IP67: Except for the shaft-through portion.)
Permitted speed at power ON	3600r/min
Permitted speed at power OFF *2	500r/min
Permitted axial loads	Radial load : Up to 19.6N, Thrust load : Up to 9.8N
Runout at input shaft tip	0.02mm(0.00079 inch) or less, (15mm(0.59 inch) from tip)
Start friction torque	0.04N·m(20°C(68°F))
Recommended coupling	Bellows coupling
Permitted angular acceleration	4000rad/s <sup>2</sup>
Vibration resistance	5G(50 to 200Hz)
Shock resistance	50G(11ms or less)
Internal current consumption [A]	0.25
Mass [kg]	0.6
Connecting cable [m(ft.)]	Q170ENCBL□M-A (□=Cable length : 2(6.56), 5 (16.40), 10 (32.81), 20 (65.62), 30 (98.43), 50 (164.04))
Communications method	Differential driver/receiver
Transmission distance	Up to 50m(164.04ft.)

\*1 When an "o-ring" is required, please purchase one separately.

\*2 If the permitted speed at power OFF is exceeded, a position displacement is generated.

#### Point

The serial absolute synchronous encoder backs up the absolute position with the battery for back up of absolute position data of the servo amplifier (MR-J4-□B-RJ) it is connected to.

## 2.4 SSCNETIII Cables

Between the Motion CPU module and servo amplifiers, or servo amplifier and servo amplifier connected by SSCNETIII cable. When using the R16MTCPU, SSCNETIII cable for connection to servo amplifier can be used for only 1 line. (Connect to CN1.) When using the R64MTCPU/R32MTCPU, SSCNETIII cables for connection to servo amplifier can be used for up to 2 lines. (Connect to CN1 and CN2.)

The following number of servo amplifiers can be connected per SSCNETIII(/H) line.

Motion CPU	Communication type	
	SSCNETIII/H	SSCNETIII
R64MTCPU	Up to 32	Up to 16
R32MTCPU	Up to 16	
R16MTCPU	Up to 16	

## Specifications

Model name		Cable length [m(ft.)]	Description
MR-J3BUS□M (Standard cord for inside panel)	MR-J3BUS015M	0.15(0.49)	<ul style="list-style-type: none"> <li>• Motion CPU ↔ Servo amplifier</li> <li>• Servo amplifier ↔ Servo amplifier</li> </ul>
	MR-J3BUS03M	0.3(0.98)	
	MR-J3BUS05M	0.5(1.64)	
	MR-J3BUS1M	1(3.28)	
	MR-J3BUS3M	3(9.84)	
MR-J3BUS□M-A (Standard cable for outside panel)	MR-J3BUS5M-A	5(16.40)	
	MR-J3BUS10M-A	10(32.81)	
	MR-J3BUS20M-A	20(65.62)	
MR-J3BUS□M-B (Long distance cable)	MR-J3BUS30M-B	30(98.43)	
	MR-J3BUS40M-B	40(131.23)	
	MR-J3BUS50M-B	50(164.04)	



# Connection between the Motion CPU module and servo amplifiers

Connect the SSCNET III cables to the following connectors.

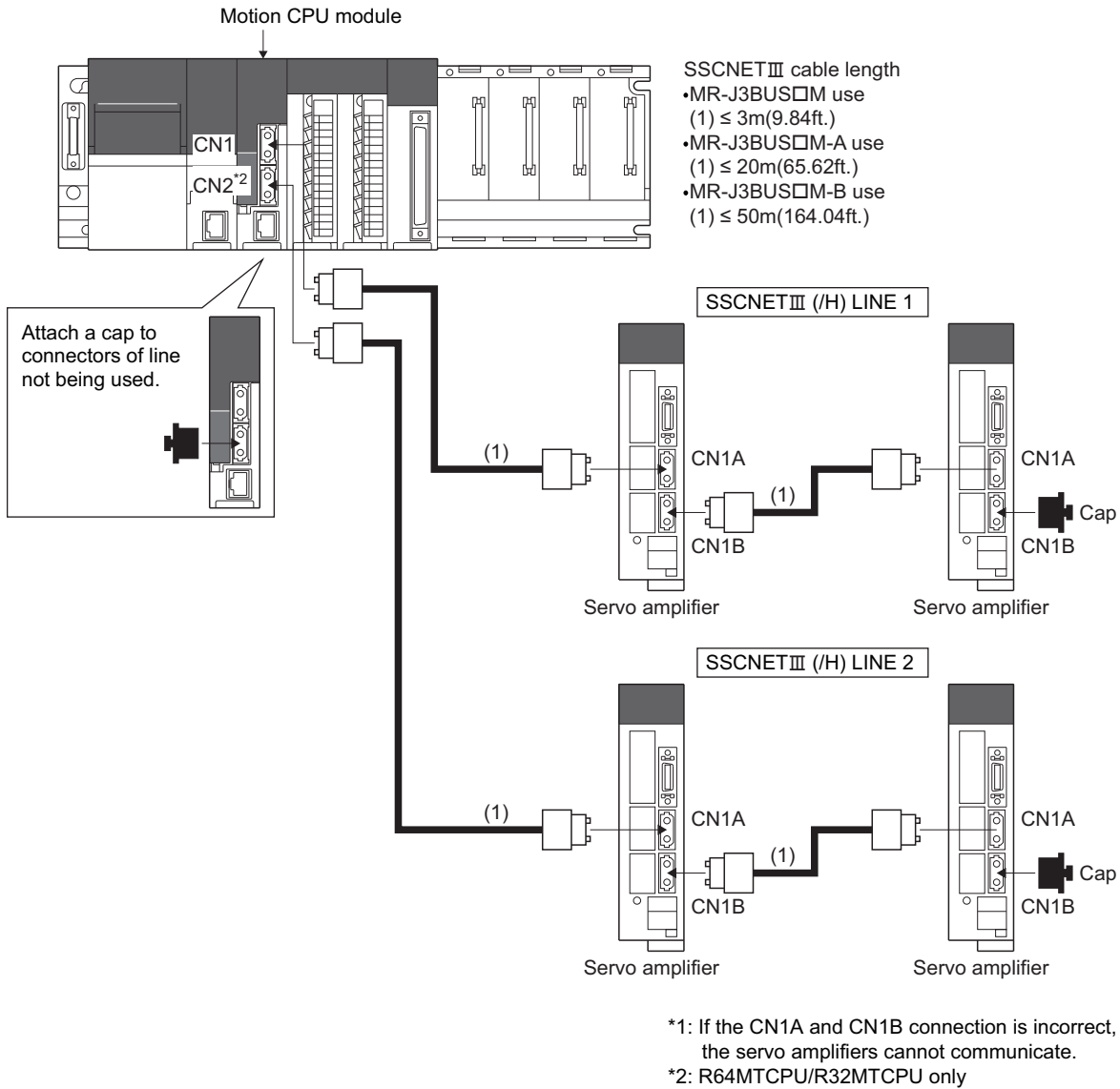

# Setting of the axis No. and switch of servo amplifier

Axis No. is used to set the axis Nos. of servo amplifiers connected to SSCNETIII connector (CNC) in the program. The following range can be set in the Motion CPU module. Axis No. is set for each SSCNETIII(H) line in servo network setting.

Motion CPU	Axis No. setting range	Setting range of station No.	
		SSCNETIII/H	SSCNETIII
R64MTCPU	1 to 64	1 to 64 <sup>*1</sup>	1 to 16
R32MTCPU	1 to 32		
R16MTCPU	1 to 16		

\*1 When using MR-JE-□B, the setting range of station No. is "1 to 16".

## Setting of Axis No. and station No.

### ■When using communication type "SSCNETIII/H"

Set the station No. and axis No. of the servo amplifier.

The station No. and axis No. of the servo amplifier can each be set individually.

- When using MR-J5(W)-□B

Match the servo amplifier station No. with the control axis No. by setting rotary switch (SW1) and rotary switch (SW2) to the appropriate combination. The table for setting the station No. with the rotary switches (SW1/SW2) of the servo amplifier is shown in the table below.

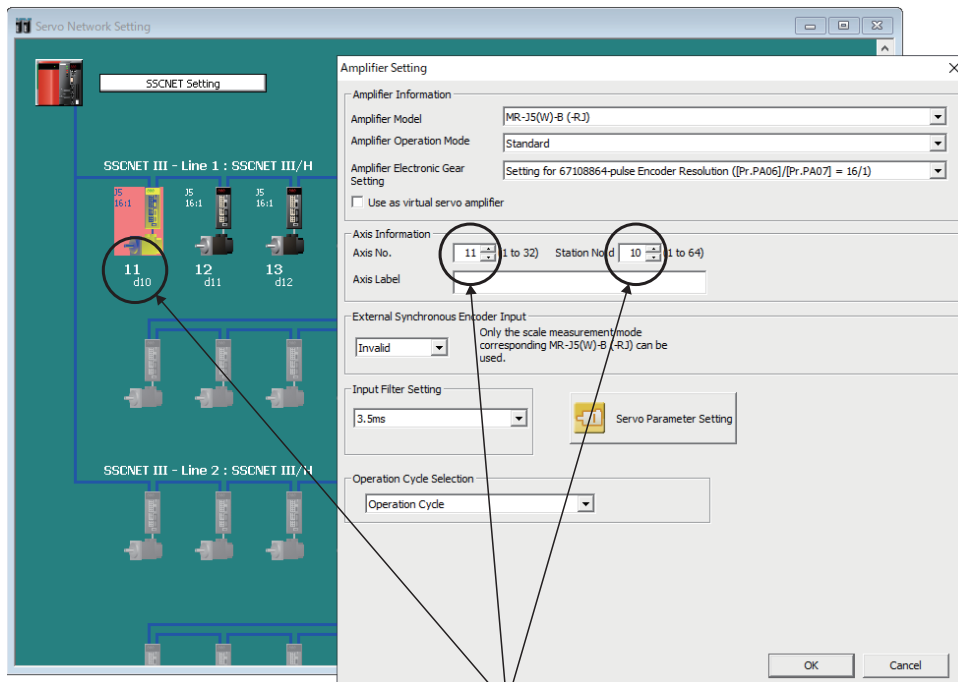

Rotary switch (SW1)

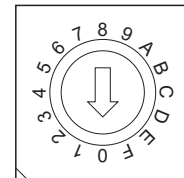

Rotary switch (SW2)

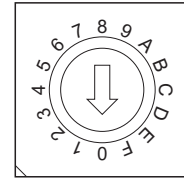

Set the Axis No. and Station No.

Rotary switch (SW1)	Rotary switch (SW2)															
	0	1	2	3	4	5	6	7	8	9	A	B	C	D	E	F
0	d01	d02	d03	d04	d05	d06	d07	d08	d09	d10	d11	d12	d13	d14	d15	d16
1	d17	d18	d19	d20	d21	d22	d23	d24	d25	d26	d27	d28	d29	d30	d31	d32
2	d33	d34	d35	d36	d37	d38	d39	d40	d41	d42	d43	d44	d45	d46	d47	d48
3	d49	d50	d51	d52	d53	d54	d55	d56	d57	d58	d59	d60	d61	d62	d63	d64
4 to F	Cannot be set															

- When using MR-J4(W)-□B

Match the servo amplifier station No. with the control axis No. by setting the axis select rotary switch (0 to F) and the auxiliary axis No. setting switches (SW3, SW4) to the appropriate combination. The table for setting the station No. with the axis select rotary switch and auxiliary axis No. setting switches of the servo amplifier is shown in the table below.

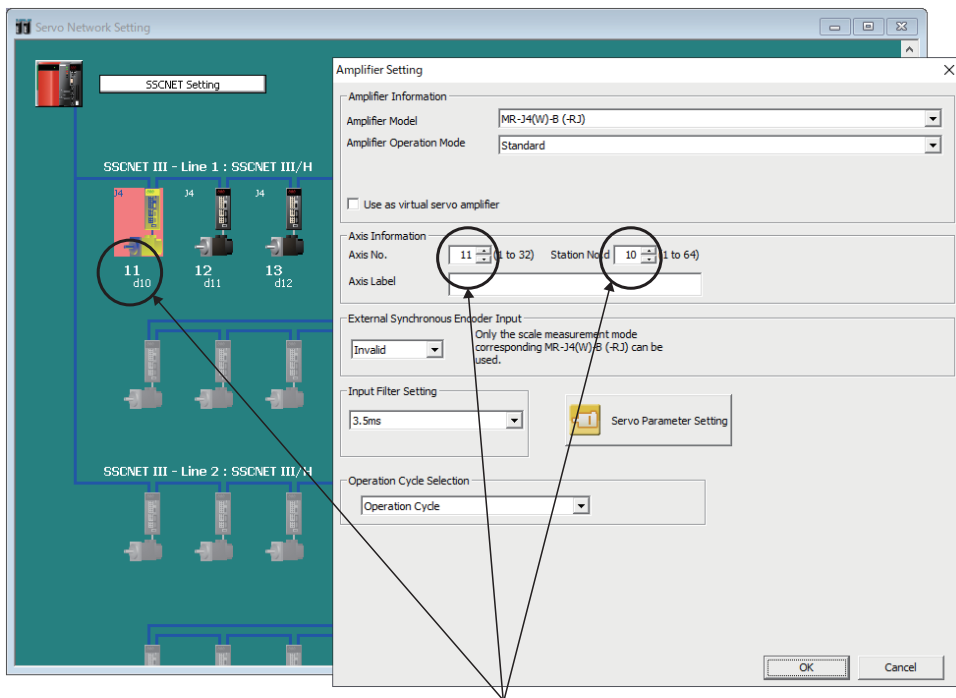

Auxiliary axis No. setting switch



Axis select rotary switch

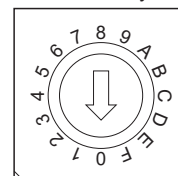

Set the Axis No. and Station No.

Auxiliary axis No. setting switch		Axis select rotary switch															
SW3	SW4	0	1	2	3	4	5	6	7	8	9	A	B	C	D	E	F
OFF	OFF	d01	d02	d03	d04	d05	d06	d07	d08	d09	d10	d11	d12	d13	d14	d15	d16
OFF	ON	d17	d18	d19	d20	d21	d22	d23	d24	d25	d26	d27	d28	d29	d30	d31	d32
ON	OFF	d33	d34	d35	d36	d37	d38	d39	d40	d41	d42	d43	d44	d45	d46	d47	d48
ON	ON	d49	d50	d51	d52	d53	d54	d55	d56	d57	d58	d59	d60	d61	d62	d63	d64

- When using MR-JE-□B

Match the servo amplifier station No. with the control axis No. by setting the axis select rotary switch (0 to F) to the appropriate combination. The table for setting the station No. with the axis select rotary switch of the servo amplifier is shown in the table below.

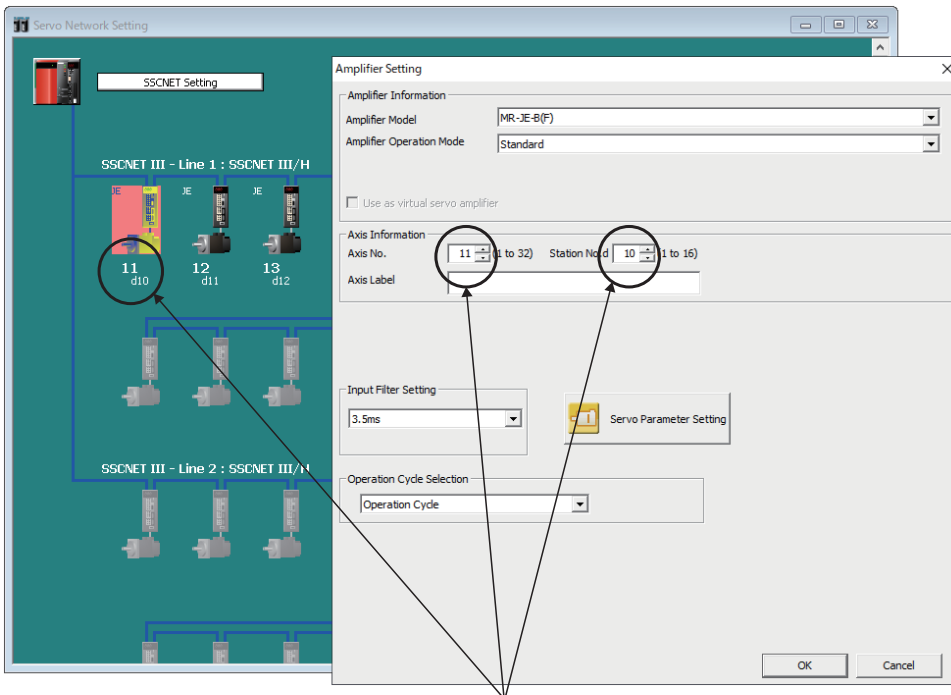

Set the Axis No. and Station No.

Axis select rotary switch															
0	1	2	3	4	5	6	7	8	9	A	B	C	D	E	F
d01	d02	d03	d04	d05	d06	d07	d08	d09	d10	d11	d12	d13	d14	d15	d16

**When using communication type "SSCNETIII"**

Set the axis No. for the station No. (d01 to d16) of each servo amplifier set on each line.

The station No. (d01 to d16) of servo amplifier on the servo network setting screen corresponds to axis select rotary switch (0 to F) of servo amplifier.

The table for setting the station No. and the axis select rotary switch of the servo amplifier is shown in the table below.

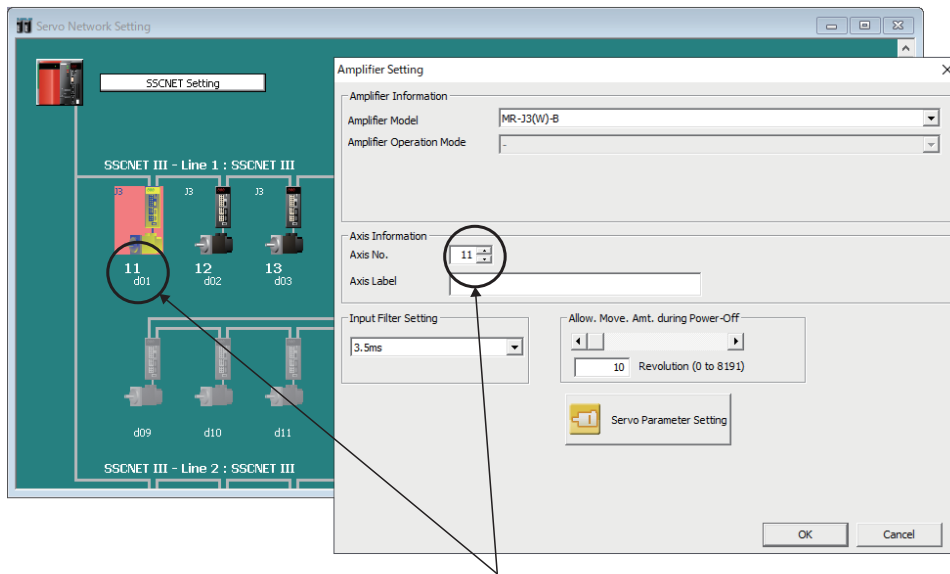

Axis select rotary switch

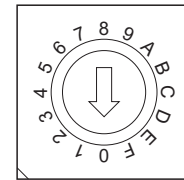

Set the Axis No. for the Station No.

Axis select rotary switch															
0	1	2	3	4	5	6	7	8	9	A	B	C	D	E	F
d01	d02	d03	d04	d05	d06	d07	d08	d09	d10	d11	d12	d13	d14	d15	d16

\*1 When using MR-J4(W)-□B, turn OFF the auxiliary axis No. setting switches.

**Connector No. of Motion CPU module**

Correspondence between SSCNETIII(/H) line and connector No. of Motion CPU module is shown in the table below.

SSCNETIII(/H) line	Connector No. of Motion CPU module
1	CN1
2	CN2

\*1 Number of SSCNETIII(/H) lines: R64MTCPU/R32MTCPU: 2 lines/R16MTCPU: 1 line

**Point**

The setting of axis select rotary switch and auxiliary axis No. setting switches differs depending on the servo amplifier.

Refer to the following for details.

Servo amplifier Instruction Manual

## Precautions for SSCNETIII cables

SSCNETIII cable is made from optical fiber. If optical fiber is added a power such as a major shock, lateral pressure, haul, sudden bending or twist, its inside distorts or breaks, and optical transmission will not be available. Especially, as optical fiber for MR-J3BUS□M and MR-J3BUS□M-A is made of synthetic resin, it melts down if being left near the fire or high temperature. Therefore, do not make it touched the part, which becomes high temperature, such as radiator or regenerative option of servo amplifier, or servo motor.

Be sure to use optical fiber within the range of operating temperature described in this manual.

Read described item of this section carefully and handle it with caution.

### Minimum bend radius

Make sure to lay the cable with greater radius than the minimum bend radius. Do not press the cable to edges of equipment or others. For SSCNETIII cable, the appropriate length should be selected with due consideration for the dimensions and arrangement of Motion controller and servo amplifier. When closing the door of control panel, pay careful attention for avoiding the case that SSCNETIII cable is hold down by the door and the cable bend becomes smaller than the minimum bend radius.

Model name of SSCNETIII cable	Minimum bend radius[mm(inch)]
MR-J3BUS□M	25(0.98)
MR-J3BUS□M-A	Enforced covering cord : 50 (1.97) Cord : 25 (0.98)
MR-J3BUS□M-B	Enforced covering cord : 50 (1.97) Cord : 30 (1.18)

### Tension

If tension is added on the SSCNETIII cable, the increase of transmission loss occurs because of external force which concentrates on the fixing part of SSCNETIII cable or the connecting part of SSCNETIII connector. At worst, the breakage of SSCNETIII cable or damage of SSCNETIII connector may occur. For cable laying, handle without putting forced tension.

Model name of SSCNETIII cable	Maximum tension[N]	
MR-J3BUS□M	□=015	70
	□=03 to 3	140
MR-J3BUS□M-A		420 (enforced covering cord)
MR-J3BUS□M-B		980 (enforced covering cord)

### Lateral pressure

If lateral pressure is added on the SSCNETIII cable, the cable itself distorts, internal optical fiber gets stressed, and then transmission loss will increase. At worst, the breakage of SSCNETIII cable may occur. As the same condition also occurs at cable laying, do not tighten up SSCNETIII cable with a thing such as nylon band (TY-RAP).

Do not stamp on it or tuck it down with the door of the control panel, etc.

### Twisting

If SSCNETIII cable is twisted, it will become the same stress added condition as when local lateral pressure or bend is added. Consequently, transmission loss increases, and the breakage of SSCNETIII cable may occur at worst.

### Disposal

When incinerating optical cable (cord) used for SSCNETIII cable, hydrogen fluoride gas or hydrogen chloride gas which is corrosive and harmful may be generated. For disposal of SSCNETIII cable, request for specialized industrial waste disposal services who has incineration facility for disposing hydrogen fluoride gas or hydrogen chloride gas.

## Wiring process of SSCNETIII cable

Put the SSCNETIII cable in the duct or fix the cable at the closest part to the Motion CPU module with bundle material in order to prevent SSCNETIII cable from putting its own weight on SSCNETIII connector.

### ■Putting in the duct

When putting in a duct, leave space for installing the module.

### ■Bundle fixing

Optical cord should be given loose slack to avoid from becoming smaller than the minimum bend radius, and it should not be twisted. When bundling the cable, fix and hold it in position by using cushioning such as sponge or rubber which does not contain migratable plasticizing. If using adhesive tape for bundling the cable, fire resistant acetate cloth adhesive tape 570F (Teraoka Seisakusho Co., Ltd) is recommended.

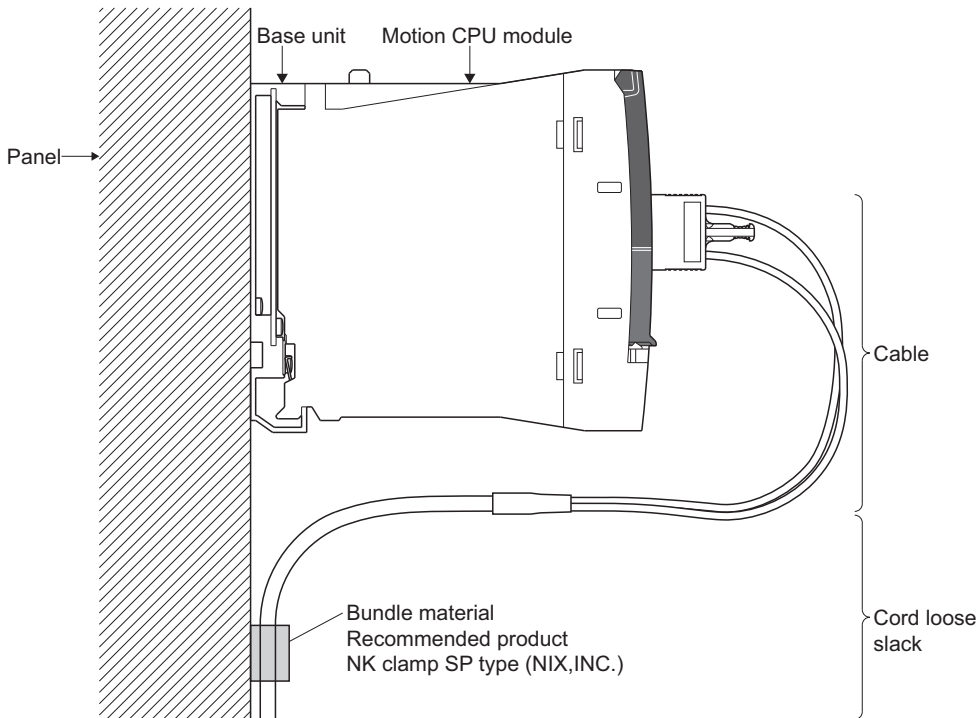

- Be sure to connect SSCNETIII cable with the above connector. If the connection is mistaken, between the Motion CPU module and servo amplifier cannot be communicated.
- Forced removal of the SSCNETIII cable from the Motion CPU module will damage the Motion CPU modules and SSCNETIII cables.
- After removal of the SSCNETIII cable, be sure to put a cap on the SSCNETIII connector. Otherwise, adhesion of dirt deteriorates in characteristic and it may cause malfunctions.
- Do not remove the SSCNETIII cable while turning on the power supply of Multiple CPU system and servo amplifier. Do not see directly the light generated from SSCNETIII connector of Motion CPU module or servo amplifier and the end of SSCNETIII cable. When the light gets into eye, may feel something is wrong for eye. (The light source of SSCNETIII cable complies with class1 defined in JISC6802 or IEC60825-1.)
- Migrating plasticizer is used for vinyl tape. Keep the MR-J3BUS□M, and MR-J3BUS□M-A cables away from vinyl tape because the optical characteristic may be affected. Generally, soft polyvinyl chloride (PVC), polyethylene resin (PE) and fluorine resin contain non-migrating plasticizer and they do not affect the optical characteristic of SSCNETIII cable. However, some wire sheaths and cable ties, which contain migrating plasticizer (phthalate ester), may affect MR-J3BUS□M and MR-J3BUS□M-A cables (made of plastic). In addition, MR-J3BUS□M-B cable (made of quartz glass) is not affected by plasticizer.

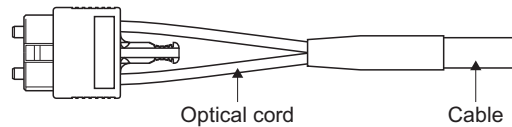

○: Normally, cable is not affected by plasticizer.

△: Phthalate ester plasticizer such as DBP and DOP may affect optical characteristic of cable.

SSCNETIII cable	Cord	Cable
MR-J3BUS□M	△	—
MR-J3BUS□M-A	△	△
MR-J3BUS□M-B	○	○

- If the adhesion of solvent and oil to the cord part of SSCNETIII cable may lower the optical characteristic and machine characteristic. If it is used such an environment, be sure to do the protection measures to the cord part.
- When keeping the Motion CPU or servo amplifier, be sure to put on a cap to connector part so that a dirt should not adhere to the end of SSCNETIII connector.
- SSCNETIII connector to connect the SSCNETIII cable is put a cap to protect light device inside connector from dust. For this reason, do not remove a cap until just before connecting SSCNETIII cable. Then, when removing SSCNETIII cable, make sure to put a cap.
- After removing the cap and the light cord end protective tube during mounting of the SSCNETIII cable, keep them in the resealable plastic bag that accompanies the SSCNETIII cable to prevent them from becoming dirty.
- When exchanging the Motion controller or servo amplifier, make sure to put a cap on SSCNETIII connector. When asking repair of Motion controller or servo amplifier for some troubles, make also sure to put a cap on SSCNETIII connector. When the connector is not put a cap, the light device may be damaged at the transit. In this case, exchange and repair of light device is required.



# 3 INSTALLATION AND WIRING

## 3.1 Mounting Environment

Set the Motion controller system according to the mounting environment indicated in the general specifications.  
Do not install the Motion controller system in the following environments.

- Where ambient temperature exceeds the range of 0 to 55[°C] (32 to 131[°F]).\*<sup>1</sup>
- Where ambient humidity exceeds the range of 5 to 95[%]RH.
- Where condensing from sudden temperature changes occurs.
- Where there is corrosive or inflammable gas.
- Where there is a lot of conductible dust, iron filings, oil mist, or salt, organic solvents.
- Where there is direct exposure to sunlight.
- Where there is strong electrical or magnetic fields.
- Where there are direct vibrations or shocks to the Motion controller.

\*<sup>1</sup> When an extended temperature range base unit is used, each module can be used in the environment of 0 to 60[°C] (32 to 140[°F]).

## 3.2 Module Installation

### Mounting position

When mounting the Motion controller to an enclosure or similar, fully consider its operability, maintainability and environmental resistance.

Refer to the following for details of mounting position of modules.

 MELSEC iQ-R Module Configuration Manual

### Installation of the base unit

Refer to the following for details of installation of base unit to control panel and installation of base unit to DIN rail.

 MELSEC iQ-R Module Configuration Manual

### Installation and removal of module

Refer to the following for details of how to install and remove a power supply module, PLC CPU module, Motion CPU module, I/O module, intelligent function module or another module to and from the base unit, and installation precautions.

 MELSEC iQ-R Module Configuration Manual

## 3.3 Installation and Removal of SD Memory Card

This section describes the methods for installation of a SD memory card to the Motion CPU module, and removal.

### Installation of SD memory card

When installing a SD memory card to the Motion CPU module, take note of the SD memory card position, and install using the following procedure.

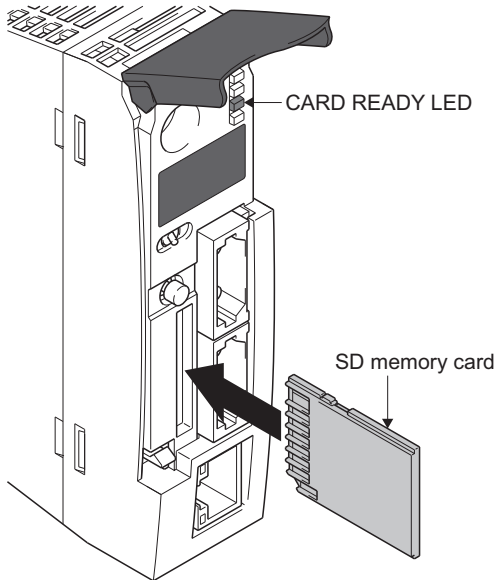

- 1.** With the notch facing downwards, insert the SD memory card straight into the slot. After inserting check the SD memory card is inserted all the way in. If the SD memory card is not inserted properly, insufficient contact may cause an operation failure.
- 2.** The CARD READY LED flickers until the SD memory card can be used. When the CARD READY LED is ON, the SD memory card can be used.
- 3.** If the CARD READY LED does not turn on after installing a SD memory card, check that "SD memory card forced disable instruction (SM606)" and "SD memory card forced disable state (SM607)" are OFF.

### Removal of the SD memory card

When removing a SD memory card from the Motion CPU module, remove the SD memory card using the following procedure.

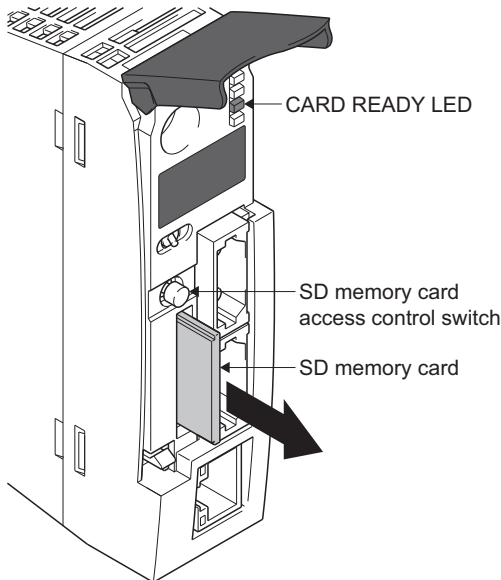

- 1.** Hold the SD memory card control access switch for longer than 1s to stop access of the SD memory card.
- 2.** During the process of stopping access to the SD memory card, the CARD READY LED flickers, then turns OFF when the process is complete.
- 3.** After pushing in the SD memory card once, pull the SD memory card out straight.

- 
- Follow the above procedures for installation or removal of SD memory card while Multiple CPU system power supply is ON. Not following the procedures may damage the data on the SD memory card.
  - When removing the SD memory card, if there is a function accessing the SD memory card, the CARD READY LED turns OFF after accessing the SD memory card is completed. Thus the time it takes for the CARD READY LED to turn OFF differs depending on the function.
  - When "Memory card remove/attach prohibit (SM605)" is ON, the CARD READY LED does not turn OFF when the SD memory card access control switch is pushed. When the CARD READY LED will not turn OFF, turning ON "SD memory card forced disable instruction (SM606)" will force the stop of the SD memory card.
  - If the SSCNETIII cable connected to CN2 of R64MTCPU/R32MTCPU prevents removal of the SD memory card, turn OFF the Multiple CPU system power supply and remove the SSCNETIII cable before removing the SD memory card.
-

# 3.4 Mounting of Serial Absolute Synchronous Encoder

This section describes precautions for handling the serial absolute synchronous encoder.

- If the serial absolute synchronous encoder is linked to a chain, a timing belt, or gears, the machine side rotary shaft should be supported by a separate bearing and connected to the serial absolute synchronous encoder through a coupling. Ensure that excessive force (greater than the permitted shaft load) is not applied to the shaft of the serial absolute synchronous encoder.

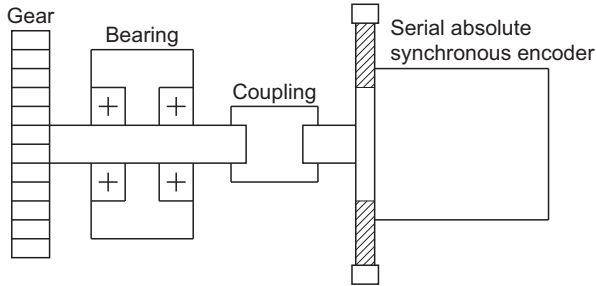

	Radial direction	Thrust direction
Permitted shaft load	Up to 19.6N	Up to 9.8N

- Excessive load applied to the shaft of the serial absolute synchronous encoder by large mounting errors in eccentricity or angle of deviation may impair encoder function or extremely shorten encoder life. Minimize loads applied to the shaft so that they remain within the permitted shaft load range.

## CAUTION

- The serial absolute synchronous encoder contains a glass disk and precision mechanism. Take care when handling it. Encoder function may be impaired if it is dropped or subjected to shocks or vibrations exceeding the prescribed limits.
- Do not connect the shaft of the serial absolute synchronous encoder directly to the machine side rotary shaft. The shaft should be supported by a separate bearing and mounted using a flexible coupling.
- Never hit the end of the serial absolute synchronous encoder shaft with a hammer or similar object when doing things such as connecting a coupling to it. Excessive shock applied to the serial absolute synchronous encoder may damage it.
- The serial absolute synchronous encoder uses optical parts. Mount it in an atmosphere containing as little moisture, oil, and dust as possible.
- When installing a serial absolute synchronous encoder in any place where it is exposed to water and/or oil, provide protection from oil and water, e.g. mount a cover. In addition, run the cable downward to prevent oil and/or water from travelling on the cable into the serial absolute synchronous encoder. When it is necessary to mount the serial absolute synchronous encoder vertically or obliquely, set up a trap on the cable.
- Use the serial absolute synchronous encoder within the specified temperature range (-5 to 55°C (23 to 131°F)).

## 3.5 Wiring

Refer to the following for details of wiring the power supply, and grounding.

📖 MELSEC iQ-R Module Configuration Manual

Refer to EMC directives for measure against noise. (📖 Page 74 EMC DIRECTIVES)

### Power supply circuit

This section describes the noise suppression techniques of the power supply circuit.

#### Grounding

The Motion system may malfunction as it is affected by various noises such as electric path noises from the power supply lines, radiated and induced noises from other equipment, servo amplifiers and their cables, and electromagnetic noises from conductors. To avoid such troubles, connect the earthing ground of each equipment and the shield grounds of the shielded cables to the earth.

For grounding, use the exclusive ground terminal wire of each equipment or a single-point earth method to avoid grounding by common wiring where possible, since noise from other equipment may occur due to common impedance.

Refer to the following for details of grounding.

📖 MELSEC iQ-R Module Configuration Manual

📖 Servo amplifier Instruction Manual

### Safety circuit

#### Concept of safety circuits

When the Multiple CPU system is powered on and off, normal control output may not be done momentarily due to a delay or a startup time difference between the Multiple CPU system power supply and the external power supply (DC in particular) for the control target.

Also, an abnormal operation may be performed if an external power supply fault or Motion controller failure takes place.

To prevent any of these abnormal operations from leading to the abnormal operation of the whole system and in a fail-safe viewpoint, areas which can result in machine breakdown and accidents due to abnormal operations (e.g. emergency stop, protective and interlock circuits) should be constructed outside the Multiple CPU system.

#### Emergency stop circuit

The circuit should be constructed outside of the Multiple CPU system or servo amplifier. Shut off the power supply to the external servo amplifier with this circuit so as to activate the electromagnetic brakes of the servo motor.

## Forced stop circuit

- The forced stop of all servo amplifiers is possible in a lump by using the forced stop input of input modules. After forced stop, the forced stop factor is removed and the forced stop canceled. (The servo error detection signal does not turn on with the forced stop.) The forced stop input can be set by allocation of the device number in [Motion CPU Common Parameter] ⇒ [Basic Setting] ⇒ "Forced Stop Input Setting". A wiring example which uses an input module(RX10) for the forced stop input is shown below.

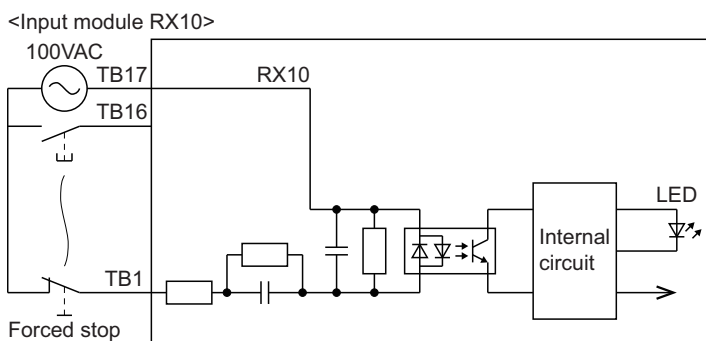
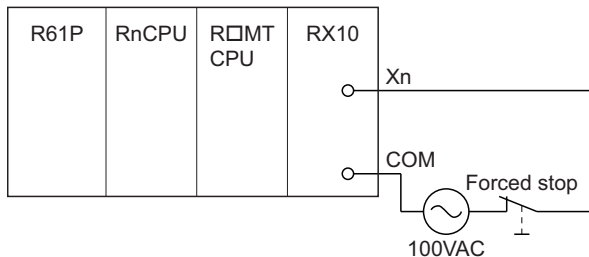

\*: The forced stop input can be set with parameters.

- It is also possible to use the forced stop signal of the servo amplifier. Refer to the Servo amplifier Instruction Manual about servo motor capacity. Operation status of the emergency stop, servo amplifier forced stop and the Motion controller forced stop are as follows.

Item	Operation of the signal ON	Remark
Emergency stop	Servo OFF	The power supply of the servo amplifier is shut off by external circuit, and the servo motor stops.
Servo amplifier forced stop		A stop command from the external circuit to the servo amplifier is output, and the servo amplifier stops the servo motor.
Motion controller forced stop		A stop command from the Motion controller to the servo amplifier is output, and the servo amplifier stops the servo motor.

# 4 START-UP PROCEDURES

## 4.1 Start-up Adjustment Procedure

This section explains the procedures for starting up the Motion controller system.

### 1. Turn OFF power supply of Multiple CPU system

Check that the power supply of Multiple CPU system is OFF.

### 2. Check wiring and module installation

- Check the installation position and condition of each module.
- Check the connecting condition of connectors.
- Check that all terminal screws are tight.
- Check the ground wires of servo amplifier etc.
- Check the servo motor wiring (U, V, W).
- Check the regenerative option wiring.
- Check the circuit of emergency stop, servo amplifier forced stop, and Motion controller forced stop. (☞ Page 59 Safety circuit)

Refer to the following for details of the installation of modules.

☞ MELSEC iQ-R Module Configuration Manual

Refer to the following for details of servo amplifier.

☞ Servo amplifier Instruction Manual

### 3. Servo amplifier setting

Set the station No. of servo amplifier. (☞ Page 48 Setting of the axis No. and switch of servo amplifier)

### 4. Parameter setting of the PLC CPU module

Set the following parameters using GX Works3.

- System parameter
- CPU parameter
- Module parameter

(☞ MELSEC iQ-R CPU Module User's Manual (Application))

### 5. Write parameters to PLC CPU module

Write the parameters set in GX Works3 to the PLC CPU module. (☞ GX Works3 Operating Manual)

### 6. Selection of device assignment method for Motion CPU module

Select the device assignment method (MELSEC iQ-R Motion device assignment/Q series Motion compatible device assignment) with MT Developer2.

(☞ MELSEC iQ-R Motion Controller Programming Manual (Common))

### 7. Parameter setting of the Motion CPU module

Set the following parameters using MT Developer2.

- R series common parameter (Divert the system parameters of GX Works3.)
- Motion CPU common parameter

(☞ MELSEC iQ-R Motion Controller Programming Manual (Common))

### 8. Positioning parameter setting for the Motion CPU module

Set the following positioning parameters using MT Developer2.

- Motion control parameter (☞ MELSEC iQ-R Motion Controller Programming Manual (Positioning Control))

### 9. Write parameters to Motion CPU module

Write the parameters set in MT Developer2 to the Motion CPU module. (☞ Help of MT Developer2)

### 10. Turn ON Multiple CPU system power supply again

Turn ON the Multiple CPU system power supply again, or reset the Multiple CPU system.

### **11.** Check external inputs

The wiring of the following external inputs can be checked in the monitor of MT Developer2.

- FLS (Upper stroke limit input)
- RLS (Lower stroke limit input)
- STOP (Stop signal)
- DOG (Proximity dog)
- Serial absolute synchronous encoder
- Incremental synchronous encoder
- Manual pulse generator

### **12.** Check I/O module

Check the wiring of I/O modules.

### **13.** Create sequence programs

Create the sequence programs for starting the Motion programs using GX Works3. ([MELSEC iQ-R CPU Module User's Manual \(Startup\)](#))

### **14.** Write sequence programs

Write the sequence programs created in GX Works3 to the PLC CPU module. ([GX Works3 Operating Manual](#))

### **15.** Create Motion programs

Create the Motion programs below using MT Developer2.

- Motion SFC program ([MELSEC iQ-R Motion Controller Programming Manual \(Program Design\)](#))
- Servo program ([MELSEC iQ-R Motion Controller Programming Manual \(Positioning Control\)](#))
- Advanced synchronous control parameters ([MELSEC iQ-R Motion Controller Programming Manual \(Advanced Synchronous Control\)](#))
- Machine control parameters ([MELSEC iQ-R Motion Controller Programming Manual \(Machine Control\)](#))
- G-code control parameters ([MELSEC iQ-R Motion Controller Programming Manual \(G-Code Control\)](#))

### **16.** Write Motion programs

Write the Motion programs created in MT Developer2 to the Motion CPU module. ([Help of MT Developer2](#))

### **17.** Turn ON power supply of Multiple CPU system again

Turn ON again or reset the Multiple CPU system power supply.

### **18.** Turn ON control circuit power supply of servo amplifiers again

Check the emergency stop ON, servo amplifier forced stop ON, Motion controller forced stop ON, and turn ON the control circuit power supply of servo amplifiers.

### **19.** Check servo amplifiers

Check that the mounted servo amplifiers operate correctly.

### **20.** Check upper/lower stroke limits

Check that the upper/lower stroke limits operate correctly.

### **21.** Check machine operation

Check the following by making the machine operate with the JOG operation of MT Developer2.

- Machine operates correctly. (no vibration, hunting, etc.)
- Stroke limits operate correctly.
- Machine stops by the emergency stop or forced stop.

### **22.** Check home position return

Check the following by executing the home position return.

- Home position return direction
- Home position return data
- Proximity dog position



### **23.** Check Motion program

Check that all positioning controls by Motion programs are correct.

### **24.** Check by automatic operation

Check the sequence operation by executing the sequence program using an actual external input.

Also, refer to the following for details of the operation to check processing times.

 MELSEC iQ-R Motion Controller Programming Manual (Common)

---

#### **Point**

When the servo amplifier, servo motor is first turned on, check the operation before the servo motor is mounted on a machine to avoid unexpected accidents such as machine breakage.





---

# 5 INSPECTION AND MAINTENANCE

In order that you can use the Motion controller in normal and optimal condition, this section describes those items that must be maintained or inspected daily or at regular intervals.

## 5.1 Daily Inspection

The items that must be inspected daily are shown below.

Item	Inspection item	Inspection	Criterion	Action	
1	Installation modules	Check that the module is mounted properly and the module fixing hook is engaged securely.	The module must be mounted properly, and module fixing hook must be engaged securely.	Engage the module fixing hook securely.	
2	Motion CPU module	READY LED	Check the READY LED is ON.	READY LED must be ON.	<a href="#">Page 37 LED display</a>  <a href="#">Page 72</a> When an error is displayed or flickering in the dot matrix LED
		ERROR LED	Check the ERROR LED is OFF.	ERROR LED must be OFF.	
		Dot matrix LED		"RUN" is displayed.	
				"STP" is displayed.	
				"E□□" does not display.	
				"W□□" does not display.	
	"AL" does not flicker.				
3	Safety stops	Perform an emergency stop.	The main circuit power supply of the servo amplifier is shut-off.	<a href="#">Page 59 Safety circuit</a>	
		Perform a servo amplifier forced stop.	AL.E6 (servo forced stop warning) occurs at the servo amplifier.		
		Perform a Motion controller forced stop.	AL.E7 (controller forced stop warning) occurs at the servo amplifier.		

## 5.2 Periodic Inspection

The items that must be inspected one or two times every 6 months to 1 year are listed below. When the equipment is moved or modified, or layout of the wiring is changed, also implement this inspection.

Item	Inspection item	Inspection	Criterion	Action	
1	Ambient environment	Ambient temperature *1	Measure with a thermometer.	0 to 55°C (32 to 131°F)*2	Make sure the environment satisfies all measurement criteria.
		Ambient humidity	Measure with a hygrometer.	5 to 95%RH	
		Atmosphere	Measure corrosive gas.	No corrosive gases.	
2	Installation	Looseness, rattling	Move the module to check for looseness and rattling.	The module must be installed firmly.	Retighten the screws. If the modules are loose, fix it with screws.
		Adhesion of dirt and foreign matter	Visual inspection	Dirt and foreign matter must not be present.  The connectors not being used must have a cover attached.	Remove dirt and foreign matter and clean. Attach a connector cover to the connectors that are not being used.
3	Connection	Looseness of terminal screws	Check for looseness of terminal screws.	Screws must not be loose.	Retighten the terminal screws.
		Proximity of solderless terminals to each other	Visual inspection	Solderless terminals must be properly spaced.	Correct spacing as appropriate.
		Looseness of connectors	Visual inspection	Connectors must not be loose.	Insert the connector securely so there is no looseness.
4	Module diagnostics	Check with the module diagnostics of GX Works3.	An error has not occurred.	Confirm details of the error, remove the error factor.	

\*1 The temperature in the control panel where the Motion CPU module is installed is the ambient temperature.

\*2 When an extended temperature range base unit is used, each module can be used in the environment of 0 to 60°C (32 to 140°F).

## 5.3 Life

The following parts must be replaced periodically as listed below.

However, these numbers depend on the operating method and environmental conditions. If any part is found to be faulty, it must be changed immediately even if it has not yet reached the end of its life.

For parts replacement, please contact your sales representative.

Module name	Part name	Life guideline	Remark
Synchronous encoder	Capacitor	20000 to 30000 hours	The times listed under life guideline are for reference. If any part is found to be faulty it must be replaced immediately even if it has not yet reached the life guideline.
	Bearings		

### Synchronous encoder

Replace the synchronous encoder using 20000 to 30000 hours under rated speed as a guideline. This number is affected by operating conditions. Bearings must also be replaced if unusual noise or vibrations are discovered during inspection.

# 6 TROUBLESHOOTING

This section describes the various types of trouble that occur when the system is operated, and causes and corrective actions of these troubles.

For troubleshooting on each individual module, refer to the manuals of each module.

## 6.1 Troubleshooting Basics

The basic three points that must be followed in troubleshooting are as follows.

### Visual inspection

Visually check the following.

- Movement of machine (stopped condition, operating condition)
- Power supply ON/OFF
- Status of input/output devices
- Installation condition of the Power supply module, Motion CPU module, PLC CPU module, I/O module, intelligent function module, SSCNETIII cable, Synchronous encoder cable
- State of wiring (I/O cables, cables)
- Display states of various types of indicators

CPU module	LED display
PLC CPU module	READY LED, ERROR LED, BATTERY LED, USER LED etc.
Motion CPU module	READY LED, ERROR LED, dot matrix LED (Installation mode, Normal mode, STOP/RUN, etc.)

After checking all of the above, monitor the operating conditions of servo motors and error code using MT Developer2 and GX Works3.

### Check of trouble

Check to see how the operating condition varies while the Motion controller is operated as follows.

- Set the RUN/STOP switch of Motion CPU module to STOP.
- Reset the trouble with the RUN/STOP/RESET switch of PLC CPU module.
- Turn ON and OFF the Multiple CPU system power supply.

### Narrowing down the range of trouble occurrence causes







Assess where the trouble is occurring based on the visual inspection and check of trouble above.

- Multiple CPU system or external devices
- Motion CPU or PLC CPU
- I/O module or others
- Servo program or Motion SFC program/Motion program
- Sequence program

## 6.2 Troubleshooting Procedure

---

When trouble occurs, conduct troubleshooting in the order of the following procedures.

- 1.** Check LED of the power supply module.  
( MELSEC iQ-R Module Configuration Manual)
- 2.** Check LED of PLC CPU module.  
( MELSEC iQ-R CPU Module User's Manual (Startup))
- 3.** Check LED of Motion CPU module. ( Page 69 Checking LED Display)
- 4.** Check LED of every I/O module and intelligent function module. ( User's Manual (Application) for each module)
- 5.** Connect GX Works3, and start system monitor. Check the module where the error has occurred.
- 6.** Select the module where the error has occurred, and start module diagnostics in GX Works3. Check the cause of the error and corrective action.
- 7.** When the cause cannot be specified using module diagnostics, check the operations and errors from the event history in GX Works3 to specify the cause.
- 8.** Connect MT Developer2 and start Motion CPU error batch monitor. Check the details of errors occurring in the Motion CPU module.
- 9.** When the cause cannot be specified in steps 1. to 8., carry out troubleshooting by circumstance. ( Page 71 Troubleshooting by Circumstance) ( User's Manual (Application) for each module)

## 6.3 Checking LED Display

Checking LEDs is a means for confirming the status of a module and should be performed as the primary diagnosis.

### Checking LED display of the Motion CPU module

The following describes the items to check when checking the LED display of the Motion CPU module.

By checking the READY LED, ERROR LED, and dot matrix LED, confirming if an error has occurred is possible by visual inspection.

#### READY LED, ERROR LED

LED display status		Error status	Program execution status	Details	Correction
READY	ERROR				
ON	OFF	No error	Continued	Operating normally	—
	ON	Minor error occurrence		Due to an incorrect program or parameter setting, or the status of external signals, axis operation cannot be started/continued. The program has detected a minor error or warning and can continue.	Use MT Developer2 to specify the cause and correct the error.
	Flickering	Moderate error occurrence	Stopped	Due to an incorrect program or parameter setting, or momentary noise, the program and axis operation cannot continue.	
OFF	ON/ flickering	Major error occurrence		Due to a hardware error etc., operation is stopped.	If the problem cannot be resolved after troubleshooting, exchange the module where the error is occurring.
	OFF	Hardware error			Check the input of power supply. If the power supply is correctly input, there may be a hardware error. If the problem cannot be resolved after troubleshooting, exchange the module where the error is occurring.
		No error		No power supply input, power failure	—
Flickering	OFF	No error		Initializing	—

#### Dot matrix LED

Refer to dot matrix LED display for the dot matrix LED displays. (  Page 37 Dot matrix LED display)

## 6.4 Checking with Engineering Tools

---

Specify the error cause by using MT Developer2 and GX Works3 to check the errors occurring and the history. Checking with engineering tools enables more detailed information, error causes, and error corrections to be checked than checking LEDs.

### Checking with MT Developer2

---

Check with the following function in MT Developer2.

- Motion CPU error batch monitor

Refer to the following for details.

 [Help of MT Developer2](#)

### Checking with GX Works3

---

Check with the following functions in GX Works3.

- System monitor
- Module diagnostics
- Event history

Refer to the following for details.

 [GX Works3 Operating Manual](#)



## 6.5 Troubleshooting by Circumstance

When the Motion CPU module is not functioning normally, check for the applicable circumstance below, and troubleshoot accordingly. If the ERROR LED is ON or flickering, use the engineering tool to remove the error factor.

### When the READY LED of the Motion CPU module has turned OFF

When the READY LED of the Motion CPU module has turned OFF, check the following items.

Check item	Corrective action
The Motion CPU module is not mounted to the main base unit correctly.	Mount the Motion CPU module to the main base unit correctly.
The READY LEDs of other modules are ON.	The Motion CPU module is detecting a major error. Exchange the Motion CPU module.
After exchanging the power supply module, and turning ON the power supply again, the READY LED turns ON. (Also check power supply module on the extension base unit by exchanging it.)	An error is occurring in the original power supply module. Exchange the power supply module.
After exchanging the power supply module, and turning ON the power supply again, the READY LED does not turn ON. (Also check power supply module on the extension base unit by exchanging it.)	An error is occurring in a module other than the power supply module. Mount each module one at a time, turning ON the power supply each time an additional module is mounted. The module that was mounted last when the READY LED no longer turns ON is the module where the error is occurring. Replace this module.

If the READY LED does not turn ON after checking the above items, there may be a hardware error. Please consult your local Mitsubishi representative.

## When an error is displayed or flickering in the dot matrix LED

When an error is displayed or flickering in the dot matrix LED, check the following items.

Check item	Corrective action
"E□□" is displayed during initializing	A hardware error, or software error is occurring. Exchange the Motion CPU module. *: □□ is the error code
"A00" is flickering.	The operating system software is not installed. Put the Motion CPU module in installation mode, and install the operating system software.
"A01" is displayed.	There is an error in the operating system software file that was installed. Reinstall the operating system software.
"ER0" is displayed during installation mode.	An access error of the SD memory card from which the operating system software was installed is occurring. Exchange the SD memory card, and reinstall the operating system software.
"ER1" is displayed during installation mode.	An error in the install file of the operating system software installed from SD memory card is occurring. Install the operating system software using another install file.  An error is occurring because installation of operating system version "05" or earlier was executed on R64MTCPU. Operating system version "05" or earlier cannot be installed on R64MTCPU. Install operating system version "07" or later.
"ER2" is displayed during installation mode.	An access error of the internal ROM of the operating system software installed from the SD memory card is occurring. Exchange the Motion CPU module.
"ER3" is displayed during installation mode.	An error has occurred with the license key file in the SD memory card. Check the license key file on the SD memory card.
"ERR" is displayed during built-in memory clear.	An error was detected during the built-in memory clear. Exchange the Motion CPU module.
"W□□" is displayed.	A watchdog timer error is occurring. Check the error cause with "Motion CPU WDT error cause (SD512)", and remove the error.
"AL" → "□□" is displayed.	A self-diagnostic error (major/moderate/minor error) is occurring. Check the description of the error code displayed with "MELSEC iQ-R Motion Controller Programming Manual (Common)", or MT Developer2, and remove the error factor.  *: □□ displays the 4-digit error code by displaying 2 digits at a time.

If an error is still displayed or flickers in the dot matrix LED after checking the above items, there may be a hardware error. Please consult your local Mitsubishi representative.

## When cannot write to Motion CPU

When cannot write to Motion CPU, check the following items.

Check item	Corrective action
Has a password been registered?	Authenticate a password in MT Developer2.
With the SD memory card as the write target, is the SD memory card write-protected?	Remove the write-protect from the SD memory card.
With the SD memory card as the write target, has the SD memory card not been formatted?	Format the SD memory card.
Does the writing data exceed the capacity of the standard ROM or the SD memory card?	Secure enough free-space on the standard ROM or the SD memory card.
With the Multiple CPU system in an erroneous state (self-diagnostic errors such as CPU configuration error, parameter error etc. occurring), is transmission via Multiple CPU being performed?	Use the PERIPHERAL I/F of the Motion CPU to write to the Motion CPU. When writing to the Motion CPU does not work using the PERIPHERAL I/F of the Motion CPU, write the system parameters to CPU No.1 PLC CPU, then write to the Motion CPU using the PERIPHERAL I/F of the Motion CPU again after turning ON the power supply of Multiple CPU system again.

If write to Motion CPU cannot be performed after checking the above items, there may be a hardware error. Please consult your local Mitsubishi representative.

## When cannot read from Motion CPU

When cannot read from Motion CPU, check the following items.

Check item	Corrective action
Has a password been registered?	Authenticate a password in MT Developer2.
Is the specified target memory for reading incorrect?	Check the target memory (standard ROM, SD memory card) for reading is correct.
With the Multiple CPU system in an erroneous state (self-diagnostic errors such as CPU configuration error, parameter error etc. occurring), is transmission via Multiple CPU being performed?	Use the PERIPHERAL I/F of the Motion CPU to read from the Motion CPU.

If read from Motion CPU cannot be performed after checking the above items, there may be a hardware error. Please consult your local Mitsubishi representative.

## When cannot install to Motion CPU

When cannot install operating system software or add-on libraries to Motion CPU, check the following items.

Check item	Corrective action
In a multiple CPU configuration with the PLC CPU (R□ENCPU) as CPU No.1 and the Motion CPU (with first and second digits from the left of its production information*1 being "26" or earlier) as CPU No.2 to No.4, was installation performed using MT Developer2?	Communication with the Motion CPU failed, and installation cannot occur.*2 Use the SD memory card for installation.*3
In a multiple CPU configuration where there is a CPU module between the self CPU and the CPU No.1 CPU module, whose module status setting is set to "Empty", was installation performed using MT Developer2 to a Motion CPU with the first and second digits from the left of its production information*1 being "26" or earlier?	Communication with the Motion CPU failed, and installation cannot occur.*4 Use the SD memory card for installation.*3 Perform installation after correcting the CPU module installation position so that the CPU modules are adjacent to each other.

\*1 Refer to checking production information for details on Motion CPU production information. (☞ Page 29 Checking production information)

\*2 Installation using MT Developer2 is possible with Motion CPUs with the first and second digits from the left of its production information being "27" or later.

\*3 Refer to the following manual for details on installation using the SD memory card.  
☞ MELSEC iQ-R Motion Controller Programming Manual (Common)

\*4 Installation through communication by direct connection to PERIPHERAL I/F is possible with Motion CPUs with the first and second digits from the left of its production information being "27" or later. Connection via another CPU is not possible.

## When the servo amplifier does not start

When the servo amplifier does not start, check the following items.

Check item	Corrective action
An error is displayed or flickering in the dot matrix LED of the Motion CPU.	Check the display of dot matrix LED, and remove the error factor. (☞ Page 72 When an error is displayed or flickering in the dot matrix LED)
Is the SSCNETIII cable connected correctly?	Connect the SSCNETIII cable correctly.
Have the applicable axes been set in the parameters?	Set the applicable axes in [Motion CPU Common Parameter] → [Servo Network Setting] of MT Developer2.
Have the setting switches on the servo amplifier been set correctly?	Set the axis select rotary switch and auxiliary axis No. setting switch correctly.
Are the servo amplifiers connected closer to the Motion controller than the applicable axis started?	Check the error on the servo amplifier that is not starting, and remove the error factor.

If the servo amplifier does not start after checking the above items, there may be a hardware error. Please consult your local Mitsubishi representative.

# 7 EMC DIRECTIVES

---

Compliance to the EMC Directive, which is one of the EU Directives, has been a legal obligation for the products sold in European countries since 1996 as well as the Low Voltage Directive since 1997.

Manufacturers who recognize their products are compliant to the EMC and Low Voltage Directives are required to declare that print a "CE mark" on their products.

## Authorized representative in Europe

---

Authorized representative in Europe is shown below.

Name: Mitsubishi Electric Europe B.V.

Address: Gothaer strasse 8, 40880 Ratingen, Germany

## 7.1 Requirements for Compliance with the EMC Directive

---

The EMC Directive specifies that products placed on the market must be so constructed that they "do not cause excessive electromagnetic interference (emissions) and are not unduly affected by electromagnetic interference (immunity)". This section summarize the precautions on compliance with the EMC Directive of the machinery constructed with the MELSEC iQ-R series modules.

These precautions are based on the requirements and the standards of the regulation, however, it does not guarantee that the entire machinery constructed according to the descriptions will comply with above-mentioned directive. The method and judgment for complying with the EMC Directive must be determined by the person who construct the entire machinery.

# Standards relevant to the EMC directive

The standards relevant to the EMC Directive are listed in table below.

Certification	Test item	Test details	Standard value
EN61000-6-4: 2007 +A1: 2011 EN61131-2: 2007	CISPR16-2-3: 2010/A1: 2010 Radiated emission *1	Radio waves from the product are measured.	<ul style="list-style-type: none"> <li>• 30M-230MHz QP*2: 40dB<math>\mu</math>V/m(10m (32.81ft.) in measurement range)</li> <li>• 230M-1000MHz QP: 47dB<math>\mu</math>V/m(10m (32.81ft.) in measurement range)</li> <li>• 1GHz-6GHz AV: 56dB<math>\mu</math>V/m PK: 76dB<math>\mu</math>V/m</li> </ul>
	CISPR16-2-1: 2008/A1: 2010*3 (Power line) CISPR22: 2008*4 (Electrical communication port) Conducted emission	Noise from the product to the power line and electrical communication port is measured.	AC power line <ul style="list-style-type: none"> <li>• 0.15M-0.5MHz QP: 79dB<math>\mu</math>V AV*5: 66dB<math>\mu</math>V</li> <li>• 0.5M-30MHz QP: 73dB<math>\mu</math>V AV: 60dB<math>\mu</math>V</li> </ul> Electrical communication port <ul style="list-style-type: none"> <li>• 0.15M-0.5MHz QP, AV: Logarithmic decrease</li> <li>• 0.5M-30MHz QP: 87dB<math>\mu</math>V AV: 74dB<math>\mu</math>V</li> </ul>
EN61000-6-2: 2005 EN61131-2: 2007	EN61000-4-2: 2009 Electrostatic discharge immunity	Immunity test in which electrostatic discharge is applied to the product.	<ul style="list-style-type: none"> <li>• 8kV: 10 times at 1 second interval, Air discharge</li> <li>• 4kV: 10 times at 1 second interval, Contact discharge</li> </ul>
	EN61000-4-3: 2006+A1: 2008 +A2: 2010 Radiated immunity *1	Immunity test in which electric fields are radiated to the product.	80%AM modulation @1kHz <ul style="list-style-type: none"> <li>• 80-1000MHz 10V/m</li> <li>• 1400M-2000MHz 3V/m</li> <li>• 2000M-2700MHz 1V/m</li> </ul>
	EN61000-4-4: 2012 Electrical fast transient/burst (EFT/B) immunity	Immunity test in which burst noise is applied to the power cable and signal line.	<ul style="list-style-type: none"> <li>• AC power line: <math>\pm 2</math>kV/5kHz</li> <li>• DC power line: <math>\pm 2</math>kV/5kHz</li> <li>• I/O, communication line: <math>\pm 1</math>kV/5kHz</li> </ul>
	EN61000-4-5: 2006 Surge immunity	Immunity test in which surge is applied to the power line and signal line.	AC power line <ul style="list-style-type: none"> <li>• Common mode: <math>\pm 2.0</math>kV</li> <li>• Differential mode: <math>\pm 1.0</math>kV</li> </ul> DC power line <ul style="list-style-type: none"> <li>• Common mode: <math>\pm 0.5</math>kV</li> <li>• Differential mode: <math>\pm 0.5</math>kV</li> </ul> I/O, communication line <ul style="list-style-type: none"> <li>• Common mode: <math>\pm 1</math>kV</li> </ul>
	EN61000-4-6: 2009 Conducted immunity	Immunity test in which high frequency noise is applied to the power line and signal line.	0.15-80MHz, 80%AM modulation @1kHz, 10Vrms
	EN61000-4-11: 2004*3 Short interruptions immunity	Immunity test in which power supply has short interruptions.	0% of rated voltage, 250cycle
	EN61000-4-11: 2004*3 Voltage dip	Test in which voltage dip is applied to the power supply.	<ul style="list-style-type: none"> <li>• 40% of rated voltage, 10cycle</li> <li>• 70% of rated voltage, 25cycle</li> </ul>
EN61131-2: 2007	EN61000-4-11: 2004*3 Voltage dip immunity	Immunity test in which voltage dip is applied to the power supply.	0% of rated voltage, 0.5cycle 20 times

\*1 This product is an open type device (a device designed to be housed inside other equipment) and must be installed inside a conductive control panel. The corresponding test has been done with the programmable controller installed inside a control panel.

\*2 QP : Quasi-peak value

\*3 For the AC power supply line.

\*4 For the electrical communication port.

\*5 AV: Average value

# Installation instructions for EMC directive

---

Motion controller is an open type device and must be installed inside a control panel for use.

This not only ensures safety but also ensures effective shielding of Motion controller-generated electromagnetic noise.

## Control panel

---

- Use a conductive control panel.
- When attaching to the control panel's top plate or base plate by bolt, mask the grounding parts to ensure they are not coated.
- To ensure good electrical contact with the control panel, mask the installation bolts of the inner plate in the control panel so that contact between surfaces can be ensured over the widest possible area.
- Ground the control panel with a thick wire so that a low impedance connection can be ensured even at high frequencies.
- Holes made in the control panel must be 10cm (3.94inch) diameter or less. If the holes are larger than 10cm (3.94inch), radio frequency noise may be emitted. In addition, because radio waves leak through a clearance between the control panel door and the main unit, reduce the clearance as much as practicable. The leakage of radio waves can be suppressed by the direct application of an EMI gasket on the paint surface.

## Connection of power line and ground wire

---

- Provide a grounding point near the power supply module. Ground the LG terminals and FG terminals of the power supply module with the thickest and shortest wire possible. (The wire length must be 30cm (11.81inch) or shorter, and  $\phi$ 2mm (0.08inch) or less.)
- Twist the grounding wire from the grounding point with the power supply wire. Twisting the power supply wire and grounding wire enables more noise from the power supply wire to run off to the ground. However, when a noise filter has been installed on the power supply wire, twisting with the grounding wire is not required.

## How to ground cables

The cables extracted from the control panel contain a high frequency noise component. On the outside of the control panel, therefore, they serve as antennas to emit noise. To prevent noise emission, use shielded cables for the cables which are connected to the I/O modules and intelligent function modules and may be extracted to the outside of the control panel. The use of a shielded cable also increases noise resistance.

The signal lines (including common line) of the programmable controller, which are connected to I/O modules, intelligent function modules and/or extension cables, have noise durability in the condition of grounding their shields by using the shielded cables. If a shielded cable is not used or not grounded correctly, the noise resistance will not meet the specified requirements.

### ■ Grounding of shield section of shield cable

- Ground as close to the module as possible. Make sure the grounded cables are not exposed to electromagnetic induction from cables that are not grounded.
- Ground the exposed shield section to spacious area on the control panel.

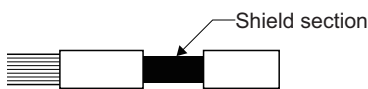

- A clamp can be used as shown below. In this case, mask the inner wall surface and clamp when coating the control panel, to prevent these from being coated as well.

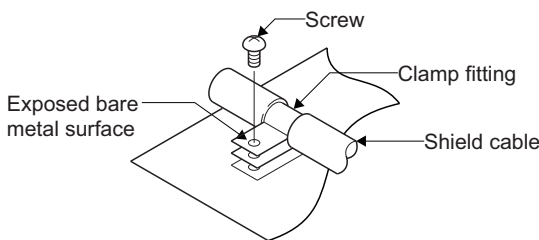

- The method of grounding with a vinyl-coated wire soldered onto the shielded section of the shielded cable as shown below is not recommended. Beware that doing so will raise the high-frequency impedance, resulting in loss of the shielding effect.

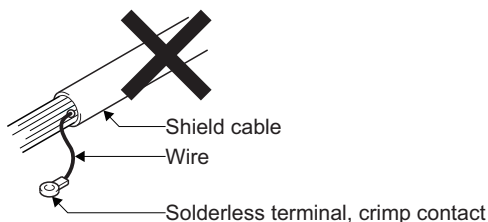

## Precautions relevant to the electrostatic discharge

There is a weak part to electrostatic discharge in the surface of the module. Before touching the module, always touch grounded metal, etc. to discharge static electricity from human body. Failure to do so may cause the module to fail or malfunction. Do not directly touch the module's conductive parts and electronic components. Touching them could cause an operation failure or damage the module.

# Parts of measure against noise

## Ferrite core

A ferrite core has the effect of reducing noise in the 30MHz to 100MHz band.

It is not required to fit ferrite cores to cables, but it is recommended to fit ferrite cores if shield cables pulled out of the enclosure do not provide sufficient shielding effects.

Note that the ferrite cores must be fitted to the cables in the position immediately before they are pulled out of the enclosure. If the fitting position is improper, the ferrite will not produce any effect.

### ■Ferrite core (Recommended product)

Manufacturer	Model name
TDK	ZCAT3035-1330

## Noise filter (power supply line filter)

A noise filter is a component which has an effect on conducted noise. The attachment of the noise filter to the power supply line of the servo amplifier and Multiple CPU system's power supply is effective for the reducing noise. (The noise filter has the effect of reducing conducted noise of 10 MHz or less.)

### ■Noise ferrite (Recommended product)

Manufacturer	Model name
Mitsubishi electric	FR-BLF
Soshin Electric	HF3010A-UN

The precautions required when installing a noise filter are described below.

- Do not bundle the wires on the input side and output side of the noise filter. When bundled, the output side noise will be induced into the input side wires from which the noise was filtered.

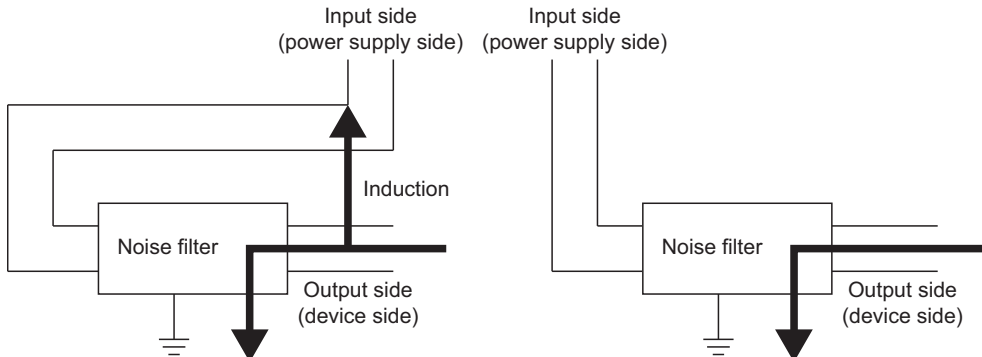

#### •Bundled example

The noise will be included when the input and output wires are bundled.

#### •Non-bundled example

Separate and lay the input and output wires.

- Ground the noise filter grounding terminal to the control cabinet with the shortest wire possible (approx. 10cm (3.94 inch)).



## Cable clamp

It is also possible to ground the exposed shielded part of the cable to the control panel with the cable clamp.

- Ground the shield at a position 20 to 30cm (7.87 to 11.81inch) away from the module.

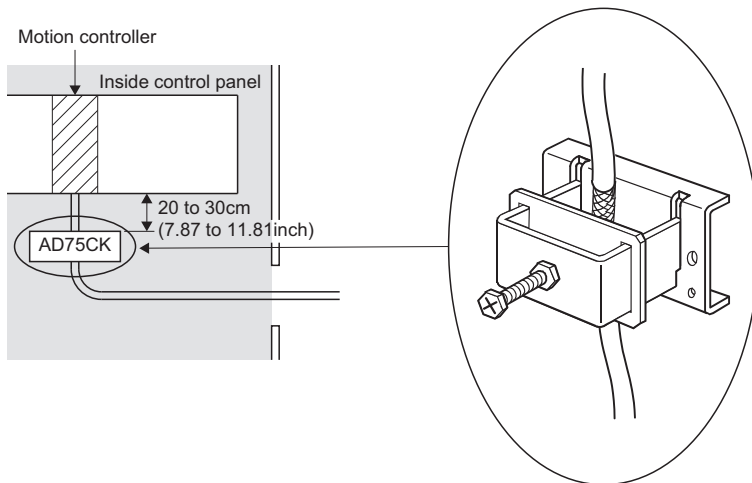

### ■Cable clamp (Recommended product)

Manufacturer	Model name
Mitsubishi electric	AERSBAN-DSET
	AERSBAN-ESET
	AD75CK

7

## ! CAUTION

- Do not ground the cable clamp to the top of control panel. Doing so may lead to damage by drop of screws, etc. during installation or removing the cable clamp.

## Measure against noise

- Refer to the following for details of wiring for the power supply module.  
📖 MELSEC iQ-R Module Configuration Manual
- When laying an Ethernet cable out from the control panel, ground with a cable clamp etc., at a position 20 to 30cm (7.87 to 11.81inch) from the module.
- Refer to peripheral device configuration for details of each cable (Ethernet cable). (📖 Page 17 Peripheral device configuration)
- In wiring inside the panel, the power line connected to the power or servo amplifier and the communication cable such as bus connection cable or network cable must not be mixed. If the cables are installed closely with each other for wiring reasons, using a separator (made of metal) can make the cables less influenced by noise. Mixing the power line and communication cable may cause malfunction due to noise.

# APPENDICES

## Appendix 1 Cables

In this cable connection diagram, maker names of connectors are omitted. Refer to connector for maker names of connectors. (☞ Page 88 Connector)

### SSCNETIII cables

In general, use the SSCNETIII cables available as our products. Refer to SSCNETIII cables manufactured by Mitsubishi Electric System & Service for long distance cables exceeding 50(164.04)[m(ft.)] and ultra-long bending life cables. (☞ Page 85 SSCNETIII cables (SC-J3BUS□M-C) manufactured by Mitsubishi Electric System & Service)

#### Model explanation

Numerals in the column of cable length on the table is a symbol put in the "□" part of cable model. Cables of which symbol exists are available.

Cable model	Cable length [m(ft.)]											Bending life	Application /remark
	0.15 (0.49) )	0.3 (0.98 )	0.5 (1.64 )	1 (3.28 )	3 (9.84 )	5 (16.40 )	10 (32.81 )	20 (65.62 )	30 (98.43 )	40 (131.23 )	50 (164.04 )		
MR-J3BUS□M	015	03	05	1	3	—	—	—	—	—	—	Standard	Standard cord for inside panel
MR-J3BUS□M-A	—	—	—	—	—	5	10	20	—	—	—	Standard	Standard cable for outside panel
MR-J3BUS□M-B <sup>*1</sup>	—	—	—	—	—	—	—	—	30	40	50	Long bending life	Long distance cable

\*1 For the cable of less than 30[m](98.43[ft.]), contact your nearest Mitsubishi sales representative.

#### Specifications

Item	Description			
SSCNETIII cable model	MR-J3BUS□M		MR-J3BUS□M-A	MR-J3BUS□M-B
SSCNETIII cable length [m(ft.)]	0.15(0.49)		0.3 to 3(0.98 to 9.84)	5 to 20(16.40 to 65.62)
Optical cable (Cord)	Minimum bend radius [mm(inch)]	25(0.98)		Enforced covering cord: 50(1.97) Cord: 25(0.98)
	Tension strength [N]	70	140	420 (Enforced covering cord)
	Temperature range for use [°C(°F)] <sup>*1</sup>	-40 to 80(-40 to 176)		-20 to 70(-4 to 158)
	Ambient	Indoors (no direct sunlight), No solvent or oil		
External appearance [mm(inch)]				

\*1 This temperature range for use is the value for optical cable (cord) only.

\*2 Dimension of connector fiber insert location. The distance of two cords is changed by how to bend it.

- If the end face of cord tip for the SSCNETⅢ cable is dirty, optical transmission is interrupted and it may cause malfunctions. If it becomes dirty, wipe with a bonded textile, etc. Do not use solvent such as alcohol.
- Do not add excessive power to the connector of the SSCNETⅢ cable.
- When incinerating the SSCNETⅢ cable (optical fiber), hydrogen fluoride gas or hydrogen chloride gas which is corrosive and harmful may be generated. For disposal of the SSCNETⅢ cable (optical fiber), request for specialized industrial waste disposal services who has incineration facility for disposing hydrogen fluoride gas or hydrogen chloride gas.

### ■MR-J3BUS□M

- Model explanation

Type: MR-J3BUS□M-\*

Symbol	Cable type
None	Standard cord for inside panel
A	Standard cable for outside panel
B	Long distance cable

Symbol	Cable length [m(ft.)]
015	0.15(0.49)
03	0.3(0.98)
05	0.5(1.64)
1	1(3.28)
3	3(9.84)
5	5(16.40)
10	10(32.81)
20	20(65.62)
30	30(98.43)
40	40(131.23)
50	50(164.04)

### ■Exterior dimensions

- MR-J3BUS015M

[Unit: mm(inch)]

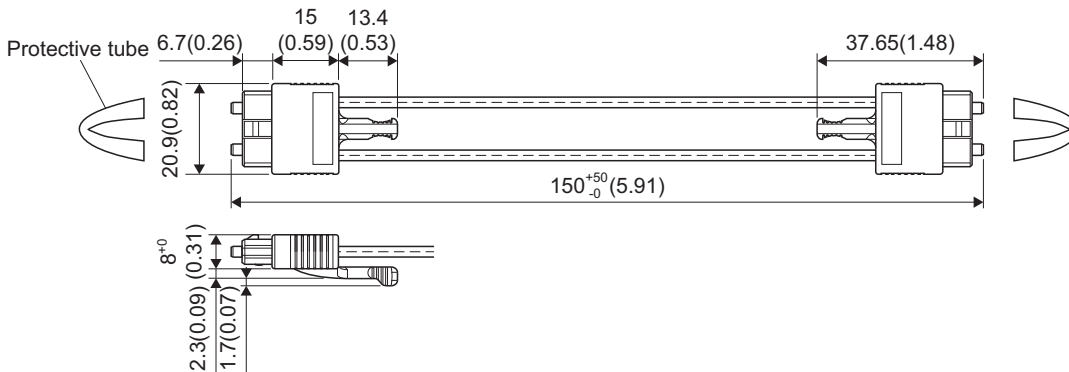

- MR-J3BUS03M to MR-J3BUS3M

Refer to model explanation for cable length (L). (☞ Page 80 Model explanation)

[Unit: mm(inch)]

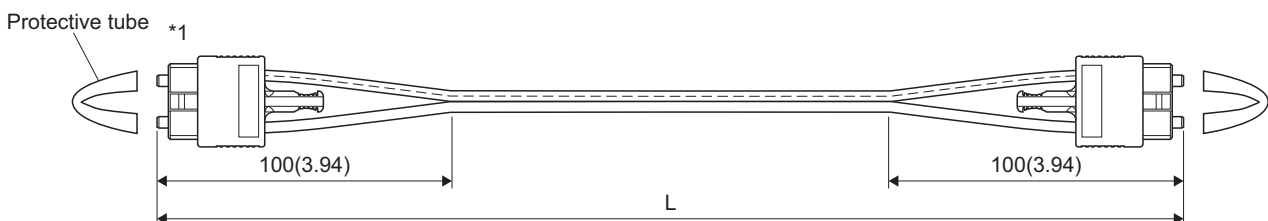

\*1 Dimension of connector part is the same as that of MR-J3BUS015M.

- MR-J3BUS5M-A to MR-J3BUS20M-A, MR-J3BUS30M-B to MR-J3BUS50M-B  
 Refer to model explanation for cable length (L). (  Page 80 Model explanation)

SSCNETIII cable	Variation [mm(inch)]	
	A	B
MR-J3BUS5M-A to MR-J3BUS20M-A	100(3.94)	30(1.18)
MR-J3BUS30M-B to MR-J3BUS50M-B	150(5.91)	50(1.97)

[Unit: mm(inch)]

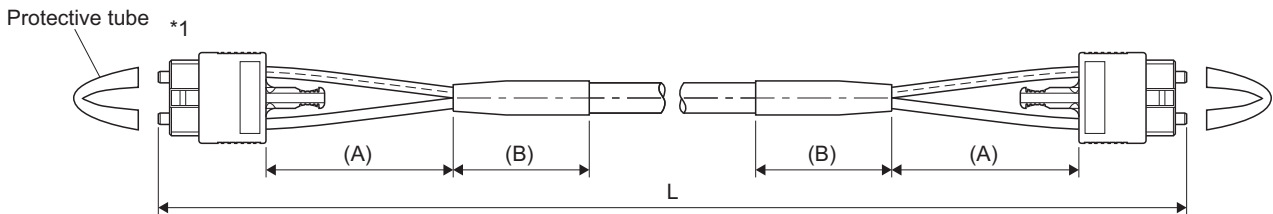

\*1 Dimension of connector part is the same as that of MR-J3BUS015M.

**Point** 

After removing the cap and the light cord end protective tube during mounting of the SSCNETIII cable, keep them in the resealable plastic bag that accompanies the SSCNETIII cable to prevent them from becoming dirty.

# Serial absolute synchronous encoder cable

In general, use the serial absolute synchronous encoder cables available as our products. If the required length is not found in our products, fabricate the cable on the customer side.

## Selection

The following table indicates the serial absolute synchronous encoder cables used with the serial absolute synchronous encoder. Connector sets are also available for your fabrication.

Type	Length [m(ft.)]	Remark
Q170ENCBL□M-A	2(6.56), 5(16.40), 10(32.81), 20(65.62), 30(98.43), 50(164.04)	Q171ENC-W8 ↔ MR-J4-□B-RJ

Use the following or equivalent twisted pair cables as the serial absolute synchronous encoder cables.

Connector sets type	Description	Remark
MR-J3CN2	Servo amplifier connector	Q171ENC-W8 ↔ MR-J4-□B-RJ

Core size [mm <sup>2</sup> ]	Number of cores	Characteristics of one core			Finished OD [mm(inch)] <sup>*2</sup>	Remark
		Structure [Number of wires/mm]	Conductor resistance [Ω/km]	Insulating sheath OD d[mm(inch)] <sup>*1</sup>		
0.2	24(12pair)	40/0.08	105 or less	0.88(0.035)	9.0(0.35)	Q171ENC-W8 ↔ MR-J4-□B-RJ

\*1 "d" is as shown below.

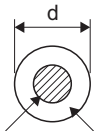

Conductor      Insulation sheath

\*2 Standard OD (Outside Diameter). Maximum OD is about 10% larger.

## CAUTION

- When fabricating the encoder cable, do not make an incorrect connection. Doing so may cause runaway or explosion.

# Q170ENCCBL□M-A

## Model explanation

Type: Q170ENCCBL□M-A

Symbol	Cable length [m(ft.)]
2	2(6.56)
5	5(16.40)
10	10(32.81)
20	20(65.62)
30	30(98.43)
50	50(164.04)

## Connection diagram

When fabricating a cable, use the recommended wire and connector set (MR-J3CN2) for encoder cable given in selection (Page 83 Selection), and make the cable as shown in the following connection diagram. Maximum cable length is 50m(164.04ft.).

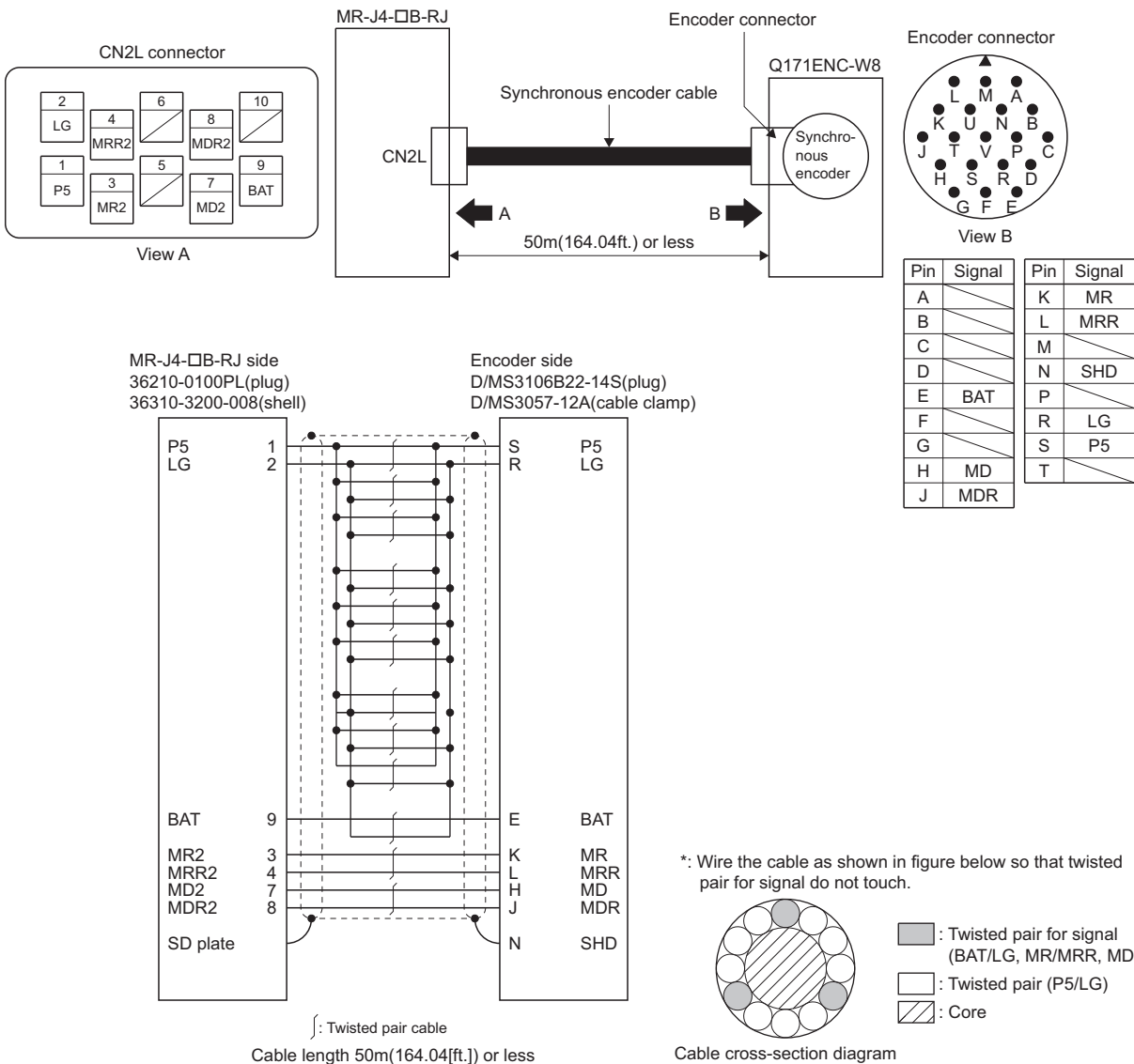

# SSCNETIII cables (SC-J3BUS□M-C) manufactured by Mitsubishi Electric System & Service

## Point

- For the details of the SSCNETIII cables, contact your local sales office.
- Do not look directly at the light generated from CN1A/CN1B connector of servo amplifier or the end of SSCNETIII cable. The light can be a discomfort when it enters the eye.

The cable is available per 1[m] up to 100[m]. The number of the length (1 to 100) will be in the □ part in the cable model.

Cable model	Cable length [m(ft.)]	Bending life	Application/remark
	1 to 100 (3.28 to 328.08)		
SC-J3BUS□M-C	1 to 100	Ultra-long bending life	Long distance cable

# Appendix 2 Exterior Dimensions

## Motion CPU module

### R16MTCPU

[Unit: mm(inch)]

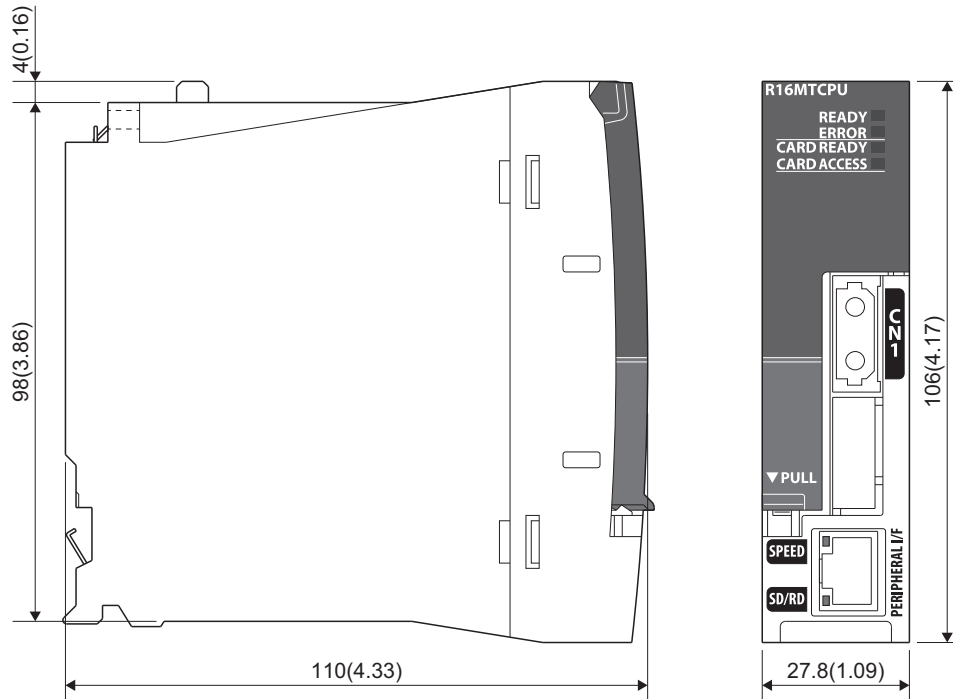

### R32MTCPU

[Unit: mm(inch)]

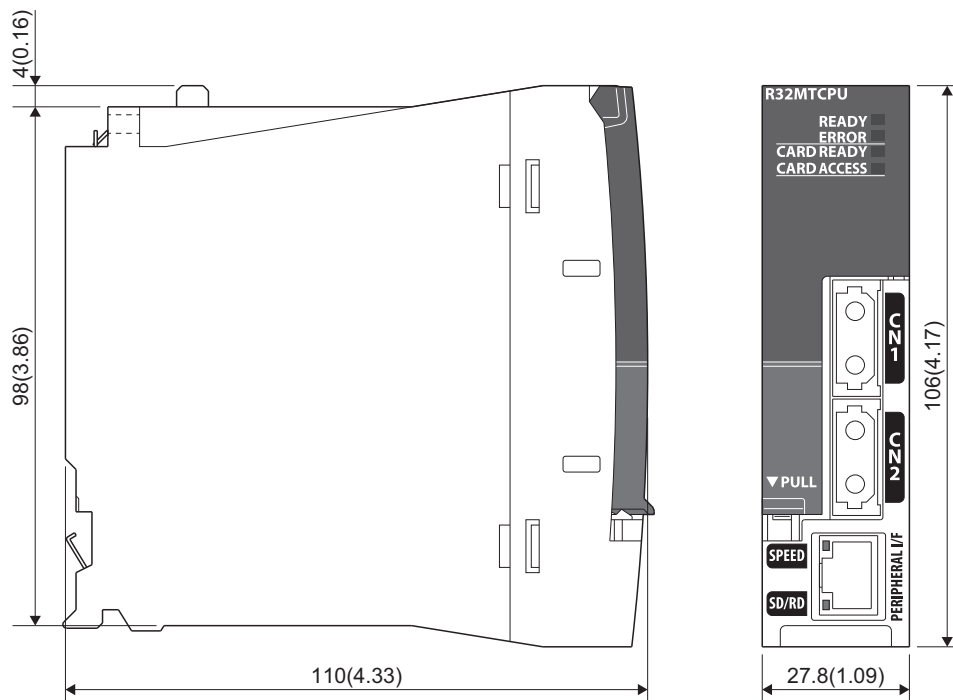



# R64MTCPU

[Unit: mm(inch)]

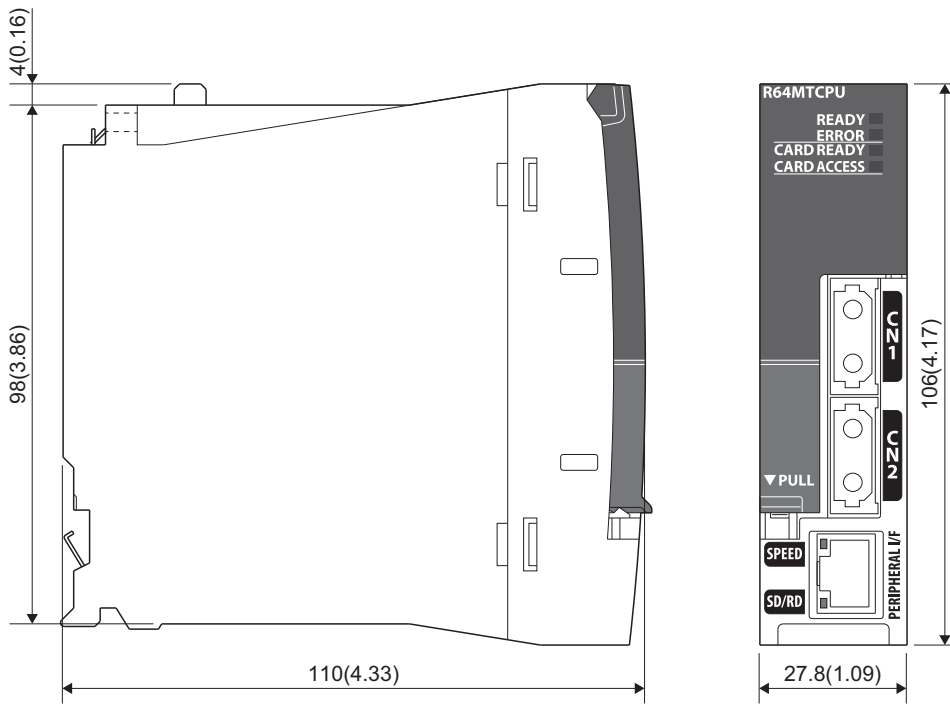

A

# Connector

## Cable connector for serial absolute synchronous encoder (3M Japan Limited make (SCR type))

### ■Type

Plug: 36210-0100PL

Shell: 36310-3200-008

[Unit: mm(inch)]

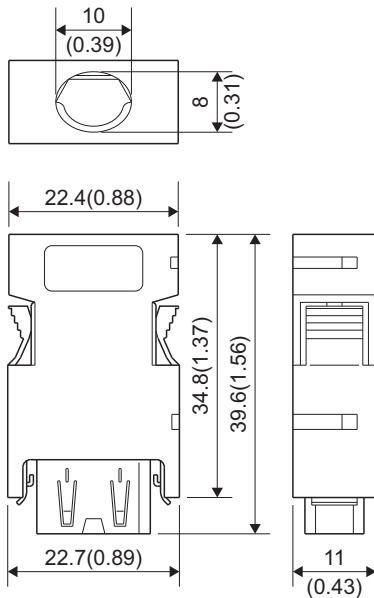

## SSCNETIII cable connector

[Unit: mm(inch)]

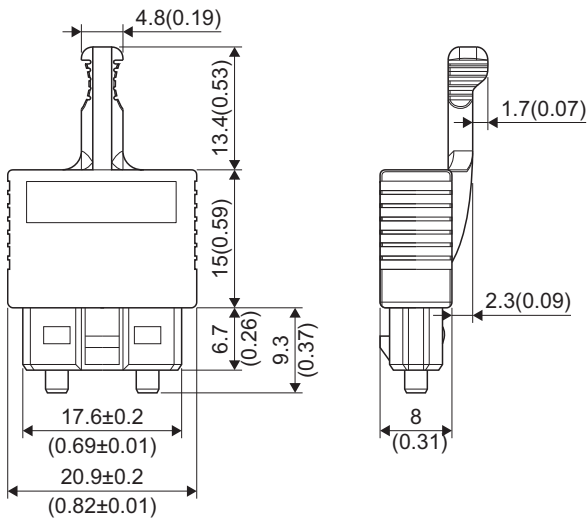

# Serial absolute synchronous encoder (Q171ENC-W8)

[Unit: mm(inch)]

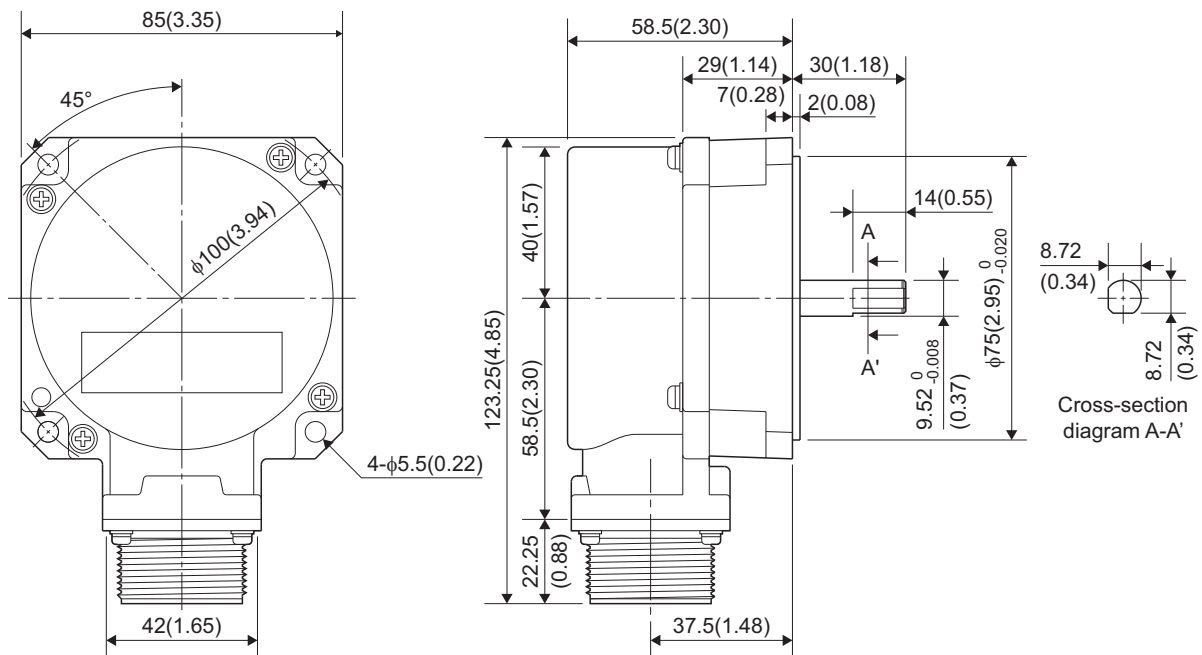

A

# REVISIONS

\* The manual number is given on the bottom left of the back cover

Revision date	*Manual number	Description
June 2014	IB(NA)-0300235-A	First edition
March 2015	IB(NA)-0300235-B	<ul style="list-style-type: none"> <li>■ Added models MR-MV200, MR-J4-□B-LL</li> <li>■ Added or modified parts SAFETY PRECAUTIONS, RELEVANT MANUALS, TERMS, Section 1.2, 1.4, 1.5, 2.2</li> </ul>
June 2015	IB(NA)-0300235-C	<ul style="list-style-type: none"> <li>■ Added models R08PCPU, R16PCPU, R32PCPU, R120PCPU, R62P, R64P, RX40PC6H, RX40NC6H, R60AD8-G, R60AD16-G, R60DA8-G, R60DA16-G, R60TD8-G, R60RD8-G</li> <li>■ Added or modified parts TERMS, Section 1.2, 1.4, 1.5, 2.2</li> </ul>
February 2016	IB(NA)-0300235-D	<ul style="list-style-type: none"> <li>■ Added models R64MTCPU</li> <li>■ Added or modified parts SAFETY PRECAUTIONS, INTRODUCTION, RELEVANT MANUALS, TERMS, MANUAL PAGE ORGANIZATION, Section 1.1, 1.2, 1.4, 1.5, 2.2, 2.4, 3.3, 4.1, 6.5, Appendix 2, WARRANTY</li> </ul>
June 2016	IB(NA)-0300235-E	<ul style="list-style-type: none"> <li>■ Added or modified parts SAFETY PRECAUTIONS, INTRODUCTION, Section 1.1, 1.2, 1.4, 2.1, 2.2, 2.4, 3.1, 5.2</li> </ul>
September 2016	IB(NA)-0300235-F	<ul style="list-style-type: none"> <li>■ Added models MR-MT2010, MR-MT2100, MR-MT2200, MR-MT2300, MR-MT2400, RY41NT2H, RY41PT2H</li> <li>■ Added or modified parts TERMS, Section 1.1, 1.2, 1.4, 1.5, 2.2</li> </ul>
December 2016	IB(NA)-0300235-G	<ul style="list-style-type: none"> <li>■ Added models RX41C6HS, RX61C6HS, R60ADH4</li> <li>■ Added or modified parts SAFETY PRECAUTIONS, Section 1.2, 1.4, 2.1, 2.2, 2.4</li> </ul>
December 2017	IB(NA)-0300235-H	<ul style="list-style-type: none"> <li>■ Added models R00CPU, R01CPU, R02CPU, R04ENCPU, R08ENCPU, R16ENCPU, R32ENCPU, R120ENCPU</li> <li>■ Added or modified parts SAFETY PRECAUTIONS, RELEVANT MANUALS, Section 1.2, 1.3, 1.4, 2.2, 4.1</li> </ul>
June 2018	IB(NA)-0300235-J	<ul style="list-style-type: none"> <li>■ Added or modified parts SAFETY PRECAUTIONS, Section 1.1, 1.4, 2.1, 6.2</li> </ul>
December 2018	IB(NA)-0300235-K	<ul style="list-style-type: none"> <li>■ Added or modified parts SAFETY PRECAUTIONS, Section 1.4, 2.3, 2.4, Appendix 1</li> </ul>
February 2020	IB(NA)-0300235-L	<ul style="list-style-type: none"> <li>■ Added models R08SF CPU, R16SF CPU, R32SF CPU, R120SF CPU, R33B, RC100B, R60MH112, R60MH112NA</li> <li>■ Added or modified parts Section 1.1, 1.2, 1.4, 3.4, 5.3</li> </ul>
June 2022	IB(NA)-0300235-M	<ul style="list-style-type: none"> <li>■ Added models MR-J5-□B, MR-J5-□B-RJ, MR-J5W2-□B, MR-J5W3-□B</li> <li>■ Added or modified parts SAFETY PRECAUTIONS, CONDITIONS OF USE FOR THE PRODUCT, TERMS, DISCONTINUED MODELS, Section 1.1, 1.2, 1.3, 1.4, 1.5, 1.6, 2.1, 2.2, 2.4, 3.4, Appendix 1</li> </ul>
January 2023	IB(NA)-0300235-N	<ul style="list-style-type: none"> <li>■ Added or modified parts Section 1.4</li> </ul>
June 2023	IB(NA)-0300235-P	<ul style="list-style-type: none"> <li>■ Added or modified parts SAFETY PRECAUTIONS, Section 1.4</li> </ul>
November 2023	IB(NA)-0300235-Q	<ul style="list-style-type: none"> <li>■ Added models MR-JE-□B</li> <li>■ Added or modified parts SAFETY PRECAUTIONS, TERMS, Section 1.1, 1.2, 1.3, 1.4, 2.4, 6.5</li> </ul>

Japanese manual number: IB-0300234-Q

This manual confers no industrial property rights of any other kind, nor does it confer any patent licenses. Mitsubishi Electric Corporation cannot be held responsible for any problems involving industrial property rights which may occur as a result of using the contents noted in this manual.

©2014 MITSUBISHI ELECTRIC CORPORATION

# WARRANTY

---

Please confirm the following product warranty details before using this product.

## **1. Gratis Warranty Term and Gratis Warranty Range**

If any faults or defects (hereinafter "Failure") found to be the responsibility of Mitsubishi occurs during use of the product within the gratis warranty term, the product shall be repaired at no cost via the sales representative or Mitsubishi Service Company.

However, if repairs are required onsite at domestic or overseas location, expenses to send an engineer will be solely at the customer's discretion. Mitsubishi shall not be held responsible for any re-commissioning, maintenance, or testing on-site that involves replacement of the failed module.

[Gratis Warranty Term]

The gratis warranty term of the product shall be for one year after the date of purchase or delivery to a designated place. Note that after manufacture and shipment from Mitsubishi, the maximum distribution period shall be six (6) months, and the longest gratis warranty term after manufacturing shall be eighteen (18) months. The gratis warranty term of repair parts shall not exceed the gratis warranty term before repairs.

[Gratis Warranty Range]

- (1) The range shall be limited to normal use within the usage state, usage methods and usage environment, etc., which follow the conditions and precautions, etc., given in the instruction manual, user's manual and caution labels on the product.
- (2) Even within the gratis warranty term, repairs shall be charged for in the following cases.
  1. Failure occurring from inappropriate storage or handling, carelessness or negligence by the user. Failure caused by the user's hardware or software design.
  2. Failure caused by unapproved modifications, etc., to the product by the user.
  3. When the Mitsubishi product is assembled into a user's device, Failure that could have been avoided if functions or structures, judged as necessary in the legal safety measures the user's device is subject to or as necessary by industry standards, had been provided.
  4. Failure that could have been avoided if consumable parts (battery, backlight, fuse, etc.) designated in the instruction manual had been correctly serviced or replaced.
  5. Failure caused by external irresistible forces such as fires or abnormal voltages, and Failure caused by force majeure such as earthquakes, lightning, wind and water damage.
  6. Failure caused by reasons unpredictable by scientific technology standards at time of shipment from Mitsubishi.
  7. Any other failure found not to be the responsibility of Mitsubishi or that admitted not to be so by the user.

## **2. Onerous repair term after discontinuation of production**

- (1) Mitsubishi shall accept onerous product repairs for seven (7) years after production of the product is discontinued. Discontinuation of production shall be notified with Mitsubishi Technical Bulletins, etc.
- (2) Product supply (including repair parts) is not available after production is discontinued.

## **3. Overseas service**

Overseas, repairs shall be accepted by Mitsubishi's local overseas FA Center. Note that the repair conditions at each FA Center may differ.

## **4. Exclusion of loss in opportunity and secondary loss from warranty liability**

Regardless of the gratis warranty term, Mitsubishi shall not be liable for compensation to:

- (1) Damages caused by any cause found not to be the responsibility of Mitsubishi.
- (2) Loss in opportunity, lost profits incurred to the user by Failures of Mitsubishi products.
- (3) Special damages and secondary damages whether foreseeable or not, compensation for accidents, and compensation for damages to products other than Mitsubishi products.
- (4) Replacement by the user, maintenance of on-site equipment, start-up test run and other tasks.

## **5. Changes in product specifications**

The specifications given in the catalogs, manuals or technical documents are subject to change without prior notice.

# INFORMATION AND SERVICES

---

For further information and services, please contact your local Mitsubishi Electric sales office or representative.  
Visit our website to find our locations worldwide.

MITSUBISHI ELECTRIC Factory Automation Global Website

Locations Worldwide

[www.MitsubishiElectric.com/fa/about-us/overseas/](http://www.MitsubishiElectric.com/fa/about-us/overseas/)

# TRADEMARKS

---

Microsoft and Windows are trademarks of the Microsoft group of companies.

The company names, system names and product names mentioned in this manual are either registered trademarks or trademarks of their respective companies.

In some cases, trademark symbols such as <sup>™</sup> or <sup>®</sup> are not specified in this manual.



IB(NA)-0300235-Q(2311)MEE

MODEL: RMT-U-E

MODEL CODE: 1XB002

## **MITSUBISHI ELECTRIC CORPORATION**

HEAD OFFICE: TOKYO BLDG., 2-7-3, MARUNOUCHI, CHIYODA-KU, TOKYO 100-8310, JAPAN  
NAGOYA WORKS: 1-14, YADA-MINAMI 5-CHOME, HIGASHI-KU, NAGOYA 461-8670, JAPAN

When exported from Japan, this manual does not require application to the  
Ministry of Economy, Trade and Industry for service transaction permission.

Specifications subject to change without notice.