

Programmable Controller

MELSEC iQ-R
series



MELSEC iQ-R CPU Module User's Manual (Startup)

-R00CPU
-R01CPU
-R02CPU
-R04CPU
-R04ENCPU
-R08CPU
-R08ENCPU
-R08PCPU
-R08PSFCPU
-R08SFCPU
-R16CPU
-R16ENCPU
-R16PCPU
-R16PSFCPU
-R16SFCPU
-R32CPU
-R32ENCPU
-R32PCPU
-R32PSFCPU
-R32SFCPU
-R120CPU
-R120ENCPU
-R120PCPU
-R120PSFCPU
-R120SFCPU
-R6RFM
-R6PSFM
-R6SFM

SAFETY PRECAUTIONS

(Read these precautions before using this product.)

Before using MELSEC iQ-R series programmable controllers, please read the manuals for the product and the relevant manuals introduced in those manuals carefully, and pay full attention to safety to handle the product correctly. If products are used in a different way from that specified by manufacturers, the protection function of the products may not work properly. In this manual, the safety precautions are classified into two levels: "⚠ WARNING" and "⚠ CAUTION".

 WARNING	Indicates that incorrect handling may cause hazardous conditions, resulting in death or severe injury.
 CAUTION	Indicates that incorrect handling may cause hazardous conditions, resulting in minor or moderate injury or property damage.

Under some circumstances, failure to observe the precautions given under "⚠ CAUTION" may lead to serious consequences.

Observe the precautions of both levels because they are important for personal and system safety.

Make sure that the end users read this manual and then keep the manual in a safe place for future reference.

[Design Precautions]

WARNING

- Configure safety circuits external to the programmable controller to ensure that the entire system operates safely even when a fault occurs in the external power supply or the programmable controller. Failure to do so may result in an accident due to an incorrect output or malfunction.
 - (1) Emergency stop circuits, protection circuits, and protective interlock circuits for conflicting operations (such as forward/reverse rotations or upper/lower limit positioning) must be configured external to the programmable controller.
 - (2) When the programmable controller detects an abnormal condition, it stops the operation and all outputs are:
 - Turned off if the overcurrent or overvoltage protection of the power supply module is activated.
 - Held or turned off according to the parameter setting if the self-diagnostic function of the CPU module detects an error such as a watchdog timer error.
 - (3) All outputs may be turned on if an error occurs in a part, such as an I/O control part, where the CPU module cannot detect any error. To ensure safety operation in such a case, provide a safety mechanism or a fail-safe circuit external to the programmable controller. For a fail-safe circuit example, refer to "General Safety Requirements" in the MELSEC iQ-R Module Configuration Manual.
 - (4) Outputs may remain on or off due to a failure of a component such as a relay and transistor in an output circuit. Configure an external circuit for monitoring output signals that could cause a serious accident.
 - In an output circuit, when a load current exceeding the rated current or an overcurrent caused by a load short-circuit flows for a long time, it may cause smoke and fire. To prevent this, configure an external safety circuit, such as a fuse.
 - Configure a circuit so that the programmable controller is turned on first and then the external power supply. If the external power supply is turned on first, an accident may occur due to an incorrect output or malfunction.
 - Configure a circuit so that the external power supply is turned off first and then the programmable controller. If the programmable controller is turned off first, an accident may occur due to an incorrect output or malfunction.
 - For the operating status of each station after a communication failure, refer to manuals for the network used. For the manuals, please consult your local Mitsubishi representative. Incorrect output or malfunction due to a communication failure may result in an accident.
 - When connecting an external device with a CPU module or intelligent function module to modify data of a running programmable controller, configure an interlock circuit in the program to ensure that the entire system will always operate safely. For other forms of control (such as program modification, parameter change, forced output, or operating status change) of a running programmable controller, read the relevant manuals carefully and ensure that the operation is safe before proceeding. Improper operation may damage machines or cause accidents.
-

[Design Precautions]

WARNING

- Especially, when a remote programmable controller is controlled by an external device, immediate action cannot be taken if a problem occurs in the programmable controller due to a communication failure. To prevent this, configure an interlock circuit in the program, and determine corrective actions to be taken between the external device and CPU module in case of a communication failure.
- Do not write any data to the "system area" and "write-protect area" of the buffer memory in the module. Also, do not use any "use prohibited" signals as an output signal from the CPU module to each module. Doing so may cause malfunction of the programmable controller system. For the "system area", "write-protect area", and the "use prohibited" signals, refer to the user's manual for the module used. For areas used for safety communications, they are protected from being written by users, and thus safety communications failure caused by data writing does not occur.
- If a communication cable is disconnected, the network may be unstable, resulting in a communication failure of multiple stations. Configure an interlock circuit in the program to ensure that the entire system will always operate safely even if communications fail. Failure to do so may result in an accident due to an incorrect output or malfunction. When safety communications are used, an interlock by the safety station interlock function protects the system from an incorrect output or malfunction.

[Precautions for using Process CPUs]

- If the redundant system fails, control of the entire system may not be maintained depending on the failure mode. The control may not be maintained in the following case either: An error in an extension base unit or in a module on an extension base unit is detected and causes a stop error of the control system, system switching occurs, and a similar error is detected and causes a stop error of the standby system (new control system). To ensure that the entire system operates safely even in these cases, configure safety circuits external to the programmable controller.
-

[Design Precautions]

WARNING

[Precautions for using SIL2 Process CPUs]

- When the programmable controller compliant with SIL2 (IEC 61508) detects a fault in the external power supply or itself, it turns off all outputs in the safety system. Configure an external circuit to ensure that the power source of a hazard is shut off by turning off the outputs. Failure to do so may result in an accident.
 - Configure short current protection circuits for safety relays and protection circuits, such as a fuse and breaker, external to the programmable controller.
 - When a load current exceeding the rated current or an overcurrent caused by a load short-circuit flows, modules operating in SIL2 mode detect an error and turn off all outputs. Note that if the overcurrent state continues for a long time, it may cause smoke and fire. To prevent this, configure an external safety circuit, such as a fuse.
 - When changing data and operating status, and modifying program of the running programmable controller from an external device such as a personal computer connected to the SIL2 Process CPU, configure an interlock circuit in the program or external to the programmable controller to ensure that the entire system always operates safely. In addition, before performing online operations, determine corrective actions to be taken between the external device and SIL2 Process CPU in case of a communication failure due to poor contact of cables.
 - Do not use any "use prohibited" signals of modules as an I/O signal since they are used by the system. Do not write any data to the "use prohibited" areas in the buffer memory of modules. For the "use prohibited" signals, refer to the user's manual for each module. Do not turn on or off these signals on a program since normal operations cannot be guaranteed. Doing so may cause malfunction of the programmable controller system.
-

[Design Precautions]

WARNING

- When a module operating in SIL2 mode detects an error in a safety communication path, it turns off outputs. However, the program does not automatically turn off outputs. Create a program that turns off outputs when an error is detected in a safety communication path. If safety communications are restored with outputs on, connected devices may suddenly operate, resulting in an accident.
- Create an interlock circuit which uses reset buttons so that the system does not restart automatically after executing safety functions and turning off outputs.
- In the case of a communication failure in the network, the status of the error station will be as follows:
 - (1) Inputs from remote stations are not refreshed.
 - (2) All outputs from remote stations are turned off.Check the communication status information and configure an interlock circuit in the program to ensure that the entire system will operate safely. Failure to do so may result in an accident due to an incorrect output or malfunction.
- Outputs may remain on or off due to a failure of an output module operating in SIL2 mode. Configure an external circuit for monitoring output signals that could cause a serious accident.

[Precautions for using Safety CPUs]

- When the safety programmable controller detects a fault in the external power supply or itself, it turns off all outputs in the safety system. Configure an external circuit to ensure that the power source of a hazard is shut off by turning off the outputs. Failure to do so may result in an accident.
 - Configure short current protection circuits for a safety relay and protection circuits, such as a fuse and breaker, external to the safety programmable controller.
 - When a load current exceeding the rated current or an overcurrent caused by a load short-circuit flows, the CC-Link IE Field Network remote I/O module (with safety functions) detects an error and turns off all outputs. Note that if the overcurrent state continues for a long time, it may cause smoke and fire. To prevent this, configure an external safety circuit, such as a fuse.
 - When changing data and operating status, and modifying program of the running safety programmable controller from an external device such as a personal computer connected to the Safety CPU, configure an interlock circuit in the program or external to the safety programmable controller to ensure that the entire system always operates safely. In addition, determine corrective actions to be taken between the external device and Safety CPU in case of a communication failure during online operations due to poor contact of cables.
 - Do not use any "use prohibited" signals as a remote I/O signal since they are used in the system. Do not write any data to the "use prohibited" areas in the remote register. For the "use prohibited" signals, refer to the MELSEC iQ-R CC-Link IE Field Network User's Manual (Application). Do not turn on or off these signals on a program since normal operations cannot be guaranteed. Doing so may cause malfunction of the programmable controller system.
 - When the CC-Link IE Field Network remote I/O module (with safety functions) detects a CC-Link IE Field Network error, it turns off outputs. However, the outputs in a program are not automatically turned off. Create a program that turns off the outputs when a CC-Link IE Field Network error has been detected. If CC-Link IE Field Network is restored with outputs on, connected machines may suddenly operate, resulting in an accident.
-

[Design Precautions]

WARNING

- Ensure that the system does not restart automatically after executing safety functions and turning off outputs. Create a circuit that does not allow the system to restart until an intentional start has been manually issued by an operator.
- In the case of a communication failure in the network, the CPU module recognizes the communication destination station as an error station. The error station will be as follows:
 - (1) All safety inputs from the error station to the CPU module are not refreshed.
 - (2) All safety outputs from the error station to external devices are turned off because the CPU module does not communicate with the error station.

Check the communication status information and configure an interlock circuit in the program to ensure that the entire system will operate safely. Failure to do so may result in an accident due to an incorrect output or malfunction.

- Outputs may remain on or off due to a failure of the CC-Link IE Field Network remote I/O module (with safety functions). Configure an external circuit for monitoring output signals that could cause a serious accident.

[Precautions for using redundant function modules]

- The optical transmitter and receiver of the redundant function module use laser diodes (class 1 in accordance with IEC 60825-1/JIS C6802). Do not look directly at a laser beam. Doing so may harm your eyes.
-

[Design Precautions]

CAUTION

- Do not install the control lines or communication cables together with the main circuit lines or power cables. Doing so may result in malfunction due to electromagnetic interference. Keep a distance of 100mm or more between those cables.
- During control of an inductive load such as a lamp, heater, or solenoid valve, a large current (approximately ten times greater than normal) may flow when the output is turned from off to on. Therefore, use a module that has a sufficient current rating.
- After the CPU module is powered on or is reset, the time taken to enter the RUN status varies depending on the system configuration, parameter settings, and/or program size. Design circuits so that the entire system will always operate safely, regardless of the time.
- Do not power off the programmable controller or reset the CPU module while the settings are being written. Doing so will make the data in the flash ROM and SD memory card undefined. The values need to be set in the buffer memory and written to the flash ROM and SD memory card again. Doing so also may cause malfunction or failure of the module.
- When changing the operating status of the CPU module from external devices (such as the remote RUN/STOP functions), select "Do Not Open by Program" for "Opening Method" of "Module Parameter". If "Open by Program" is selected, an execution of the remote STOP function causes the communication line to close. Consequently, the CPU module cannot reopen the line, and external devices cannot execute the remote RUN function.

[Precautions for using SIL2 Process CPUs]

- Do not install the control lines or communication cables together with the main circuit lines or power cables. Doing so may result in malfunction due to noise. Keep a distance of 100mm or more between those cables.
- When selecting external devices to be connected to modules that operate in SIL2 mode, consider the maximum inrush current described in the user's manual for each module. Exceeding the maximum inrush current may cause malfunction or failure of the module.

[Precautions for using Safety CPUs]

- When selecting external devices to be connected to the CC-Link IE Field Network remote I/O module (with safety functions), consider the maximum inrush current described in the CC-Link IE Field Network Remote I/O Module (With Safety Functions) User's Manual. Exceeding the maximum inrush current may cause malfunction or failure of the module.

[Security Precautions]

WARNING

- To maintain the security (confidentiality, integrity, and availability) of the programmable controller and the system against unauthorized access, denial-of-service (DoS) attacks, computer viruses, and other cyberattacks from external devices via the network, take appropriate measures such as firewalls, virtual private networks (VPNs), and antivirus solutions.
-

[Installation Precautions]

WARNING

- Shut off the external power supply (all phases) used in the system before mounting or removing the module. Failure to do so may result in electric shock or cause the module to fail or malfunction.
-

[Installation Precautions]

CAUTION

- Use the programmable controller in an environment that meets the general specifications in the Safety Guidelines (IB-0800525). Failure to do so may result in electric shock, fire, malfunction, or damage to or deterioration of the product.
- To mount a module, place the concave part(s) located at the bottom onto the guide(s) of the base unit, and push in the module until the hook(s) located at the top snaps into place. Incorrect interconnection may cause malfunction, failure, or drop of the module.
- To mount a module with no module fixing hook, place the concave part(s) located at the bottom onto the guide(s) of the base unit, push in the module, and fix it with screw(s). Incorrect interconnection may cause malfunction, failure, or drop of the module.
- When using the programmable controller in an environment of frequent vibrations, fix the module with a screw.
- Tighten the screws within the specified torque range. Undertightening can cause drop of the component or wire, short circuit, or malfunction. Overtightening can damage the screw and/or module, resulting in drop, short circuit, or malfunction. For the specified torque range, refer to the MELSEC iQ-R Module Configuration Manual.
- When using an extension cable, connect it to the extension cable connector of the base unit securely. Check the connection for looseness. Poor contact may cause malfunction.
- When using an SD memory card, fully insert it into the SD memory card slot. Check that it is inserted completely. Poor contact may cause malfunction.
- Securely insert an extended SRAM cassette or a battery-less option cassette into the cassette connector of the CPU module. After insertion, close the cassette cover and check that the cassette is inserted completely. Poor contact may cause malfunction.
- Beware that the module could be very hot while power is on and immediately after power-off.
- Do not directly touch any conductive parts and electronic components of the module, SD memory card, extended SRAM cassette, battery-less option cassette, or connector. Doing so can cause malfunction or failure of the module.

[Precautions for using Safety CPUs]

- Use the CC-Link IE Field Network remote I/O module (with safety functions) and CC-Link IE Field Network remote I/O module in an environment that meets the general specifications in the corresponding manuals (CC-Link IE Field Network Remote I/O Module (With Safety Functions) User's Manual and CC-Link IE Field Network Remote I/O Module User's Manual). Failure to do so may result in electric shock, fire, malfunction, or damage to or deterioration of the product.
 - Securely fix the CC-Link IE Field Network remote I/O module (with safety functions) or CC-Link IE Field Network remote I/O module with a DIN rail or module fixing screws. Tighten the screws within the specified torque range. Undertightening can cause drop of the screw, short circuit, or malfunction. Overtightening can damage the screw and/or module, resulting in drop, short circuit, or malfunction.
-

[Wiring Precautions]

WARNING

- Shut off the external power supply (all phases) used in the system before installation and wiring. Failure to do so may result in electric shock or cause the module to fail or malfunction.
 - After installation and wiring, attach a blank cover module (RG60) to each empty slot and an included extension connector protective cover to the unused extension cable connector before powering on the system for operation. Failure to do so may result in electric shock.
-

[Wiring Precautions]

CAUTION

- Individually ground the FG and LG terminals of the programmable controller with a ground resistance of 100 ohms or less. Failure to do so may result in electric shock or malfunction.
 - Use applicable solderless terminals and tighten them within the specified torque range. If any spade solderless terminal is used, it may be disconnected when the terminal screw comes loose, resulting in failure.
 - Check the rated voltage and signal layout before wiring to the module, and connect the cables correctly. Connecting a power supply with a different voltage rating or incorrect wiring may cause fire or failure.
 - Connectors for external devices must be crimped or pressed with the tool specified by the manufacturer, or must be correctly soldered. Incomplete connections may cause short circuit, fire, or malfunction.
 - Securely connect the connector to the module. Poor contact may cause malfunction.
 - Do not install the control lines or communication cables together with the main circuit lines or power cables. Doing so may result in malfunction due to noise. Keep a distance of 100mm or more between those cables.
 - Place the cables in a duct or clamp them. If not, dangling cables may swing or inadvertently be pulled, resulting in malfunction or damage to modules or cables.
In addition, the weight of the cables may put stress on modules in an environment of strong vibrations and shocks.
Do not clamp the extension cables with the jacket stripped. Doing so may change the characteristics of the cables, resulting in malfunction.
 - Check the interface type and correctly connect the cable. Incorrect wiring (connecting the cable to an incorrect interface) may cause failure of the module and external device.
 - Tighten the terminal screws or connector screws within the specified torque range. Undertightening can cause drop of the screw, short circuit, fire, or malfunction. Overtightening can damage the screw and/or module, resulting in drop, short circuit, fire, or malfunction.
 - When disconnecting the cable from the module, do not pull the cable by the cable part. For the cable with connector, hold the connector part of the cable. For the cable connected to the terminal block, loosen the terminal screw. Pulling the cable connected to the module may result in malfunction or damage to the module or cable.
-

[Wiring Precautions]

CAUTION

- Prevent foreign matter such as dust or wire chips from entering the module. Such foreign matter can cause a fire, failure, or malfunction.
- When a protective film is attached to the top of the module, remove it before system operation. If not, inadequate heat dissipation of the module may cause a fire, failure, or malfunction.
- Programmable controllers must be installed in control panels. Connect the main power supply to the power supply module in the control panel through a relay terminal block. Wiring and replacement of a power supply module must be performed by qualified maintenance personnel with knowledge of protection against electric shock. For wiring, refer to the MELSEC iQ-R Module Configuration Manual.
- For Ethernet cables to be used in the system, select the ones that meet the specifications in the user's manual for the module used. If not, normal data transmission is not guaranteed.

[Precautions for using redundant function modules]

- For tracking cables to be used in the system, select the ones that meet the specifications in this manual. If not, normal data transmission is not guaranteed.
-

[Startup and Maintenance Precautions]

WARNING

- Do not touch any terminal while power is on. Doing so will cause electric shock or malfunction.
 - Correctly connect the battery connector. Do not charge, disassemble, heat, short-circuit, solder, or throw the battery into the fire. Also, do not expose it to liquid or strong shock. Doing so will cause the battery to produce heat, explode, ignite, or leak, resulting in injury and fire.
 - Shut off the external power supply (all phases) used in the system before cleaning the module or retightening the terminal screws, connector screws, or module fixing screws. Failure to do so may result in electric shock.
-

[Startup and Maintenance Precautions]

CAUTION

- When connecting an external device with a CPU module or intelligent function module to modify data of a running programmable controller, configure an interlock circuit in the program to ensure that the entire system will always operate safely. For other forms of control (such as program modification, parameter change, forced output, or operating status change) of a running programmable controller, read the relevant manuals carefully and ensure that the operation is safe before proceeding. Improper operation may damage machines or cause accidents.
 - Especially, when a remote programmable controller is controlled by an external device, immediate action cannot be taken if a problem occurs in the programmable controller due to a communication failure. To prevent this, configure an interlock circuit in the program, and determine corrective actions to be taken between the external device and CPU module in case of a communication failure.
 - Do not disassemble or modify the modules. Doing so may cause failure, malfunction, injury, or a fire.
 - Use any radio communication device such as a cellular phone or PHS (Personal Handy-phone System) more than 25cm away in all directions from the programmable controller. Failure to do so may cause malfunction.
 - Shut off the external power supply (all phases) used in the system before mounting or removing the module. Failure to do so may cause the module to fail or malfunction.
 - Tighten the screws within the specified torque range. Undertightening can cause drop of the component or wire, short circuit, or malfunction. Overtightening can damage the screw and/or module, resulting in drop, short circuit, or malfunction.
 - After the first use of the product, do not perform each of the following operations more than 50 times (IEC 61131-2/JIS B 3502 compliant). Exceeding the limit may cause malfunction.
 - Mounting/removing the module to/from the base unit
 - Inserting/removing the extended SRAM cassette or battery-less option cassette to/from the CPU module
 - Mounting/removing the terminal block to/from the module
 - Connecting/disconnecting the extension cable to/from the base unit
 - After the first use of the product, do not insert/remove the SD memory card to/from the CPU module more than 500 times. Exceeding the limit may cause malfunction.
 - Do not touch the metal terminals on the back side of the SD memory card. Doing so may cause malfunction or failure of the module.
 - Do not touch the integrated circuits on the circuit board of an extended SRAM cassette or a battery-less option cassette. Doing so may cause malfunction or failure of the module.
 - Do not drop or apply shock to the battery to be installed in the module. Doing so may damage the battery, causing the battery fluid to leak inside the battery. If the battery is dropped or any shock is applied to it, dispose of it without using.
 - Startup and maintenance of a control panel must be performed by qualified maintenance personnel with knowledge of protection against electric shock. Lock the control panel so that only qualified maintenance personnel can operate it.
 - Before handling the module, touch a conducting object such as a grounded metal to discharge the static electricity from the human body. Wearing a grounded antistatic wrist strap is recommended. Failure to discharge the static electricity may cause the module to fail or malfunction.
 - Use a clean and dry cloth to wipe off dirt on the module.
-

[Startup and Maintenance Precautions]

CAUTION

[Precautions for using SIL2 Process CPUs]

- When performing online operations to the running SIL2 Process CPU such as program modification, device test, and operating status change (for example, from RUN to STOP) of the running programmable controller from an external device such as a personal computer connected, read relevant manuals carefully and ensure the safety before operation. The operations must be performed by qualified operators following the operating procedure that is predetermined at the design stage. Modifying a program while the SIL2 Process CPU is running (the online change) may cause corruption of the program depending on operating conditions. Fully understand the precautions described in the GX Works3 Operating Manual before operation.
-

[Operating Precautions]

CAUTION

- When changing data and operating status, and modifying program of the running programmable controller from an external device such as a personal computer connected to an intelligent function module, read relevant manuals carefully and ensure the safety before operation. Incorrect change or modification may cause system malfunction, damage to the machines, or accidents.
 - Do not power off the programmable controller or reset the CPU module while the setting values in the buffer memory are being written to the flash ROM in the module. Doing so will make the data in the flash ROM and SD memory card undefined. The values need to be set in the buffer memory and written to the flash ROM and SD memory card again. Doing so also may cause malfunction or failure of the module.
-

[Computer Connection Precautions]

CAUTION

- When connecting a personal computer to a module having a USB interface, observe the following precautions as well as the instructions described in the manual for the personal computer used. Failure to do so may cause the module to fail.
 - (1) When the personal computer is AC-powered
 - When the personal computer has a 3-pin AC plug or an AC plug with a grounding wire, connect the plug to a grounding receptacle or ground the grounding wire. Ground the personal computer and the module with a ground resistance of 100 ohms or less.
 - When the personal computer has a 2-pin AC plug without a grounding wire, connect the computer to the module by following the procedure below. For power supplied to the personal computer and the module, using the same power source is recommended.
 1. Unplug the personal computer from the AC receptacle.
 2. Check that the personal computer is unplugged. Then, connect the personal computer to the module with a USB cable.
 3. Plug the personal computer into the AC receptacle.
 - (2) When the personal computer is battery-powered
 - The personal computer can be connected to the module without taking specific measures. For details, refer to the following.

Cautions When Using Mitsubishi Programmable Controllers or GOTs Connected to a Personal Computer With the RS-232/USB Interface (FA-A-0298)

When the USB cable used is the GT09-C30USB-5P manufactured by Mitsubishi Electric, specific measures are not required to connect the AC-powered personal computer to the module. However, note that the signal ground (SG) is common for the module and its USB interface. Therefore, if an SG potential difference occurs between the module and the connected devices, it causes failures of the module and the connected devices.

[Disposal Precautions]

CAUTION

- When disposing of this product, treat it as industrial waste.
- When disposing of batteries, separate them from other wastes according to the local regulations. For details on battery regulations in EU member states, refer to the MELSEC iQ-R Module Configuration Manual.

[Transportation Precautions]

CAUTION

- When transporting lithium batteries, follow the transportation regulations. For details on the regulated models, refer to the MELSEC iQ-R Module Configuration Manual.
- The halogens (such as fluorine, chlorine, bromine, and iodine), which are contained in a fumigant used for disinfection and pest control of wood packaging materials, may cause failure of the product. Prevent the entry of fumigant residues into the product or consider other methods (such as heat treatment) instead of fumigation. The disinfection and pest control measures must be applied to unprocessed raw wood.

CONDITIONS OF USE FOR THE PRODUCT

- (1) MELSEC programmable controller ("the PRODUCT") shall be used in conditions;
- i) where any problem, fault or failure occurring in the PRODUCT, if any, shall not lead to any major or serious accident; and
 - ii) where the backup and fail-safe function are systematically or automatically provided outside of the PRODUCT for the case of any problem, fault or failure occurring in the PRODUCT.
- (2) The PRODUCT has been designed and manufactured for the purpose of being used in general industries. MITSUBISHI ELECTRIC SHALL HAVE NO RESPONSIBILITY OR LIABILITY (INCLUDING, BUT NOT LIMITED TO ANY AND ALL RESPONSIBILITY OR LIABILITY BASED ON CONTRACT, WARRANTY, TORT, PRODUCT LIABILITY) FOR ANY INJURY OR DEATH TO PERSONS OR LOSS OR DAMAGE TO PROPERTY CAUSED BY the PRODUCT THAT ARE OPERATED OR USED IN APPLICATION NOT INTENDED OR EXCLUDED BY INSTRUCTIONS, PRECAUTIONS, OR WARNING CONTAINED IN MITSUBISHI ELECTRIC USER'S, INSTRUCTION AND/OR SAFETY MANUALS, TECHNICAL BULLETINS AND GUIDELINES FOR the PRODUCT.
- ("Prohibited Application")
- Prohibited Applications include, but not limited to, the use of the PRODUCT in;
- Nuclear Power Plants and any other power plants operated by Power companies, and/or any other cases in which the public could be affected if any problem or fault occurs in the PRODUCT.
 - Railway companies or Public service purposes, and/or any other cases in which establishment of a special quality assurance system is required by the Purchaser or End User.
 - Aircraft or Aerospace, Medical applications, Train equipment, transport equipment such as Elevator and Escalator, Incineration and Fuel devices, Vehicles, Manned transportation, Equipment for Recreation and Amusement, and Safety devices, handling of Nuclear or Hazardous Materials or Chemicals, Mining and Drilling, and/or other applications where there is a significant risk of injury to the public or property.
- Notwithstanding the above restrictions, Mitsubishi Electric may in its sole discretion, authorize use of the PRODUCT in one or more of the Prohibited Applications, provided that the usage of the PRODUCT is limited only for the specific applications agreed to by Mitsubishi Electric and provided further that no special quality assurance or fail-safe, redundant or other safety features which exceed the general specifications of the PRODUCTS are required. For details, please contact the Mitsubishi Electric representative in your region.
- (3) Mitsubishi Electric shall have no responsibility or liability for any problems involving programmable controller trouble and system trouble caused by DoS attacks, unauthorized access, computer viruses, and other cyberattacks.

- For SIL2 Process CPUs

- (1) Although Mitsubishi Electric has declared Product's compliance with the international safety standards IEC61508, IEC61511, this fact does not guarantee that Product will be free from any malfunction or failure. The user of this Product shall comply with any and all applicable safety standard, regulation or law and take appropriate safety measures for the system in which the Product is installed or used and shall take the second or third safety measures other than the Product. Mitsubishi Electric is not liable for damages that could have been prevented by compliance with any applicable safety standard, regulation or law.
- (2) Mitsubishi Electric prohibits the use of Products with or in any application involving, and Mitsubishi Electric shall not be liable for a default, a liability for defect warranty, a quality assurance, negligence or other tort and a product liability in these applications.
 - (a) power plants,
 - (b) trains, railway systems, airplanes, airline operations, other transportation systems,
 - (c) hospitals, medical care, dialysis and life support facilities or equipment,
 - (d) amusement equipments,
 - (e) incineration and fuel devices,
 - (f) handling of nuclear or hazardous materials or chemicals,
 - (g) mining and drilling,
 - (h) and other applications where the level of risk to human life, health or property are elevated.
- (3) Mitsubishi Electric shall have no responsibility or liability for any problems involving programmable controller trouble and system trouble caused by DoS attacks, unauthorized access, computer viruses, and other cyberattacks.

- For Safety CPUs

- (1) Although Mitsubishi Electric has obtained the certification for Product's compliance to the international safety standards IEC61508, ISO13849-1 from TUV Rheinland, this fact does not guarantee that Product will be free from any malfunction or failure. The user of this Product shall comply with any and all applicable safety standard, regulation or law and take appropriate safety measures for the system in which the Product is installed or used and shall take the second or third safety measures other than the Product. Mitsubishi Electric is not liable for damages that could have been prevented by compliance with any applicable safety standard, regulation or law.
- (2) Mitsubishi Electric prohibits the use of Products with or in any application involving, and Mitsubishi Electric shall not be liable for a default, a liability for defect warranty, a quality assurance, negligence or other tort and a product liability in these applications.
 - (a) power plants,
 - (b) trains, railway systems, airplanes, airline operations, other transportation systems,
 - (c) hospitals, medical care, dialysis and life support facilities or equipment,
 - (d) amusement equipments,
 - (e) incineration and fuel devices,
 - (f) handling of nuclear or hazardous materials or chemicals,
 - (g) mining and drilling,
 - (h) and other applications where the level of risk to human life, health or property are elevated.
- (3) Mitsubishi Electric shall have no responsibility or liability for any problems involving programmable controller trouble and system trouble caused by DoS attacks, unauthorized access, computer viruses, and other cyberattacks.

INTRODUCTION

Thank you for purchasing the Mitsubishi Electric MELSEC iQ-R series programmable controllers.

This manual describes the specifications, procedures before operation, and troubleshooting of the relevant products listed below.

Before using this product, please read this manual and the relevant manuals carefully and develop familiarity with the functions and performance of the MELSEC iQ-R series programmable controller to handle the product correctly.

Please make sure that the end users read this manual.

Relevant products

Item	Model
CPU module	R00CPU, R01CPU, R02CPU, R04CPU, R04ENCPU, R08CPU, R08ENCPU, R08PCPU, R08PSFCPU, R08SFPCPU, R16CPU, R16ENCPU, R16PCPU, R16PSFCPU, R16SFPCPU, R32CPU, R32ENCPU, R32PCPU, R32PSFCPU, R32SFPCPU, R120CPU, R120ENCPU, R120PCPU, R120PSFCPU, R120SFPCPU
Redundant function module	R6RFM
SIL2 function module	R6PSFM
Safety function module	R6SFM

To users who use this manual

Since the user's manuals "Startup" and "Application" for the CPU module are unified, we offer the user's manual for each CPU module type.

Type	Manual name	Manual number	Replacement timing
Programmable controller CPU	MELSEC iQ-R Programmable Controller CPU Module User's Manual	SH-082488ENG	July 2022
Process CPU	MELSEC iQ-R Process CPU Module User's Manual	SH-082493ENG	July 2022
Safety CPU	MELSEC iQ-R Safety CPU Module User's Manual	—	In the future
SIL2 Process CPU	MELSEC iQ-R SIL2 Process CPU Module User's Manual	—	In the future

For the operation method of CPU Module Logging Configuration Tool, which is included in the user's manual (Application), we offer the operating manual separately.

 CPU Module Logging Configuration Tool Version 1 Operating Manual (MELSEC iQ-R Series)

For details on the manual unification, refer to the following technical bulletin.

 Change of the MELSEC iQ-R Series User's Manual Configuration (FA-A-0378)

COMPLIANCE WITH EMC AND LOW VOLTAGE DIRECTIVES

Method of ensuring compliance

To ensure that Mitsubishi Electric programmable controllers maintain the EMC and Low Voltage Directives or other regulations when incorporated into other machinery or equipment, certain measures may be necessary. Please refer to one of the following manuals.

- MELSEC iQ-R Module Configuration Manual (SH-081262ENG)
- Safety Guidelines (IB-0800525)

Certification marks on the side of the programmable controller indicate compliance with the relevant regulations.

Additional measures

To ensure that this product maintains the EMC and Low Voltage Directives or other regulations, please refer to the following.

- MELSEC iQ-R Module Configuration Manual (SH-081262ENG)
- Safety Guidelines (IB-0800525)

COMPLIANCE WITH THE MACHINERY DIRECTIVE

Method of ensuring compliance

To ensure that Mitsubishi safety programmable controllers maintain Machinery Directive when incorporated into other machinery or equipment, certain measures may be necessary. Please refer to one of the following manuals.

- MELSEC iQ-R Module Configuration Manual (SH-081262ENG)
- Safety Guidelines (IB-0800525)

The CE mark on the side of the safety programmable controller indicates compliance with Machinery Directive.

Additional measures

To ensure that this product maintains Machinery Directive, please refer to one of the following manuals.

- MELSEC iQ-R Module Configuration Manual (SH-081262ENG)
- Safety Guidelines (IB-0800525)

CONTENTS

SAFETY PRECAUTIONS	1
CONDITIONS OF USE FOR THE PRODUCT	14
INTRODUCTION	16
COMPLIANCE WITH EMC AND LOW VOLTAGE DIRECTIVES	17
COMPLIANCE WITH THE MACHINERY DIRECTIVE	17
RELEVANT MANUALS	20
TERMS	22
GENERIC TERMS AND ABBREVIATIONS	24
CHAPTER 1 PART NAMES	25
1.1 CPU Module	25
R00CPU	25
R01CPU, R02CPU	27
RnCPU (except for R00CPU, R01CPU, or R02CPU), Process CPU, SIL2 Process CPU, Safety CPU	29
RnENCPU	32
1.2 Extended SRAM Cassette and Battery-less Option Cassette	34
1.3 Redundant Function Module	35
1.4 SIL2 Function Module and Safety Function Module	37
CHAPTER 2 SPECIFICATIONS	38
2.1 CPU Module	38
2.2 Extended SRAM Cassette	56
2.3 Battery-less Option Cassette	56
2.4 Redundant Function Module	57
2.5 SIL2 Function Module	58
2.6 Safety Function Module	59
CHAPTER 3 FUNCTION LIST	60
CHAPTER 4 PROCEDURES BEFORE OPERATION	66
4.1 Overview	66
Programmable controller CPU, Process CPU	66
SIL2 Process CPU	67
Safety CPU	68
4.2 Installing a Battery	70
Installation procedure	70
4.3 Inserting or Removing an Extended SRAM Cassette	71
Insertion procedure	71
Removal procedure	71
4.4 Inserting and Removing an SD Memory Card	72
Insertion procedure	72
Removal procedure	73
4.5 Creating a Project	74
4.6 Connecting a Personal Computer	75
4.7 Initializing the CPU Module	76
4.8 Setting Parameters	76
4.9 Programming	79
Registering labels	79

Inserting program elements.....	80
Inserting POUs by key input.....	82
4.10 Converting the Program.....	83
4.11 Saving the Project.....	83
4.12 Writing Data to the Programmable Controller.....	83
4.13 Resetting the CPU Module.....	84
4.14 Executing the Program.....	85
4.15 Monitoring the program.....	86
4.16 Troubleshooting.....	87
Troubleshooting procedure.....	87
Troubleshooting with LED indicators.....	88
Troubleshooting using the engineering tool.....	88
CHAPTER 5 SYSTEM CONFIGURATION.....	90
<hr/>	
APPENDIX.....	92
<hr/>	
Appendix 1 External Dimensions.....	92
INDEX.....	99
<hr/>	
REVISIONS.....	101
WARRANTY.....	103
TRADEMARKS.....	108

RELEVANT MANUALS

Manual name [manual number]	Description	Available form
MELSEC iQ-R CPU Module User's Manual (Startup) [SH-081263ENG] (this manual)	Specifications, procedures before operation, and troubleshooting of the CPU module	Print book e-Manual PDF
MELSEC iQ-R CPU Module User's Manual (Application) [SH-081264ENG]	Memory, functions, devices, and parameters of the CPU module	Print book e-Manual PDF
MELSEC iQ-R Programmable Controller CPU Module User's Manual [SH-082488ENG]	Procedures before operation, specifications, devices, memory, functions, parameters, and troubleshooting of the programmable controller CPU module	Print book e-Manual PDF
MELSEC iQ-R Process CPU Module User's Manual [SH-082493ENG]	Procedures before operation, specifications, devices, memory, functions, parameters, and troubleshooting of the process CPU module	Print book e-Manual PDF
MELSEC iQ-R Ethernet/CC-Link IE User's Manual (Startup) [SH-081256ENG]	Specifications, procedures before operation, system configuration, wiring, and communication examples of Ethernet, CC-Link IE Controller Network, and CC-Link IE Field Network	Print book e-Manual PDF
MELSEC iQ-R Ethernet User's Manual (Application) [SH-081257ENG]	Functions, parameter settings, programming, troubleshooting, I/O signals, and buffer memory of Ethernet	Print book e-Manual PDF
MELSEC iQ-R CPU Module Function Block Reference [BCN-P5999-0374]	Specifications of the MELSEC iQ-R series CPU module FBs	e-Manual PDF
MELSEC iQ-R Ethernet, CC-Link IE, and MELSECNET/H Function Block Reference [BCN-P5999-0381]	Specifications of the following MELSEC iQ-R series module FBs: Ethernet-equipped module FBs, CC-Link IE TSN module FBs, CC-Link IE Controller Network module FBs, CC-Link IE Field Network module FBs, and MELSECNET/H network module FBs	e-Manual PDF
MELSEC iQ-R Safety Function Block Reference [BCN-P5999-0815]	Specifications of the safety FBs	e-Manual PDF
MELSEC iQ-R Programming Manual (Program Design) [SH-081265ENG]	Program specifications (ladder, ST, FBD/LD, and SFC programs)	e-Manual PDF
MELSEC iQ-R Programming Manual (CPU Module Instructions, Standard Functions/Function Blocks) [SH-081266ENG]	Instructions for the CPU module and standard functions/function blocks	e-Manual PDF
MELSEC iQ-R Programming Manual (Process Control Function Blocks/Instructions) [SH-081749ENG]	General process FBs, tag access FBs, tag FBs, and process control instructions designed for process control	e-Manual PDF
MELSEC iQ-R Programming Manual (Module Dedicated Instructions) [SH-081976ENG]	Dedicated instructions for the intelligent function modules	e-Manual PDF
GX Works3 Operating Manual [SH-081215ENG]	System configuration, parameter settings, and online operations of GX Works3	e-Manual PDF
CPU Module Logging Configuration Tool Version 1 Operating Manual (MELSEC iQ-R Series) [SH-082478ENG]	System configuration and operation/setting procedures when using CPU Module Logging Configuration Tool	e-Manual PDF

This manual does not include detailed information on the following:

- General specifications
- Applicable combinations of CPU modules and the other modules, and the number of mountable modules
- Installation

For details, refer to the following.

 MELSEC iQ-R Module Configuration Manual

This manual does not include information on the module function blocks.

For details, refer to the Function Block Reference for the module used.

e-Manual refers to the Mitsubishi Electric FA electronic book manuals that can be browsed using a dedicated tool.

e-Manual has the following features:

- Required information can be cross-searched in multiple manuals.
 - Other manuals can be accessed from the links in the manual.
 - The hardware specifications of each part can be found from the product figures.
 - Pages that users often browse can be bookmarked.
 - Sample programs can be copied to an engineering tool.
-

TERMS

Unless otherwise specified, this manual uses the following terms.

Term	Description
Backup mode	An operation mode of the redundant system. This mode can continue the operation by switching the systems from the control system to the standby system when an error occurs in the control system.
Control system	A system that takes control and performs network communications in a redundant system
Device	A memory of a CPU module to store data. Devices such as X, Y, M, D, and others are provided depending on the intended use.
Engineering tool	A tool used for setting up programmable controllers, programming, debugging, and maintenance
FB instance	A function block that is inserted to a sequence program
Global label	A label that is valid for all the program data when multiple program data are created in the project. There are two types of global label: a module specific label (module label), which is generated automatically by GX Works3, and an optional label, which can be created for any specified device.
Intelligent function module	A module that has functions other than input and output, such as an A/D converter module and D/A converter module
Label	A variable consisting of a specified string used in I/O data or internal processing
Module label	A label that represents one of memory areas (I/O signals and buffer memory areas) specific to each module in a given character string. For the module used, GX Works3 automatically generates this label, which can be used as a global label.
POU	A unit that configures a program. Units are categorized and provided in accordance with functions. Use of POUs enables dividing the lower-layer processing in a hierarchical program into some units in accordance with processing or functions, and creating programs for each unit.
Process CPU (process mode)	A Process CPU operating in process mode. Process control function blocks and the online module change function can be used.
Process CPU (redundant mode)	A Process CPU operating in redundant mode. A redundant system is configured with this CPU module. Process control function blocks and the online module change function can be used even in this mode.
Program block	A group of POUs that configure a program
Program executed in both systems	A program that is executed in both CPU modules of the control system and the standby system
Redundant function module	A module that configures a redundant system and is used with a Process CPU (redundant mode) or a SIL2 Process CPU. The redundant function module model name is R6RFM.
Redundant system	A system consisting of two systems that have same configuration (CPU module, power supply module, network module, and other modules). Even after an error occurs in one of the two system, the other system takes over the control of the entire system. For details, refer to "Redundant system" of the following manual.  MELSEC iQ-R Module Configuration Manual
Redundant system with redundant extension base unit	A redundant system that is configured using extension base unit(s)
Safety CPU	A module that performs both standard control and safety control and is used with a safety function module. The Safety CPU models include the R08SF CPU, R16SF CPU, R32SF CPU, and R120SF CPU.
Safety function module	A module that performs safety control and must be used with a Safety CPU. This module can only be used with the Safety CPU. The safety function module model name is R6SFM.
Separate mode	A mode for system maintenance in a redundant system. This mode can maintain a redundant system without stopping control while the system is running.
SIL2 function module	A module that performs safety control and must be used with a SIL2 Process CPU. This module can only be used with the SIL2 Process CPU. The SIL2 function module model name is R6PSFM.
SIL2 Process CPU	A module that performs both standard control and safety control and is used with a SIL2 function module. This module is also used with a redundant function module and configures a redundant system. The SIL2 Process CPU models include the R08PSF CPU, R16PSF CPU, R32PSF CPU, and R120PSF CPU.
Standby system	A backup system in a redundant system
System A	A system that is set as system A to distinguish two systems, which are connected with two tracking cables. When the two systems start up at the same time, this system will be a control system. System switching does not affect the system A/B setting.
System B	A system that is set as system B to distinguish two systems, which are connected with two tracking cables. When the two systems start up at the same time, this system will be a standby system. System switching does not affect the system A/B setting.

Term	Description
Tracking cable	An optical fiber cable used to connect two redundant function modules in a redundant system

The following terms are used to explain systems using the SIL2 Process CPU and the Safety CPU.

Term	Description
Pair version	Version information to determine the pairs of the SIL2 Process CPU and SIL2 function module and the pairs of the Safety CPU and Safety function module.
Safety communications	Communication service that performs send/receive processing in the safety layer of the safety communication protocol
Safety control	Machine control by safety programs and safety data communications. When an error occurs, the machine in operation is securely stopped.
Safety device	A device that can be used in safety programs
Safety program	A program that performs safety control
Standard communications	Communications other than safety communications, such as cyclic transmission and transient transmission of CC-Link IE Field Network
Standard control	Machine control by standard programs and standard data communications. Programmable controllers other than the safety programmable controller perform only standard control. (This term is used to distinguish from safety control.)
Standard device	A device (X, Y, M, D, or others) in a CPU module. (Safety devices are excluded.) This device can be used only in standard programs. (This term is used to distinguish from a safety device.)
Standard program	A program that performs sequence control. (Safety programs are excluded.) (This term is used to distinguish from a safety program.)

GENERIC TERMS AND ABBREVIATIONS

Unless otherwise specified, this manual uses the following generic terms and abbreviations.

Generic term and abbreviation	Description
Base unit	A main base unit, an extension base unit, an RQ extension base unit
I/O module	An input module, an output module, an I/O combined module, and an interrupt module
Power supply module	A MELSEC iQ-R series power supply module
Process CPU	R08PCPU, R16PCPU, R32PCPU, R120PCPU
Programmable controller CPU	R00CPU, R01CPU, R02CPU, R04CPU, R04ENCPU, R08CPU, R08ENCPU, R16CPU, R16ENCPU, R32CPU, R32ENCPU, R120CPU, R120ENCPU
RAS	Reliability, Availability, Serviceability. This term refers to the overall usability of automated equipment.
Redundant extension base unit	An extension base unit which is essential for configuring a redundant system with redundant extension base unit
RnCPU	R00CPU, R01CPU, R02CPU, R04CPU, R08CPU, R16CPU, R32CPU, R120CPU
RnENCPU	R04ENCPU, R08ENCPU, R16ENCPU, R32ENCPU, R120ENCPU
RnENCPU (CPU part)	A module on the left-hand side of the RnENCPU (see MELSEC iQ-R Ethernet/CC-Link IE User's Manual (Startup))
RnENCPU (network part)	A module on the right-hand side of the RnENCPU (see MELSEC iQ-R Ethernet/CC-Link IE User's Manual (Startup))

The following generic terms and abbreviations are used to explain systems using the SIL2 Process CPU and the Safety CPU.

Generic term and abbreviation	Description
Safety programmable controller	A MELSEC iQ-R series module that performs safety control: a Safety CPU, a safety function module, a CC-Link IE Field Network remote I/O module (with safety functions)
Standard CPU	A MELSEC iQ-R series CPU module that performs standard control (This term is used to distinguish such CPU modules from the CPU modules that perform safety control.)
Standard programmable controller	A MELSEC iQ-R series module that performs standard control (This term is used to distinguish such modules from the safety programmable controller.)

1 PART NAMES

1.1 CPU Module

This section describes the part names of the CPU module.

R00CPU

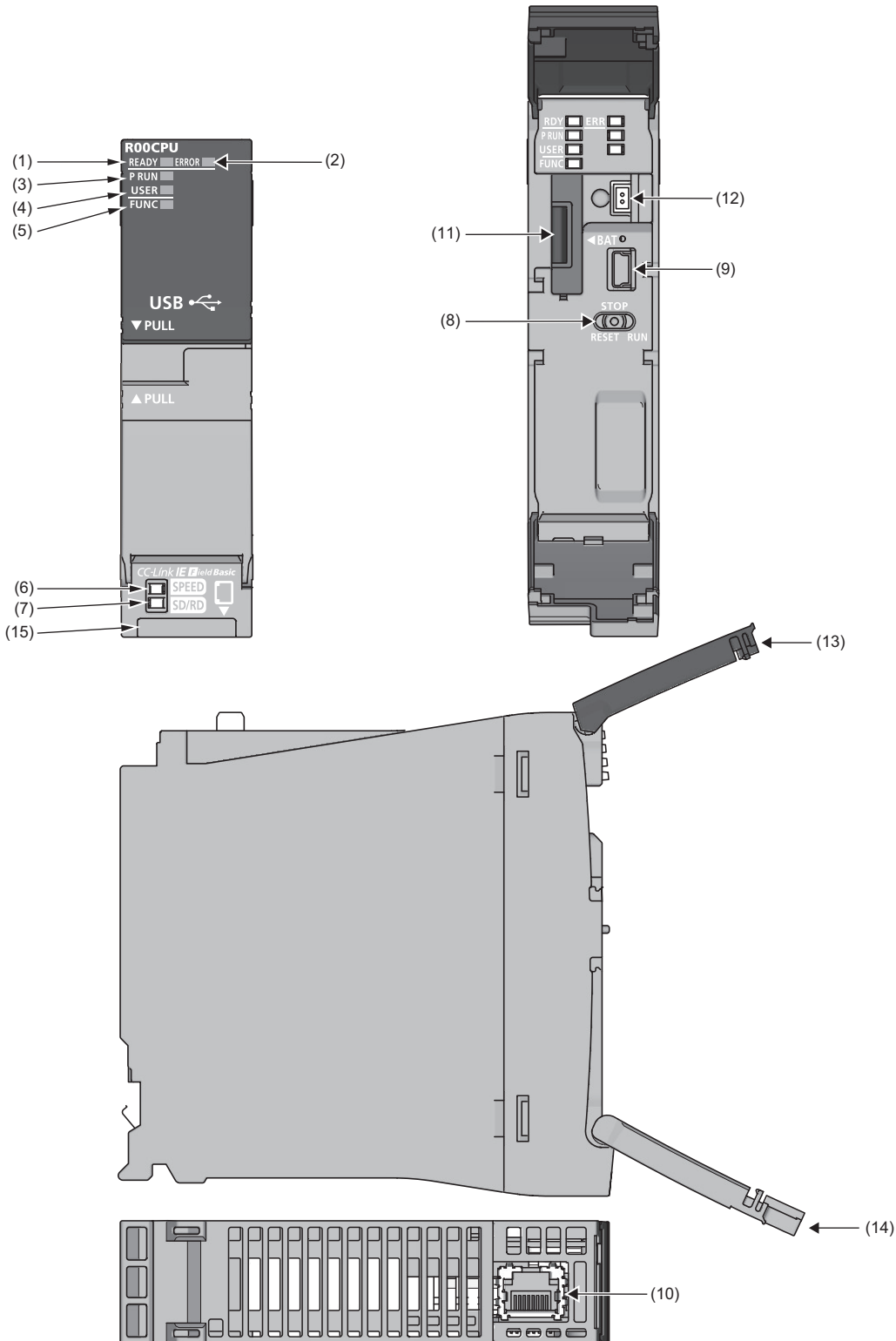

No.	Name	Description
(1)	READY LED	Indicates the operating status of the CPU module and the error level. (☞ Page 88 LED status of the CPU module)
(2)	ERROR LED	<ul style="list-style-type: none"> ● READY LED—ERROR LED status On—off: Normal operation On—on: Minor error On—flashing: Moderate error Flashing—on: Minor error Flashing (every 2s)—off: Initial processing Off—on/flashing: Major error
(3)	P RUN LED	Indicates the operating status of the program. On: Being executed (RUN state) Flashing: Being suspended (PAUSE state) Off: Stopped (STOP state) or stop error
(4)	USER LED	Indicates the status of the annunciator (F). (☞ MELSEC iQ-R CPU Module User's Manual (Application)) On: Annunciator (F) ON Off: Normal operation
(5)	FUNC LED	Turns on or flashes when the following functions are used: <ul style="list-style-type: none"> • LED setting • External input/output forced on/off function • Program restoration information write • Device test with execution condition For the LED status, refer to the description of each function. ☞ MELSEC iQ-R CPU Module User's Manual (Application)
(6)	SPEED LED	Refer to the following.
(7)	SD/RD LED	☞ MELSEC iQ-R Ethernet/CC-Link IE User's Manual (Startup)
(8)	RUN/STOP/RESET switch	A switch for controlling the operating status of the CPU module. (☞ Page 85 Executing the Program) RUN: Executes the program. STOP: Stops the program. RESET: Resets the CPU module. (Keep the switch in the RESET position for approximately one second.) Operate the RUN/STOP/RESET switch with your fingers. To prevent the switch from being damaged, do not use any tool such as a screwdriver.
(9)	USB port ^{*1}	A connector for a USB-compatible peripheral (connector type: miniB)
(10)	Ethernet port	Refer to the following. ☞ MELSEC iQ-R Ethernet/CC-Link IE User's Manual (Startup)
(11)	Battery compartment	A compartment for storing the body of the battery (FX3U-32BL) when the battery is connected.
(12)	Battery connector	A connector for connecting to the battery (FX3U-32BL)
(13)	LED cover	A cover for the LEDs, USB port, and battery. Open this cover and connect/disconnect a USB-compatible peripheral or the battery. Otherwise, keep the cover closed to prevent entry of foreign matter such as dust.
(14)	Switch cover	A cover for the RUN/STOP/RESET switch. Open this cover and set the RUN/STOP/RESET switch. Otherwise, keep the cover closed to prevent entry of foreign matter such as dust.
(15)	Production information marking	Shows the production information (16 digits) of the module.

*1 When a cable is connected to the USB connector at all times, clamp the cable to prevent a poor connection, moving, and disconnection by unintentional pulling.

R01CPU, R02CPU

The R01CPU is used as an example.

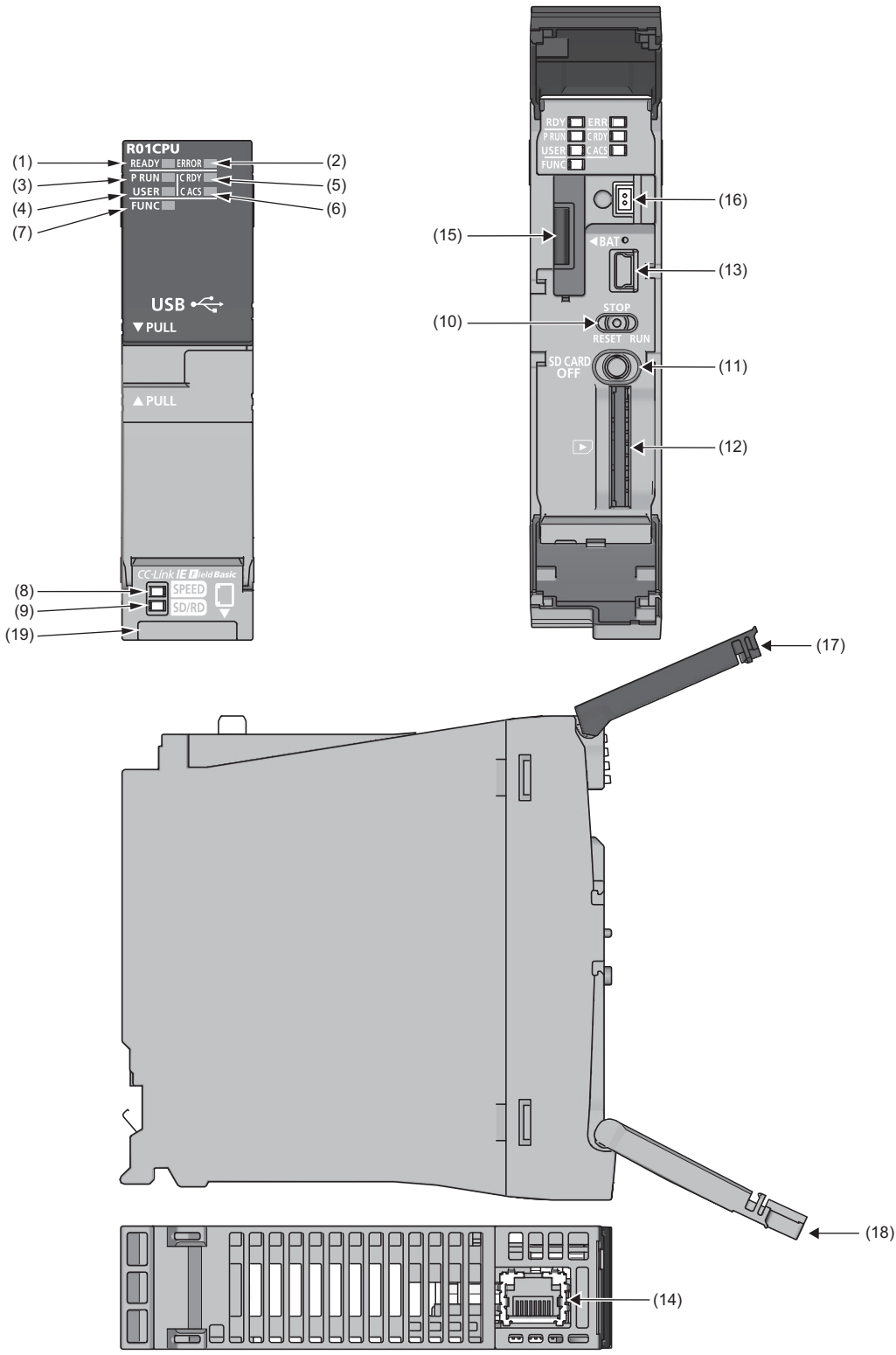







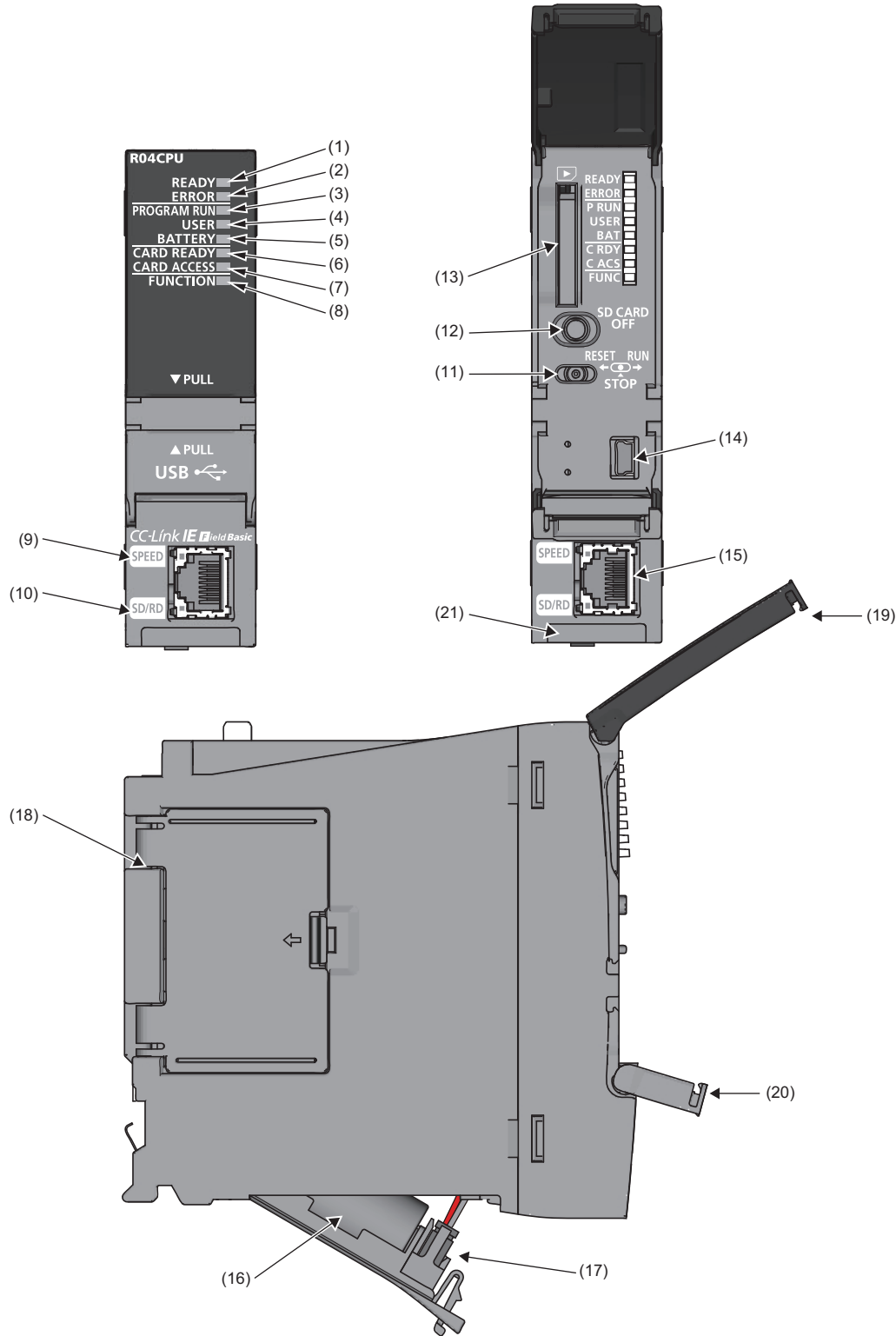

No.	Name	Description
(1)	READY LED	Indicates the operating status of the CPU module and the error level. (☞ Page 88 LED status of the CPU module) ● READY LED—ERROR LED status On—off: Normal operation On—on: Minor error On—flashing: Moderate error Flashing—on: Minor error Flashing (every 2s)—off: Initial processing Off—on/flashing: Major error
(2)	ERROR LED	
(3)	P RUN LED	Indicates the operating status of the program. On: Being executed (RUN state) Flashing: Being suspended (PAUSE state) Off: Stopped (STOP state) or stop error
(4)	USER LED	Indicates the status of the annunciator (F). (☞ MELSEC iQ-R CPU Module User's Manual (Application)) On: Annunciator (F) ON Off: Normal operation
(5)	C RDY LED	Indicates the availability of the SD memory card. On: Available Flashing: Ready Off: Not available or not inserted
(6)	C ACS LED	Indicates the access status of the SD memory card. On: Being accessed Off: Not accessed
(7)	FUNC LED	Turns on or flashes when the following functions are used: • LED setting • External input/output forced on/off function • Program restoration information write • Device test with execution condition For the LED status, refer to the description of each function. ☞ MELSEC iQ-R CPU Module User's Manual (Application)
(8)	SPEED LED	Refer to the following. ☞ MELSEC iQ-R Ethernet/CC-Link IE User's Manual (Startup)
(9)	SD/RD LED	
(10)	RUN/STOP/RESET switch	A switch for controlling the operating status of the CPU module. (☞ Page 85 Executing the Program) RUN: Executes the program. STOP: Stops the program. RESET: Resets the CPU module. (Keep the switch in the RESET position for approximately one second.) Operate the RUN/STOP/RESET switch with your fingers. To prevent the switch from being damaged, do not use any tool such as a screwdriver.
(11)	SD CARD OFF button	A switch for disabling access to the SD memory card to remove it from the CPU module (☞ Page 72 Inserting and Removing an SD Memory Card)
(12)	SD memory card slot	A slot where an SD memory card is inserted
(13)	USB port*1	A connector for a USB-compatible peripheral (connector type: miniB)
(14)	Ethernet port	Refer to the following. ☞ MELSEC iQ-R Ethernet/CC-Link IE User's Manual (Startup)
(15)	Battery compartment	A compartment for storing the body of the battery (FX3U-32BL) when the battery is connected.
(16)	Battery connector	A connector for connecting to the battery (FX3U-32BL)
(17)	LED cover	A cover for the LEDs, USB port, and battery. Open this cover and connect/disconnect a USB-compatible peripheral or the battery. Otherwise, keep the cover closed to prevent entry of foreign matter such as dust.
(18)	Switch cover	A cover for the RUN/STOP/RESET switch and SD memory card slot. Open this cover and set the RUN/STOP/RESET switch or insert or remove an SD memory card. Otherwise, keep the cover closed to prevent entry of foreign matter such as dust.
(19)	Production information marking	Shows the production information (16 digits) of the module.



*1 When a cable is connected to the USB connector at all times, clamp the cable to prevent a poor connection, moving, and disconnection by unintentional pulling.

RnCPU (except for R00CPU, R01CPU, or R02CPU), Process CPU, SIL2 Process CPU, Safety CPU

The R04CPU is used as an example.



No.	Name	Description
(1)	READY LED	Indicates the operating status of the CPU module and the error level. ( Page 88 LED status of the CPU module)
(2)	ERROR LED	<p>● READY LED—ERROR LED status</p> <p>On—off: Normal operation</p> <p>On—on: Minor error</p> <p>On—flashing: Moderate error</p> <p>Flashing—on: Minor error (Changing module online)</p> <p>Flashing (every 2s)—off: Initial processing</p> <p>Flashing (every 400ms)—off: Changing module online</p> <p>Off—on/flashing: Major error</p>
(3)	PROGRAM RUN LED	Indicates the operating status of the program. On: Being executed (RUN state) Flashing: Being suspended (PAUSE state) Off: Stopped (STOP state) or stop error
	PROGRAM RUN LED (When the Process CPU (redundant mode) or the SIL2 Process CPU is used)	<p>Indicates the operating status of the program.</p> <p>■Control system (CTRL LED of the redundant function module: On)</p> <p>On: Being executed (RUN state)</p> <p>Flashing: Being suspended (PAUSE state)</p> <p>Off: Stopped (STOP state) or stop error</p> <p>■Standby system (SBY LED of the redundant function module: On)</p> <p>[Backup mode]</p> <p>On: Being executed (programs being executed in both systems)</p> <p>Flashing: Being suspended (PAUSE state) (programs being executed in both systems)</p> <p>Off: Stopped (STOP state/RUN state/PAUSE state) (no program being executed in both systems) or stop error</p> <p>[Separate mode]</p> <p>On: Being executed (RUN state)</p> <p>Flashing: Being suspended (PAUSE state) or waiting for state transition to RUN (same as STOP state)</p> <p>Off: Stopped (STOP state) or stop error</p> <p>■Systems not determined</p> <p>Flashing: Waiting for state transition to RUN by switch operation (same as STOP state)</p> <p>Off: Normal operation</p>
(4)	USER LED	Indicates the status of the annunciator (F). ( MELSEC iQ-R CPU Module User's Manual (Application)) On: Annunciator (F) ON Off: Normal operation
(5)	BATTERY LED	Indicates the battery status. Flashing: Battery low Off: Normal operation
(6)	CARD READY LED	Indicates the availability of the SD memory card. On: Available Flashing: Ready Off: Not available or not inserted
(7)	CARD ACCESS LED	Indicates the access status of the SD memory card. On: Being accessed Off: Not accessed
(8)	FUNCTION LED	Turns on or flashes when the following functions are used: <ul style="list-style-type: none"> • LED setting • External input/output forced on/off function • Program restoration information write • Device test with execution condition For the LED status, refer to the description of each function.  MELSEC iQ-R CPU Module User's Manual (Application)
(9)	SPEED LED	Refer to the following.
(10)	SD/RD LED	 MELSEC iQ-R Ethernet/CC-Link IE User's Manual (Startup)
(11)	RUN/STOP/RESET switch	A switch for controlling the operating status of the CPU module ( Page 85 Executing the Program) RUN: Executes the program. STOP: Stops the program. RESET: Resets the CPU module. (Keep the switch in the RESET position for approximately one second.) Operate the RUN/STOP/RESET switch with your fingers. To prevent the switch from being damaged, do not use any tool such as a screwdriver.
(12)	SD CARD OFF button	A switch for disabling access to the SD memory card to remove it from the CPU module ( Page 72 Inserting and Removing an SD Memory Card)
(13)	SD memory card slot	A slot where an SD memory card is inserted
(14)	USB port ^{*1}	A connector for a USB-compatible peripheral (connector type: miniB)
(15)	Ethernet port	Refer to the following.  MELSEC iQ-R Ethernet/CC-Link IE User's Manual (Startup)

No.	Name	Description
(16)	Battery	A backup battery to hold clock data and to use the backup power function for the device/label memory
(17)	Battery connector pin	A pin for connecting a lead wire of the battery (To save the battery, the lead wire is disconnected from the connector before shipment.)
(18)	Cassette cover	A cover for the connector where an extended SRAM cassette or a battery-less option cassette is inserted ( Page 71 Inserting or Removing an Extended SRAM Cassette,  MELSEC iQ-R CPU Module User's Manual (Application))
(19)	LED cover	A cover for the LED indicators, SD memory card slot, and switches. Open this cover and insert or remove an SD memory card or set the RUN/STOP/RESET switch. Otherwise, keep the cover closed to prevent entry of foreign matter such as dust.
(20)	USB cover	A cover for the USB port. Open this cover and connect a USB-compatible peripheral. Otherwise, keep the cover closed to prevent entry of foreign matter such as dust.
(21)	Production information marking	Shows the production information (16 digits) of the module.

*1 When a cable is connected to the USB connector at all times, clamp the cable to prevent a poor connection, moving, and disconnection by unintentional pulling.

RnENCPU

The R04ENCPU is used as an example.

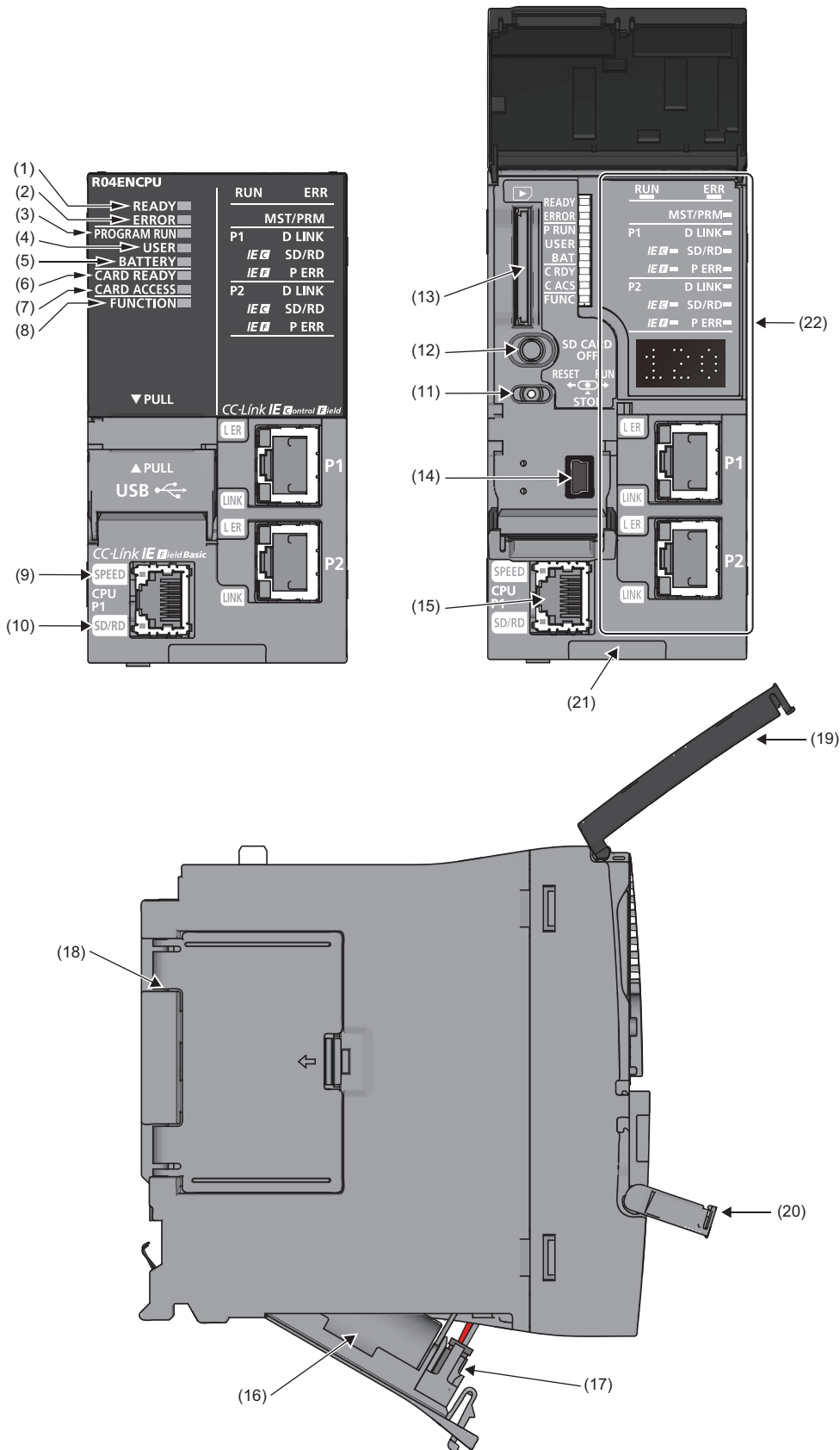

No.	Name	Description
(1)	READY LED	Indicates the operating status of the CPU module and the error level. (☞ Page 88 LED status of the CPU module)
(2)	ERROR LED	<ul style="list-style-type: none"> ● READY LED—ERROR LED status On—off: Normal operation On—on: Minor error On—flashing: Moderate error Flashing—off: Initial processing Off—on/flashing: Major error
(3)	PROGRAM RUN LED	Indicates the operating status of the program. On: Being executed (RUN state) Flashing: Being suspended (PAUSE state) Off: Stopped (STOP state) or stop error
(4)	USER LED	Indicates the status of the annunciator (F). (☞ MELSEC iQ-R CPU Module User's Manual (Application)) On: Annunciator (F) ON Off: Normal operation
(5)	BATTERY LED	Indicates the battery status. Flashing: Battery low Off: Normal operation
(6)	CARD READY LED	Indicates the availability of the SD memory card. On: Available Flashing: Ready Off: Not available or not inserted
(7)	CARD ACCESS LED	Indicates the access status of the SD memory card. On: Being accessed Off: Not accessed
(8)	FUNCTION LED	Turns on or flashes when the following functions are used: <ul style="list-style-type: none"> • LED setting • External input/output forced on/off function • Program restoration information write • Device test with execution condition For the LED status, refer to the description of each function. ☞ MELSEC iQ-R CPU Module User's Manual (Application)
(9)	SPEED LED	Refer to the following.
(10)	SD/RD LED	☞ MELSEC iQ-R Ethernet/CC-Link IE User's Manual (Startup)
(11)	RUN/STOP/RESET switch	A switch for controlling the operating status of the CPU module (☞ Page 85 Executing the Program) RUN: Executes the program. STOP: Stops the program. RESET: Resets the CPU module. (Keep the switch in the RESET position for approximately one second.) Operate the RUN/STOP/RESET switch with your fingers. To prevent the switch from being damaged, do not use any tool such as a screwdriver.
(12)	SD CARD OFF button	A switch for disabling access to the SD memory card to remove it from the CPU module (☞ Page 72 Inserting and Removing an SD Memory Card)
(13)	SD memory card slot	A slot where an SD memory card is inserted
(14)	USB port*1	A connector for a USB-compatible peripheral (connector type: miniB)
(15)	Ethernet port (CPU P1)	Refer to the following. ☞ MELSEC iQ-R Ethernet/CC-Link IE User's Manual (Startup)
(16)	Battery	A backup battery to hold clock data and to use the backup power function for the device/label memory
(17)	Battery connector pin	A pin for connecting a lead wire of the battery (To save the battery, the lead wire is disconnected from the connector before shipment.)
(18)	Cassette cover	A cover for the connector where an extended SRAM cassette or a battery-less option cassette is inserted (☞ Page 71 Inserting or Removing an Extended SRAM Cassette, ☞ MELSEC iQ-R CPU Module User's Manual (Application))
(19)	LED cover	A cover for the LED indicators, SD memory card slot, and switches. Open this cover and insert or remove an SD memory card or set the RUN/STOP/RESET switch. Otherwise, keep the cover closed to prevent entry of foreign matter such as dust.
(20)	USB cover	A cover for the USB port. Open this cover and connect a USB-compatible peripheral. Otherwise, keep the cover closed to prevent entry of foreign matter such as dust.
(21)	Production information marking	Shows the production information (16 digits) of the module.
(22)	Network part	Refer to the following. ☞ MELSEC iQ-R Ethernet/CC-Link IE User's Manual (Startup)

*1 When a cable is connected to the USB connector at all times, clamp the cable to prevent a poor connection, moving, and disconnection by unintentional pulling.

1.2 Extended SRAM Cassette and Battery-less Option Cassette

This section describes the part names of the extended SRAM cassette and the battery-less option cassette.

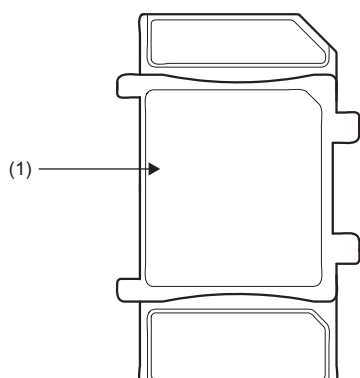

No.	Name	Description
(1)	Tab for cassette insertion/removal	A part which is held when an extended SRAM cassette or a battery-less option cassette is inserted or removed (📖 Page 71 Inserting or Removing an Extended SRAM Cassette, 📖 MELSEC iQ-R CPU Module User's Manual (Application))

1.3 Redundant Function Module

This section describes the part names of the redundant function module.

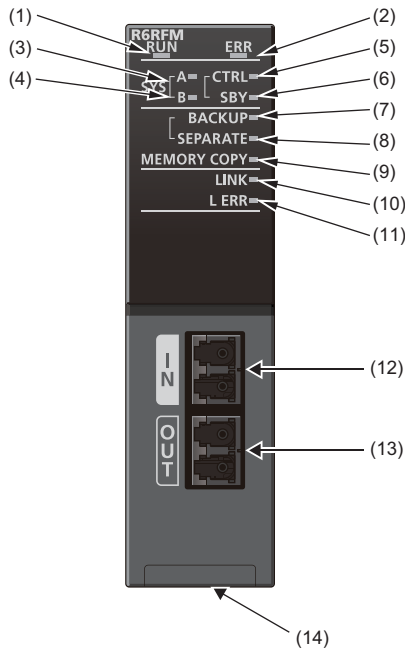

No.	Name	Description
(1)	RUN LED	Indicates the operating status. On: Normal operation Flashing: Changing module online or executing a module communication test Off: Error (MELSEC iQ-R CPU Module User's Manual (Application))
(2)	ERR LED	Indicates the error status of the module. On: Error or module communication test completed with an error (MELSEC iQ-R CPU Module User's Manual (Application)) Flashing: Error (MELSEC iQ-R CPU Module User's Manual (Application)) Off: Normal operation
(3)	SYS A LED	Indicates the system A/B setting. On: System A Flashing: Parameter (set to system A) invalid Off: System B or not set
(4)	SYS B LED	Indicates the system A/B setting. On: System B Flashing: Parameter (set to system B) invalid Off: System A or not set
(5)	CTRL LED	Indicates the control status of the CPU module. Flashing: Control system Off: Standby system or not determined
(6)	SBY LED	Indicates the control status of the CPU module. On: Standby system Off: Control system or not determined
(7)	BACKUP LED	Indicates the operation mode. On: Backup mode Flashing: Cause of system switching failure being present ^{*1} Off: Separate mode
(8)	SEPARATE LED	Indicates the operation mode. On: Separate mode Flashing: Cause of system switching failure being present ^{*1} Off: Backup mode
(9)	MEMORY COPY LED	Indicates the memory copy status. On: Memory copy completed (standby system) Flashing (every 200ms): Memory copy being executed Flashing (every 1s): Memory copy error (standby system) Off: Memory copy not executed, or memory copy completed (control system)

No.	Name	Description
(10)	LINK LED	Indicates the tracking communication status. On: Tracking communications being performed Off: Tracking communications not performed
(11)	L ERR LED	Indicates the tracking communication error. On: Tracking communication error (one of the following) <ul style="list-style-type: none"> • A receive data is faulty (receive frame error). • A tracking cable is disconnected. • A tracking cable is incorrectly inserted. Off: Normal operation
(12)	Optical connector (IN)	A connector for one of two tracking cables. The other end of the cable is connected to the OUT connector of the redundant function module in the other system.
(13)	Optical connector (OUT)	A connector for one of two tracking cables. The other end of the cable is connected to the IN connector of the redundant function module in the other system.
(14)	Production information marking	Shows the production information (16 digits) of the module.

*1 The cause of flashing can be checked in SD1642 (BACKUP/SEPARATE LED flashing cause).

1.4 SIL2 Function Module and Safety Function Module

The safety function module is used as an example.



No.	Name	Description
(1)	READY LED	Indicates the operating status of the CPU module and the error level of the safety control. (Page 88 LED status of the CPU module)
(2)	ERROR LED	<ul style="list-style-type: none"> ● READY LED—ERROR LED status On—off: Normal operation On—on: Minor error On—flashing: Moderate error Off—on/flashing: Major error
(3)	PROGRAM RUN LED	Indicates the operating status of safety programs. <ul style="list-style-type: none"> On: Safety program being executed Off: Safety program not executed or stopped
(4)	SAFETY COM RUN LED	Indicates the status of safety communications. <ul style="list-style-type: none"> On: Safety communications being executed Off: Safety communications not executed or stopped
(5)	SAFETY COM ERR LED	Indicates the status of safety communications. <ul style="list-style-type: none"> On: Error during safety communications Off: No error
(6)	TEST LED	Indicates the status in TEST MODE. <ul style="list-style-type: none"> On: TEST MODE Flashing: SAFETY MODE (wait-for-restart) Off: SAFETY MODE
(7)	Production information marking	Shows the production information (16 digits) of the module.

2 SPECIFICATIONS

2.1 CPU Module

This section describes the specifications of the CPU module.

Hardware specifications

■Programmable controller CPU

Item		R00	R01	R02	R04 R04EN	R08 R08EN	R16 R16EN	R32 R32EN	R120 R120EN		
Operation control method		Stored program cyclic operation									
I/O control mode		Refresh mode (The direct access input/output is available by specifying the direct access input/output (DX, DY).)									
Instruction processing time	LD instruction	31.3ns		3.92ns	0.98ns						
	MOV instruction	62.7ns		7.84ns	1.96ns						
Instruction processing time (structured text)	IF	31.3ns		3.92ns	1.96ns						
	CASE	31.3ns		3.92ns	1.96ns						
	FOR	31.3ns		3.92ns	1.96ns						
Memory capacity	Program capacity	10K steps (40K bytes)	15K steps (60K bytes)	20K steps (80K bytes)	40K steps (160K bytes)	80K steps (320K bytes)	160K steps (640K bytes)	320K steps (1280K bytes)	1200K steps (4800K bytes)		
	Program memory	40K bytes	60K bytes	80K bytes	160K bytes	320K bytes	640K bytes	1280K bytes	4800K bytes		
	SD memory card	— Differs depending on the SD memory card used. (SD/SDHC memory card: 32G bytes maximum)									
	Device/label memory	Total	252K bytes			400K bytes	1188K bytes	1720K bytes	2316K bytes	3380K bytes	
		Device area ^{*1}	60K bytes			80K bytes					
		Label area ^{*1}	60K bytes				80K bytes	100K bytes	180K bytes	220K bytes	
		Latch label area ^{*1}	4K bytes						8K bytes		
		File storage area ^{*1}	128K bytes			256K bytes	1024K bytes	1536K bytes	2048K bytes	3072K bytes	
	Signal flow memory	Area for programs	1.25K bytes	1.87K bytes	2.5K bytes	5K bytes	10K bytes	20K bytes	40K bytes	150K bytes	
		Area for function blocks	256K bytes			256K bytes ^{*2}					
Data memory	1.5M bytes			2M bytes	5M bytes	10M bytes	20M bytes	40M bytes			
Function memory	—			20480K bytes/5120 bytes ^{*11}							
CPU buffer memory	1072K bytes (536K words) (including the fixed scan communication area (24K words))										
Refresh memory	2048K bytes ^{*3}										
Number of storable files ^{*10}	Program memory (P: number of program files, FB: number of FB files)	P: 32, FB ^{*7} : 16		P: 64, FB ^{*7} : 32	P: 124, FB ^{*7} : 64	P: 252, FB ^{*7} : 128					
	Device/label memory (file storage area)	128 ^{*4}			324 (with or without an extended SRAM cassette) ^{*4}						
	Data memory	256 ^{*5}				512 ^{*5}					
	Function memory	—			512 ^{*6}						
	SD memory card	—		<ul style="list-style-type: none"> • NZ1MEM-2GBSD: 256^{*5} • NZ1MEM-4GBSD, NZ1MEM-8GBSD, NZ1MEM-16GBSD: 32767^{*5} 							

Item		R00	R01	R02	R04 R04EN	R08 R08EN	R16 R16EN	R32 R32EN	R120 R120EN	
Number of storable folders*10	Data memory	256*5				512*5				
	Function memory	—			512*6					
	SD memory card	—								• NZ1MEM-2GBSD: 256*5 • NZ1MEM-4GBSD, NZ1MEM-8GBSD, NZ1MEM-16GBSD: 32767*5
USB port		USB2.0 High Speed (miniB)×1								
Ethernet port		Refer to the following. 📖 MELSEC iQ-R Ethernet/CC-Link IE User's Manual (Startup)								
Clock function	Display	Year, month, date, hour, minute, second, and day of the week (automatic leap year adjustment)								
	Accuracy	-2.43 to +3.52s (TYP. +0.55s)/d at 0°C -3.08 to +3.53s (TYP. +0.23s)/d at 25°C -13.03 to +1.91s (TYP. -5.56s)/d at 55°C			-1.00 to +1.00s/d at 0 to 55°C					
Number of occupied I/O points		—			RnENCPU (network part): 32					
Backup power	Backup method	Capacitor								
	Backup power time*8	10 days			Three minutes					
	Data retained	Clock data			Device/label memory, clock data					
Allowable momentary power failure time		The time differs depending on the power supply module used. (📖 MELSEC iQ-R Module Configuration Manual)								
Internal current consumption (5VDC)		0.67A			• RnCPU: 0.67A*9 • RnENCPU: 1.49A*9					
External dimensions	Height	106mm (Base unit mounting side: 98mm)								
	Width	27.8mm			• RnCPU: 27.8mm • RnENCPU: 56mm					
	Depth	110mm								
Weight		0.20kg			• RnCPU: 0.20kg • RnENCPU: 0.40kg					

*1 The capacity of device area, label area, latch label area, and file storage area can be changed in parameter. The capacity of the device/label memory can be increased by inserting an extended SRAM cassette. (📖 MELSEC iQ-R CPU Module User's Manual (Application))

*2 For the programmable controller CPU with the firmware version "27" or earlier, the memory capacity is 20K bytes.

*3 This is the total capacity of the device area and module label area.

*4 System files are included.

*5 The number indicates the number of files and folders (including system files and system folders) can be created in the root directory on the condition that the number of characters in the file or folder name is 13 or less. In a subdirectory, up to 32767 folders can be created. Note that the number of storable files and folders will decrease if many folders with a long name, more than 13 characters (including an extension), are created.

*6 The number indicates the number of files and folders (including system files and system folders) can be created in the root directory on the condition that the number of characters in the file or folder name is 13 or less. In a subdirectory, up to 2482 folders can be created.

*7 One FB file can store 64 function blocks.

*8 These backup power times apply under the ambient temperature of 25 °C.

*9 The internal current consumption increases by 0.15A maximum when a battery-less option cassette is inserted.

10 The following characters cannot be used for file or folder names: A space, "%+./:;<=>?[\\]{}&~@^".



*11 The capacity differs depending on the firmware version and the production information of the CPU module. (📖 MELSEC iQ-R CPU Module User's Manual (Application))

Point

For the hardware specifications of the RnENCPU (network part), refer to the following.



📖 MELSEC iQ-R Ethernet/CC-Link IE User's Manual (Startup)

■ Process CPU

Item		R08P	R16P	R32P	R120P	
Operation control method		Stored program cyclic operation				
I/O control mode		Refresh mode (The direct access input/output is available by specifying the direct access input/output (DX, DY).)				
Instruction processing time	LD instruction	0.98ns				
	MOV instruction	1.96ns				
Instruction processing time (structured text)	IF	1.96ns				
	CASE	1.96ns				
	FOR	1.96ns				
Memory capacity	Program capacity	80K steps (320K bytes)	160K steps (640K bytes)	320K steps (1280K bytes)	1200K steps (4800K bytes)	
	Program memory	320K bytes	640K bytes	1280K bytes	4800K bytes	
	SD memory card	Differs depending on the SD memory card used. (SD/SDHC memory card: 32G bytes maximum)				
	Device/label memory	Total	1188K bytes	1720K bytes	2316K bytes	3380K bytes
		Device area ^{*1}	80K bytes			
		Label area ^{*1}	80K bytes	100K bytes	180K bytes	220K bytes
		Latch label area ^{*1}	4K bytes			8K bytes
	Signal flow memory	File storage area ^{*1}	1024K bytes	1536K bytes	2048K bytes	3072K bytes
		Area for programs	10K bytes	20K bytes	40K bytes	150K bytes
		Area for function blocks	256K bytes ^{*5}			
	Data memory	5M bytes	10M bytes	20M bytes	40M bytes	
CPU buffer memory	1072K bytes (536K words) (including the fixed scan communication area (24K words))					
Refresh memory	2048K bytes ^{*2}					
Number of storable files ^{*6}	Program memory (P: number of program files, FB: number of FB files)	P: 252, FB: 128 (One FB file can store 64 function blocks.)				
	Device/label memory (file storage area)	324 (with or without an extended SRAM cassette) ^{*3}				
	Data memory	512 ^{*4}				
	SD memory card	<ul style="list-style-type: none"> NZ1MEM-2GBSD: 256^{*4} NZ1MEM-4GBSD, NZ1MEM-8GBSD, NZ1MEM-16GBSD: 32767^{*4} 				
Number of storable folders ^{*6}	Data memory	512 ^{*4}				
	SD memory card	<ul style="list-style-type: none"> NZ1MEM-2GBSD: 256^{*4} NZ1MEM-4GBSD, NZ1MEM-8GBSD, NZ1MEM-16GBSD: 32767^{*4} 				
USB port		USB2.0 High Speed (miniB)×1				
Ethernet port		Refer to the following.  MELSEC iQ-R Ethernet/CC-Link IE User's Manual (Startup)				
Clock function		Year, month, date, hour, minute, second, and day of the week (automatic leap year adjustment) -1.00 to +1.00s/d at 0 to 55°C				
Allowable momentary power failure time		The time differs depending on the power supply module used. ( MELSEC iQ-R Module Configuration Manual)				
Internal current consumption (5VDC)		0.76A				
External dimensions	Height	106mm (Base unit mounting side: 98mm)				
	Width	27.8mm				
	Depth	110mm				
Weight		0.20kg				

- *1 The capacity of device area, label area, latch label area, and file storage area can be changed in parameter. The capacity of the device/label memory can be increased by inserting an extended SRAM cassette. (MELSEC iQ-R CPU Module User's Manual (Application))
- *2 This is the total capacity of the device area and module label area.
- *3 System files are included.
- *4 The number indicates the number of files and folders (including system files and system folders) can be created in the root directory on the condition that the number of characters in the file or folder name is 13 or less. In a subdirectory, up to 32767 folders can be created. Note that the number of storable files and folders will decrease if many folders with a long name, more than 13 characters (including an extension), are created.
- *5 For the programmable controller CPU with the firmware version "27" or earlier, the memory capacity is 20K bytes.
- *6 The following characters cannot be used for file or folder names: A space, "%*+./:;<=>?[\\]!{}&~@^".

■SIL2 Process CPU



Item		R08PSF	R16PSF	R32PSF	R120PSF	
Operation control method		Stored program cyclic operation				
I/O control mode		Refresh mode (The direct access input/output is available by specifying the direct access input/output (DX, DY).)				
Instruction processing time	LD instruction	0.98ns				
	MOV instruction	1.96ns				
Memory capacity	Program capacity	80K steps (320K bytes) (For safety programs: 40K steps (160K bytes))	160K steps (640K bytes) (For safety programs: 40K steps (160K bytes))	320K steps (1280K bytes) (For safety programs: 40K steps (160K bytes))	1200K steps (4800K bytes) (For safety programs: 40K steps (160K bytes))	
	Program memory	320K bytes (For safety programs: 160K bytes)	640K bytes (For safety programs: 160K bytes)	1280K bytes (For safety programs: 160K bytes)	4800K bytes (For safety programs: 160K bytes)	
	Device/label memory ^{*1}	1178K bytes	1710K bytes	2306K bytes	3370K bytes	
	Signal flow memory	Area for standard/safety programs	10K bytes	20K bytes	40K bytes	150K bytes
		Area for standard/safety function blocks	256K bytes			
	Data memory	5M bytes	10M bytes	20M bytes	40M bytes	
	CPU buffer memory	1024K bytes (512K words) (including the built-in function information area capacity 4M bytes (2K words))				
	Refresh memory	2048K bytes ^{*2}				
Number of storable files ^{*5}	Program memory (P: number of program files, FB: number of FB files)	380 (including safety programs) (P: 252, FB: 128 (One FB file can store 64 function blocks.))				
	Program memory (P: number of safety program files, FB: number of safety FB files)	48 (P: 32, FB: 16 (One FB file can store 64 function blocks.))				
	Device/label memory (file storage area)	323 (with or without an extended SRAM cassette) ^{*3}				
	Data memory	512 ^{*4}				
	SD memory card	NZ1MEM-2GBSD: 256 ^{*4} NZ1MEM-4GBSD, NZ1MEM-8GBSD, NZ1MEM-16GBSD: 32767 ^{*4}				
Number of storable folders ^{*5}	Data memory	512 ^{*4}				
	SD memory card	NZ1MEM-2GBSD: 256 ^{*4} NZ1MEM-4GBSD, NZ1MEM-8GBSD, NZ1MEM-16GBSD: 32767 ^{*4}				
USB port		USB2.0 High Speed (miniB)×1				
Ethernet port		Refer to the following.  MELSEC iQ-R Ethernet/CC-Link IE User's Manual (Startup)				
Clock function		Year, month, date, hour, minute, second, and day of the week (automatic leap year adjustment) -1.00 to +1.00s/d at 0 to 55°C				
Allowable momentary power failure time		The time differs depending on the power supply module used. ( MELSEC iQ-R Module Configuration Manual)				
Internal current consumption (5VDC)		0.76A				
External dimensions	Height	106mm (Base unit mounting side: 98mm)				
	Width	27.8mm				
	Depth	110mm				
Weight		0.20kg				

- *1 The capacity of device area, label area, latch label area, and file storage area can be changed in parameter. The capacity of the device/label memory can be increased by inserting an extended SRAM cassette. ( MELSEC iQ-R CPU Module User's Manual (Application))
- *2 This is the total capacity of the device area and module label area.
- *3 System files are included.
- *4 The number indicates the number of files and folders (including system files and system folders) can be created in the root directory on the condition that the number of characters in the file or folder name is 13 or less. In a subdirectory, up to 32767 folders can be created. Note that the number of storable files and folders will decrease if many folders with a long name, more than 13 characters (including an extension), are created.
- *5 The following characters cannot be used for file or folder names: A space, "%*+./:;<=>?[]'{}&~@^".

Point 

Wait for five seconds or longer after power-off and power on the system again. If the interval between the power-off and the power-on is short, the module may not start up.

■ Safety CPU

Item		R08SF	R16SF	R32SF	R120SF	
Operation control method		Stored program cyclic operation				
I/O control mode		Refresh mode (The direct access input/output is available by specifying the direct access input/output (DX, DY).)				
Instruction processing time	LD instruction	0.98ns				
	MOV instruction	1.96ns				
Memory capacity	Program capacity	80K steps (320K bytes) (For safety programs: 40K steps (160K bytes))	160K steps (640K bytes) (For safety programs: 40K steps (160K bytes))	320K steps (1280K bytes) (For safety programs: 40K steps (160K bytes))	1200K steps (4800K bytes) (For safety programs: 40K steps (160K bytes))	
	Program memory	320K bytes (For safety programs: 160K bytes)	640K bytes (For safety programs: 160K bytes)	1280K bytes (For safety programs: 160K bytes)	4800K bytes (For safety programs: 160K bytes)	
	Device/label memory ^{*1}	1178K bytes	1710K bytes	2306K bytes	3370K bytes	
	Signal flow memory	Area for standard/safety programs	10K bytes	20K bytes	40K bytes	150K bytes
		Area for standard/safety function blocks	256K bytes ^{*5}			
	Data memory	5M bytes	10M bytes	20M bytes	40M bytes	
	CPU buffer memory	1024K bytes (512K words) (including the built-in function information area capacity 4M bytes (2K words))				
	Refresh memory	2048K bytes ^{*2}				
Number of storable files ^{*6}	Program memory (P: number of program files, FB: number of FB files)	380 (including safety programs) (P: 252, FB: 128 (One FB file can store 64 function blocks.))				
	Program memory (P: number of safety program files, FB: number of safety FB files)	48 (P: 32, FB: 16 (One FB file can store 64 function blocks.))				
	Device/label memory (file storage area)	323 (with or without an extended SRAM cassette) ^{*3}				
	Data memory	512 ^{*4}				
	SD memory card	<ul style="list-style-type: none"> • NZ1MEM-2GBSD: 256^{*4} • NZ1MEM-4GBSD, NZ1MEM-8GBSD, NZ1MEM-16GBSD: 32767^{*4} 				
Number of storable folders ^{*6}	Data memory	512 ^{*4}				
	SD memory card	<ul style="list-style-type: none"> • NZ1MEM-2GBSD: 256^{*4} • NZ1MEM-4GBSD, NZ1MEM-8GBSD, NZ1MEM-16GBSD: 32767^{*4} 				
USB port	USB2.0 High Speed (miniB)×1					
Ethernet port	Refer to the following.  MELSEC iQ-R Ethernet/CC-Link IE User's Manual (Startup)					
Clock function	Year, month, date, hour, minute, second, and day of the week (automatic leap year adjustment) -1.00 to +1.00s/d at 0 to 55°C					
Allowable momentary power failure time	The time differs depending on the power supply module used. ( MELSEC iQ-R Module Configuration Manual)					
Internal current consumption (5VDC)	0.76A					
External dimensions	Height	106mm (Base unit mounting side: 98mm)				
	Width	27.8mm				
	Depth	110mm				
Weight	0.20kg					

- *1 The capacity of device area, label area, latch label area, and file storage area can be changed in parameter. The capacity of the device/label memory can be increased by inserting an extended SRAM cassette. (MELSEC iQ-R CPU Module User's Manual (Application))
- *2 This is the total capacity of the device area and module label area.
- *3 System files are included.
- *4 The number indicates the number of files and folders (including system files and system folders) can be created in the root directory on the condition that the number of characters in the file or folder name is 13 or less. In a subdirectory, up to 32767 folders can be created. Note that the number of storable files and folders will decrease if many folders with a long name, more than 13 characters (including an extension), are created.
- *5 For the programmable controller CPU with the firmware version "27" or earlier, the memory capacity is 20K bytes.
- *6 The following characters cannot be used for file or folder names: A space, "%*+./:;<=>?[\\]!{}&~@^".

Point 

Wait for five seconds or longer after power-off and power on the system again. If the interval between the power-off and the power-on is short, the module may not start up.

Programming specifications

■Programmable controller CPU

Item		R00	R01	R02	R04 R04EN	R08 R08EN	R16 R16EN	R32 R32EN	R120 R120EN
Programming language		<ul style="list-style-type: none"> • Ladder diagram (LD) • Sequential function chart (SFC)⁵ • Structured text (ST) • Function block diagram (FBD/LD) 							
Programming supporting function		<ul style="list-style-type: none"> • Function block (FB) • Label programming (system/local/global) 							
Program operation	Execution type	<ul style="list-style-type: none"> • Initial execution type • Scan execution type • Fixed scan execution type • Event execution type • Standby type 							
	Type of interrupt	<ul style="list-style-type: none"> • Interrupt using the internal timer (I28 to I31) • Interrupt by a module • Inter-module synchronous interrupt (I44) • Multiple CPU synchronous interrupt (I45) 				<ul style="list-style-type: none"> • Interrupt using the internal timer (I28 to I31) • High-speed internal timer interrupt 1 (I49) • High-speed internal timer interrupt 2 (I48) • Interrupt by a module • Inter-module synchronous interrupt (I44) • Multiple CPU synchronous interrupt (I45)⁶ 			
Number of executable programs		32		64		124		252	
Number of FB files		16		32		64		128	
Tact performance	Constant scan		0.5 to 2000ms (The value can be set in increments of 0.1ms.)			0.2 to 2000ms (The value can be set in increments of 0.1ms.)			
	Fixed scan interrupt	Interrupt using the internal timer (I28 to I31)	0.5 to 1000ms (The value can be set in increments of 0.5ms.)						
		High-speed internal timer interrupt 1 (I49)	—			0.05 to 1000ms (The value can be set in increments of 0.05ms.)			
		High-speed internal timer interrupt 2 (I48)	—			0.05 to 1000ms (The value can be set in increments of 0.05ms.)			
		Inter-module synchronous interrupt (I44)	0.5 to 10.00ms (The value can be set in increments of 0.05ms.)			0.1 to 10.00ms (The value can be set in increments of 0.05ms.)			
		Multiple CPU synchronous interrupt (I45) ⁶	0.5 to 10.00ms (The value can be set in increments of 0.05ms.)			0.1 to 10.00ms (The value can be set in increments of 0.05ms.)			
Timer performance	Low-speed timer		1 to 1000ms (Default: 100ms)						
	High-speed timer		0.01 to 100ms (Default: 10ms)						
	Long timer		0.001 to 1000ms (Default: 0.001ms)						
Number of I/O points		4096 points							

Item		R00	R01	R02	R04 R04EN	R08 R08EN	R16 R16EN	R32 R32EN	R120 R120EN	
Number of user device points (default)	Input (X)	8192 points (fixed)			12288 points (fixed)					
	Output (Y)	8192 points (fixed)			12288 points (fixed)					
	Internal relay (M)	8192 points (user-changeable) ^{*1}			12288 points (user-changeable) ^{*1}					
	Link relay (B)	8192 points (user-changeable) ^{*1}								
	Link special relay (SB)	2048 points (user-changeable) ^{*1}								
	Annunciator (F)	2048 points (user-changeable) ^{*1}								
	Edge relay (V)	2048 points (user-changeable) ^{*1}								
	Step relay (S) ^{*4*5}	0 points (user-changeable) ^{*1}								
	Timer device	Timer (T)	2048 points (user-changeable) ^{*1}			1024 points (user-changeable) ^{*1}				
		Long timer (LT)	0 points (user-changeable) ^{*1}			1024 points (user-changeable) ^{*1}				
	Retentive timer device	Retentive timer (ST)	0 points (user-changeable) ^{*1}							
		Long retentive timer (LST)	0 points (user-changeable) ^{*1}							
	Counter device	Counter (C)	1024 points (user-changeable) ^{*1}			512 points (user-changeable) ^{*1}				
		Long counter (LC)	0 points (user-changeable) ^{*1}			512 points (user-changeable) ^{*1}				
	Data register (D)	12288 points (user-changeable) ^{*1}			18432 points (user-changeable) ^{*1}					
	Link register (W)	8192 points (user-changeable) ^{*1}								
	Link special register (SW)	2048 points (user-changeable) ^{*1}								
Latch relay (L)	8192 points (user-changeable) ^{*1}									
Number of system device points	Special relay (SM)	4096 points (fixed)								
	Special register (SD)	4096 points (fixed)								
	Function input (FX)	16 points (fixed)								
	Function output (FY)	16 points (fixed)								
	Function register (FD)	5 points × 4 words (fixed)								
Number of file register points (default)	File register (R/ZR)	0 points (user-changeable) ^{*1}								
Number of index register points (default)	Index register (Z)	20 points (user-changeable, up to 24 points)								
	Long index register (LZ)	2 points (user-changeable, up to 12 points)								
Number of pointer points	Pointer (P) (global/local) (default)	8192 points (user-changeable, up to 16384 points)							16384 points (user-changeable, up to 32768 points)	
	Interrupt pointer (I)	1024 points (fixed)								
Number of link direct device points	Link input (J□\X□)	160K points maximum ^{*2*7}								
	Link output (J□\Y□)	160K points maximum ^{*2*7}								
	Link relay (J□\B□)	640K points maximum ^{*2*7}								
	Link register (J□\W□)	2560K points maximum ^{*2*7}								
	Link special relay (J□\SB□)	5120 points maximum ^{*2*7}								
	Link special register (J□\SW□)	5120 points maximum ^{*2*7}								
Number of module access device points	Intelligent function module device (U□\G□)	268435456 points maximum ^{*2}								

Item		R00	R01	R02	R04 R04EN	R08 R08EN	R16 R16EN	R32 R32EN	R120 R120EN
Number of CPU buffer memory access device points	Buffer memory (U3E□\G□)	268435456 points maximum*2							
	Fixed scan communication area in the buffer memory (U3E□\HG□)	12288 points maximum*3							
Number of refresh data register points (default)	Refresh data register (RD)	524288 points (1048576 points maximum)							
Number of nesting points	Nesting (N)	15 points							
Number of other device points	SFC block device (BL)*4*5	128 points			320 points				
	SFC transition device (TR)*4*5	0 points (Used only as device comments.)							

*1 For the setting range, refer to the following.

 MELSEC iQ-R CPU Module User's Manual (Application)

*2 These are the maximum points that can be handled in the CPU module. The number of points actually used differs depending on the module used.

*3 The maximum point differs depending on the parameter setting (Multiple CPU Setting).

*4 These devices are used in SFC programs. For details on SFC programs, refer to the following.

 MELSEC iQ-R Programming Manual (Program Design)

*5 If using the devices with the RnCPU, check the versions of the CPU module and engineering tool used. ( MELSEC iQ-R CPU Module User's Manual (Application))

*6 The RnENCPU does not support the use of this interrupt.

*7 The maximum number of points varies depending on "Link Direct Device Setting" of an engineering tool. When using "Link Direct Device Setting", check the versions of the CPU module and engineering tool used. ( MELSEC iQ-R CPU Module User's Manual (Application))

Point

For the programming specifications of the RnENCPU (network part), refer to the following.

 MELSEC iQ-R Ethernet/CC-Link IE User's Manual (Startup)

■ Process CPU

Item		R08P	R16P	R32P	R120P	
Programming language		<ul style="list-style-type: none"> • Ladder diagram (LD) • Sequential function chart (SFC)^{*5} • Structured text (ST) • Function block diagram (FBD/LD) 				
Programming supporting function		<ul style="list-style-type: none"> • Function block (FB) • Label programming (system/local/global) 				
Program operation	Execution type	<ul style="list-style-type: none"> • Initial execution type • Scan execution type • Fixed scan execution type • Event execution type • Standby type 				
	Type of interrupt	<ul style="list-style-type: none"> • Interrupt using the internal timer (I28 to I31) • High-speed internal timer interrupt 1 (I49) • High-speed internal timer interrupt 2 (I48) • Interrupt by a module • Inter-module synchronous interrupt (I44)^{*6} • Multiple CPU synchronous interrupt (I45)^{*6} 				
Number of executable programs		252				
Number of FB files		128				
Tact performance	Constant scan		0.2 to 2000ms (The value can be set in increments of 0.1ms.)			
	Fixed scan interrupt	Interrupt using the internal timer (I28 to I31)	0.5 to 1000ms (The value can be set in increments of 0.5ms.)			
		High-speed internal timer interrupt 1 (I49)	0.05 to 1000ms (The value can be set in increments of 0.05ms.)			
		High-speed internal timer interrupt 2 (I48)	0.05 to 1000ms (The value can be set in increments of 0.05ms.)			
		Inter-module synchronous interrupt (I44) ^{*6}	0.1 to 10.00ms (The value can be set in increments of 0.05ms.)			
		Multiple CPU synchronous interrupt (I45) ^{*6}	0.1 to 10.00ms (The value can be set in increments of 0.05ms.)			
Timer performance	Low-speed timer		1 to 1000ms (Default: 100ms)			
	High-speed timer		0.01 to 100ms (Default: 10ms)			
	Long timer		0.001 to 1000ms (Default: 0.001ms)			
Number of I/O points		4096 points				
Number of user device points (default)	Input (X)		12288 points (fixed)			
	Output (Y)		12288 points (fixed)			
	Internal relay (M)		12288 points (user-changeable) ^{*1}			
	Link relay (B)		8192 points (user-changeable) ^{*1}			
	Link special relay (SB)		2048 points (user-changeable) ^{*1}			
	Annunciator (F)		2048 points (user-changeable) ^{*1}			
	Edge relay (V)		2048 points (user-changeable) ^{*1}			
	Step relay (S) ^{*4*5}		0 points (user-changeable) ^{*1}			
	Timer device	Timer (T)		1024 points (user-changeable) ^{*1}		
		Long timer (LT)		1024 points (user-changeable) ^{*1}		
	Retentive timer device	Retentive timer (ST)		0 points (user-changeable) ^{*1}		
		Long retentive timer (LST)		0 points (user-changeable) ^{*1}		
	Counter device	Counter (C)		512 points (user-changeable) ^{*1}		
		Long counter (LC)		512 points (user-changeable) ^{*1}		
	Data register (D)		18432 points (user-changeable) ^{*1}			
	Link register (W)		8192 points (user-changeable) ^{*1}			
Link special register (SW)		2048 points (user-changeable) ^{*1}				
Latch relay (L)		8192 points (user-changeable) ^{*1}				

Item		R08P	R16P	R32P	R120P
Number of system device points	Special relay (SM)	4096 points (fixed)			
	Special register (SD)	4096 points (fixed)			
	Function input (FX)	16 points (fixed)			
	Function output (FY)	16 points (fixed)			
	Function register (FD)	5 points × 4 words (fixed)			
Number of file register points (default)	File register (R/ZR)	0 points (user-changeable) ^{*1}			
Number of index register points (default)	Index register (Z)	20 points (user-changeable, up to 24 points)			
	Long index register (LZ)	2 points (user-changeable, up to 12 points)			
Number of pointer points	Pointer (P) (global/local) (default)	8192 points (user-changeable, up to 16384 points)			16384 points (user-changeable, up to 32768 points)
	Interrupt pointer (I)	1024 points (fixed)			
Number of link direct device points	Link input (J□\X□)	16384 points maximum ^{*2}			
	Link output (J□\Y□)	16384 points maximum ^{*2}			
	Link relay (J□\B□)	32768 points maximum ^{*2}			
	Link register (J□\W□)	131072 points maximum ^{*2}			
	Link special relay (J□\SB□)	512 points maximum ^{*2}			
	Link special register (J□\SW□)	512 points maximum ^{*2}			
Number of module access device points	Intelligent function module device (U□\G□)	268435456 points maximum ^{*2}			
Number of CPU buffer memory access device points	Buffer memory (U3E□\G□)	524288 points			
	Fixed scan communication area in the buffer memory (U3E□\HG□) ^{*6}	12288 points maximum ^{*3}			
Number of refresh data register points (default)	Refresh data register (RD)	524288 points (1048576 points maximum)			
Number of nesting points	Nesting (N)	15 points			
Number of other device points	SFC block device (BL) ^{*4*5}	320 points			
	SFC transition device (TR) ^{*4*5}	0 points (Used only as device comments.)			

*1 For the setting range, refer to the following.

 MELSEC iQ-R CPU Module User's Manual (Application)

*2 These are the maximum points that can be handled in the CPU module. The number of points actually used differs depending on the module used.

*3 The maximum point differs depending on the parameter setting (Multiple CPU Setting).

*4 These devices are used in SFC programs. For details on SFC programs, refer to the following.

 MELSEC iQ-R Programming Manual (Program Design)

*5 Before using these devices, check the versions of the CPU module and engineering tool used. ( MELSEC iQ-R CPU Module User's Manual (Application))

*6 The Process CPU (redundant mode) does not support these items.

■ SIL2 Process CPU

Item			R08PSF	R16PSF	R32PSF	R120PSF	
Programming language			<ul style="list-style-type: none"> • Ladder diagram (LD) • Structured text (ST)^{*3} • Function block diagram (FBD/LD)^{*3} 				
Programming supporting function			<ul style="list-style-type: none"> • Function block (FB) • Label programming (local/global) 				
Program operation	Execution type	Standard program	<ul style="list-style-type: none"> • Initial execution type • Scan execution type • Fixed scan execution type • Event execution type • Standby type 				
		Safety program	<ul style="list-style-type: none"> • Fixed scan execution type 				
	Type of interrupt	Standard program	<ul style="list-style-type: none"> • Interrupt using the internal timer (I28 to I31) • Interrupt by a module 				
Number of executable programs		Standard program	252 (including safety programs)				
		Safety program	32				
Number of FB files		FB file	128, including the number of safety FB files (One FB file can store 64 function blocks.)				
		Safety FB file	16 (One safety FB file can store 64 function blocks.)				
Tact performance	Constant scan		0.2 to 2000ms (The value can be set in increments of 0.1ms.)				
	Fixed scan interrupt	Interrupt using the internal timer (I28 to I31)	0.5 to 1000ms (The value can be set in increments of 0.5ms.)				
Timer performance	Low-speed timer		1 to 1000ms (Default: 100ms)				
	High-speed timer		0.01 to 100ms (Default: 10ms)				
	Long timer ^{*3}		0.001 to 1000ms (Default: 0.001ms)				
Number of I/O points			4096 points				
Number of user device points (default)	Input (X) ^{*3}		12288 points (fixed)				
	Output (Y) ^{*3}		12288 points (fixed)				
	Internal relay (M) ^{*3}		12288 points (user-changeable) ^{*1}				
	Link relay (B) ^{*3}		8192 points (user-changeable) ^{*1}				
	Link special relay (SB) ^{*3}		2048 points (user-changeable) ^{*1}				
	Annunciator (F) ^{*3}		2048 points (user-changeable) ^{*1}				
	Edge relay (V) ^{*3}		2048 points (user-changeable) ^{*1}				
	Timer device	Timer (T) ^{*3}		1024 points (user-changeable) ^{*1}			
		Long timer (LT) ^{*3}		1024 points (user-changeable) ^{*1}			
	Retentive timer device	Retentive timer (ST) ^{*3}		0 points (user-changeable) ^{*1}			
		Long retentive timer (LST) ^{*3}		0 points (user-changeable) ^{*1}			
	Counter device	Counter (C) ^{*3}		512 points (user-changeable) ^{*1}			
		Long counter (LC) ^{*3}		512 points (user-changeable) ^{*1}			
	Data register (D) ^{*3}		18432 points (user-changeable) ^{*1}				
	Link register (W) ^{*3}		8192 points (user-changeable) ^{*1}				
	Link special register (SW) ^{*3}		2048 points (user-changeable) ^{*1}				
	Latch relay (L) ^{*3}		8192 points (user-changeable) ^{*1}				
Number of safety user device points (default)	Safety input (SAIX) ^{*4}		8192 points (user-selectable to either 8192 or 12288 points)				
	Safety output (SAIY) ^{*4}		8192 points (user-selectable to either 8192 or 12288 points)				
	Safety internal relay (SAIM) ^{*4}		6144 points (user-changeable) ^{*1}				
	Safety link relay (SAIB) ^{*4}		4096 points (user-changeable) ^{*1}				
	Safety timer (SAIT) ^{*4}		512 points (user-changeable) ^{*1}				
	Safety retentive timer (SAIST) ^{*4}		0 points (user-changeable) ^{*1}				
	Safety counter (SAIC) ^{*4}		512 points (user-changeable) ^{*1}				
	Safety data register (SAID) ^{*4}		12288 points (user-changeable) ^{*1}				
Safety link register (SAIW) ^{*4}		4096 points (user-changeable) ^{*1}					

Item		R08PSF	R16PSF	R32PSF	R120PSF
Number of system device points	Special relay (SM) ^{*3}	4096 points (fixed)			
	Special register (SD) ^{*3}	4096 points (fixed)			
	Function input (FX) ^{*3}	16 points (fixed)			
	Function output (FY) ^{*3}	16 points (fixed)			
	Function register (FD) ^{*3}	5 points × 4 words (fixed)			
Number of safety system device points	Safety special relay (SA\SM) ^{*4}	4096 points (fixed)			
	Safety special register (SA\SD) ^{*4}	4096 points (fixed)			
Number of file register points (default)	File register (R/ZR) ^{*3}	0 points (user-changeable) ^{*1}			
Number of index register points (default)	Index register (Z) ^{*3}	20 points (user-changeable, up to 24 points)			
	Long index register (LZ) ^{*3}	2 points (user-changeable, up to 12 points)			
Number of pointer points	Pointer (P) ^{*3} (global/local) (default)	8192 points (user-changeable, up to 16384 points)			16384 points (user-changeable, up to 32768 points)
	Interrupt pointer (I) ^{*3}	1024 points (fixed)			
Number of link direct device points	Link input (J□\X□) ^{*3}	16384 points maximum ^{*2}			
	Link output (J□\Y□) ^{*3}	16384 points maximum ^{*2}			
	Link relay (J□\B□) ^{*3}	32768 points maximum ^{*2}			
	Link register (J□\W□) ^{*3}	131072 points maximum ^{*2}			
	Link special relay (J□\SB□) ^{*3}	512 points maximum ^{*2}			
	Link special register (J□\SW□) ^{*3}	512 points maximum ^{*2}			
Number of module access device points	Intelligent function module device (U□\G□) ^{*3}	268435456 points maximum ^{*2}			
Number of CPU buffer memory access device points	Buffer memory (U3E□\G□) ^{*3}	268435456 points maximum ^{*2}			
Number of refresh data register points (default)	Refresh data register (RD) ^{*3}	524288 points (1048576 points maximum)			
Number of nesting points	Nesting (N)	15 points			

*1 For the setting range, refer to the following.

 MELSEC iQ-R CPU Module User's Manual (Application)

*2 These are the maximum points that can be handled in the CPU module. The number of points actually used differs depending on the module used.





*3 These devices cannot be used in safety programs.

*4 These devices cannot be used in standard programs.

■ Safety CPU

Item			R08SF	R16SF	R32SF	R120SF	
Programming language			<ul style="list-style-type: none"> • Ladder diagram (LD) • Sequential function chart (SFC)^{*7} • Structured text (ST)^{*4} • Function block diagram (FBD/LD)^{*4} 				
Programming supporting function			<ul style="list-style-type: none"> • Function block (FB) • Label programming (local/global) 				
Program operation	Execution type	Standard program	<ul style="list-style-type: none"> • Initial execution type • Scan execution type • Fixed scan execution type • Event execution type • Standby type 				
		Safety program	<ul style="list-style-type: none"> • Fixed scan execution type 				
	Type of interrupt	Standard program	<ul style="list-style-type: none"> • Interrupt using the internal timer (I28 to I31) • Interrupt by a module • Inter-module synchronous interrupt (I44)^{*7} • Multiple CPU synchronous interrupt (I45)^{*7} 				
Number of executable programs		Standard program	252 (including safety programs)				
		Safety program	32				
Number of FB files		FB file	128, including the number of safety FB files (One FB file can store 64 function blocks.)				
		Safety FB file	16 (One safety FB file can store 64 function blocks.)				
Tact performance	Constant scan		0.2 to 2000ms (The value can be set in increments of 0.1ms.)				
	Fixed scan interrupt	Interrupt using the internal timer (I28 to I31) ^{*4}	0.5 to 1000ms (The value can be set in increments of 0.5ms.)				
		Inter-module synchronous interrupt (I44) ^{*4*7}	1.00 to 10.00ms (The value can be set in increments of 0.05ms.)				
		Multiple CPU synchronous interrupt (I45) ^{*4*7}	1.00 to 10.00ms (The value can be set in increments of 0.05ms.)				
Timer performance	Low-speed timer		1 to 1000ms (Default: 100ms)				
	High-speed timer		0.01 to 100ms (Default: 10ms)				
	Long timer ^{*4}		0.001 to 1000ms (Default: 0.001ms)				
Number of I/O points			4096 points				
Number of user device points (default)	Input (X) ^{*4}		12288 points (fixed)				
	Output (Y) ^{*4}		12288 points (fixed)				
	Internal relay (M) ^{*4}		12288 points (user-changeable) ^{*1}				
	Link relay (B) ^{*4}		8192 points (user-changeable) ^{*1}				
	Link special relay (SB) ^{*4}		2048 points (user-changeable) ^{*1}				
	Annunciator (F) ^{*4}		2048 points (user-changeable) ^{*1}				
	Edge relay (V) ^{*4}		2048 points (user-changeable) ^{*1}				
	Step relay (S) ^{*4*7*9}		0 points (user-changeable) ^{*1}				
	Timer device	Timer (T) ^{*4}		1024 points (user-changeable) ^{*1}			
		Long timer (LT) ^{*4}		1024 points (user-changeable) ^{*1}			
	Retentive timer device	Retentive timer (ST) ^{*4}		0 points (user-changeable) ^{*1}			
		Long retentive timer (LST) ^{*4}		0 points (user-changeable) ^{*1}			
	Counter device	Counter (C) ^{*4}		512 points (user-changeable) ^{*1}			
		Long counter (LC) ^{*4}		512 points (user-changeable) ^{*1}			
	Data register (D) ^{*4}		18432 points (user-changeable) ^{*1}				
Link register (W) ^{*4}		8192 points (user-changeable) ^{*1}					
Link special register (SW) ^{*4}		2048 points (user-changeable) ^{*1}					
Latch relay (L) ^{*4}		8192 points (user-changeable) ^{*1}					

Item		R08SF	R16SF	R32SF	R120SF
Number of safety user device points (default)	Safety input (SAIX) ^{*5}	8192 points (user-selectable to either 8192 or 12288 points) ^{*6}			
	Safety output (SAIY) ^{*5}	8192 points (user-selectable to either 8192 or 12288 points) ^{*6}			
	Safety internal relay (SAIM) ^{*5}	6144 points (user-changeable) ^{*1}			
	Safety link relay (SAIB) ^{*5}	4096 points (user-changeable) ^{*1}			
	Safety timer (SAIT) ^{*5}	512 points (user-changeable) ^{*1}			
	Safety retentive timer (SAIST) ^{*5}	0 points (user-changeable) ^{*1}			
	Safety counter (SAIC) ^{*5}	512 points (user-changeable) ^{*1}			
	Safety data register (SAID) ^{*5}	12288 points (user-changeable) ^{*1}			
	Safety link register (SAIW) ^{*5}	4096 points (user-changeable) ^{*1}			
Number of system device points	Special relay (SM) ^{*4}	4096 points (fixed)			
	Special register (SD) ^{*4}	4096 points (fixed)			
	Function input (FX) ^{*4}	16 points (fixed)			
	Function output (FY) ^{*4}	16 points (fixed)			
	Function register (FD) ^{*4}	5 points × 4 words (fixed)			
Number of safety system device points	Safety special relay (SAISM) ^{*5}	4096 points (fixed)			
	Safety special register (SAISD) ^{*5}	4096 points (fixed)			
Number of file register points (default)	File register (RZR) ^{*4}	0 points (user-changeable) ^{*1}			
Number of index register points (default)	Index register (Z) ^{*4}	20 points (user-changeable, up to 24 points)			
	Long index register (LZ) ^{*4}	2 points (user-changeable, up to 12 points)			
Number of pointer points	Pointer (P) ^{*4} (global/local) (default)	8192 points (user-changeable, up to 16384 points)			16384 points (user-changeable, up to 32768 points)
	Interrupt pointer (I) ^{*4}	1024 points (fixed)			
Number of link direct device points	Link input (JIX) ^{*4}	160K points maximum ^{*2*8}			
	Link output (JIY) ^{*4}	160K points maximum ^{*2*8}			
	Link relay (JIB) ^{*4}	640K points maximum ^{*2*8}			
	Link register (JIW) ^{*4}	2560K points maximum ^{*2*8}			
	Link special relay (JISB) ^{*4}	5120 points maximum ^{*2*8}			
	Link special register (JISW) ^{*4}	5120 points maximum ^{*2*8}			
Number of module access device points	Intelligent function module device (UIG) ^{*4}	268435456 points maximum ^{*2}			
Number of CPU buffer memory access device points	Buffer memory (U3EIG) ^{*4}	268435456 points maximum ^{*2}			
	Fixed scan communication area in the buffer memory (U3EIHG) ^{*4}	12288 points maximum ^{*3}			
Number of refresh data register points (default)	Refresh data register (RD) ^{*4}	524288 points (1048576 points maximum)			
Number of nesting points	Nesting (N)	15 points			
Number of other device points	SFC block device (BL) ^{*4*7*9}	320 points			

- *1 For the setting range, refer to the following.
 MELSEC iQ-R CPU Module User's Manual (Application)
- *2 These are the maximum points that can be handled in the CPU module. The number of points actually used differs depending on the module used.
- *3 The maximum point differs depending on the parameter setting (Multiple CPU Setting).
- *4 These devices cannot be used in safety programs.
- *5 These devices cannot be used in standard programs.
- *6 If selecting 12288 points, check the versions of the CPU module and engineering tool used. ( MELSEC iQ-R CPU Module User's Manual (Application))
- *7 Before use, check the versions of the CPU module and engineering tool used. ( MELSEC iQ-R CPU Module User's Manual (Application))
- *8 The maximum number of points varies depending on "Link Direct Device Setting" of an engineering tool. When using "Link Direct Device Setting", check the versions of the CPU module and engineering tool used. ( MELSEC iQ-R CPU Module User's Manual (Application))
- *9 These devices are used in SFC programs. For details on SFC programs, refer to the following.
 MELSEC iQ-R Programming Manual (Program Design)

2.2 Extended SRAM Cassette

This section describes the performance specifications of the extended SRAM cassette.

Item	NZ2MC-1MBS	NZ2MC-2MBS	NZ2MC-4MBS	NZ2MC-8MBS	NZ2MC-16MBS	NZ2MC-2MBSE (ECC-compatible)	NZ2MC-8MBSE (ECC-compatible)
Capacity	1M bytes	2M bytes	4M bytes	8M bytes	16M bytes	2M bytes	8M bytes
Number of insertions and removals	Limited to 50 times						
External dimensions	Height	49mm					
	Width	32mm					
	Depth	18.5mm					
Weight	20g						
Applicable CPU module	<ul style="list-style-type: none"> Programmable controller CPU^{*2} Safety CPU 				Programmable controller CPU ^{*1*2}	<ul style="list-style-type: none"> Process CPU SIL2 Process CPU^{*1} Safety CPU 	<ul style="list-style-type: none"> Process CPU SIL2 Process CPU Safety CPU

*1 Check the versions of the CPU module and engineering tool used. (MELSEC iQ-R CPU Module User's Manual (Application))

*2 The R00CPU, R01CPU, and R02CPU do not support the use of these devices.

2.3 Battery-less Option Cassette

This section describes the performance specifications of the battery-less option cassette.

Item	NZ1BLC	
Number of insertions and removals	Limited to 50 times	
Internal current consumption (5VDC)	0.15A	
External dimensions	Height	49mm
	Width	32mm
	Depth	18.5mm
Weight	20g	
Applicable CPU module	Programmable controller CPU ^{*1*2}	

*1 Check the versions of the CPU module and engineering tool used. (MELSEC iQ-R CPU Module User's Manual (Application))

*2 The R00CPU, R01CPU, and R02CPU do not support the use of these devices.

2.4 Redundant Function Module

This section describes the specifications of the redundant function module.

Item		R6RFM
Tracking cable	Cable specifications	An optical fiber cable compliant with the following standards (multimode optical fiber (GI)) <ul style="list-style-type: none"> • IEEE 802.3 (1000BASE-SX) • IEC 60793-2-10 (Types A1a.1)
	Maximum cable length	550m
Optical fiber specifications		Standard: IEEE 802.3, IEC 60793-2-10 (Types A1a.1) Outside diameter of the core/clad: 50μm/125μm Transmission loss: 3.5dB/km or lower [$\lambda=850\text{nm}$] Transmission band: 500MHz·km or more [$\lambda=850\text{nm}$]
Connector specifications		Duplex LC connector Standard: IEC 61754-20 (Type LC connector) Connection loss: 0.3dB or lower Polished surface: PC (Physical Contact) polishing
Laser class (IEC60825-1)		Class 1 laser product
Number of occupied I/O points		32 points ^{*1}
Internal current consumption (5VDC)		0.88A
External dimensions	Height	106mm (Base unit mounting side: 98mm)
	Width	27.8mm
	Depth	110mm
Weight		0.18kg

*1 The use of all the I/O signals is prohibited because they are used by the system.

Point

Optical fiber cables with connectors are available from Mitsubishi Electric System & Service Co., Ltd. (Catalogs of the optical fiber cables are also available.)

- Type: Multimode optical fiber (GI)
- Model: QG series

In addition, on-site connector polishing, terminal assembly, and fusion splicing is available. Please consult Mitsubishi Electric System & Service Co., Ltd.

2.5 SIL2 Function Module

This section describes the specifications of the SIL2 function module.

Hardware specifications

Item		R6PSFM
Operation control method		Stored program cyclic operation
Memory capacity	Program capacity	40K steps (160K bytes)
	Program memory	160K bytes
	Device/label memory	80K bytes
Number of occupied I/O points		16 points*1
Buffer memory		4096K bytes
Allowable momentary power failure time		The time differs depending on the power supply module used. (☞ MELSEC iQ-R Module Configuration Manual)
Internal current consumption (5VDC)		0.67A
External dimensions	Height	106mm (Base unit mounting side: 98mm)
	Width	27.8mm
	Depth	110mm
Weight		0.16kg

*1 The use of all the I/O signals is prohibited because they are used by the system. These I/O signals are not used for safety control, and thus they do not cause a malfunction of the safety control system.

Point

Wait for five seconds or longer after power-off and power on the system again. If the interval between the power-off and the power-on is short, the module may not start up.

2.6 Safety Function Module

This section describes the specifications of the safety function module.

Hardware specifications

Item			R6SFM
Operation control method			Stored program cyclic operation
Memory capacity	Program capacity	Safety program	40K steps (160K bytes)
	Program memory	Safety program	160K bytes
	Device/label memory	Safety program	80K bytes
Number of occupied I/O points			16 points*1
Buffer memory			4096K bytes
Allowable momentary power failure time			The time differs depending on the power supply module used. (MELSEC iQ-R Module Configuration Manual)
Internal current consumption (5VDC)			0.67A
External dimensions	Height	106mm (Base unit mounting side: 98mm)	
	Width	27.8mm	
	Depth	110mm	
Weight			0.16kg

*1 The use of all the I/O signals is prohibited because they are used by the system. These I/O signals are not used for safety control, and thus they do not cause a malfunction of the safety control system.

Point

Wait for five seconds or longer after power-off and power on the system again. If the interval between the power-off and the power-on is short, the module may not start up.

3 FUNCTION LIST

The following table lists the functions of the CPU module.



Numbers in the Availability column indicate the CPU modules:

Rn: RnCPU, RnEN: RnENCPU, RnP(P): Process CPU (process mode), RnP(R): Process CPU (redundant mode), RnPSF: SIL2 Process CPU, RnSF: Safety CPU

○: Supported, ×: Not supported

For details on the functions, refer to the following.

 MELSEC iQ-R CPU Module User's Manual (Application)

Function		Description	Availability*1					
			Rn	RnEN	RnP(P)	RnP(R)	RnPSF	RnSF
Constant scan		Repeatedly runs a program while retaining the scan time constant.	○	○	○	○	○	○
Device/label access service processing setting		Sets the time or execution timing of the device/label access service processing performed in the END processing in parameter.	○	○	○	○	○	○
Device/label access service processing constant wait function		Improves the communication response of device/label access service processing requests. Based on SM315 (Service processing constant wait setting flag) and SD315 (Service processing constant wait status setting), device/label access service processing requests are accepted until the time or ratio set for the device/label access service processing setting of the CPU parameters is reached.	×	×	○	○	×	×
Interrupt function	Multiple interrupt function	When an interrupt occurs while an interrupt program triggered by another cause is running, stops the program if its priority is lower than that of the new interrupt, and runs the higher-priority program whenever its execution condition is satisfied.	○	○	○	○	○	○
Output mode setting when the status changed from STOP to RUN		Sets the output (Y) status when the operating status of the CPU module is switched from STOP to RUN.	○	○	○	○	○	○
Device/label memory area setting		Sets the capacity of each area in the device/label memory.	○	○	○	○	○	○
Internal buffer capacity setting		Sets the capacity of the area (internal buffer) used by the system to temporarily store the results of data logging and memory dump processing.	○ ^{*3}	○	○	○	×	○
SD memory card forced disable		Forcibly disables an access to the SD memory card without powering off the system even when the function that accesses the SD memory card is being executed. ( MELSEC iQ-R CPU Module User's Manual (Application))	○ ^{*3}	○	○	○	○	○
Clock function		Manages time for the system functions such as time stamps for the event history function and date information for the data logging function.	○	○	○	○	○	○
Writing data to the CPU module	Writing data to the programmable controller	Writes the specified data of the project with the engineering tool to the memory of the CPU module. ( GX Works3 Operating Manual)	○	○	○	○	○	○
	Online change (ladder block)	Writes the part of a program edited on the ladder editor using the engineering tool to the running CPU module in units of ladder blocks. Edited contents spanning multiple files or multiple portions can be written to the CPU module at once.	○	○	○	○	○	○
	Online change (files)	Writes programs and other data to the running CPU module in units of files. ( GX Works3 Operating Manual)	○	○	○	○	○	○

Function		Description	Availability ^{*1}					
			Rn	RnEN	RnP(P)	RnP(R)	RnPSF	RnSF
RAS function	Scan monitoring function	Detects a hardware failure or program error by monitoring that the END processing is performed within a set scan time.	○	○	○	○	○	○
	Self-diagnostics function	Self-diagnoses the CPU module to see whether an error exist or not.	○	○	○	○	○	○
	FB hierarchy information	Displays the FB hierarchy information of the function block with an error in the "Module Diagnostics" window. (GX Works3 Operating Manual)	○	○	○	○	×	×
	Error clear	Batch-clears all the continuation errors being detected.	○	○	○	○	○	○
	Event history function	Collects operations executed and errors detected from the modules, and saves them in the CPU module. The saved logs can be checked in chronological order.	○	○	○	○	○	○
	Online module change	Replaces a module without stopping the system. (MELSEC iQ-R Online Module Change Manual)	×	×	○	○	○	×
	Program cache memory auto recovery function	Automatically detects and recovers the data stored in the program cache memory of the CPU module at the time of program execution if the data is overwritten due to the factors such as excessive electrical noise.	○	○	○	○	○	○
Remote operation		Remotely controls the operating status of the CPU module without switch operation.	○	○	○	○	○	○
Boot operation		Transfers files in the SD memory card to the built-in memory of the CPU module when the CPU module is powered off and on or reset.	○ ^{*3}	○	○	○	×	×
Monitor function	Circuit monitor	Checks the status of a running program on the program editor. (GX Works3 Operating Manual)	○	○	○	○	○	○
	Device/buffer memory batch monitor	Monitors values in devices and buffer memory using the engineering tool connected. (GX Works3 Operating Manual)	○	○	○	○	○	○
	Watch	Registers devices and labels, and checks the current values. (GX Works3 Operating Manual)	○	○	○	○	○	○
	Program monitor list	Monitors the execution time of each program and the number of executions using the engineering tool connected. (GX Works3 Operating Manual)	○	○	○	○	○	○
	Interrupt program monitor list	Monitors the number of executions of interrupt programs using the engineering tool connected. (GX Works3 Operating Manual)	○	○	○	○	○	○
	Real-time monitor function	Monitors the data in the specified device of the CPU module at a specified interval or at a desired timing in real time.	○	○	×	×	×	○
	Scan time measurement	Measures the processing time of the set program section and displays it on the engineering tool.	○	○	×	×	×	○
	Scan time clear	Clears values of the scan time at a desired timing without stopping the CPU module. (GX Works3 Operating Manual)	○	○	×	×	×	○
	Specified program monitor	Checks (monitors) device/label values in the program specified by the engineering tool on the program editor and changes current values.	○	○	×	×	×	○
Test function	External input/output forced on/off function	Forcibly turns on/off the external input/output from the engineering tool.	○	○	○	○	×	○
	Device test with execution condition	Changes a device value for the specified step of a program, using the engineering tool.	○	○	○	○	×	○
Data logging function		Collects data at a specified interval or a desired timing, and stores them as a file.	○ ^{*3}	○	○	○	×	○
Recording function		Saves the device/label data set in the engineering tool into an SD memory card in the recorder module at the specified timing. (MELSEC iQ-R System Recorder User's Manual (Startup), MELSEC iQ-R System Recorder User's Manual (Application))	○ ^{*2}	○	×	×	×	○
Debug function	Memory dump function	Saves the data in the devices of the CPU module at a desired timing.	○ ^{*3}	○	×	×	×	○

Function		Description	Availability ^{*1}					
			Rn	RnEN	RnP(P)	RnP(R)	RnPSF	RnSF
SFC function		Executes programs written in sequential function chart (SFC). (MELSEC iQ-R Programming Manual (Program Design))	○	○	○	○	×	○
Database function	Database access instruction	Adds, updates, obtains, or deletes data with respect to the tabular data such as product and production information managed as databases on a SD memory card of the CPU module.	○ ^{*2}	○	×	×	×	×
	CPU module database access (from external device) function	Operates a database, that is built in an SD memory card inserted into the CPU module, through the Ethernet port of the CPU module from an application on a personal computer.	○ ^{*2}	○	×	×	×	×
PID control function		Performs PID control by using the PID operation instruction. (MELSEC iQ-R Programming Manual (CPU Module Instructions, Standard Functions/Function Blocks))	○	○	○	○	○	○
Process control function		A process control program can be easily created by using process control function blocks. (MELSEC iQ-R Programming Manual (Process Control Function Blocks/Instructions))	×	×	○	○	○	×
CPU module data backup/restoration function		Backs up data such as program files, parameter files, and device/label data files in a CPU module to an SD memory card. The data backed up can be restored as necessary.	○ ^{*2}	○	○	○	×	○
Multiple CPU system function	Out-of-group I/O fetch	Enables loading the input and output data of non-controlled modules.	○	○	○	×	×	○
	Multiple CPU synchronized startup	Synchronizes the startup of CPU modules in a multiple CPU system so that operations of all the CPU modules start at the unified time.	○	○	○	×	×	○
	Data communications between CPU modules	Communicates data between CPU modules in a multiple CPU system.	○	○	○	×	×	○
	Multiple CPU synchronous interrupt	Executes an interrupt program at the fixed communication timing set in parameter.	○	○	○	×	×	○
Security function	User authentication function	Limits access to the project or the CPU module by setting a user name and password.	×	×	×	×	○	○
	Block password function	Prevents unauthorized access to programs (in units of POU's).	○	○	○	○	○	○
	Security key authentication function	Prevents unauthorized access to programs (in units of program files) or unauthorized execution of programs.	○	○	○	○	○	○
	File password function	Prevents unauthorized reading/writing of data from/to files.	○	○	○	○	○	○
	IP filter function	Identifies the IP address of external devices over Ethernet, and blocks access from an invalid IP address.	○	○	○	○	○	○
	Remote password function	Limits access from external devices to the CPU module to the specific communication route via Ethernet.	○	○	○	○	○	○
	Write-protect function for device data (from outside the CPU module)	Disables writing to devices from engineering tools and GOTs. Protected devices and their ranges can be set by the user. By using this function, desired device data can be protected from tampering.	○	○	×	×	×	×
Sequence scan synchronization sampling function		Collects data of the CPU module in synchronization with the sequence scan of the CPU module between each module.	○	○	×	×	×	○

Function		Description	Availability ^{*1}					
			Rn	RnEN	RnP(P)	RnP(R)	RnPSF	RnSF
Label initialization function	Label initialization after converting all programs (reassignment)	Initializes (sets initial values or clears to zero) all the labels by powering off and on the CPU module or changing its operating status from STOP to RUN after all programs are converted by using the engineering tool (the label memory area is reassigned) and written to the programmable controller.	×	×	○	○	○	×
	Label initialization with label initial values	Sets whether to initialize the labels with label initial values or not when the operating status changes from STOP to RUN. Label initial values are not set to the labels by default when the operating status changes from STOP to RUN.	×	×	○	○	○	×
Routing setting		Sets the communication path required for transient communication to the stations on the different network.	○	○	○	○	○	○
Label access setting from external device		Enables communications specifying the global label name from the GOT and external devices using SLMP.	○ ^{*2}	○	○	○	○	○
Latch function	Latch with a battery	Holds the device/label data in the CPU module even at power-off.	○	○	○	○	○	○
	Latch with a battery-less option cassette	Holds the device/label data in the CPU module without a battery when a battery-less option cassette is inserted into the CPU module.	○ ^{*2}	○	×	×	×	×
Initial device/label value setting		Sets the initial values of devices and labels used in the program directly (not via the program) to the devices, labels, and buffer memory areas of intelligent function modules.	○	○	○	○	○	○

Function		Description	Availability ^{*1}					
			Rn	RnEN	RnP(P)	RnP(R)	RnPSF	RnSF
Redundant function	Operation mode change	Switches the operation mode of the redundant system between the backup mode for normal operation and the separate mode for system maintenance while it is running.	×	×	×	○	×	×
	System switching	Switches the systems between the control system and the standby system to continue operation of the redundant system when a failure or an error occurs in the control system. For debugging and maintenance purpose, users can switch the systems at any desired timing.	×	×	×	○	○	×
	Tracking transfer	Transfers the control data from the control system to the standby system and maintains the consistency of the data in the two systems to continue operation of the redundant system when a failure or an error occurs in the control system.	×	×	×	○	○	×
	Memory copy from control system to standby system	Transfers data such as parameters and programs in the CPU module of the control system to the CPU module of the standby system to maintain the consistency of the memory in the two CPU modules.	×	×	×	○	○	×
	System consistency check	Checks whether the system configurations and files in the CPU modules are the same between the control system and the standby system when the redundant system is in backup mode.	×	×	×	○	○	×
	Program execution in both systems	Detects an error in the external device or network of the systems (control system and standby system) by executing a program that diagnoses external devices or networks of both systems.	×	×	×	○	○	×
	Redundant system operation setting	Set the redundant system operation in the redundant system settings of the CPU parameter.	×	×	×	○	○	×
	Redundant function module communication test	Checks a redundant function module for error when the communications of the redundant function module are unstable.	×	×	×	○	○	×
	Setting for redundant system with redundant extension base unit	Set the operation of the redundant system with redundant extension base unit in the redundant system settings of the CPU parameter.	×	×	×	○	×	×
	Automatic standby system recovery	Automatically recover the CPU module of the standby system if a specific error occurs in the CPU module of the standby system. (Manual operation (turning off and on or resetting the system) is not required to recover the system.)	×	×	×	○	×	×
Replacement/addition of an extension cable (online)	The extension cable on the inactive side (ACTIVE LED is turned off) between the redundant extension base units can be replaced or added while the system is running.	×	×	×	○	×	×	
Safety operation mode	There are two modes for the SIL2 Process CPU and Safety CPU: TEST MODE and SAFETY MODE. One mode is for changing the safety program or safety parameters, and the other is for operating the system as a safety system.	×	×	×	×	○	○	
Safety operation mode	There are two modes for the SIL2 Process CPU and Safety CPU: TEST MODE and SAFETY MODE. One mode is for changing the safety program or safety parameters, and the other is for operating the system as a safety system.	×	×	×	×	○	○	
Continuous RUN prevention in TEST MODE	Starts the measurement of RUN time when the Safety CPU enters the RUN state in TEST MODE, and generates a continuation error when the continuous RUN time has exceeded the allowed time.	×	×	×	×	×	○	
Safety diagnostic function	Self-diagnostic function of the SIL2 Process CPU and Safety CPU	×	×	×	×	○	○	

Function		Description	Availability ^{*1}					
			Rn	RnEN	RnP(P)	RnP(R)	RnPSF	RnSF
Safety data identify check		Checks if the project data created using the engineering tool and the data in the CPU module are the same, and confirms that the program executed in SAFETY MODE is the one written by the user.	×	×	×	×	○	○
Safety communication function		Communicates data between the SIL2 Process CPU or Safety CPU and modules supporting safety functions using safety protocols.	×	×	×	×	○	○
Ethernet function		Accesses the CPU module over Ethernet. Using this function, the CPU module can connect to MELSOFT products and GOTs, perform socket communications, and transfer FTP files.	📖 MELSEC iQ-R Ethernet/CC-Link IE User's Manual (Startup)					
SLMP communication function		Enables accesses to devices/labels and remote operations from external devices other than the engineering tool by sending request messages using SLMP. (📖 SLMP Reference Manual)	○	○	○	○	○	○
Inter-module synchronization function		Controls multiple modules synchronously. (📖 MELSEC iQ-R Inter-Module Synchronization Function Reference Manual)	○	○	○	×	×	○
CC-Link IE Field Network Basic function		Function available in CC-Link IE Field Network Basic	📖 CC-Link IE Field Network Basic Reference Manual					
iQ Sensor Solution function		Functions provided by iQ Sensor Solution	📖 iQ Sensor Solution Reference Manual					
Firmware update function	Update using the engineering tool	Enables users to update firmware versions of CPU modules and intelligent function modules using the engineering tool. (📖 MELSEC iQ-R Module Configuration Manual)	○	○	○	○	×	×
	Update using an SD memory card	Enables users to update firmware versions of CPU modules and intelligent function modules using an SD memory card. (📖 MELSEC iQ-R Module Configuration Manual)	○ ^{*3}	○	○	○	×	×

*1 Some functions have restrictions on the firmware version and the production information of the CPU module used or the version of the engineering tool used. Refer to "Added and Enhanced Functions" in the following.

📖 MELSEC iQ-R CPU Module User's Manual (Application)

*2 The R00CPU, R01CPU, and R02CPU does not support the use of these functions.

*3 The R00CPU does not support the use of these functions.

4 PROCEDURES BEFORE OPERATION

This chapter describes the procedures before operation.

Point

Unless otherwise specified, windows of the engineering tool used for explanation in this chapter are those of the project using the RnCPU. If the CPU module other than the RnCPU is used, windows actually displayed may be different from those in this manual.

4.1 Overview

This section describes an outline of the procedure before operation for each CPU module.

Programmable controller CPU, Process CPU

Take the following procedure when using the programmable controller CPU and Process CPU (process mode).

Point

The procedure in a redundant system using the Process CPU (redundant mode) is partially different. For details, refer to the following.

 MELSEC iQ-R CPU Module User's Manual (Application)

1. Installing a battery

Install a battery to the CPU module. ( Page 70 Installing a Battery)



Point

R00CPU, R01CPU, and R02CPU are the CPU modules that do not need a battery for holding data.

Use the battery (FX3U-32BL) to save clock data in the event of a long-term (10 days or more) power failure.

( Page 70 FX3U-32BL)

2. Inserting a cassette (an extended SRAM cassette or a battery-less option cassette) or an SD memory card

Insert a cassette (an extended SRAM cassette or a battery-less option cassette) or an SD memory card into the CPU module as needed. ( Page 71 Inserting or Removing an Extended SRAM Cassette,  Page 72 Inserting and Removing an SD Memory Card)

Point

When inserting a battery-less option cassette, refer to "Latch with Battery-less Option Cassette". ( MELSEC iQ-R CPU Module User's Manual (Application))

3. Mounting modules and connecting cables

Mount modules on the base unit, and connect cables. ( MELSEC iQ-R Module Configuration Manual)

4. Powering on the system

Check the following before powering on the system.

- A cable is correctly connected to the power supply.
- Power supply voltage is within the specified range.
- The CPU module is in the STOP state.
- A personal computer on which an engineering tool has been installed is connected to the CPU module. ( Page 75 Connecting a Personal Computer)

5. Powering on the personal computer

Power on the personal computer on which the engineering tool has been installed (the personal computer connected to the CPU module).

6. Starting up the engineering tool

Start up the engineering tool that has been installed on the personal computer connected to the CPU module.

7. Initializing the CPU module

Initialize the CPU module using the engineering tool. (☞ Page 76 Initializing the CPU Module)

8. Setting parameters

The following table shows which parameters are required when changing the number of slots/the number of occupied points of a module, using an SD memory card, or using specific functions.

When	Required parameter	Reference
Changing the number of slots or the number of occupied points of a module	<ul style="list-style-type: none"> • System parameters • CPU parameters 	☞ Page 76 Setting Parameters
Using an SD memory card	<ul style="list-style-type: none"> • Memory card parameters 	📖 MELSEC iQ-R CPU Module User's Manual (Application)
Using the Ethernet function of the CPU module	<ul style="list-style-type: none"> • Module parameters Some intelligent function modules require multiple module parameters and module extension parameters.	📖 MELSEC iQ-R CPU Module User's Manual (Application)
Using the CC-Link IE Field Network Basic function of the CPU module		📖 CC-Link IE Field Network Basic Reference Manual
Using an intelligent function module		📖 User's manual for the module used

When the RnENCPU is used, set network parameters to the network part as well. (📖 User's Manual (Application) for the network used)

System parameters are automatically set by loading an actual system configuration to the Module Configuration window of the engineering tool.

9. Programming

Create a program using the engineering tool. (☞ Page 79 Programming)

10. Writing data to the programmable controller

Write the parameters set and the program created by using the engineering tool to the CPU module. (☞ Page 83 Writing Data to the Programmable Controller)

11. Resetting the CPU module

Restart the system in either of the following ways.

- Power off and on the system.
- Reset the CPU module. (☞ Page 84 Resetting the CPU Module)

12. Checking for errors

Check the status of the READY LED and ERROR LED of the CPU module. If an error is detected, identify the error using the engineering tool, and eliminate the error cause. (☞ Page 87 Troubleshooting)

13. Executing the program

Run the CPU module, and check that the PROGRAM RUN LED (P RUN LED) turns on. (☞ Page 85 Executing the Program)

14. Monitoring the program

Check that the program operates normally using the engineering tool. (☞ Page 86 Monitoring the program)

SIL2 Process CPU

For the procedure in a system using the SIL2 Process CPU, refer to the following.

📖 MELSEC iQ-R CPU Module User's Manual (Application)

Safety CPU

Take the following procedure.

1. Installing a battery

Install a battery to the CPU module. (☞ Page 70 Installing a Battery)

2. Inserting an extended SRAM cassette and an SD memory card

Insert an extended SRAM cassette or an SD memory card or both to the CPU module as needed. (☞ Page 71 Inserting or Removing an Extended SRAM Cassette, ☞ Page 72 Inserting and Removing an SD Memory Card)

3. Mounting modules and connecting cables

Mount modules on the base unit, and connect cables.

Mount the safety function module on the right of the Safety CPU. The Safety CPU and the safety function module must be the same version. (📖 MELSEC iQ-R Module Configuration Manual)

4. Powering on the system

Check the following before powering on the system.

- A cable is correctly connected to the power supply.
- Power supply voltage is within the specified range.
- The CPU module is in the STOP state.
- A personal computer on which an engineering tool has been installed is connected to the CPU module. (☞ Page 75 Connecting a Personal Computer)

5. Powering on the personal computer

Power on the personal computer on which the engineering tool has been installed (the personal computer connected to the CPU module).

6. Starting up the engineering tool

Start up the engineering tool that has been installed on the personal computer connected to the CPU module.

7. Registering user information (user authentication function)

Register a user name and password used to log in to the project. Then, write the user information to the Safety CPU. (📖 GX Works3 Operating Manual)

8. Initializing the CPU module

Initialize the CPU module using the engineering tool. (☞ Page 76 Initializing the CPU Module)

9. Setting parameters

The following table shows which parameters are required when changing the number of slots/the number of occupied points of a module, using an SD memory card, or using specific functions.

When	Required parameter	Reference
Changing the number of slots or the number of occupied points of a module	<ul style="list-style-type: none"> • System parameters • CPU parameters 	☞ Page 76 Setting Parameters
Setting the safety function (safety cycle time) or safety communications	<ul style="list-style-type: none"> • Safety CPU parameters • Safety module parameters 	<ul style="list-style-type: none"> • 📖 MELSEC iQ-R CPU Module User's Manual (Application) • 📖 User's manual for the module used
Using an SD memory card	<ul style="list-style-type: none"> • Memory card parameters 	📖 MELSEC iQ-R CPU Module User's Manual (Application)
Using the Ethernet function of the CPU module	<ul style="list-style-type: none"> • Module parameters 	📖 MELSEC iQ-R CPU Module User's Manual (Application)
Using the CC-Link IE Field Network Basic function of the CPU module	Some intelligent function modules require multiple module parameters and module extension parameters.	📖 CC-Link IE Field Network Basic Reference Manual
Using an intelligent function module		📖 User's manual for the module used

System parameters are automatically set by loading an actual system configuration to the Module Configuration window of the engineering tool.

10. Programming

Create a standard program or safety program using the engineering tool. (☞ Page 79 Programming)

11. Writing data to the programmable controller

Write the parameters set and programs (standard programs and safety programs) created using the engineering tool to the Safety CPU. (👉 Page 83 Writing Data to the Programmable Controller)

When the data is written to the Safety CPU, the safety CPU parameters, safety module parameters, and safety programs are also written to the safety function module.

12. Resetting the CPU module

Restart the system in either of the following ways.

- Power off and on the system.
- Reset the CPU module. (👉 Page 84 Resetting the CPU Module)

13. Checking for errors

Check the status of the READY LED and ERROR LED of the Safety CPU and safety function module. If an error is detected, identify the error using the engineering tool, and eliminate the error cause.

14. Executing the program

Run the CPU module, and check that the PROGRAM RUN LED turns on. (👉 Page 85 Executing the Program)

15. Switching TEST MODE to SAFETY MODE

Switch the safety operation mode from TEST MODE to SAFETY MODE using the engineering tool. (📖 MELSEC iQ-R CPU Module User's Manual (Application))

The engineering tool switches the safety operation mode to SAFETY MODE (wait-for-restart). Power on or reset the CPU module to switch the mode to SAFETY MODE.

16. Checking the LED status

Check the following LED status and check that the modules are operating normally.

- The PROGRAM RUN LED of the Safety CPU is on.
- The PROGRAM RUN LED and SAFETY COM RUN LED of the safety function module are on.
- The SAFETY COM ERROR LED and TEST LED of the safety function module are off.

17. Monitoring the program

Check that the program operates normally using the engineering tool. (👉 Page 86 Monitoring the program)

Point

To change the programs and parameters during system operation, switch the safety operation mode from SAFETY MODE to TEST MODE. (📖 MELSEC iQ-R CPU Module User's Manual (Application))

4.2 Installing a Battery

Install a battery to the CPU module.

Installation procedure

Q6BAT

The connector plug of the Q6BAT is disconnected from the jack of the CPU module before shipment. To use the battery, connect the connector plug of the Q6BAT and the jack of the CPU module by following the procedure below.

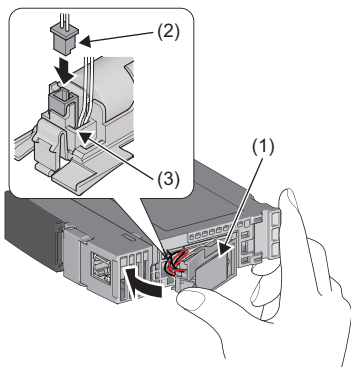

1. Open the battery cover located on the bottom of the CPU module.
2. Check that the Q6BAT (1) is correctly installed.
3. Check the direction and securely insert the connector plug (2) of the Q6BAT to the jack (3) of the CPU module.
4. Close the battery cover.

■Precautions

- When using the CPU module with the battery removed, check that the jack (3) of the CPU module is inserted in the socket on the battery cover located on the bottom of the CPU module.
- Do not drop or apply strong shock to the module and the battery.

FX3U-32BL

To use the battery in the R00CPU, R01CPU, or R02CPU, connect the battery, following the procedure below.

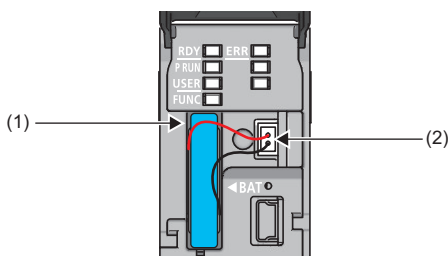

1. Open the LED cover on the front side of the CPU module.
2. Connect the lead connectors to the battery connector (1) in the right orientation. Insert the battery in the battery compartment (2).
3. Close the LED cover.

■Battery error detection setting in the engineering tool

The following setting is required to use the battery in the R00CPU, R01CPU, or R02CPU.

[CPU Parameter] ⇒ [RAS Setting] ⇒ [Error Detection Setting] ⇒ [Battery Error]

Set the parameter to "Detect". (The default setting is "Not Detected".)

Item	Setting
Error Detection Setting	
<i>Battery Error</i>	Detect
Module Verification Error	Detect
Fuse Blown	Not Detected
Redundant Power Supply System Error	Detect

4.3 Inserting or Removing an Extended SRAM Cassette

Insert an extended SRAM cassette to the CPU module as needed.

Insertion procedure

Insert an extended SRAM cassette while the programmable controller is powered off.

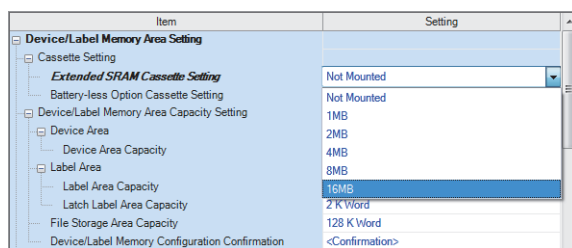
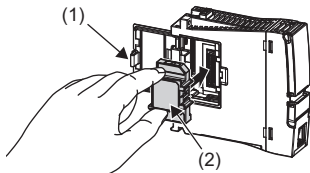

1. Open the cassette cover (1) located on the side of the CPU module.
2. Hold the top and bottom of the tab (2) of an extended SRAM cassette (with the notched edge facing to the right), and insert the cassette straight into the connector. After inserting the cassette, check that it is inserted completely.
3. Close the cover, and mount the CPU module on the base unit.
4. Power on the programmable controller.
5. Set the capacity of the inserted cassette to "Extended SRAM Cassette Setting" in "CPU Parameter" using the engineering tool.
[CPU Parameter] ⇒ [Memory/Device Setting] ⇒ [Device/Label Memory Area Setting] ⇒ [Cassette Setting] ⇒ [Extended SRAM Cassette Setting]
6. Using the engineering tool, check that SM626 (Extended SRAM cassette insertion flag) is on.

Precautions

- The availability of the extended SRAM cassette differs depending on the CPU module used. For the availability, refer to the performance specifications of the extended SRAM cassette. (Page 56 Extended SRAM Cassette)
- When the extended SRAM cassette is inserted or removed, all the data such as devices and the file register stored in the device/label memory are erased. Back up the data in the programmable controller before replacing the cassette.
- If the capacity of the extended SRAM cassette differs before and after the replacement, the ERROR LED of the CPU module may flash. But, it is not an error. Change the capacity setting in the CPU parameters. (Refer to step 5 above.)

Restriction

- The extended SRAM cassette for the Universal model QCPU (Q4MCA-□MBS) cannot be used.

Removal procedure

Remove the extended SRAM cassette while the programmable controller is powered off.

1. Read the data on the device/label memory from the CPU module, and save it in advance using the engineering tool. (When the extended SRAM cassette is removed, all of the data on the device/label memory are erased.)
2. Power off the programmable controller.
3. Remove the CPU module from the base unit, and open the cassette cover located on the side of the CPU module.
4. Hold the top and bottom of the tab of the extended SRAM cassette, and pull the cassette straight out of the connector.
5. Close the cover, and mount the CPU module back on the base unit.
6. Power on the programmable controller.
7. Set the "Extended SRAM Cassette Setting" in "CPU Parameter" to "Not Mounted".

4.4 Inserting and Removing an SD Memory Card

Insert an SD memory card to the CPU module as needed.

Insertion procedure

Check the direction and insert an SD memory card, following the procedure below.

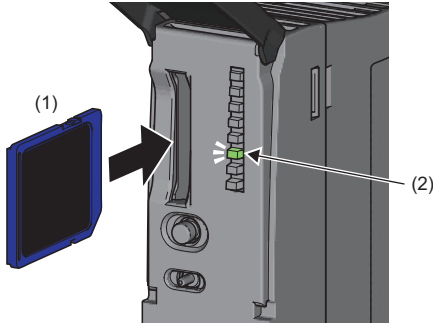

For the R01CPU and R02CPU, insert an SD memory card as shown below.

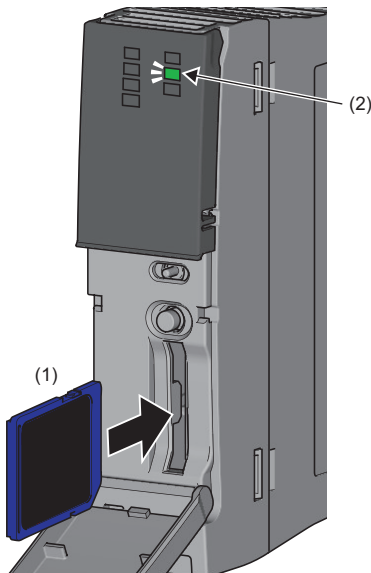

- 1.** Insert an SD memory card (1) into the card slot until it clicks with the notched edge in the direction as illustrated. After inserting the SD memory card, check that it is inserted completely. Poor contact may cause malfunction.
- 2.** The CARD READY LED (C RDY LED) (2) starts flashing. When the card is ready to be used, the CARD READY LED (C RDY LED) stops flashing and turns on.
- 3.** If the CARD READY LED (C RDY LED) does not turn on even after the card is inserted, check that SM606 (SD memory card forced disable instruction) and SM607 (SD memory card forced disable status flag) are off.

Removal procedure

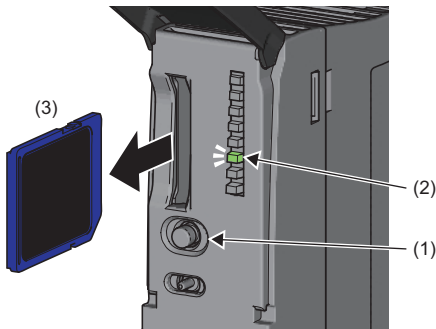

For the R01CPU and R02CPU, remove an SD memory card as shown below.

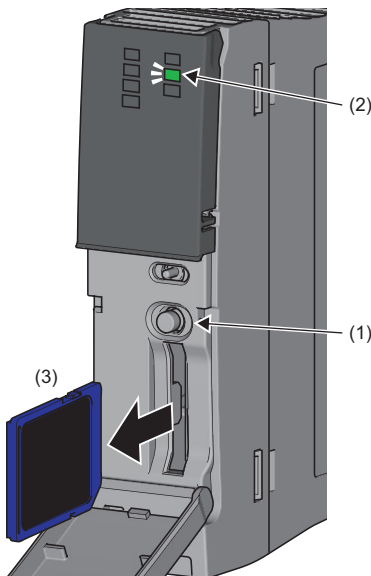

1. Press the SD CARD OFF button (1) for one second or longer to disable access to the card.*¹
2. The CARD READY LED (C RDY LED) (2) flashes during the access stop processing, and turns off upon completion of the processing.
3. Push in and release the SD memory card (3), and then pull the card out of the slot.

*¹ SM606 (SD memory card forced disable instruction) can also disable access to an SD memory card. For details, refer to the following.
📖 MELSEC iQ-R CPU Module User's Manual (Application)

Precautions

- Do not drop or apply strong shock to the module and SD memory cards.
- Follow the procedure above when inserting or removing the SD memory card while the system is powered on. If not, the data on the SD memory card may corrupt.
- If any function that accesses the SD memory card is being executed when the SD CARD OFF button is pressed to remove the card, the CARD READY LED turns off after the processing of the function is completed. For this reason, the time required until the LED turns off differs depending on the function being executed.
- If SM605 (Memory card remove/insert prohibit flag) is on, the CARD READY LED does not turn off even if the SD CARD OFF button is pressed. If not, turn on SM606 (SD memory card forced disable instruction) to forcibly disable access to the card.

4.5 Creating a Project

Activate the engineering tool and create a project.

 [Project] ⇨ [New]

Procedure

Create a program, following the procedure below. The procedure is for the program described in ladder diagrams.

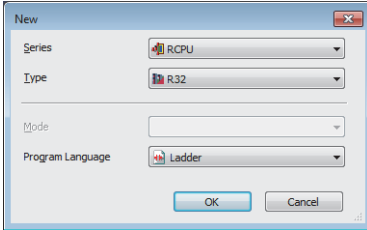

1. Select "RCPU" in "Series", and the CPU module model to use in "Type". Then, select a programming language to use in the project in "Program". Select "Ladder", and click the [OK] button.

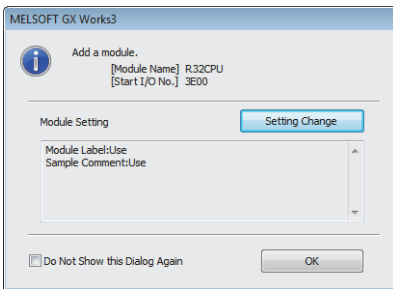

2. Click the [OK] button when the window for adding module labels of the CPU module appears.

Point

Module label is a label where the I/O signals and buffer memory areas of a module have already been defined. Use of module labels allows programming without being aware of module internal addresses.

4.6 Connecting a Personal Computer

Connect a personal computer where an engineering tool has been installed to the CPU module.

Procedure

Connect a personal computer directly to the CPU module, following the procedure below.

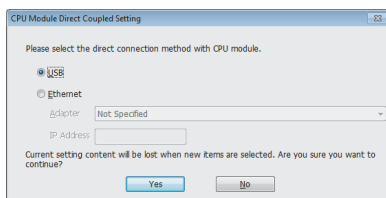
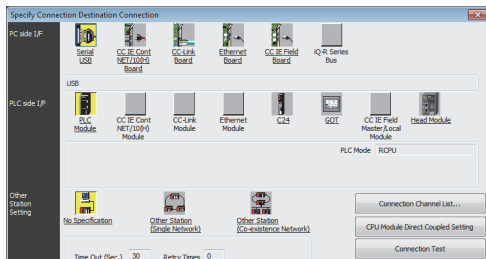
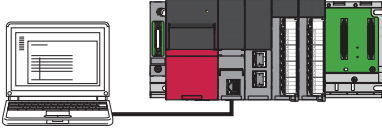

1. Connect a personal computer to the CPU module using a USB cable or Ethernet cable.
2. Select [Online] ⇨ [Current Connection Destination] on the menu bar of the engineering tool.
3. Click the [CPU Module Direct Coupled Setting] button on the "Specify Connection Destination Connection" window.
4. Select the connection method, and click the [Yes] button.
5. Click the [Connection Test] button, and check if the personal computer is connected to the CPU module.

Install a USB driver to use a USB cable for the first time. (📖 GX Works3 Operating Manual)

4.7 Initializing the CPU Module

Initialize the CPU module.

 [Online] ⇒ [CPU Memory Operation]

Procedure

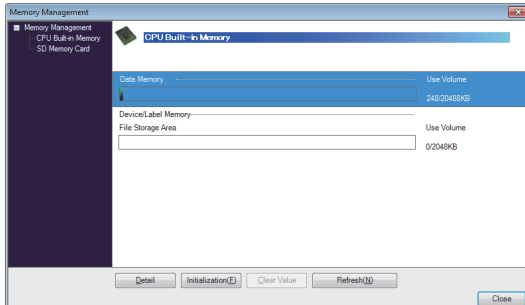

1. Select "Data Memory" on the "Memory Management" window, and click the [Initialization] button.
2. Select "File Storage Area", and click the [Initialization] button.
3. After the initialization processing completes, click the [Close] button.

4.8 Setting Parameters

Set system parameters and parameters for each module.

When the engineering tool is connected to the actual system

Set parameters by loading an actual system configuration to the Module Configuration window of the engineering tool.

 [Navigation window] ⇒ [Module Configuration]

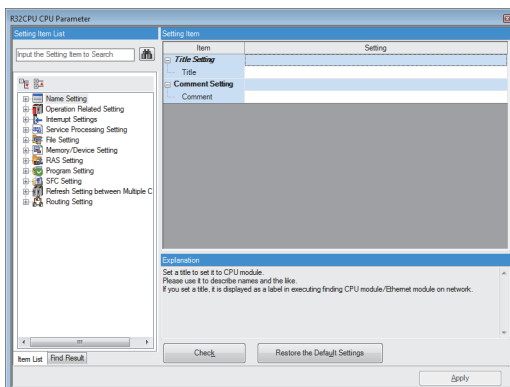
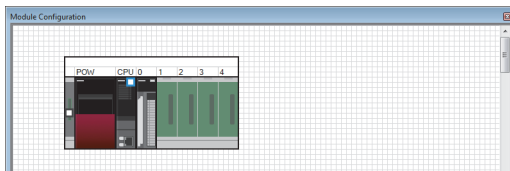

1. Open the Module Configuration window, and select [Online] ⇒ [Read Module Configuration from PLC] on the menu bar.
2. Click the [Yes] button when the window for adding module labels of the mounted modules appears.
3. The system parameters are automatically set, and the actual system configuration is displayed on the Module Configuration window.
4. Double-click each module (CPU module, I/O module, or intelligent function module) to display the corresponding module parameter editor.
5. Set parameters, and click the [Apply] button to close the window.

■Precautions

The RQ extension base units, MELSEC-Q series extension base units, and modules mounted on those base units cannot be loaded. For those cannot be loaded, select the units and modules on the Element Selection window, and drag and drop them to the system configured on the Module Configuration window.

When the engineering tool is not connected to the actual system

Set parameters by configuring a system manually on the Module Configuration window of the engineering tool.

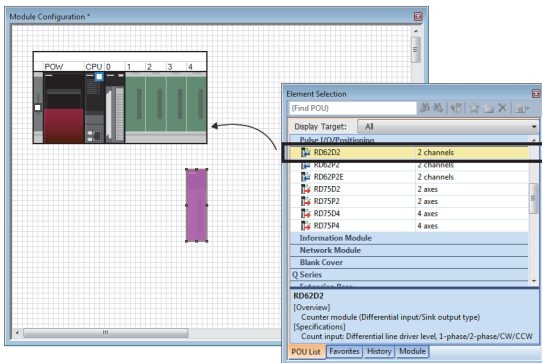

1. Select a base unit on the Element Selection window, and drag and drop it to the Module Configuration window.
2. Drag and drop modules to be used on the base unit placed.
3. Select [Edit] ⇒ [Parameter] ⇒ [Fix] on the menu bar.
4. Click the [Yes] button when the window for adding module labels of the configured modules appears.
5. Open the parameter editor of each module by double-clicking the module.
6. Set parameters, and click the [Apply] button to close the window.

4

Point

To use the RnENCPU, the modules can be found from different categories. Select each module from the following categories on the Element Selection window.

- RnENCPU (CPU part): "PLC CPU"
- RnENCPU (network part): "CPU Extension"

Setting parameters from the Navigation window

Set the following parameters from the Navigation window.

■ System parameters

These parameters need to be set from the Navigation window in the following cases: to change the number of slots on the base unit or the number of occupied points of the module; for a multiple CPU system; and for module synchronization operations.

 [Navigation window] ⇒ [Parameter] ⇒ [System Parameter]

■ Module parameters of the CPU module

These parameters are required to execute the Ethernet function or CC-Link IE Field Network Basic function of the CPU module.

 [Navigation window] ⇒ [Parameter] ⇒ [Module model name] ⇒ [Module Parameter]

■ Memory card parameters

These parameters are required to execute functions that access the SD memory card.

 [Navigation window] ⇒ [Parameter] ⇒ [Module model name] ⇒ [Memory Card Parameter]

■ Multiple module parameters and module extension parameters

Some intelligent function modules require multiple module parameters and module extension parameters.

 [Navigation window] ⇒ [Parameter] ⇒ [Module Information] ⇒ [Intelligent function module] ⇒ [Module Parameter] or [Module Extended Parameter]

Point

System parameters can be set on the following windows. Select the window depending on their application purposes.

- Module Configuration window: Use this window when using the module specific data (such as number of occupied points) as is.
- System Parameter window: Use this window when changing the number of slots or the number of occupied points.

4.9 Programming

Create a program. This section describes how to create a program using the following program example.

Program example

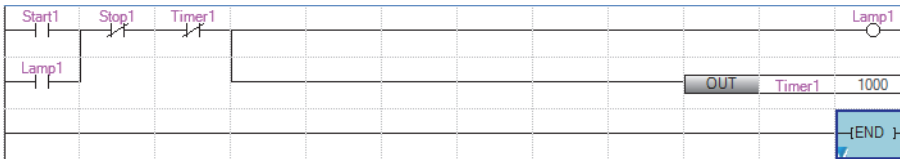

- When Start1 turns on, Timer1 starts counting, and Lamp1 turns on.
- When the current value of Timer1 reaches 1000, Lamp1 turns off.
- When Stop1 turns on, Lamp1 turns off.

Registering labels

Label is a variable whose name and data type can be declared by a user.

Use of labels allows programming without being aware of devices and buffer memory addresses. For this reason, programs using labels can be used in other systems where the module configuration is different.

Labels can be registered on the label editor.

[Navigation window] ⇒ [Program] ⇒ [Scan] ⇒ [MAIN] ⇒ [ProgPou] ⇒ [Local Label]

Procedure

Register the label "Start1" in the program example, following the procedure below.

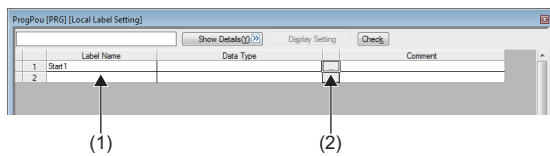

1. Enter the name, "Start1", in the "Label Name" field (1).
2. Click the button (2) on the right of the "Data Type" field to open the "Data Type Selection" window.
3. Specify the data type. Select "Bit", and click the [OK] button.

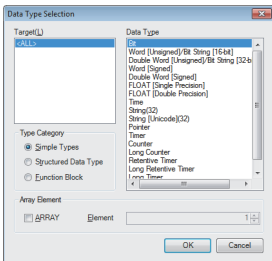

Register other labels in the program example in the same way.

Point

- The class, initial value, and constant of labels can be set as needed by clicking the [Show Details] button on the label editor.
- Labels can also be registered while programming without opening the label editor. (Page 82 Inserting POU's by key input)
- Devices can be assigned to global labels. Open the global label editor, and enter a device in the "Assign (Device/Label)" field.

Inserting program elements

Drag and drop required program elements to the ladder editor.

[Navigation window] ⇒ [Program] ⇒ [Scan] ⇒ [MAIN] ⇒ [ProgPou] ⇒ [ProgramBody]

Procedure

Insert a normally open contact of "Start1" in the program example, following the procedure below.

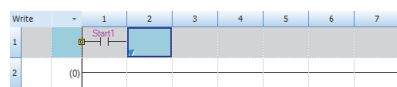
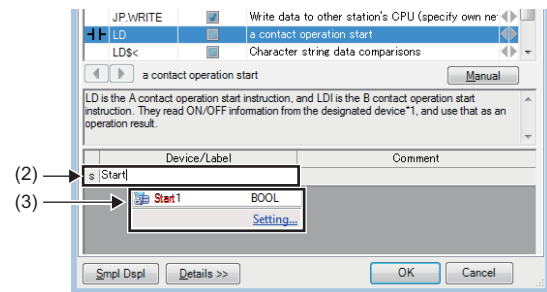
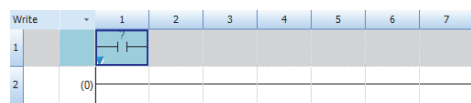
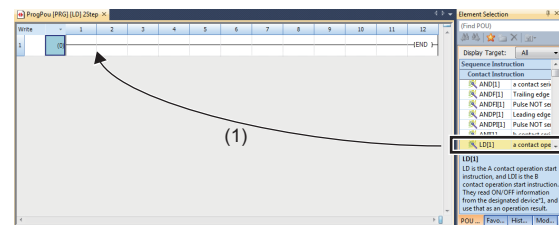

1. Select a program element from the Element Selection window, and drag and drop (1) it to the desired position on the ladder editor. In this example, drag and drop "LD[1]".
2. Double-click the inserted program element, and click the [ExtDsp] button to open the ladder entry window.
3. Specify the operand. In this example, enter "Start" for "s" in the "Device/Label" field.
4. Select an item from the displayed list (3). In this example, select "Start1".
5. The normally open contact of "Start1" is inserted to the program.

Insert other program elements in the program example in the same way.

Point

- Common instructions, such as contacts and coils, standard functions/function blocks, and user-defined function blocks/functions can be found in the [POU List] (1) in the Element Selection window. Narrow the list using the drop-down menu (2) for "Display Target", and select program elements.
- Module labels and module function blocks can be found in the [Module] list (3). Programs are efficiently created only by dragging and dropping the module labels and module function blocks on the editor.

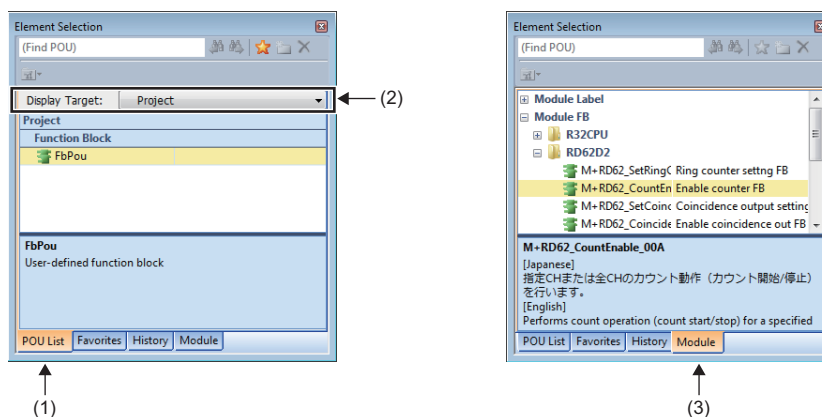

■Inserting function blocks

Insert function blocks, following the procedure below.

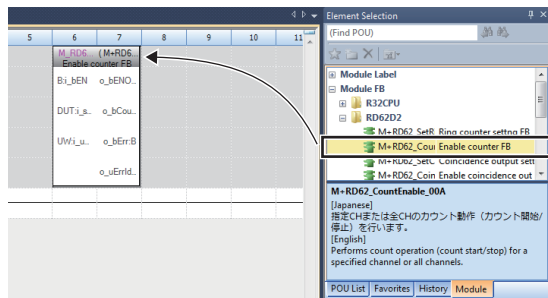

1. Select a function block from the Element Selection window, and drag and drop it to the desired position on the ladder editor.



2. The "FB Instance Name" window opens. Select the target label (global label or local label), and enter an instance name.

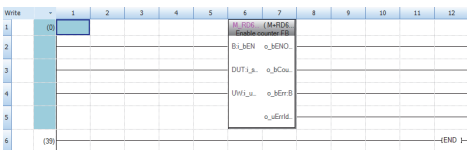

3. Select [Convert] ⇨ [Convert] on the menu bar. The ladder is converted, and the rungs are connected to the input and output labels of the FB instance.

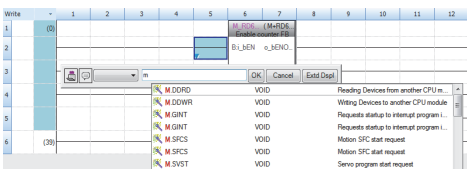

4. Add the input and output parts of the inserted function block to complete the program. For details on the input and output parts, refer to the following.

Function Block Reference for the module used

■Creating function blocks/functions

User-defined function blocks/functions must be created before inserted to the program.

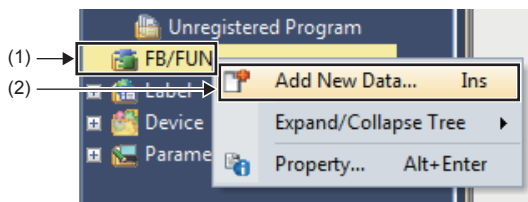

1. Right-click "FB/FUN" (1) on the Navigation window, and select "Add New Data" (2) to open the setting window.

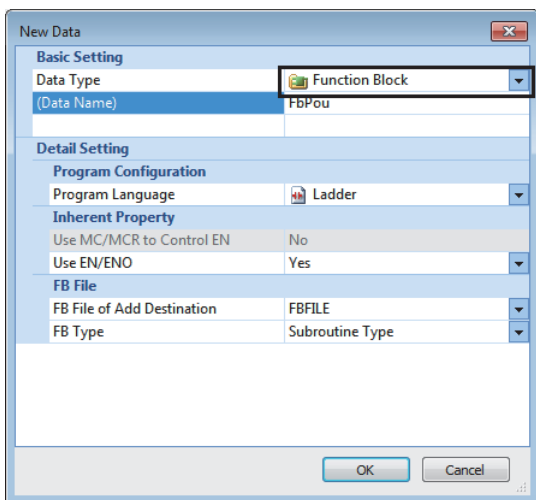

2. To create a function block, set the data type to "Function Block" using the drop-down list. To create a function, set the data type to "Function". Then, click the [OK] button.

3. Program the operation of the function block or function in "ProgramBody".

Inserting POUs by key input

POUs can be inserted by key input.

Procedure

Inserting a normally open contact of "Start1" in the program example, following the procedure below.

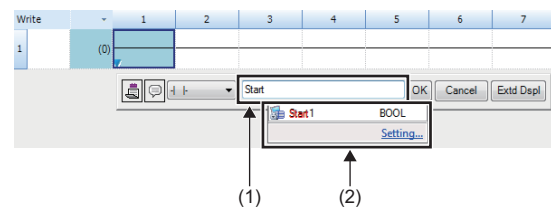

1. Click the insertion position on the ladder editor, and press **[F5]**.
2. Enter the name, "Start", in the entry field (1). Select "Start1" from the displayed list (2).

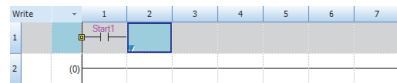

3. The normally open contact of "Start1" is inserted to the program.

Point

A new label can be registered during insertion. Enter the name of a new label on the ladder entry window, and click the [OK] button. Then, specify the registered destination, class, and data type of the label on the "Undefined Label Registration" window, and click the [OK] button.

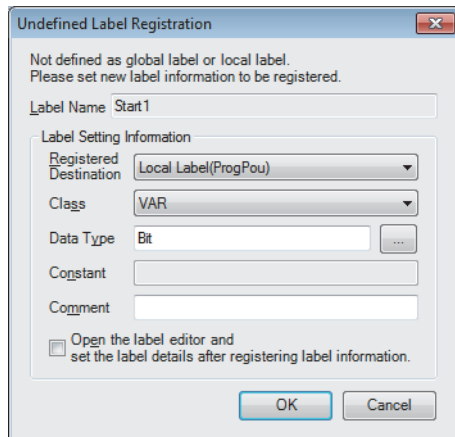

4.10 Converting the Program

Determine the input ladder blocks.

Procedure

1. Select [Convert] ⇒ [Convert] on the menu bar.
2. When the conversion processing completes and the input ladder blocks are determined, the color of those ladder blocks changes from gray to white.

4.11 Saving the Project

Save the created project.

 [Project] ⇒ [Save as]

4.12 Writing Data to the Programmable Controller

Write the set parameters and the created program to the CPU module.

 [Online] ⇒ [Write to PLC]

Procedure

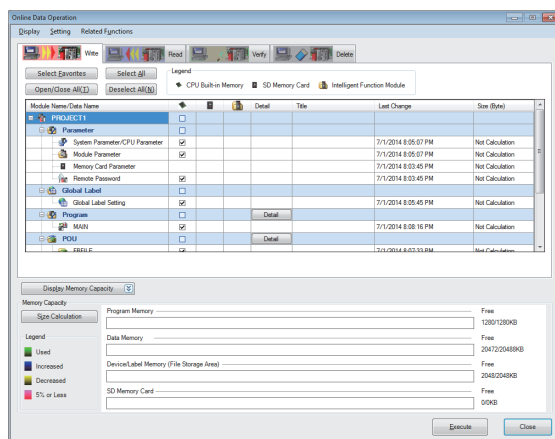

1. Select the system parameter file, CPU parameter file, module parameter file, and program file on the "Online Data Operation" window. If any function block is used, select the corresponding FB/FUN file as well.
2. Click the [Execute] button.
3. After the write processing completes, click the [Close] button.

Point

- For the operation of the CPU module, the system parameter file, CPU parameter file, and program file must be written. For the operation of the I/O modules and intelligent function modules, the module parameter files and module extension parameter file must be written as well.
- When a parameter setting is changed, reset the CPU module. ( Page 84 Resetting the CPU Module)
- Use of the [Select Favorites] button enables users to easily select frequently-used files, such as the system parameter file, CPU parameter file, and program file. Register items as favorites on the window opened by selecting [Setting] ⇒ [Register Favorites Selection] on the menu bar.

4.13 Resetting the CPU Module

Reset the CPU module using the RUN/STOP/RESET switch located on the front of the CPU module.

Procedure

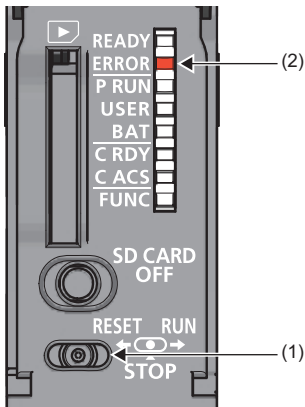

1. Set the RUN/STOP/RESET switch (1) to the RESET position for a second or longer.
2. Check that the ERROR LED (2) flashes for several times and turns off.
3. Set the switch back to the STOP position.

For the R00CPU, R01CPU, and R02CPU, the switch and LED are located as shown below.

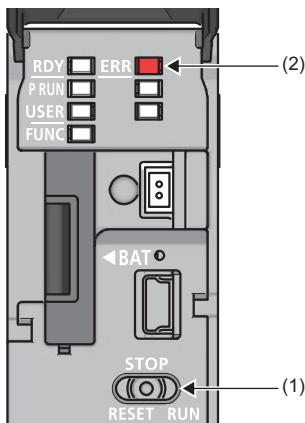

Point

Operate the RUN/STOP/RESET switch with your fingers. Use of a tool such as a screwdriver may damage the switch.

4.14 Executing the Program

Execute the program written to the programmable controller by using the RUN/STOP/RESET switch.

Procedure

1. Set the RUN/STOP/RESET switch (1) to the RUN position.
2. Check that the PROGRAM RUN LED (P RUN) (2) turns on.

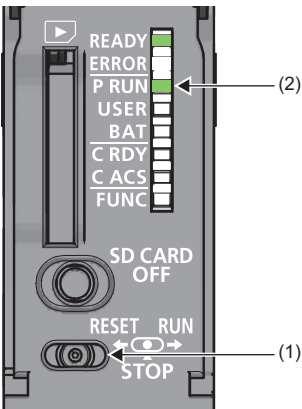

For the R00CPU, R01CPU, and R02CPU, the switch and LED are located as shown below.

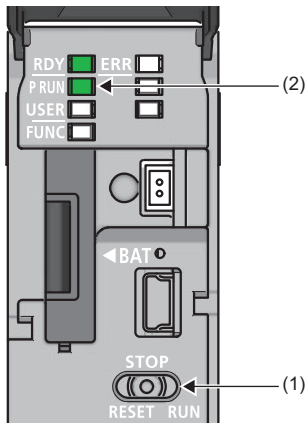

4.15 Monitoring the program

Monitor the program operation using the engineering tool.

Monitoring on the monitor status bar

For the monitor status bar, refer to the following.

GX Works3 Operating Manual

Monitoring on the ladder editor

The on/off states of contacts and coils and the current values of word devices and labels can be monitored on the ladder editor.

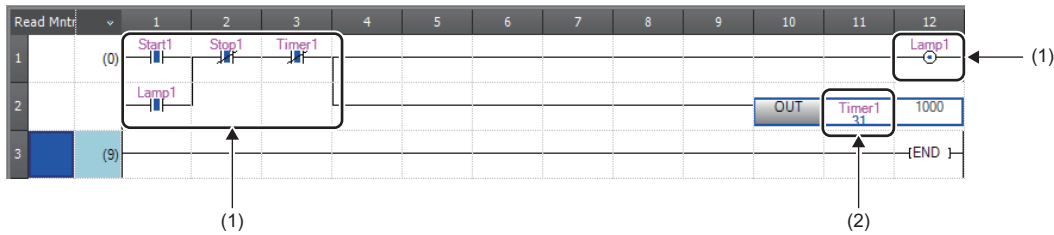

- (1) The on/off states of the contacts and coils are displayed.
- (2) The current value of the word/double word type data is displayed.

1. Select [Online] ⇒ [Monitor] ⇒ [Start Monitoring] on the menu bar.
2. Monitor the on/off states of contacts and coils and the current values of word devices and labels.

■ On/off state display

The on/off states are displayed on the editor as follows:



■ Changing the current value

To change the current value, select the cell on the ladder editor, and press **[Shift]** + double-click the cell or press **[Shift]** + **[Enter]** while the program is being monitored.



The program can also be monitored on the Device/Buffer Memory Batch window or the Watch window. (GX Works3 Operating Manual)

4.16 Troubleshooting

This section describes errors that may occur during system operation, error causes, and actions to be taken. For the troubleshooting specific to each module, refer to the manual for the module used.

Point







Saving the program and devices at the time of an error helps to analyze the error cause.

For reading data from the programmable controller, refer to the following.

 GX Works3 Operating Manual

Troubleshooting procedure

When the system has any trouble, perform troubleshooting in the following order.

1. Check the LED status of the power supply module.
( MELSEC iQ-R Module Configuration Manual)
2. Check the LED status of the CPU module. ( Page 88 LED status of the CPU module)
3. Check the LED status of each I/O module and intelligent function module. ( User's Manual (Application) for the module used)
4. Connect an engineering tool, and execute the system monitor function. The error module can be identified. ( Page 89 System monitor)
5. Select the error module, and execute the module diagnostics function. The error cause and the action to be taken can be displayed. ( Page 89 Module diagnostics)
6. If the error cause cannot be identified by the module diagnostics, check the executed operations and detected error logs on the event history window. ( Page 89 Event history)
7. If the error cause cannot be identified in steps 1 to 6, perform troubleshooting by symptom. ( User's Manual (Application) for the module used)

Troubleshooting with LED indicators

Check the LED status of each module as primary diagnostics.

LED status of the CPU module

The following table lists the check points on the LED status of the CPU module.

The error status can be checked visually using the READY LED and ERROR LED.

LED indicator		Error status	Program execution status	Description	Action
READY	ERROR				
On	Off	No error	Continued	Normal operation	—
	On	Minor error		A minor error or warning has been detected. Program execution and data communications with network stations are continued.	Identify the error cause using the engineering tool, and take an action.
	Flashing	Moderate error	Stopped	A programming error, parameter setting error, or temporal noise has been detected. Program execution and data communications with network stations are stopped.	Identify the error cause using the engineering tool, and take an action.
Off	On/ flashing	Major error		A hardware failure has been detected. No operation cannot be performed.	Perform troubleshooting for the error module. If the problem still exists after troubleshooting, replace the error module. (MELSEC iQ-R CPU Module User's Manual (Application))
	Off	Hardware failure		A hardware failure has been detected. No operation cannot be performed.	Check that the power is supplied to the system. If the power is supplied properly, the possible cause is a hardware failure. Perform troubleshooting for the error module. If the problem still exists after troubleshooting, replace the error module. (MELSEC iQ-R CPU Module User's Manual (Application))
		No error		Power is not supplied or power went out.	—
Flashing	On	Minor error		A minor error has been detected during online module change.	Identify the error cause using the engineering tool, and take an action.
	Off	No error		<ul style="list-style-type: none"> The READY LED is flashing every 400ms: A module is being changed online. The READY LED is flashing every 2s: Initial processing is being performed. 	—

Point

The LED status can also be checked on the module diagnostics window using the engineering tool. (GX Works3 Operating Manual)

Troubleshooting using the engineering tool

Check the error or history using the engineering tool, and identify the error cause. More detailed information on the error as well as the error cause and action to be taken can be checked by using the engineering tool.

The engineering tool has the following functions for troubleshooting.

Function	Description
System monitor	Displays the module configuration, and detailed information and error status of each module. (Page 89 System monitor)
Module diagnostics	Diagnoses the module. (The current error and its details can be checked.) (Page 89 Module diagnostics)
Event history	Displays the event information collected by the CPU module, such as errors occurred in each module, executed operations, and network errors. (Page 89 Event history)

For details on each function, refer to the following.

GX Works3 Operating Manual

System monitor

This function displays the module configuration, and detailed information and error status of each module. For the error module identified, the module diagnostics function can be executed from this window.

 [Diagnostics] ⇒ [System Monitor]

Point

- When the RnENCPU is used, information of the RnENCPU (CPU part) and RnENCPU (network part) is displayed individually. When an error occurs, the module diagnostics function can be executed for each module.
- In a redundant system, the systems A and B are both displayed on the main base information part (on the left side of the window). The display of the details on the system A or B (on the right side of the window) can be switched with this part.

4

Module diagnostics

This function diagnoses the module. (The current error and its details can be checked.)

Information required for troubleshooting, such as the current error, details and cause of the error, and action to be taken, are displayed. The incorrect parameter setting and program error location can also be identified by selecting the error and clicking the [Error Jump] button.

On the [Module Information List] tab, the LED status and the switch status of the target module can be checked.

 [Diagnostics] ⇒ [System Monitor] ⇒ Double-click the error module.

Restriction

In a multiple CPU system, when the I/O assignment setting in a system parameter differs from the configuration of the modules actually mounted, correct information may not be displayed on "Module Information List".

Event history

This function displays the event information, such as errors occurred in the module(s) mounted, executed operations, and network errors.

Since information collected before the CPU module is powered off or reset can also be displayed, the error cause can be identified based on the past operations and errors.

The displayed information can also be saved in CSV file format.

 [Diagnostics] ⇒ [System Monitor] ⇒ [Event History] button

Point

Use this function for the following purposes:

- To check the error status and identify the cause of error occurred in machinery or equipment
- To check when and how the program and parameters of the programmable controller have been changed
- To check for unauthorized access

For details on this function and collected information, refer to the following.

 MELSEC iQ-R CPU Module User's Manual (Application)

5 SYSTEM CONFIGURATION

For system configurations using the MELSEC iQ-R series modules, applicable combinations of CPU modules and the other modules, the number of mountable modules, installation, and wiring, refer to the following.

 MELSEC iQ-R Module Configuration Manual

APPENDIX

Appendix 1 External Dimensions

CPU module

■R00CPU, R01CPU, R02CPU

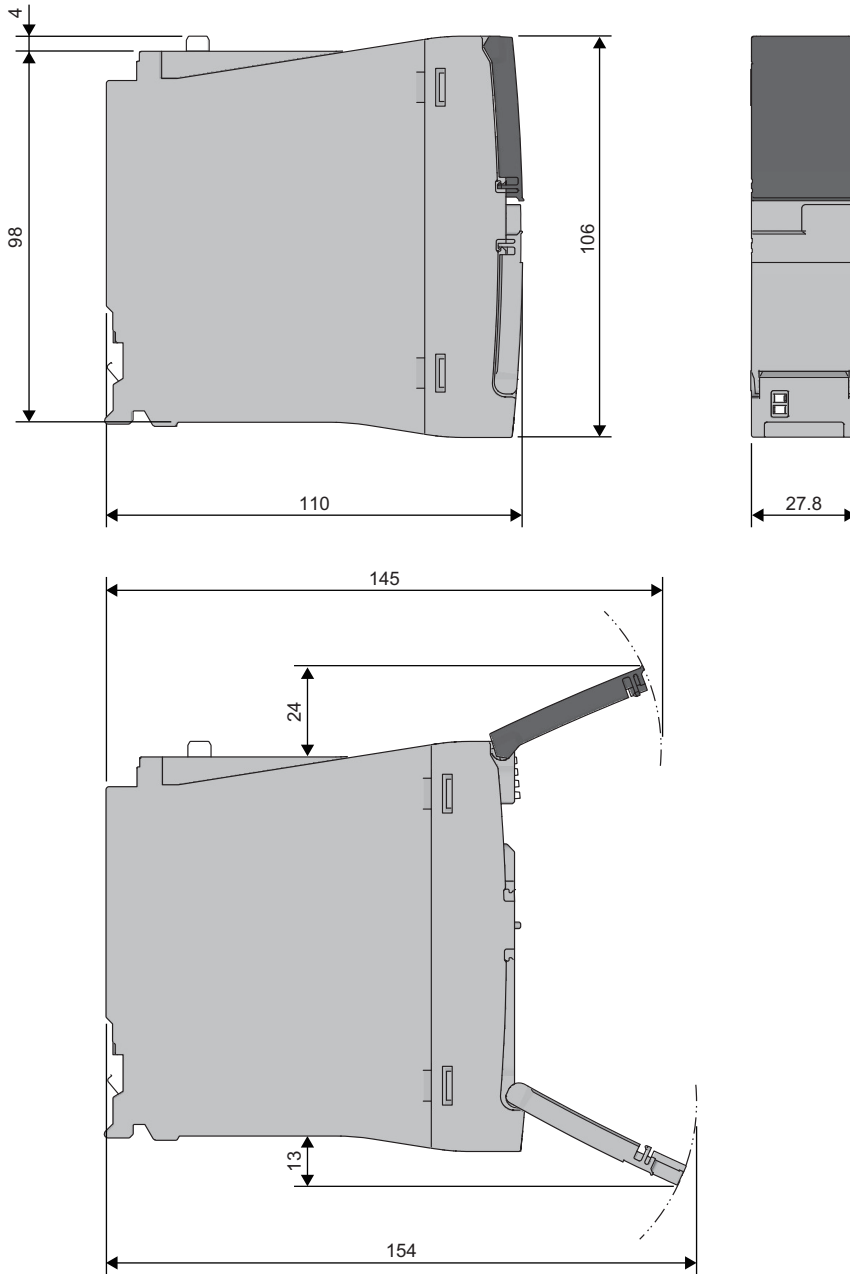

(Unit: mm)

■RnCPU (except for R00CPU, R01CPU, or R02CPU), Process CPU, SIL2 Process CPU, Safety CPU

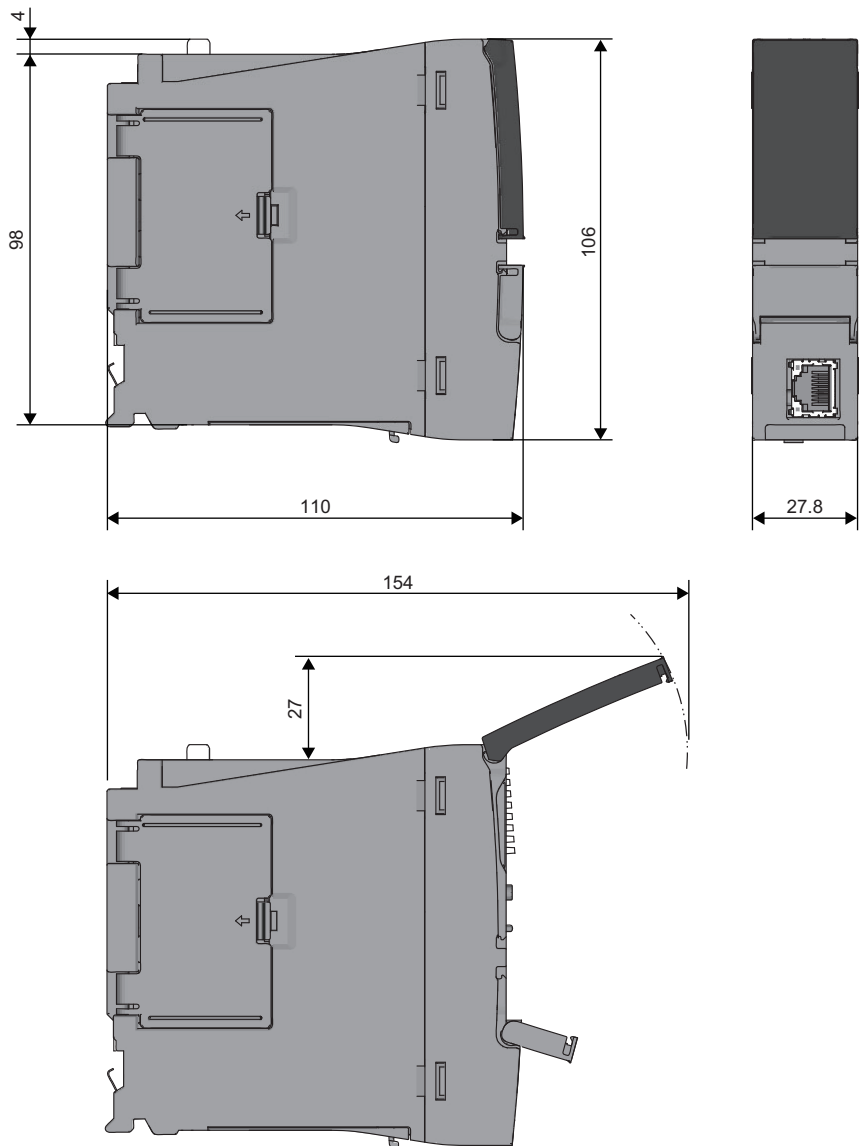

(Unit: mm)

A

- With the Q7BATN-SET

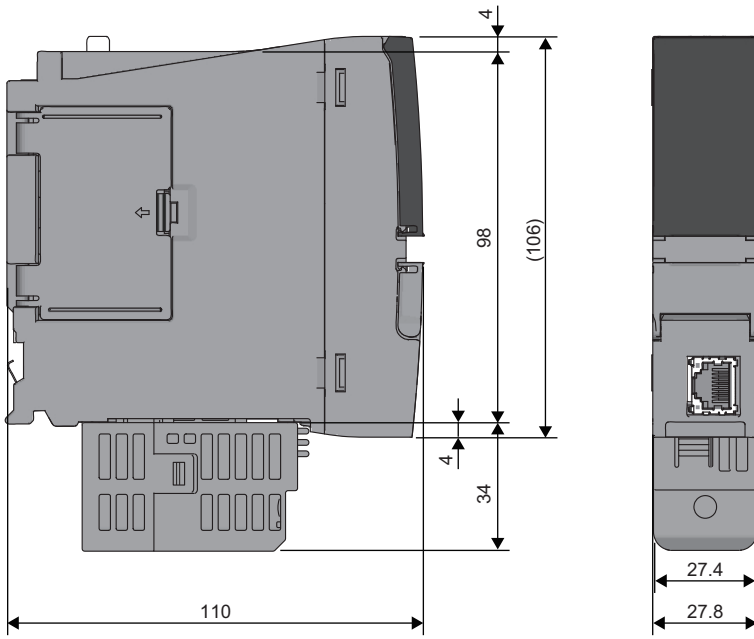

(Unit: mm)

- With the Q7BAT-SET

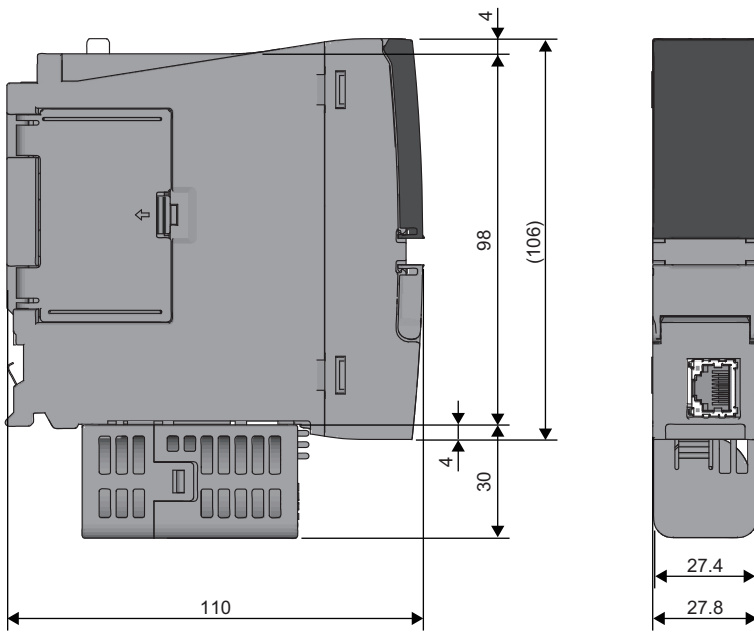

(Unit: mm)

■RnENCPU

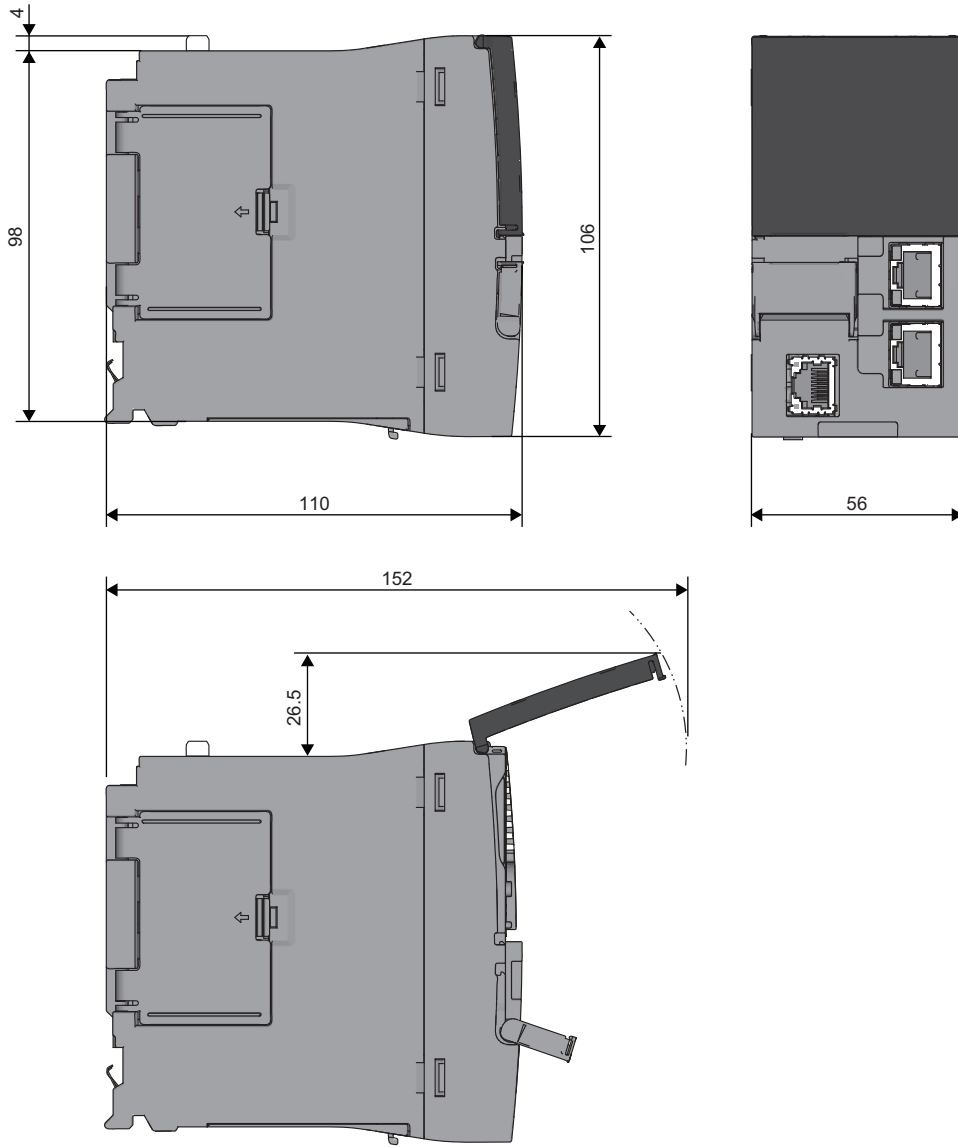

(Unit: mm)

A

- With the Q7BATN-SET

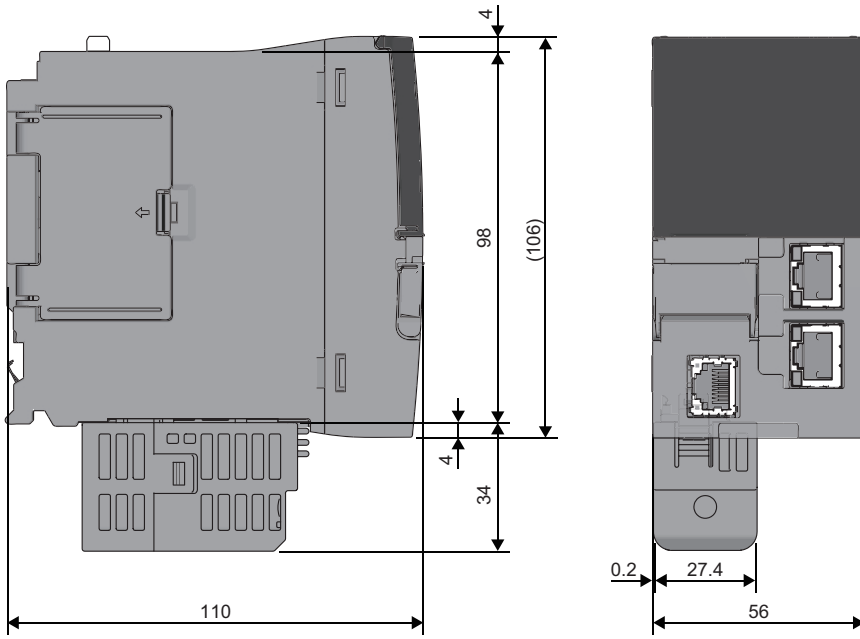

(Unit: mm)

- With the Q7BAT-SET

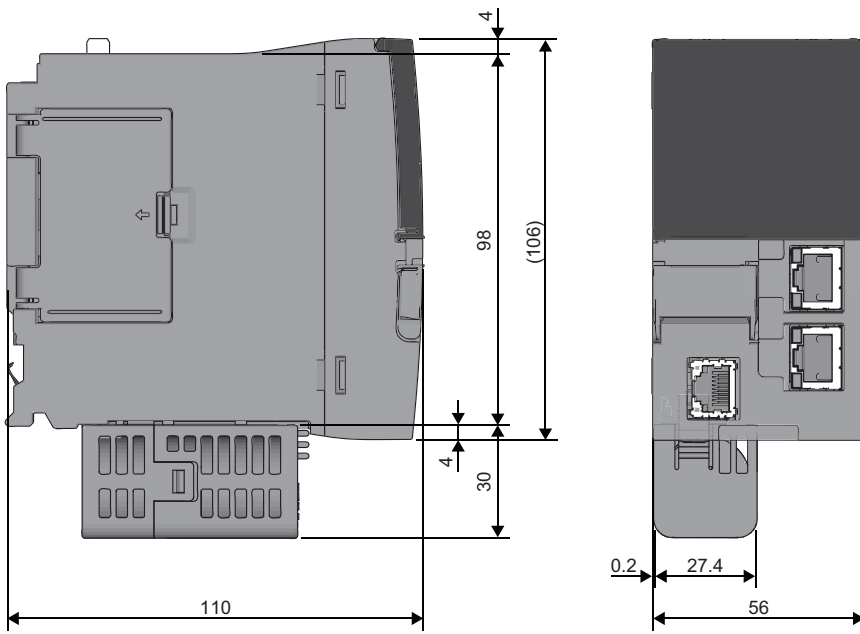

(Unit: mm)

Redundant function module

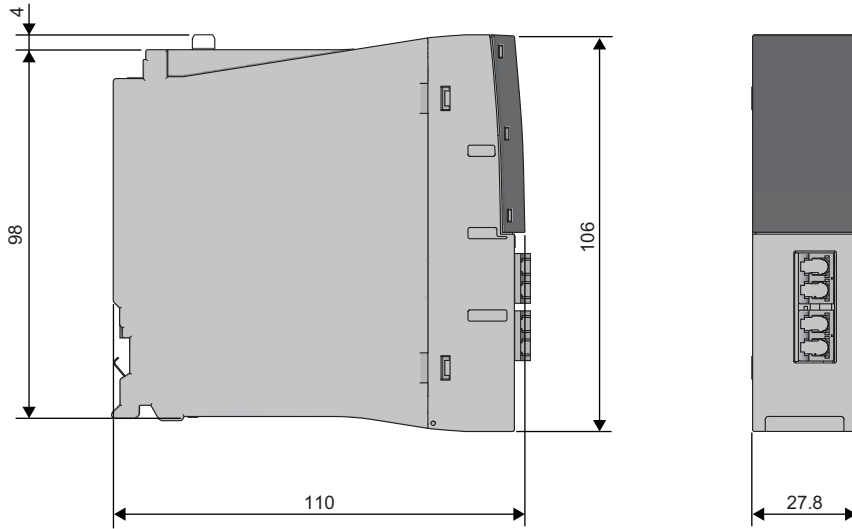

(Unit: mm)

SIL2 function module, safety function module

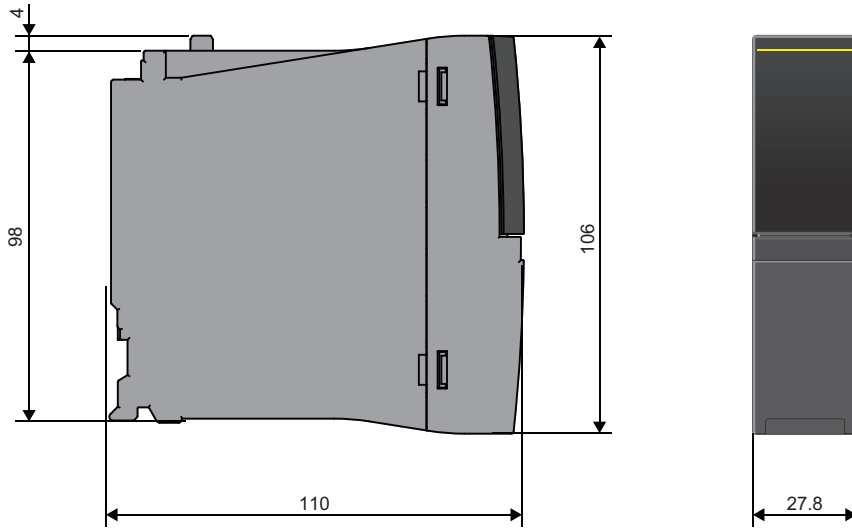

(Unit: mm)

A

MEMO

INDEX

A

Annunciator (F) 47,49,51,53

B

BACKUP LED 35
Backup mode 22
Battery 31,33,70
BATTERY LED 30,33
Battery-less option cassette 56

C

CARD ACCESS LED 28,30,33
CARD READY LED 28,30,33
Constant scan 46,49,51,53
Control system 22
Counter (C) 47,49,51,53
CPU buffer memory 38,40,42,44
CPU buffer memory access device 48,50,54
CPU module 38,92
CPU parameter 83
CTRL LED 35

D

Data memory 38,40,42,44
Data register (D) 47,49,51,53
Device area 38,40
Device/label memory 38,40,42,44,58,59

E

Edge relay (V) 47,49,51,53
ERR LED 35
ERROR LED 26,28,30,33,37,84,88
Ethernet port 26,28,30,33,39,40,42,44
Extended SRAM cassette 56,71
External dimensions 39,40,42,44,56,58,59,92

F

File register (R/ZR) 47,50,52,54
File storage area 38,40
Function block 81
Function input (FX) 47,50,52,54
FUNCTION LED 26,28,30,33
Function memory 38
Function output (FY) 47,50,52,54
Function register (FD) 47,50,52,54

H

High-speed internal timer interrupt 1 (I49) 46,49
High-speed internal timer interrupt 2 (I48) 46,49

I

Index register (Z) 47,50,52,54
Initializing the CPU module 76
Input (X) 47,49,51,53

Intelligent function module device 52,54
Inter-module synchronous interrupt (I44) 46,49,53
Internal current consumption (5VDC) 39,40,42,44,58,59
Internal relay (M) 47,49,51,53
Interrupt pointer (I) 47,50,52,54
Interrupt using the internal timer (I28 to I31) 46,49,51,53

L

L ERR LED 36
Label 79
Label area 38,40
Latch label area 38,40
Latch relay (L) 47,49,51,53
Link direct device 47,50
LINK LED 36
Link register (W) 47,49,51,53
Link relay (B) 47,49,51,53
Link special register (SW) 47,49,51,53
Link special relay (SB) 47,49,51,53
Long counter (LC) 47,49,51,53
Long index register (LZ) 47,50,52,54
Long retentive timer (LST) 47,49,51,53
Long timer (LT) 47,49,51,53

M

Memory capacity 38,40,42,44,58,59
MEMORY COPY LED 35
Module access device 47,50
Module extension parameter 83
Module label 74
Module parameter 83
Multiple CPU synchronous interrupt (I45) 46,49,53

N

Nesting (N) 48,50
Number of FB files 46,49,51,53
Number of I/O points 46,49
NZ2MC-16MBS 56
NZ2MC-1MBS 56
NZ2MC-2MBS 56
NZ2MC-2MBSE 56
NZ2MC-4MBS 56
NZ2MC-8MBS 56
NZ2MC-8MBSE 56

O

Optical connector (IN) 36
Optical connector (OUT) 36
Output (Y) 47,49,51,53

P

Parameter 76
Pointer (P) 47,50,52,54
Process CPU 24
Process CPU (process mode) 22

Process CPU (redundant mode)	22
Production information marking	26,28,31,33,36,37
Program capacity	38,40,42,44,58,59
Program executed in both systems	22
Program file	83
Program memory	38,40,42,44,58,59
PROGRAM RUN LED	26,28,30,33,37,85
Programmable controller CPU	24
Programming language	46,49,51,53,74

Q

Q6BAT	70
-----------------	----

R

READY LED	26,28,30,33,37,88
Redundant extension base unit	24
Redundant function module	22
Redundant system	22
Redundant system with redundant extension base unit	22
Refresh data register	48,50
Refresh data register (RD)	52,54
Refresh memory	38,40,42,44
Resetting the CPU module	84
Retentive timer (ST)	47,49,51,53
RnCPU	24
RnENCPU	24
RnENCPU (CPU part)	24
RnENCPU (network part)	24
RUN LED	35
RUN/STOP/RESET switch	26,28,30,33,84,85

S

SAFETY COM ERR LED	37
SAFETY COM RUN LED	37
Safety communications	23
Safety control	23
Safety counter	51,54
Safety CPU	22
Safety data register	51,54
Safety device	23
Safety function module	22
Safety input	51,54
Safety internal relay	51,54
Safety link register	51,54
Safety link relay	51,54
Safety output	51,54
Safety program	23
Safety programmable controller	24
Safety retentive timer	51,54
Safety special register	52,54
Safety special relay	52,54
Safety system device	52,54
Safety timer	51,54
Safety user device	51,54
SBY LED	35
SD CARD OFF button	28,30,33
SD memory card	38,40,72
SD/RD LED	26,28,30,33
SEPARATE LED	35
Separate mode	22
SFC block device (BL)	48,50,54

SFC transition device (TR)	48,50
Signal flow memory	38,40,42,44
SIL2 function module	22
SIL2 Process CPU	22
Special register (SD)	47,50,52,54
Special relay (SM)	47,50,52,54
SPEED LED	26,28,30,33
Standard communications	23
Standard control	23
Standard CPU	24
Standard device	23
Standard program	23
Standard programmable controller	24
Standby system	22
Step relay (S)	47,49,53
SYS A LED	35
SYS B LED	35
System A	22
System B	22
System parameter	83
System switching	64

T

TEST LED	37
Timer (T)	47,49,51,53
Tracking cable	23
Tracking transfer	64
Troubleshooting	87

U

USB port	26,28,30,33,39,40,42,44
USER LED	26,28,30,33

W

Weight	39,40,42,44,56,58,59
------------------	----------------------

REVISIONS

*The manual number is given on the bottom left of the back cover.

Revision date	*Manual number	Description
June 2014	SH(NA)-081263ENG-A	First edition
October 2014	SH(NA)-081263ENG-B	<ul style="list-style-type: none"> ■ Added functions Memory dump function, real-time monitor function, LED indication expansion ■ Added or modified parts SAFETY PRECAUTIONS, TERMS, Section 1.1, Chapter 3, Section 4.4, 4.5, 4.7, 4.8, 4.11
January 2015	SH(NA)-081263ENG-C	<ul style="list-style-type: none"> ■ Added models R08PCPU, R16PCPU, R32PCPU, R120PCPU, NZ2MC-8MBSE ■ Added functions Process control function, online module change function ■ Added or modified parts INTRODUCTION, TERMS, Section 1.1, 2.1, 2.2, Chapter 3, Section 4.2, 4.8, 4.15, Appendix 1
August 2015	SH(NA)-081263ENG-D	<ul style="list-style-type: none"> ■ Added models R04ENCPU, R08ENCPU, R08SFCPU, R16ENCPU, R16SFCPU, R32ENCPU, R32SFCPU, R120ENCPU, R120SFCPU, NZ2MC-16MBS, R6SFM ■ Added functions User authentication function, safety function ■ Added or modified parts SAFETY PRECAUTIONS, CONDITIONS OF USE FOR THE PRODUCT, INTRODUCTION, COMPLIANCE WITH MACHINERY DIRECTIVE, TERMS, Section 1.1, 1.3, 2.1, 2.2, 2.3, Chapter 3, Section 4.1, 4.3, 4.8, 4.16, Appendix 1, WARRANTY
January 2016	SH(NA)-081263ENG-E	<ul style="list-style-type: none"> ■ Added function Sequence scan synchronization sampling function ■ Added or modified parts SAFETY PRECAUTIONS, Section 2.1, Chapter 3, Section 4.3, 4.6
May 2016	SH(NA)-081263ENG-F	<ul style="list-style-type: none"> ■ Added model R6RFM ■ Added functions CPU module data backup/restoration function, iQ Sensor Solution data backup/restoration function, redundant function, label initialization function ■ Added or modified parts SAFETY PRECAUTIONS, INTRODUCTION, TERMS, Section 1.1, 1.3, 2.1, 2.3, Chapter 3, Section 4.1, Appendix 1
October 2016	SH(NA)-081263ENG-G	<ul style="list-style-type: none"> ■ Added functions External input/output forced on/off function, CC-Link IE Field Network Basic function, firmware update function ■ Added or modified parts Section 1.1, Chapter 3, Section 4.1, 4.8
January 2017	SH(NA)-081263ENG-H	<ul style="list-style-type: none"> ■ Added or modified part Chapter 3
April 2017	SH(NA)-081263ENG-I	<ul style="list-style-type: none"> ■ Added or modified parts Chapter 2, 3
October 2017	SH(NA)-081263ENG-J	<ul style="list-style-type: none"> ■ Added models R00CPU, R01CPU, R02CPU, R08PSFCPU, R16PSFCPU, R32PSFCPU, R120PSFCPU, R6PSFM ■ Added or modified parts SAFETY PRECAUTIONS, CONDITIONS OF USE FOR THE PRODUCT, INTRODUCTION, TERMS, Section 1.1, 1.4, 2.1, 2.2, 2.4, Chapter 3, Section 4.1, 4.2, 4.4, 4.13, 4.14, 4.15, Appendix 1, WARRANTY
April 2018	SH(NA)-081263ENG-K	<ul style="list-style-type: none"> ■ Added model NZ1BLC ■ Added or modified parts SAFETY PRECAUTIONS, INTRODUCTION, Section 1.1, 1.2, 2.1, 2.3, Chapter 3, Section 4.1, 4.2, 4.3, Chapter 5
July 2018	SH(NA)-081263ENG-L	<ul style="list-style-type: none"> ■ Added function Device test with execution condition ■ Added or modified parts Section 1.1, Chapter 3
October 2018	SH(NA)-081263ENG-M	<ul style="list-style-type: none"> ■ Added or modified part Section 2.1

Revision date	*Manual number	Description
May 2019	SH(NA)-081263ENG-N	<ul style="list-style-type: none"> ■Added model NZ2MC-2MBSE ■Added or modified parts TERMS, GENERIC TERMS AND ABBREVIATIONS, Section 2.1, 2.2, Chapter 3, Appendix 1
August 2019	SH(NA)-081263ENG-O	<ul style="list-style-type: none"> ■Added or modified parts TERMS, GENERIC TERMS AND ABBREVIATIONS, Chapter 3
October 2019	SH(NA)-081263ENG-P	<ul style="list-style-type: none"> ■Added function Firmware update function (Update using the engineering tool) ■Added or modified part Chapter 3
May 2020	SH(NA)-081263ENG-Q	<ul style="list-style-type: none"> ■Added function Recording function ■Added or modified parts Section 2.1, 2.2, 2.4, 2.5, 2.6, Chapter 3, Section 4.1
July 2020	SH(NA)-081263ENG-R	<ul style="list-style-type: none"> ■Added or modified parts SAFETY PRECAUTIONS, CONDITIONS OF USE FOR THE PRODUCT
October 2020	SH(NA)-081263ENG-S	<ul style="list-style-type: none"> ■Added or modified parts SAFETY PRECAUTIONS, CONDITIONS OF USE FOR THE PRODUCT, TERMS, GENERIC TERMS AND ABBREVIATIONS, Chapter 3
April 2021	SH(NA)-081263ENG-T	<ul style="list-style-type: none"> ■Added functions Specified program monitor, device/label access service processing constant wait function ■Added or modified parts Chapter 3, Section 4.15
October 2021	SH(NA)-081263ENG-U	<ul style="list-style-type: none"> ■Added function Scan time clear ■Added or modified parts Section 2.1, Chapter 3
January 2022	SH(NA)-081263ENG-V	<ul style="list-style-type: none"> ■Added function Scan time measurement ■Added or modified part Chapter 3
April 2022	SH(NA)-081263ENG-W	<ul style="list-style-type: none"> ■Added function Write-protect function for device data (from outside the CPU module) ■Added or modified part Chapter 3
July 2022	SH(NA)-081263ENG-X	<ul style="list-style-type: none"> ■Added or modified parts INTRODUCTION, RELEVANT MANUALS, COMPLIANCE WITH EMC AND LOW VOLTAGE DIRECTIVES
November 2022	SH(NA)-081263ENG-Y	<ul style="list-style-type: none"> ■Added or modified parts CONDITIONS OF USE FOR THE PRODUCT, WARRANTY
April 2023	SH(NA)-081263ENG-Z	<ul style="list-style-type: none"> ■Added or modified part Chapter 3

Japanese manual number: SH-081223-Z

This manual confers no industrial property rights or any rights of any other kind, nor does it confer any patent licenses. Mitsubishi Electric Corporation cannot be held responsible for any problems involving industrial property rights which may occur as a result of using the contents noted in this manual.

© 2014 MITSUBISHI ELECTRIC CORPORATION

WARRANTY

Please confirm the following product warranty details before using this product.

1. Gratis Warranty Term and Gratis Warranty Range

If any faults or defects (hereinafter "Failure") found to be the responsibility of Mitsubishi occurs during use of the product within the gratis warranty term, the product shall be repaired at no cost via the sales representative or Mitsubishi Service Company.

However, if repairs are required onsite at domestic or overseas location, expenses to send an engineer will be solely at the customer's discretion. Mitsubishi shall not be held responsible for any re-commissioning, maintenance, or testing on-site that involves replacement of the failed module.

[Gratis Warranty Term]

The gratis warranty term of the product shall be for one year after the date of purchase or delivery to a designated place. Note that after manufacture and shipment from Mitsubishi, the maximum distribution period shall be six (6) months, and the longest gratis warranty term after manufacturing shall be eighteen (18) months. The gratis warranty term of repair parts shall not exceed the gratis warranty term before repairs.

[Gratis Warranty Range]

- (1) The range shall be limited to normal use within the usage state, usage methods and usage environment, etc., which follow the conditions and precautions, etc., given in the instruction manual, user's manual and caution labels on the product.
- (2) Even within the gratis warranty term, repairs shall be charged for in the following cases.
 1. Failure occurring from inappropriate storage or handling, carelessness or negligence by the user. Failure caused by the user's hardware or software design.
 2. Failure caused by unapproved modifications, etc., to the product by the user.
 3. When the Mitsubishi product is assembled into a user's device, Failure that could have been avoided if functions or structures, judged as necessary in the legal safety measures the user's device is subject to or as necessary by industry standards, had been provided.
 4. Failure that could have been avoided if consumable parts (battery, backlight, fuse, etc.) designated in the instruction manual had been correctly serviced or replaced.
 5. Failure caused by external irresistible forces such as fires or abnormal voltages, and Failure caused by force majeure such as earthquakes, lightning, wind and water damage.
 6. Failure caused by reasons unpredictable by scientific technology standards at time of shipment from Mitsubishi.
 7. Any other failure found not to be the responsibility of Mitsubishi or that admitted not to be so by the user.

2. Onerous repair term after discontinuation of production

- (1) Mitsubishi shall accept onerous product repairs for seven (7) years after production of the product is discontinued. Discontinuation of production shall be notified with Mitsubishi Technical Bulletins, etc.
- (2) Product supply (including repair parts) is not available after production is discontinued.

3. Overseas service

Overseas, repairs shall be accepted by Mitsubishi's local overseas FA Center. Note that the repair conditions at each FA Center may differ.

4. Exclusion of loss in opportunity and secondary loss from warranty liability

Regardless of the gratis warranty term, Mitsubishi shall not be liable for compensation to:

- (1) Damages caused by any cause found not to be the responsibility of Mitsubishi.
- (2) Loss in opportunity, lost profits incurred to the user by Failures of Mitsubishi products.
- (3) Special damages and secondary damages whether foreseeable or not, compensation for accidents, and compensation for damages to products other than Mitsubishi products.
- (4) Replacement by the user, maintenance of on-site equipment, start-up test run and other tasks.

5. Changes in product specifications

The specifications given in the catalogs, manuals or technical documents are subject to change without prior notice.

· For SIL2 Process CPUs

Please confirm the following product warranty details before using this product.

1. Limited Warranty and Product Support.

- a. Mitsubishi Electric Company ("MELCO") warrants that for a period of eighteen (18) months after date of delivery from the point of manufacture or one year from date of Customer's purchase, whichever is less, Mitsubishi programmable logic controllers (the "Products") will be free from defects in material and workmanship.
- b. At MELCO's option, for those Products MELCO determines are not as warranted, MELCO shall either repair or replace them or issue a credit or return the purchase price paid for them.
- c. For this warranty to apply:
 - (1) Customer shall give MELCO (i) notice of a warranty claim to MELCO and the authorized dealer or distributor from whom the Products were purchased, (ii) the notice shall describe in reasonable details the warranty problem, (iii) the notice shall be provided promptly and in no event later than thirty (30) days after the Customer knows or has reason to believe that Products are not as warranted, and (iv) in any event, the notice must be given within the warranty period;
 - (2) Customer shall cooperate with MELCO and MELCO's representatives in MELCO's investigation of the warranty claim, including preserving evidence of the claim and its causes, meaningfully responding to MELCO's questions and investigation of the problem, grant MELCO access to witnesses, personnel, documents, physical evidence and records concerning the warranty problem, and allow MELCO to examine and test the Products in question offsite or at the premises where they are installed or used; and
 - (3) If MELCO requests, Customer shall remove Products it claims are defective and ship them to MELCO or MELCO's authorized representative for examination and, if found defective, for repair or replacement. The costs of removal, shipment to and from MELCO's designated examination point, and reinstallation of repaired or replaced Products shall be at Customer's expense.
 - (4) If Customer requests and MELCO agrees to effect repairs onsite at any domestic or overseas location, the Customer will pay for the costs of sending repair personnel and shipping parts. MELCO is not responsible for any re-commissioning, maintenance, or testing on-site that involves repairs or replacing of the Products.
- d. Repairs of Products located outside of Japan are accepted by MELCO's local authorized service facility centers ("FA Centers"). Terms and conditions on which each FA Center offers repair services for Products that are out of warranty or not covered by MELCO's limited warranty may vary.
- e. Subject to availability of spare parts, MELCO will offer Product repair services for (7) years after each Product model or line is discontinued, at MELCO's or its FA Centers' rates and charges and standard terms in effect at the time of repair. MELCO usually produces and retains sufficient spare parts for repairs of its Products for a period of seven (7) years after production is discontinued.
- f. MELCO generally announces discontinuation of Products through MELCO's Technical Bulletins. Products discontinued and repair parts for them may not be available after their production is discontinued.

2. Limits of Warranties.

- a. MELCO does not warrant or guarantee the design, specify, manufacture, construction or installation of the materials, construction criteria, functionality, use, properties or other characteristics of the equipment, systems, or production lines into which the Products may be incorporated, including any safety, fail-safe and shut down systems using the Products.
- b. MELCO is not responsible for determining the suitability of the Products for their intended purpose and use, including determining if the Products provide appropriate safety margins and redundancies for the applications, equipment or systems into which they are incorporated.
- c. Customer acknowledges that qualified and experienced personnel are required to determine the suitability, application, design, construction and proper installation and integration of the Products. MELCO does not supply such personnel.
- d. MELCO is not responsible for designing and conducting tests to determine that the Product functions appropriately and meets application standards and requirements as installed or incorporated into the end-user's equipment, production lines or systems.
- e. MELCO does not warrant any Product:
 - (1) repaired or altered by persons other than MELCO or its authorized engineers or FA Centers;
 - (2) subjected to negligence, carelessness, accident, misuse, or damage;
 - (3) improperly stored, handled, installed or maintained;
 - (4) integrated or used in connection with improperly designed, incompatible or defective hardware or software;
 - (5) that fails because consumable parts such as batteries, backlights, or fuses were not tested, serviced or replaced;
 - (6) operated or used with equipment, production lines or systems that do not meet applicable and commensurate legal, safety and industry-accepted standards;
 - (7) operated or used in abnormal applications;
 - (8) installed, operated or used in contravention of instructions, precautions or warnings contained in MELCO's user, instruction and/or safety manuals, technical bulletins and guidelines for the Products;
 - (9) used with obsolete technologies or technologies not fully tested and widely accepted and in use at the time of the Product's manufacture;
 - (10) subjected to excessive heat or moisture, abnormal voltages, shock, excessive vibration, physical damage or other improper environment; or
 - (11) damaged or malfunctioning due to Acts of God, fires, acts of vandals, criminals or terrorists, communication or power failures, or any other cause or failure that results from circumstances beyond MELCO's control.
- f. All Product information and specifications contained on MELCO's website and in catalogs, manuals, or technical information materials provided by MELCO are subject to change without prior notice.

- g. The Product information and statements contained on MELCO's website and in catalogs, manuals, technical bulletins or other materials provided by MELCO are provided as a guide for Customer's use. They do not constitute warranties and are not incorporated in the contract of sale for the Products.
- h. These terms and conditions constitute the entire agreement between Customer and MELCO with respect to warranties, remedies and damages and supersede any other understandings, whether written or oral, between the parties. Customer expressly acknowledges that any representations or statements made by MELCO or others concerning the Products outside these terms are not part of the basis of the bargain between the parties and are not factored into the pricing of the Products.
- i. THE WARRANTIES AND REMEDIES SET FORTH IN THESE TERMS ARE THE EXCLUSIVE AND ONLY WARRANTIES AND REMEDIES THAT APPLY TO THE PRODUCTS.
- j. MELCO DISCLAIMS THE IMPLIED WARRANTIES OF MERCHANTABILITY AND FITNESS FOR A PARTICULAR PURPOSE.

3. Limits on Damages.

- a. MELCO'S MAXIMUM CUMULATIVE LIABILITY BASED ON ANY CLAIMS FOR BREACH OF WARRANTY OR CONTRACT, NEGLIGENCE, STRICT TORT LIABILITY OR OTHER THEORIES OF RECOVERY REGARDING THE SALE, REPAIR, REPLACEMENT, DELIVERY, PERFORMANCE, CONDITION, SUITABILITY, COMPLIANCE, OR OTHER ASPECTS OF THE PRODUCTS OR THEIR SALE, INSTALLATION OR USE SHALL BE LIMITED TO THE PRICE PAID FOR PRODUCTS NOT AS WARRANTED.
- b. Although MELCO has declared Product's compliance with the international safety standards IEC61508, IEC61511, this fact does not guarantee that Product will be free from any malfunction or failure. The user of this Product shall comply with any and all applicable safety standard, regulation or law and take appropriate safety measures for the system in which the Product is installed or used and shall take the second or third safety measures other than the Product. MELCO is not liable for damages that could have been prevented by compliance with any applicable safety standard, regulation or law.
- c. MELCO prohibits the use of Products with or in any application involving power plants, trains, railway systems, airplanes, airline operations, other transportation systems, amusement equipments, hospitals, medical care, dialysis and life support facilities or equipment, incineration and fuel devices, handling of nuclear or hazardous materials or chemicals, mining and drilling, and other applications where the level of risk to human life, health or property are elevated.
- d. MELCO SHALL NOT BE LIABLE FOR SPECIAL, INCIDENTAL, CONSEQUENTIAL, INDIRECT OR PUNITIVE DAMAGES, FOR LOSS OF PROFITS, SALES, OR REVENUE, FOR INCREASED LABOR OR OVERHEAD COSTS, FOR DOWNTIME OR LOSS OF PRODUCTION, FOR COST OVERRUNS, OR FOR ENVIRONMENTAL OR POLLUTION DAMAGES OR CLEAN-UP COSTS, WHETHER THE LOSS IS BASED ON CLAIMS FOR BREACH OF CONTRACT OR WARRANTY, VIOLATION OF STATUTE, NEGLIGENCE OR OTHER TORT, STRICT LIABILITY OR OTHERWISE.
- e. In the event that any damages which are asserted against MELCO arising out of or relating to the Products or defects in them, consist of personal injury, wrongful death and/or physical property damages as well as damages of a pecuniary nature, the disclaimers and limitations contained in these terms shall apply to all three types of damages to the fullest extent permitted by law. If, however, the personal injury, wrongful death and/or physical property damages cannot be disclaimed or limited by law or public policy to the extent provided by these terms, then in any such event the disclaimer of and limitations on pecuniary or economic consequential and incidental damages shall nevertheless be enforceable to the fullest extent allowed by law.
- f. In no event shall any cause of action arising out of breach of warranty or otherwise concerning the Products be brought by Customer more than one year after the cause of action accrues.
- g. Each of the limitations on remedies and damages set forth in these terms is separate and independently enforceable, notwithstanding the unenforceability or failure of essential purpose of any warranty, undertaking, damage limitation, other provision of these terms or other terms comprising the contract of sale between Customer and MELCO.

4. Delivery/Force Majeure.

- a. Any delivery date for the Products acknowledged by MELCO is an estimated and not a promised date. MELCO will make all reasonable efforts to meet the delivery schedule set forth in Customer's order or the purchase contract but shall not be liable for failure to do so.
- b. Products stored at the request of Customer or because Customer refuses or delays shipment shall be at the risk and expense of Customer.
- c. MELCO shall not be liable for any damage to or loss of the Products or any delay in or failure to deliver, service, repair or replace the Products arising from shortage of raw materials, failure of suppliers to make timely delivery, labor difficulties of any kind, earthquake, fire, windstorm, flood, theft, criminal or terrorist acts, war, embargoes, governmental acts or rulings, loss or damage or delays in carriage, acts of God, vandals or any other circumstances reasonably beyond MELCO's control.

5. Choice of Law/Jurisdiction.

These terms and any agreement or contract between Customer and MELCO shall be governed by the laws of the State of New York without regard to conflicts of laws. To the extent any action or dispute is not arbitrated, the parties consent to the exclusive jurisdiction and venue of the federal and state courts located in the Southern District of the State of New York. Any judgment there obtained may be enforced in any court of competent jurisdiction.

6. Arbitration.

Any controversy or claim arising out of, or relating to or in connection with the Products, their sale or use or these terms, shall be settled by arbitration conducted in accordance with the Center for Public Resources (CPR) Rules for Non-Administered Arbitration of International Disputes, by a sole arbitrator chosen from the CPR's panels of distinguished neutrals. Judgment upon the award rendered by the Arbitrator shall be final and binding and may be entered by any court having jurisdiction thereof. The place of the arbitration shall be New York City, New York. The language of the arbitration shall be English. The neutral organization designated to perform the functions specified in Rule 6 and Rules 7.7(b), 7.8 and 7.9 shall be the CPR.

· For Safety CPUs

Please confirm the following product warranty details before using this product.

1. Limited Warranty and Product Support.

- a. Mitsubishi Electric Company ("MELCO") warrants that for a period of eighteen (18) months after date of delivery from the point of manufacture or one year from date of Customer's purchase, whichever is less, Mitsubishi MELSEC Safety programmable logic controllers (the "Products") will be free from defects in material and workmanship.
- b. At MELCO's option, for those Products MELCO determines are not as warranted, MELCO shall either repair or replace them or issue a credit or return the purchase price paid for them.
- c. For this warranty to apply:
 - (1) Customer shall give MELCO (i) notice of a warranty claim to MELCO and the authorized dealer or distributor from whom the Products were purchased, (ii) the notice shall describe in reasonable details the warranty problem, (iii) the notice shall be provided promptly and in no event later than thirty (30) days after the Customer knows or has reason to believe that Products are not as warranted, and (iv) in any event, the notice must be given within the warranty period;
 - (2) Customer shall cooperate with MELCO and MELCO's representatives in MELCO's investigation of the warranty claim, including preserving evidence of the claim and its causes, meaningfully responding to MELCO's questions and investigation of the problem, grant MELCO access to witnesses, personnel, documents, physical evidence and records concerning the warranty problem, and allow MELCO to examine and test the Products in question offsite or at the premises where they are installed or used; and
 - (3) If MELCO requests, Customer shall remove Products it claims are defective and ship them to MELCO or MELCO's authorized representative for examination and, if found defective, for repair or replacement. The costs of removal, shipment to and from MELCO's designated examination point, and reinstallation of repaired or replaced Products shall be at Customer's expense.
 - (4) If Customer requests and MELCO agrees to effect repairs onsite at any domestic or overseas location, the Customer will pay for the costs of sending repair personnel and shipping parts. MELCO is not responsible for any re-commissioning, maintenance, or testing on-site that involves repairs or replacing of the Products.
- d. Repairs of Products located outside of Japan are accepted by MELCO's local authorized service facility centers ("FA Centers"). Terms and conditions on which each FA Center offers repair services for Products that are out of warranty or not covered by MELCO's limited warranty may vary.
- e. Subject to availability of spare parts, MELCO will offer Product repair services for (7) years after each Product model or line is discontinued, at MELCO's or its FA Centers' rates and charges and standard terms in effect at the time of repair. MELCO usually produces and retains sufficient spare parts for repairs of its Products for a period of seven (7) years after production is discontinued.
- f. MELCO generally announces discontinuation of Products through MELCO's Technical Bulletins. Products discontinued and repair parts for them may not be available after their production is discontinued.

2. Limits of Warranties.

- a. MELCO does not warrant or guarantee the design, specify, manufacture, construction or installation of the materials, construction criteria, functionality, use, properties or other characteristics of the equipment, systems, or production lines into which the Products may be incorporated, including any safety, fail-safe and shut down systems using the Products.
- b. MELCO is not responsible for determining the suitability of the Products for their intended purpose and use, including determining if the Products provide appropriate safety margins and redundancies for the applications, equipment or systems into which they are incorporated.
- c. Customer acknowledges that qualified and experienced personnel are required to determine the suitability, application, design, construction and proper installation and integration of the Products. MELCO does not supply such personnel.
- d. MELCO is not responsible for designing and conducting tests to determine that the Product functions appropriately and meets application standards and requirements as installed or incorporated into the end-user's equipment, production lines or systems.
- e. MELCO does not warrant any Product:
 - (1) repaired or altered by persons other than MELCO or its authorized engineers or FA Centers;
 - (2) subjected to negligence, carelessness, accident, misuse, or damage;
 - (3) improperly stored, handled, installed or maintained;
 - (4) integrated or used in connection with improperly designed, incompatible or defective hardware or software;
 - (5) that fails because consumable parts such as batteries, backlights, or fuses were not tested, serviced or replaced;
 - (6) operated or used with equipment, production lines or systems that do not meet applicable and commensurate legal, safety and industry-accepted standards;
 - (7) operated or used in abnormal applications;
 - (8) installed, operated or used in contravention of instructions, precautions or warnings contained in MELCO's user, instruction and/or safety manuals, technical bulletins and guidelines for the Products;
 - (9) used with obsolete technologies or technologies not fully tested and widely accepted and in use at the time of the Product's manufacture;
 - (10) subjected to excessive heat or moisture, abnormal voltages, shock, excessive vibration, physical damage or other improper environment; or
 - (11) damaged or malfunctioning due to Acts of God, fires, acts of vandals, criminals or terrorists, communication or power failures, or any other cause or failure that results from circumstances beyond MELCO's control.
- f. All Product information and specifications contained on MELCO's website and in catalogs, manuals, or technical information materials provided by MELCO are subject to change without prior notice.

- g. The Product information and statements contained on MELCO's website and in catalogs, manuals, technical bulletins or other materials provided by MELCO are provided as a guide for Customer's use. They do not constitute warranties and are not incorporated in the contract of sale for the Products.
- h. These terms and conditions constitute the entire agreement between Customer and MELCO with respect to warranties, remedies and damages and supersede any other understandings, whether written or oral, between the parties. Customer expressly acknowledges that any representations or statements made by MELCO or others concerning the Products outside these terms are not part of the basis of the bargain between the parties and are not factored into the pricing of the Products.
- i. THE WARRANTIES AND REMEDIES SET FORTH IN THESE TERMS ARE THE EXCLUSIVE AND ONLY WARRANTIES AND REMEDIES THAT APPLY TO THE PRODUCTS.
- j. MELCO DISCLAIMS THE IMPLIED WARRANTIES OF MERCHANTABILITY AND FITNESS FOR A PARTICULAR PURPOSE.

3. Limits on Damages.

- a. MELCO'S MAXIMUM CUMULATIVE LIABILITY BASED ON ANY CLAIMS FOR BREACH OF WARRANTY OR CONTRACT, NEGLIGENCE, STRICT TORT LIABILITY OR OTHER THEORIES OF RECOVERY REGARDING THE SALE, REPAIR, REPLACEMENT, DELIVERY, PERFORMANCE, CONDITION, SUITABILITY, COMPLIANCE, OR OTHER ASPECTS OF THE PRODUCTS OR THEIR SALE, INSTALLATION OR USE SHALL BE LIMITED TO THE PRICE PAID FOR PRODUCTS NOT AS WARRANTED.
- b. Although MELCO has obtained the certification for Product's compliance to the international safety standards IEC61508 and ISO13849-1 from TUV Rheinland, this fact does not guarantee that Product will be free from any malfunction or failure. The user of this Product shall comply with any and all applicable safety standard, regulation or law and take appropriate safety measures for the system in which the Product is installed or used and shall take the second or third safety measures other than the Product. MELCO is not liable for damages that could have been prevented by compliance with any applicable safety standard, regulation or law.
- c. MELCO prohibits the use of Products with or in any application involving power plants, trains, railway systems, airplanes, airline operations, other transportation systems, amusement equipments, hospitals, medical care, dialysis and life support facilities or equipment, incineration and fuel devices, handling of nuclear or hazardous materials or chemicals, mining and drilling, and other applications where the level of risk to human life, health or property are elevated.
- d. MELCO SHALL NOT BE LIABLE FOR SPECIAL, INCIDENTAL, CONSEQUENTIAL, INDIRECT OR PUNITIVE DAMAGES, FOR LOSS OF PROFITS, SALES, OR REVENUE, FOR INCREASED LABOR OR OVERHEAD COSTS, FOR DOWNTIME OR LOSS OF PRODUCTION, FOR COST OVERRUNS, OR FOR ENVIRONMENTAL OR POLLUTION DAMAGES OR CLEAN-UP COSTS, WHETHER THE LOSS IS BASED ON CLAIMS FOR BREACH OF CONTRACT OR WARRANTY, VIOLATION OF STATUTE, NEGLIGENCE OR OTHER TORT, STRICT LIABILITY OR OTHERWISE.
- e. In the event that any damages which are asserted against MELCO arising out of or relating to the Products or defects in them, consist of personal injury, wrongful death and/or physical property damages as well as damages of a pecuniary nature, the disclaimers and limitations contained in these terms shall apply to all three types of damages to the fullest extent permitted by law. If, however, the personal injury, wrongful death and/or physical property damages cannot be disclaimed or limited by law or public policy to the extent provided by these terms, then in any such event the disclaimer of and limitations on pecuniary or economic consequential and incidental damages shall nevertheless be enforceable to the fullest extent allowed by law.
- f. In no event shall any cause of action arising out of breach of warranty or otherwise concerning the Products be brought by Customer more than one year after the cause of action accrues.
- g. Each of the limitations on remedies and damages set forth in these terms is separate and independently enforceable, notwithstanding the unenforceability or failure of essential purpose of any warranty, undertaking, damage limitation, other provision of these terms or other terms comprising the contract of sale between Customer and MELCO.

4. Delivery/Force Majeure.

- a. Any delivery date for the Products acknowledged by MELCO is an estimated and not a promised date. MELCO will make all reasonable efforts to meet the delivery schedule set forth in Customer's order or the purchase contract but shall not be liable for failure to do so.
- b. Products stored at the request of Customer or because Customer refuses or delays shipment shall be at the risk and expense of Customer.
- c. MELCO shall not be liable for any damage to or loss of the Products or any delay in or failure to deliver, service, repair or replace the Products arising from shortage of raw materials, failure of suppliers to make timely delivery, labor difficulties of any kind, earthquake, fire, windstorm, flood, theft, criminal or terrorist acts, war, embargoes, governmental acts or rulings, loss or damage or delays in carriage, acts of God, vandals or any other circumstances reasonably beyond MELCO's control.

5. Choice of Law/Jurisdiction.

These terms and any agreement or contract between Customer and MELCO shall be governed by the laws of the State of New York without regard to conflicts of laws. To the extent any action or dispute is not arbitrated, the parties consent to the exclusive jurisdiction and venue of the federal and state courts located in the Southern District of the State of New York. Any judgment there obtained may be enforced in any court of competent jurisdiction.

6. Arbitration.

Any controversy or claim arising out of, or relating to or in connection with the Products, their sale or use or these terms, shall be settled by arbitration conducted in accordance with the Center for Public Resources (CPR) Rules for Non-Administered Arbitration of International Disputes, by a sole arbitrator chosen from the CPR's panels of distinguished neutrals. Judgment upon the award rendered by the Arbitrator shall be final and binding and may be entered by any court having jurisdiction thereof. The place of the arbitration shall be New York City, New York. The language of the arbitration shall be English. The neutral organization designated to perform the functions specified in Rule 6 and Rules 7.7(b), 7.8 and 7.9 shall be the CPR.

TRADEMARKS

The company names, system names and product names mentioned in this manual are either registered trademarks or trademarks of their respective companies.

In some cases, trademark symbols such as [™] or [®] are not specified in this manual.

SH(NA)-081263ENG-Z(2304)MEE

MODEL: RCPU-U-IN-E

MODEL CODE: 13JX02

MITSUBISHI ELECTRIC CORPORATION

HEAD OFFICE : TOKYO BUILDING, 2-7-3 MARUNOUCHI, CHIYODA-KU, TOKYO 100-8310, JAPAN
NAGOYA WORKS : 1-14, YADA-MINAMI 5-CHOME, HIGASHI-KU, NAGOYA, JAPAN

When exported from Japan, this manual does not require application to the
Ministry of Economy, Trade and Industry for service transaction permission.

Specifications subject to change without notice.