



Programmable Controller

MELSEC **Q** series

MELSEC-Q
QD77GF Simple Motion Module
User's Manual (Positioning Control)

-QD77GF4
-QD77GF8
-QD77GF16

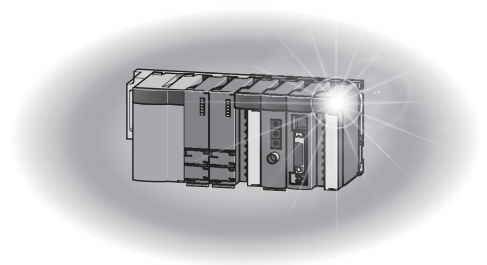

● SAFETY PRECAUTIONS ●

(Please read these instructions before using this equipment.)

Before using this product, please read this manual and the relevant manuals introduced in this manual carefully and pay full attention to safety to handle the product correctly.

The precautions given in this manual are concerned with this product only. Refer to the user's manual of the CPU module to use for a description of the PLC system safety precautions.

In this manual, the safety instructions are ranked as "DANGER" and "CAUTION".

 **DANGER**

Indicates that incorrect handling may cause hazardous conditions, resulting in death or severe injury.

 **CAUTION**

Indicates that incorrect handling may cause hazardous conditions, resulting in medium or slight personal injury or physical damage.

Depending on circumstances, procedures indicated by  CAUTION may also be linked to serious results.

In any case, it is important to follow the directions for usage.

Please save this manual to make it accessible when required and always forward it to the end user.

For Safe Operations

1. Prevention of electric shocks

DANGER

- Never open the front case or terminal covers while the power is ON or the unit is running, as this may lead to electric shocks.
- Never run the unit with the front case or terminal cover removed. The high voltage terminal and charged sections will be exposed and may lead to electric shocks.
- Never open the front case or terminal cover at times other than wiring work or periodic inspections even if the power is OFF. The insides of the module and servo amplifier are charged and may lead to electric shocks.
- Completely turn off the externally supplied power used in the system before mounting or removing the module, performing wiring work, or inspections. Failing to do so may lead to electric shocks.
- When performing wiring work or inspections, turn the power OFF, wait at least ten minutes, and then check the voltage with a tester, etc. Failing to do so may lead to electric shocks.
- Be sure to ground the module, servo amplifier and servomotor (Ground resistance: 100 Ω or less). Do not ground commonly with other devices.
- The wiring work and inspections must be done by a qualified technician.
- Wire the units after installing the module, servo amplifier and servomotor. Failing to do so may lead to electric shocks or damage.
- Never operate the switches with wet hands, as this may lead to electric shocks.
- Do not damage, apply excessive stress, place heavy things on or sandwich the cables, as this may lead to electric shocks.
- Do not touch the module, servo amplifier, servomotor connector or terminal blocks while the power is ON, as this may lead to electric shocks.
- Do not touch the built-in power supply, built-in grounding or signal wires of the module and servo amplifier, as this may lead to electric shocks.

2. For fire prevention

CAUTION

- Install the module, servo amplifier, servomotor and regenerative resistor on incombustible. Installing them directly or close to combustibles will lead to fire.
- If a fault occurs in the module or servo amplifier, shut the power OFF at the servo amplifier's power source. If a large current continues to flow, fire may occur.
- When using a regenerative resistor, shut the power OFF with an error signal. The regenerative resistor may abnormally overheat due to a fault in the regenerative transistor, etc., and may lead to fire.
- Always take heat measures such as flame proofing for the inside of the control panel where the servo amplifier or regenerative resistor is installed and for the wires used. Failing to do so may lead to fire.
- Do not damage, apply excessive stress, place heavy things on or sandwich the cables, as this may lead to fire.

3. For injury prevention

CAUTION

- Do not apply a voltage other than that specified in the instruction manual on any terminal. Doing so may lead to destruction or damage.
- Do not mistake the terminal connections, as this may lead to destruction or damage.
- Do not mistake the polarity (+ / -), as this may lead to destruction or damage.
- Do not touch the heat radiating fins of module or servo amplifier, regenerative resistor and servomotor, etc., while the power is ON and for a short time after the power is turned OFF. In this timing, these parts become very hot and may lead to burns.
- Always turn the power OFF before touching the servomotor shaft or coupled machines, as these parts may lead to injuries.
- Do not go near the machine during test operations or during operations such as teaching. Doing so may lead to injuries.

4. Various precautions

Strictly observe the following precautions. Mistaken handling of the unit may lead to faults, injuries or electric shocks.

(1) System structure

CAUTION

- Always install a leakage breaker on the module and servo amplifier power source.
- If installation of an electromagnetic contactor for power shut off during an error, etc., is specified in the instruction manual for the servo amplifier, etc., always install the electromagnetic contactor.
- Install the emergency stop circuit externally so that the operation can be stopped immediately and the power shut off.
- Use the module, servo amplifier, servomotor and regenerative resistor with the correct combinations listed in the instruction manual. Other combinations may lead to fire or faults.
- Use the CPU module, base unit, and Simple Motion module with the correct combinations listed in the instruction manual. Other combinations may lead to faults.
- If safety standards (ex., robot safety rules, etc.) apply to the system using the module, servo amplifier and servomotor, make sure that the safety standards are satisfied.
- Construct a safety circuit externally of the module or servo amplifier if the abnormal operation of the module or servo amplifier differs from the safety directive operation in the system.
- In systems where coasting of the servomotor will be a problem during the forced stop, emergency stop, servo OFF or power supply OFF, use the dynamic brake.
- Make sure that the system considers the coasting amount even when using the dynamic brake.
- In systems where perpendicular shaft dropping may be a problem during the forced stop, emergency stop, servo OFF or power supply OFF, use both the dynamic brake and electromagnetic brake.
- The dynamic brake must be used only on errors that cause the forced stop, emergency stop, or servo OFF. This brake must not be used for normal braking.
- The brake (electromagnetic brake) assembled into the servomotor are for holding applications, and must not be used for normal braking.

CAUTION

- The system must have a mechanical allowance so that the machine itself can stop even if the stroke limits switch is passed through at the max. speed.
- Use wires and cables that have a wire diameter, heat resistance and bending resistance compatible with the system.
- Use wires and cables within the length of the range described in the instruction manual.
- The ratings and characteristics of the parts (other than module, servo amplifier and servomotor) used in a system must be compatible with the module, servo amplifier and servomotor.
- Install a cover on the shaft so that the rotary parts of the servomotor are not touched during operation.
- There may be some cases where holding by the electromagnetic brake is not possible due to the life or mechanical structure (when the ball screw and servomotor are connected with a timing belt, etc.). Install a stopping device to ensure safety on the machine side.

(2) Security

CAUTION

- To maintain the security (confidentiality, integrity, and availability) of the programmable controller and the system against unauthorized access, denial-of-service (DoS) attacks, computer viruses, and other cyberattacks from external devices via the network, take appropriate measures such as firewalls, virtual private networks (VPNs), and antivirus solutions.

(3) Parameter settings and programming

DANGER

- Set the parameter values to those that are compatible with the module, servo amplifier, servomotor and regenerative resistor model and the system application. The protective functions may not function if the settings are incorrect.
- The regenerative resistor model and capacity parameters must be set to values that conform to the operation mode and servo amplifier. The protective functions may not function if the settings are incorrect.
- Set the mechanical brake output and dynamic brake output validity parameters to values that are compatible with the system application. The protective functions may not function if the settings are incorrect.
- Set the stroke limit input validity parameter to a value that is compatible with the system application. The protective functions may not function if the setting is incorrect.
- Set the servomotor encoder type (increment, absolute position type, etc.) parameter to a value that is compatible with the system application. The protective functions may not function if the setting is incorrect.
- Use the program commands for the program with the conditions specified in the instruction manual.

DANGER

- Set the sequence function program capacity setting, device capacity, latch validity range, I/O assignment setting, and validity of continuous operation during error detection to values that are compatible with the system application. The protective functions may not function if the settings are incorrect.
- The input devices and data registers assigned to the link will hold the data previous to when communication is terminated by an error, etc. Thus, an error correspondence interlock program specified in the instruction manual must be used.
- Use the interlock program specified in the intelligent function module's instruction manual for the program corresponding to the intelligent function module.
- When connecting GX Works2 with the CPU module or connecting a personal computer with an intelligent function module to modify data of a running programmable controller, configure an interlock circuit in the program to ensure that the entire system will always operate safely. For other forms of control (such as program modification or operating status change) of a running programmable controller, read the relevant manuals carefully and ensure that the operation is safe before proceeding. Especially, when a remote programmable controller is controlled by an external device, immediate action cannot be taken if a problem occurs in the programmable controller due to a communication failure. To prevent this, configure an interlock circuit in the program, and determine corrective actions to be taken between the external device and CPU module in case of a communication failure.
- For the operating status of each station after a communication failure, refer to the "MELSEC-Q QD77GF Simple Motion Module User's Manual (Network)". Incorrect output or malfunction due to a communication failure may result in an accident.
- Do not write any data to the "system area" of the buffer memory in the intelligent function module. Also, do not use any "use prohibited" signals as an output signal from the CPU module to the intelligent function module.
Doing so may cause malfunction of the programmable controller system.
- To set a refresh device in the network parameter, select the device Y for the remote output (RY) refresh device. If a device other than Y, such as M and L, is selected, the CPU module holds the device status even after its status is changed to STOP.
- If a communication cable is disconnected, the network may be unstable, resulting in a communication failure of multiple stations. Configure an interlock circuit in the program to ensure that the entire system will always operate safely even if communications fail.
Failure to do so may result in an accident due to an incorrect output or malfunction.

(4) Transportation and installation

DANGER

- Shut off the external power supply (all phases) used in the system before mounting or removing a module. Failure to do so may result in electric shock or cause the module to fail or malfunction.

⚠ CAUTION

- Transport the product with the correct method according to the mass.
- Use the servomotor suspension bolts only for the transportation of the servomotor. Do not transport the servomotor with machine installed on it.
- Do not stack products past the limit.
- When transporting the module or servo amplifier, never hold the connected wires or cables.
- When transporting the servomotor, never hold the cables, shaft or detector.
- When transporting the module or servo amplifier, never hold the front case as it may fall off.
- When transporting, installing or removing the module or servo amplifier, never hold the edges.
- Install the unit according to the instruction manual in a place where the mass can be withstood.
- Do not get on or place heavy objects on the product.
- Always observe the installation direction.
- Keep the designated clearance between the module or servo amplifier and control panel inner surface or the module and servo amplifier, module or servo amplifier and other devices.
- Do not install or operate modules, servo amplifiers or servomotors that are damaged or that have missing parts.
- Do not block the intake/outtake ports of the servo amplifier and servomotor with cooling fan.
- Do not allow conductive matter such as screw or cutting chips or combustible matter such as oil enter the module, servo amplifier or servomotor.
- The module, servo amplifier and servomotor are precision machines, so do not drop or apply strong impacts on them.
- Securely fix the module, servo amplifier and servomotor to the machine according to the instruction manual. If the fixing is insufficient, these may come off during operation.
- Always install the servomotor with reduction gears in the designated direction. Failing to do so may lead to oil leaks.
- Store and use the unit in the following environmental conditions.

| Environment | Conditions | |
|---------------------|---|--|
| | Module/Servo amplifier | Servomotor |
| Ambient temperature | According to each instruction manual. | 0°C to +40°C (With no freezing) |
| Ambient humidity | According to each instruction manual. | 80% RH or less (With no dew condensation) |
| Storage temperature | According to each instruction manual. | -20°C to +65°C |
| Atmosphere | Indoors (where not subject to direct sunlight). No corrosive gases, flammable gases, oil mist or dust must exist | |
| Altitude | According to each instruction manual | |
| Vibration | According to each instruction manual | |

- When coupling with the servomotor shaft end, do not apply impact such as by hitting with a hammer. Doing so may lead to detector damage.
- Do not apply a load larger than the tolerable load onto the servomotor shaft. Doing so may lead to shaft breakage.

CAUTION

- When not using the module for a long time, disconnect the power line from the module or servo amplifier.
- Place the module and servo amplifier in static electricity preventing vinyl bags and store.
- When storing for a long time, please contact with our sales representative.
Also, execute a trial operation.
- Make sure that the connectors for the servo amplifier and peripheral devices have been securely installed until a click is heard.
Not doing so could lead to a poor connection, resulting in erroneous input and output.
- Use the programmable controller in an environment that meets the general specifications in the user's manual for the CPU module used. Failure to do so may result in electric shock, fire, malfunction, or damage to or deterioration of the product.
- To mount the module, while pressing the module mounting lever located in the lower part of the module, fully insert the module fixing projection(s) into the hole(s) in the base unit and press the module until it snaps into place. Incorrect mounting may cause malfunction, failure or drop of the module.
When using the programmable controller in an environment of frequent vibrations, fix the module with a screw.
- Tighten the screws within the specified torque range. Undertightening can cause drop of the screw, short circuit or malfunction. Overtightening can damage the screw and/or module, resulting in drop, short circuit, or malfunction.
- Do not directly touch any conductive parts and electronic components of the module. Doing so can cause malfunction or failure of the module.
- When fumigants that contain halogen materials such as fluorine, chlorine, bromine, and iodine are used for disinfecting and protecting wooden packaging from insects, they cause malfunction when entering our products.
Please take necessary precautions to ensure that remaining materials from fumigant do not enter our products, or treat packaging with methods other than fumigation (heat method). Additionally, disinfect and protect wood from insects before packing products.
- The module and the servo amplifier must not be used with parts which contain halogen-series flame retardant materials (such as bromine) under coexisting conditions.

(5) Wiring

⚠ DANGER

- Shut off the external power supply (all phases) used in the system before wiring.
Failure to do so may result in electric shock or cause the module to fail or malfunction.

⚠ CAUTION

- Correctly and securely wire the wires. Reconfirm the connections for mistakes and the terminal screws for tightness after wiring. Failing to do so may lead to run away of the servomotor.
- After wiring, install the protective covers such as the terminal covers to the original positions.
- Do not install a phase advancing capacitor, surge absorber or radio noise filter (option FR-BIF) on the output side of the servo amplifier.
- Correctly connect the output side (terminal U, V, W). Incorrect connections will lead the servomotor to operate abnormally.
- Do not connect a commercial power supply to the servomotor, as this may lead to trouble.
- Do not mistake the direction of the surge absorbing diode installed on the DC relay for the control signal output of brake signals, etc. Incorrect installation may lead to signals not being output when trouble occurs or the protective functions not functioning.

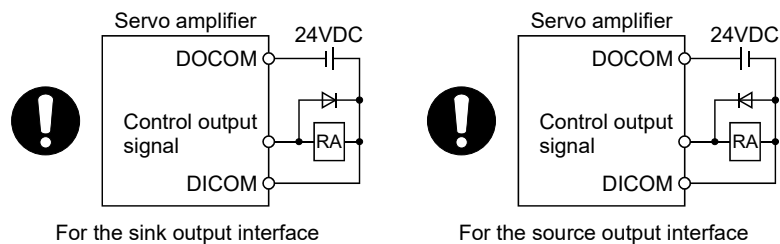

- Do not connect or disconnect the connection cables between each unit, the encoder cable or PLC expansion cable while the power is ON.
- Securely tighten the cable connector fixing screws and fixing mechanisms. Insufficient fixing may lead to the cables coming off during operation.
- Do not bundle the power line or cables.
- Use applicable solderless terminals and tighten them with the specified torque.
If any solderless spade terminal is used, it may be disconnected when the terminal screw comes loose, resulting in failure.
- Do not install the control lines or communication cables together with the main circuit lines or power cables. Keep a distance of 100mm or more between them. Failure to do so may result in malfunction due to noise.
- Prevent foreign matter such as dust or wire chips from entering the module. Such foreign matter can cause a fire, failure, or malfunction.
- A protective film is attached to the top of the module to prevent foreign matter, such as wire chips, from entering the module during wiring. Do not remove the film during wiring. Remove it for heat dissipation before system operation.

⚠ CAUTION

- Place the cables in a duct or clamp them. If not, dangling cable may swing or inadvertently be pulled, resulting in damage to the module or cables or malfunction due to poor contact. Do not clamp the extension cables with the jacket stripped. Doing so may change the characteristics of the cables, resulting in malfunction.
- When disconnecting the cable from the module, do not pull the cable by the cable part. For the cable with connector, hold the connector part of the cable. Pulling the cable connected to the module may result in malfunction or damage to the module or cable.
- Use 1000BASE-T-compliant Ethernet cables for Ethernet connection. For the maximum station-to-station distance and the overall cable distance, follow the specifications in this manual. If not, normal data transmission is not guaranteed.

(6) Trial operation and adjustment

⚠ CAUTION

- Confirm and adjust the program and each parameter before operation. Unpredictable movements may occur depending on the machine.
- Extreme adjustments and changes may lead to unstable operation, so never make them.
- When using the absolute position system function, on starting up, and when the module or absolute position motor has been replaced, always perform a home position return.
- Before starting test operation, set the parameter speed limit value to the slowest value, and make sure that operation can be stopped immediately by the forced stop, etc. if a hazardous state occurs.
- Before starting the operation, confirm the brake function.

(7) Usage methods

⚠ CAUTION

- Immediately turn OFF the power if smoke, abnormal sounds or odors are emitted from the module, servo amplifier or servomotor.
- Always execute a test operation before starting actual operations after the program or parameters have been changed or after maintenance and inspection.
- Do not attempt to disassemble and repair the units excluding a qualified technician whom our company recognized.
- Do not make any modifications to the unit.
- Keep the effect or electromagnetic obstacles to a minimum by installing a noise filter or by using wire shields, etc.
Electromagnetic obstacles may affect the electronic devices used near the module or servo amplifier.
- When using the CE Mark-compliant equipment design, refer to the "EMC Installation Guidelines" (data number IB(NA)-67339) and refer to the corresponding EMC guideline information for the servo amplifiers and other equipment.

⚠ CAUTION

- Note that when the reference axis speed is designated for interpolation operation, the speed of the partner axis (2nd axis, 3rd axis and 4th axis) may be larger than the set speed (larger than the speed limit value).
- Use the units with the following conditions.

| Item | Conditions |
|-----------------------------------|---------------------------------------|
| Input power | According to each instruction manual. |
| Input frequency | According to each instruction manual. |
| Tolerable momentary power failure | According to each instruction manual. |

(8) Corrective actions for errors

⚠ CAUTION

- If an error occurs in the self diagnosis of the module or servo amplifier, confirm the check details according to the instruction manual, and restore the operation.
- If a dangerous state is predicted in case of a power failure or product failure, use a servomotor with an electromagnetic brake or install a brake mechanism externally.
- Use a double circuit construction so that the electromagnetic brake operation circuit can be operated by emergency stop signals set externally.

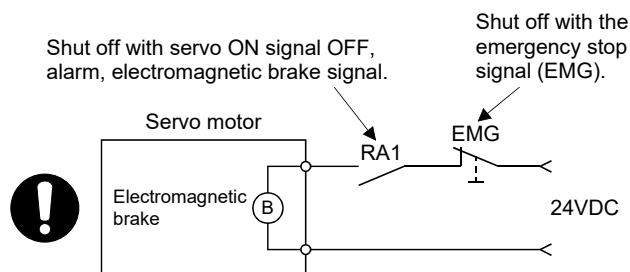

- If an error occurs, remove the cause, secure the safety and then resume operation after alarm release.
- The unit may suddenly resume operation after a power failure is restored, so do not go near the machine. (Design the machine so that personal safety can be ensured even if the machine restarts suddenly.)

(9) Maintenance, inspection and part replacement

DANGER

- Do not touch any terminal while power is on. Doing so will cause electric shock or malfunction.
- Shut off the external power supply (all phases) used in the system before cleaning the module or retightening the module fixing screw. Failure to do so may result in electric shock.

CAUTION

- Before performing online operations (especially, program modification, forced output, and operating status change) for the running CPU module on another station from GX Works2 over CC-Link IE Field Network, read relevant manuals carefully and ensure the safety. Improper operation may damage machines or cause accidents.
- Do not disassemble or modify the modules. Doing so may cause failure, malfunction, injury, or a fire.
- Use any radio communication device such as a cellular phone or PHS (Personal Handy-phone System) more than 25cm away in all directions from the programmable controller. Failure to do so may cause malfunction.
- Shut off the external power supply (all phases) used in the system before mounting or removing a module. Failure to do so may cause the module to fail or malfunction.
- Tighten the screw within the specified torque range. Undertightening can cause drop of the screw, short circuit or malfunction. Overtightening can damage the screw and/or module, resulting in drop, short circuit, or malfunction.
- Perform the daily and periodic inspections according to the instruction manual.
- Perform maintenance and inspection after backing up the program and parameters for the module and servo amplifier.
- Do not place fingers or hands in the clearance when opening or closing any opening.
- Periodically replace consumable parts such as batteries according to the instruction manual.
- Do not touch the lead sections such as ICs or the connector contacts.
- Before touching the module, always touch grounded metal, etc. to discharge static electricity from human body. Failure to do so may cause the module to fail or malfunction.
- Do not directly touch the module's conductive parts and electronic components. Touching them could cause an operation failure or give damage to the module.
- Do not place the module or servo amplifier on metal that may cause a power leakage or wood, plastic or vinyl that may cause static electricity buildup.
- Do not perform a megger test (insulation resistance measurement) during inspection.
- When replacing the module or servo amplifier, always set the new module settings correctly.

⚠ CAUTION

- When the module or absolute position motor has been replaced, carry out a home position return operation using the following method, otherwise position displacement could occur.
 - After writing the servo data to the Simple Motion module using programming software, switch on the power again, then perform a home position return operation.
- After maintenance and inspections are completed, confirm that the position detection of the absolute position detector function is correct.
- Do not drop or impact the battery installed to the module.
Doing so may damage the battery, causing battery liquid to leak in the battery. Do not use the dropped or impacted battery, but dispose of it.
- Do not short circuit, charge, overheat, incinerate or disassemble the batteries.
- The electrolytic capacitor will generate gas during a fault, so do not place your face near the module or servo amplifier.
- The electrolytic capacitor and fan will deteriorate. Periodically replace these to prevent secondary damage from faults. Please contact with our sales representative.
- Lock the control panel and prevent access to those who are not certified to handle or install electric equipment.
- Do not mount/remove the module and base or terminal block more than 50 times (IEC61131-2-compliant), after the first use of the product. Failure to do so may cause malfunction.
- Do not burn or break a module and servo amplifier. Doing so may cause a toxic gas.

(10) About processing of waste

When you discard module, servo amplifier, a battery (primary battery) and other option articles, please follow the law of each country (area).

⚠ CAUTION

- This product is not designed or manufactured to be used in equipment or systems in situations that can affect or endanger human life.
- When considering this product for operation in special applications such as machinery or systems used in passenger transportation, medical, aerospace, atomic power, electric power, or submarine repeating applications, please contact your nearest Mitsubishi sales representative.
- Although this product was manufactured under conditions of strict quality control, you are strongly advised to install safety devices to forestall serious accidents when it is used in facilities where a breakdown in the product is likely to cause a serious accident.

(11) General cautions

- All drawings provided in the instruction manual show the state with the covers and safety partitions removed to explain detailed sections. When operating the product, always return the covers and partitions to the designated positions, and operate according to the instruction manual.

INTRODUCTION

Thank you for purchasing the Mitsubishi Electric MELSEC-Q series programmable controllers. This manual describes the functions and programming of the Simple Motion module.

Before using this product, please read this manual and the relevant manuals carefully and develop familiarity with the functions and performance of the MELSEC-Q series programmable controller to handle the product correctly.

When applying the program examples introduced in this manual to the actual system, ensure the applicability and confirm that it will not cause system control problems.

Please make sure that the end users read this manual.

REMARK

- Unless otherwise specified, this manual describes the program examples in which the I/O numbers of X/Y00 to X/Y1F are assigned for a Q series Simple Motion module. I/O number assignment is required for using the program examples described in the manual.

For I/O number assignment, refer to the following.

QnUCPU User's Manual (Function Explanation, Program Fundamentals)

- Operating procedures are explained using GX Works2.

REVISIONS

* The manual number is given on the bottom left of the back cover.

| Print Date | * Manual Number | Revision |
|------------|------------------|---|
| Mar., 2013 | IB(NA)-0300202-A | First edition |
| Feb., 2014 | IB(NA)-0300202-B | [Additional function] Speed-torque control [Additional correction/partial correction] SAFETY PRECAUTIONS, RELEVANT MANUALS, Restrictions by the SERIAL No. and version, Parameters, Monitor data, Control data, List of errors, List of warnings, List of buffer memory addresses |
| Apr., 2016 | IB(NA)-0300202-C | [Additional model] QD77GF4/QD77GF8 [Additional function] Communication mode switching, Synchronous encoder via servo amplifier, Linear servo motor control mode, Direct drive motor control mode, Fully closed loop control mode [Additional correction/partial correction] SAFETY PRECAUTIONS, RELEVANT MANUALS, MANUAL PAGE ORGANIZATION, TERMS, General image of system, Restrictions by the SERIAL No. and version, Performance specifications, Parameters, Monitor data, Control data, HPR method, Control Sub Functions, Virtual servo amplifier function, List of errors, List of buffer memory addresses, Connection with servo amplifiers, WARRANTY |
| Sep., 2017 | IB(NA)-0300202-D | [Additional correction/partial correction] SAFETY PRECAUTIONS, Restrictions by the SERIAL No. and version, List of functions, Specifications of interfaces with external devices, Machine HPR, Outline of sub functions, External signal selection function, External input signal cable, WARRANTY |
| Nov., 2022 | IB(NA)-0300202-E | [Additional correction/partial correction] SAFETY PRECAUTIONS, WARRANTY |
| | | |

Japanese Manual Version IB-0300200

This manual confers no industrial property rights or any rights of any other kind, nor does it confer any patent licenses. Mitsubishi Electric Corporation cannot be held responsible for any problems involving industrial property rights which may occur as a result of using the contents noted in this manual.

CONTENTS

| | |
|---|------|
| SAFETY PRECAUTIONS..... | A- 1 |
| INTRODUCTION..... | A-13 |
| REVISIONS..... | A-14 |
| CONTENTS..... | A-15 |
| COMPLIANCE WITH THE EMC AND LOW VOLTAGE DIRECTIVES..... | A-22 |
| RELEVANT MANUALS | A-22 |
| MANUAL PAGE ORGANIZATION | A-24 |
| TERMS | A-25 |
| PACKING LIST..... | A-26 |

Section 1 Product Specifications and Handling

1. Product Outline 1- 1 to 1-28

| | |
|--|------|
| 1.1 Positioning control..... | 1- 2 |
| 1.1.1 Features of QD77GF..... | 1- 2 |
| 1.1.2 Purpose and applications of positioning control..... | 1- 5 |
| 1.1.3 Mechanism of positioning control | 1- 7 |
| 1.1.4 Overview of positioning control functions..... | 1- 8 |
| 1.1.5 Outline design of positioning system..... | 1-18 |
| 1.1.6 Communicating signals between QD77GF and each module | 1-19 |
| 1.2 Flow of system operation..... | 1-22 |
| 1.2.1 Flow of all processes..... | 1-22 |
| 1.2.2 Outline of starting | 1-24 |
| 1.2.3 Outline of stopping | 1-26 |
| 1.2.4 Outline for restarting..... | 1-28 |

2. System Configuration 2- 1 to 2- 8

| | |
|---|------|
| 2.1 General image of system..... | 2- 2 |
| 2.2 Component list | 2- 3 |
| 2.3 Applicable system | 2- 5 |
| 2.4 How to check the function version and SERIAL No. | 2- 7 |
| 2.5 Restrictions by the SERIAL No. and version. | 2- 8 |

3. Specifications and Functions 3- 1 to 3-34

| | |
|--|------|
| 3.1 Performance specifications..... | 3- 2 |
| 3.2 List of functions | 3- 4 |
| 3.2.1 QD77GF control functions | 3- 4 |
| 3.2.2 QD77GF main functions | 3- 7 |
| 3.2.3 QD77GF sub functions | 3- 9 |
| 3.2.4 QD77GF common functions | 3-11 |
| 3.2.5 Combination of QD77GF main functions and sub functions | 3-12 |
| 3.3 Specifications of input/output signals with PLC CPU | 3-14 |
| 3.3.1 List of input/output signals with PLC CPU..... | 3-14 |
| 3.3.2 Details of input signals (Simple Motion module → PLC CPU)..... | 3-15 |

| | |
|---|------|
| 3.3.3 Details of output signals (PLC CPU → Simple Motion module)..... | 3-17 |
| 3.4 Specifications of interfaces with external devices..... | 3-18 |
| 3.4.1 Electrical specifications of input signals | 3-18 |
| 3.4.2 Signal layout for external input connection connector | 3-20 |
| 3.4.3 List of input signal details..... | 3-22 |
| 3.4.4 Interface internal circuit..... | 3-24 |
| 3.5 External circuit design..... | 3-30 |

| | |
|---|---------------------|
| 4. Installation, Wiring and Maintenance of the Product | 4- 1 to 4-18 |
|---|---------------------|

| | |
|---|------|
| 4.1 Outline of installation, wiring and maintenance..... | 4- 2 |
| 4.1.1 Installation, wiring and maintenance procedures..... | 4- 2 |
| 4.1.2 Names of each part..... | 4- 3 |
| 4.1.3 Handling precautions | 4- 6 |
| 4.2 Installation | 4- 8 |
| 4.2.1 Precautions for installation..... | 4- 8 |
| 4.3 Wiring..... | 4- 9 |
| 4.3.1 Precautions for wiring..... | 4- 9 |
| 4.4 Confirming the installation and wiring..... | 4-17 |
| 4.4.1 Items to confirm when installation and wiring are completed | 4-17 |
| 4.5 Maintenance..... | 4-18 |
| 4.5.1 Precautions for maintenance | 4-18 |
| 4.5.2 Disposal instructions | 4-18 |

| | |
|---|----------------------|
| 5. Data Used for Positioning Control | 5- 1 to 5-162 |
|---|----------------------|

| | |
|--|------|
| 5.1 Types of data..... | 5- 2 |
| 5.1.1 Parameters and data required for control | 5- 2 |
| 5.1.2 Setting items for positioning parameters..... | 5- 5 |
| 5.1.3 Setting items for HPR parameters..... | 5- 7 |
| 5.1.4 Setting items for expansion parameters..... | 5- 8 |
| 5.1.5 Setting items for servo parameters..... | 5- 8 |
| 5.1.6 Setting items for positioning data..... | 5- 9 |
| 5.1.7 Setting items for block start data | 5-10 |
| 5.1.8 Setting items for condition data | 5-11 |
| 5.1.9 Types and roles of monitor data | 5-12 |
| 5.1.10 Types and roles of control data | 5-16 |
| 5.2 List of parameters | 5-20 |
| 5.2.1 Basic parameters 1 | 5-20 |
| 5.2.2 Basic parameters 2 | 5-26 |
| 5.2.3 Detailed parameters 1..... | 5-27 |
| 5.2.4 Detailed parameters 2..... | 5-38 |
| 5.2.5 HPR basic parameters..... | 5-50 |
| 5.2.6 HPR detailed parameters..... | 5-56 |
| 5.2.7 Expansion parameters | 5-61 |
| 5.2.8 Servo parameters | 5-63 |
| 5.3 List of positioning data | 5-64 |
| 5.4 List of block start data | 5-80 |
| 5.5 List of condition data | 5-84 |
| 5.6 List of monitor data..... | 5-90 |
| 5.6.1 System monitor data | 5-90 |

| | |
|---------------------------------|-------|
| 5.6.2 Axis monitor data..... | 5-104 |
| 5.7 List of control data..... | 5-130 |
| 5.7.1 System control data | 5-130 |
| 5.7.2 Axis control data | 5-134 |

| | |
|---|---------------------|
| 6. Sequence Program Used for Positioning Control | 6- 1 to 6-76 |
|---|---------------------|

| | |
|--|------|
| 6.1 Precautions for creating program | 6- 2 |
| 6.2 List of devices used..... | 6- 5 |
| 6.3 Creating a program | 6-16 |
| 6.3.1 General configuration of program | 6-16 |
| 6.3.2 Positioning control operation program..... | 6-17 |
| 6.4 Positioning program examples [RJ010 mode]..... | 6-21 |
| 6.5 Program details | 6-53 |
| 6.5.1 Initialization program | 6-53 |
| 6.5.2 Start details setting program..... | 6-54 |
| 6.5.3 Start program..... | 6-56 |
| 6.5.4 Continuous operation interrupt program..... | 6-68 |
| 6.5.5 Restart program | 6-70 |
| 6.5.6 Stop program..... | 6-73 |

| | |
|---|---------------------|
| 7. Memory Configuration and Data Process | 7- 1 to 7-16 |
|---|---------------------|

| | |
|--|------|
| 7.1 Configuration and roles of QD77GF memory | 7- 2 |
| 7.1.1 Configuration and roles of QD77GF memory | 7- 2 |
| 7.1.2 Buffer memory area configuration | 7- 5 |
| 7.2 Data transmission process | 7- 7 |

Section 2 Control Details and Setting

8. HPR Control 8- 1 to 8-24

| | |
|---|------|
| 8.1 Outline of HPR control | 8- 2 |
| 8.1.1 Two types of HPR control | 8- 2 |
| 8.2 Machine HPR | 8- 5 |
| 8.2.1 Outline of the machine HPR operation | 8- 5 |
| 8.2.2 Machine HPR method | 8- 7 |
| 8.2.3 HPR method (1): Proximity dog method [RJ010 mode] | 8- 8 |
| 8.2.4 HPR method (2): Count method 1) [RJ010 mode] | 8-10 |
| 8.2.5 HPR method (3): Count method 2) [RJ010 mode] | 8-12 |
| 8.2.6 HPR method (4): Data set method [RJ010 mode] | 8-14 |
| 8.2.7 HPR method (5): Scale origin signal detection method [RJ010 mode] | 8-15 |
| 8.2.8 HPR method (6): Driver HPR method [CiA402 mode] | 8-18 |
| 8.3 Fast HPR | 8-21 |
| 8.3.1 Outline of the fast HPR operation | 8-21 |
| 8.4 Selection of the HPR setting condition | 8-23 |
| 8.4.1 Outline of the HPR setting condition | 8-23 |

9. Major Positioning Control 9- 1 to 9-128

| | |
|--|-------|
| 9.1 Outline of major positioning controls | 9- 2 |
| 9.1.1 Data required for major positioning control | 9- 4 |
| 9.1.2 Operation patterns of major positioning controls | 9- 5 |
| 9.1.3 Designating the positioning address | 9-15 |
| 9.1.4 Confirming the current value | 9-16 |
| 9.1.5 Control unit "degree" handling | 9-18 |
| 9.1.6 Interpolation control | 9-21 |
| 9.2 Setting the positioning data | 9-26 |
| 9.2.1 Relation between each control and positioning data | 9-26 |
| 9.2.2 1-axis linear control | 9-28 |
| 9.2.3 2-axis linear interpolation control | 9-32 |
| 9.2.4 3-axis linear interpolation control | 9-37 |
| 9.2.5 4-axis linear interpolation control | 9-43 |
| 9.2.6 1-axis fixed-feed control | 9-46 |
| 9.2.7 2-axis fixed-feed control (interpolation) | 9-49 |
| 9.2.8 3-axis fixed-feed control (interpolation) | 9-51 |
| 9.2.9 4-axis fixed-feed control (interpolation) | 9-56 |
| 9.2.10 2-axis circular interpolation control with sub point designation | 9-59 |
| 9.2.11 2-axis circular interpolation control with center point designation | 9-65 |
| 9.2.12 1-axis speed control | 9-73 |
| 9.2.13 2-axis speed control | 9-76 |
| 9.2.14 3-axis speed control | 9-80 |
| 9.2.15 4-axis speed control | 9-84 |
| 9.2.16 Speed-position switching control (INC mode) | 9-89 |
| 9.2.17 Speed-position switching control (ABS mode) | 9-99 |
| 9.2.18 Position-speed switching control | 9-108 |
| 9.2.19 Current value changing | 9-117 |

| | |
|-------------------------------|-------|
| 9.2.20 NOP instruction | 9-122 |
| 9.2.21 JUMP instruction | 9-123 |
| 9.2.22 LOOP | 9-125 |
| 9.2.23 LEND | 9-127 |

| | |
|---|-----------------------|
| 10. High-Level Positioning Control | 10- 1 to 10-26 |
|---|-----------------------|

| | |
|--|-------|
| 10.1 Outline of high-level positioning control | 10- 2 |
| 10.1.1 Data required for high-level positioning control | 10- 3 |
| 10.1.2 "Block start data" and "condition data" configuration | 10- 4 |
| 10.2 High-level positioning control execution procedure | 10- 6 |
| 10.3 Setting the block start data | 10- 7 |
| 10.3.1 Relation between various controls and block start data | 10- 7 |
| 10.3.2 Block start (normal start) | 10- 8 |
| 10.3.3 Condition start | 10-10 |
| 10.3.4 Wait start | 10-11 |
| 10.3.5 Simultaneous start | 10-12 |
| 10.3.6 Repeated start (FOR loop) | 10-13 |
| 10.3.7 Repeated start (FOR condition) | 10-14 |
| 10.3.8 Restrictions when using the NEXT start | 10-15 |
| 10.4 Setting the condition data | 10-16 |
| 10.4.1 Relation between various controls and the condition data | 10-16 |
| 10.4.2 Condition data setting examples | 10-18 |
| 10.5 Multiple axes simultaneous start control | 10-19 |
| 10.6 Start program for high-level positioning control | 10-22 |
| 10.6.1 Starting high-level positioning control | 10-22 |
| 10.6.2 Example of a start program for high-level positioning control | 10-23 |

| | |
|---------------------------|-----------------------|
| 11. Manual Control | 11- 1 to 11-32 |
|---------------------------|-----------------------|

| | |
|--|-------|
| 11.1 Outline of manual control | 11- 2 |
| 11.1.1 Three manual control methods | 11- 2 |
| 11.2 JOG operation | 11- 4 |
| 11.2.1 Outline of JOG operation | 11- 4 |
| 11.2.2 JOG operation execution procedure | 11- 7 |
| 11.2.3 Setting the required parameters for JOG operation | 11- 8 |
| 11.2.4 Creating start programs for JOG operation | 11-10 |
| 11.2.5 JOG operation example | 11-12 |
| 11.3 Inching operation | 11-15 |
| 11.3.1 Outline of inching operation | 11-15 |
| 11.3.2 Inching operation execution procedure | 11-18 |
| 11.3.3 Setting the required parameters for inching operation | 11-19 |
| 11.3.4 Creating a program to start the inching operation | 11-20 |
| 11.3.5 Inching operation example | 11-22 |
| 11.4 Manual pulse generator operation | 11-24 |
| 11.4.1 Outline of manual pulse generator operation | 11-24 |
| 11.4.2 Manual pulse generator operation execution procedure | 11-28 |
| 11.4.3 Setting the required parameters for manual pulse generator operation | 11-29 |
| 11.4.4 Creating a program to enable/disable the manual pulse generator operation | 11-30 |

| | |
|-----------------------|----------------|
| 12. Expansion Control | 12- 1 to 12-18 |
|-----------------------|----------------|

| | |
|--|-------|
| 12.1 Speed-torque control | 12- 2 |
| 12.1.1 Outline of speed-torque control | 12- 2 |
| 12.1.2 Setting the required parameters for speed-torque control..... | 12- 3 |
| 12.1.3 Setting the required data for speed-torque control | 12- 4 |
| 12.1.4 Operation of speed-torque control..... | 12- 5 |
| 12.2 Synchronous control | 12-18 |

| | |
|---------------------------|-----------------|
| 13. Control Sub Functions | 13- 1 to 13-108 |
|---------------------------|-----------------|

| | |
|--|--------|
| 13.1 Outline of sub functions | 13- 2 |
| 13.1.1 Outline of sub functions | 13- 2 |
| 13.2 Sub functions specifically for machine HPR | 13- 4 |
| 13.2.1 HPR retry function [RJ010 mode]..... | 13- 4 |
| 13.2.2 HP shift function [RJ010 mode] | 13- 8 |
| 13.3 Functions for compensating the control | 13-11 |
| 13.3.1 Backlash compensation function | 13-11 |
| 13.3.2 Electronic gear function | 13-13 |
| 13.3.3 Near pass function | 13-21 |
| 13.4 Functions to limit the control | 13-23 |
| 13.4.1 Speed limit function | 13-23 |
| 13.4.2 Torque limit function | 13-25 |
| 13.4.3 Software stroke limit function | 13-30 |
| 13.4.4 Hardware stroke limit function | 13-37 |
| 13.4.5 Forced stop function..... | 13-41 |
| 13.5 Functions to change the control details..... | 13-44 |
| 13.5.1 Speed change function | 13-44 |
| 13.5.2 Override function | 13-51 |
| 13.5.3 Acceleration/deceleration time change function | 13-54 |
| 13.5.4 Torque change function | 13-59 |
| 13.5.5 Target position change function | 13-63 |
| 13.6 Absolute position system | 13-67 |
| 13.7 Other functions | 13-69 |
| 13.7.1 Step function..... | 13-69 |
| 13.7.2 Skip function | 13-74 |
| 13.7.3 M code output function..... | 13-78 |
| 13.7.4 Teaching function | 13-82 |
| 13.7.5 Command in-position function | 13-88 |
| 13.7.6 Acceleration/deceleration processing function..... | 13-91 |
| 13.7.7 Pre-reading start function..... | 13-94 |
| 13.7.8 Deceleration start flag function | 13-96 |
| 13.7.9 Stop command processing for deceleration stop function..... | 13-99 |
| 13.7.10 Speed control 10 x multiplier setting for degree axis function | 13-102 |
| 13.7.11 Operation setting for incompleteness of HPR function..... | 13-104 |
| 13.8 Servo ON/OFF | 13-106 |
| 13.8.1 Servo ON/OFF | 13-106 |
| 13.8.2 Follow up function | 13-108 |

| | |
|---|-----------------------------------|
| 14. Common Functions | 14- 1 to 14-32 |
| 14.1 Outline of common functions | 14- 2 |
| 14.2 Parameter initialization function..... | 14- 3 |
| 14.3 Execution data backup function | 14- 5 |
| 14.4 External signal selection function | 14- 7 |
| 14.5 External I/O signal logic switching function | 14-12 |
| 14.6 History monitor function | 14-14 |
| 14.7 Virtual servo amplifier function | 14-18 |
| 14.8 Mark detection function..... | 14-21 |
| 14.9 Module error collection function..... | 14-32 |
| 15. Dedicated Instructions | 15- 1 to 15- 2 |
| 15.1 List of dedicated instructions | 15- 2 |
| 16. Troubleshooting | 16- 1 to 16-54 |
| 16.1 Checking errors using GX Works2..... | 16- 2 |
| 16.2 Troubleshooting | 16- 5 |
| 16.3 Error and warning details..... | 16- 6 |
| 16.4 List of errors | 16-12 |
| 16.5 List of warnings | 16-44 |
| Appendices | Appendix- 1 to Appendix-30 |
| Appendix 1 List of buffer memory addresses..... | Appendix- 2 |
| Appendix 2 Connection with servo amplifiers | Appendix-14 |
| Appendix 3 Connection with external device | Appendix-17 |
| Appendix 3.1 Connector..... | Appendix-17 |
| Appendix 3.2 External input signal cable..... | Appendix-20 |
| Appendix 3.3 Manual pulse generator (MR-HDP01) | Appendix-26 |
| Appendix 4 When using GX Works2..... | Appendix-27 |
| Appendix 5 External dimension drawing | Appendix-28 |

COMPLIANCE WITH THE EMC AND LOW VOLTAGE DIRECTIVES

(1) For programmable controller system

To ensure that Mitsubishi programmable controllers maintain EMC and Low Voltage Directives when incorporated into other machinery or equipment, certain measures may be necessary. Please refer to one of the following manuals.

- QCPU User's Manual (Hardware Design, Maintenance and Inspection)
- Safety Guidelines

(This manual is included with the CPU module or base unit.)

The CE mark on the side of the programmable controller indicates compliance with EMC and Low Voltage Directives.

(2) For the product

To make this product comply with EMC and Low Voltage Directives, refer to Section 4.3.1 "Precautions for wiring".

RELEVANT MANUALS

(1) Simple Motion module

| Manual Name <Manual number (model code)> | Description |
|--|--|
| MELSEC-Q QD77GF Simple Motion Module User's Manual (Positioning Control) <IB-0300202, 1XB956> | Specifications of the QD77GF and information on how to establish a system, maintenance and inspection, and troubleshooting Functions, programming and buffer memory for the positioning control of the QD77GF |
| MELSEC-Q/L QD77MS/QD77GF/LD77MS/LD77MH Simple Motion Module User's Manual (Synchronous Control) <IB-0300174, 1XB943> | Functions, programming and buffer memory for the synchronous control of the Simple Motion module |
| MELSEC-Q QD77GF Simple Motion Module User's Manual (Network) <IB-0300203, 1XB957> | Overview of CC-Link IE Field Network, and specifications, procedures before operation, system configuration, installation, wiring, settings, functions, programming, and troubleshooting of the MELSEC-Q series Simple Motion module |

(2) CPU module

| Manual Name <Manual number (model code)> | Description |
|--|---|
| QCPU User's Manual (Hardware Design, Maintenance and Inspection) <SH-080483ENG, 13JR73> | Specifications of the hardware (CPU modules, power supply modules, base units, batteries, and memory cards), system maintenance and inspection, and troubleshooting |
| QnUCPU User's Manual (Function Explanation, Program Fundamentals) <SH-080807ENG, 13JZ27> | Functions and devices of the CPU module, and programming |

(3) Programming tool

| Manual Name <Manual number (model code)> | Description |
|--|---|
| GX Works2 Version1 Operating Manual (Common) <SH-080779ENG, 13JU63> | System configuration, parameter settings, and online operations (common to Simple project and Structured project) of GX Works2 |
| GX Works2 Version1 Operating Manual (Intelligent Function Module) <SH-080921ENG, 13JU69> | Parameter settings, monitoring, and operations of the predefined protocol support function of intelligent function modules, using GX Works2 |

(4) Servo amplifier

| Manual Name <Manual number (model code)> | Description |
|---|--|
| CC-Link IE Field Network Interface with Motion MR-J4-_B-RJ010/MR-J4-_B4-RJ010/MR-J3-T10 Servo Amplifier Instruction Manual <SH-030117, 1CW810> | I/O signals, parts names, parameters, start-up procedure and others for CC-Link IE Field Network interface AC servo amplifier with Motion MR-J4-_B-RJ010/ MR-J4-_B4-RJ010 and CC-Link IE Field Network interface unit MR-J3-T10 |
| CC-Link IE Field Network Interface MR-J4-_GF_(-RJ) Servo Amplifier Instruction Manual (Motion Mode) <SH-030218, 1CW861> | I/O signals, parts names, parameters, start-up procedure and others for CC-Link IE Field Network interface AC servo amplifier with MR-J4-_GF_(-RJ) |
| CC-Link IE Field Network Interface MR-J4-_GF_(-RJ) Servo Amplifier Instruction Manual (I/O Mode) <SH-030221, 1CW863> | Parameters for point table operation, start-up procedure and others for CC-Link IE Field Network interface AC servo amplifier with MR-J4-_GF_(-RJ) |

MANUAL PAGE ORGANIZATION

■ The symbols used in this manual are shown below.

- A serial No. is inserted in the "*" mark.

| Symbol | Description | Reference |
|---------------|--|-----------|
| [Pr. *] | Symbol that indicates positioning parameter and HPR parameter item. | Chapter 5 |
| [Da. *] | Symbol that indicates positioning data, block start data and condition data item. | |
| [Md. *] | Symbol that indicates monitor data item. | |
| [Cd. *] | Symbol that indicates control data item. | |
| [RJ010 mode] | Symbol that indicates specifications during the communication mode compatible with MR-J4-B-RJ010. This mode corresponds to the MR-J4-_B_-RJ010+MR-J3-T10 servo amplifier. When using the virtual servo amplifier function, it operates in MR-J4-B-RJ010 communication mode regardless of the communication mode setting. | - |
| [CiA402 mode] | Symbol that indicates specifications during the communication mode compatible with CiA402. This mode corresponds to the MR-J4-_GF_(-RJ) servo amplifier and others. | |

■ Representation of numerical values used in this manual.

- Buffer memory addresses, error codes and warning codes are represented in decimal.
- X/Y devices are represented in hexadecimal.
- Setting data and monitor data are represented in decimal or hexadecimal. Data ended by "H" or "h" is represented in hexadecimal.

(Example) 10.....Decimal

10H.....Hexadecimal

■ Operation examples in this manual

Unless otherwise specified, this manual describes the examples of QD77GF16.

TERMS

Unless otherwise specified, this manual uses the following terms.

| Term | Description |
|---|---|
| PLC CPU | The abbreviation for the MELSEC-Q series PLC CPU module |
| QCPU | The abbreviation term for the MELSEC-Q series PLC CPU module |
| Simple Motion module | The abbreviation for the QD77GF CC-Link IE Field Network Simple Motion module |
| MR-J4-B | MR-J4-_B_-RJ010+MR-J3-T10 servo amplifier series |
| MR-J4-GF | MR-J4-_GF_(-RJ) Servo amplifier series |
| Programming tool | A generic term for GX Works2 and MR Configurator2 |
| GX Works2 | The product name of the software package for the MELSEC programmable controllers (Version 1.98C or later) |
| MR Configurator2 | The product name of the setup software for the servo amplifier (Version 1.19V or later) |
| Intelligent function module | A MELSEC-Q/L series module that has functions other than input or output, such as A/D converter module and D/A converter module |
| Servo amplifier (drive unit) | A generic term for a drive unit Unless specified in particular, indicates the motor driver unit of the sequential command method which is controlled by the Simple Motion module (belonging to own station). |
| Axis | Another term for a servo amplifier |
| HPR | A generic term for "Home position return" |
| HP | A generic term for "Home position" |
| CC-Link IE Field Network | A high-speed and large-capacity open field network that is based on Ethernet (1000BASE-T) |
| Slave station | A generic term for remote I/O station, remote device station, and intelligent device station |
| Communication mode correspond to CiA402 | Communication mode that corresponds to open network standard CiA402 |

PACKING LIST

The following items are included in the package of this product. Before use, check that all the items are included.

(1) QD77GF4

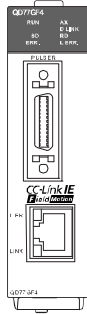

QD77GF4



Before Using the Product

(2) QD77GF8

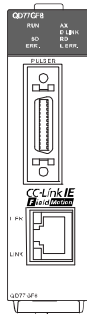

QD77GF8

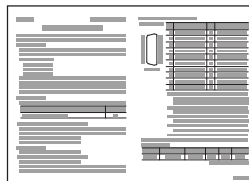

Before Using the Product

(3) QD77GF16

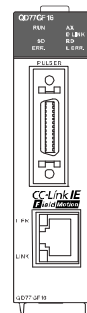

QD77GF16



Before Using the Product

Section 1 Product Specifications and Handling

Section 1 is configured for the following purposes (1) to (5).

- (1) To understand the outline of positioning control, and the Simple Motion module specifications and functions
- (2) To carry out actual work such as installation and wiring
- (3) To set parameters and data required for positioning control
- (4) To create a sequence program required for positioning control
- (5) To understand the memory configuration and data transmission process

When diverting any of the program examples introduced in this manual to the actual system, fully verify that there are no problems in the controllability of the target system.

Read "Section 2" for details on each control.

| | | |
|-----------|---|---------------|
| Chapter 1 | Product Outline | 1- 1 to 1- 28 |
| Chapter 2 | System Configuration..... | 2- 1 to 2- 8 |
| Chapter 3 | Specifications and Functions..... | 3- 1 to 3- 34 |
| Chapter 4 | Installation, Wiring and Maintenance of the Product | 4- 1 to 4- 18 |
| Chapter 5 | Data Used for Positioning Control | 5- 1 to 5-162 |
| Chapter 6 | Sequence Program Used for Positioning Control..... | 6- 1 to 6- 76 |
| Chapter 7 | Memory Configuration and Data Process..... | 7- 1 to 7- 16 |

Chapter 1 Product Outline

The purpose and outline of positioning control using the Simple Motion module are explained in this chapter.
Reading this chapter will help you understand what can be done using the positioning system and which procedure to use for a specific purpose.

By understanding "What can be done", and "Which procedure to use" beforehand, the positioning system can be structured smoothly.

| | | |
|-------|---|------|
| 1.1 | Positioning control | 1- 2 |
| 1.1.1 | Features of QD77GF | 1- 2 |
| 1.1.2 | Purpose and applications of positioning control | 1- 5 |
| 1.1.3 | Mechanism of positioning control..... | 1- 7 |
| 1.1.4 | Overview of positioning control functions | 1- 8 |
| 1.1.5 | Outline design of positioning system | 1-18 |
| 1.1.6 | Communicating signals between QD77GF and each module..... | 1-19 |
| 1.2 | Flow of system operation | 1-22 |
| 1.2.1 | Flow of all processes | 1-22 |
| 1.2.2 | Outline of starting..... | 1-24 |
| 1.2.3 | Outline of stopping..... | 1-26 |
| 1.2.4 | Outline for restarting | 1-28 |

1.1 Positioning control

1.1.1 Features of QD77GF

The QD77GF has the following features.

(1) Wide variety of positioning control functions

The main functions (such as HPR control, positioning control and manual control) which are required for any positioning system and the sub functions which limit and add functions to those controls are supported.

(a) Enhanced HPR control

1) Additional features of HPR control

Six machine HPR methods are provided: one proximity dog method, two count methods, one data set method, one scale origin signal detection method and one driver HPR method. Select an applicable method according to the system.

2) HPR retry function

The HPR retry function is provided so that the machine HPR control can be performed from any position, regardless of the machine stop position when the system is powered on.

(b) Wide variety of control methods

Positioning controls, such as position control, speed control, speed-position switching control, position-speed switching control, and other controls, are provided.

1) Independent control of each axis

Controls, such as position control and speed control, can be performed independently for each axis at any given timing.

2) Interpolation control

Interpolation controls using multiple axes can be performed.
(2- to 4-axis linear interpolation control, 2-axis circular interpolation control, 2- to 4-axis speed control, etc.)

3) Speed-torque control

Speed control and torque control not including position loop can be performed.

(c) Large amount of data

Up to 600 positioning data (combinations of data, such as control method, positioning address, and command speed) per axis can be set.

(d) Continuous processing of multiple positioning data

Multiple positioning data can be processed continuously within one positioning operation.

Continuous positioning control can be executed over multiple blocks, where each block consists of multiple positioning data.

This reduces the number of executions of positioning, management of execution status, and others.

- (e) Acceleration/deceleration processing
Two acceleration/deceleration processing methods are provided:
trapezoidal acceleration/deceleration and S-curve acceleration/deceleration.
The acceleration/deceleration curve can be selected according to the
machine characteristic.
- (2) Synchronous control
The synchronous control and electronic cam control can be performed.
- (3) Mark detection function
The mark detection to latch any data by the external command signal [DI1 to DI4]
can be performed.
- (4) High maintainability
Maintainability is enhanced in the QD77GF.
 - (a) Data retention without battery
Data such as the positioning data and parameters can be stored in the flash
ROM inside the QD77GF. This feature allows the module retain the data
without a battery.
 - (b) Module error collection function
The QD77GF notifies error details to the PLC CPU when an error occurs.
Storing the error information in the PLC CPU allows the user to check the
error from the programming tool even after the module is powered off or
reset.
- (5) Setting, monitoring, and testing through GX Works2
Parameters and positioning data for the QD77GF can be set using GX Works2
(Simple Motion Module Setting).
Moreover, using the test function of GX Works2 (Simple Motion Module Setting),
users can check the wiring status and the validity of the preset parameters and
positioning data by performing test operation before creating a program for
positioning control.
The control monitor function of GX Works2 allows user to debug programs
efficiently.
The servo parameters can be set easily by using the GX Works2 in combination
with the MR Configurator2.
- (6) Forced stop function
The batch forced stop is available for all axes of servo amplifier by the forced
stop signal.
"Valid/Invalid" of the forced stop input signal can be selected by the parameters.

(7) Connection between the QD77GF and servo amplifier with CC-Link IE Field Network

- (a) The servo parameters can be set on the QD77GF side to write or read them to/from the servo amplifier using the CC-Link IE Field Network in MR Configurator2. ^(Note-1)
- (b) The actual current value and error description contained in the servo can be checked by the buffer memory of the QD77GF.
- (c) The communication between the MR Configurator2 and servo amplifiers is possible via the PLC CPU. ^(Note-1)

(Note-1): It is available in MR-J4-B-RJ010 communication mode.

(8) Easy application to the absolute position system

- (a) The servo amplifier MR-J4-_B_-RJ010 and MR-J4-GF corresponding to the CC-Link IE Field Network and servo motors correspond to the absolute position system. It can be realized only at connecting the battery for absolute position system to the servo amplifier.
- (b) Once the HP have been established, the HPR operation is unnecessary at the system's power supply ON.
- (c) With the absolute position system, the data set method HPR is used to establish the HP. The wiring of proximity dog, etc. is unnecessary.
- (d) When the setting unit is "degree", the absolute position system with unlimited length fed can be configured.

1.1.2 Purpose and applications of positioning control

"Positioning" refers to moving a moving body, such as a workpiece or tool (hereinafter, generically called "workpiece") at a designated speed, and accurately stopping it at the target position. The main application examples are shown below.

■ Punch press (X, Y feed positioning)

- To punch insulation material or leather, etc., as the same shape at a high yield, positioning is carried out with the X axis and Y axis servos.
- After positioning the table with the X axis servo, the press head is positioned with the Y axis servo, and is then punched with the press.
- When the material type or shape changes, the press head die is changed, and the positioning pattern is changed.

■ Palletizer

- Using the servo for one axis, the palletizer is positioned at a high accuracy.
- The amount to lower the palletizer according to the material thickness is saved.

■ Compact machining center (ATC magazine positioning)

Rotation direction for calling 11, 12, 1, 2 or 3

Rotation direction for calling 17 to 20, 1 to 5

Rotation direction for calling 5, 6, 7, 8, 9 or 10

Rotation direction for calling 7 to 16

<Number of tools: 12> <Number of tools: 20>

- The ATC tool magazine for a compact machining center is positioned.
- The relation of the magazine's current value and target value is calculated, and positioning is carried out with forward run or reverse run to achieve the shortest access time.

■ Lifter

- During the aging process, storage onto the rack is carried out by positioning with the AC servo.
- The up/down positioning of the lifter is carried out with the 1-axis servo, and the horizontal position of the aging rack is positioned with the 2-axis servo.

■ Index table (High-accuracy indexing of angle)

- The index table is positioned at a high accuracy using the 1-axis servo.

■ Inner surface grinder

(Fix the grinding stone, feed the workpiece, and grind.)

Operation panel

| | | | |
|--------------------------|---|--------------------------|---|
| <input type="checkbox"/> | a | <input type="checkbox"/> | d |
| <input type="checkbox"/> | b | <input type="checkbox"/> | e |
| <input type="checkbox"/> | c | | |

a. Total feed amount (μm) d. Rough grinding speed (μm/s)
 b. Finishing feed amount (μm) e. Fine grinding speed (μm/s)
 c. Compensation amount (μm)

- The grinding of the workpiece's inner surface is controlled with the servo and inverter.
- The rotation of the workpiece is controlled with the 1-axis inverter, and the rotation of the grinding stone is controlled with the 2-axis inverter. The workpiece is fed and ground with the 3-axis servo.

1.1.3 Mechanism of positioning control

In the positioning system using the Simple Motion module, various software and devices are used for the following roles.

The Simple Motion module realizes complicated positioning control when it reads in various signals, parameters and data and is controlled with the PLC CPU.

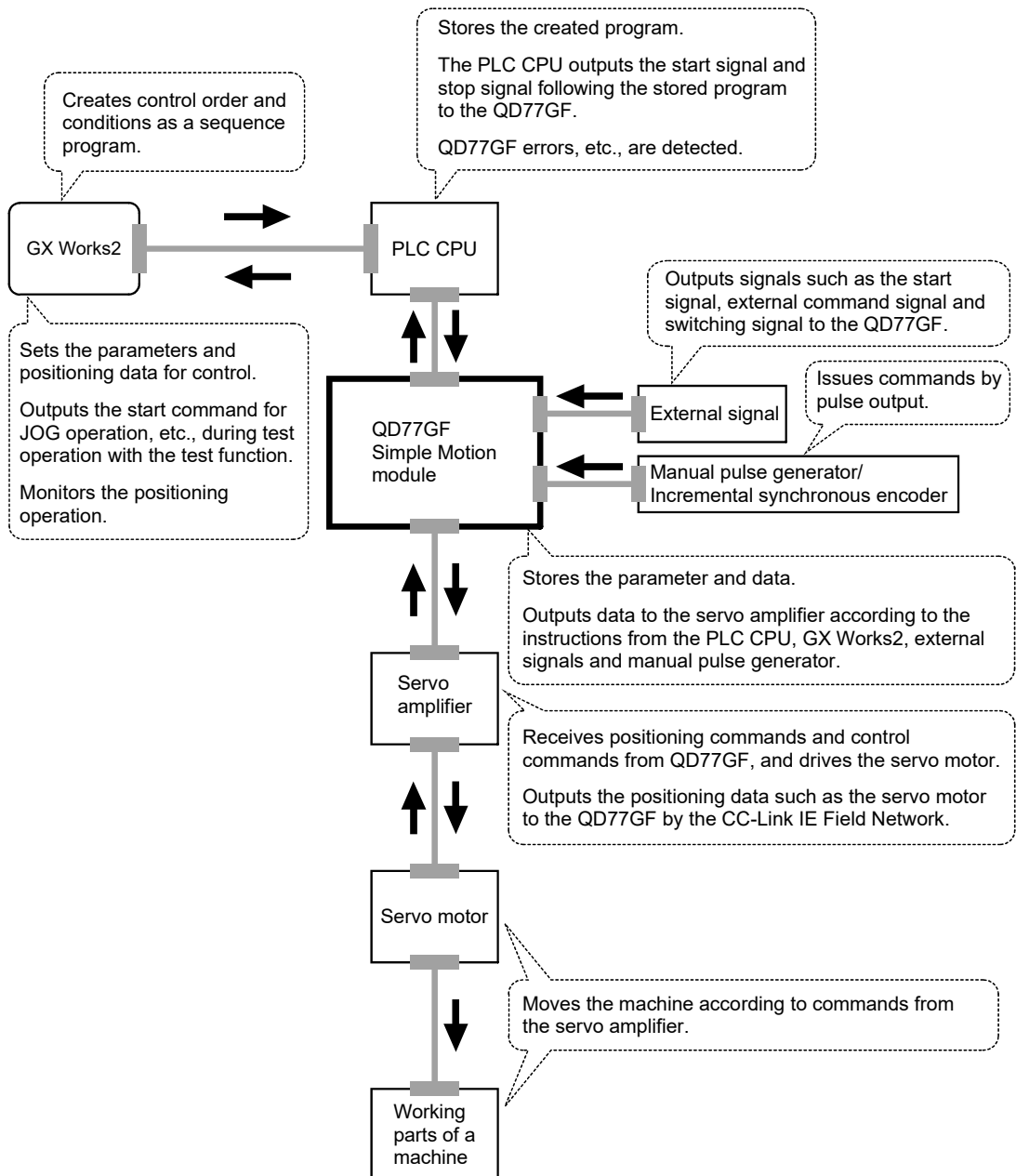

1.1.4 Overview of positioning control functions

The outline of the "overview of positioning control", "overview of independent positioning control and continuous positioning control", "overview of block positioning control" and "overview of acceleration/deceleration processing control" is shown below.

■ Positioning control

An overview of positioning using positioning data is described below.

(1) Linear control

(a) 1-axis linear control

This performs positioning from the start point address (location the axis is presently stopped) defined on the specified axis to the specified position.

[Control using the absolute system]

- 1) This performs positioning from the start point address to the specified position.
- 2) The start point address and the specified address determine the movement direction.

[Example]

The following figure shows the operations when the start point address is 5000 and the positioning addresses are 2000 and 8000:

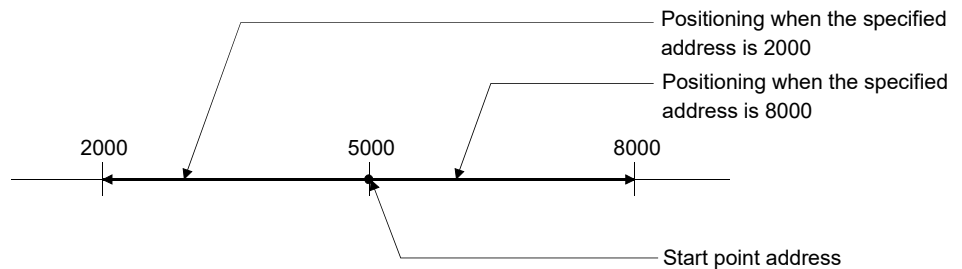

[Control using the increment system]

- 1) This performs positioning from the specified increment of travel from the start point address.
- 2) The sign of the travel increment determines the direction of travel.
 - For positive travel increment.....Positioning in the positive direction (direction of address increase)
 - For negative travel increment.....Positioning in the negative direction (direction of address decrease)

[Example]

The following figure shows the operations when the start point address is 5000 and the travel increments are 3000 and -3000:

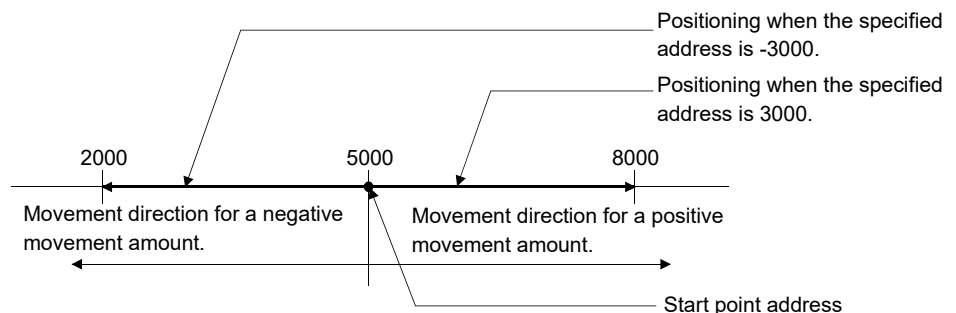

(b) 2-axis linear interpolation control (Note-1)

This controls interpolation along a linear locus from the start point address (current stop position) defined by two axes.

[Control using the absolute system]

- 1) This performs linear interpolation using two axes from the start point address to the specified address.
- 2) The start point address and the specified address determine the direction of travel.

[Example]

The operation when the start point address is 800 for axis 1 and 2000 for axis 2 and the positioning address specified to 2000 for axis 1 and 8000 for axis 2, is shown below.

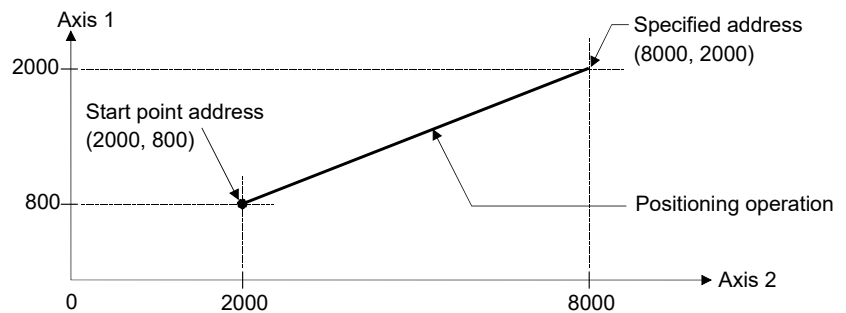

[Control using the increment system]

- 1) This performs positioning to the composite position of the travel direction and the travel increment specified by each axis from the start point address.
- 2) The sign of the travel increment determines the direction of travel.
 - For positive travel increment.....Positioning in the positive direction (direction of address increase)
 - For negative travel increment.....Positioning in the negative direction (direction of address decrease)

[Example]

The operation when the start point address is 800 for axis 1 and 2000 for axis 2 and the positioning address specified to 1200 for axis 1 and 6000 for axis 2, is shown below.

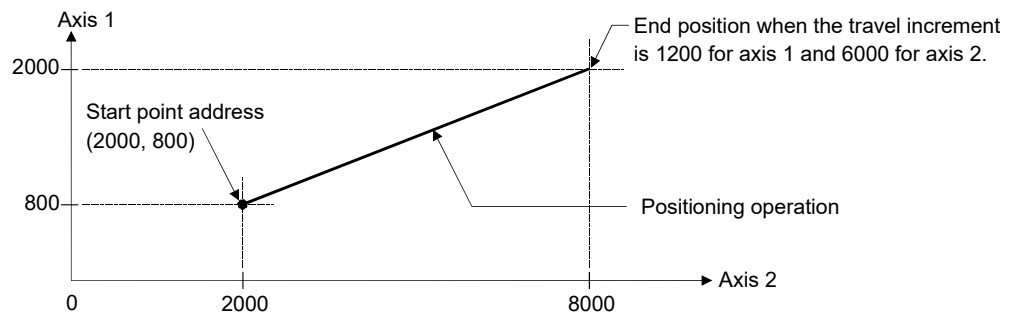

REMARK

(Note-1): The interpolation speed during linear interpolation control can be selected from "composite speed" and "reference axis speed" using the interpolation speed designation method of detailed parameter 1. (Refer to Section 5.2.3 information about setting "[Pr.20] Interpolation speed designation method" of the detailed parameter 1.)

(2) Circular interpolation control (Note-1)

There are two types of circular interpolation controls: circular interpolation with a specified sub point and circular interpolation with the specified center point.

(a) Circular interpolation with a specified sub point

Circular interpolation is performed using the specified endpoint address and sub point (passing point) address.

Two methods are available: absolute system and increment system.

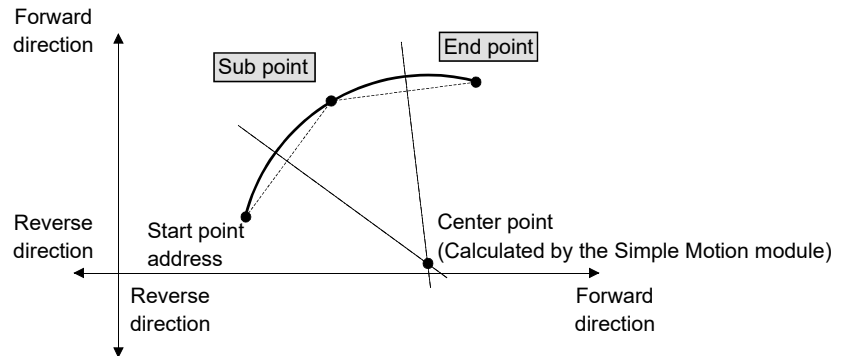

(b) Circular interpolation with the specified center point

Circular interpolation is performed using the specified endpoint address and center point address.

Two methods are available: absolute system and increment system.

Also, the direction of movement can be selected from clockwise or counterclockwise.

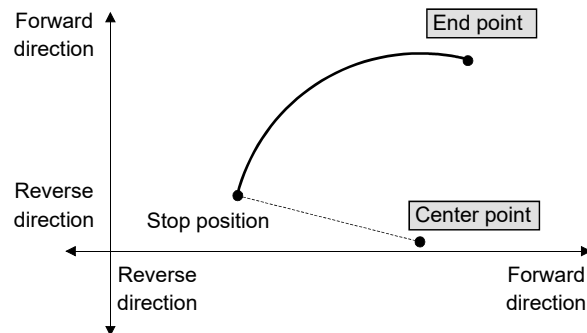
**REMARK**

(Note-1): The interpolation speed during circular interpolation control may only be set to "composite speed" for the interpolation speed designation method of detailed parameter 1. (Refer to Section 5.2.3 information about setting "[Pr.20] Interpolation speed designation method" of the detailed parameter 1.)

(3) Fixed-feed control

This performs positioning for the specified increment of travel.

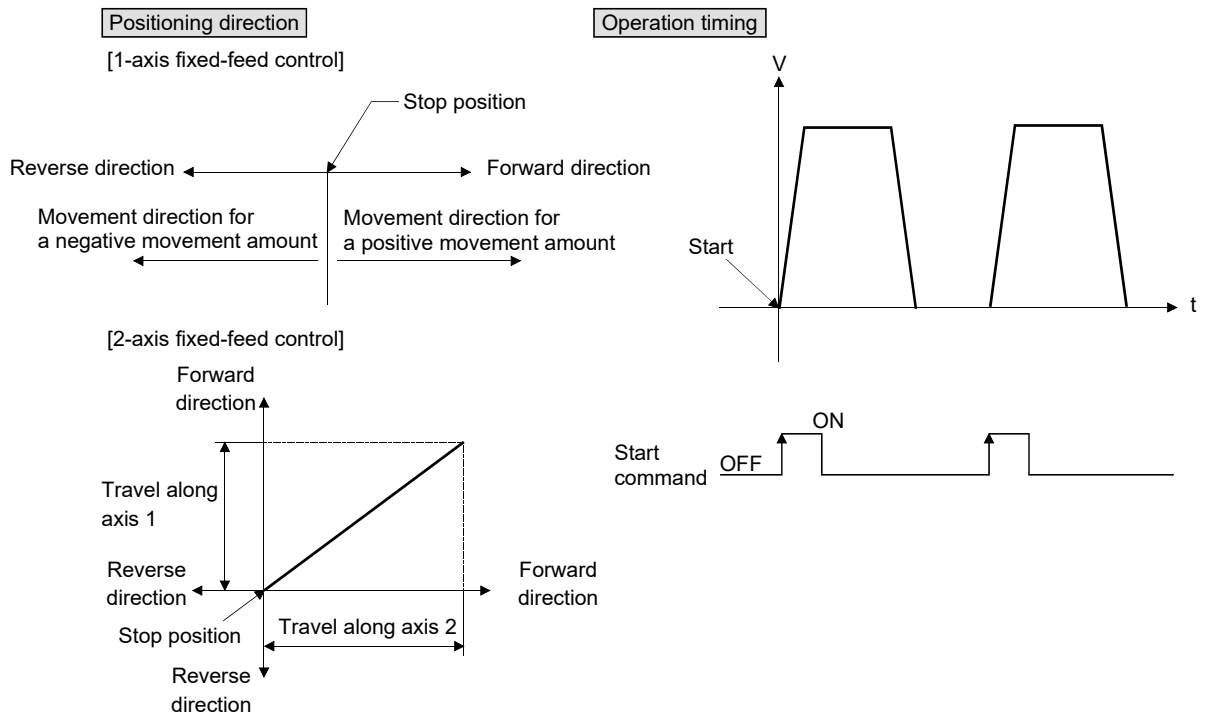

(4) Speed control

After command is executed, control continues with the command speed until the stop command is input.

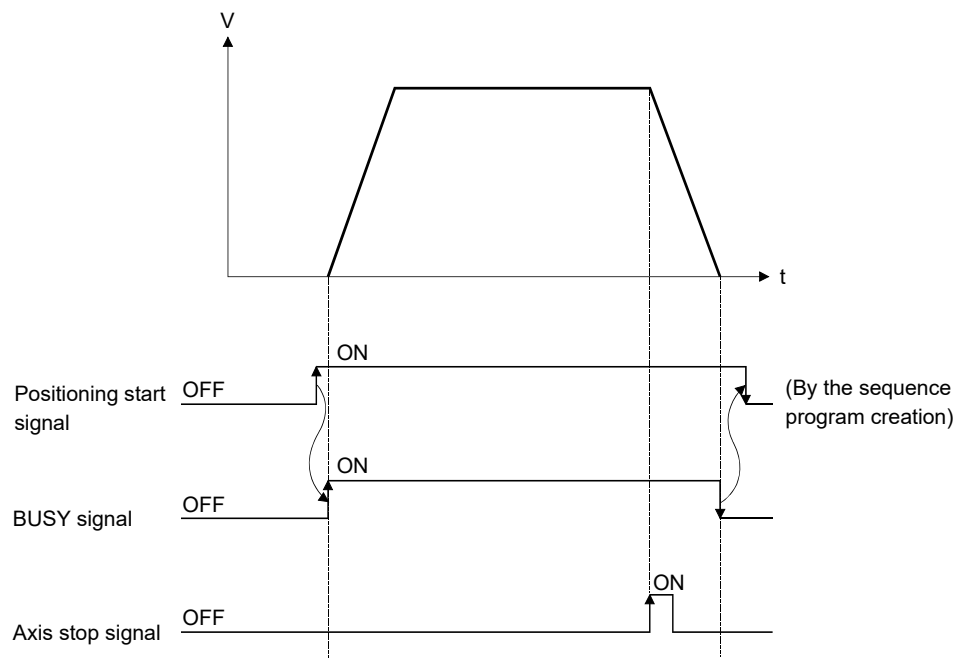

(5) Speed-position switching control

This starts positioning under speed control, and switches to position control according to the input of the Simple Motion module speed-position switching signal and perform positioning for the specified increment of travel.

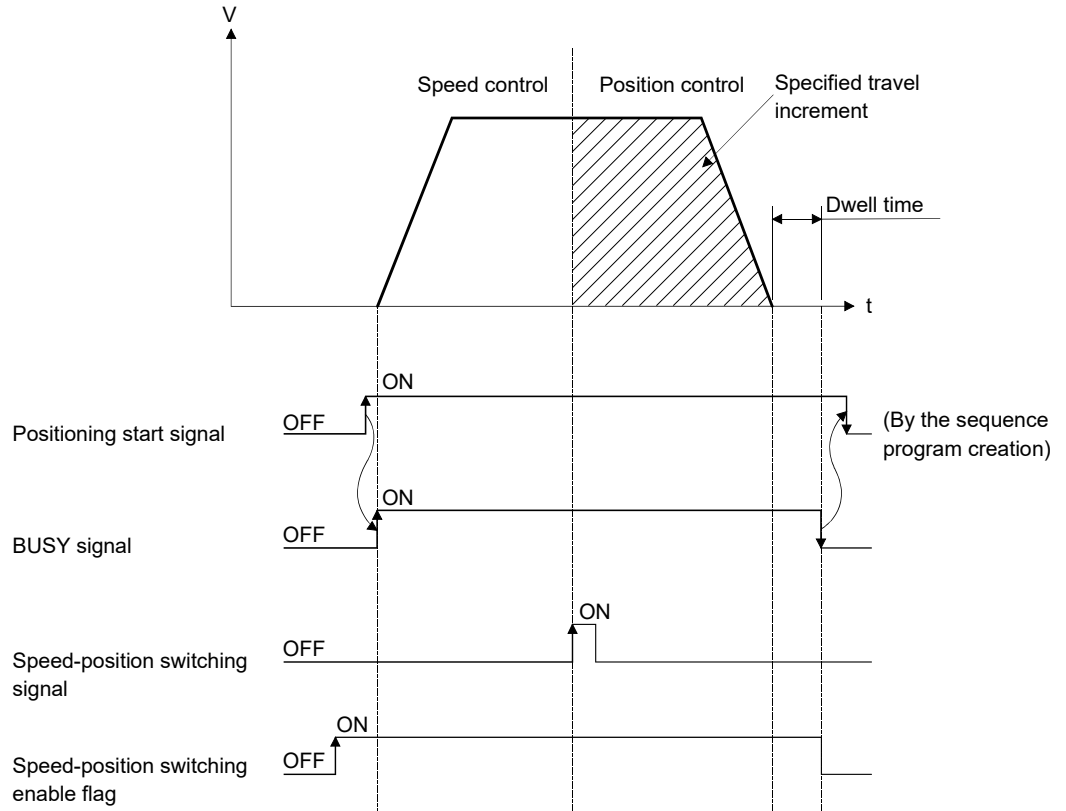

■ Independent positioning control and continuous positioning control

The Simple Motion module performs positioning according to the user-set positioning data, which is a set of information comprised of the control method (position control, speed control, speed-position switching control), positioning address, operation pattern, and so on.

Up to 600 of positioning data are assigned respectively to positioning data Nos. 1 to 600 per axis and registered to the Simple Motion module.

The operation pattern set in each positioning data by the user determines whether to perform positioning operation with one positioning data item or to perform continuous positioning operation with multiple positioning data items.

(1) Independent positioning control (operation pattern = 00: positioning complete)

The operation completed upon completion of positioning for the specified positioning data. The positioning completion of this operation pattern is also used as the operation pattern for the last positioning data of continuous positioning and continuous path positioning.

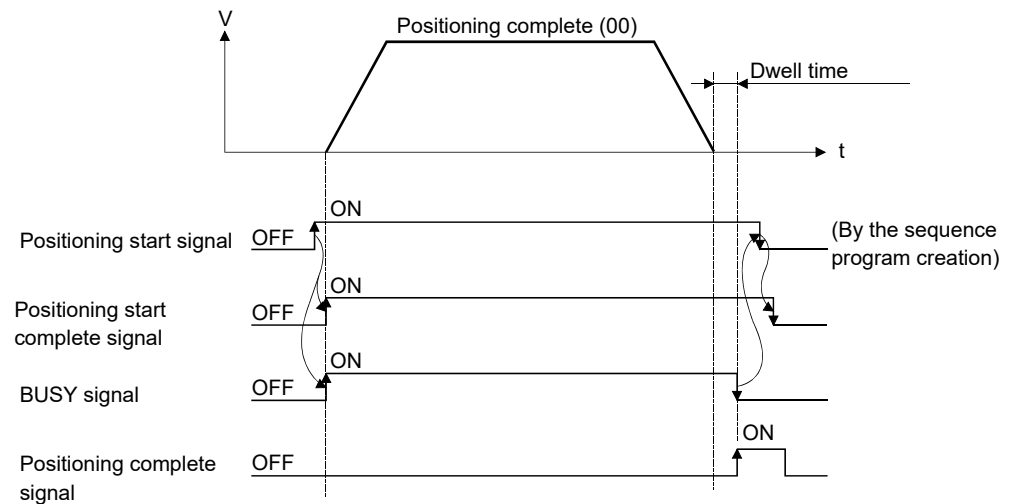

(2) Continuous positioning control (operation pattern = 01: positioning continue)

The operation stops temporarily upon the completion of positioning for the specified positioning data, and then continues with the next positioning data number.

This is specified when performing positioning in which the direction changes because of multiple positioning data items having consecutive positioning data numbers.

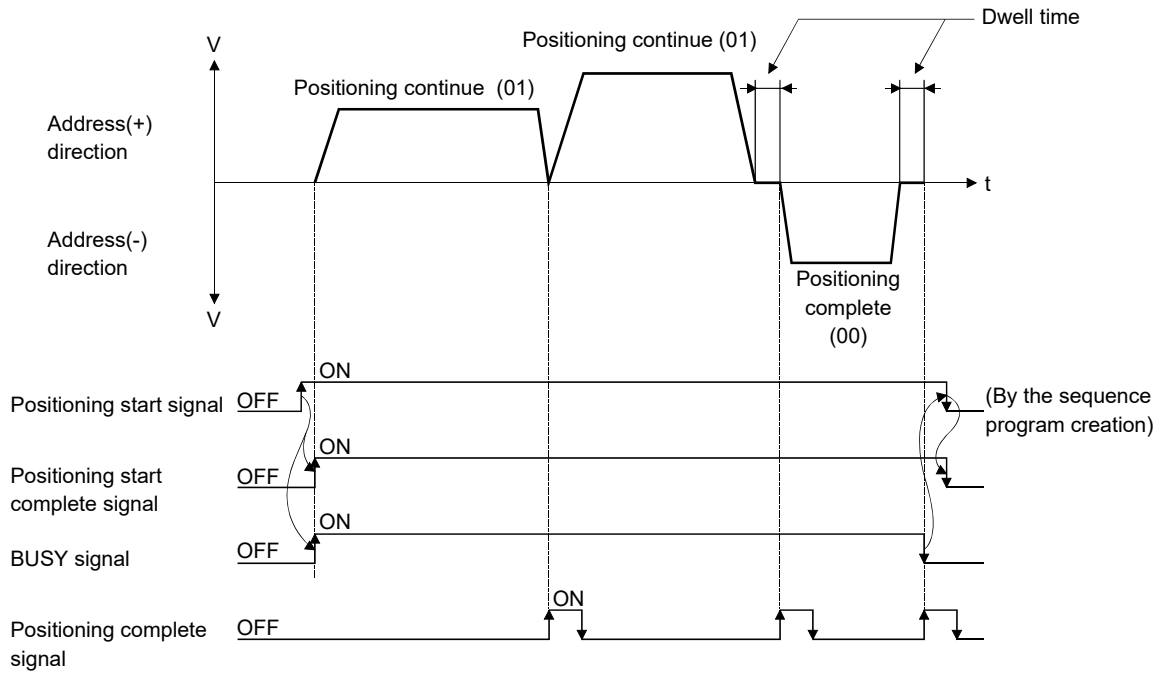

(3) Continuous path control (operation pattern = 11: positioning continue)

After executing positioning using the specified positioning data, the operation changes its speed to that of the next positioning data number and continues positioning.

This is specified when continuously executing multiple positioning data items having consecutive positioning data numbers at a specified speed.

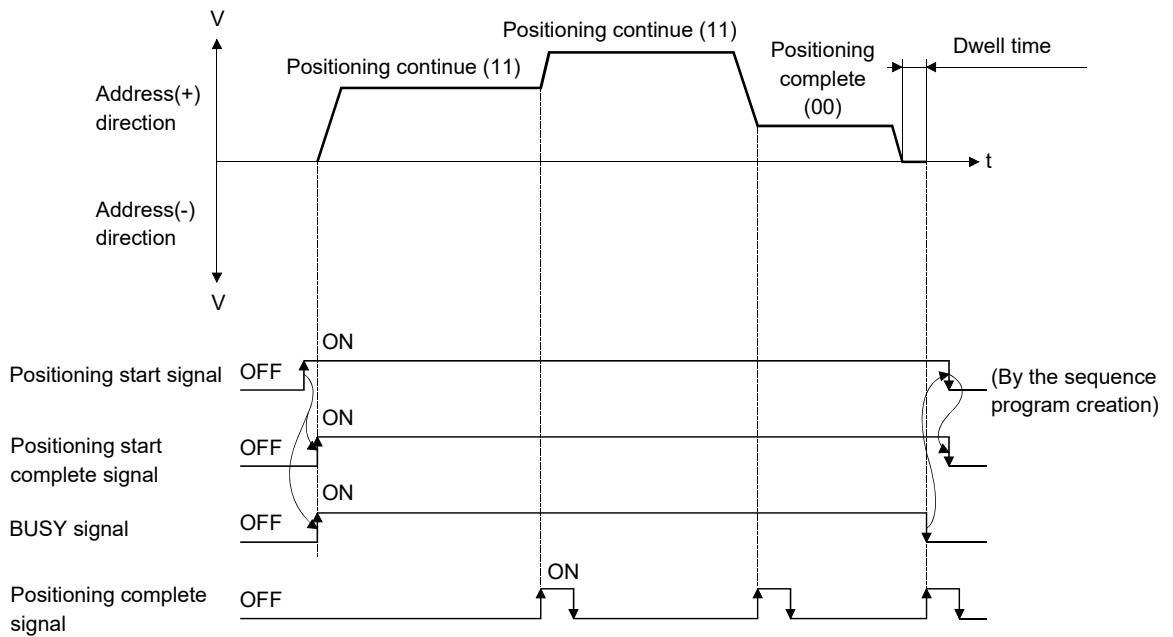

■ Block positioning control

Block positioning is a control that continuously executes the positioning of specified blocks. One block equivalent to a series of positioning data up to the completion of positioning (operation pattern = 00) by Independent or continuous positioning control. A maximum of 50 blocks per axis can be specified.

Using a one-time start command from the PLC CPU or external, complex positioning control can be performed.

The block positioning control can be performed by specifying the positioning start number and positioning start information in the buffer memory.

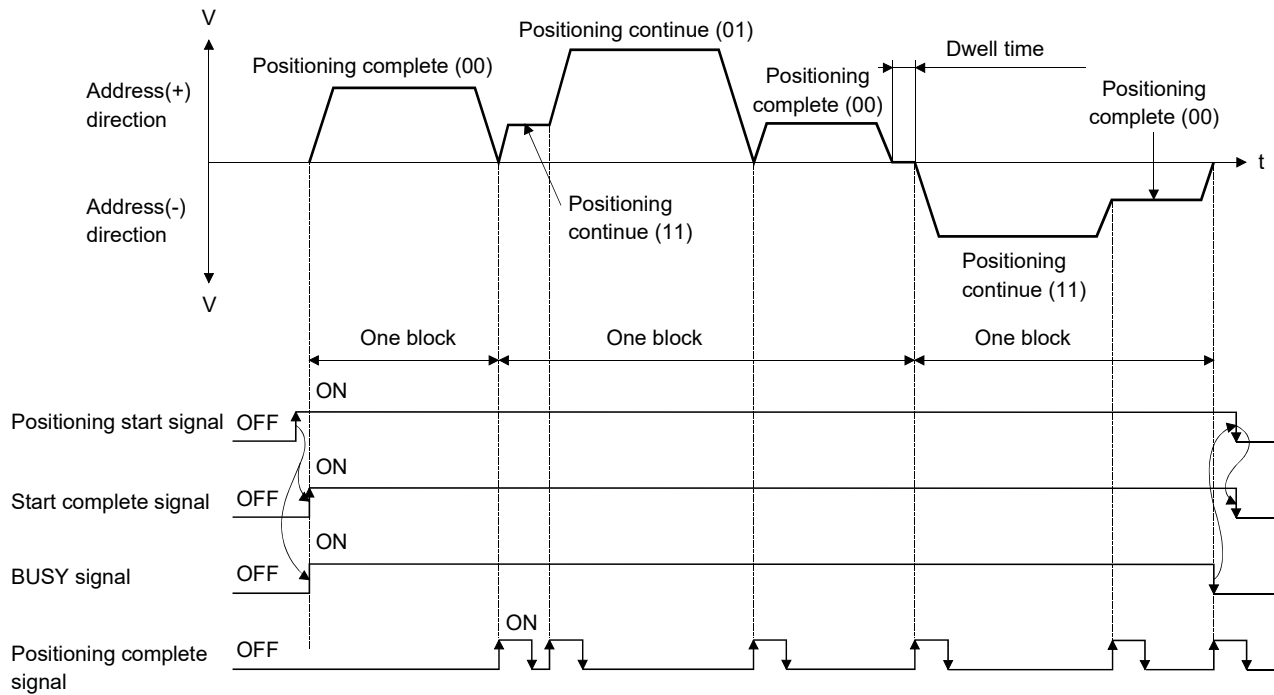

■ Overview of acceleration/deceleration processing control

Acceleration/deceleration processing for the positioning processing, manual pulse-generator processing, HPR processing and JOG processing is performed using the user-specified method, acceleration time and deceleration time.

(1) Acceleration/deceleration method

There are two types of acceleration and deceleration processing: the trapezoidal acceleration/deceleration processing method and S-curve acceleration/deceleration processing method. A detailed parameter is used to set which method is used. The specified acceleration/deceleration method is applied to all accelerations and decelerations when starting and completing positioning processing, HPR processing and JOG processing, as well as when changing the speed.

(a) Trapezoidal acceleration/deceleration processing method

This is a method in which linear acceleration/deceleration is carried out based on the acceleration time, deceleration time, and speed limit value set by the user.

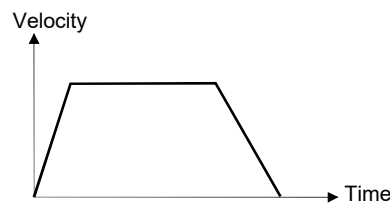

(b) S-curve acceleration/deceleration processing method

This method reduces the load on the motor when starting and stopping. This is a method in which acceleration/deceleration is carried out gradually, based on the acceleration time, deceleration time, speed limit value, and S-curve ratio (1 to 100%) set by the user.

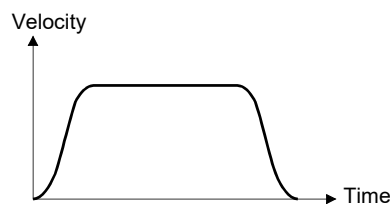

(2) Acceleration time, deceleration time, rapid-stop deceleration time

(a) Four types each of the acceleration time and deceleration time for positioning control can be set using basic parameters 2 and detailed parameters 2.

- Acceleration time.....The time elapses before the speed of 0 reaches the limit value.
- Deceleration time.....The time elapses before the speed at the limit value reaches 0.

(b) The rapid-stop deceleration time (1 to 8388608 ms) is set using the detailed parameters 2.

1.1.5 Outline design of positioning system

The outline of the positioning system operation and design using the Simple Motion module is shown below.

(1) Positioning system using Simple Motion module

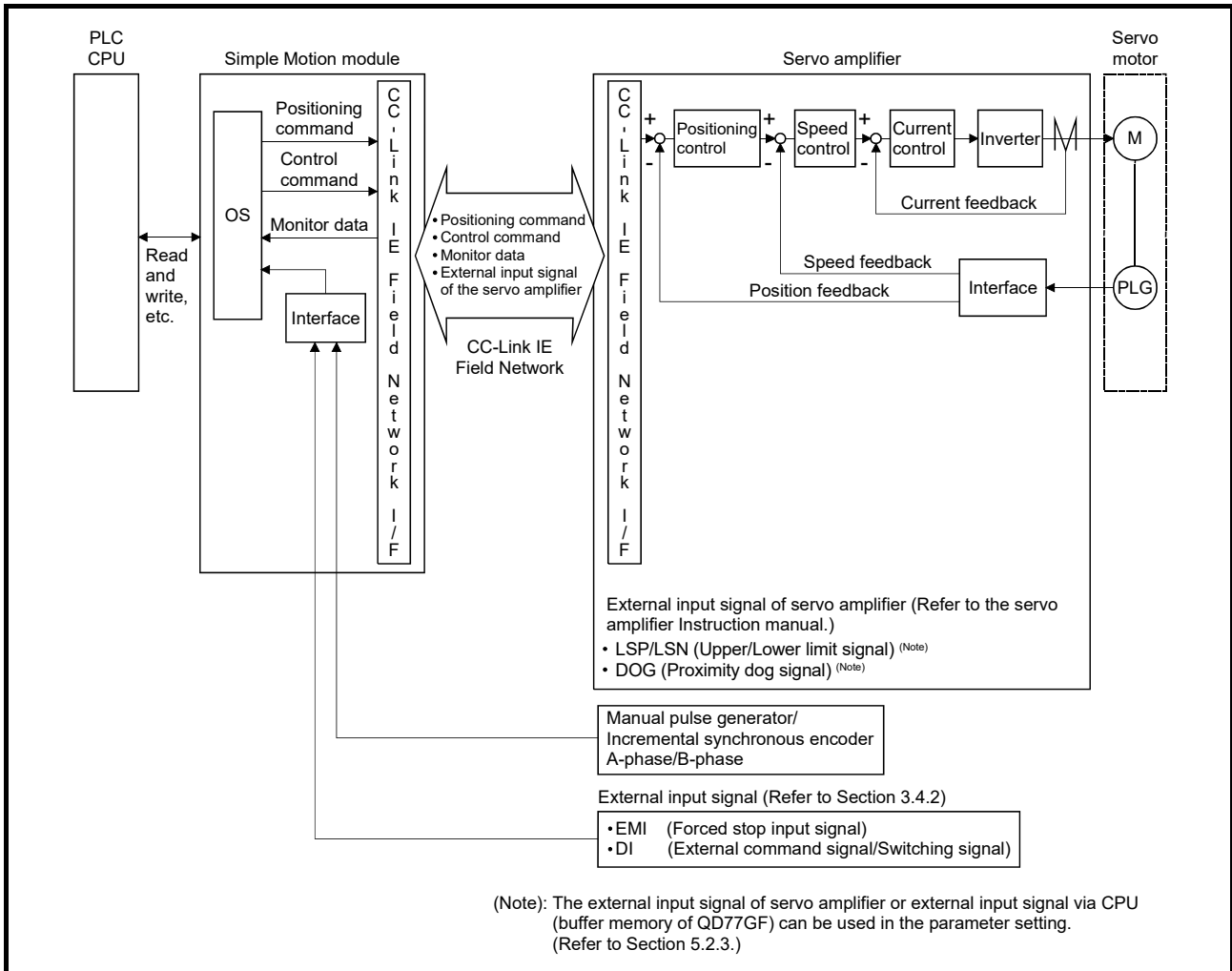
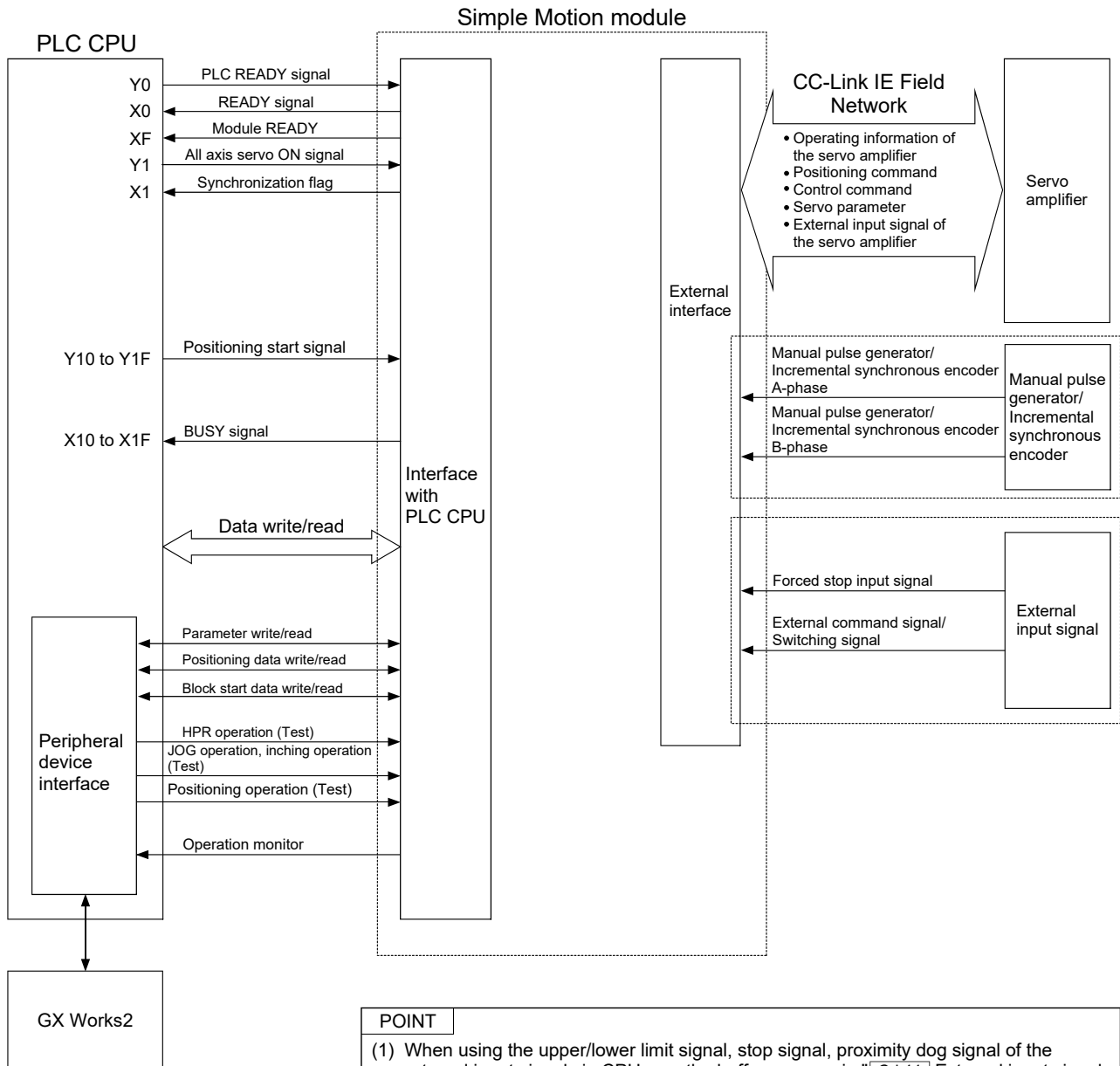

Fig. 1.1 Outline of the operation of positioning system using Simple Motion module

1.1.6 Communicating signals between QD77GF and each module

The outline of the signal communication between the Simple Motion module and PLC CPU, GX Works2 and servo amplifier, etc., is shown below.

(GX Works2 communicates with the Simple Motion module via the PLC CPU to which it is connected.)



POINT
 (1) When using the upper/lower limit signal, stop signal, proximity dog signal of the external input signal via CPU, use the buffer memory in "Cd.44 External input signal operation device".

■ Simple Motion module ↔ PLC CPU

The Simple Motion module and PLC CPU communicate the following data.

| Direction Communication | Simple Motion module → PLC CPU | PLC CPU → Simple Motion module |
|----------------------------|---|--|
| Control signal * | Signal indicating Simple Motion module state • READY signal • BUSY signal etc. | Signal related to commands • PLC READY signal • All axis servo ON signal • Positioning start signal etc. |
| Data (read/write) | • Parameter • Positioning data • Block start data • Control data • Monitor data | • Parameter • Positioning data • Block start data • Control data |

* Refer to Section 3.3 "Specifications of input/output signals with PLC CPU" for details.

■ Simple Motion module ↔ GX Works2

The Simple Motion module and GX Works2 communicate the following data via the PLC CPU.

| Direction Communication | Simple Motion module → GX Works2 | GX Works2 → Simple Motion module |
|----------------------------|-----------------------------------|--|
| Data (read/write) | • Parameter • Positioning data | • Parameter • Positioning data |
| Test operation | — | • HPR control start command • Positioning control start command • JOG/Inching operation start command • Teaching start command • Manual pulse generator operation enable/disable command |
| Operation monitor | • Monitor data | — |

■ Simple Motion module ↔ Servo amplifier

The Simple Motion module and servo amplifier communicate the following data via the CC-Link IE Field Network.

| Direction Communication | Simple Motion module → Servo amplifier | Servo amplifier → Simple Motion module |
|----------------------------|--|--|
| CC-Link IE Field Network | • Positioning commands • Control commands • Servo parameter (Note-1) | • Operating information of the servo amplifier • Servo parameter (Note-1) • External input signal of the servo amplifier |

(Note-1): It cannot be used in the communication mode corresponding to CiA402. In the communication mode corresponding to CiA402, edit the servo parameters using MR Configurator2.

■ Simple Motion module ↔ Manual pulse generator/Incremental synchronous encoder

The Simple Motion module and manual pulse generator/incremental synchronous encoder communicate the following data via the external input connection connector.

| | | |
|----------------------------|--|--|
| Direction Communication | Simple Motion module → Manual pulse generator/Incremental synchronous encoder | Manual pulse generator/Incremental synchronous encoder → Simple Motion module |
| Pulse signal | - | <ul style="list-style-type: none"> • Manual pulse generator/Incremental synchronous encoder A-phase • Manual pulse generator/Incremental synchronous encoder B-phase |

■ Simple Motion module ↔ External signal

The Simple Motion module and external signal communicate the following data via the external input connection connector.

| | | |
|----------------------------|---|--|
| Direction Communication | Simple Motion module → External signal | External signal → Simple Motion module |
| Control signal | - | <ul style="list-style-type: none"> • Forced stop input signal • External command signal/switching signal |

1.2 Flow of system operation

1.2.1 Flow of all processes

The positioning control processes, using the Simple Motion module, are shown below.

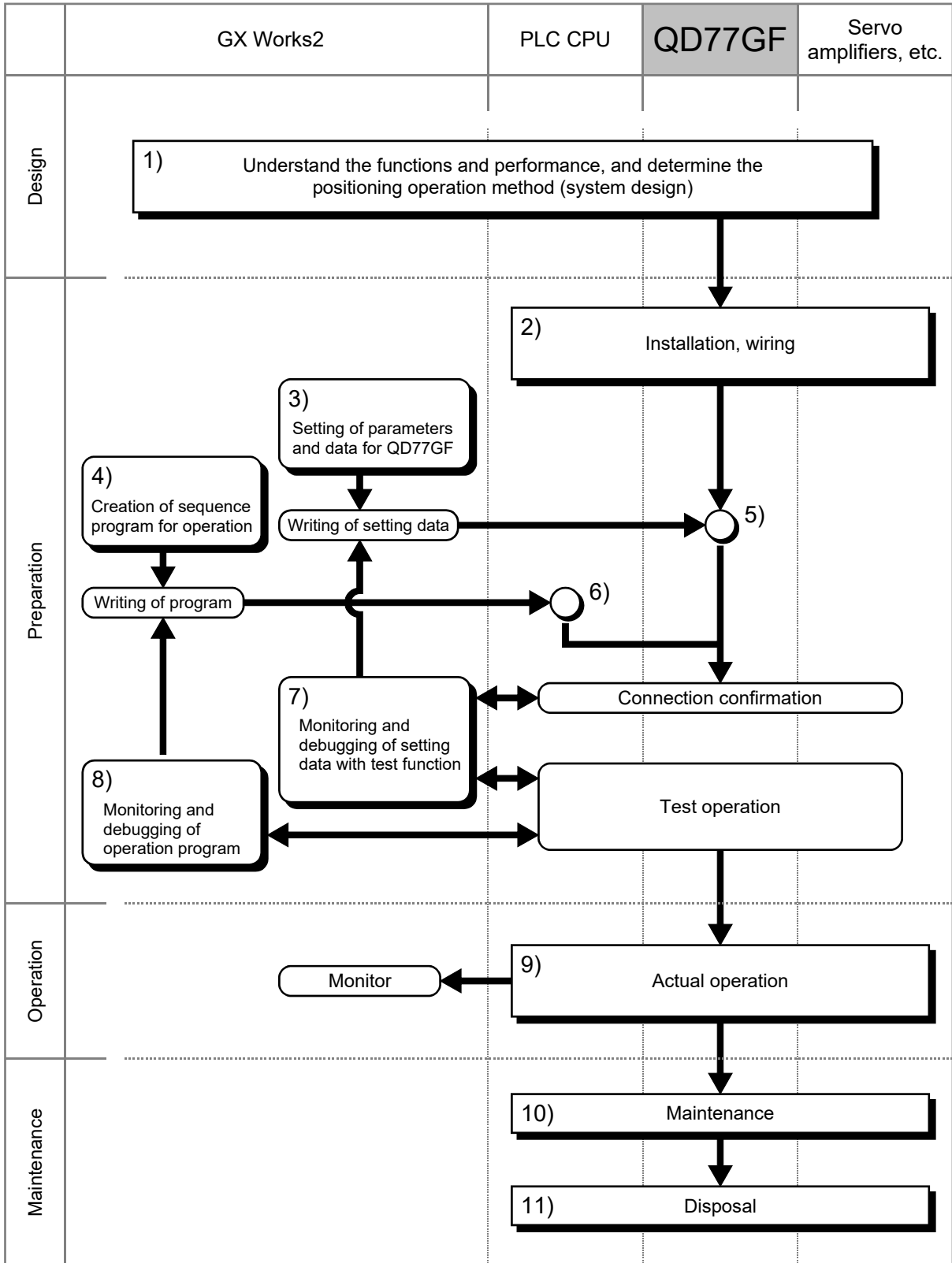

The following work is carried out with the processes shown on the previous page.

| | Details | Reference |
|-----|---|---|
| 1) | Understand the product functions and usage methods, the configuration devices and specifications required for positioning control, and design the system. | <ul style="list-style-type: none"> • Chapter 1 • Chapter 2 • Chapter 3 • Chapter 8 to Chapter 14 |
| 2) | Install the Simple Motion module onto the base unit, wire the Simple Motion module and external connected devices (servo amplifier, etc.) and wire the PLC CPU and peripheral devices. | <ul style="list-style-type: none"> • Chapter 4 |
| 3) | Using GX Works2, set the servo parameters, parameter, positioning data, block start data and condition data required for the positioning control to be executed. | <ul style="list-style-type: none"> • Chapter 5 • Chapter 8 to Chapter 14 • Simple Motion Module Setting Tool Help |
| 4) | Using GX Works2, create the sequence program required for positioning operation. | <ul style="list-style-type: none"> • Chapter 6 • GX Works2 Version1 Operating Manual (Common) |
| 5) | Write the parameters and positioning data, etc., created with GX Works2 into the Simple Motion module. | <ul style="list-style-type: none"> • Chapter 7 • Simple Motion Module Setting Tool Help |
| 6) | Using GX Works2, write the created sequence program into the PLC CPU. | <ul style="list-style-type: none"> • Chapter 7 • GX Works2 Version1 Operating Manual (Common) |
| 7) | Carry out test operation and adjustments in the test function of GX Works2 to check the connection with the Simple Motion module and external connected device, and to confirm that the designated positioning operation is executed correctly. (Debug the set "parameters" and "positioning data", etc.) | <ul style="list-style-type: none"> • Chapter 14 • Simple Motion Module Setting Tool Help |
| 8) | Carry out test operation and adjustment to confirm that the designated positioning operation is executed correctly. (Debug the created sequence program.) | <ul style="list-style-type: none"> • GX Works2 Version1 Operating Manual (Common) |
| 9) | Actually operate the positioning operation. At this time, monitor the operation state as required. If an error or warning occurs, remedy. | <ul style="list-style-type: none"> • Chapter 5 • Chapter 16 • Simple Motion Module Setting Tool Help • GX Works2 Version1 Operating Manual (Common) |
| 10) | Maintenance of the Simple Motion module as required. | <ul style="list-style-type: none"> • Chapter 4 |
| 11) | Dispose of the Simple Motion module. | <ul style="list-style-type: none"> • Chapter 4 |

1.2.2 Outline of starting

The outline for starting each control is shown with the following flowchart. (It is assumed that each module is installed, and the required system configuration, etc., has been prepared.)

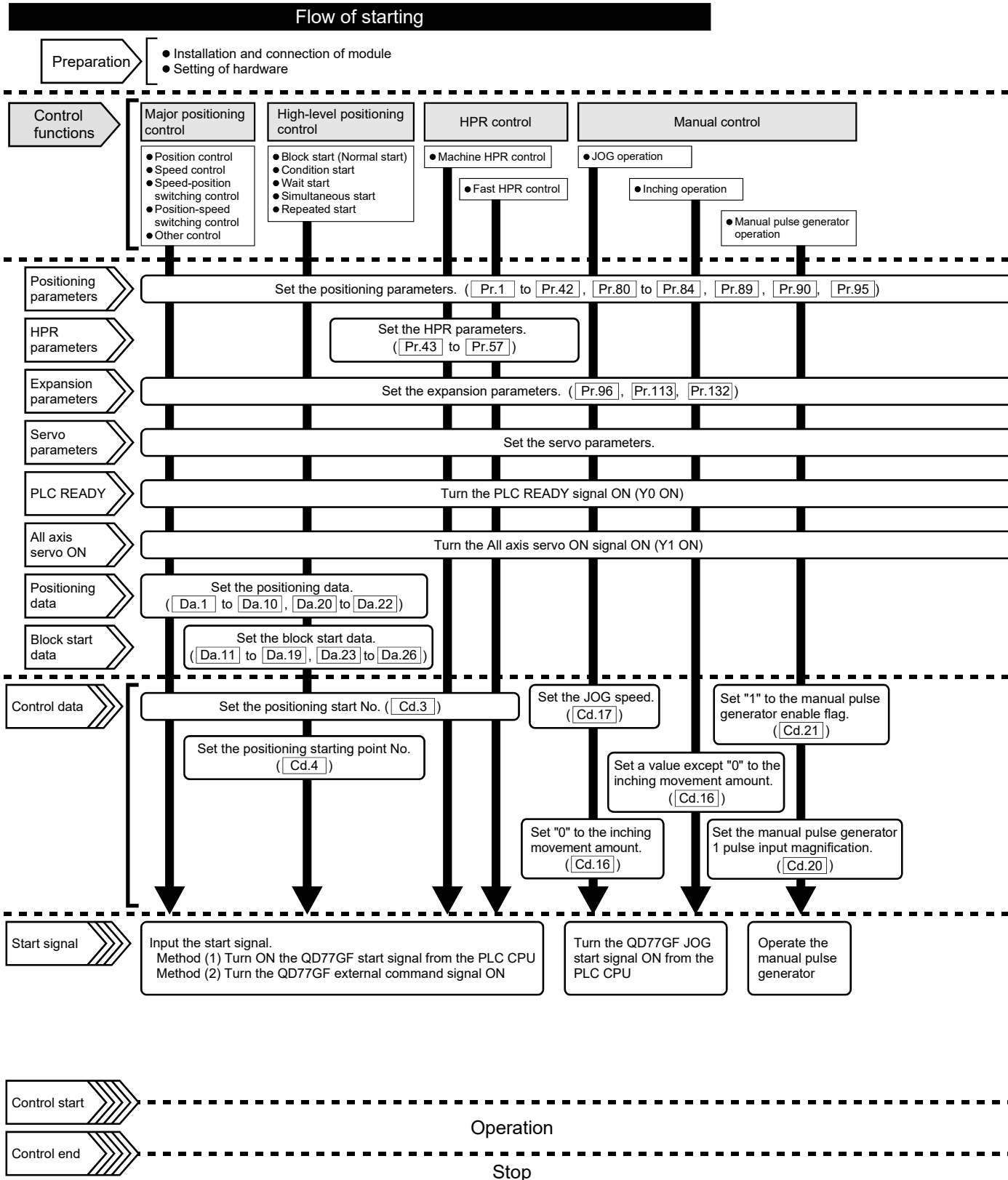

Setting method

 : Indicates the sequence program that must be created.

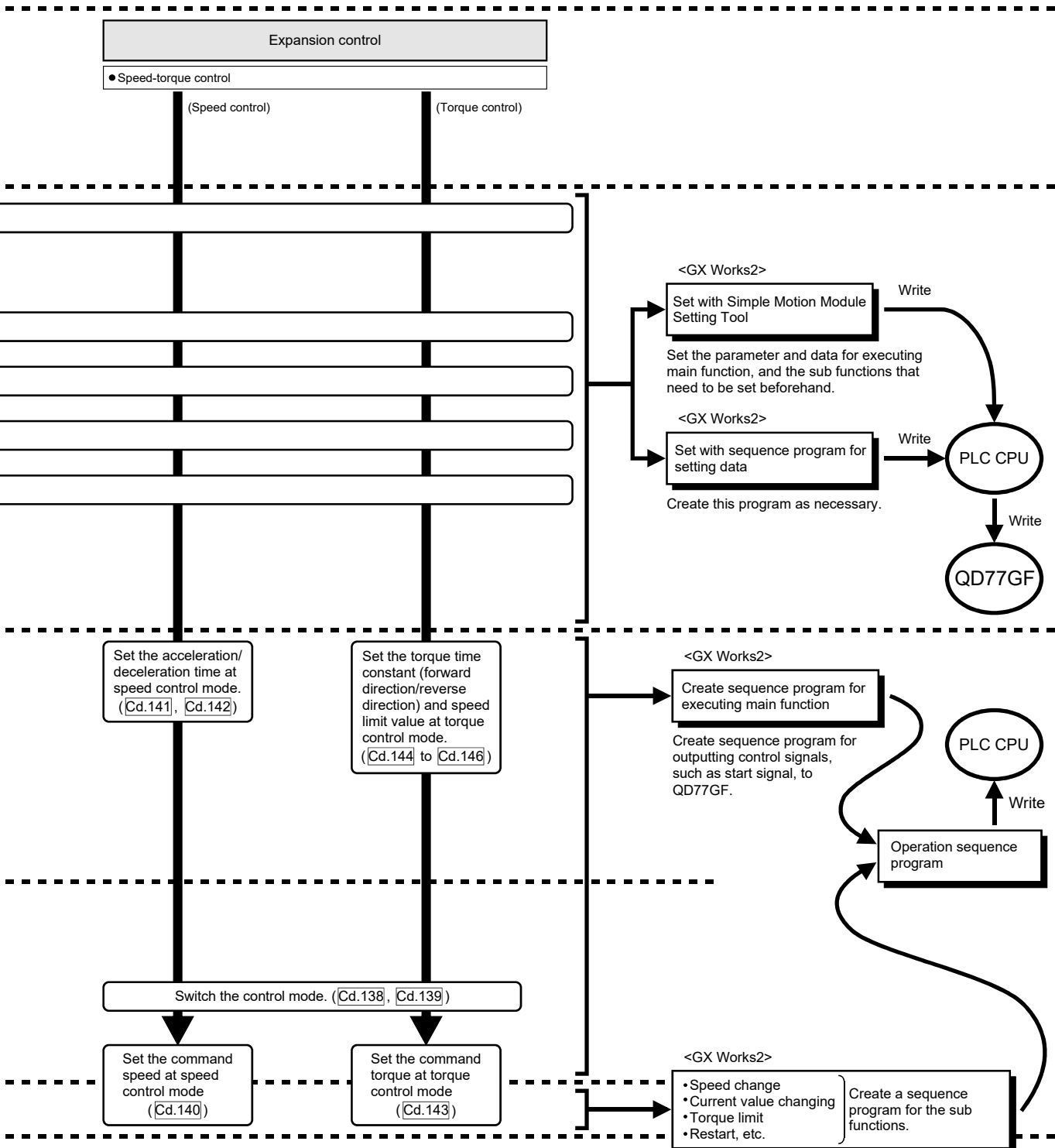

1.2.3 Outline of stopping

Each control is stopped in the following cases.

- (1) When each control is completed normally.
- (2) When the servo READY signal is turned OFF.
- (3) When a PLC CPU error occurs.
- (4) When the PLC READY signal is turned OFF.
- (5) When an error occurs in the Simple Motion module.
- (6) When control is intentionally stopped
(Stop signal from PLC CPU turned ON, "Stop signal" of external input signal turned ON, etc.).

The outline for the stop process in above cases is shown below. (Excluding "(1) When each control is completed normally" above.)

Refer to Section 12.1 "Speed-torque control" for the stop process during the speed control mode and torque control mode.

| Stop cause | | Stop axis | M code ON signal after stop | Axis operation status after stopping ([Md.26]) | Stop process | | | | | |
|--|--|-----------|-----------------------------|--|---|------------------|---------------------------|--------------------------------|-----------------------|----------------------------------|
| | | | | | HPR control | | Major positioning control | High-level positioning control | Manual control | |
| | | | | | Machine HPR control (Note-3) | Fast HPR control | | | JOG/Inching operation | Manual pulse generator operation |
| Forced stop | Forced stop input to Simple Motion module | All axes | No change | Servo OFF | Immediate stop For the stop method of the servo amplifier, refer to each servo amplifier instruction manual. | | | | | |
| | Servo READY OFF | Each axis | No change | Servo amplifier has not been connected | | | | | | |
| | • Servo amplifier power supply OFF | | | Error | | | | | | |
| | • Servo alarm | | | Servo OFF | | | | | | |
| • Forced stop input to servo amplifier | | | | | | | | | | |
| Fatal stop (Stop group 1) | Hardware stroke limit upper/lower limit error occurrence | Each axis | No change | Error | Deceleration stop/rapid stop (Select with "[Pr.37] Stop group 1 rapid stop selection".) | | | | | |
| Emergency stop (Stop group 2) | Error occurs in PLC CPU | All axes | No change | Error | Deceleration stop/rapid stop (Select with "[Pr.38] Stop group 2 rapid stop selection".) | | | | | |
| | PLC READY signal OFF | | Turns OFF | | | | | | | |
| | Error in test mode (Note-2) | | No change | | | | | | | |

| Stop cause | | Stop axis | M code ON signal after stop | Axis operation status after stopping ([Md.26]) | Stop process | | | | | |
|-------------------------------------|--|-----------|-----------------------------|--|---|------------------|---------------------------|--------------------------------|-----------------------|----------------------------------|
| | | | | | HPR control | | Major positioning control | High-level positioning control | Manual control | |
| | | | | | Machine HPR control | Fast HPR control | | | JOG/Inching operation | Manual pulse generator operation |
| Relatively safe stop (Stop group 3) | Axis error detection (Error other than stop group 1 or 2) (Note-1) | Each axis | No change | Error | Deceleration stop/rapid stop (Select with "[Pr.39] Stop group 3 rapid stop selection".) | | | | | |
| Intentional stop (Stop group 3) | "Axis stop signal" ON from PLC CPU (Note-4) | Each axis | No change | Stopped (Standby) | | | | | | |
| | "Stop" input from GX Works2 | | | | | | | | | |

(Note-1): If an error occurs in a positioning data due to an invalid setting value, when the continuous positioning control uses multiple positioning data successively, it automatically decelerates at the previous positioning data. It does not stop rapidly even the setting value is rapid stop in stop group 3. If any of the following error occurs, the operation is performed up to the positioning data immediately before the positioning data where an error occurred, and then stops immediately.

- No command speed (Error code 503)
- Outside linear movement amount range (Error code 504)
- Large arc error deviation (Error code 506)
- Software stroke limit + (Error code 507)
- Software stroke limit - (Error code 508)
- Sub point setting error (Error code 525)
- End point setting error (Error code 526)
- Center point setting error (Error code 527)
- Outside radius range (Error code 544)
- Illegal setting of ABS direction in unit of degree (Error code 546)

(Note-2): The failure during the test mode occurs in the following case.

- When the communication cannot be executed between the personal computer and the PLC CPU

(Note-3): The stop process when using the driver HPR method follows the specification of the servo amplifier. [CiA402 mode]

(Note-4): For the stop signal, it is recommended to check the condition that the axis is BUSY to perform the control, such as including the condition that the BUSY signal is ON in the interlock condition. The error "Stop signal ON at start" (error code: 106) can be prevented from occurring depending on the timing.

REMARK

Provide the emergency stop circuits outside the servo system to prevent cases where danger may result from abnormal operation of the overall system in the event of an external power supply fault or servo system failure.

1.2.4 Outline for restarting

When a stop cause has occurred during operation with position control causing the axis to stop, positioning to the end point of the positioning data can be restarted from the stopped position by using the "[Cd.6] Restart command".

If issued during a continuous positioning or continuous path control operation, the restart command will cause the positioning to be re-executed using the current position (pointed by the positioning data No. associated with the moment when the movement was interrupted) as the start point.

■ When "[Cd.6] Restart command" is ON

- (1) If the "[Md.26] Axis operation status" is stopped, positioning to the end point of the positioning data will be restarted from the stopped position regardless of the absolute system or incremental system.
- (2) When "[Md.26] Axis operation status" is not stopped, the warning "Restart not possible" (warning code: 104) will be applied, and the restart command will be ignored.

- (a) The restart operation when the axis 1 movement amount is 300 and the axis 2 movement amount is 600 is shown below.

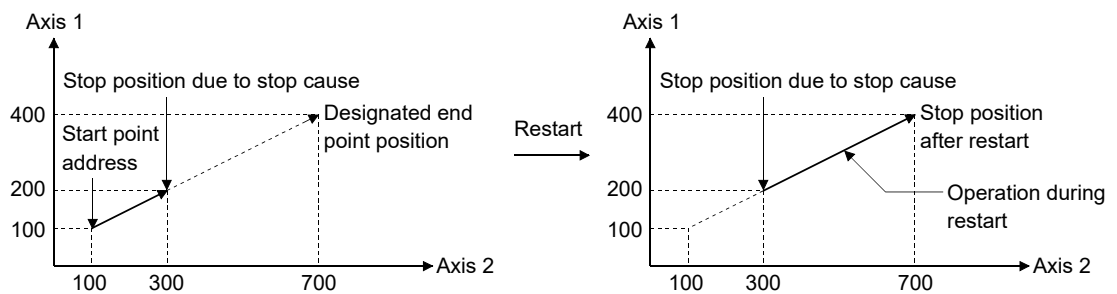

REMARK

If the positioning start signal/external command signal * is turned ON while the "[Md.26] Axis operation status" is standby or stopped, positioning will be restarted from the start of the positioning start data regardless of the absolute system or incremental system. (*: When the external command signal is set to "External positioning start") (Same as normal positioning.)

[Example for incremental system]

- (a) The positioning start operation, which stops the positioning control while executing that the axis 1 movement amount is 300 and the axis 2 movement amount is 600, is shown below.

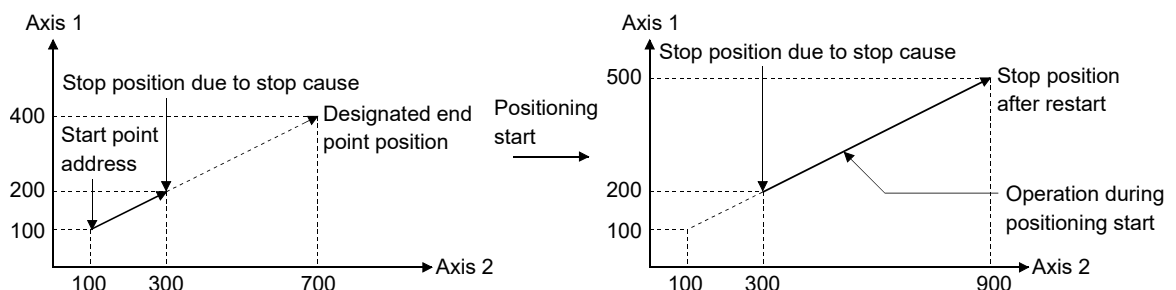

Chapter 2 System Configuration

In this chapter, the general image of the system configuration of the positioning control using Simple Motion module, the configuration devices, applicable CPU and the precautions of configuring the system are explained.
Prepare the required configuration devices to match the positioning control system.

| | | |
|-----|--|------|
| 2.1 | General image of system | 2- 2 |
| 2.2 | Component list | 2- 3 |
| 2.3 | Applicable system | 2- 5 |
| 2.4 | How to check the function version and SERIAL No..... | 2- 7 |
| 2.5 | Restrictions by the SERIAL No. and version | 2- 8 |

2.1 General image of system

The general image of the system, including such as the QD77GF, PLC CPU and peripheral devices is shown below.

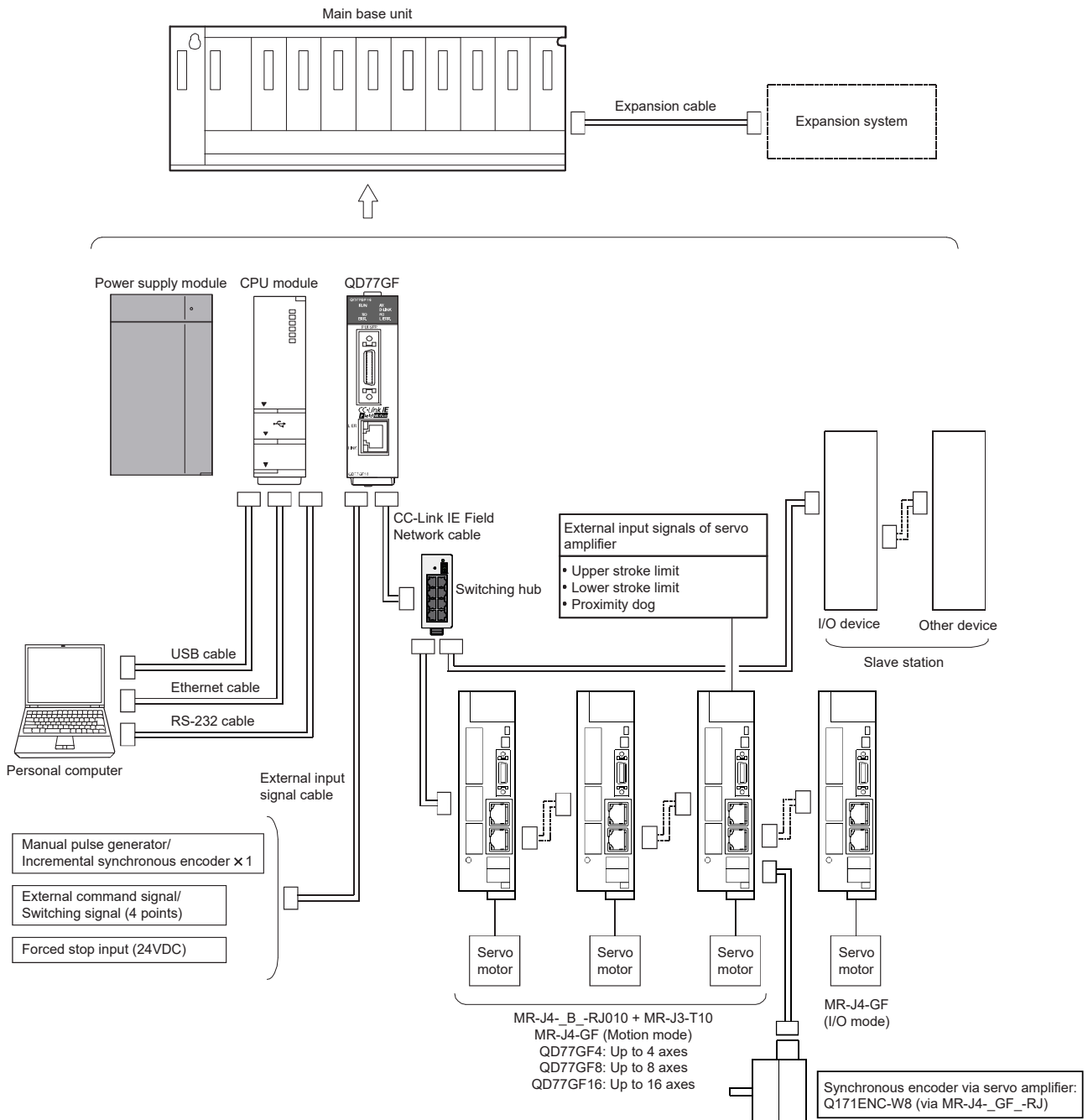

REMARK

- (Note-1): Refer to Section "2.3 Applicable system" for the CPU modules that can be used.
- (Note-2): Refer to the CPU module User's Manual for the base units that can be used.
- (Note-3): The external input signal cannot be used depending on the connected device.
Confirm the specification of the connected device.
- (Note-4): MR-J4- _B_-RJ010 + MR-J3-T10 and MR-J4-GF cannot be mixed.

2.2 Component list

The positioning system using the QD77GF is configured of the following devices.

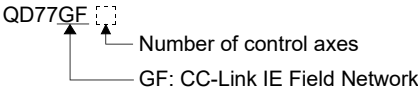
| No. | Part name | Type | Remarks |
|-----|---|---|---|
| 1 | Simple Motion module | QD77GF4 |  |
| | | QD77GF8 | |
| | | QD77GF16 | |
| 2 | Personal computer | Personal computer which supports Windows® | (Prepared by user) Refer to the "GX Works2 Version1 Operating Manual (Common)" for details. |
| 3 | RS-232 cable | QC30R2 | (Prepared by user) An RS-232 cable is needed for connecting the CPU module with a personal computer. Refer to the "GX Works2 Version1 Operating Manual (Common)" for details. |
| 4 | USB cable | — | (Prepared by user) A USB cable is needed for connecting the CPU module with a personal computer. Refer to the "GX Works2 Version1 Operating Manual (Common)" for details. |
| 5 | Ethernet cable | — | (Prepared by user) An Ethernet cable is needed for connecting the CPU module with a personal computer. Refer to the "GX Works2 Version1 Operating Manual (Common)" for details. |
| 6 | Servo amplifier | — | (Prepared by user) |
| 7 | I/O device | — | (Prepared by user) |
| 8 | Manual pulse generator | — | (Prepared by user) Recommended: MR-HDP01 (Manufactured by Mitsubishi Electric Corporation) |
| 9 | CC-Link IE Field Network cable (Note-1) | — | (Prepared by user) An Ethernet cable is needed for connecting the Simple Motion module with a servo amplifier and an I/O device. |
| 10 | External input signal cable (Note-2) | — | (Prepared by user) Cables are needed for connecting the Simple Motion module with an external device. |
| 11 | Hub (Note-1) | — | (Prepared by user) Switching hubs are needed for connecting the Simple Motion module with a servo amplifier and an I/O device in star topology. Recommended: DT135TX (Mitsubishi Electric System & Service Co., Ltd.) |

(Note-1): Refer to the "MELSEC-Q QD77GF Simple Motion Module User's Manual (Network)" for details of cables and hubs.

(Note-2): The external input wiring connector has been prepared.

[External input wiring connector]

| Part name | Specification |
|----------------------|---|
| Applicable connector | LD77MHIOCON |
| Applicable wire size | AWG30 to AWG24 (0.05 to 0.2mm ²) (Note-3) |

(Note-3): AWG24 (0.2mm²) is recommended.

■ Specifications of recommended manual pulse generator

| Item | Specification |
|---------------------------|---|
| Model name | MR-HDP01 |
| Ambient temperature | -10 to 60°C |
| Pulse resolution | 25PLS/rev (100 PLS/rev after magnification by 4) |
| Output method | Voltage-output, Output current Max. 20mA |
| Power supply voltage | 4.5 to 13.2VDC |
| Current consumption | 60mA |
| Output level | "H" level : Power supply voltage ^(Note-1) -1V or more (in no load) "L" level : 0.5V or less (with maximum leading-in) |
| Life time | 1000000 revolutions (at 200r/min) |
| Permitted axial loads | Radial load: Max. 19.6N |
| | Thrust load: Max. 9.8N |
| Weight | 0.4 [kg] |
| Number of max. revolution | Instantaneous Max. 600r/min. normal 200r/min |
| Pulse signal status | 2 signals: A phase, B phase, 90° phase difference |
| Start friction torque | 0.06N•m (20°C) |

(Note-1): If a separate power supply is used, use a stabilized power supply of voltage 5VDC ± 0.25V.

2.3 Applicable system

(1) Number of applicable modules

Pay attention to the power supply capacity before mounting modules because power supply capacity may be insufficient depending on the combination with other modules or the number of mounted modules.

If the power supply capacity is insufficient, change the combination of the modules.

(a) When mounted with a CPU module

| Applicable CPU module | | Number of modules (Note-1) | |
|-----------------------|--|-------------------------------|-----------------|
| CPU type | CPU model | | |
| PLC CPU | Universal model QCPU | Q00UJCPU | Up to 2 modules |
| | | Q00UCPU | |
| | | Q01UCPU | |
| | | Q02UCPU | Up to 4 modules |
| | Universal model QnUDV (High speed type CPU) | Q03UDCPU | Up to 8 modules |
| | | Q04UDHCPU | |
| | | Q06UDHCPU | |
| | | Q10UDHCPU | |
| | | Q13UDHCPU | |
| | | Q20UDHCPU | |
| | | Q26UDHCPU | |
| | | Q03UDECPU | |
| | | Q04UDEHCPU | |
| | | Q06UDEHCPU | |
| | | Q10UDEHCPU | |
| | | Q13UDEHCPU | |
| | | Q20UDEHCPU | |
| | | Q26UDEHCPU | |
| | | Q50UDEHCPU | |
| | | Q100UDEHCPU | |
| | | Q03UDVCPU | |
| | | Q04UDVCPU | |
| Q06UDVCPU | | | |
| Q13UDVCPU | | | |
| Q26UDVCPU | | | |

(Note-1): The total mounted number of the QD77GF and the QJ71GF11-T2 set by GX Works2. To mount the QJ71GF11-T2 more than the maximum applicable number, set by the dedicated instruction CCPASET. The QD77GF does not support the dedicated instruction CCPASET.

Examples for mounting the QD77GF and the QJ71GF11-T2 with the Q03UD(E)CPU are shown in the table below.

| Applicability | Number of modules | | | Total |
|---------------|-------------------|-------------|-----------------------|-------|
| | QD77GF | QJ71GF11-T2 | | |
| | GX Works2 | GX Works2 | Dedicated instruction | |
| ○ | 4 | 4 | 0 | 8 |
| × | 4 | 5 | 0 | 9 |
| ○ | 4 | 4 | 1 | 9 |

○: Applicable, ×: N/A

(b) Mounting to a MELSECNET/H remote I/O station

The QD77GF cannot be mounted to any MELSECNET/H remote I/O stations.
Mount the module on a base unit on which a CPU module is mounted.

(2) Compatibility with multiple CPU system

When using the Simple Motion module in a multiple CPU system, refer to the QCPU User's Manual (multiple CPU system). The Simple Motion module supports the multiple CPU system.

(a) Network parameters

Network parameters are set to the control CPU of the Simple Motion module.

(b) Diagnosing from another station using GX Works2

When there is the CPU module that does not support the Simple Motion module in another CPU other than the control CPU, it cannot diagnose from another station using GX Works2. (e.g. PC diagnostics, system monitor)

To diagnose the CPU, connect GX Works2 to the control CPU when diagnosing cannot be executed from another station.

(3) Programming tool

The applicable programming tool's versions of the Simple Motion module are shown below.

(For the applicable programming tool's versions of the CPU module, refer to the "QCPU User's Manual (Hardware Design, Maintenance and Inspection)".)

| | Version | |
|------------------------|-------------------------|------------------------|
| | GX Works2 | MR Configurator2 |
| QD77GF4 | Version 1.540N or later | Version 1.49B or later |
| QD77GF8 | | |
| QD77GF16 [CiA402 mode] | | |
| QD77GF16 [RJ010 mode] | Version 1.98C or later | Version 1.19V or later |

REMARK

QD77GF cannot be supported with GX Developer, GX Configurator-QP and MR Configurator.

Use GX Works2 and MR Configurator2 to use QD77GF.

2.4 How to check the function version and SERIAL No.

The function version and the SERIAL No. of the Simple Motion module can be checked in the following methods.

(1) Checking on the front of the module

The serial No. on the rating plate is also indicated on the front of the module (lower part).

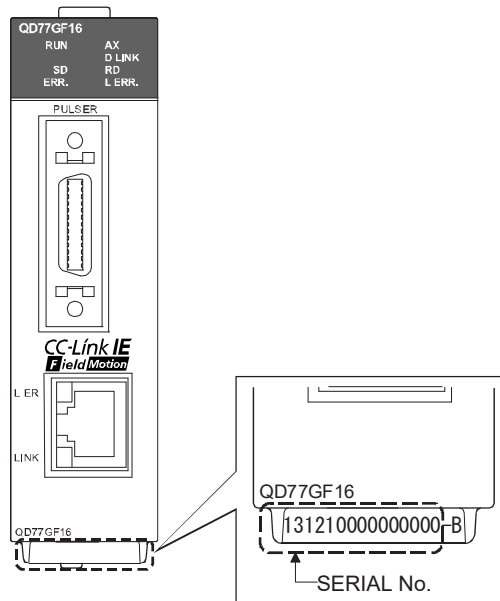

(2) Confirming by the software

Check the function version and SERIAL No. in "Product Information" displayed on System monitor "Product Information List" of GX Works2.

2.5 Restrictions by the SERIAL No. and version

There are restrictions in the function that can be used by the SERIAL No. of the Simple Motion module and the version of GX Works2.

The combination of each version and function is shown below.

| Function | QD77GF4/QD77GF8 | | QD77GF16 | | Reference |
|--|--|--------------------------------|--|--------------------------------|---------------|
| | First five digits of SERIAL No. (Note-1) | GX Works2 | First five digits of SERIAL No. (Note-1) | GX Works2 | |
| Speed-torque control (Other than continuous operation to torque control) | — | 1.540N or later | 15092 or later | 1.501X or later | Section 12.1 |
| Gain switching | | | 15092 or later | 1.98C or later | Section 5.7.2 |
| PI-PID switching | | | 15092 or later | 1.98C or later | Section 5.7.2 |
| Communication mode switching (Connected to MR-J4-GF) (Note-2) | | | 17102 or later | 1.540N or later | Section 5.2.7 |
| Linear servo motor control mode/Direct drive motor control mode/Fully closed loop control mode (Connected to MR-J4-GF) | 18022 or later | Scheduled to be 1.545T or late | 18022 or later | Scheduled to be 1.545T or late | Appendix 2 |
| Synchronous encoder via servo amplifier | | | | | _(Note-3) |
| Improvement of cyclic data integrity assurance function | 19072 or later | — | 19072 or later | — | _(Note-4) |

—: There is no restriction in the function by the version.

(Note-1): The serial number can be checked on the "Product Information List" screen in GX Works2.

(Note-2): Even though the MR-J4-GF is used, the specification when the virtual servo amplifier is set is in the MR-J4-B-RJ010 communication mode.

(Note-3): Refer to "MELSEC-Q/L QD77MS/QD77GF/LD77MS/LD77MH Simple Motion Module User's Manual (Synchronous Control)" for details.

(Note-4): Refer to "MELSEC-Q QD77GF Simple Motion Module User's Manual (Network)" for details.

Chapter 3 Specifications and Functions

The various specifications of the Simple Motion module are explained in this chapter.

The "Performance specifications", "List of functions", "Specifications of input/output signals with PLC CPU", and "Specifications of interfaces with external devices", etc., are described as information required when designing the positioning system. Confirm each specification before designing the positioning system.

| | | |
|-------|---|------|
| 3.1 | Performance specifications | 3- 2 |
| 3.2 | List of functions | 3- 4 |
| 3.2.1 | QD77GF control functions | 3- 4 |
| 3.2.2 | QD77GF main functions | 3- 7 |
| 3.2.3 | QD77GF sub functions | 3- 9 |
| 3.2.4 | QD77GF common functions | 3-11 |
| 3.2.5 | Combination of QD77GF main functions and sub functions..... | 3-12 |
| 3.3 | Specifications of input/output signals with PLC CPU..... | 3-14 |
| 3.3.1 | List of input/output signals with PLC CPU | 3-14 |
| 3.3.2 | Details of input signals (Simple Motion module → PLC CPU) | 3-15 |
| 3.3.3 | Details of output signals (PLC CPU → Simple Motion module)..... | 3-17 |
| 3.4 | Specifications of interfaces with external devices..... | 3-18 |
| 3.4.1 | Electrical specifications of input signals..... | 3-18 |
| 3.4.2 | Signal layout for external input connection connector | 3-20 |
| 3.4.3 | List of input signal details | 3-22 |
| 3.4.4 | Interface internal circuit..... | 3-24 |
| 3.5 | External circuit design | 3-30 |

3.1 Performance specifications

| Model | | QD77GF4 | QD77GF8 | QD77GF16 |
|--------------------------------|---------------------------------------|---|---------|----------|
| Item | | | | |
| Number of control axes | | 4 axes | 8 axes | 16 axes |
| Operation cycle | | [RJ010 mode] 0.88ms/1.77ms/3.55ms, [CiA402 mode] 1.00ms/2.00ms/4.00ms | | |
| Interpolation function | | 2-, 3-, or 4-axis linear interpolation, 2-axis circular interpolation | | |
| Control method | | PTP (Point To Point) control, path control (both linear and arc can be set), speed control, speed-position switching control, position-speed switching control, speed-torque control | | |
| Control unit | | mm, inch, degree, PLS | | |
| Positioning data | | 600 data/axis (Can be set with GX Works2 or sequence program.) | | |
| Execution data backup function | | Parameters, positioning data, and block start data can be saved on flash ROM (battery-less backup) | | |
| Positioning | Positioning system | PTP control: Incremental system/absolute system Speed-position switching control: Incremental system/absolute system Position-speed switching control: Incremental system Path control: Incremental system/absolute system | | |
| | Positioning range | <div style="border: 1px solid black; padding: 2px;">In absolute system</div> <ul style="list-style-type: none"> • -214748364.8 to 214748364.7 (μm) • -21474.83648 to 21474.83647 (inch) • 0 to 359.99999 (degree) • -2147483648 to 2147483647 (PLS) <div style="border: 1px solid black; padding: 2px;">In incremental system</div> <ul style="list-style-type: none"> • -214748364.8 to 214748364.7 (μm) • -21474.83648 to 21474.83647 (inch) • -21474.83648 to 21474.83647 (degree) • -2147483648 to 2147483647 (PLS) <div style="border: 1px solid black; padding: 2px;">In speed-position switching control (INC mode) / position-speed switching control</div> <ul style="list-style-type: none"> • 0 to 214748364.7 (μm) • 0 to 21474.83647 (inch) • 0 to 21474.83647 (degree) • 0 to 2147483647 (PLS) <div style="border: 1px solid black; padding: 2px;">In speed-position switching control (ABS mode) ^(Note-1)</div> <ul style="list-style-type: none"> • 0 to 359.99999 (degree) | | |
| | Speed command | 0.01 to 20000000.00 (mm/min) 0.001 to 2000000.000 (inch/min) 0.001 to 2000000.000 (degree/min) ^(Note-2) 1 to 1000000000 (PLS/s) | | |
| | Acceleration/ deceleration process | Trapezoidal acceleration/deceleration, S-curve acceleration/deceleration | | |
| | Acceleration/ deceleration time | 1 to 8388608 (ms) Four patterns can be set for each of acceleration time and deceleration time | | |
| | Rapid stop deceleration time | 1 to 8388608 (ms) | | |

| Item | Model | QD77GF4 | QD77GF8 | QD77GF16 | | | | | | | | |
|--|--------------------|---|---------|----------|----------------------|--------------------|------|------|------|------|------|------|
| Starting time (ms) (Note-3) | | <p>Starting time = Operation cycle × 2</p> <table border="1"> <thead> <tr> <th>Operation cycle (ms)</th> <th>Starting time (ms)</th> </tr> </thead> <tbody> <tr> <td>0.88</td> <td>1.77</td> </tr> <tr> <td>1.77</td> <td>3.55</td> </tr> <tr> <td>3.55</td> <td>7.11</td> </tr> </tbody> </table> | | | Operation cycle (ms) | Starting time (ms) | 0.88 | 1.77 | 1.77 | 3.55 | 3.55 | 7.11 |
| Operation cycle (ms) | Starting time (ms) | | | | | | | | | | | |
| 0.88 | 1.77 | | | | | | | | | | | |
| 1.77 | 3.55 | | | | | | | | | | | |
| 3.55 | 7.11 | | | | | | | | | | | |
| 1-axis linear control | | | | | | | | | | | | |
| 1-axis speed control | | | | | | | | | | | | |
| 2-axis linear interpolation control (Composite speed) | | | | | | | | | | | | |
| 2-axis linear interpolation control (Reference axis speed) | | | | | | | | | | | | |
| 2-axis circular interpolation control | | | | | | | | | | | | |
| 2-axis speed control | | | | | | | | | | | | |
| 3-axis linear interpolation control (Composite speed) | | | | | | | | | | | | |
| 3-axis linear interpolation control (Reference axis speed) | | | | | | | | | | | | |
| 3-axis speed control | | | | | | | | | | | | |
| 4-axis linear interpolation control | | | | | | | | | | | | |
| 4-axis speed control | | | | | | | | | | | | |
| External wiring connection system | | 26-pin connector | | | | | | | | | | |
| Applicable wire size | | AWG30 to AWG24 (0.05 to 0.2mm ²) (Note-4) | | | | | | | | | | |
| External input wiring connector | | LD77MHIOCON | | | | | | | | | | |
| CC-Link IE Field Network cable (Note-5) | | <ul style="list-style-type: none"> • QD77GF ↔ CC-Link IE Field device • CC-Link IE Field device ↔ CC-Link IE Field device • Category 5e or higher, (Double shielded/STP) Straight cable • RJ-45 connector • The following conditioning cables: IEEE802.3 (1000BASE-T) ANSI/TIA/EIA-568-B (Category 5e) | | | | | | | | | | |
| Hub | | <ul style="list-style-type: none"> • QD77GF ↔ Servo amplifier • QD77GF ↔ I/O device • Servo amplifier ↔ I/O device Recommended product: DT135TX (Mitsubishi Electric System & Service Co., Ltd.) (Note-7) | | | | | | | | | | |
| Internal current consumption (5VDC) [A] | | 0.8 | | | | | | | | | | |
| Flash ROM write count | | Max. 100000 times | | | | | | | | | | |
| Number of occupied I/O points [points] | | 32 (I/O assignment: Intelligent function module 32 points) | | | | | | | | | | |
| External dimensions [mm(inch)] | | 98.0 (3.86) (H) × 27.4 (1.08) (W) × 115 (4.53) (D) | | | | | | | | | | |
| Mass [kg] | | 0.26 | | | | | | | | | | |

(Note-1): The speed-position switching control (ABS mode) can be used only when the control unit is "degree". (For details, refer to Section 9.2.17.)

(Note-2): When "Speed control 10 x multiplier setting for degree axis function" is valid, this will be the setting range 0.01 to 20000000.00 (degree/min). (For details, refer to Section 13.7.10.)

(Note-3): Time from accepting the positioning start signal until BUSY signal turns ON.

(Note-4): AWG24 (0.2mm²) is recommended.

(Note-5): Cables for CC-Link IE Field Network are available from Mitsubishi Electric System & Service Co., Ltd. To prevent from a malfunction caused by noise, recommend using the recommended product.

| Type | Model (manufacturer) |
|--------------------------------|---|
| CC-Link IE Field Network cable | SC-E5EW series (Mitsubishi Electric System & Service Co., Ltd.) |

(Note-6): For the performance specification of CC-Link IE Field Network, refer to the "MELSEC-Q QD77GF Simple Motion Module User's Manual (Network)".

(Note-7): Use the CC-Link IE Field Network synchronization communication-compatible switching hubs when using the CC-Link IE Field Network synchronization communication function.

CC-Link IE Field Network synchronization communication-compatible switching hubs are available from Mitsubishi Electric System & Service Co., Ltd. Please consult your local Mitsubishi representative.

3.2 List of functions

3.2.1 QD77GF control functions

The Simple Motion module has several functions. In this manual, the functions of Simple Motion module are categorized and explained as follows.

■ Main functions

(1) HPR control

"HPR control" is a function (Fast HPR) that established the start point for carrying out positioning control (Machine HPR), and carries out positioning toward that start point. This is used to return a workpiece, located at a position other than the HP when the power is turned ON or after positioning stop, to the HP. The "HPR control" is pre-registered in the Simple Motion module as the "Positioning start data No. 9001 (Machine HPR)", and "Positioning start data No. 9002 (Fast HPR)". (Refer to Chapter 8 "HPR Control".)

(2) Major positioning control

This control is carried out using the "Positioning data" stored in the Simple Motion module. Positioning control, such as position control and speed control, is executed by setting the required items in this "positioning data" and starting that positioning data. An "operation pattern" can be set in this "positioning data", and with this whether to carry out control with continuous positioning data (ex.: positioning data No. 1, No. 2, No. 3, ...) can be set. (Refer to Chapter 9 "Major Positioning Control".)

(3) High-level positioning control

This control executes the "positioning data" stored in the Simple Motion module using the "block start data". The following types of applied positioning control can be carried out.

- Random blocks, handling several continuing positioning data items as "blocks", can be executed in the designated order.
- "Condition judgment" can be added to position control and speed control.
- The operation of the designated positioning data No. that is set for multiple axes can be started simultaneously. (Command is output simultaneously to multiple servo amplifiers.)
- The designated positioning data can be executed repeatedly, etc., (Refer to Chapter 10 "High-Level Positioning Control".)

(4) Manual control

This control executes the random positioning operation by inputting a signal into the Simple Motion module from an external device. Use this manual control to move the workpiece to a random position (JOG operation), and to finely adjust the positioning (inching operation, manual pulse generator operation), etc. (Refer to Chapter 11 "Manual Control".)

(5) Expansion control

The following controls other than the positioning control can be executed. (Refer to Chapter 12 "Expansion Control".)

- Speed control and torque control not including the position loop for the command to servo amplifier (Speed-torque control).
- Synchronous control with gear, shaft, change gear and cam not by mechanical, but by software use "synchronous control parameter", and is synchronized with input axis (Synchronous control).

■ Sub functions

When executing the main functions, control compensation, limits and functions can be added. (Refer to Chapter 13 "Control Sub Functions".)

■ Common functions

Common control using the Simple Motion module for "parameter initialization" or "backup of execution data" can be carried out. (Refer to Chapter 14 "Common Functions".)

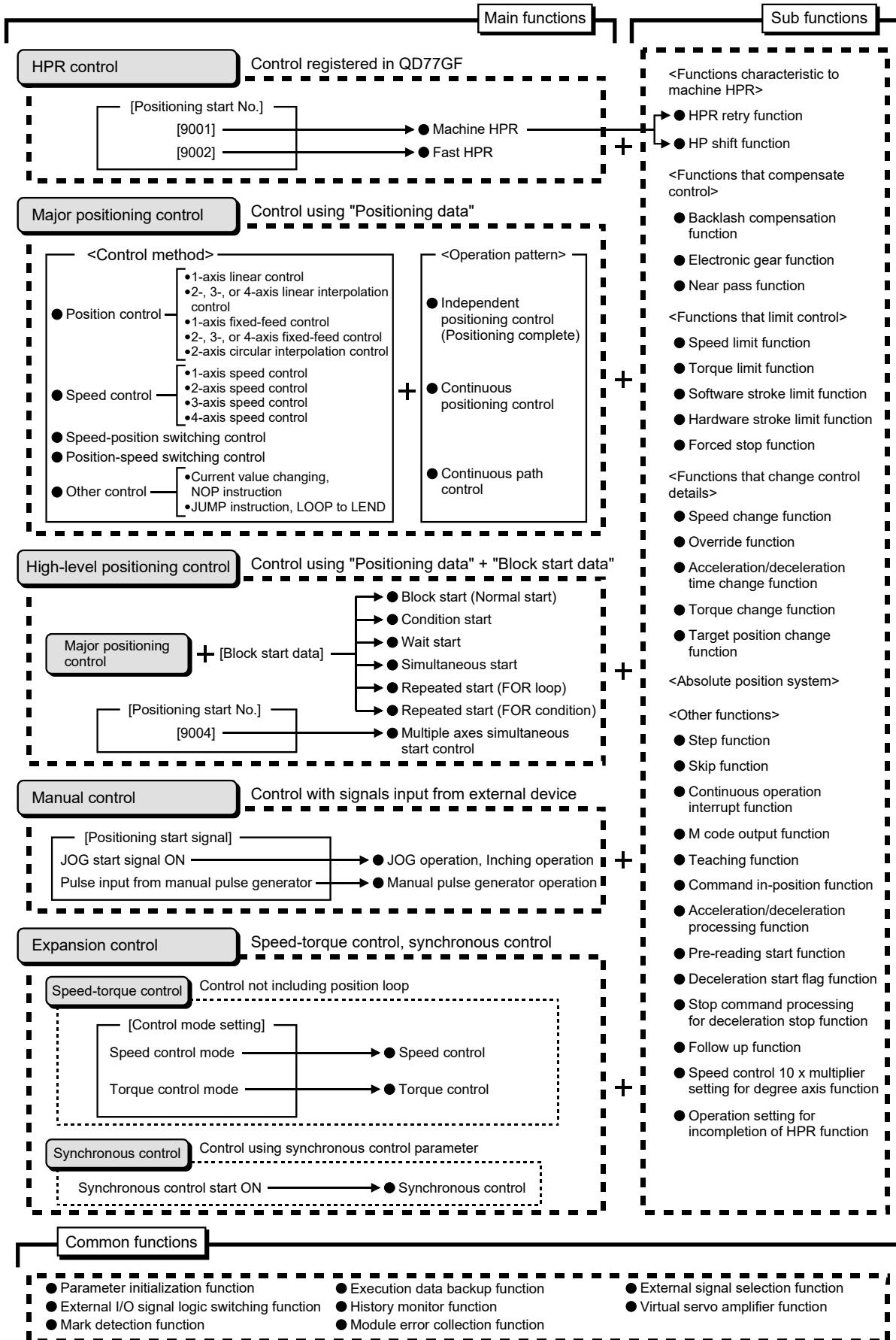

3.2.2 QD77GF main functions

The outline of the main functions for positioning control with the Simple Motion module is described below. (Refer to "Section 2" for details on each function.)

| Main functions | | Details | Reference section | |
|---------------------------|----------------------------------|---|--|--------|
| HPR control | Machine HPR control | Mechanically establishes the positioning start point using a proximity dog, etc. In the data setting method, no axis movement occurs since the current position is set as the home position. (Positioning start No. 9001) | 8.2 | |
| | Fast HPR control | Positions a target to the HP address ([Md.21] Feed machine value) stored in the Simple Motion module using machine HPR. (Positioning start No. 9002) | 8.3 | |
| Major positioning control | Position control | Linear control (1-axis linear control) (2-axis linear interpolation control) (3-axis linear interpolation control) (4-axis linear interpolation control) | 9.2.2 9.2.3 9.2.4 9.2.5 | |
| | | Fixed-feed control (1-axis fixed-feed control) (2-axis fixed-feed control) (3-axis fixed-feed control) (4-axis fixed-feed control) | 9.2.6 9.2.7 9.2.8 9.2.9 | |
| | | 2-axis circular interpolation control | 9.2.10 9.2.11 | |
| | | Speed control (1-axis speed control) (2-axis speed control) (3-axis speed control) (4-axis speed control) | 9.2.12 9.2.13 9.2.14 9.2.15 | |
| | Speed-position switching control | First, carries out speed control, and then carries out position control (positioning with designated address or movement amount) by turning the "speed-position switching signal" ON. | 9.2.16 9.2.17 | |
| | Position-speed switching control | First, carries out position control, and then carries out speed control (continuous output of the command corresponding to the designated command speed) by turning the "position-speed switching signal" ON. | 9.2.18 | |
| | Other control | Current value changing | Changes the feed current value ([Md.20]) to the address set in the positioning data. The following two methods can be used. (The feed machine value ([Md.21]) cannot be changed.) • Current value changing using positioning data • Current value changing using current value changing start No. (No. 9003) | 9.2.19 |
| | | NOP instruction | No execution control method. When NOP instruction is set, this instruction is not executed and the operation of the next data is started. | 9.2.20 |
| | | JUMP instruction | Unconditionally or conditionally jumps to designated positioning data No. | 9.2.21 |
| | | LOOP | Carries out loop control with repeated LOOP to LEND. | 9.2.22 |
| | | LEND | Returns to the beginning of the loop control with repeated LOOP to LEND. | 9.2.23 |

| Main functions | | Details | Reference section |
|--------------------------------|--|---|-------------------|
| High-level positioning control | Block start (Normal start) | With one start, executes the positioning data in a random block with the set order. | 10.3.2 |
| | Condition start | Carries out condition judgment set in the "condition data" for the designated positioning data, and then executes the "block start data". When the condition is established, the "block start data" is executed. When not established, that "block start data" is ignored, and the next point's "block start data" is executed. | 10.3.3 |
| | Wait start | Carries out condition judgment set in the "condition data" for the designated positioning data, and then executes the "block start data". When the condition is established, the "block start data" is executed. When not established, stops the control until the condition is established. (Waits.) | 10.3.4 |
| | Simultaneous start | Simultaneously executes the designated positioning data of the axis designated with the "condition data". (Outputs commands at the same timing.) | 10.3.5 |
| | Repeated start (FOR loop) | Repeats the program from the block start data set with the "FOR loop" to the block start data set in "NEXT" for the designated number of times. | 10.3.6 |
| | Repeated start (FOR condition) | Repeats the program from the block start data set with the "FOR condition" to the block start data set in "NEXT" until the conditions set in the "condition data" are established. | 10.3.7 |
| | Multiple axes simultaneous start control | Starts the operation of multiple axes simultaneously according to the command output level. (Positioning start No. 9004, same as the "simultaneous start" above) | 10.5 |
| Manual control | JOG operation | Outputs a command to servo amplifier while the JOG start signal is ON. | 11.2 |
| | Inching operation | Outputs commands corresponding to minute movement amount by manual operation to servo amplifier. (Performs fine adjustment with the JOG start signal.) | 11.3 |
| | Manual pulse generator operation | Outputs pulses commanded with the manual pulse generator to servo amplifier. | 11.4 |
| Expansion control | Speed-torque control | Carries out the speed control or torque control that does not include the position loop for the command to servo amplifier by switching control mode. | 12.1 |
| | Synchronous control | Carries out the synchronous control that synchronizes with input axis by setting the system such as gear, shaft, change gear and cam to the "synchronous control parameter". | 12.2 |

In "major positioning control" ("high-level positioning control"), "Operation pattern" can be set to designate whether to continue executing positioning data. Outlines of the "operation patterns" are given below.

| [Da.1] Operation pattern | Details | Reference section |
|--|---|-------------------|
| Independent positioning control (positioning complete) | When "independent positioning control" is set for the operation pattern of the started positioning data, only the designated positioning data will be executed, and then the positioning will end. | 9.1.2 |
| Continuous positioning control | When "continuous positioning control" is set for the operation pattern of the started positioning data, after the designated positioning data is executed, the program will stop once, and then the next following positioning data will be executed. | |
| Continuous path control | When "continuous path control" is set for the operation pattern of the started positioning data, the designated positioning data will be executed, and then without decelerating, the next following positioning data will be executed. | |

3.2.3 QD77GF sub functions

The outline of the functions that assist positioning control using the Simple Motion module is described below. (Refer to "Section 2" for details on each function.)

| Sub function | Details | Reference section | |
|---|--|--|--------|
| Functions characteristic to machine HPR | HPR retry function [RJ010 mode] | This function retries the machine HPR with the upper/lower limit switches during HPR. This allows machine HPR to be carried out even if the axis is not returned to before the proximity dog with JOG operation, etc. | 13.2.1 |
| | HP shift function [RJ010 mode] | After returning to the machine HP, this function compensates the position by the designated distance from the machine HP and sets that position as the HP address. | 13.2.2 |
| Functions that compensate control | Backlash compensation function | This function compensates the mechanical backlash amount. Feed commands equivalent to the set backlash amount are output each time the movement direction changes. | 13.3.1 |
| | Electronic gear function | By setting the movement amount per pulse, this function can freely change the machine movement amount per commanded pulse. When the movement amount per pulse is set, a flexible positioning system that matches the machine system can be structured. | 13.3.2 |
| | Near pass function *1 | This function suppresses the machine vibration when the positioning data is switched during continuous path control in the interpolation control. | 13.3.3 |
| Functions that limit control | Speed limit function | If the command speed exceeds "[Pr.8] Speed limit value" during control, this function limits the commanded speed to within the "[Pr.8] Speed limit value" setting range. | 13.4.1 |
| | Torque limit function | If the torque generated by the servomotor exceeds "[Pr.17] Torque limit setting value" during control, this function limits the generated torque to within the "[Pr.17] Torque limit setting value" setting range. | 13.4.2 |
| | Software stroke limit function | If a command outside of the upper/lower limit stroke limit setting range, set in the parameters, is issued, this function will not execute positioning for that command. | 13.4.3 |
| | Hardware stroke limit function | This function carries out deceleration stop with the hardware stroke limit switch. | 13.4.4 |
| | Forced stop function | This function stops all axes of the servo amplifier with the forced stop signal. | 13.4.5 |
| Functions that change control details | Speed change function | This function changes the speed during positioning. Set the new speed in the speed change buffer memory ([Cd.14] New speed value), and change the speed with the speed change request ([Cd.15]). | 13.5.1 |
| | Override function | This function changes the speed within a percentage of 1 to 300% during positioning. This is executed using "[Cd.13] Positioning operation speed override". | 13.5.2 |
| | Acceleration/deceleration time change function | This function changes the acceleration/deceleration time during speed change. (Functions added to the speed change function and override function) | 13.5.3 |
| | Torque change function | This function changes the "torque limit value" during control. | 13.5.4 |
| | Target position change function | This function changes the target position during positioning. Position and speed can be changed simultaneously. | 13.5.5 |

| Sub function | | Details | Reference section |
|--|---|---|-------------------|
| Absolute position system | | This function restores the absolute position of designated axis. If the HPR is executed at the start of system, after that, it is unnecessary to carry out the HPR when the power is turned ON. | 13.6 |
| Other functions | Step function | This function temporarily stops the operation to confirm the positioning operation during debugging, etc. The operation can be stopped at each "automatic deceleration" or "positioning data". | 13.7.1 |
| | Skip function | This function stops (decelerates to a stop) the positioning being executed when the skip signal is input, and carries out the next positioning. | 13.7.2 |
| | M code output function | This function issues a command for a sub work (clamp or drill stop, tool change, etc.) corresponding to the M code No. (0 to 65535) that can be set for each positioning data. | 13.7.3 |
| | Teaching function | This function stores the address positioned with manual control into the "[Da.6] Positioning address/movement amount" having the designated positioning data No. ([Cd.39]). | 13.7.4 |
| | Command in-position function | At each automatic deceleration, this function calculates the remaining distance for the Simple Motion module to reach the positioning stop position. When the value is less than the set value, the "command in-position flag" is set to "1". When using another auxiliary work before ending the control, use this function as a trigger for the sub work. | 13.7.5 |
| | Acceleration/deceleration processing function | This function adjusts the acceleration/deceleration. | 13.7.6 |
| | Continuous operation interrupt function | This function interrupts continuous operation. When this request is accepted, the operation stops when the execution of the current positioning data is completed. | 6.5.4 |
| | Pre-reading start function | This function shortens the virtual start time. | 13.7.7 |
| | Deceleration start flag function | Function that turns ON the flag when the constant speed status or acceleration status switches to the deceleration status during position control, whose operation pattern is "Positioning complete", to make the stop timing known. | 13.7.8 |
| | Stop command processing for deceleration stop function | Function that selects a deceleration curve when a stop cause occurs during deceleration stop processing to speed 0. | 13.7.9 |
| Follow up function | This function monitors the motor rotation amount with the servo turned OFF, and reflects it on the feed current value. | 13.8.2 | |
| Speed control 10 x multiplier setting for degree axis function | This function is executed the positioning control by the 10 x speed of the command speed and the speed limit value when the setting unit is "degree". | 13.7.10 | |
| Operation setting for incompleteness of HPR function | This function is provided to select whether positioning control is operated or not, when HPR request flag is ON. | 13.7.11 | |

* 1: The near pass function is featured as standard and is valid only for setting continuous path control for position control. It cannot be set to be invalid with parameters.

3.2.4 QD77GF common functions

The outline of the functions executed as necessary is described below.
(Refer to "Section 2" for details on each function.)

| Common functions | Details | Reference section |
|--|---|-------------------|
| Parameter initialization function | This function returns the "parameters" stored in the buffer memory/internal memory and flash ROM/internal memory (nonvolatile) of Simple Motion module to the default values. The following two methods can be used. 1) Method using sequence program 2) Method using GX Works2 | 14.2 |
| Execution data backup function | This function stores the "setting data", currently being executed, into the flash ROM/internal memory (nonvolatile). 1) Method using sequence program 2) Method using GX Works2 | 14.3 |
| External signal selection function | This function selects from the following signals when using the upper/lower limit signal and the proximity dog signal. • External input signal of servo amplifier • External input signal via CPU (buffer memory of QD77GF) | 14.4 |
| External I/O signal logic switching function | This function switches I/O signal logic according to externally connected devices. This function enables the use of the system that does not use b (N.C.)-contact signals, such as Upper/lower limit signal, by setting parameters to positive logic. | 14.5 |
| History monitor function | This function monitors errors, warnings, and start history of all axes. | 14.6 |
| Virtual servo amplifier function | This function executes the operation as the axis (virtual servo amplifier axis) that operates only command (instruction) virtually without servo amplifiers. | 14.7 |
| Mark detection function | This function is used to latch any data at the input timing of the mark detection signal (DI1 to DI4). | 14.8 |
| Module error collection function | This function collects errors occurred in the Simple Motion module in the PLC CPU. Holding the error contents in the PLC CPU, this function enables to check the error history even after the PLC CPU in powered off or reset. | 14.9 |

3.2.5 Combination of QD77GF main functions and sub functions

With positioning control using the Simple Motion module, the main functions and sub functions can be combined and used as necessary. A list of the main function and sub function combinations is given below.

| Main functions | | Sub functions | Combination with operation pattern.*1 | Functions characteristic to machine HPR | | Functions that compensate control | | |
|---------------------------|-----------------------------------|---|---|---|----------------------|-----------------------------------|--------------------------|--------------------|
| | | | | HPR retry function*13 | HP shift function*13 | Backlash compensation function | Electronic gear function | Near pass function |
| HPR control | Machine HPR control | | × | △*11 | ○ | ○ | ○ | |
| | Fast HPR control | | × | × | × | ○ | ○ | |
| Major positioning control | Position control | 1-axis linear control | ○ | × | × | ○ | ○ | *2 |
| | | 2-, 3-, or 4-axis linear interpolation control | ○ | × | × | ○ | ○ | |
| | | 1-axis fixed-feed control (Continuous path control cannot be set) | △ | × | × | ○ | ○ | |
| | | 2-, 3-, or 4-axis fixed-feed control (interpolation) (Continuous path control cannot be set) | △ | × | × | ○ | ○ | |
| | | 2-axis circular interpolation control | ○ | × | × | ○ | ○ | |
| | Speed control (1- to 4-axis) | | △ (Only independent positioning control can be set) | × | × | ○ | ○ | |
| | Speed-position switching control | | △ (Continuous path control cannot be set) | × | × | ○ | ○ | |
| | Position-speed switching control | | △ (Only independent positioning control can be set) | × | × | ○ | ○ | |
| | Other control | Current value changing | △ (Continuous path control cannot be set) | × | × | × | × | |
| | | NOP instruction | × | × | × | × | × | |
| JUMP instruction | | × | × | × | × | × | | |
| LOOP to LEND | | × | × | × | × | × | | |
| Manual control | JOG operation, inching operation | × | × | × | ○ | ○ | × | |
| | Manual pulse generator operation | × | × | × | ○ | ○ | × | |
| Expansion control | Speed-torque control | × | × | × | × | ○ | × | |
| | Synchronous control (Output axis) | × | × | × | ○ | ○ | × | |

- *1: The operation pattern is one of the "positioning data" setting items.
- *2: The near pass function is featured as standard and is valid only for setting continuous path control for position control.
- *3: Invalid during creep speed.
- *4: Invalid during continuous path control.
- *5: Combination with the inching operation is not available. (Inching operation does not perform acceleration/deceleration processing.)
- *6: Valid for the reference axis only.
- *7: Valid for only the case where a deceleration start is made during position control.
- *8: Change the current value using the positioning data. Disabled for a start of positioning start No. 9003.
- *9: Valid for "[Md.22] Feedrate" and "[Md.28] Axis feedrate".
- *10: Valid for a start of positioning start No.9003, but invalid for a start of positioning data (No. 1 to 600).
- *11: HPR retry function cannot be used during the scale origin signal detection method machine HPR.
- *12: Refer to Section 12.1 "Speed-torque control" for acceleration/deceleration processing in the speed-torque control.

| | Functions that limit control | | | | | Functions that change control details | | | | | Other functions | | | | | | | | | | |
|--|------------------------------|-----------------------|--------------------------------|--------------------------------|----------------------|---------------------------------------|-------------------|---|------------------------|---------------------------------|-----------------|---------------|------------------------|-------------------|------------------------------|---|----------------------------|----------------------------------|--|--|--|
| | Speed limit function | Torque limit function | Software stroke limit function | Hardware stroke limit function | Forced stop function | Speed change function | Override function | Acceleration/ deceleration time change function | Torque change function | Target position change function | Step function | Skip function | M code output function | Teaching function | Command in-position function | Acceleration/deceleration processing function | Pre-reading start function | Deceleration start flag function | Stop command processing for deceleration stop function | Speed control 10 x multiplier setting for degree axis function | Operation setting for incompleteness of HPR function |
| | ○ | ○ | × | ⊙ | ○ | △ ^{*3} | △ ^{*3} | △ ^{*3} | ○ | × | × | × | × | × | ○ | × | × | ○ | ○ | ○ | × |
| | ○ | ○ | × | ⊙ | ○ | ○ | ○ | ○ | ○ | × | × | × | × | × | ○ | ○ | × | × | ○ | ○ | × |
| | ○ | ○ | ○ | ⊙ | ○ | ○ | ○ | ○ | ○ | △ ^{*4} | ○ | ○ | ○ | × | ○ | ○ | ○ | ○ | ○ | ○ | ○ |
| | ○ | ○ | ○ | ⊙ | ○ | ○ | ○ | ○ | ○ | × | ○ | ○ | ○ | × | ○ | ○ | ○ | ○ | ○ | ○ | ○ |
| | ○ | ○ | ○ | ⊙ | ○ | ○ | ○ | ○ | ○ | × | ○ | ○ | ○ | × | ○ | ○ | ○ | △ ⁺⁶ | ○ | ○ | ○ |
| | ○ | ○ | ○ | ⊙ | ○ | ○ | ○ | ○ | ○ | × | ○ | ○ | ○ | × | ○ | ○ | ○ | △ ⁺⁶ | ○ | ○ | ○ |
| | ○ | ○ | ○ | ⊙ | ○ | ○ | ○ | ○ | ○ | × | ○ | ○ | ○ | × | ○ | ○ | ○ | × | ○ | × | ○ |
| | ○ | ○ | ○ | ⊙ | ○ | ○ | ○ | ○ | ○ | × | × | ○ | × | × | ○ | ○ | ○ | × | ○ | ○ | ○ |
| | ○ | ○ | ○ | ⊙ | ○ | ○ | ○ | ○ | ○ | × | ○ | ○ | ○ | × | ○ | ○ | ○ | △ ⁺⁷ | ○ | ○ | ○ |
| | × | × | ○ | ⊙ | ○ | × | × | × | × | × | ○ | ○ | △ ⁺⁸ | × | × | × | × | × | × | × | △ ⁺¹⁰ |
| | | | × | × | | | | | | | | | | | | | | | | | × |
| | × | × | × | × | ○ | × | × | × | × | × | × | × | × | × | × | × | × | × | × | × | × |
| | ○ | ○ | ○ | ⊙ | ○ | △ ⁺⁵ | △ ⁺⁵ | △ ⁺⁵ | ○ | × | × | × | × | ○ | × | △ ⁺⁵ | × | × | × | ○ | × |
| | × | ○ | ○ | ⊙ | ○ | × | × | × | ○ | × | × | × | ○ | × | × | × | × | × | × | △ ⁺⁹ | × |
| | ○ | ○ | ○ | ⊙ | ○ | × | × | × | ○ | × | × | × | × | × | △ ⁺¹² | × | × | × | × | ○ | ○ |
| | × | ○ | ○ | ⊙ | ○ | × | × | × | ○ | × | × | × | × | × | △ ⁺¹⁴ | × | × | × | × | △ ⁺¹⁴ | ○ |

⊙: Always combine, ○: Combination possible, △: Combination limited, ×: Combination not possible

*13: It is available only in MR-J4-B-RJ010 communication mode.

*14: Refer to "MELSEC-Q/L QD77MS/QD77GF/LD77MS/LD77MH Simple Motion Module User's Manual (Synchronous Control)" for details.

3.3 Specifications of input/output signals with PLC CPU

3.3.1 List of input/output signals with PLC CPU

The Simple Motion module uses 32 input points and 32 output points for exchanging data with the PLC CPU.

The input/output signals when the head I/O number of Simple Motion module is set to "0H" are shown below.

If it is set to other than "0H", change the I/O number according to setting of head I/O number.

Device X refers to the signals input from the Simple Motion module to the PLC CPU, and device Y refers to the signals output from the PLC CPU to the Simple Motion module.

| Signal direction: Simple Motion module → PLC CPU | | Signal direction: PLC CPU → Simple Motion module | |
|--|----------------------|--|-------------------|
| Device No. | Signal name | Device No. | Signal name |
| X0 | READY | Y0 | PLC READY |
| X1 | Synchronization flag | Y1 | All axis servo ON |
| X2 | Use prohibited | Y2 | Use prohibited |
| X3 | | Y3 | |
| X4 | | Y4 | |
| X5 | | Y5 | |
| X6 | | Y6 | |
| X7 | | Y7 | |
| X8 | | Y8 | |
| X9 | | Y9 | |
| XA | | YA | |
| XB | | YB | |
| XC | | YC | |
| XD | | YD | |
| XE | | YE | |
| XF | | Module READY | |
| X10 | Axis 1 | Y10 | Axis 1 |
| X11 | Axis 2 | Y11 | Axis 2 |
| X12 | Axis 3 | Y12 | Axis 3 |
| X13 | Axis 4 | Y13 | Axis 4 |
| X14 | Axis 5 | Y14 | Axis 5 |
| X15 | Axis 6 | Y15 | Axis 6 |
| X16 | Axis 7 | Y16 | Axis 7 |
| X17 | Axis 8 | Y17 | Axis 8 |
| X18 | Axis 9 | Y18 | Axis 9 |
| X19 | Axis 10 | Y19 | Axis 10 |
| X1A | Axis 11 | Y1A | Axis 11 |
| X1B | Axis 12 | Y1B | Axis 12 |
| X1C | Axis 13 | Y1C | Axis 13 |
| X1D | Axis 14 | Y1D | Axis 14 |
| X1E | Axis 15 | Y1E | Axis 15 |
| X1F | Axis 16 | Y1F | Axis 16 |

Important
 [Y2 to YF] and [X2 to XE] are used by the system, and cannot be used by the user.
 If these devices are used, the operation of the Simple Motion module will not be guaranteed.

3.3.2 Details of input signals (Simple Motion module → PLC CPU)

The ON/OFF timing and conditions of the input signals are shown below.

| Device No. | Signal name | Details |
|------------|----------------------|--|
| X0 | READY | <p>ON: READY OFF: Not READY/ Watch dog timer error</p> <ul style="list-style-type: none"> When the PLC READY signal [Y0] turns from OFF to ON, the parameter setting range is checked. If no error is found, this signal turns ON. When the PLC READY signal [Y0] turns OFF, this signal turns OFF. When watch dog timer error occurs, this signal turns OFF. This signal is used for interlock in a sequence program, etc. |
| X1 | Synchronization flag | <p>OFF: Module access disabled ON: Module access enabled</p> <ul style="list-style-type: none"> After the PLC is turned ON or the CPU module is reset, this signal turns ON if the access from the CPU module to the Simple Motion module is possible. When "Asynchronous" is selected in the module synchronization setting of the CPU module, this signal can be used as interlock for the access from a sequence program to the Simple Motion module. |
| XF | Module READY | <p>OFF: Module operation disabled ON: Module operation enabled</p> <p>[Normal]</p> <p>[Error]</p> |

| Device No. | Signal name | | Details |
|------------|-------------|--|---|
| X10 | Axis 1 | BUSY (Note-1) OFF: Not BUSY ON: BUSY | <ul style="list-style-type: none"> • This signal turns ON at the start of positioning, HPR or JOG operation. It turns OFF when the "[Da.9] Dwell time/JUMP destination positioning data No." has passed after positioning stops. (This signal remains ON during positioning.) • This signal turns OFF when the positioning is stopped with step operation. • During manual pulse generator operation, this signal turns ON while the "[Cd.21] Manual pulse generator enable flag" is ON. • This signal turns OFF at error completion or positioning stop. |
| X11 | Axis 2 | | |
| X12 | Axis 3 | | |
| X13 | Axis 4 | | |
| X14 | Axis 5 | | |
| X15 | Axis 6 | | |
| X16 | Axis 7 | | |
| X17 | Axis 8 | | |
| X18 | Axis 9 | | |
| X19 | Axis 10 | | |
| X1A | Axis 11 | | |
| X1B | Axis 12 | | |
| X1C | Axis 13 | | |
| X1D | Axis 14 | | |
| X1E | Axis 15 | | |
| X1F | Axis 16 | | |

| | |
|------------------|--|
| Important | (Note-1): The BUSY signal turns ON even when position control of movement amount 0 is executed. However, since the ON time is short, the ON status may not to be detected in the sequence program. |
|------------------|--|

3.3.3 Details of output signals (PLC CPU → Simple Motion module)

The ON/OFF timing and conditions of the output signals are shown below.

| Device No. | Signal name | | Details |
|--|---|-------------------|--|
| Y0 | PLC READY | | OFF: PLC READY OFF ON: PLC READY ON (a) This signal notifies the Simple Motion module that the PLC CPU is normal. <ul style="list-style-type: none"> • It is turned ON/OFF with the sequence program. • This signal is turned ON during positioning control, HPR control, JOG operation, inching operation, manual pulse generator operation and speed-torque control, etc. unless the system is in the GX Works2 test function. (b) When the data (parameter etc.) are changed, this signal is turned OFF depending on the parameter (Refer to Chapter 7.). (c) The following processes are carried out when this signal turns from OFF to ON. <ul style="list-style-type: none"> • The parameter setting range is checked. • The READY signal [X0] turns ON. (d) The following processes are carried out when this signal turns from ON to OFF. <p>In these cases, the OFF time should be set to 100ms or more.</p> <ul style="list-style-type: none"> • The READY signal [X0] turns OFF. • The operating axis stops. • The M code ON signal ([Md.31] Status: b12) for each axis turns OFF, and "0" is stored in "[Md.25] Valid M code". (e) When parameters or positioning data (No. 1 to 600) are written from the GX Works2 or PLC CPU to the flash ROM, this signal will turn OFF. |
| Y1 | All axis servo ON | | OFF: Servo OFF ON: Servo ON • All the servo amplifiers connected to the Simple Motion module are set to servo ON or servo OFF. |
| Y10 Y11 Y12 Y13 Y14 Y15 Y16 Y17 Y18 Y19 Y1A Y1B Y1C Y1D Y1E Y1F | Axis 1 Axis 2 Axis 3 Axis 4 Axis 5 Axis 6 Axis 7 Axis 8 Axis 9 Axis 10 Axis 11 Axis 12 Axis 13 Axis 14 Axis 15 Axis 16 | Positioning start | OFF: Positioning start not requested ON: Positioning start requested • HPR operation or positioning operation is started. • The positioning start signal is valid at the rising edge, and the operation is started. • When this signal turns ON during BUSY, the warning "Start during operation" (warning code: 100) will occur. |

3.4 Specifications of interfaces with external devices

3.4.1 Electrical specifications of input signals

(1) External command

(a) Specifications of external command signal/switching signal

| Item | | Specifications |
|--|-----------|---|
| Number of input points | | 4 points |
| Input method | | Positive common/Negative common shared |
| Common terminal arrangement | | 4 points/common (Common contact: COM) |
| Isolation method | | Photocoupler |
| Rated input voltage | | 24VDC |
| Rated input current (I _{IN}) | | Approx. 5mA |
| Operating voltage range | | 21.6 to 26.4VDC (24VDC±10%, ripple ratio 5% or less) |
| ON voltage/current | | 17.5VDC or more/3.5mA or more |
| OFF voltage/current | | 5VDC or less/0.9mA or less |
| Input resistance | | Approx. 5.6kΩ |
| Response time | OFF to ON | 1ms or less |
| | ON to OFF | |
| Recommended wire size | | AWG24 (0.2mm ²) |

(2) Forced stop input

(a) Specifications of forced stop input signal

| Item | | Specifications |
|--|-----------|---|
| Number of input points | | 1 point |
| Input method | | Positive common/Negative common shared |
| Common terminal arrangement | | 1 point/common (Common contact: EMI.COM) |
| Isolation method | | Photocoupler |
| Rated input voltage | | 24VDC |
| Rated input current (I _{IN}) | | Approx. 2.4mA |
| Operating voltage range | | 20.4 to 26.4VDC (24VDC+10/-15%, ripple ratio 5% or less) |
| ON voltage/current | | 17.5VDC or more/2.0mA or more |
| OFF voltage/current | | 1.8VDC or less/0.18mA or less |
| Input resistance | | Approx. 10kΩ |
| Response time | OFF to ON | 1ms or less |
| | ON to OFF | |
| Recommended wire size | | AWG24 (0.2mm ²) |

(3) Manual pulse generator/Incremental synchronous encoder input

(a) Specifications of manual pulse generator/incremental synchronous encoder

| Item | | Specifications |
|--|---------------------------------|--|
| Signal input form (Note-1) | | Phase A/Phase B (Magnification by 4/ Magnification by 2/Magnification by 1), PLS/SIGN |
| Differential-output type (26LS31 or equivalent) | Maximum input pulse frequency | 1Mpps (After magnification by 4, up to 4Mpps) (Note-2) |
| | Pulse width | 1μs or more |
| | Leading edge/trailing edge time | 0.25μs or less |
| | Phase difference | 0.25μs or more |
| | Rated input voltage | 5.5VDC or less |
| | High-voltage | 2.0 to 5.25VDC |
| | Low-voltage | 0 to 0.8VDC |
| | Differential voltage | ±0.2V |
| | Cable length | Up to 30m (98.43ft.) |
| | Example of waveform | <p>(Note): Duty ratio 50%</p> |
| Voltage-output type/Open-collector type (5VDC) | Maximum input pulse frequency | 200kpps (After magnification by 4, up to 800kpps) (Note-2) |
| | Pulse width | 5μs or more |
| | Leading edge/trailing edge time | 1.2μs or less |
| | Phase difference | 1.2μs or more |
| | Rated input voltage | 5.5VDC or less |
| | High-voltage | 3.0 to 5.25VDC/2mA or less |
| | Low-voltage | 0 to 1.0VDC/5mA or more |
| | Cable length | Up to 10m (32.81ft.) |
| | Example of waveform | <p>(Note): Duty ratio 50%</p> |

(Note-1): Set the signal input form in "[Pr.24] Manual pulse generator/Incremental synchronous encoder input selection".

| [Pr.24] Manual pulse generator/ Incremental synchronous encoder input selection | [Pr.22] Input signal logic selection | | | |
|---|--------------------------------------|-------------|----------------|-------------|
| | Positive logic | | Negative logic | |
| | Forward run | Reverse run | Forward run | Reverse run |
| Phase A/Phase B | | | | |
| PLS/SIGN | | | | |

(Note-2): Maximum input pulse frequency is magnified by 4, when "A-phase/B-phase Magnification by 4" is set in "[Pr.24] Manual pulse generator/Incremental synchronous encoder input selection".

3.4.2 Signal layout for external input connection connector

The specifications of the connector section, which is the input/output interface for the Simple Motion module and external device, are shown below.

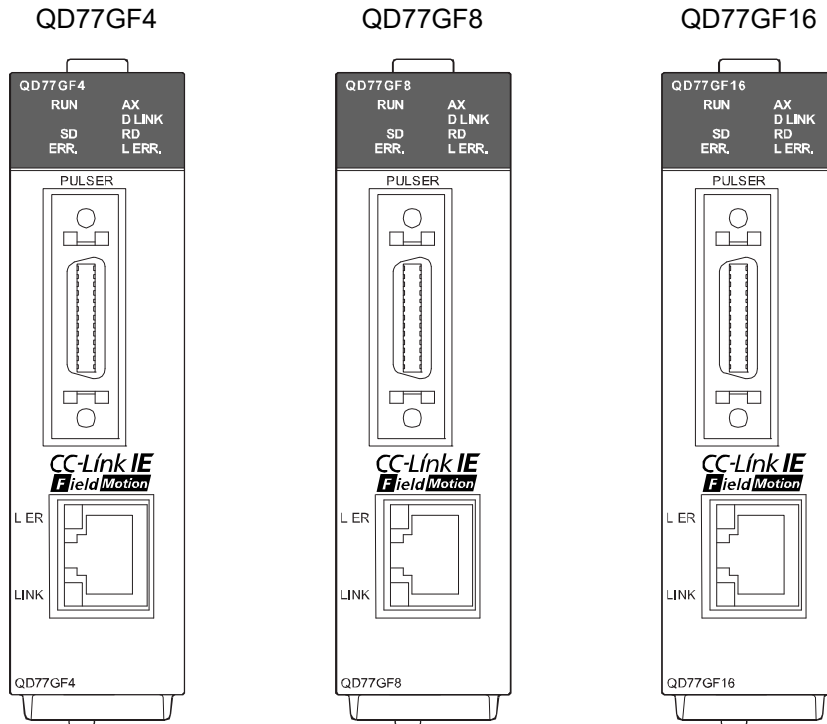

The signal layout for the external input connection connector of Simple Motion module is shown.

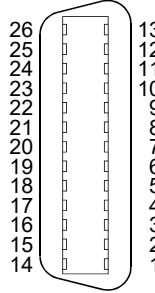
| Pin layout | Pin No. | Signal name | Pin No. | Signal name |
|---|---------|----------------------------------|---------|----------------------------------|
|  <p>Front view of the module</p> | 1 | 5V (Note-8) | 14 | 5V (Note-8) |
| | 2 | SG (Note-8) | 15 | SG (Note-8) |
| | 3 | HA (Note-1), (Note-2), (Note-3) | 16 | HB (Note-1), (Note-2), (Note-3) |
| | 4 | HAH (Note-1), (Note-2), (Note-4) | 17 | HBH (Note-1), (Note-2), (Note-4) |
| | 5 | HAL (Note-1), (Note-2), (Note-4) | 18 | HBL (Note-1), (Note-2), (Note-4) |
| | 6 | No connect (Note-5) | 19 | No connect (Note-5) |
| | 7 | | 20 | |
| | 8 | | 21 | |
| | 9 | | 22 | |
| | 10 | EMI | 23 | EMI.COM |
| | 11 | DI1 (Note-6) | 24 | DI2 (Note-6) |
| | 12 | DI3 (Note-6) | 25 | DI4 (Note-6) |
| | 13 | COM (Note-7) | 26 | COM (Note-7) |

(Note-1): Input type from manual pulse generator/incremental synchronous encoder is switched in "[Pr.89] Manual pulse generator/Incremental synchronous encoder input type selection". (Only the value specified against the axis 1 is valid.)

- 0: Differential-output type
- 1: Voltage-output/open-collector type (Default value)

(Note-2): Set the signal input form in "[Pr.24] Manual pulse generator/Incremental synchronous encoder input selection".

(Note-3): Voltage-output/open-collector type
Connect the A-phase/PLS signal to HA, and the B-phase/SIGN signal to HB.

(Note-4): Differential-output type
Connect the A-phase/PLS signal to HAH, and the A-phase/PLS inverse signal to HAL.
Connect the B-phase/SIGN signal to HBH, and the B-phase/SIGN inverse signal to HBL.

(Note-5): Do not connect to any of the terminal explained as "No connect".

(Note-6): Set the external command signal [DI] in "[Pr.95] External command signal selection".

(Note-7): "COM" is the common terminal of DI1, DI2, DI3 and DI4.

(Note-8): Do not use 1, 2, 14 and 15 for other than the power supply of manual pulse generator.
Note that 2 and 15 are also used for the pulse signal ground of the manual pulse generator/incremental synchronous encoder A-phase and B-phase.

3.4.3 List of input signal details

The details of each external input connection connector of Simple Motion module are shown below.

| Signal name | | Pin No. | Signal details |
|---|---|----------|----------------|
| Differential-output type | Manual pulse generator/Incremental synchronous encoder A phase/PLS | HAH (A+) | 4 |
| | | HAL (A-) | 5 |
| | Manual pulse generator/Incremental synchronous encoder B phase/SIGN | HBH (B+) | 17 |
| | | HBL (B-) | 18 |
| Voltage-output type/open-collector type | Manual pulse generator/Incremental synchronous encoder A phase/PLS | HA (A) | 3 |
| | Manual pulse generator/Incremental synchronous encoder B phase/SIGN | HB (B) | 16 |

(1) Phase A/Phase B

- Input the pulse signal from the manual pulse generator/incremental synchronous encoder A phase and B phase.
- If the A phase leads the B phase, the positioning address will increase at the rising and falling edges of each phase.
- If the B phase leads the A phase, the positioning address will decrease at the rising and falling edges of each phase.

(a) Magnification by 4

[When increased]

Positioning address: +1 +1 +1 +1 +1 +1 +1 +1

[When decreased]

Positioning address: -1 -1 -1 -1 -1 -1 -1 -1

(b) Magnification by 2

[When increased]

Positioning address: +1 +1 +1 +1 +1 +1 +1 +1

[When decreased]

Positioning address: -1 -1 -1 -1 -1 -1 -1 -1

(c) Magnification by 1

1) Positive logic

[When increased]

Positioning address: +1 +1 +1 +1

[When decreased]

Positioning address: -1 -1 -1 -1

2) Negative logic

[When increased]

Positioning address: +1 +1 +1 +1

[When decreased]

Positioning address: -1 -1 -1 -1

| Signal name | | Pin No. | Signal details |
|--|---|----------|--|
| Differential-output type | Manual pulse generator/Incremental synchronous encoder A phase/PLS | HAH (A+) | 4 |
| | | HAL (A-) | 5 |
| | Manual pulse generator/Incremental synchronous encoder B phase/SIGN | HBH (B+) | 17 |
| | | HBL (B-) | 18 |
| Voltage-output type/open-collector type | Manual pulse generator/Incremental synchronous encoder A phase/PLS | HA (A) | 3 |
| | Manual pulse generator/Incremental synchronous encoder B phase/SIGN | HB (B) | 16 |
| External command/ Switching signal | (D11) | 11 | <ul style="list-style-type: none"> Input a control switching signal during speed-position or position-speed switching control. Use this signal as the input signal of positioning start, speed change request, skip request and mark detection from an external device. Set the function to use this signal in "[Pr.42] External command function selection". (Note): Set the signal in "[Pr.95] External command signal selection". |
| | (D12) | 24 | |
| | (D13) | 12 | |
| | (D14) | 25 | |
| Common (COM) | | 13 26 | <ul style="list-style-type: none"> Common for external command/switching signals. |
| Forced stop input signal (EMI) | | 10 | <ul style="list-style-type: none"> This signal is input when batch forced stop is available for all axes of servo amplifier. |
| Forced stop input signal common (EMI.COM) | | 23 | EMI ON (Opened) : Forced stop EMI OFF (24VDC input) : Forced stop release |
| Manual pulse generator power supply output (+ 5VDC) (5V) | | 1 14 | <ul style="list-style-type: none"> Power supply for manual pulse generator. (+ 5VDC) (Note): This power supply is used for manual pulse generator. It must not be used except for the manual pulse generator power supply. |
| Manual pulse generator power supply output (GND) (SG) | | 2 15 | <ul style="list-style-type: none"> Power supply for manual pulse generator. (GND) (Note): This power supply is used for manual pulse generator. It must not be used except for the manual pulse generator power supply. |

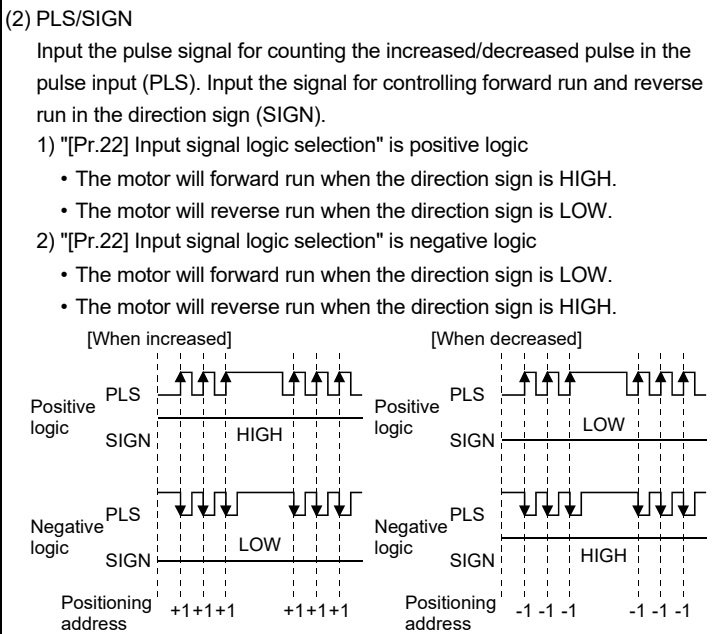

3.4.4 Interface internal circuit

The outline diagrams of the internal circuits for the external device connection interface (for the Simple Motion module, axis 1) are shown below.

(1) Interface between external command signal/switching signal

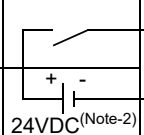
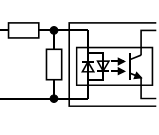
| Input or output | Signal name | | Pin No. | | | | Wiring example | Internal circuit | Description |
|-----------------|-----------------------------|--------------|----------|----|----|----|--|---|---|
| | | | 1 | 2 | 3 | 4 | | | |
| Input | External command/ Switching | DI_ (Note-1) | 11 | 24 | 12 | 25 |  |  | External command signal, Switching signal |
| | | COM | 13 26 | | | | | | |

(Note-1): _=1 to 4

(Note-2): As for the 24VDC sign, both "+" and "-" are possible.

(2) Interface between forced stop input signal

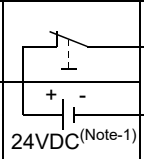
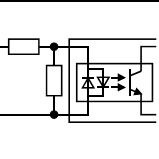
| Input or output | Signal name | | Pin No. | Wiring example | Internal circuit | Description |
|-----------------|-------------------|---------|---------|---|--|--------------------------|
| Input | Forced stop input | EMI | 10 |  |  | Forced stop input signal |
| | | EMI.COM | 23 | | | |

(Note-1): As for the 24VDC sign, both "+" and "-" are possible.

(3) Manual pulse generator/Incremental synchronous encoder input

(a) Interface between manual pulse generator/incremental synchronous encoder (Differential-output type)

| Input or Output | Signal name | | Pin No. | When using the external power supply (Recommended) | | When using the internal power supply | |
|--------------------------------|---------------------------------------|----------|---------|--|------------------|--------------------------------------|------------------|
| | | | | Wiring example | Internal circuit | Wiring example | Internal circuit |
| Input (Note-1), (Note-2) | Manual pulse generator, phase A/ PLS | HAH (A+) | 4 | | | | |
| | | HAL (A-) | 5 | | | | |
| | Manual pulse generator, phase B/ SIGN | HBH (B+) | 17 | | | | |
| | | HBL (B-) | 18 | | | | |
| Power supply | 5V(Note-3) | 14 | | | | | |
| | SG(Note-4) | 2 15 | | | | | |

(Note-1): Set "0: Differential-output type" in "Pr.89 Manual pulse generator/Incremental synchronous encoder input type selection" if the manual pulse generator/Incremental synchronous encoder of differential-output type is used. The default value is "1: Voltage-output/open-collector type".

(Note-2): Set the signal input form in "Pr.24 Manual pulse generator/Incremental synchronous encoder input selection".

(Note-3): The 5VDC power supply from the Simple Motion module must not be used if a separate power supply is applied to the manual pulse generator/incremental synchronous encoder.

If a separate power supply is used, use a stabilized power supply of voltage 5VDC. Anything else may cause a failure.

(Note-4): Be sure to connect the 0 V (-) of the manual pulse generator/incremental synchronous encoder and the SG of the Simple Motion module.

(b) Interface between manual pulse generator/incremental synchronous encoder (Voltage-output/open-collector type)

| Input or Output | Signal name | | Pin No. | When using the external power supply (Recommended) | | When using the internal power supply | |
|--------------------------------|---------------------------------------|--------|---------|--|------------------|--------------------------------------|------------------|
| | | | | Wiring example | Internal circuit | Wiring example | Internal circuit |
| Input (Note-1), (Note-2) | Manual pulse generator, phase A/ PLS | HA (A) | 3 | | | | |
| | Manual pulse generator, phase B/ SIGN | HB (B) | 16 | | | | |
| Power supply | 5V(Note-3) | | 1 14 | | | | |
| | SG(Note-4) | | 2 15 | | | | |

(Note-1): Set "1: Voltage-output/open-collector type" in "[Pr.89] Manual pulse generator/Incremental synchronous encoder input type selection" if the manual pulse generator/Incremental synchronous encoder of voltage-output/open-collector type is used.
The default value is "1: Voltage-output/open-collector type".

(Note-2): Set the signal input form in "[Pr.24] Manual pulse generator/Incremental synchronous encoder input selection".

(Note-3): The 5VDC power supply from the Simple Motion module must not be used if a separate power supply is applied to the manual pulse generator/Incremental synchronous encoder.

If a separate power supply is used, use a stabilized power supply of voltage 5VDC.
Anything else may cause a failure.

(Note-4): Be sure to connect the 0 V (-) of the manual pulse generator/incremental synchronous encoder and the SG of the Simple Motion module.

(4) Wiring example for manual pulse generator/incremental synchronous encoder

Wire the manual pulse generator/incremental synchronous encoder of differential output type and voltage output type/open-collector type as follows.

Switch the input type of the Simple Motion module by "[Pr.89] Manual pulse generator/Incremental synchronous encoder input type selection". It is recommended to use the external 5V power supply (5VDC±5%) for the power supply of the manual pulse generator/incremental synchronous encoder. When using the external power supply, do not connect with the 5V terminal of the Simple Motion module. When using the internal power supply, connect the 5V terminal of the Simple Motion module and the 5V (+) of the manual pulse generator/incremental synchronous encoder.

In either case, connect the 0V (-) of the manual pulse generator/incremental synchronous encoder and the SG of the Simple Motion module. Do not use the 5V terminal of the Simple Motion module except for connecting the manual pulse generator/incremental synchronous encoder. It may cause a failure. Also, do not connect the manual pulse generator/incremental synchronous encoder whose current consumption exceeds 200mA.

(a) Manual pulse generator/Incremental synchronous encoder of differential output type

When using the external power supply (Recommended)

When using the internal power supply

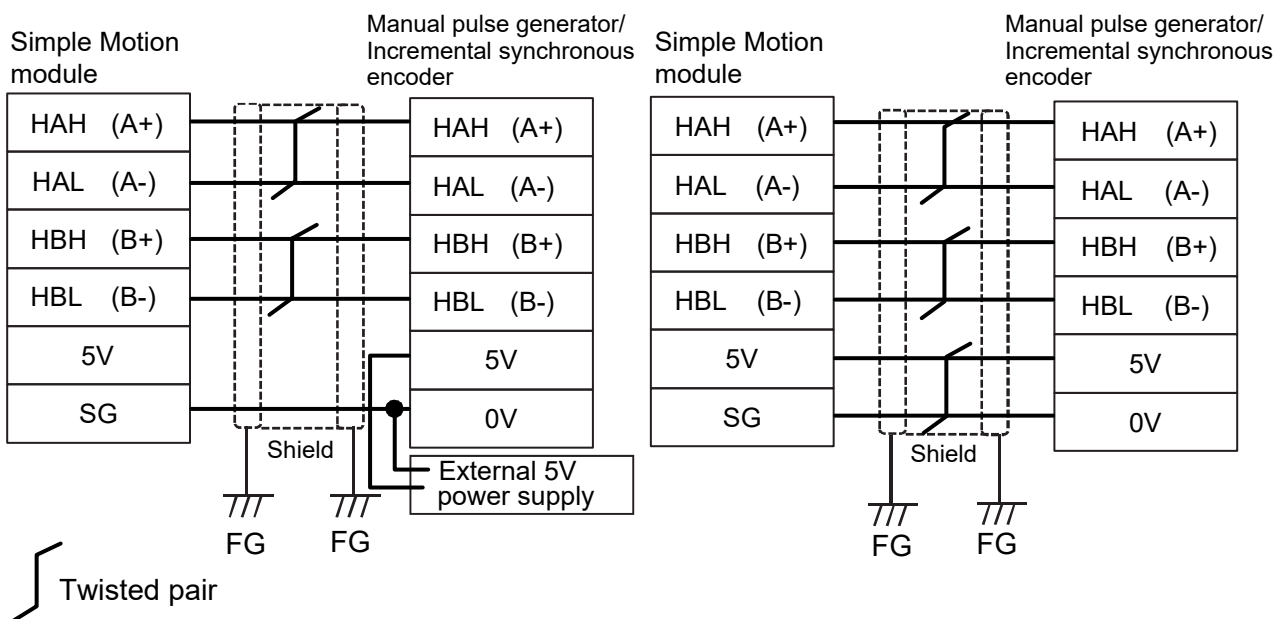

(b) Manual pulse generator/Incremental synchronous encoder of voltage output type/open-collector type

When using the external power supply (Recommended)

When using the internal power supply

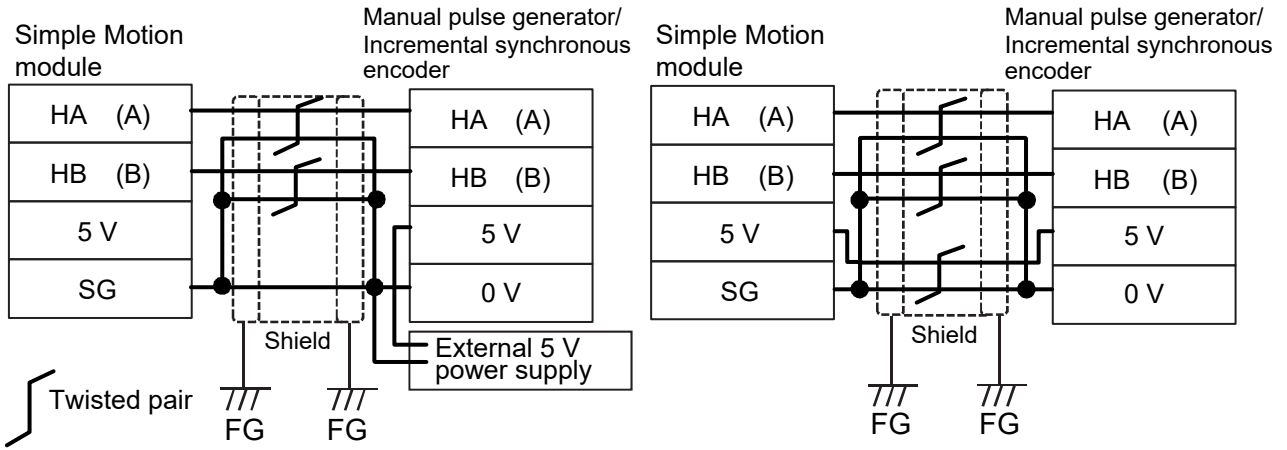

3.5 External circuit design

Configure up the power supply circuit and main circuit which turn off the power supply after detection alarm occurrence and servo forced stop. When designing the main circuit of the power supply, make sure to use a circuit breaker (MCCB).

The outline diagrams for the external device connection interface using the servo amplifier MR-J4-GF are shown below.

(1) Example when using the forced stop of the QD77GF

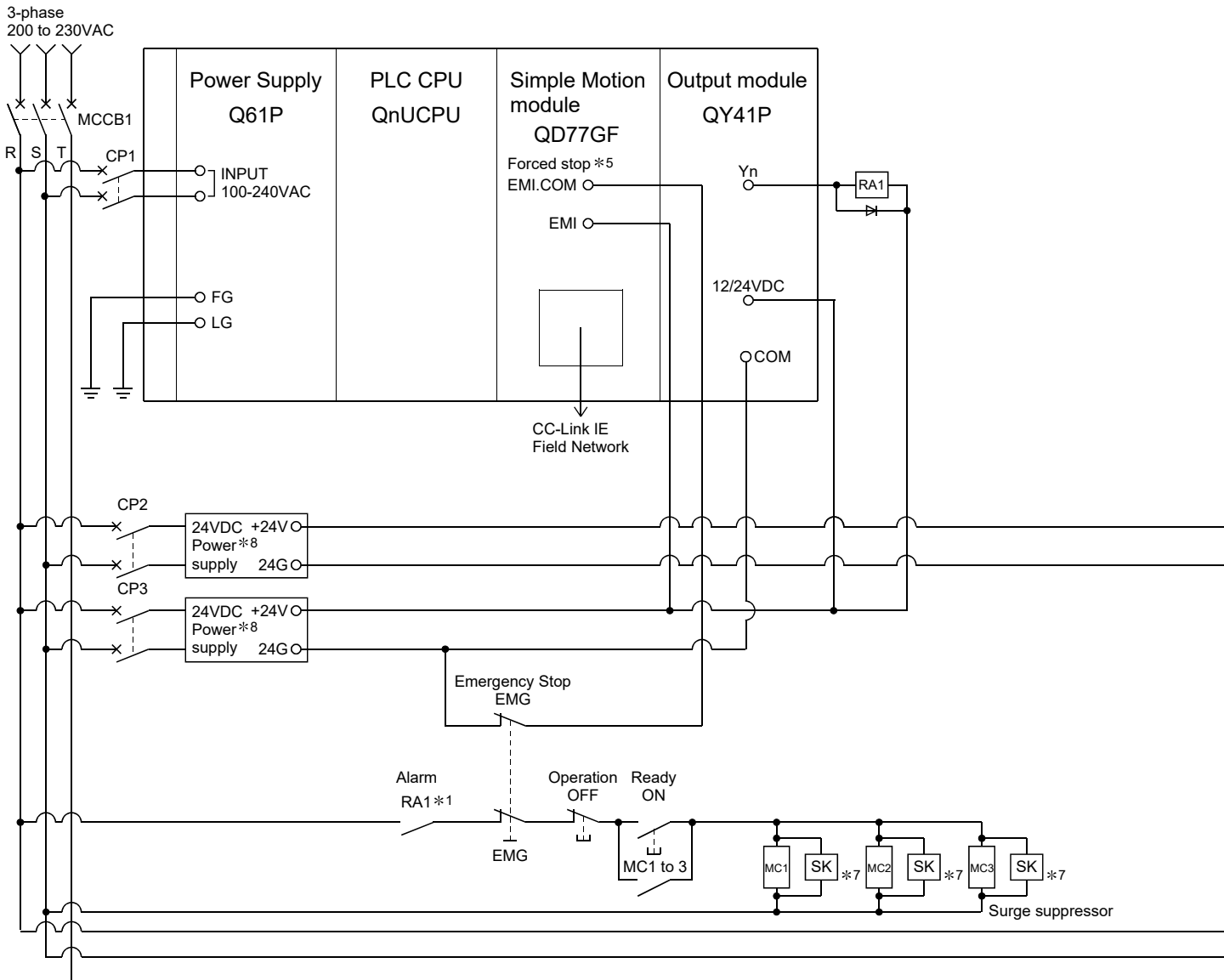

POINT

- (1) *1: Configure up the power supply circuit which switch off the electromagnetic contactor (MC) after detection alarm occurrence on the PLC CPU.
- (2) *2: It is also possible to use a full wave rectified power supply as the power supply for the electromagnetic brake.
- (3) *3: It is also possible to use forced stop signal of the servo amplifier.
- (4) *4: When MR-J4-GF is used, to set the axis number of servo amplifier, set it using the axis select rotary switch of servo amplifier. Refer to the servo amplifier instruction manual for details.
- (5) *5: The status of forced stop input signal can be confirmed with "[Md.50] Forced stop input". Be sure that the forced stop 24VDC power supply is not used with the electromagnetic brake of the motor or the electromagnetic valve power supply.
- (6) *6: Refer to the servo amplifier instruction manual for selection of the circuit breaker and electromagnetic contactor.
- (7) *7: The surge suppressor is recommended to be used for an AC relay or electromagnetic contactor (MC) near the servo amplifier. Refer to the servo amplifier instruction manual for selection of the surge suppressor for wiring.
- (8) *8: Wire the electromagnetic brake power supply and the control power supply using a separate power supply.

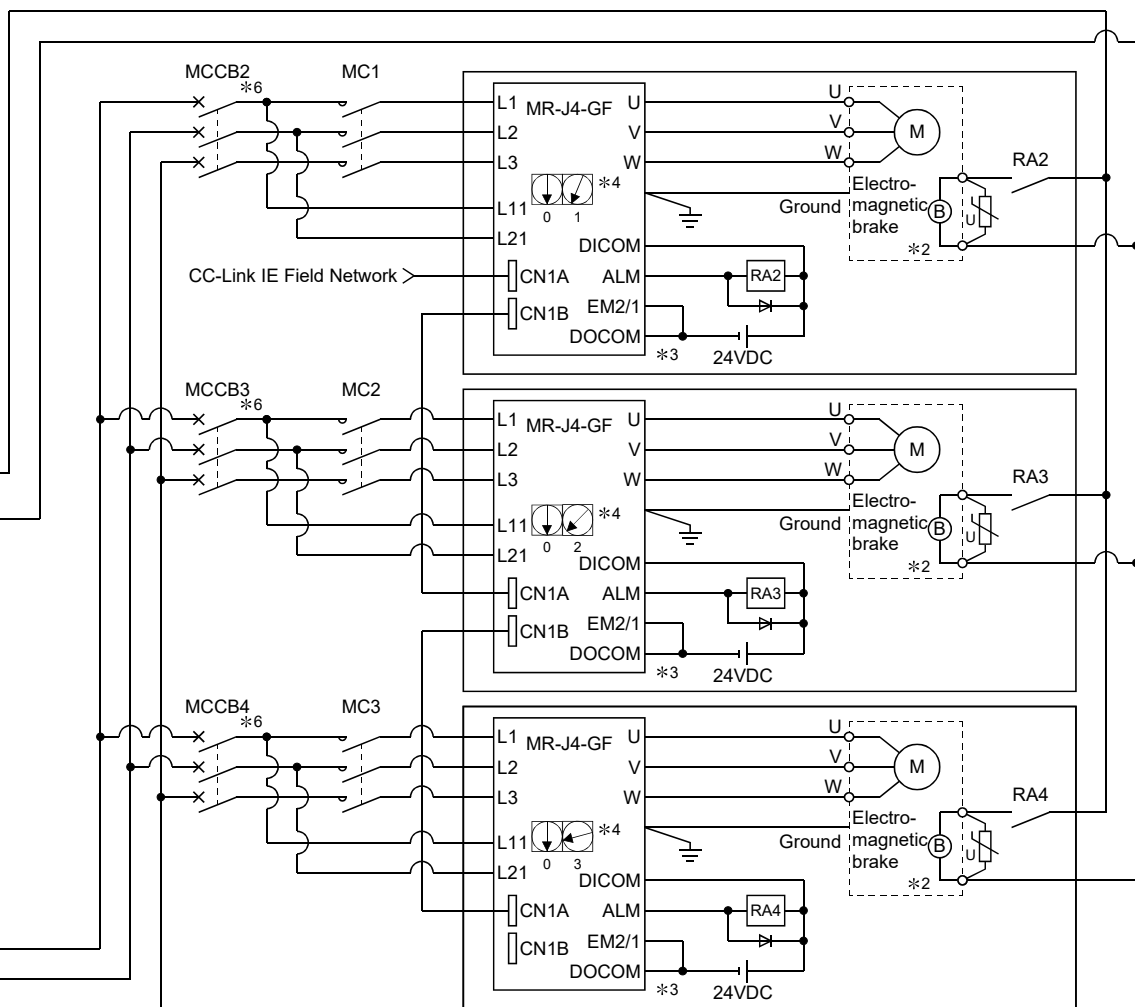

(Note-1): Be sure to shut off the both of main circuit power supply L1/L2/L3 and control power supply L11/L21 after disconnection of CC-Link IE Field Network communication at the time of exchange of servo amplifier. At this time, it is not possible to communicate between the servo amplifier and Simple Motion module. Therefore, be sure to exchange the servo amplifier after stopping the operating of machine beforehand.

(Note-2): If the emergency stop signal of Simple Motion module turns OFF when setting of "[Pr.82] Forced stop valid/invalid selection" to "0: Valid", servomotor is stopped with dynamic brake. (The LED display of servo amplifier indicates "E7.1" (Controller forced stop input warning).)

(2) Example when using the forced stop of the QD77GF and MR-J4-GF

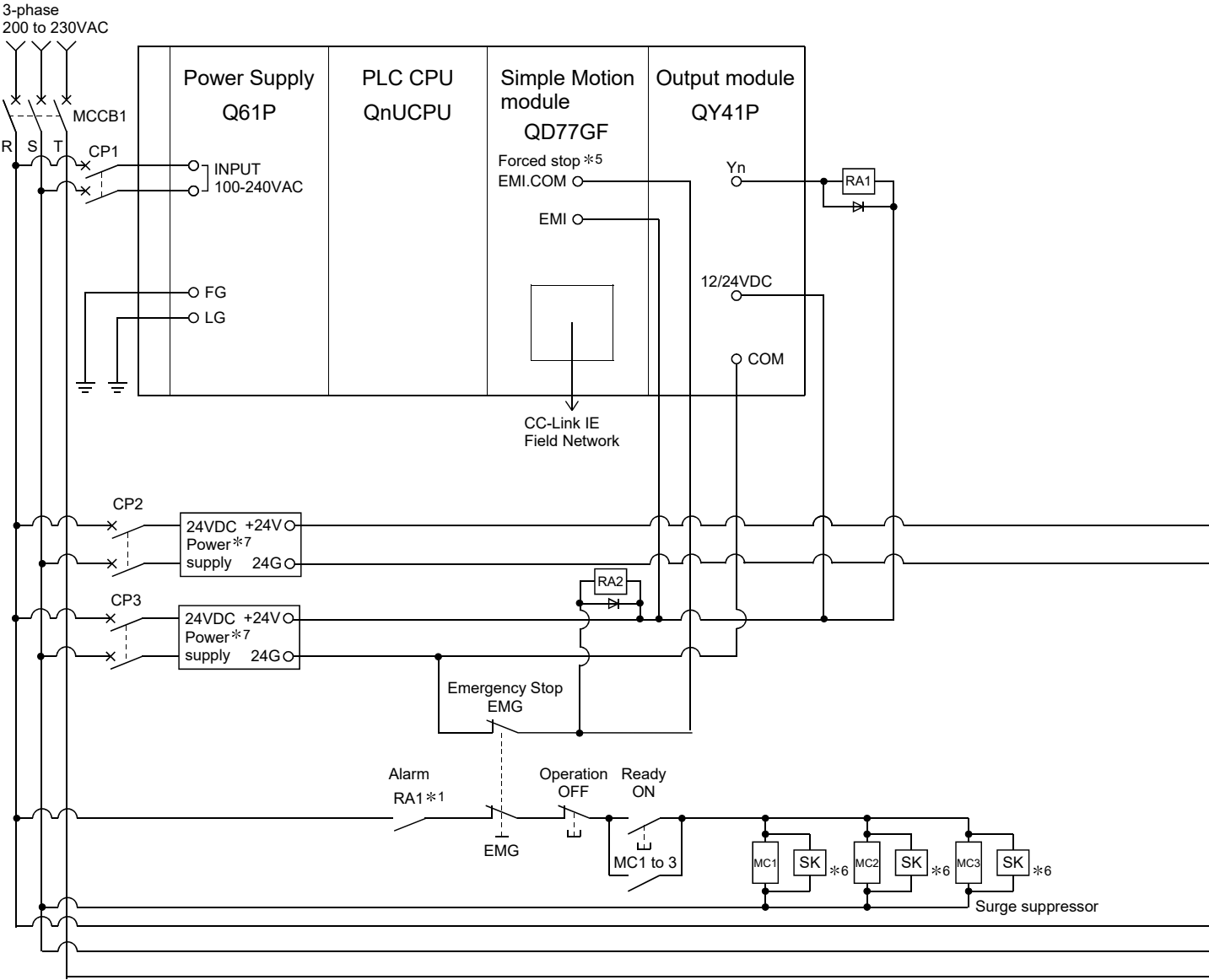

POINT

- (1) *1: Configure up the power supply circuit which switch off the electromagnetic contactor (MC) after detection alarm occurrence on the PLC CPU.
- (2) *2: It is also possible to use a full wave rectified power supply as the power supply for the electromagnetic brake.
- (3) *3: When MR-J4-GF is used, to set the axis number of servo amplifier, set it using the axis select rotary switch of servo amplifier. Refer to the servo amplifier instruction manual for details.
- (4) *4: Refer to the servo amplifier instruction manual for selection of the circuit breaker and electromagnetic contactor.
- (5) *5: The status of forced stop input signal can be confirmed with "[Md.50] Forced stop input". Be sure that the forced stop 24VDC power supply is not used with the electromagnetic brake of the motor or the electromagnetic valve power supply.
- (6) *6: The surge suppressor is recommended to be used for an AC relay or electromagnetic contactor (MC) near the servo amplifier. Refer to the servo amplifier instruction manual for selection of the surge suppressor for wiring.
- (7) *7: Wire the electromagnetic brake power supply and the control power supply using a separate power supply.

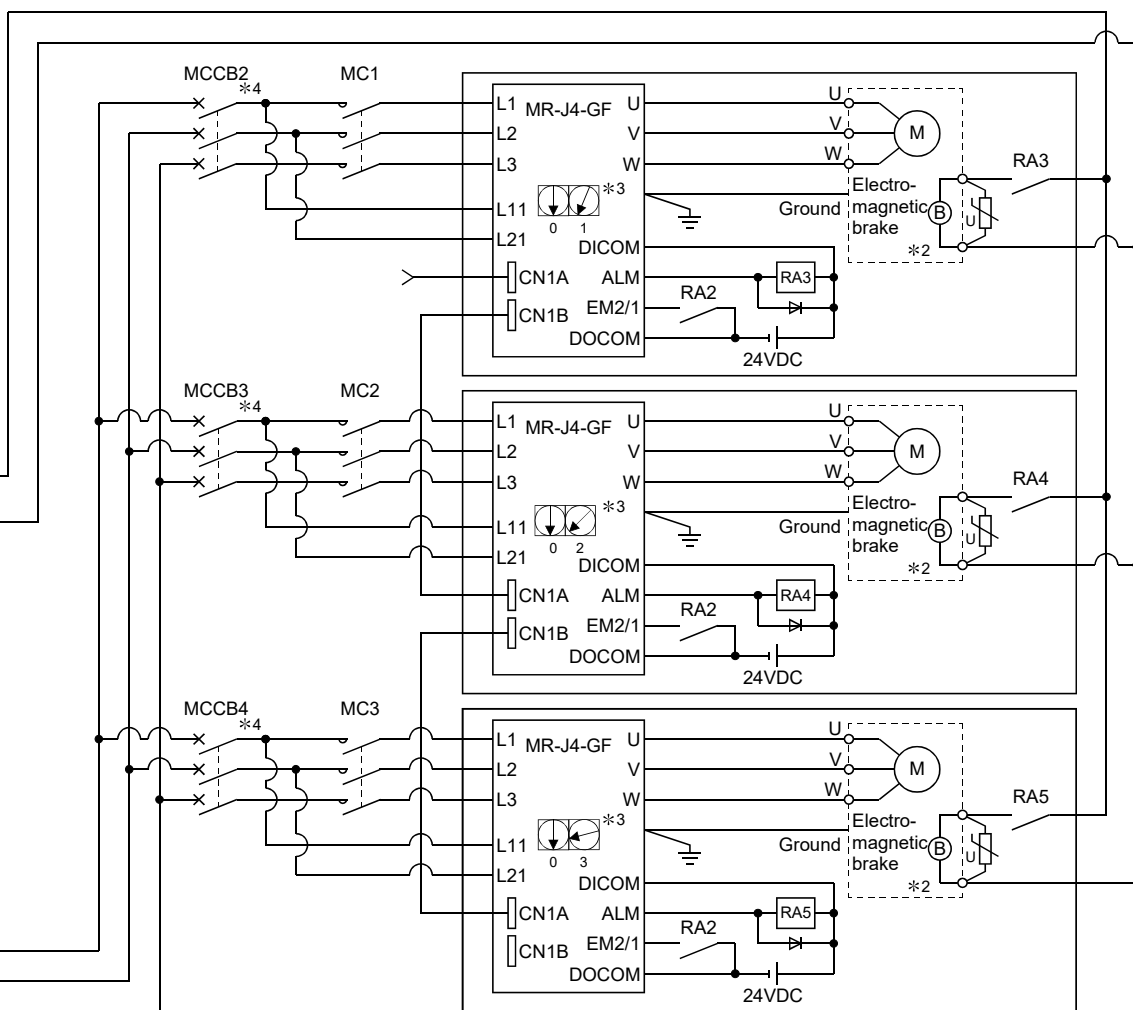

(Note-1): Be sure to shut off the both of main circuit power supply L1/L2/L3 and control power supply L11/L21 after disconnection of CC-Link IE Field Network communication at the time of exchange of servo amplifier. At this time, it is not possible to communicate between the servo amplifier and Simple Motion module. Therefore, be sure to exchange the servo amplifier after stopping the operating of machine beforehand.

(Note-2): The dynamic brake is operated, and servomotor occurs to the free run when EM1 (forced stop) of servo amplifier turn OFF. At the time, the display shows the servo forced stop warning (E6.1). During ordinary operation, do not used forced stop signal to alternate stop and run. The service life of the servo amplifier may be shortened.

MEMO

Chapter 4 Installation, Wiring and Maintenance of the Product

The installation, wiring and maintenance of the Simple Motion module are explained in this chapter.

Important information such as precautions to prevent malfunctioning of the Simple Motion module, accidents and injuries as well as the proper work methods are described. Read this chapter thoroughly before starting installation, wiring or maintenance, and always following the precautions.

| | | |
|-------|--|------|
| 4.1 | Outline of installation, wiring and maintenance..... | 4- 2 |
| 4.1.1 | Installation, wiring and maintenance procedures | 4- 2 |
| 4.1.2 | Names of each part | 4- 3 |
| 4.1.3 | Handling precautions | 4- 6 |
| 4.2 | Installation..... | 4- 8 |
| 4.2.1 | Precautions for installation | 4- 8 |
| 4.3 | Wiring..... | 4- 9 |
| 4.3.1 | Precautions for wiring | 4- 9 |
| 4.4 | Confirming the installation and wiring..... | 4-17 |
| 4.4.1 | Items to confirm when installation and wiring are completed..... | 4-17 |
| 4.5 | Maintenance | 4-18 |
| 4.5.1 | Precautions for maintenance..... | 4-18 |
| 4.5.2 | Disposal instructions..... | 4-18 |

4.1 Outline of installation, wiring and maintenance

4.1.1 Installation, wiring and maintenance procedures

The outline and procedures for Simple Motion module installation, wiring and maintenance are shown below.

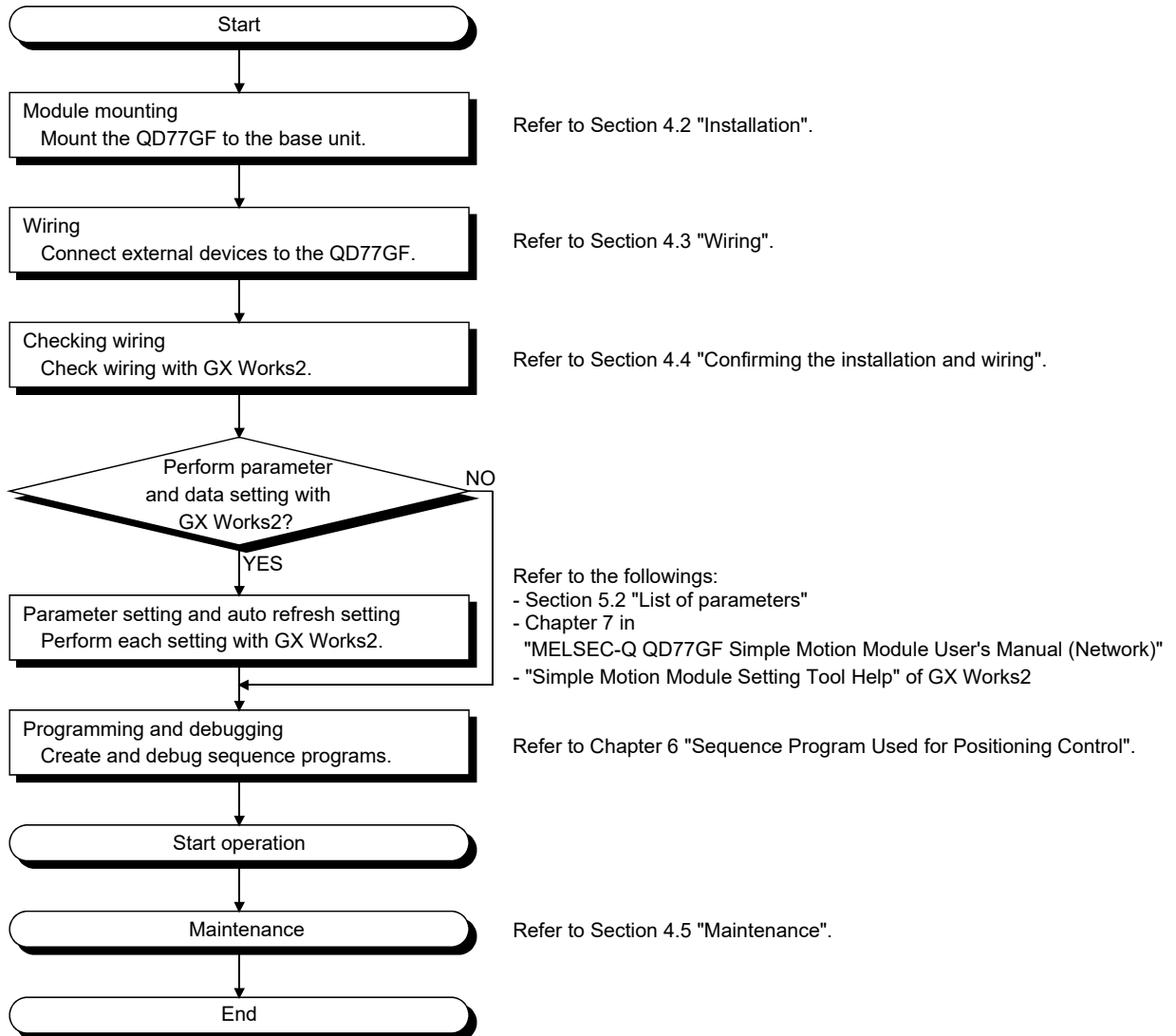

4.1.2 Names of each part

The part names of the Simple Motion module are shown below.

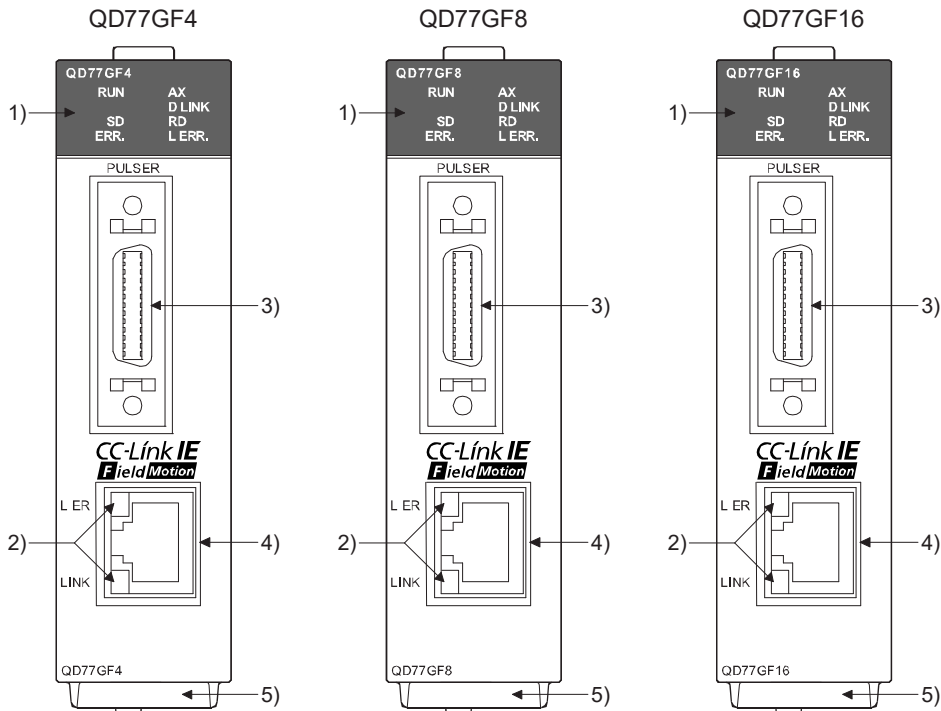

| No. | Name | Description |
|-----|--|---|
| 1) | LED (upper part on the front) | Refer to this section (1). |
| 2) | LED (CC-Link IE Field connector section) | Refer to this section (2). |
| 3) | External input connection connector | Connector to connect the mechanical system input, manual pulse generator/incremental synchronous encoder, or forced stop input. (26-pin connector) Refer to Section 3.4.2 for details. |
| 4) | CC-Link IE Field Network cable connector | Connector to connect the servo amplifier. |
| 5) | Serial number plate | Shows the serial number printed on the rating plate. |

(1) LED (upper part on the front)

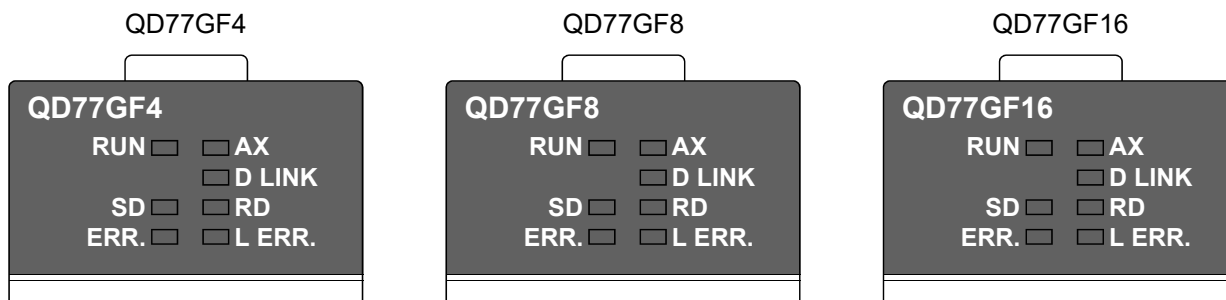

| LED Display | | Description |
|--|--|--|
| RUN LED is OFF. | RUN <input type="checkbox"/> <input type="checkbox"/> AX <input type="checkbox"/> D LINK SD <input type="checkbox"/> <input type="checkbox"/> RD ERR. <input type="checkbox"/> <input type="checkbox"/> L ERR. | Hardware failure, watch dog timer error |
| RUN LED is ON. ERR. LED is OFF. | RUN <input checked="" type="checkbox"/> <input type="checkbox"/> AX <input type="checkbox"/> D LINK SD <input type="checkbox"/> <input type="checkbox"/> RD ERR. <input type="checkbox"/> <input type="checkbox"/> L ERR. | Operates normally. |
| ERR. LED is flashing. AX LED is OFF. | RUN <input checked="" type="checkbox"/> <input type="checkbox"/> AX <input type="checkbox"/> D LINK SD <input type="checkbox"/> <input type="checkbox"/> RD ERR. <input checked="" type="checkbox"/> <input type="checkbox"/> L ERR. | Token pass not executed for some stations |
| ERR. LED is flashing. AX LED is flashing. | RUN <input checked="" type="checkbox"/> <input checked="" type="checkbox"/> AX <input type="checkbox"/> D LINK SD <input type="checkbox"/> <input type="checkbox"/> RD ERR. <input checked="" type="checkbox"/> <input type="checkbox"/> L ERR. | Axis error |
| ERR. LED is ON. | RUN <input checked="" type="checkbox"/> <input type="checkbox"/> AX <input type="checkbox"/> D LINK SD <input type="checkbox"/> <input type="checkbox"/> RD ERR. <input checked="" type="checkbox"/> <input type="checkbox"/> L ERR. | System error, CPU stop error, error in all stations, station number duplication, invalid network parameter |
| AX LED is ON. | RUN <input checked="" type="checkbox"/> <input checked="" type="checkbox"/> AX <input type="checkbox"/> D LINK SD <input type="checkbox"/> <input type="checkbox"/> RD ERR. <input type="checkbox"/> <input type="checkbox"/> L ERR. | Axis operation in progress |
| AX LED is OFF. | RUN <input checked="" type="checkbox"/> <input type="checkbox"/> AX <input type="checkbox"/> D LINK SD <input type="checkbox"/> <input type="checkbox"/> RD ERR. <input type="checkbox"/> <input type="checkbox"/> L ERR. | An axis stops or is on standby. |

| LED Display | | Description |
|-------------------------|---|--|
| SD LED is ON. | RUN <input checked="" type="checkbox"/> <input type="checkbox"/> AX <input type="checkbox"/> D LINK SD <input checked="" type="checkbox"/> <input type="checkbox"/> RD ERR. <input type="checkbox"/> <input type="checkbox"/> L ERR. | Sending data. |
| SD LED is OFF. | RUN <input checked="" type="checkbox"/> <input type="checkbox"/> AX <input type="checkbox"/> D LINK SD <input type="checkbox"/> <input type="checkbox"/> RD ERR. <input type="checkbox"/> <input type="checkbox"/> L ERR. | Data not sent |
| D LINK LED is ON. | RUN <input checked="" type="checkbox"/> <input type="checkbox"/> AX <input checked="" type="checkbox"/> D LINK SD <input type="checkbox"/> <input type="checkbox"/> RD ERR. <input type="checkbox"/> <input type="checkbox"/> L ERR. | Data link in operation (cyclic transmission in progress) |
| D LINK LED is flashing. | RUN <input checked="" type="checkbox"/> <input type="checkbox"/> AX <input checked="" type="checkbox"/> D LINK SD <input type="checkbox"/> <input type="checkbox"/> RD ERR. <input type="checkbox"/> <input type="checkbox"/> L ERR. | Data link in operation (cyclic transmission stopped) |
| D LINK LED is OFF. | RUN <input checked="" type="checkbox"/> <input type="checkbox"/> AX <input type="checkbox"/> D LINK SD <input type="checkbox"/> <input type="checkbox"/> RD ERR. <input type="checkbox"/> <input type="checkbox"/> L ERR. | Data link not performed (disconnected) |
| RD LED is ON. | RUN <input checked="" type="checkbox"/> <input type="checkbox"/> AX <input type="checkbox"/> D LINK SD <input type="checkbox"/> <input checked="" type="checkbox"/> RD ERR. <input type="checkbox"/> <input type="checkbox"/> L ERR. | Receiving data. |
| RD LED is OFF. | RUN <input checked="" type="checkbox"/> <input type="checkbox"/> AX <input type="checkbox"/> D LINK SD <input type="checkbox"/> <input type="checkbox"/> RD ERR. <input type="checkbox"/> <input type="checkbox"/> L ERR. | Data not received |
| L ERR. LED is ON. | RUN <input checked="" type="checkbox"/> <input type="checkbox"/> AX <input type="checkbox"/> D LINK SD <input type="checkbox"/> <input type="checkbox"/> RD ERR. <input type="checkbox"/> <input checked="" type="checkbox"/> L ERR. | Frame error detection |
| L ERR. LED is OFF. | RUN <input checked="" type="checkbox"/> <input type="checkbox"/> AX <input type="checkbox"/> D LINK SD <input type="checkbox"/> <input type="checkbox"/> RD ERR. <input type="checkbox"/> <input type="checkbox"/> L ERR. | Frame error not detected |

■: ON, ◆: Flashing, □: OFF

(2) CC-Link IE Field Network connector section

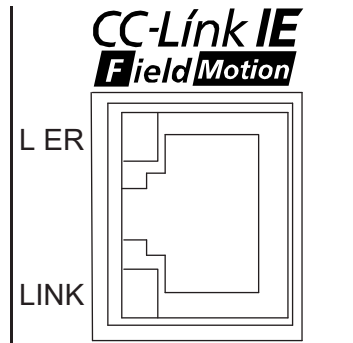

| LED Display | | Description |
|------------------|---|---------------------------------|
| L ER LED is ON. | L ER <input checked="" type="checkbox"/> LINK <input type="checkbox"/> | Receive data error |
| L ER LED is OFF. | L ER <input type="checkbox"/> LINK <input type="checkbox"/> | Receive data operates normally. |
| LINK LED is ON. | L ER <input type="checkbox"/> LINK <input checked="" type="checkbox"/> | Linkup in progress. |
| LINK LED is OFF. | L ER <input type="checkbox"/> LINK <input type="checkbox"/> | Linkdown in progress. |

■: ON, □: OFF

4.1.3 Handling precautions

Handle the Simple Motion module and cable while observing the following precautions.

[1] Handling precautions

CAUTION

- Use the programmable controller in an environment that meets the general specifications in the manual "Safety Guidelines", the manual supplied with the main base unit.
Using the programmable controller in an environment outside the range could result in electric shock, fire, operation failure, and damage to or deterioration of the product.
- Do not directly touch the module's conductive parts and electronic components. Doing so may cause an operation failure or give damage to the module.
- Be sure there are no foreign matters such as sawdust or wiring debris inside the module. Such debris could cause fire, damage, or operation failure.
- Never try to disassemble or modify the modules. It may cause product failure, operation failure, injury or fire.
- Completely turn off the externally supplied power used in the system before installation or removing the module. Not doing so could result in damage to the module.
- Because the connector has its orientation, check it before attaching or detaching the connector straight from the front.
Unless it is properly installed, a poor contact may occur, resulting in erroneous input and output.

[2] Other precautions

(1) Main body

- The main body case is made of plastic. Take care not to drop or apply strong impacts onto the case.
- Do not remove the PCB of Simple Motion module from the case. Failure to observe this could lead to faults.
- Before touching the module, always touch grounded metal, etc. to discharge static electricity from human body. Failure to do so may cause the module to fail or malfunction.

(2) Cable

- Do not press on the cable with a sharp object.
- Do not twist the cable with force.
- Do not forcibly pull on the cable.
- Do not step on the cable.
- Do not place objects on the cable.
- Do not damage the cable sheath.

(3) Installation environment

Do not install the module in the following type of environment.

- Where the ambient temperature exceeds the 0 to 55°C range.
- Where the ambient humidity exceeds the 5 to 95%RH range.
- Where temperature rapid changes and dew condenses.
- Where there is corrosive gas or flammable gas.
- Where there are high levels of dust, conductive powder, such as iron chips, oil mist, salt or organic solvents.
- Where the module is subject to direct sunlight.
- Where there are strong electric fields or magnetic fields.
- Where vibration or impact could be directly applied onto the main body.

4.2 Installation

4.2.1 Precautions for installation

The precautions for installing the Simple Motion module are given below. Refer to this section as well as Section 4.1.3 "Handling precautions" when carrying out the work.

Precautions for installation

DANGER

- Completely turn off the externally supplied power used in the system before installing or removing the module.
Not doing so could result in electric shocks, an operation failure or damage to the module.

CAUTION

- Never try to disassemble or modify the modules. It may cause product failure, operation failure, injury or fire.
- Completely turn off the externally supplied power used in the system before installation or removing the module.
Not doing so could result in an operation failure or damage to the module.
- After the first use of the module, the number of connections/disconnections is limited to 50 times (in accordance with IEC 61131-2). Exceeding the limit may cause malfunction.
- Use the programmable controller in an environment that meets the general specifications in the manual "Safety Guidelines", the manual supplied with the main base unit.
Using the programmable controller in an environment outside the range could result in electric shock, fire, operation failure, and damage to or deterioration of the product.
- Do not directly touch the module's conductive parts and electronic components. Doing so may cause an operation failure or give damage to the module.
- While pressing the installation lever located at the bottom of module, insert the module fixing tab into the fixing hole in the base unit until it stops. Then, securely mount the module with the fixing hole as a supporting point.
Incorrect loading of the module can cause a malfunction, failure or drop.
When using the module in the environment of much vibration, tighten the module with a screw.
Tighten the screw within the range of the specified tightening torque.
Insufficient tightening may lead to dropping, short-circuit, or malfunctioning.
Excessive tightening may damage the screw or module, leading to dropping, short-circuit, or malfunctioning.
- Lock the control panel and prevent access to those who are not certified to handle or install electric equipment.

4.3 Wiring

The precautions for wiring the Simple Motion module are given below. Refer to this section as well as Section 4.1.3 "Handling precautions" when carrying out the work.

4.3.1 Precautions for wiring

DANGER

- Completely turn off the externally supplied power used in the system before installation or wiring. Not doing so could result in electric shock or damage to the product.

CAUTION

- Check the layout of the terminals and then properly route the wires to the module.
- Connectors for external input wiring must be crimped or pressured with the tool specified by the manufacturer, or must be correctly soldered. Insufficient connections may cause short circuit, fire, or malfunction.
- Be careful not to let foreign matter such as sawdust or wire chips get inside the module. These may cause fires, failure or malfunction.
- The top surface of the module is covered with protective films to prevent foreign objects such as cable off cuts from entering the module when wiring. Do not remove this film until the wiring is complete. Before operating the system, be sure to remove the film to provide adequate ventilation.
- Connect a CC-Link IE Field Network cable to a CC-Link IE Field Network cable connector. Otherwise, failure may be caused.
- When removing the cable from the module, do not pull the cable. Hold the connector that is connected to the module. Pulling the cable that is still connected to the module may cause malfunction or damage to the module or cable.
- The external input/output signal cable and the communication cable should not be routed near or bundled with the main circuit cable, power cable and/or other such load - carrying cables other than those for the PLC. These cables should be separated by at least 100mm (3.94inch) or more. They can cause electrical interference, surges and inductance that can lead to mis-operation.
- The shielded cable for connecting Simple Motion module can be secured in place. If the shielded cable is not secured, unevenness or movement of the shielded cable or careless pulling on it could result in damage to the Simple Motion module, servo amplifier or shielded cable or defective cable connections could cause mis-operation of the unit.
- If the external input/output signal cable and the power line must be adjacently laid (less than 100mm (3.94inch)), use a shielded cable. Ground the shield of the cable securely to the control panel on the Simple Motion module side. (A wiring example is given on this section "[1] Precautions for wiring".)
- Forcibly removal the cable from the Simple Motion module will damage the Simple Motion module and cables.

[1] Precautions for wiring

- (1) Use separate cables for connecting to the Simple Motion module and for the power cable that create surge and inductance.
- (2) The cable for connecting the Simple Motion module can be placed in the duct or secured in place by clamps. If the cable is not placed in the duct or secured by clamps, unevenness or movement of the cable or careless pulling on it could result in damage to the unit or cable or defective cable connections could cause mis-operation of the unit.
- (3) If a duct is being used, separate the cables to connect the Simple Motion module from the power line duct, or use metal piping.
Ground the pipes securely after metal piping.
- (4) Use the twisted pair shielded cable (wire size 0.3 mm² or more). The shielded must be grounded on the Simple Motion module side.
- (5) Use separate shielded cables of the forced stop input signal (EMI, EMI.COM), limit signal (FLS, RLS, DOG, STOP), external command signal/switching signal (DI, COM), and manual pulse generator/incremental synchronous encoder input signal (HAH, HAL, HBH, HBL, HA, HB, 5V, SG) for connecting to the Simple Motion module. They can cause electrical interference, surges and inductance that can lead to mis-operation.

[Wiring example of shielded cable]

The following shows a wiring example for noise reduction in the case when the connector (LD77MHIOCON) is used.

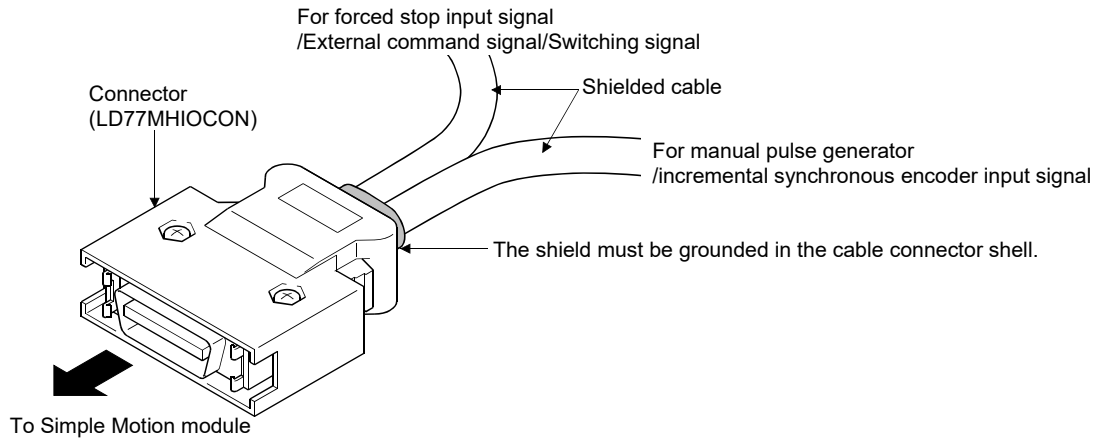

[Processing example of shielded cables]

Connections of FG wire and each shielded cable

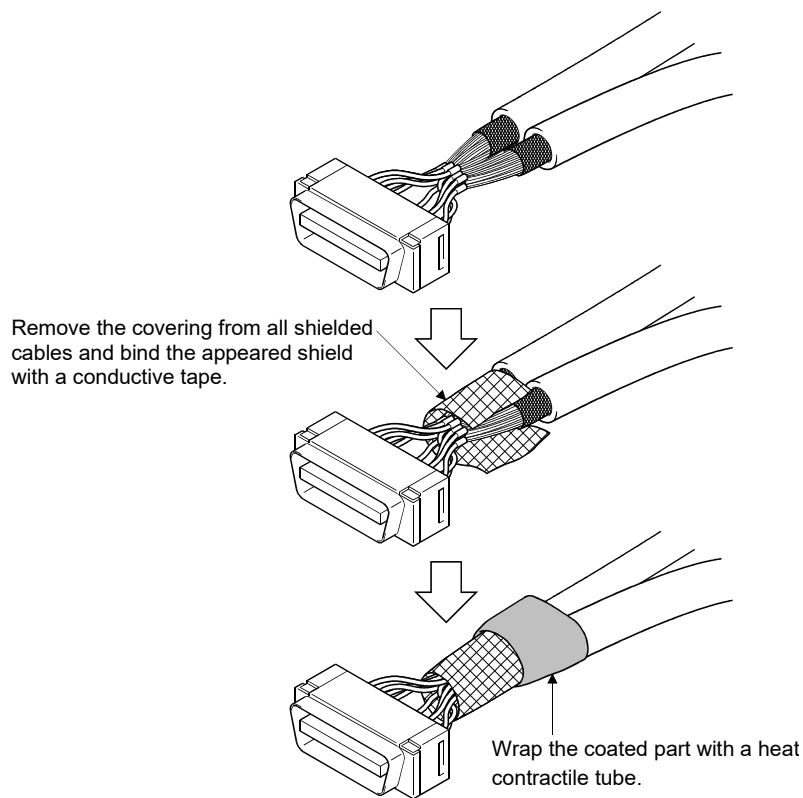

Assembling of connector (LD77MHIOCON)

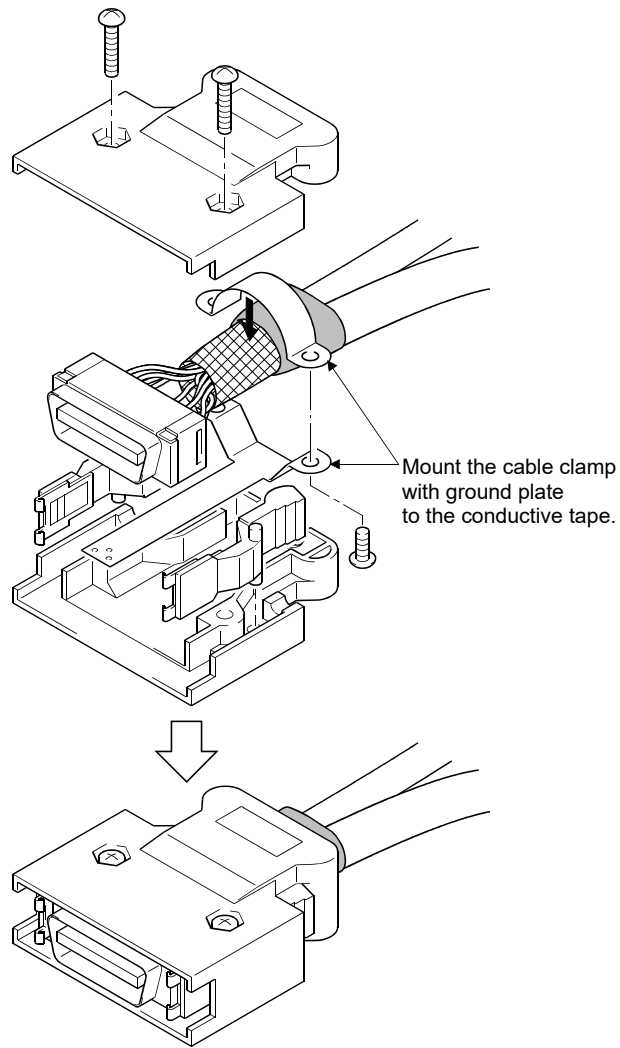

- (6) To make this product conform to the EMC directive instruction and Low Voltage Directives, be sure to use an AD75CK type cable clamp (manufactured by Mitsubishi Electric) for grounding connected to the control box and the shielded cable.

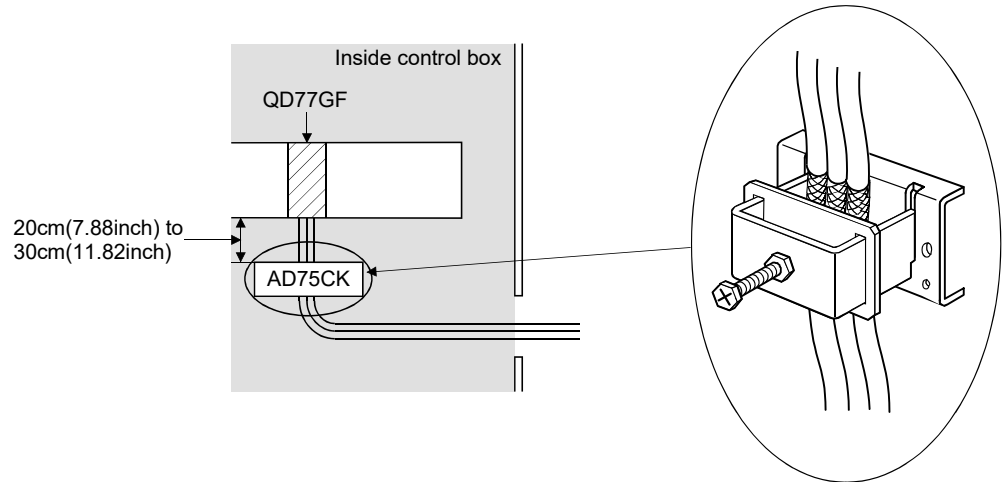

[How to ground shielded cable using AD75CK]

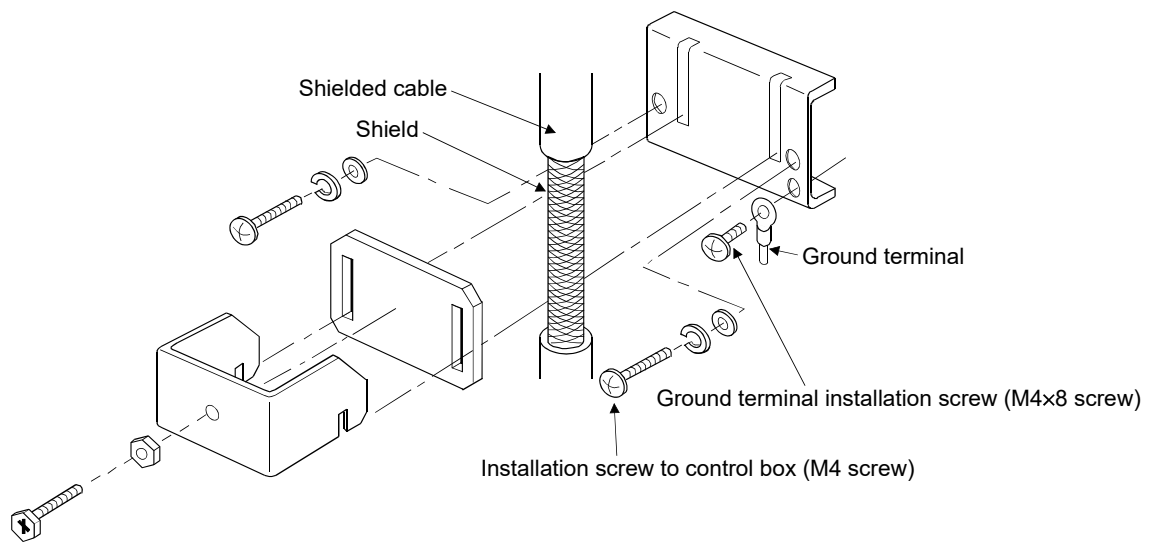

Using the AD75CK, you can tie four cables of about 7 mm (0.28 inch) outside diameter together for grounding.

(Refer to the "AD75CK-type Cable Clamping Instruction Manual" (IB-68682).)

⚠ CAUTION

- Do not ground the cable clamp to the top of control panel. Doing so may lead to damage by damage of screws, etc. during installation or removing the cable clamp.

[2] Precautions for CC-Link IE Field Network cable wiring

This section describes the CC-Link IE Field Network cable wiring and precautions. For network configuration, cables, and hubs used for the wiring, refer to the system configuration. (Refer to Chapter 2.)

(1) CC-Link IE Field Network cable connection

(a) Connecting the cable

- 1) Power off the Simple Motion module and the connected device.
- 2) Push the CC-Link IE Field Network cable connector into the Simple Motion module until it clicks. Pay attention to the connector's direction.

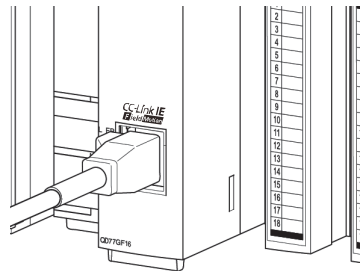

- 3) Power on the Simple Motion module and the connected device.
- 4) Check whether the LINK LED of the port connected with CC-Link IE Field Network cable is on.

The time between the power-on and the LINK LED turning on may vary. The LINK LED usually turns on in a few seconds. Note, however, that the time may be extended further if the linkup process is repeated depending on the status of the device on the line.

If the LINK LED does not turn on, refer to the troubleshooting section and take corrective actions. (Refer to Section 16.2.)

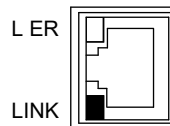

(b) Disconnecting the cable

- 1) Power off the system.
- 2) Press the latch down and unplug the CC-Link IE Field Network cable.

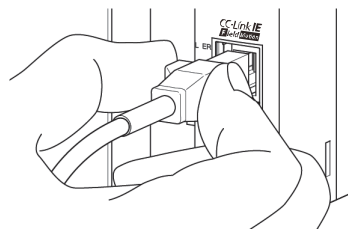

(2) Precautions

This section describes wiring precautions.

(a) Handling of CC-Link IE Field Network cable

- Place the CC-Link IE Field Network cable in a duct or clamp them. If not, dangling cable may swing or inadvertently be pulled, resulting in damage to the module or cables or malfunction due to poor contact.
- Do not touch the core of the cable-side or module-side connector, and protect it from dirt or dust. If oil from your hand, dirt or dust is attached to the core, it can increase transmission loss, arising a problem in data link.
- Check the following:
 - Is any CC-Link IE Field Network cable disconnected?
 - Is any of the CC-Link IE Field Network cables shorted?
 - Are the connectors securely connected?

(b) Broken cable latch

Do not use CC-Link IE Field Network cables with broken latches. Doing so may cause the cable to unplug or malfunction.

(c) Connecting and disconnecting the CC-Link IE Field Network cable

Hold the connector part when connecting and disconnecting the CC-Link IE Field Network cable. Pulling a cable connected to the module may damage the module or cable, or result in malfunction due to poor contact.

(d) Maximum station-to-station distance (maximum cable length)

The maximum station-to-station distance is 100m. However, the distance may be shorter depending on the operating environment of the cable. For details, contact your cable manufacturer.

(e) Bend radius

The bend radius of the CC-Link IE Field Network cable is limited. For details, see the specifications of the CC-Link IE Field Network cable to be used.

(f) Network configuration

Check the wiring to prevent incorrect wiring. (Refer to Chapter 5 of "MELSEC-Q QD77GF Simple Motion Module User's Manual (Network)").

[3] Example of measure against noise for compliance with the EMC directive.

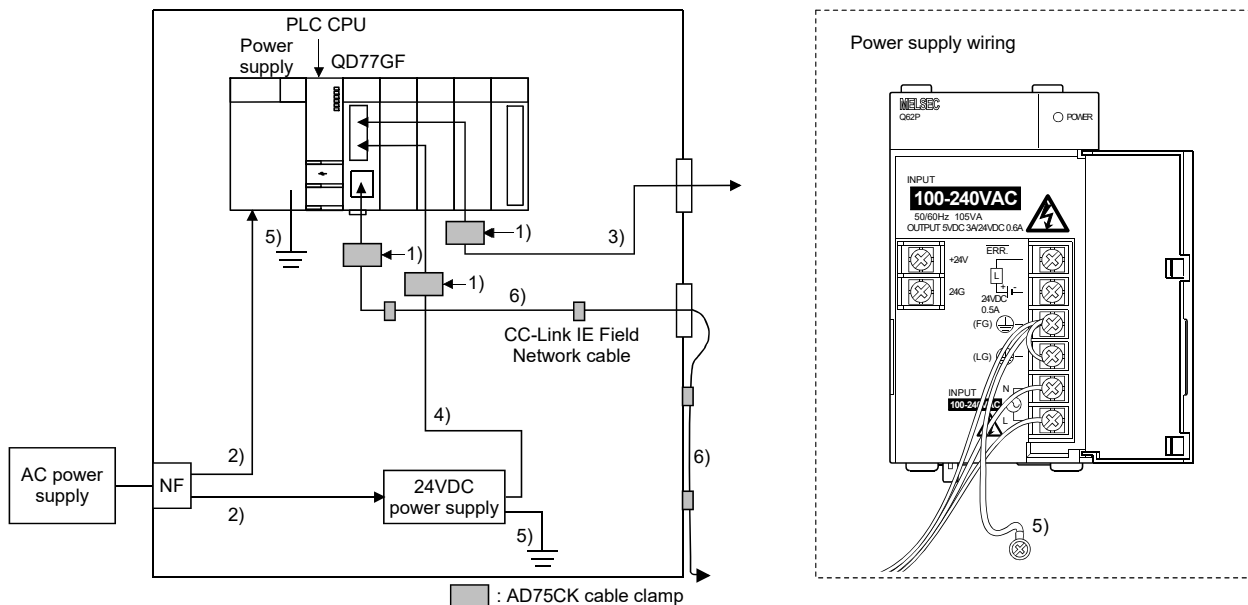

- : AD75CK cable clamp
- 1) Ground the cables at a position within 30cm (11.82inch) from the module with the cable clamp, etc.
 - 2) Wire the power supply cable as short as possible using the twisted cable (2mm² or more).
 - 3) Use the shielded twisted cable (cable length: 30m (98.43ft.) or less) for each I/O signal cable.
 - 4) Wire the cable connected to secondary side of 24VDC power supply module as short as possible in the control panel. (Cable length: 30m (98.43ft.) or less)
 - 5) Wire the power supply and 24VDC power supply as short as possible using the cable of approx. 2mm², and ground to the control panel.
 - 6) CC-Link IE Field Network cable is fixed with bundle material, etc. to grand side such as a wall of the control panel. Do not wire the cable in the air.

- (1) Refer to this chapter or "EMC and Low Voltage Directives" of "QCPU User's Manual (Hardware Design, Maintenance and Inspection)" for basic wire. We examined QD77GF by the above example.
- (2) In wiring inside the panel, the power line connected to the power or servo amplifier and the communication cable such as an expansion cable or a network cable must not be mixed. In the duct, leave 10 cm (3.94 inch) or more between the power line and the communication cable, and separate using a separator (made of metal), etc. It is required in the same control panel as well. Mixing the power line and communication cable may cause increase of noise or malfunction due to noise influence.

4.4 Confirming the installation and wiring

4.4.1 Items to confirm when installation and wiring are completed

Check the following points when completed with the installation of Simple Motion module and wiring.

- Is the module correctly wired?

The following four points are confirmed using the positioning test function of GX Works2.

With this function, "whether the direction that the Simple Motion module recognizes as forward run matches the address increment direction in the actual positioning work", and "whether the Simple Motion module recognizes the external input signals such as the manual pulse generator and forced stop", etc., can be checked.

- Are the Simple Motion module and servo amplifier correctly connected?
- Are the servo amplifier and servomotor correctly connected?
- Are the Simple Motion module and external devices (input signals) correctly connected?
- Are the servo amplifier and external wiring (FLS, RLS and DOG) correctly connected?

Refer to the "Simple Motion Module Setting Tool Help" of GX Works2 for details of "Positioning test function".

Note that the monitor data of the "[Md.30] External input signal" in the GX Works2 may also be used to "confirm the connection between the Simple Motion module and external devices (input signals)".

| |
|------------------|
| Important |
|------------------|

| |
|--|
| <p>If the Simple Motion module is faulty, or when the required signals such as the proximity dog signal and forced stop signal are not recognized, unexpected accidents such as "not decelerating at the proximity dog during machine HPR and colliding with the stopper", or "not being able to stop with the forced stop signal" may occur. Execute a checking wiring of external input signal. The connection confirmation by positioning test function must be carried out not only when structuring the positioning system, but also when the system has been changed with module replacement or rewiring, etc.</p> |
|--|

4.5 Maintenance

4.5.1 Precautions for maintenance

The precautions for servicing the Simple Motion module are given below. Refer to this section as well as Section 4.1.3 "Handling precautions" when carrying out the work.

DANGER

- Completely turn off the externally supplied power used in the system before clearing or tightening the connector screws.
Not doing so could result in electric shocks.

CAUTION

- Never try to disassemble or modify the modules.
It may cause product failure, operation failure, injury or fires.
- Completely turn off the externally supplied power used in the system before installation or removing the module.
Not doing so could result in electric shock, damage to the module or operation failure.

4.5.2 Disposal instructions

When you discard a Simple Motion module, a servo amplifier, a battery (primary battery) and other option articles, please follow the law of each country (area).

CAUTION

- This product is not designed or manufactured to be used in equipment or systems in situations that can affect or endanger human life.
- When considering this product for operation in special applications such as machinery or systems used in passenger transportation, medical, aerospace, atomic power, electric power, or submarine repeating applications, please contact your nearest Mitsubishi sales representative.
- Although this product was manufactured under conditions of strict quality control, you are strongly advised to install safety devices to forestall serious accidents when it is used in facilities where a breakdown in the product is likely to cause a serious accident.

Chapter 5 Data Used for Positioning Control

The parameters and data used to carry out positioning control with the Simple Motion module are explained in this chapter.

With the positioning system using the Simple Motion module, the various parameters and data explained in this chapter are used for control. The parameters and data include parameters set according to the device configuration, such as the system configuration, and parameters and data set according to each control. Read this section thoroughly and make settings according to each control or application.

*: Refer to "Section 2" for details on each control.

| | | |
|--------|--|-------|
| 5.1 | Types of data | 5- 2 |
| 5.1.1 | Parameters and data required for control | 5- 2 |
| 5.1.2 | Setting items for positioning parameters..... | 5- 5 |
| 5.1.3 | Setting items for HPR parameters | 5- 7 |
| 5.1.4 | Setting items for expansion parameters | 5- 8 |
| 5.1.5 | Setting items for servo parameters | 5- 8 |
| 5.1.6 | Setting items for positioning data | 5- 9 |
| 5.1.7 | Setting items for block start data | 5-10 |
| 5.1.8 | Setting items for condition data | 5-11 |
| 5.1.9 | Types and roles of monitor data..... | 5-12 |
| 5.1.10 | Types and roles of control data | 5-16 |
| 5.2 | List of parameters..... | 5-20 |
| 5.2.1 | Basic parameters 1 | 5-20 |
| 5.2.2 | Basic parameters 2..... | 5-26 |
| 5.2.3 | Detailed parameters 1 | 5-27 |
| 5.2.4 | Detailed parameters 2 | 5-38 |
| 5.2.5 | HPR basic parameters | 5-50 |
| 5.2.6 | HPR detailed parameters | 5-56 |
| 5.2.7 | Expansion parameters..... | 5-61 |
| 5.2.8 | Servo parameters | 5-63 |
| 5.3 | List of positioning data..... | 5-64 |
| 5.4 | List of block start data | 5-80 |
| 5.5 | List of condition data | 5-84 |
| 5.6 | List of monitor data | 5-90 |
| 5.6.1 | System monitor data..... | 5-90 |
| 5.6.2 | Axis monitor data | 5-104 |
| 5.7 | List of control data | 5-130 |
| 5.7.1 | System control data | 5-130 |
| 5.7.2 | Axis control data | 5-134 |

5.1 Types of data

5.1.1 Parameters and data required for control

The parameters and data required to carry out control with the Simple Motion module include the "setting data", "monitor data" and "control data" shown below.

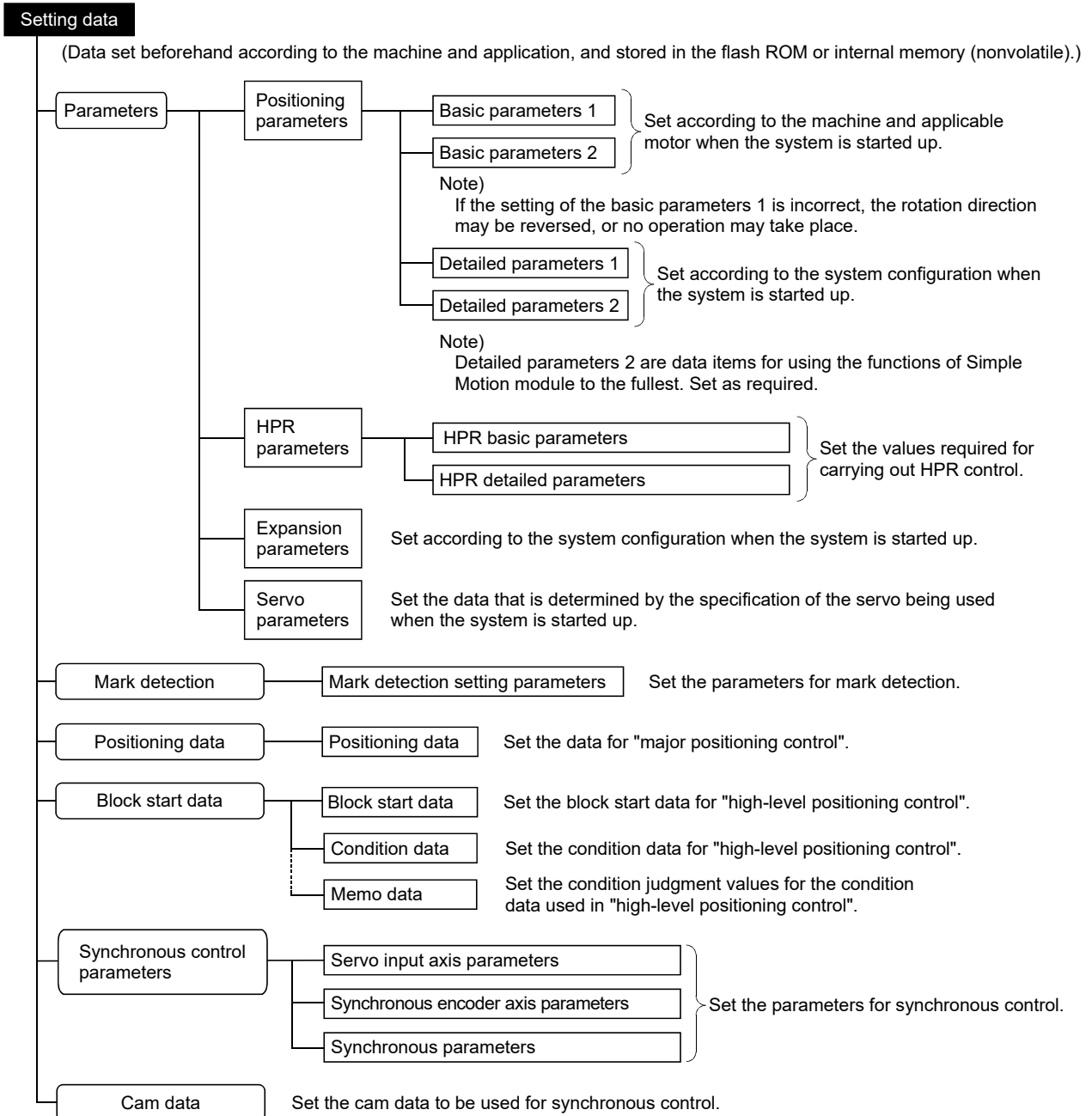

Restriction

The setting data backup is executed only in the flash ROM or internal memory of the Simple Motion module. The backup cannot be executed in the PLC CPU or SD memory cards mounted with the PLC CPU.

- ◇ The following methods are available for data setting:
 - Set using GX Works2.
 - Create the sequence program for data setting using GX Works2 and execute it. In this manual, the method using the GX Works2 will be explained. (Refer to "Point" on the next page.)
- ◇ The basic parameters 1, detailed parameters 1, HPR parameters, "[Pr.83] Speed control 10 x multiplier setting for degree axis", "[Pr.89] Manual pulse generator/Incremental synchronous encoder input type selection", "[Pr.90] Operation setting for speed-torque control mode" and "[Pr.95] External command signal selection" become valid when the PLC READY signal [Y0] turns from OFF to ON.
- ◇ The basic parameters 2, detailed parameters 2 (Note that this excludes "[Pr.83] Speed control 10 x multiplier setting for degree axis", "[Pr.89] Manual pulse generator/Incremental synchronous encoder input type selection", "[Pr.90] Operation setting for speed-torque control mode" and "[Pr.95] External command signal selection".) become valid immediately when they are written to the buffer memory, regardless of the state of the PLC READY signal [Y0].
- ◇ Even when the PLC READY signal [Y0] is ON, the values or contents of the following can be changed: basic parameters 2, detailed parameters 2, positioning data, and block start data.
- ◇ The expansion parameter and servo parameter is transmitted from the Simple Motion module to the servo amplifier when the initialized communication carried out after the power supply is turned ON or the PLC CPU is reset. (MR-J4-B use)
The power supply is turned ON or the PLC CPU is reset after writing servo parameter in flash ROM of Simple Motion module if the servo parameter is transmitted to the servo amplifier.
- ◇ The only valid data assigned to basic parameter 2, detailed parameter 2, positioning data or block start data are the data read at the moment when a positioning or JOG operation is started. Once the operation has started, any modification to the data is ignored.
Exceptionally, however, modifications to the following are valid even when they are made during a positioning operation: acceleration time 0 to 3, deceleration time 0 to 3, and external command function.
 - Acceleration time 0 to 3 and deceleration time 0 to 3:
Positioning data are pre-read and pre-analyzed. Modifications to the data four or more steps after the current step are valid.
 - External command function selection: The value at the time of detection is valid.

Monitor data (Data that indicates the control state. Stored in the buffer memory, and monitors as necessary.)

| | |
|-----------------------------|--|
| System monitor data | Monitors the specifications and the operation history of Simple Motion module. |
| Axis monitor data | Monitors the data related to the operating axis, such as the current position and speed. |
| Synchronous control data | Monitors the data for synchronous control. |
| Mark detection monitor data | Monitors the data for mark detection. |

- ◇ The following methods are available for data monitoring:
- Set using GX Works2.
 - Create the sequence program for monitoring using GX Works2 and execute it.
- In this manual, the method using the GX Works2 will be explained.

Control data (Data for user to control positioning system.)

| | |
|-----------------------------|--|
| System control data | Writes/initializes the "positioning data" in the module. Sets the setting for operation of all axes. |
| Axis control data | Makes settings related to the operation, and controls the speed change during operation, and stops/restarts the operation for each axis. |
| Expansion axis control data | Output signals (Axis stop signal, JOG start signal and execution prohibition flag) from PLC CPU to Simple Motion module. |
| Synchronous control data | Sets the data for synchronous control. |
| Mark detection control data | Sets the data for mark detection. |

- ◇ Control using the control data is carried out with the sequence program. "[Cd.41] Deceleration start flag valid" is valid for only the value at the time when the PLC READY signal [Y0] turns from OFF to ON.

POINT

- (1) The "setting data" is created for each axis.
- (2) The "setting data" parameters have determined default values, and are set to the default values before shipment from the factory. (Parameters related to axes that are not used are left at the default value.)
- (3) The "setting data" can be initialized with GX Works2 or the sequence program.
- (4) It is recommended to set the "setting data" with GX Works2. The sequence program for data setting is complicated and many devices must be used. This will increase the scan time.

5.1.2 Setting items for positioning parameters

The table below lists items set to the positioning parameters. Setting of positioning parameters is done for individual axes for all controls achieved by the Simple Motion module.

For details of controls, refer to "Section 2". For details of setting items, refer to Section 5.2 "List of parameters".

| Positioning parameter | Control | Major positioning control | | | | | | | | Manual control | | | Expansion control | Related sub function |
|---|--|---------------------------|--|--|---------------------------------------|--|---------------------------|------------------------|----------------------------------|-------------------|---------------|----------------------|---|----------------------|
| | | HPR control | Position control | | | Speed-position or position-speed control | Other control | | Manual pulse generator operation | Inching operation | JOG operation | Speed-torque control | | |
| | | | 1-axis linear control 2/3/4-axis linear interpolation control | 1-axis fixed-feed control 2/3/4-axis fixed-feed control | 2-axis circular interpolation control | | 1 to 4 axis speed control | Current value changing | | | | | JUMP instruction, NOP instruction, LOOP to LEND | |
| Basic parameters 1 | [Pr.1] Unit setting | ◎ | ◎ | ◎ | △ | ◎ | ◎ | ◎ | ◎ | ◎ | ◎ | ◎ | ◎ | - |
| | [Pr.2] Number of pulses per rotation (AP) (Unit: PLS) | ◎ | ◎ | ◎ | ◎ | ◎ | ◎ | ◎ | ◎ | ◎ | ◎ | ◎ | ◎ | 13.3.2 |
| | [Pr.3] Movement amount per rotation (AL) | ◎ | ◎ | ◎ | ◎ | ◎ | ◎ | ◎ | ◎ | ◎ | ◎ | ◎ | ◎ | |
| | [Pr.4] Unit magnification (AM) | ◎ | ◎ | ◎ | ◎ | ◎ | ◎ | ◎ | ◎ | ◎ | ◎ | ◎ | ◎ | |
| | [Pr.7] Bias speed at start | ○ | ○ | ○ | ○ | ○ | ○ | - | - | - | - | ○ | × | - |
| Basic parameters 2 | [Pr.8] Speed limit value | ◎ | ◎ | ◎ | ◎ | ◎ | ◎ | - | - | - | ◎ | ◎ | ◎ | 13.4.1 |
| | [Pr.9] Acceleration time 0 | ◎ | ◎ | ◎ | ◎ | ◎ | ◎ | - | - | - | ◎ | - | - | 13.7.6 |
| | [Pr.10] Deceleration time 0 | ◎ | ◎ | ◎ | ◎ | ◎ | ◎ | - | - | - | ◎ | - | - | |
| Detailed parameters 1 | [Pr.11] Backlash compensation amount | ○ | ○ | ○ | ○ | ○ | ○ | - | - | ○ | ○ | ○ | - | 13.3.1 |
| | [Pr.12] Software stroke limit upper limit value | - | ○ | ○ | ○ | ○ | ○ | ○ | - | ○ | ○ | ○ | ○ | 13.4.3 |
| | [Pr.13] Software stroke limit lower limit value | - | ○ | ○ | ○ | ○ | ○ | ○ | - | ○ | ○ | ○ | ○ | |
| | [Pr.14] Software stroke limit selection | - | ○ | ○ | ○ | ○ | ○ | ○ | - | ○ | ○ | ○ | ○ | |
| | [Pr.15] Software stroke limit valid/invalid setting | - | - | - | - | - | - | - | - | ○ | ○ | ○ | - | |
| | [Pr.16] Command in-position width | - | ○ | ○ | ○ | - | ○ | - | - | - | - | - | - | 13.7.5 |
| | [Pr.17] Torque limit setting value | △ | ○ | ○ | ○ | ○ | ○ | - | - | △ | △ | △ | ○ | 13.4.2 |
| | [Pr.18] M code ON signal output timing | - | ○ | ○ | ○ | ○ | ○ | ○ | - | - | - | - | - | 13.7.3 |
| | [Pr.19] Speed switching mode | - | ○ | ○ | ○ | - | - | - | - | - | - | - | - | - |
| | [Pr.20] Interpolation speed designation method | - | △ | △ | △ | △ | - | - | - | - | - | - | - | - |
| | [Pr.21] Feed current value during speed control | - | - | - | - | ○ | ○ | - | - | - | - | - | - | - |
| | [Pr.22] Input signal logic selection | ◎ | ◎ | ◎ | ◎ | ◎ | ◎ | ◎ | ◎ | ◎ | ◎ | ◎ | ◎ | - |
| | [Pr.24] Manual pulse generator/Incremental synchronous encoder input selection | - | - | - | - | - | - | - | - | ◎ | - | - | - | - |
| | [Pr.80] External input signal selection | ○ | ○ | ○ | ○ | ○ | ○ | ○ | ○ | ○ | ○ | ○ | ○ | 14.4 |
| [Pr.81] Speed-position function selection | - | - | - | - | - | ◎ | - | - | - | - | - | - | - | |
| [Pr.82] Forced stop valid/invalid selection | ○ | ○ | ○ | ○ | ○ | ○ | ○ | ○ | ○ | ○ | ○ | ○ | 13.4.5 | |

- ◎ : Always set
- : Set as required ("-" when not required)
- × : Setting not possible
- △ : Setting restricted
- : Setting not required (If the value is the default value or within the setting range, there is no problem.)

| Positioning parameter | | | Control | | Major positioning control | | | | | | | Manual control | | | Expansion control | Related sub function |
|-----------------------|---|---|---------|---|--|--|---------------------------------------|--|---|---------------------------|------------------------|----------------------------------|-------------------|---------------|----------------------|----------------------|
| | | | | | Position control | | | Speed-position or position-speed control | | Other control | | Manual pulse generator operation | Inching operation | JOG operation | Speed-torque control | |
| | | | | | 1-axis linear control 2/3/4-axis linear interpolation control | 1-axis fixed-feed control 2/3/4-axis fixed-feed control | 2-axis circular interpolation control | | | 1 to 4 axis speed control | Current value changing | | | | | |
| | | | | | | | | HPR control | | | | | | | | |
| Detailed parameters 2 | [Pr.25] | Acceleration time 1 | ○ | ○ | ○ | ○ | ○ | ○ | - | - | - | - | ○ | - | 13.7.6 | |
| | [Pr.26] | Acceleration time 2 | ○ | ○ | ○ | ○ | ○ | ○ | - | - | - | - | ○ | - | | |
| | [Pr.27] | Acceleration time 3 | ○ | ○ | ○ | ○ | ○ | ○ | - | - | - | - | ○ | - | | |
| | [Pr.28] | Deceleration time 1 | ○ | ○ | ○ | ○ | ○ | ○ | - | - | - | - | ○ | - | | |
| | [Pr.29] | Deceleration time 2 | ○ | ○ | ○ | ○ | ○ | ○ | - | - | - | - | ○ | - | | |
| | [Pr.30] | Deceleration time 3 | ○ | ○ | ○ | ○ | ○ | ○ | - | - | - | - | ○ | - | | |
| | [Pr.31] | JOG speed limit value | - | - | - | - | - | - | - | - | - | ◎ | ◎ | - | 13.4.1 | |
| | [Pr.32] | JOG operation acceleration time selection | - | - | - | - | - | - | - | - | - | - | ◎ | - | - | |
| | [Pr.33] | JOG operation deceleration time selection | - | - | - | - | - | - | - | - | - | - | ◎ | - | - | |
| | [Pr.34] | Acceleration/deceleration process selection | ○ | ○ | ○ | ○ | ○ | ○ | - | - | - | - | ○ | - | 13.7.6 | |
| | [Pr.35] | S-curve ratio | ○ | ○ | ○ | ○ | ○ | ○ | - | - | - | - | ○ | - | | |
| | [Pr.36] | Rapid stop deceleration time | ○ | ○ | ○ | ○ | ○ | ○ | - | - | - | - | ○ | - | | |
| | [Pr.37] | Stop group 1 rapid stop selection | ○ | ○ | ○ | ○ | ○ | ○ | - | - | - | - | ○ | - | | |
| | [Pr.38] | Stop group 2 rapid stop selection | ○ | ○ | ○ | ○ | ○ | ○ | - | - | - | - | ○ | - | | |
| | [Pr.39] | Stop group 3 rapid stop selection | ○ | ○ | ○ | ○ | ○ | ○ | - | - | - | - | ○ | - | | |
| | [Pr.40] | Positioning complete signal output time | - | ○ | ○ | ○ | ○ | ○ | ○ | - | - | - | - | - | - | |
| | [Pr.41] | Allowable circular interpolation error width | - | - | - | ○ | - | - | - | - | - | - | - | - | - | |
| | [Pr.42] | External command function selection | ○ | ○ | ○ | ○ | ○ | ◎ | ○ | - | - | - | ○ | - | 13.5.1 13.7.2 | |
| | [Pr.83] | Speed control 10 x multiplier setting for degree axis | ○ | ○ | ○ | ○ | ○ | ○ | - | - | ○ | ○ | ○ | ○ | 13.7.10 | |
| | [Pr.84] | Restart allowable range when servo OFF to ON | ○ | ○ | ○ | ○ | ○ | ○ | ○ | ○ | ○ | ○ | ○ | - | 5.2.4 | |
| [Pr.89] | Manual pulse generator/Incremental synchronous encoder input type selection | - | - | - | - | - | - | - | - | ◎ | - | - | - | 5.2.4 | | |
| [Pr.90] | Operation setting for speed-torque control mode | - | - | - | - | - | - | - | - | - | - | - | ○ | 12.1 | | |
| [Pr.95] | External command signal selection | ○ | ○ | ○ | ○ | ○ | ◎ | ○ | - | - | - | ○ | - | - | | |

- ◎: Always set
- : Set as required ("-" when not required)
- : Setting not required (If the value is the default value or within the setting range, there is no problem.)

■ Checking the positioning parameters

[Pr.1] to [Pr.90], [Pr.95] are checked with the following timing.

- When the "PLC READY signal [Y0]" output from the PLC CPU to the Simple Motion module changes from OFF to ON.
- When the positioning test of GX Works2 is executed.

REMARK

"High-level positioning control" is carried out in combination with the "major positioning control".

Refer to the "major positioning control" parameter settings for details on the parameters required for "high-level positioning control".

5.1.3 Setting items for HPR parameters

When carrying out "HPR control", the "HPR parameters" must be set. The setting items for the "HPR parameters" are shown below.

The "HPR parameters" are set for each axis.

Refer to Chapter 8 "HPR control" for details on the "HPR control", and refer to Section 5.2 "List of parameters" for details on each setting item.

| HPR parameters | | HPR control | Machine HPR control | | | | | Fast HPR control | |
|-------------------------|--|---|----------------------|-----------------|-----------------|-----------------|--------------------------------------|-------------------|---|
| HPR basic parameters | [Pr.43] HPR method | | [RJ010 mode] | | | | | [CiA402 mode] | - |
| | | | Proximity dog method | Count method 1) | Count method 2) | Data set method | Scale origin signal detection method | Driver HPR method | |
| [Pr.44] | HPR direction | | ⊙ | ⊙ | ⊙ | ⊙ | ⊙ | ○ (Note-1) | - |
| [Pr.45] | HP address | | ⊙ | ⊙ | ⊙ | ⊙ | ⊙ | ⊙ | ⊙ |
| [Pr.46] | HPR speed | | ⊙ | ⊙ | ⊙ | - | ⊙ | - | ⊙ |
| [Pr.47] | Creep speed [RJ010 mode] | | ⊙ | ⊙ | ⊙ | - | ⊙ | - | - |
| [Pr.48] | HPR retry [RJ010 mode] | | R | R | R | - | - | - | - |
| HPR detailed parameters | [Pr.50] | Setting for the movement amount after proximity dog ON [RJ010 mode] | - | ⊙ | ⊙ | - | - | - | - |
| | [Pr.51] | HPR acceleration time selection | ⊙ | ⊙ | ⊙ | - | ⊙ | - | ⊙ |
| | [Pr.52] | HPR deceleration time selection | ⊙ | ⊙ | ⊙ | - | ⊙ | - | ⊙ |
| | [Pr.53] | HP shift amount [RJ010 mode] | S | S | S | - | S | - | - |
| | [Pr.54] | HPR torque limit value [RJ010 mode] | ○ | ○ | ○ | - | ○ | - | ⊙ |
| | [Pr.55] | Operation setting for incompleteness of HPR | ○ | ○ | ○ | ○ | ○ | ○ | - |
| | [Pr.56] | Speed designation during HP shift [RJ010 mode] | S | S | S | - | S | - | - |
| [Pr.57] | Dwell time during HPR retry [RJ010 mode] | R | R | R | - | - | - | - | |

⊙ : Always set

○ : Set as required

- : Setting not required (If the value is the default value or within the setting range, there is no problem.)

R : Set when using the "13.2.1 HPR retry function". ("-" when not set.)

S : Set when using the "13.2.2 HP shift function". ("-" when not set.)

(Note-1): The HPR operation follows the HPR direction set in the driver (servo amplifier) and does not refer to "[Pr.44] HPR direction". However, "[Pr.44] HPR direction" must be set when using the backlash compensation function.

When the positioning is executed in the reverse direction against "[Pr.44] HPR direction", the backlash compensation is executed in the axis operation such as positioning after the driver HPR. Set the same direction to "[Pr.44] HPR direction" of the Simple Motion module and the last HPR direction of the driver (servo amplifier).

■ Checking the HPR parameters

[Pr.43] to [Pr.57] are checked with the following timing.

- When the "PLC READY signal [Y0]" output from the PLC CPU to the Simple Motion module changes from OFF to ON.
- When the positioning test of GX Works2 is executed.

5.1.4 Setting items for expansion parameters

The setting items for the "expansion parameters" are shown below. The "expansion parameters" are set for each axis.

Refer to "Section 2" for details on the each control, and refer to Section 5.2 "List of parameters" for details on each setting item.

| Expansion parameter | | Related sub function |
|---------------------|---|----------------------|
| [Pr.96] | Operation cycle setting | — |
| [Pr.113] | Servo parameter transmission [RJ010 mode] | — |
| [Pr.132] | Communication mode setting | — |

5.1.5 Setting items for servo parameters

The servo parameters are used to control the servo motor and the data that is determined by the specification of the servo amplifier being used.

The setting item is different depending on the servo amplifier being used.

Refer to Section 5.2.8 "Servo parameters" for details.

5.1.6 Setting items for positioning data

Positioning data must be set for carrying out any "major positioning control". The table below lists the items to be set for producing the positioning data.

One to 600 positioning data items can be set for each axis.

For details of the major positioning controls, refer to Chapter 9 "Major Positioning Control". For details of the individual setting items, refer to Section 5.3 "List of positioning data".

| Major positioning control | | | Position control | | | | | Other control | | | | | |
|---------------------------|---|--|--|---|--|--|--|-------------------------------------|------------------------------|--|---|------|------|
| | | | 1-axis linear control 2/3/4-axis linear interpolation control | 1-axis fixed-feed control 2/3/4-axis fixed-feed control | 2-axis circular interpolation control | 1 to 4 axis speed control | Speed-position switching control | Position-speed switching control | NOP instruction | Current value changing | JUMP instruction | LOOP | LEND |
| [Da.1] | Operation pattern | Independent positioning control (Positioning complete) | ◎ | ◎ | ◎ | ◎ | ◎ | ◎ | - | ◎ | - | - | - |
| | | Continuous positioning control | ◎ | ◎ | ◎ | × | ◎ | × | - | ◎ | - | - | - |
| | | Continuous path control | ◎ | × | ◎ | × | × | × | - | × | - | - | - |
| [Da.2] | Control method | Linear 1 Linear 2 Linear 3 Linear 4 * | Fixed- feed 1 Fixed- feed 2 Fixed- feed 3 Fixed- feed 4 | Circular sub Circular right Circular left * | Forward run speed 1 Reverse run speed 1 Forward run speed 2 Reverse run speed 2 Forward run speed 3 Reverse run speed 3 Forward run speed 4 Reverse run speed 4 | Forward run speed/ position Reverse run speed/ position | Forward run position/ speed Reverse run position/ speed | NOP | Current value changing | JUMP instruction | LOOP | LEND | |
| [Da.3] | Acceleration time No. | ◎ | ◎ | ◎ | ◎ | ◎ | ◎ | - | - | - | - | - | |
| [Da.4] | Deceleration time No. | ◎ | ◎ | ◎ | ◎ | ◎ | ◎ | - | - | - | - | - | |
| [Da.6] | Positioning address/ movement amount | ◎ | ◎ | ◎ | - | ◎ | ◎ | - | New address | - | - | - | |
| [Da.7] | Arc address | - | - | ◎ | - | - | - | - | - | - | - | - | |
| [Da.8] | Command speed | ◎ | ◎ | ◎ | ◎ | ◎ | ◎ | - | - | - | - | - | |
| [Da.9] | Dwell time/JUMP destination positioning data No. | ○ | ○ | ○ | - | ○ | ○ | - | - | JUMP destination positioning data No. | - | - | |
| [Da.10] | M code/Condition data No./ Number of LOOP to LEND repetitions | ○ | ○ | ○ | ○ | ○ | ○ | - | ○ | JUMP condition data No. | Number of LOOP to LEND repetitions | - | |

◎ : Always set

○ : Set as required ("-" when not required)

× : Setting not possible (If set, the error "Continuous path control not possible" (error code: 516) will occur at start.)

- : Setting not required (If the value is the default value or within the setting range, there is no problem.)

* : Two control systems are available: the absolute (ABS) system and incremental (INC) system.

| Major positioning control | | Position control | | | 1 to 4 axis speed control | Speed-position switching control | Position-speed switching control | Other control | | | | | |
|---------------------------|---------------------------|--|--|---------------------------------------|---------------------------|----------------------------------|----------------------------------|-----------------|------------------------|------------------|------|------|---|
| | | 1-axis linear control 2/3/4-axis linear interpolation control | 1-axis fixed-feed control 2/3/4-axis fixed-feed control | 2-axis circular interpolation control | | | | NOP instruction | Current value changing | JUMP instruction | LOOP | LEND | |
| Positioning data | | | | | | | | | | | | | |
| [Da.20] | Axis to be interpolated 1 | ◎: 2 axes, 3 axes, 4 axes -: 1 axis | | | - | - | - | - | - | - | - | - | - |
| [Da.21] | Axis to be interpolated 2 | ◎: 3 axes, 4 axes -: 1 axis, 2 axes | | | - | - | - | - | - | - | - | - | - |
| [Da.22] | Axis to be interpolated 3 | ◎: 4 axes -: 1 axis, 2 axes, 3 axes | | | - | - | - | - | - | - | - | - | - |

- ◎ : Always set
- : Set as required ("-" when not required)
- × : Setting not possible (If set, the error "Continuous path control not possible" (error code: 516) will occur at start.)
- : Setting not required (If the value is the default value or within the setting range, there is no problem.)
- * : Two control systems are available: the absolute (ABS) system and incremental (INC) system.

■ Checking the positioning data

[Da. 1] to [Da. 10], [Da.20] to [Da.22] are checked at the following timings:

- Startup of a positioning operation

5.1.7 Setting items for block start data

The "block start data" must be set when carrying out "high-level positioning control". The setting items for the "block start data" are shown below. Up to 50 points of "block start data" can be set for each axis. Refer to Chapter 10 "High-Level Positioning Control" for details on the "high-level positioning control", and to Section 5.4 "List of block start data" for details on each setting item.

| High-level positioning control | | Block start (Normal start) | Condition start | Wait start | Simultaneous start | Repeated start (FOR loop) | Repeated start (FOR condition) |
|--------------------------------|---------------------------|----------------------------|-----------------|------------|--------------------|---------------------------|--------------------------------|
| Block start data | | | | | | | |
| [Da. 11] | Shape (end/continue) | ○ | ○ | ○ | ○ | ○ | ○ |
| [Da. 12] | Start data No. | ○ | ○ | ○ | ○ | ○ | ○ |
| [Da. 13] | Special start instruction | - | ○ | ○ | ○ | ○ | ○ |
| [Da. 14] | Parameter | - | ○ | ○ | ○ | ○ | ○ |

- : Set as required ("-" when not required)
- : Setting not required (If the value is the default value or within the setting range, there is no problem.)

■ Checking the block start data

[Da. 11] to [Da. 14] are checked with the following timing.

- When "Block start data" starts

5.1.8 Setting items for condition data

When carrying out "high-level positioning control" or using the JUMP instruction in the "major positioning control", the "condition data" must be set as required. The setting items for the "condition data" are shown below.

Up to 10 "condition data" items can be set for each axis.

Refer to Chapter 10 "High-Level Positioning Control" for details on the "high-level positioning control", and to Section 5.5 "List of condition data" for details on each setting item.

| Control Condition data | | Major positioning control | | High-level positioning control | | | | | |
|---------------------------|--------------------------------------|-----------------------------|------------------|--------------------------------|-----------------|------------|--------------------|---------------------------|--------------------------------|
| | | Other than JUMP instruction | JUMP instruction | Block start (Normal start) | Condition start | Wait start | Simultaneous start | Repeated start (FOR loop) | Repeated start (FOR condition) |
| [Da.15] | Condition target | – | ○ | – | ○ | ○ | ○ | – | ○ |
| [Da.16] | Condition operator | – | ○ | – | ○ | ○ | ○ | – | ○ |
| [Da.17] | Address | – | △ | – | △ | △ | – | – | △ |
| [Da.18] | Parameter 1 | – | ○ | – | ○ | ○ | △ | – | ○ |
| [Da.19] | Parameter 2 | – | △ | – | △ | △ | △ | – | △ |
| [Da.23] | Number of simultaneous starting axes | – | – | – | – | – | ○ | – | – |
| [Da.24] | Simultaneous starting axis No.1 | – | – | – | – | – | ○ | – | – |
| [Da.25] | Simultaneous starting axis No.2 | – | – | – | – | – | ○ | – | – |
| [Da.26] | Simultaneous starting axis No.3 | – | – | – | – | – | ○ | – | – |

○ : Set as required ("–" when not required)

△ : Setting limited

– : Setting not required (If the value is the default value or within the setting range, there is no problem.)

■ Checking the condition data

[Da.15] to [Da.19], [Da.23] to [Da.26] are checked with the following timing.

- When "Block start data" starts
- When "JUMP instruction" starts

5.1.9 Types and roles of monitor data

The monitor data area in the buffer memory stores data relating to the operating state of the positioning system, which are monitored as required while the positioning system is operating.

The following data are available for monitoring.

- System monitoring:

Monitoring of the specification and operation history of Simple Motion module (system monitor data [Md.1] to [Md.19], [Md.50], [Md.54] to [Md.59], [Md.130] to [Md.135])

- Axis operation monitoring:

Monitoring of the current position and speed, and other data related to the movements of axes (axis monitor data [Md.20] to [Md.48], [Md.100] to [Md.117], [Md.120] to [Md.123], [Md.514])

[1] Monitoring the system

■ Monitoring the positioning system operation history

| Monitoring details | | Corresponding item | | |
|--|--|--------------------|--|--|
| Whether the system is in the test mode or not | | [Md.1] | In test mode flag | |
| History of data that started an operation | Start information | [Md.3] | Start information | |
| | Start No. | [Md.4] | Start No. | |
| | Start | Year: month | [Md.54] | Start Year: month |
| | | Day: hour | [Md.5] | Start Day: hour |
| | | Minute: second | [Md.6] | Start Minute: second |
| | Error upon starting | | [Md.7] | Error judgment |
| Pointer No. next to the pointer No. where the latest history is stored | | [Md.8] | Start history pointer | |
| History of all errors | Axis in which the error occurred | | [Md.9] Axis in which the error occurred | |
| | Axis error No. | | [Md.10] Axis error No. | |
| | Servo alarm | | [Md.57] Servo alarm | |
| | Axis error occurrence | Year: month | [Md.55] | Axis error occurrence (Year: month) |
| | | Day: hour | [Md.11] | Axis error occurrence (Day: hour) |
| | | Minute: second | [Md.12] | Axis error occurrence (Minute: second) |
| Pointer No. next to the pointer No. where the latest history is stored | | [Md.13] | Error history pointer | |
| History of all warnings | Axis in which the warning occurred | | [Md.14] Axis in which the warning occurred | |
| | Axis warning No. | | [Md.15] Axis warning No. | |
| | Servo warning | | [Md.58] Servo warning | |
| | Axis warning occurrence | Year: month | [Md.56] | Axis warning occurrence (Year: month) |
| | | Day: hour | [Md.16] | Axis warning occurrence (Day: hour) |
| | | Minute: second | [Md.17] | Axis warning occurrence (Minute: second) |
| Pointer No. next to the pointer No. where the latest history is stored | | [Md.18] | Warning history pointer | |
| Number of write accesses to the flash ROM after the power is switched ON | Number of write accesses to flash ROM | [Md.19] | Number of write accesses to flash ROM | |
| Forced stop input signal (EMI) turn ON/OFF | Forced stop input signal (EMI) information | [Md.50] | Forced stop input | |
| Monitor the first five digits of product information. | | [Md.130] | OS version | |
| Monitor the RUN status of digital oscilloscope. | | [Md.131] | Digital oscilloscope running flag | |
| Monitor the current operation cycle. | | [Md.132] | Operation cycle setting | |
| Monitor whether the operation cycle time exceeds operation cycle. | | [Md.133] | Operation cycle over flag | |
| Monitor the time that took for operation every operation cycle. | | [Md.134] | Operation time | |
| Monitor the maximum value of operation time after each module's power supply ON. | | [Md.135] | Maximum operation time | |
| Store the module information. | | [Md.59] | Module information | |

[2] Monitoring the axis operation state

■ Monitoring the position

| Monitor details | Corresponding item |
|---|----------------------------|
| Monitor the current feed machine value. | [Md.21] Feed machine value |
| Monitor the current "feed current value". | [Md.20] Feed current value |
| Monitor the current target value. | [Md.32] Target value |

■ Monitoring the speed

| Monitor details | | Corresponding item | |
|--|--|--|-------------------------------------|
| Monitor the current speed. | During independent axis control | Indicates the speed of each axis. | |
| | During interpolation control | When "0: Composite speed" is set for "[Pr.20] Interpolation speed designation method" | Indicates the composite speed. |
| | | When "1: Reference axis speed" is set for "[Pr.20] Interpolation speed designation method" | Indicates the reference axis speed. |
| | Monitor "[Da.8] Command speed" currently being executed. | | [Md.27] Current speed |
| | Constantly indicates the speed of each axis. | | [Md.28] Axis feedrate |
| Monitor the current target speed. | | [Md.33] Target speed | |
| Monitor the command speed at speed control mode in the speed-torque control. | | [Md.122] Speed during command | |

■ Monitoring the status of servo amplifier

| Monitor details | Corresponding item |
|---|---|
| Monitor the real current value (feed current value - deviation counter). | [Md.101] Real current value |
| Monitor the droop pulse. | [Md.102] Deviation counter value |
| Monitor the motor speed of servo motor. | [Md.103] Motor rotation speed |
| Monitor the current value of servo motor. | [Md.104] Motor current value |
| Monitor the parameter No. that an error occurred. | [Md.107] Parameter error No. |
| Monitor the status (servo status) of servo amplifier. | [Md.108] Servo status |
| Monitor the percentage of regenerative power to permissible regenerative value. | [Md.109] Regenerative load ratio |
| Monitor the continuous effective load current. | [Md.110] Effective load torque |
| Monitor the maximum generated torque. | [Md.111] Peak torque ratio |
| Monitor the status of semi closed loop control/fully closed loop control. | [Md.113] Semi/Fully closed loop status |
| Monitor the alarm of servo amplifier. | [Md.114] Servo alarm |
| Monitor the CiA402 Statusword of servo amplifier. | [Md.117] Statusword [CiA402 mode] |
| Monitor the HPR operating status of servo amplifier. | [Md.514] HPR operating status [CiA402 mode] |

■ Monitoring the state

| Monitor details | Corresponding item |
|---|--|
| Monitor the axis operation state. | [Md.26] Axis operation status |
| Monitor the latest error code that occurred with the axis. | [Md.23] Axis error No. |
| Monitor the latest warning code that occurred with the axis. | [Md.24] Axis warning No. |
| Monitor the external input/output signal and flag. | [Md.30] External input signal |
| | [Md.31] Status |
| Monitor the valid M codes. | [Md.25] Valid M code |
| Monitor whether the speed is being limited. | [Md.39] In speed limit flag |
| Monitor whether the speed is being changed. | [Md.40] In speed change processing flag |
| Monitor the "start data" point currently being executed. | [Md.43] Start data pointer being executed |
| Monitor the "positioning data No." currently being executed. | [Md.44] Positioning data No. being executed |
| Monitor the remaining number of repetitions (special start). | [Md.41] Special start repetition counter |
| Monitor the remaining number of repetitions (control system). | [Md.42] Control system repetition counter |
| Monitor the block No. | [Md.45] Block No. being executed |
| Monitor the current torque limit value. | [Md.35] Torque limit stored value/forward torque limit stored value |
| | [Md.120] Reverse torque limit stored value |
| Monitor the command torque at torque control mode in the speed-torque control. | [Md.123] Torque during command |
| Monitor the "instruction code" of the special start data when using special start. | [Md.36] Special start data instruction code setting value |
| Monitor the "instruction parameter" of the special start data when using special start. | [Md.37] Special start data instruction parameter setting value |
| Monitor the "start data No." of the special start data when using special start. | [Md.38] Start positioning data No. setting value |
| Monitor the "positioning data No." executed last. | [Md.46] Last executed positioning data No. |
| Monitor the positioning data currently being executed. | [Md.47] Positioning data being executed |
| Monitor the movement amount after the current position control switching when using "speed-position switching control". | [Md.29] Speed-position switching control positioning movement amount |
| Monitor switching from the constant speed status or acceleration status to the deceleration status during position control whose operation pattern is "Positioning complete". | [Md.48] Deceleration start flag |
| Monitor the movement amount from proximity dog ON to machine HPR completion. | [Md.34] Movement amount after proximity dog ON [RJ010 mode] |
| Monitor the distance that travels to zero point after stop once at HPR. | [Md.100] HPR re-travel value [RJ010 mode] |

5.1.10 Types and roles of control data

Operation of the positioning system is achieved through the execution of necessary controls. (Data required for controls are given through the default values when the power is switched ON, which can be modified as required by the sequence program.) Items that can be controlled are described below.

- Controlling the system data :
Setting and resetting "setting data" of Simple Motion module (system control data [Cd.1], [Cd.2])
- Controlling the operation :
Setting operation parameters, changing speed during operation, interrupting or restarting operation, etc. (system control data [Cd.41], [Cd.42], [Cd.44], axis control data [Cd.3] to [Cd.40], [Cd.43], [Cd.45], [Cd.46], [Cd.100], [Cd.101], [Cd.108], [Cd.112], [Cd.113], [Cd.133], [Cd.136], [Cd.138] to [Cd.146], [Cd.180] to [Cd.183])

[1] Controlling the system data

■ Setting and resetting the setting data

| Control details | Controlled data item |
|---|---|
| Write setting data from buffer memory to flash ROM. | [Cd.1] Flash ROM write request |
| Reset (initialize) parameters. | [Cd.2] Parameter initialization request |

[2] Controlling the operation

■ Controlling the operation

| Control details | Corresponding item |
|---|---|
| Set which positioning to execute (start No.). | [Cd.3] Positioning start No. |
| Clear (reset) the axis error ([Md.23]) and warning ([Md.24]). | [Cd.5] Axis error reset |
| Issue instruction to restart (When axis operation is stopped). | [Cd.6] Restart command |
| Stop axis in control. | [Cd.180] Axis stop |
| Execute start request of JOG operation or inching operation. | [Cd.181] Forward run JOG start |
| | [Cd.182] Reverse run JOG start |
| Execute pre-reading at positioning start. | [Cd.183] Execution prohibition flag |
| Set start point No. for executing block start. | [Cd.4] Positioning starting point No. |
| Stop continuous control. | [Cd.18] Interrupt request during continuous operation |
| Set number of simultaneous starting axes and target axis. | [Cd.43] Simultaneous starting axis |
| Set start data No. of own axis at multiple axes simultaneous starting. | [Cd.30] Simultaneous starting own axis start data No. |
| Set start data No.1 for axes that start up simultaneously. | [Cd.31] Simultaneous starting axis start data No.1 |
| Set start data No.2 for axes that start up simultaneously. | [Cd.32] Simultaneous starting axis start data No.2 |
| Set start data No.3 for axes that start up simultaneously. | [Cd.33] Simultaneous starting axis start data No.3 |
| Specify write destination for teaching results. | [Cd.38] Teaching data selection |
| Specify data to be taught. | [Cd.39] Teaching positioning data No. |
| Set the status of the external input signal (upper/lower limit switch signal, proximity dog signal, stop signal). | [Cd.44] External input signal operation device |

■ Controlling operation per step

| Control details | Corresponding item |
|--|--------------------------------|
| Stop positioning operation after each operation. | [Cd.35] Step valid flag |
| Set unit to carry out step. | [Cd.34] Step mode |
| Continuous operation from stopped step. | [Cd.36] Step start information |

■ Controlling the speed

| Control details | Corresponding item |
|--|---|
| Set new speed when changing speed during operation. | [Cd.14] New speed value |
| Issue instruction to change speed in operation to [Cd.14] value. (Only during positioning operation and JOG operation). | [Cd.15] Speed change request |
| Change positioning operation speed between 1 and 300% range. | [Cd.13] Positioning operation speed override |
| Set inching movement amount. | [Cd.16] Inching movement amount |
| Set JOG speed. | [Cd.17] JOG speed |
| When changing acceleration time during speed change, set new acceleration time. | [Cd.10] New acceleration time value |
| When changing deceleration time during speed change, set new deceleration time. | [Cd.11] New deceleration time value |
| Set acceleration/deceleration time validity during speed change. | [Cd.12] Acceleration/deceleration time change value during speed change, enable/disable |

■ Making settings related to operation

| Control details | Corresponding item |
|--|--|
| Turn M code ON signal OFF. | [Cd.7] M code OFF request |
| Set new value when changing current value. | [Cd.9] New current value |
| Validate switching signal set in "[Cd.45] Speed-position switching device selection". | [Cd.24] Speed-position switching enable flag |
| Change movement amount for position control during speed-position switching control (INC mode). | [Cd.23] Speed-position switching control movement amount change register |
| Validate switching signal set in "[Cd.45] Speed-position switching device selection". | [Cd.26] Position-speed switching enable flag |
| Change speed for speed control during position-speed switching control. | [Cd.25] Position-speed switching control speed change register |
| Set up a flag when target position is changed during positioning. | [Cd.29] Target position change request flag |
| Set new positioning address when changing target position during positioning. | [Cd.27] Target position change value (New address) |
| Set new speed when changing target position during positioning. | [Cd.28] Target position change value (New speed) |
| Set absolute (ABS) moving direction in degrees. | [Cd.40] ABS direction in degrees |
| Set manual pulse generator operation validity. | [Cd.21] Manual pulse generator enable flag |
| Set scale per pulse of number of input pulses from manual pulse generator. | [Cd.20] Manual pulse generator 1 pulse input magnification |
| Change HPR request flag from "ON to OFF". | [Cd.19] HPR request flag OFF request |
| Validate external command signal. | [Cd.8] External command valid |
| Set "same setting/individual setting" of the forward torque limit value or reverse torque limit value in the torque change function. | [Cd.112] Torque change function switching request |
| Change "[Md.35] Torque limit stored value/forward torque limit stored value". | [Cd.22] New torque value/forward new torque value |
| Change "[Md.120] Reverse torque limit stored value". | [Cd.113] New reverse torque value |
| Set whether "[Md.48] Deceleration start flag" is valid or invalid. | [Cd.41] Deceleration start flag valid |

| Control details | | Corresponding item |
|---|---|---|
| Set the stop command processing for deceleration stop function (deceleration curve re-processing/deceleration curve continuation) | | [Cd.42] Stop command processing for deceleration stop selection |
| Set the device used for speed-position switching. | | [Cd.45] Speed-position switching device selection |
| Switch speed-position control. | | [Cd.46] Speed-position switching command |
| Turn the servo OFF for each axis. | | [Cd.100] Servo OFF command |
| Set torque limit value | | [Cd.101] Torque output setting value |
| Set whether gain switching is execution or not. | | [Cd.108] Gain switching command flag |
| Set the semi closed loop control/fully closed loop control. | | [Cd.133] Semi/Fully closed loop switching request |
| Set the PI-PID switching to servo amplifier. | | [Cd.136] PI-PID switching request |
| Speed-torque control | Switch the control mode. | [Cd.138] Control mode switching request |
| | Set the control mode to switch. | [Cd.139] Control mode setting |
| | Set the command speed during speed control mode. | [Cd.140] Command speed at speed control mode |
| | Set the acceleration time during speed control mode. | [Cd.141] Acceleration time at speed control mode |
| | Set the deceleration time during speed control mode. | [Cd.142] Deceleration time at speed control mode |
| | Set the command torque during torque control mode. | [Cd.143] Command torque at torque control mode |
| | Set the time constant at driving of torque control mode. | [Cd.144] Torque time constant at torque control mode (Forward direction) |
| | Set the time constant at regeneration of torque control mode. | [Cd.145] Torque time constant at torque control mode (Negative direction) |
| Set the speed limit value during torque control mode. | | [Cd.146] Speed limit value at torque control mode |

5.2 List of parameters

The setting items of the setting data are explained in this section.

- Guide to buffer memory address

In the buffer memory address, "n" in "1+150n", etc. indicates a value corresponding to axis No. such as the following table.

| Axis No. | n | Axis No. | n | Axis No. | n | Axis No. | n |
|----------|---|----------|---|----------|----|----------|----|
| 1 | 0 | 5 | 4 | 9 | 8 | 13 | 12 |
| 2 | 1 | 6 | 5 | 10 | 9 | 14 | 13 |
| 3 | 2 | 7 | 6 | 11 | 10 | 15 | 14 |
| 4 | 3 | 8 | 7 | 12 | 11 | 16 | 15 |

(Note-1): Calculate as follows for the buffer memory address corresponding to each axis.

(Example) For axis No. 16

$$1+150n \text{ ([Pr.4] Unit magnification (AM))} = 1+150 \times 15 = 2251$$

For the valid timing of each parameter, refer to "7.1.1 Configuration and roles of QD77GF memory".

5.2.1 Basic parameters 1

| Item | Setting value, setting range | | Default value | Buffer memory address |
|----------------------------|---|---|---------------|---------------------------|
| | Value set with GX Works2 | Value set with sequence program | | |
| [Pr.1] Unit setting | 0 : mm 1 : inch 2 : degree 3 : PLS | 0 1 2 3 | 3 | 0+150n |
| Movement amount per pulse | [Pr.2] Number of pulses per rotation (AP) (Unit : PLS) | 1 to 200000000 | 20000 | 2+150n 3+150n |
| | [Pr.3] Movement amount per rotation (AL) | The setting value range differs according to the "[Pr.1] Unit setting". | | 20000 4+150n 5+150n |
| Movement amount per pulse | [Pr.4] Unit magnification (AM) | 1 : 1 times | 1 | 1+150n |
| | | 10 : 10 times | 10 | |
| | | 100 : 100 times | 100 | |
| | | 1000 : 1000 times | 1000 | |
| [Pr.7] Bias speed at start | The setting value range differs according to the "[Pr.1] Unit setting". | | 0 | 6+150n 7+150n |

n: Axis No.-1

[Pr.1] Unit setting

Set the unit used for defining positioning operations. Choose from the following units depending on the type of the control target: mm, inch, degree, or PLS. Different units can be defined for different axes.

(Example) Different units (mm, inch, degree, and PLS) are applicable to different systems:

- mm or inch X-Y table, conveyor (Select mm or inch depending on the machine specifications.)
- degree Rotating body (360 degrees/rotation)
- PLS..... X-Y table, conveyor

*: When you change the unit, note that the values of other parameters and data will not be changed automatically.

After changing the unit, check if the parameter and data values are within the allowable range.

Set "degree" to exercise speed-position switching control (ABS mode).

[Pr.2] to [Pr.4] Electronic gear (Movement amount per pulse)

Mechanical system value used when the Simple Motion module performs positioning control.

The settings are made using [Pr.2] to [Pr.4].

The electronic gear is expressed by the following equation.

| |
|--|
| $\text{Electronic gear} = \frac{\text{[Pr.2] Number of pulses per rotation (AP)}}{\text{[Pr.3] Movement amount per rotation (AL)} \times \text{[Pr.4] Unit magnification (AM)}}$ |
|--|

*: When positioning has been performed, an error (mechanical system error) may be produced between the specified movement amount and the actual movement amount. (Refer to Section 13.3.2 "Electronic gear function".)

POINT

(1) Set the electronic gear within the following range.

If the value outside the setting range is set, the error "Outside electronic gear setting range" (error code: 907) will occur.

- Product information is before 150920000000000.

$$0.001 \leq \text{Electronic gear} \left(\frac{AP}{AL \times AM} \right) \leq 20000$$

- Product information is 150920000000000 or later.

$$0.001 \leq \text{Electronic gear} \left(\frac{AP}{AL \times AM} \right) \leq 320000$$

※: For the movement amount per rotation (AL) which is used for the calculation of the electronic gear above, convert into the unit shown in the "Value set with sequence program" of the table in "[Pr.3] Movement amount per rotation (AL)" and "[Pr.4] Unit magnification (AM)".

(2) The result of below calculation (round up after decimal point) is a minimum pulse when the feed current value is updated at follow-up processing. (The movement amount for droop pulse is reflected as the feed current value when the droop pulse becomes more than above calculated value in pulse unit of motor end.)

$$[\text{Pr.2}] \text{ Number of pulses per rotation (AP)} \div ([\text{Pr.3}] \text{ Movement amount per rotation (AL)} \times [\text{Pr.4}] \text{ Unit magnification (AM)})[\text{PLS}]$$

Refer to Section 13.8.2 for the follow-up processing.

(Example)

- When an error does not occur

In the case of AP = 4194304 [PLS], AL = 2000000 [$\times 10^{-5}$ degree], and AM = 1, the value is within the range as follows.

$$\text{Electronic gear} = \frac{AP}{AL \times AM} = \frac{4194304}{2000000 \times 1} = 2.097152$$

- When an error occurs

In the case of AP = 4194304 [PLS], AL = 10 [$\times 10^{-1}\mu\text{m}$], and AM = 1, the value is out of the range as follows.

$$\text{Electronic gear} = \frac{AP}{AL \times AM} = \frac{4194304}{10 \times 1} = 419430.4$$

[Pr.2] Number of pulses per rotation (AP)

Set the number of pulses required for a complete rotation of the motor shaft.
If you are using the Mitsubishi servo amplifier, set the value given as the "resolution per servomotor rotation" in the speed/position detector specifications.

$$\text{Number of pulses per rotation (AP)} = \text{Resolution per servomotor rotation}$$

[Pr.3] Movement amount per rotation (AL), [Pr.4] Unit magnification (AM)

The amount how the workpiece moves with one motor rotation is determined by the mechanical structure.

If the worm gear lead ($\mu\text{m}/\text{rev}$) is PB and the deceleration rate is $1/n$, then

$$\text{Movement amount per rotation (AL)} = \text{PB} \times 1/n$$

However, the maximum value that can be set for this "movement amount per rotation (AL)" parameter is 20000000.0 μm (20m). Set the "movement amount per rotation (AL)" as shown below so that the "movement amount per rotation (AL)" does not exceed this maximum value.

$$\begin{aligned} \text{Movement amount per rotation (AL)} \\ &= \text{PB} \times 1/n \\ &= \text{Movement amount per rotation (AL)} \times \text{Unit magnification (AM)} \end{aligned}$$

Note) The unit magnification (AM) is a value of 1, 10, 100 or 1000. If the "PB \times 1/n" value exceeds 20000000.0 μm (20m), adjust with the unit magnification so that the "movement amount per rotation (AL)" does not exceed 20000000.0 μm (20m).

*: Refer to Section 13.3.2 "Electronic gear function" information about electric gear.

| [Pr.1] setting value | Value set with GX Works2 (unit) | Value set with sequence program (unit) |
|----------------------|------------------------------------|--|
| 0 : mm | 0.1 to 2000000.0 (μm) | 1 to 200000000 ($\times 10^{-1}\mu\text{m}$) |
| 1 : inch | 0.00001 to 2000.00000 (inch) | 1 to 200000000 ($\times 10^{-5}\text{inch}$) |
| 2 : degree | 0.00001 to 2000.00000 (degree) | 1 to 200000000 ($\times 10^{-5}\text{degree}$) |
| 3 : PLS | 1 to 200000000 (PLS) | 1 to 200000000 (PLS) |

[Pr.7] Bias speed at start

Set the bias speed (minimum speed) upon starting. When using a stepping motor, etc., set it to start the motor smoothly. (If the motor speed at start is low, the stepping motor does not start smoothly.)

The specified "bias speed at start" will be valid during the following operations:

- Positioning operation
- HPR operation
- JOG operation

Set the value that the bias speed should not exceed "[Pr.8] Speed limit value".

| [Pr.1] setting value | Value set with GX Works2 (unit) | Value set with sequence program (unit) |
|----------------------|--------------------------------------|---|
| 0 : mm | 0.00 to 20000000.00 (mm/min) | 0 to 2000000000 ($\times 10^{-2}$ mm/min) |
| 1 : inch | 0.000 to 2000000.000 (inch/min) | 0 to 2000000000 ($\times 10^{-3}$ inch/min) |
| 2 : degree | 0.000 to 2000000.000 (degree/min) *1 | 0 to 2000000000 ($\times 10^{-3}$ degree/min) *2 |
| 3 : PLS | 0 to 1000000000 (PLS/s) | 0 to 1000000000 (PLS/s) |

*1: Range of speed limit value when "[Pr.83] Speed control 10 x multiplier setting for degree axis" is set to valid: 0.00 to 20000000.00 (degree/min)

*2: Range of speed limit value when "[Pr.83] Speed control 10 x multiplier setting for degree axis" is set to valid: 0 to 2000000000 ($\times 10^{-2}$ degree/min)

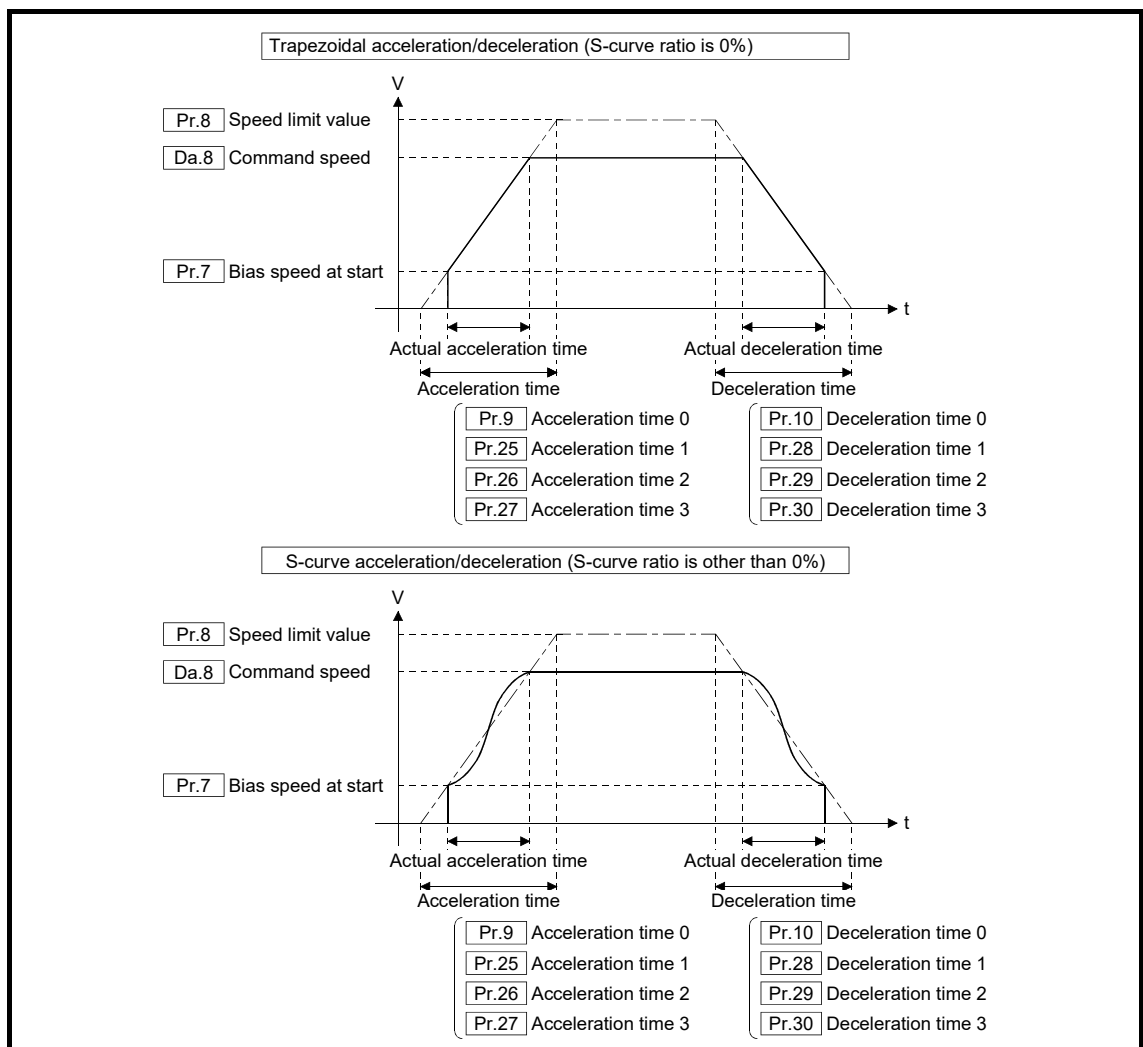

POINT

For the 2-axis or more interpolation control, the bias speed at start is applied by the setting of "[Pr.20] Interpolation speed designation method".

- "0: Composite speed" : Bias speed at start set to the reference axis is applied to the composite command speed.
- "1: Reference axis speed": Bias speed at start is applied to the reference axis.

(1) Precautionary notes

- (a) "[Pr.7] Bias speed at start" is valid regardless of motor type. Set "0" when using the motor other than the stepping motor. Otherwise, it may cause vibration or impact even though an error does not occur.
- (b) Set "[Pr.7] Bias speed at start" according to the specification of stepping motor driver. If the setting is outside the range, it may cause the following troubles by rapid speed change or overload.
 - Stepping motor steps out.
 - An error occurs in the stepping motor driver.
- (c) In synchronous control, when "[Pr.7] Bias speed at start" is set to the servo input axis, the bias speed at start is applied to the servo input axis. Note that the unexpected operation might be generated to the output axis.
- (d) Set "[Pr.7] Bias speed at start" within the following range.

"[Pr.8] Speed limit value" \geq "[Pr.46] HPR speed" \geq "[Pr.47] Creep speed" \geq "[Pr.7] Bias speed at start"

- (e) If following data are less than "[Pr.7] Bias speed at start", the warning "Below bias speed" (warning code: 114) will occur, and it will operate at "[Pr.7] Bias speed at start".
 - "[Da.8] Command speed" of positioning data
 - "[Da.8] Command speed" of next point for continuous path control
 - "[Cd.14] New speed value" for speed change function
- (f) When using S-curve acceleration/deceleration processing and bias speed at start together, S-curve acceleration/deceleration processing is carried out based on the acceleration/deceleration time set by user, "[Pr.8] Speed limit value" and "[Pr.35] S-curve ratio" (1 to 100%) in the section of acceleration/deceleration from bias speed at start to command speed.

5.2.2 Basic parameters 2

| Item | Setting value, setting range | | Default value | Buffer memory address |
|--------------------------------|---|---------------------------------|---------------|-----------------------|
| | Value set with GX Works2 | Value set with sequence program | | |
| [Pr.8] Speed limit value | The setting range differs depending on the "[Pr.1] Unit setting". | | 200000 | 10+150n 11+150n |
| [Pr.9] Acceleration time 0 | 1 to 8388608 (ms) | 1 to 8388608 (ms) | 1000 | 12+150n 13+150n |
| [Pr.10] Deceleration time 0 | 1 to 8388608 (ms) | 1 to 8388608 (ms) | 1000 | 14+150n 15+150n |

n: Axis No.-1

[Pr.8] Speed limit value

Set the maximum speed during positioning, HPR and speed-torque operations.

| [Pr.1] setting value | Value set with GX Works2 (unit) | Value set with sequence program (unit) |
|----------------------|--------------------------------------|---|
| 0 : mm | 0.01 to 20000000.00 (mm/min) | 1 to 2000000000 ($\times 10^{-2}$ mm/min) |
| 1 : inch | 0.001 to 2000000.000 (inch/min) | 1 to 2000000000 ($\times 10^{-3}$ inch/min) |
| 2 : degree | 0.001 to 2000000.000 (degree/min) *1 | 1 to 2000000000 ($\times 10^{-3}$ degree/min) *2 |
| 3 : PLS | 1 to 1000000000 (PLS/s) | 1 to 1000000000 (PLS/s) |

*1: Range of speed limit value when "[Pr.83] Speed control 10 x multiplier setting for degree axis" is set to valid: 0.01 to 20000000.00 (degree/min).

*2: Range of speed limit value when "[Pr.83] Speed control 10 x multiplier setting for degree axis" is set to valid: 1 to 2000000000 ($\times 10^{-2}$ degree/min)

[Pr.9] Acceleration time 0, [Pr.10] Deceleration time 0

"[Pr.9] Acceleration time 0" specifies the time for the speed to increase from zero to the "[Pr.8] Speed limit value" ("[Pr.31] JOG speed limit value" at JOG operation control).

"[Pr.10] Deceleration time 0" specifies the time for the speed to decrease from the "[Pr.8] Speed limit value" ("[Pr.31] JOG speed limit value" at JOG operation control) to zero.

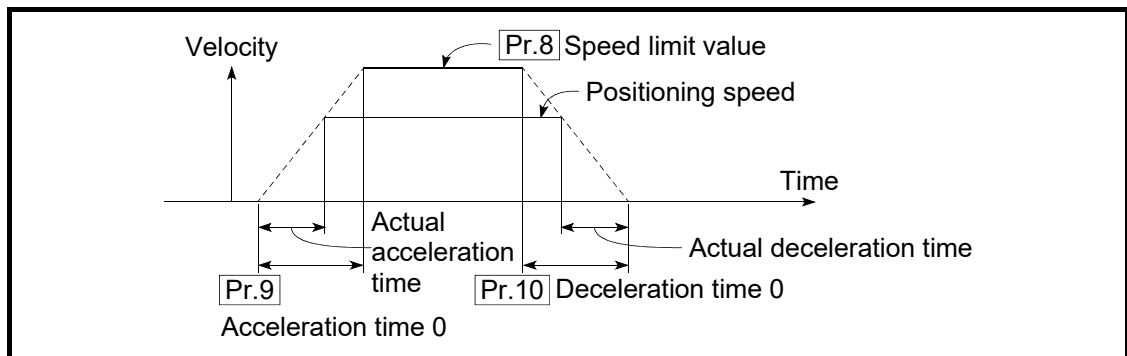

- 1) If the positioning speed is set lower than the parameter-defined speed limit value, the actual acceleration/deceleration time will be relatively short. Thus, set the maximum positioning speed equal to or only a little lower than the parameter-defined speed limit value.
- 2) These settings are valid for HPR, positioning and JOG operations.
- 3) When the positioning involves interpolation, the acceleration/deceleration time defined for the reference axis is valid.

5.2.3 Detailed parameters 1

| Item | Setting value, setting range | | Default value | Buffer memory address |
|--|---|---------------------------------|---------------|-----------------------|
| | Value set with GX Works2 | Value set with sequence program | | |
| [Pr.11] Backlash compensation amount | | | 0 | 17+150n |
| [Pr.12] Software stroke limit upper limit value | The setting value range differs according to the "[Pr.1] Unit setting". | | 2147483647 | 18+150n 19+150n |
| [Pr.13] Software stroke limit lower limit value | | | -2147483648 | 20+150n 21+150n |
| [Pr.14] Software stroke limit selection | 0: Apply software stroke limit on feed current value | 0 | 0 | 22+150n |
| | 1: Apply software stroke limit on feed machine value | 1 | | |
| [Pr.15] Software stroke limit valid/invalid setting | 0: Software stroke limit valid during JOG operation, inching operation and manual pulse generator operation | 0 | 0 | 23+150n |
| | 1: Software stroke limit invalid during JOG operation, inching operation and manual pulse generator operation | 1 | | |
| [Pr.16] Command in-position width | The setting value range differs depending on the "[Pr.1] Unit setting". | | 100 | 24+150n 25+150n |
| [Pr.17] Torque limit setting value | 1 to 1000 (%) | 1 to 1000 (%) | 300 | 26+150n |
| [Pr.18] M code ON signal output timing | 0: WITH mode | 0 | 0 | 27+150n |
| | 1: AFTER mode | 1 | | |
| [Pr.19] Speed switching mode | 0: Standard speed switching mode | 0 | 0 | 28+150n |
| | 1: Front-loading speed switching mode | 1 | | |
| [Pr.20] Interpolation speed designation method | 0: Composite speed | 0 | 0 | 29+150n |
| | 1: Reference axis speed | 1 | | |
| [Pr.21] Feed current value during speed control | 0: Do not update feed current value | 0 | 0 | 30+150n |
| | 1: Update feed current value | 1 | | |
| | 2: Clear feed current value to zero | 2 | | |

n: Axis No.-1

| Item | Setting value, setting range | | Default value | Buffer memory address |
|---|--|---|---------------|-----------------------|
| | Value set with GX Works2 | Value set with sequence program | | |
| [Pr.22] Input signal logic selection | b0 | Lower limit | 0 | 31+150n |
| | b1 | Upper limit | | |
| | b2 | Not used | | |
| | b3 | Stop signal | | |
| | b4 | External command/switching signal | | |
| | b5 | Not used | | |
| | b6 | Proximity dog signal | | |
| | b7 | Not used | | |
| | b8 | Manual pulse generator input (Note-1) | | |
| | b9 to b15 | Not used | | |
| | | 0: Negative logic 1: Positive logic (Note-1): Only the value specified against the axis 1 is valid. | | |
| | | | | |
| [Pr.80] External input signal selection | 1: External input signal of servo amplifier | 1 | 1 | 32+150n |
| | 2: Buffer memory of QD77GF | 2 | | |
| [Pr.24] Manual pulse generator/Incremental synchronous encoder input selection | 0: A-phase/B-phase multiplied by 4 | 0 | 0 | 33 |
| | 1: A-phase/B-phase multiplied by 2 | 1 | | |
| | 2: A-phase/B-phase multiplied by 1 | 2 | | |
| | 3: PLS/SIGN | 3 | | |
| [Pr.81] Speed-position function selection | 0: Speed-position switching control (INC mode) | 0 | 0 | 34+150n |
| | 2: Speed-position switching control (ABS mode) | 2 | | |
| [Pr.82] Forced stop valid/invalid selection | 0: Valid (External input signal) | 0 | 0 | 35 |
| | 1: Invalid | 1 | | |

n: Axis No.-1

[Pr.11] Backlash compensation amount

The error that occurs due to backlash when moving the machine via gears can be compensated.

(When the backlash compensation amount is set, commands equivalent to the compensation amount will be output each time the direction changes during positioning.)

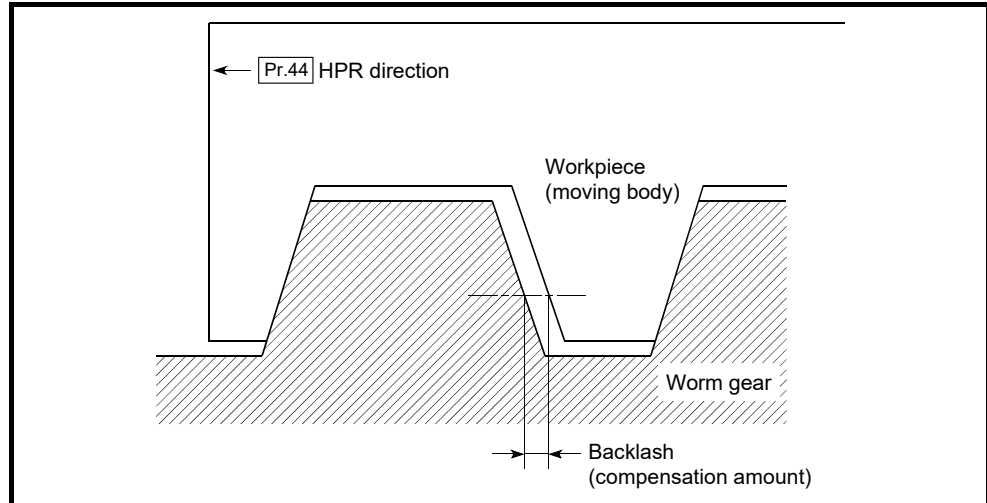

- 1) The backlash compensation is valid after machine HPR. Thus, if the backlash compensation amount is set or changed, always carry out machine HPR once.
- 2) "[Pr.2] Number of pulses per rotation (AP)", "[Pr.3] Movement amount per rotation (AL)", "[Pr.4] Unit magnification (AM)" and "[Pr.11] Backlash compensation amount" which satisfies the following (1) can be set up.

$$0 \leq \frac{([\text{Pr.11}] \text{ Backlash compensation amount}) \times ([\text{Pr.2}] \text{ Number of pulses per rotation (AP)})}{([\text{Pr.3}] \text{ Movement amount per rotation (AL)}) \times ([\text{Pr.4}] \text{ Unit magnification (AM)})} (= A) \leq 4194303 \text{ (PLS) } \dots(1)$$

(round down after decimal point)

The error "Backlash compensation amount error" (error code: 920) occurs when the setting is outside the range of the calculation result of (1).

A servo alarm (error code: 2031, 2035, etc.) may occur by kinds of servo amplifier (servomotor), load inertia moment and the amount of command of a cycle time (Simple Motion module) even if the setting is within the calculation result of (1).

Reduce the setting value of "[Pr.11] Backlash compensation amount" or increase the operation cycle by "[Pr.96] Operation cycle setting" if a servo alarm occurs. Use the value of the following (2) as a measure that a servo alarm does not occur.

$$A \leq \frac{(\text{Maximum motor speed (r/min)}) \times 1.2 \times (\text{Encoder resolution (PLS/r)}) \times (\text{Operation cycle (ms)})}{60(\text{s}) \times 1000 \text{ (ms)}} \text{ (PLS) } \dots(2)$$

All the backlash compensation amount is output in one operation cycle.

| [Pr.1] setting value | Value set with GX Works2 (unit) | Value set with sequence program (unit) * |
|----------------------|---------------------------------|--|
| 0 : mm | 0 to 6553.5 (μm) | 0 to 65535 (×10 ⁻¹ μm) |
| 1 : inch | 0 to 0.65535 (inch) | 0 to 65535 (×10 ⁻⁵ inch) |
| 2 : degree | 0 to 0.65535 (degree) | 0 to 65535 (×10 ⁻⁵ degree) |
| 3 : PLS | 0 to 65535 (PLS) | 0 to 65535 (PLS) |

* 0 to 32767 : Set as a decimal
 32768 to 65535 : Convert into hexadecimal and set

[Pr.12] Software stroke limit upper limit value

Set the upper limit for the machine's movement range during positioning control.

| [Pr.1] setting value | Value set with GX Works2 (unit) | Value set with sequence program (unit) |
|----------------------|------------------------------------|--|
| 0 : mm | -214748364.8 to 214748364.7 (μm) | -2147483648 to 2147483647 (×10 ⁻¹ μm) |
| 1 : inch | -21474.83648 to 21474.83647 (inch) | -2147483648 to 2147483647 (×10 ⁻⁵ inch) |
| 2 : degree | 0 to 359.99999 (degree) | 0 to 35999999 (×10 ⁻⁵ degree) |
| 3 : PLS | -2147483648 to 2147483647 (PLS) | -2147483648 to 2147483647 (PLS) |

[Pr.13] Software stroke limit lower limit value

Set the lower limit for the machine's movement range during positioning control.

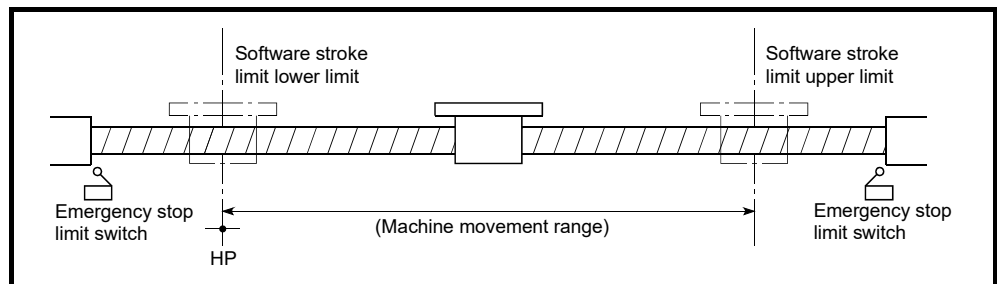

- 1) Generally, the HP is set at the lower limit or upper limit of the stroke limit.
- 2) By setting the upper limit value or lower limit value of the software stroke limit, overrun can be prevented in the software. However, an emergency stop limit switch must be installed nearby outside the range.
 To invalidate the software stroke limit, set the setting value to "upper limit value = lower limit value". (If it is within the setting range, the setting value can be anything.)
 When the unit is "degree", the software stroke limit check is invalid during speed control (including the speed control in speed-position and position-speed switching control) or during manual control.

[Pr.14] Software stroke limit selection

Set whether to apply the software stroke limit on the "feed current value" or the "feed machine value". The software stroke limit will be validated according to the set value.

To invalidate the software stroke limit, set the setting value to "feed current value". When "2: degree" is set in "[Pr.1] Unit setting", set the setting value of software stroke limit to "feed current value".

The error "Software stroke limit selection" (error code: 923) will occur if "feed machine value" is set.

[Pr.15] Software stroke limit valid/invalid setting

Set whether to validate the software stroke limit during JOG/Inching operation and manual pulse generator operation.

[Pr.16] Command in-position width

Set the remaining distance that turns the command in-position flag ON. When the remaining distance to the stop position during the automatic deceleration of positioning control becomes equal to or less than the value set in the command in-position width, the command in-position flag turns ON.

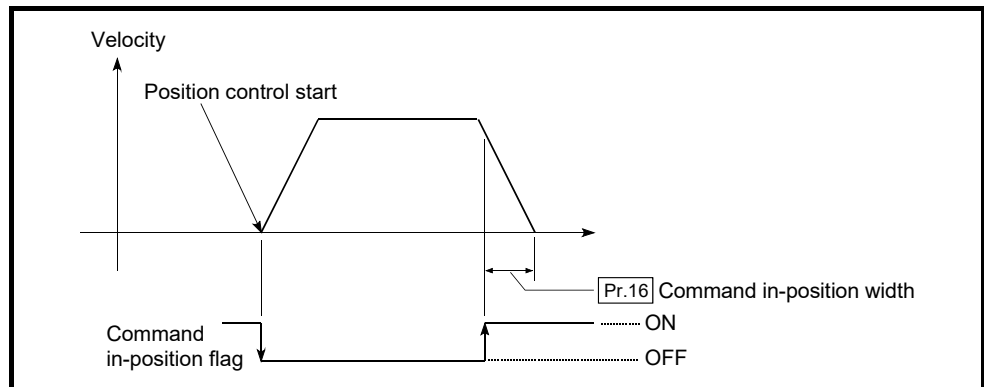

| [Pr.1] setting value | Value set with GX Works2 (unit) | Value set with sequence program (unit) |
|----------------------|--------------------------------------|--|
| 0 : mm | 0.1 to 214748364.7 (μm) | 1 to 2147483647 ($\times 10^{-1} \mu\text{m}$) |
| 1 : inch | 0.00001 to 21474.83647 (inch) | 1 to 2147483647 ($\times 10^{-5} \text{inch}$) |
| 2 : degree | 0.00001 to 21474.83647 (degree) | 1 to 2147483647 ($\times 10^{-5} \text{degree}$) |
| 3 : PLS | 1 to 2147483647 (PLS) | 1 to 2147483647 (PLS) |

[Pr.17] Torque limit setting value

Set the maximum value of the torque generated by the servomotor as a percentage between 1 and 1000%.

* The torque limit function limits the torque generated by the servomotor within the set range.

If the torque required for control exceeds the torque limit value, it is controlled with the set torque limit value.

(Refer to Section 13.4.2 "Torque limit function".)

[Pr.18] M code ON signal output timing

This parameter sets the M code ON signal output timing.

Choose either WITH mode or AFTER mode as the M code ON signal output timing.

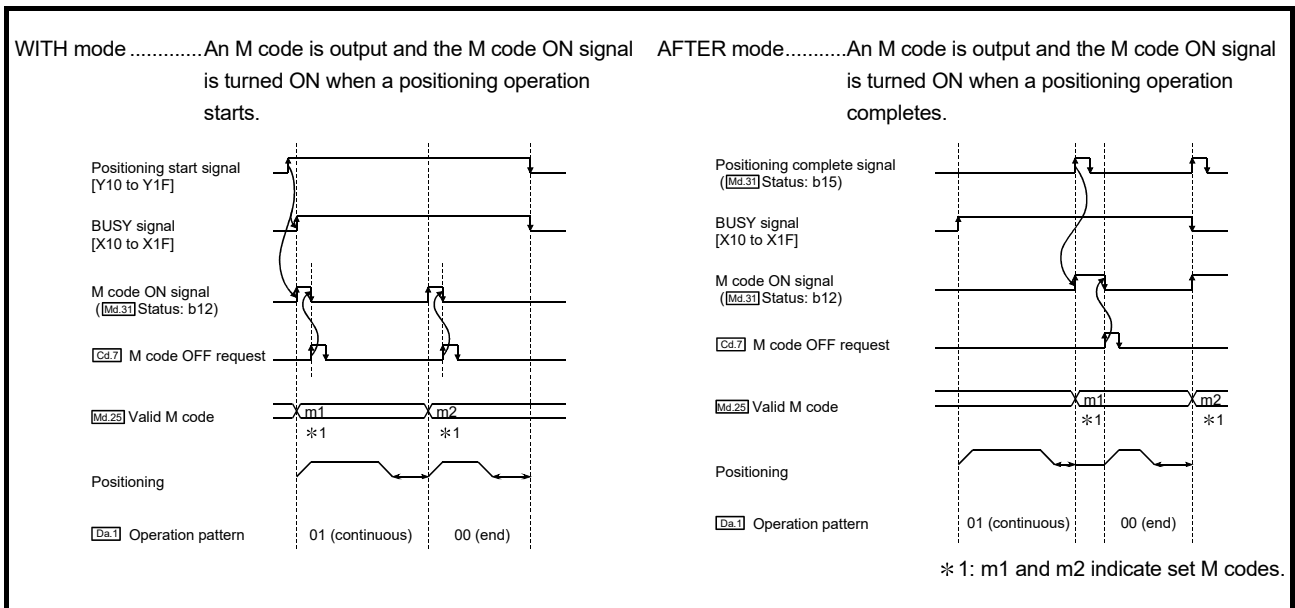

Note: If AFTER mode is used with speed control, an M code will not be output and the M code ON signal will not be turned ON.

An M code is a number between 0 and 65535 that can be assigned to each positioning data ([Da.10]).

The sequence program can be coded to read an M code from the buffer memory address specified by "[Md.25] Valid M code" whenever the M code ON signal turns ON so that a command for the sub work (e.g. clamping, drilling, or tool change) associated with the M code can be issued.

[Pr.19] Speed switching mode

Set whether to switch the speed switching mode with the standard switching or front-loading switching mode.

- Speed of positioning data No.n > Speed of positioning data No.n + 1
The speed decelerates by deceleration time No. of positioning data No.n + 1.
- Speed of positioning data No.n < Speed of positioning data No.n + 1
The speed accelerates by acceleration time No. of positioning data No.n + 1.

0 : Standard switching Switch the speed when executing the next positioning data.

1 : Front-loading switching..... The speed switches at the end of the positioning data currently being executed.

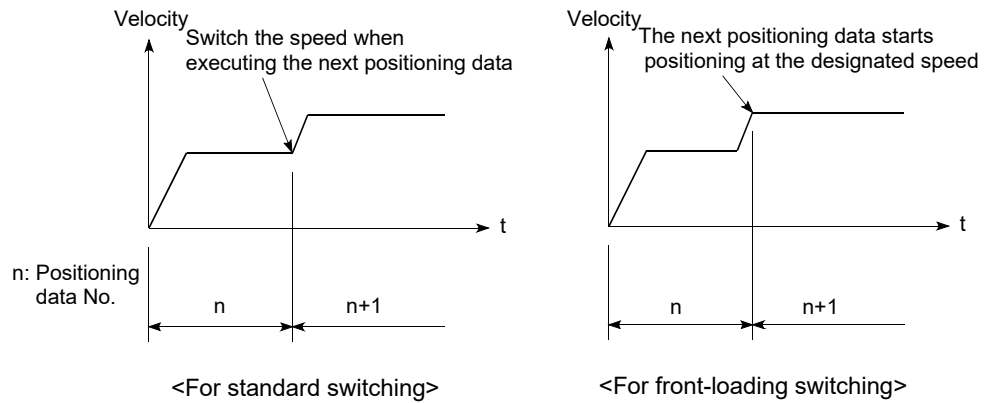

[Pr.20] Interpolation speed designation method

When carrying out linear interpolation/circular interpolation, set whether to designate the composite speed or reference axis speed.

0: Composite speed The movement speed for the control target is designated, and the speed for each axis is calculated by the Simple Motion module.

1: Reference axis speed The axis speed set for the reference axis is designated, and the speed for the other axis carrying out interpolation is calculated by the Simple Motion module.

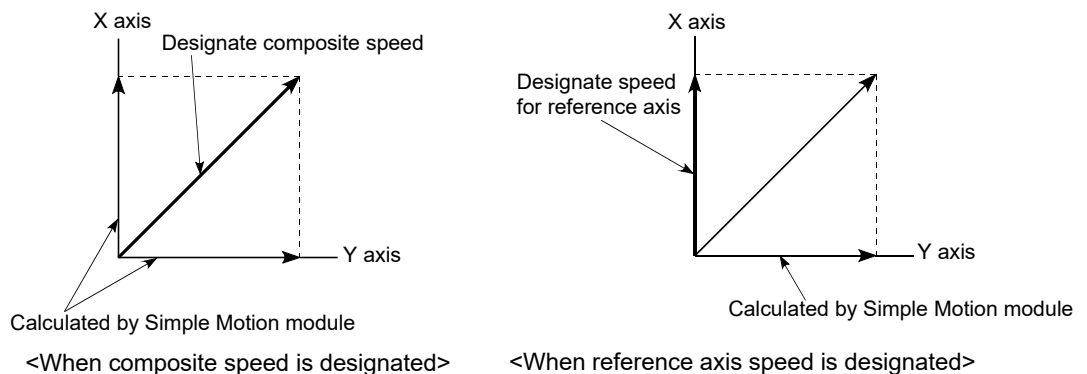

Note: Always specify the reference axis speed if the 4-axis linear interpolation or 2 to 4 axis speed control has to be performed.

If you specify the composite speed for a positioning operation that involves the 4-axis linear interpolation or 2 to 4 axis speed control, the error "Interpolation mode error" (error code: 523) will be output when the positioning operation is attempted.

For a positioning operation that involves the circular interpolation, specify the composite speed always. If you specify the reference axis speed for a positioning operation that involves the circular interpolation, the error "Interpolation mode error" (error code: 523) will occur when the positioning operation is attempted.

[Pr.21] Feed current value during speed control

Specify whether you wish to enable or disable the update of "[Md.20] Feed current value" while operations are performed under the speed control (including the speed control in speed-position and position-speed switching control).

0: The update of the feed current value is disabled

The feed current value will not change.
(The value at the beginning of the speed control will be kept.)

1: The update of the feed current value is enabled

The feed current value will be updated.
(The feed current value will change from the initial.)

2: The feed current value is cleared to zero

The feed current value will be set initially to zero and change from zero while the speed control is in effect.

Note1: When the speed control is performed over two to four axes, the choice between enabling and disabling the update of "[Md.20] Feed current value" depends on how the reference axis is set.

Note2: Set "1" to exercise speed-position switching control (ABS mode).

[Pr.22] Input signal logic selection

Set the input signal logic that matches the signaling specification of the connected external device, "[Cd.44] External input signal operation device" or external input signal of servo amplifier (upper/lower limit switch, proximity dog).

Negative logic

(1) The current is not flowed through the input signal contact.

(a) FLS, RLSLimit signal ON

(b) DOG, DI, STOP ..Invalid

(2) The current is flowed through the input signal contact.

(a) FLS, RLSLimit signal OFF

(b) DOG, DI, STOP ..Valid

Positive logic

Opposite the concept of negative logic.

Note1: A mismatch in the signal logic will disable normal operation. Be careful of this when you change from the default value.

Note2: Set the manual pulse generator input logic selection (b8) to axis 1. (Setting of any of axes 2 to 4 is invalid.)

Note3: If the same external input signal is set to use to "[Pr.80] External input signal selection" or "[Pr.95] External command signal selection" for the multiple axes "Input signal logic selection" of those axes should be the same. Otherwise, the error "Input signal logic selection setting error" (error code: 938) will occur when the PLC READY signal [Y0] is turned ON, and the READY signal [X0] will not be turned ON.

Note4: When using the servo amplifier input, the logic selection setting for FLS/RLS is ignored. (The LSP/LSN input is used for the MR-J4-GF.) [CiA402 mode]

[Pr.80] External input signal selection

Set whether to use "external input signal of servo amplifier" or "buffer memory of QD77GF" as an external input signal (upper/lower limit signal or proximity dog signal)".

- 1: External input signal of servo amplifier
- 2: Buffer memory of QD77GF

| POINT |
|--|
| (1) When "2: Buffer memory of QD77GF" is set, operation is affected by the PLC scan time. |
| (2) When "1: External input signal of servo amplifier" is set, use a servo amplifier which enables input of the external input signal. |
| (3) When "0" or "3" to "6" is set, the error "External input signal selection error" (error code: 936) occurs at turning the PLC READY signal [Y0] ON, and the READY signal [X0] is not turned ON. |

[Pr.24] Manual pulse generator/Incremental synchronous encoder input selection

Set the manual pulse generator/incremental synchronous encoder input pulse mode. (Only the value specified against the axis 1 is valid.)

- 0: A-phase/B-phase multiplied by 4
- 1: A-phase/B-phase multiplied by 2
- 2: A-phase/B-phase multiplied by 1
- 3: PLS/SIGN

Set the positive logic or negative logic in "[Pr.22] Input signal logic selection".

- (1) A-phase/B-phase mode
 - When the A-phase is 90° ahead of the B-phase, the motor will forward run.
 - When the B-phase is 90° ahead of the A-phase, the motor will reverse run.
- (a) A-phase/B-phase multiplied by 4

The positioning address increases or decreases at rising or falling edges of A-phase/B-phase.

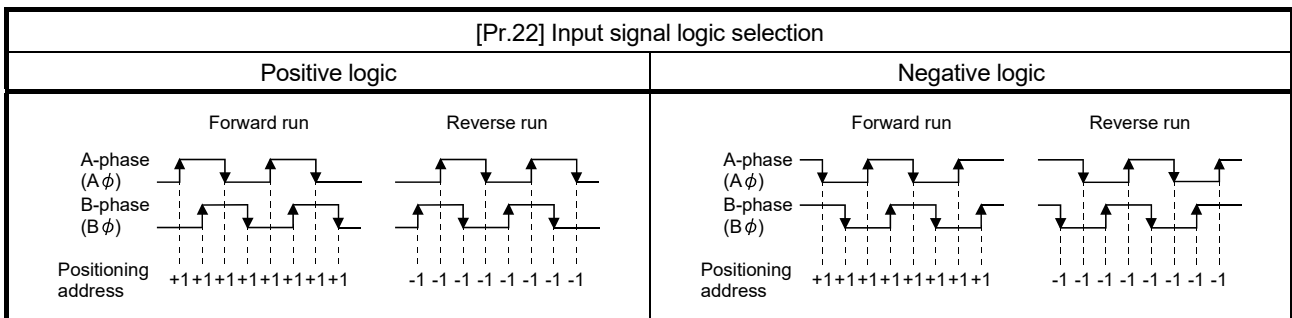

- (b) A-phase/B-phase multiplied by 2
 The positioning address increases or decreases at twice rising or twice falling edges of A-phase/B-phase.

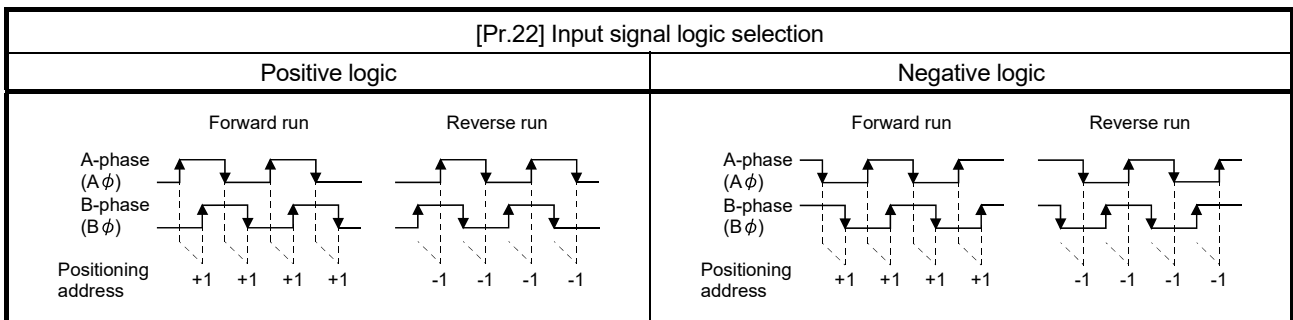

- (c) A-phase/B-phase multiplied by 1
 The positioning address increases or decreases at twice rising or twice falling edges of A-phase/B-phase.

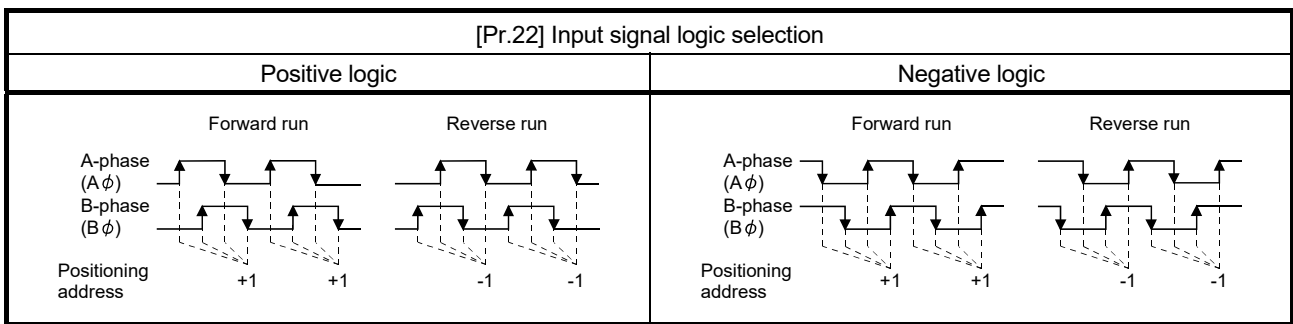

(2) PLS/SIGN

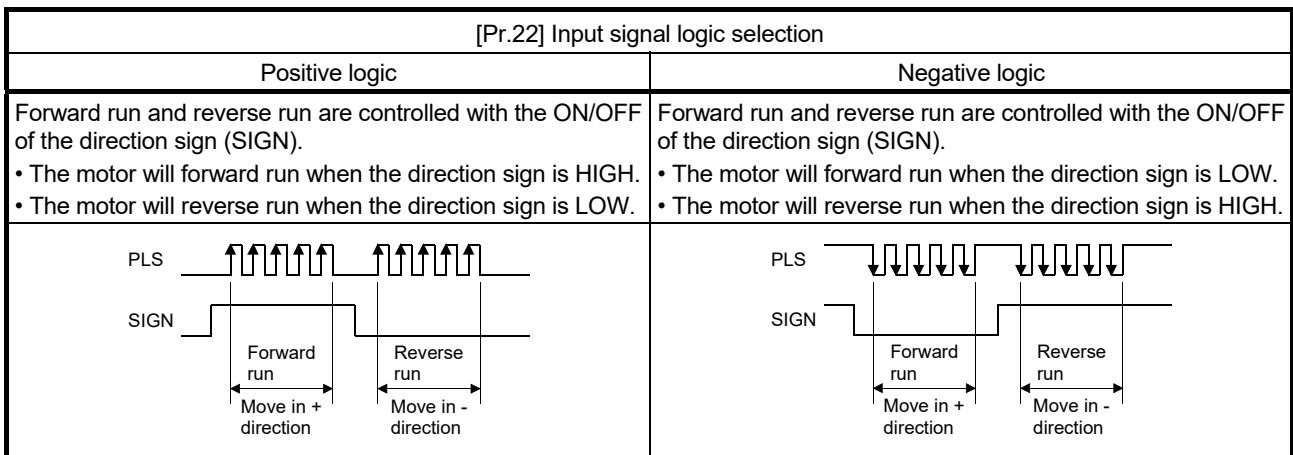

[Pr.81] Speed-position function selection
 Select the mode of speed-position switching control.

- 0: INC mode
- 2: ABS mode

Note1: If the setting is other than 0 and 2, operation is performed in the INC mode with the setting regarded as 0.

[Pr.82] Forced stop valid/invalid selection

Set the forced stop valid/invalid. (Only the value specified against the axis 1 is valid.)

All axes of the servo amplifier are made to batch forced stop when the forced stop input signal is turned on.

The error "Servo READY signal OFF during operation" (error code: 102) does not occur if the forced input signal is turned on during operation.

0: Valid (External input signal) Forced stop (External input signal) is used.

1: Invalid Forced stop is not used

Note1: If the setting is other than 0 and 1, the error "Forced stop valid/invalid setting error" (error code: 937) occurs.

Note2: The "[Md.50] Forced stop input" is stored "1" by setting "Forced stop valid/invalid selection" to invalid.

5.2.4 Detailed parameters 2

| Item | Setting value, setting range | | Default value | Buffer memory address |
|--|---|---|---------------|-----------------------|
| | Value set with GX Works2 | Value set with sequence program | | |
| [Pr.25] Acceleration time 1 | 1 to 8388608 (ms) | 1 to 8388608 (ms) | 1000 | 36+150n |
| [Pr.26] Acceleration time 2 | | | | 37+150n |
| [Pr.27] Acceleration time 3 | | | | 38+150n |
| [Pr.28] Deceleration time 1 | | | | 39+150n |
| [Pr.29] Deceleration time 2 | | | | 40+150n |
| [Pr.30] Deceleration time 3 | | | | 41+150n |
| [Pr.30] Deceleration time 3 | | | | 42+150n |
| [Pr.31] JOG speed limit value | The setting range differs depending on the "[Pr.1] Unit setting". | | 20000 | 43+150n |
| [Pr.32] JOG operation acceleration time selection | 0: [Pr.9] Acceleration time 0 | 0 | 0 | 50+150n |
| | 1: [Pr.25] Acceleration time 1 | 1 | | |
| | 2: [Pr.26] Acceleration time 2 | 2 | | |
| | 3: [Pr.27] Acceleration time 3 | 3 | | |
| [Pr.33] JOG operation deceleration time selection | 0: [Pr.10] Deceleration time 0 | 0 | 0 | 51+150n |
| | 1: [Pr.28] Deceleration time 1 | 1 | | |
| | 2: [Pr.29] Deceleration time 2 | 2 | | |
| | 3: [Pr.30] Deceleration time 3 | 3 | | |
| [Pr.34] Acceleration/deceleration process selection | 0: Trapezoid acceleration/ deceleration process | 0 | 0 | 52+150n |
| | 1: S-curve acceleration/ deceleration process | 1 | | |
| [Pr.35] S-curve ratio | 1 to 100 (%) | 1 to 100 (%) | 100 | 53+150n |
| [Pr.36] Rapid stop deceleration time | 1 to 8388608 (ms) | 1 to 8388608 (ms) | 1000 | 54+150n 55+150n |
| [Pr.37] Stop group 1 rapid stop selection | 0: Normal deceleration stop | 0 | 0 | 56+150n |
| [Pr.38] Stop group 2 rapid stop selection | | | | 57+150n |
| [Pr.39] Stop group 3 rapid stop selection | 1: Rapid stop | 1 | | 58+150n |
| [Pr.40] Positioning complete signal output time | 0 to 65535 (ms) | 0 to 65535 (ms) 0 to 32767 : Set as a decimal 32768 to 65535 : Convert into hexadecimal and set | 300 | 59+150n |

n: Axis No.-1

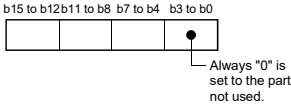
| Item | Setting value, setting range | | Default value | Buffer memory address |
|---|---|---|---------------|-----------------------|
| | Value set with GX Works2 | Value set with sequence program | | |
| [Pr.41] Allowable circular interpolation error width | The setting value range differs depending on the "[Pr.1] Unit setting". | | 100 | 60+150n 61+150n |
| [Pr.42] External command function selection | 0: External positioning start | 0 | 0 | 62+150n |
| | 1: External speed change request | 1 | | |
| | 2: Speed-position, position-speed switching request | 2 | | |
| | 3: Skip request | 3 | | |
| | 4: High speed input request | 4 | | |
| [Pr.83] Speed control 10 x multiplier setting for degree axis | 0: Invalid | 0 | 0 | 63+150n |
| | 1: Valid | 1 | | |
| [Pr.84] Restart allowable range when servo OFF to ON | 0, 1 to 327680 [PLS] 0: restart not allowed | | 0 | 64+150n 65+150n |
| [Pr.89] Manual pulse generator/ Incremental synchronous encoder input type selection | 0: Differential output type | 0 | 1 | 67 |
| | 1: Voltage output/open collector type | 1 | | |
| [Pr.90] Operation setting for speed-torque control mode | b0 to b3 | Not used | 0000H | 68+150n |
| | b4 to b7 | Torque initial value selection 0: Command torque 1: Feedback torque | | |
| | b8 to b11 | Speed initial value selection 0: Command speed 1: Feedback speed | | |
| | b12 to b15 | Condition selection at mode switching [RJ010 mode] 0: Switching conditions valid (for switching control mode) 1: Zero speed ON condition invalid (for switching control mode) [CiA402 mode] 0: Check the switching conditions in Simple Motion module 1: According to the servo amplifier specification | | |
| | |  | | |
| [Pr.95] External command signal selection | 0: Not used | 0 | 0 | 69+150n |
| | 1: DI1 | 1 | | |
| | 2: DI2 | 2 | | |
| | 3: DI3 | 3 | | |
| | 4: DI4 | 4 | | |

n: Axis No.-1

[Pr.25] Acceleration time 1 to [Pr.27] Acceleration time 3

These parameters set the time for the speed to increase from zero to the "[Pr.8] Speed limit value" ("[Pr.31] JOG speed limit value" at JOG operation control) during a positioning operation.

[Pr.28] Deceleration time 1 to [Pr.30] Deceleration time 3

These parameters set the time for the speed to decrease from the "[Pr.8] Speed limit value" ("[Pr.31] JOG speed limit value" at JOG operation control) to zero during a positioning operation.

[Pr.31] JOG speed limit value

Set the maximum speed for JOG operation.

Note) Set the "JOG speed limit value" to a value less than "[Pr.8] Speed limit value".

If the "speed limit value" is exceeded, the error "JOG speed limit value error" (error code: 956) will occur.

| [Pr.1] setting value | Value set with GX Works2 (unit) | Value set with sequence program (unit) |
|----------------------|---|--|
| 0 : mm | 0.01 to 20000000.00 (mm/min) | 1 to 2000000000 ($\times 10^{-2}$ mm/min) |
| 1 : inch | 0.001 to 2000000.000 (inch/min) | 1 to 2000000000 ($\times 10^{-3}$ inch/min) |
| 2 : degree | 0.001 to 2000000.000 (degree/min) *1 | 1 to 2000000000 ($\times 10^{-3}$ degree/min) *2 |
| 3 : PLS | 1 to 1000000000 (PLS/s) | 1 to 1000000000 (PLS/s) |

*1: The JOG speed limit value setting range is 0.001 to 2000000.000[degree/min], but it will be decupled and become 0.01 to 20000000.00[degree/min] by setting "[Pr.83] Speed control 10 x multiplier setting for degree axis" to valid.

*2: The JOG speed limit value setting range is 1 to 2000000000($\times 10^{-3}$ degree/min), but it will be decupled and become 1 to 2000000000 ($\times 10^{-2}$ degree/min) by setting "[Pr.83] Speed control 10 x multiplier setting for degree axis" to valid.

[Pr.32] JOG operation acceleration time selection

Set which of "acceleration time 0 to 3" to use for the acceleration time during JOG operation.

- 0: Use value set in "[Pr.9] Acceleration time 0".
- 1: Use value set in "[Pr.25] Acceleration time 1".
- 2: Use value set in "[Pr.26] Acceleration time 2".
- 3: Use value set in "[Pr.27] Acceleration time 3".

[Pr.33] JOG operation deceleration time selection

Set which of "deceleration time 0 to 3" to use for the deceleration time during JOG operation.

- 0: Use value set in "[Pr.10] Deceleration time 0".
- 1: Use value set in "[Pr.28] Deceleration time 1".
- 2: Use value set in "[Pr.29] Deceleration time 2".
- 3: Use value set in "[Pr.30] Deceleration time 3".

[Pr.34] Acceleration/deceleration process selection

Set whether to use trapezoid acceleration/deceleration or S-curve acceleration/deceleration for the acceleration/deceleration process.

Note) Refer to Section 13.7.6 "Acceleration/deceleration processing function" for details.

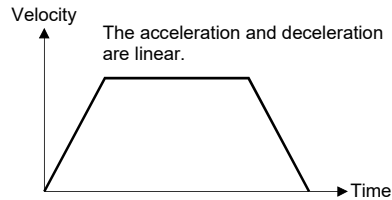

<Trapezoid acceleration/deceleration>

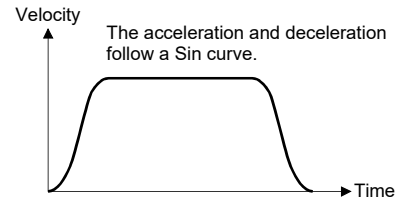

<S-curve acceleration/deceleration>

[Pr.35] S-curve ratio

Set the S-curve ratio (1 to 100%) for carrying out the S-curve acceleration/deceleration process.

The S-curve ratio indicates where to draw the acceleration/deceleration curve using the Sin curve as shown below.

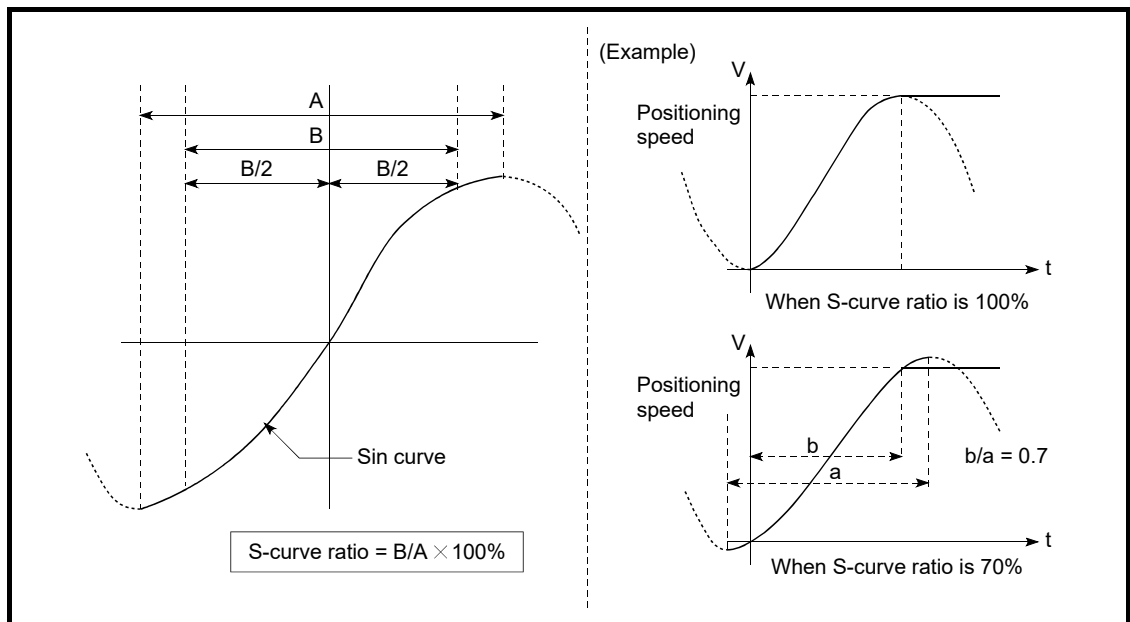

[Pr.36] Rapid stop deceleration time

Set the time to reach speed 0 from "[Pr.8] Speed limit value" ("[Pr.31] JOG speed limit value" at JOG operation control) during the rapid stop. The illustration below shows the relationships with other parameters.

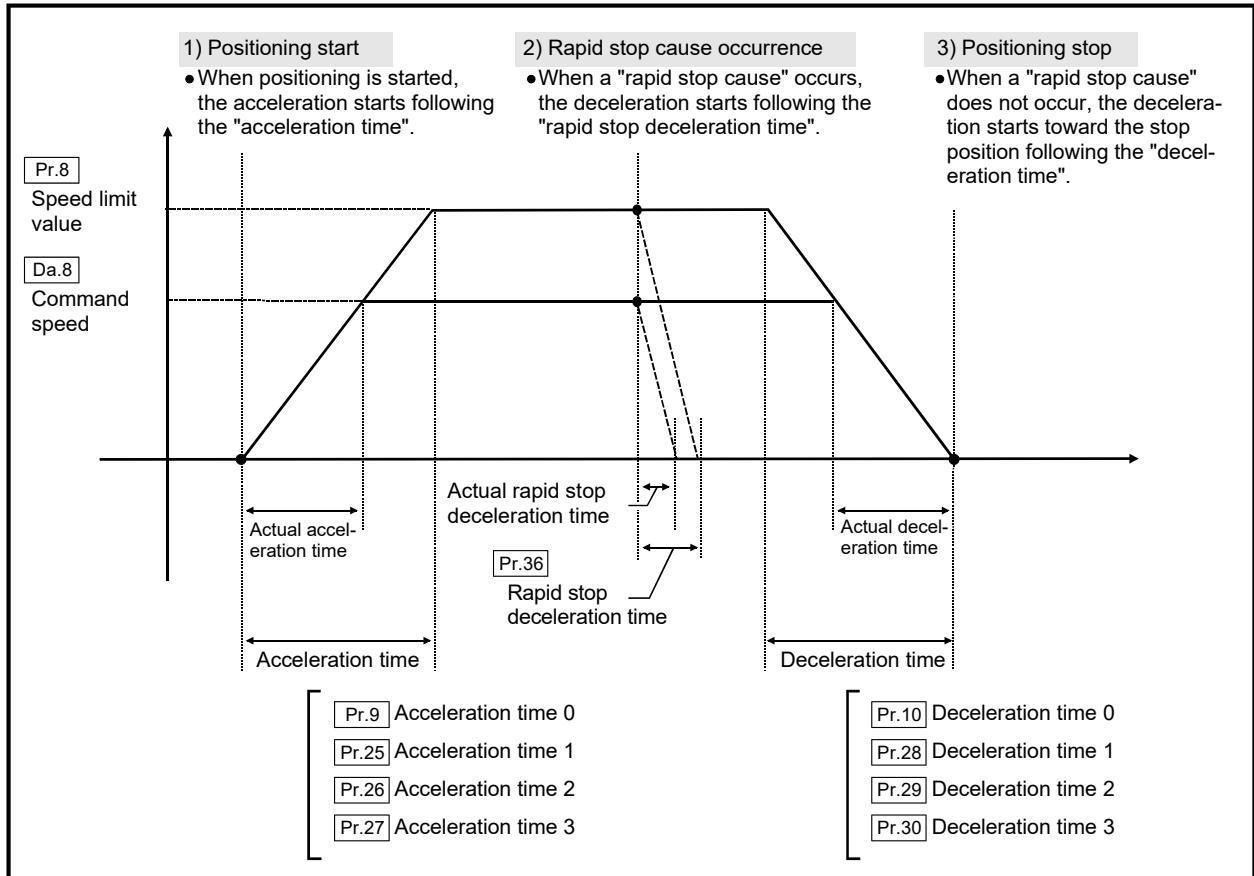

[Pr.37] Stop group 1 rapid stop selection to

[Pr.39] Stop group 3 rapid stop selection

Set the method to stop when the stop causes in the following stop groups occur.

- Stop group 1 Stop with hardware stroke limit
- Stop group 2 Error occurrence of the PLC CPU, PLC READY signal [Y0] OFF, Fault in test mode
- Stop group 3 Axis stop signal from PLC CPU
 Stop signal from test function of GX Works2
 Error occurrence (excludes errors in stop groups 1 and 2: includes only the software stroke limit errors during JOG operation, speed control, speed-position switching control, and position-speed switching control)

The methods of stopping include "0: Normal deceleration stop" and "1: Rapid stop". If "1: Rapid stop" is selected, the axis will rapidly decelerate to a stop when the stop cause occurs.

[Pr.40] Positioning complete signal output time

Set the output time of the positioning complete signal output from the Simple Motion module.

A positioning completes when the specified dwell time has passed after the Simple Motion module had terminated the command output.

For the interpolation control, the positioning completed signal of interpolation axis is output only during the time set to the reference axis.

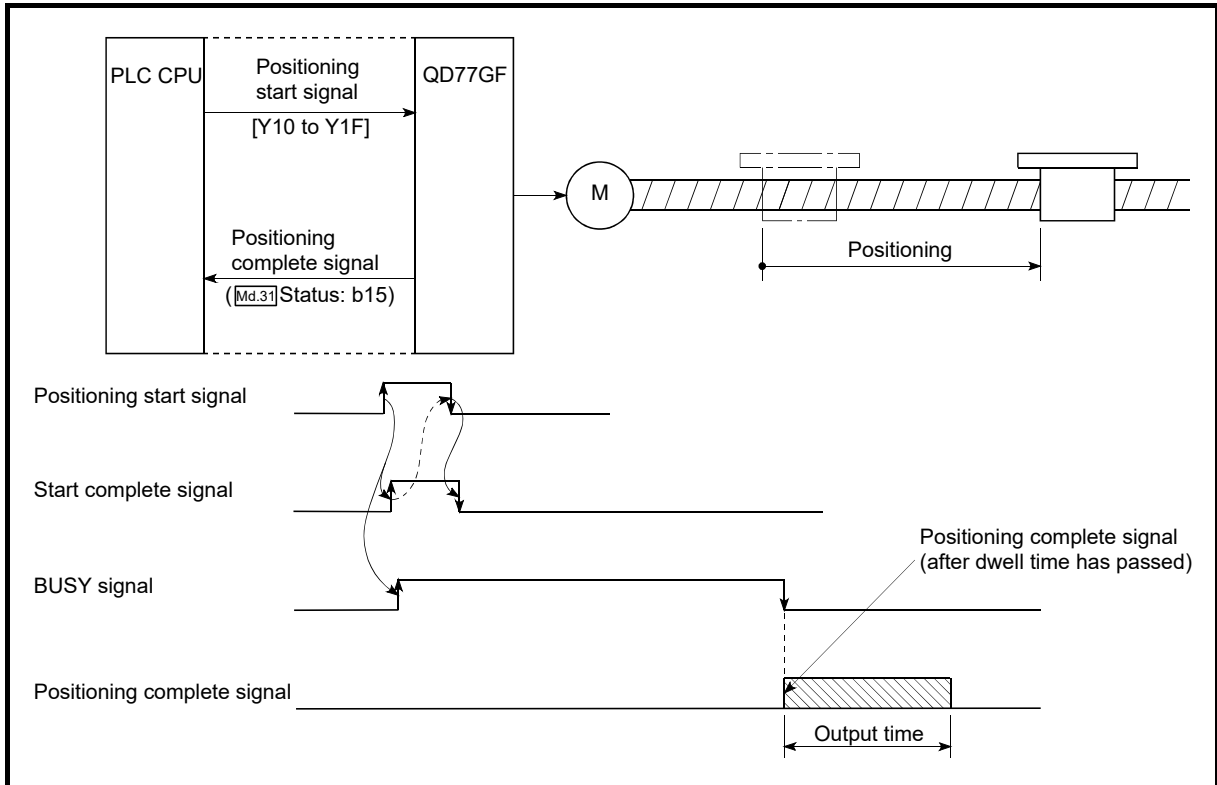

Positioning complete signal output time

[Pr.41] Allowable circular interpolation error width

The allowable error range of the calculated arc path and end point address is set.

*1 If the error of the calculated arc path and end point address is within the set range, circular interpolation will be carried out to the set end point address while compensating the error with spiral interpolation.

The allowable circular interpolation error width is set in the following axis buffer memory addresses.

- (Example)
- If axis 1 is the reference axis, set in the axis 1 buffer memory addresses [60, 61].
 - If axis 4 is the reference axis, set in the axis 4 buffer memory addresses [510, 511].

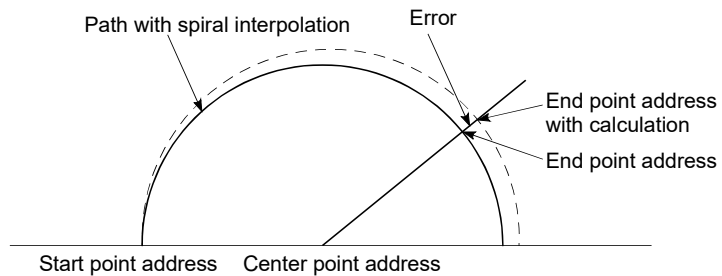

*1: With circular interpolation control using the center point designation, the arc path calculated with the start point address and center point address and the end point address may deviate.

| [Pr.1] setting value | Value set with GX Works2 (unit) | Value set with sequence program (unit) |
|----------------------|---------------------------------|--|
| 0 : mm | 0 to 10000.0 (μm) | 0 to 100000 (×10 ⁻¹ μm) |
| 1 : inch | 0 to 1.00000 (inch) | 0 to 100000 (×10 ⁻⁵ inch) |
| 2 : degree | 0 to 1.00000 (degree) | 0 to 100000 (×10 ⁻⁵ degree) |
| 3 : PLS | 0 to 100000 (PLS) | 0 to 100000 (PLS) |

[Pr.42] External command function selection

Select a command with which the external command signal should be associated.

0: External positioning start

The external command signal input is used to start a positioning operation.

1: External speed change request

The external command signal input is used to change the speed in the current positioning operation. The new speed should be set in the "[Cd.14] New speed value"

2: Speed-position, position-speed switching request

The external command signal input is used to switch from the speed control to the position control while in the speed-position switching control mode, or from the position control to the speed control while in the position-speed switching control mode.

To enable the speed-position switching control, set the "[Cd.24] Speed-position switching enable flag" to "1".

To enable the position-speed switching control, set the "[Cd.26] Position-speed switching enable flag" to "1".

3: Skip request

The external command signal input is used skip the current positioning operation.

4: High speed input request

The external command signal input is used to execute the mark detection. And, also set to use the external command signal in the synchronous control.

POINT

To enable the external command signal, set the "[Cd.8] External command valid" to "1".

[Pr.83] Speed control 10 x multiplier setting for degree axis

Set the speed control 10 x multiplier setting for degree axis when you use command speed and speed limit value set by the positioning data and the parameter at "[Pr.1] Unit setting" setup degree by ten times at the speed.

0: Invalid

1: Valid

Normally, the speed specification range is 0.001 to 2000000.000[degree/min], but it will be decupled and become 0.01 to 20000000.00[degree/min] by setting "[Pr.83] Speed control 10 x multiplier setting for degree axis" to valid.

Note) The speed control 10 x multiplier setting for degree axis is included in detailed parameters 2, but it will be valid at the rising edge (OFF to ON) of the PLC READY signal [Y0].

*1: Refer to Section 13.7.10 "Speed control 10 x multiplier setting for degree axis function" about speed control 10 x multiplier setting for degree axis.

| [Pr.83] setting value | Value set with GX Works2 (unit) | Value set with sequence program (unit) |
|-----------------------|-----------------------------------|--|
| 0 : Invalid | 0.001 to 2000000.000 (degree/min) | 1 to 2000000000 ($\times 10^{-3}$ degree/min) |
| 1 : Valid | 0.01 to 20000000.00 (degree/min) | 1 to 2000000000 ($\times 10^{-2}$ degree/min) |

[Pr.84] Restart allowable range when servo OFF to ON

(1) Restart function at switching servo OFF to ON

The restart function at switching servo OFF to ON performs continuous positioning operation (positioning start, restart) when switching servo OFF to ON while the Simple Motion module is stopped (including forced stop, servo forced stop).

Restart at switching servo OFF to ON can be performed when the difference between the last command position of Simple Motion module at stop and the present value at switching servo OFF to ON is equal to or less than the value set in the buffer memory for the restart allowable range setting.

(a) Servo emergency stop processing

- 1) When the difference between the last command position of Simple Motion module at the forced stop input or the servo forced stop input and the present value at the forced stop release or the servo forced stop release is equal to or less than the value set in the buffer memory for the restart allowable range setting, the positioning operation is judged as stopped and can be restarted.
- 2) When the difference between the last command position of Simple Motion module at the forced stop input or the servo forced stop input and the present value at the forced stop release or the servo forced stop release is greater than the value set in the buffer memory for the restart allowable range setting, the positioning operation is judged as on-standby and cannot be restarted.

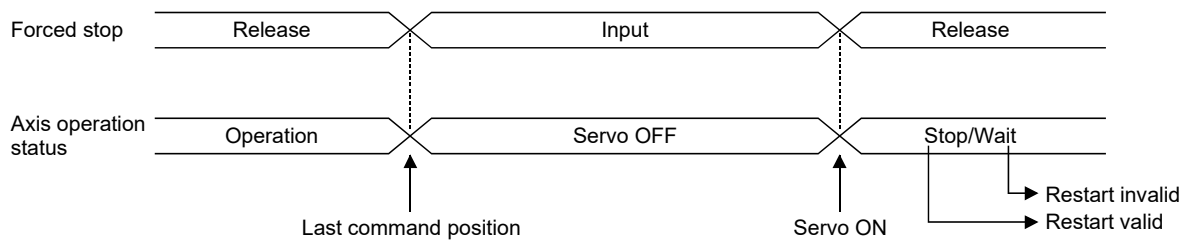

(b) Processing at switching the servo ON signal from OFF to ON

- 1) When the difference between the last command position of Simple Motion module at switching the servo ON signal from ON to OFF and the present value at switching the servo ON signal from OFF to ON is equal to or less than the value set in the buffer memory for the restart allowable range setting, the positioning operation is judged as stopped and can be restarted.
- 2) When the difference between the last command position of Simple Motion module at switching the servo ON signal from ON to OFF and the present value at switching the servo ON signal from OFF to ON is greater than the value set in the buffer memory for the restart allowable range setting, the positioning operation is judged as on-standby and cannot be restarted.

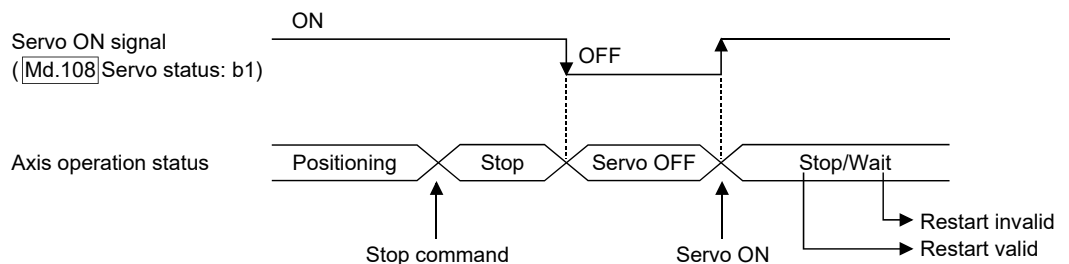

(2) Setting method

For performing restart at switching servo OFF to ON, set the restart allowable range in the following buffer memory.

| Buffer memory address | Item | Setting range | Default value |
|-----------------------|--|--|---------------|
| 64+150n 65+150n | [Pr.84] Restart allowable range when servo OFF to ON | 0, 1 to 327680 (PLS) 0: restart not allowed | 0 |

[Setting example]

A program to set the restart allowable range for axis 1 to 10000 PLS is shown below.

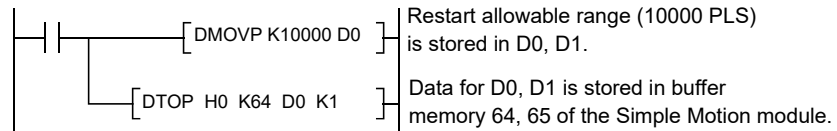

(3) Precautionary notes

- (a) The difference between the last command position at servo OFF and the present value at servo ON is output at once at the first restart. If the restart allowable range is large at this time, an overload may occur on the servo side.
Set a value which does not affect the mechanical system by output once to the restart allowable range when switching servo OFF to ON.
- (b) The restart at switching servo OFF to ON is valid only at switching servo OFF to ON at the first time. At the second time or later, the setting for restart allowable range when switching servo OFF to ON is disregarded.
- (c) Execute servo OFF when the mechanical system is in complete stop state. The restart at switching servo OFF to ON cannot be applied to a system in which the mechanical system is operated by external pressure or other force during servo OFF.
- (d) Restart can be executed only while the axis operation status is "stop". Restart cannot be executed when the axis operation status is other than "stop".
- (e) When the PLC READY signal is switched from OFF to ON during servo OFF, restart cannot be executed.
If restart is requested, the warning "Restart not possible" (warning code: 104) occurs.
- (f) Do not restart while a stop command is ON.
When restart is executed during a stop, the error "Stop signal ON at start" (error code: 106) occurs and the axis operation status becomes "ERR".
Therefore, restart cannot be performed even if the error is reset.

- (g) Restart can also be executed while the positioning start signal is ON. However, do not set the positioning start signal from OFF to ON during a stop.
If the positioning start signal is switched from OFF to ON, positioning is performed from the positioning data number set in "[Cd.3] Positioning start No." or from the positioning data number of the specified point.
- (h) When positioning is terminated by a continuous-operation interrupt request, restart cannot be performed.
If a restart request is executed, the warning "Restart not possible" (warning code: 104) occurs.

[Operation at emergency stop input]

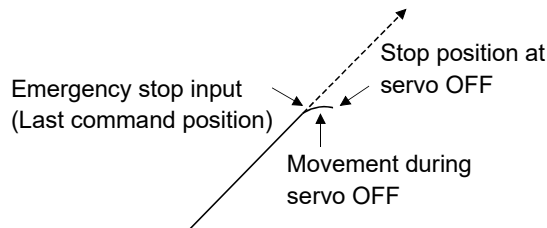

[Operation at restart]

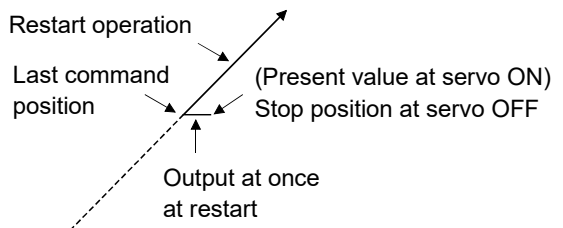

[Pr.89] Manual pulse generator/Incremental synchronous encoder input type selection

Set the input type from the manual pulse generator/incremental synchronous encoder. (Only the value specified against the axis 1 is valid.)

- 0: Differential output type
- 1: Voltage output/open collector type

Note) The "Manual pulse generator/Incremental synchronous encoder input type selection" is included in detailed parameters 2, but it will be valid at the rising edge (OFF to ON) of the PLC READY signal [Y0].

Refer to Section 3.4 "Specifications of interfaces with external devices" for details.

[Pr.90] Operation setting for speed-torque control mode

Operation setting of the speed control mode or torque control mode at the speed-torque control is executed.

(1) Torque initial value selection

Set the torque initial value at switching to torque control mode.

- 0: Command torqueCommand torque value at switching. (following axis control data)

Switching to torque control mode:

"[Cd.143] Command torque at torque control mode"

- 1: Feedback torque.....Motor torque value at switching.

(2) Speed initial value selection

Set the initial speed at switching from position control mode to speed control mode.

- 0: Command speedSpeed that position command at switching is converted into the motor speed.

- 1: Feedback speedMotor speed received from servo amplifier at switching

- (3) Condition selection at mode switching
 Set the valid/invalid of switching conditions for switching control mode.
 [RJ010 mode]
 0: Switching conditions valid (for switching control mode)
 1: Zero speed ON condition invalid (for switching control mode)
 [CiA402 mode]
 0: Check the switching conditions in Simple Motion module
 1: According to the servo amplifier specification

Note) The "Operation setting for speed-torque control mode" is included in detailed parameters 2, but it will be valid at the rising edge (OFF to ON) of the PLC READY signal [Y0].

| |
|--|
| POINT |
| <p>Set as follows to switch the control mode without waiting for the servo motor to stop. Note that it may cause vibration or impact at control switching. [RJ0101 mode] Set "1: Zero speed ON condition invalid (for switching control mode)" to "Condition selection at mode switching (b12 to b15)". [CiA402 mode] Set "1: According to the servo amplifier specification" to "Condition selection at mode switching (b12 to b15)". When using MR-J4-GF, set "1: Disabled" in "ZSP disabled selection at control switching" of the servo parameter "Function selection C-E (PC76)".</p> |

[Pr.95] External command signal selection

- Set the external command signal.
 0: Not used..... External command signal is not used.
 1: DI1..... DI1 is used as external command signal.
 2: DI2..... DI2 is used as external command signal.
 3: DI3..... DI3 is used as external command signal.
 4: DI4..... DI4 is used as external command signal.

Note) The "External command signal selection" is included in detailed parameters 2, but it will be valid at the rising edge (OFF to ON) of the PLC READY signal [Y0].

| |
|---|
| POINT |
| <p>Same external command signal can be used in the multiple axes.</p> |

5.2.5 HPR basic parameters

| Item | Setting value, setting range | | Default value | Buffer memory address |
|-------------------------------------|---|---------------------------------|--|-----------------------|
| | Value set with GX Works2 | Value set with sequence program | | |
| [Pr.43] HPR method | 0 : Proximity dog method [RJ010 mode] | 0 | 0 | 70+150n |
| | 4 : Count method 1) [RJ010 mode] | 4 | | |
| | 5 : Count method 2) [RJ010 mode] | 5 | | |
| | 6 : Data set method [RJ010 mode] | 6 | | |
| | 7 : Scale origin signal detection method [RJ010 mode] | 7 | | |
| | 8 : Driver HPR method [CiA402 mode] | 8 | | |
| [Pr.44] HPR direction | 0 : Positive direction (address increment direction) | 0 | 0 | 71+150n |
| | 1 : Negative direction (address decrement direction) | 1 | | |
| [Pr.45] HP address | | | 0 | 72+150n 73+150n |
| [Pr.46] HPR speed | The setting value range differs depending on the "[Pr.1] Unit setting". | | 1 | 74+150n 75+150n |
| [Pr.47] Creep speed [RJ010 mode] | | | 1 | 76+150n 77+150n |
| [Pr.48] HPR retry [RJ010 mode] | | | 0 : Do not retry HPR with limit switch | 0 |
| | 1 : Retry HPR with limit switch | 1 | | |

n: Axis No.-1

[Pr.43] HPR method

Set the "HPR method" for carrying out machine HPR.

0: Proximity dog method [RJ010 mode]

..... After decelerating at the proximity dog ON, stop at the zero signal and complete the machine HPR.

4: Count method 1) [RJ010 mode]

..... After decelerating at the proximity dog ON, move the designated distance, and complete the machine HPR with the zero signal.

5: Count method 2) [RJ010 mode]

..... After decelerating at the proximity dog ON, move the designated distance, and complete the machine HPR.

6: Data set method [RJ010 mode]

..... The position where the machine HPR has been made will be the HP.

7: Scale origin signal detection method [RJ010 mode]

..... After deceleration stop at the proximity dog ON, move to the opposite direction against the HPR direction, and move to the HPR direction after deceleration stop once at the detection of the first zero signal. Then, it stops at the detected nearest zero signal, and completes the machine HPR.

8: Driver HPR method [CiA402 mode]

..... Carry out the HPR operation on the driver side. The HPR operation and parameters depend on the specifications of the driver.
Refer to Section 8.2.8 "Driver HPR method" for details.

When HPR method that cannot be executed is set, the error "HPR method invalid" (error code: 232) occurs and the HPR is not executed.

Note) Refer to Section 8.2 "Machine HPR" for details on the HPR methods.

0 : Proximity dog method [RJ010 mode]

- (1) Start machine HPR.
(Start movement at the "[Pr.46] HPR speed" in the "[Pr.44] HPR direction".)
- (2) Detect the proximity dog ON, and start deceleration.
- (3) Decelerate to "[Pr.47] Creep speed", and move with the creep speed.
(At this time, the proximity dog must be ON. If the proximity dog is OFF, the axis will decelerate to a stop.)
- (4) At the first zero signal after the proximity dog turned OFF, machine HPR is completed.

Note) After the home position return (HPR) has been started, the zero point of the encoder must be passed at least once before point A is reached.
However, if selecting "1: Not need to pass servo motor Z-phase after power on" with "Function selection C-4 (PC17)", it is possible to carry out the home position return (HPR) without passing the zero point.

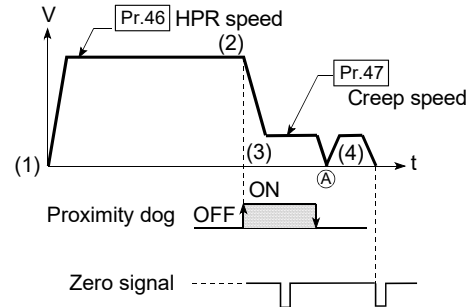

4 : Count method 1) [RJ010 mode]

- (1) Start machine HPR.
(Start movement at the "[Pr.46] HPR speed" in the "[Pr.44] HPR direction".)
- (2) Detect the proximity dog ON, and start deceleration.
- (3) Decelerate to "[Pr.47] Creep speed", and move with the creep speed.
- (4) After the proximity dog turns ON and the movement amount set in "[Pr.50] Setting for the movement amount after proximity dog ON" has passed, the Simple Motion module stops with the first zero signal, and the machine HPR is completed.

Note) After the home position return (HPR) has been started, the zero point of the encoder must be passed at least once before point A is reached.
However, if selecting "1: Not need to pass servo motor Z-phase after power on" with "Function selection C-4 (PC17)", it is possible to carry out the home position return (HPR) without passing the zero point.

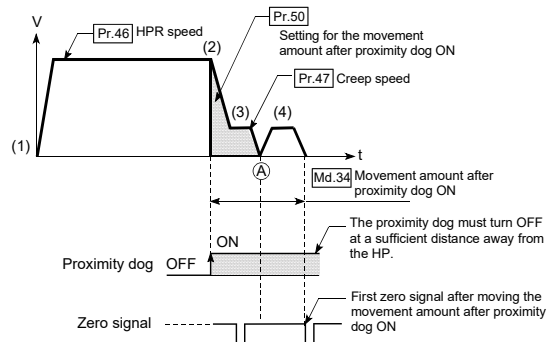

5 : Count method 2) [RJ010 mode]

- (1) Start machine HPR.
(Start movement at the "[Pr.46] HPR speed" in the "[Pr.44] HPR direction".)
- (2) Detect the proximity dog ON, and start deceleration.
- (3) Decelerate to "[Pr.47] Creep speed", and move with the creep speed.
- (4) After the proximity dog turns ON and the movement amount set in "[Pr.50] Setting for the movement amount after proximity dog ON" has passed, machine HPR is completed.

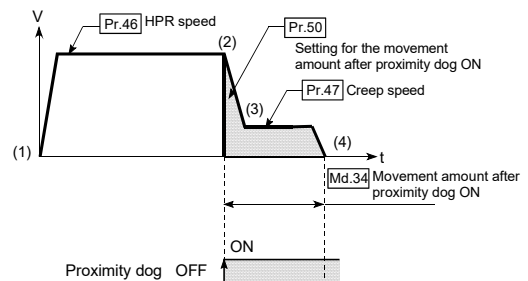

6 : Data set method [RJ010 mode]

The position where the machine HPR has been made will be the HP.
 (Perform after the servo amplifier has been turned ON and the servomotor has been rotated at least once using the JOG or similar operation. However, if selecting "1: Not need to pass servo motor Z-phase after power on" with "Function selection C-4 (PC17)", it is possible to carry out the home position return (HPR) without passing the zero point.)

7 : Scale origin signal detection method [RJ010 mode]

- (1) Start machine HPR.
 (Start movement at the "[Pr.46] HPR speed" in the "[Pr.44] HPR direction".)
- (2) Detect the proximity dog ON, and start deceleration.
- (3) After deceleration stop, it moves in the opposite direction against of HPR at the "[Pr.46] HPR speed".
- (4) During movement, the machine begins decelerating when the first zero signal is detected.
- (5) After deceleration stop, it moves in direction of HPR at the speed set in "[Pr.47] Creep speed", and stops at the detected nearest zero signal to complete the machine HPR.

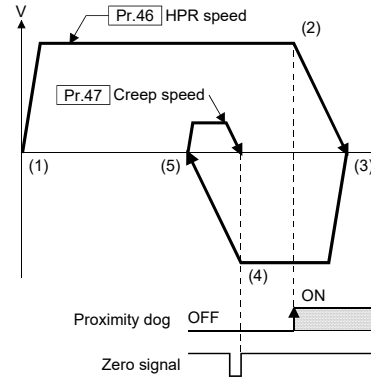

[Pr.44] HPR direction

Set the direction to start movement when starting machine HPR.

0: Positive direction (address increment direction)

Moves in the direction that the address increments. (Arrow 2))

1: Negative direction (address decrement direction)

Moves in the direction that the address decrements. (Arrow 1))

Normally, the HP is set near the lower limit or the upper limit, so "[Pr.44] HPR direction" is set as shown below.

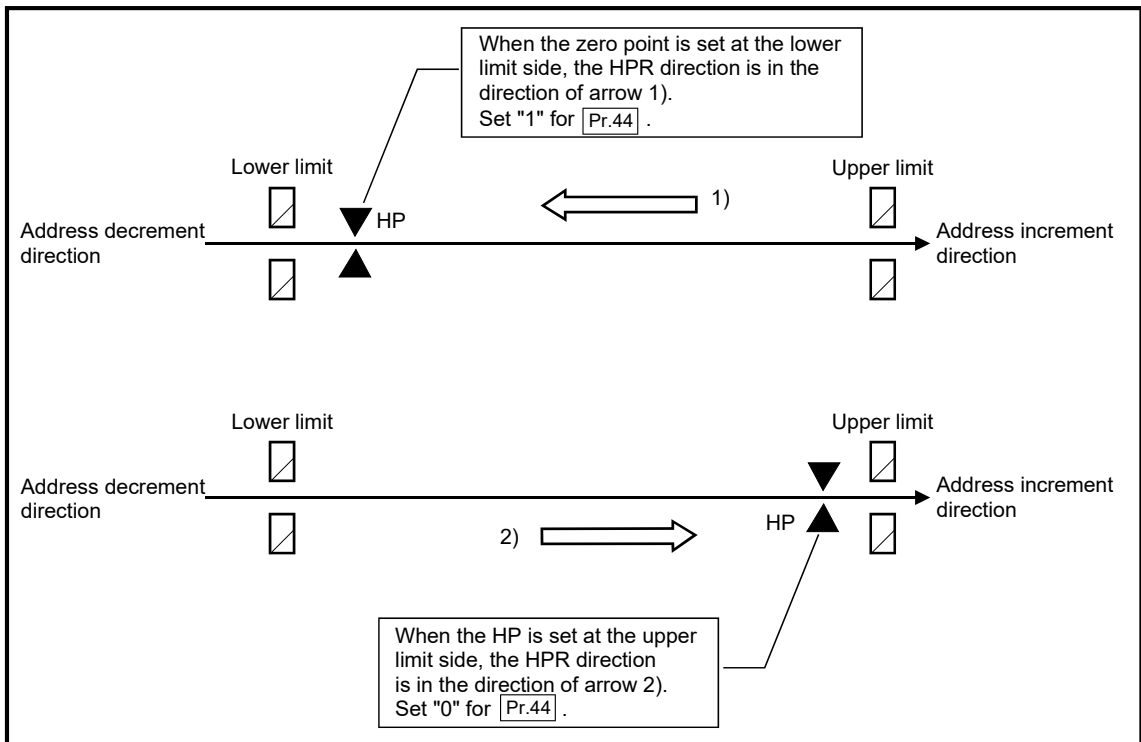

[Pr.45] HP address

Set the address used as the reference point for positioning control (ABS system).
 (When the machine HPR is completed, the stop position address is changed to the address set in "[Pr.45] HP address". At the same time, the "[Pr.45] HP address" is stored in "[Md.20] Feed current value" and "[Md.21] Feed machine value".)

| [Pr.1] setting value | Value set with GX Works2 (unit) | Value set with sequence program (unit) |
|----------------------|---|---|
| 0 : mm | -214748364.8 to 214748364.7 (μm) | -2147483648 to 2147483647 ($\times 10^{-1}\mu\text{m}$) |
| 1 : inch | -21474.83648 to 21474.83647 (inch) | -2147483648 to 2147483647 ($\times 10^{-5}\text{inch}$) |
| 2 : degree | 0 to 359.99999 (degree) | 0 to 35999999 ($\times 10^{-5}\text{degree}$) |
| 3 : PLS | -2147483648 to 2147483647 (PLS) | -2147483648 to 2147483647 (PLS) |

[Pr.46] HPR speed

Set the speed for HPR.

The fast HPR is executed at the HPR speed. [CiA402 mode]

Note) Set the "HPR speed" to less than "[Pr.8] Speed limit value". If the "speed limit value" is exceeded, the error "Outside speed limit value range" (error code: 910) will occur, and HPR will not be executed.

[RJ010 mode]

The "HPR speed" should be equal to or faster than the "[Pr.7] Bias speed at start" and "[Pr.47] Creep speed".

| [Pr.1] setting value | Value set with GX Works2 (unit) | Value set with sequence program (unit) |
|----------------------|--------------------------------------|--|
| 0 : mm | 0.01 to 20000000.00 (mm/min) | 1 to 2000000000 ($\times 10^{-2}\text{mm/min}$) |
| 1 : inch | 0.001 to 2000000.000 (inch/min) | 1 to 2000000000 ($\times 10^{-3}\text{inch/min}$) |
| 2 : degree | 0.001 to 2000000.000 (degree/min) *1 | 1 to 2000000000 ($\times 10^{-3}\text{degree/min}$) *2 |
| 3 : PLS | 1 to 1000000000 (PLS/s) | 1 to 1000000000 (PLS/s) |

*1: The HPR speed setting range is 0.001 to 2000000.000[degree/min], but it will be decupled and become 0.01 to 20000000.00[degree/min] by setting "[Pr.83] Speed control 10 x multiplier setting for degree axis" to valid.

*2: The HPR speed setting range is 1 to 2000000000($\times 10^{-3}\text{degree/min}$), but it will be decupled and become 1 to 2000000000 ($\times 10^{-2}\text{degree/min}$) by setting "[Pr.83] Speed control 10 x multiplier setting for degree axis" to valid.

[Pr.47] Creep speed [RJ010 mode]

Set the creep speed after proximity dog ON (the low speed just before stopping after decelerating from the HPR speed).

The creep speed is set within the following range.

$$([\text{Pr.46}] \text{ HPR speed}) \geq ([\text{Pr.47}] \text{ Creep speed}) \geq ([\text{Pr.7}] \text{ Bias speed at start})$$

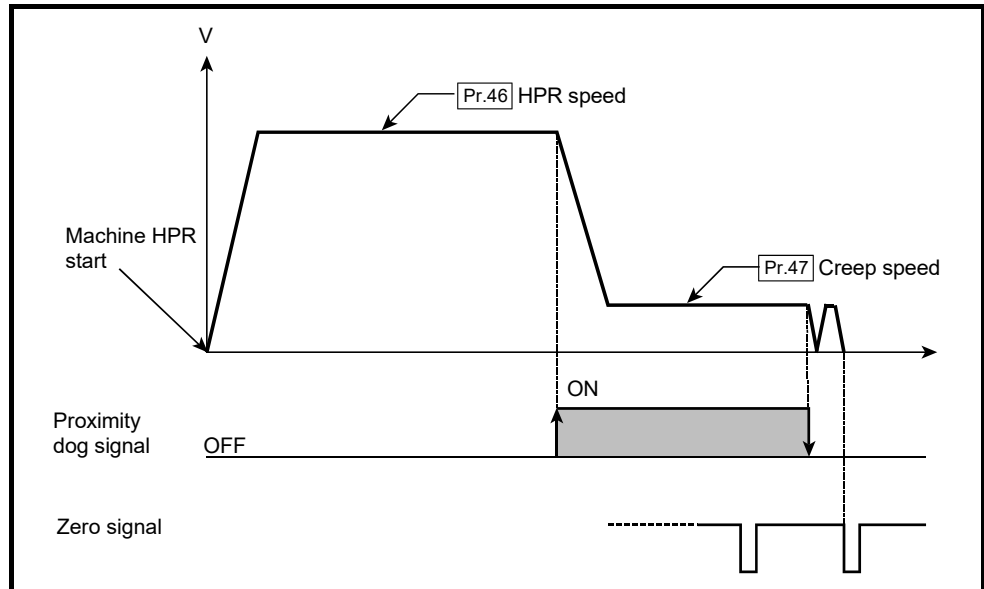

| [Pr.1] setting value | Value set with GX Works2 (unit) | Value set with sequence program (unit) |
|----------------------|---|--|
| 0 : mm | 0.01 to 20000000.00 (mm/min) | 1 to 2000000000 ($\times 10^{-2}$ mm/min) |
| 1 : inch | 0.001 to 2000000.000 (inch/min) | 1 to 2000000000 ($\times 10^{-3}$ inch/min) |
| 2 : degree | 0.001 to 2000000.000 (degree/min) *1 | 1 to 2000000000 ($\times 10^{-3}$ degree/min) *2 |
| 3 : PLS | 1 to 1000000000 (PLS/s) | 1 to 1000000000 (PLS/s) |

*1: The creep speed setting range is 0.001 to 2000000.000[degree/min], but it will be decupled and become 0.01 to 20000000.00[degree/min] by setting "[Pr.83] Speed control 10 x multiplier setting for degree axis" to valid.

*2: The creep speed setting range is 1 to 2000000000($\times 10^{-3}$ degree/min), but it will be decupled and become 1 to 2000000000 ($\times 10^{-2}$ degree/min) by setting "[Pr.83] Speed control 10 x multiplier setting for degree axis" to valid.

[Pr.48] HPR retry [RJ010 mode]

Set whether to carry out HPR retry.

When the HPR retry function is validated and the machine HPR is started, first the axis will move in the HPR direction (1)). If the upper/lower limit signal turns OFF before the proximity dog signal ON is detected (2)), the axis will decelerate to a stop, and then will move in the direction opposite the HPR direction (3)). If the following edge of the proximity dog signal is detected during movement in the opposite direction, the axis will decelerate to a stop (4)), and then will carry out machine HPR again (5), 6)).

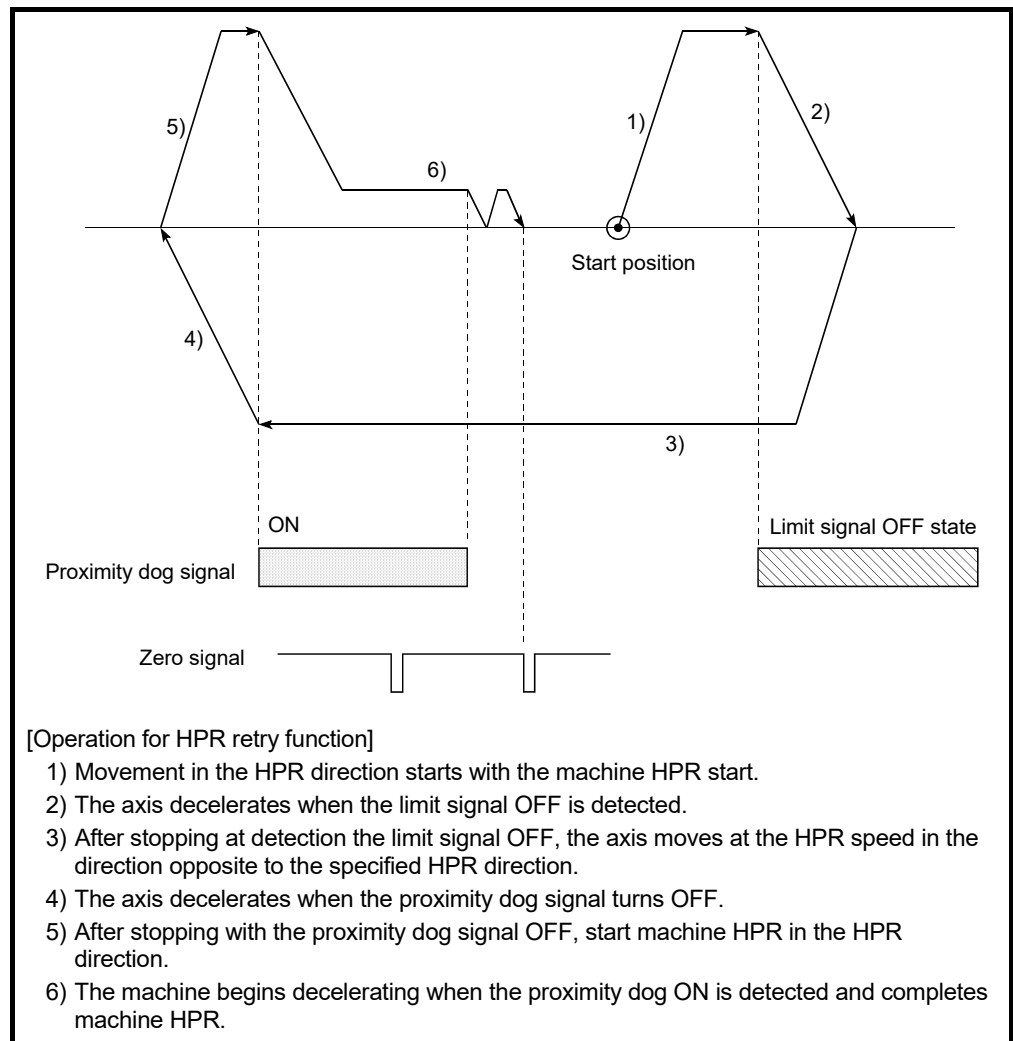

5.2.6 HPR detailed parameters

| Item | Setting value, setting range | | Default value | Buffer memory address |
|--|---|---|---------------|-----------------------|
| | Value set with GX Works2 | Value set with sequence program | | |
| [Pr.50] Setting for the movement amount after proximity dog ON [RJ010 mode] | The setting value range differs depending on the "[Pr.1] Unit setting". | | 0 | 80+150n 81+150n |
| [Pr.51] HPR acceleration time selection | 0 : [Pr.9] Acceleration time 0 | 0 | 0 | 82+150n |
| | 1 : [Pr.25] Acceleration time 1 | 1 | | |
| | 2 : [Pr.26] Acceleration time 2 | 2 | | |
| | 3 : [Pr.27] Acceleration time 3 | 3 | | |
| [Pr.52] HPR deceleration time selection | 0 : [Pr.10] Deceleration time 0 | 0 | 0 | 83+150n |
| | 1 : [Pr.28] Deceleration time 1 | 1 | | |
| | 2 : [Pr.29] Deceleration time 2 | 2 | | |
| | 3 : [Pr.30] Deceleration time 3 | 3 | | |
| [Pr.53] HP shift amount [RJ010 mode] | The setting value range differs depending on the "[Pr.1] Unit setting". | | 0 | 84+150n 85+150n |
| [Pr.54] HPR torque limit value [RJ010 mode] | 1 to 1000 (%) | 1 to 1000 (%) | 300 | 86+150n |
| [Pr.55] Operation setting for incompleteness of HPR | 0 : Positioning control is not executed. | 0 | 0 | 87+150n |
| | 1 : Positioning control is executed. | 1 | | |
| [Pr.56] Speed designation during HP shift [RJ010 mode] | 0 : HPR speed | 0 | 0 | 88+150n |
| | 1 : Creep speed | 1 | | |
| [Pr.57] Dwell time during HPR retry [RJ010 mode] | 0 to 65535 (ms) | 0 to 65535 (ms) 0 to 32767 : Set as a decimal 32768 to 65535 : Convert into hexadecimal and set | 0 | 89+150n |

n: Axis No.-1

[Pr.50] Setting for the movement amount after proximity dog ON
[RJ010 mode]

When using the count method 1) or 2), set the movement amount to the HP after the proximity dog signal turns ON.

(The movement amount after proximity dog ON should be equal to or greater than the sum of the "distance covered by the deceleration from the HPR speed to the creep speed" and "distance of movement in 10 ms at the HPR speed".)

Example of setting for "[Pr. 50] Setting for the movement amount after proximity dog ON"

Assuming that the "[Pr. 8] Speed limit value" is set to 200 kPLS/s, "[Pr. 46] HPR speed" to 10 kPLS/s, "[Pr. 47] Creep speed" to 1 kPLS/s, and deceleration time to 300 ms, the minimum value of "[Pr. 50] Setting for the movement amount after proximity dog ON" is calculated as follows:

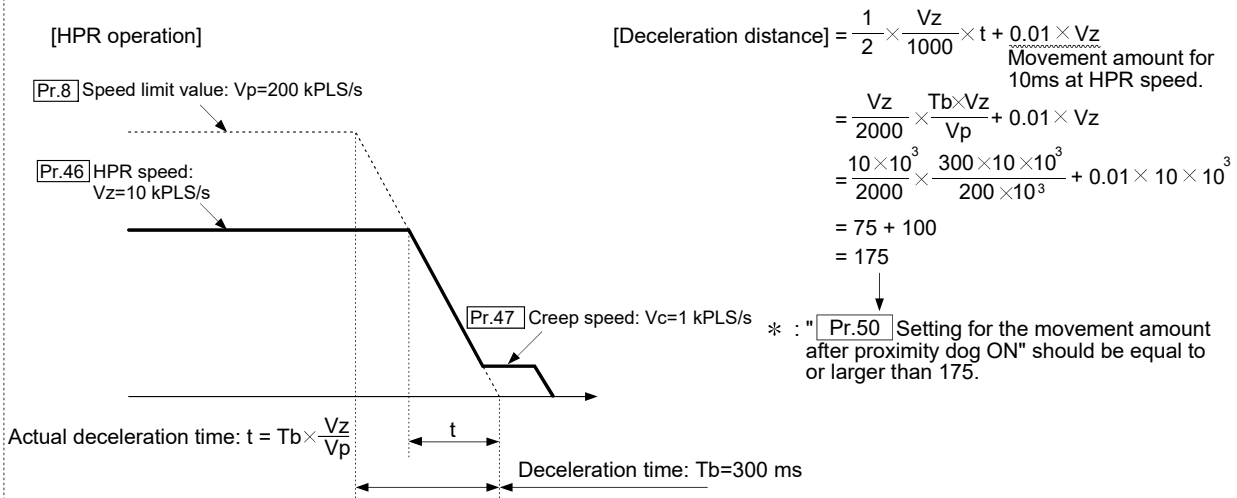

| [Pr.1] setting value | Value set with GX Works2 (unit) | Value set with sequence program (unit) |
|----------------------|---------------------------------|--|
| 0 : mm | 0 to 214748364.7 (μm) | 0 to 2147483647 (×10 ⁻¹ μm) |
| 1 : inch | 0 to 21474.83647 (inch) | 0 to 2147483647 (×10 ⁻⁵ inch) |
| 2 : degree | 0 to 21474.83647 (degree) | 0 to 2147483647 (×10 ⁻⁵ degree) |
| 3 : PLS | 0 to 2147483647 (PLS) | 0 to 2147483647 (PLS) |

POINT

Regardless of the unit setting, calculate the movement amount in the same procedure as for the example of setting.

[Pr.51] HPR acceleration time selection

Set which of "acceleration time 0 to 3" to use for the acceleration time during HPR. Valid only during fast HPR. [CiA402 mode]

- 0 : Use the value set in "[Pr.9] Acceleration time 0".
- 1 : Use the value set in "[Pr.25] Acceleration time 1".
- 2 : Use the value set in "[Pr.26] Acceleration time 2".
- 3 : Use the value set in "[Pr.27] Acceleration time 3".

[Pr.52] HPR deceleration time selection

Set which of "deceleration time 0 to 3" to use for the deceleration time during HPR. Valid only during fast HPR. [CiA402 mode]

- 0 : Use the value set in "[Pr.10] Deceleration time 0".
- 1 : Use the value set in "[Pr.28] Deceleration time 1".
- 2 : Use the value set in "[Pr.29] Deceleration time 2".
- 3 : Use the value set in "[Pr.30] Deceleration time 3".

[Pr.53] HP shift amount [RJ010 mode]

Set the amount to shift (move) from the position stopped at with machine HPR.
 * The HP shift function is used to compensate the HP stopped at with machine HPR.

If there is a physical limit to the HP, due to the relation of the proximity dog installation position, use this function to compensate the HP to an optimum position.

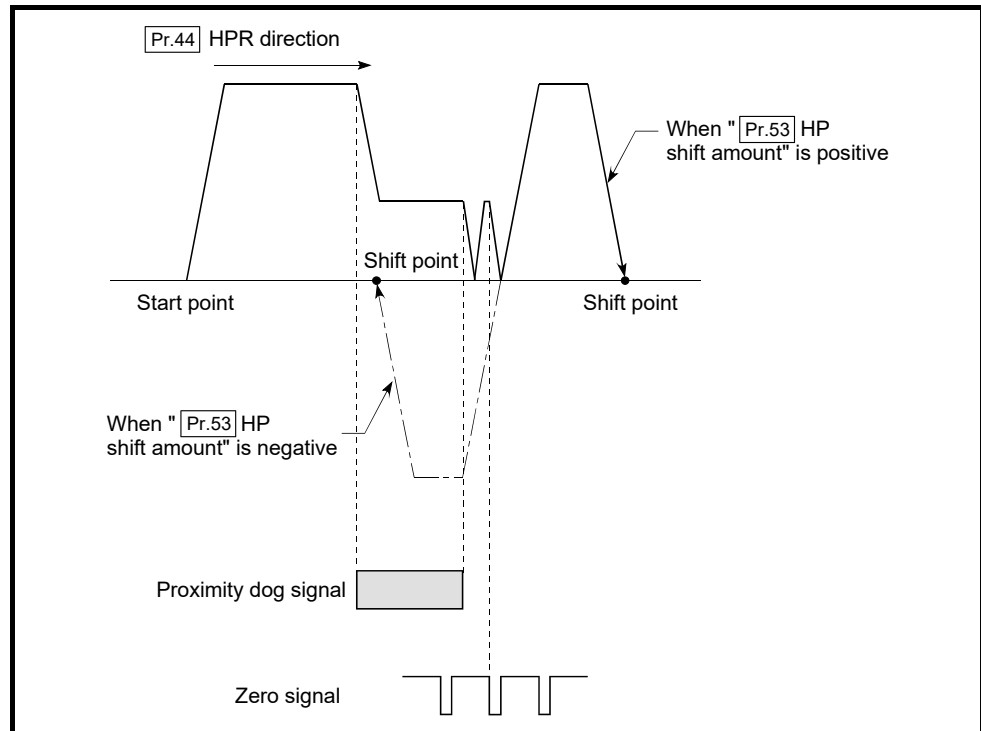

| [Pr.1] setting value | Value set with GX Works2 (unit) | Value set with sequence program (unit) |
|----------------------|--------------------------------------|--|
| 0 : mm | -214748364.8 to 214748364.7 (μm) | -2147483648 to 2147483647 (×10 ⁻¹ μm) |
| 1 : inch | -21474.83648 to 21474.83647 (inch) | -2147483648 to 2147483647 (×10 ⁻⁵ inch) |
| 2 : degree | -21474.83648 to 21474.83647 (degree) | -2147483648 to 2147483647 (×10 ⁻⁵ degree) |
| 3 : PLS | -2147483648 to 2147483647 (PLS) | -2147483648 to 2147483647 (PLS) |

[Pr.54] HPR torque limit value [RJ010 mode]

Set the value to limit the servomotor torque after reaching the creep speed during machine HPR.

Refer to Section 13.4.2 "Torque limit function" for details on the torque limits.

[Pr.55] Operation setting for incompleteness of HPR

Set whether the positioning control is executed or not (When the HPR request flag is ON.).

0: Positioning control is not executed.

1: Positioning control is executed.

- (1) When HPR request flag is ON, selecting "0: Positioning control is not executed" will result in the error "Start at HPR incomplete" (error code: 547), and positioning control will not be performed. At this time, operation with the manual control (JOG operation, inching operation, manual pulse generator operation) is available.
The positioning control can be executed even if the HPR request flag is ON when selecting "1: Positioning control is executed".
- (2) The following shows whether the positioning control is possible to start/restart or not when selecting "0: Positioning control is not executed".
 - (a) Start possible
Machine HPR, JOG operation, inching operation, manual pulse generator operation, and current value changing using current value changing start No. (9003)
 - (b) Start/restart impossible control
The positioning control is impossible to start/restart in the following cases. 1-axis linear control, 2/3/4-axis linear interpolation control, 1/2/3/4-axis fixed-feed control, 2-axis circular interpolation control with sub point designation, 2-axis circular interpolation control with center point designation, 1/2/3/4-axis speed control, speed-position switching control (INC mode/ ABS mode), position-speed switching control, and current value changing using current value changing (No.1 to 600)
- (3) When HPR request flag is ON, starting Fast HPR will result in the error "HPR request ON" (error code: 207) despite the setting value of "Operation setting for incompleteness of HPR", and Fast HPR will not be executed.

 CAUTION

- Do not execute the positioning control in home position return request signal ON for the axis which uses in the positioning control.
Failure to observe this could lead to an accident such as a collision.

[Pr.56] Speed designation during HP shift [RJ010 mode]

Set the operation speed for when a value other than "0" is set for "[Pr.53] HP shift amount". Select the setting from "[Pr.46] HPR speed" or "[Pr.47] Creep speed".

0 : Designate "[Pr.46] HPR speed" as the setting value.

1 : Designate "[Pr.47] Creep speed" as the setting value.

[Pr.57] Dwell time during HPR retry [RJ010 mode]

When HPR retry is validated (when "1" is set for [Pr.48]), set the stop time after decelerating in 2) and 4) in the following drawing.

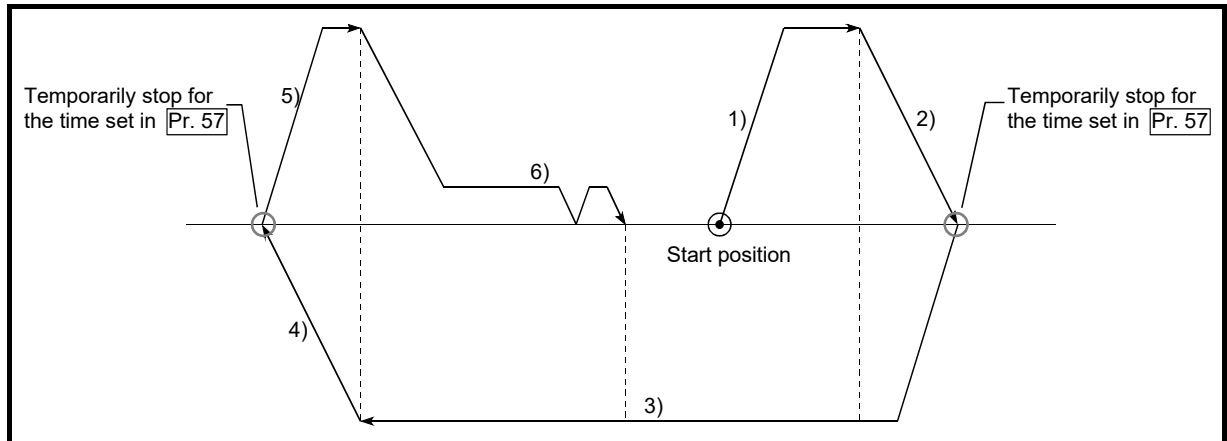

5.2.7 Expansion parameters

| Item | Setting value, setting range | | Default value | Buffer memory address |
|--|---|---|---------------|-----------------------|
| | Value set with GX Works2 | Value set with sequence program | | |
| [Pr.96] Operation cycle setting | [RJ010 mode] 0: 0.88ms 1: 1.77ms 2: 3.55ms [CiA402 mode] 1000h: 1.00ms 1001h: 2.00ms 1002h: 4.00ms | [RJ010 mode] 0 1 2 [CiA402 mode] 1000h 1001h 1002h | 1 | 105 (Note-1) |
| [Pr.113] Servo parameter transmission [RJ010 mode] | 0: Transfer the servo parameter 1: Do not transfer the servo parameter | 0 1 | 1 | 113+150n |
| [Pr.132] Communication mode setting | 0: MR-J4-B-RJ010 communication mode 1: Communication mode correspond to CiA402 | 0 1 | 0 | 132+150n |

n: Axis No. -1

(Note-1): Only the value specified against the axis 1 is valid.

[Pr.96] Operation cycle setting

Set the operation cycle. (Only the value specified against the axis 1 is valid.)

[RJ010 mode]

0: 0.88ms

1: 1.77ms

2: 3.55ms

[CiA402 mode]

1000h: 1.00ms

1001h: 2.00ms

1002h: 4.00ms

POINT

- (1) In this parameter, the value set in flash ROM of the Simple Motion module is valid at power supply ON or PLC CPU reset. Fetch by PLC READY signal OFF to ON is not executed. Execute flash ROM writing to change after setting a value to buffer memory. Confirm the current operation cycle in "[Md.132] Operation cycle setting".
- (2) Confirm that "[Md.133] Operation cycle over flag" does not turn ON. If the flag is ON, the operation cycle over has been generated. Correct the positioning content or the operation cycle setting.
- (3) Set the operation cycle according to the specification of the connected device.

[Pr.113] Servo parameter transmission [RJ010 mode]

When MR-J4-B is used, set whether to transmit the servo parameter from the Simple Motion module to the servo amplifier.

- 0: Transfer the servo parameter
- 1: Do not transfer the servo parameter

* When using the servo amplifier excluding MR-J4-B, the setting is ignored and it operates as if "1: Do not transfer the servo parameter" is set.

Important

When this parameter is set to "1: Do not transfer the servo parameter", servo parameter transmission is not executed at starting communication with MR-J4-B. (It is operated by the parameter that MR-J4-B holds.)

Time for establishing the communication with the servo amplifier can be short by this setting. However, the servo parameter written in the Simple Motion module does not become valid. Set "0: Transfer the servo parameter" excluding the following cases.

- A system which is not required to change the servo parameter such as when starting up the device
- Turn OFF/ON the power of servo amplifier frequently

POINT

In this parameter, the value set in flash ROM of Simple Motion module is valid at power supply ON or PLC CPU reset. Fetch by PLC READY signal OFF to ON is not executed. Execute flash ROM writing to change after setting a value to buffer memory.

[Pr.132] Communication mode setting

Select the protocol setting. This parameter is applied to all axes.

- 0: MR-J4-B-RJ010 communication mode
- 1: Communication mode correspond to CiA402

*1 The virtual servo amplifier operates as "0: MR-J4-B-RJ010 communication mode" even though "1: Communication mode correspond to CiA402" is set.

*2 When other than "1: Communication mode correspond to CiA402" is set, it operates as "0: MR-J4-B-RJ010 communication mode".

POINT

In this parameter, the value set in flash ROM of the Simple Motion module is valid at power supply ON or PLC CPU reset. Fetch by PLC READY signal [Y0] OFF to ON is not executed. Execute flash ROM writing to change after setting a value to buffer memory.

5.2.8 Servo parameters

(1) Servo amplifier setting

| Item | | Setting details | Setting range | Default value | Buffer memory address |
|----------|---------------------------------|---|---|---------------|-----------------------|
| [Pr.101] | Virtual servo amplifier setting | Set whether to use as the virtual servo amplifier axis. | 0: Use for the actual servo amplifier 1: Use for the virtual servo amplifier | 0 | 28401+100n |

n: Axis No. -1

[Pr.101] Virtual servo amplifier setting

Set whether to use as the virtual servo amplifier axis.

0: Use for the actual servo amplifier

1: Use for the virtual servo amplifier

POINT

Do not set the station number in the network parameter of GX Works2 to the axis to use as the virtual servo amplifier. If the virtual servo amplifier setting is executed to the station set in the network parameter of GX Works2, the error "Virtual servo amplifier setting error" (error code: 1004) will occur when the PLC READY signal [Y0] is turned ON, and the READY signal [X0] will not be turned ON.

(2) Servo parameters

When MR-J4-B is used, the servo parameter can be saved in the Simple Motion module, and it is possible to transmit the servo parameter to the servo amplifier at starting communication. Set and write the servo parameter with Simple Motion Module Setting Tool of GX Works2.

Set the servo parameter to the servo amplifier directly when using the servo amplifier excluding MR-J4-B.

Refer to each servo amplifier instruction manual for details of setting items.

POINT

Set the parameter value and switch power off once (The parameter is transferred to servo amplifier from Simple Motion module), and then switch it on again to make that parameter setting valid.

5.3 List of positioning data

Before explaining the positioning data setting items [Da.1] to [Da.10], [Da.20] to [Da.22] the configuration of the positioning data will be shown below.

The positioning data stored in the buffer memory of Simple Motion module has the following type of configuration.

| Positioning data No.1 | data No.2 | data No.99 | data No.100 |
|--|--------------------------|--------------------------|--------------------------|
| Positioning identifier [Da.1] to [Da.4] | 6000+1000n | 6010+1000n | 6980+1000n |
| [Da.10] M code/Condition data No. Number of LOOP to LEND repetitions | 6001+1000n | 6011+1000n | 6981+1000n |
| [Da.9] Dwell time/JUMP destination positioning data No. | 6002+1000n | 6012+1000n | 6982+1000n |
| Axis to be interpolated No. [Da.20] to [Da.22] | 6003+1000n | 6013+1000n | 6983+1000n |
| [Da.8] Command speed | 6004+1000n 6005+1000n | 6014+1000n 6015+1000n | 6984+1000n 6985+1000n |
| [Da.6] Positioning address/movement amount | 6006+1000n 6007+1000n | 6016+1000n 6017+1000n | 6986+1000n 6987+1000n |
| [Da.7] Arc address | 6008+1000n 6009+1000n | 6018+1000n 6019+1000n | 6988+1000n 6989+1000n |
| | | | 6990+1000n |
| | | | 6991+1000n |
| | | | 6992+1000n |
| | | | 6993+1000n |
| | | | 6994+1000n |
| | | | 6995+1000n |
| | | | 6996+1000n |
| | | | 6997+1000n |
| | | | 6998+1000n |
| | | | 6999+1000n |

n: Axis No.-1

Buffer memory address

- Up to 100 positioning data items can be set (stored) for each axis in the buffer memory address shown on the left. No.101 to No.600 are not allocated to buffer memory. Set with GX Works2. Data is controlled as positioning data No. 1 to 600 for each axis.
- One positioning data item is configured of the items shown in the bold box.

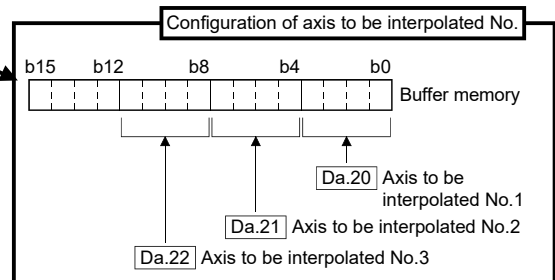
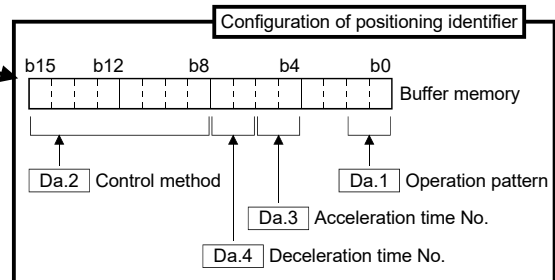

The descriptions that follow relate to the positioning data set items [Da.1] to [Da.10], [Da.20] to [Da.22].

(The buffer memory addresses shown are those of the "positioning data No. 1".)

- Guide to buffer memory address

In the buffer memory address, "n" in "6001+1000n", etc. indicates a value corresponding to axis No. such as the following table.

| Axis No. | n | Axis No. | n | Axis No. | n | Axis No. | n |
|----------|---|----------|---|----------|----|----------|----|
| 1 | 0 | 5 | 4 | 9 | 8 | 13 | 12 |
| 2 | 1 | 6 | 5 | 10 | 9 | 14 | 13 |
| 3 | 2 | 7 | 6 | 11 | 10 | 15 | 14 |
| 4 | 3 | 8 | 7 | 12 | 11 | 16 | 15 |

(Note-1): Calculate as follows for the buffer memory address corresponding to each axis.

(Example) For axis No. 16

$$6001+1000n \text{ ([Da.10] M code/Condition data No./Number of LOOP to LEND repetitions)} = 6001+1000 \times 15 = 21001$$

| Item | Setting value | | Default value | Buffer memory address |
|---------------------------------|------------------------------------|---------------------------------|---------------------|-----------------------|
| | Value set with GX Works2 | Value set with sequence program | | |
| [Da.1] Operation pattern | 00: Positioning complete | 00 | ● Operation pattern | |
| | 01: Continuous positioning control | 01 | | |
| | 11: Continuous path control | 11 | | |
| [Da.2] Control method | 01h: ABS Linear 1 | 01H | ● Control method | 0000H 6000+1000n |
| | 02h: INC Linear 1 | 02H | | |
| | 03h: Feed 1 | 03H | | |
| | 04h: FWD V1 | 04H | | |
| | 05h: RVS V1 | 05H | | |
| | 06h: FWD V/P | 06H | | |
| | 07h: RVS V/P | 07H | | |
| | 08h: FWD P/V | 08H | | |
| | 09h: RVS P/V | 09H | | |
| | 0Ah: ABS Linear 2 | 0AH | | |
| | 0Bh: INC Linear 2 | 0BH | | |
| | 0Ch: Feed 2 | 0CH | | |
| | 0Dh: ABS ArcMP | 0DH | | |
| | 0Eh: INC ArcMP | 0EH | | |
| | 0Fh: ABS ArcRGT | 0FH | | |
| | 10h: ABS ArcLFT | 10H | | |
| | 11h: INC ArcRGT | 11H | | |
| | 12h: INC ArcLFT | 12H | | |
| | 13h: FWD V2 | 13H | | |
| | 14h: RVS V2 | 14H | | |
| | 15h: ABS Linear 3 | 15H | | |
| | 16h: INC Linear 3 | 16H | | |
| | 17h: Feed 3 | 17H | | |
| | 18h: FWD V3 | 18H | | |
| | 19h: RVS V3 | 19H | | |
| | 1Ah: ABS Linear 4 | 1AH | | |
| | 1Bh: INC Linear 4 | 1BH | | |
| | 1Ch: Feed 4 | 1CH | | |
| | 1Dh: FWD V4 | 1DH | | |
| | 1Eh: RVS V4 | 1EH | | |
| | 80h: NOP | 80H | | |
| | 81h: Address CHG | 81H | | |
| 82h: JUMP | 82H | | | |
| 83h: LOOP | 83H | | | |
| 84h: LEND | 84H | | | |
| [Da.3] Acceleration time No. | 0: [Pr.9] Acceleration time 0 | 00 | ● Acceleration time | |
| | 1: [Pr.25] Acceleration time 1 | 01 | | |
| | 2: [Pr.26] Acceleration time 2 | 10 | | |
| | 3: [Pr.27] Acceleration time 3 | 11 | | |
| [Da.4] Deceleration time No. | 0: [Pr.10] Deceleration time 0 | 00 | ● Deceleration time | |
| | 1: [Pr.28] Deceleration time 1 | 01 | | |
| | 2: [Pr.29] Deceleration time 2 | 10 | | |
| | 3: [Pr.30] Deceleration time 3 | 11 | | |

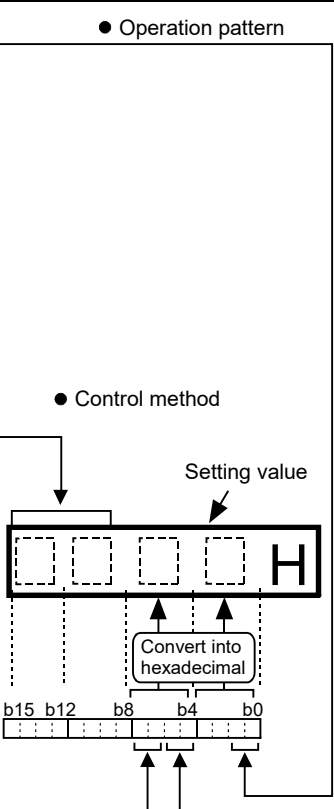

n: Axis No.-1

| Item | Setting value, setting range | | Default value | Buffer memory address | | |
|--|---|---|---------------|--|-------|------------|
| | Value set with GX Works2 | Value set with sequence program | | | | |
| [Da.6] Positioning address/ movement amount | The setting value range differs according to the "[Da.2] Control method". | | 0 | 6006+1000n 6007+1000n | | |
| [Da.7] Arc address | | | 0 | 6008+1000n 6009+1000n | | |
| [Da.8] Command speed | The setting value range differs depending on the "[Pr.1] Unit setting". -1: Current speed (Speed set for previous positioning data No.) | | 0 | 6004+1000n 6005+1000n | | |
| [Da.9] Dwell time/ JUMP destination positioning data No. | Dwell time | The setting value range differs according to the "[Da.2] Control method". | 0 | 6002+1000n | | |
| | JUMP destination positioning data No. | | | | | |
| [Da.10] M code/ Condition data No./Number of LOOP to LEND repetitions | M code Condition data No. Number of LOOP to LEND repetitions | | | | | |
| Axis to be interpolated | [Da.20] Axis to be interpolated No.1 | 0: Axis 1 selected | 0H | <p>(Note): Always "0" is set to the part not used.</p> | 0000H | 6003+1000n |
| | | 1: Axis 2 selected | 1H | | | |
| | | 2: Axis 3 selected | 2H | | | |
| | | 3: Axis 4 selected | 3H | | | |
| | | 4: Axis 5 selected | 4H | | | |
| | | 5: Axis 6 selected | 5H | | | |
| | 6: Axis 7 selected | 6H | | | | |
| | 7: Axis 8 selected | 7H | | | | |
| | 8: Axis 9 selected | 8H | | | | |
| | 9: Axis 10 selected | 9H | | | | |
| | A: Axis 11 selected | AH | | | | |
| | B: Axis 12 selected | BH | | | | |
| | C: Axis 13 selected | CH | | | | |
| | D: Axis 14 selected | DH | | | | |
| | E: Axis 15 selected | EH | | | | |
| | F: Axis 16 selected | FH | | | | |

n: Axis No.-1

[Da.1] Operation pattern

The operation pattern designates whether positioning of a certain data No. is to be ended with just that data, or whether the positioning for the next data No. is to be carried out in succession.

[Operation pattern]

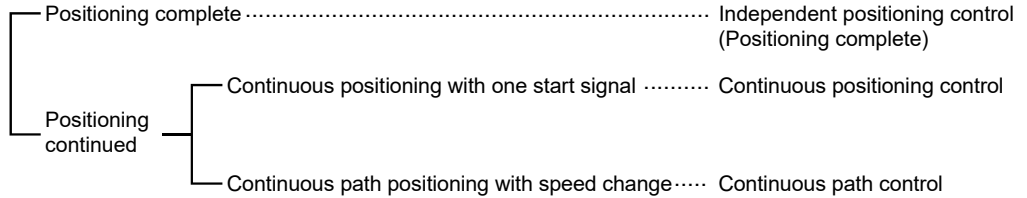

- 1) Positioning complete Set to execute positioning to the designated address, and then complete positioning.
- 2) Continuous positioning control Positioning is carried out successively in order of data Nos. with one start signal. The operation halts at each position indicated by a positioning data.
- 3) Continuous path control..... Positioning is carried out successively in order of data Nos. with one start signal. The operation does not stop at each positioning data.

[Da.2] Control method

Set the "control method" for carrying out positioning control.

- Note)
- When "JUMP instruction" is set for the control method, the "[Da.9] Dwell time/JUMP destination positioning data No." and "[Da.10] M code/Condition data No./Number of LOOP to LEND repetitions" setting details will differ.
 - In case you selected "LOOP" as the control method, the "[Da.10] M code/Condition data No./Number of LOOP to LEND repetitions" should be set differently from other cases.
 - Refer to Chapter 9 "Major Positioning Control" for details on the control methods.
 - If "degree" is set for "[Pr.1] Unit setting", circular interpolation control cannot be carried out. (The error "Circular interpolation not possible" (error code: 535) will occur when executed.)

[Da.3] Acceleration time No.

Set which of "acceleration time 0 to 3" to use for the acceleration time during positioning.

- 0: Use the value set in "[Pr.9] Acceleration time 0".
- 1: Use the value set in "[Pr.25] Acceleration time 1".
- 2: Use the value set in "[Pr.26] Acceleration time 2".
- 3: Use the value set in "[Pr.27] Acceleration time 3".

[Da.4] Deceleration time No.

Set which of "deceleration time 0 to 3" to use for the deceleration time during positioning.

- 0: Use the value set in "[Pr.10] Deceleration time 0".
- 1: Use the value set in "[Pr.28] Deceleration time 1".
- 2: Use the value set in "[Pr.29] Deceleration time 2".
- 3: Use the value set in "[Pr.30] Deceleration time 3".

[Da.6] Positioning address/movement amount

Set the address to be used as the target value for positioning control.

The setting value range differs according to the "[Da.2] Control method".

((1) to (4))

(1) Absolute (ABS) system, current value changing

- The setting value (positioning address) for the ABS system and current value changing is set with an absolute address (address from HP).

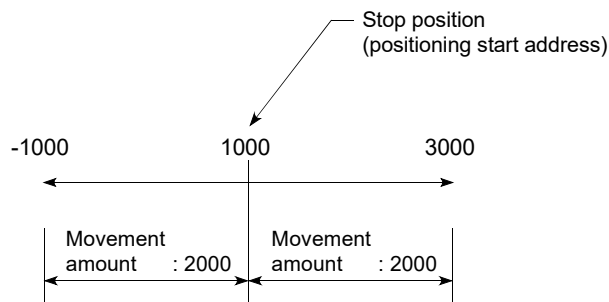

(2) Incremental (INC) system, fixed-feed 1, fixed-feed 2, fixed-feed 3, fixed-feed 4

- The setting value (movement amount) for the INC system is set as a movement amount with sign.

When movement amount is positive: Moves in the positive direction (address increment direction)

When movement amount is negative: Moves in the negative direction (address decrement direction)

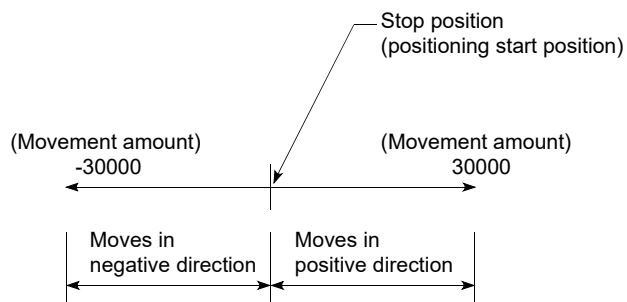

(3) Speed-position switching control

- INC mode:
Set the amount of movement after the switching from speed control to position control.
- ABS mode:
Set the absolute address which will be the target value after speed control is switched to position control. (The unit is "degree" only)

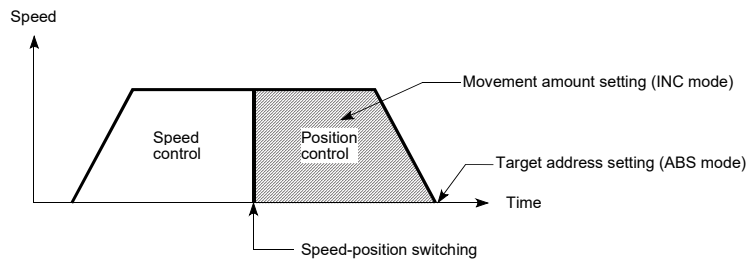

(4) Position-speed switching control

- Set the amount of movement before the switching from position control to speed control.

■ When "[Pr.1] Unit setting" is "mm"

The table below lists the control methods that require the setting of the positioning address or movement amount and the associated setting ranges.

(With any control method excluded from the table below, neither the positioning address nor the movement amount needs to be set.)

| [Da.2] setting value | Value set with GX Works2 (μm) | Value set with sequence program *1 ($\times 10^{-1}\mu\text{m}$) |
|--|--|---|
| ABS Linear 1 : 01H ABS Linear 2 : 0AH ABS Linear 3 : 15H ABS Linear 4 : 1AH Current value changing : 81H | ◇ Set the address -214748364.8 to 214748364.7 | ◇ Set the address -2147483648 to 2147483647 |
| INC Linear 1 : 02H INC Linear 2 : 0BH INC Linear 3 : 16H INC Linear 4 : 1BH Fixed-feed 1 : 03H Fixed-feed 2 : 0CH Fixed-feed 3 : 17H Fixed-feed 4 : 1CH | ◇ Set the movement amount -214748364.8 to 214748364.7 | ◇ Set the movement amount -2147483648 to 2147483647 |
| Forward run speed/position : 06H Reverse run speed/position : 07H Forward run position/speed : 08H Reverse run position/speed : 09H | ◇ Set the movement amount 0 to 214748364.7 | ◇ Set the movement amount 0 to 2147483647 |
| ABS circular sub : 0DH ABS circular right : 0FH ABS circular left : 10H | ◇ Set the address -214748364.8 to 214748364.7 | ◇ Set the address -2147483648 to 2147483647 |
| INC circular sub : 0EH INC circular right : 11H INC circular left : 12H | ◇ Set the movement amount -214748364.8 to 214748364.7 | ◇ Set the movement amount -2147483648 to 2147483647 |

*1: Set an integer because the sequence program cannot handle fractions.
(The value will be converted properly within the system.)

■ When "[Pr.1] Unit setting" is "degree"

The table below lists the control methods that require the setting of the positioning address or movement amount and the associated setting ranges.

(With any control method excluded from the table below, neither the positioning address nor the movement amount needs to be set.)

| [Da.2] setting value | Value set with GX Works2 (degree) | Value set with sequence program *1 ($\times 10^{-5}$ degree) |
|--|--|--|
| ABS Linear 1 : 01H ABS Linear 2 : 0AH ABS Linear 3 : 15H ABS Linear 4 : 1AH Current value changing : 81H | ◇ Set the address 0 to 359.99999 | ◇ Set the address 0 to 35999999 |
| INC Linear 1 : 02H INC Linear 2 : 0BH INC Linear 3 : 16H INC Linear 4 : 1BH Fixed-feed 1 : 03H Fixed-feed 2 : 0CH Fixed-feed 3 : 17H Fixed-feed 4 : 1CH | ◇ Set the movement amount -21474.83648 to 21474.83647 | ◇ Set the movement amount -2147483648 to 2147483647 *2 |
| Forward run speed/position : 06H Reverse run speed/position : 07H | In INC mode ◇ Set the movement amount 0 to 21474.83647 In ABS mode ◇ Set the address 0 to 359.99999 | In INC mode ◇ Set the movement amount 0 to 2147483647 In ABS mode ◇ Set the address 0 to 35999999 |
| Forward run position/speed : 08H Reverse run position/speed : 09H | ◇ Set the movement amount 0 to 21474.83647 | ◇ Set the movement amount 0 to 2147483647 |

*1: Set an integer because the sequence program cannot handle fractions.
(The value will be converted properly within the system.)

*2: When the software stroke limit is valid, -35999999 to 35999999 is set.

■ When "[Pr.1] Unit setting" is "PLS"

The table below lists the control methods that require the setting of the positioning address or movement amount and the associated setting ranges.

(With any control method excluded from the table below, neither the positioning address nor the movement amount needs to be set.)

| [Da.2] setting value | Value set with GX Works2 (PLS) | Value set with sequence program ※1 (PLS) |
|--|--|--|
| ABS Linear 1 : 01H ABS Linear 2 : 0AH ABS Linear 3 : 15H ABS Linear 4 : 1AH Current value changing : 81H | ◇ Set the address -2147483648 to 2147483647 | ◇ Set the address -2147483648 to 2147483647 |
| INC Linear 1 : 02H INC Linear 2 : 0BH INC Linear 3 : 16H INC Linear 4 : 1BH Fixed-feed 1 : 03H Fixed-feed 2 : 0CH Fixed-feed 3 : 17H Fixed-feed 4 : 1CH | ◇ Set the movement amount -2147483648 to 2147483647 | ◇ Set the movement amount -2147483648 to 2147483647 |
| Forward run speed/position : 06H Reverse run speed/position : 07H Forward run position/speed : 08H Reverse run position/speed : 09H | ◇ Set the movement amount 0 to 2147483647 | ◇ Set the movement amount 0 to 2147483647 |
| ABS circular sub : 0DH ABS circular right : 0FH ABS circular left : 10H | ◇ Set the address -2147483648 to 2147483647 | ◇ Set the address -2147483648 to 2147483647 |
| INC circular sub : 0EH INC circular right : 11H INC circular left : 12H | ◇ Set the movement amount -2147483648 to 2147483647 | ◇ Set the movement amount -2147483648 to 2147483647 |

■ When "[Pr.1] Unit setting" is "inch"

The table below lists the control methods that require the setting of the positioning address or movement amount and the associated setting ranges.
(With any control method excluded from the table below, neither the positioning address nor the movement amount needs to be set.)

| [Da.2] setting value | Value set with GX Works2 (inch) | Value set with sequence program *1 ($\times 10^{-5}$ inch) |
|--|--|---|
| ABS Linear 1 : 01H ABS Linear 2 : 0AH ABS Linear 3 : 15H ABS Linear 4 : 1AH Current value changing : 81H | ◇ Set the address -21474.83648 to 21474.83647 | ◇ Set the address -2147483648 to 2147483647 |
| INC Linear 1 : 02H INC Linear 2 : 0BH INC Linear 3 : 16H INC Linear 4 : 1BH Fixed-feed 1 : 03H Fixed-feed 2 : 0CH Fixed-feed 3 : 17H Fixed-feed 4 : 1CH | ◇ Set the movement amount -21474.83648 to 21474.83647 | ◇ Set the movement amount -2147483648 to 2147483647 |
| Forward run speed/position : 06H Reverse run speed/position : 07H Forward run position/speed : 08H Reverse run position/speed : 09H | ◇ Set the movement amount 0 to 21474.83647 | ◇ Set the movement amount 0 to 2147483647 |
| ABS circular sub : 0DH ABS circular right : 0FH ABS circular left : 10H | ◇ Set the address -21474.83648 to 21474.83647 | ◇ Set the address -2147483648 to 2147483647 |
| INC circular sub : 0EH INC circular right : 11H INC circular left : 12H | ◇ Set the movement amount -21474.83648 to 21474.83647 | ◇ Set the movement amount -2147483648 to 2147483647 |

*1: Set an integer because the sequence program cannot handle fractions.
(The value will be converted properly within the system.)

[Da.7] Arc address

The arc address is data required only when carrying out circular interpolation control.

- (1) When carrying out circular interpolation with sub point designation, set the sub point (passing point) address as the arc address.
- (2) When carrying out circular interpolation with center point designation, set the center point address of the arc as the arc address.

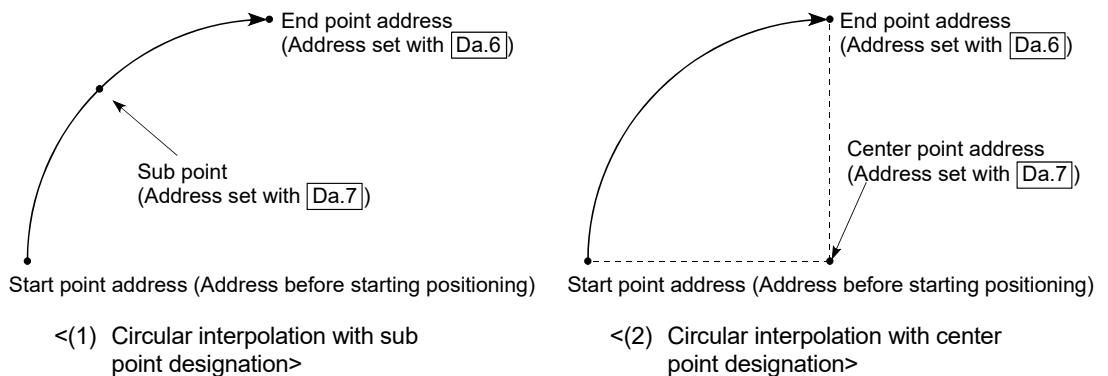

When not carrying out circular interpolation control, the value set in "[Da.7] Arc address" will be invalid.

■ When "[Pr.1] Unit setting" is "mm"

The table below lists the control methods that require the setting of the arc address and shows the setting range.

(With any control method excluded from the table below, the arc address does not need to be set.)

| [Da.2] setting value | Value set with GX Works2 (μm) | Value set with sequence program *1 ($\times 10^{-1}\mu\text{m}$) |
|---|---|---|
| ABS circular sub : 0DH ABS circular right : 0FH ABS circular left : 10H | ◇ Set the address -214748364.8 to 214748364.7 *2 | ◇ Set the address -2147483648 to 2147483647 |
| INC circular sub : 0EH INC circular right : 11H INC circular left : 12H | ◇ Set the movement amount -214748364.8 to 214748364.7 *2 | ◇ Set the movement amount -2147483648 to 2147483647 *2 |

*1: Set an integer because the sequence program cannot handle fractions.
(The value will be converted properly within the system.)

*2: Note that the maximum radius that circular interpolation control is possible is 536870912 ($\times 10^{-1}\mu\text{m}$), although the setting value can be input within the range shown in the above table, as an arc address.

■ When "[Pr.1] Unit setting" is "degree"

No control method requires the setting of the arc address by "degree".

■ When "[Pr.1] Unit setting" is "PLS"

The table below lists the control methods that require the setting of the arc address and shows the setting range.

(With any control method excluded from the table below, the arc address does not need to be set.)

| [Da.2] setting value | Value set with GX Works2 (PLS) | Value set with sequence program *1 (PLS) |
|---|---|---|
| ABS circular sub : 0DH ABS circular right : 0FH ABS circular left : 10H | ◇ Set the address -2147483648 to 2147483647 *1 | ◇ Set the address -2147483648 to 2147483647 |
| INC circular sub : 0EH INC circular right : 11H INC circular left : 12H | ◇ Set the movement amount -2147483648 to 2147483647 *1 | ◇ Set the movement amount -2147483648 to 2147483647 *1 |

*1: Note that the maximum radius that circular interpolation control is possible is 536870912 (PLS), although the setting value can be input within the range shown in the above table, as an arc address.

■ When "[Pr.1] Unit setting" is "inch"

The table below lists the control methods that require the setting of the arc address and shows the setting range.

(With any control method excluded from the table below, the arc address does not need to be set.)

| [Da.2] setting value | Value set with GX Works2 (inch) | Value set with sequence program *1 ($\times 10^{-5}$ inch) |
|---|---|--|
| ABS circular sub : 0DH ABS circular right : 0FH ABS circular left : 10H | ◇ Set the address -21474.83648 to 21474.83647 *2 | ◇ Set the address -2147483648 to 2147483647 |
| INC circular sub : 0EH INC circular right : 11H INC circular left : 12H | ◇ Set the movement amount -21474.83648 to 21474.83647 *2 | ◇ Set the movement amount -2147483648 to 2147483647 *2 |

*1: Set an integer because the sequence program cannot handle fractions.
(The value will be converted properly within the system.)

*2: Note that the maximum radius that circular interpolation control is possible is 536870912 ($\times 10^{-5}$ inch), although the setting value can be input within the range shown in the above table, as an arc address.

[Da.8] Command speed

Set the command speed for positioning.

- (1) If the set command speed exceeds "[Pr.8] Speed limit value", positioning will be carried out at the speed limit value.
- (2) If "-1" is set for the command speed, the current speed (speed set for previous positioning data No.) will be used for positioning control. Use the current speed for uniform speed control, etc. If "-1" is set for continuing positioning data, and the speed is changed, the following speed will also change.

(Note that when starting positioning, if the "-1" speed is set for the positioning data that carries out positioning control first, the error "No command speed" (error code: 503) will occur, and the positioning will not start.
Refer to Section 16.4 "List of errors" for details on the errors.)

| [Pr.1] setting value | Value set with GX Works2 (unit) | Value set with sequence program (unit) |
|----------------------|---|--|
| 0 : mm | 0.01 to 20000000.00 (mm/min) | 1 to 2000000000 ($\times 10^{-2}$ mm/min) |
| 1 : inch | 0.001 to 2000000.000 (inch/min) | 1 to 2000000000 ($\times 10^{-3}$ inch/min) |
| 2 : degree | 0.001 to 2000000.000 (degree/min) *1 | 1 to 2000000000 ($\times 10^{-3}$ degree/min) *2 |
| 3 : PLS | 1 to 1000000000 (PLS/s) | 1 to 1000000000 (PLS/s) |

*1: The command speed setting range is 0.001 to 2000000.000[degree/min], but it will be decupled and become 0.01 to 20000000.00[degree/min] by setting "[Pr.83] Speed control 10 x multiplier setting for degree axis" to valid.

*2: The command speed setting range is 1 to 2000000000($\times 10^{-3}$ degree/min), but it will be decupled and become 1 to 2000000000 ($\times 10^{-2}$ degree/min) by setting "[Pr.83] Speed control 10 x multiplier setting for degree axis" to valid.

[Da.9] Dwell time/JUMP designation positioning data No.

Set the "dwell time" or "positioning data No." corresponding to the "[Da.2] Control method".

- When a method other than "JUMP instruction" is set for "[Da.2] Control method" Set the "dwell time".
- When "JUMP instruction" is set for "[Da.2] Control method" Set the "positioning data No." for the JUMP destination.

When the "dwell time" is set, the setting details of the "dwell time" will be as follows according to "[Da.1] Operation pattern".

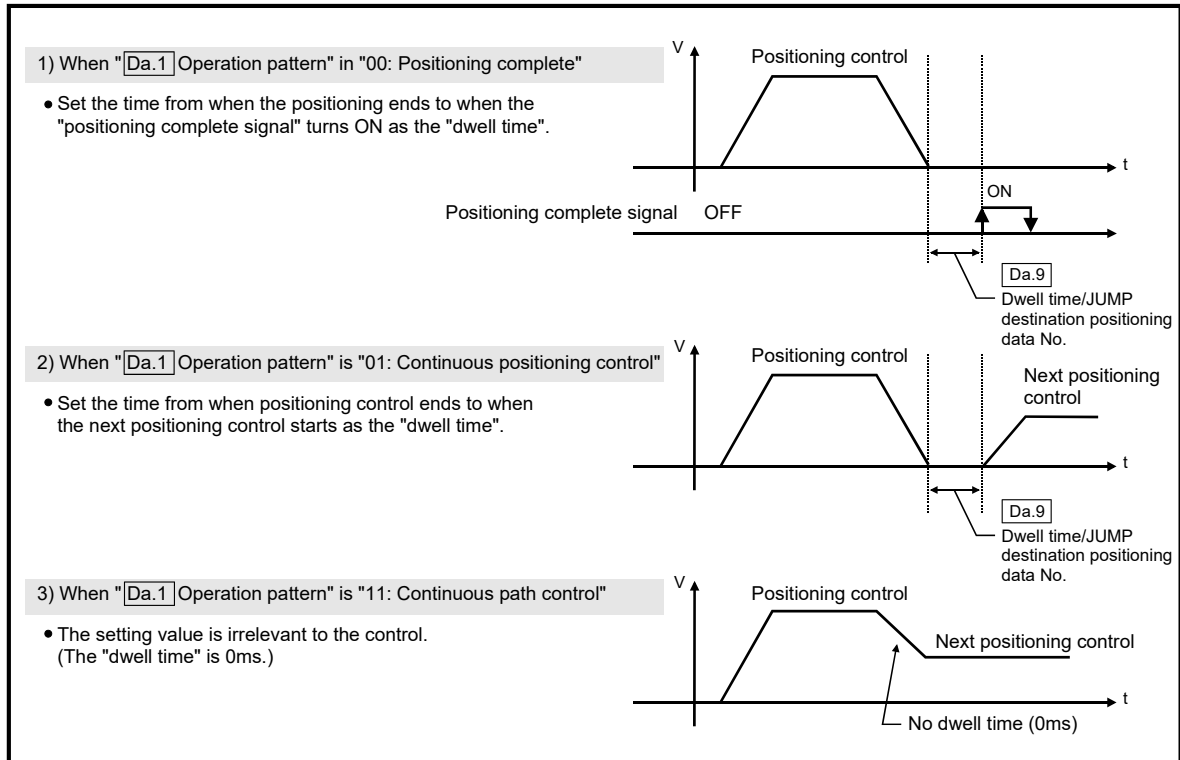

| [Da.2] setting value | Setting item | Value set with GX Works2 | Value set with sequence program |
|-----------------------------|----------------------|--------------------------|---------------------------------|
| JUMP instruction: 82H | Positioning data No. | 1 to 600 | 1 to 600 |
| Other than JUMP instruction | Dwell time | 0 to 65535 (ms) | 0 to 65535 (ms) |

[Da.10] M code/Condition data No./Number of LOOP to LEND repetitions

Set an "M code", a "condition data No.", or the "Number of LOOP to LEND repetitions" depending on how the "[Da.2] Control method" is set. *1

- If a method other than "JUMP instruction" and "LOOP" is selected as the "[Da.2] Control method"
 - Set an "M code".
 - If no "M code" needs to be output, set "0" (default value).
- If "JUMP instruction" or "LOOP" is selected as the "[Da.2] Control method"
 - Set the "condition data No." for JUMP.
 - 0 : Unconditional JUMP to the positioning data specified by [Da.9].
 - 1 to 10 : JUMP performed according to the condition data No. specified (a number between 1 and 10).

Make sure that you specify the number of LOOP to LEND repetitions by a number other than "0". The error "Control method LOOP setting error" (error code: 545) will occur if you specify "0".

*1: The condition data specifies the condition for the JUMP instruction to be executed.

(A JUMP will take place when the condition is satisfied.)

| [Da.2] setting value | Setting item | Value set with GX Works2 | Value set with sequence program |
|-----------------------------|--------------------|--------------------------|---------------------------------|
| JUMP instruction: 82H | Condition data No. | 0 to 10 | 0 to 10 |
| Other than JUMP instruction | M code | 0 to 65535 | 0 to 65535 |
| LOOP: 83H | Repetition count | 1 to 65535 | 1 to 65535 |

[Da.20] Axis to be interpolated No.1 to [Da.22] Axis to be interpolated No.3

Set the axis to be interpolated to execute the 2 to 4-axis interpolation operation.

- 2-axis interpolation..... Set the target axis number in "[Da.20] Axis to be interpolated No.1".
- 3-axis interpolation..... Set the target axis number in "[Da.20] Axis to be interpolated No.1" and "[Da.21] Axis to be interpolated No.2".
- 4-axis interpolation..... Set the target axis number in "[Da.20] Axis to be interpolated No.1" to "[Da.22] Axis to be interpolated No.3".

Set the axis set as axis to be interpolated.

| | |
|-----------|------------|
| 0: Axis 1 | 8: Axis 9 |
| 1: Axis 2 | 9: Axis 10 |
| 2: Axis 3 | A: Axis 11 |
| 3: Axis 4 | B: Axis 12 |
| 4: Axis 5 | C: Axis 13 |
| 5: Axis 6 | D: Axis 14 |
| 6: Axis 7 | E: Axis 15 |
| 7: Axis 8 | F: Axis 16 |

- Note)
- Do not specify the own axis number. (If you do, the error "Illegal interpolation description command" (error code: 521) will occur during the program execution.)
 - When the same axis number or axis number of own axis is set to multiple axis to be interpolated number, the error "Illegal interpolation description command" (error code: 521) will occur during the program execution.
 - Do not specify the axis to be interpolated No.2 and axis to be interpolated No.3 for 2-axis interpolation, and do not specify the axis to be interpolated No.3 for 3-axis interpolation. The setting value is ignored.

5.4 List of block start data

The illustrations below show the organization of the block start data stored in the buffer memory of Simple Motion module. The block start data setting items [Da.11] to [Da.14] are explained in the pages that follow.

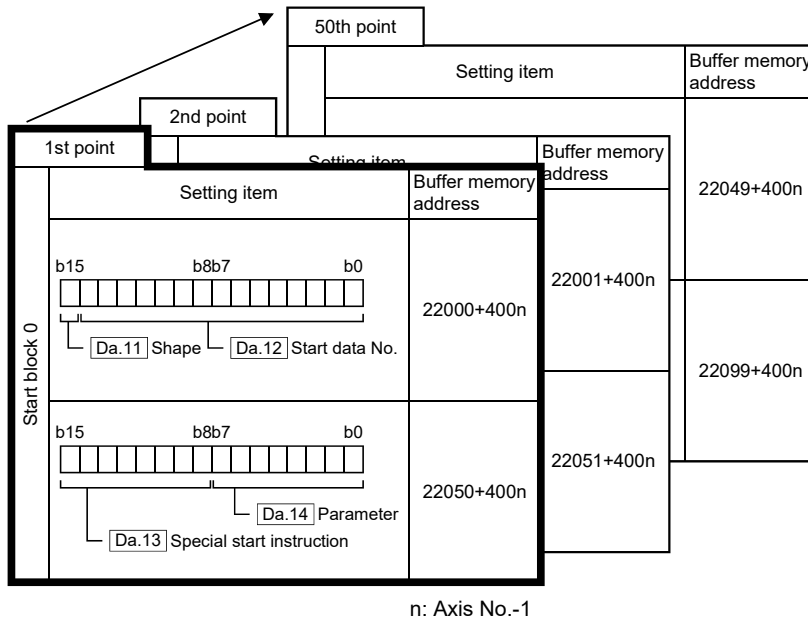

- Up to 50 block start data points can be set (stored) for each axis in the buffer memory addresses shown on the left.
- Items in a single unit of block start data are shown included in a bold frame.
- Each axis has five start blocks (block Nos. 0 to 4). Start block 2 to 4 are not allocated to buffer memory. Set with GX Works2.

(Note): For information on the organization of the buffer memory addresses assigned to the start block 1, refer to Appendix 1 "List of buffer memory addresses".

The following pages explain the block start data setting items [Da.11] to [Da.14]. (The buffer memory addresses shown are those of the "1st point block start data (block No. 7000)".)

• Guide to buffer memory address

In the buffer memory address, "n" in "22000+400n", etc. indicates a value corresponding to axis No. such as the following table.

| Axis No. | n | Axis No. | n | Axis No. | n | Axis No. | n |
|----------|---|----------|---|----------|----|----------|----|
| 1 | 0 | 5 | 4 | 9 | 8 | 13 | 12 |
| 2 | 1 | 6 | 5 | 10 | 9 | 14 | 13 |
| 3 | 2 | 7 | 6 | 11 | 10 | 15 | 14 |
| 4 | 3 | 8 | 7 | 12 | 11 | 16 | 15 |

(Note-1): Calculate as follows for the buffer memory address corresponding to each axis.

(Example) For axis No. 16

$$22000+400n \text{ ([Da.11] Shape)} = 22000+400 \times 15 = 28000$$

REMARK

To perform a high-level positioning control using block start data, set a number between 7000 and 7004 to the "[Cd.3] Positioning start No." and use the "[Cd.4] Positioning starting point No." to specify a point number between 1 and 50, a position counted from the beginning of the block.

The number between 7000 and 7004 specified here is called the "block No.". With the Simple Motion module, up to 50 "block start data" points and up to 10 "condition data" items can be assigned to each "block No.".

| Block No. *1 | Axis | Block start data | Condition | Buffer memory | GX Works2 |
|-----------------|--------------------------|------------------|--------------------------|-----------------------|-----------|
| 7000 | Axis 1 | Start block 0 | Condition data (1 to 10) | Supports the settings | |
| | to | | to | | |
| | Maximum control axis No. | | Condition data (1 to 10) | | |
| 7001 | Axis 1 | Start block 1 | Condition data (1 to 10) | | |
| | to | | to | | |
| | Maximum control axis No. | | Condition data (1 to 10) | | |
| 7002 | Axis 1 | Start block 2 | Condition data (1 to 10) | | |
| | to | | to | | |
| | Maximum control axis No. | | Condition data (1 to 10) | | |
| 7003 | Axis 1 | Start block 3 | Condition data (1 to 10) | | |
| | to | | to | | |
| | Maximum control axis No. | | Condition data (1 to 10) | | |
| 7004 | Axis 1 | Start block 4 | Condition data (1 to 10) | | |
| | to | | to | | |
| | Maximum control axis No. | | Condition data (1 to 10) | | |

*1: Setting cannot be made when the "Pre-reading start function" is used. If you set any of Nos. 7000 to 7004 and perform the Pre-reading start function, the error "Outside start No. range" (error code: 543) will occur.

(For details, refer to Section 13.7.7 "Pre-reading start function".)

| Item | Setting value | | Default value | Buffer memory address |
|--------------------------------------|--|---------------------------------|---------------|-----------------------|
| | Value set with GX Works2 | Value set with sequence program | | |
| [Da.11] Shape | 0 : End | 0 | 0000H | 22000+400n |
| | 1 : Continue | 1 | | |
| [Da.12] Start data No. | Positioning data No.: 1 to 600 (01H to 258H) | 01H to 258H | | |
| [Da.13] Special start instruction | 0 : Block start (normal start) | 00H | 0000H | 22050+400n |
| | 1 : Condition start | 01H | | |
| | 2 : Wait start | 02H | | |
| | 3 : Simultaneous start | 03H | | |
| | 4 : FOR loop | 04H | | |
| | 5 : FOR condition | 05H | | |
| | 6 : NEXT start | 06H | | |
| [Da.14] Parameter | Condition data No.: 1 to 10 (01H to 0AH) Number of repetitions: 0 to 255 (00H to FFH) | 00H to FFH | | |

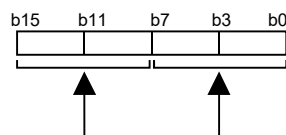
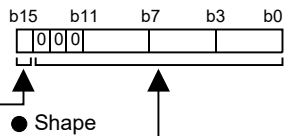

n: Axis No.-1

[Da.11] Shape

Set whether to carry out only the local "block start data" and then end control, or to execute the "block start data" set in the next point.

| Setting value | Setting details |
|---------------|---|
| 0 : End | Execute the designated point's "block start data", and then complete the control. |
| 1 : Continue | Execute the designated point's "block start data", and after completing control, execute the next point's "block start data". |

[Da.12] Start data No.

Set the "positioning data No." designated with the "block start data".

[Da.13] Special start instruction

Set the "special start instruction" for using "high-level positioning control". (Set how to start the positioning data set in "[Da.12] Start data No.".)

| Setting value | Setting details |
|-------------------------------------|--|
| 00H: Block start (Normal start) | Execute the random block positioning data in the set order with one start. |
| 01H: Condition start | Carry out the condition judgment set in "condition data" for the designated positioning data, and when the conditions are established, execute the "block start data". If not established, ignore that "block start data", and then execute the next point's "block start data". |
| 02H: Wait start | Carry out the condition judgment set in "condition data" for the designated positioning data, and when the conditions are established, execute the "block start data". If not established, stop the control (wait) until the conditions are established. |
| 03H: Simultaneous start | Simultaneous execute (output command at same timing) the positioning data with the No. designated for the axis designated in the "condition data". Up to four axes can start simultaneously. |
| 04H: Repeated start (FOR loop) | Repeat the program from the block start data with the "FOR loop" to the block start data with "NEXT" for the designated number of times. |
| 05H: Repeated start (FOR condition) | Repeat the program from the block start data with the "FOR condition" to the block start data with "NEXT" until the conditions set in the "condition data" are established. |
| 06H: NEXT start | Set the end of the repetition when "04H: Repetition start (FOR loop)" or "05H: Repetition start (FOR condition)" is set. |

Refer to Chapter 10 "High-Level Positioning Control" for details on the control.

[Da.14] Parameter

Set the value as required for "[Da.13] Special start instruction".

| [Da.13] Special start instruction | Setting value | Setting details |
|-----------------------------------|---------------|---|
| Block start (Normal start) | – | Not used. (There is no need to set.) |
| Condition start | 1 to 10 | Set the condition data No. (Data No. of "condition data" is set up for the condition judgment.) |
| Wait start | | |
| Simultaneous start | | |
| Repeated start (FOR loop) | 0 to 255 | Set the number of repetitions. |
| Repeated start (FOR condition) | 1 to 10 | Set the condition data No. (Data No. of "condition data" is set up for the condition judgment.) |

5.5 List of condition data

The illustrations below show the organization of the condition data stored in the buffer memory of Simple Motion module. The condition data setting items [Da.15] to [Da.19] and [Da.23] to [Da.26] are explained in the pages that follow.

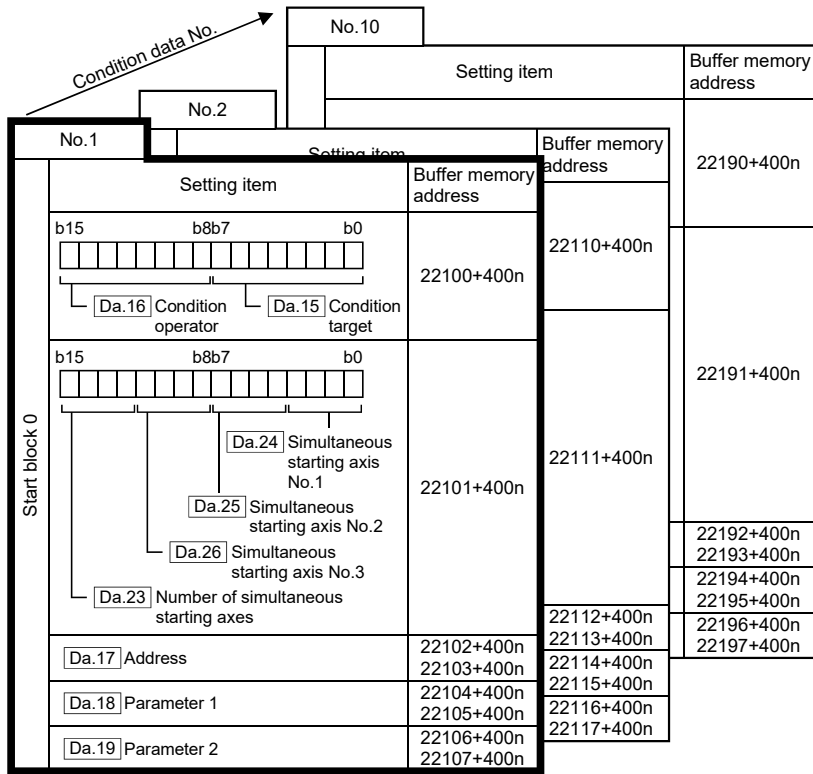

n: Axis No.-1

- Up to 10 condition data points can be set (stored) for each block No. in the buffer memory addresses shown on the left.
- Items in a single unit of condition data are shown included in a bold frame.
- Each axis has five start blocks (block Nos. 0 to 4). Start block 2 to 4 are not allocated to buffer memory. Set with GX Works2.

(Note): For information on the organization of the buffer memory addresses assigned to the start block 1, refer to Appendix 1 "List of buffer memory addresses".

The following pages explain the condition data setting items [Da.15] to [Da.19] and [Da.23] to [Da.26].
(The buffer memory addresses shown are those of the "condition data No. 1 (block No. 7000)".)

• Guide to buffer memory address

In the buffer memory address, "n" in "22100+400n", etc. indicates a value corresponding to axis No. such as the following table.

| Axis No. | n | Axis No. | n | Axis No. | n | Axis No. | n |
|----------|---|----------|---|----------|----|----------|----|
| 1 | 0 | 5 | 4 | 9 | 8 | 13 | 12 |
| 2 | 1 | 6 | 5 | 10 | 9 | 14 | 13 |
| 3 | 2 | 7 | 6 | 11 | 10 | 15 | 14 |
| 4 | 3 | 8 | 7 | 12 | 11 | 16 | 15 |

(Note-1): Calculate as follows for the buffer memory address corresponding to each axis.

(Example) For axis No. 16

$$22100+400n \text{ ([Da.16] Condition operator)} = 22100+400 \times 15 = 28100$$

REMARK

To perform a high-level positioning control using block start data, set a number between 7000 and 7004 to the "[Cd.3] Positioning start No." and use the "[Cd.4] Positioning starting point No." to specify a point number between 1 and 50, a position counted from the beginning of the block.

The number between 7000 and 7004 specified here is called the "block No.". With the Simple Motion module, up to 50 "block start data" points and up to 10 "condition data" items can be assigned to each "block No.".

| Block No. *1 | Axis | Block start data | Condition | Buffer memory | GX Works2 |
|-----------------|--------------------------|------------------|--------------------------|-----------------------|-----------|
| 7000 | Axis 1 | Start block 0 | Condition data (1 to 10) | Supports the settings | |
| | to | | to | | |
| | Maximum control axis No. | | Condition data (1 to 10) | | |
| 7001 | Axis 1 | Start block 1 | Condition data (1 to 10) | | |
| | to | | to | | |
| | Maximum control axis No. | | Condition data (1 to 10) | | |
| 7002 | Axis 1 | Start block 2 | Condition data (1 to 10) | | |
| | to | | to | | |
| | Maximum control axis No. | | Condition data (1 to 10) | | |
| 7003 | Axis 1 | Start block 3 | Condition data (1 to 10) | | |
| | to | | to | | |
| | Maximum control axis No. | | Condition data (1 to 10) | | |
| 7004 | Axis 1 | Start block 4 | Condition data (1 to 10) | | |
| | to | | to | | |
| | Maximum control axis No. | | Condition data (1 to 10) | | |

*1: Setting cannot be made when the "Pre-reading start function" is used. If you set any of Nos. 7000 to 7004 and perform the Pre-reading start function, the error "Outside start No. range" (error code: 543) will occur.

(For details, refer to Section 13.7.7 "Pre-reading start function".)

| Item | Setting value | | Default value | Buffer memory address | | | | |
|----------------------------|--|---|---------------------------------|-----------------------|------------|--|--------------------------|------------|
| | Value set with GX Works2 | Value set with sequence program | | | | | | |
| Condition identifier | [Da.15] Condition target | 01 : Device X 02 : Device Y 03 : Buffer memory (1-word) 04 : Buffer memory (2-word) 05 : Positioning data No. | 01H 02H 03H 04H 05H | 0000H | 22100+400n | | | |
| | [Da.16] Condition operator | 01 : **=P1 02 : **≠P1 03 : **≤P1 04 : **≥P1 05 : P1≤**≤ P2 06 : **≤P1, P2≤** 07 : DEV=ON 08 : DEV=OFF | | | | 01H 02H 03H 04H 05H 06H 07H 08H | | |
| [Da.17] Address | Buffer memory address | Example) 22103 (High-order) 22102 (Low-order) b31 b16 b15 b0 Buffer memory address → | | | | 0000H | 22102+400n 22103+400n | |
| [Da.18] Parameter 1 | Value | Example) 22105 (High-order) 22104 (Low-order) b31 b16 b15 b0 Value → | | | | 0000H | 22104+400n 22105+400n | |
| [Da.19] Parameter 2 | Value | Example) 22107 (High-order) 22106 (Low-order) b31 b16 b15 b0 Value → | | | | 0000H | 22106+400n 22107+400n | |
| Simultaneous starting axis | [Da.23] Number of simultaneous starting axes | 2: 2 axes 3: 3 axes 4: 4 axes | | | | 2H 3H 4H | 0000H | 22101+400n |
| | [Da.24] Simultaneous starting axis No.1 | 0: Axis 1 selected 1: Axis 2 selected 2: Axis 3 selected 3: Axis 4 selected 4: Axis 5 selected 5: Axis 6 selected 6: Axis 7 selected 7: Axis 8 selected 8: Axis 9 selected 9: Axis 10 selected | | | | 0H 1H 2H 3H 4H 5H 6H 7H 8H 9H | | |
| | [Da.25] Simultaneous starting axis No.2 | A: Axis 11 selected B: Axis 12 selected C: Axis 13 selected D: Axis 14 selected E: Axis 15 selected F: Axis 16 selected | | | | AH BH CH DH EH FH | | |
| | [Da.26] Simultaneous starting axis No.3 | | | | | | | |

n: Axis No.-1

[Da.15] Condition target

Set the condition target as required for each control.

| Setting value | Setting details |
|------------------------------|---|
| 01H : Device X | Set the input/output signal ON/OFF as the conditions. |
| 02H : Device Y | |
| 03H : Buffer memory (1-word) | Set the value stored in the buffer memory as the condition. 03H: The target buffer memory is "1-word (16 bits)" 04H: The target buffer memory is "2-word (32 bits)" |
| 04H : Buffer memory (2-word) | |
| 05H : Positioning data No. | Select only for "simultaneous start". |

[Da.16] Condition operator

Set the condition operator as required for the "[Da.15] Condition target".

| [Da.15] Condition target | Setting value | Setting details |
|--|--------------------|---|
| 01H: Device X | 07H : DEV=ON | The state (ON/OFF) of an I/O signal is defined as the condition. Select ON or OFF as the trigger. |
| 02H: Device Y | 08H : DEV=OFF | |
| 03H: Buffer memory (1-word) 04H: Buffer memory (2-word) | 01H : **=P1 | Select how to use the value (**) in the buffer memory as a part of the condition. |
| | 02H : **≠P1 | |
| | 03H : **≤P1 | |
| | 04H : **≥P1 | |
| | 05H : P1≤**≤P2 | |
| | 06H : **≤P1, P2≤** | |

[Da.17] Address

Set the address as required for the "[Da.15] Condition target".

| [Da.15] Condition target | Setting value | Setting details |
|------------------------------|----------------------------------|--|
| 01H : Device X | - | Not used. (There is no need to set.) |
| 02H : Device Y | | |
| 03H : Buffer memory (1-word) | Value (Buffer memory address) | Set the target "buffer memory address". (For 2 words, set the low-order buffer memory address.) |
| 04H : Buffer memory (2-word) | | |
| 05H : Positioning data No. | - | Not used. (There is no need to set.) |

[Da.18] Parameter 1

Set the parameters as required for the "[Da.16] Condition operator" and "[Da.23] Number of simultaneous starting axes".

| [Da.16] Condition operator | [Da.23] Number of simultaneous starting axes | Setting value | Setting details |
|----------------------------|--|------------------------------|--|
| 01H : $==P1$ | / | Value | The value of P1 should be equal to or smaller than the value of P2. ($P1 \leq P2$) If P1 is greater than P2 ($P1 > P2$), the error "Condition data error" (error code 533) will occur. |
| 02H : $\neq P1$ | | | |
| 03H : $\leq P1$ | | | |
| 04H : $\geq P1$ | | | |
| 05H : $P1 \leq P2$ | | | |
| 06H : $\leq P1, P2 \leq$ | | | |
| 07H : DEV=ON | | Value (bit No.) | Set the device bit No. X: 0H to 1H, 10H to 1FH Y: 0H, 1H, 10H to 1FH |
| 08H : DEV=OFF | | | |
| / | 2 to 4 | Value (positioning data No.) | Set the positioning data No. for starting axis set in "[Da.24] Simultaneous starting axis No.1" and/or "[Da.25] Simultaneous starting axis No.2". Low-order 16-bit : Simultaneous starting axis No.1 positioning data No.1 to 600 (01H to 258H) High-order 16-bit : Simultaneous starting axis No.2 positioning data No.1 to 600 (01H to 258H) |

[Da.19] Parameter 2

Set the parameters as required for the "[Da.16] Condition operator" and "[Da.23] Number of simultaneous starting axes".

| [Da.16] Condition operator | [Da.23] Number of simultaneous starting axes | Setting value | Setting details | |
|----------------------------|--|------------------------------|---|--------------------------------|
| 01H : $==P1$ | / | — | Not used. (No need to be set.) | |
| 02H : $\neq P1$ | | | | |
| 03H : $\leq P1$ | | | | |
| 04H : $\geq P1$ | | | | |
| 05H : $P1 \leq P2$ | | Value | The value of P2 should be equal to or greater than the value of P1. ($P1 \leq P2$) If P1 is greater than P2 ($P1 > P2$), the error "Condition data error" (error code 533) will occur. | |
| 06H : $\leq P1, P2 \leq$ | | | | |
| 07H : DEV=ON | | / | — | Not used. (No need to be set.) |
| 08H : DEV=OFF | | | | |
| / | 2 to 3 | | | |
| / | 4 | Value (positioning data No.) | Set the positioning data No. for starting axis set in "[Da.26] Simultaneous starting axis No.3" Low-order 16-bit : Simultaneous starting axis No.3 positioning data No. 1 to 600 (01H to 258H) High-order 16-bit : Not used (Set "0") | |

[Da.23] Number of simultaneous starting axes

Set the number of simultaneous starting axes to execute the simultaneous start.

- 2: Simultaneous start by 2 axes of the starting axis and axis set in "[Da.24] Simultaneous starting axis No.1".
- 3: Simultaneous start by 3 axes of the starting axis and axis set in "[Da.24] Simultaneous starting axis No.1" and "[Da.25] Simultaneous starting axis No.2".
- 4: Simultaneous start by 4 axes of the starting axis and axis set in "[Da.24] Simultaneous starting axis No.1" to "[Da.26] Simultaneous starting axis No.3".

[Da.24] Simultaneous starting axis No.1 to [Da.26] Simultaneous starting axis No.3

Set the simultaneous starting axis to execute the 2 to 4-axis simultaneous start.

- 2-axis interpolation Set the target axis number in "[Da.24] Simultaneous starting axis No.1".
- 3-axis interpolation Set the target axis number in "[Da.24] Simultaneous starting axis No.1" and "[Da.25] Simultaneous starting axis No.2".
- 4-axis interpolation Set the target axis number in "[Da.24] Simultaneous starting axis No.1" to "[Da.26] Simultaneous starting axis No.3".

Set the axis set as simultaneous starting axis.

- | | |
|-----------|------------|
| 0: Axis 1 | 8: Axis 9 |
| 1: Axis 2 | 9: Axis 10 |
| 2: Axis 3 | A: Axis 11 |
| 3: Axis 4 | B: Axis 12 |
| 4: Axis 5 | C: Axis 13 |
| 5: Axis 6 | D: Axis 14 |
| 6: Axis 7 | E: Axis 15 |
| 7: Axis 8 | F: Axis 16 |

- Note)
- Do not specify the own axis number. (If you do, the error "Condition data error" (error code: 533) will occur during the program execution.)
 - When the same axis number or axis number of own axis is set to multiple simultaneous starting axis number, the error "Condition data error" (error code: 533) will occur during the program execution.
 - Do not specify the simultaneous starting axis No.2 and simultaneous starting axis No.3 for 2-axis simultaneously start, and not specify the simultaneous starting axis No.3 for 3-axis simultaneously start. The setting value is ignored.

5.6 List of monitor data

The setting items of the monitor data are explained in this section.

- Guide to buffer memory address

In the buffer memory address, "n" in "2406+100n", etc. indicates a value corresponding to axis No. such as the following table.

| Axis No. | n | Axis No. | n | Axis No. | n | Axis No. | n |
|----------|---|----------|---|----------|----|----------|----|
| 1 | 0 | 5 | 4 | 9 | 8 | 13 | 12 |
| 2 | 1 | 6 | 5 | 10 | 9 | 14 | 13 |
| 3 | 2 | 7 | 6 | 11 | 10 | 15 | 14 |
| 4 | 3 | 8 | 7 | 12 | 11 | 16 | 15 |

(Note-1): Calculate as follows for the buffer memory address corresponding to each axis.

(Example) For axis No. 16

$$2406+100n \text{ ([Md.23] Axis error No.)} = 2406+100 \times 15 = 3906$$

5.6.1 System monitor data

| Storage item | Storage details |
|--------------------------|--|
| [Md.1] In test mode flag | <p>Whether the mode is the test mode from the GX Works2 or not is stored.</p> <ul style="list-style-type: none"> • When not in test mode : OFF • When in test mode : ON <p><u>Refresh cycle: Immediate</u></p> |

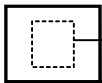
| Reading the monitor value | Default value | Buffer memory address |
|---|---------------|-----------------------|
| <p>■ Monitoring is carried out with a decimal.</p> <p>Monitor value </p> <p>● Storage value 0: Not in test mode 1: In test mode</p> | 0 | 4000 |

(Unless noted in particular, the monitor value is saved as binary data.)

| Storage item | Storage details | Reading the monitor value | | | | | | | | | | | | | | | | | | | | | | | | | | | | | | | | | | | | | | | | | | | | | | | | | | | | | | | | | | | | | | | | | | | | | | | | | | | | | | | | | | | | | | | | | | | | | | | | | | | | | | | | | | | | | | | | | | | | | | | | | | | | | | | | | | | | | | | | | | | | | | | | | | | | | | | | | | | | | | | | | | | | | | | | | |
|---|--|---------------------------|---------------|------------------|---------------------|-----------------|---|-----------------|---------------|---------|----|-----------------|----|-----------|----|-----------------|---------------|--------|---|--------|---|--------|---|--------|---|--------|---|-----|-----|---------|----|--|-----------------|---------------|--|--|--|---------------------|---|---|---|---|--|---|---|---|---|-----|--|----|--|--|--|--|--|---|---|---|---|-----|-----------------------|---|---|---|---|------|---|---|---|---|------|---|---|---|---|------|---|---|---|---|------|--|---|---|---|---|------|---------------|---|---|---|---|------|------------------------|---|---|---|---|------|-------------|---|---|---|---|------|----------|---|---|---|---|------|------------------------|---|---|---|---|------|--------------------|---|---|---|---|------|-------------------------------|---|---|---|---|------|--|---|---|---|---|------|---|---|---|---|---|------|--|---|---|---|---|------|--|---|---|---|---|------|--|---|---|---|---|------|---|---|---|---|---|------|---|---|---|---|---|------|
| Starting history (Up to 16 records can be stored) | <p>[Md.3] Start information</p> <p>[Storage details]</p> <p>This area stores the start information (restart flag, start origin, and start axis):</p> <ul style="list-style-type: none"> Restart flag: Indicates whether the operation has or has not been halted and restarted. Start origin: Indicates the source of the start signal. Start axis : Indicates the started axis. <p>Refresh cycle: At start</p> <p>[Reading the monitor value] ■ Monitoring is carried out with a hexadecimal display.</p> <table border="1"> <thead> <tr> <th>Stored contents</th> <th>Storage value</th> </tr> </thead> <tbody> <tr> <td>Restart flag OFF</td> <td>0</td> </tr> <tr> <td>Restart flag ON</td> <td>1</td> </tr> </tbody> </table> <table border="1"> <thead> <tr> <th>Stored contents</th> <th>Storage value</th> </tr> </thead> <tbody> <tr> <td>PLC CPU</td> <td>00</td> </tr> <tr> <td>External signal</td> <td>01</td> </tr> <tr> <td>GX Works2</td> <td>10</td> </tr> </tbody> </table> <table border="1"> <thead> <tr> <th>Stored contents</th> <th>Storage value</th> </tr> </thead> <tbody> <tr> <td>Axis 1</td> <td>1</td> </tr> <tr> <td>Axis 2</td> <td>2</td> </tr> <tr> <td>Axis 3</td> <td>3</td> </tr> <tr> <td>Axis 4</td> <td>4</td> </tr> <tr> <td>Axis 5</td> <td>5</td> </tr> <tr> <td>...</td> <td>...</td> </tr> <tr> <td>Axis 16</td> <td>10</td> </tr> </tbody> </table> | Stored contents | Storage value | Restart flag OFF | 0 | Restart flag ON | 1 | Stored contents | Storage value | PLC CPU | 00 | External signal | 01 | GX Works2 | 10 | Stored contents | Storage value | Axis 1 | 1 | Axis 2 | 2 | Axis 3 | 3 | Axis 4 | 4 | Axis 5 | 5 | ... | ... | Axis 16 | 10 | <p>[Md.4] Start No.</p> <p>The starting No. is stored.</p> <p>Refresh cycle: At start</p> <p>■ Monitoring is carried out with a hexadecimal display.</p> <table border="1"> <thead> <tr> <th rowspan="2">Stored contents</th> <th colspan="4">Storage value</th> <th rowspan="2">Reference (Decimal)</th> </tr> <tr> <th>A</th> <th>B</th> <th>C</th> <th>D</th> </tr> </thead> <tbody> <tr> <td></td> <td>0</td> <td>0</td> <td>0</td> <td>1</td> <td>001</td> </tr> <tr> <td></td> <td colspan="4" style="text-align:center">to</td> <td></td> </tr> <tr> <td></td> <td>0</td> <td>2</td> <td>5</td> <td>8</td> <td>600</td> </tr> <tr> <td rowspan="4">Positioning operation</td> <td>1</td> <td>B</td> <td>5</td> <td>8</td> <td>7000</td> </tr> <tr> <td>1</td> <td>B</td> <td>5</td> <td>9</td> <td>7001</td> </tr> <tr> <td>1</td> <td>B</td> <td>5</td> <td>A</td> <td>7002</td> </tr> <tr> <td>1</td> <td>B</td> <td>5</td> <td>B</td> <td>7003</td> </tr> <tr> <td></td> <td>1</td> <td>B</td> <td>5</td> <td>C</td> <td>7004</td> </tr> <tr> <td>JOG operation</td> <td>2</td> <td>3</td> <td>3</td> <td>2</td> <td>9010</td> </tr> <tr> <td>Manual pulse generator</td> <td>2</td> <td>3</td> <td>3</td> <td>3</td> <td>9011</td> </tr> <tr> <td>Machine HPR</td> <td>2</td> <td>3</td> <td>2</td> <td>9</td> <td>9001</td> </tr> <tr> <td>Fast HPR</td> <td>2</td> <td>3</td> <td>2</td> <td>A</td> <td>9002</td> </tr> <tr> <td>Current value changing</td> <td>2</td> <td>3</td> <td>2</td> <td>B</td> <td>9003</td> </tr> <tr> <td>Simultaneous start</td> <td>2</td> <td>3</td> <td>2</td> <td>C</td> <td>9004</td> </tr> <tr> <td>Synchronous control operation</td> <td>2</td> <td>3</td> <td>3</td> <td>C</td> <td>9020</td> </tr> <tr> <td>Position control mode → speed control mode switching</td> <td>2</td> <td>3</td> <td>4</td> <td>6</td> <td>9030</td> </tr> <tr> <td>Position control mode → torque control mode switching</td> <td>2</td> <td>3</td> <td>4</td> <td>7</td> <td>9031</td> </tr> <tr> <td>Speed control mode → torque control mode switching</td> <td>2</td> <td>3</td> <td>4</td> <td>8</td> <td>9032</td> </tr> <tr> <td>Torque control mode → speed control mode switching</td> <td>2</td> <td>3</td> <td>4</td> <td>9</td> <td>9033</td> </tr> <tr> <td>Speed control mode → position control mode switching</td> <td>2</td> <td>3</td> <td>4</td> <td>A</td> <td>9034</td> </tr> <tr> <td>Torque control mode → position control mode switching</td> <td>2</td> <td>3</td> <td>4</td> <td>B</td> <td>9035</td> </tr> <tr> <td>Outside the range of control mode setting</td> <td>2</td> <td>3</td> <td>4</td> <td>C</td> <td>9036</td> </tr> </tbody> </table> | Stored contents | Storage value | | | | Reference (Decimal) | A | B | C | D | | 0 | 0 | 0 | 1 | 001 | | to | | | | | | 0 | 2 | 5 | 8 | 600 | Positioning operation | 1 | B | 5 | 8 | 7000 | 1 | B | 5 | 9 | 7001 | 1 | B | 5 | A | 7002 | 1 | B | 5 | B | 7003 | | 1 | B | 5 | C | 7004 | JOG operation | 2 | 3 | 3 | 2 | 9010 | Manual pulse generator | 2 | 3 | 3 | 3 | 9011 | Machine HPR | 2 | 3 | 2 | 9 | 9001 | Fast HPR | 2 | 3 | 2 | A | 9002 | Current value changing | 2 | 3 | 2 | B | 9003 | Simultaneous start | 2 | 3 | 2 | C | 9004 | Synchronous control operation | 2 | 3 | 3 | C | 9020 | Position control mode → speed control mode switching | 2 | 3 | 4 | 6 | 9030 | Position control mode → torque control mode switching | 2 | 3 | 4 | 7 | 9031 | Speed control mode → torque control mode switching | 2 | 3 | 4 | 8 | 9032 | Torque control mode → speed control mode switching | 2 | 3 | 4 | 9 | 9033 | Speed control mode → position control mode switching | 2 | 3 | 4 | A | 9034 | Torque control mode → position control mode switching | 2 | 3 | 4 | B | 9035 | Outside the range of control mode setting | 2 | 3 | 4 | C | 9036 |
| | Stored contents | Storage value | | | | | | | | | | | | | | | | | | | | | | | | | | | | | | | | | | | | | | | | | | | | | | | | | | | | | | | | | | | | | | | | | | | | | | | | | | | | | | | | | | | | | | | | | | | | | | | | | | | | | | | | | | | | | | | | | | | | | | | | | | | | | | | | | | | | | | | | | | | | | | | | | | | | | | | | | | | | | | | | | | | | | | | | | |
| Restart flag OFF | 0 | | | | | | | | | | | | | | | | | | | | | | | | | | | | | | | | | | | | | | | | | | | | | | | | | | | | | | | | | | | | | | | | | | | | | | | | | | | | | | | | | | | | | | | | | | | | | | | | | | | | | | | | | | | | | | | | | | | | | | | | | | | | | | | | | | | | | | | | | | | | | | | | | | | | | | | | | | | | | | | | | | | | | | | | | | |
| Restart flag ON | 1 | | | | | | | | | | | | | | | | | | | | | | | | | | | | | | | | | | | | | | | | | | | | | | | | | | | | | | | | | | | | | | | | | | | | | | | | | | | | | | | | | | | | | | | | | | | | | | | | | | | | | | | | | | | | | | | | | | | | | | | | | | | | | | | | | | | | | | | | | | | | | | | | | | | | | | | | | | | | | | | | | | | | | | | | | | |
| Stored contents | Storage value | | | | | | | | | | | | | | | | | | | | | | | | | | | | | | | | | | | | | | | | | | | | | | | | | | | | | | | | | | | | | | | | | | | | | | | | | | | | | | | | | | | | | | | | | | | | | | | | | | | | | | | | | | | | | | | | | | | | | | | | | | | | | | | | | | | | | | | | | | | | | | | | | | | | | | | | | | | | | | | | | | | | | | | | | | |
| PLC CPU | 00 | | | | | | | | | | | | | | | | | | | | | | | | | | | | | | | | | | | | | | | | | | | | | | | | | | | | | | | | | | | | | | | | | | | | | | | | | | | | | | | | | | | | | | | | | | | | | | | | | | | | | | | | | | | | | | | | | | | | | | | | | | | | | | | | | | | | | | | | | | | | | | | | | | | | | | | | | | | | | | | | | | | | | | | | | | |
| External signal | 01 | | | | | | | | | | | | | | | | | | | | | | | | | | | | | | | | | | | | | | | | | | | | | | | | | | | | | | | | | | | | | | | | | | | | | | | | | | | | | | | | | | | | | | | | | | | | | | | | | | | | | | | | | | | | | | | | | | | | | | | | | | | | | | | | | | | | | | | | | | | | | | | | | | | | | | | | | | | | | | | | | | | | | | | | | | |
| GX Works2 | 10 | | | | | | | | | | | | | | | | | | | | | | | | | | | | | | | | | | | | | | | | | | | | | | | | | | | | | | | | | | | | | | | | | | | | | | | | | | | | | | | | | | | | | | | | | | | | | | | | | | | | | | | | | | | | | | | | | | | | | | | | | | | | | | | | | | | | | | | | | | | | | | | | | | | | | | | | | | | | | | | | | | | | | | | | | | |
| Stored contents | Storage value | | | | | | | | | | | | | | | | | | | | | | | | | | | | | | | | | | | | | | | | | | | | | | | | | | | | | | | | | | | | | | | | | | | | | | | | | | | | | | | | | | | | | | | | | | | | | | | | | | | | | | | | | | | | | | | | | | | | | | | | | | | | | | | | | | | | | | | | | | | | | | | | | | | | | | | | | | | | | | | | | | | | | | | | | | |
| Axis 1 | 1 | | | | | | | | | | | | | | | | | | | | | | | | | | | | | | | | | | | | | | | | | | | | | | | | | | | | | | | | | | | | | | | | | | | | | | | | | | | | | | | | | | | | | | | | | | | | | | | | | | | | | | | | | | | | | | | | | | | | | | | | | | | | | | | | | | | | | | | | | | | | | | | | | | | | | | | | | | | | | | | | | | | | | | | | | | |
| Axis 2 | 2 | | | | | | | | | | | | | | | | | | | | | | | | | | | | | | | | | | | | | | | | | | | | | | | | | | | | | | | | | | | | | | | | | | | | | | | | | | | | | | | | | | | | | | | | | | | | | | | | | | | | | | | | | | | | | | | | | | | | | | | | | | | | | | | | | | | | | | | | | | | | | | | | | | | | | | | | | | | | | | | | | | | | | | | | | | |
| Axis 3 | 3 | | | | | | | | | | | | | | | | | | | | | | | | | | | | | | | | | | | | | | | | | | | | | | | | | | | | | | | | | | | | | | | | | | | | | | | | | | | | | | | | | | | | | | | | | | | | | | | | | | | | | | | | | | | | | | | | | | | | | | | | | | | | | | | | | | | | | | | | | | | | | | | | | | | | | | | | | | | | | | | | | | | | | | | | | | |
| Axis 4 | 4 | | | | | | | | | | | | | | | | | | | | | | | | | | | | | | | | | | | | | | | | | | | | | | | | | | | | | | | | | | | | | | | | | | | | | | | | | | | | | | | | | | | | | | | | | | | | | | | | | | | | | | | | | | | | | | | | | | | | | | | | | | | | | | | | | | | | | | | | | | | | | | | | | | | | | | | | | | | | | | | | | | | | | | | | | | |
| Axis 5 | 5 | | | | | | | | | | | | | | | | | | | | | | | | | | | | | | | | | | | | | | | | | | | | | | | | | | | | | | | | | | | | | | | | | | | | | | | | | | | | | | | | | | | | | | | | | | | | | | | | | | | | | | | | | | | | | | | | | | | | | | | | | | | | | | | | | | | | | | | | | | | | | | | | | | | | | | | | | | | | | | | | | | | | | | | | | | |
| ... | ... | | | | | | | | | | | | | | | | | | | | | | | | | | | | | | | | | | | | | | | | | | | | | | | | | | | | | | | | | | | | | | | | | | | | | | | | | | | | | | | | | | | | | | | | | | | | | | | | | | | | | | | | | | | | | | | | | | | | | | | | | | | | | | | | | | | | | | | | | | | | | | | | | | | | | | | | | | | | | | | | | | | | | | | | | | |
| Axis 16 | 10 | | | | | | | | | | | | | | | | | | | | | | | | | | | | | | | | | | | | | | | | | | | | | | | | | | | | | | | | | | | | | | | | | | | | | | | | | | | | | | | | | | | | | | | | | | | | | | | | | | | | | | | | | | | | | | | | | | | | | | | | | | | | | | | | | | | | | | | | | | | | | | | | | | | | | | | | | | | | | | | | | | | | | | | | | | |
| Stored contents | Storage value | | | | Reference (Decimal) | | | | | | | | | | | | | | | | | | | | | | | | | | | | | | | | | | | | | | | | | | | | | | | | | | | | | | | | | | | | | | | | | | | | | | | | | | | | | | | | | | | | | | | | | | | | | | | | | | | | | | | | | | | | | | | | | | | | | | | | | | | | | | | | | | | | | | | | | | | | | | | | | | | | | | | | | | | | | | | | | | | | | | |
| | A | B | C | D | | | | | | | | | | | | | | | | | | | | | | | | | | | | | | | | | | | | | | | | | | | | | | | | | | | | | | | | | | | | | | | | | | | | | | | | | | | | | | | | | | | | | | | | | | | | | | | | | | | | | | | | | | | | | | | | | | | | | | | | | | | | | | | | | | | | | | | | | | | | | | | | | | | | | | | | | | | | | | | | | | | | | | | |
| | 0 | 0 | 0 | 1 | 001 | | | | | | | | | | | | | | | | | | | | | | | | | | | | | | | | | | | | | | | | | | | | | | | | | | | | | | | | | | | | | | | | | | | | | | | | | | | | | | | | | | | | | | | | | | | | | | | | | | | | | | | | | | | | | | | | | | | | | | | | | | | | | | | | | | | | | | | | | | | | | | | | | | | | | | | | | | | | | | | | | | | | | | |
| | to | | | | | | | | | | | | | | | | | | | | | | | | | | | | | | | | | | | | | | | | | | | | | | | | | | | | | | | | | | | | | | | | | | | | | | | | | | | | | | | | | | | | | | | | | | | | | | | | | | | | | | | | | | | | | | | | | | | | | | | | | | | | | | | | | | | | | | | | | | | | | | | | | | | | | | | | | | | | | | | | | | | | | | | | | | |
| | 0 | 2 | 5 | 8 | 600 | | | | | | | | | | | | | | | | | | | | | | | | | | | | | | | | | | | | | | | | | | | | | | | | | | | | | | | | | | | | | | | | | | | | | | | | | | | | | | | | | | | | | | | | | | | | | | | | | | | | | | | | | | | | | | | | | | | | | | | | | | | | | | | | | | | | | | | | | | | | | | | | | | | | | | | | | | | | | | | | | | | | | | |
| Positioning operation | 1 | B | 5 | 8 | 7000 | | | | | | | | | | | | | | | | | | | | | | | | | | | | | | | | | | | | | | | | | | | | | | | | | | | | | | | | | | | | | | | | | | | | | | | | | | | | | | | | | | | | | | | | | | | | | | | | | | | | | | | | | | | | | | | | | | | | | | | | | | | | | | | | | | | | | | | | | | | | | | | | | | | | | | | | | | | | | | | | | | | | | | |
| | 1 | B | 5 | 9 | 7001 | | | | | | | | | | | | | | | | | | | | | | | | | | | | | | | | | | | | | | | | | | | | | | | | | | | | | | | | | | | | | | | | | | | | | | | | | | | | | | | | | | | | | | | | | | | | | | | | | | | | | | | | | | | | | | | | | | | | | | | | | | | | | | | | | | | | | | | | | | | | | | | | | | | | | | | | | | | | | | | | | | | | | | |
| | 1 | B | 5 | A | 7002 | | | | | | | | | | | | | | | | | | | | | | | | | | | | | | | | | | | | | | | | | | | | | | | | | | | | | | | | | | | | | | | | | | | | | | | | | | | | | | | | | | | | | | | | | | | | | | | | | | | | | | | | | | | | | | | | | | | | | | | | | | | | | | | | | | | | | | | | | | | | | | | | | | | | | | | | | | | | | | | | | | | | | | |
| | 1 | B | 5 | B | 7003 | | | | | | | | | | | | | | | | | | | | | | | | | | | | | | | | | | | | | | | | | | | | | | | | | | | | | | | | | | | | | | | | | | | | | | | | | | | | | | | | | | | | | | | | | | | | | | | | | | | | | | | | | | | | | | | | | | | | | | | | | | | | | | | | | | | | | | | | | | | | | | | | | | | | | | | | | | | | | | | | | | | | | | |
| | 1 | B | 5 | C | 7004 | | | | | | | | | | | | | | | | | | | | | | | | | | | | | | | | | | | | | | | | | | | | | | | | | | | | | | | | | | | | | | | | | | | | | | | | | | | | | | | | | | | | | | | | | | | | | | | | | | | | | | | | | | | | | | | | | | | | | | | | | | | | | | | | | | | | | | | | | | | | | | | | | | | | | | | | | | | | | | | | | | | | | | |
| JOG operation | 2 | 3 | 3 | 2 | 9010 | | | | | | | | | | | | | | | | | | | | | | | | | | | | | | | | | | | | | | | | | | | | | | | | | | | | | | | | | | | | | | | | | | | | | | | | | | | | | | | | | | | | | | | | | | | | | | | | | | | | | | | | | | | | | | | | | | | | | | | | | | | | | | | | | | | | | | | | | | | | | | | | | | | | | | | | | | | | | | | | | | | | | | |
| Manual pulse generator | 2 | 3 | 3 | 3 | 9011 | | | | | | | | | | | | | | | | | | | | | | | | | | | | | | | | | | | | | | | | | | | | | | | | | | | | | | | | | | | | | | | | | | | | | | | | | | | | | | | | | | | | | | | | | | | | | | | | | | | | | | | | | | | | | | | | | | | | | | | | | | | | | | | | | | | | | | | | | | | | | | | | | | | | | | | | | | | | | | | | | | | | | | |
| Machine HPR | 2 | 3 | 2 | 9 | 9001 | | | | | | | | | | | | | | | | | | | | | | | | | | | | | | | | | | | | | | | | | | | | | | | | | | | | | | | | | | | | | | | | | | | | | | | | | | | | | | | | | | | | | | | | | | | | | | | | | | | | | | | | | | | | | | | | | | | | | | | | | | | | | | | | | | | | | | | | | | | | | | | | | | | | | | | | | | | | | | | | | | | | | | |
| Fast HPR | 2 | 3 | 2 | A | 9002 | | | | | | | | | | | | | | | | | | | | | | | | | | | | | | | | | | | | | | | | | | | | | | | | | | | | | | | | | | | | | | | | | | | | | | | | | | | | | | | | | | | | | | | | | | | | | | | | | | | | | | | | | | | | | | | | | | | | | | | | | | | | | | | | | | | | | | | | | | | | | | | | | | | | | | | | | | | | | | | | | | | | | | |
| Current value changing | 2 | 3 | 2 | B | 9003 | | | | | | | | | | | | | | | | | | | | | | | | | | | | | | | | | | | | | | | | | | | | | | | | | | | | | | | | | | | | | | | | | | | | | | | | | | | | | | | | | | | | | | | | | | | | | | | | | | | | | | | | | | | | | | | | | | | | | | | | | | | | | | | | | | | | | | | | | | | | | | | | | | | | | | | | | | | | | | | | | | | | | | |
| Simultaneous start | 2 | 3 | 2 | C | 9004 | | | | | | | | | | | | | | | | | | | | | | | | | | | | | | | | | | | | | | | | | | | | | | | | | | | | | | | | | | | | | | | | | | | | | | | | | | | | | | | | | | | | | | | | | | | | | | | | | | | | | | | | | | | | | | | | | | | | | | | | | | | | | | | | | | | | | | | | | | | | | | | | | | | | | | | | | | | | | | | | | | | | | | |
| Synchronous control operation | 2 | 3 | 3 | C | 9020 | | | | | | | | | | | | | | | | | | | | | | | | | | | | | | | | | | | | | | | | | | | | | | | | | | | | | | | | | | | | | | | | | | | | | | | | | | | | | | | | | | | | | | | | | | | | | | | | | | | | | | | | | | | | | | | | | | | | | | | | | | | | | | | | | | | | | | | | | | | | | | | | | | | | | | | | | | | | | | | | | | | | | | |
| Position control mode → speed control mode switching | 2 | 3 | 4 | 6 | 9030 | | | | | | | | | | | | | | | | | | | | | | | | | | | | | | | | | | | | | | | | | | | | | | | | | | | | | | | | | | | | | | | | | | | | | | | | | | | | | | | | | | | | | | | | | | | | | | | | | | | | | | | | | | | | | | | | | | | | | | | | | | | | | | | | | | | | | | | | | | | | | | | | | | | | | | | | | | | | | | | | | | | | | | |
| Position control mode → torque control mode switching | 2 | 3 | 4 | 7 | 9031 | | | | | | | | | | | | | | | | | | | | | | | | | | | | | | | | | | | | | | | | | | | | | | | | | | | | | | | | | | | | | | | | | | | | | | | | | | | | | | | | | | | | | | | | | | | | | | | | | | | | | | | | | | | | | | | | | | | | | | | | | | | | | | | | | | | | | | | | | | | | | | | | | | | | | | | | | | | | | | | | | | | | | | |
| Speed control mode → torque control mode switching | 2 | 3 | 4 | 8 | 9032 | | | | | | | | | | | | | | | | | | | | | | | | | | | | | | | | | | | | | | | | | | | | | | | | | | | | | | | | | | | | | | | | | | | | | | | | | | | | | | | | | | | | | | | | | | | | | | | | | | | | | | | | | | | | | | | | | | | | | | | | | | | | | | | | | | | | | | | | | | | | | | | | | | | | | | | | | | | | | | | | | | | | | | |
| Torque control mode → speed control mode switching | 2 | 3 | 4 | 9 | 9033 | | | | | | | | | | | | | | | | | | | | | | | | | | | | | | | | | | | | | | | | | | | | | | | | | | | | | | | | | | | | | | | | | | | | | | | | | | | | | | | | | | | | | | | | | | | | | | | | | | | | | | | | | | | | | | | | | | | | | | | | | | | | | | | | | | | | | | | | | | | | | | | | | | | | | | | | | | | | | | | | | | | | | | |
| Speed control mode → position control mode switching | 2 | 3 | 4 | A | 9034 | | | | | | | | | | | | | | | | | | | | | | | | | | | | | | | | | | | | | | | | | | | | | | | | | | | | | | | | | | | | | | | | | | | | | | | | | | | | | | | | | | | | | | | | | | | | | | | | | | | | | | | | | | | | | | | | | | | | | | | | | | | | | | | | | | | | | | | | | | | | | | | | | | | | | | | | | | | | | | | | | | | | | | |
| Torque control mode → position control mode switching | 2 | 3 | 4 | B | 9035 | | | | | | | | | | | | | | | | | | | | | | | | | | | | | | | | | | | | | | | | | | | | | | | | | | | | | | | | | | | | | | | | | | | | | | | | | | | | | | | | | | | | | | | | | | | | | | | | | | | | | | | | | | | | | | | | | | | | | | | | | | | | | | | | | | | | | | | | | | | | | | | | | | | | | | | | | | | | | | | | | | | | | | |
| Outside the range of control mode setting | 2 | 3 | 4 | C | 9036 | | | | | | | | | | | | | | | | | | | | | | | | | | | | | | | | | | | | | | | | | | | | | | | | | | | | | | | | | | | | | | | | | | | | | | | | | | | | | | | | | | | | | | | | | | | | | | | | | | | | | | | | | | | | | | | | | | | | | | | | | | | | | | | | | | | | | | | | | | | | | | | | | | | | | | | | | | | | | | | | | | | | | | |

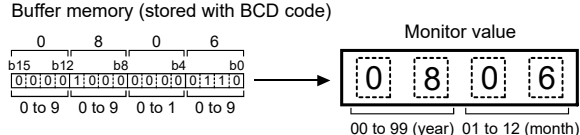
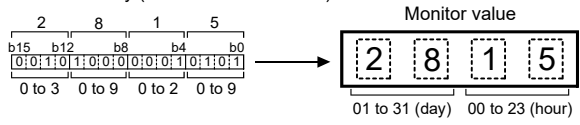
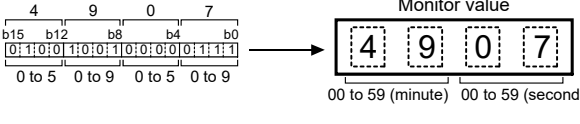
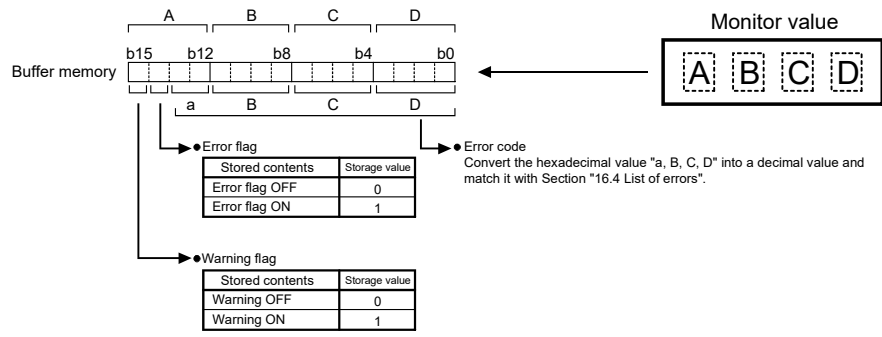
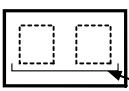

Note: If a start signal is issued against an operating axis, a record relating to this event may be output before a record relating to an earlier start signal is output.

| Default value | Buffer memory address | | | | | | | | | | | | | | | | | | | | | | | | | | | | | | | | | | | | | | | | | | | | | | | | | | | | | | | | | | | | | | | | | | | | | | | | | | | | | | | | | | | | | | | | | | | | | | | | | | | | | | | | | | | | | | | | | | | | | | | | | | | | | | | | | | | | | | | |
|---------------|---|------|------|------|------|------|------|------|------|------|------|------|------|------|------|------|-------------|---|---|---|---|---|---|---|---|---|---|----|----|----|----|----|----|------|---------------------------|------|------|------|------|------|------|------|------|------|------|------|------|------|------|------|------|-------------------|------|------|------|------|------|------|------|------|------|------|------|------|------|------|------|------|----------------------------|------|------|------|------|------|------|------|------|------|------|------|------|------|------|------|------|-------------------------|------|------|------|------|------|------|------|------|------|------|------|------|------|------|------|------|------------------------------|------|------|------|------|------|------|------|------|------|------|------|------|------|------|------|------|------------------------|------|------|------|------|------|------|------|------|------|------|------|------|------|------|------|------|
| 0000H | <div style="display: flex; align-items: center; margin-bottom: 10px;"> <div style="border: 1px solid black; padding: 2px; margin-right: 5px;">Md.8</div> <div style="border: 1px solid black; padding: 2px; margin-right: 5px;">Start history pointer</div> <div style="border: 1px solid black; padding: 2px; margin-left: 10px;">4092</div> </div> <p style="margin-left: 20px;">Indicates a pointer No. that is next to the pointer No. assigned to the latest of the existing starting history records.</p> <table border="1" style="margin-left: 20px; border-collapse: collapse; text-align: center;"> <thead> <tr> <th style="width: 10%;">Pointer No.</th> <th>0</th><th>1</th><th>2</th><th>3</th><th>4</th><th>5</th><th>6</th><th>7</th><th>8</th><th>9</th><th>10</th><th>11</th><th>12</th><th>13</th><th>14</th><th>15</th> </tr> </thead> <tbody> <tr> <td rowspan="7" style="writing-mode: vertical-rl; transform: rotate(180deg);">Item</td> <td>Md.3 Start information</td> <td>4012</td><td>4017</td><td>4022</td><td>4027</td><td>4032</td><td>4037</td><td>4042</td><td>4047</td><td>4052</td><td>4057</td><td>4062</td><td>4067</td><td>4072</td><td>4077</td><td>4082</td><td>4087</td> </tr> <tr> <td>Md.4 Start No.</td> <td>4013</td><td>4018</td><td>4023</td><td>4028</td><td>4033</td><td>4038</td><td>4043</td><td>4048</td><td>4053</td><td>4058</td><td>4063</td><td>4068</td><td>4073</td><td>4078</td><td>4083</td><td>4088</td> </tr> <tr> <td>Md.54 Start Year: month</td> <td>4240</td><td>4241</td><td>4242</td><td>4243</td><td>4244</td><td>4245</td><td>4246</td><td>4247</td><td>4248</td><td>4249</td><td>4250</td><td>4251</td><td>4252</td><td>4253</td><td>4254</td><td>4255</td> </tr> <tr> <td>Md.5 Start Day: hour</td> <td>4014</td><td>4019</td><td>4024</td><td>4029</td><td>4034</td><td>4039</td><td>4044</td><td>4049</td><td>4054</td><td>4059</td><td>4064</td><td>4069</td><td>4074</td><td>4079</td><td>4084</td><td>4089</td> </tr> <tr> <td>Md.6 Start Minute: second</td> <td>4015</td><td>4020</td><td>4025</td><td>4030</td><td>4035</td><td>4040</td><td>4045</td><td>4050</td><td>4055</td><td>4060</td><td>4065</td><td>4070</td><td>4075</td><td>4080</td><td>4085</td><td>4090</td> </tr> <tr> <td>Md.7 Error judgment</td> <td>4016</td><td>4021</td><td>4026</td><td>4031</td><td>4036</td><td>4041</td><td>4046</td><td>4051</td><td>4056</td><td>4061</td><td>4066</td><td>4071</td><td>4076</td><td>4081</td><td>4086</td><td>4091</td> </tr> </tbody> </table> <ul style="list-style-type: none"> • Each group of buffer memory addresses storing a complete starting history record is assigned a pointer No. Example: Pointer No. 0 = Buffer memory addresses 4012 to 4016, 4240 Pointer No. 1 = Buffer memory addresses 4017 to 4021, 4241 Pointer No. 2 = Buffer memory addresses 4022 to 4026, 4242 ⋮ Pointer No. 15 = Buffer memory addresses 4087 to 4091, 4255 • Each history record is assigned a pointer No. in the range between 0 and 15. If the pointer No. 15 has been assigned to a new record, the next record will be assigned the pointer number 0. (A new record replaces an older record when a pointer No. is reassigned.) | | | | | | | | | | | | | | | | Pointer No. | 0 | 1 | 2 | 3 | 4 | 5 | 6 | 7 | 8 | 9 | 10 | 11 | 12 | 13 | 14 | 15 | Item | Md.3 Start information | 4012 | 4017 | 4022 | 4027 | 4032 | 4037 | 4042 | 4047 | 4052 | 4057 | 4062 | 4067 | 4072 | 4077 | 4082 | 4087 | Md.4 Start No. | 4013 | 4018 | 4023 | 4028 | 4033 | 4038 | 4043 | 4048 | 4053 | 4058 | 4063 | 4068 | 4073 | 4078 | 4083 | 4088 | Md.54 Start Year: month | 4240 | 4241 | 4242 | 4243 | 4244 | 4245 | 4246 | 4247 | 4248 | 4249 | 4250 | 4251 | 4252 | 4253 | 4254 | 4255 | Md.5 Start Day: hour | 4014 | 4019 | 4024 | 4029 | 4034 | 4039 | 4044 | 4049 | 4054 | 4059 | 4064 | 4069 | 4074 | 4079 | 4084 | 4089 | Md.6 Start Minute: second | 4015 | 4020 | 4025 | 4030 | 4035 | 4040 | 4045 | 4050 | 4055 | 4060 | 4065 | 4070 | 4075 | 4080 | 4085 | 4090 | Md.7 Error judgment | 4016 | 4021 | 4026 | 4031 | 4036 | 4041 | 4046 | 4051 | 4056 | 4061 | 4066 | 4071 | 4076 | 4081 | 4086 | 4091 |
| Pointer No. | 0 | 1 | 2 | 3 | 4 | 5 | 6 | 7 | 8 | 9 | 10 | 11 | 12 | 13 | 14 | 15 | | | | | | | | | | | | | | | | | | | | | | | | | | | | | | | | | | | | | | | | | | | | | | | | | | | | | | | | | | | | | | | | | | | | | | | | | | | | | | | | | | | | | | | | | | | | | | | | | | | | | | | | | | | | | | | | | | | | | | | | |
| Item | Md.3 Start information | 4012 | 4017 | 4022 | 4027 | 4032 | 4037 | 4042 | 4047 | 4052 | 4057 | 4062 | 4067 | 4072 | 4077 | 4082 | 4087 | | | | | | | | | | | | | | | | | | | | | | | | | | | | | | | | | | | | | | | | | | | | | | | | | | | | | | | | | | | | | | | | | | | | | | | | | | | | | | | | | | | | | | | | | | | | | | | | | | | | | | | | | | | | | | | | | | | | | | | |
| | Md.4 Start No. | 4013 | 4018 | 4023 | 4028 | 4033 | 4038 | 4043 | 4048 | 4053 | 4058 | 4063 | 4068 | 4073 | 4078 | 4083 | 4088 | | | | | | | | | | | | | | | | | | | | | | | | | | | | | | | | | | | | | | | | | | | | | | | | | | | | | | | | | | | | | | | | | | | | | | | | | | | | | | | | | | | | | | | | | | | | | | | | | | | | | | | | | | | | | | | | | | | | | | | |
| | Md.54 Start Year: month | 4240 | 4241 | 4242 | 4243 | 4244 | 4245 | 4246 | 4247 | 4248 | 4249 | 4250 | 4251 | 4252 | 4253 | 4254 | 4255 | | | | | | | | | | | | | | | | | | | | | | | | | | | | | | | | | | | | | | | | | | | | | | | | | | | | | | | | | | | | | | | | | | | | | | | | | | | | | | | | | | | | | | | | | | | | | | | | | | | | | | | | | | | | | | | | | | | | | | | |
| | Md.5 Start Day: hour | 4014 | 4019 | 4024 | 4029 | 4034 | 4039 | 4044 | 4049 | 4054 | 4059 | 4064 | 4069 | 4074 | 4079 | 4084 | 4089 | | | | | | | | | | | | | | | | | | | | | | | | | | | | | | | | | | | | | | | | | | | | | | | | | | | | | | | | | | | | | | | | | | | | | | | | | | | | | | | | | | | | | | | | | | | | | | | | | | | | | | | | | | | | | | | | | | | | | | | |
| | Md.6 Start Minute: second | 4015 | 4020 | 4025 | 4030 | 4035 | 4040 | 4045 | 4050 | 4055 | 4060 | 4065 | 4070 | 4075 | 4080 | 4085 | 4090 | | | | | | | | | | | | | | | | | | | | | | | | | | | | | | | | | | | | | | | | | | | | | | | | | | | | | | | | | | | | | | | | | | | | | | | | | | | | | | | | | | | | | | | | | | | | | | | | | | | | | | | | | | | | | | | | | | | | | | | |
| | Md.7 Error judgment | 4016 | 4021 | 4026 | 4031 | 4036 | 4041 | 4046 | 4051 | 4056 | 4061 | 4066 | 4071 | 4076 | 4081 | 4086 | 4091 | | | | | | | | | | | | | | | | | | | | | | | | | | | | | | | | | | | | | | | | | | | | | | | | | | | | | | | | | | | | | | | | | | | | | | | | | | | | | | | | | | | | | | | | | | | | | | | | | | | | | | | | | | | | | | | | | | | | | | | |
| | 0000H | | | | | | | | | | | | | | | | | | | | | | | | | | | | | | | | | | | | | | | | | | | | | | | | | | | | | | | | | | | | | | | | | | | | | | | | | | | | | | | | | | | | | | | | | | | | | | | | | | | | | | | | | | | | | | | | | | | | | | | | | | | | | | | | | | | | | | | |





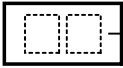

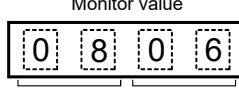
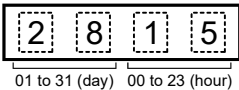
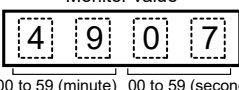
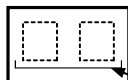
| Storage item | Storage details | Reading the monitor value | | |
|---|--|--|---|--|
| Starting history (Up to 16 records can be stored) | [Md.54] Start Year: month | The starting time (Year: month) is stored. <u>Refresh cycle: At start</u> | <p>■ Monitoring is carried out with a hexadecimal display.</p> <p>Buffer memory (stored with BCD code)</p>  | |
| | [Md.5] Start Day: hour | The starting time (Day: hour) is stored. <u>Refresh cycle: At start</u> | <p>■ Monitoring is carried out with a hexadecimal display.</p> <p>Buffer memory (stored with BCD code)</p>  | |
| | [Md.6] Start Minute: second | The starting time (Minute: second) is stored. <u>Refresh cycle: At start</u> | <p>■ Monitoring is carried out with a hexadecimal display.</p> <p>Buffer memory (stored with BCD code)</p>  | |
| [Md.7] Error judgment | [Storage details] This area stores the following results of the error judgment performed upon starting: | <ul style="list-style-type: none"> Warning flag BUSY start Control mode switching during BUSY Control mode switching during zero speed OFF Outside control mode range Control mode switching Error flag Error code <p><u>Refresh cycle: At start</u></p> | | |
| | [Reading the monitor value] | <p>■ Monitoring is carried out with a hexadecimal display.</p>  | | |
| [Md.8] Start history pointer | Indicates a pointer No. that is next to the pointer No. assigned to the latest of the existing starting history records. <u>Refresh cycle: At start</u> | <p>■ Monitoring is carried out with a decimal display.</p> <p>Monitor value </p> <p>● Storage value (Pointer number) 0 to 15</p> | | |

Note: If a start signal is issued against an operating axis, a record relating to this event may be output before a record relating to an earlier start signal is output.

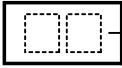

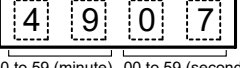

| Default value | Buffer memory address | | | | | | | | | | | | | | | | | | | | | | | | | | | | | | | | | | | | | | | | | | | | | | | | | | | | | | | | | | | | | | | | | | | | | | | | | | | | | | | | | | | | | | | | | | | | | | | | | | | | | | | | | | | | | | | | | | | | | | | | | | | | | | | | | | | | | | | | |
|---------------|--|------|------|------|------|------|------|------|------|------|------|------|------|------|------|------|------|-------------|---|---|---|---|---|---|---|---|---|---|----|----|----|----|----|----|------|---------------------------|------|------|------|------|------|------|------|------|------|------|------|------|------|------|------|------|-------------------|------|------|------|------|------|------|------|------|------|------|------|------|------|------|------|------|----------------------------|------|------|------|------|------|------|------|------|------|------|------|------|------|------|------|------|-------------------------|------|------|------|------|------|------|------|------|------|------|------|------|------|------|------|------|------------------------------|------|------|------|------|------|------|------|------|------|------|------|------|------|------|------|------|------------------------|------|------|------|------|------|------|------|------|------|------|------|------|------|------|------|------|
| 0000H | | | | | | | | | | | | | | | | | | | | | | | | | | | | | | | | | | | | | | | | | | | | | | | | | | | | | | | | | | | | | | | | | | | | | | | | | | | | | | | | | | | | | | | | | | | | | | | | | | | | | | | | | | | | | | | | | | | | | | | | | | | | | | | | | | | | | | | | | |
| 0000H | | | | | | | | | | | | | | | | | | | | | | | | | | | | | | | | | | | | | | | | | | | | | | | | | | | | | | | | | | | | | | | | | | | | | | | | | | | | | | | | | | | | | | | | | | | | | | | | | | | | | | | | | | | | | | | | | | | | | | | | | | | | | | | | | | | | | | | | | |
| 0000H | <div style="display: flex; align-items: center; margin-bottom: 10px;"> <div style="border: 1px solid black; padding: 2px; margin-right: 5px;">Md.8</div> <div style="border: 1px solid black; padding: 2px; margin-right: 5px;">Start history pointer</div> <div style="border: 1px solid black; padding: 2px; margin-left: 5px;">4092</div> </div> <p>Indicates a pointer No. that is next to the pointer No. assigned to the latest of the existing starting history records.</p> | | | | | | | | | | | | | | | | | | | | | | | | | | | | | | | | | | | | | | | | | | | | | | | | | | | | | | | | | | | | | | | | | | | | | | | | | | | | | | | | | | | | | | | | | | | | | | | | | | | | | | | | | | | | | | | | | | | | | | | | | | | | | | | | | | | | | | | | |
| 0000H | <table border="1" style="width: 100%; border-collapse: collapse; text-align: center;"> <thead> <tr> <th style="width: 5%;"></th> <th style="width: 10%;">Pointer No.</th> <th>0</th><th>1</th><th>2</th><th>3</th><th>4</th><th>5</th><th>6</th><th>7</th><th>8</th><th>9</th><th>10</th><th>11</th><th>12</th><th>13</th><th>14</th><th>15</th> </tr> </thead> <tbody> <tr> <td rowspan="7" style="writing-mode: vertical-rl; transform: rotate(180deg);">Item</td> <td>Md.3 Start information</td> <td>4012</td><td>4017</td><td>4022</td><td>4027</td><td>4032</td><td>4037</td><td>4042</td><td>4047</td><td>4052</td><td>4057</td><td>4062</td><td>4067</td><td>4072</td><td>4077</td><td>4082</td><td>4087</td> </tr> <tr> <td>Md.4 Start No.</td> <td>4013</td><td>4018</td><td>4023</td><td>4028</td><td>4033</td><td>4038</td><td>4043</td><td>4048</td><td>4053</td><td>4058</td><td>4063</td><td>4068</td><td>4073</td><td>4078</td><td>4083</td><td>4088</td> </tr> <tr> <td>Md.54 Start Year: month</td> <td>4240</td><td>4241</td><td>4242</td><td>4243</td><td>4244</td><td>4245</td><td>4246</td><td>4247</td><td>4248</td><td>4249</td><td>4250</td><td>4251</td><td>4252</td><td>4253</td><td>4254</td><td>4255</td> </tr> <tr> <td>Md.5 Start Day: hour</td> <td>4014</td><td>4019</td><td>4024</td><td>4029</td><td>4034</td><td>4039</td><td>4044</td><td>4049</td><td>4054</td><td>4059</td><td>4064</td><td>4069</td><td>4074</td><td>4079</td><td>4084</td><td>4089</td> </tr> <tr> <td>Md.6 Start Minute: second</td> <td>4015</td><td>4020</td><td>4025</td><td>4030</td><td>4035</td><td>4040</td><td>4045</td><td>4050</td><td>4055</td><td>4060</td><td>4065</td><td>4070</td><td>4075</td><td>4080</td><td>4085</td><td>4090</td> </tr> <tr> <td>Md.7 Error judgment</td> <td>4016</td><td>4021</td><td>4026</td><td>4031</td><td>4036</td><td>4041</td><td>4046</td><td>4051</td><td>4056</td><td>4061</td><td>4066</td><td>4071</td><td>4076</td><td>4081</td><td>4086</td><td>4091</td> </tr> </tbody> </table> <ul style="list-style-type: none"> • Each group of buffer memory addresses storing a complete starting history record is assigned a pointer No. Example: Pointer No. 0 = Buffer memory addresses 4012 to 4016, 4240 Pointer No. 1 = Buffer memory addresses 4017 to 4021, 4241 Pointer No. 2 = Buffer memory addresses 4022 to 4026, 4242 ⋮ Pointer No. 15 = Buffer memory addresses 4087 to 4091, 4255 • Each history record is assigned a pointer No. in the range between 0 and 15. If the pointer No. 15 has been assigned to a new record, the next record will be assigned the pointer number 0. (A new record replaces an older record when a pointer No. is reassigned.) | | | | | | | | | | | | | | | | | Pointer No. | 0 | 1 | 2 | 3 | 4 | 5 | 6 | 7 | 8 | 9 | 10 | 11 | 12 | 13 | 14 | 15 | Item | Md.3 Start information | 4012 | 4017 | 4022 | 4027 | 4032 | 4037 | 4042 | 4047 | 4052 | 4057 | 4062 | 4067 | 4072 | 4077 | 4082 | 4087 | Md.4 Start No. | 4013 | 4018 | 4023 | 4028 | 4033 | 4038 | 4043 | 4048 | 4053 | 4058 | 4063 | 4068 | 4073 | 4078 | 4083 | 4088 | Md.54 Start Year: month | 4240 | 4241 | 4242 | 4243 | 4244 | 4245 | 4246 | 4247 | 4248 | 4249 | 4250 | 4251 | 4252 | 4253 | 4254 | 4255 | Md.5 Start Day: hour | 4014 | 4019 | 4024 | 4029 | 4034 | 4039 | 4044 | 4049 | 4054 | 4059 | 4064 | 4069 | 4074 | 4079 | 4084 | 4089 | Md.6 Start Minute: second | 4015 | 4020 | 4025 | 4030 | 4035 | 4040 | 4045 | 4050 | 4055 | 4060 | 4065 | 4070 | 4075 | 4080 | 4085 | 4090 | Md.7 Error judgment | 4016 | 4021 | 4026 | 4031 | 4036 | 4041 | 4046 | 4051 | 4056 | 4061 | 4066 | 4071 | 4076 | 4081 | 4086 | 4091 |
| | Pointer No. | 0 | 1 | 2 | 3 | 4 | 5 | 6 | 7 | 8 | 9 | 10 | 11 | 12 | 13 | 14 | 15 | | | | | | | | | | | | | | | | | | | | | | | | | | | | | | | | | | | | | | | | | | | | | | | | | | | | | | | | | | | | | | | | | | | | | | | | | | | | | | | | | | | | | | | | | | | | | | | | | | | | | | | | | | | | | | | | | | | | | | | | |
| Item | Md.3 Start information | 4012 | 4017 | 4022 | 4027 | 4032 | 4037 | 4042 | 4047 | 4052 | 4057 | 4062 | 4067 | 4072 | 4077 | 4082 | 4087 | | | | | | | | | | | | | | | | | | | | | | | | | | | | | | | | | | | | | | | | | | | | | | | | | | | | | | | | | | | | | | | | | | | | | | | | | | | | | | | | | | | | | | | | | | | | | | | | | | | | | | | | | | | | | | | | | | | | | | | | |
| | Md.4 Start No. | 4013 | 4018 | 4023 | 4028 | 4033 | 4038 | 4043 | 4048 | 4053 | 4058 | 4063 | 4068 | 4073 | 4078 | 4083 | 4088 | | | | | | | | | | | | | | | | | | | | | | | | | | | | | | | | | | | | | | | | | | | | | | | | | | | | | | | | | | | | | | | | | | | | | | | | | | | | | | | | | | | | | | | | | | | | | | | | | | | | | | | | | | | | | | | | | | | | | | | | |
| | Md.54 Start Year: month | 4240 | 4241 | 4242 | 4243 | 4244 | 4245 | 4246 | 4247 | 4248 | 4249 | 4250 | 4251 | 4252 | 4253 | 4254 | 4255 | | | | | | | | | | | | | | | | | | | | | | | | | | | | | | | | | | | | | | | | | | | | | | | | | | | | | | | | | | | | | | | | | | | | | | | | | | | | | | | | | | | | | | | | | | | | | | | | | | | | | | | | | | | | | | | | | | | | | | | | |
| | Md.5 Start Day: hour | 4014 | 4019 | 4024 | 4029 | 4034 | 4039 | 4044 | 4049 | 4054 | 4059 | 4064 | 4069 | 4074 | 4079 | 4084 | 4089 | | | | | | | | | | | | | | | | | | | | | | | | | | | | | | | | | | | | | | | | | | | | | | | | | | | | | | | | | | | | | | | | | | | | | | | | | | | | | | | | | | | | | | | | | | | | | | | | | | | | | | | | | | | | | | | | | | | | | | | | |
| | Md.6 Start Minute: second | 4015 | 4020 | 4025 | 4030 | 4035 | 4040 | 4045 | 4050 | 4055 | 4060 | 4065 | 4070 | 4075 | 4080 | 4085 | 4090 | | | | | | | | | | | | | | | | | | | | | | | | | | | | | | | | | | | | | | | | | | | | | | | | | | | | | | | | | | | | | | | | | | | | | | | | | | | | | | | | | | | | | | | | | | | | | | | | | | | | | | | | | | | | | | | | | | | | | | | | |
| | Md.7 Error judgment | 4016 | 4021 | 4026 | 4031 | 4036 | 4041 | 4046 | 4051 | 4056 | 4061 | 4066 | 4071 | 4076 | 4081 | 4086 | 4091 | | | | | | | | | | | | | | | | | | | | | | | | | | | | | | | | | | | | | | | | | | | | | | | | | | | | | | | | | | | | | | | | | | | | | | | | | | | | | | | | | | | | | | | | | | | | | | | | | | | | | | | | | | | | | | | | | | | | | | | | |
| | 0 | | | | | | | | | | | | | | | | | | | | | | | | | | | | | | | | | | | | | | | | | | | | | | | | | | | | | | | | | | | | | | | | | | | | | | | | | | | | | | | | | | | | | | | | | | | | | | | | | | | | | | | | | | | | | | | | | | | | | | | | | | | | | | | | | | | | | | | | |

| Storage item | Storage details | Reading the monitor value | | | | | | | | | | | | | | | | | |
|--|---|--|---------|---------|---|-----|-----|-----|----|---------|---------|---------|---------|---------|--------|--------|--------|--------|--|
| Error history (Up to 16 records can be stored) | [Md.9] Axis in which the error occurred <u>Refresh cycle: Immediate</u> | <p>■ Monitoring is carried out with a decimal display.</p> <p>Monitor value </p> <p>● Storage value 1: Axis 1 5: Axis 5 9: Axis 9 13: Axis 13 2: Axis 2 6: Axis 6 10: Axis 10 14: Axis 14 3: Axis 3 7: Axis 7 11: Axis 11 15: Axis 15 4: Axis 4 8: Axis 8 12: Axis 12 16: Axis 16</p> | | | | | | | | | | | | | | | | | |
| | [Md.10] Axis error No. <u>Refresh cycle: Immediate</u> | <p>■ Monitoring is carried out with a decimal display.</p> <p>Monitor value </p> <p>● Axis error No. For details of error codes, refer to Section 16.4 "List of errors".</p> | | | | | | | | | | | | | | | | | |
| | [Md.57] Servo alarm <u>Refresh cycle: Immediate</u> | <p>■ Monitoring is carried out with a hexadecimal display.</p> <p>Monitor value </p> <p>● Servo alarm code</p> | | | | | | | | | | | | | | | | | |
| | [Md.55] Axis error occurrence (Year: month) <u>Refresh cycle: Immediate</u> | <p>■ Monitoring is carried out with a hexadecimal display.</p> <p>Buffer memory (stored with BCD code)</p> <table border="1" style="margin-left: auto; margin-right: auto;"> <tr> <td style="text-align: center;">0</td> <td style="text-align: center;">8</td> <td style="text-align: center;">0</td> <td style="text-align: center;">6</td> </tr> <tr> <td style="text-align: center;">b15</td> <td style="text-align: center;">b12</td> <td style="text-align: center;">b8</td> <td style="text-align: center;">b4</td> </tr> <tr> <td style="text-align: center;">0:0:0:0</td> <td style="text-align: center;">1:1:0:0</td> <td style="text-align: center;">0:0:0:0</td> <td style="text-align: center;">0:0:1:1</td> </tr> <tr> <td style="text-align: center;">0 to 9</td> <td style="text-align: center;">0 to 9</td> <td style="text-align: center;">0 to 1</td> <td style="text-align: center;">0 to 9</td> </tr> </table> <p>→</p> <p>Monitor value </p> <p>00 to 99 (year) 01 to 12 (month)</p> | 0 | 8 | 0 | 6 | b15 | b12 | b8 | b4 | 0:0:0:0 | 1:1:0:0 | 0:0:0:0 | 0:0:1:1 | 0 to 9 | 0 to 9 | 0 to 1 | 0 to 9 | |
| | 0 | 8 | 0 | 6 | | | | | | | | | | | | | | | |
| | b15 | b12 | b8 | b4 | | | | | | | | | | | | | | | |
| | 0:0:0:0 | 1:1:0:0 | 0:0:0:0 | 0:0:1:1 | | | | | | | | | | | | | | | |
| 0 to 9 | 0 to 9 | 0 to 1 | 0 to 9 | | | | | | | | | | | | | | | | |
| [Md.11] Axis error occurrence (Day: hour) <u>Refresh cycle: Immediate</u> | <p>■ Monitoring is carried out with a hexadecimal display.</p> <p>Buffer memory (stored with BCD code)</p> <table border="1" style="margin-left: auto; margin-right: auto;"> <tr> <td style="text-align: center;">2</td> <td style="text-align: center;">8</td> <td style="text-align: center;">1</td> <td style="text-align: center;">5</td> </tr> <tr> <td style="text-align: center;">b15</td> <td style="text-align: center;">b12</td> <td style="text-align: center;">b8</td> <td style="text-align: center;">b4</td> </tr> <tr> <td style="text-align: center;">0:1:0:0</td> <td style="text-align: center;">1:1:0:0</td> <td style="text-align: center;">0:0:0:0</td> <td style="text-align: center;">1:0:1:0</td> </tr> <tr> <td style="text-align: center;">0 to 3</td> <td style="text-align: center;">0 to 9</td> <td style="text-align: center;">0 to 2</td> <td style="text-align: center;">0 to 9</td> </tr> </table> <p>→</p> <p>Monitor value </p> <p>01 to 31 (day) 00 to 23 (hour)</p> | 2 | 8 | 1 | 5 | b15 | b12 | b8 | b4 | 0:1:0:0 | 1:1:0:0 | 0:0:0:0 | 1:0:1:0 | 0 to 3 | 0 to 9 | 0 to 2 | 0 to 9 | | |
| 2 | 8 | 1 | 5 | | | | | | | | | | | | | | | | |
| b15 | b12 | b8 | b4 | | | | | | | | | | | | | | | | |
| 0:1:0:0 | 1:1:0:0 | 0:0:0:0 | 1:0:1:0 | | | | | | | | | | | | | | | | |
| 0 to 3 | 0 to 9 | 0 to 2 | 0 to 9 | | | | | | | | | | | | | | | | |
| [Md.12] Axis error occurrence (Minute: second) <u>Refresh cycle: Immediate</u> | <p>■ Monitoring is carried out with a hexadecimal display.</p> <p>Buffer memory (stored with BCD code)</p> <table border="1" style="margin-left: auto; margin-right: auto;"> <tr> <td style="text-align: center;">4</td> <td style="text-align: center;">9</td> <td style="text-align: center;">0</td> <td style="text-align: center;">7</td> </tr> <tr> <td style="text-align: center;">b15</td> <td style="text-align: center;">b12</td> <td style="text-align: center;">b8</td> <td style="text-align: center;">b4</td> </tr> <tr> <td style="text-align: center;">0:1:0:0</td> <td style="text-align: center;">1:0:0:0</td> <td style="text-align: center;">1:0:0:0</td> <td style="text-align: center;">0:1:1:1</td> </tr> <tr> <td style="text-align: center;">0 to 5</td> <td style="text-align: center;">0 to 9</td> <td style="text-align: center;">0 to 5</td> <td style="text-align: center;">0 to 9</td> </tr> </table> <p>→</p> <p>Monitor value </p> <p>00 to 59 (minute) 00 to 59 (second)</p> | 4 | 9 | 0 | 7 | b15 | b12 | b8 | b4 | 0:1:0:0 | 1:0:0:0 | 1:0:0:0 | 0:1:1:1 | 0 to 5 | 0 to 9 | 0 to 5 | 0 to 9 | | |
| 4 | 9 | 0 | 7 | | | | | | | | | | | | | | | | |
| b15 | b12 | b8 | b4 | | | | | | | | | | | | | | | | |
| 0:1:0:0 | 1:0:0:0 | 1:0:0:0 | 0:1:1:1 | | | | | | | | | | | | | | | | |
| 0 to 5 | 0 to 9 | 0 to 5 | 0 to 9 | | | | | | | | | | | | | | | | |
| [Md.13] Error history pointer <u>Refresh cycle: Immediate</u> | <p>■ Monitoring is carried out with a decimal display.</p> <p>Monitor value </p> <p>● Storage value (Pointer number) 0 to 15</p> | | | | | | | | | | | | | | | | | | |



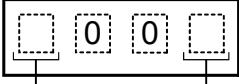
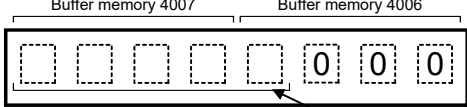

| Default value | Buffer memory address | | | | | | | | | | | | | | | | |
|---------------|--|-------|-------|-------|-------|-------|-------|-------|-------|-------|-------|-------|-------|-------|-------|-------|-------|
| 0 | | | | | | | | | | | | | | | | | |
| 0 | | | | | | | | | | | | | | | | | |
| | Md.13 Error history pointer | | 4157 | | | | | | | | | | | | | | |
| | Indicates a pointer No. that is next to the pointer No. assigned to the latest of the existing error history records. | | | | | | | | | | | | | | | | |
| 0000H | Pointer No. | 0 | 1 | 2 | 3 | 4 | 5 | 6 | 7 | 8 | 9 | 10 | 11 | 12 | 13 | 14 | 15 |
| | Md.9 Axis in which the error occurred | 4093 | 4097 | 4101 | 4105 | 4109 | 4113 | 4117 | 4121 | 4125 | 4129 | 4133 | 4137 | 4141 | 4145 | 4149 | 4153 |
| | Md.10 Axis error No. | 4094 | 4098 | 4102 | 4106 | 4110 | 4114 | 4118 | 4122 | 4126 | 4130 | 4134 | 4138 | 4142 | 4146 | 4150 | 4154 |
| | Md.57 Servo alarm | 31300 | 31301 | 31302 | 31303 | 31304 | 31305 | 31306 | 31307 | 31308 | 31309 | 31310 | 31311 | 31312 | 31313 | 31314 | 31315 |
| 0000H | Md.55 Axis error occurrence (Year: month) | 4256 | 4257 | 4258 | 4259 | 4260 | 4261 | 4262 | 4263 | 4264 | 4265 | 4266 | 4267 | 4268 | 4269 | 4270 | 4271 |
| | Md.11 Axis error occurrence (Day: hour) | 4095 | 4099 | 4103 | 4107 | 4111 | 4115 | 4119 | 4123 | 4127 | 4131 | 4135 | 4139 | 4143 | 4147 | 4151 | 4155 |
| | Md.12 Axis error occurrence (Minute: second) | 4096 | 4100 | 4104 | 4108 | 4112 | 4116 | 4120 | 4124 | 4128 | 4132 | 4136 | 4140 | 4144 | 4148 | 4152 | 4156 |
| 0000H | <ul style="list-style-type: none"> Each group of buffer memory addresses storing a complete error history record is assigned a pointer No. Example: Pointer No. 0 = Buffer memory addresses 4093 to 4096, 4256, 31300 Pointer No. 1 = Buffer memory addresses 4097 to 4100, 4257, 31301 Pointer No. 2 = Buffer memory addresses 4101 to 4104, 4258, 31302 ⋮ Pointer No. 15 = Buffer memory addresses 4153 to 4156, 4271, 31315 Each history record is assigned a pointer No. in the range between 0 and 15. If the pointer No. 15 has been assigned to a new record, the next record will be assigned the pointer number 0. (A new record replaces an older record when a pointer No. is reassigned.) | | | | | | | | | | | | | | | | |
| 0000H | | | | | | | | | | | | | | | | | |
| 0 | | | | | | | | | | | | | | | | | |

| Storage item | Storage details | Reading the monitor value | | | | | | | | | | | | | | | | |
|--|--|---|---------|----|---|-----|-----|-----|----|---------|---------|---------|---------|---------|--------|--------|--------|--------|
| Warning history (Up to 16 records can be stored) | [Md.14] Axis in which the warning occurred <u>Refresh cycle: Immediate</u> | <p>■ Monitoring is carried out with a decimal display.</p> <p>Monitor value  ● Storage value</p> <p>1: Axis 1 5: Axis 5 9: Axis 9 13: Axis 13 2: Axis 2 6: Axis 6 10: Axis 10 14: Axis 14 3: Axis 3 7: Axis 7 11: Axis 11 15: Axis 15 4: Axis 4 8: Axis 8 12: Axis 12 16: Axis 16</p> | | | | | | | | | | | | | | | | |
| | [Md.15] Axis warning No. <u>Refresh cycle: Immediate</u> | <p>■ Monitoring is carried out with a decimal display.</p> <p>Monitor value  ● Axis warning No. For details of warning codes, refer to Section 16.5 "List of warnings".</p> | | | | | | | | | | | | | | | | |
| | [Md.58] Servo warning <u>Refresh cycle: Immediate</u> | <p>■ Monitoring is carried out with a hexadecimal display.</p> <p>Monitor value  ● Servo warning code</p> | | | | | | | | | | | | | | | | |
| | [Md.56] Axis warning occurrence (Year: month) <u>Refresh cycle: Immediate</u> | <p>■ Monitoring is carried out with a hexadecimal display.</p> <p>Buffer memory (stored with BCD code)</p> <table border="1" style="margin-left: auto; margin-right: auto;"> <tr> <td style="text-align: center;">0</td> <td style="text-align: center;">8</td> <td style="text-align: center;">0</td> <td style="text-align: center;">6</td> </tr> <tr> <td style="text-align: center;">b15</td> <td style="text-align: center;">b12</td> <td style="text-align: center;">b8</td> <td style="text-align: center;">b4</td> </tr> <tr> <td style="text-align: center;">0:0:0:0</td> <td style="text-align: center;">1:1:0:0</td> <td style="text-align: center;">0:0:0:0</td> <td style="text-align: center;">0:0:1:1</td> </tr> <tr> <td style="text-align: center;">0 to 9</td> <td style="text-align: center;">0 to 9</td> <td style="text-align: center;">0 to 1</td> <td style="text-align: center;">0 to 9</td> </tr> </table> <p>→ Monitor value </p> <p style="text-align: right;">00 to 99 (year) 01 to 12 (month)</p> | 0 | 8 | 0 | 6 | b15 | b12 | b8 | b4 | 0:0:0:0 | 1:1:0:0 | 0:0:0:0 | 0:0:1:1 | 0 to 9 | 0 to 9 | 0 to 1 | 0 to 9 |
| | 0 | 8 | 0 | 6 | | | | | | | | | | | | | | |
| | b15 | b12 | b8 | b4 | | | | | | | | | | | | | | |
| 0:0:0:0 | 1:1:0:0 | 0:0:0:0 | 0:0:1:1 | | | | | | | | | | | | | | | |
| 0 to 9 | 0 to 9 | 0 to 1 | 0 to 9 | | | | | | | | | | | | | | | |
| [Md.16] Axis warning occurrence (Day: hour) <u>Refresh cycle: Immediate</u> | <p>■ Monitoring is carried out with a hexadecimal display.</p> <p>Buffer memory (stored with BCD code)</p> <table border="1" style="margin-left: auto; margin-right: auto;"> <tr> <td style="text-align: center;">2</td> <td style="text-align: center;">8</td> <td style="text-align: center;">1</td> <td style="text-align: center;">5</td> </tr> <tr> <td style="text-align: center;">b15</td> <td style="text-align: center;">b12</td> <td style="text-align: center;">b8</td> <td style="text-align: center;">b4</td> </tr> <tr> <td style="text-align: center;">0:0:1:0</td> <td style="text-align: center;">1:1:0:0</td> <td style="text-align: center;">0:0:0:1</td> <td style="text-align: center;">0:1:0:1</td> </tr> <tr> <td style="text-align: center;">0 to 3</td> <td style="text-align: center;">0 to 9</td> <td style="text-align: center;">0 to 2</td> <td style="text-align: center;">0 to 9</td> </tr> </table> <p>→ Monitor value </p> <p style="text-align: right;">01 to 31 (day) 00 to 23 (hour)</p> | 2 | 8 | 1 | 5 | b15 | b12 | b8 | b4 | 0:0:1:0 | 1:1:0:0 | 0:0:0:1 | 0:1:0:1 | 0 to 3 | 0 to 9 | 0 to 2 | 0 to 9 | |
| 2 | 8 | 1 | 5 | | | | | | | | | | | | | | | |
| b15 | b12 | b8 | b4 | | | | | | | | | | | | | | | |
| 0:0:1:0 | 1:1:0:0 | 0:0:0:1 | 0:1:0:1 | | | | | | | | | | | | | | | |
| 0 to 3 | 0 to 9 | 0 to 2 | 0 to 9 | | | | | | | | | | | | | | | |
| [Md.17] Axis warning occurrence (Minute: second) <u>Refresh cycle: Immediate</u> | <p>■ Monitoring is carried out with a hexadecimal display.</p> <p>Buffer memory (stored with BCD code)</p> <table border="1" style="margin-left: auto; margin-right: auto;"> <tr> <td style="text-align: center;">4</td> <td style="text-align: center;">9</td> <td style="text-align: center;">0</td> <td style="text-align: center;">7</td> </tr> <tr> <td style="text-align: center;">b15</td> <td style="text-align: center;">b12</td> <td style="text-align: center;">b8</td> <td style="text-align: center;">b4</td> </tr> <tr> <td style="text-align: center;">0:1:0:0</td> <td style="text-align: center;">1:0:0:1</td> <td style="text-align: center;">0:0:0:0</td> <td style="text-align: center;">0:1:1:1</td> </tr> <tr> <td style="text-align: center;">0 to 5</td> <td style="text-align: center;">0 to 9</td> <td style="text-align: center;">0 to 5</td> <td style="text-align: center;">0 to 9</td> </tr> </table> <p>→ Monitor value </p> <p style="text-align: right;">00 to 59 (minute) 00 to 59 (second)</p> | 4 | 9 | 0 | 7 | b15 | b12 | b8 | b4 | 0:1:0:0 | 1:0:0:1 | 0:0:0:0 | 0:1:1:1 | 0 to 5 | 0 to 9 | 0 to 5 | 0 to 9 | |
| 4 | 9 | 0 | 7 | | | | | | | | | | | | | | | |
| b15 | b12 | b8 | b4 | | | | | | | | | | | | | | | |
| 0:1:0:0 | 1:0:0:1 | 0:0:0:0 | 0:1:1:1 | | | | | | | | | | | | | | | |
| 0 to 5 | 0 to 9 | 0 to 5 | 0 to 9 | | | | | | | | | | | | | | | |
| [Md.18] Warning history pointer <u>Refresh cycle: Immediate</u> | <p>■ Monitoring is carried out with a decimal display.</p> <p>Monitor value  ● Storage value (Pointer number) 0 to 15</p> | | | | | | | | | | | | | | | | | |

| Default value | Buffer memory address | | | | | | | | | | | | | | | | | | | | | | | | | | | | | | | | | | | | | | | | | | | | | | | | | | | | | | | | | | | | | | | | | | | | | | | | | | | | | | | | | | | | | | | | | | | | | | | | | | | | | | | | | | | | | | | | | | | | | | | | | | | | | | | | | | | | | | |
|---|--|-------|-------|-------|-------|-------|-------|-------|-------|-------|-------|-------|-------|-------|-------|-------|-------------|---|---|---|---|---|---|---|---|---|---|----|----|----|----|----|----|---|------|------|------|------|------|------|------|------|------|------|------|------|------|------|------|------|---------------------------|------|------|------|------|------|------|------|------|------|------|------|------|------|------|------|------|------------------------|-------|-------|-------|-------|-------|-------|-------|-------|-------|-------|-------|-------|-------|-------|-------|-------|--|------|------|------|------|------|------|------|------|------|------|------|------|------|------|------|------|--|------|------|------|------|------|------|------|------|------|------|------|------|------|------|------|------|---|------|------|------|------|------|------|------|------|------|------|------|------|------|------|------|------|
| 0 | | | | | | | | | | | | | | | | | | | | | | | | | | | | | | | | | | | | | | | | | | | | | | | | | | | | | | | | | | | | | | | | | | | | | | | | | | | | | | | | | | | | | | | | | | | | | | | | | | | | | | | | | | | | | | | | | | | | | | | | | | | | | | | | | | | | | | | |
| 0 | | | | | | | | | | | | | | | | | | | | | | | | | | | | | | | | | | | | | | | | | | | | | | | | | | | | | | | | | | | | | | | | | | | | | | | | | | | | | | | | | | | | | | | | | | | | | | | | | | | | | | | | | | | | | | | | | | | | | | | | | | | | | | | | | | | | | | | |
| | Md.18 Warning history pointer | | 4222 | | | | | | | | | | | | | | | | | | | | | | | | | | | | | | | | | | | | | | | | | | | | | | | | | | | | | | | | | | | | | | | | | | | | | | | | | | | | | | | | | | | | | | | | | | | | | | | | | | | | | | | | | | | | | | | | | | | | | | | | | | | | | | | | | | | | |
| | Indicates a pointer No. that is next to the pointer No. assigned to the latest of the existing warning history records. | | | | | | | | | | | | | | | | | | | | | | | | | | | | | | | | | | | | | | | | | | | | | | | | | | | | | | | | | | | | | | | | | | | | | | | | | | | | | | | | | | | | | | | | | | | | | | | | | | | | | | | | | | | | | | | | | | | | | | | | | | | | | | | | | | | | | | |
| 0000H | <table border="1"> <thead> <tr> <th>Pointer No.</th> <th>0</th> <th>1</th> <th>2</th> <th>3</th> <th>4</th> <th>5</th> <th>6</th> <th>7</th> <th>8</th> <th>9</th> <th>10</th> <th>11</th> <th>12</th> <th>13</th> <th>14</th> <th>15</th> </tr> </thead> <tbody> <tr> <td>Md.14 Axis in which the warning occurred</td> <td>4158</td> <td>4162</td> <td>4166</td> <td>4170</td> <td>4174</td> <td>4178</td> <td>4182</td> <td>4186</td> <td>4190</td> <td>4194</td> <td>4198</td> <td>4202</td> <td>4206</td> <td>4210</td> <td>4214</td> <td>4218</td> </tr> <tr> <td>Md.15 Axis warning No.</td> <td>4159</td> <td>4163</td> <td>4167</td> <td>4171</td> <td>4175</td> <td>4179</td> <td>4183</td> <td>4187</td> <td>4191</td> <td>4195</td> <td>4199</td> <td>4203</td> <td>4207</td> <td>4211</td> <td>4215</td> <td>4219</td> </tr> <tr> <td>Md.58 Servo warning</td> <td>31316</td> <td>31317</td> <td>31318</td> <td>31319</td> <td>31320</td> <td>31321</td> <td>31322</td> <td>31323</td> <td>31324</td> <td>31325</td> <td>31326</td> <td>31327</td> <td>31328</td> <td>31329</td> <td>31330</td> <td>31331</td> </tr> <tr> <td>Md.56 Axis warning occurrence (Year: month)</td> <td>4272</td> <td>4273</td> <td>4274</td> <td>4275</td> <td>4276</td> <td>4277</td> <td>4278</td> <td>4279</td> <td>4280</td> <td>4281</td> <td>4282</td> <td>4283</td> <td>4284</td> <td>4285</td> <td>4286</td> <td>4287</td> </tr> <tr> <td>Md.16 Axis warning occurrence (Day: hour)</td> <td>4160</td> <td>4164</td> <td>4168</td> <td>4172</td> <td>4176</td> <td>4180</td> <td>4184</td> <td>4188</td> <td>4192</td> <td>4196</td> <td>4200</td> <td>4204</td> <td>4208</td> <td>4212</td> <td>4216</td> <td>4220</td> </tr> <tr> <td>Md.17 Axis warning occurrence (Minute: second)</td> <td>4161</td> <td>4165</td> <td>4169</td> <td>4173</td> <td>4177</td> <td>4181</td> <td>4185</td> <td>4189</td> <td>4193</td> <td>4197</td> <td>4201</td> <td>4205</td> <td>4209</td> <td>4213</td> <td>4217</td> <td>4221</td> </tr> </tbody> </table> | | | | | | | | | | | | | | | | Pointer No. | 0 | 1 | 2 | 3 | 4 | 5 | 6 | 7 | 8 | 9 | 10 | 11 | 12 | 13 | 14 | 15 | Md.14 Axis in which the warning occurred | 4158 | 4162 | 4166 | 4170 | 4174 | 4178 | 4182 | 4186 | 4190 | 4194 | 4198 | 4202 | 4206 | 4210 | 4214 | 4218 | Md.15 Axis warning No. | 4159 | 4163 | 4167 | 4171 | 4175 | 4179 | 4183 | 4187 | 4191 | 4195 | 4199 | 4203 | 4207 | 4211 | 4215 | 4219 | Md.58 Servo warning | 31316 | 31317 | 31318 | 31319 | 31320 | 31321 | 31322 | 31323 | 31324 | 31325 | 31326 | 31327 | 31328 | 31329 | 31330 | 31331 | Md.56 Axis warning occurrence (Year: month) | 4272 | 4273 | 4274 | 4275 | 4276 | 4277 | 4278 | 4279 | 4280 | 4281 | 4282 | 4283 | 4284 | 4285 | 4286 | 4287 | Md.16 Axis warning occurrence (Day: hour) | 4160 | 4164 | 4168 | 4172 | 4176 | 4180 | 4184 | 4188 | 4192 | 4196 | 4200 | 4204 | 4208 | 4212 | 4216 | 4220 | Md.17 Axis warning occurrence (Minute: second) | 4161 | 4165 | 4169 | 4173 | 4177 | 4181 | 4185 | 4189 | 4193 | 4197 | 4201 | 4205 | 4209 | 4213 | 4217 | 4221 |
| Pointer No. | 0 | 1 | 2 | 3 | 4 | 5 | 6 | 7 | 8 | 9 | 10 | 11 | 12 | 13 | 14 | 15 | | | | | | | | | | | | | | | | | | | | | | | | | | | | | | | | | | | | | | | | | | | | | | | | | | | | | | | | | | | | | | | | | | | | | | | | | | | | | | | | | | | | | | | | | | | | | | | | | | | | | | | | | | | | | | | | | | | | | | | |
| Md.14 Axis in which the warning occurred | 4158 | 4162 | 4166 | 4170 | 4174 | 4178 | 4182 | 4186 | 4190 | 4194 | 4198 | 4202 | 4206 | 4210 | 4214 | 4218 | | | | | | | | | | | | | | | | | | | | | | | | | | | | | | | | | | | | | | | | | | | | | | | | | | | | | | | | | | | | | | | | | | | | | | | | | | | | | | | | | | | | | | | | | | | | | | | | | | | | | | | | | | | | | | | | | | | | | | | |
| Md.15 Axis warning No. | 4159 | 4163 | 4167 | 4171 | 4175 | 4179 | 4183 | 4187 | 4191 | 4195 | 4199 | 4203 | 4207 | 4211 | 4215 | 4219 | | | | | | | | | | | | | | | | | | | | | | | | | | | | | | | | | | | | | | | | | | | | | | | | | | | | | | | | | | | | | | | | | | | | | | | | | | | | | | | | | | | | | | | | | | | | | | | | | | | | | | | | | | | | | | | | | | | | | | | |
| Md.58 Servo warning | 31316 | 31317 | 31318 | 31319 | 31320 | 31321 | 31322 | 31323 | 31324 | 31325 | 31326 | 31327 | 31328 | 31329 | 31330 | 31331 | | | | | | | | | | | | | | | | | | | | | | | | | | | | | | | | | | | | | | | | | | | | | | | | | | | | | | | | | | | | | | | | | | | | | | | | | | | | | | | | | | | | | | | | | | | | | | | | | | | | | | | | | | | | | | | | | | | | | | | |
| Md.56 Axis warning occurrence (Year: month) | 4272 | 4273 | 4274 | 4275 | 4276 | 4277 | 4278 | 4279 | 4280 | 4281 | 4282 | 4283 | 4284 | 4285 | 4286 | 4287 | | | | | | | | | | | | | | | | | | | | | | | | | | | | | | | | | | | | | | | | | | | | | | | | | | | | | | | | | | | | | | | | | | | | | | | | | | | | | | | | | | | | | | | | | | | | | | | | | | | | | | | | | | | | | | | | | | | | | | | |
| Md.16 Axis warning occurrence (Day: hour) | 4160 | 4164 | 4168 | 4172 | 4176 | 4180 | 4184 | 4188 | 4192 | 4196 | 4200 | 4204 | 4208 | 4212 | 4216 | 4220 | | | | | | | | | | | | | | | | | | | | | | | | | | | | | | | | | | | | | | | | | | | | | | | | | | | | | | | | | | | | | | | | | | | | | | | | | | | | | | | | | | | | | | | | | | | | | | | | | | | | | | | | | | | | | | | | | | | | | | | |
| Md.17 Axis warning occurrence (Minute: second) | 4161 | 4165 | 4169 | 4173 | 4177 | 4181 | 4185 | 4189 | 4193 | 4197 | 4201 | 4205 | 4209 | 4213 | 4217 | 4221 | | | | | | | | | | | | | | | | | | | | | | | | | | | | | | | | | | | | | | | | | | | | | | | | | | | | | | | | | | | | | | | | | | | | | | | | | | | | | | | | | | | | | | | | | | | | | | | | | | | | | | | | | | | | | | | | | | | | | | | |
| 0000H | <ul style="list-style-type: none"> Each group of buffer memory addresses storing a complete warning history record is assigned a pointer No. Example: Pointer No. 0 = Buffer memory addresses 4158 to 4161, 4272, 31316 Pointer No. 1 = Buffer memory addresses 4162 to 4165, 4273, 31317 Pointer No. 2 = Buffer memory addresses 4166 to 4169, 4274, 31318 ⋮ Pointer No. 15 = Buffer memory addresses 4218 to 4221, 4287, 31331 Each history record is assigned a pointer No. in the range between 0 and 15. If the pointer No. 15 has been assigned to a new record, the next record will be assigned the pointer number 0. (A new record replaces an older record when a pointer No. is reassigned.) | | | | | | | | | | | | | | | | | | | | | | | | | | | | | | | | | | | | | | | | | | | | | | | | | | | | | | | | | | | | | | | | | | | | | | | | | | | | | | | | | | | | | | | | | | | | | | | | | | | | | | | | | | | | | | | | | | | | | | | | | | | | | | | | | | | | | | |
| 0000H | | | | | | | | | | | | | | | | | | | | | | | | | | | | | | | | | | | | | | | | | | | | | | | | | | | | | | | | | | | | | | | | | | | | | | | | | | | | | | | | | | | | | | | | | | | | | | | | | | | | | | | | | | | | | | | | | | | | | | | | | | | | | | | | | | | | | | | |
| 0 | | | | | | | | | | | | | | | | | | | | | | | | | | | | | | | | | | | | | | | | | | | | | | | | | | | | | | | | | | | | | | | | | | | | | | | | | | | | | | | | | | | | | | | | | | | | | | | | | | | | | | | | | | | | | | | | | | | | | | | | | | | | | | | | | | | | | | | |

| Storage item | Storage details | Reading the monitor value | |
|--|--|--|--|
| [Md.19] Number of write accesses to flash ROM | Stores the number of write accesses to the flash ROM after the power is switched ON. The count is cleared to "0" when the number of write accesses reaches 26 and an error reset operation is performed. <u>Refresh cycle: Immediate</u> | <p>■ Monitoring is carried out with a decimal display.</p> <p>Monitor value </p> <p>● Storage value 0 to 25</p> | |
| [Md.50] Forced stop input | This area stores the states (ON/OFF) of forced stop input. <u>Refresh cycle: Operation cycle</u> | <p>■ Monitoring is carried out with a decimal display.</p> <p>Monitor value </p> <p>● Storage value 0: Forced stop input ON (Forced stop) 1: Forced stop input OFF (Forced stop release)</p> | |
| [Md.59] Module information | Stores the module information. <u>Refresh cycle: At power supply ON</u> | <p>■ Monitoring is carried out with a hexadecimal display.</p> <p>Monitor value </p> <p>● Storage value 2: QD77GF</p> <p>● Storage value 0: 4 axes 1: 8 axes 2: 16 axes</p> | |
| [Md.130] OS version | Stores the first five digits of the module product information. <u>Refresh cycle: At power supply ON</u> | <p>■ Monitoring is carried out with a hexadecimal display.</p> <p>Buffer memory (stored with BCD code)</p> <p>Monitor value </p> <p>● Storage value First five digits of product information</p> | |
| [Md.131] Digital oscilloscope running flag | Stores the RUN status of digital oscilloscope. <u>Refresh cycle: Main cycle</u> | <p>■ Monitoring is carried out with a decimal display.</p> <p>Monitor value </p> <p>● Storage value 0: Stop 1: Run -1: Stop by error</p> | |

| Default value | Buffer memory address |
|---|-----------------------|
| 0 | 4224 4225 |
| 0 | 4231 |
| QD77GF4: 2000H QD77GF8: 2001H QD77GF16: 2002H | 31332 |
| Factory-set product information | 4006 4007 |
| 0 | 4011 |

| Storage item | Storage details | Reading the monitor value | |
|---|--|--|--|
| <p>[Md.132] Operation cycle setting</p> | <p>Stores the current operation cycle. <u>Refresh cycle: At power supply ON</u></p> | <p>[RJ010 mode] ■ Monitoring is carried out with a decimal display. Monitor value  ● Storage value 0: 0.88ms 1: 1.77ms 2: 3.55ms</p> <p>[CiA402 mode] ■ Monitoring is carried out with a hexadecimal display. Monitor value  ● Storage value 1000H: 1.00ms 1001H: 2.00ms 1002H: 4.00ms</p> | |
| <p>[Md.133] Operation cycle over flag</p> | <p>This flag turns ON when the operation cycle time exceeds operation cycle. <u>Refresh cycle: Immediate</u></p> | <p>■ Monitoring is carried out with a decimal display. Monitor value  ● Storage value 0: OFF 1: ON (Operation cycle over occurred.)</p> <p>POINT Latch status of operation cycle over is indicated. When this flag turns ON, correct the positioning detail or change the operation cycle longer than current setting.</p> | |
| <p>[Md.134] Operation time</p> | <p>Stores the time that took for operation every operation cycle. <u>Refresh cycle: Operation cycle</u></p> | <p>■ Monitoring is carried out with a decimal display. Monitor value  ● Storage value Unit: μs</p> | |
| <p>[Md.135] Maximum operation time</p> | <p>Stores the maximum value of operation time after each module's power supply ON. <u>Refresh cycle: Immediate</u></p> | <p>■ Monitoring is carried out with a decimal display. Monitor value  ● Storage value Unit: μs</p> | |





| | Default value | Buffer memory address |
|--|---|-----------------------|
| | [RJ010 mode] 0 [CiA402 mode] 0000H | 4238 |
| | 0 | 4239 |
| | 0 | 4008 |
| | 0 | 4009 |

5.6.2 Axis monitor data

| Storage item | Storage details |
|----------------------------|---|
| [Md.20] Feed current value | <p>The currently commanded address is stored. (Different from the actual motor position during operation)</p> <p>The current position address is stored.</p> <p>If "degree" is selected as the unit, the addresses will have a ring structure for values between 0 and 359.99999 degrees.</p> <ul style="list-style-type: none"> • The HP address is stored when the machine HPR is completed. • When the current value is changed with the current value changing function, the changed value is stored. <p><u>Refresh cycle: Operation cycle</u></p> |
| [Md.21] Feed machine value | <p>The address of the current position according to the machine coordinates will be stored. (Different from the actual motor position during operation)</p> <p>Note that the current value changing function will not change the feed machine value.</p> <p>Under the speed control mode, the feed machine value is constantly updated always, irrespective of the parameter setting.</p> <p>The value will not be cleared to "0" at the beginning of fixed-feed control.</p> <p>Even if "degree" is selected as the unit, the addresses will become a cumulative value. (They will not have a ring structure for values between 0 and 359.99999 degrees).</p> <p>However, the feed machine value is restored with cumulating the feed machine value before the power supply OFF (the rounded value within the range of 0 to 359.99999 degrees) to the movement amount during the power supply OFF at the communication start with servo amplifier after the power supply ON or PLC CPU reset.</p> <ul style="list-style-type: none"> • Machine coordinates: Characteristic coordinates determined with machine <p><u>Refresh cycle: Operation cycle</u></p> |
| [Md.22] Feedrate | <p>The speed of the operating workpiece is stored. (May be different from the actual motor speed during operation)</p> <ul style="list-style-type: none"> • During interpolation operation, the speed is stored in the following manner. Reference axis : Composite speed or reference axis speed (Set with [Pr.20]) Interpolation axis : 0 <p><u>Refresh cycle: Operation cycle</u></p> <p>POINT</p> <p>In case of the single axis operation, "[Md.22] Feedrate" and "[Md.28] Axis feedrate" are identical.</p> <p>In the composite mode of the interpolation operation, "[Md.22] Feedrate" is a speed in a composite direction and "[Md.28] Axis feedrate" is that in each axial direction.</p> <p>"[Md.22] Feedrate" is indicated as an absolute value. Check the operation direction with "[Md.20] Feed current value"</p> |
| [Md.23] Axis error No. | <p>When an axis error is detected, the error code corresponding to the error details is stored.</p> <ul style="list-style-type: none"> • The latest error code is always stored. (When a new axis error occurs, the error code is overwritten.) • When "[Cd.5] Axis error reset" (axis control data) turns ON, the axis error No. is cleared (set to 0). <p><u>Refresh cycle: Immediate</u></p> |

| Reading the monitor value | Default value | Buffer memory address | | | | | | | | | | | | | | | | | | | | | | | | | | |
|---|--------------------|------------------------|---------|--------------------|---------|----------|---|------|----|----|----|------|----|--------|---|-----|---|------|----|--------|----|----------|------|------------|---|-------|-------|------------------------|
| <p>■ Monitoring is carried out with a hexadecimal display.</p> | 0000H | 2400+100n 2401+100n | | | | | | | | | | | | | | | | | | | | | | | | | | |
| <p>(High-order buffer memory) (Low-order buffer memory)</p> <p>◆ Sorting</p> <p>◆ Converted from hexadecimal to decimal</p> <p>Decimal integer value</p> <p>R</p> <p>◆ Unit conversion</p> <p>$R \times 10^m$</p> <p>Actual value</p> <table border="1" data-bbox="327 1355 582 1489"> <tr><td>[Md.20]</td><td>Feed current value</td></tr> <tr><td>[Md.21]</td><td>Feed machine value</td></tr> <tr><td>[Md.22]</td><td>Feedrate</td></tr> </table> <p>● Unit conversion table ([Md.20] [Md.21])</p> <table border="1" data-bbox="758 1086 973 1243"> <thead> <tr><th>m</th><th>Unit</th></tr> </thead> <tbody> <tr><td>-1</td><td>μm</td></tr> <tr><td>-5</td><td>inch</td></tr> <tr><td>-5</td><td>degree</td></tr> <tr><td>0</td><td>PLS</td></tr> </tbody> </table> <p>● Unit conversion table ([Md.22])</p> <table border="1" data-bbox="758 1321 973 1478"> <thead> <tr><th>m</th><th>Unit</th></tr> </thead> <tbody> <tr><td>-2</td><td>mm/min</td></tr> <tr><td>-3</td><td>inch/min</td></tr> <tr><td>-3 *</td><td>degree/min</td></tr> <tr><td>0</td><td>PLS/s</td></tr> </tbody> </table> <p>*: When "[Pr.83] Speed control 10 x multiplier setting for degree axis" is valid: "-2"</p> | [Md.20] | Feed current value | [Md.21] | Feed machine value | [Md.22] | Feedrate | m | Unit | -1 | μm | -5 | inch | -5 | degree | 0 | PLS | m | Unit | -2 | mm/min | -3 | inch/min | -3 * | degree/min | 0 | PLS/s | 0000H | 2402+100n 2403+100n |
| [Md.20] | Feed current value | | | | | | | | | | | | | | | | | | | | | | | | | | | |
| [Md.21] | Feed machine value | | | | | | | | | | | | | | | | | | | | | | | | | | | |
| [Md.22] | Feedrate | | | | | | | | | | | | | | | | | | | | | | | | | | | |
| m | Unit | | | | | | | | | | | | | | | | | | | | | | | | | | | |
| -1 | μm | | | | | | | | | | | | | | | | | | | | | | | | | | | |
| -5 | inch | | | | | | | | | | | | | | | | | | | | | | | | | | | |
| -5 | degree | | | | | | | | | | | | | | | | | | | | | | | | | | | |
| 0 | PLS | | | | | | | | | | | | | | | | | | | | | | | | | | | |
| m | Unit | | | | | | | | | | | | | | | | | | | | | | | | | | | |
| -2 | mm/min | | | | | | | | | | | | | | | | | | | | | | | | | | | |
| -3 | inch/min | | | | | | | | | | | | | | | | | | | | | | | | | | | |
| -3 * | degree/min | | | | | | | | | | | | | | | | | | | | | | | | | | | |
| 0 | PLS/s | | | | | | | | | | | | | | | | | | | | | | | | | | | |
| <p>■ Monitoring is carried out with a decimal display.</p> <p>Monitor value</p> <p>● Axis error No. For details of error codes, refer to Section 16.4 "List of errors".</p> | 0 | 2406+100n | | | | | | | | | | | | | | | | | | | | | | | | | | |

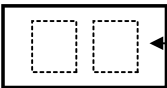
| Storage item | Storage details | |
|-------------------------------|---|--|
| [Md.24] Axis warning No. | <p>Whenever an axis warning is reported, a related warning code is stored.</p> <ul style="list-style-type: none"> • This area stores the latest warning code always. (Whenever an axis warning is reported, a new warning code replaces the stored warning code.) • When the "[Cd.5] Axis error reset" (axis control data) is set to ON, the axis warning No. is cleared to "0". <p><u>Refresh cycle: Immediate</u></p> | |
| [Md.25] Valid M code | <p>This area stores an M code that is currently active (i.e. set to the positioning data relating to the current operation).</p> <p>When the PLC READY signal [Y0] goes OFF, the value is set to "0".</p> <p><u>Refresh cycle: Immediate</u></p> | |
| [Md.26] Axis operation status | <p>This area stores the axis operation status.</p> <p><u>Refresh cycle: Immediate</u></p> | |
| [Md.27] Current speed | <p>The "[Da.8] Command speed" used by the positioning data currently being executed is stored.</p> <ul style="list-style-type: none"> • If "[Da.8] Command speed" is set to "-1", this area stores the command speed set by the positioning data used one step earlier. • If "[Da.8] Command speed" is set to a value other than "-1", this area stores the command speed set by the current positioning data. • When speed change function is executed, this area stores "[Cd.14] New speed value". (For details of change speed function, refer to Section 13.5.1.) <p><u>Refresh cycle: Immediate</u></p> | |

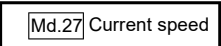
| Reading the monitor value | Default value | Buffer memory address | | | | | | | | | | |
|--|---------------|-----------------------|----|--------|----|----------|-----|------------|---|-------|---|------------------------|
| <p>■ Monitoring is carried out with a decimal display.</p> <p>Monitor value  ● Axis warning No. For details of warning codes, refer to Section 16.5 "List of warnings".</p> | 0 | 2407+100n | | | | | | | | | | |
| <p>■ Monitoring is carried out with a decimal display.</p> <p>Monitor value  ● M code No. (0 to 65535)</p> | 0 | 2408+100n | | | | | | | | | | |
| <p>■ Monitoring is carried out with a decimal display.</p> <p>Monitor value  ● Axis operation status</p> <ul style="list-style-type: none"> -2: Step standby -1: Error 0: Standby 1: Stopped 2: Interpolation 3: JOG operation 4: Manual pulse generator operation 5: Analyzing 6: Special start standby 7: HPR 8: Position control 9: Speed control 10: Speed control in speed-position switching control 11: Position control in speed-position switching control 12: Position control in position-speed switching control 13: Speed control in position-speed switching control 15: Synchronous control 20: Servo amplifier has not been connected/ servo amplifier power OFF 21: Servo OFF 30: Control mode switch 31: Speed control 32: Torque control | 0 | 2409+100n | | | | | | | | | | |
| <p>■ Monitoring is carried out with a decimal display.</p> <p>Monitor value  (Decimal integer value)</p> <p>◇ Unit conversion $R \times 10^m$</p> <p>Actual value </p> <p>● Unit conversion table (Md.27)</p> <table border="1" data-bbox="719 1626 940 1783"> <thead> <tr> <th>m</th> <th>Unit</th> </tr> </thead> <tbody> <tr> <td>-2</td> <td>mm/min</td> </tr> <tr> <td>-3</td> <td>inch/min</td> </tr> <tr> <td>-3*</td> <td>degree/min</td> </tr> <tr> <td>0</td> <td>PLS/s</td> </tr> </tbody> </table> <p>*: When "[Pr.83] Speed control 10 x multiplier setting for degree axis" is valid: "-2"</p> | m | Unit | -2 | mm/min | -3 | inch/min | -3* | degree/min | 0 | PLS/s | 0 | 2410+100n 2411+100n |
| m | Unit | | | | | | | | | | | |
| -2 | mm/min | | | | | | | | | | | |
| -3 | inch/min | | | | | | | | | | | |
| -3* | degree/min | | | | | | | | | | | |
| 0 | PLS/s | | | | | | | | | | | |

n: Axis No.-1

| Storage item | Storage details |
|--|--|
| [Md.28] Axis feedrate | <ul style="list-style-type: none"> The speed which is actually output as a command at that time in each axis is stored. (May be different from the actual motor speed) "0" is stored when the axis is at a stop. <p><u>Refresh cycle: Operation cycle</u></p> <p>POINT Refer to "[Md.22] Feedrate". "[Md.28] Axis feedrate" is indicated as an absolute value. Check the operation direction with "[Md.20] Feed current value".</p> |
| [Md.29] Speed-position switching control positioning movement amount | <ul style="list-style-type: none"> The movement amount for the position control to end after changing to position control with the speed-position switching control is stored. When the control method is "Reverse run: position/speed", the negative value is stored. <p><u>Refresh cycle: Immediate</u></p> |
| [Md.30] External input signal | <p>The ON/OFF state of the external input signal is stored. The following items are stored.</p> <ul style="list-style-type: none"> Lower limit signal * Upper limit signal * Stop signal ** External command signal/switching signal Proximity dog signal * <p>*: This area stores the states of the external input signal (servo amplifier) or buffer memory of QD77GF set by "[Pr.80] External input signal selection". **: Regardless of the "[Pr.80] External input signal selection" setting, this area stores the states of the buffer memory of QD77GF.</p> <p><u>Refresh cycle: Operation cycle</u></p> |

| Reading the monitor value | Default value | Buffer memory address | | | | | | | | | | | | | | | | | | | | |
|--|---------------|------------------------|---------|--------|----|-----------------|------|------------|----|-------|----|------|----|----|----|------|----|--------|----|-----|-------|------------------------|
| <p>■ Monitoring is carried out with a hexadecimal.</p> | 0000H | 2412+100n 2413+100n | | | | | | | | | | | | | | | | | | | | |
| <p>• Unit conversion table (Md.28)</p> <table border="1" data-bbox="758 857 981 1014"> <thead> <tr> <th>m</th> <th>Unit</th> </tr> </thead> <tbody> <tr> <td>-2</td> <td>mm/min</td> </tr> <tr> <td>-3</td> <td>inch/min</td> </tr> <tr> <td>-3 *</td> <td>degree/min</td> </tr> <tr> <td>0</td> <td>PLS/s</td> </tr> </tbody> </table> <p>*: When "Pr.83 Speed control 10 x multiplier setting for degree axis" is valid: "-2"</p> <p>• Unit conversion table (Md.29)</p> <table border="1" data-bbox="758 1171 981 1328"> <thead> <tr> <th>m</th> <th>Unit</th> </tr> </thead> <tbody> <tr> <td>-1</td> <td>μm</td> </tr> <tr> <td>-5</td> <td>inch</td> </tr> <tr> <td>-5</td> <td>degree</td> </tr> <tr> <td>0</td> <td>PLS</td> </tr> </tbody> </table> | m | Unit | -2 | mm/min | -3 | inch/min | -3 * | degree/min | 0 | PLS/s | m | Unit | -1 | μm | -5 | inch | -5 | degree | 0 | PLS | 0000H | 2414+100n 2415+100n |
| m | Unit | | | | | | | | | | | | | | | | | | | | | |
| -2 | mm/min | | | | | | | | | | | | | | | | | | | | | |
| -3 | inch/min | | | | | | | | | | | | | | | | | | | | | |
| -3 * | degree/min | | | | | | | | | | | | | | | | | | | | | |
| 0 | PLS/s | | | | | | | | | | | | | | | | | | | | | |
| m | Unit | | | | | | | | | | | | | | | | | | | | | |
| -1 | μm | | | | | | | | | | | | | | | | | | | | | |
| -5 | inch | | | | | | | | | | | | | | | | | | | | | |
| -5 | degree | | | | | | | | | | | | | | | | | | | | | |
| 0 | PLS | | | | | | | | | | | | | | | | | | | | | |
| <p>■ Monitoring is carried out with a hexadecimal.</p> <table border="1" data-bbox="635 1637 981 1872"> <thead> <tr> <th>Stored items</th> <th>Default value</th> <th>Meaning</th> </tr> </thead> <tbody> <tr> <td>b0</td> <td>0</td> <td rowspan="8">0: OFF 1: ON</td> </tr> <tr> <td>b1</td> <td>0</td> </tr> <tr> <td>b2</td> <td>0</td> </tr> <tr> <td>b3</td> <td>0</td> </tr> <tr> <td>b4</td> <td>0</td> </tr> <tr> <td>b5</td> <td>0</td> </tr> <tr> <td>b6</td> <td>0</td> </tr> <tr> <td>b7</td> <td>0</td> </tr> </tbody> </table> | Stored items | Default value | Meaning | b0 | 0 | 0: OFF 1: ON | b1 | 0 | b2 | 0 | b3 | 0 | b4 | 0 | b5 | 0 | b6 | 0 | b7 | 0 | 0000H | 2416+100n |
| Stored items | Default value | Meaning | | | | | | | | | | | | | | | | | | | | |
| b0 | 0 | 0: OFF 1: ON | | | | | | | | | | | | | | | | | | | | |
| b1 | 0 | | | | | | | | | | | | | | | | | | | | | |
| b2 | 0 | | | | | | | | | | | | | | | | | | | | | |
| b3 | 0 | | | | | | | | | | | | | | | | | | | | | |
| b4 | 0 | | | | | | | | | | | | | | | | | | | | | |
| b5 | 0 | | | | | | | | | | | | | | | | | | | | | |
| b6 | 0 | | | | | | | | | | | | | | | | | | | | | |
| b7 | 0 | | | | | | | | | | | | | | | | | | | | | |

n: Axis No.-1

| Storage item | Storage details |
|----------------|---|
| [Md.31] Status | <p>This area stores the states (ON/OFF) of various flags. Information on the following flags is stored.</p> <ul style="list-style-type: none"> ● In speed control flag This signal that comes ON under the speed control can be used to judge whether the operation is performed under the speed control or position control. The signal goes OFF when the power is switched ON, under the position control, and during JOG operation or manual pulse generator operation. During the speed-position or position-speed switching control, this signal comes ON only when the speed control is in effect. During the speed-position switching control, this signal goes OFF when the speed-position switching signal executes a switching over from speed control to position control. During the position-speed switching control, this signal comes ON when the position-speed switching signal executes a switching over from position control to speed control. ● Speed-position switching latch flag This signal is used during the speed-position switching control for interlocking the movement amount change function. During the speed-position switching control, this signal comes ON when position control takes over. This signal goes OFF when the next positioning data is processed, and during JOG operation or manual pulse generator operation. ● Command in-position flag This signal is ON when the remaining distance is equal to or less than the command in-position range (set by a detailed parameter). This signal remains OFF with data that specify the continuous path control (P11) as the operation pattern. The state of this signal is monitored every operation cycle except when the monitoring is canceled under the speed control or while the speed control is in effect during the speed-position or position-speed switching control. While operations are performed with interpolation, this signal comes ON only in respect of the starting axis. (This signal goes OFF in respect of all axes upon starting.) ● HPR request flag This signal comes ON when an HPR operation is required, and goes OFF when the HPR operation completes. (For details of HPR request flag, refer to the remark of Section 8.1.1.) ● HPR complete flag This signal comes ON when a machine HPR operation completes normally. This signal goes OFF when the operation start. ● Position-speed switching latch flag This signal is used during the position-speed switching control for interlocking the command speed change function. During the position-speed switching control, this signal comes ON when speed control takes over. This signal goes OFF when the next positioning data is processed, and during JOG operation or manual pulse generator operation. ● Axis warning detection flag This signal comes On when an axis warning is reported and goes OFF when the axis error reset signal comes ON. ● Speed change 0 flag This signal comes ON when a speed change request that specifies 0 as the new speed value is issued. This signal comes ON when a speed change request that specifies a new speed value other than 0 is issued. ● M code ON In the WITH mode, this signal turns ON when the positioning data operation is started. In the AFTER mode, this signal turns ON when the positioning data operation is completed. This signal turns OFF with the "[Cd.7] M code OFF request". When M code is not designated (when "[Da.10] M code/Condition data No./Number of LOOP to LEND repetitions" is "0"), this signal will remain OFF. With using continuous path control for the positioning operation, the positioning will continue even when this signal does not turn OFF. However, the warning "M code ON signal ON" (warning code: 503) will occur. When the PLC READY signal [Y0] turns OFF, the M code ON signal will also turn OFF. If operation is started while the M code is ON, the error "M code ON signal start" (error code: 536) will occur. ● Error detection This signal turns ON when an error listed in Section 16.3 occurs, and turns OFF when the error is reset on "[Cd.5] Axis error reset". ● Start complete This signal turns ON when the positioning start signal turns ON and the Simple Motion module starts the positioning process. (The start complete signal also turns ON during HPR control.) ● Positioning complete This signal turns ON for the time set in "[Pr.40] Positioning complete signal output time" from the instant when the positioning control for each positioning data No. is completed. For the interpolation control, the positioning complete signal of interpolation axis turns ON during the time set to the reference axis. (It does not turn ON when "[Pr.40] Positioning complete signal output time" is "0".) If positioning (including HPR), JOG/Inching operation, or manual pulse generator operation is started while this signal is ON, the signal will turn OFF. This signal will not turn ON when speed control or positioning is canceled midway. <p><u>Refresh cycle: Immediate</u></p> |

| Reading the monitor value | Default value | Buffer memory address | | | | | | | | | | | | | | | | | | | | | | | | | | | | |
|---|---------------|-----------------------|---------|----|---|-----------------|----|---|----|---|----|---|----|---|----|---|----|---|-----|---|-----|---|-----|---|-----|---|-----|---|-------|-----------|
| <p>■ Monitoring is carried out with a hexadecimal display.</p> <table border="1" data-bbox="598 1102 967 1406"> <thead> <tr> <th>Stored items</th> <th>Default value</th> <th>Meaning</th> </tr> </thead> <tbody> <tr> <td>b0</td> <td>0</td> <td rowspan="14">0: OFF 1: ON</td> </tr> <tr> <td>b1</td> <td>0</td> </tr> <tr> <td>b2</td> <td>0</td> </tr> <tr> <td>b3</td> <td>1</td> </tr> <tr> <td>b4</td> <td>0</td> </tr> <tr> <td>b5</td> <td>0</td> </tr> <tr> <td>b9</td> <td>0</td> </tr> <tr> <td>b10</td> <td>0</td> </tr> <tr> <td>b12</td> <td>0</td> </tr> <tr> <td>b13</td> <td>0</td> </tr> <tr> <td>b14</td> <td>0</td> </tr> <tr> <td>b15</td> <td>0</td> </tr> </tbody> </table> | Stored items | Default value | Meaning | b0 | 0 | 0: OFF 1: ON | b1 | 0 | b2 | 0 | b3 | 1 | b4 | 0 | b5 | 0 | b9 | 0 | b10 | 0 | b12 | 0 | b13 | 0 | b14 | 0 | b15 | 0 | 0008H | 2417+100n |
| Stored items | Default value | Meaning | | | | | | | | | | | | | | | | | | | | | | | | | | | | |
| b0 | 0 | 0: OFF 1: ON | | | | | | | | | | | | | | | | | | | | | | | | | | | | |
| b1 | 0 | | | | | | | | | | | | | | | | | | | | | | | | | | | | | |
| b2 | 0 | | | | | | | | | | | | | | | | | | | | | | | | | | | | | |
| b3 | 1 | | | | | | | | | | | | | | | | | | | | | | | | | | | | | |
| b4 | 0 | | | | | | | | | | | | | | | | | | | | | | | | | | | | | |
| b5 | 0 | | | | | | | | | | | | | | | | | | | | | | | | | | | | | |
| b9 | 0 | | | | | | | | | | | | | | | | | | | | | | | | | | | | | |
| b10 | 0 | | | | | | | | | | | | | | | | | | | | | | | | | | | | | |
| b12 | 0 | | | | | | | | | | | | | | | | | | | | | | | | | | | | | |
| b13 | 0 | | | | | | | | | | | | | | | | | | | | | | | | | | | | | |
| b14 | 0 | | | | | | | | | | | | | | | | | | | | | | | | | | | | | |
| b15 | 0 | | | | | | | | | | | | | | | | | | | | | | | | | | | | | |

| Storage item | Storage details |
|---|--|
| [Md.32] Target value | <p>This area stores the target value ([Da.6] Positioning address/movement amount) for a positioning operation.</p> <ul style="list-style-type: none"> • At the beginning of positioning control and current value changing: Stores the value of "[Da.6] Positioning address/movement amount". • At the HP shift operation of HPR control: Stores the value of HP shift amount. • At other times : Stores "0". <p><u>Refresh cycle: Immediate</u></p> |
| [Md.33] Target speed | <ul style="list-style-type: none"> • During operation with positioning data : The actual target speed, considering the override and speed limit value, etc., is stored. "0" is stored when positioning is completed. • During interpolation of position control : The composite speed or reference axis speed is stored in the reference axis address, and "0" is stored in the interpolation axis address. • During interpolation of speed control : The target speeds of each axis are stored in the monitor of the reference axis and interpolation axis. • During JOG operation : The actual target speed, considering the JOG speed limit value for the JOG speed, is stored. • During manual pulse generator operation : "0" is stored. <p><u>Refresh cycle: Immediate</u></p> <p>POINT</p> <p>The target speed is when an override is made to the command speed. When the speed limit value is overridden, the target speed is restricted to the speed limit value. The target speed changes every time data is switched, but does not change in an acceleration/deceleration state inside each piece of data (changes with the speed change because the target speed changes.)</p> |
| [Md.34] Movement amount after proximity dog ON [RJ010 mode] | <ul style="list-style-type: none"> • "0" is stored when machine HPR starts. • After machine HPR starts, the movement amount from the proximity dog ON to the machine HPR completion is stored. (Movement amount: Movement amount to machine HPR completion using proximity dog ON as "0".) <p><u>Refresh cycle: Immediate</u></p> |

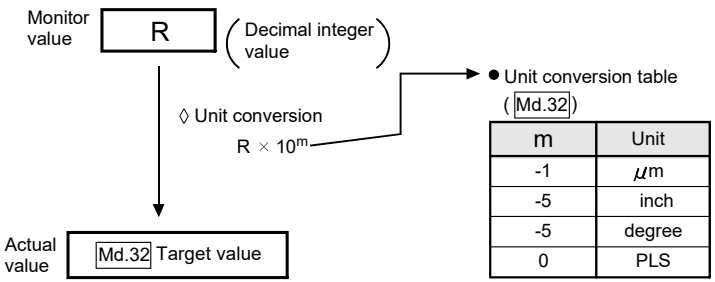
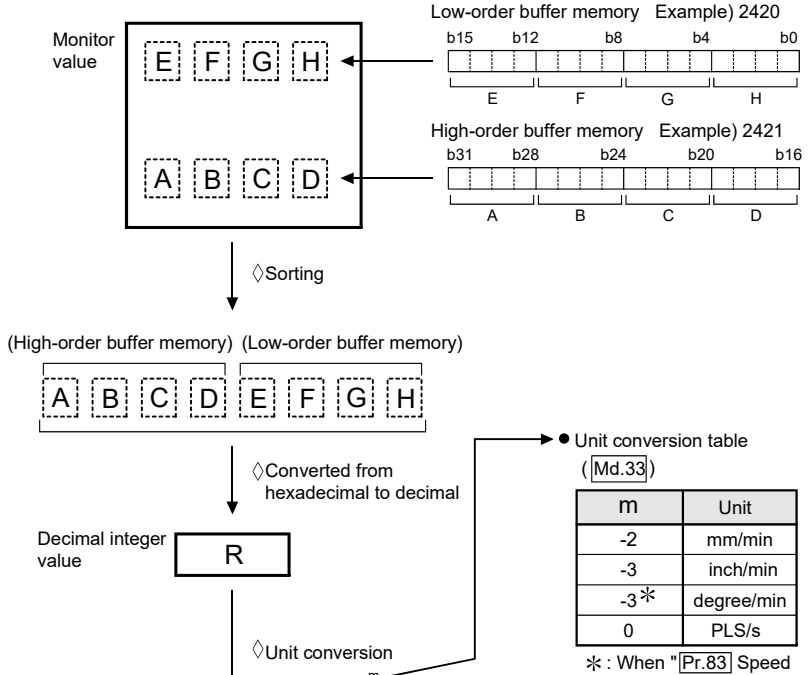
| Reading the monitor value | Default value | Buffer memory address | | | | | | | | | | | | | | | | | | | | |
|---|---------------|------------------------|----|--------|----|----------|-----|------------|---|-------|---|------------------------|----|----|----|------|----|--------|---|-----|-------|------------------------|
| <p>■ Monitoring is carried out with a decimal display.</p>  <table border="1" data-bbox="718 459 941 616"> <thead> <tr> <th>m</th> <th>Unit</th> </tr> </thead> <tbody> <tr> <td>-1</td> <td>μm</td> </tr> <tr> <td>-5</td> <td>inch</td> </tr> <tr> <td>-5</td> <td>degree</td> </tr> <tr> <td>0</td> <td>PLS</td> </tr> </tbody> </table> | m | Unit | -1 | μm | -5 | inch | -5 | degree | 0 | PLS | 0 | 2418+100n 2419+100n | | | | | | | | | | |
| m | Unit | | | | | | | | | | | | | | | | | | | | | |
| -1 | μm | | | | | | | | | | | | | | | | | | | | | |
| -5 | inch | | | | | | | | | | | | | | | | | | | | | |
| -5 | degree | | | | | | | | | | | | | | | | | | | | | |
| 0 | PLS | | | | | | | | | | | | | | | | | | | | | |
| <p>■ Monitoring is carried out with a hexadecimal display.</p>  <p>Low-order buffer memory Example) 2420 b15 b12 b8 b4 b0 E F G H</p> <p>High-order buffer memory Example) 2421 b31 b28 b24 b20 b16 A B C D</p> <p>(High-order buffer memory) (Low-order buffer memory) A B C D E F G H</p> <p>Converted from hexadecimal to decimal</p> <p>Decimal integer value R</p> <p>Unit conversion R × 10^m</p> <table border="1" data-bbox="758 1187 981 1344"> <thead> <tr> <th>m</th> <th>Unit</th> </tr> </thead> <tbody> <tr> <td>-2</td> <td>mm/min</td> </tr> <tr> <td>-3</td> <td>inch/min</td> </tr> <tr> <td>-3*</td> <td>degree/min</td> </tr> <tr> <td>0</td> <td>PLS/s</td> </tr> </tbody> </table> <p>* : When "[Pr.83] Speed control 10 x multiplier setting for degree axis" is valid: "-2"</p> <table border="1" data-bbox="758 1500 981 1657"> <thead> <tr> <th>m</th> <th>Unit</th> </tr> </thead> <tbody> <tr> <td>-1</td> <td>μm</td> </tr> <tr> <td>-5</td> <td>inch</td> </tr> <tr> <td>-5</td> <td>degree</td> </tr> <tr> <td>0</td> <td>PLS</td> </tr> </tbody> </table> | m | Unit | -2 | mm/min | -3 | inch/min | -3* | degree/min | 0 | PLS/s | m | Unit | -1 | μm | -5 | inch | -5 | degree | 0 | PLS | 0000H | 2420+100n 2421+100n |
| m | Unit | | | | | | | | | | | | | | | | | | | | | |
| -2 | mm/min | | | | | | | | | | | | | | | | | | | | | |
| -3 | inch/min | | | | | | | | | | | | | | | | | | | | | |
| -3* | degree/min | | | | | | | | | | | | | | | | | | | | | |
| 0 | PLS/s | | | | | | | | | | | | | | | | | | | | | |
| m | Unit | | | | | | | | | | | | | | | | | | | | | |
| -1 | μm | | | | | | | | | | | | | | | | | | | | | |
| -5 | inch | | | | | | | | | | | | | | | | | | | | | |
| -5 | degree | | | | | | | | | | | | | | | | | | | | | |
| 0 | PLS | | | | | | | | | | | | | | | | | | | | | |
| <p>Actual value</p> <p>Md.33 Target speed Md.34 Movement amount after proximity dog ON</p> | 0000H | 2424+100n 2425+100n | | | | | | | | | | | | | | | | | | | | |





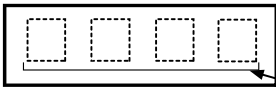
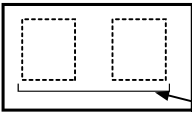
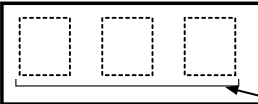
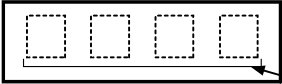

n: Axis No.-1

| Storage item | Storage details | |
|---|---|--|
| <p>[Md.35] Torque limit stored value/ forward torque limit stored value</p> | <p>[RJ010 mode] The "[Pr.17] Torque limit setting value", "[Cd.101] Torque output setting value", "[Cd.22] New torque value/forward new torque value" or "[Pr.54] HPR torque limit value" is stored.</p> <p>[CiA402 mode] The "[Pr.17] Torque limit setting value", "[Cd.101] Torque output setting value" or "[Cd.22] New torque value/forward new torque value" is stored.</p> <ul style="list-style-type: none"> • During positioning start, JOG operation start, manual pulse generator operation : The "[Pr.17] Torque limit setting value" or "[Cd.101] Torque output setting value" is stored. • When value is changed to "[Cd.22] New torque value/forward new torque value" during operation : The "[Cd.22] New torque value/forward new torque value" is stored. • When HPR : The "[Pr.17] Torque limit setting value" or "[Cd.101] Torque output setting value" is stored. But "[Pr.54] HPR torque limit value" is stored after the "[Pr.47] Creep speed" completion. [RJ010 mode] <p><u>Refresh cycle: Immediate</u></p> | |
| <p>[Md.36] Special start data instruction code setting value</p> | <ul style="list-style-type: none"> • The "instruction code" used with special start and indicated by the start data pointer currently being executed is stored. <p><u>Refresh cycle: Immediate</u></p> | |
| <p>[Md.37] Special start data instruction parameter setting value</p> | <p>The "instruction parameter" used with special start and indicated by the start data pointer currently being executed is stored. The stored value differs according to the value set for [Md.36].</p> <p><u>Refresh cycle: Immediate</u></p> | |
| <p>[Md.38] Start positioning data No. setting value</p> | <ul style="list-style-type: none"> • The "positioning data No." indicated by the start data pointer currently being executed is stored. <p><u>Refresh cycle: Immediate</u></p> | |

| Reading the monitor value | Default value | Buffer memory address | | | | | | | | | | | | |
|---|-----------------------|-----------------------|---------------|----------|------|------|----------------------|--------------------|---------|----|-----------------------|----------|---|-----------|
| <p>■ Monitoring is carried out with a decimal display.</p> <p>Monitor value </p> <p>● Storage value 1 to 1000 (%)</p> | 0 | 2426+100n | | | | | | | | | | | | |
| <p>■ Monitoring is carried out with a decimal display.</p> <p>Monitor value </p> <p>● Storage value 00: Block start (Normal start) 01: Condition start 02: Wait start 03: Simultaneous start 04: FOR loop 05: FOR condition 06: NEXT</p> | 0 | 2427+100n | | | | | | | | | | | | |
| <p>■ Monitoring is carried out with a decimal display.</p> <p>Monitor value </p> <p>● Storage value</p> <table border="1" data-bbox="539 1406 994 1675"> <thead> <tr> <th>Md.36 setting value</th> <th>Stored contents</th> <th>Storage value</th> </tr> </thead> <tbody> <tr> <td>00 06</td> <td>None</td> <td>None</td> </tr> <tr> <td>01 02 03 05</td> <td>Condition data No.</td> <td>1 to 10</td> </tr> <tr> <td>04</td> <td>Number of repetitions</td> <td>0 to 255</td> </tr> </tbody> </table> | Md.36 setting value | Stored contents | Storage value | 00 06 | None | None | 01 02 03 05 | Condition data No. | 1 to 10 | 04 | Number of repetitions | 0 to 255 | 0 | 2428+100n |
| Md.36 setting value | Stored contents | Storage value | | | | | | | | | | | | |
| 00 06 | None | None | | | | | | | | | | | | |
| 01 02 03 05 | Condition data No. | 1 to 10 | | | | | | | | | | | | |
| 04 | Number of repetitions | 0 to 255 | | | | | | | | | | | | |
| <p>■ Monitoring is carried out with a decimal display.</p> <p>Monitor value </p> <p>● Storage value 1 to 600, 9001 to 9003</p> | 0 | 2429+100n | | | | | | | | | | | | |

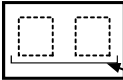

n: Axis No.-1

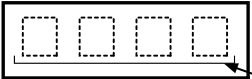
| Storage item | Storage details | |
|---|--|--|
| [Md.39] In speed limit flag | <ul style="list-style-type: none"> • If the speed exceeds the "[Pr.8] Speed limit value" ("[Pr.31] JOG speed limit value" at JOG operation control) due to a speed change or override, the speed limit functions, and the in speed limit flag turns ON. • When the speed drops to less than "[Pr.8] Speed limit value" ("[Pr.31] JOG speed limit value" at JOG operation control), or when the axis stops, the in speed limit flag turns OFF. <p><u>Refresh cycle: Immediate</u></p> | |
| [Md.40] In speed change processing flag | <ul style="list-style-type: none"> • The speed change process flag turns ON when the speed is changed during positioning control. • After the speed change process is completed or when deceleration starts with the stop signal during the speed change process, the in speed change process flag turns OFF. <p><u>Refresh cycle: Immediate</u></p> | |
| [Md.41] Special start repetition counter | <ul style="list-style-type: none"> • This area stores the remaining number of repetitions during "repetitions" specific to special starting. • The count is decremented by one (-1) at the loop end. • The control comes out of the loop when the count reaches "0". • This area stores "0" within an infinite loop. <p><u>Refresh cycle: Immediate</u></p> | |
| [Md.42] Control system repetition counter | <ul style="list-style-type: none"> • This area stores the remaining number of repetitions during "repetitions" specific to control system. • The count is decremented by one (-1) at the loop start. • The loop is terminated with the positioning data of the control method "LEND", after the counter becomes "0". <p><u>Refresh cycle: Immediate</u></p> | |
| [Md.43] Start data pointer being executed | <ul style="list-style-type: none"> • This area stores a point No. (1 to 50) attached to the start data currently being executed. • This area stores "0" after completion of a positioning operation. <p><u>Refresh cycle: Immediate</u></p> | |
| [Md.44] Positioning data No. being executed | <ul style="list-style-type: none"> • This area stores a positioning data No. attached to the positioning data currently being executed. • This area stores "0" when the JOG/inching operation is executed. <p><u>Refresh cycle: Immediate</u></p> | |
| [Md.45] Block No. being executed | <ul style="list-style-type: none"> • When the operation is controlled by "block start data", this area stores a block number (7000 to 7004) attached to the block currently being executed. • At other times, this area stores "0". <p><u>Refresh cycle: At start</u></p> | |

| Reading the monitor value | Default value | Buffer memory address |
|--|---------------|-----------------------|
| <p>■ Monitoring is carried out with a decimal display.</p> <p>Monitor value  ● Storage value 0: Not in speed limit (OFF) 1: In speed limit (ON)</p> | 0 | 2430+100n |
| <p>■ Monitoring is carried out with a decimal display.</p> <p>Monitor value  ● Storage value 0: Not in speed change (OFF) 1: In speed change (ON)</p> | 0 | 2431+100n |
| <p>■ Monitoring is carried out with a decimal display.</p> <p>Monitor value  ● Storage value 0 to 255</p> | 0 | 2432+100n |
| <p>■ Monitoring is carried out with a hexadecimal display.</p> <p>Monitor value  ● Storage value 0 to FFFF</p> | 0000H | 2433+100n |
| <p>■ Monitoring is carried out with a decimal display.</p> <p>Monitor value  ● Storage value 1 to 50</p> | 0 | 2434+100n |
| <p>■ Monitoring is carried out with a decimal display.</p> <p>Monitor value  ● Storage value 1 to 600, 9001 to 9003</p> | 0 | 2435+100n |
| <p>■ Monitoring is carried out with a decimal display.</p> <p>Monitor value  ● Storage value 7000 to 7004</p> | 0 | 2436+100n |

n: Axis No.-1

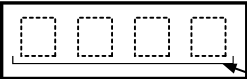
| Storage item | Storage details |
|--|---|
| [Md.46] Last executed positioning data No. | <ul style="list-style-type: none"> • This area stores the positioning data No. attached to the positioning data that was executed last time. • The value is retained until a new positioning operation is executed. • This area stores "0" when the JOG/inching operation is executed. <p><u>Refresh cycle: Immediate</u></p> |
| [Md.47] Positioning data being executed | <ul style="list-style-type: none"> • The addresses shown to the right store details of the positioning data currently being executed (positioning data No. given by [Md.44]). <p><u>Refresh cycle: Immediate</u></p> |
| [Md.48] Deceleration start flag | <ul style="list-style-type: none"> • "1" is stored when the constant speed status or acceleration status switches to the deceleration status during position control whose operation pattern is "Positioning complete". • "0" is stored at the next operation start or manual pulse generator operation enable. <p><u>Refresh cycle: Immediate</u></p> <p>POINT This parameter is possible to monitor when "[Cd.41] Deceleration start flag valid" is valid.</p> |

| Reading the monitor value | Default value | Buffer memory address | | | | | | | | | | | | | | | | | | | | | | | | | | | |
|--|--|-----------------------|-----------|-----------|------------------------|------------------|-----------|--|---------|-----------|--|--------|-----------|-------------------------|--------------------|-----------|---------------|--------|-----------|-----------|---------------------|--------|-----------|-----------|-------------|--------|-----------|---|------------------------|
| <p>■ Monitoring is carried out with a decimal display.</p> <p>Monitor value </p> <p>● Storage value 1 to 600, 9001 to 9003</p> | 0 | 2437+100n | | | | | | | | | | | | | | | | | | | | | | | | | | | |
| <p>Information is stored in the following addresses:</p> <table border="1" data-bbox="172 580 1003 1180"> <thead> <tr> <th>Stored address (Monitor value)</th> <th>Stored item</th> <th>Reference</th> </tr> </thead> <tbody> <tr> <td>2438+100n</td> <td>Positioning identifier</td> <td>[Da.1] to [Da.4]</td> </tr> <tr> <td>2439+100n</td> <td>M code/Condition data No./Number of LOOP to LEND repetitions</td> <td>[Da.10]</td> </tr> <tr> <td>2440+100n</td> <td>Dwell time/JUMP destination positioning data No.</td> <td>[Da.9]</td> </tr> <tr> <td>2441+100n</td> <td>Axis to be interpolated</td> <td>[Da.20] to [Da.22]</td> </tr> <tr> <td>2442+100n</td> <td rowspan="2">Command speed</td> <td rowspan="2">[Da.8]</td> </tr> <tr> <td>2443+100n</td> </tr> <tr> <td>2444+100n</td> <td rowspan="2">Positioning address</td> <td rowspan="2">[Da.6]</td> </tr> <tr> <td>2445+100n</td> </tr> <tr> <td>2446+100n</td> <td rowspan="2">Arc address</td> <td rowspan="2">[Da.7]</td> </tr> <tr> <td>2447+100n</td> </tr> </tbody> </table> | Stored address (Monitor value) | Stored item | Reference | 2438+100n | Positioning identifier | [Da.1] to [Da.4] | 2439+100n | M code/Condition data No./Number of LOOP to LEND repetitions | [Da.10] | 2440+100n | Dwell time/JUMP destination positioning data No. | [Da.9] | 2441+100n | Axis to be interpolated | [Da.20] to [Da.22] | 2442+100n | Command speed | [Da.8] | 2443+100n | 2444+100n | Positioning address | [Da.6] | 2445+100n | 2446+100n | Arc address | [Da.7] | 2447+100n | 0 | 2438+100n to 2447+100n |
| Stored address (Monitor value) | Stored item | Reference | | | | | | | | | | | | | | | | | | | | | | | | | | | |
| 2438+100n | Positioning identifier | [Da.1] to [Da.4] | | | | | | | | | | | | | | | | | | | | | | | | | | | |
| 2439+100n | M code/Condition data No./Number of LOOP to LEND repetitions | [Da.10] | | | | | | | | | | | | | | | | | | | | | | | | | | | |
| 2440+100n | Dwell time/JUMP destination positioning data No. | [Da.9] | | | | | | | | | | | | | | | | | | | | | | | | | | | |
| 2441+100n | Axis to be interpolated | [Da.20] to [Da.22] | | | | | | | | | | | | | | | | | | | | | | | | | | | |
| 2442+100n | Command speed | [Da.8] | | | | | | | | | | | | | | | | | | | | | | | | | | | |
| 2443+100n | | | | | | | | | | | | | | | | | | | | | | | | | | | | | |
| 2444+100n | Positioning address | [Da.6] | | | | | | | | | | | | | | | | | | | | | | | | | | | |
| 2445+100n | | | | | | | | | | | | | | | | | | | | | | | | | | | | | |
| 2446+100n | Arc address | [Da.7] | | | | | | | | | | | | | | | | | | | | | | | | | | | |
| 2447+100n | | | | | | | | | | | | | | | | | | | | | | | | | | | | | |
| <p>■ Monitoring is carried out with a decimal display.</p> <p>Monitor value </p> <p>● Storage value 0: Status other than below 1: Status from deceleration start to next operation start or manual pulse generator operation enable</p> | 0 | 2499+100n | | | | | | | | | | | | | | | | | | | | | | | | | | | |

n: Axis No.-1

| Storage item | Storage details | |
|--|---|--|
| [Md.100] HPR re-travel value [RJ010 mode] | <ul style="list-style-type: none"> This area stores the travel distance during the HPR travel to the zero point that was executed last time. "0" is stored at machine HPR start. For setting units Example) mm (Buffer memory \times 0.1) μ m <u>Refresh cycle: At HPR re-movement</u> | |
| [Md.101] Real current value | <ul style="list-style-type: none"> This area stores the current value (feed current value – deviation counter droop pulses). Example) mm (Buffer memory \times 0.1) μ m <u>Refresh cycle: Operation cycle</u> | |
| [Md.102] Deviation counter value | <ul style="list-style-type: none"> This area stores the droop pulse. (Buffer memory details) PLS <u>Refresh cycle: Operation cycle</u> | |
| [Md.103] Motor rotation speed | <ul style="list-style-type: none"> This area stores the motor speed updated in real time. (Buffer memory \times 0.1) r/min *1 *1: The unit is mm/s at linear servo use. <u>Refresh cycle: Operation cycle</u> | |
| [Md.104] Motor current value | <ul style="list-style-type: none"> This area stores the present motor current value of the motor. (Buffer memory \times 0.1) % <u>Refresh cycle: Operation cycle</u> | |



| Reading the monitor value | Default value | Buffer memory address | | | | | | | | | | | | | | | | | | |
|---|---------------|------------------------|----|---------------|----|-----------|----|--------|---|-----|---|------|---|-----|---|------|----|-----------|-------|------------------------|
| <p>■ Monitoring is carried out with a hexadecimal display.</p> <p>Low-order buffer memory Example) 2448 b15 b12 b8 b4 b0 E F G H</p> <p>High-order buffer memory Example) 2449 b31 b28 b24 b20 b16 A B C D</p> <p>Monitor value E F G H A B C D</p> <p>◇ Sorting</p> <p>(High-order buffer memory) (Low-order buffer memory) A B C D E F G H</p> <p>◇ Converted from hexadecimal to decimal</p> <p>Decimal integer value R</p> <p>◇ Unit conversion $R \times 10^m$</p> <p>Actual value [Md.100] HPR re-travel value [Md.101] Real current value [Md.102] Deviation counter value [Md.103] Motor rotation speed</p> <ul style="list-style-type: none"> Unit conversion table ([Md.100] [Md.101]) <table border="1"> <thead> <tr> <th>m</th> <th>Unit</th> </tr> </thead> <tbody> <tr> <td>-1</td> <td>μm</td> </tr> <tr> <td>-5</td> <td>inch</td> </tr> <tr> <td>-5</td> <td>degree</td> </tr> <tr> <td>0</td> <td>PLS</td> </tr> </tbody> </table> Unit conversion table ([Md.102]) <table border="1"> <thead> <tr> <th>m</th> <th>Unit</th> </tr> </thead> <tbody> <tr> <td>0</td> <td>PLS</td> </tr> </tbody> </table> Unit conversion table ([Md.103]) <table border="1"> <thead> <tr> <th>m</th> <th>Unit</th> </tr> </thead> <tbody> <tr> <td>-1</td> <td>r/min * 1</td> </tr> </tbody> </table> | m | Unit | -1 | μm | -5 | inch | -5 | degree | 0 | PLS | m | Unit | 0 | PLS | m | Unit | -1 | r/min * 1 | 0000H | 2448+100n 2449+100n |
| m | Unit | | | | | | | | | | | | | | | | | | | |
| -1 | μm | | | | | | | | | | | | | | | | | | | |
| -5 | inch | | | | | | | | | | | | | | | | | | | |
| -5 | degree | | | | | | | | | | | | | | | | | | | |
| 0 | PLS | | | | | | | | | | | | | | | | | | | |
| m | Unit | | | | | | | | | | | | | | | | | | | |
| 0 | PLS | | | | | | | | | | | | | | | | | | | |
| m | Unit | | | | | | | | | | | | | | | | | | | |
| -1 | r/min * 1 | | | | | | | | | | | | | | | | | | | |
| | 0000H | 2450+100n 2451+100n | | | | | | | | | | | | | | | | | | |
| | 0000H | 2452+100n 2453+100n | | | | | | | | | | | | | | | | | | |
| | 0000H | 2454+100n 2455+100n | | | | | | | | | | | | | | | | | | |
| <p>■ Monitoring is carried out with a decimal display.</p> <p>Decimal integer value R</p> <p>◇ Converted from hexadecimal to decimal</p> <p>◇ Unit conversion $R \times 10^m$</p> <p>Actual value [Md.104] Motor current value</p> <ul style="list-style-type: none"> Unit conversion table ([Md.104]) <table border="1"> <thead> <tr> <th>m</th> <th>Unit</th> </tr> </thead> <tbody> <tr> <td>-1</td> <td>%</td> </tr> </tbody> </table> | m | Unit | -1 | % | 0 | 2456+100n | | | | | | | | | | | | | | |
| m | Unit | | | | | | | | | | | | | | | | | | | |
| -1 | % | | | | | | | | | | | | | | | | | | | |

n: Axis No.-1

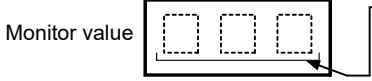
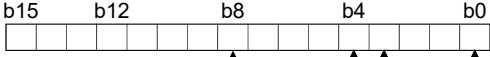
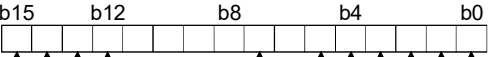
| Storage item | Storage details |
|------------------------------|---|
| [Md.107] Parameter error No. | <ul style="list-style-type: none"> • When a servo parameter error occurs, the area that corresponds to the parameter number affected by the error comes ON. • When the "[Cd.5] Axis error reset" (axis control data) is set to ON after remove the error factor of servo amplifier side, the servo alarm is cleared (set to 0). <p><u>Refresh cycle: Immediate</u></p> |
| [Md.108] Servo status | <p>This area stores the servo status.</p> <ul style="list-style-type: none"> • Zero point pass Turns ON if the zero point of the encoder has been passed even once. • Zero speed Turns ON when the motor speed is lower than the servo parameter "zero speed." • Speed limit Turns ON during the speed limit in torque control mode. • PID control Turns ON when the servo amplifier is PID control. • READY ON Indicates the ready ON/OFF. • Servo ON Indicates the servo ON/OFF. • Control mode Indicates the control mode of the servo amplifier. [CiA402 mode] Stores "Position control mode" when the status of the control mode of the servo amplifier is other than CSV and CST. • Gain switching Turns ON during the gain switching. • Fully closed loop control switching Turns ON during the fully closed loop control. • Servo alarm Turns ON during the servo alarm. • In-position The dwell pulse turns ON within the servo parameter "in-position". • Torque limit Turns ON when the servo amplifier is having the torque restricted. • Absolute position lost Turns ON when the servo amplifier is lost the absolute position. • Servo warning Turns ON during the servo warning. <p><u>Refresh cycle: Operation cycle</u></p> |

| Reading the monitor value | Default value | Buffer memory address | | | | | | | | | | | | | | | | | | | | | | | | | | | | | | | | | | | |
|---|-------------------------------------|-----------------------|---------|-----------------|-----------|--------------|------------|---------------|------------|--------------|----------------|--------------|-------------------------------------|--------------|-------------|--------------|-------------|--------------|--------------|--------------|------------------------|-----------|---------------|----|----|--------------|---|---|-----------------------|---|---|--------------------|---|---|---------------------|-------|-----------|
| <p>■ Monitoring is carried out with a decimal display.</p>  <p>● Storage value</p> <table border="1" data-bbox="652 450 920 752"> <thead> <tr> <th>Storage value</th> <th>Parameter No.</th> </tr> </thead> <tbody> <tr><td>1 to 64</td><td>PA01 to PA64</td></tr> <tr><td>64 to 128</td><td>PB01 to PB64</td></tr> <tr><td>129 to 192</td><td>PC01 to PC64</td></tr> <tr><td>193 to 256</td><td>PD01 to PD64</td></tr> <tr><td>257 to 320</td><td>PE01 to PE64</td></tr> <tr><td>321 to 384</td><td>PF01 to PF64</td></tr> <tr><td>385 to 448</td><td>Po01 to Po64</td></tr> <tr><td>449 to 512</td><td>PS01 to PS64</td></tr> <tr><td>513 to 576</td><td>PL01 to PL64</td></tr> </tbody> </table> | Storage value | Parameter No. | 1 to 64 | PA01 to PA64 | 64 to 128 | PB01 to PB64 | 129 to 192 | PC01 to PC64 | 193 to 256 | PD01 to PD64 | 257 to 320 | PE01 to PE64 | 321 to 384 | PF01 to PF64 | 385 to 448 | Po01 to Po64 | 449 to 512 | PS01 to PS64 | 513 to 576 | PL01 to PL64 | 0 | 2470+100n | | | | | | | | | | | | | | | |
| Storage value | Parameter No. | | | | | | | | | | | | | | | | | | | | | | | | | | | | | | | | | | | | |
| 1 to 64 | PA01 to PA64 | | | | | | | | | | | | | | | | | | | | | | | | | | | | | | | | | | | | |
| 64 to 128 | PB01 to PB64 | | | | | | | | | | | | | | | | | | | | | | | | | | | | | | | | | | | | |
| 129 to 192 | PC01 to PC64 | | | | | | | | | | | | | | | | | | | | | | | | | | | | | | | | | | | | |
| 193 to 256 | PD01 to PD64 | | | | | | | | | | | | | | | | | | | | | | | | | | | | | | | | | | | | |
| 257 to 320 | PE01 to PE64 | | | | | | | | | | | | | | | | | | | | | | | | | | | | | | | | | | | | |
| 321 to 384 | PF01 to PF64 | | | | | | | | | | | | | | | | | | | | | | | | | | | | | | | | | | | | |
| 385 to 448 | Po01 to Po64 | | | | | | | | | | | | | | | | | | | | | | | | | | | | | | | | | | | | |
| 449 to 512 | PS01 to PS64 | | | | | | | | | | | | | | | | | | | | | | | | | | | | | | | | | | | | |
| 513 to 576 | PL01 to PL64 | | | | | | | | | | | | | | | | | | | | | | | | | | | | | | | | | | | | |
| <p>■ Monitoring is carried out with a hexadecimal display.</p>  <table border="1" data-bbox="657 958 1010 1115"> <thead> <tr> <th>Stored items</th> <th>Meaning</th> </tr> </thead> <tbody> <tr><td>b0</td><td>Zero point pass</td></tr> <tr><td>b3</td><td>Zero speed</td></tr> <tr><td>b4</td><td>Speed limit</td></tr> <tr><td>b8</td><td>PID control</td></tr> </tbody> </table> | Stored items | Meaning | b0 | Zero point pass | b3 | Zero speed | b4 | Speed limit | b8 | PID control | 0000H | 2476+100n | | | | | | | | | | | | | | | | | | | | | | | | | |
| Stored items | Meaning | | | | | | | | | | | | | | | | | | | | | | | | | | | | | | | | | | | | |
| b0 | Zero point pass | | | | | | | | | | | | | | | | | | | | | | | | | | | | | | | | | | | | |
| b3 | Zero speed | | | | | | | | | | | | | | | | | | | | | | | | | | | | | | | | | | | | |
| b4 | Speed limit | | | | | | | | | | | | | | | | | | | | | | | | | | | | | | | | | | | | |
| b8 | PID control | | | | | | | | | | | | | | | | | | | | | | | | | | | | | | | | | | | | |
| <p>■ Monitoring is carried out with a hexadecimal display.</p>  <table border="1" data-bbox="657 1279 1010 1671"> <thead> <tr> <th>Stored items</th> <th>Meaning</th> </tr> </thead> <tbody> <tr><td>b0</td><td>READY ON</td></tr> <tr><td>b1</td><td>Servo ON</td></tr> <tr><td>b2</td><td rowspan="2">Control mode*</td></tr> <tr><td>b3</td></tr> <tr><td>b4</td><td>Gain switching</td></tr> <tr><td>b5</td><td>Fully closed loop control switching</td></tr> <tr><td>b7</td><td>Servo alarm</td></tr> <tr><td>b12</td><td>In-position</td></tr> <tr><td>b13</td><td>Torque limit</td></tr> <tr><td>b14</td><td>Absolute position lost</td></tr> <tr><td>b15</td><td>Servo warning</td></tr> </tbody> </table> <p>*: Control mode</p> <table border="1" data-bbox="715 1704 1010 1827"> <thead> <tr> <th>b2</th> <th>b3</th> <th>Control mode</th> </tr> </thead> <tbody> <tr><td>0</td><td>0</td><td>Position control mode</td></tr> <tr><td>1</td><td>0</td><td>Speed control mode</td></tr> <tr><td>0</td><td>1</td><td>Torque control mode</td></tr> </tbody> </table> <p>POINT</p> <p>(1) When the forced stop of controller and servo amplifier occurs, the servo warning is turned ON. When the forced stop is reset, the servo warning is turned OFF.</p> | Stored items | Meaning | b0 | READY ON | b1 | Servo ON | b2 | Control mode* | b3 | b4 | Gain switching | b5 | Fully closed loop control switching | b7 | Servo alarm | b12 | In-position | b13 | Torque limit | b14 | Absolute position lost | b15 | Servo warning | b2 | b3 | Control mode | 0 | 0 | Position control mode | 1 | 0 | Speed control mode | 0 | 1 | Torque control mode | 0000H | 2477+100n |
| Stored items | Meaning | | | | | | | | | | | | | | | | | | | | | | | | | | | | | | | | | | | | |
| b0 | READY ON | | | | | | | | | | | | | | | | | | | | | | | | | | | | | | | | | | | | |
| b1 | Servo ON | | | | | | | | | | | | | | | | | | | | | | | | | | | | | | | | | | | | |
| b2 | Control mode* | | | | | | | | | | | | | | | | | | | | | | | | | | | | | | | | | | | | |
| b3 | | | | | | | | | | | | | | | | | | | | | | | | | | | | | | | | | | | | | |
| b4 | Gain switching | | | | | | | | | | | | | | | | | | | | | | | | | | | | | | | | | | | | |
| b5 | Fully closed loop control switching | | | | | | | | | | | | | | | | | | | | | | | | | | | | | | | | | | | | |
| b7 | Servo alarm | | | | | | | | | | | | | | | | | | | | | | | | | | | | | | | | | | | | |
| b12 | In-position | | | | | | | | | | | | | | | | | | | | | | | | | | | | | | | | | | | | |
| b13 | Torque limit | | | | | | | | | | | | | | | | | | | | | | | | | | | | | | | | | | | | |
| b14 | Absolute position lost | | | | | | | | | | | | | | | | | | | | | | | | | | | | | | | | | | | | |
| b15 | Servo warning | | | | | | | | | | | | | | | | | | | | | | | | | | | | | | | | | | | | |
| b2 | b3 | Control mode | | | | | | | | | | | | | | | | | | | | | | | | | | | | | | | | | | | |
| 0 | 0 | Position control mode | | | | | | | | | | | | | | | | | | | | | | | | | | | | | | | | | | | |
| 1 | 0 | Speed control mode | | | | | | | | | | | | | | | | | | | | | | | | | | | | | | | | | | | |
| 0 | 1 | Torque control mode | | | | | | | | | | | | | | | | | | | | | | | | | | | | | | | | | | | |

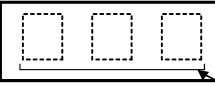
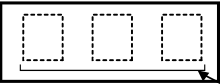
| Storage item | Storage details |
|--|--|
| [Md.109] Regenerative load ratio | <ul style="list-style-type: none"> • The rate of regenerative power to the allowable regenerative power is indicated as a percentage. • When the regenerative option is used, the rate to the allowable regenerative power of the option is indicated. (Buffer memory) % <p><u>Refresh cycle: Operation cycle</u></p> |
| [Md.110] Effective load torque | <ul style="list-style-type: none"> • The continuous effective load current is indicated. • The effective value for the past 15 seconds is indicated as a percentage, rated current being 100%. (Buffer memory) % <p><u>Refresh cycle: Operation cycle</u></p> |
| [Md.111] Peak torque ratio | <ul style="list-style-type: none"> • The maximum torque is indicated. (Holding value) • The peak values for the past 15 seconds are indicated, rated torque being 100%. (Buffer memory) % <p><u>Refresh cycle: Operation cycle</u></p> |
| [Md.113] Semi/Fully closed loop status | <ul style="list-style-type: none"> • The switching status of semi closed loop control/fully closed loop control is indicated. <p><u>Refresh cycle: Operation cycle</u></p> |
| [Md.114] Servo alarm | <ul style="list-style-type: none"> • This area stores the servo alarm code and servo warning code of servo amplifier. • When the "[Cd.5] Axis error reset" (axis control data) is set to ON after remove the error factor of servo amplifier side, the servo alarm is cleared (set to 0). <p><u>Refresh cycle: Immediate</u></p> |

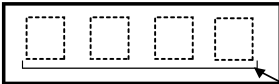
| | Reading the monitor value | Default value | Buffer memory address |
|--|---|---------------|-----------------------|
| | <p>■ Monitoring is carried out with a decimal display.</p> <p>Monitor value  Regenerative load ratio</p> | 0 | 2478+100n |
| | <p>■ Monitoring is carried out with a decimal display.</p> <p>Monitor value  Effective load torque ratio</p> | 0 | 2479+100n |
| | <p>■ Monitoring is carried out with a decimal display.</p> <p>Monitor value  Peek torque ratio</p> | 0 | 2480+100n |
| | <p>■ Monitoring is carried out with a decimal display.</p> <p>Monitor value  <ul style="list-style-type: none"> ● Semi/Fully closed loop status 0: In semi closed loop control 1: In fully closed loop control </p> | 0 | 2487+100n |
| | <p>■ Monitoring is carried out with a hexadecimal display.</p> <p>Monitor value  <ul style="list-style-type: none"> ● Servo alarm code ● Servo warning code </p> | 0000H | 2488+100n |

n: Axis No.-1

| Storage item | Storage details | |
|---|--|--|
| <p>[Md.117] Statusword [CiA402 mode]</p> | <ul style="list-style-type: none"> This area stores the Statusword. <p><u>Refresh cycle: Operation cycle</u></p> | |
| <p>[Md.120] Reverse torque limit stored value</p> | <p>[RJ010 mode] "[Pr.17] Torque limit setting value", "[Cd.101] Torque output setting value", "[Cd.113] New reverse torque value" or "[Pr.54] HPR torque limit value" is stored.</p> <p>[CiA402 mode] "[Pr.17] Torque limit setting value", "[Cd.101] Torque output setting value" or "[Cd.113] New reverse torque value" is stored.</p> <ul style="list-style-type: none"> At the positioning start/JOG operation start/ manual pulse generator operation : The "[Pr.17] Torque limit setting value" or "[Cd.101] Torque output setting value" is stored. When a value is set in "[Cd.22] New torque value/forward new torque value" or "[Cd.113] New reverse torque value" during operation. : "[Cd.22] New torque value/forward new torque value" is stored when "0" is set in "[Cd.112] Torque change function switching request". "[Cd.113] New reverse torque value" is stored when "1" is set in "[Cd.112] Torque change function switching request". At the HPR : "[Pr.17] Torque limit setting value" or "[Cd.101] Torque output setting value" is stored. However, "[Pr.54] HPR torque limit value" is stored after it reach to "[Pr.47] Creep speed" completion. [RJ010 mode] <p><u>Refresh cycle: Immediate</u></p> | |

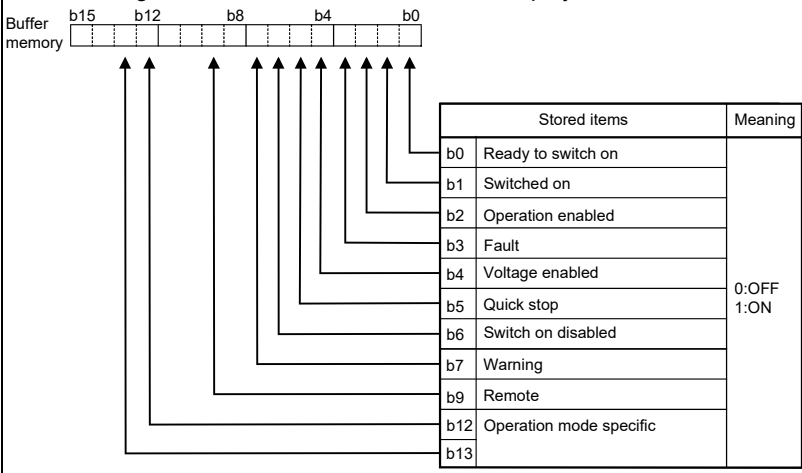
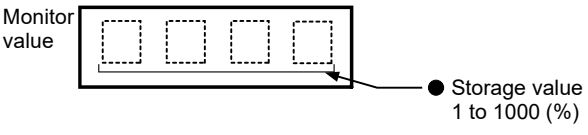
| Reading the monitor value | Default value | Buffer memory address | | | | | | | | | | | | | | | | | | | | | | | | |
|---|-------------------------|-----------------------|----|--------------------|----|-------------|----|-------------------|----|-------|----|-----------------|----|------------|----|--------------------|----|---------|----|--------|-----|-------------------------|-----|--|-------|-----------|
| <p>■ Monitoring is carried out with a hexadecimal display.</p>  <table border="1" data-bbox="592 448 957 817"> <thead> <tr> <th>Stored items</th> <th>Meaning</th> </tr> </thead> <tbody> <tr> <td>b0</td> <td>Ready to switch on</td> </tr> <tr> <td>b1</td> <td>Switched on</td> </tr> <tr> <td>b2</td> <td>Operation enabled</td> </tr> <tr> <td>b3</td> <td>Fault</td> </tr> <tr> <td>b4</td> <td>Voltage enabled</td> </tr> <tr> <td>b5</td> <td>Quick stop</td> </tr> <tr> <td>b6</td> <td>Switch on disabled</td> </tr> <tr> <td>b7</td> <td>Warning</td> </tr> <tr> <td>b9</td> <td>Remote</td> </tr> <tr> <td>b12</td> <td>Operation mode specific</td> </tr> <tr> <td>b13</td> <td></td> </tr> </tbody> </table> <p>0:OFF 1:ON</p> | Stored items | Meaning | b0 | Ready to switch on | b1 | Switched on | b2 | Operation enabled | b3 | Fault | b4 | Voltage enabled | b5 | Quick stop | b6 | Switch on disabled | b7 | Warning | b9 | Remote | b12 | Operation mode specific | b13 | | 0000H | 2482+100n |
| Stored items | Meaning | | | | | | | | | | | | | | | | | | | | | | | | | |
| b0 | Ready to switch on | | | | | | | | | | | | | | | | | | | | | | | | | |
| b1 | Switched on | | | | | | | | | | | | | | | | | | | | | | | | | |
| b2 | Operation enabled | | | | | | | | | | | | | | | | | | | | | | | | | |
| b3 | Fault | | | | | | | | | | | | | | | | | | | | | | | | | |
| b4 | Voltage enabled | | | | | | | | | | | | | | | | | | | | | | | | | |
| b5 | Quick stop | | | | | | | | | | | | | | | | | | | | | | | | | |
| b6 | Switch on disabled | | | | | | | | | | | | | | | | | | | | | | | | | |
| b7 | Warning | | | | | | | | | | | | | | | | | | | | | | | | | |
| b9 | Remote | | | | | | | | | | | | | | | | | | | | | | | | | |
| b12 | Operation mode specific | | | | | | | | | | | | | | | | | | | | | | | | | |
| b13 | | | | | | | | | | | | | | | | | | | | | | | | | | |
| <p>■ Monitoring is carried out with a decimal display.</p>  <p>Storage value 1 to 1000 (%)</p> | 0 | 2491+100n | | | | | | | | | | | | | | | | | | | | | | | | |

n: Axis No.-1

| Storage item | Storage details | |
|--|--|--|
| [Md.122] Speed during command | <ul style="list-style-type: none"> • This area stores the command speed during speed control mode. • "0" is stored other than during speed control mode. <p><u>Refresh cycle: Operation cycle (Speed control mode only)</u></p> | |
| [Md.123] Torque during command | <ul style="list-style-type: none"> • This area stores the command torque during torque control mode. (Buffer memory × 0.1)% • "0" is stored other than during torque control mode. <p><u>Refresh cycle: Operation cycle (Torque control mode only)</u></p> | |
| [Md.514] HPR operating status [CiA402 mode] | <ul style="list-style-type: none"> • This area stores the HPR operating status. <p><u>Refresh cycle: Operation cycle</u></p> | |

| | Reading the monitor value | Default value | Buffer memory address | | | | | | | | | | | | | | | | | | |
|---|---|----------------------|-----------------------|---|---|---------------------------------|-------|--|--------|---|----------|--|------------|--|-------|--------------------------------------|-------|-----------|---|---|------------------------|
| <p>■ Monitoring is carried out with a decimal display.</p> <p>Monitor value R</p> <p>◇ Unit conversion $R \times 10^m$</p> <p>Actual value</p> <table border="1"> <tr> <td>[Md.122]</td> <td>Speed during command</td> </tr> <tr> <td>[Md.123]</td> <td>Torque during command</td> </tr> </table> | [Md.122] | Speed during command | [Md.123] | Torque during command | <p>● Unit conversion table (Md.122)</p> <table border="1"> <thead> <tr> <th>m</th> <th>Unit</th> </tr> </thead> <tbody> <tr> <td>-2</td> <td>mm/min</td> </tr> <tr> <td>-3</td> <td>inch/min</td> </tr> <tr> <td>-3*</td> <td>degree/min</td> </tr> <tr> <td>0</td> <td>PLS/s</td> </tr> </tbody> </table> <p>* : When "[Pr.83] Speed control 10 x multiplier setting for degree axis" is valid: "-2"</p> <p>● Unit conversion table (Md.123)</p> <table border="1"> <thead> <tr> <th>m</th> <th>Unit</th> </tr> </thead> <tbody> <tr> <td>-1</td> <td>%</td> </tr> </tbody> </table> | m | Unit | -2 | mm/min | -3 | inch/min | -3* | degree/min | 0 | PLS/s | m | Unit | -1 | % | 0 | 2492+100n 2493+100n |
| | [Md.122] | Speed during command | | | | | | | | | | | | | | | | | | | |
| [Md.123] | Torque during command | | | | | | | | | | | | | | | | | | | | |
| m | Unit | | | | | | | | | | | | | | | | | | | | |
| -2 | mm/min | | | | | | | | | | | | | | | | | | | | |
| -3 | inch/min | | | | | | | | | | | | | | | | | | | | |
| -3* | degree/min | | | | | | | | | | | | | | | | | | | | |
| 0 | PLS/s | | | | | | | | | | | | | | | | | | | | |
| m | Unit | | | | | | | | | | | | | | | | | | | | |
| -1 | % | | | | | | | | | | | | | | | | | | | | |
| <p>■ Monitoring is carried out with a hexadecimal display.</p> <p>Monitor value</p>  <p>● Storage value</p> <table border="1"> <thead> <tr> <th>Storage value</th> <th>Status</th> </tr> </thead> <tbody> <tr> <td>FFFFH</td> <td>The servo amplifier is not set to the home position return mode</td> </tr> <tr> <td>0000H</td> <td>Homing procedure is in progress</td> </tr> <tr> <td>0001H</td> <td>Homing procedure is interrupted or not started</td> </tr> <tr> <td>0002H</td> <td>Homing is attained, but target is not reached</td> </tr> <tr> <td>0003H</td> <td>Homing procedure is completed successfully</td> </tr> <tr> <td>0004H</td> <td>Homing error occurred, velocity is not 0</td> </tr> <tr> <td>0005H</td> <td>Homing error occurred, velocity is 0</td> </tr> </tbody> </table> <p>● When a virtual servo amplifier is used, "FFFFH" is always stored.</p> | Storage value | Status | FFFFH | The servo amplifier is not set to the home position return mode | 0000H | Homing procedure is in progress | 0001H | Homing procedure is interrupted or not started | 0002H | Homing is attained, but target is not reached | 0003H | Homing procedure is completed successfully | 0004H | Homing error occurred, velocity is not 0 | 0005H | Homing error occurred, velocity is 0 | FFFFH | 2457+100n | | | |
| | Storage value | Status | | | | | | | | | | | | | | | | | | | |
| FFFFH | The servo amplifier is not set to the home position return mode | | | | | | | | | | | | | | | | | | | | |
| 0000H | Homing procedure is in progress | | | | | | | | | | | | | | | | | | | | |
| 0001H | Homing procedure is interrupted or not started | | | | | | | | | | | | | | | | | | | | |
| 0002H | Homing is attained, but target is not reached | | | | | | | | | | | | | | | | | | | | |
| 0003H | Homing procedure is completed successfully | | | | | | | | | | | | | | | | | | | | |
| 0004H | Homing error occurred, velocity is not 0 | | | | | | | | | | | | | | | | | | | | |
| 0005H | Homing error occurred, velocity is 0 | | | | | | | | | | | | | | | | | | | | |

n: Axis No.-1

5.7 List of control data

The setting items of the control data are explained in this section.

- Guide to buffer memory address

In the buffer memory address, "n" in "4303+100n", etc. indicates a value corresponding to axis No. such as the following table.

| Axis No. | n | Axis No. | n | Axis No. | n | Axis No. | n |
|----------|---|----------|---|----------|----|----------|----|
| 1 | 0 | 5 | 4 | 9 | 8 | 13 | 12 |
| 2 | 1 | 6 | 5 | 10 | 9 | 14 | 13 |
| 3 | 2 | 7 | 6 | 11 | 10 | 15 | 14 |
| 4 | 3 | 8 | 7 | 12 | 11 | 16 | 15 |

(Note-1): Calculate as follows for the buffer memory address corresponding to each axis.

(Example) For axis No. 16

$$4303+100n \text{ ([Cd.6] Restart command)} = 4303+100 \times 15 = 5803$$

5.7.1 System control data

| Setting item | Setting details |
|---|---|
| [Cd.1] Flash ROM write request | <ul style="list-style-type: none"> • Writes not only "positioning data (No.1 to 600)" and "block start data (No.7000 to 7004)" stored in the buffer memory/internal memory area, but also "parameters" and "servo parameters" to the flash ROM/internal memory (nonvolatile). <p>Fetch cycle: 103 [ms] [RJ010 mode] 116 [ms] [CiA402 mode]</p> <p>POINT</p> <p>(1) Do not turn the power OFF or reset the PLC CPU while writing to the flash ROM. If the power is turned OFF or the PLC CPU is reset to forcibly end the process, the data backed up in the flash ROM will be lost.</p> <p>(2) Do not write the data to the buffer memory before writing to the flash ROM is completed.</p> <p>(3) The number of writes to the flash ROM with the sequence program is 25 max. while the power is turned ON. Writing to the flash ROM beyond 25 times will cause the error "Flash ROM write number error" (error code: 805). Refer to Section 16.4 "List of errors" for details.</p> <p>(4) Monitoring is the number of writes to the flash ROM after the power is switched ON by the "[Md.19] Number of write accesses to flash ROM".</p> |
| [Cd.2] Parameter initialization request | <ul style="list-style-type: none"> • Requests initialization of setting data. Refer to Section 14.2 for initialized setting data. Initialization: Resetting of setting data to default values <p>Fetch cycle: 103 [ms] [RJ010 mode] 116 [ms] [CiA402 mode]</p> <p>Note: After completing the initialization of setting data, switch the power ON or reset the PLC CPU.</p> |

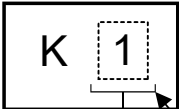
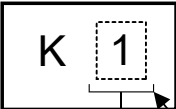
| | Setting value | Default value | Buffer memory address |
|---|---------------|---------------|-----------------------|
| <p>■ Set with a decimal.</p> <p>Setting value</p>  <p>● Flash ROM write request 1: Requests write access to flash ROM.</p> <p>The Simple Motion module resets the value to "0" automatically when the write access completes. (This indicates the completion of write operation.)</p> | | 0 | 5900 |
| <p>■ Set with a decimal.</p> <p>Setting value</p>  <p>● Parameter initialization request 1: Requests parameter initialization.</p> <p>The Simple Motion module resets the value to "0" automatically when the initialization completes. (This indicates the completion of parameter initialization.)</p> | | 0 | 5901 |

| Setting item | Setting details | |
|---|---|--|
| [Cd.41] Deceleration start flag valid | <ul style="list-style-type: none"> • Set whether "[Md.48] Deceleration start flag" is made valid or invalid. <p><u>Fetch cycle: At PLC READY ON</u></p> <p><input type="checkbox"/> POINT</p> <p>The "[Cd.41] Deceleration start flag valid" become valid when the PLC READY signal [Y0] turns from OFF to ON.</p> | |
| [Cd.42] Stop command processing for deceleration stop selection | <ul style="list-style-type: none"> • Set the stop command processing for deceleration stop function (deceleration curve re-processing/deceleration curve continuation). <p><u>Fetch cycle: At deceleration stop causes occurrence</u></p> | |
| [Cd.44] External input signal operation device (Axis 1 to 16) | <ul style="list-style-type: none"> • Operate the stop signal input status of QD77GF when "1" is set in "[Pr.80] External input signal selection". • Operate the external input signal status (Upper/lower limit signal, proximity dog signal, stop signal) of QD77GF when "2" is set in "[Pr.80] External input signal selection". <p><u>Fetch cycle: Operation cycle</u></p> | |

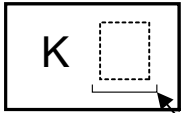
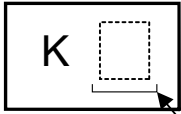
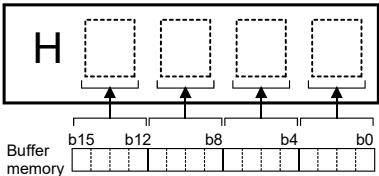
| | Setting value | Default value | Buffer memory address | | | | | | | | | | | | | | | | | | | | | | | | | | | | | | | | | | | | | | | | | | | | | | | | | | | | | | | | | | | | | | | | | | | | | | | | | | | | | | | | | | | | | | | | | | | | | | | | | | | | | | | | | | | | | | | | | | | | | | | | | | | | | | | | | | | | | | | | | | | | | | | | | | | | | | | | | | | | | | | | | | | | | | | | | | | | | | | | | | | | | | | | | | | | | | | | | | | | | | | | | | | | |
|---|---|------------------------------------|-----------------------|---------------|---------|------|----|---------------------------------|---|----|---------------------------------|---|----|-----------------------------------|---|----|---------------------------|---|----|---------------------------------|---|----|---------------------------------|---|----|-----------------------------------|---|----|---------------------------|---|----|---------------------------------|---|----|---------------------------------|---|-----|-----------------------------------|---|-----|---------------------------|---|-----|---------------------------------|---|-----|---------------------------------|---|-----|-----------------------------------|---|-----|---------------------------|---|------|----|---------------------------------|---|----|---------------------------------|---|----|-----------------------------------|---|----|---------------------------|---|----|---------------------------------|---|----|---------------------------------|---|----|-----------------------------------|---|----|---------------------------|---|----|---------------------------------|---|----|---------------------------------|---|-----|-----------------------------------|---|-----|---------------------------|---|-----|---------------------------------|---|-----|---------------------------------|---|-----|-----------------------------------|---|-----|---------------------------|---|---------------|---------------|---------------|---------|------|----|---------------------------------|---|----|---------------------------------|---|----|-----------------------------------|---|----|---------------------------|---|----|----------------------------------|---|----|----------------------------------|---|----|------------------------------------|---|----|----------------------------|---|----|----------------------------------|---|----|----------------------------------|---|-----|------------------------------------|---|-----|----------------------------|---|-----|----------------------------------|---|-----|----------------------------------|---|-----|------------------------------------|---|-----|----------------------------|---|------|----|----------------------------------|---|----|----------------------------------|---|----|------------------------------------|---|----|----------------------------|---|----|----------------------------------|---|----|----------------------------------|---|----|------------------------------------|---|----|----------------------------|---|----|----------------------------------|---|----|----------------------------------|---|-----|------------------------------------|---|-----|----------------------------|---|-----|----------------------------------|---|-----|----------------------------------|---|-----|------------------------------------|---|-----|----------------------------|---|-------|--------------|
| <p>■ Set with a decimal.</p> <p>Setting value </p> <p>● Deceleration start flag valid 0: Deceleration start flag invalid 1: Deceleration start flag valid</p> | 0 | 5905 | | | | | | | | | | | | | | | | | | | | | | | | | | | | | | | | | | | | | | | | | | | | | | | | | | | | | | | | | | | | | | | | | | | | | | | | | | | | | | | | | | | | | | | | | | | | | | | | | | | | | | | | | | | | | | | | | | | | | | | | | | | | | | | | | | | | | | | | | | | | | | | | | | | | | | | | | | | | | | | | | | | | | | | | | | | | | | | | | | | | | | | | | | | | | | | | | | | | | | | | | | | | | |
| <p>■ Set with a decimal.</p> <p>Setting value </p> <p>● Stop command processing for deceleration stop selection 0: Deceleration curve re-processing 1: Deceleration curve continuation</p> | 0 | 5907 | | | | | | | | | | | | | | | | | | | | | | | | | | | | | | | | | | | | | | | | | | | | | | | | | | | | | | | | | | | | | | | | | | | | | | | | | | | | | | | | | | | | | | | | | | | | | | | | | | | | | | | | | | | | | | | | | | | | | | | | | | | | | | | | | | | | | | | | | | | | | | | | | | | | | | | | | | | | | | | | | | | | | | | | | | | | | | | | | | | | | | | | | | | | | | | | | | | | | | | | | | | | | |
| <p>■ Set with a hexadecimal.</p> <p>Setting value </p> | <table border="1"> <thead> <tr> <th>Buffer memory</th> <th>Setting items</th> <th>Default value</th> <th>Meaning</th> </tr> </thead> <tbody> <tr><td rowspan="15">5928</td><td>b0</td><td>Axis 1 Upper limit signal (FLS)</td><td>0</td></tr> <tr><td>b1</td><td>Axis 1 Lower limit signal (RLS)</td><td>0</td></tr> <tr><td>b2</td><td>Axis 1 Proximity dog signal (DOG)</td><td>0</td></tr> <tr><td>b3</td><td>Axis 1 STOP signal (STOP)</td><td>0</td></tr> <tr><td>b4</td><td>Axis 2 Upper limit signal (FLS)</td><td>0</td></tr> <tr><td>b5</td><td>Axis 2 Lower limit signal (RLS)</td><td>0</td></tr> <tr><td>b6</td><td>Axis 2 Proximity dog signal (DOG)</td><td>0</td></tr> <tr><td>b7</td><td>Axis 2 STOP signal (STOP)</td><td>0</td></tr> <tr><td>b8</td><td>Axis 3 Upper limit signal (FLS)</td><td>0</td></tr> <tr><td>b9</td><td>Axis 3 Lower limit signal (RLS)</td><td>0</td></tr> <tr><td>b10</td><td>Axis 3 Proximity dog signal (DOG)</td><td>0</td></tr> <tr><td>b11</td><td>Axis 3 STOP signal (STOP)</td><td>0</td></tr> <tr><td>b12</td><td>Axis 4 Upper limit signal (FLS)</td><td>0</td></tr> <tr><td>b13</td><td>Axis 4 Lower limit signal (RLS)</td><td>0</td></tr> <tr><td>b14</td><td>Axis 4 Proximity dog signal (DOG)</td><td>0</td></tr> <tr><td>b15</td><td>Axis 4 STOP signal (STOP)</td><td>0</td></tr> <tr><td rowspan="15">5929</td><td>b0</td><td>Axis 5 Upper limit signal (FLS)</td><td>0</td></tr> <tr><td>b1</td><td>Axis 5 Lower limit signal (RLS)</td><td>0</td></tr> <tr><td>b2</td><td>Axis 5 Proximity dog signal (DOG)</td><td>0</td></tr> <tr><td>b3</td><td>Axis 5 STOP signal (STOP)</td><td>0</td></tr> <tr><td>b4</td><td>Axis 6 Upper limit signal (FLS)</td><td>0</td></tr> <tr><td>b5</td><td>Axis 6 Lower limit signal (RLS)</td><td>0</td></tr> <tr><td>b6</td><td>Axis 6 Proximity dog signal (DOG)</td><td>0</td></tr> <tr><td>b7</td><td>Axis 6 STOP signal (STOP)</td><td>0</td></tr> <tr><td>b8</td><td>Axis 7 Upper limit signal (FLS)</td><td>0</td></tr> <tr><td>b9</td><td>Axis 7 Lower limit signal (RLS)</td><td>0</td></tr> <tr><td>b10</td><td>Axis 7 Proximity dog signal (DOG)</td><td>0</td></tr> <tr><td>b11</td><td>Axis 7 STOP signal (STOP)</td><td>0</td></tr> <tr><td>b12</td><td>Axis 8 Upper limit signal (FLS)</td><td>0</td></tr> <tr><td>b13</td><td>Axis 8 Lower limit signal (RLS)</td><td>0</td></tr> <tr><td>b14</td><td>Axis 8 Proximity dog signal (DOG)</td><td>0</td></tr> <tr><td>b15</td><td>Axis 8 STOP signal (STOP)</td><td>0</td></tr> </tbody> </table> <table border="1"> <thead> <tr> <th>Buffer memory</th> <th>Setting items</th> <th>Default value</th> <th>Meaning</th> </tr> </thead> <tbody> <tr><td rowspan="15">5930</td><td>b0</td><td>Axis 9 Upper limit signal (FLS)</td><td>0</td></tr> <tr><td>b1</td><td>Axis 9 Lower limit signal (RLS)</td><td>0</td></tr> <tr><td>b2</td><td>Axis 9 Proximity dog signal (DOG)</td><td>0</td></tr> <tr><td>b3</td><td>Axis 9 STOP signal (STOP)</td><td>0</td></tr> <tr><td>b4</td><td>Axis 10 Upper limit signal (FLS)</td><td>0</td></tr> <tr><td>b5</td><td>Axis 10 Lower limit signal (RLS)</td><td>0</td></tr> <tr><td>b6</td><td>Axis 10 Proximity dog signal (DOG)</td><td>0</td></tr> <tr><td>b7</td><td>Axis 10 STOP signal (STOP)</td><td>0</td></tr> <tr><td>b8</td><td>Axis 11 Upper limit signal (FLS)</td><td>0</td></tr> <tr><td>b9</td><td>Axis 11 Lower limit signal (RLS)</td><td>0</td></tr> <tr><td>b10</td><td>Axis 11 Proximity dog signal (DOG)</td><td>0</td></tr> <tr><td>b11</td><td>Axis 11 STOP signal (STOP)</td><td>0</td></tr> <tr><td>b12</td><td>Axis 12 Upper limit signal (FLS)</td><td>0</td></tr> <tr><td>b13</td><td>Axis 12 Lower limit signal (RLS)</td><td>0</td></tr> <tr><td>b14</td><td>Axis 12 Proximity dog signal (DOG)</td><td>0</td></tr> <tr><td>b15</td><td>Axis 12 STOP signal (STOP)</td><td>0</td></tr> <tr><td rowspan="15">5931</td><td>b0</td><td>Axis 13 Upper limit signal (FLS)</td><td>0</td></tr> <tr><td>b1</td><td>Axis 13 Lower limit signal (RLS)</td><td>0</td></tr> <tr><td>b2</td><td>Axis 13 Proximity dog signal (DOG)</td><td>0</td></tr> <tr><td>b3</td><td>Axis 13 STOP signal (STOP)</td><td>0</td></tr> <tr><td>b4</td><td>Axis 14 Upper limit signal (FLS)</td><td>0</td></tr> <tr><td>b5</td><td>Axis 14 Lower limit signal (RLS)</td><td>0</td></tr> <tr><td>b6</td><td>Axis 14 Proximity dog signal (DOG)</td><td>0</td></tr> <tr><td>b7</td><td>Axis 14 STOP signal (STOP)</td><td>0</td></tr> <tr><td>b8</td><td>Axis 15 Upper limit signal (FLS)</td><td>0</td></tr> <tr><td>b9</td><td>Axis 15 Lower limit signal (RLS)</td><td>0</td></tr> <tr><td>b10</td><td>Axis 15 Proximity dog signal (DOG)</td><td>0</td></tr> <tr><td>b11</td><td>Axis 15 STOP signal (STOP)</td><td>0</td></tr> <tr><td>b12</td><td>Axis 16 Upper limit signal (FLS)</td><td>0</td></tr> <tr><td>b13</td><td>Axis 16 Lower limit signal (RLS)</td><td>0</td></tr> <tr><td>b14</td><td>Axis 16 Proximity dog signal (DOG)</td><td>0</td></tr> <tr><td>b15</td><td>Axis 16 STOP signal (STOP)</td><td>0</td></tr> </tbody> </table> | Buffer memory | Setting items | Default value | Meaning | 5928 | b0 | Axis 1 Upper limit signal (FLS) | 0 | b1 | Axis 1 Lower limit signal (RLS) | 0 | b2 | Axis 1 Proximity dog signal (DOG) | 0 | b3 | Axis 1 STOP signal (STOP) | 0 | b4 | Axis 2 Upper limit signal (FLS) | 0 | b5 | Axis 2 Lower limit signal (RLS) | 0 | b6 | Axis 2 Proximity dog signal (DOG) | 0 | b7 | Axis 2 STOP signal (STOP) | 0 | b8 | Axis 3 Upper limit signal (FLS) | 0 | b9 | Axis 3 Lower limit signal (RLS) | 0 | b10 | Axis 3 Proximity dog signal (DOG) | 0 | b11 | Axis 3 STOP signal (STOP) | 0 | b12 | Axis 4 Upper limit signal (FLS) | 0 | b13 | Axis 4 Lower limit signal (RLS) | 0 | b14 | Axis 4 Proximity dog signal (DOG) | 0 | b15 | Axis 4 STOP signal (STOP) | 0 | 5929 | b0 | Axis 5 Upper limit signal (FLS) | 0 | b1 | Axis 5 Lower limit signal (RLS) | 0 | b2 | Axis 5 Proximity dog signal (DOG) | 0 | b3 | Axis 5 STOP signal (STOP) | 0 | b4 | Axis 6 Upper limit signal (FLS) | 0 | b5 | Axis 6 Lower limit signal (RLS) | 0 | b6 | Axis 6 Proximity dog signal (DOG) | 0 | b7 | Axis 6 STOP signal (STOP) | 0 | b8 | Axis 7 Upper limit signal (FLS) | 0 | b9 | Axis 7 Lower limit signal (RLS) | 0 | b10 | Axis 7 Proximity dog signal (DOG) | 0 | b11 | Axis 7 STOP signal (STOP) | 0 | b12 | Axis 8 Upper limit signal (FLS) | 0 | b13 | Axis 8 Lower limit signal (RLS) | 0 | b14 | Axis 8 Proximity dog signal (DOG) | 0 | b15 | Axis 8 STOP signal (STOP) | 0 | Buffer memory | Setting items | Default value | Meaning | 5930 | b0 | Axis 9 Upper limit signal (FLS) | 0 | b1 | Axis 9 Lower limit signal (RLS) | 0 | b2 | Axis 9 Proximity dog signal (DOG) | 0 | b3 | Axis 9 STOP signal (STOP) | 0 | b4 | Axis 10 Upper limit signal (FLS) | 0 | b5 | Axis 10 Lower limit signal (RLS) | 0 | b6 | Axis 10 Proximity dog signal (DOG) | 0 | b7 | Axis 10 STOP signal (STOP) | 0 | b8 | Axis 11 Upper limit signal (FLS) | 0 | b9 | Axis 11 Lower limit signal (RLS) | 0 | b10 | Axis 11 Proximity dog signal (DOG) | 0 | b11 | Axis 11 STOP signal (STOP) | 0 | b12 | Axis 12 Upper limit signal (FLS) | 0 | b13 | Axis 12 Lower limit signal (RLS) | 0 | b14 | Axis 12 Proximity dog signal (DOG) | 0 | b15 | Axis 12 STOP signal (STOP) | 0 | 5931 | b0 | Axis 13 Upper limit signal (FLS) | 0 | b1 | Axis 13 Lower limit signal (RLS) | 0 | b2 | Axis 13 Proximity dog signal (DOG) | 0 | b3 | Axis 13 STOP signal (STOP) | 0 | b4 | Axis 14 Upper limit signal (FLS) | 0 | b5 | Axis 14 Lower limit signal (RLS) | 0 | b6 | Axis 14 Proximity dog signal (DOG) | 0 | b7 | Axis 14 STOP signal (STOP) | 0 | b8 | Axis 15 Upper limit signal (FLS) | 0 | b9 | Axis 15 Lower limit signal (RLS) | 0 | b10 | Axis 15 Proximity dog signal (DOG) | 0 | b11 | Axis 15 STOP signal (STOP) | 0 | b12 | Axis 16 Upper limit signal (FLS) | 0 | b13 | Axis 16 Lower limit signal (RLS) | 0 | b14 | Axis 16 Proximity dog signal (DOG) | 0 | b15 | Axis 16 STOP signal (STOP) | 0 | 0000H | 5928 to 5931 |
| Buffer memory | Setting items | Default value | Meaning | | | | | | | | | | | | | | | | | | | | | | | | | | | | | | | | | | | | | | | | | | | | | | | | | | | | | | | | | | | | | | | | | | | | | | | | | | | | | | | | | | | | | | | | | | | | | | | | | | | | | | | | | | | | | | | | | | | | | | | | | | | | | | | | | | | | | | | | | | | | | | | | | | | | | | | | | | | | | | | | | | | | | | | | | | | | | | | | | | | | | | | | | | | | | | | | | | | | | | | | | | | | |
| 5928 | b0 | Axis 1 Upper limit signal (FLS) | 0 | | | | | | | | | | | | | | | | | | | | | | | | | | | | | | | | | | | | | | | | | | | | | | | | | | | | | | | | | | | | | | | | | | | | | | | | | | | | | | | | | | | | | | | | | | | | | | | | | | | | | | | | | | | | | | | | | | | | | | | | | | | | | | | | | | | | | | | | | | | | | | | | | | | | | | | | | | | | | | | | | | | | | | | | | | | | | | | | | | | | | | | | | | | | | | | | | | | | | | | | | | | | |
| | b1 | Axis 1 Lower limit signal (RLS) | 0 | | | | | | | | | | | | | | | | | | | | | | | | | | | | | | | | | | | | | | | | | | | | | | | | | | | | | | | | | | | | | | | | | | | | | | | | | | | | | | | | | | | | | | | | | | | | | | | | | | | | | | | | | | | | | | | | | | | | | | | | | | | | | | | | | | | | | | | | | | | | | | | | | | | | | | | | | | | | | | | | | | | | | | | | | | | | | | | | | | | | | | | | | | | | | | | | | | | | | | | | | | | | |
| | b2 | Axis 1 Proximity dog signal (DOG) | 0 | | | | | | | | | | | | | | | | | | | | | | | | | | | | | | | | | | | | | | | | | | | | | | | | | | | | | | | | | | | | | | | | | | | | | | | | | | | | | | | | | | | | | | | | | | | | | | | | | | | | | | | | | | | | | | | | | | | | | | | | | | | | | | | | | | | | | | | | | | | | | | | | | | | | | | | | | | | | | | | | | | | | | | | | | | | | | | | | | | | | | | | | | | | | | | | | | | | | | | | | | | | | |
| | b3 | Axis 1 STOP signal (STOP) | 0 | | | | | | | | | | | | | | | | | | | | | | | | | | | | | | | | | | | | | | | | | | | | | | | | | | | | | | | | | | | | | | | | | | | | | | | | | | | | | | | | | | | | | | | | | | | | | | | | | | | | | | | | | | | | | | | | | | | | | | | | | | | | | | | | | | | | | | | | | | | | | | | | | | | | | | | | | | | | | | | | | | | | | | | | | | | | | | | | | | | | | | | | | | | | | | | | | | | | | | | | | | | | |
| | b4 | Axis 2 Upper limit signal (FLS) | 0 | | | | | | | | | | | | | | | | | | | | | | | | | | | | | | | | | | | | | | | | | | | | | | | | | | | | | | | | | | | | | | | | | | | | | | | | | | | | | | | | | | | | | | | | | | | | | | | | | | | | | | | | | | | | | | | | | | | | | | | | | | | | | | | | | | | | | | | | | | | | | | | | | | | | | | | | | | | | | | | | | | | | | | | | | | | | | | | | | | | | | | | | | | | | | | | | | | | | | | | | | | | | |
| | b5 | Axis 2 Lower limit signal (RLS) | 0 | | | | | | | | | | | | | | | | | | | | | | | | | | | | | | | | | | | | | | | | | | | | | | | | | | | | | | | | | | | | | | | | | | | | | | | | | | | | | | | | | | | | | | | | | | | | | | | | | | | | | | | | | | | | | | | | | | | | | | | | | | | | | | | | | | | | | | | | | | | | | | | | | | | | | | | | | | | | | | | | | | | | | | | | | | | | | | | | | | | | | | | | | | | | | | | | | | | | | | | | | | | | |
| | b6 | Axis 2 Proximity dog signal (DOG) | 0 | | | | | | | | | | | | | | | | | | | | | | | | | | | | | | | | | | | | | | | | | | | | | | | | | | | | | | | | | | | | | | | | | | | | | | | | | | | | | | | | | | | | | | | | | | | | | | | | | | | | | | | | | | | | | | | | | | | | | | | | | | | | | | | | | | | | | | | | | | | | | | | | | | | | | | | | | | | | | | | | | | | | | | | | | | | | | | | | | | | | | | | | | | | | | | | | | | | | | | | | | | | | |
| | b7 | Axis 2 STOP signal (STOP) | 0 | | | | | | | | | | | | | | | | | | | | | | | | | | | | | | | | | | | | | | | | | | | | | | | | | | | | | | | | | | | | | | | | | | | | | | | | | | | | | | | | | | | | | | | | | | | | | | | | | | | | | | | | | | | | | | | | | | | | | | | | | | | | | | | | | | | | | | | | | | | | | | | | | | | | | | | | | | | | | | | | | | | | | | | | | | | | | | | | | | | | | | | | | | | | | | | | | | | | | | | | | | | | |
| | b8 | Axis 3 Upper limit signal (FLS) | 0 | | | | | | | | | | | | | | | | | | | | | | | | | | | | | | | | | | | | | | | | | | | | | | | | | | | | | | | | | | | | | | | | | | | | | | | | | | | | | | | | | | | | | | | | | | | | | | | | | | | | | | | | | | | | | | | | | | | | | | | | | | | | | | | | | | | | | | | | | | | | | | | | | | | | | | | | | | | | | | | | | | | | | | | | | | | | | | | | | | | | | | | | | | | | | | | | | | | | | | | | | | | | |
| | b9 | Axis 3 Lower limit signal (RLS) | 0 | | | | | | | | | | | | | | | | | | | | | | | | | | | | | | | | | | | | | | | | | | | | | | | | | | | | | | | | | | | | | | | | | | | | | | | | | | | | | | | | | | | | | | | | | | | | | | | | | | | | | | | | | | | | | | | | | | | | | | | | | | | | | | | | | | | | | | | | | | | | | | | | | | | | | | | | | | | | | | | | | | | | | | | | | | | | | | | | | | | | | | | | | | | | | | | | | | | | | | | | | | | | |
| | b10 | Axis 3 Proximity dog signal (DOG) | 0 | | | | | | | | | | | | | | | | | | | | | | | | | | | | | | | | | | | | | | | | | | | | | | | | | | | | | | | | | | | | | | | | | | | | | | | | | | | | | | | | | | | | | | | | | | | | | | | | | | | | | | | | | | | | | | | | | | | | | | | | | | | | | | | | | | | | | | | | | | | | | | | | | | | | | | | | | | | | | | | | | | | | | | | | | | | | | | | | | | | | | | | | | | | | | | | | | | | | | | | | | | | | |
| | b11 | Axis 3 STOP signal (STOP) | 0 | | | | | | | | | | | | | | | | | | | | | | | | | | | | | | | | | | | | | | | | | | | | | | | | | | | | | | | | | | | | | | | | | | | | | | | | | | | | | | | | | | | | | | | | | | | | | | | | | | | | | | | | | | | | | | | | | | | | | | | | | | | | | | | | | | | | | | | | | | | | | | | | | | | | | | | | | | | | | | | | | | | | | | | | | | | | | | | | | | | | | | | | | | | | | | | | | | | | | | | | | | | | |
| | b12 | Axis 4 Upper limit signal (FLS) | 0 | | | | | | | | | | | | | | | | | | | | | | | | | | | | | | | | | | | | | | | | | | | | | | | | | | | | | | | | | | | | | | | | | | | | | | | | | | | | | | | | | | | | | | | | | | | | | | | | | | | | | | | | | | | | | | | | | | | | | | | | | | | | | | | | | | | | | | | | | | | | | | | | | | | | | | | | | | | | | | | | | | | | | | | | | | | | | | | | | | | | | | | | | | | | | | | | | | | | | | | | | | | | |
| | b13 | Axis 4 Lower limit signal (RLS) | 0 | | | | | | | | | | | | | | | | | | | | | | | | | | | | | | | | | | | | | | | | | | | | | | | | | | | | | | | | | | | | | | | | | | | | | | | | | | | | | | | | | | | | | | | | | | | | | | | | | | | | | | | | | | | | | | | | | | | | | | | | | | | | | | | | | | | | | | | | | | | | | | | | | | | | | | | | | | | | | | | | | | | | | | | | | | | | | | | | | | | | | | | | | | | | | | | | | | | | | | | | | | | | |
| | b14 | Axis 4 Proximity dog signal (DOG) | 0 | | | | | | | | | | | | | | | | | | | | | | | | | | | | | | | | | | | | | | | | | | | | | | | | | | | | | | | | | | | | | | | | | | | | | | | | | | | | | | | | | | | | | | | | | | | | | | | | | | | | | | | | | | | | | | | | | | | | | | | | | | | | | | | | | | | | | | | | | | | | | | | | | | | | | | | | | | | | | | | | | | | | | | | | | | | | | | | | | | | | | | | | | | | | | | | | | | | | | | | | | | | | |
| b15 | Axis 4 STOP signal (STOP) | 0 | | | | | | | | | | | | | | | | | | | | | | | | | | | | | | | | | | | | | | | | | | | | | | | | | | | | | | | | | | | | | | | | | | | | | | | | | | | | | | | | | | | | | | | | | | | | | | | | | | | | | | | | | | | | | | | | | | | | | | | | | | | | | | | | | | | | | | | | | | | | | | | | | | | | | | | | | | | | | | | | | | | | | | | | | | | | | | | | | | | | | | | | | | | | | | | | | | | | | | | | | | | | | |
| 5929 | b0 | Axis 5 Upper limit signal (FLS) | 0 | | | | | | | | | | | | | | | | | | | | | | | | | | | | | | | | | | | | | | | | | | | | | | | | | | | | | | | | | | | | | | | | | | | | | | | | | | | | | | | | | | | | | | | | | | | | | | | | | | | | | | | | | | | | | | | | | | | | | | | | | | | | | | | | | | | | | | | | | | | | | | | | | | | | | | | | | | | | | | | | | | | | | | | | | | | | | | | | | | | | | | | | | | | | | | | | | | | | | | | | | | | | |
| | b1 | Axis 5 Lower limit signal (RLS) | 0 | | | | | | | | | | | | | | | | | | | | | | | | | | | | | | | | | | | | | | | | | | | | | | | | | | | | | | | | | | | | | | | | | | | | | | | | | | | | | | | | | | | | | | | | | | | | | | | | | | | | | | | | | | | | | | | | | | | | | | | | | | | | | | | | | | | | | | | | | | | | | | | | | | | | | | | | | | | | | | | | | | | | | | | | | | | | | | | | | | | | | | | | | | | | | | | | | | | | | | | | | | | | |
| | b2 | Axis 5 Proximity dog signal (DOG) | 0 | | | | | | | | | | | | | | | | | | | | | | | | | | | | | | | | | | | | | | | | | | | | | | | | | | | | | | | | | | | | | | | | | | | | | | | | | | | | | | | | | | | | | | | | | | | | | | | | | | | | | | | | | | | | | | | | | | | | | | | | | | | | | | | | | | | | | | | | | | | | | | | | | | | | | | | | | | | | | | | | | | | | | | | | | | | | | | | | | | | | | | | | | | | | | | | | | | | | | | | | | | | | |
| | b3 | Axis 5 STOP signal (STOP) | 0 | | | | | | | | | | | | | | | | | | | | | | | | | | | | | | | | | | | | | | | | | | | | | | | | | | | | | | | | | | | | | | | | | | | | | | | | | | | | | | | | | | | | | | | | | | | | | | | | | | | | | | | | | | | | | | | | | | | | | | | | | | | | | | | | | | | | | | | | | | | | | | | | | | | | | | | | | | | | | | | | | | | | | | | | | | | | | | | | | | | | | | | | | | | | | | | | | | | | | | | | | | | | |
| | b4 | Axis 6 Upper limit signal (FLS) | 0 | | | | | | | | | | | | | | | | | | | | | | | | | | | | | | | | | | | | | | | | | | | | | | | | | | | | | | | | | | | | | | | | | | | | | | | | | | | | | | | | | | | | | | | | | | | | | | | | | | | | | | | | | | | | | | | | | | | | | | | | | | | | | | | | | | | | | | | | | | | | | | | | | | | | | | | | | | | | | | | | | | | | | | | | | | | | | | | | | | | | | | | | | | | | | | | | | | | | | | | | | | | | |
| | b5 | Axis 6 Lower limit signal (RLS) | 0 | | | | | | | | | | | | | | | | | | | | | | | | | | | | | | | | | | | | | | | | | | | | | | | | | | | | | | | | | | | | | | | | | | | | | | | | | | | | | | | | | | | | | | | | | | | | | | | | | | | | | | | | | | | | | | | | | | | | | | | | | | | | | | | | | | | | | | | | | | | | | | | | | | | | | | | | | | | | | | | | | | | | | | | | | | | | | | | | | | | | | | | | | | | | | | | | | | | | | | | | | | | | |
| | b6 | Axis 6 Proximity dog signal (DOG) | 0 | | | | | | | | | | | | | | | | | | | | | | | | | | | | | | | | | | | | | | | | | | | | | | | | | | | | | | | | | | | | | | | | | | | | | | | | | | | | | | | | | | | | | | | | | | | | | | | | | | | | | | | | | | | | | | | | | | | | | | | | | | | | | | | | | | | | | | | | | | | | | | | | | | | | | | | | | | | | | | | | | | | | | | | | | | | | | | | | | | | | | | | | | | | | | | | | | | | | | | | | | | | | |
| | b7 | Axis 6 STOP signal (STOP) | 0 | | | | | | | | | | | | | | | | | | | | | | | | | | | | | | | | | | | | | | | | | | | | | | | | | | | | | | | | | | | | | | | | | | | | | | | | | | | | | | | | | | | | | | | | | | | | | | | | | | | | | | | | | | | | | | | | | | | | | | | | | | | | | | | | | | | | | | | | | | | | | | | | | | | | | | | | | | | | | | | | | | | | | | | | | | | | | | | | | | | | | | | | | | | | | | | | | | | | | | | | | | | | |
| | b8 | Axis 7 Upper limit signal (FLS) | 0 | | | | | | | | | | | | | | | | | | | | | | | | | | | | | | | | | | | | | | | | | | | | | | | | | | | | | | | | | | | | | | | | | | | | | | | | | | | | | | | | | | | | | | | | | | | | | | | | | | | | | | | | | | | | | | | | | | | | | | | | | | | | | | | | | | | | | | | | | | | | | | | | | | | | | | | | | | | | | | | | | | | | | | | | | | | | | | | | | | | | | | | | | | | | | | | | | | | | | | | | | | | | |
| | b9 | Axis 7 Lower limit signal (RLS) | 0 | | | | | | | | | | | | | | | | | | | | | | | | | | | | | | | | | | | | | | | | | | | | | | | | | | | | | | | | | | | | | | | | | | | | | | | | | | | | | | | | | | | | | | | | | | | | | | | | | | | | | | | | | | | | | | | | | | | | | | | | | | | | | | | | | | | | | | | | | | | | | | | | | | | | | | | | | | | | | | | | | | | | | | | | | | | | | | | | | | | | | | | | | | | | | | | | | | | | | | | | | | | | |
| | b10 | Axis 7 Proximity dog signal (DOG) | 0 | | | | | | | | | | | | | | | | | | | | | | | | | | | | | | | | | | | | | | | | | | | | | | | | | | | | | | | | | | | | | | | | | | | | | | | | | | | | | | | | | | | | | | | | | | | | | | | | | | | | | | | | | | | | | | | | | | | | | | | | | | | | | | | | | | | | | | | | | | | | | | | | | | | | | | | | | | | | | | | | | | | | | | | | | | | | | | | | | | | | | | | | | | | | | | | | | | | | | | | | | | | | |
| | b11 | Axis 7 STOP signal (STOP) | 0 | | | | | | | | | | | | | | | | | | | | | | | | | | | | | | | | | | | | | | | | | | | | | | | | | | | | | | | | | | | | | | | | | | | | | | | | | | | | | | | | | | | | | | | | | | | | | | | | | | | | | | | | | | | | | | | | | | | | | | | | | | | | | | | | | | | | | | | | | | | | | | | | | | | | | | | | | | | | | | | | | | | | | | | | | | | | | | | | | | | | | | | | | | | | | | | | | | | | | | | | | | | | |
| | b12 | Axis 8 Upper limit signal (FLS) | 0 | | | | | | | | | | | | | | | | | | | | | | | | | | | | | | | | | | | | | | | | | | | | | | | | | | | | | | | | | | | | | | | | | | | | | | | | | | | | | | | | | | | | | | | | | | | | | | | | | | | | | | | | | | | | | | | | | | | | | | | | | | | | | | | | | | | | | | | | | | | | | | | | | | | | | | | | | | | | | | | | | | | | | | | | | | | | | | | | | | | | | | | | | | | | | | | | | | | | | | | | | | | | |
| | b13 | Axis 8 Lower limit signal (RLS) | 0 | | | | | | | | | | | | | | | | | | | | | | | | | | | | | | | | | | | | | | | | | | | | | | | | | | | | | | | | | | | | | | | | | | | | | | | | | | | | | | | | | | | | | | | | | | | | | | | | | | | | | | | | | | | | | | | | | | | | | | | | | | | | | | | | | | | | | | | | | | | | | | | | | | | | | | | | | | | | | | | | | | | | | | | | | | | | | | | | | | | | | | | | | | | | | | | | | | | | | | | | | | | | |
| | b14 | Axis 8 Proximity dog signal (DOG) | 0 | | | | | | | | | | | | | | | | | | | | | | | | | | | | | | | | | | | | | | | | | | | | | | | | | | | | | | | | | | | | | | | | | | | | | | | | | | | | | | | | | | | | | | | | | | | | | | | | | | | | | | | | | | | | | | | | | | | | | | | | | | | | | | | | | | | | | | | | | | | | | | | | | | | | | | | | | | | | | | | | | | | | | | | | | | | | | | | | | | | | | | | | | | | | | | | | | | | | | | | | | | | | |
| b15 | Axis 8 STOP signal (STOP) | 0 | | | | | | | | | | | | | | | | | | | | | | | | | | | | | | | | | | | | | | | | | | | | | | | | | | | | | | | | | | | | | | | | | | | | | | | | | | | | | | | | | | | | | | | | | | | | | | | | | | | | | | | | | | | | | | | | | | | | | | | | | | | | | | | | | | | | | | | | | | | | | | | | | | | | | | | | | | | | | | | | | | | | | | | | | | | | | | | | | | | | | | | | | | | | | | | | | | | | | | | | | | | | | |
| Buffer memory | Setting items | Default value | Meaning | | | | | | | | | | | | | | | | | | | | | | | | | | | | | | | | | | | | | | | | | | | | | | | | | | | | | | | | | | | | | | | | | | | | | | | | | | | | | | | | | | | | | | | | | | | | | | | | | | | | | | | | | | | | | | | | | | | | | | | | | | | | | | | | | | | | | | | | | | | | | | | | | | | | | | | | | | | | | | | | | | | | | | | | | | | | | | | | | | | | | | | | | | | | | | | | | | | | | | | | | | | | |
| 5930 | b0 | Axis 9 Upper limit signal (FLS) | 0 | | | | | | | | | | | | | | | | | | | | | | | | | | | | | | | | | | | | | | | | | | | | | | | | | | | | | | | | | | | | | | | | | | | | | | | | | | | | | | | | | | | | | | | | | | | | | | | | | | | | | | | | | | | | | | | | | | | | | | | | | | | | | | | | | | | | | | | | | | | | | | | | | | | | | | | | | | | | | | | | | | | | | | | | | | | | | | | | | | | | | | | | | | | | | | | | | | | | | | | | | | | | |
| | b1 | Axis 9 Lower limit signal (RLS) | 0 | | | | | | | | | | | | | | | | | | | | | | | | | | | | | | | | | | | | | | | | | | | | | | | | | | | | | | | | | | | | | | | | | | | | | | | | | | | | | | | | | | | | | | | | | | | | | | | | | | | | | | | | | | | | | | | | | | | | | | | | | | | | | | | | | | | | | | | | | | | | | | | | | | | | | | | | | | | | | | | | | | | | | | | | | | | | | | | | | | | | | | | | | | | | | | | | | | | | | | | | | | | | |
| | b2 | Axis 9 Proximity dog signal (DOG) | 0 | | | | | | | | | | | | | | | | | | | | | | | | | | | | | | | | | | | | | | | | | | | | | | | | | | | | | | | | | | | | | | | | | | | | | | | | | | | | | | | | | | | | | | | | | | | | | | | | | | | | | | | | | | | | | | | | | | | | | | | | | | | | | | | | | | | | | | | | | | | | | | | | | | | | | | | | | | | | | | | | | | | | | | | | | | | | | | | | | | | | | | | | | | | | | | | | | | | | | | | | | | | | |
| | b3 | Axis 9 STOP signal (STOP) | 0 | | | | | | | | | | | | | | | | | | | | | | | | | | | | | | | | | | | | | | | | | | | | | | | | | | | | | | | | | | | | | | | | | | | | | | | | | | | | | | | | | | | | | | | | | | | | | | | | | | | | | | | | | | | | | | | | | | | | | | | | | | | | | | | | | | | | | | | | | | | | | | | | | | | | | | | | | | | | | | | | | | | | | | | | | | | | | | | | | | | | | | | | | | | | | | | | | | | | | | | | | | | | |
| | b4 | Axis 10 Upper limit signal (FLS) | 0 | | | | | | | | | | | | | | | | | | | | | | | | | | | | | | | | | | | | | | | | | | | | | | | | | | | | | | | | | | | | | | | | | | | | | | | | | | | | | | | | | | | | | | | | | | | | | | | | | | | | | | | | | | | | | | | | | | | | | | | | | | | | | | | | | | | | | | | | | | | | | | | | | | | | | | | | | | | | | | | | | | | | | | | | | | | | | | | | | | | | | | | | | | | | | | | | | | | | | | | | | | | | |
| | b5 | Axis 10 Lower limit signal (RLS) | 0 | | | | | | | | | | | | | | | | | | | | | | | | | | | | | | | | | | | | | | | | | | | | | | | | | | | | | | | | | | | | | | | | | | | | | | | | | | | | | | | | | | | | | | | | | | | | | | | | | | | | | | | | | | | | | | | | | | | | | | | | | | | | | | | | | | | | | | | | | | | | | | | | | | | | | | | | | | | | | | | | | | | | | | | | | | | | | | | | | | | | | | | | | | | | | | | | | | | | | | | | | | | | |
| | b6 | Axis 10 Proximity dog signal (DOG) | 0 | | | | | | | | | | | | | | | | | | | | | | | | | | | | | | | | | | | | | | | | | | | | | | | | | | | | | | | | | | | | | | | | | | | | | | | | | | | | | | | | | | | | | | | | | | | | | | | | | | | | | | | | | | | | | | | | | | | | | | | | | | | | | | | | | | | | | | | | | | | | | | | | | | | | | | | | | | | | | | | | | | | | | | | | | | | | | | | | | | | | | | | | | | | | | | | | | | | | | | | | | | | | |
| | b7 | Axis 10 STOP signal (STOP) | 0 | | | | | | | | | | | | | | | | | | | | | | | | | | | | | | | | | | | | | | | | | | | | | | | | | | | | | | | | | | | | | | | | | | | | | | | | | | | | | | | | | | | | | | | | | | | | | | | | | | | | | | | | | | | | | | | | | | | | | | | | | | | | | | | | | | | | | | | | | | | | | | | | | | | | | | | | | | | | | | | | | | | | | | | | | | | | | | | | | | | | | | | | | | | | | | | | | | | | | | | | | | | | |
| | b8 | Axis 11 Upper limit signal (FLS) | 0 | | | | | | | | | | | | | | | | | | | | | | | | | | | | | | | | | | | | | | | | | | | | | | | | | | | | | | | | | | | | | | | | | | | | | | | | | | | | | | | | | | | | | | | | | | | | | | | | | | | | | | | | | | | | | | | | | | | | | | | | | | | | | | | | | | | | | | | | | | | | | | | | | | | | | | | | | | | | | | | | | | | | | | | | | | | | | | | | | | | | | | | | | | | | | | | | | | | | | | | | | | | | |
| | b9 | Axis 11 Lower limit signal (RLS) | 0 | | | | | | | | | | | | | | | | | | | | | | | | | | | | | | | | | | | | | | | | | | | | | | | | | | | | | | | | | | | | | | | | | | | | | | | | | | | | | | | | | | | | | | | | | | | | | | | | | | | | | | | | | | | | | | | | | | | | | | | | | | | | | | | | | | | | | | | | | | | | | | | | | | | | | | | | | | | | | | | | | | | | | | | | | | | | | | | | | | | | | | | | | | | | | | | | | | | | | | | | | | | | |
| | b10 | Axis 11 Proximity dog signal (DOG) | 0 | | | | | | | | | | | | | | | | | | | | | | | | | | | | | | | | | | | | | | | | | | | | | | | | | | | | | | | | | | | | | | | | | | | | | | | | | | | | | | | | | | | | | | | | | | | | | | | | | | | | | | | | | | | | | | | | | | | | | | | | | | | | | | | | | | | | | | | | | | | | | | | | | | | | | | | | | | | | | | | | | | | | | | | | | | | | | | | | | | | | | | | | | | | | | | | | | | | | | | | | | | | | |
| | b11 | Axis 11 STOP signal (STOP) | 0 | | | | | | | | | | | | | | | | | | | | | | | | | | | | | | | | | | | | | | | | | | | | | | | | | | | | | | | | | | | | | | | | | | | | | | | | | | | | | | | | | | | | | | | | | | | | | | | | | | | | | | | | | | | | | | | | | | | | | | | | | | | | | | | | | | | | | | | | | | | | | | | | | | | | | | | | | | | | | | | | | | | | | | | | | | | | | | | | | | | | | | | | | | | | | | | | | | | | | | | | | | | | |
| | b12 | Axis 12 Upper limit signal (FLS) | 0 | | | | | | | | | | | | | | | | | | | | | | | | | | | | | | | | | | | | | | | | | | | | | | | | | | | | | | | | | | | | | | | | | | | | | | | | | | | | | | | | | | | | | | | | | | | | | | | | | | | | | | | | | | | | | | | | | | | | | | | | | | | | | | | | | | | | | | | | | | | | | | | | | | | | | | | | | | | | | | | | | | | | | | | | | | | | | | | | | | | | | | | | | | | | | | | | | | | | | | | | | | | | |
| | b13 | Axis 12 Lower limit signal (RLS) | 0 | | | | | | | | | | | | | | | | | | | | | | | | | | | | | | | | | | | | | | | | | | | | | | | | | | | | | | | | | | | | | | | | | | | | | | | | | | | | | | | | | | | | | | | | | | | | | | | | | | | | | | | | | | | | | | | | | | | | | | | | | | | | | | | | | | | | | | | | | | | | | | | | | | | | | | | | | | | | | | | | | | | | | | | | | | | | | | | | | | | | | | | | | | | | | | | | | | | | | | | | | | | | |
| | b14 | Axis 12 Proximity dog signal (DOG) | 0 | | | | | | | | | | | | | | | | | | | | | | | | | | | | | | | | | | | | | | | | | | | | | | | | | | | | | | | | | | | | | | | | | | | | | | | | | | | | | | | | | | | | | | | | | | | | | | | | | | | | | | | | | | | | | | | | | | | | | | | | | | | | | | | | | | | | | | | | | | | | | | | | | | | | | | | | | | | | | | | | | | | | | | | | | | | | | | | | | | | | | | | | | | | | | | | | | | | | | | | | | | | | |
| b15 | Axis 12 STOP signal (STOP) | 0 | | | | | | | | | | | | | | | | | | | | | | | | | | | | | | | | | | | | | | | | | | | | | | | | | | | | | | | | | | | | | | | | | | | | | | | | | | | | | | | | | | | | | | | | | | | | | | | | | | | | | | | | | | | | | | | | | | | | | | | | | | | | | | | | | | | | | | | | | | | | | | | | | | | | | | | | | | | | | | | | | | | | | | | | | | | | | | | | | | | | | | | | | | | | | | | | | | | | | | | | | | | | | |
| 5931 | b0 | Axis 13 Upper limit signal (FLS) | 0 | | | | | | | | | | | | | | | | | | | | | | | | | | | | | | | | | | | | | | | | | | | | | | | | | | | | | | | | | | | | | | | | | | | | | | | | | | | | | | | | | | | | | | | | | | | | | | | | | | | | | | | | | | | | | | | | | | | | | | | | | | | | | | | | | | | | | | | | | | | | | | | | | | | | | | | | | | | | | | | | | | | | | | | | | | | | | | | | | | | | | | | | | | | | | | | | | | | | | | | | | | | | |
| | b1 | Axis 13 Lower limit signal (RLS) | 0 | | | | | | | | | | | | | | | | | | | | | | | | | | | | | | | | | | | | | | | | | | | | | | | | | | | | | | | | | | | | | | | | | | | | | | | | | | | | | | | | | | | | | | | | | | | | | | | | | | | | | | | | | | | | | | | | | | | | | | | | | | | | | | | | | | | | | | | | | | | | | | | | | | | | | | | | | | | | | | | | | | | | | | | | | | | | | | | | | | | | | | | | | | | | | | | | | | | | | | | | | | | | |
| | b2 | Axis 13 Proximity dog signal (DOG) | 0 | | | | | | | | | | | | | | | | | | | | | | | | | | | | | | | | | | | | | | | | | | | | | | | | | | | | | | | | | | | | | | | | | | | | | | | | | | | | | | | | | | | | | | | | | | | | | | | | | | | | | | | | | | | | | | | | | | | | | | | | | | | | | | | | | | | | | | | | | | | | | | | | | | | | | | | | | | | | | | | | | | | | | | | | | | | | | | | | | | | | | | | | | | | | | | | | | | | | | | | | | | | | |
| | b3 | Axis 13 STOP signal (STOP) | 0 | | | | | | | | | | | | | | | | | | | | | | | | | | | | | | | | | | | | | | | | | | | | | | | | | | | | | | | | | | | | | | | | | | | | | | | | | | | | | | | | | | | | | | | | | | | | | | | | | | | | | | | | | | | | | | | | | | | | | | | | | | | | | | | | | | | | | | | | | | | | | | | | | | | | | | | | | | | | | | | | | | | | | | | | | | | | | | | | | | | | | | | | | | | | | | | | | | | | | | | | | | | | |
| | b4 | Axis 14 Upper limit signal (FLS) | 0 | | | | | | | | | | | | | | | | | | | | | | | | | | | | | | | | | | | | | | | | | | | | | | | | | | | | | | | | | | | | | | | | | | | | | | | | | | | | | | | | | | | | | | | | | | | | | | | | | | | | | | | | | | | | | | | | | | | | | | | | | | | | | | | | | | | | | | | | | | | | | | | | | | | | | | | | | | | | | | | | | | | | | | | | | | | | | | | | | | | | | | | | | | | | | | | | | | | | | | | | | | | | |
| | b5 | Axis 14 Lower limit signal (RLS) | 0 | | | | | | | | | | | | | | | | | | | | | | | | | | | | | | | | | | | | | | | | | | | | | | | | | | | | | | | | | | | | | | | | | | | | | | | | | | | | | | | | | | | | | | | | | | | | | | | | | | | | | | | | | | | | | | | | | | | | | | | | | | | | | | | | | | | | | | | | | | | | | | | | | | | | | | | | | | | | | | | | | | | | | | | | | | | | | | | | | | | | | | | | | | | | | | | | | | | | | | | | | | | | |
| | b6 | Axis 14 Proximity dog signal (DOG) | 0 | | | | | | | | | | | | | | | | | | | | | | | | | | | | | | | | | | | | | | | | | | | | | | | | | | | | | | | | | | | | | | | | | | | | | | | | | | | | | | | | | | | | | | | | | | | | | | | | | | | | | | | | | | | | | | | | | | | | | | | | | | | | | | | | | | | | | | | | | | | | | | | | | | | | | | | | | | | | | | | | | | | | | | | | | | | | | | | | | | | | | | | | | | | | | | | | | | | | | | | | | | | | |
| | b7 | Axis 14 STOP signal (STOP) | 0 | | | | | | | | | | | | | | | | | | | | | | | | | | | | | | | | | | | | | | | | | | | | | | | | | | | | | | | | | | | | | | | | | | | | | | | | | | | | | | | | | | | | | | | | | | | | | | | | | | | | | | | | | | | | | | | | | | | | | | | | | | | | | | | | | | | | | | | | | | | | | | | | | | | | | | | | | | | | | | | | | | | | | | | | | | | | | | | | | | | | | | | | | | | | | | | | | | | | | | | | | | | | |
| | b8 | Axis 15 Upper limit signal (FLS) | 0 | | | | | | | | | | | | | | | | | | | | | | | | | | | | | | | | | | | | | | | | | | | | | | | | | | | | | | | | | | | | | | | | | | | | | | | | | | | | | | | | | | | | | | | | | | | | | | | | | | | | | | | | | | | | | | | | | | | | | | | | | | | | | | | | | | | | | | | | | | | | | | | | | | | | | | | | | | | | | | | | | | | | | | | | | | | | | | | | | | | | | | | | | | | | | | | | | | | | | | | | | | | | |
| | b9 | Axis 15 Lower limit signal (RLS) | 0 | | | | | | | | | | | | | | | | | | | | | | | | | | | | | | | | | | | | | | | | | | | | | | | | | | | | | | | | | | | | | | | | | | | | | | | | | | | | | | | | | | | | | | | | | | | | | | | | | | | | | | | | | | | | | | | | | | | | | | | | | | | | | | | | | | | | | | | | | | | | | | | | | | | | | | | | | | | | | | | | | | | | | | | | | | | | | | | | | | | | | | | | | | | | | | | | | | | | | | | | | | | | |
| | b10 | Axis 15 Proximity dog signal (DOG) | 0 | | | | | | | | | | | | | | | | | | | | | | | | | | | | | | | | | | | | | | | | | | | | | | | | | | | | | | | | | | | | | | | | | | | | | | | | | | | | | | | | | | | | | | | | | | | | | | | | | | | | | | | | | | | | | | | | | | | | | | | | | | | | | | | | | | | | | | | | | | | | | | | | | | | | | | | | | | | | | | | | | | | | | | | | | | | | | | | | | | | | | | | | | | | | | | | | | | | | | | | | | | | | |
| | b11 | Axis 15 STOP signal (STOP) | 0 | | | | | | | | | | | | | | | | | | | | | | | | | | | | | | | | | | | | | | | | | | | | | | | | | | | | | | | | | | | | | | | | | | | | | | | | | | | | | | | | | | | | | | | | | | | | | | | | | | | | | | | | | | | | | | | | | | | | | | | | | | | | | | | | | | | | | | | | | | | | | | | | | | | | | | | | | | | | | | | | | | | | | | | | | | | | | | | | | | | | | | | | | | | | | | | | | | | | | | | | | | | | |
| | b12 | Axis 16 Upper limit signal (FLS) | 0 | | | | | | | | | | | | | | | | | | | | | | | | | | | | | | | | | | | | | | | | | | | | | | | | | | | | | | | | | | | | | | | | | | | | | | | | | | | | | | | | | | | | | | | | | | | | | | | | | | | | | | | | | | | | | | | | | | | | | | | | | | | | | | | | | | | | | | | | | | | | | | | | | | | | | | | | | | | | | | | | | | | | | | | | | | | | | | | | | | | | | | | | | | | | | | | | | | | | | | | | | | | | |
| | b13 | Axis 16 Lower limit signal (RLS) | 0 | | | | | | | | | | | | | | | | | | | | | | | | | | | | | | | | | | | | | | | | | | | | | | | | | | | | | | | | | | | | | | | | | | | | | | | | | | | | | | | | | | | | | | | | | | | | | | | | | | | | | | | | | | | | | | | | | | | | | | | | | | | | | | | | | | | | | | | | | | | | | | | | | | | | | | | | | | | | | | | | | | | | | | | | | | | | | | | | | | | | | | | | | | | | | | | | | | | | | | | | | | | | |
| | b14 | Axis 16 Proximity dog signal (DOG) | 0 | | | | | | | | | | | | | | | | | | | | | | | | | | | | | | | | | | | | | | | | | | | | | | | | | | | | | | | | | | | | | | | | | | | | | | | | | | | | | | | | | | | | | | | | | | | | | | | | | | | | | | | | | | | | | | | | | | | | | | | | | | | | | | | | | | | | | | | | | | | | | | | | | | | | | | | | | | | | | | | | | | | | | | | | | | | | | | | | | | | | | | | | | | | | | | | | | | | | | | | | | | | | |
| b15 | Axis 16 STOP signal (STOP) | 0 | | | | | | | | | | | | | | | | | | | | | | | | | | | | | | | | | | | | | | | | | | | | | | | | | | | | | | | | | | | | | | | | | | | | | | | | | | | | | | | | | | | | | | | | | | | | | | | | | | | | | | | | | | | | | | | | | | | | | | | | | | | | | | | | | | | | | | | | | | | | | | | | | | | | | | | | | | | | | | | | | | | | | | | | | | | | | | | | | | | | | | | | | | | | | | | | | | | | | | | | | | | | | |

5.7.2 Axis control data

| Setting item | Setting details |
|---------------------------------------|---|
| [Cd.3] Positioning start No. | <ul style="list-style-type: none"> • Set the positioning start No. (Only 1 to 600 for the Pre-reading start function. For details, refer to Section 13.7.7 "Pre-reading start function".) <p><u>Fetch cycle: At start</u></p> <p>Note) After the positioning start is requested, do not change the setting value before the start complete signal ([Md.31] Status) is turned ON.</p> |
| [Cd.4] Positioning starting point No. | <ul style="list-style-type: none"> • Set a "starting point No." (1 to 50) if block start data is used for positioning. (Handled as "1" if the value of other than 1 to 50 is set.) <p><u>Fetch cycle: At start</u></p> |
| [Cd.5] Axis error reset | <ul style="list-style-type: none"> • Clears the axis error detection, axis error No., axis warning detection and axis warning No. • When the axis operation state of Simple Motion module is "in error occurrence", the error is cleared and the Simple Motion module is returned to the "waiting" state. • Clears the both of Simple Motion module errors and servo amplifier errors by axis error reset. (Some servo amplifier alarms cannot be reset even if error reset is requested. At the time, "0" is not stored in [Cd.5] by the Simple Motion module. It remains "1". Set "0" in [Cd.5] and then set "1" to execute the error reset again by user side. Refer to each servo amplifier instruction manual for details.) • The error cannot be reset during a forced stop. Execute the axis error reset after the forced stop is released. [CiA402 mode] <p><u>Fetch cycle: 14.2 [ms] [RJ010 mode]</u> <u>16.0 [ms] [CiA402 mode]</u></p> |
| [Cd.6] Restart command | <ul style="list-style-type: none"> • When positioning is stopped for any reason (when axis operation state is "stopped"), set "1" in [Cd.6]. Positioning will be carried out again from the stopped position to the end point of the stopped positioning data. <p><u>Fetch cycle: 14.2 [ms] [RJ010 mode]</u> <u>16.0 [ms] [CiA402 mode]</u></p> |

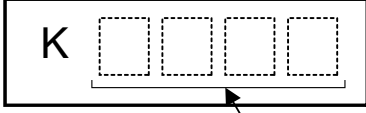
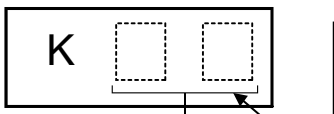
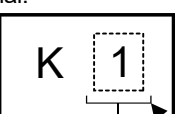
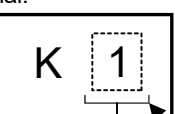
| | Setting value | Default value | Buffer memory address |
|--|---------------|---------------|-----------------------|
| <p>■ Set with a decimal.</p> <p>Setting value</p>  <ul style="list-style-type: none"> ● Positioning data No. ● 1 to 600 : Positioning data No. ● 7000 to 7004 : Block start designation ● 9001 : Machine HPR ● 9002 : Fast-HPR ● 9003 : Current value changing ● 9004 : Simultaneous starting of multiple axes | 0 | 4300+100n | |
| <p>■ Set with a decimal.</p> <p>Setting value</p>  <ul style="list-style-type: none"> ● Positioning starting point No. 1 to 50 <p>The Simple Motion module resets the value to "0" automatically when the continuous operation is interrupted.</p> | 0 | 4301+100n | |
| <p>■ Set with a decimal.</p> <p>Setting value</p>  <ul style="list-style-type: none"> ● Error reset request 1: Axis error is reset. <p>The Simple Motion module resets the value to "0" automatically after the axis error reset is completed. (Indicates that the axis error reset is completed.)</p> | 0 | 4302+100n | |
| <p>■ Set with a decimal.</p> <p>Setting value</p>  <ul style="list-style-type: none"> ● Restart command 1: Restarts <p>The Simple Motion module resets the value to "0" automatically after restart acceptance is completed. (Indicates that the restart acceptance is completed.)</p> | 0 | 4303+100n | |

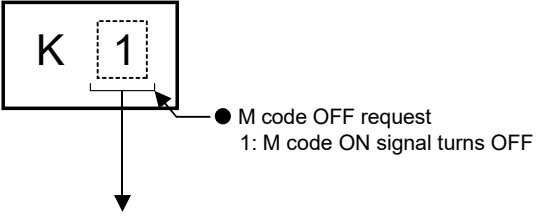
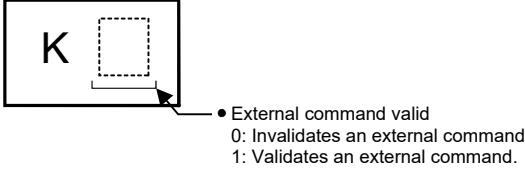

n: Axis No.-1

| Setting item | Setting details | | | | | | | | | | | |
|-------------------------------------|---|----------------------------------|--|----------------------------------|--------------------------------------|--------------|---------------|---------------------------------|---------------------------------|---------------|---------------------------------|--|
| [Cd.7] M code OFF request | <ul style="list-style-type: none"> The M code ON signal turns OFF. <p><u>Fetch cycle: Operation cycle</u></p> | | | | | | | | | | | |
| [Cd.8] External command valid | <ul style="list-style-type: none"> Validates or invalidates external command signals. <p><u>Fetch cycle: At request by external command signal</u></p> | | | | | | | | | | | |
| [Cd.9] New current value | <ul style="list-style-type: none"> When changing the "feed current value" using the start No. "9003", use this data item to specify a new feed value. The setting value range differs according to the "[Pr.1] Unit setting". <table border="1" data-bbox="584 985 1407 1182"> <thead> <tr> <th>[Pr.1] Unit setting</th> <th>mm ($\times 10^{-1} \mu\text{m}$)</th> <th>inch ($\times 10^{-5}$ inch)</th> <th>degree ($\times 10^{-5}$ degree)</th> <th>PLS (PLS)</th> </tr> </thead> <tbody> <tr> <td>Setting range</td> <td>-2147483648 to 2147483647</td> <td>-2147483648 to 2147483647</td> <td>0 to 35999999</td> <td>-2147483648 to 2147483647</td> </tr> </tbody> </table> <p><u>Fetch cycle: At change request</u></p> | [Pr.1] Unit setting | mm ($\times 10^{-1} \mu\text{m}$) | inch ($\times 10^{-5}$ inch) | degree ($\times 10^{-5}$ degree) | PLS (PLS) | Setting range | -2147483648 to 2147483647 | -2147483648 to 2147483647 | 0 to 35999999 | -2147483648 to 2147483647 | |
| [Pr.1] Unit setting | mm ($\times 10^{-1} \mu\text{m}$) | inch ($\times 10^{-5}$ inch) | degree ($\times 10^{-5}$ degree) | PLS (PLS) | | | | | | | | |
| Setting range | -2147483648 to 2147483647 | -2147483648 to 2147483647 | 0 to 35999999 | -2147483648 to 2147483647 | | | | | | | | |
| [Cd.10] New acceleration time value | <ul style="list-style-type: none"> When changing the acceleration time during a speed change, use this data item to specify a new acceleration time. <table border="1" data-bbox="584 1346 1007 1462"> <tr> <td>[Cd.10] setting range (unit)</td> </tr> <tr> <td>0 to 8388608 (ms)</td> </tr> </table> <p><u>Fetch cycle: At change request</u></p> | [Cd.10] setting range (unit) | 0 to 8388608 (ms) | | | | | | | | | |
| [Cd.10] setting range (unit) | | | | | | | | | | | | |
| 0 to 8388608 (ms) | | | | | | | | | | | | |
| [Cd.11] New deceleration time value | <ul style="list-style-type: none"> When changing the deceleration time during a speed change, use this data item to specify a new deceleration time. <table border="1" data-bbox="584 1626 1007 1742"> <tr> <td>[Cd.11] setting range (unit)</td> </tr> <tr> <td>0 to 8388608 (ms)</td> </tr> </table> <p><u>Fetch cycle: At change request</u></p> | [Cd.11] setting range (unit) | 0 to 8388608 (ms) | | | | | | | | | |
| [Cd.11] setting range (unit) | | | | | | | | | | | | |
| 0 to 8388608 (ms) | | | | | | | | | | | | |

| | Setting value | Default value | Buffer memory address | | | | | | | | | |
|---|---------------|------------------------|------------------------|----|---|------|---|--------|---|-----|---|------------------------|
| <p>■ Set with a decimal.</p> <p>Setting value</p>  <p>● M code OFF request 1: M code ON signal turns OFF</p> <p>After the M code ON signal turns OFF, "0" is stored by the Simple Motion module automatically. (Indicates that the OFF request is completed.)</p> | 0 | 4304+100n | | | | | | | | | | |
| <p>■ Set with a decimal.</p> <p>Setting value</p>  <p>● External command valid 0: Invalidates an external command. 1: Validates an external command.</p> | 0 | 4305+100n | | | | | | | | | | |
| <p>■ Set with a decimal.</p> <p>Actual value [Cd.9] New current value</p> <p>◇ Conversion into an integer value</p> <p>× 10^m</p> <p>● Unit conversion table ([Cd.9])</p> <table border="1" data-bbox="734 1064 957 1220"> <thead> <tr> <th>m</th> <th>Unit</th> </tr> </thead> <tbody> <tr> <td>1</td> <td>μm</td> </tr> <tr> <td>5</td> <td>inch</td> </tr> <tr> <td>5</td> <td>degree</td> </tr> <tr> <td>0</td> <td>PLS</td> </tr> </tbody> </table> <p>Setting value (Decimal) R</p> | m | Unit | 1 | μm | 5 | inch | 5 | degree | 0 | PLS | 0 | 4306+100n 4307+100n |
| m | Unit | | | | | | | | | | | |
| 1 | μm | | | | | | | | | | | |
| 5 | inch | | | | | | | | | | | |
| 5 | degree | | | | | | | | | | | |
| 0 | PLS | | | | | | | | | | | |
| <p>■ Set with a decimal.</p> <p>Setting value</p> <p>[Cd.10] New acceleration time value</p> <p>[Cd.11] New deceleration time value</p> <p>Example: When the "[Cd. 10] New acceleration time value" is set as "60000 ms", the buffer memory stores "60000".</p> | 0 | 4308+100n 4309+100n | | | | | | | | | | |
| | | 0 | 4310+100n 4311+100n | | | | | | | | | |

n: Axis No.-1

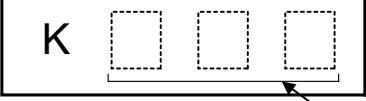
| Setting item | Setting details | | | | | | | | | | | |
|--|--|--------------------------------------|---|--------------------------------------|---|----------------|---------------|--------------------|--------------------|--------------------|--------------------|--|
| <p>[Cd.12] Acceleration/deceleration time change value during speed change, enable/disable</p> | <ul style="list-style-type: none"> Enables or disables modifications to the acceleration/deceleration time during a speed change. <p>Fetch cycle: <u>At change request</u></p> | | | | | | | | | | | |
| <p>[Cd.13] Positioning operation speed override</p> | <ul style="list-style-type: none"> To use the positioning operation speed override function, use this data item to specify an "override" value. *: For details of the override function, refer to Section 13.5.2 "Override function". <p>If the command speed is set to less than the minimum unit using the override function, the speed is raised to the minimum unit and the warning "Less than minimum speed" (warning code: 110) occurs.</p> <p>Fetch cycle: <u>Operation cycle</u></p> | | | | | | | | | | | |
| <p>[Cd.14] New speed value</p> | <ul style="list-style-type: none"> When changing the speed, use this data item to specify a new speed. The operation halts if you specify "0". The setting value range differs according to the "[Pr.1] Unit setting". <table border="1" data-bbox="587 1171 1426 1312"> <thead> <tr> <th>[Pr.1] Unit setting</th> <th>mm ($\times 10^{-2}$ mm/min)</th> <th>inch ($\times 10^{-3}$ inch/min)</th> <th>degree* ($\times 10^{-3}$ degree/min)</th> <th>PLS (PLS/s)</th> </tr> </thead> <tbody> <tr> <td>Setting range</td> <td>0 to 2000000000</td> <td>0 to 2000000000</td> <td>0 to 2000000000</td> <td>0 to 1000000000</td> </tr> </tbody> </table> <p>*: When "[Pr.83] Speed control 10 x multiplier setting for degree axis" is valid, this will be the setting range 0 to 2000000000 ($\times 10^{-2}$ degree/min).</p> <p>Fetch cycle: <u>At change request</u></p> | [Pr.1] Unit setting | mm ($\times 10^{-2}$ mm/min) | inch ($\times 10^{-3}$ inch/min) | degree* ($\times 10^{-3}$ degree/min) | PLS (PLS/s) | Setting range | 0 to 2000000000 | 0 to 2000000000 | 0 to 2000000000 | 0 to 1000000000 | |
| [Pr.1] Unit setting | mm ($\times 10^{-2}$ mm/min) | inch ($\times 10^{-3}$ inch/min) | degree* ($\times 10^{-3}$ degree/min) | PLS (PLS/s) | | | | | | | | |
| Setting range | 0 to 2000000000 | 0 to 2000000000 | 0 to 2000000000 | 0 to 1000000000 | | | | | | | | |
| <p>[Cd.15] Speed change request</p> | <ul style="list-style-type: none"> After setting the "[Cd.14] New speed value", set this data item to "1" to execute the speed change (through validating the new speed value). <p>Fetch cycle: <u>Operation cycle</u></p> | | | | | | | | | | | |

| | Setting value | Default value | Buffer memory address | | | | | | | | | |
|--|---------------|---------------|-----------------------|--------|---|----------|----|------------|---|-------|---|------------------------|
| <p>■ Set with a decimal.</p> <p>Setting value</p>  <ul style="list-style-type: none"> ● Acceleration/deceleration time change value during speed change, enable/disable 1 : Enables modifications to acceleration/deceleration time Other than 1: Disables modifications to acceleration/deceleration time | 0 | 4312+100n | | | | | | | | | | |
| <p>■ Set with a decimal.</p> <p>Setting value</p>  <ul style="list-style-type: none"> ● Override value (%) 1 to 300 | 100 | 4313+100n | | | | | | | | | | |
| <p>■ Set with a decimal.</p> <p>Actual value</p> <div style="border: 1px solid black; padding: 2px; display: inline-block;">Cd.14 New speed value</div> <p>↓ Conversion into an integer value</p> <p>◇ $\times 10^m$</p> <p>Setting value (Decimal)</p> <div style="border: 1px solid black; padding: 2px; display: inline-block;">R</div> <p>● Unit conversion table (Cd.14)</p> <table border="1" style="margin-left: 20px;"> <thead> <tr> <th>m</th> <th>Unit</th> </tr> </thead> <tbody> <tr> <td>2</td> <td>mm/min</td> </tr> <tr> <td>3</td> <td>inch/min</td> </tr> <tr> <td>3*</td> <td>degree/min</td> </tr> <tr> <td>0</td> <td>PLS/s</td> </tr> </tbody> </table> <p>* When "[Pr.83] Speed control 10 x multiplier setting for degree axis" is valid: "2"</p> <div style="border: 1px dashed black; padding: 5px; margin-top: 10px;"> <p>Example: When the "Cd. 14 New speed value" is set as "20000.00mm/min", the buffer memory stores "2000000".</p> </div> | m | Unit | 2 | mm/min | 3 | inch/min | 3* | degree/min | 0 | PLS/s | 0 | 4314+100n 4315+100n |
| m | Unit | | | | | | | | | | | |
| 2 | mm/min | | | | | | | | | | | |
| 3 | inch/min | | | | | | | | | | | |
| 3* | degree/min | | | | | | | | | | | |
| 0 | PLS/s | | | | | | | | | | | |
| <p>■ Set with a decimal.</p> <p>Setting value</p>  <ul style="list-style-type: none"> ● Speed change request 1: Executes speed change. <p>The Simple Motion module resets the value to "0" automatically when the speed change request has been processed. (This indicates the completion of speed change request.)</p> | 0 | 4316+100n | | | | | | | | | | |

n: Axis No.-1

| Setting item | Setting details | | | | | | | | | | | |
|---|---|--|--|--|--|----------------|---------------|--------------------|--------------------|--------------------|-----------------|--|
| [Cd.16] Inching movement amount | <ul style="list-style-type: none"> • Use this data item to set the amount of movement by inching. • The machine performs a JOG operation if "0" is set. • Set a value within the following range: <table border="1" data-bbox="587 504 1426 645"> <thead> <tr> <th>[Pr.1] Unit setting</th> <th>mm ($\times 10^{-1} \mu\text{m}$)</th> <th>inch ($\times 10^{-5} \text{inch}$)</th> <th>degree ($\times 10^{-5} \text{degree}$)</th> <th>PLS (PLS)</th> </tr> </thead> <tbody> <tr> <td>Setting range</td> <td>0 to 65535</td> <td>0 to 65535</td> <td>0 to 65535</td> <td>0 to 65535</td> </tr> </tbody> </table> <p>Fetch cycle: At start</p> | [Pr.1] Unit setting | mm ($\times 10^{-1} \mu\text{m}$) | inch ($\times 10^{-5} \text{inch}$) | degree ($\times 10^{-5} \text{degree}$) | PLS (PLS) | Setting range | 0 to 65535 | 0 to 65535 | 0 to 65535 | 0 to 65535 | |
| [Pr.1] Unit setting | mm ($\times 10^{-1} \mu\text{m}$) | inch ($\times 10^{-5} \text{inch}$) | degree ($\times 10^{-5} \text{degree}$) | PLS (PLS) | | | | | | | | |
| Setting range | 0 to 65535 | 0 to 65535 | 0 to 65535 | 0 to 65535 | | | | | | | | |
| [Cd.17] JOG speed | <ul style="list-style-type: none"> • Use this data item to set the JOG speed. • The setting value range differs according to the "[Pr.1] Unit setting". <table border="1" data-bbox="587 1126 1426 1267"> <thead> <tr> <th>[Pr.1] Unit setting</th> <th>mm ($\times 10^{-2} \text{mm/min}$)</th> <th>inch ($\times 10^{-3} \text{inch/min}$)</th> <th>degree * ($\times 10^{-3} \text{degree/min}$)</th> <th>PLS (PLS/s)</th> </tr> </thead> <tbody> <tr> <td>Setting range</td> <td>1 to 2000000000</td> <td>1 to 2000000000</td> <td>1 to 2000000000</td> <td>1 to 1000000000</td> </tr> </tbody> </table> <p>*: When "[Pr.83] Speed control 10 x multiplier setting for degree axis" is valid, this will be the setting range 1 to 2000000000 ($\times 10^{-2} \text{degree/min}$).</p> <p>Fetch cycle: At start</p> | [Pr.1] Unit setting | mm ($\times 10^{-2} \text{mm/min}$) | inch ($\times 10^{-3} \text{inch/min}$) | degree * ($\times 10^{-3} \text{degree/min}$) | PLS (PLS/s) | Setting range | 1 to 2000000000 | 1 to 2000000000 | 1 to 2000000000 | 1 to 1000000000 | |
| [Pr.1] Unit setting | mm ($\times 10^{-2} \text{mm/min}$) | inch ($\times 10^{-3} \text{inch/min}$) | degree * ($\times 10^{-3} \text{degree/min}$) | PLS (PLS/s) | | | | | | | | |
| Setting range | 1 to 2000000000 | 1 to 2000000000 | 1 to 2000000000 | 1 to 1000000000 | | | | | | | | |
| [Cd.18] Interrupt request during continuous operation | <ul style="list-style-type: none"> • To interrupt a continuous operation, set "1" to this data item. • After processing the interruption request ("1"), the Simple Motion module automatically resets the value to "0". <p>Fetch cycle: Operation cycle</p> | | | | | | | | | | | |

| Setting value | Default value | Buffer memory address | | | | | | | | | | |
|---|---------------|-----------------------|---|---------------|---|----------|----|------------|---|-------|---|------------------------|
| <p>■ Set with a decimal.</p> <p>Actual value Cd.16 Inching movement amount</p> <p style="text-align: center;">↓ Conversion into an integer value</p> <p style="text-align: center;">$\times 10^m$</p> <p>Setting value (Decimal) R</p> <p>● Unit conversion table (Cd.16)</p> <table border="1" style="margin-left: auto; margin-right: auto;"> <thead> <tr> <th>m</th> <th>Unit</th> </tr> </thead> <tbody> <tr> <td>1</td> <td>μm</td> </tr> <tr> <td>5</td> <td>inch</td> </tr> <tr> <td>5</td> <td>degree</td> </tr> <tr> <td>0</td> <td>PLS</td> </tr> </tbody> </table> <p style="border: 1px dashed black; padding: 5px; margin-top: 10px;">Example: When the "Cd. 16 Inching movement amount" is set as "1.0 μm", the buffer memory stores "10".</p> | m | Unit | 1 | μm | 5 | inch | 5 | degree | 0 | PLS | 0 | 4317+100n |
| m | Unit | | | | | | | | | | | |
| 1 | μm | | | | | | | | | | | |
| 5 | inch | | | | | | | | | | | |
| 5 | degree | | | | | | | | | | | |
| 0 | PLS | | | | | | | | | | | |
| <p>■ Set with a decimal.</p> <p>Actual value Cd.17 JOG speed</p> <p style="text-align: center;">↓ Conversion into an integer value</p> <p style="text-align: center;">$\times 10^m$</p> <p>Setting value (Decimal) R</p> <p>● Unit conversion table (Cd.17)</p> <table border="1" style="margin-left: auto; margin-right: auto;"> <thead> <tr> <th>m</th> <th>Unit</th> </tr> </thead> <tbody> <tr> <td>2</td> <td>mm/min</td> </tr> <tr> <td>3</td> <td>inch/min</td> </tr> <tr> <td>3*</td> <td>degree/min</td> </tr> <tr> <td>0</td> <td>PLS/s</td> </tr> </tbody> </table> <p style="font-size: small; margin-top: 5px;">*: When "Pr.83 Speed control 10 x multiplier setting for degree axis" is valid: "2"</p> <p style="border: 1px dashed black; padding: 5px; margin-top: 10px;">Example: When the "Cd. 17 JOG speed" is set as "20000.00mm/min", the buffer memory stores "2000000".</p> | m | Unit | 2 | mm/min | 3 | inch/min | 3* | degree/min | 0 | PLS/s | 0 | 4318+100n 4319+100n |
| m | Unit | | | | | | | | | | | |
| 2 | mm/min | | | | | | | | | | | |
| 3 | inch/min | | | | | | | | | | | |
| 3* | degree/min | | | | | | | | | | | |
| 0 | PLS/s | | | | | | | | | | | |
| <p>■ Set with a decimal.</p> <p>Setting value K 1</p> <p>● Interruption request continuous operation 1: Interrupts continuous operation control or continuous path control.</p> <p style="margin-top: 10px;">The Simple Motion module resets the value to "0" automatically when the continuous control interruption request is processed. (This indicates the completion of continuous operation interruption request.)</p> | 0 | 4320+100n | | | | | | | | | | |

| Setting item | Setting details | |
|--|---|--|
| [Cd.19] HPR request flag OFF request | <ul style="list-style-type: none"> The sequence program can use this data item to forcibly turn the HPR request flag from ON to OFF. <p>Fetch cycle: 14.2 [ms] [RJ010 mode] 16.0 [ms] [CiA402 mode]</p> <p><input type="checkbox"/> POINT</p> <p>This parameter is made valid when the increment system is valid.</p> | |
| [Cd.20] Manual pulse generator 1 pulse input magnification | <ul style="list-style-type: none"> This data item determines the factor by which the number of pulses from the manual pulse generator is magnified. Value "0" : read as "1". Value "10001 or more" or negative value : read as "10000". <p>Fetch cycle: Operation cycle (At manual pulse generator enabled)</p> | |
| [Cd.21] Manual pulse generator enable flag | <ul style="list-style-type: none"> This data item enables or disables operations using a manual pulse generator. <p>Fetch cycle: Operation cycle</p> | |
| [Cd.22] New torque value/ forward new torque value | <ul style="list-style-type: none"> When "0" is set to "[Cd.112] Torque change function switching request", a new torque limit value is set. (This value is set to the forward torque limit value and reverse torque limit value.) When "1" is set to "[Cd.112] Torque change function switching request", a new forward torque limit value is set. Set a value within "0" to "[Pr.17] Torque limit setting value". Set a ratio against the rated torque in percentage unit. (The new torque value is invalid when "0" is set, and "[Pr.17] Torque limit setting value" or "[Cd.101] Torque output setting value" becomes valid. The range of torque change is 1 to "[Pr.17] Torque limit setting value".) <p>Fetch cycle: Operation cycle</p> | |

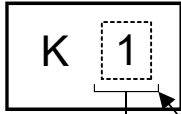
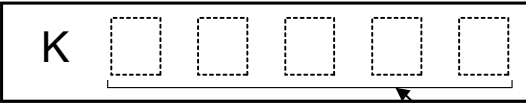
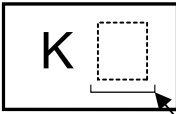
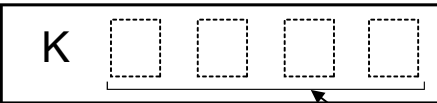
| Setting value | Default value | Buffer memory address |
|--|---------------|------------------------|
| <p>■ Set with a decimal.</p> <p>Setting value </p> <ul style="list-style-type: none"> ● HPR request flag OFF request 1: Turns the "HPR request flag" from ON to OFF. <p>The Simple Motion module resets the value to "0" automatically when the HPR request flag is turned OFF. (This indicates the completion of HPR request flag OFF request.)</p> | 0 | 4321+100n |
| <p>■ Set with a decimal.</p> <p>Setting value </p> <ul style="list-style-type: none"> ● Manual pulse generator 1 pulse input magnification 1 to 10000 | 1 | 4322+100n 4323+100n |
| <p>■ Set with a decimal.</p> <p>Setting value </p> <ul style="list-style-type: none"> ● Manual pulse generator enable flag 0: Disable manual pulse generator operation. 1: Enable manual pulse generator operation. | 0 | 4324+100n |
| <p>■ Set with a decimal.</p> <p>Setting value </p> <ul style="list-style-type: none"> ● New torque value/forward new torque value 0 to $\frac{\text{Pr.17}}{\text{Torque limit setting value}} \times 100$ (%) | 0 | 4325+100n |

n: Axis No.-1

| Setting item | Setting details | | | | | | | | | | |
|---|---|--|---|--|---|----------------|---------------|-----------------|-----------------|-----------------|-----------------|
| <p>[Cd.23] Speed-position switching control movement amount change register</p> | <ul style="list-style-type: none"> • During the speed control stage of the speed-position switching control (INC mode), it is possible to change the specification of the movement amount during the position control stage. For that, use this data item to specify a new movement amount. • The new movement amount has to be set during the speed control stage of the speed-position switching control (INC mode). • The value is reset to "0" when the next operation starts. • Set a value within the following range: <table border="1" data-bbox="587 584 1425 752"> <thead> <tr> <th>[Pr.1] Unit setting</th> <th>mm ($\times 10^{-1} \mu\text{m}$)</th> <th>inch ($\times 10^{-5} \text{inch}$)</th> <th>degree ($\times 10^{-5} \text{degree}$)</th> <th>PLS (PLS)</th> </tr> </thead> <tbody> <tr> <td>Setting range</td> <td>0 to 2147483647</td> <td>0 to 2147483647</td> <td>0 to 2147483647</td> <td>0 to 2147483647</td> </tr> </tbody> </table> <p>Fetch cycle: <u>At switching request</u></p> | [Pr.1] Unit setting | mm ($\times 10^{-1} \mu\text{m}$) | inch ($\times 10^{-5} \text{inch}$) | degree ($\times 10^{-5} \text{degree}$) | PLS (PLS) | Setting range | 0 to 2147483647 | 0 to 2147483647 | 0 to 2147483647 | 0 to 2147483647 |
| [Pr.1] Unit setting | mm ($\times 10^{-1} \mu\text{m}$) | inch ($\times 10^{-5} \text{inch}$) | degree ($\times 10^{-5} \text{degree}$) | PLS (PLS) | | | | | | | |
| Setting range | 0 to 2147483647 | 0 to 2147483647 | 0 to 2147483647 | 0 to 2147483647 | | | | | | | |
| <p>[Cd.24] Speed-position switching enable flag</p> | <ul style="list-style-type: none"> • Set whether the switching signal set in "[Cd.45] Speed-position switching device selection" is enabled or not. <p>Fetch cycle: <u>At switching request</u></p> | | | | | | | | | | |
| <p>[Cd.25] Position-speed switching control speed change register</p> | <ul style="list-style-type: none"> • During the position control stage of the position-speed switching control, it is possible to change the specification of the speed during the speed control stage. For that, use this data item to specify a new speed. • The new speed has to be set during the position control stage of the position-speed switching control. • The value is reset to "0" when the next operation starts. • The setting value range differs according to the "[Pr.1] Unit setting". <table border="1" data-bbox="587 1608 1425 1753"> <thead> <tr> <th>[Pr.1] Unit setting</th> <th>mm ($\times 10^{-2} \text{mm/min}$)</th> <th>inch ($\times 10^{-3} \text{inch/min}$)</th> <th>degree* ($\times 10^{-3} \text{degree/min}$)</th> <th>PLS (PLS/s)</th> </tr> </thead> <tbody> <tr> <td>Setting range</td> <td>0 to 2000000000</td> <td>0 to 2000000000</td> <td>0 to 2000000000</td> <td>0 to 1000000000</td> </tr> </tbody> </table> <p>*: When "[Pr.83] Speed control 10 x multiplier setting for degree axis" is valid, this will be the setting range 0 to 2000000000 ($\times 10^{-2} \text{degree/min}$).</p> <p>Fetch cycle: <u>At switching request</u></p> | [Pr.1] Unit setting | mm ($\times 10^{-2} \text{mm/min}$) | inch ($\times 10^{-3} \text{inch/min}$) | degree* ($\times 10^{-3} \text{degree/min}$) | PLS (PLS/s) | Setting range | 0 to 2000000000 | 0 to 2000000000 | 0 to 2000000000 | 0 to 1000000000 |
| [Pr.1] Unit setting | mm ($\times 10^{-2} \text{mm/min}$) | inch ($\times 10^{-3} \text{inch/min}$) | degree* ($\times 10^{-3} \text{degree/min}$) | PLS (PLS/s) | | | | | | | |
| Setting range | 0 to 2000000000 | 0 to 2000000000 | 0 to 2000000000 | 0 to 1000000000 | | | | | | | |

| Setting value | Default value | Buffer memory address | | | | | | | | | | |
|---|---------------|-----------------------|---|--------|---|----------|----|------------|---|-------|---|------------------------|
| <p>■ Set with a decimal.</p> <p>Actual value Cd.23 Speed-position switching control movement amount change register</p> <p style="text-align: center;">◇ Conversion into an integer value</p> <p style="text-align: center;">× 10^m →</p> <p>Setting value (Decimal) R</p> <div style="border: 1px dashed black; padding: 5px; margin-top: 10px;"> <p>Example: If "Cd. 23 Speed-position switching control movement amount change register" is set as "20000.0 μm", the buffer memory stores "200000".</p> </div> <div style="margin-top: 10px;"> <p>● Unit conversion table (Cd.23)</p> <table border="1" style="border-collapse: collapse; text-align: center;"> <thead> <tr> <th>m</th> <th>Unit</th> </tr> </thead> <tbody> <tr> <td>1</td> <td>μm</td> </tr> <tr> <td>5</td> <td>inch</td> </tr> <tr> <td>5</td> <td>degree</td> </tr> <tr> <td>0</td> <td>PLS</td> </tr> </tbody> </table> </div> | m | Unit | 1 | μm | 5 | inch | 5 | degree | 0 | PLS | 0 | 4326+100n 4327+100n |
| m | Unit | | | | | | | | | | | |
| 1 | μm | | | | | | | | | | | |
| 5 | inch | | | | | | | | | | | |
| 5 | degree | | | | | | | | | | | |
| 0 | PLS | | | | | | | | | | | |
| <p>■ Set with a decimal.</p> <p>Setting value K </p> <p>● Speed-position switching enable flag</p> <p>0: Speed control will not be taken over by position control even when the signal set in "Cd.45 Speed-position switching device selection" comes ON.</p> <p>1: Speed control will be taken over by position control even when the signal set in "Cd.45 Speed-position switching device selection" comes ON.</p> | 0 | 4328+100n | | | | | | | | | | |
| <p>■ Set with a decimal.</p> <p>Actual value Cd.25 Position-speed switching control speed change register</p> <p style="text-align: center;">◇ Conversion into an integer value</p> <p style="text-align: center;">× 10^m →</p> <p>Setting value (Decimal) R</p> <div style="border: 1px dashed black; padding: 5px; margin-top: 10px;"> <p>Example: If "Cd. 25 Position-speed switching control speed change register" is set as "2000.00 mm/min", the buffer memory stores "200000".</p> </div> <div style="margin-top: 10px;"> <p>● Unit conversion table (Cd.25)</p> <table border="1" style="border-collapse: collapse; text-align: center;"> <thead> <tr> <th>m</th> <th>Unit</th> </tr> </thead> <tbody> <tr> <td>2</td> <td>mm/min</td> </tr> <tr> <td>3</td> <td>inch/min</td> </tr> <tr> <td>3*</td> <td>degree/min</td> </tr> <tr> <td>0</td> <td>PLS/s</td> </tr> </tbody> </table> <p>*: When "Pr.83 Speed control 10 x multiplier setting for degree axis" is valid: "2"</p> </div> | m | Unit | 2 | mm/min | 3 | inch/min | 3* | degree/min | 0 | PLS/s | 0 | 4330+100n 4331+100n |
| m | Unit | | | | | | | | | | | |
| 2 | mm/min | | | | | | | | | | | |
| 3 | inch/min | | | | | | | | | | | |
| 3* | degree/min | | | | | | | | | | | |
| 0 | PLS/s | | | | | | | | | | | |

n: Axis No.-1

| Setting item | Setting details | | | | | | | | | | | | | | | |
|--|--|--------------------------------------|--|--------------------------------------|--|----------------|---------------|---------------------------|---------------------------|-----------------|---------------------------|-----|---------------------------|---------------------------|---------------------------|---------------------------|
| [Cd.26] Position-speed switching enable flag | <ul style="list-style-type: none"> Set whether the switching signal set in "[Cd.45] Speed-position switching device selection" is enabled or not. <p>Fetch cycle: At switching request</p> | | | | | | | | | | | | | | | |
| [Cd.27] Target position change value (New address) | <ul style="list-style-type: none"> When changing the target position during a positioning operation, use this data item to specify a new positioning address. The setting value range differs according to the "[Pr.1] Unit setting". <table border="1" data-bbox="587 797 1425 1077"> <thead> <tr> <th>[Pr.1] Unit setting</th> <th>mm ($\times 10^{-1}$ μm)</th> <th>inch ($\times 10^{-5}$ inch)</th> <th>degree ($\times 10^{-5}$ degree)</th> <th>PLS (PLS)</th> </tr> </thead> <tbody> <tr> <td>ABS</td> <td>-2147483648 to 2147483647</td> <td>-2147483648 to 2147483647</td> <td>0 to 35999999</td> <td>-2147483648 to 2147483647</td> </tr> <tr> <td>INC</td> <td>-2147483648 to 2147483647</td> <td>-2147483648 to 2147483647</td> <td>-2147483648 to 2147483647</td> <td>-2147483648 to 2147483647</td> </tr> </tbody> </table> <p>Fetch cycle: At change request</p> | [Pr.1] Unit setting | mm ($\times 10^{-1}$ μm) | inch ($\times 10^{-5}$ inch) | degree ($\times 10^{-5}$ degree) | PLS (PLS) | ABS | -2147483648 to 2147483647 | -2147483648 to 2147483647 | 0 to 35999999 | -2147483648 to 2147483647 | INC | -2147483648 to 2147483647 | -2147483648 to 2147483647 | -2147483648 to 2147483647 | -2147483648 to 2147483647 |
| [Pr.1] Unit setting | mm ($\times 10^{-1}$ μm) | inch ($\times 10^{-5}$ inch) | degree ($\times 10^{-5}$ degree) | PLS (PLS) | | | | | | | | | | | | |
| ABS | -2147483648 to 2147483647 | -2147483648 to 2147483647 | 0 to 35999999 | -2147483648 to 2147483647 | | | | | | | | | | | | |
| INC | -2147483648 to 2147483647 | -2147483648 to 2147483647 | -2147483648 to 2147483647 | -2147483648 to 2147483647 | | | | | | | | | | | | |
| [Cd.28] Target position change value (New speed) | <ul style="list-style-type: none"> When changing the target position during a positioning operation, use this data item to specify a new speed. The speed will not change if "0" is set. The setting value range differs according to the "[Pr.1] Unit setting". <table border="1" data-bbox="587 1319 1425 1473"> <thead> <tr> <th>[Pr.1] Unit setting</th> <th>mm ($\times 10^{-2}$ mm/min)</th> <th>inch ($\times 10^{-3}$ inch/min)</th> <th>degree * ($\times 10^{-3}$ degree/min)</th> <th>PLS (PLS/s)</th> </tr> </thead> <tbody> <tr> <td>Setting range</td> <td>0 to 2000000000</td> <td>0 to 2000000000</td> <td>0 to 2000000000</td> <td>0 to 1000000000</td> </tr> </tbody> </table> <p>*: When "[Pr.83] Speed control 10 x multiplier setting for degree axis" is valid, this will be the setting range 0 to 2000000000 ($\times 10^{-2}$ degree/min).</p> <p>Fetch cycle: At change request</p> | [Pr.1] Unit setting | mm ($\times 10^{-2}$ mm/min) | inch ($\times 10^{-3}$ inch/min) | degree * ($\times 10^{-3}$ degree/min) | PLS (PLS/s) | Setting range | 0 to 2000000000 | 0 to 2000000000 | 0 to 2000000000 | 0 to 1000000000 | | | | | |
| [Pr.1] Unit setting | mm ($\times 10^{-2}$ mm/min) | inch ($\times 10^{-3}$ inch/min) | degree * ($\times 10^{-3}$ degree/min) | PLS (PLS/s) | | | | | | | | | | | | |
| Setting range | 0 to 2000000000 | 0 to 2000000000 | 0 to 2000000000 | 0 to 1000000000 | | | | | | | | | | | | |
| [Cd.29] Target position change request flag | <ul style="list-style-type: none"> Requests a change in the target position during a positioning operation. <p>Fetch cycle: Operation cycle</p> | | | | | | | | | | | | | | | |

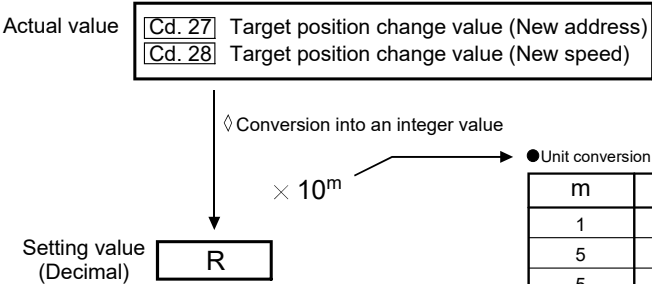
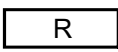
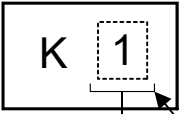
| Setting value | Default value | Buffer memory address | | | | | | | | | | |
|---|---------------|-----------------------|---|---------------|---|----------|-----|------------|---|-------|---|------------------------|
| <p>■ Set with a decimal.</p> <p>Setting value </p> <p>● Position-speed switching enable flag 0: Position control will not be taken over by speed control even when the signal set in "[Cd.45]Speed-position switching device selection" comes ON. 1: Position control will be taken over by speed control when the signal set in "[Cd.45]Speed-position switching device selection" comes ON.</p> | 0 | 4332+100n | | | | | | | | | | |
| <p>■ Set with a decimal.</p> <p>Actual value </p> <p>◇ Conversion into an integer value $\times 10^m$</p> <p>● Unit conversion table ([Cd.27])</p> <table border="1" data-bbox="737 1016 959 1173"> <thead> <tr> <th>m</th> <th>Unit</th> </tr> </thead> <tbody> <tr> <td>1</td> <td>μm</td> </tr> <tr> <td>5</td> <td>inch</td> </tr> <tr> <td>5</td> <td>degree</td> </tr> <tr> <td>0</td> <td>PLS</td> </tr> </tbody> </table> <p>Setting value (Decimal) </p> | m | Unit | 1 | μm | 5 | inch | 5 | degree | 0 | PLS | 0 | 4334+100n 4335+100n |
| m | Unit | | | | | | | | | | | |
| 1 | μm | | | | | | | | | | | |
| 5 | inch | | | | | | | | | | | |
| 5 | degree | | | | | | | | | | | |
| 0 | PLS | | | | | | | | | | | |
| <p>Example: If "[Cd. 28] Target position change value (New speed)" is set as "10000.00 mm/min", the buffer memory stores "1000000".</p> <p>● Unit conversion table ([Cd.28])</p> <table border="1" data-bbox="737 1234 959 1391"> <thead> <tr> <th>m</th> <th>Unit</th> </tr> </thead> <tbody> <tr> <td>2</td> <td>mm/min</td> </tr> <tr> <td>3</td> <td>inch/min</td> </tr> <tr> <td>3 *</td> <td>degree/min</td> </tr> <tr> <td>0</td> <td>PLS/s</td> </tr> </tbody> </table> <p>*: When "[Pr.83] Speed control 10 x multiplier setting for degree axis" is valid: "2"</p> | m | Unit | 2 | mm/min | 3 | inch/min | 3 * | degree/min | 0 | PLS/s | 0 | 4336+100n 4337+100n |
| m | Unit | | | | | | | | | | | |
| 2 | mm/min | | | | | | | | | | | |
| 3 | inch/min | | | | | | | | | | | |
| 3 * | degree/min | | | | | | | | | | | |
| 0 | PLS/s | | | | | | | | | | | |
| <p>■ Set with a decimal.</p> <p>Setting value </p> <p>● Target position change request flag 1: Requests a change in the target position</p> <p>The Simple Motion module resets the value to "0" automatically when the new target position value has been written. (This indicates the completion of target position change request.)</p> | 0 | 4338+100n | | | | | | | | | | |

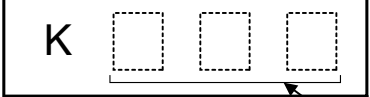
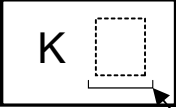
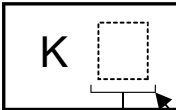

n: Axis No.-1

| Setting item | Setting details | |
|---|---|--|
| [Cd.30] Simultaneous starting own axis start data No. | <ul style="list-style-type: none"> Use these data items to specify a start data No. of own axis at multiple axes simultaneous starting. <u>Fetch cycle: At start</u> | |
| [Cd.31] Simultaneous starting axis start data No.1 | <ul style="list-style-type: none"> Use these data items to specify a start data No.1 for each axis that has to start simultaneously. <u>Fetch cycle: At start</u> | |
| [Cd.32] Simultaneous starting axis start data No.2 | <ul style="list-style-type: none"> Use these data items to specify a start data No.2 for each axis that has to start simultaneously. Note) For 2 axis simultaneous starting, the axis setting is not required. (Setting value is ignored.) <u>Fetch cycle: At start</u> | |
| [Cd.33] Simultaneous starting axis start data No.3 | <ul style="list-style-type: none"> Use these data items to specify a start data No.3 for each axis that has to start simultaneously. Note) For 2 axis simultaneous starting and 3 axis simultaneous starting, the axis setting is not required. (Setting value is ignored.) <u>Fetch cycle: At start</u> | |
| [Cd.34] Step mode | <ul style="list-style-type: none"> To perform a step operation, use this data item to specify the units by which the stepping should be performed. <u>Fetch cycle: At start</u> | |
| [Cd.35] Step valid flag | <ul style="list-style-type: none"> This data item validates or invalidates step operations. <u>Fetch cycle: At start</u> | |
| [Cd.36] Step start information | <ul style="list-style-type: none"> To continue the step operation when the step function is used, set "1" in the data item. <u>Fetch cycle: 14.2 [ms] [RJ010 mode]</u> <u>16.0 [ms] [CiA402 mode]</u> | |

| Setting value | Default value | Buffer memory address |
|--|---------------|-----------------------|
| | 0 | 4340+100n |
| <p>■ Set with a decimal.</p> | 0 | 4341+100n |
| <p>Setting value</p>  <div data-bbox="719 689 959 864" style="border: 1px solid black; padding: 5px;"> <p>Cd.30 Simultaneous starting own axis start data No.</p> <p>Cd.31 to Cd.33 Simultaneous starting axis start data No. 1 to 600</p> </div> | 0 | 4342+100n |
| | 0 | 4343+100n |
| <p>■ Set with a decimal.</p> | 0 | 4344+100n |
| <p>Setting value</p>  <div data-bbox="596 1317 890 1384" style="border: 1px solid black; padding: 5px;"> <p>● Step mode 0: Stepping by deceleration units 1: Stepping by data No. units</p> </div> | 0 | 4345+100n |
| <p>Setting value</p>  <div data-bbox="580 1816 831 1868" style="border: 1px solid black; padding: 5px;"> <p>● Step valid flag 0: Invalidates step operations 1: Validates step operations</p> </div> <div data-bbox="368 1816 900 1980" style="border: 1px solid black; padding: 5px; margin-top: 10px;"> <p>● Step start information 1: Continues step operation</p> <p>The Simple Motion module resets the value to "0" automatically when processing of the step start request completes.</p> </div> | 0 | 4346+100n |

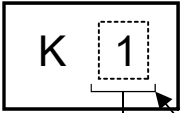

n: Axis No.-1

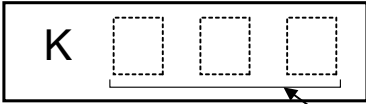
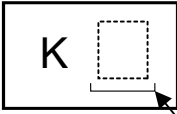
| Setting item | Setting details | |
|---------------------------------------|--|--|
| [Cd.37] Skip command | <ul style="list-style-type: none"> To skip the current positioning operation, set "1" in this data item. <p><u>Fetch cycle: Operation cycle (During positioning operation)</u></p> | |
| [Cd.38] Teaching data selection | <ul style="list-style-type: none"> This data item specifies the teaching result write destination. Data are cleared to zero when the teaching ends. <p><u>Fetch cycle: At operation request</u></p> | |
| [Cd.39] Teaching positioning data No. | <ul style="list-style-type: none"> This data item specifies data to be produced by teaching. If a value between 1 and 600 is set, a teaching operation is done. The value is cleared to "0" when the Simple Motion module is initialized, when a teaching operation completes, and when an illegal value (601 or higher) is entered. <p><u>Fetch cycle: 103 [ms] [RJ010 mode]</u> <u>116 [ms] [CiA402 mode]</u></p> | |
| [Cd.40] ABS direction in degrees | <ul style="list-style-type: none"> This data item specifies the ABS moving direction carrying out the position control when "degree" is selected as the unit. <p><u>Fetch cycle: At start</u></p> | |

| Setting value | Default value | Buffer memory address |
|--|---------------|-----------------------|
| <p>■ Set with a decimal.</p> <p>Setting value</p>  <ul style="list-style-type: none"> ● Skip request 1: Issues a skip request to have the machine decelerate, stop, and then start the next positioning operation. <p>The Simple Motion module resets the value to "0" automatically when processing of the skip request completes.</p> | 0 | 4347+100n |
| <p>■ Set with a decimal.</p> <p>Setting value</p>  <ul style="list-style-type: none"> ● Teaching data selection 0: Takes the feed current value as a positioning address. 1: Takes the feed current value as an arc data. | 0 | 4348+100n |
| <p>■ Set with a decimal.</p> <p>Setting value</p>  <ul style="list-style-type: none"> ● Teaching positioning data No. 1 to 600 | 0 | 4349+100n |
| <p>■ Set with a decimal.</p> <p>Setting value</p>  <ul style="list-style-type: none"> ● ABS direction in degrees 0: Takes a shortcut. (Specified direction ignored.) 1: ABS circular right 2: ABS circular left | 0 | 4350+100n |

n: Axis No.-1

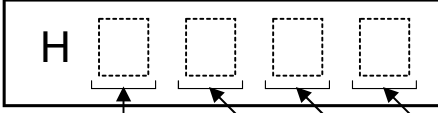
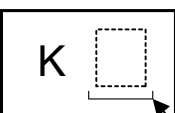
| Setting item | Setting details | |
|---|---|--|
| [Cd.43] Simultaneous starting axis | <ul style="list-style-type: none"> • Set the number of simultaneous starting axes and target axis. When "2" is set to the number of simultaneous starting axes, set the target axis No. to the simultaneous starting axis No. 1. When "3" is set to the number of simultaneous starting axes, set the target axis No. to the simultaneous starting axis No.1 and 2. When "4" is set to the number of simultaneous starting axes, set the target axis No. to the simultaneous starting axis No.1 to 3. • When the same axis No. or axis No. of own axis is set to the multiple simultaneous starting axis No, or the value outside the range is set to the number of simultaneous starting axes, the error "Error before simultaneous start" (error code: 501) occurs, and the operation is not executed. <p>Note) Do not set the simultaneous starting axis No.2 and 3 for 2-axis interpolation, and do not set the simultaneous starting axis No.3 for 3-axis interpolation. The setting value is ignored.</p> <p><u>Fetch cycle: At start</u></p> | |
| [Cd.45] Speed-position switching device selection | <ul style="list-style-type: none"> • Select the device used for speed-position switching. <p>Note) If the setting is outside the range at start, operation is performed with the setting regarded as "0".</p> <p><u>Fetch cycle: At positioning start for speed-position switching control/position-speed switching control</u></p> | |
| [Cd.46] Speed-position switching command | <ul style="list-style-type: none"> • Speed-position control switching is performed when "2" is set in "[Cd.45] Speed-position switching device selection". Other than setting value is ignored. <p>Note) This parameter is made valid only when "2" is set in "[Cd.45] Speed-position switching device selection" at start.</p> <p><u>Fetch cycle: Operation cycle</u></p> | |
| [Cd.100] Servo OFF command | <ul style="list-style-type: none"> • Executes servo OFF for each axis. <p><u>Fetch cycle: Operation cycle</u></p> <p>POINT</p> <p>To execute servo ON for axes other than axis 1 being servo OFF, write "1" to storage buffer memory address of axis 1 and then turn ON all axis servo ON [Y1] signal.</p> | |

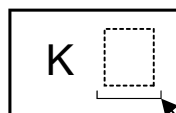
| Setting value | Default value | Buffer memory address |
|---|---------------|-----------------------|
| <p>■ Set with a hexadecimal.</p> <p>Setting value</p>  <ul style="list-style-type: none"> ● Simultaneous starting axis No.1 0 to F: Axis 1 to Axis 16 ● Simultaneous starting axis No.2 0 to F: Axis 1 to Axis 16 ● Simultaneous starting axis No.3 0 to F: Axis 1 to Axis 16 ● Number of simultaneous starting axes 2 to 4: 2 axes to 4 axes | 0000H | 4339+100n |
| <p>■ Set with a decimal.</p> <p>Setting value</p>  <ul style="list-style-type: none"> ● Speed-position switching device selection <Speed-position switching control> 0: Use the external command signal for switching from speed control to position control 1: Use the proximity dog signal for switching from speed control to position control 2: Use "[Cd.46]Speed-position switching command" for switching from speed control to position control <Position-speed switching control> 0: Use the external command signal for switching from position control to speed control 1: Use the proximity dog signal for switching from position control to speed control 2: Use "[Cd.46]Speed-position switching command" for switching from position control to speed control | 0 | 4366+100n |
| <p>■ Set with a decimal.</p> <p>Setting value</p>  <ul style="list-style-type: none"> ● Speed-position switching command <Speed-position switching control> 0: Not switch from speed control to position control 1: Switch from speed control to position control <Position-speed switching control> 0: Not switch from position control to speed control 1: Switch from position control to speed control | 0 | 4367+100n |
| <p>■ Set with a decimal.</p> <p>Setting value</p>  <ul style="list-style-type: none"> ● Servo OFF command 0: Servo ON 1: Servo OFF <p>Valid only during servo ON for all axes.</p> | 0 | 4351+100n |

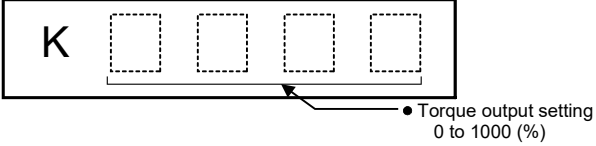
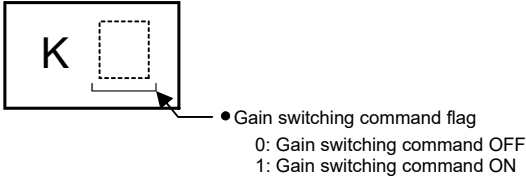
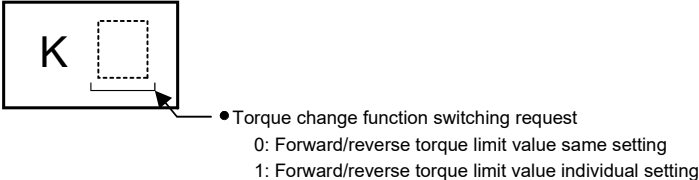
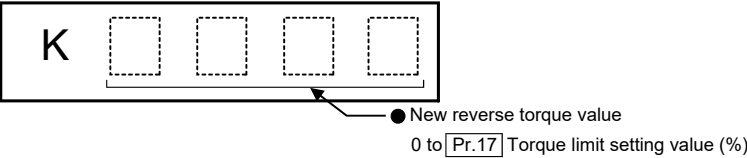
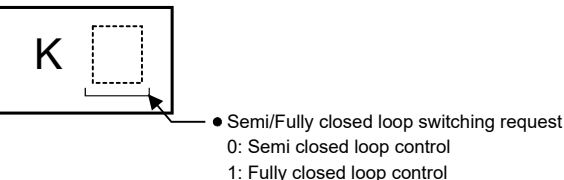

n: Axis No.-1

| Setting item | Setting details |
|---|--|
| [Cd.101] Torque output setting value | <ul style="list-style-type: none"> • Sets the torque output value. Set a ratio against the rated torque in percentage unit. <p><u>Fetch cycle: At start</u></p> <p>POINT</p> <ul style="list-style-type: none"> • If the "[Cd.101] Torque output setting value" is "0", the "[Pr.17] Torque limit setting value" will be its value. • If a value beside "0" is set in the "[Cd.101] Torque output setting value", the torque generated by the servomotor will be limited by that value. • The "[Pr.17] Torque limit setting value" of the detailed parameter becomes effective at the PLC ready signal rising edge. • The "[Cd.101] Torque output setting value" (refer to the start) axis control data can be changed at all times. Therefore in the "[Cd.101] Torque output setting value" is used when you must change. (Refer to Section 13.5.4 "Torque change function".) |
| [Cd.108] Gain switching command flag | <ul style="list-style-type: none"> • The command required to carry out "gain switching" of the servo amplifier from the Simple Motion module. <p><u>Fetch cycle: Operation cycle</u></p> <p>POINT</p> <ul style="list-style-type: none"> • If the setting is other than "0" and "1", operation is performed in the "gain switching" with the setting regard as "0". (Refer to each servo amplifier instruction manual.) |
| [Cd.112] Torque change function switching request | <ul style="list-style-type: none"> • Sets "same setting/individual setting" of the forward torque limit value or reverse torque limit value in the torque change function. <p><u>Fetch cycle: Operation cycle</u></p> <p>POINT</p> <ul style="list-style-type: none"> • Set "0" normally. (when the forward torque limit value and reverse torque limit value are not divided.) • When a value except "1" is set, it operates as "forward/reverse torque limit value same setting". |
| [Cd.113] New reverse torque value | <ul style="list-style-type: none"> • "1" is set in "[Cd.112] Torque change function switching request", a new reverse torque limit value is set. (when "0" is set in "[Cd.112] Torque change function switching request", the setting value is invalid.) • Set a value within "0" to "[Pr.17] Torque limit setting value". Set a ratio against the rated torque in percentage unit. (The new torque value is invalid when "0" is set, and "[Pr.17] Torque limit setting value" or "[Cd.101] Torque output setting value" becomes valid. The range of torque change is 1 to "[Pr.17] Torque limit setting value".) <p><u>Fetch cycle: Operation cycle</u></p> |
| [Cd.133] Semi/Fully closed loop switching request | <ul style="list-style-type: none"> • Set the switching of semi closed control and fully closed control. <p><u>Fetch cycle: Operation cycle (Fully closed loop control servo amplifier only)</u></p> |

| Setting value | Default value | Buffer memory address |
|---|---------------|-----------------------|
| <p>■ Set with a decimal.</p> <p>Setting value</p>  <p>● Torque output setting 0 to 1000 (%)</p> | 0 | 4352+100n |
| <p>■ Set with a decimal.</p> <p>Setting value</p>  <p>● Gain switching command flag 0: Gain switching command OFF 1: Gain switching command ON</p> | 0 | 4359+100n |
| <p>■ Set with a decimal.</p> <p>Setting value</p>  <p>● Torque change function switching request 0: Forward/reverse torque limit value same setting 1: Forward/reverse torque limit value individual setting</p> | 0 | 4363+100n |
| <p>■ Set with a decimal.</p> <p>Setting value</p>  <p>● New reverse torque value 0 to [Pr.17] Torque limit setting value (%)</p> | 0 | 4364+100n |
| <p>■ Set with a decimal.</p> <p>Setting value</p>  <p>● Semi/Fully closed loop switching request 0: Semi closed loop control 1: Fully closed loop control</p> | 0 | 4358+100n |

n: Axis No.-1

| Setting item | Setting details | | | | | | | | | | | |
|--|--|--------------------------------------|---|--------------------------------------|---|----------------|---------------|---------------------------|---------------------------|---------------------------|---------------------------|--|
| [Cd.136] PI-PID switching request | <ul style="list-style-type: none"> Set the PI-PID switching to servo amplifier. <p><u>Fetch cycle: Operation cycle</u></p> | | | | | | | | | | | |
| [Cd.138] Control mode switching request | <ul style="list-style-type: none"> Request the control mode switching. Set "1" after setting "[Cd.139] Control mode setting". The Simple Motion module sets "0" at completion of control mode switching. <p><u>Fetch cycle: Operation cycle</u></p> | | | | | | | | | | | |
| [Cd.139] Control mode setting | <ul style="list-style-type: none"> Set the control mode to be changed in the speed-torque control. <p><u>Fetch cycle: At control mode switching</u></p> | | | | | | | | | | | |
| [Cd.140] Command speed at speed control mode | <ul style="list-style-type: none"> Set the command speed at speed control mode. The setting value range differs according to the "[Pr. 1] Unit setting". <table border="1" data-bbox="582 1281 1428 1451"> <thead> <tr> <th>[Pr.1] Unit setting</th> <th>mm ($\times 10^{-2}$ mm/min)</th> <th>inch ($\times 10^{-3}$ inch/min)</th> <th>degree* ($\times 10^{-3}$ degree/min)</th> <th>PLS (PLS/s)</th> </tr> </thead> <tbody> <tr> <td>Setting range</td> <td>-2000000000 to 2000000000</td> <td>-2000000000 to 2000000000</td> <td>-2000000000 to 2000000000</td> <td>-1000000000 to 1000000000</td> </tr> </tbody> </table> <p>* : When "[Pr.83] Speed control 10 x multiplier setting for degree axis" is valid, this will be the setting range -2000000000 to 2000000000 ($\times 10^{-2}$ degree/min).</p> <p><u>Fetch cycle: Operation cycle (At speed control mode)</u></p> | [Pr.1] Unit setting | mm ($\times 10^{-2}$ mm/min) | inch ($\times 10^{-3}$ inch/min) | degree* ($\times 10^{-3}$ degree/min) | PLS (PLS/s) | Setting range | -2000000000 to 2000000000 | -2000000000 to 2000000000 | -2000000000 to 2000000000 | -1000000000 to 1000000000 | |
| [Pr.1] Unit setting | mm ($\times 10^{-2}$ mm/min) | inch ($\times 10^{-3}$ inch/min) | degree* ($\times 10^{-3}$ degree/min) | PLS (PLS/s) | | | | | | | | |
| Setting range | -2000000000 to 2000000000 | -2000000000 to 2000000000 | -2000000000 to 2000000000 | -1000000000 to 1000000000 | | | | | | | | |
| [Cd.141] Acceleration time at speed control mode | <ul style="list-style-type: none"> Set the acceleration time at speed control mode. (Set the time for the speed to increase from "0" to "[Pr.8] Speed limit value".) 0 to 65535 (ms) <p><u>Fetch cycle: At control mode switching</u></p> | | | | | | | | | | | |

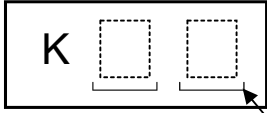
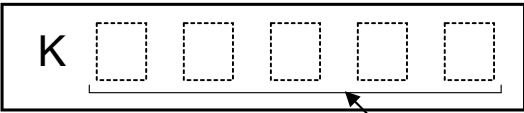
| | Setting value | Default value | Buffer memory address | | | | | | | | | |
|--|---------------|---------------|-----------------------|--------|---|----------|----|------------|---|-------|---|------------------------|
| <p>■ Set with a decimal.</p> <p>Setting value</p>  <p>● PI-PID switching request 1 : PID control switching request Other than 1: Not request</p> | 0 | 4365+100n | | | | | | | | | | |
| <p>■ Set with a decimal.</p> <p>Setting value</p>  <p>● Control mode switching request 1 : Switching request Other than 1: Not request</p> | 0 | 4374+100n | | | | | | | | | | |
| <p>■ Set with a decimal.</p> <p>Setting value</p>  <p>● Control mode setting 0: Position control mode 10: Speed control mode 20: Torque control mode</p> | 0 | 4375+100n | | | | | | | | | | |
| <p>■ Set with a decimal.</p> <p>Actual value</p> <div style="border: 1px solid black; padding: 2px; display: inline-block;">Cd.140 Command speed at speed control mode</div> <p>◇ Conversion into an integer value</p> <p>Setting value</p> <div style="border: 1px solid black; padding: 2px; display: inline-block;">R</div> <p>× 10^m</p> <p>● Unit conversion table ([Cd.140])</p> <table border="1" data-bbox="727 1352 951 1509"> <thead> <tr> <th>m</th> <th>Unit</th> </tr> </thead> <tbody> <tr> <td>2</td> <td>mm/min</td> </tr> <tr> <td>3</td> <td>inch/min</td> </tr> <tr> <td>3*</td> <td>degree/min</td> </tr> <tr> <td>0</td> <td>PLS/s</td> </tr> </tbody> </table> <p>*: When " Pr.83 Speed control 10 x multiplier setting for degree axis" is valid: "2"</p> | m | Unit | 2 | mm/min | 3 | inch/min | 3* | degree/min | 0 | PLS/s | 0 | 4376+100n 4377+100n |
| m | Unit | | | | | | | | | | | |
| 2 | mm/min | | | | | | | | | | | |
| 3 | inch/min | | | | | | | | | | | |
| 3* | degree/min | | | | | | | | | | | |
| 0 | PLS/s | | | | | | | | | | | |
| <p>■ Set with a decimal.</p> <p>Setting value</p>  <p>● Acceleration time at speed control mode (ms) 0 to 65535</p> | 1000 | 4378+100n | | | | | | | | | | |



n: Axis No.-1

| Setting item | Setting details | | | | | | | | | | |
|---|---|--------------------------------------|---|--------------------------------------|---|----------------|---------------|-----------------|-----------------|-----------------|-----------------|
| [Cd.142] Deceleration time at speed control mode | <ul style="list-style-type: none"> Set the deceleration time at speed control mode. (Set the time for the speed to decrease from "[Pr.8] Speed limit value" to "0".) 0 to 65535 (ms) <p><u>Fetch cycle: At control mode switching</u></p> | | | | | | | | | | |
| [Cd.143] Command torque at torque control mode | <ul style="list-style-type: none"> Set the command torque at torque control mode. Set a ratio against the rated torque in percentage unit. -10000 to 10000 (×0.1%) <p><u>Fetch cycle: Operation cycle (At torque control mode)</u></p> | | | | | | | | | | |
| [Cd.144] Torque time constant at torque control mode (Forward direction) | <ul style="list-style-type: none"> Set the time constant at driving during torque control mode. (Set the time for the torque to increase from "0" to "[Pr.17] Torque limit setting value".) 0 to 65535 (ms) <p><u>Fetch cycle: At control mode switching</u></p> | | | | | | | | | | |
| [Cd.145] Torque time constant at torque control mode (Negative direction) | <ul style="list-style-type: none"> Set the time constant at regeneration during torque control mode. (Set the time for the torque to decrease from "[Pr.17] Torque limit setting value" to "0".) 0 to 65535 (ms) <p><u>Fetch cycle: At control mode switching</u></p> | | | | | | | | | | |
| [Cd.146] Speed limit value at torque control mode | <ul style="list-style-type: none"> Set the speed limit value at torque control mode. The setting value range differs according to the "[Pr.1] Unit setting". <table border="1" data-bbox="584 1518 1426 1666"> <thead> <tr> <th>[Pr.1] Unit setting</th> <th>mm (×10⁻² mm/min)</th> <th>inch (×10⁻³ inch/min)</th> <th>degree* (×10⁻³ degree/min)</th> <th>PLS (PLS/s)</th> </tr> </thead> <tbody> <tr> <td>Setting range</td> <td>0 to 2000000000</td> <td>0 to 2000000000</td> <td>0 to 2000000000</td> <td>0 to 1000000000</td> </tr> </tbody> </table> <p>*: When "[Pr.83] Speed control 10 x multiplier setting for degree axis" is valid, this will be the setting range 0 to 2000000000 (×10⁻²degree/min).</p> <p><u>Fetch cycle: Operation cycle (At torque control mode)</u></p> | [Pr.1] Unit setting | mm (×10 ⁻² mm/min) | inch (×10 ⁻³ inch/min) | degree* (×10 ⁻³ degree/min) | PLS (PLS/s) | Setting range | 0 to 2000000000 | 0 to 2000000000 | 0 to 2000000000 | 0 to 1000000000 |
| [Pr.1] Unit setting | mm (×10 ⁻² mm/min) | inch (×10 ⁻³ inch/min) | degree* (×10 ⁻³ degree/min) | PLS (PLS/s) | | | | | | | |
| Setting range | 0 to 2000000000 | 0 to 2000000000 | 0 to 2000000000 | 0 to 1000000000 | | | | | | | |

| | Setting value | Default value | Buffer memory address | | | | | | | | | |
|---|---------------|---------------|-----------------------|--------|---|----------|----|------------|---|-------|---|------------------------|
| <p>■ Set with a decimal.</p> <p>Setting value</p> <div style="border: 1px solid black; padding: 5px; display: inline-block;"> K </div> <p style="margin-left: 300px;">● Deceleration time at speed control mode (ms) 0 to 65535</p> | 1000 | 4379+100n | | | | | | | | | | |
| <p>■ Set with a decimal.</p> <p>Setting value</p> <div style="border: 1px solid black; padding: 5px; display: inline-block;"> K </div> <p style="margin-left: 300px;">● Command torque at torque control mode(x0.1%) -10000 to 10000</p> | 0 | 4380+100n | | | | | | | | | | |
| <p>■ Set with a decimal.</p> <p>Setting value</p> <div style="border: 1px solid black; padding: 5px; display: inline-block;"> K </div> <p style="margin-left: 300px;">● Torque time constant at torque control mode (Forward direction) (ms) 0 to 65535</p> | 1000 | 4381+100n | | | | | | | | | | |
| <p>■ Set with a decimal.</p> <p>Setting value</p> <div style="border: 1px solid black; padding: 5px; display: inline-block;"> K </div> <p style="margin-left: 300px;">● Torque time constant at torque control mode (Negative direction) (ms) 0 to 65535</p> | 1000 | 4382+100n | | | | | | | | | | |
| <p>■ Set with a decimal.</p> <p>Actual value</p> <div style="border: 1px solid black; padding: 5px; display: inline-block; margin-bottom: 10px;"> [Cd.146] Speed limit value at torque control mode </div> <p style="margin-left: 100px;">◇ Conversion into an integer value</p> <p style="margin-left: 150px;">$\times 10^m$</p> <p>Setting value</p> <div style="border: 1px solid black; padding: 5px; display: inline-block; margin-left: 100px;">R</div> <div style="margin-left: 150px;"> <p>● Unit conversion table ([Cd.146])</p> <table border="1" style="border-collapse: collapse; text-align: center;"> <thead> <tr> <th>m</th> <th>Unit</th> </tr> </thead> <tbody> <tr> <td>2</td> <td>mm/min</td> </tr> <tr> <td>3</td> <td>inch/min</td> </tr> <tr> <td>3*</td> <td>degree/min</td> </tr> <tr> <td>0</td> <td>PLS/s</td> </tr> </tbody> </table> <p>※: When "[Pr.83] Speed control 10 x multiplier setting for degree axis" is valid: "2"</p> </div> | m | Unit | 2 | mm/min | 3 | inch/min | 3* | degree/min | 0 | PLS/s | 1 | 4384+100n 4385+100n |
| m | Unit | | | | | | | | | | | |
| 2 | mm/min | | | | | | | | | | | |
| 3 | inch/min | | | | | | | | | | | |
| 3* | degree/min | | | | | | | | | | | |
| 0 | PLS/s | | | | | | | | | | | |

n: Axis No.-1

| Setting item | Setting details |
|-------------------------------------|---|
| [Cd.180] Axis stop | <ul style="list-style-type: none"> • When the axis stop signal turns ON, the HPR control, positioning control, JOG operation, inching operation, manual pulse generator operation, speed-torque control, etc. will stop. • By turning the axis stop signal ON during positioning operation, the positioning operation will be "stopped". • Whether to decelerate stop or rapidly stop can be selected with "[Pr.39] Stop group 3 rapid stop selection". • During interpolation control of the positioning operation, if the axis stop signal of any axis turns ON, all axes in the interpolation control will decelerate and stop. <p><u>Fetch cycle: Operation cycle</u></p> |
| [Cd.181] Forward run JOG start | <ul style="list-style-type: none"> • When the JOG start signal is ON, JOG operation will be carried out at the "[Cd.17] JOG speed". When the JOG start signal turns OFF, the operation will decelerate and stop. |
| [Cd.182] Reverse run JOG start | <ul style="list-style-type: none"> • When inching movement amount is set, the designated movement amount is output for one operation cycle and then the operation stops. <p><u>Fetch cycle: Operation cycle</u></p> |
| [Cd.183] Execution prohibition flag | <ul style="list-style-type: none"> • If the execution prohibition flag is ON when the positioning start signal turns ON, positioning control does not start until the execution prohibition flag turns OFF. Used with the "Pre-reading start function". (Refer to Section 13.7.7) <p><u>Fetch cycle: At start</u></p> |

| Setting value | Default value | Buffer memory address |
|---|---------------|-----------------------|
| <p>■ Set with a decimal.</p> <p>Setting value</p>  <ul style="list-style-type: none"> ● Axis stop 1 : Axis stop requested Other than 1: Axis stop not requested | 0 | 30100+10n |
| <p>■ Set with a decimal.</p> <p>Setting value</p>  <ul style="list-style-type: none"> ● Forward run JOG start/Reverse run JOG start 1 : JOG started Other than 1: JOG not started | 0 | 30101+10n |
| | 0 | 30102+10n |
| <p>■ Set with a decimal.</p> <p>Setting value</p>  <ul style="list-style-type: none"> ● Execution prohibition flag 1 : During execution prohibition Other than 1: Not during execution prohibition | 0 | 30103+10n |

n: Axis No.-1

Chapter 6 Sequence Program Used for Positioning Control

The programs required to carry out positioning control with the Simple Motion module are explained in this chapter.

The sequence program required for control is created allowing for the "start conditions", "start time chart", "device settings" and general control configuration. (The parameters, positioning data, block start data and condition data, etc., must be set in the Simple Motion module according to the control to be executed, and program for setting the control data or a program for starting the various controls must be created.)

The first half of this chapter explains the program configuration of general control, and the latter half explains the program details. Create the required program while referring to the various control details explained in "Section 2", and to Chapter 5 "Data Used for Positioning Control".

| | | |
|-------|---|------|
| 6.1 | Precautions for creating program | 6- 2 |
| 6.2 | List of devices used | 6- 5 |
| 6.3 | Creating a program | 6-16 |
| 6.3.1 | General configuration of program | 6-16 |
| 6.3.2 | Positioning control operation program | 6-17 |
| 6.4 | Positioning program examples [RJ010 mode] | 6-21 |
| 6.5 | Program details | 6-53 |
| 6.5.1 | Initialization program..... | 6-53 |
| 6.5.2 | Start details setting program | 6-54 |
| 6.5.3 | Start program | 6-56 |
| 6.5.4 | Continuous operation interrupt program | 6-68 |
| 6.5.5 | Restart program..... | 6-70 |
| 6.5.6 | Stop program | 6-73 |

6.1 Precautions for creating program

The common precautions to be taken when writing data from the PLC CPU to the buffer memory of Simple Motion module are described below.

When diverting any of the program examples introduced in this manual to the actual system, fully verify that there are no problems in the controllability of the target system.

(1) Reading/writing the data

Setting the data explained in this chapter (various parameters, positioning data, block start data) should be set using GX Works2.

When set with the sequence program, many sequence programs and devices must be used. This will not only complicate the program, but will also increase the scan time.

When rewriting the positioning data during continuous path control or continuous positioning control, rewrite the data four positioning data items before the actual execution. If the positioning data is not rewritten before the positioning data four items earlier is executed, the process will be carried out as if the data was not rewritten.

(2) Restrictions to speed change execution interval

Provide an interval of 100ms or more when changing the speed or performing override function with the Simple Motion module.

(3) Process during overrun

Overrun is prevented by the setting of the upper and lower stroke limits with the detailed parameter 1.

However, this applies only when the Simple Motion module is operating correctly. It is recommended to create an external circuit including a boundary limit switch to ensure the whole system safety as follows: the external circuit that turns OFF the main circuit power of the servo amplifier when the boundary limit switch operates.

(4) System configuration

Refer to Section 6.2 for the application of the devices to be used.

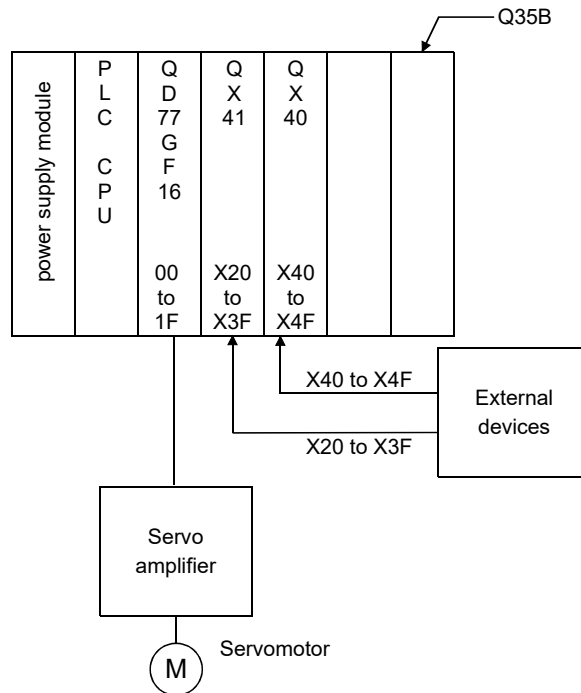

(5) Control unit

In the program, the unit of "0: mm, 2: degree" is set for the basic parameter 1.

(6) Communication with the Simple Motion module

There are two methods for communication with the Simple Motion module using the sequence program: a method using an "intelligent function device" and a method using a FROM/TO command.

In the sequence program in this chapter and subsequent, the program example using the "intelligent function device" is shown without using a FROM/TO command for communication with the Simple Motion module.

When using the FROM/TO command for communication with the Simple Motion module, change the circuit incorporating the "intelligent function device" as follows.

(a) When the circuit uses the "intelligent function device" on the destination (D) side of a MOV command, change the command to a TO command.

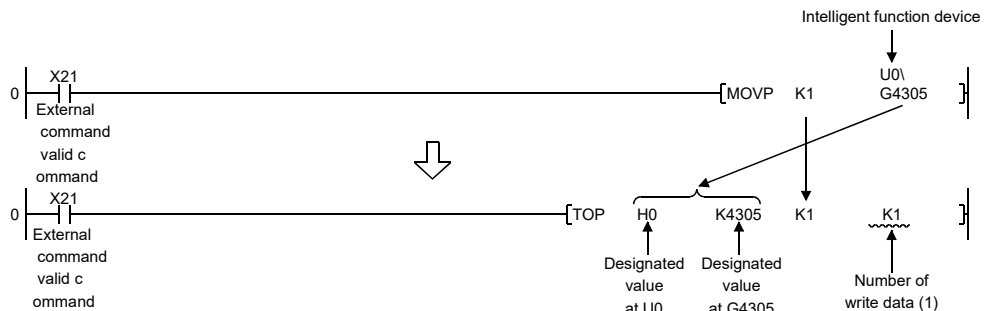

(b) When the circuit uses the "intelligent function device" on the source(s) side and the destination (D) side of a MOV command, change the command to a FROM command and a TO command.

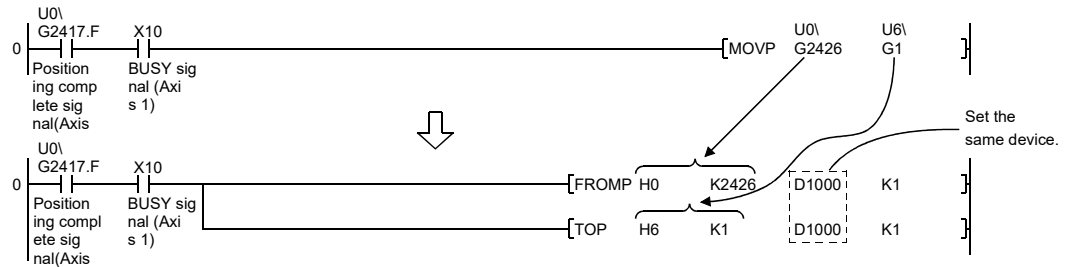

(c) When the circuit uses the "intelligent function device" for a COMPARISON command, change the command to a FROM command and a COMPARISON command.

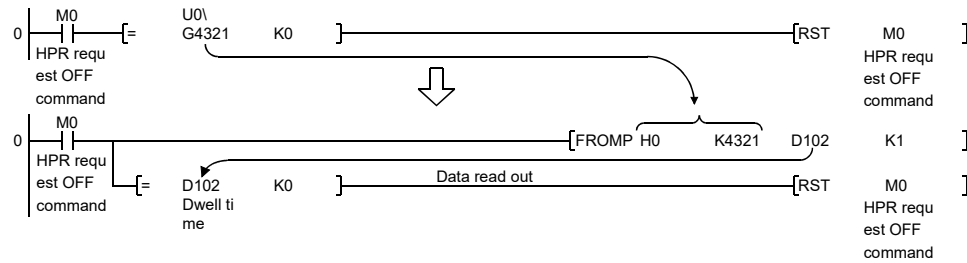

(d) When the circuit uses the "intelligent function device" for a WAND command, change the command to a FROM command and a WAND command.

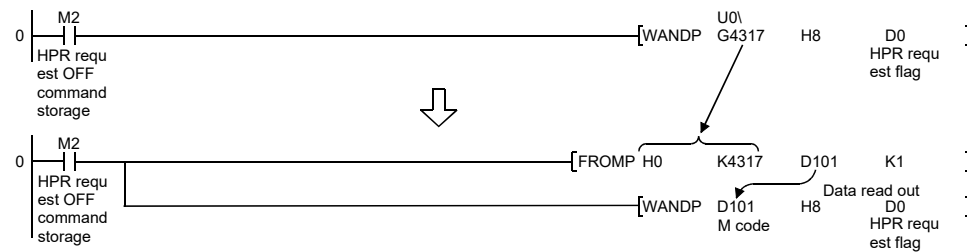

REMARK

Refer to the "QnUCPU User's Manual (Function Explanation, Program Fundamentals)" for the intelligent function devices.

Refer to the "MELSEC-Q/L Programming Manual (Common Instructions)" for detail commands used in those programs shown in this chapter and subsequent.

6.2 List of devices used

In the sequence programs using QD77GF16 shown in this chapter and subsequent, the application of the devices used are as follows.

The I/O numbers for Simple Motion module indicate those when the head I/O number is set to "0H".

If it is set to other than "0H", change the I/O number according to setting of head I/O number.

In addition, change the external inputs, external outputs, internal relays, data registers, and timers according to the system used.

(1) Inputs/outputs, external inputs/external outputs, and internal relays of QD77GF16

| Device name | Device | Application | Details when ON | |
|--------------------------------------|---------------|-----------------------------|---------------------------------|------------------|
| Inputs/ outputs of QD77GF16 | X0 | READY signal | QD77GF preparation completed | |
| | X1 | Synchronization flag | QD77GF buffer memory accessible | |
| | 2417+100n b12 | M code ON signal | M code outputting | |
| | 2417+100n b13 | Error detection signal | Error detected | |
| | Axis 1 | X10 | BUSY signal | BUSY (operating) |
| | Axis 2 | X11 | | |
| | Axis 3 | X12 | | |
| | Axis 4 | X13 | | |
| | Axis 5 | X14 | | |
| | Axis 6 | X15 | | |
| | Axis 7 | X16 | | |
| | Axis 8 | X17 | | |
| | Axis 9 | X18 | | |
| | Axis 10 | X19 | | |
| | Axis 11 | X1A | | |
| | Axis 12 | X1B | | |
| | Axis 13 | X1C | | |
| | Axis 14 | X1D | | |
| | Axis 15 | X1E | | |
| | Axis 16 | X1F | | |
| | 2417+100n b14 | Start complete signal | Start completed | |
| | 2417+100n b15 | Positioning complete signal | Positioning completed | |

n: Axis No.-1

| Device name | | Device | Application | Details when ON | |
|--------------------------------------|-----------|-------------------------------|------------------------------|-------------------------------|------------------|
| Inputs/ outputs of QD77GF16 | output | Y0 | PLC READY signal | PLC CPU preparation completed | |
| | | Y1 | All axis servo ON signal | All axis servo ON signal | |
| | | 30100+10n | Axis stop signal | Requesting stop | |
| | | 30101+10n | Forward run JOG start signal | Starting forward run JOG | |
| | | 30102+10n | Reverse run JOG start signal | Starting reverse run JOG | |
| | | Axis 1 | Y10 | Positioning start signal | Requesting start |
| | | Axis 2 | Y11 | | |
| | | Axis 3 | Y12 | | |
| | | Axis 4 | Y13 | | |
| | | Axis 5 | Y14 | | |
| | | Axis 6 | Y15 | | |
| | | Axis 7 | Y16 | | |
| | | Axis 8 | Y17 | | |
| | | Axis 9 | Y18 | | |
| | | Axis 10 | Y19 | | |
| | | Axis 11 | Y1A | | |
| | | Axis 12 | Y1B | | |
| | | Axis 13 | Y1C | | |
| | | Axis 14 | Y1D | | |
| Axis 15 | Y1E | | | | |
| Axis 16 | Y1F | | | | |
| | 30103+10n | Execution prohibition request | Execution prohibition | | |

n: Axis No.-1

| Device name | Device | | Application | Details when ON |
|-----------------------------|--------|-------------------|---|--|
| | Axis 1 | Axis 2 to Axis 16 | | |
| External input (command) | X20 | — | HPR request OFF command | Commanding HPR request OFF |
| | X21 | | External command valid command | Commanding external command valid setting |
| | X22 | | External command invalid command | Commanding external command invalid |
| | X23 | | Machine HPR command | Commanding machine HPR |
| | X24 | | Fast HPR command | Commanding fast HPR |
| | X25 | | Positioning start command | Commanding positioning start |
| | X26 | | Speed-position switching operation command | Commanding speed-position switching operation |
| | X27 | | Speed-position switching enable command | Commanding speed-position switching enable |
| | X28 | | Speed-position switching prohibit command | Commanding speed-position switching prohibit |
| | X29 | | Movement amount change command | Commanding movement amount change |
| | X2A | | High-level positioning control start command | Commanding high-level positioning control start |
| | X2C | | M code OFF command | Commanding M code OFF |
| | X2D | | JOG operation speed setting command | Commanding JOG operation speed setting |
| | X2E | | Forward run JOG/inching command | Commanding forward run JOG/inching operation |
| | X2F | | Reverse run JOG/inching command | Commanding reverse run JOG/inching operation |
| | X30 | | Manual pulse generator operation enable command | Commanding manual pulse generator operation enable |
| | X31 | | Manual pulse generator operation disable command | Commanding manual pulse generator operation disable |
| | X32 | | Speed change command | Commanding speed change |
| | X33 | | Override command | Commanding override |
| | X34 | | Acceleration/deceleration time change command | Commanding acceleration/deceleration time change |
| | X35 | | Acceleration/deceleration time change disable command | Commanding acceleration/deceleration time change disable |
| | X36 | | Torque change command | Commanding torque change |
| | X37 | | Step operation command | Commanding step operation |
| | X38 | | Skip command | Commanding skip |
| | X39 | | Teaching command | Commanding teaching |
| | X3A | | Continuous operation interrupt command | Commanding continuous operation interrupt |
| | X3B | | Restart command | Commanding restart |

| Device name | Device | | Application | Details when ON |
|--------------------------|---------------------------|-------------------|--|--|
| | Axis 1 | Axis 2 to Axis 16 | | |
| External input (command) | X3C | | Parameter initialization command | Commanding parameter initialization |
| | X3D | | Flash ROM write command | Commanding flash ROM write |
| | X3E | — | Error reset command | Commanding error reset |
| | X3F | | Stop command | Commanding stop |
| | X40 | | Position-speed switching operation command | Position-speed switching operation command |
| | X41 | | Position-speed switching enable command | Position-speed switching enable command |
| | X42 | | Position-speed switching prohibit command | Position-speed switching prohibit command |
| | X43 | | Speed change command | Speed change command |
| | X44 | | Inching movement amount setting command | Inching movement amount setting command |
| | X45 | | Target position change command | Target position change command |
| | X46 | | Step start information command | Step start information command |
| | X47 | | Positioning start command k10 | Positioning start command k10 |
| | X48 | | Override initialization value command | Override initialization value command |
| | X4B | | PLC READY ON | PLC READY ON |
| | X4C | | Error reset clear command | Error reset clear command |
| | X4D | | For unit (degree) | For unit (degree) |
| | X4E | | Positioning start signal command (Y start) | Positioning start command being given |
| X4F | All axis servo ON command | | All axis servo ON command | |

| Device name | Device | | Application | Details when ON | | |
|----------------|--------|---------------------------------------|--|---|--|-------------------------------------|
| | Axis 1 | Axis 2 to Axis 16 | | | | |
| Internal relay | M0 | — | HPR request OFF command | Commanding HPR request OFF | | |
| | M1 | | HPR request OFF command pulse | HPR request OFF commanded | | |
| | M2 | | HPR request OFF command storage | HPR request OFF command held | | |
| | M3 | | Fast HPR command | Commanding fast HPR | | |
| | M4 | | Fast HPR command storage | Fast HPR command held | | |
| | M5 | | Positioning start command pulse | Positioning start commanded | | |
| | M6 | | Positioning start command storage | Positioning start command held | | |
| | M7 | | In-JOG/Inching operation flag | In-JOG/Inching operation flag | | |
| | M8 | | Manual pulse generator operation enable command | Commanding manual pulse generator operation enable | | |
| | M9 | | Manual pulse generator operating flag | Manual pulse generator operating flag | | |
| | M10 | | Manual pulse generator operation disable command | Commanding manual pulse generator operation disable | | |
| | M11 | | Speed change enable pulse | Speed change commanded | | |
| | M12 | | Speed change command storage | Speed change command held | | |
| | M13 | | Override command | Requesting override | | |
| | M14 | | Acceleration/deceleration time change command | Requesting acceleration/deceleration time change | | |
| | M15 | | Torque change command | Requesting torque change | | |
| | M16 | | Step operation command pulse | Step operation commanded | | |
| | M17 | | Skip command pulse | Skip commanded | | |
| | M18 | | Skip command storage | Skip command held | | |
| | M19 | | Teaching command pulse | Teaching commanded | | |
| | M20 | | Teaching command storage | Teaching command held | | |
| | M21 | | Continuous operation interrupt command pulse | Requesting continuous operation interrupt | | |
| | M22 | | Restart command | Requesting restart | | |
| | M23 | | Restart command storage | Restart command held | | |
| | | | M24 | Parameter initialization command pulse | Parameter initialization commanded | |
| | | | M25 | Parameter initialization command storage | Parameter initialization command held | |
| | | | M26 | Flash ROM write command pulse | Flash ROM write commanded | |
| | | | M27 | Flash ROM write command storage | Flash ROM write command held | |
| | | | M28 | — | Error reset | Error reset completed |
| | | | M29 | | Stop command pulse | Stop commanded |
| | | | M30 | | Target position change command pulse | Target position change commanded |
| | | | M31 | | Target position change command storage | Target position change command held |
| | M40 | Override initialization value command | Override initialization value | | | |
| | M50 | Parameter setting complete device | Parameter setting completed | | | |

(2) Data registers and timers

| Device name | Device | | Application | Details of storage |
|---------------|--------------------------------|---|---|---|
| | Axis 1 | Axis 2 to Axis 16 | | |
| Data register | D0 | — | HPR request flag | [Md.31] Status: b3 |
| | D1 | | Speed (low-order 16 bits) | [Cd.25] Position-speed switching control speed change register |
| | D2 | | Speed (high-order 16 bits) | |
| | D3 | | Movement amount (low-order 16 bits) | [Cd.23] Speed-position switching control movement amount change register |
| | D4 | | Movement amount (high-order 16 bits) | |
| | D5 | | Inching movement amount | [Cd.16] Inching movement amount |
| | D6 | | JOG operation speed (low-order 16 bits) | [Cd.17] JOG speed |
| | D7 | | JOG operation speed (high-order 16 bits) | |
| | D8 | | Manual pulse generator 1 pulse input magnification (low-order) | [Cd.20] Manual pulse generator 1 pulse input magnification |
| | D9 | | Manual pulse generator 1 pulse input magnification (high-order) | |
| | D10 | | Manual pulse generator operation enable | [Cd.21] Manual pulse generator enable flag |
| | D11 | | Speed change value (low-order 16 bits) | [Cd.14] New speed value |
| | D12 | | Speed change value (high-order 16 bits) | |
| | D13 | | Speed change request | [Cd.15] Speed change request |
| | D14 | | Override value | [Cd.13] Positioning operation speed override |
| | D15 | | Acceleration time setting (low-order 16 bits) | [Cd.10] New acceleration time value |
| | D16 | | Acceleration time setting (high-order 16 bits) | |
| | D17 | | Deceleration time setting (low-order 16 bits) | [Cd.11] New deceleration time value |
| | D18 | | Deceleration time setting (high-order 16 bits) | |
| | D19 | | Acceleration/deceleration time change enable | [Cd.12] Acceleration/deceleration time change value during speed change, enable/disable |
| | D20 | | Step mode | [Cd.34] Step mode |
| | D21 | | Step valid flag | [Cd.35] Step valid flag |
| | D22 | | Step start information | — |
| | D23 | | Target position (low-order 16 bits) | [Cd.27] Target position change value (New address) |
| | D24 | | Target position (high-order 16 bits) | |
| | D25 | | Target speed (low-order 16 bits) | [Cd.28] Target position change value (New speed) |
| | D26 | | Target speed (high-order 16 bits) | |
| D27 | Target position change request | [Cd.29] Target position change request flag | | |

| Device name | Device | | Application | Details of storage | |
|---------------|--------|-------------------|--|---|---|
| | Axis 1 | Axis 2 to Axis 16 | | | |
| Data register | D32 | — | Start number | — | |
| | D50 | | Unit setting | [Pr.1] Unit setting | |
| | D51 | | Unit magnification | [Pr.4] Unit magnification (AM) | |
| | D52 | | Number of pulses per rotation (low-order 16 bits) | [Pr.2] Number of pulses per rotation (AP) | |
| | D53 | | Number of pulses per rotation (high-order 16 bits) | | |
| | D54 | | Movement amount per rotation (low-order 16 bits) | [Pr.3] Movement amount per rotation (AL) | |
| | D55 | | Movement amount per rotation (high-order 16 bits) | | |
| | D68 | | Block start data (Block 0) | Point 1 (shape, start No.) | [Da.11] Shape [Da.12] Start data No. [Da.13] Special start instruction [Da.14] Parameter |
| | D69 | | | Point 2 (shape, start No.) | |
| | D70 | | | Point 3 (shape, start No.) | |
| | D71 | | | Point 4 (shape, start No.) | |
| | D72 | | | Point 5 (shape, start No.) | |
| | D73 | | | Point 1 (special start instruction) | |
| | D74 | | | Point 2 (special start instruction) | |
| | D75 | | | Point 3 (special start instruction) | |
| | D76 | | | Point 4 (special start instruction) | |
| | D77 | | | Point 5 (special start instruction) | |
| | D78 | | | Torque change value | — |
| | D79 | | | Error code | [Md.23] Axis error No. |
| | D100 | | | Positioning identifier | Data No. 1 |
| | D101 | | | M code | [Da.1] Operation pattern |
| | D102 | | | Dwell time | [Da.2] Control method |
| | D103 | | | Dummy | [Da.3] Acceleration time No. |
| | D104 | | | Command speed (low-order 16 bits) | [Da.4] Deceleration time No. |
| | D105 | | | Command speed (high-order 16 bits) | [Da.6] Positioning address/ movement amount |
| | D106 | | | Positioning address (low-order 16 bits) | [Da.7] Arc address |
| | D107 | | | Positioning address (high-order 16 bits) | [Da.8] Command speed |
| | D108 | | | Arc address (low-order 16 bits) | [Da.9] Dwell time/JUMP destination positioning data No. |
| | D109 | | | Arc address (high-order 16 bits) | [Da.10] M code/Condition data No./Number of LOOP to LEND repetitions |

| Device name | Device | | Application | Details of storage |
|---------------|--------|-------------------|--|--|
| | Axis 1 | Axis 2 to Axis 16 | | |
| Data register | D110 | — | Positioning identifier | Data No.2 [Da.1] Operation pattern [Da.2] Control method [Da.3] Acceleration time No. [Da.4] Deceleration time No. [Da.6] Positioning address/ movement amount [Da.7] Arc address [Da.8] Command speed [Da.9] Dwell time/JUMP destination positioning data No. [Da.10] M code/Condition data No./Number of LOOP to LEND repetitions |
| | D111 | | M code | |
| | D112 | | Dwell time | |
| | D113 | | Dummy | |
| | D114 | | Command speed (low-order 16 bits) | |
| | D115 | | Command speed (high-order 16 bits) | |
| | D116 | | Positioning address (low-order 16 bits) | |
| | D117 | | Positioning address (high-order 16 bits) | |
| | D118 | | Arc address (low-order 16 bits) | |
| | D119 | | Arc address (high-order 16 bits) | |
| | D120 | | Positioning identifier | Data No.3 [Da.1] Operation pattern [Da.2] Control method [Da.3] Acceleration time No. [Da.4] Deceleration time No. [Da.6] Positioning address/ movement amount [Da.7] Arc address [Da.8] Command speed [Da.9] Dwell time/JUMP destination positioning data No. [Da.10] M code/Condition data No./Number of LOOP to LEND repetitions |
| | D121 | | M code | |
| | D122 | | Dwell time | |
| | D123 | | Dummy | |
| | D124 | | Command speed (low-order 16 bits) | |
| | D125 | | Command speed (high-order 16 bits) | |
| | D126 | | Positioning address (low-order 16 bits) | |
| | D127 | | Positioning address (high-order 16 bits) | |
| | D128 | | Arc address (low-order 16 bits) | |
| | D129 | | Arc address (high-order 16 bits) | |
| | D130 | | Positioning identifier | Data No.4 [Da.1] Operation pattern [Da.2] Control method [Da.3] Acceleration time No. [Da.4] Deceleration time No. [Da.6] Positioning address/ movement amount [Da.7] Arc address [Da.8] Command speed [Da.9] Dwell time/JUMP destination positioning data No. [Da.10] M code/Condition data No./Number of LOOP to LEND repetitions |
| | D131 | | M code | |
| | D132 | | Dwell time | |
| | D133 | | Dummy | |
| | D134 | | Command speed (low-order 16 bits) | |
| | D135 | | Command speed (high-order 16 bits) | |
| | D136 | | Positioning address (low-order 16 bits) | |
| | D137 | | Positioning address (high-order 16 bits) | |
| | D138 | | Arc address (low-order 16 bits) | |
| | D139 | | Arc address (high-order 16 bits) | |

| Device name | Device | | Application | Details of storage |
|---------------|--------|-------------------|--|---|
| | Axis 1 | Axis 2 to Axis 16 | | |
| Data register | D140 | — | Positioning identifier | Data No.5 [Da.1] Operation pattern [Da.2] Control method [Da.3] Acceleration time No. [Da.4] Deceleration time No. [Da.6] Positioning address/ movement amount [Da.7] Arc address [Da.8] Command speed [Da.9] Dwell time/JUMP destination positioning data No. [Da.10] M code/Condition data No./Number of LOOP to LEND repetitions |
| | D141 | | M code | |
| | D142 | | Dwell time | |
| | D143 | | Dummy | |
| | D144 | | Command speed (low-order 16 bits) | |
| | D145 | | Command speed (high-order 16 bits) | |
| | D146 | | Positioning address (low-order 16 bits) | |
| | D147 | | Positioning address (high-order 16 bits) | |
| | D148 | | Arc address (low-order 16 bits) | |
| | D149 | | Arc address (high-order 16 bits) | |
| | D150 | | Positioning identifier | Data No.6 [Da.1] Operation pattern [Da.2] Control method [Da.3] Acceleration time No. [Da.4] Deceleration time No. [Da.6] Positioning address/ movement amount [Da.7] Arc address [Da.8] Command speed [Da.9] Dwell time/JUMP destination positioning data No. [Da.10] M code/Condition data No./Number of LOOP to LEND repetitions |
| | D151 | | M code | |
| | D152 | | Dwell time | |
| | D153 | | Dummy | |
| | D154 | | Command speed (low-order 16 bits) | |
| | D155 | | Command speed (high-order 16 bits) | |
| | D156 | | Positioning address (low-order 16 bits) | |
| | D157 | | Positioning address (high-order 16 bits) | |
| | D158 | | Arc address (low-order 16 bits) | |
| | D159 | | Arc address (high-order 16 bits) | |
| | D190 | | Positioning identifier | Data No.10 [Da.1] Operation pattern [Da.2] Control method [Da.3] Acceleration time No. [Da.4] Deceleration time No. [Da.6] Positioning address/ movement amount [Da.7] Arc address [Da.8] Command speed [Da.9] Dwell time/JUMP destination positioning data No. [Da.10] M code/Condition data No./Number of LOOP to LEND repetitions |
| | D191 | | M code | |
| | D192 | | Dwell time | |
| | D193 | | Dummy | |
| | D194 | | Command speed (low-order 16 bits) | |
| | D195 | | Command speed (high-order 16 bits) | |
| | D196 | | Positioning address (low-order 16 bits) | |
| | D197 | | Positioning address (high-order 16 bits) | |
| | D198 | | Arc address (low-order 16 bits) | |
| | D199 | | Arc address (high-order 16 bits) | |

| Device name | Device | | Application | Details of storage |
|---------------|--------|-------------------|--|---|
| | Axis 1 | Axis 2 to Axis 16 | | |
| Data register | D200 | — | Positioning identifier | Data No.11 [Da.1] Operation pattern [Da.2] Control method [Da.3] Acceleration time No. [Da.4] Deceleration time No. [Da.6] Positioning address/ movement amount [Da.7] Arc address [Da.8] Command speed [Da.9] Dwell time/JUMP destination positioning data No. [Da.10] M code/Condition data No./Number of LOOP to LEND repetitions |
| | D201 | | M code | |
| | D202 | | Dwell time | |
| | D203 | | Dummy | |
| | D204 | | Command speed (low-order 16 bits) | |
| | D205 | | Command speed (high-order 16 bits) | |
| | D206 | | Positioning address (low-order 16 bits) | |
| | D207 | | Positioning address (high-order 16 bits) | |
| | D208 | | Arc address (low-order 16 bits) | |
| | D209 | | Arc address (high-order 16 bits) | |
| | D240 | — | Positioning identifier | Data No.15 [Da.1] Operation pattern [Da.2] Control method [Da.3] Acceleration time No. [Da.4] Deceleration time No. [Da.6] Positioning address/ movement amount [Da.7] Arc address [Da.8] Command speed [Da.9] Dwell time/JUMP destination positioning data No. [Da.10] M code/Condition data No./Number of LOOP to LEND repetitions |
| | D241 | | M code | |
| | D242 | | Dwell time | |
| | D243 | | Dummy | |
| | D244 | | Command speed (low-order 16 bits) | |
| | D245 | | Command speed (high-order 16 bits) | |
| | D246 | | Positioning address (low-order 16 bits) | |
| | D247 | | Positioning address (high-order 16 bits) | |
| | D248 | | Arc address (low-order 16 bits) | |
| | D249 | | Arc address (high-order 16 bits) | |
| Timer | T0 | — | PLC READY signal OFF confirmation | PLC READY signal OFF |
| | T1 | | PLC READY signal OFF confirmation | |

| Device name | Device | Application | Details of storage |
|-------------|--------------|--|--|
| Code | U0\G2406 | Error code | [Md.23] Axis error No. |
| | U0\G2409 | Axis operation status | [Md.26] Axis operation status |
| | U0\G2417 | Status | [Md.31] Status |
| | U0\G4300 | Positioning start No. | [Cd.3] Positioning start No. |
| | U0\G4301 | Positioning starting point No. | [Cd.4] Positioning starting point No. |
| | U0\G4302 | Error reset | [Cd.5] Axis error reset |
| | U0\G4303 | Restart command | [Cd.6] Restart command |
| | U0\G4304 | M code OFF request (Buffer memory) | [Cd.7] M code OFF request |
| | U0\G4305 | External command valid | [Cd.8] External command valid |
| | U0\G4313 | Override request | [Cd.13] Positioning operation speed override |
| | U0\G4316 | Speed change request | [Cd.15] Speed change request |
| | U0\G4317 | Inching movement amount | [Cd.16] Inching movement amount |
| | U0\G4320 | Interrupt request during continuous operation | [Cd.18] Interrupt request during continuous operation |
| | U0\G4321 | HPR request flag OFF request | [Cd.19] HPR request flag OFF request |
| | U0\G4324 | Manual pulse generator enable flag | [Cd.21] Manual pulse generator enable flag |
| | U0\G4326 | Speed-position switching control movement amount | [Cd.23] Speed-position switching control movement amount change register |
| | U0\G4328 | Speed-position switching enable flag | [Cd.24] Speed-position switching enable flag |
| | U0\G4330 | Position-speed switching control speed change | [Cd.25] Position-speed switching control speed change register |
| | U0\G4332 | Position-speed switching enable flag | [Cd.26] Position-speed switching enable flag |
| | U0\G4338 | Target position change request flag | [Cd.29] Target position change request flag |
| U0\G4344 | Step mode | [Cd.34] Step mode | |
| U0\G4347 | Skip command | [Cd.37] Skip command | |

6.3 Creating a program

The "positioning control operation program" actually used is explained in this chapter. The functions and programs explained in "Section 2" are assembled into the "positioning control operation program" explained here. (To monitor the control, add the required monitor program that matches the system. Refer to Section 5.6 "List of monitor data" for details on the monitor items.)

6.3.1 General configuration of program

The general configuration of the "positioning control operation program" is shown below.

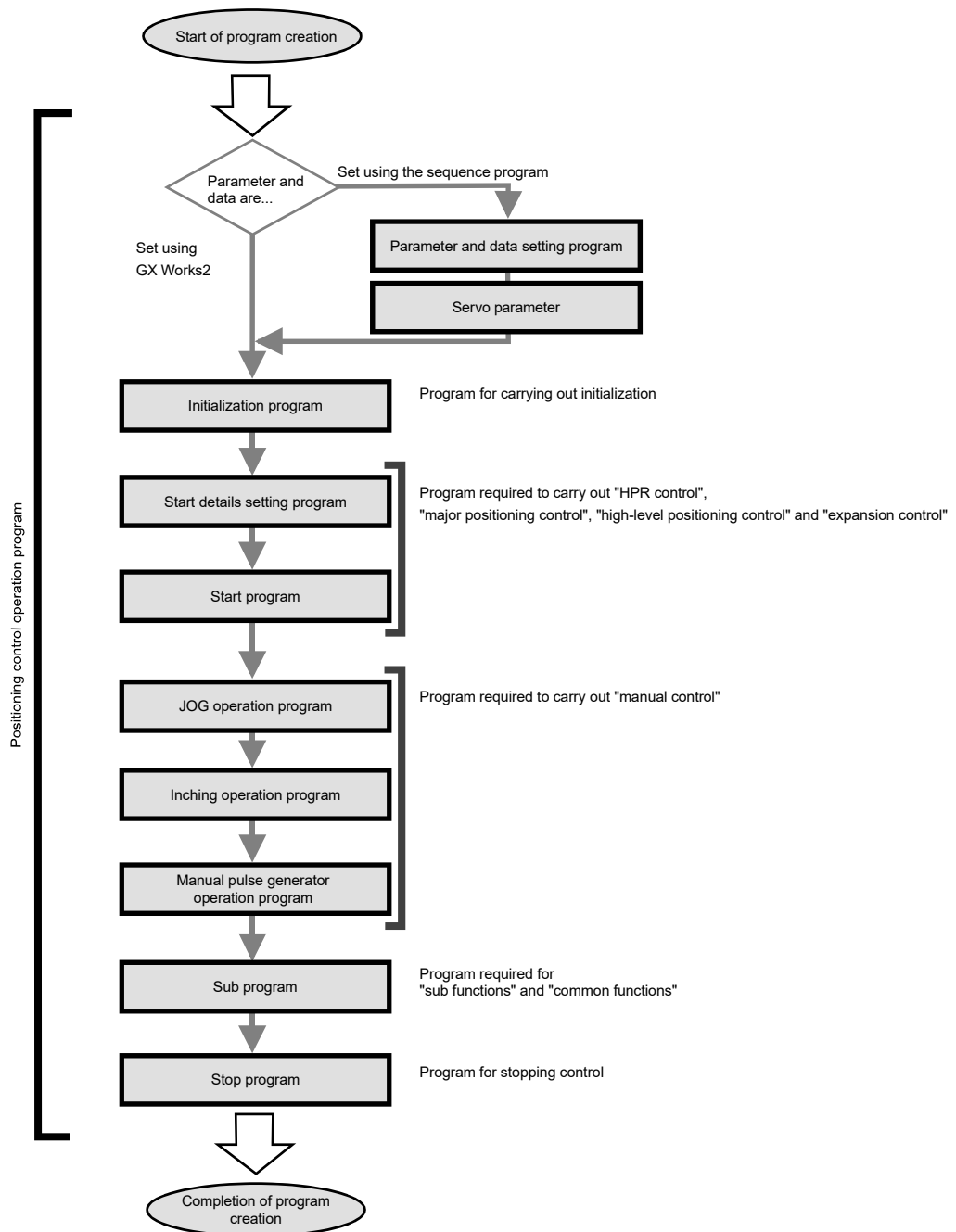

6.3.2 Positioning control operation program

The various programs that configure the "positioning control operation program" are shown below. When creating the program, refer to the explanation of each program and Section 6.4 "Positioning program examples", and create an operation program that matches the positioning system. (Numbers are assigned to the following programs. Configuring the program in the order of these numbers is recommended.)

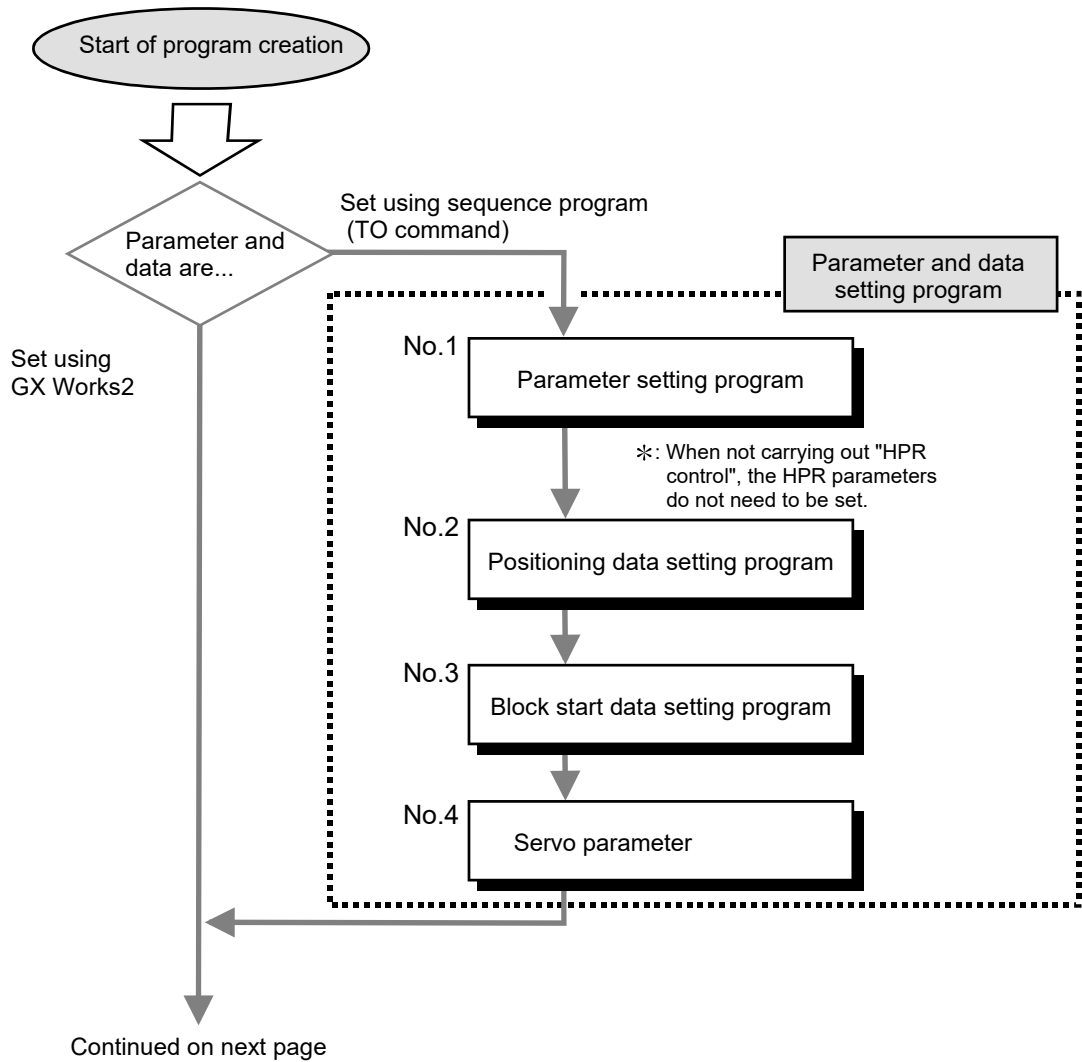

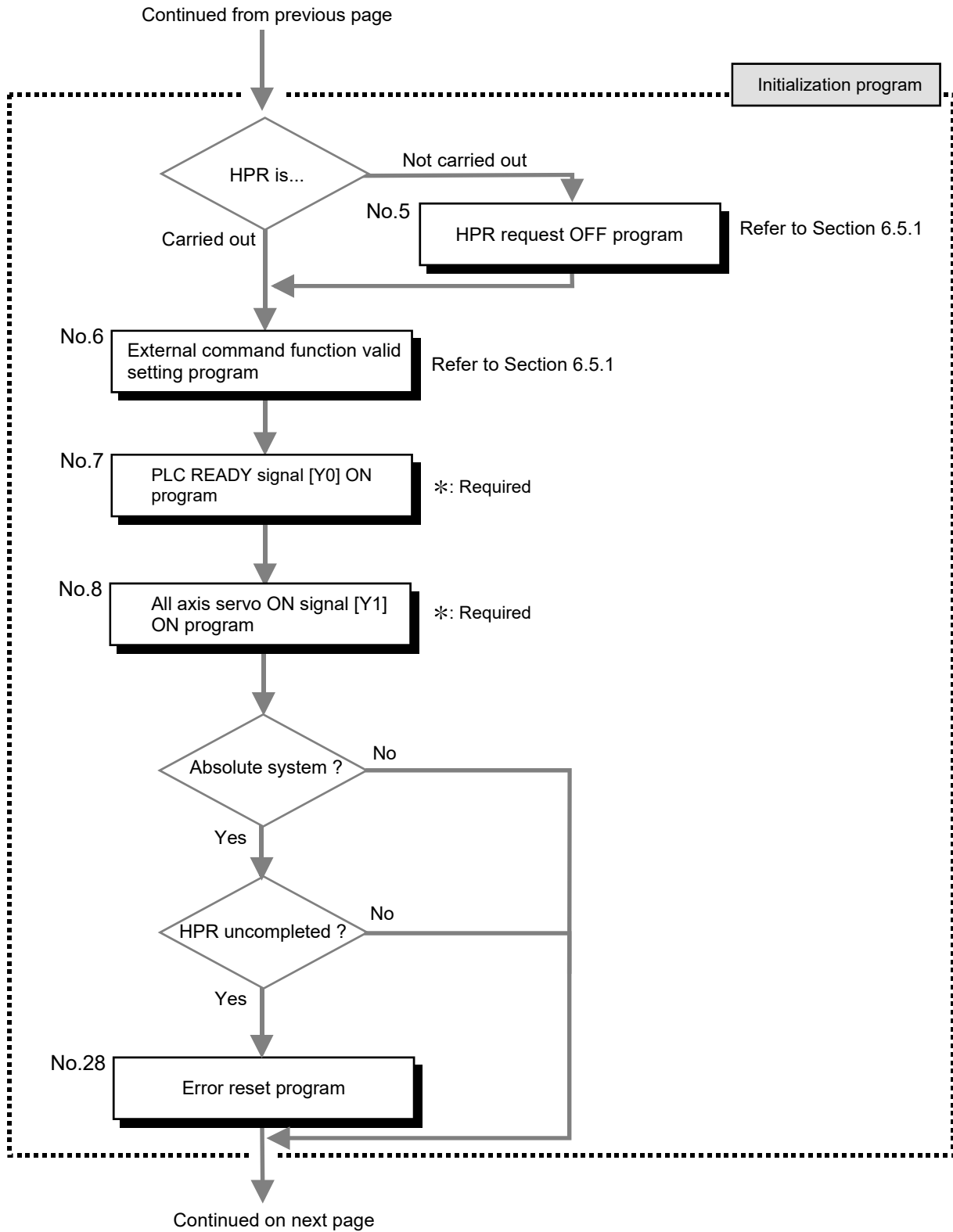

Continued from previous page

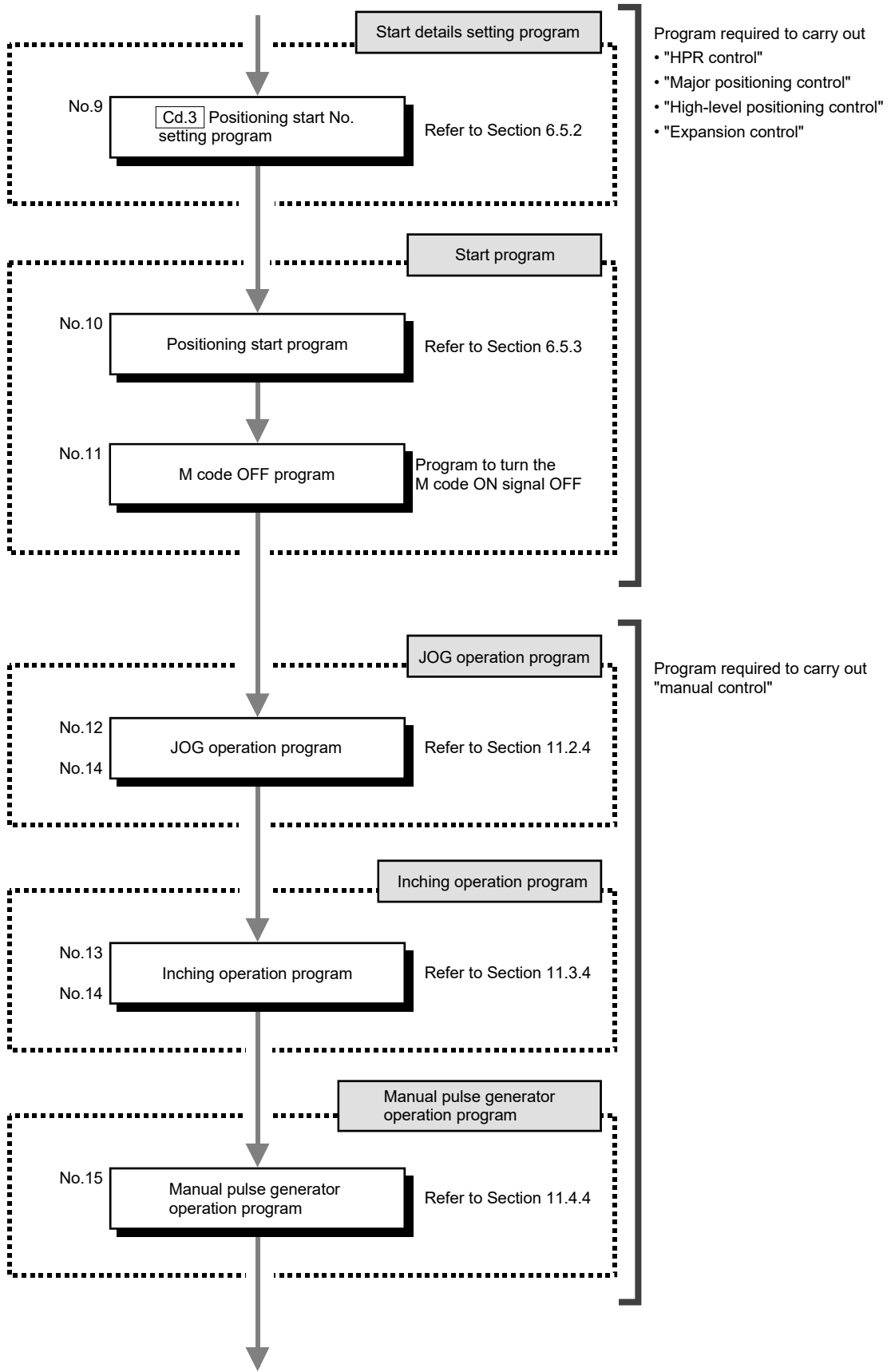

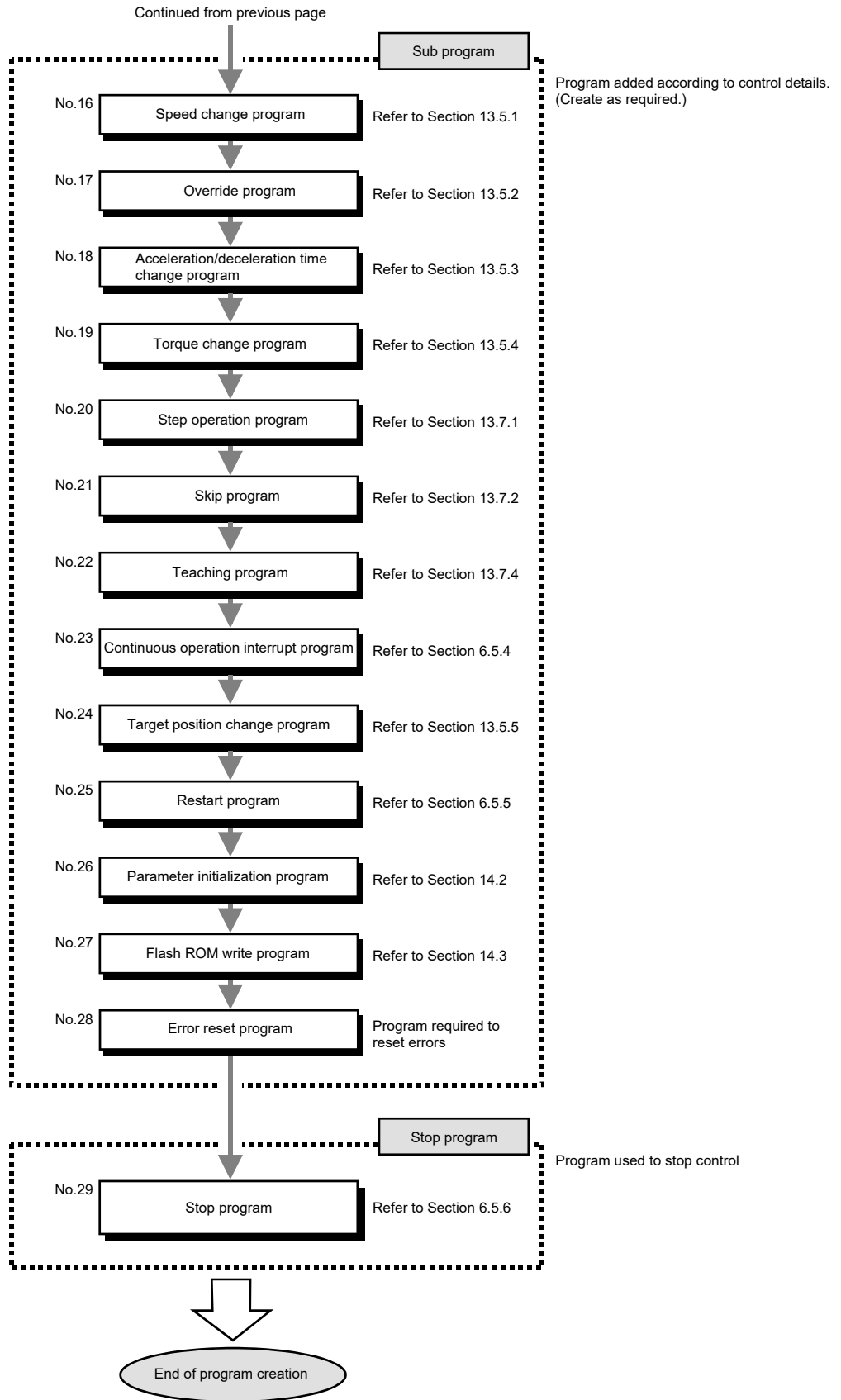

6.4 Positioning program examples [RJ010 mode]

An example of the "Axis 1" positioning program using QD77GF16 is given in this section.

--- [No. 1] to [No. 4] parameter and data setting program ---
 * When setting the parameters or data with the sequence program, set them in the Simple Motion module using the TO command from the PLC CPU. (Carry out the settings while the PLC READY signal [Y0] is OFF.)
 * When setting the parameters or data with GX Works2, the [No. 1] to [No. 4] program is not necessary.

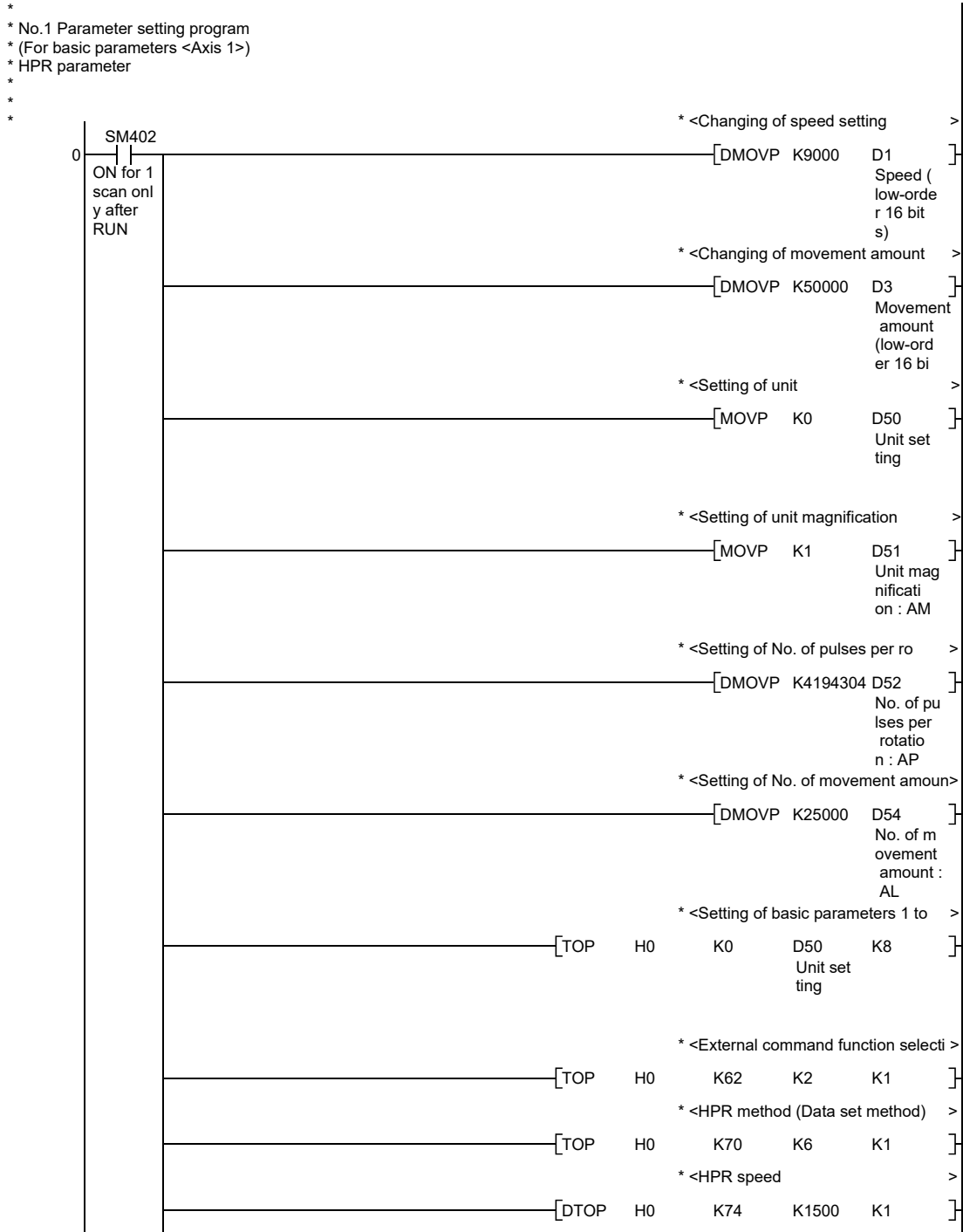

Chapter 6 Sequence Program Used for Positioning Control

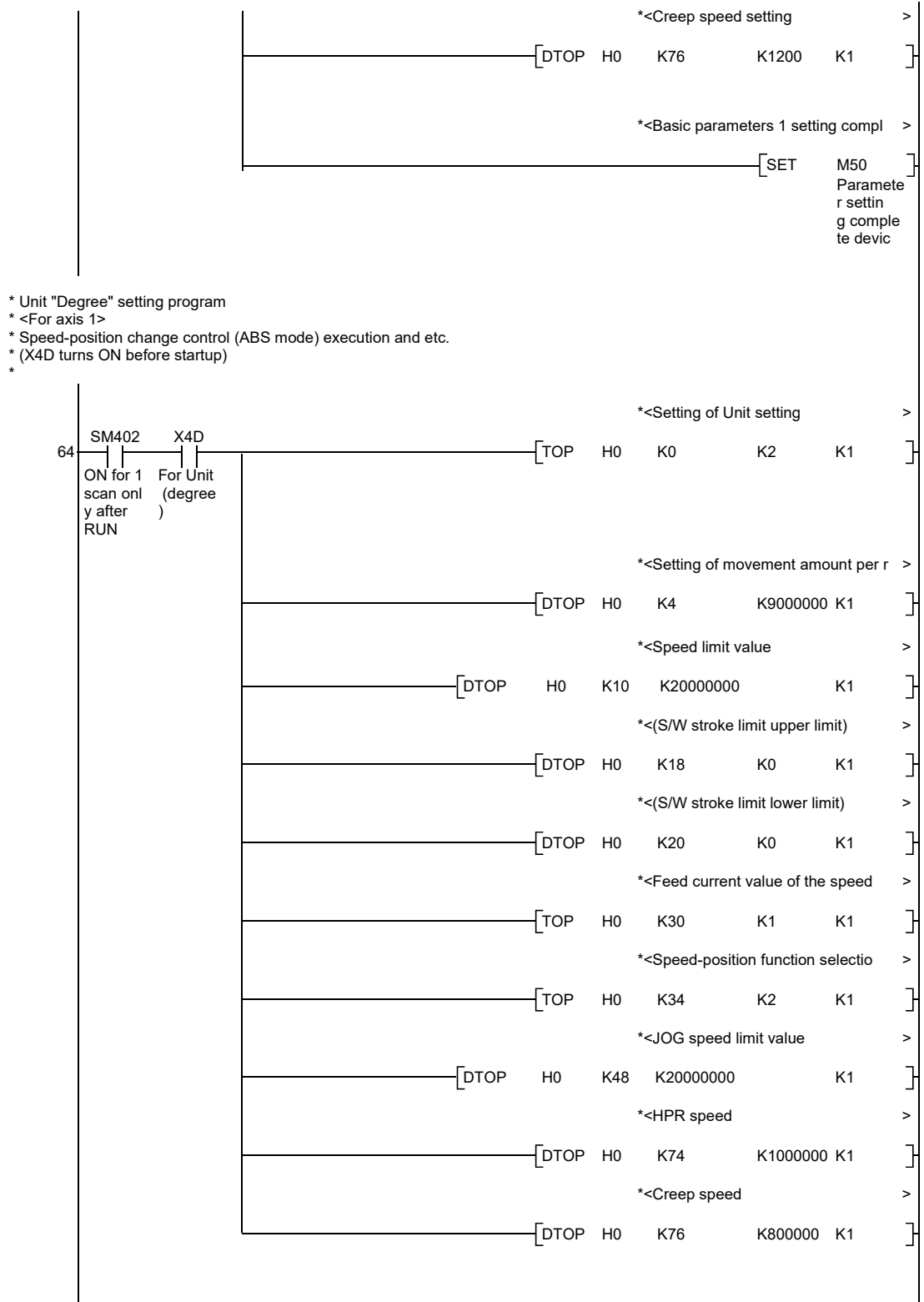

* Unit "Degree" setting program
 * <For axis 1>
 * Speed-position change control (ABS mode) execution and etc.
 * (X4D turns ON before startup)
 *

*
 * No.2-1 Positioning data setting program
 * (For positioning data No.1 <Axis 1>)
 * <Positioning identifier>
 * Operation pattern: Positioning terminated
 * Control method: 1 axis linear control (ABS)
 * Acceleration time No. : 1, deceleration time No. :2
 *

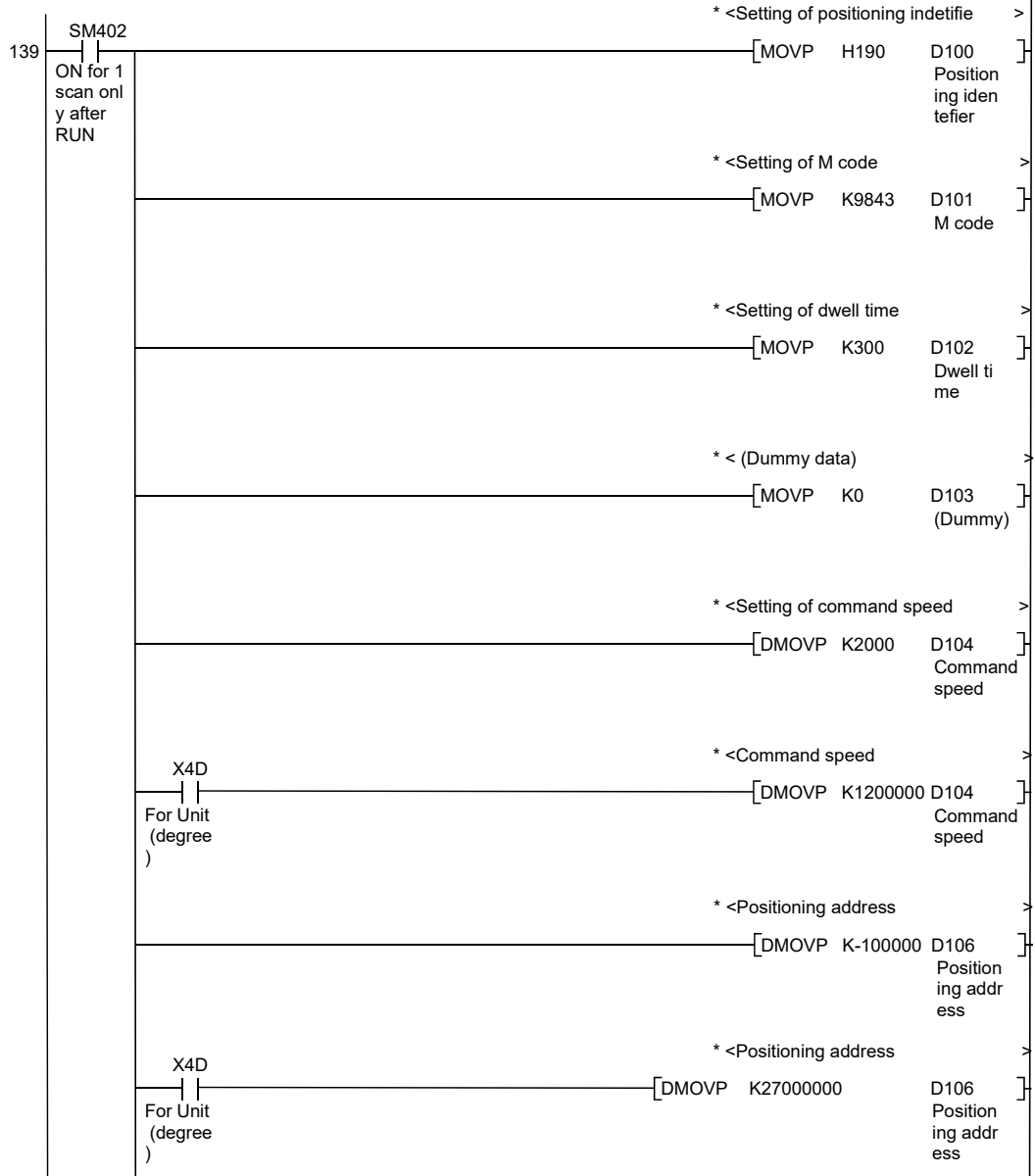

Chapter 6 Sequence Program Used for Positioning Control

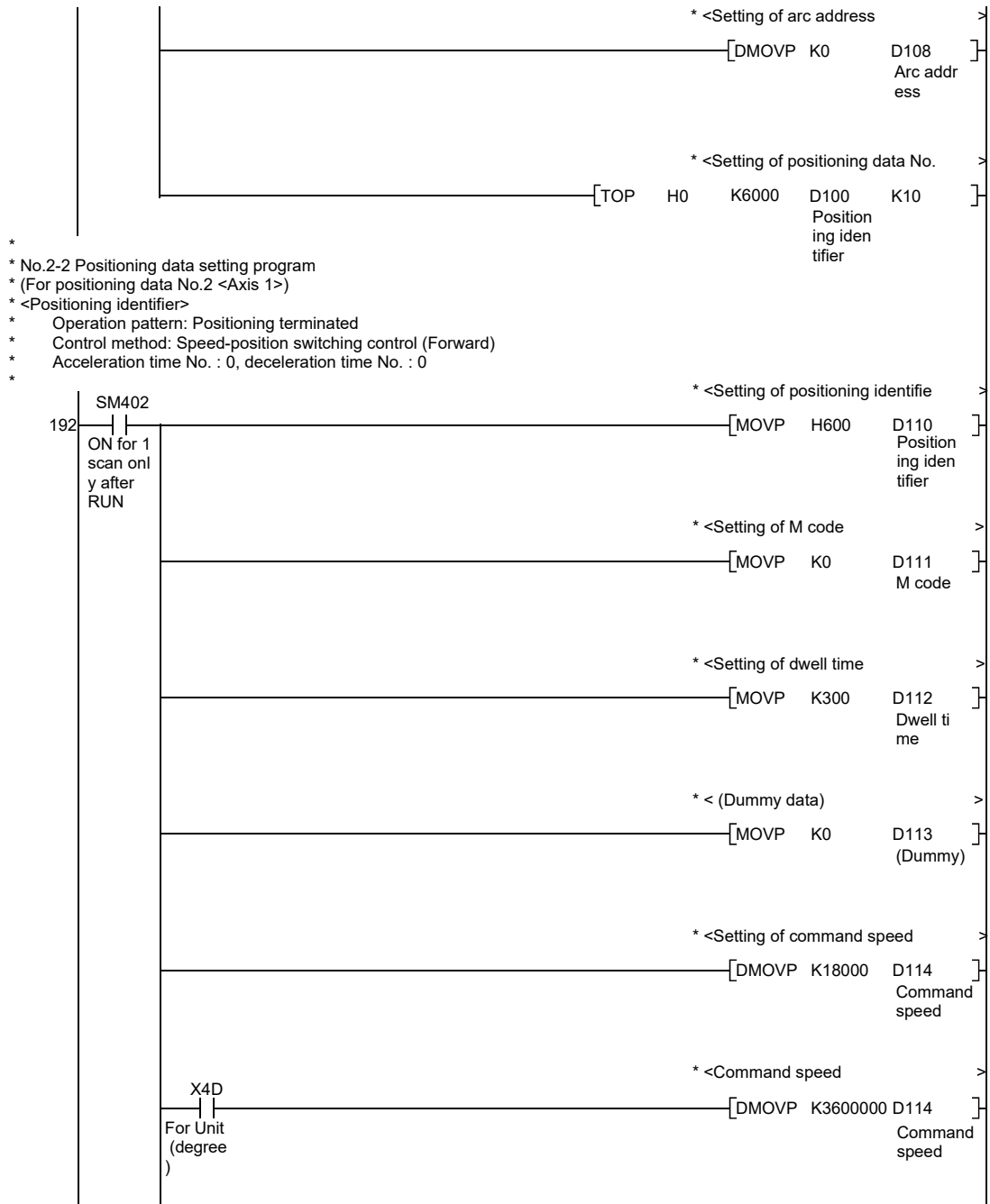

Chapter 6 Sequence Program Used for Positioning Control

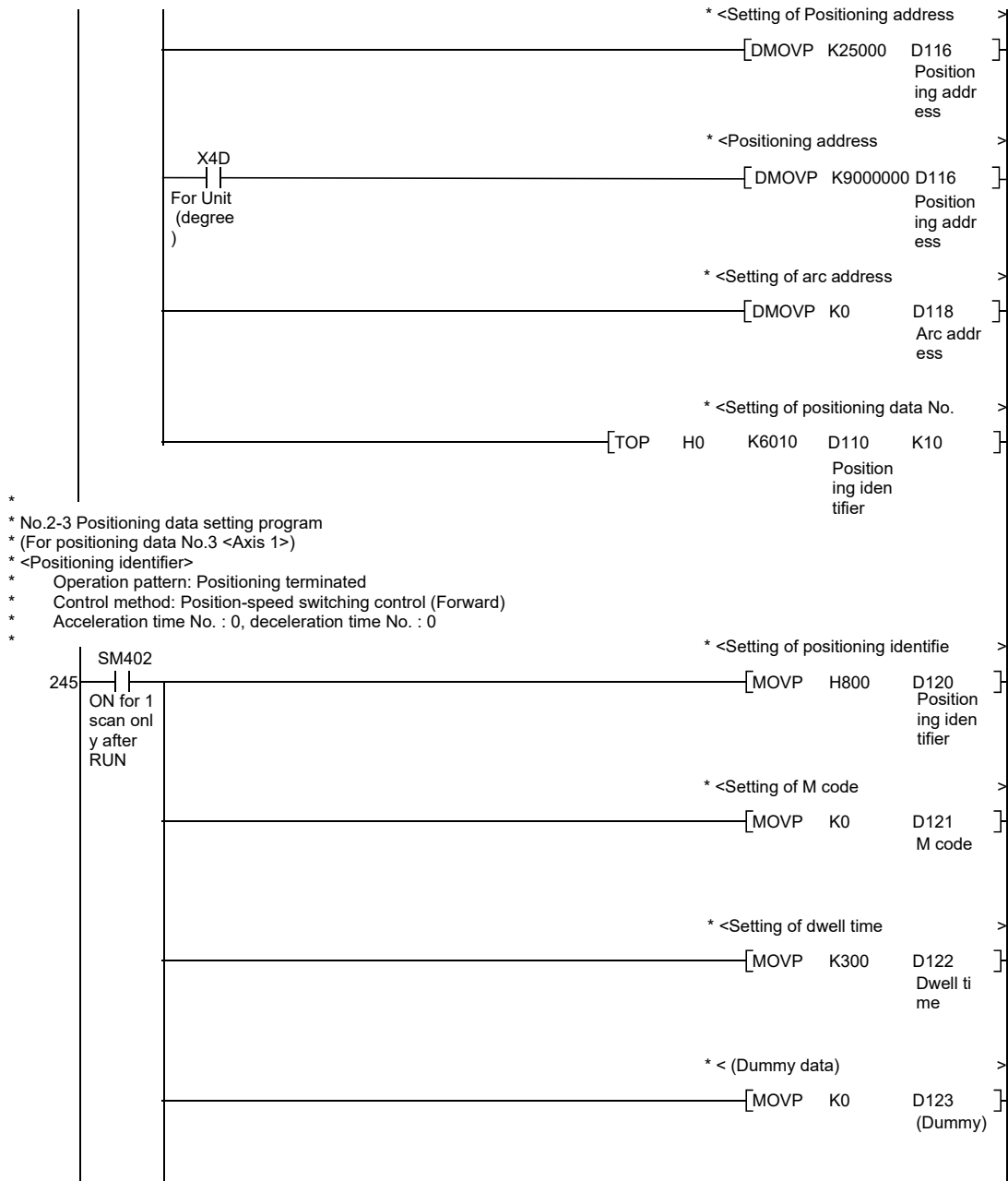

Chapter 6 Sequence Program Used for Positioning Control

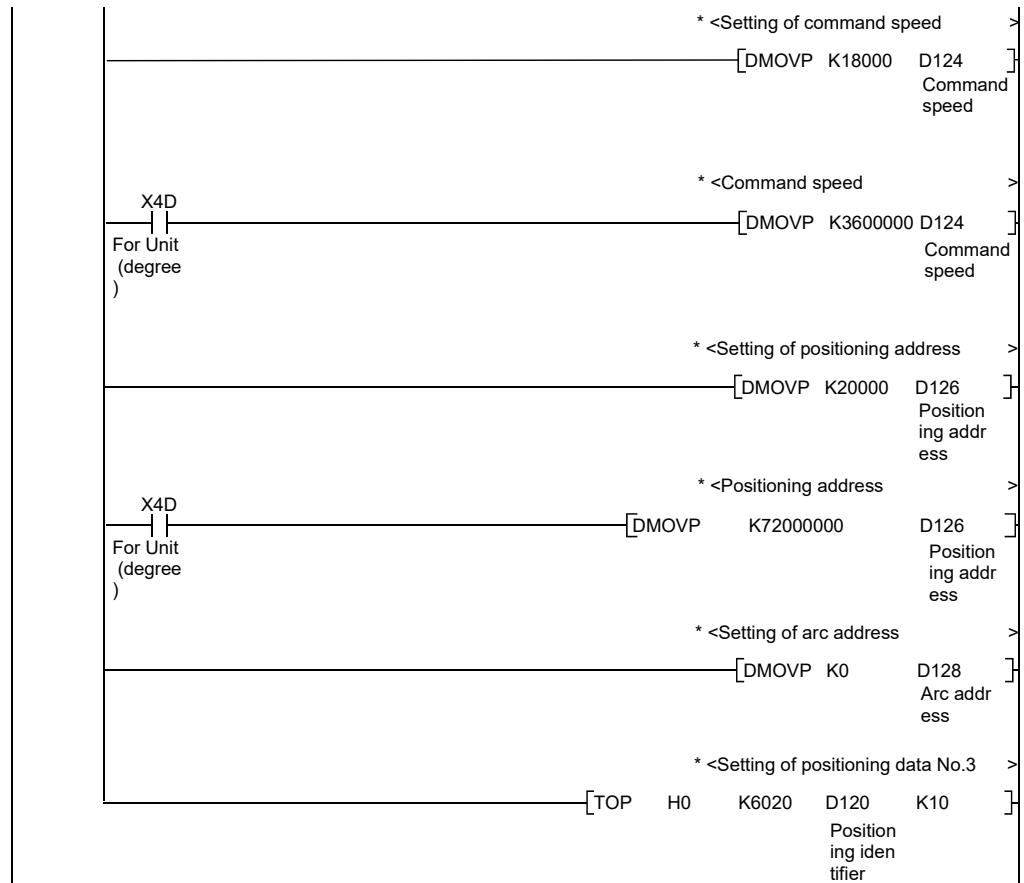

- *
- * No.2-4 Positioning data setting program
- * (For positioning data No.4 <Axis 1>)
- * <Positioning identifier>
- * Operation pattern: Positioning terminated
- * Control method: 1-axis linear control (INC)
- * Acceleration time No. : 0, deceleration time No. : 0
- *

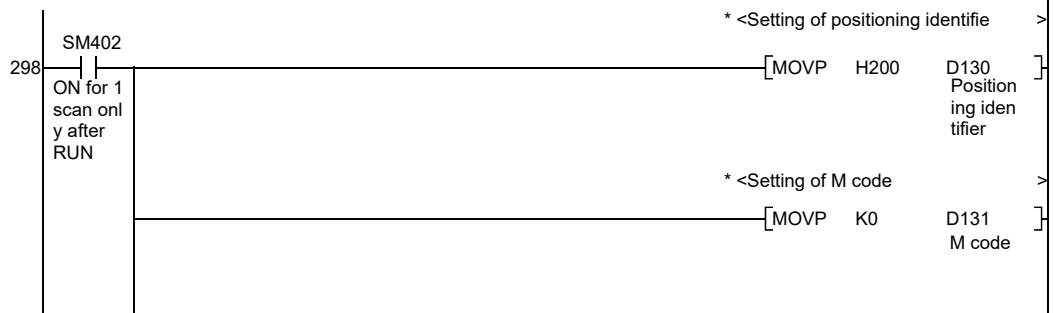

Chapter 6 Sequence Program Used for Positioning Control

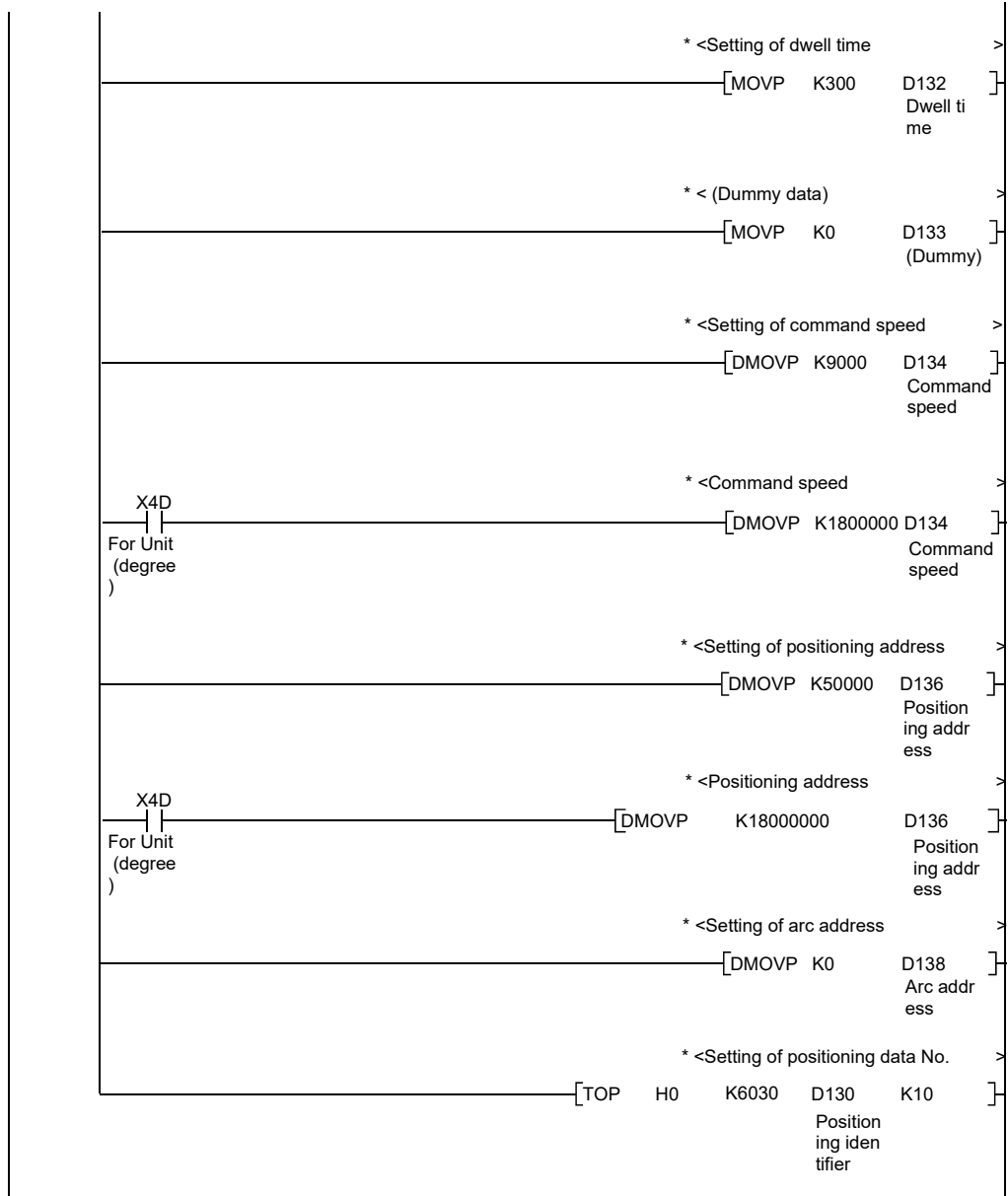

*
 * No.2-5 Positioning data setting program
 * (For positioning data No.5 <Axis 1>)
 * <Positioning identifier>
 * Operation pattern: Positioning terminated
 * Control method: 1-axis liner control (INC)
 * Acceleration time No. : 0, deceleration time No. : 0
 *

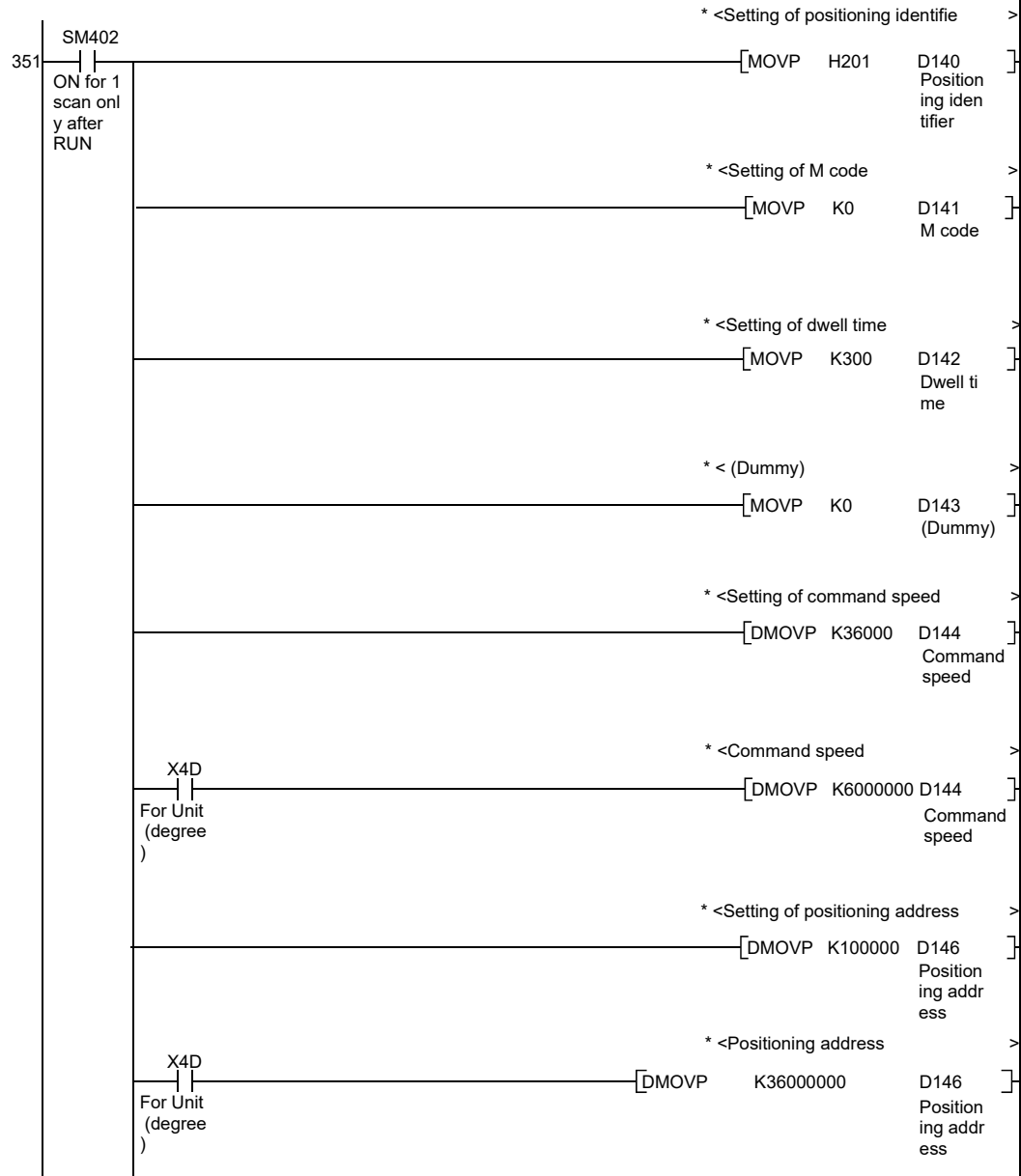

Chapter 6 Sequence Program Used for Positioning Control

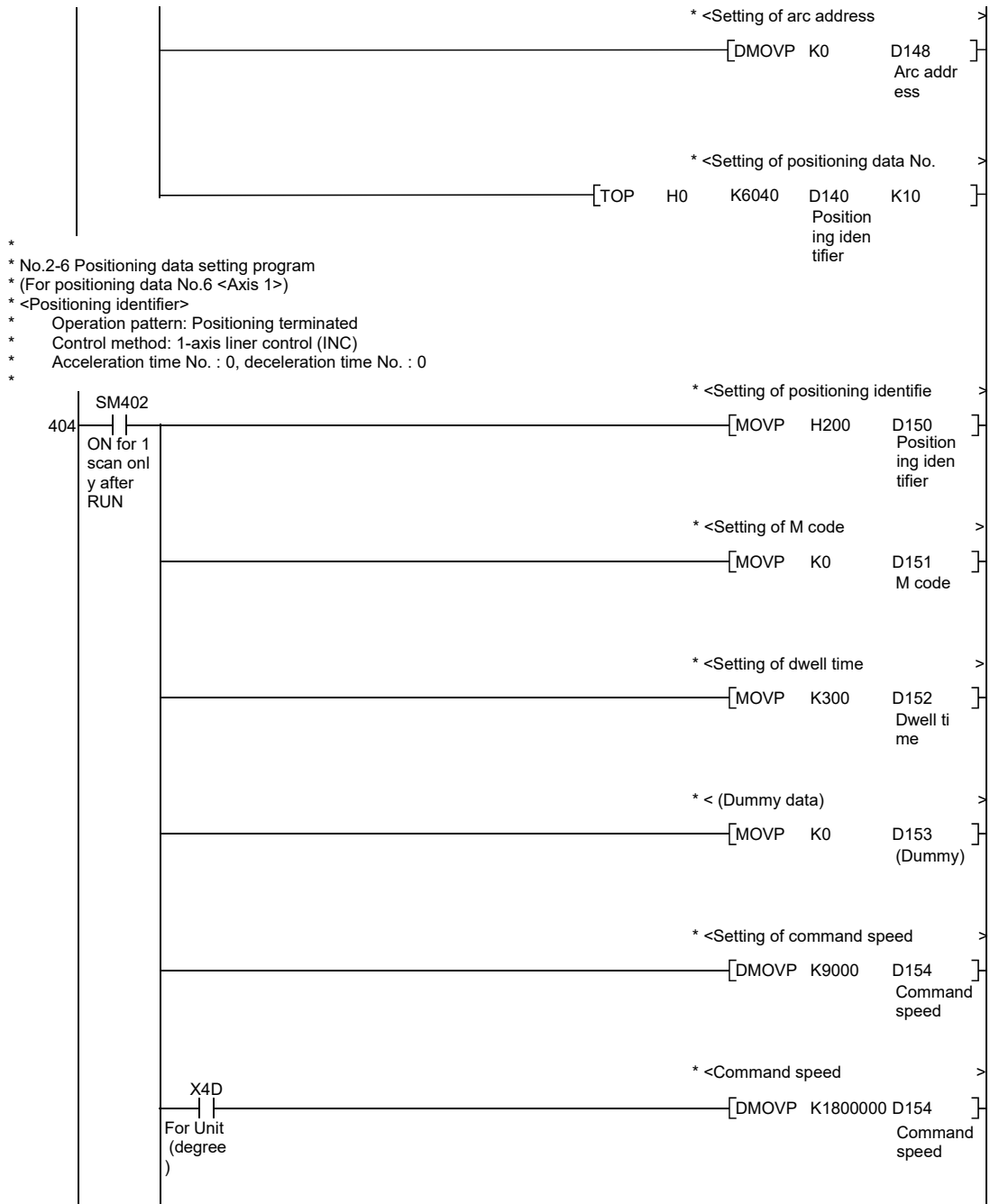

Chapter 6 Sequence Program Used for Positioning Control

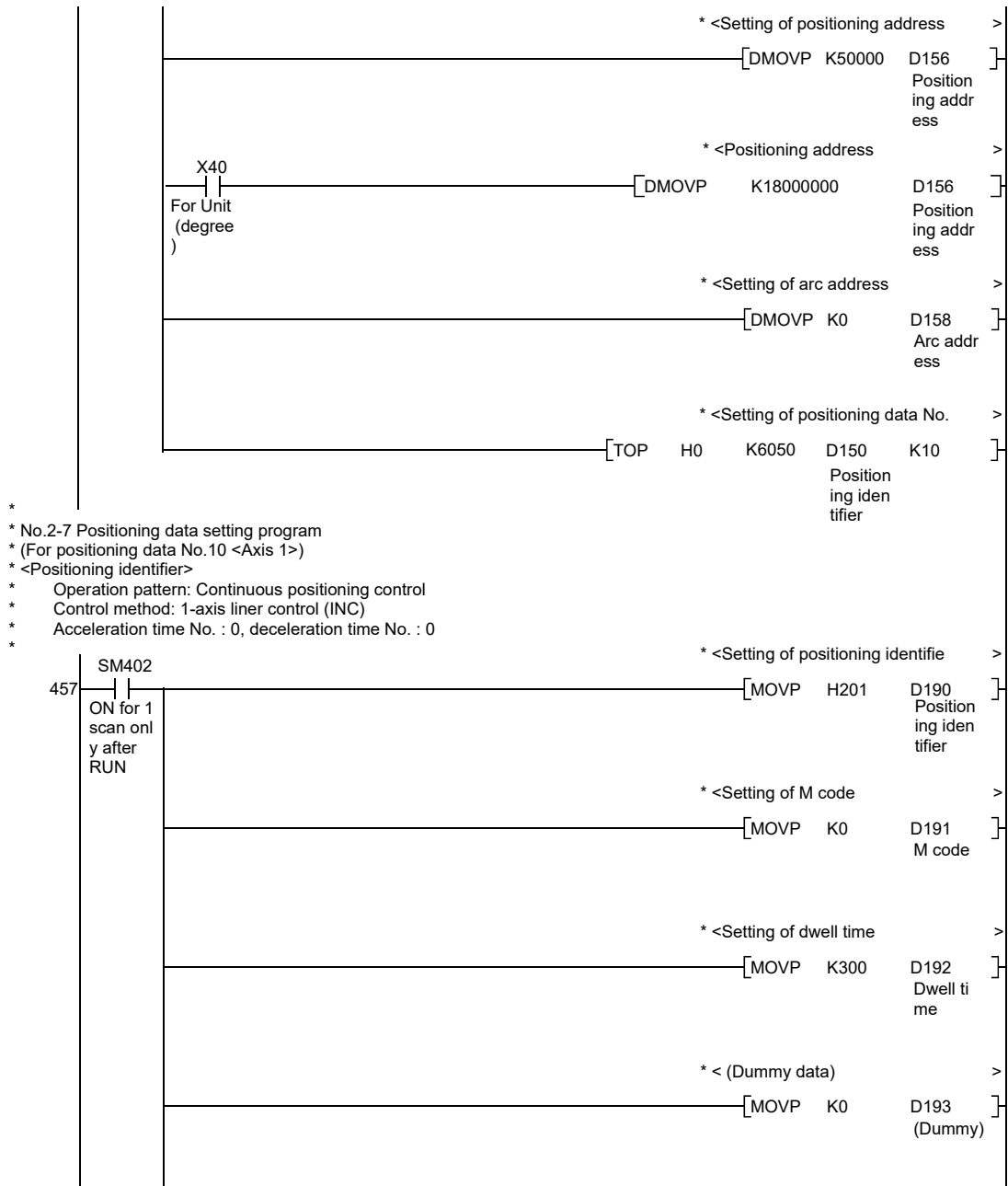

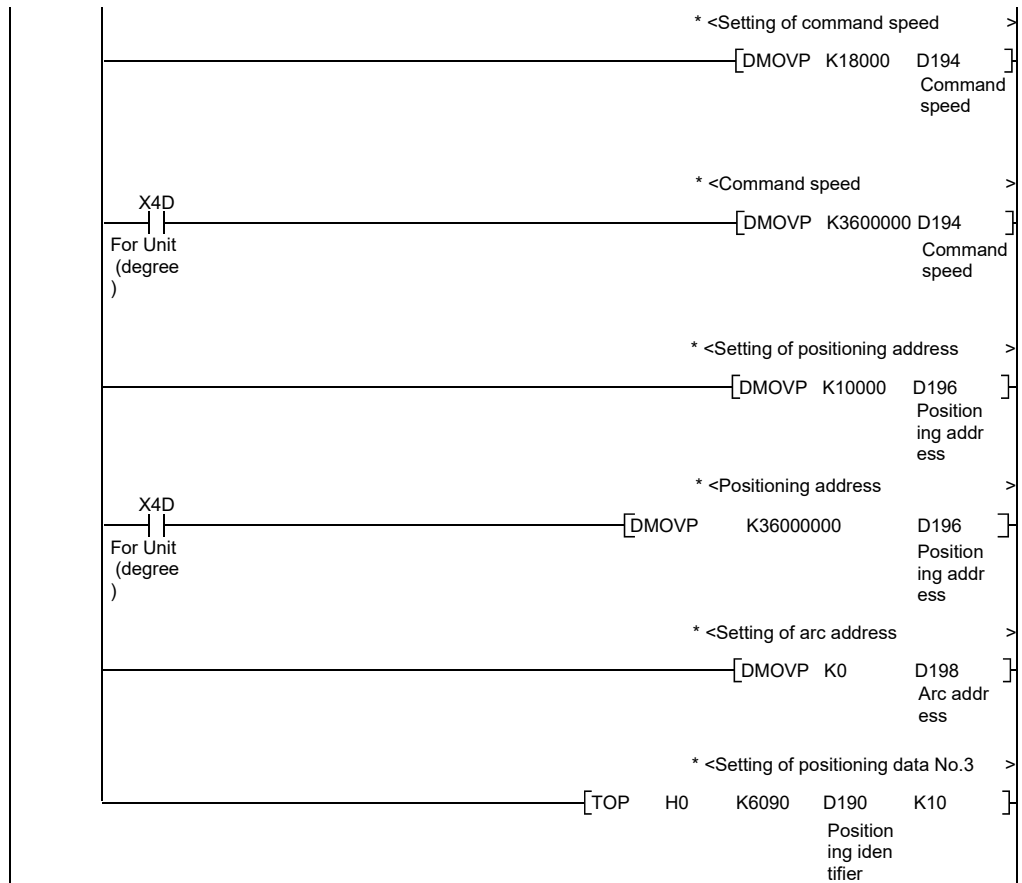

- *
- * No.2-8 Positioning data setting program
- * (For positioning data No.11 <Axis 1>)
- * <Positioning identifier>
- * Operation pattern: Positioning terminated
- * Control method: 1-axis liner control (INC)
- * Acceleration time No. : 0, deceleration time No. : 0
- *

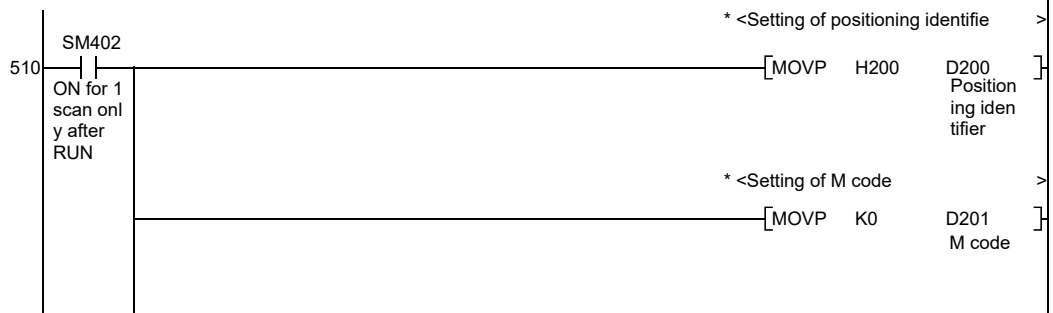

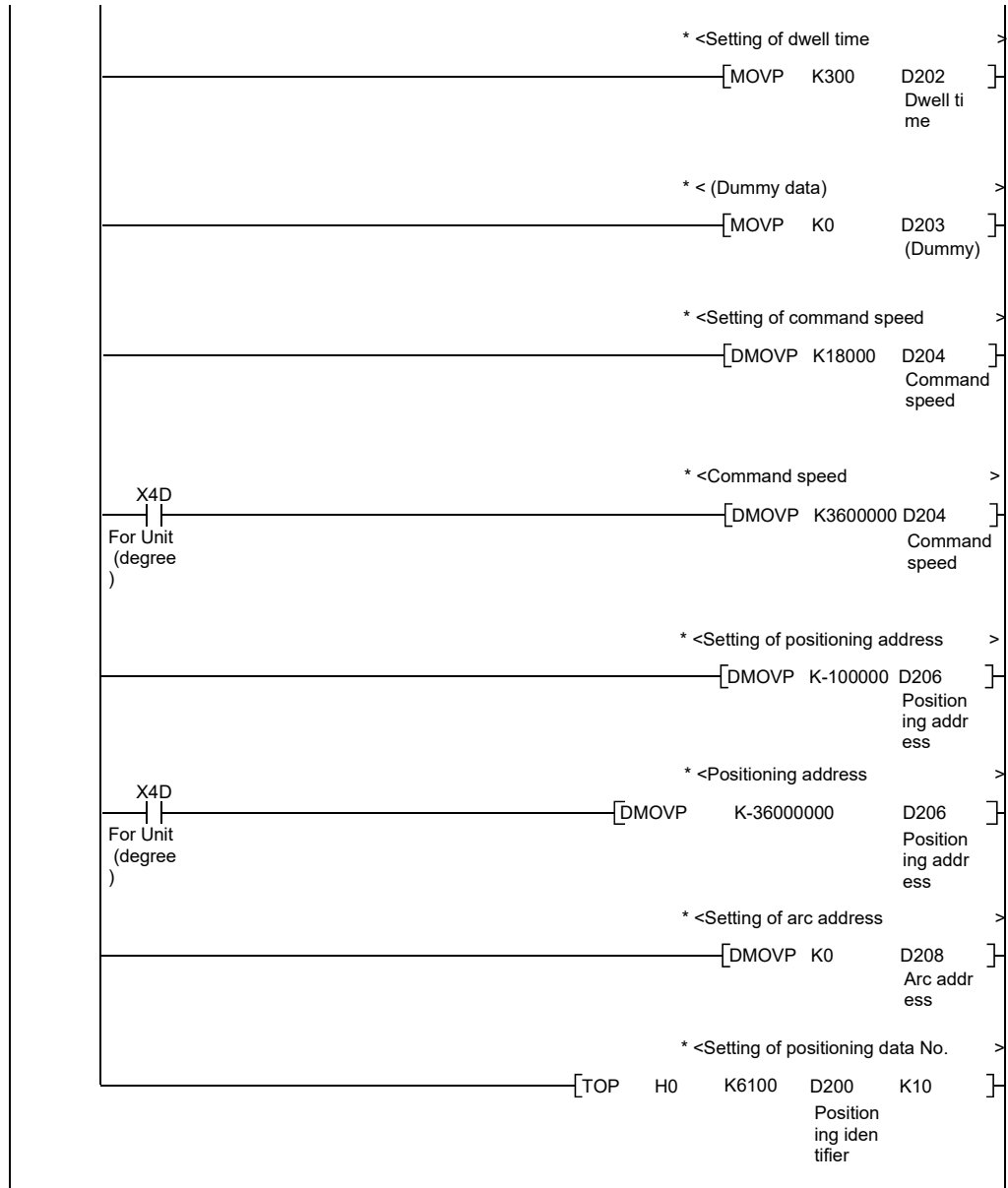

- * No.2-9 Positioning data setting program
- * (For positioning data No.15 <Axis 1>)
- * <Positioning identifier>
- * Operation pattern: Positioning terminated
- * Control method: 1-axis liner control (INC)
- * Acceleration time No. : 0, deceleration time No. : 0
- *

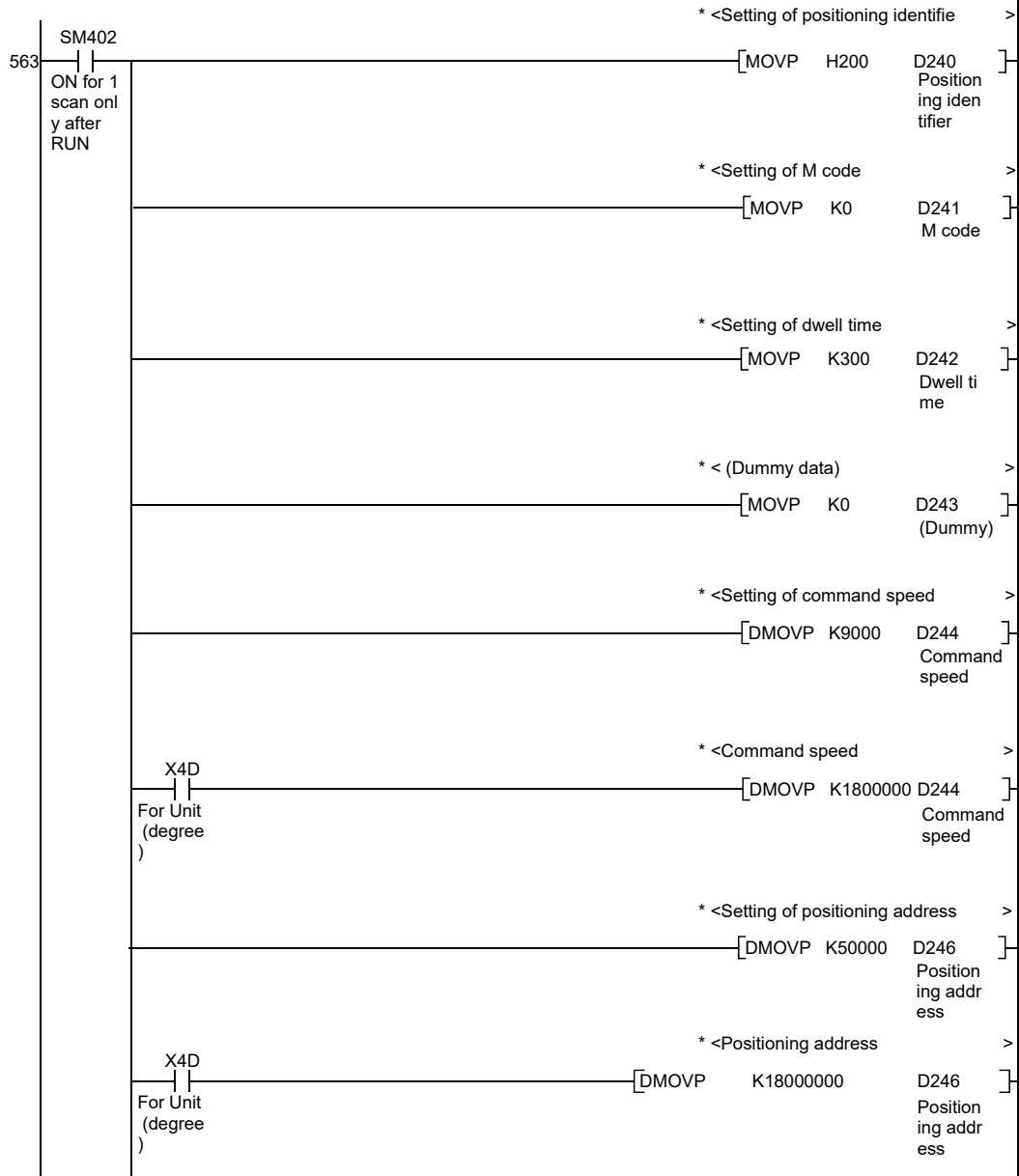

Chapter 6 Sequence Program Used for Positioning Control

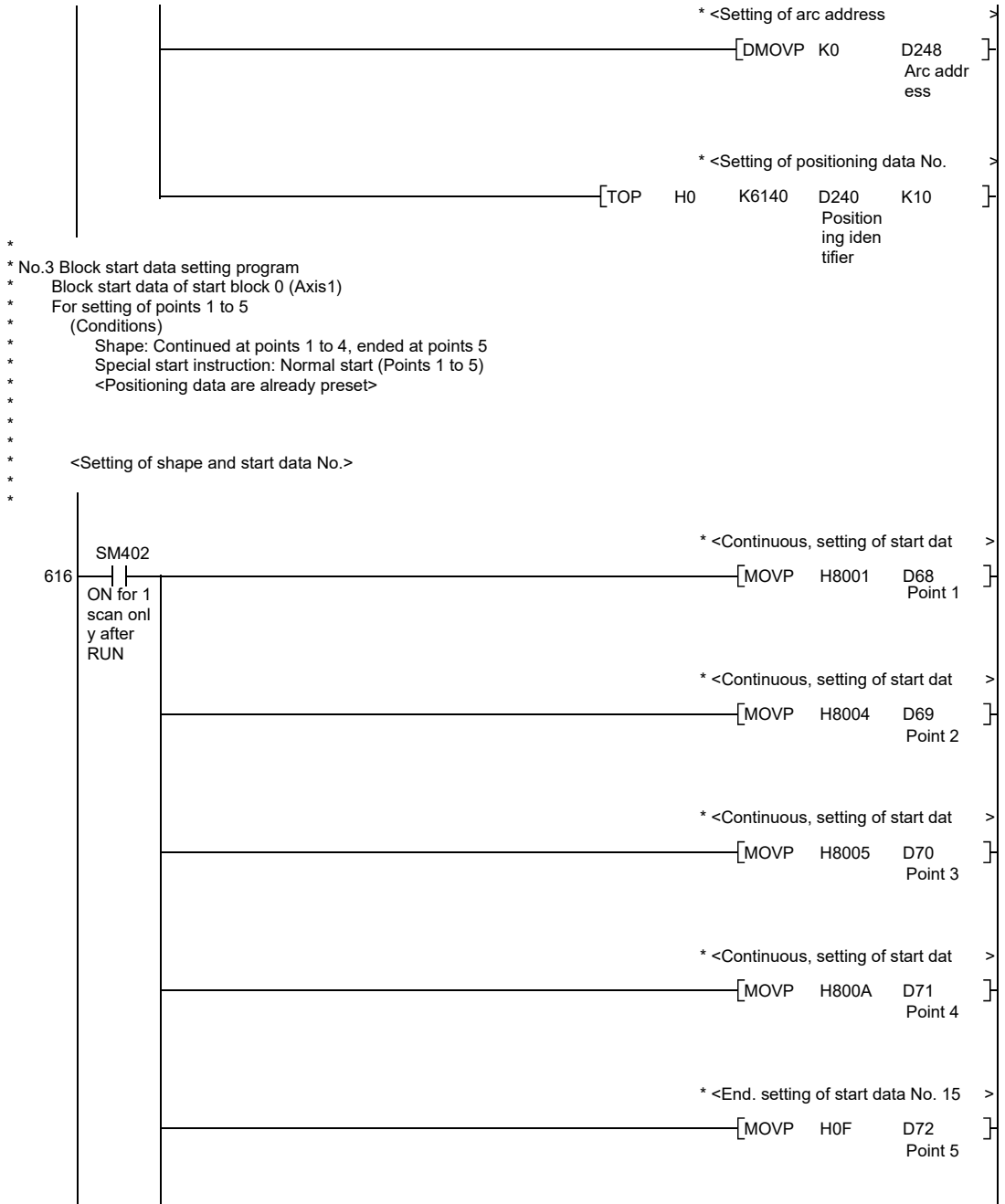

Chapter 6 Sequence Program Used for Positioning Control

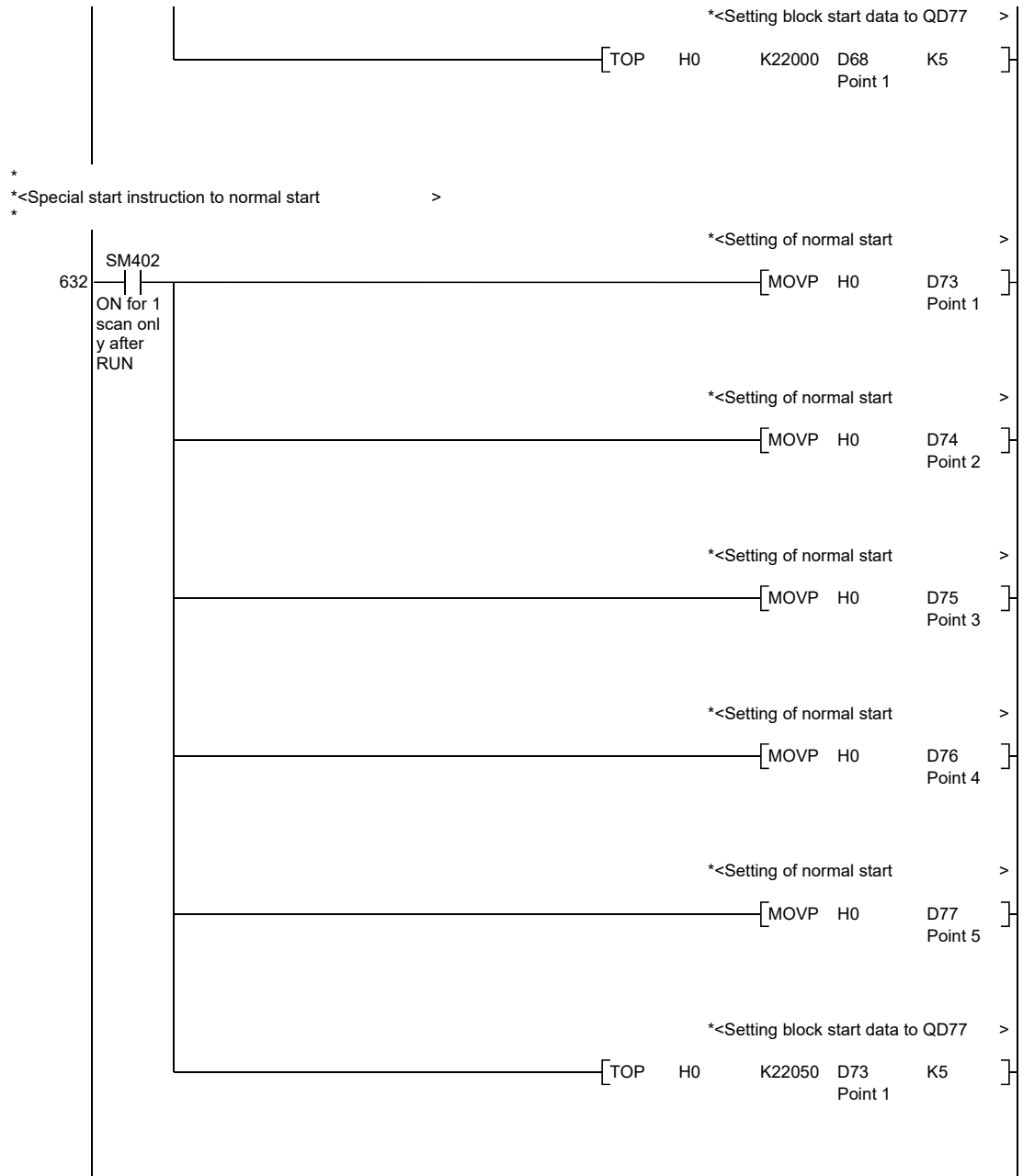

*
*No.5 HPR request OFF program
*

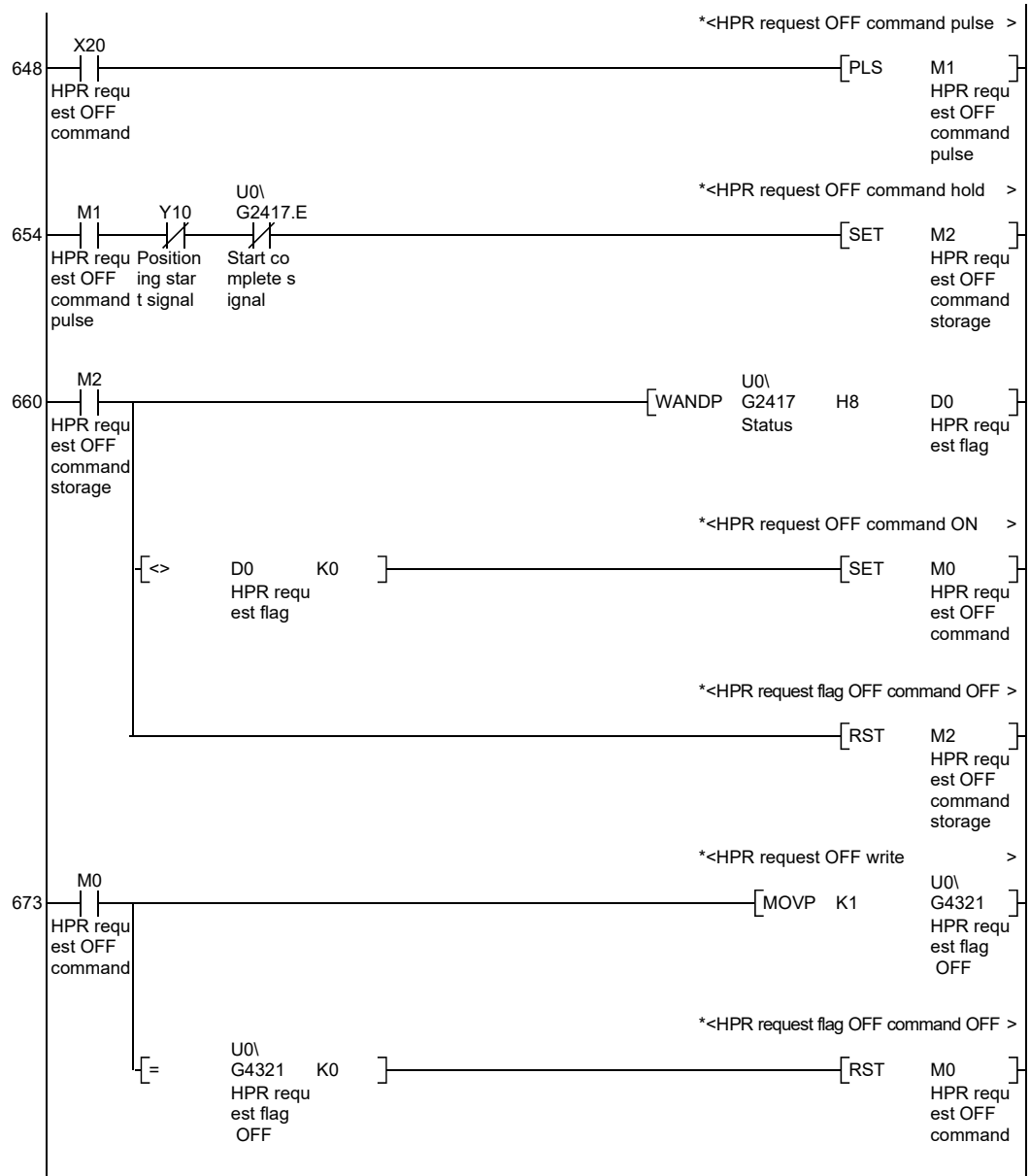

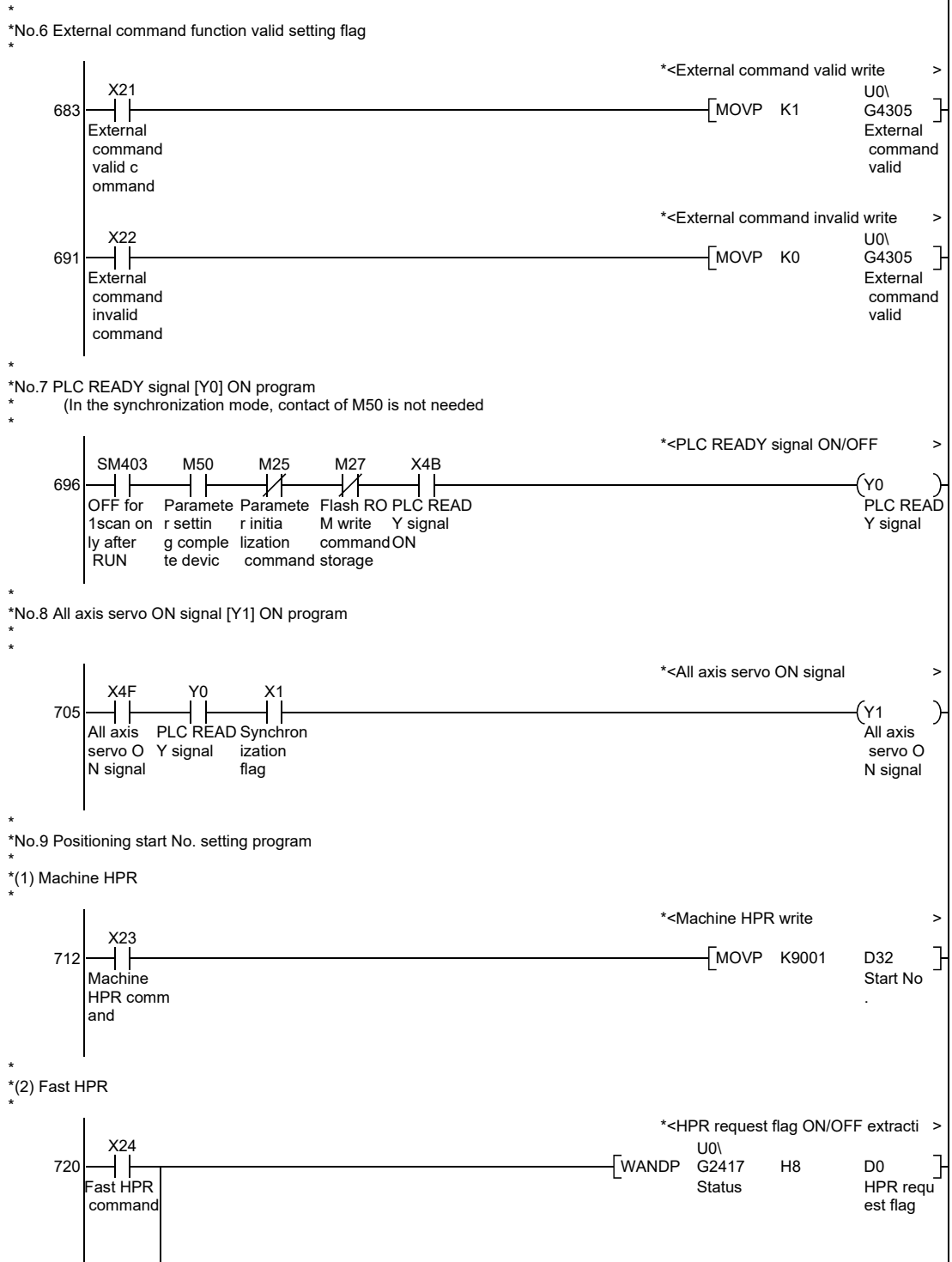

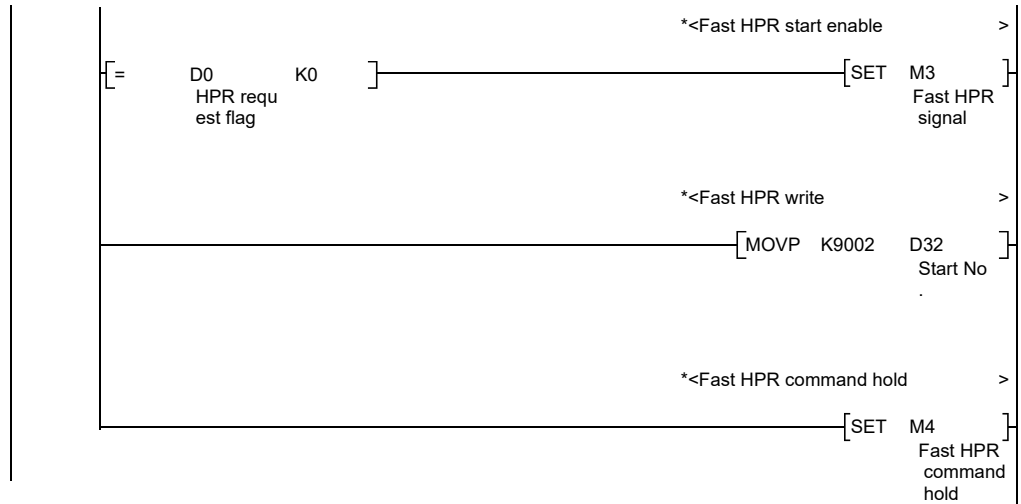

*
* (3) Positioning with positioning data No.1
*

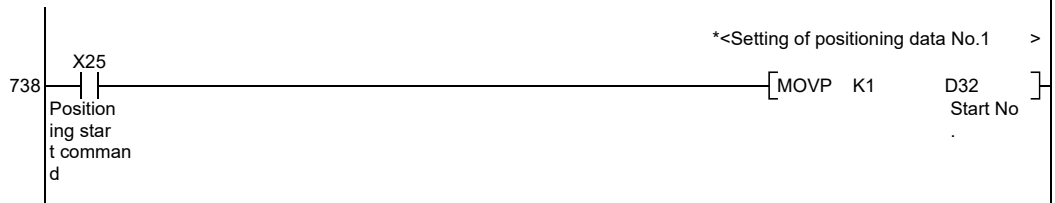

*
* (4) Speed-position switching operation (Positioning data No.2)
* (In the ABS mode, new movement amount write is not needed)
*

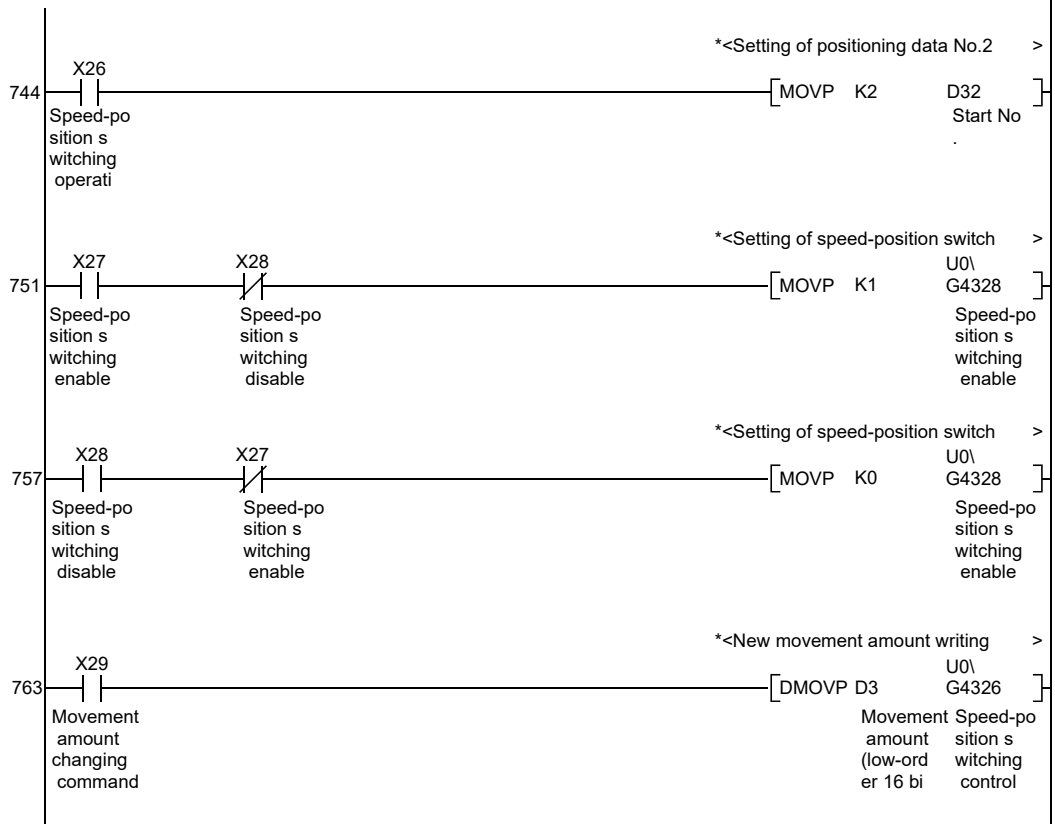

*
 * (5) Position-speed switching operation (Positioning data No.3)
 *

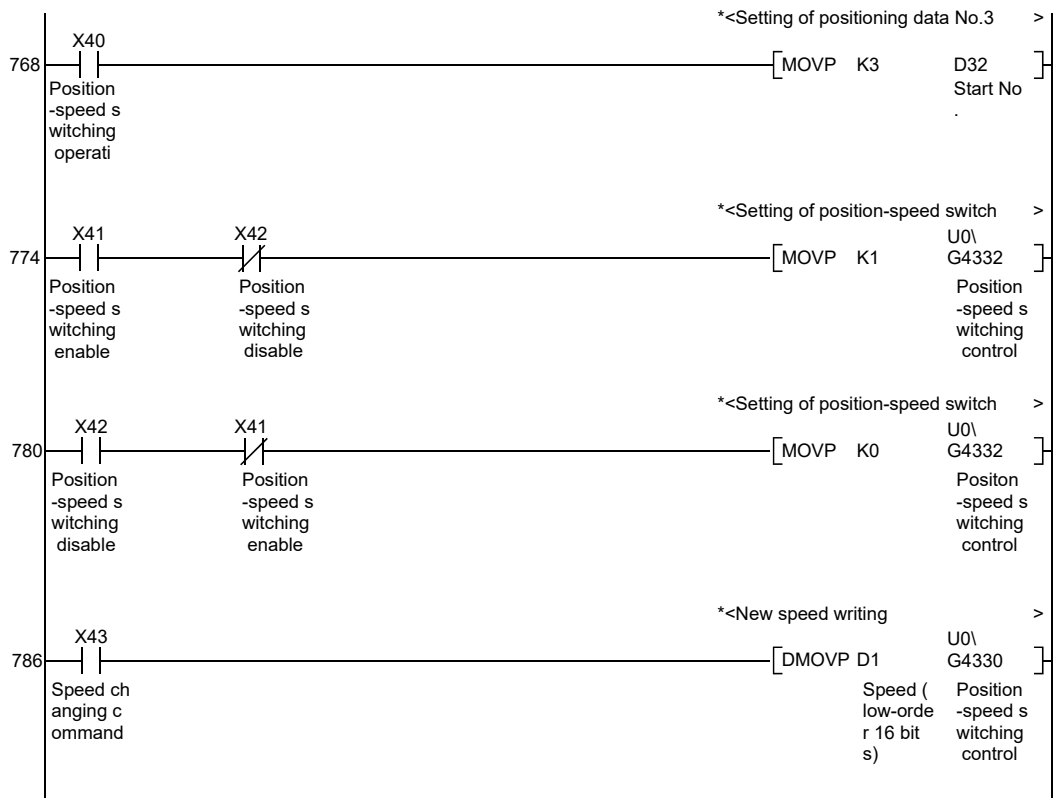

*
 * (6) High-level positioning control
 *

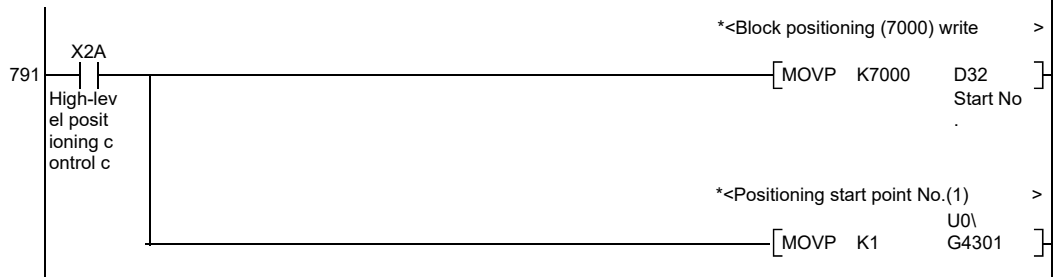

*
 * (7) Fast HPR command and fast HPR command storage OFF
 (Not required when fast HPR is not used)
 *

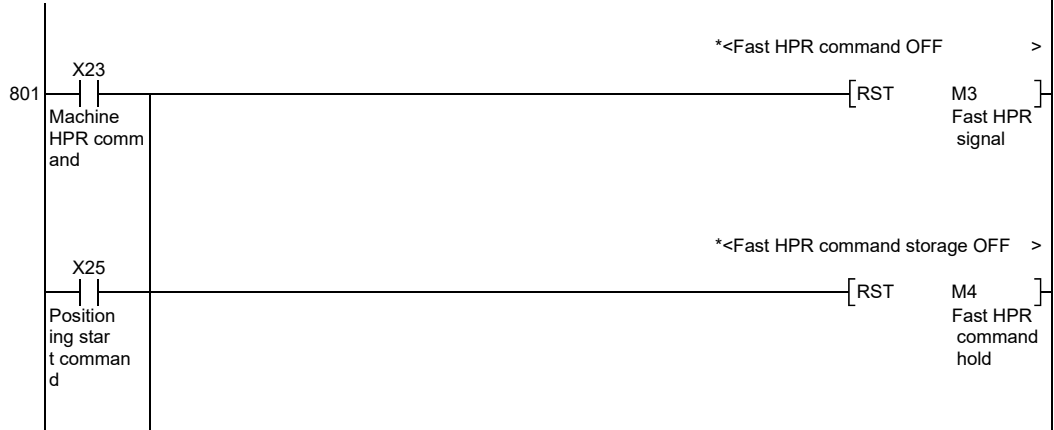

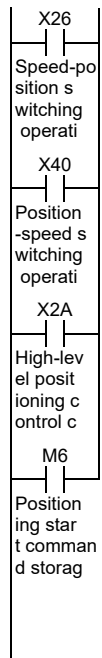

- * No.10 Positioning start program
- * (1) When positioning start signal [Y10] is used
(When fast HPR is not made, contacts of M3 and M4 are not needed)
- * (When M code is not used, contact of X04 is not needed)
- * (When JOG operation/inching operation is not performed, contact of M7 is not needed)
- * (When manual pulse generator is not performed, contacts of M9 is not needed)

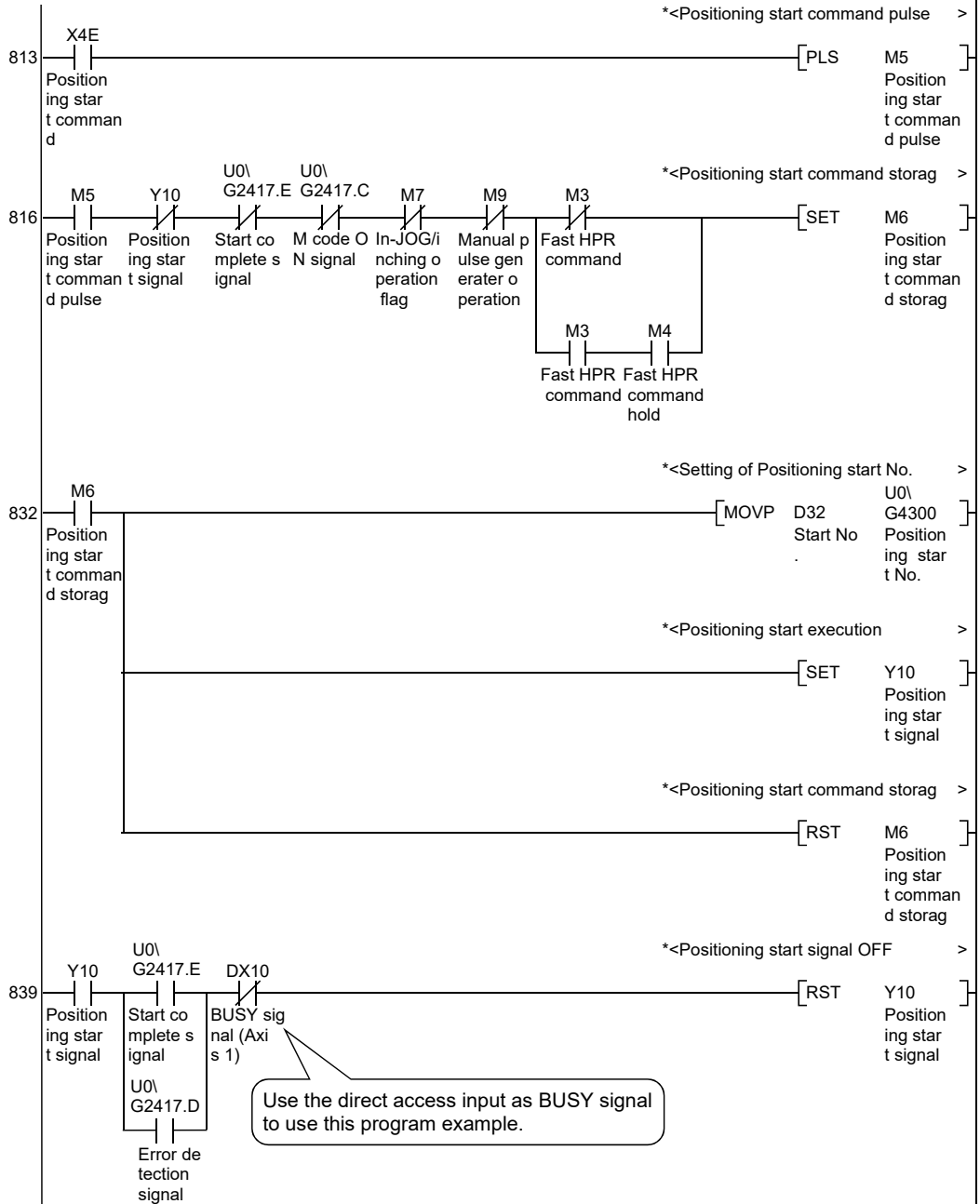

*
 * No.11 M code OFF program
 * (Not required when M code is not used)



*
 * No.12 JOG operation/inching operation execution program
 *

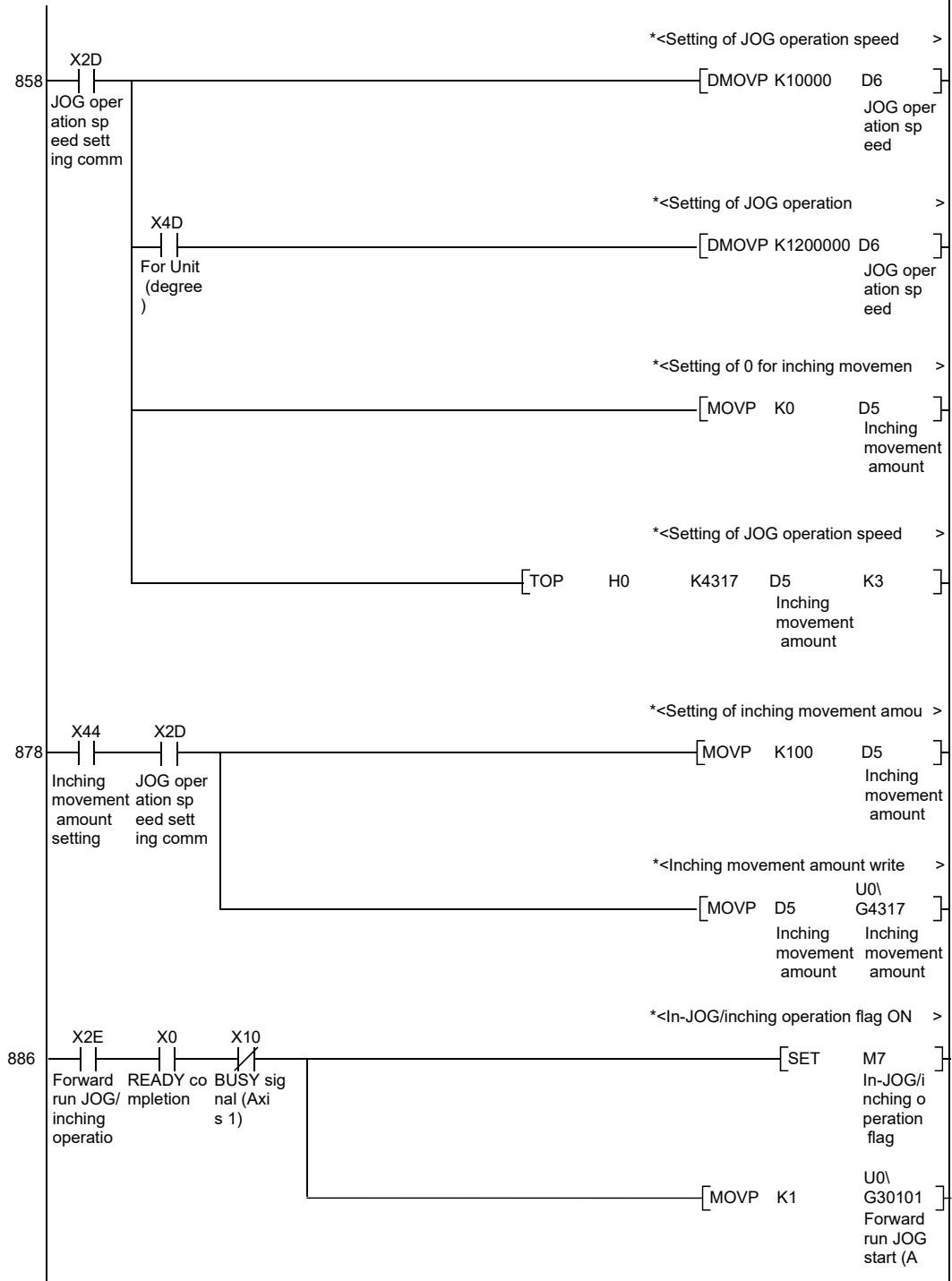

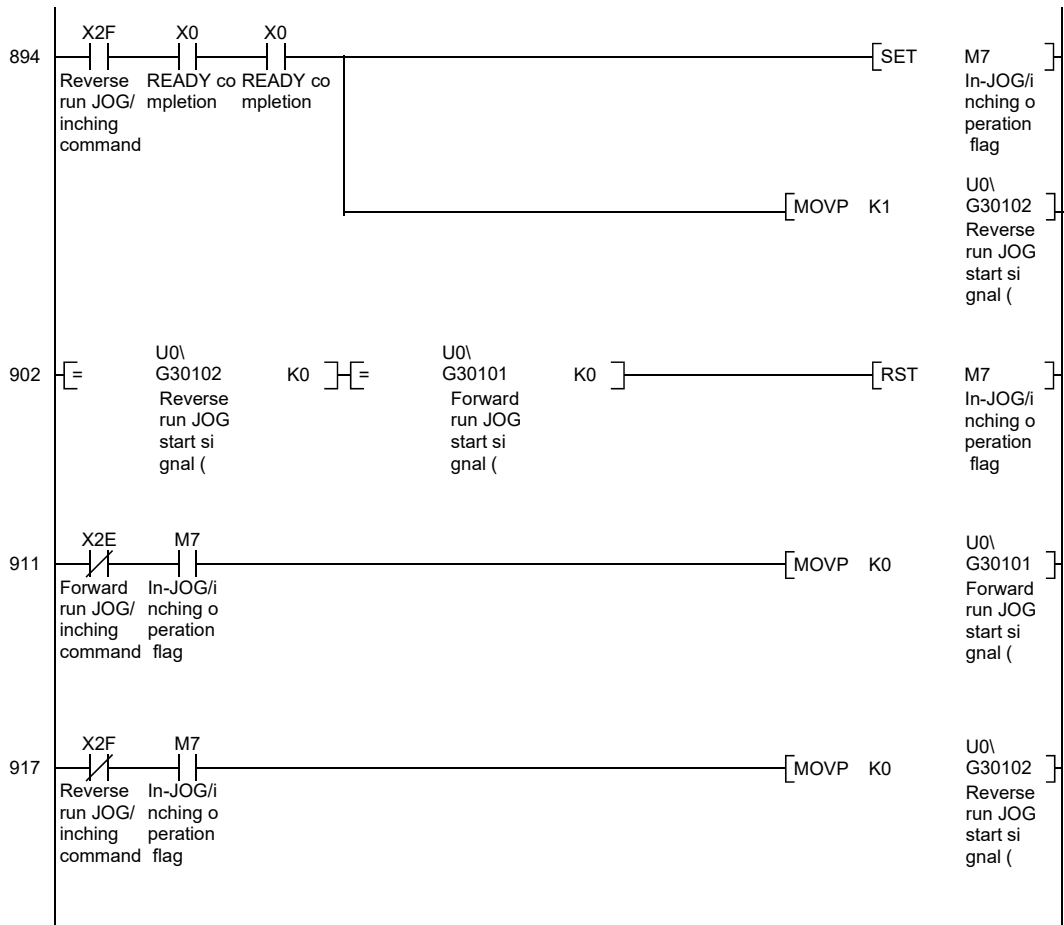

*
*No.13 Manual pulse generator operation program
*

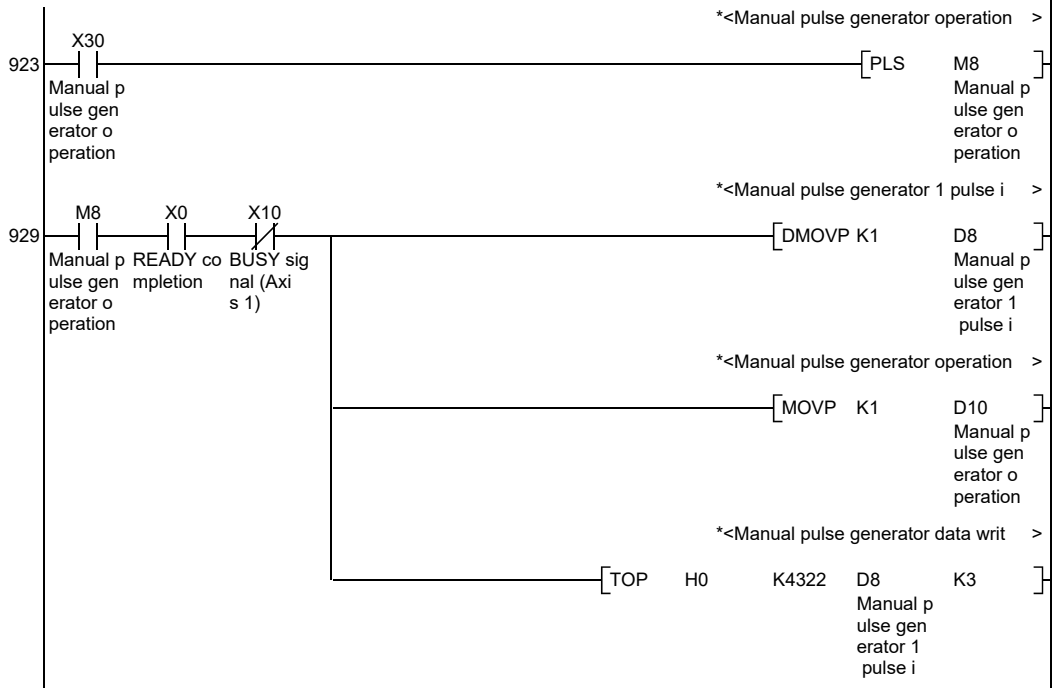

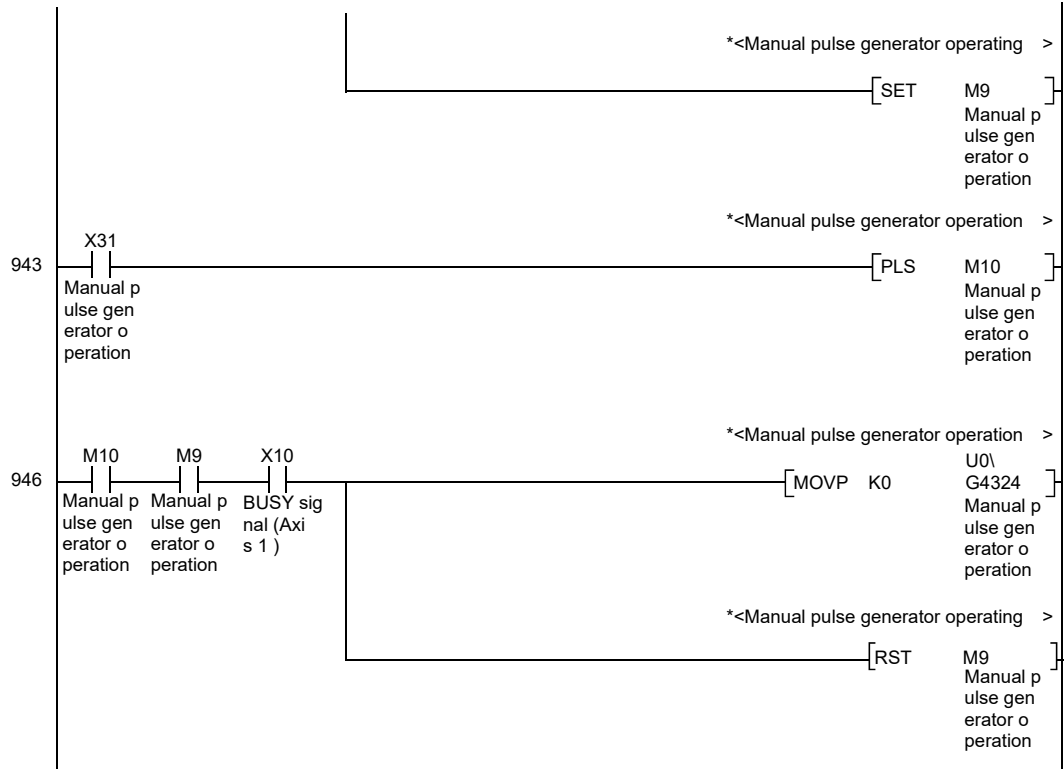

*
* No.14 Speed change program
*

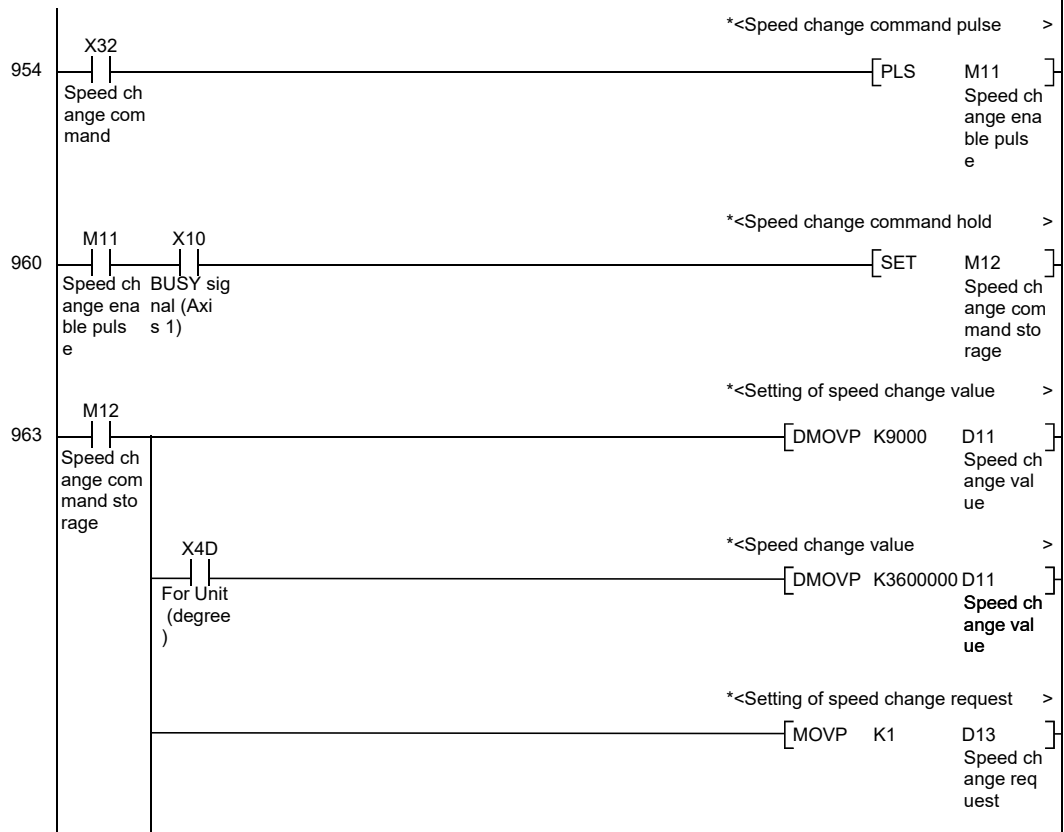

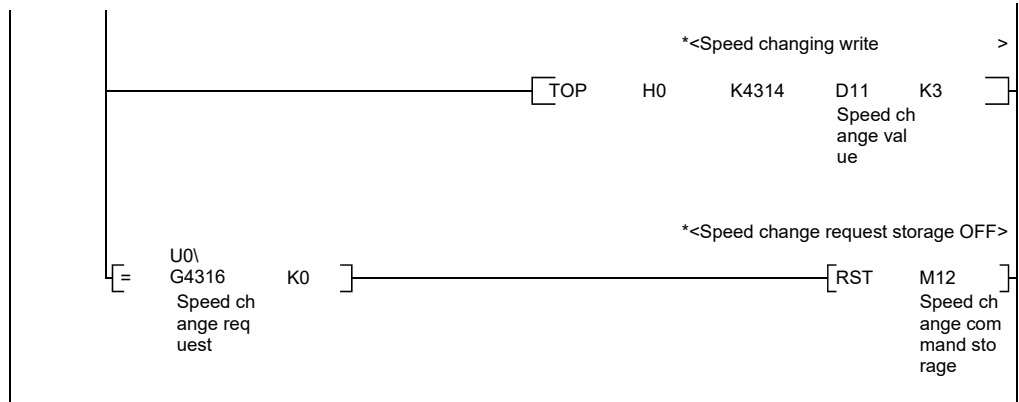

*
 * No.15 Override program
 *

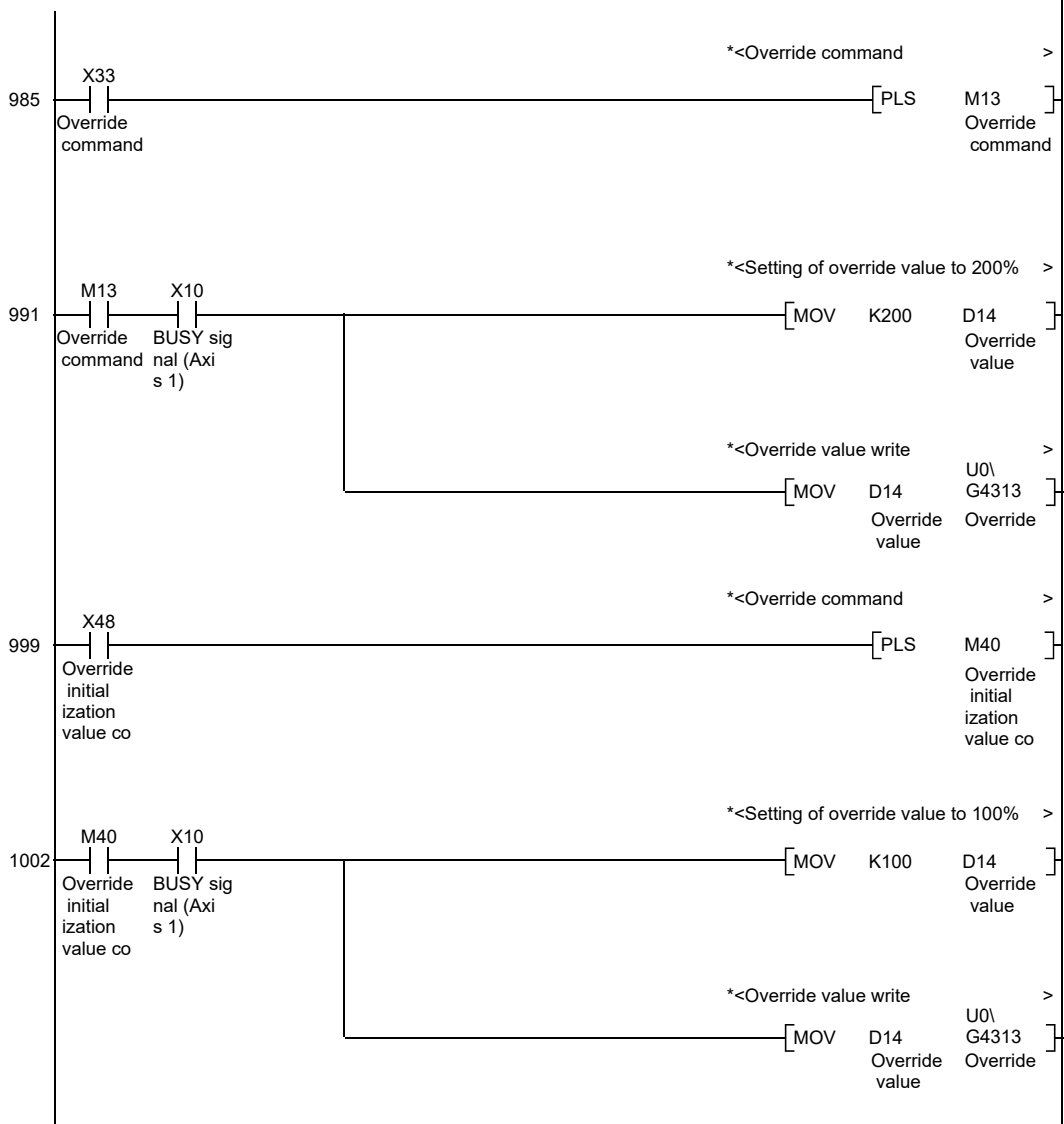

Chapter 6 Sequence Program Used for Positioning Control

*
* No.16 Acceleration/deceleration time change program
*

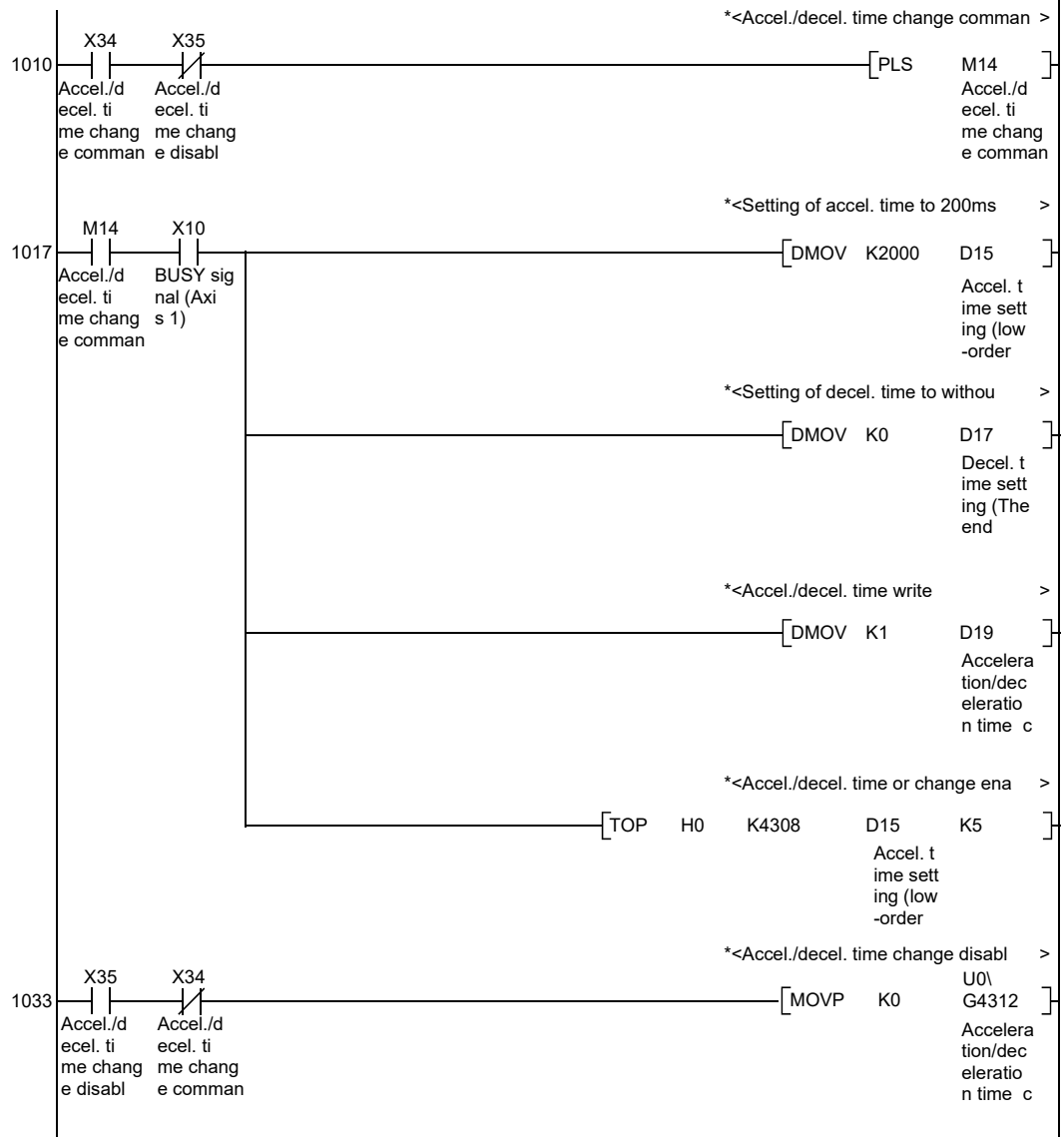

*
* No.17 Torque change program
*

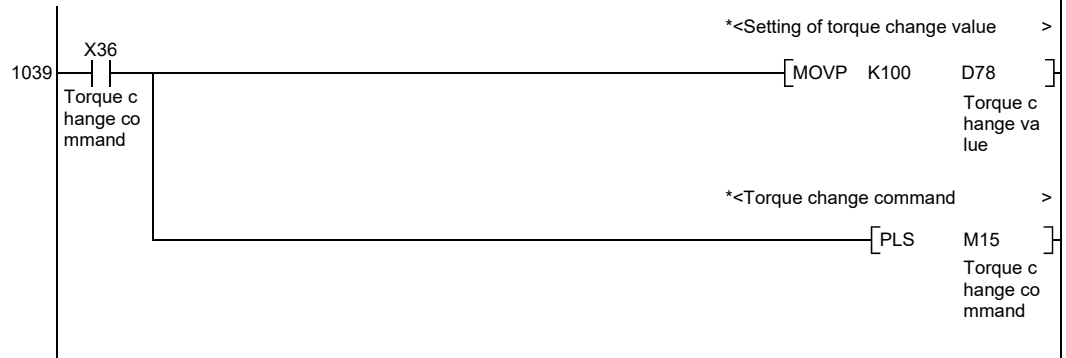

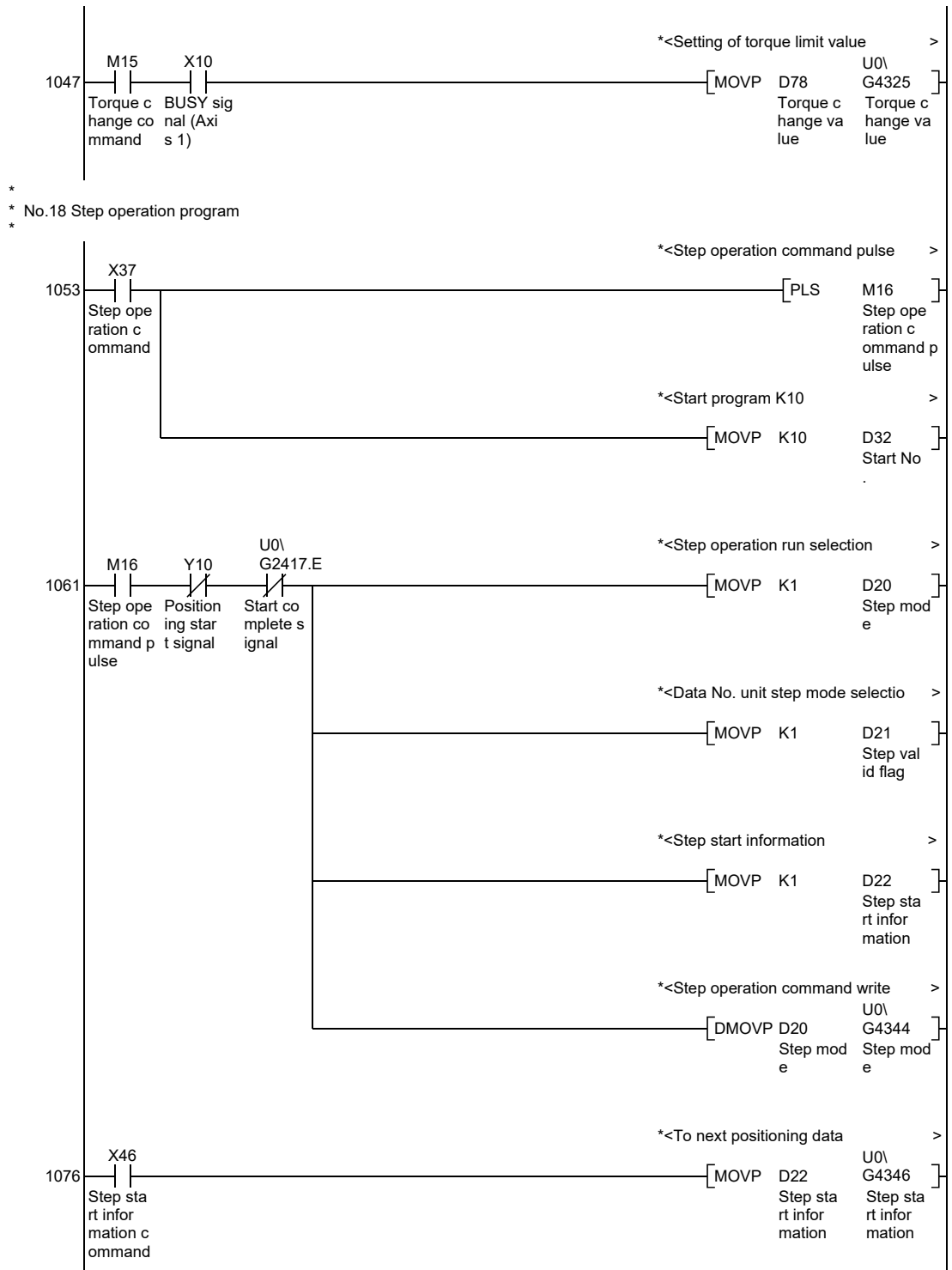

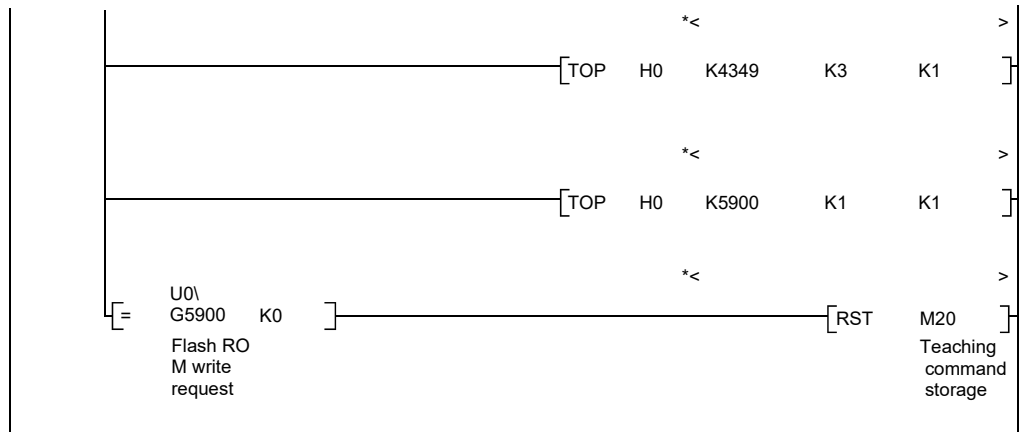

*
* No. 21 Continuous operation interrupt program
*

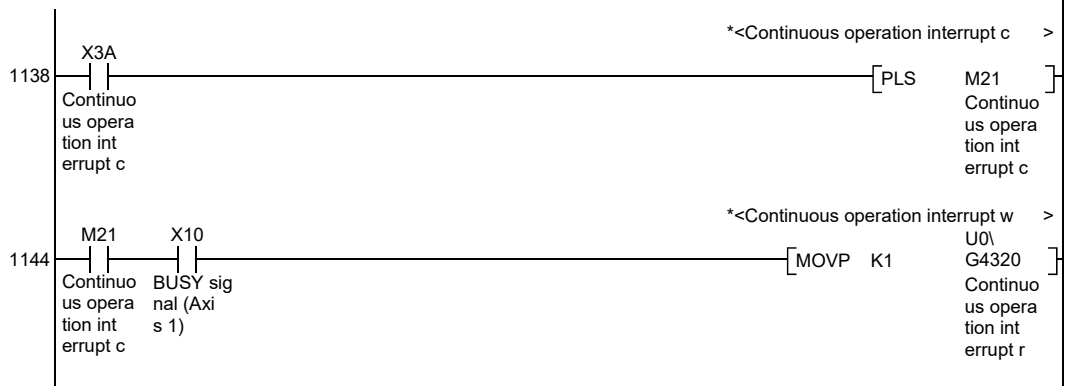

*
* No. 22 Target position change program
*

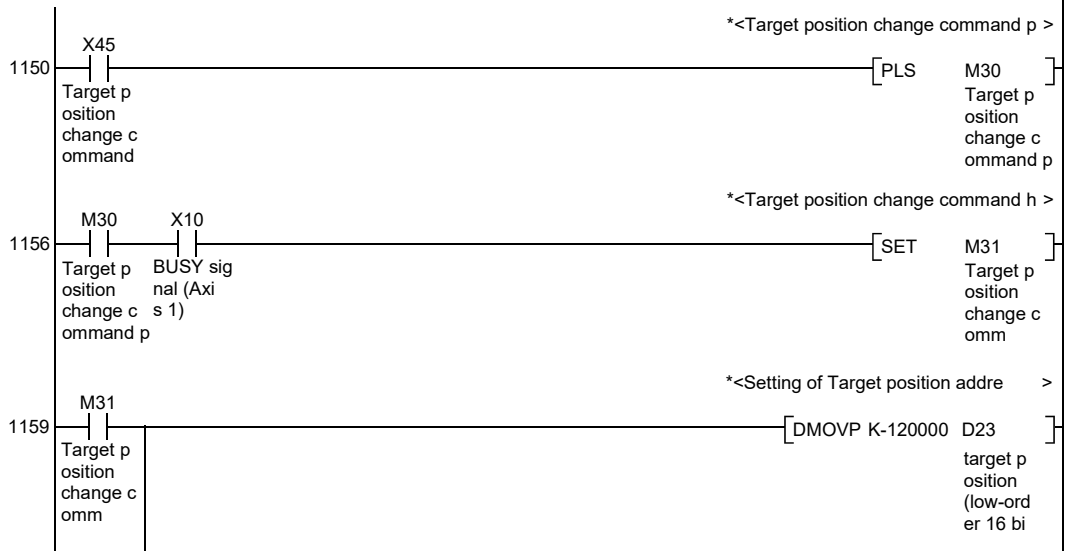

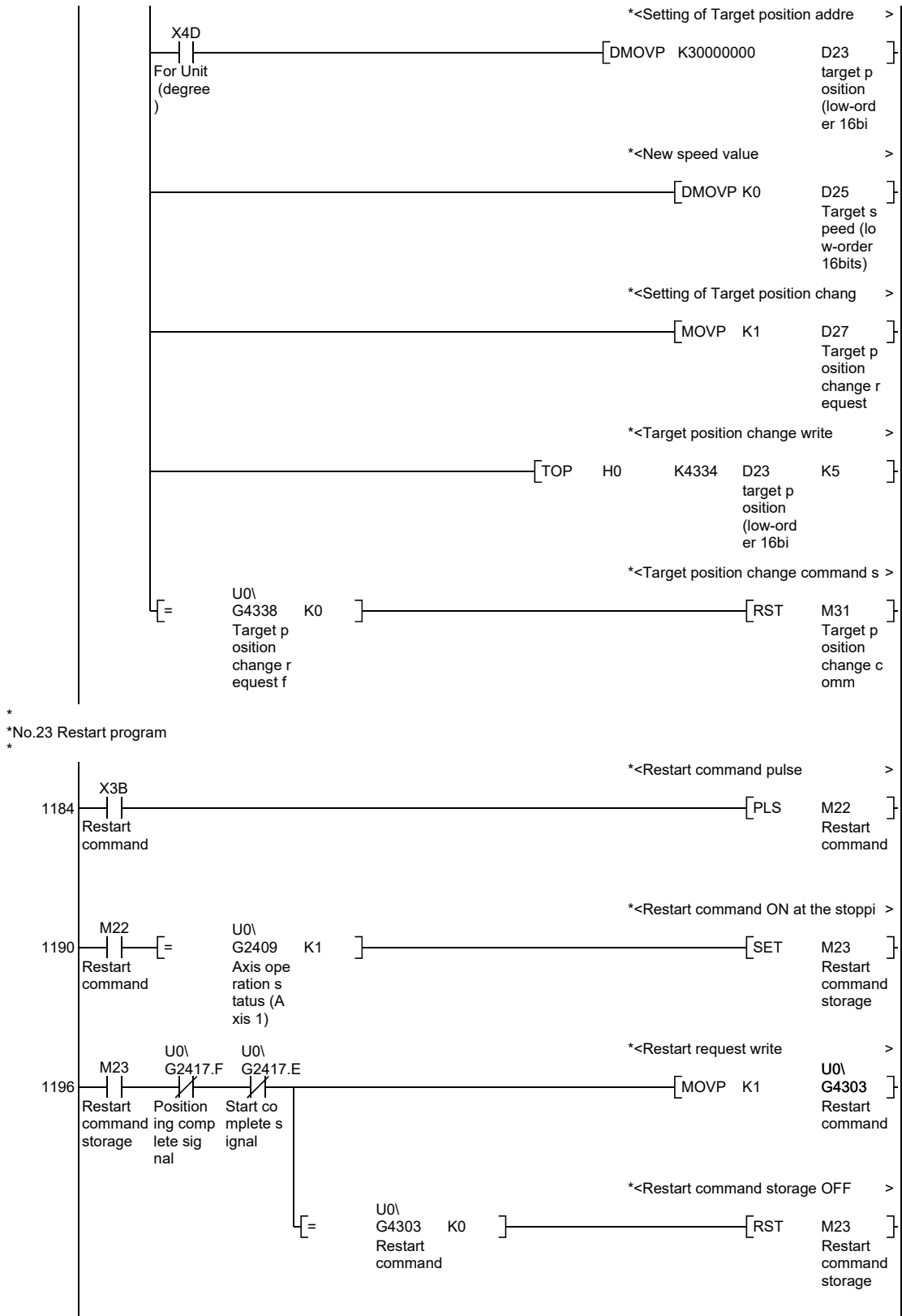

*
*No.24 Parameter initialization program
*

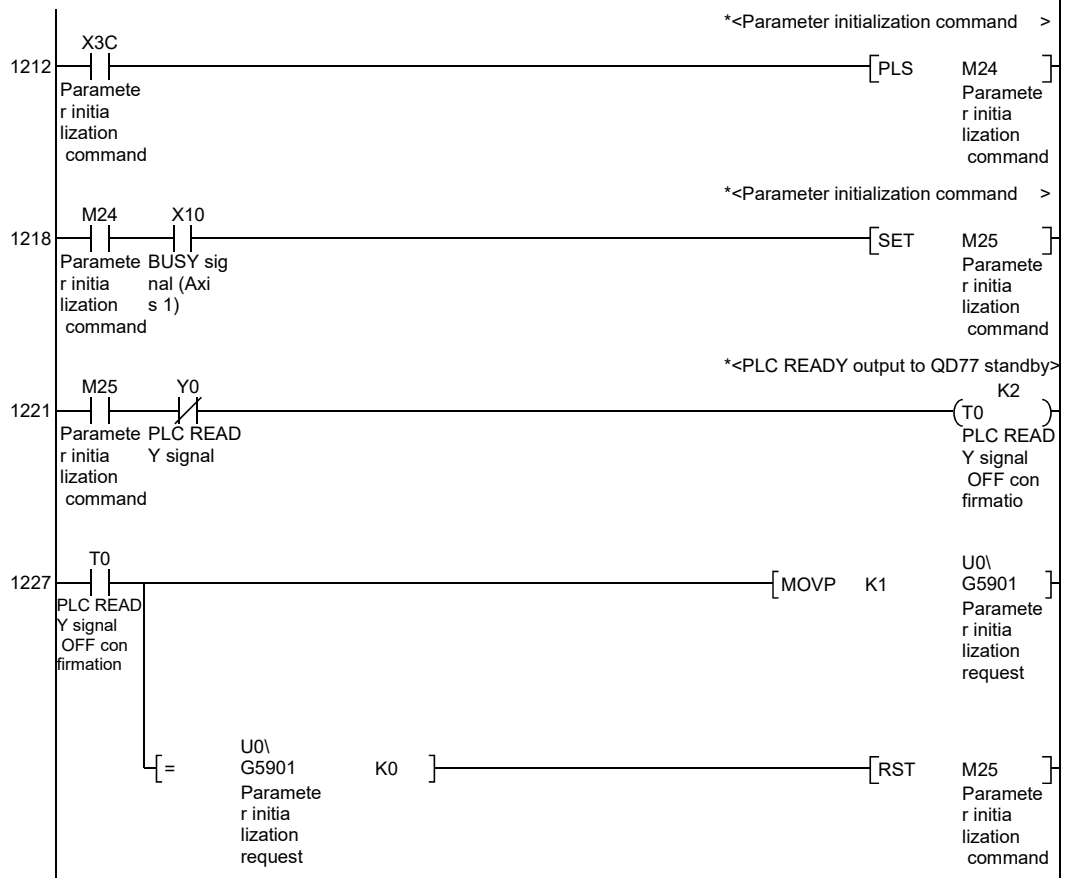

*
*No.25 Flash ROM write program
*

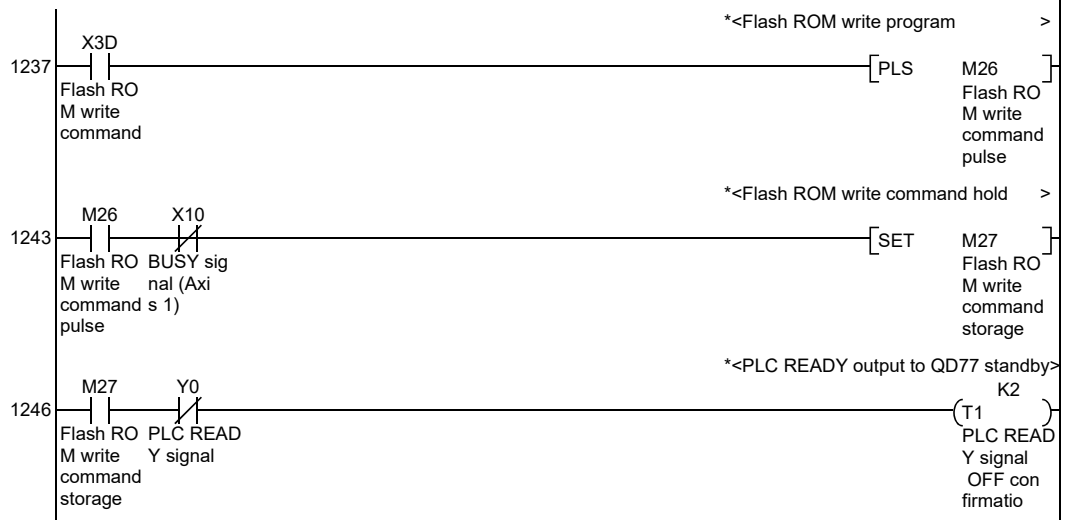

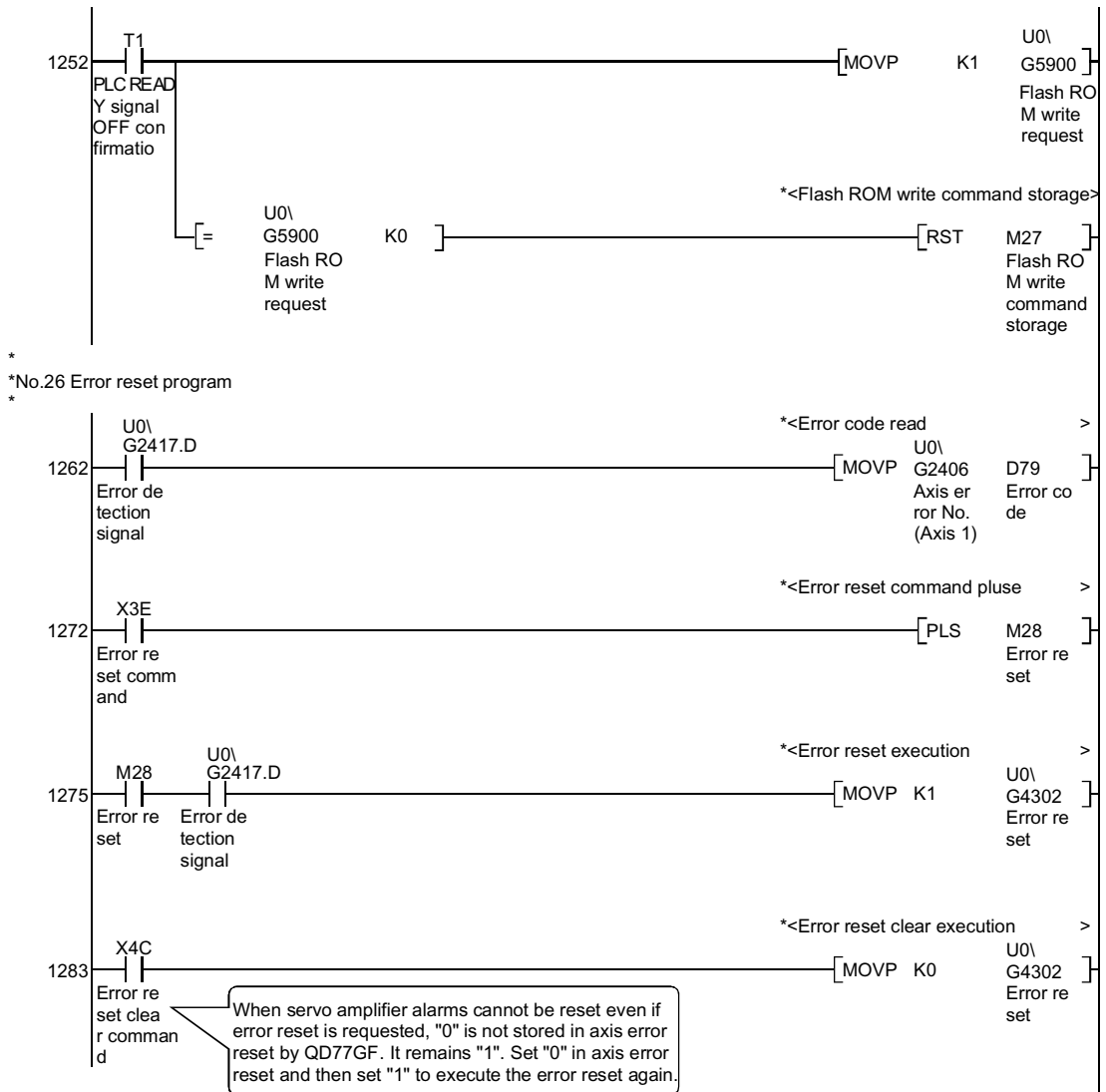

This program stores and resets only error codes.
 To reset warnings, create OR circuits for the error detection signal (axis 1) G2417.D and warning detection signal (axis 1) G2417.9 with step 1275.
 In addition, create a program to store the warning codes by referring to step 1262.

*No.27 Stop program

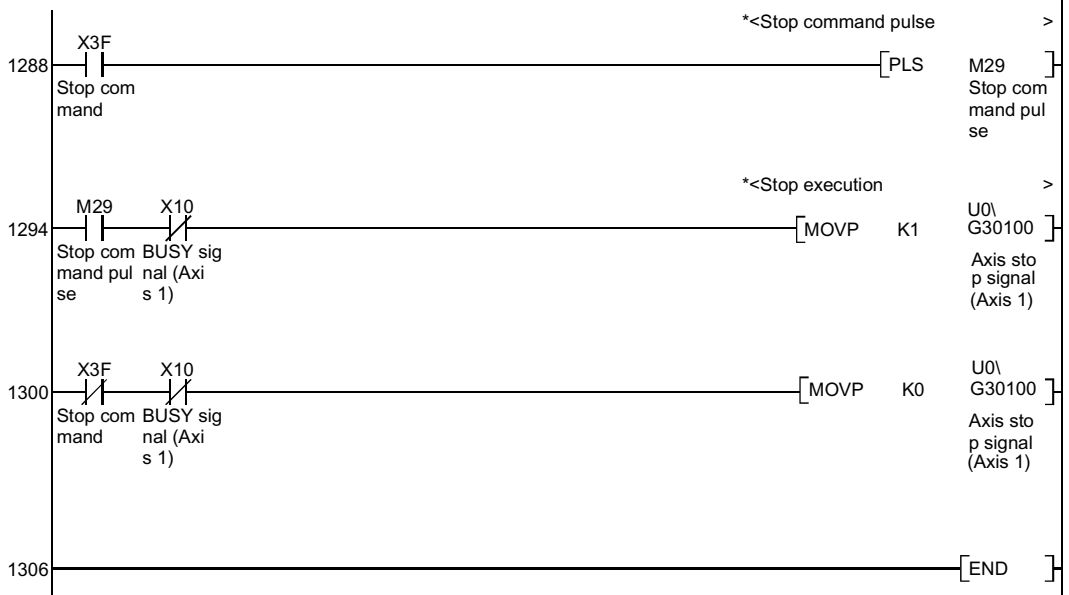

6.5 Program details

6.5.1 Initialization program

[1] HPR request OFF program

This program forcibly turns OFF the "HPR request flag" ([Md.31] Status: b3) which is ON.

When using a system that does not require HPR, assemble the program to cancel the "HPR request" made by the Simple Motion module when the power is turned ON, etc.

■ Data requiring setting

Set the following data to use the HPR request flag OFF request.

| Setting item | Setting value | Setting details | Buffer memory address |
|--------------------------------------|---------------|--|-----------------------|
| [Cd.19] HPR request flag OFF request | 1 | Set to "1: Turn HPR request flag OFF". | 4321+100n |

n: Axis No.-1

*: Refer to Section 5.7 "List of control data" for details on the setting details.

■ Time chart for HPR OFF request

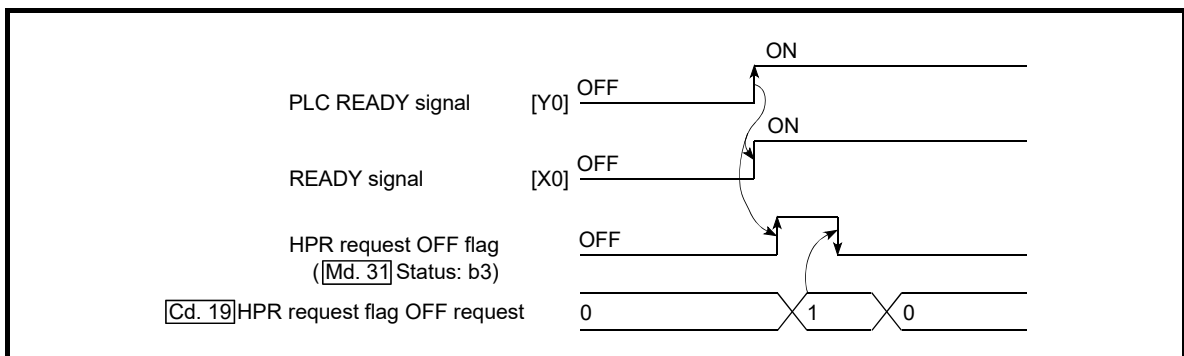

Fig. 6.1 Time chart for HPR OFF request

[2] External command function valid setting program

This program is used to validate the "external command signal" beforehand when using the external command functions (external start, speed change, speed-position switching, position-speed switching, skip). Set which function to use beforehand in "[Pr.42] External command function selection".

(Set the external command signal (DI) in "[Pr.95] External command signal selection".)

Set the following data to validate the "external command signal".

| Setting item | Setting value | Setting details | Buffer memory address |
|-------------------------------|---------------|--|-----------------------|
| [Cd.8] External command valid | 1 | Set to "1: Validate external command". | 4305+100n |

n: Axis No.-1

*: Refer to Section 5.7 "List of control data" for details on the setting details.

6.5.2 Start details setting program

This program sets which control, out of "HPR", "major positioning control", "high-level positioning control" or "expansion control" to execute. For "high-level positioning control", "fast HPR", "speed-position switching control" and "position-speed switching control", add the respectively required sequence program. (Refer to "Chapter 10" for details of "high-level positioning control" and "Chapter 12" for details on the "expansion control".)

■ Procedures for setting the starting details

- (1) Set the "positioning start No." corresponding to the control to be started in "[Cd.3] Positioning start No."

| Setting item | | Setting value | Setting details | Buffer memory address |
|--------------|-----------------------|---------------|--|-----------------------|
| [Cd.3] | Positioning start No. | → | 1 to 600 : Positioning data No. 9001 : Machine HPR 9002 : Fast HPR 9003 : Current value changing 9004 : Simultaneous start 7000 to 7004 : Block No. (For "high-level positioning control") | 4300+100n |

n: Axis No.-1

*: Refer to Section 5.7 "List of control data" for details on the setting details.

- (2) For "high-level positioning control", set the "positioning start point No." of the block to be started in "[Cd.4] Positioning starting point No."

| Setting item | | Setting value | Setting details | Buffer memory address |
|--------------|--------------------------------|---------------|---|-----------------------|
| [Cd.4] | Positioning starting point No. | → | 1 to 50 : Point No. of block start data | 4301+100n |

n: Axis No.-1

*: Refer to Section 5.7 "List of control data" for details on the setting details.

- (3) Set the following control data for "speed-position switching control (INC mode)".
(Set "[Cd.23] Speed-position switching control movement amount change register" as required. Setting is not required in the ABS mode.)

| Setting item | | Setting value | Setting details | Buffer memory address |
|--------------|--|---------------|--|------------------------|
| [Cd.23] | Speed-position switching control movement amount change register | → | Set the new value when the position control's movement amount is to be changed during speed control. | 4326+100n 4327+100n |
| [Cd.24] | Speed-position switching enable flag | 1 | When "1" is set, the speed-position switching signal will be validated. | 4328+100n |

n: Axis No.-1

*: Refer to Section 5.7 "List of control data" for details on the setting details.

- (4) For "position-speed switching control", set the control data shown below.
 (As required, set the "[Cd.25] Position-speed switching control speed change register".)

| Setting item | Setting value | Setting details | Buffer memory address |
|--|---------------|---|------------------------|
| [Cd.25] Position-speed switching control speed change register | → | Used to set a new value when speed is changed during positioning control. | 4330+100n 4331+100n |
| [Cd.26] Position-speed switching enable flag | 1 | To validate position-speed switching signal, this is set to 1. | 4332+100n |

n: Axis No.-1

*: Refer to Section 5.7 "List of control data" for details on the setting details.

6.5.3 Start program

This program is used to start the control with start commands.

The control can be started with the following two methods.

- [1] Starting by inputting positioning start signal
- [2] Starting by inputting external command signal

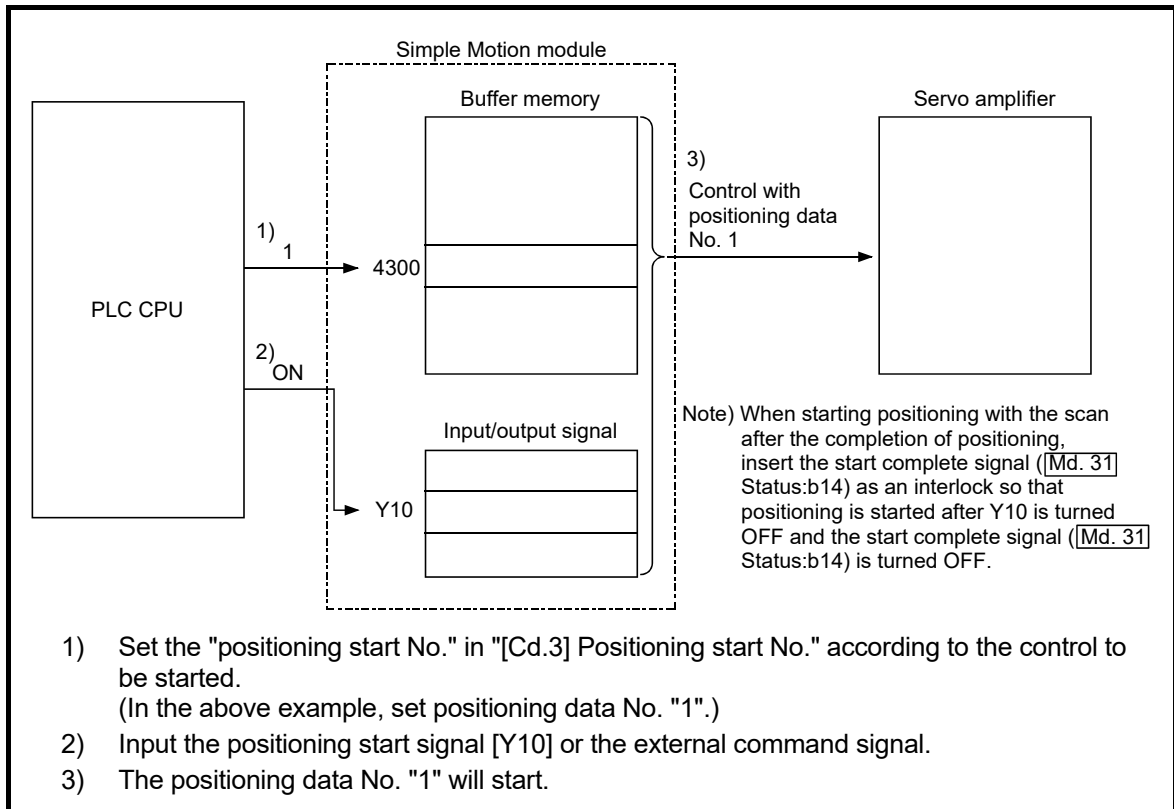

Fig. 6.2 Procedures for starting control (for axis 1)

■ Servo ON conditions

Setting of servo parameter



PLC READY signal [Y0] ON



All axis servo ON [Y1] ON

■ Starting conditions

To start the control, the following conditions must be satisfied.

The necessary start conditions must be incorporated in the sequence program so that the control is not started when the conditions are not satisfied.

(1) Operation state

| Monitor item | Operation state | Buffer memory address |
|-------------------------------|------------------------------|-----------------------|
| [Md.26] Axis operation status | "0: Standby" or "1: Stopped" | 2409+100n |

n: Axis No.-1

(2) Signal state

| Signal name | | Signal state | | Device |
|------------------|--------------------------|--------------|---------------------------------|---------------------|
| Interface signal | PLC READY signal | ON | PLC CPU preparation completed | Y0 |
| | READY signal | ON | QD77GF preparation completed | X0 |
| | All axis servo ON | ON | All axis servo ON | Y1 |
| | Synchronization flag * | ON | QD77GF buffer memory Accessible | X1 |
| | Axis stop signal | OFF | Axis stop signal is OFF | [Cd.180] Axis stop |
| | M code ON signal | OFF | M code ON signal is OFF | [Md.31] Status: b12 |
| | Error detection signal | OFF | There is no error | [Md.31] Status: b13 |
| | BUSY signal | OFF | BUSY signal is OFF | X10 to X1F |
| | Start complete signal | OFF | Start complete signal is OFF | [Md.31] Status: b14 |
| External signal | Forced stop input signal | ON | There is no forced stop input | — |
| | Stop signal | OFF | Stop signal is OFF | — |
| | Upper limit (FLS) | ON | Within limit range | — |
| | Lower limit (RLS) | ON | Within limit range | — |

*: When the synchronous setting of the PLC CPU is made in the nonsynchronous mode, this must be provided as an interlock.

When it is made in the synchronous mode, no interlock must be provided in the program because the flag is turned ON when calculation is run on the PLC CPU.

[1] Starting by inputting positioning start signal

■ Operation when starting

- (1) When the positioning start signal turns ON, the start complete signal and BUSY signal turn ON, and the positioning operation starts.
It can be seen that the axis is operating when the BUSY signal is ON.
- (2) When the positioning start signal turns OFF, the start complete signal also turns OFF.
If the positioning start signal is ON even after positioning is completed, the start complete signal will remain ON.
- (3) If the positioning start signal turns ON again while the BUSY signal is ON, the warning "operating start (warning code: 100)" will occur.
- (4) The process taken when positioning is completed will differ according to case (a) and (b) below.
 - (a) When next positioning is not to be carried out
 - If a dwell time is set, the system will wait for the set time to pass, and then positioning will be completed.
 - When positioning is completed, the BUSY signal will turn OFF and the positioning complete signal will turn ON. However, when using speed control or when the positioning complete signal ON time is "0", the signal will not turn ON.
 - When the positioning complete signal ON time is passed, the positioning complete signal will turn OFF.
 - (b) When next positioning is to be carried out
 - If a dwell time is set, the system will wait for the set time to pass.
 - When the set dwell time is passed, the next positioning will start.

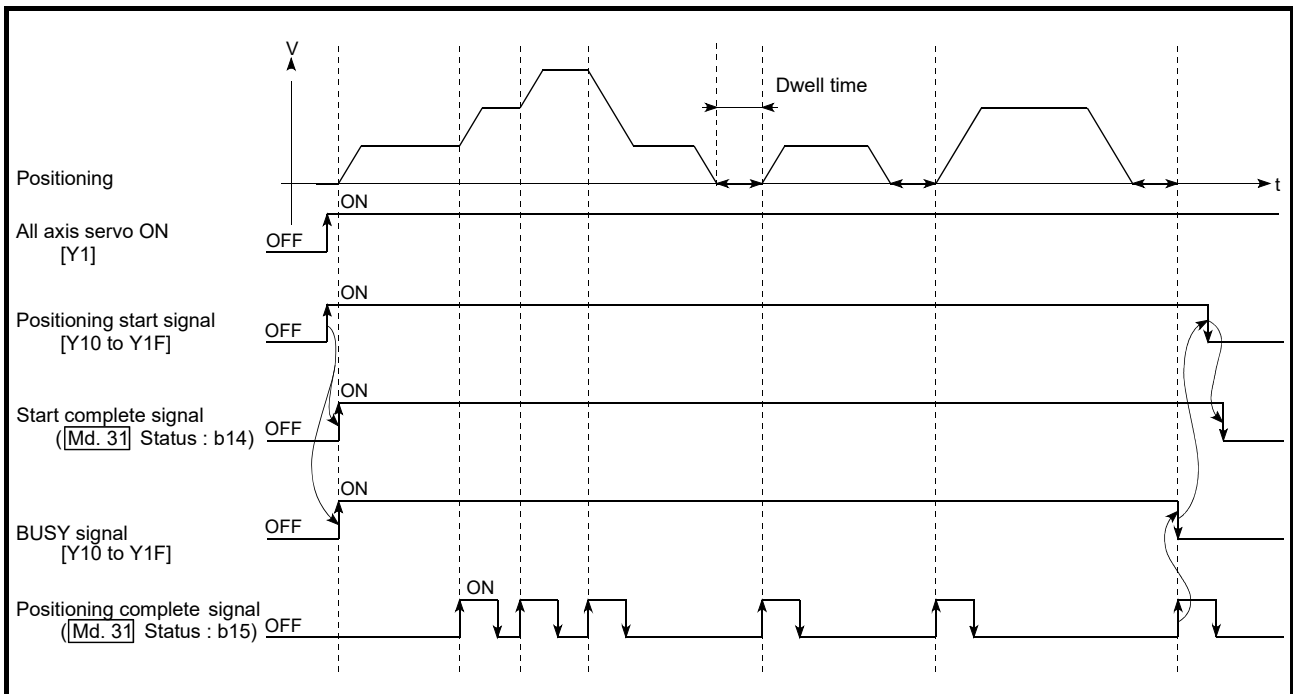

Fig. 6.3 ON/OFF timing of each signal at start of positioning

POINT

The BUSY signal turns ON even when position control of movement amount 0 is executed. However, since the ON time is short, the ON status may not be detected in the sequence program.
 (The ON status of the start complete signal, positioning complete signal and M code ON signal can be detected in the sequence program.)

■ Starting time chart

The time chart for starting each control is shown below.

(1) Time chart for starting "machine HPR"

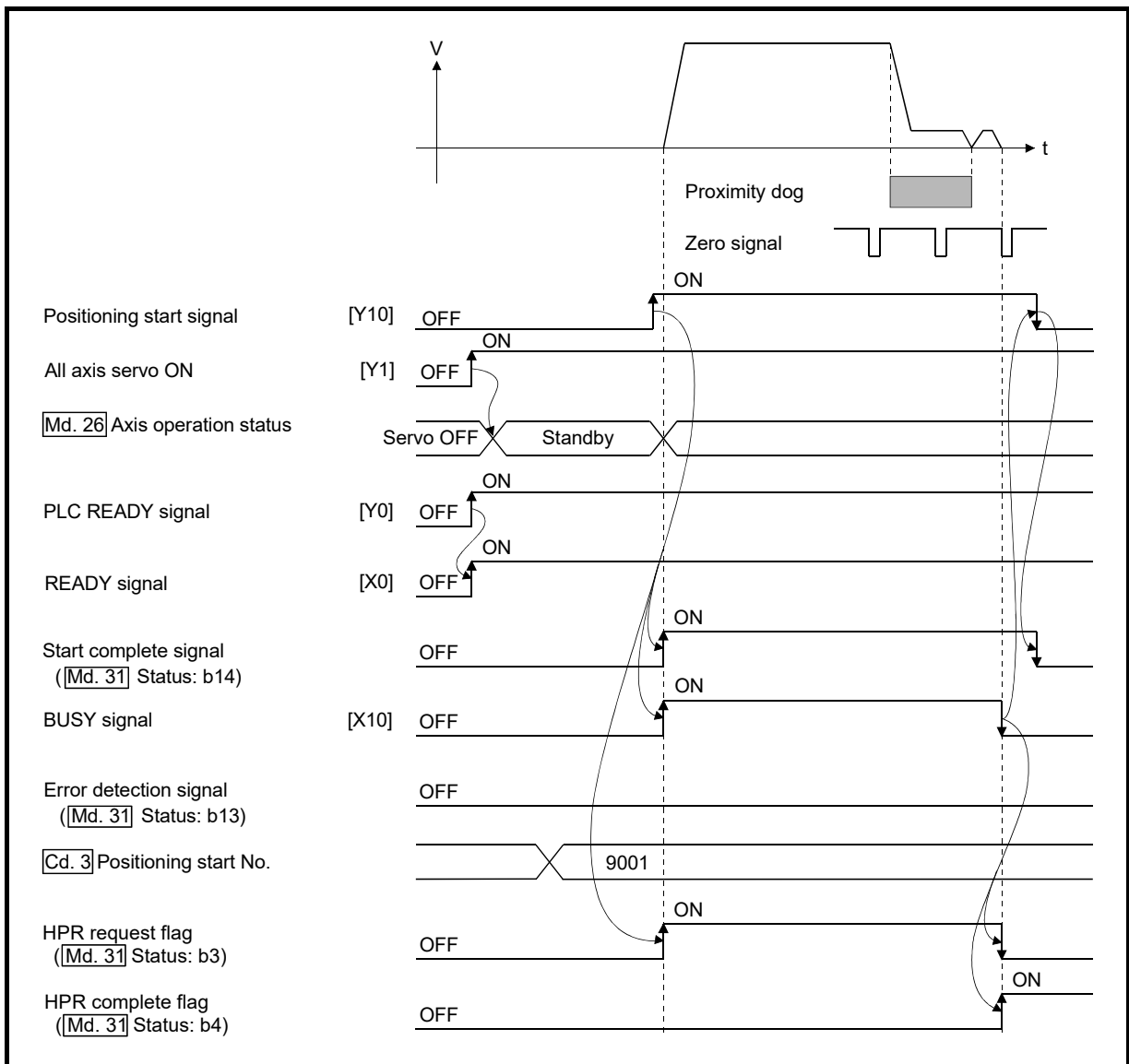

Fig. 6.4 Time chart for starting "machine HPR"

(2) Time chart for starting "fast HPR"

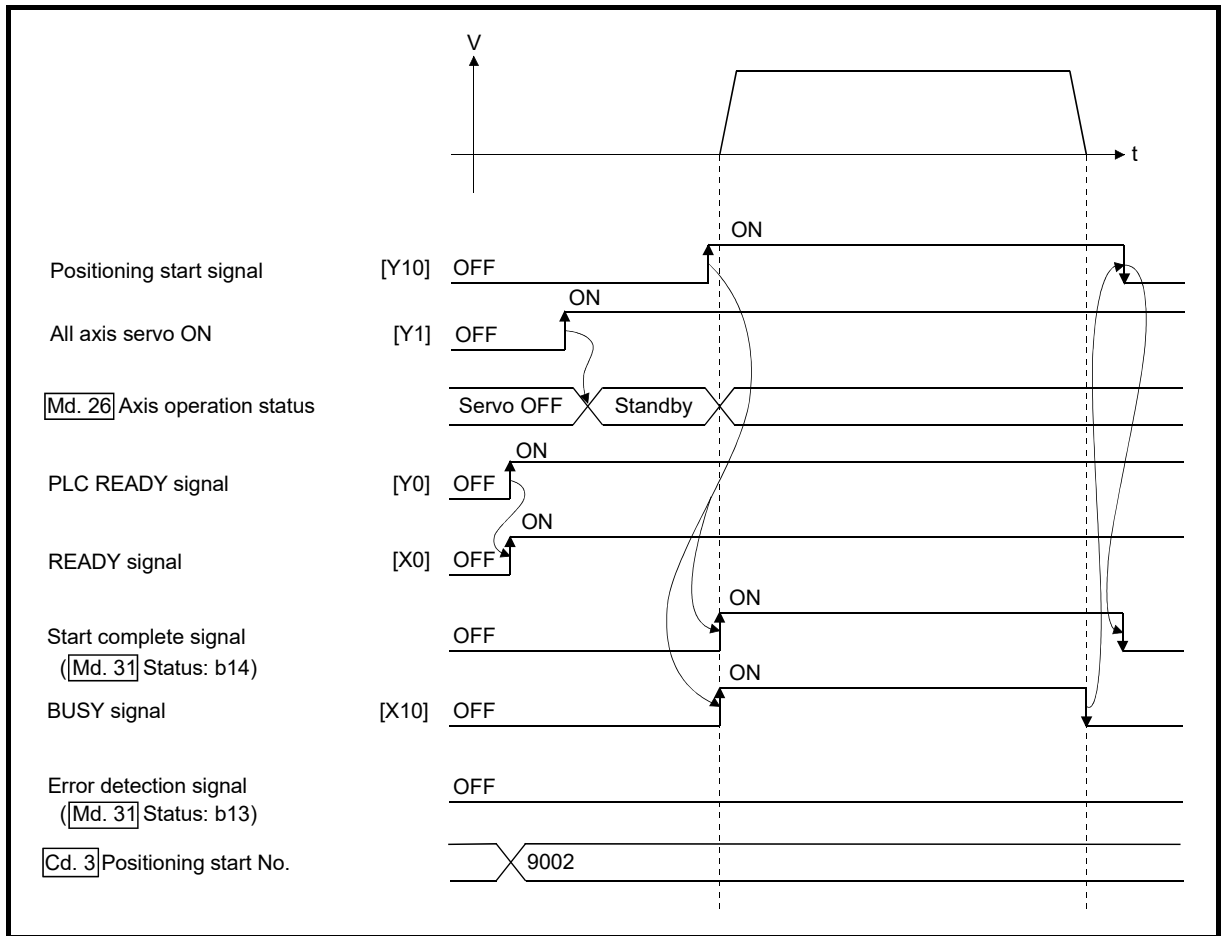

Fig. 6.5 Time chart for starting "fast HPR"

(3) Time chart for starting "major positioning control"

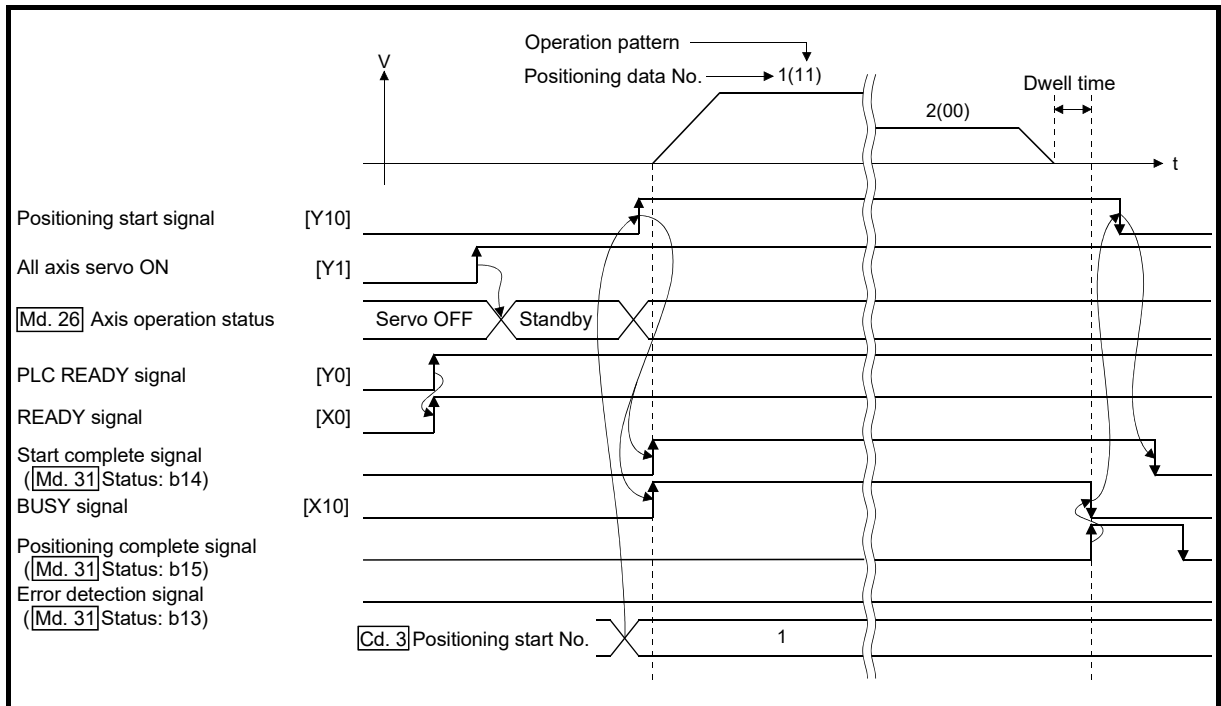

Fig. 6.6 Time chart for starting "major positioning control"

(4) Time chart for starting "speed-position switching control"

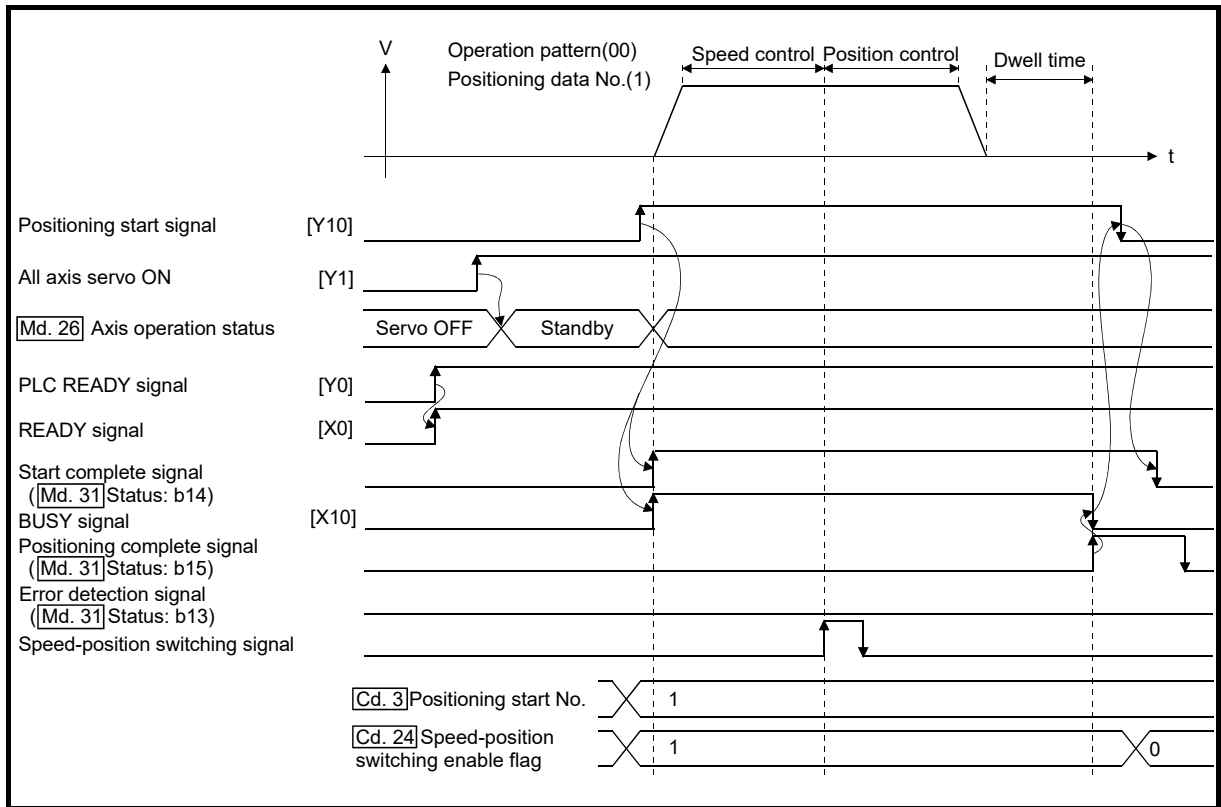

Fig. 6.7 Time chart for starting "speed-position switching control"

(5) Time chart for starting "position-speed switching control"

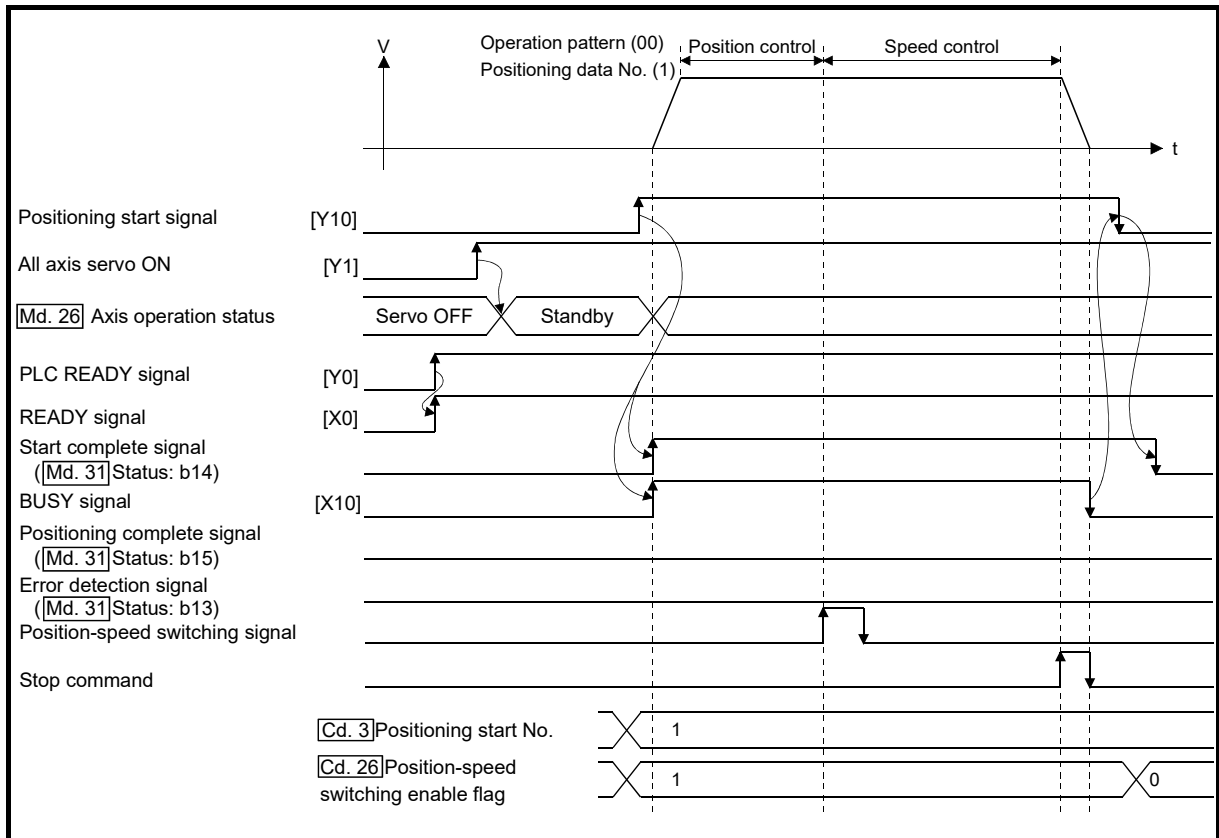

Fig. 6.8 Time chart for starting "position-speed switching control"

■ Machine HPR operation timing and process time

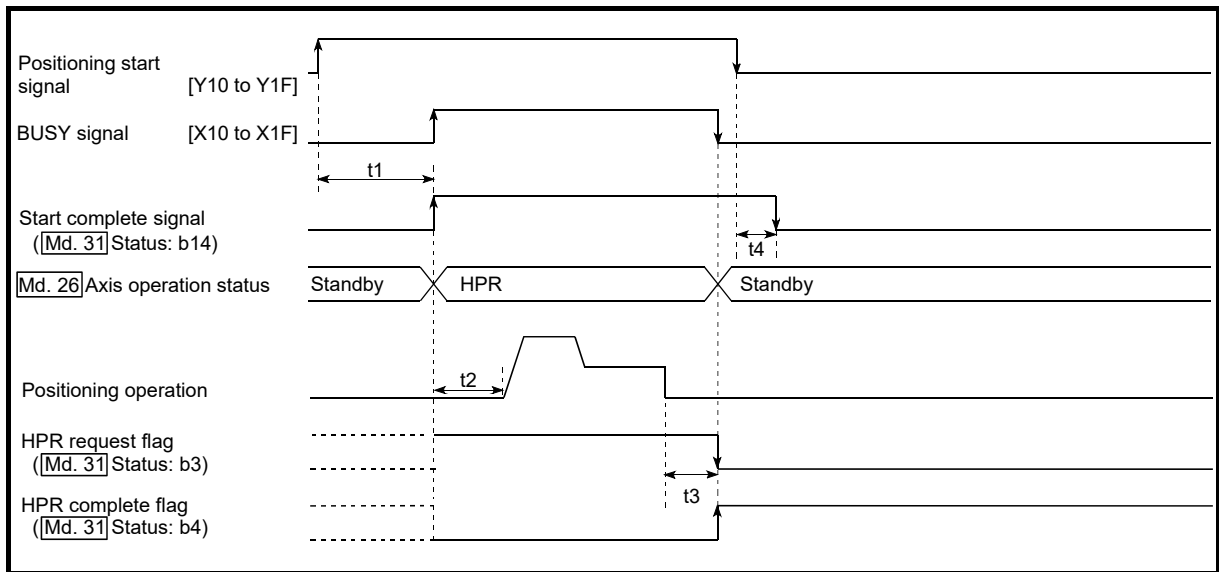

Fig. 6.9 Machine HPR operation timing and process time

Normal timing time

Unit: [ms]

| [Pr.132] Communication mode setting | Operation cycle | t1 | t2 | t3 | t4 |
|---|-----------------|------------|--------------|----------|----------|
| MR-J4-B-RJ010 communication mode | 0.88 | 0.7 to 1.6 | 7.1 to 10.3 | 0 to 0.9 | 0 to 0.9 |
| | 1.77 | 1.1 to 2.5 | 7.1 to 10.3 | 0 to 1.8 | 0 to 1.8 |
| | 3.55 | 1.1 to 4.2 | 9.0 to 14.0 | 0 to 3.6 | 0 to 3.6 |
| Communication mode correspond to CiA402 | 1.00 | 1.0 to 1.7 | 7.1 to 10.5 | – | 0 to 1.0 |
| | 2.00 | 1.1 to 2.8 | 14.9 to 17.7 | – | 0 to 2.0 |
| | 4.00 | 1.9 to 4.7 | 29.0 to 33.2 | – | 0 to 4.0 |

- The t1 timing time could be delayed depending on the operating conditions of the other axis.

■ Position control operation timing and process time

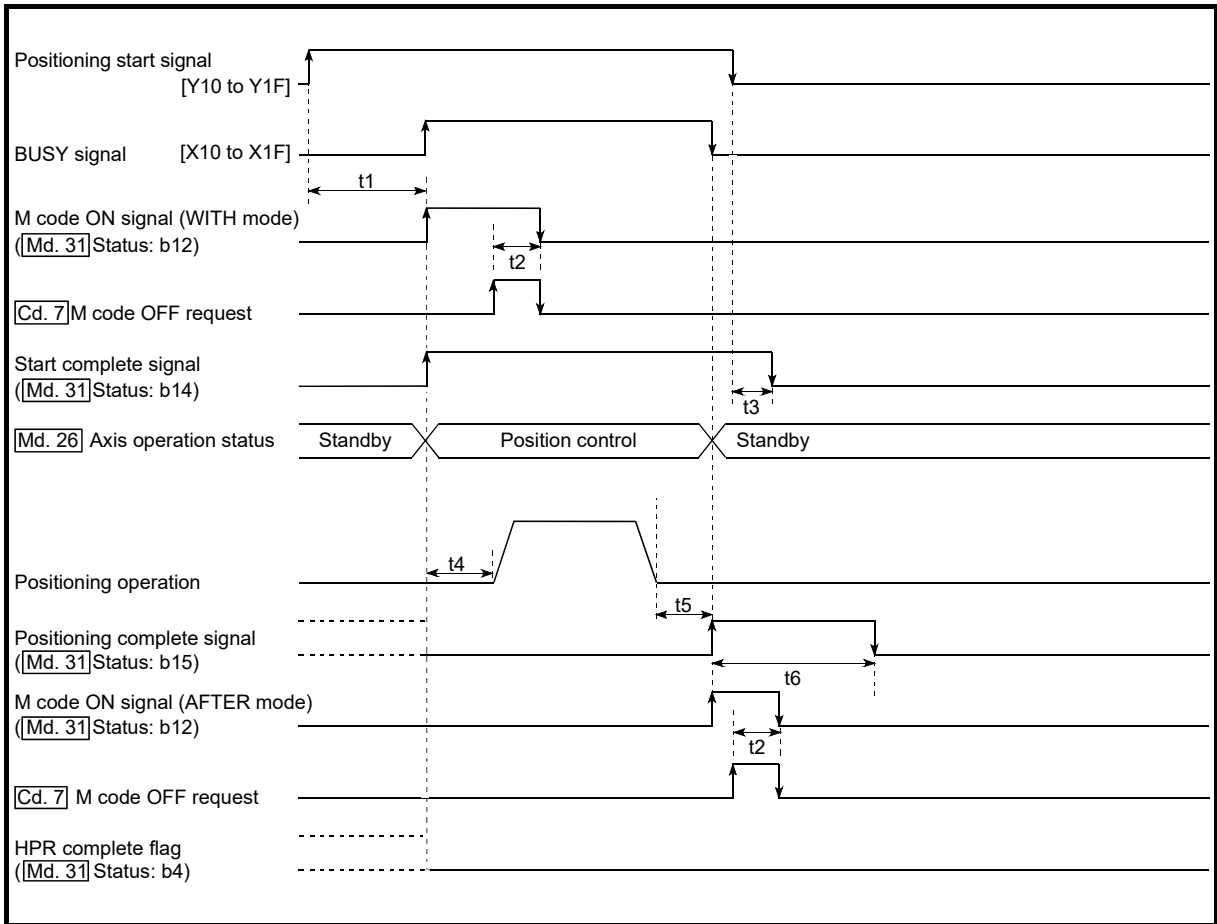

Fig. 6.10 Position control operation timing and process time

When the positioning start signal turns ON, if the "positioning complete signal" or "HPR complete flag" are already ON, the "positioning complete signal" or "HPR complete flag" will turn OFF when the positioning start signal turns ON.

Normal timing time

Unit: [ms]

| [Pr.132] Communication mode setting | Operation cycle | t1 | t2 | t3 | t4 | t5 | t6 |
|---|-----------------|------------|----------|----------|--------------|----------|--------------------|
| MR-J4-B-RJ010 communication mode | 0.88 | 0.8 to 1.5 | 0 to 0.9 | 0 to 0.9 | 2.5 to 3.2 | 0 to 0.9 | Follows parameters |
| | 1.77 | 1.1 to 2.5 | 0 to 1.8 | 0 to 1.8 | 5.6 to 6.9 | 0 to 1.8 | Follows parameters |
| | 3.55 | 1.1 to 4.2 | 0 to 3.6 | 0 to 3.6 | 10.8 to 13.8 | 0 to 3.6 | Follows parameters |
| Communication mode correspond to CiA402 | 1.00 | 0.9 to 1.7 | 0 to 1.0 | 0 to 1.0 | 2.5 to 3.2 | 0 to 1.0 | Follows parameters |
| | 2.00 | 1.1 to 2.8 | 0 to 2.0 | 0 to 2.0 | 5.6 to 6.9 | 0 to 2.0 | Follows parameters |
| | 4.00 | 2.2 to 4.2 | 0 to 4.0 | 0 to 4.0 | 11.5 to 13.8 | 0 to 4.0 | Follows parameters |

- The t1 timing time could be delayed depending on the operating conditions of the other axis.

[2] Starting by inputting external command signal

When starting positioning control by inputting the external command signal, the start command can be directly input into the Simple Motion module. This allows the variation time equivalent to one scan time of the PLC CPU to be eliminated. This is an effective procedure when operation is to be started as quickly as possible with the start command or when the starting variation time is to be suppressed. To start positioning control by inputting the external command signal, set the "data required to be set" and then turn ON the external command signal.

■ Restrictions

When starting by inputting the external command signal, the start complete signal will not turn ON.

■ Data required to be set

To execute positioning start with the external command signal, set parameter ([Pr.42]) beforehand, and validate the "external command signal" with the "external command signal validity setting program (program No.5).

| Setting item | | Setting value | Setting details | Buffer memory address |
|--------------|-------------------------------------|---------------|---|-----------------------|
| [Pr.42] | External command function selection | 0 | Set to "0: External positioning start". | 62+150n |
| [Cd.8] | External command valid | 1 | Set to "1: Validate external command". | 4305+100n |

n: Axis No.-1

*: Set the external command signal (DI) in "[Pr.95] External command signal selection".
Refer to Chapter 5 "Data Used for Positioning Control" for details on the setting details.

■ Starting time chart

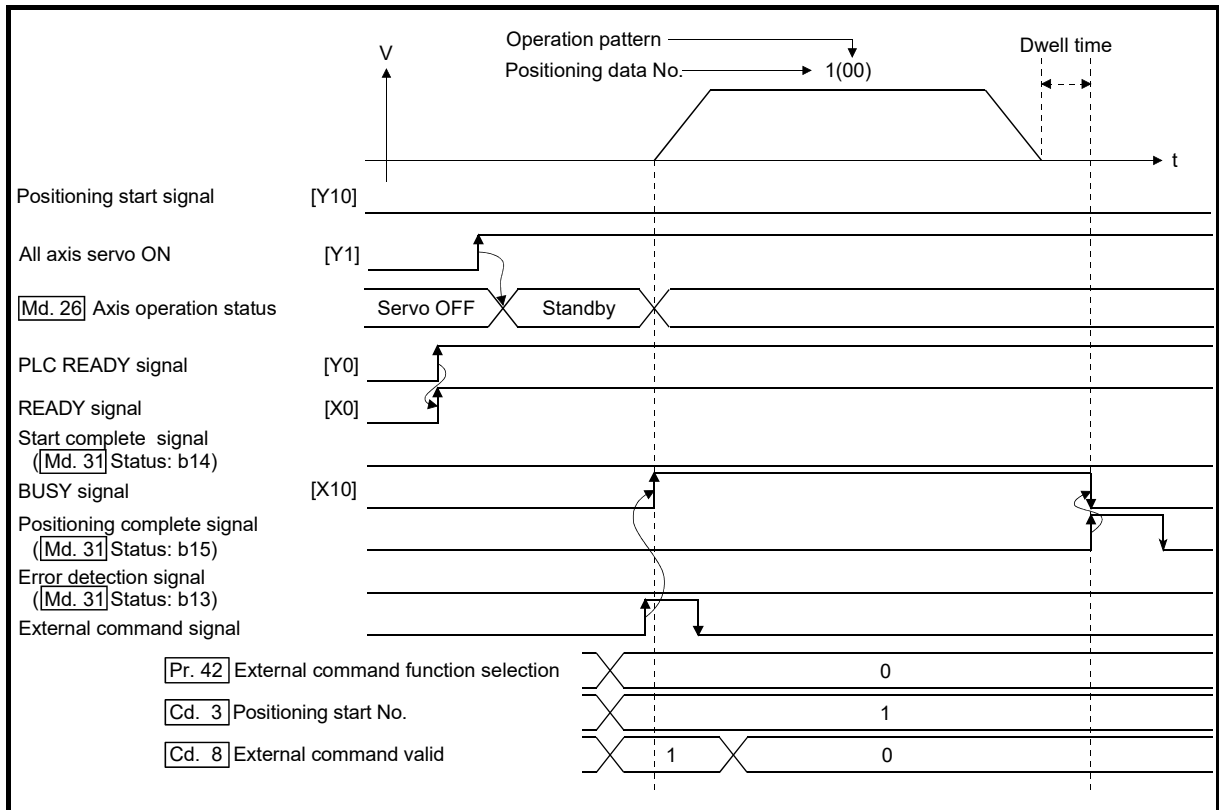

Fig. 6.11 Time chart for starting with external start signal

6.5.4 Continuous operation interrupt program

During positioning control, the control can be interrupted during continuous positioning control and continuous path control (continuous operation interrupt function). When "continuous operation interruption" is execution, the control will stop when the operation of the positioning data being executed ends. To execute continuous operation interruption, set "1: Interrupts continuous operation control or continuous path control." for "[Cd.18] Interrupt request during continuous operation".

[1] Operation during continuous operation interruption

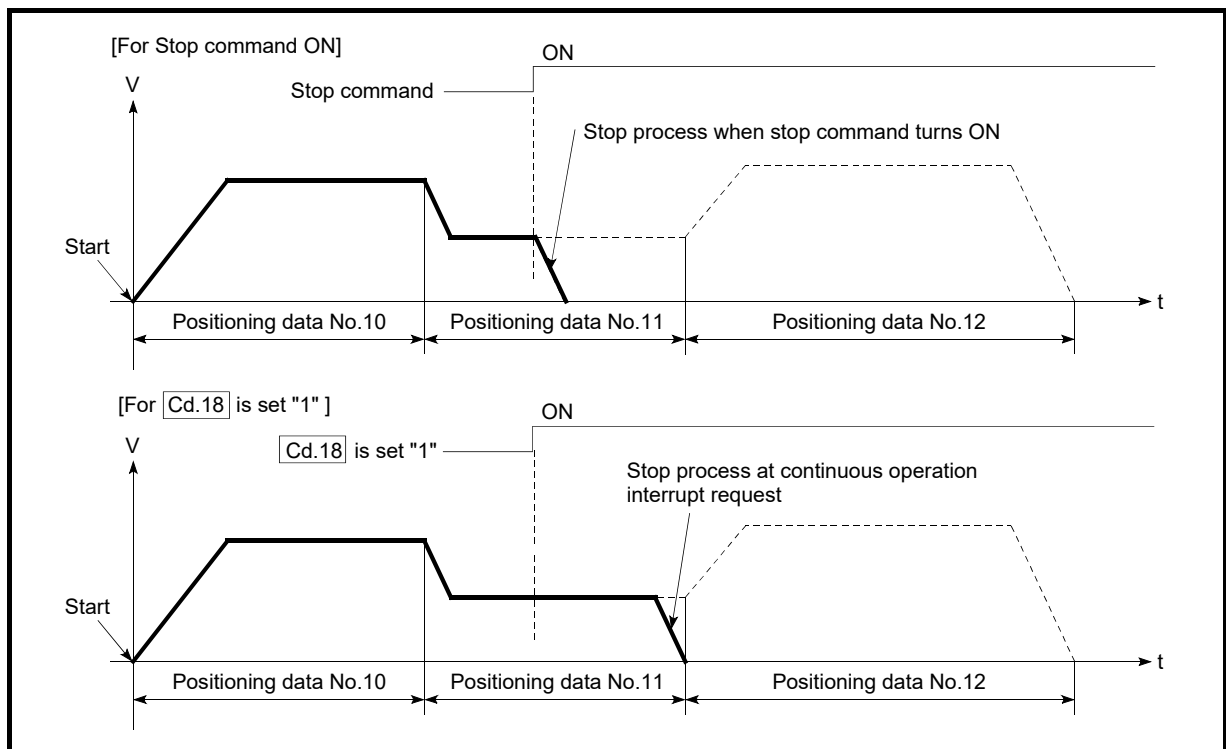

Fig. 6.12 Operation during continuous operation interruption

[2] Restrictions

- (1) When the "continuous operation interrupt request" is executed, the positioning will end.
 Thus, after stopping, the operation cannot be "restarted".
 When "[Cd.6] Restart command" is issued, the warning "Restart not possible" (warning code: 104) will occur.

- (2) Even if the stop command is turned ON after executing the "continuous operation interrupt request", the "continuous operation interrupt request" cannot be canceled.

Thus, if "restart" is executed after stopping by turning the stop command ON, the operation will stop when the positioning data No. where "continuous operation interrupt request" was executed is completed.

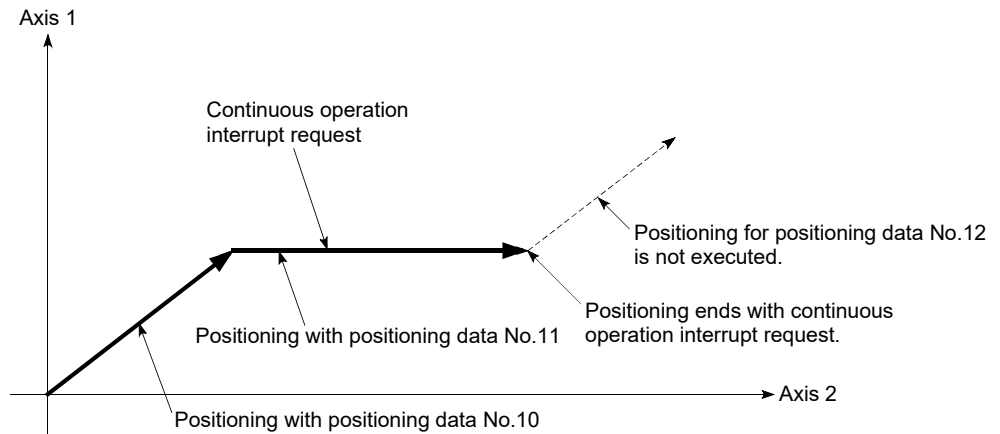

- (3) If the operation cannot be decelerated to a stop because the remaining distance is insufficient when "continuous operation interrupt request" is executed with continuous path control, the interruption of the continuous operation will be postponed until the positioning data shown below.

- Positioning data No. have sufficient remaining distance
- Positioning data No. for positioning complete (pattern: 00)
- Positioning data No. for continuous positioning control (pattern: 01)

Even when the continuous operation interrupt is requested, the remaining distance is insufficient, and thus, the operation cannot stop at the positioning No. being executed.

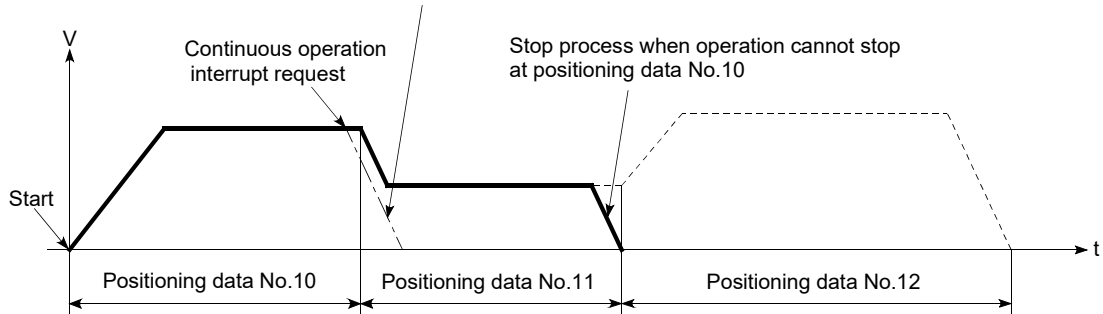

- (4) When operation is not performed (BUSY signal is OFF), the interrupt request during continuous operation is not accepted. It is cleared to 0 at a start or restart.

[3] Control data requiring settings

Set the following data to interrupt continuous operation.

| Setting item | Setting value | Setting details | Buffer memory address |
|---|---------------|--|-----------------------|
| [Cd.18] Interrupt request during continuous operation | 1 | Set "1: Interrupts continuous operation control or continuous path control." | 4320+100n |

n: Axis No.-1

*: Refer to Section 5.7 "List of control data" for details on the setting details.

6.5.5 Restart program

When a stop factor occurs during position control and the operation stops, the positioning can be restarted from the stopped position to the position control end point by using the "restart command" ([Cd.6] Restart command).

("Restarting" is not possible when "continuous operation is interrupted.")

This instruction is efficient when performing the remaining positioning from the stopped position in the positioning control of incremental method such as INC linear 1.

(Calculation of remaining distance is not required.)

[1] Restart operation

After a deceleration stop by the stop command is completed, write "1" to the "[Cd.6] Restart command" with "[Md.26] Axis operation status" is "stopped" and the positioning restarts.

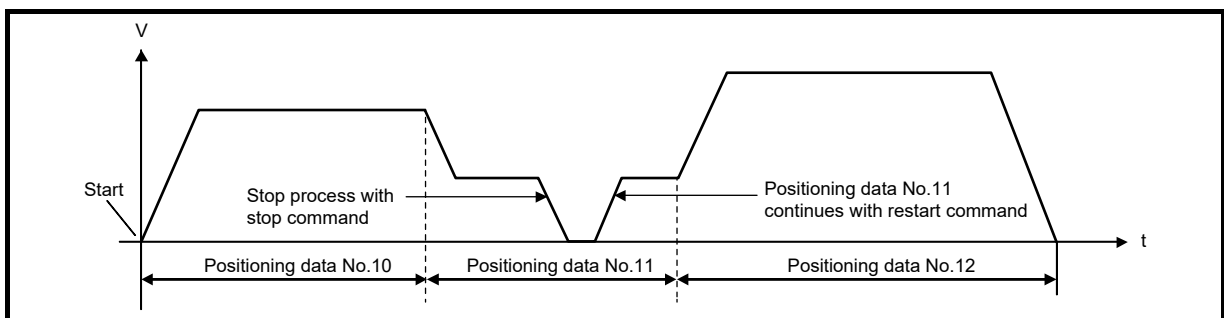

Fig. 6.13 Restart operation

[2] Restrictions

- (1) Restarting can be executed only when the "[Md.26] Axis operation status" is "stopped (the deceleration stop by stop command is completed)".
If the axis operation is not "stopped", restarting is not possible.
In this case, the warning "Restart not possible" (warning code: 104) will occur, and the process at that time will be continued.
- (2) Do not execute restart while the stop command is ON.
If restart is executed while stopped, the error "Stop signal ON at start" (error code: 106) will occur, and the "[Md.26] Axis operation status" will change to "Error".
Thus, even if the error is reset, the operation cannot be restarted.
- (3) Restarting can be executed even while the positioning start signal is ON.
However, make sure that the positioning start signal does not change from OFF to ON while stopped.
- (4) If the positioning start signal is changed from OFF to ON while "[Md.26] Axis operation status" is "stopped", the normal positioning (the positioning data set in "[Cd.3] Positioning start No.") is started.
- (5) If positioning is ended with the continuous operation interrupt request, the operation cannot be restarted.
If restart is requested, the warning "Restart not possible" (warning code: 104) will occur.

- (6) When stopped with interpolation operation, write "1: Restarts" into "[Cd.6] Restart command" for the reference axis, and then restart.
- (7) If the PLC READY signal is changed from OFF to ON while stopped, restarting is not possible.
If restart is requested, the warning "Restart not possible" (warning code: 104) will occur.
- (8) When the machine HPR and fast HPR is stopped, the error "HPR restart not possible" (error code: 209) will occur and the positioning cannot restarts.
- (9) If any of reference partner axes executes the positioning operation once after interpolation operation stop, the warning "Restart not possible" (warning code: 104) will occur, and the positioning cannot restarts.

[3] Control data requiring setting

Set the following data to execute restart.

| Setting item | Setting value | Setting details | Buffer memory address |
|------------------------|---------------|--------------------|-----------------------|
| [Cd.6] Restart command | 1 | Set "1: Restarts". | 4303+100n |

n: Axis No.-1

※: Refer to Section 5.7 "List of control data" for details on the setting details.

[4] Starting conditions

The following conditions must be satisfied when restarting. (Assemble the required conditions into the sequence program as an interlock.)

(1) Operation state

- "[Md.26] Axis operation status" is "1: Stopped".

(2) Signal state

| | Signal name | Signal state | Device | |
|------------------|--------------------------|--------------|---------------------------------|---------------------|
| Interface signal | PLC READY signal | ON | PLC CPU preparation completed | Y0 |
| | READY signal | ON | QD77GF preparation completed | X0 |
| | All axis servo ON | ON | All axis servo ON | Y1 |
| | Synchronization flag * | ON | QD77GF buffer memory Accessible | X1 |
| | Axis stop signal | OFF | Axis stop signal is OFF | [Cd.180] Axis stop |
| | M code ON signal | OFF | M code ON signal is OFF | [Md.31] Status: b12 |
| | Error detection signal | OFF | There is no error | [Md.31] Status: b13 |
| | BUSY signal | OFF | BUSY signal is OFF | X10 to X1F |
| External signal | Start complete signal | OFF | Start complete signal is OFF | [Md.31] Status: b14 |
| | Forced stop input signal | ON | There is no forced stop input | — |
| | Stop signal | OFF | Stop signal is OFF | — |
| | Upper limit (FLS) | ON | Within limit range | — |
| | Lower limit (RLS) | ON | Within limit range | — |

※: When the synchronous setting of the PLC CPU is made in the nonsynchronous mode, this must be provided as an interlock.

When it is made in the synchronous mode, no interlock must be provided in the program because the flag is turned ON when calculation is run on the PLC CPU.

[5] Time chart for restarting

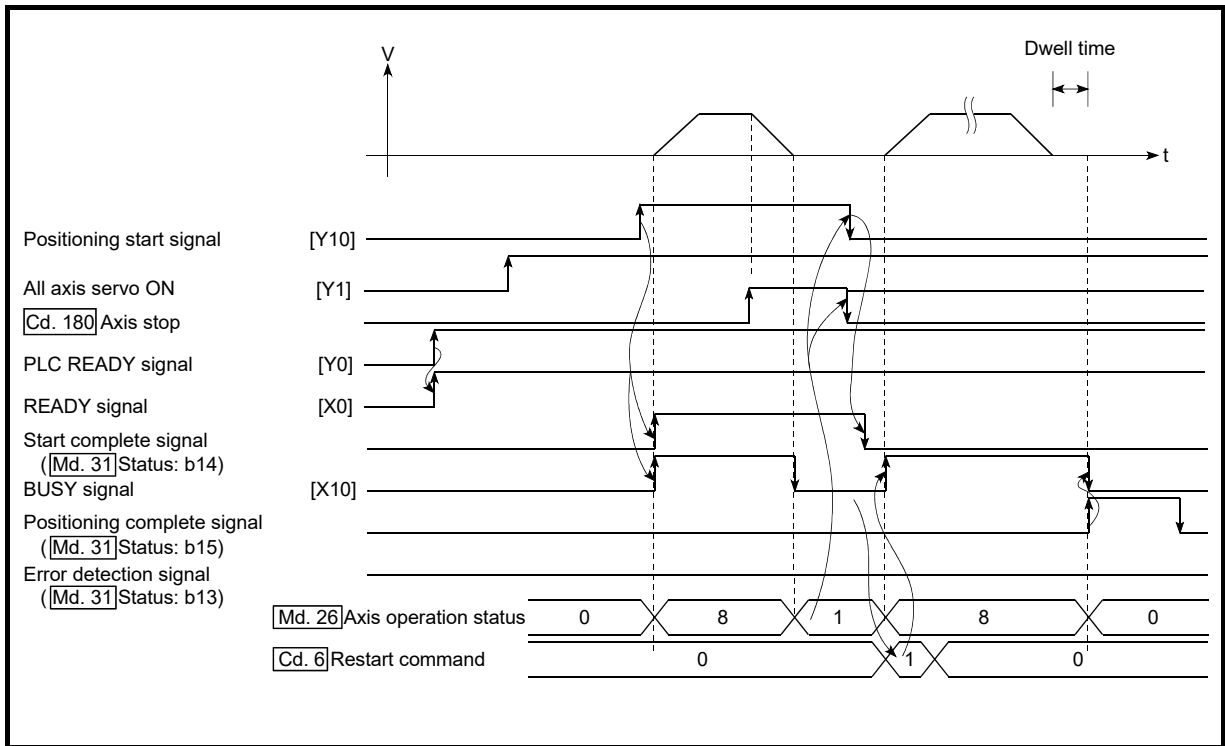

Fig. 6.14 Time chart for restarting

6.5.6 Stop program

The axis stop signal or stop signal from external input signal is used to stop the control. Create a program to turn ON the axis stop signal ([Cd.180]) as the stop program.

Each control is stopped in the following cases.

- (1) When each control is completed normally.
- (2) When the servo READY signal is turned OFF.
- (3) When a PLC CPU error occurs.
- (4) When the PLC READY signal is turned OFF.
- (5) When an error occurs in the Simple Motion module.
- (6) When control is intentionally stopped
(Stop signal from PLC CPU turned ON, "Stop signal" of external input signal turned ON, etc.)

The outline for the stop process in above cases is shown below.
(Excluding "(1) When each control is completed normally" above.)

Refer to Section 12.1 "Speed-torque control" for the stop process during the speed control mode and torque control mode.

[1] Stop process

| Stop cause | Stop axis | M code ON signal after stop | Axis operation status after stopping ([Md.26]) | Stop process | | | | | |
|-------------------------------------|--|-----------------------------|--|--|---|---------------------------|--------------------------------|------------------------|----------------------------------|
| | | | | HPR control | | Major positioning control | High-level positioning control | Manual control | |
| | | | | Machine HPR control | Fast HPR control | | | JOG/ Inching operation | Manual pulse generator operation |
| Forced stop | Forced stop input to Simple Motion module | All axes | No change | Servo OFF | Immediate stop For the stop method of the servo amplifier, refer to each servo amplifier instruction manual. | | | | — |
| | Servo READY OFF • Servo amplifier power supply OFF • Servo alarm • Forced stop input to servo amplifier | Each axis | No change | Servo amplifier has not been connected | | | | | |
| | | | | Error | | | | | |
| | | | | Servo OFF | | | | | |
| Fatal stop (Stop group 1) | Hardware stroke limit upper/lower limit error occurrence | Each axis | No change | Error | Deceleration stop/rapid stop (Select with "[Pr.37] Stop group 1 rapid stop selection".) | | | | Deceleration stop |
| Emergency stop (Stop group 2) | Error occurs in PLC CPU | All axes | No change | Error | Delegation stop/rapid stop (Select with "[Pr.38] Stop group 2 rapid stop selection".) | | | | Deceleration stop |
| | PLC READY signal OFF | | Turns OFF | | | | | | |
| | Error in test mode | | No change | | | | | | |
| Relatively safe stop (Stop group 3) | Axis error detection (Error other than stop group 1 or 2) | Each axis | No change | Error | Deceleration stop/rapid stop (Select with "[Pr.39] Stop group 3 rapid stop selection".) | | | | Deceleration stop |
| Intentional stop (Stop group 3) | "Axis stop signal" ON from PLC CPU | Each axis | No change | Stopped (Standby) | | | | | |
| | "Stop signal" of external input signal ON "Stop" input from GX Works2 | | | | | | | | |

[2] Types of stop processes

The operation can be stopped with deceleration stop, rapid stop or immediate stop.

(1) Deceleration stop *1

The operation stops with "deceleration time 0 to 3" ([Pr.10], [Pr.28], [Pr.29], [Pr.30]).

Which time from "deceleration time 0 to 3" to use for control is set in positioning data ([Da.4]).

(2) Rapid stop

The operation stops with "[Pr.36] Rapid stop deceleration time".

(3) Immediate stop

The operation does not decelerate.

The Simple Motion module immediately stops the command. For the stop method of the servo amplifier, refer to each servo amplifier instruction manual.

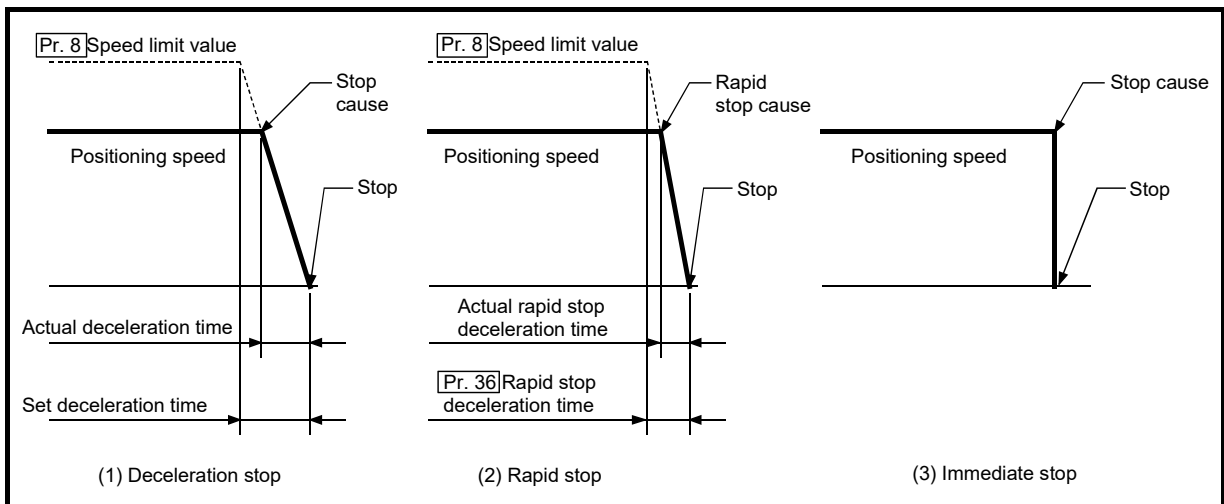

Fig. 6.15 Types of stop processes

REMARK

*1 "Deceleration stop" and "rapid stop" are selected with the detailed parameter 2 "stop group 1 to 3 rapid stop selection". (The default setting is "deceleration stop".)

[3] Order of priority for stop process

The order of priority for the Simple Motion module stop process is as follows.

Deceleration stop < Rapid stop < Immediate stop

- (1) If the deceleration stop command ON (stop signal ON) or deceleration stop cause occurs during deceleration to speed 0 (including automatic deceleration), operation changes depending on the setting of "[Cd.42] Stop command processing for deceleration stop selection".
 - (a) Manual control
Independently of the [Cd.42] setting, a deceleration curve is re-processed from the speed at stop cause occurrence.
 - (b) HPR control ^(Note-1), positioning control
 - When [Cd.42] = 0 (deceleration curve re-processing):
A deceleration curve is re-processed from the speed at stop cause occurrence.
 - When [Cd.42] = 1 (deceleration curve continuation):
The current deceleration curve is continued after stop cause occurrence.
(For details, refer to Section 13.7.9 "Stop command processing for deceleration stop function".)

(Note-1): The stop process when using the driver HPR method follows the specification of the servo amplifier. [CiA402 mode]

- (2) If the stop signal designated for rapid stop turns ON or a stop cause occurs during deceleration, the rapid stop process will start from that point. However, if the rapid stop deceleration time is longer than the deceleration time, the deceleration stop process will be continued even if a rapid stop cause occurs during the deceleration stop process.

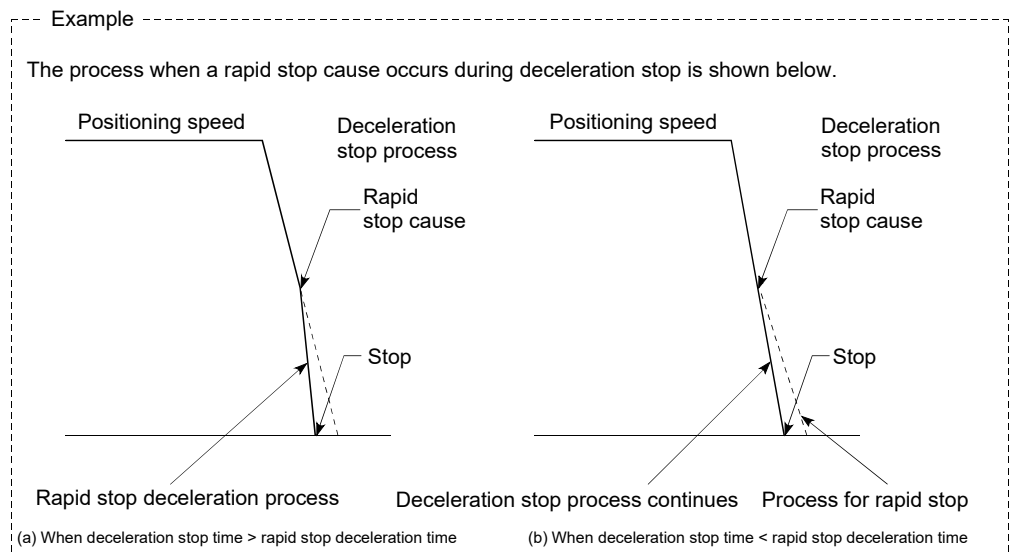

[4] Inputting the stop signal during deceleration

- (1) Even if stop is input during deceleration (including automatic deceleration), the operation will stop at that deceleration speed.
- (2) If stop is input during deceleration for HPR, the operation will stop at that deceleration speed. If input at the creep speed, the operation will stop immediately.
The stop process when using the driver HPR method follows the specification of the servo amplifier. [CiA402 mode]
- (3) If a stop cause, designated for rapid stop, occurs during deceleration, the rapid stop process will start from that point.
The rapid stop process during deceleration is carried out only when the rapid stop time is shorter than the deceleration stop time.

Chapter 7 Memory Configuration and Data Process

The memory configuration and data transmission of Simple Motion module are explained in this chapter.

The Simple Motion module is configured of four memories. By understanding the configuration and roles of two memories, the internal data transmission process of Simple Motion module, such as "when the power is turned ON" or "when the PLC READY signal changes from OFF to ON", can be easily understood. This also allows the transmission process to be carried out correctly when saving or changing the data.

| | | |
|-------|---|------|
| 7.1 | Configuration and roles of QD77GF memory..... | 7- 2 |
| 7.1.1 | Configuration and roles of QD77GF memory..... | 7- 2 |
| 7.1.2 | Buffer memory area configuration..... | 7- 5 |
| 7.2 | Data transmission process..... | 7- 7 |

7.1 Configuration and roles of QD77GF memory

7.1.1 Configuration and roles of QD77GF memory

The Simple Motion module is configured of the following four memories.

| Model | Memory configuration | Role | Area configuration | | | | | | | | | | Backup | | | |
|--------|-------------------------------|--|--------------------|-------------------|-------------------|--|--|--|--|------------------------------------|---|--------------------------|--------|-------------------------------|--------------|--------------|
| | | | Parameter area | Monitor data area | Control data area | Positioning data area (No.1 to 100) | Positioning data area (No.101 to 600) | Block start data area (No.7000 to 7001) | Block start data area (No.7002 to 7004) | Servo amplifier setting ([Pr.101]) | Servo amplifier parameter (MR-J4-B use) | Synchronous control area | | CC-Link IE Field Network area | Cam area | |
| QD77GF | Buffer memory | Area that can be directly accessed with sequence program with PLC CPU. | ○ | ○ | ○ | ○ | — | ○ | — | ○ | — | ○ | ○ | — | Not possible | |
| | Internal memory | Area that can be set only with GX Works2. | — | — | — | — | ○ | — | ○ | — | — | *2 | — | — | — | Not possible |
| | | Area that can be set only using buffer memory. | — | — | — | — | — | — | — | — | — | — | — | — | ○ | Not possible |
| | Flash ROM | Area for backing up data required for positioning. | ○ | — | — | ○ | ○ | ○ | ○ | — | — | *1 | — | — | — | Possible |
| | Internal memory (nonvolatile) | Area for backing up servo parameter or cam data. | — | — | — | — | — | — | — | ○ | *2 | — | — | — | ○ | Possible |

○: Setting and storage area provided

—: Setting and storage area not provided

Possible : Data is held even when power is turned OFF.

Not possible: Data is lost when power is turned OFF.

*1: Parameter only

*2: "-" when MR-J4-GF or another servo amplifier is used.

■ Details of areas

- Parameter area
Area where parameters, such as positioning parameters and HPR parameters, required for positioning control are set and stored.
- Monitor data area
Area where the operation status of positioning system is stored.
- Control data area
Area where data for operating and controlling positioning system is set and stored.
- Positioning data area (No.1 to 600)
Area where positioning data No.1 to 600 is set and stored.
- Block start data area (No.7000 to 7004)
Area where information required only when carrying out block No. 7000 to 7004 high-level positioning is set and stored.
- Servo parameter area
Area where parameters, such as servo parameters, required for positioning control on servo amplifier are set and stored.
- Synchronous control area ^(Note-1)
Area where parameters and control data required for synchronous control are set and stored. Also, the operation status of synchronous control is stored.
- CC-Link IE Field Network area ^(Note-2)
Area where data is exchanged with CPU module.
- Cam area ^(Note-1)
Area where cam data, etc., are set and stored. There are cam storage area and cam open area.

(Note-1): Refer to "MELSEC-Q/L QD77MS/QD77GF/LD77MS/LD77MH Simple Motion Module User's Manual (Synchronous Control)" for details of synchronous control area and cam area.

(Note-2): Refer to "MELSEC-Q QD77GF Simple Motion Module User's Manual (Network)" for details of CC-Link IE Field Network area.

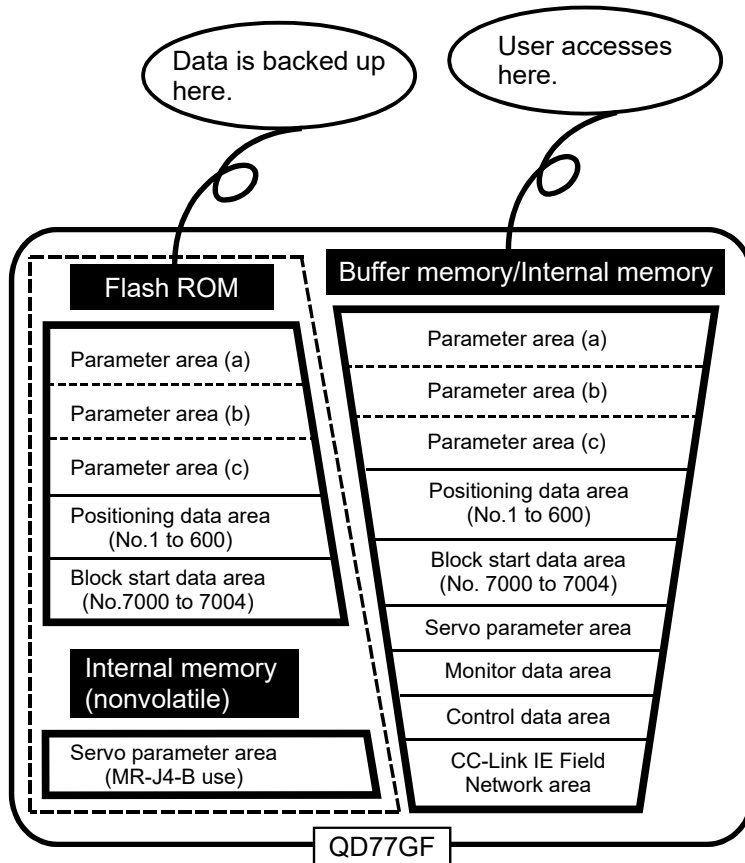

| Area name | Description | |
|--------------------|--|---|
| Parameter area (a) | Parameters validated when PLC READY signal [Y0] changes from OFF to ON | [Pr.1] to [Pr.7], [Pr.11] to [Pr.24], [Pr.43] to [Pr.57], [Pr.80] to [Pr.83], [Pr.89], [Pr.90], [Pr.95], [Pr.801], [Pr.805] to [Pr.807] |
| Parameter area (b) | Parameters validated when the TO command is executed from the CPU module (validated when the next control is started after the TO command is executed) | [Pr.8] to [Pr.10], [Pr.25] to [Pr.41], [Pr.84] |
| Parameter area (c) | Parameters validated with power supply ON/CPU module reset | [Pr.96], [Pr.101], [Pr.113], [Pr.132], [Pr.800] to [Pr.807] |

7.1.2 Buffer memory area configuration

The buffer memory of Simple Motion module is configured of the following types of areas.

| Buffer memory area configuration | | Buffer memory address*1 | Writing possibility |
|---------------------------------------|--|--|---------------------|
| Parameter area | Basic parameter | 0+150n to 15+150n | Possible |
| | Detailed parameter | 17+150n to 69+150n | |
| | HPR basic parameter | 70+150n to 78+150n | |
| | HPR detailed parameter | 80+150n to 89+150n | |
| | Expansion parameter | 100+150n to 149+150n | |
| | Mark detection setting parameter | 54000+20k to 54019+20k | |
| Monitor data area | System monitor | 4000 to 4299 31300 to 31549 | Not possible |
| | Axis monitor | 2400+100n to 2499+100n | |
| | Mark detection monitor data | 54960+80k to 55039+80k | |
| Control data area | System control data | 5900 to 5999 | Possible |
| | Axis control data | 4300+100n to 4399+100n 30100+10n to 30109+10n | |
| | Mark detection control data | 54640+10k to 54649+10k | |
| Positioning data area (No.1 to 100) | 6000+1000n to 6999+1000n | | |
| Positioning data area (No.101 to 600) | Positioning data Set with GX Works2 | | |
| Block start data area (No.7000) | Block start data | 22000+400n to 22049+400n 22050+400n to 22099+400n | |
| | Condition data | 22100+400n to 22199+400n | |
| | Block start data area (No.7001) | Block start data 22200+400n to 22249+400n 22250+400n to 22299+400n | |
| Block start data area (No.7002) | Block start data | Set with GX Works2 | |
| | Condition data | | |
| Block start data area (No.7003) | Block start data | | |
| | Condition data | | |
| Block start data area (No.7004) | Block start data | | |
| | Condition data | | |

| Buffer memory area configuration | | Buffer memory address*1 | Writing possibility |
|----------------------------------|---|--------------------------|---------------------------|
| Servo parameter area | Servo amplifier setting [Pr.101] | 28400+100n to 28499+100n | Possible |
| | Servo amplifier parameter (MR-J4-B use) | Set with GX Works2 | |
| Synchronous control area*2 | Servo input axis parameter | 32800+10n to 32805+10n | Possible |
| | Servo input axis monitor data | 33120+10n to 33127+10n | Not possible |
| | Synchronous encoder axis parameter | 34720+20j to 34735+20j | Possible |
| | Synchronous encoder axis control data | 35040+10j to 35047+10j | Possible |
| | Synchronous encoder axis monitor data | 35200+20j to 35212+20j | Not possible |
| | Synchronous control system control data | 36320, 36322 | Possible |
| | Synchronous parameter | 36400+200n to 36513+200n | Possible |
| | Synchronous control monitor data | 42800+40n to 42835+40n | Not possible |
| | Control data for synchronous control | 44080+20n to 44090+20n | Possible |
| | Cam operation control data | 45000 to 53791 | Possible |
| | Cam operation monitor data | 53800 to 53801 | Not possible |
| CC-Link IE Field Network area | Link device (RX) | 59392 to 59903 | Possible |
| | Link device (RY) | 59904 to 60415 | Not possible |
| | Link device (RWw) | 60416 to 61439 | Possible |
| | Link device (RWr) | 61440 to 62463 | Not possible |
| | Link device (SB) | 62464 to 62495 | Possible/ Not possible |
| | Link device (SW) | 62496 to 63007 | Possible/ Not possible |
| | System | 63008 to 63151 | Not possible |
| | Slave station offset/size information | 63152 to 63983 | Not possible |
| | Station information | 64016 to 64047 | Not possible |

n: Axis No.-1

k: Mark detection setting No.-1

j: Synchronous encoder axis No.-1

*1: Use of address Nos. skipped above is prohibited. If used, the system may not operate correctly.

*2: Refer to "MELSEC-Q/L QD77MS/QD77GF/LD77MS/LD77MH Simple Motion Module User's Manual (Synchronous Control)" for details.

| POINT |
|--|
| <p>When the parameter of the servo amplifier side is changed by the following methods, the Simple Motion module reads parameters automatically, and the data is transmitted to the servo parameter area in the buffer memory/internal memory and internal memory (nonvolatile).</p> <p>(1) When changing the servo parameters by the auto tuning. (2) When the servo parameter is changing after the MR Configurator2 is connected directly with the servo amplifier.</p> |

7.2 Data transmission process

The data is transmitted between the memories of Simple Motion module with steps (1) to (10) shown below.

*: The data transmission patterns correspond to the numbers (1) to (10) in the following drawings.

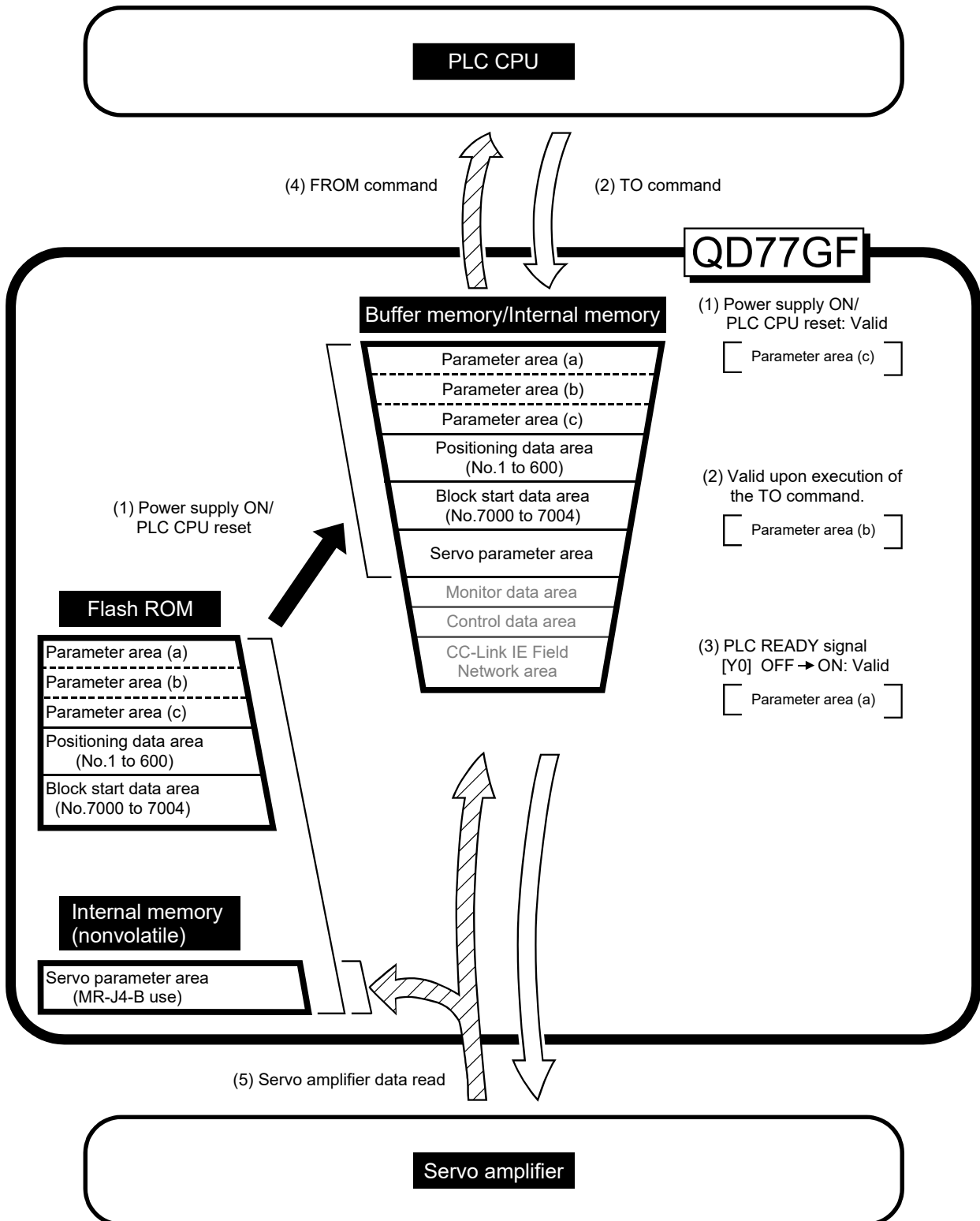

- (1) Transmitting data when power is turned ON or PLC CPU is reset ()

When the power is turned ON or the PLC CPU is reset, the "parameter area (c)^{*1}", "positioning data", "block start data" and "servo parameter (MR-J4-B use)" stored (backed up) in the flash ROM/internal memory (nonvolatile) are transmitted to the buffer memory and internal memory.

The value stored in the flash ROM is valid for "[Pr.96] Operation cycle setting", "[Pr.113] Servo parameter transfer" and "[Pr.132] Communication mode setting".

*1: Refer to Section 7.1.1 "Configuration and roles of QD77GF memory" for details of the area.

- (2) Transmitting data with TO command from PLC CPU ()

The parameters or data is written from the PLC CPU to the buffer memory using the TO command^{*2}. At this time, when the "parameter area (b)^{*3}", "positioning data", "block start data" and "control data" are written into the buffer memory with the TO command, it is simultaneously valid.

*2: "Servo parameter (MR-J4-B use)", "Positioning data (No.101 to 600)" and "Block start data (No.7002 to 7004)" can be set with only GX Works2.

*3: Refer to Section 7.1.1 "Configuration and roles of QD77GF memory" for details of the area.

- (3) Validate parameters when PLC READY signal [Y0] changes from OFF to ON

When the PLC READY signal [Y0] changes from OFF to ON, the data stored in the buffer memory's "parameter area (a)^{*4}" is validated.

*4: Refer to Section 7.1.1 "Configuration and roles of QD77GF memory" for details of the area.

| |
|--------------|
| POINT |
|--------------|

| |
|--|
| <p>The setting values of the parameters that correspond to parameter area (b) are valid when written into the buffer memory with the TO command.</p> |
|--|

| |
|--|
| <p>However, the setting values of the parameters that correspond to parameter area (a) are not validated until the PLC READY signal [Y0] changes from OFF to ON.</p> |
|--|

- (4) Accessing with FROM command from PLC CPU ()

The data is read from the buffer memory to the PLC CPU using the FROM command^{*5}.

*5: "Servo parameter (MR-J4-B use)", "Positioning data (No.101 to 600)" and "Block start data (No.7002 to 7004)" can be read with only GX Works2.

- (5) Reading the servo parameter from the servo amplifier ()
[RJ010 mode]

When the parameter of the servo amplifier is changed, the servo parameter is read automatically from the servo amplifier to the internal memory and internal memory (nonvolatile).

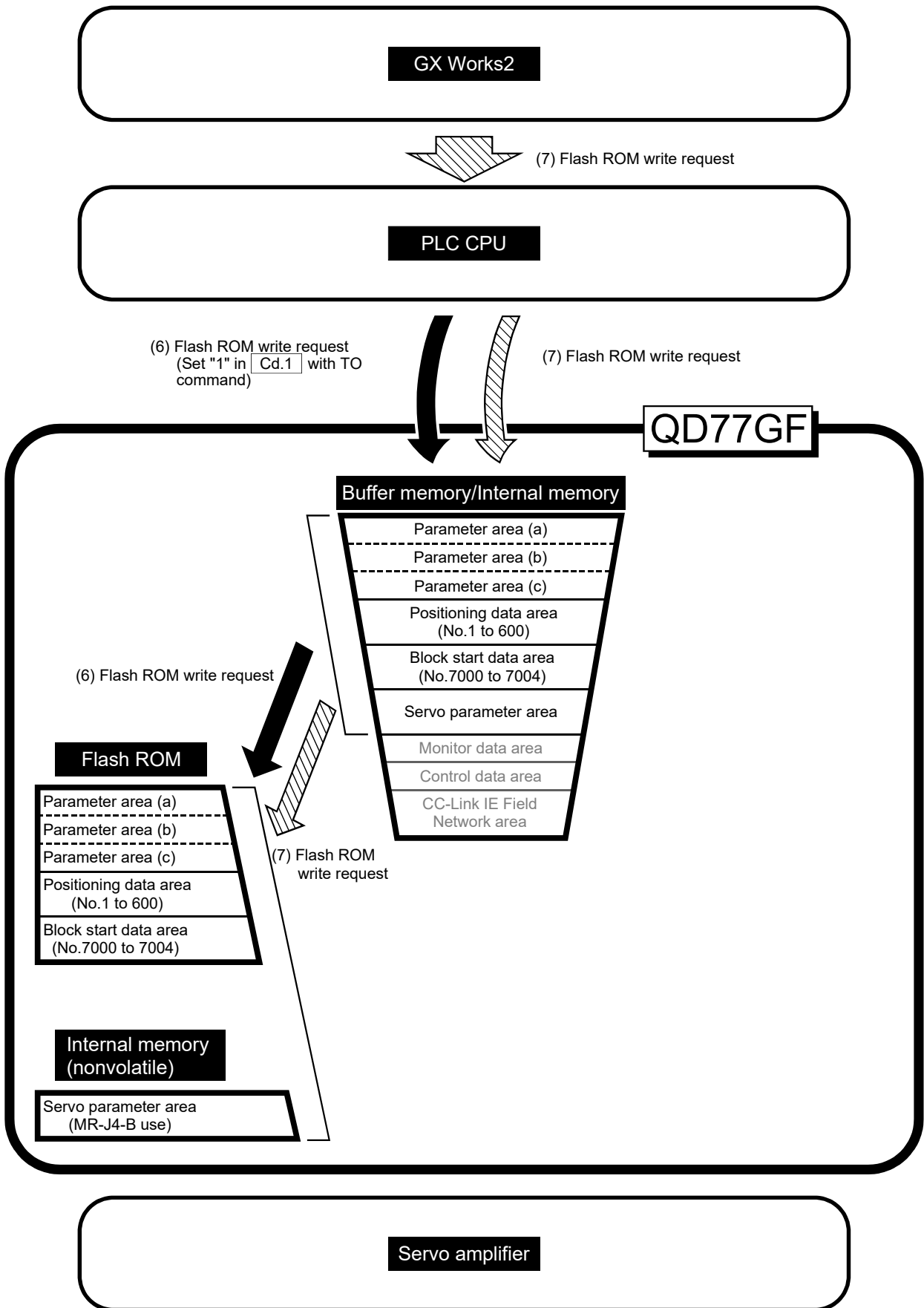

(6) Writing the flash ROM by a PLC CPU request ()

The following transmission process is carried out by setting "1" in "[Cd.1] Flash ROM write request".

- 1) The "parameters", "positioning data (No. 1 to 600)", "block start data (No. 7000 to 7004)" and "servo parameter (MR-J4-B use)" in the buffer memory/internal memory area are transmitted to the flash ROM/internal memory (nonvolatile).

(7) Writing the flash ROM by a GX Works2 request ()

The following transmission processes are carried out with the [flash ROM write request] from the GX Works2.

- 1) The "parameters", "positioning data (No. 1 to 600)", "block start data (No. 7000 to 7004)" and "servo parameter (MR-J4-B use)" in the buffer memory/internal memory area are transmitted to the flash ROM/internal memory (nonvolatile).

Note) This transmission process is the same as (6) above.

IMPORTANT

- (1) Do not turn the power OFF or reset the PLC CPU while writing to the flash ROM. If the power is turned OFF or the PLC CPU is reset to forcibly end the process, the data backed up in the flash ROM/internal memory (nonvolatile) will be lost.
- (2) Do not write the data to the buffer memory/internal memory before writing to the flash ROM is completed.
- (3) The number of writes to the flash ROM with the sequence program is 25 max. while the power is turned ON.
Writing to the flash ROM beyond 25 times will cause the error "Flash ROM write number error" (error code: 805).
Refer to Section 16.4 "List of errors" for details.
- (4) Monitoring is the number of writes to the flash ROM after power supply ON by the "[Md.19] Number of write accesses to flash ROM".

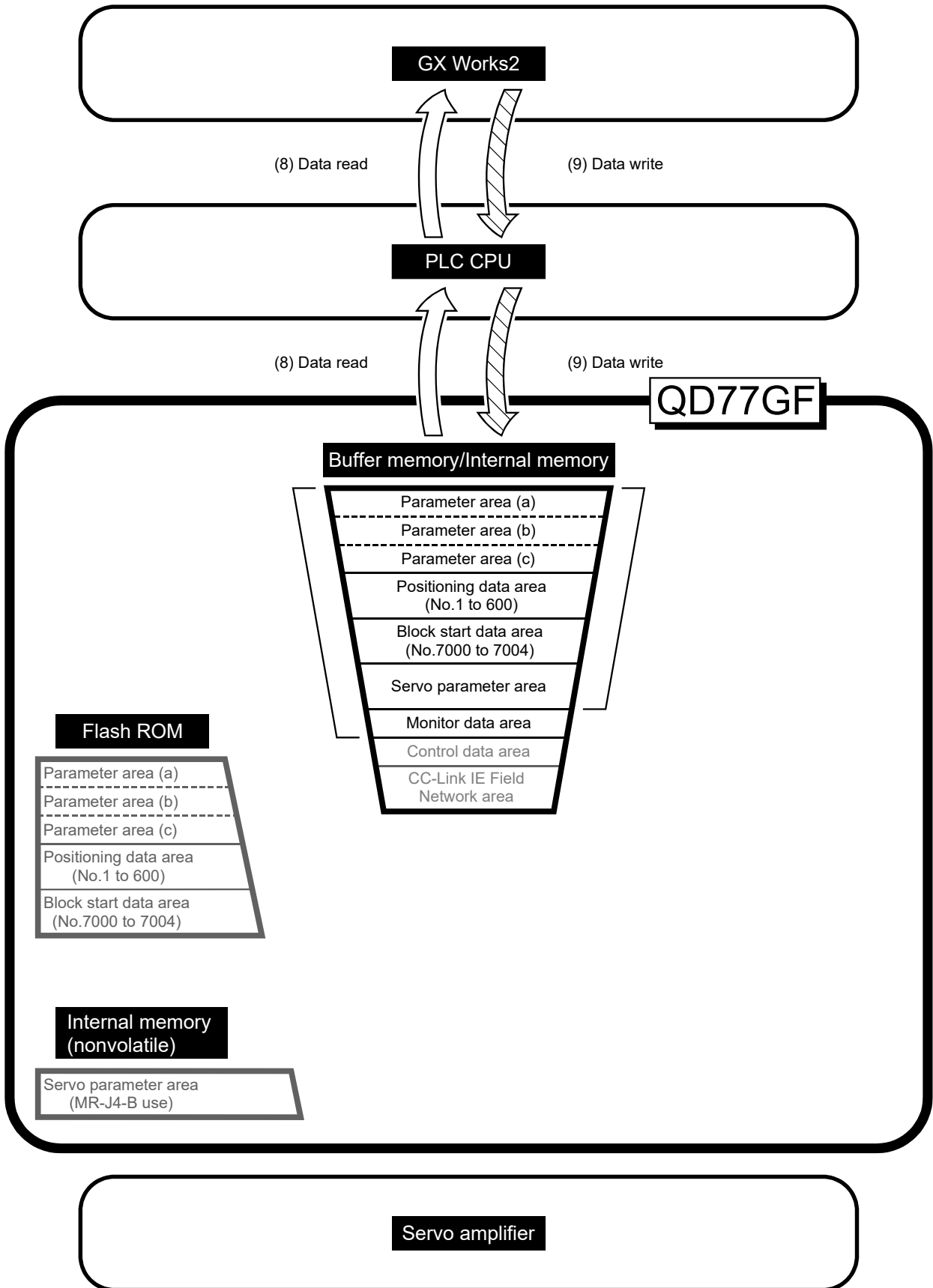

(8) Reading data from buffer memory/internal memory to GX Works2



The following transmission processes are carried out with the [Read from module (Read from QD77GF)] from the GX Works2.

- 1) The "parameters", "positioning data (No. 1 to 600)", "block start data (No. 7000 to 7004)" and "servo parameter (MR-J4-B use)" in the buffer memory/internal memory area are transmitted to the GX Works2 via the PLC CPU.

The following transmission processes are carried out with the [monitor] from the GX Works2.

- 2) The "monitor data" in the buffer memory area is transmitted to the GX Works2 via the PLC CPU.

(9) Writing data from GX Works2 to buffer memory/internal memory

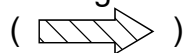

The following transmission processes are carried out with the [Write to module (Write to QD77GF)] from the GX Works2.

- 1) The "parameters", "positioning data (No. 1 to 600)", "block start data (No. 7000 to 7004)" and "servo parameter (MR-J4-B use)" in the GX Works2 are transmitted to the buffer memory/internal memory via the PLC CPU.

At this time, when [Flash ROM automatic write] is set with the GX Works2, the transmission processes indicated with "(7) Writing the flash ROM by a GX Works2 request" are carried out.

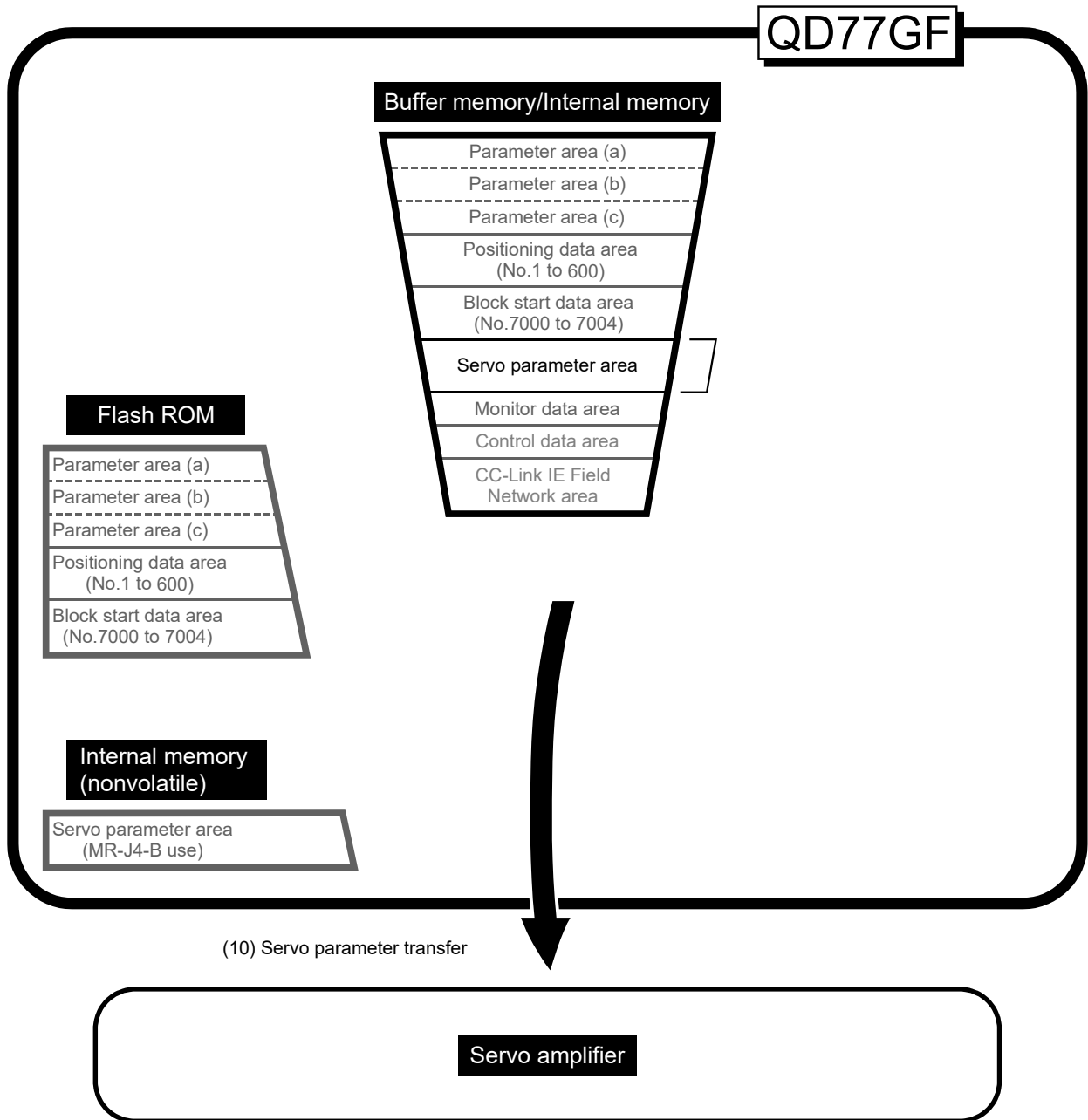

(10) Transmitting servo parameter from the internal memory area to servo amplifier () [RJ010 mode]

The servo parameter in the internal memory area is transmitted to the servo amplifier by the following timing.

- 1) The servo parameter is transmitted to the servo amplifier when communications with servo amplifier start.
The "servo parameter" in the internal memory area is transmitted to the servo amplifier.

■ About the communication start with servo amplifier

Communication with servo amplifier is valid when following condition is realized together.

- 1) The power of Simple Motion module and servo amplifier is turned ON.
- 2) When the station number of servo amplifier is set by the network parameter in GX Works2 and "0: Use for the actual servo amplifier" is set in "[Pr.101] Virtual servo amplifier setting" inside the buffer memory area of Simple Motion module.

■ Servo parameter of the internal memory

The followings show details about the operation timing and details at transmitting the servo parameter of the internal memory.

| |
|-------|
| POINT |
|-------|

- | |
|--|
| <p>(1) Axis connection time varies depending on the number of axes and the servo amplifier's power supply ON timing. And, time when "20: Servo amplifier has not been connected/servo amplifier power OFF" is set in "[Md.26] Axis operation status" is also varies.</p> |
|--|

(1) When the servo amplifier's power supply is turned ON before the system's power supply ON.

Communication start timing to the servo amplifier: Initialization completion (Fig. 7.1 (A))

Transfer the servo parameter : The data stored (backed up) in the internal memory (nonvolatile).

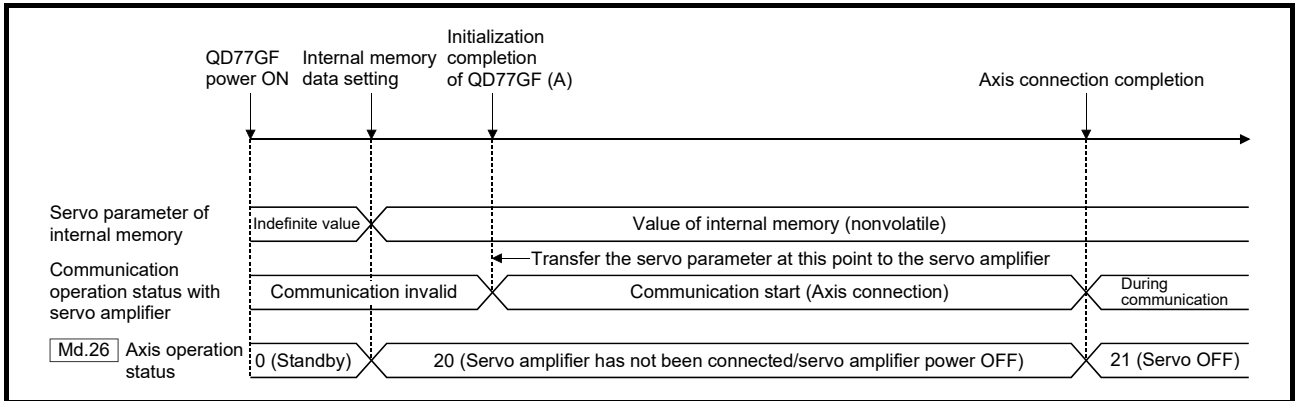

Fig. 7.1 When the servo amplifier had started before the system's power supply ON

(2) When the servo amplifier's power supply is turned ON after the PLC READY signal [Y0] is turned OFF to ON (Fig. 7.2 (B)).

Communication start timing to the servo amplifier: When the servo amplifier had started (Fig. 7.2 (A)).

Transfer the servo parameter : The data stored (backed up) in the internal memory (nonvolatile).

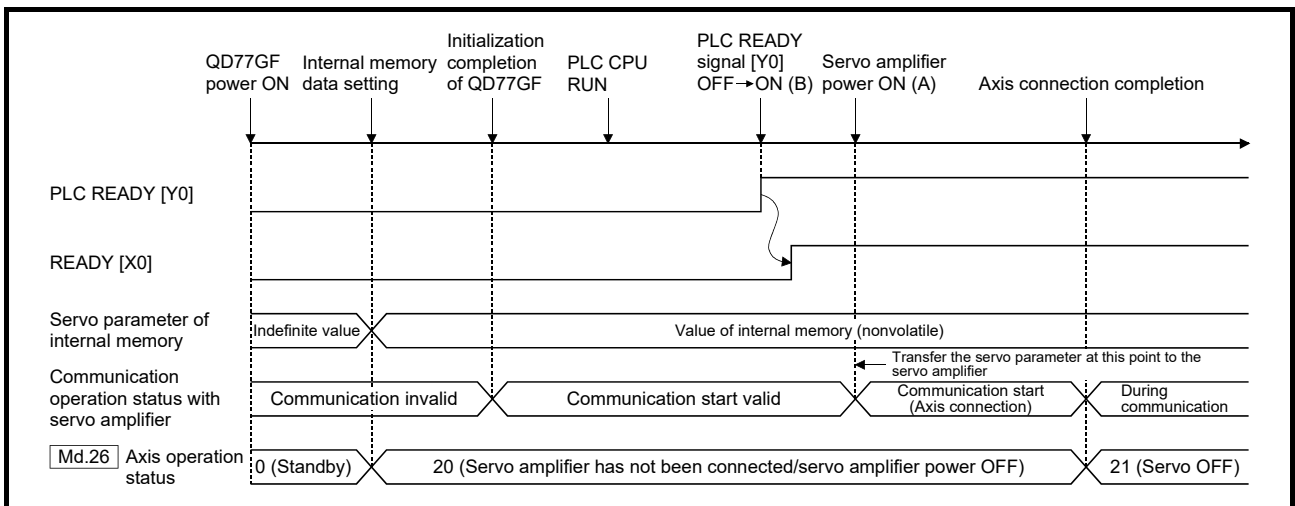

Fig. 7.2 When the servo amplifier had started after the PLC READY signal [Y0] is turned OFF to ON

Section 2 Control Details and Setting

Section 2 is configured for the following purposes shown in (1) to (3).

- (1) Understanding of the operation and restrictions of each control.
- (2) Carrying out the required settings in each control
- (3) Dealing with errors

The required settings in each control include parameter setting, positioning data setting, control data setting by a sequence program, etc.

Carry out these settings while referring to "Chapter 5 Data Used for Positioning Control". Also refer to "Chapter 6 Sequence Program Used for Positioning Control" when creating the sequence programs required in each control, and consider the entire control program configuration when creating each program.

| | | |
|------------|--------------------------------------|----------------|
| Chapter 8 | HPR Control | 8- 1 to 8- 24 |
| Chapter 9 | Major Positioning Control..... | 9- 1 to 9-128 |
| Chapter 10 | High-Level Positioning Control | 10-1 to 10- 26 |
| Chapter 11 | Manual Control..... | 11-1 to 11- 32 |
| Chapter 12 | Expansion Control..... | 12-1 to 12- 18 |
| Chapter 13 | Control Sub Functions | 13-1 to 13-108 |
| Chapter 14 | Common Functions..... | 14-1 to 14- 32 |
| Chapter 15 | Dedicated Instructions | 15-1 to 15- 2 |
| Chapter 16 | Troubleshooting | 16-1 to 16- 54 |

Chapter 8 HPR Control

The details and usage of "HPR control" are explained in this chapter.

HPR control includes "machine HPR" that establish a machine HP without using address data, and "fast HPR" that store the coordinates established by the machine HPR, and carry out positioning to that position.

HPR carried out by sequence programs from the PLC CPU are explained in this chapter. Refer to the "Simple Motion Module Setting Tool Help" of GX Works2 for details on HPR using the GX Works2.

| | | |
|-------|---|------|
| 8.1 | Outline of HPR control..... | 8- 2 |
| 8.1.1 | Two types of HPR control..... | 8- 2 |
| 8.2 | Machine HPR | 8- 5 |
| 8.2.1 | Outline of the machine HPR operation | 8- 5 |
| 8.2.2 | Machine HPR method | 8- 7 |
| 8.2.3 | HPR method (1): Proximity dog method [RJ010 mode]..... | 8- 8 |
| 8.2.4 | HPR method (2): Count method 1) [RJ010 mode] | 8-10 |
| 8.2.5 | HPR method (3): Count method 2) [RJ010 mode] | 8-12 |
| 8.2.6 | HPR method (4): Data set method [RJ010 mode] | 8-14 |
| 8.2.7 | HPR method (5): Scale origin signal detection method [RJ010 mode] | 8-15 |
| 8.2.8 | HPR method (6): Driver HPR method [CiA402 mode] | 8-18 |
| 8.3 | Fast HPR | 8-21 |
| 8.3.1 | Outline of the fast HPR operation | 8-21 |
| 8.4 | Selection of the HPR setting condition | 8-23 |
| 8.4.1 | Outline of the HPR setting condition | 8-23 |

8.1 Outline of HPR control

8.1.1 Two types of HPR control

In "HPR control", a position is established as the starting point (or "HP") when carrying out positioning control, and positioning is carried out toward that starting point. It is used to return a machine system at any position other than the HP to the HP when the Simple Motion module issues an "HPR request" ^(Note-1) with the power turned ON or others, or after a positioning stop.

In the Simple Motion module, the two types of controls shown below are defined as "HPR control", following the flow of the HPR work.

These two types of HPR control can be executed by setting the "HPR parameters", setting "Positioning start No. 9001" and "positioning start No. 9002" prepared beforehand in the Simple Motion module to "[Cd.3] Positioning start No.", and turning ON the positioning start signal.

- (1) Establish a positioning control HP
 - "Machine HPR" (positioning start No. 9001)
- (2) Carry out positioning toward the HP
 - "Fast HPR" (positioning start No. 9002).

The "machine HPR" above must always be carried out before executing the "fast HPR".

⚠ CAUTION

- When using the absolute position system function, on starting up, and when the controller or absolute position motor has been replaced, always perform an HPR. In the case of the absolute position system, use the sequence program to check the HPR request before performing the positioning control. Failure to observe this could lead to an accident such as a collision.

REMARK

HPR request ^(Note-1)

The "HPR request flag" ([Md.31] Status: b3) must be turned ON in the Simple Motion module, and a machine HPR must be executed in the following cases.

- (1) When not using an absolute position system

- (a) This flag turns on in the following cases:

- System's power supply on or reset
- Servo amplifier power supply on
- Machine HPR start

(Unless a machine HPR is completed normally, the HPR request flag does not turn off.)

- (b) This flag turns off by the completion of machine HPR.

(2) When using an absolute position system

(a) This flag turns on in the following cases:

- When not executing a machine HPR once after system start.
- Machine HPR start
(Unless a machine HPR is completed normally, the HPR request flag does not turn off.)
- Erase of an absolute position data in the Simple Motion module according to causes, such as memory error (the error "HPR data incorrect" (error code: 1201) occurrence)
- [Md.108] Servo status (high-order buffer memory address) b14 ON

| | Buffer memory address (high-order) |
|----------------------------|------------------------------------|
| [Md.108] Servo status: b14 | 2477+100n |

n: Axis No.-1

- When the "Rotation direction selection/travel direction selection (PA14)" of servo parameter is changed.

(b) This flag turns off by the completion of the machine HPR.

The address information stored in the Simple Motion module cannot be guaranteed while the "HPR request flag" is ON.

The "HPR request flag" turns OFF and the "HPR complete flag" ([Md.31] Status: b4) turns ON if the machine HPR is executed and is completed normally.

■ Wiring the proximity dog

When using the proximity dog signal, wire the signal contact that supports the proximity dog of the equipment to be used as follows.

Refer to the instruction manual of the servo amplifier to be used for details on input and wiring of the signal.

As for the 24VDC power supply, the direction of current can be switched.

Example) When the servo parameter "Function selection T-3 (PT29)" is set to the initial value

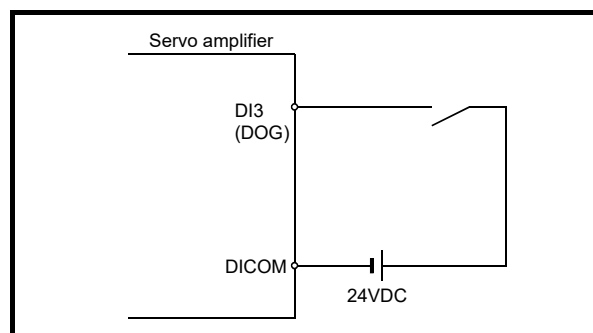

Fig. 8.1 Wiring when using the proximity dog

When the "buffer memory of QD77GF" is selected, the wiring differs according to the input module used.

For the wiring, refer to the manual of the input module to be used.

■ HPR sub functions

Refer to Section 3.2.5 "Combination of QD77GF main functions and sub functions" for details on "sub functions" that can be combined with HPR control. Also refer to Chapter 13 "Control Sub Functions" for details on each sub function.

[Remarks]

The following two sub functions are only related to machine HPR.

| Sub function name | Machine HPR | Fast HPR | Reference |
|---------------------------------|----------------------|----------|----------------|
| HPR retry function [RJ010 mode] | △ (Note-1), (Note-2) | × | Section 13.2.1 |
| HP shift function [RJ010 mode] | ○ (Note-1) | × | Section 13.2.2 |

○ : Combination possible, △: Restricted, ×: Combination not possible

(Note-1): When using the driver HPR method, the available function is depending on the specification of the servo amplifier. Confirm the specification of the servo amplifier. [CiA402 mode]

(Note-2): The Simple Motion module executes the HPR request to the servo amplifier, regardless of the status of the proximity dog or the workpiece position. Depending on the specification of HPR executed in the servo amplifier, it may be required to return the workpiece to the forward position of the proximity dog according to the position relation between the proximity dog and the workpiece. Also, if you try to move a workpiece to the forward position of the proximity dog, JOG operation cannot be used depending on the specification of the servo amplifier. For the operation method, confirm the specification of the servo amplifier. [CiA402 mode]

■ When an HPR is not required

Control can be carried out ignoring the "HPR request flag" ([Md.31] Status: b3) in systems that do not require an HPR.

In this case, the "HPR parameters ([Pr.43] to [Pr.57])" must all be set to their initial values or a value at which an error does not occur.

■ HPR from GX Works2

"Machine HPR" and "fast HPR" can be executed from the test function of the GX Works2.

Refer to the "Simple Motion Module Setting Tool Help" of GX Works2 for details on HPR from the GX Works2.

8.2 Machine HPR

8.2.1 Outline of the machine HPR operation

■ Machine HPR operation

In a machine HPR, HP is established.

None of the address information stored in the Simple Motion module, PLC CPU, or servo amplifier is used at this time. The position mechanically established after the machine HPR is regarded as the "HP" to be the starting point for positioning control.

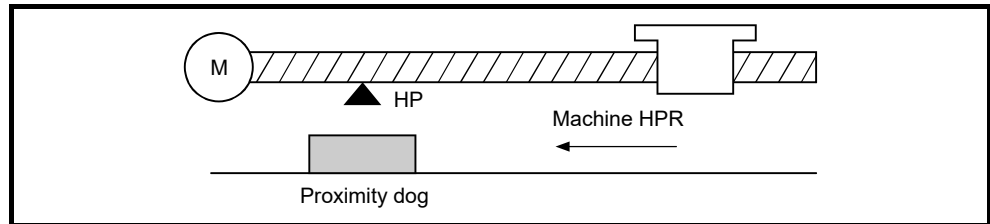

Fig. 8.2 Example of a machine HPR

The method for establishing an "HP" by a machine HPR differs according to the method set in "[Pr.43] HPR method".

The following shows the operation when starting a machine HPR.

When "[Pr.43] HPR method" is set to other than "driver HPR method" [RJ010 mode]

| | |
|----|---|
| 1) | The machine HPR is started. |
| 2) | The operation starts according to the speed and direction set in the HPR parameters ([Pr.43] to [Pr.57]). |
| 3) | The "HP" is established by the method set in "[Pr.43] HPR method", and the machine stops. (Refer to Sections 8.2.2 to 8.2.7) |
| 4) | If "a" is set as "[Pr.45] HP address", "a" will be stored as the current position in the "[Md.20] Feed current value" and "[Md.21] Feed machine value" which are monitoring the position. |
| 5) | The machine HPR is completed. |

POINT

Use the HPR retry function when the HP is not always in the same direction from the workpiece operation area (when the HP is not set near the upper or lower limit of the machine).

The machine HPR may not complete unless the HPR retry function is used.

When "[Pr.43] HPR method" is set to "driver HPR method" [CiA402 mode]

| | |
|----|---|
| 1) | Set the HPR parameters of the driver (servo amplifier). |
| 2) | The machine HPR is started. |
| 3) | The operation starts according to the speed and direction set in the driver (servo amplifier). |
| 4) | The "HP" is established and the machine stops. (Refer to Section 8.2.8) |
| 5) | If "a" is set as "[Pr.45] HP address", "a" will be stored as the current position in the "[Md.20] Feed current value" and "[Md.21] Feed machine value" which are monitoring the position. |
| 6) | The machine HPR is completed. |

POINT

The method for establishing an "HP" by a driver HPR method differs according to the setting of the servo amplifier. For details, refer to the servo amplifier instruction manual.

8.2.2 Machine HPR method

The method by which the machine HP is established (method for judging the HP and machine HPR completion) is designated in the machine HPR according to the configuration and application of the positioning method.

The following table shows the methods that can be used for this HPR method.

(The HPR method is one of the items set in the HPR parameters. It is set in "[Pr.43] HPR method" of the basic parameters for HPR.)

| [Pr.43] HPR method | Operation details |
|---|--|
| Proximity dog method [RJ010 mode] | Deceleration starts by the OFF → ON of the proximity dog. (Speed is reduced to "[Pr.47] Creep speed".) The operation stops once after the proximity dog turns ON and then OFF. Later the operation restarts and then stops at the first zero signal to complete the HPR. |
| Count method 1) [RJ010 mode] | The deceleration starts by the OFF → ON of the proximity dog, and the machine moves at the "[Pr.47] Creep speed". The machine stops once after moving the distance set in the "[Pr.50] Setting for the movement amount after proximity dog ON" from the OFF → ON position. Later the operation restarts and then stops at the first zero point to complete the machine HPR. |
| Count method 2) [RJ010 mode] | The deceleration starts by the OFF → ON of the proximity dog, and the machine moves at the "[Pr.47] Creep speed". The machine moves the distance set in the "[Pr.50] Setting for the movement amount after proximity dog ON" from the proximity dog OFF → ON position, and stops at that position. The machine HPR is then regarded as completed. |
| Data set method [RJ010 mode] | The position where the machine HPR has been performed becomes an HP. The feed current value and feed machine value are overwritten to the HP address. |
| Scale origin signal detection method [RJ010 mode] | The machine moves in the opposite direction against of "[Pr.44] HPR direction" at the "[Pr.46] HPR speed" by the OFF → ON of the proximity dog, and a deceleration stop is carried out once at the first zero signal. Later the operation moves in direction of "[Pr.44] HPR direction" at the "[Pr.47] Creep speed", and then stops at the detected nearest zero point to complete the machine HPR. |
| Driver HPR method [CiA402 mode] | The servo amplifier is switched to the HPR mode and the HPR set in the servo amplifier starts. After the HPR is completed, the servo amplifier is returned to the previous control mode. |

REMARK

Creep speed

The stopping accuracy is poor when the machine rapidly stops from fast speeds.

To improve the machine's stopping accuracy, it is required to slow down the speed before it stops. This speed is set in the "[Pr.47] Creep speed".

The following shows the signals as required for machine HPR.

| [Pr.43] HPR method | | Signals required for control | | |
|--------------------------------------|---------------|------------------------------|-------------|-------------------|
| | | Proximity dog | Zero signal | Upper/lower limit |
| Proximity dog method | [RJ010 mode] | ◎ | ◎ | ○ |
| Count method 1) | | ◎ | ◎ | ○ |
| Count method 2) | | ◎ | — | ○ |
| Data set method | | — | — | — |
| Scale origin signal detection method | | ◎ | ◎ | — |
| Driver HPR method | [CiA402 mode] | ○ (Note-1) | ○ (Note-1) | ○ (Note-1) |

◎: Necessary, ○: Necessary as required, —: Unnecessary

(Note-1): Confirm the HPR specification of the servo amplifier for the signals required for control.

8.2.3 HPR method (1): Proximity dog method [RJ010 mode]

The following shows an operation outline of the "proximity dog method" HPR method.

■ Operation chart

| | |
|----|--|
| 1) | The machine HPR is started. (The machine begins the acceleration designated in "[Pr.51] HPR acceleration time selection", in the direction designated in "[Pr.44] HPR direction". It then moves at the "[Pr.46] HPR speed" when the acceleration is completed.) |
| 2) | The machine begins decelerating when the proximity dog ON is detected. |
| 3) | The machine decelerates to the "[Pr.47] Creep speed", and subsequently moves at that speed. (At this time, the proximity dog must be ON. The workpiece will continue decelerating and stop if the proximity dog is OFF.) |
| 4) | After the proximity dog turns OFF, the machine stops. It then restarts and stops at the first zero point. |
| 5) | The HPR complete flag ([Md.31] Status: b4) turns from OFF to ON and the HPR request flag ([Md.31] Status: b3) turns from ON to OFF. |

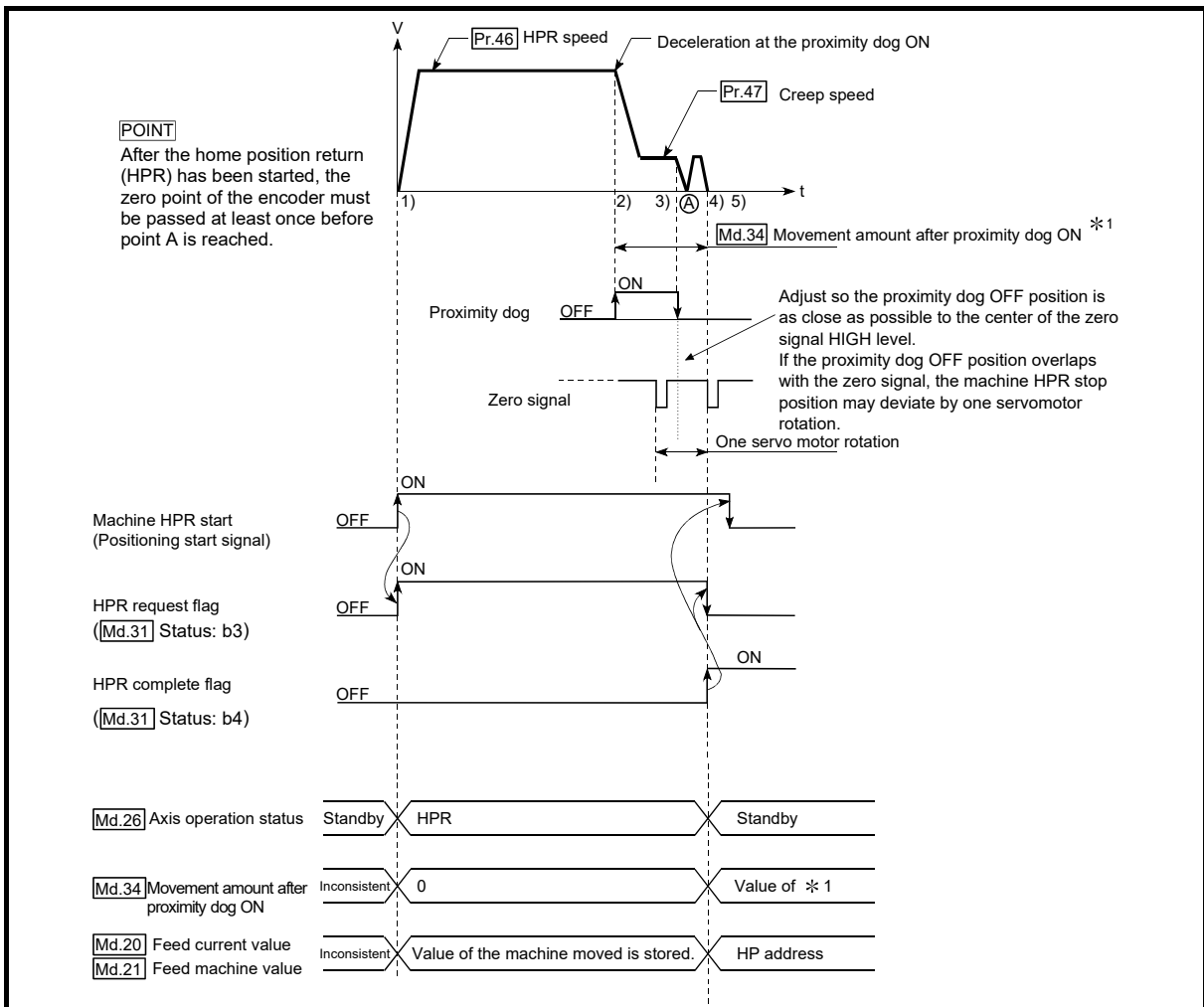

Fig. 8.3 Proximity dog method machine HPR

■ Precautions during operation

- (1) The error "Start at HP" (error code: 201) will occur if another machine HPR is attempted after a machine HPR completion when the HPR retry function is not set ("0" is set in "[Pr.48] HPR retry").
- (2) Machine HPR carried out from the proximity dog ON position will start at the "[Pr.47] Creep speed".
- (3) The proximity dog must be ON during deceleration from the HPR speed "[Pr.47] Creep speed".
- (4) When the stop signal stops the machine HPR, carry out the machine HPR again. When restart command is turned ON after the stop signal stops the HPR, the error "HPR restart not possible" (error code: 209) will occur.
- (5) After the home position return (HPR) has been started, the zero point of the encoder must be passed at least once before point A is reached.
 However, if selecting "1: Not need to pass servo motor Z-phase after power on" with "Function selection C-4 (PC17)", it is possible to carry out the home position return (HPR) without passing the zero point.
 The workpiece will continue decelerating and stop if the proximity dog is turned OFF before it has decelerated to the creep speed, thus causing the error "Dog detection timing fault" (error code: 203).

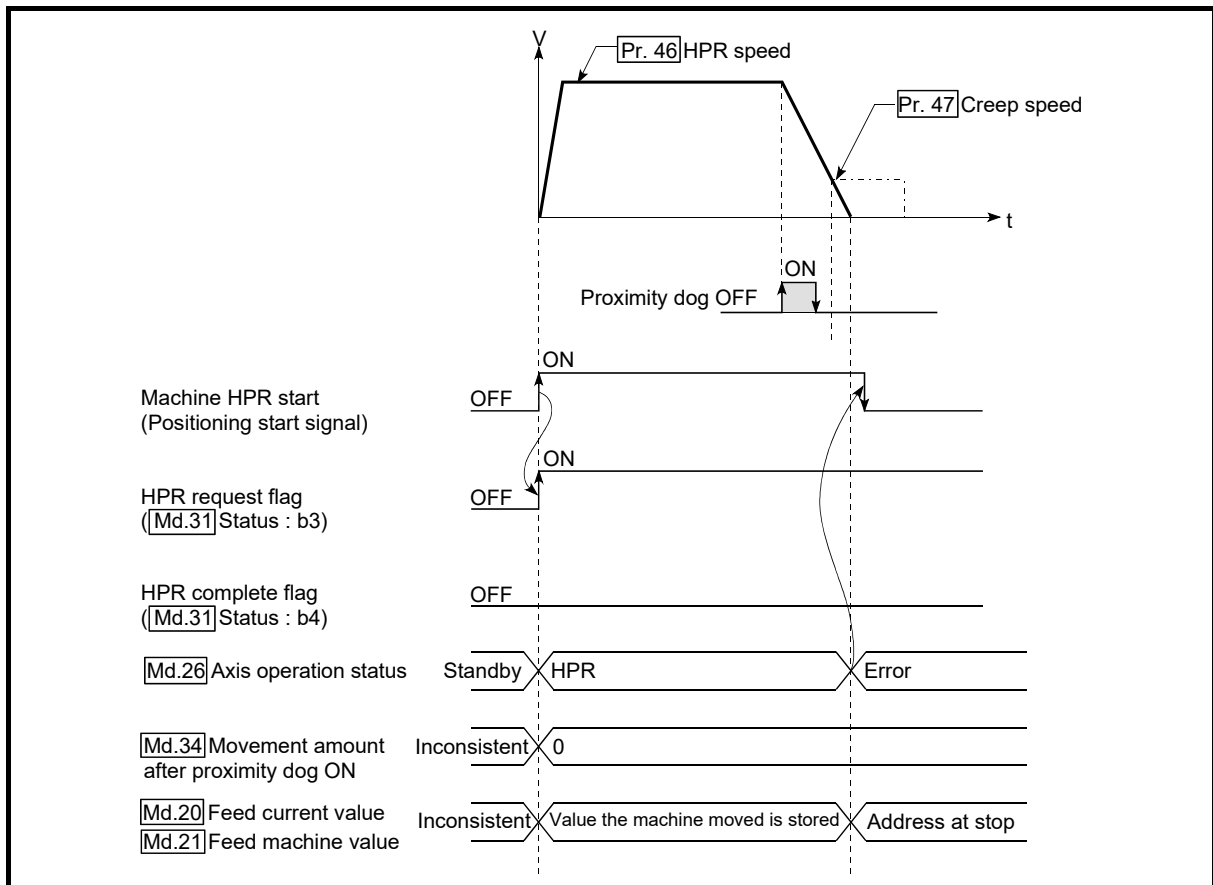

Fig. 8.4 Operation when the proximity dog is turned OFF before the creep speed is reached

8.2.4 HPR method (2): Count method 1) [RJ010 mode]

The following shows an operation outline of the HPR method "count method 1)". In the HPR with the "count method 1)", the following operations can be performed:

- The machine HPR on the proximity dog
- The machine HPR again after the machine HPR is completed

■ Operation chart

| | |
|----|--|
| 1) | The machine HPR is started. (The machine begins the acceleration designated in "[Pr.51] HPR acceleration time selection", in the direction designated in "[Pr.44] HPR direction". It then moves at the "[Pr.46] HPR speed" when the acceleration is completed.) |
| 2) | The machine begins decelerating when the proximity dog ON is detected. |
| 3) | The machine decelerates to the "[Pr.47] Creep speed", and subsequently moves at that speed. |
| 4) | The machine stops after the workpiece has been moved the amount set in the "[Pr.50] Setting for the movement amount after proximity dog ON" after the proximity dog turned ON. It then restarts and stops at the first zero point. |
| 5) | The HPR complete flag ([Md.31] Status: b4) turns from OFF to ON, and the HPR request flag ([Md.31] Status: b3) turns from ON to OFF. |

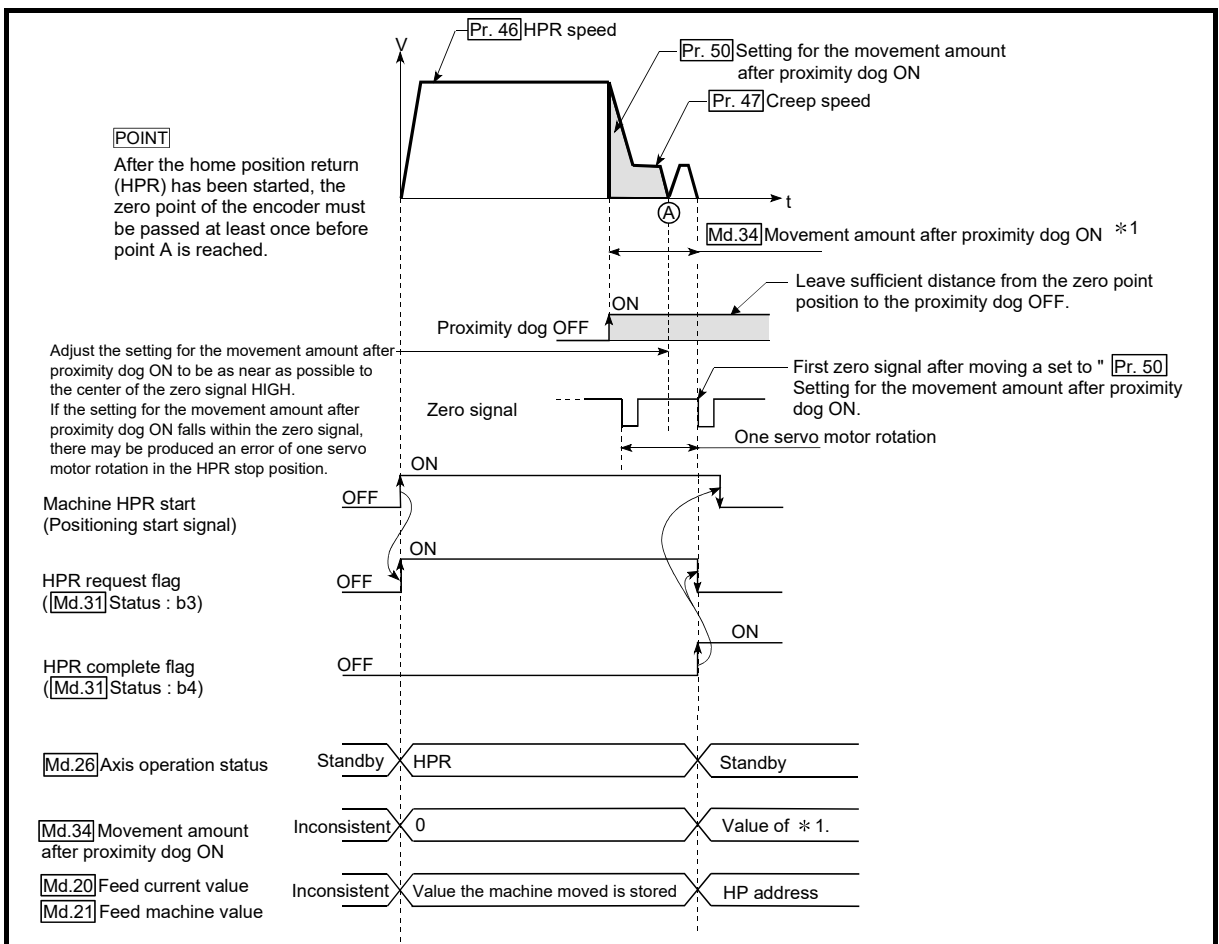

Fig. 8.5 Count method1) machine HPR

■ Precautions during operation

- (1) The error "Count method movement amount fault" (error code: 206) will occur if the "[Pr.50] Setting for the movement amount after proximity dog ON" is smaller than the deceleration distance from the "[Pr.46] HPR speed" to "[Pr.47] Creep speed".
- (2) If the speed is changed to a speed faster than "[Pr.46] HPR speed" by the speed change function (refer to "13.5.1 Speed change function".) during a machine HPR, the distance to decelerate to "[Pr.47] Creep speed" may not be ensured, depending on the setting value of "[Pr.50] Setting for the movement amount after proximity dog ON". In this case, the error "Count method movement amount fault" (error code: 206) occurs and the machine HPR is stopped.
- (3) The following shows the operation when a machine HPR is started while the proximity dog is ON.

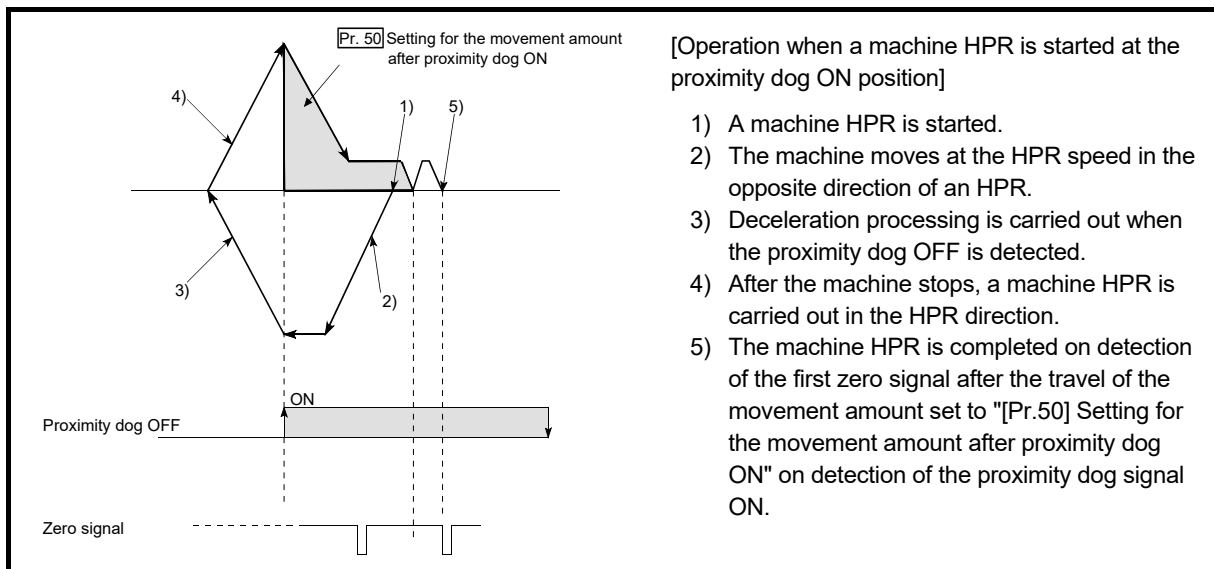

Fig. 8.6 Count method 1) machine HPR on the proximity dog ON position

- (4) Turn OFF the proximity dog at a sufficient distance from the HP. Although there is no harm in operation if the proximity dog is turned OFF during a machine HPR, it is recommended to leave a sufficient distance from the HP when the proximity dog is turned OFF for the following reason. If machine HPRs are performed consecutively after the proximity dog is turned OFF at the time of machine HPR completion, operation will be performed at the HPR speed until the hardware stroke limit (upper/lower limit) is reached. If a sufficient distance cannot be kept, consider the use of the HPR retry function.
- (5) When the stop signal stops the machine HPR, carry out the machine HPR again. When restart command is turned ON after the stop signal stops the HPR, the error "HPR restart not possible" (error code: 209) will occur.
- (6) After the home position return (HPR) has been started, the zero point of the encoder must be passed at least once before point A is reached. However, if selecting "1: Not need to pass servo motor Z-phase after power on" with "Function selection C-4 (PC17)", it is possible to carry out the home position return (HPR) without passing the zero point.

8.2.5 HPR method (3): Count method 2) [RJ010 mode]

The following shows an operation outline of the HPR method "count method 2)".
 The "count method 2)" method is effective when a "zero signal" cannot be received.
 (Note that compared to the "count method 1)" method, using this method will result in more deviation in the stop position during machine HPR.)

■ Operation chart

| | |
|----|--|
| 1) | The machine HPR is started. (The machine begins the acceleration designated in "[Pr.51] HPR acceleration time selection", in the direction designated in "[Pr.44] HPR direction". It then moves at the "[Pr.46] HPR speed" when the acceleration is completed.) |
| 2) | The machine begins decelerating when the proximity dog ON is detected. |
| 3) | The machine decelerates to the "[Pr.47] Creep speed", and subsequently moves at that speed. |
| 4) | The command from the Simple Motion module will stop and the machine HPR will be completed when the machine moves the movement amount set in "[Pr.50] Setting for the movement amount after proximity dog ON" from the proximity dog ON position. |

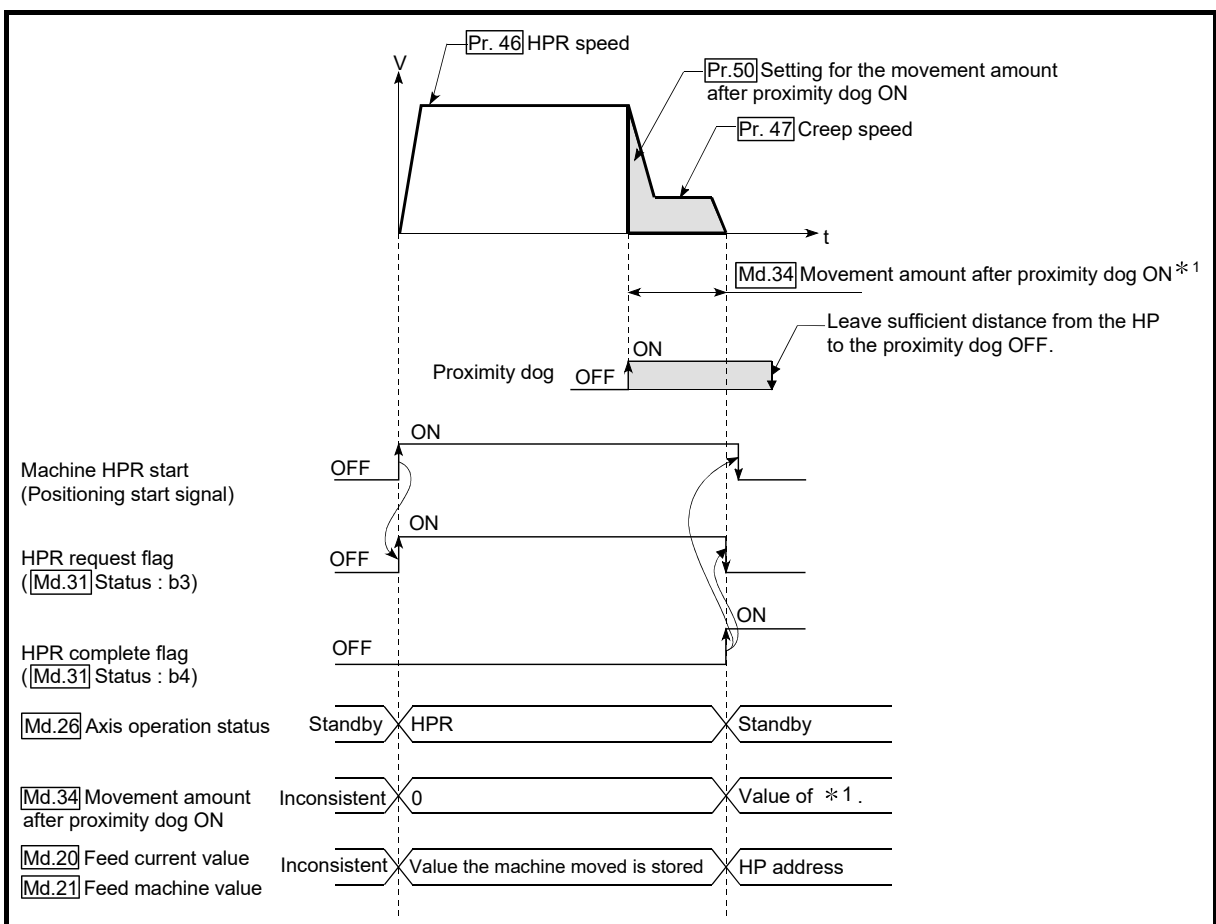

Fig. 8.7 Count method 2) machine HPR

■ Restrictions

When this method is used, a deviation will occur in the stop position (HP) compared to other HPR methods because an error of about 1 ms occurs in taking in the proximity dog ON.

■ Precautions during operation

- (1) The error "Count method movement amount fault" (error code: 206) will occur and the operation will not start if the "[Pr.50] Setting for the movement amount after proximity dog ON" is smaller than the deceleration distance from the "[Pr.46] HPR speed" to "[Pr.47] Creep speed".
- (2) If the speed is changed to a speed faster than "[Pr.46] HPR speed" by the speed change function (refer to "13.5.1 Speed change function".) during a machine HPR, the distance to decelerate to "[Pr.47] Creep speed" may not be ensured, depending on the setting value of "[Pr.50] Setting for the movement amount after proximity dog ON". In this case, the error "Count method movement amount fault" (error code: 206) occurs and the machine HPR is stopped.
- (3) The following shows the operation when a machine HPR is started while the proximity dog is ON.

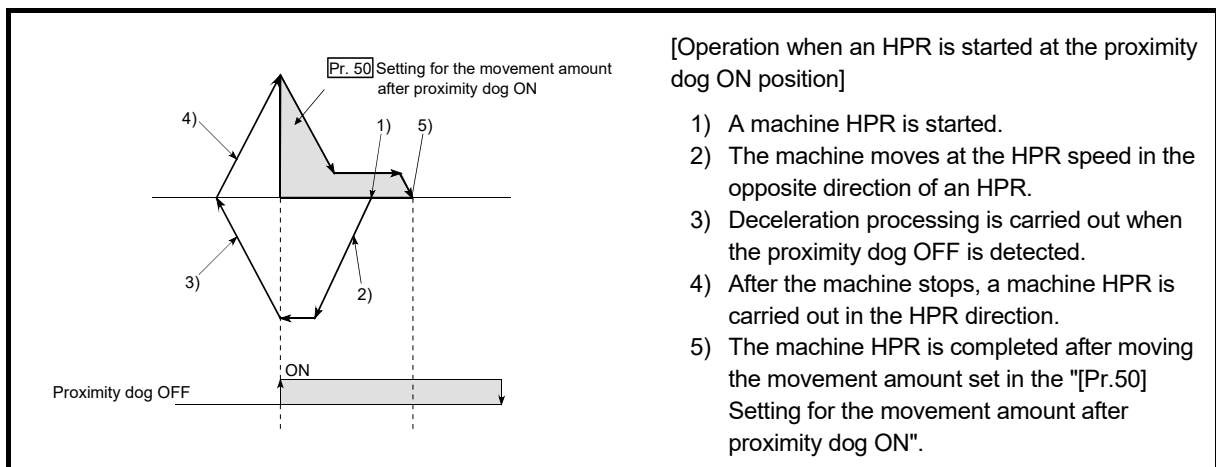

Fig. 8.8 Count method 2) machine HPR on the proximity dog ON position

- (4) Turn OFF the proximity dog at a sufficient distance from the HP.
Although there is no harm in operation if the proximity dog is turned OFF during a machine HPR, it is recommended to leave a sufficient distance from the HP when the proximity dog is turned OFF for the following reason.
If machine HPRs are performed consecutively after the proximity dog is turned OFF at the time of machine HPR completion, operation will be performed at the HPR speed until the hardware stroke limit (upper/lower limit) is reached.
If a sufficient distance cannot be kept, consider the use of the HPR retry function.
- (5) When the stop signal stops the machine HPR, carry out the machine HPR again. When restart command is turned ON after the stop signal stops the HPR, the error "HPR restart not possible" (error code: 209) will occur.

8.2.6 HPR method (4): Data set method [RJ010 mode]

The following shows an operation outline of the "data set method" HPR method. The "Data set method" method is effective when a "Proximity dog" is not used. With the data set method HPR, the position where the machine HPR has been carried out, is registered into the Simple Motion module as the HP, and the feed current value and feed machine value is overwritten to an HP address. Use the JOG or manual pulse generator operation to move the HP.

■ Operation chart

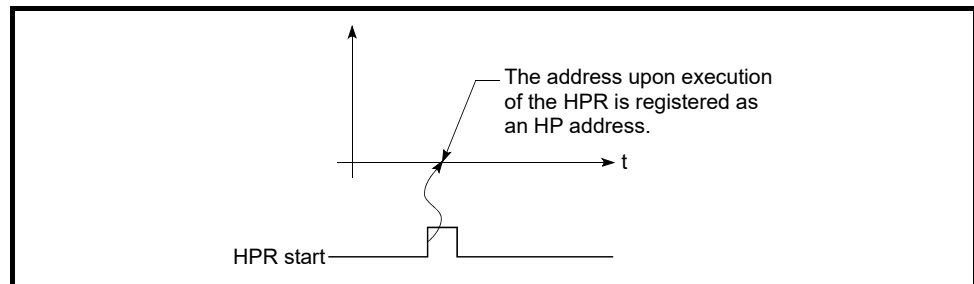

Fig. 8.9 Data set method HPR

■ Precautions during operation

- (1) The zero point must have been passed before the HPR is carried out after the power supply is turned ON. If the HPR is carried out without passing the zero point even once, the error "HPR zero point not passed" (error code: 210) will occur. When the error "HPR zero point not passed" (error code: 210) occurs, perform the JOG or similar operation so that the servomotor makes more than one revolution after an error reset, before carrying out the machine HPR again. However, if selecting "1: Not need to pass servo motor Z-phase after power on" with "Function selection C-4 (PC17)", it is possible to carry out the home position return (HPR) without passing the zero point.
- (2) The HPR data used for the data set method is the "HPR direction" and "HP address".
The HPR data other than that for the HPR direction and HP address is not used for the data set method HPR method, but if a value is set the outside the setting range, an error will occur when the PLC READY signal [Y0] is turned ON so that the READY signal [X0] is not turned ON.
With the HPR data other than that for the HPR direction and HP address, set an arbitrary value (default value can be allowed) within each data setting range so that an error will not occur upon receiving the PLC READY signal [Y0] ON.

8.2.7 HPR method (5): Scale origin signal detection method [RJ010 mode]

The following shows an operation outline of the "scale origin signal detection method" HPR method.

| POINT |
|---|
| Set "0: Need to pass servo motor Z-phase after power on" in "Function selection C-4 (PC17)". If "1: Not need to pass servo motor Z-phase after power on" is set, the error "Z-phase passing parameter invalid" (error code: 231) will occur at the start of scale origin signal detection method HPR. |

■ Operation chart

| | |
|----|--|
| 1) | The machine HPR is started. (The machine begins the acceleration designated in "[Pr.51] HPR acceleration time selection", in the direction designated in "[Pr.44] HPR direction". It then moves at the "[Pr.46] HPR speed" when the acceleration is completed.) |
| 2) | The machine begins decelerating when the proximity dog ON is detected. |
| 3) | After deceleration stop, the machine moves in the opposite direction against of HPR at the "[Pr.46] HPR speed". |
| 4) | During movement, the machine begins decelerating when the first zero signal is detected. |
| 5) | After deceleration stop, the operation moves in direction of HPR at the "[Pr.47] Creep speed", and then stops at the detected nearest zero signal. |
| 6) | The HPR complete flag ([Md.31] Status: b4) turns from OFF to ON, and the HPR request flag ([Md.31] Status: b3) turns from ON to OFF. |

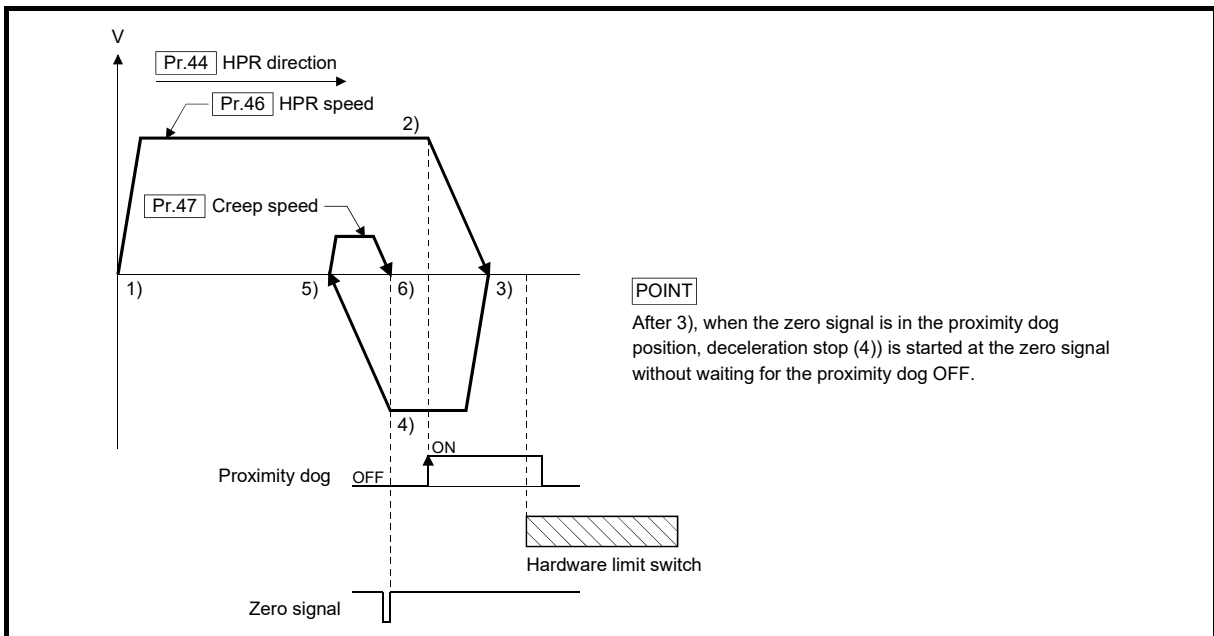

Fig. 8.10 Scale origin signal detection method machine HPR

■ Precautions during operation

- (1) The error "Start at HP" (error code: 201) will occur if another machine HPR is attempted immediately after a machine HPR completion when the HP is in the proximity dog ON position.
- (2) The following shows the operation when a machine HPR is started from the proximity dog ON position.

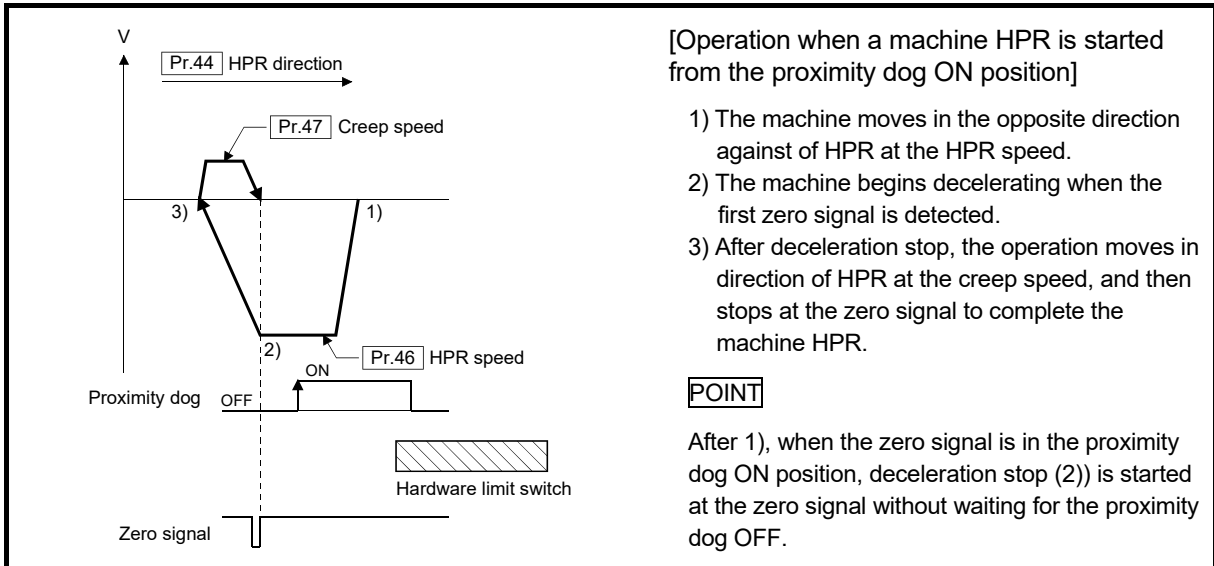
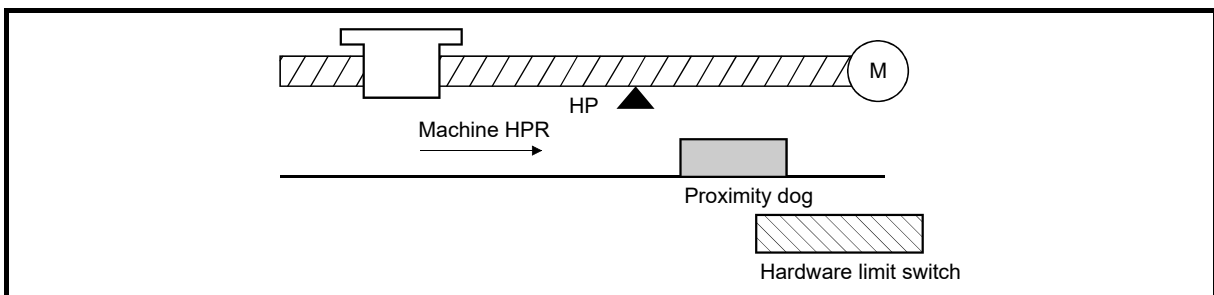

Fig. 8.11 Operation when a machine HPR is started from the proximity dog ON position

- (3) When the stop signal stops the machine HPR, carry out the machine HPR again. When restart command is turned ON after the stop signal stops the HPR, the error "HPR restart not possible" (error code: 209) will occur.
- (4) The HPR retry will not be performed regardless of setting set in "[Pr.48] HPR retry" in the scale origin signal detection method. When a hardware limit switch is detected during machine HPR, the error "Hardware stroke limit (+)" (error code: 104) or "Hardware stroke limit (-)" (error code: 105) will occur.
- (5) Position the proximity dog forward to overlaps with the hardware limit switch in direction of HPR. When the proximity dog is in the opposite direction against of HPR from the machine HPR start position, the error "Hardware stroke limit (+)" (error code: 104) or "Hardware stroke limit (-)" (error code: 105) will occur.



- (6) When the zero signal is detected again during deceleration (4) of Fig. 8.12) with detection of zero signal, the operation stops at the zero signal detected lastly to complete the HPR.

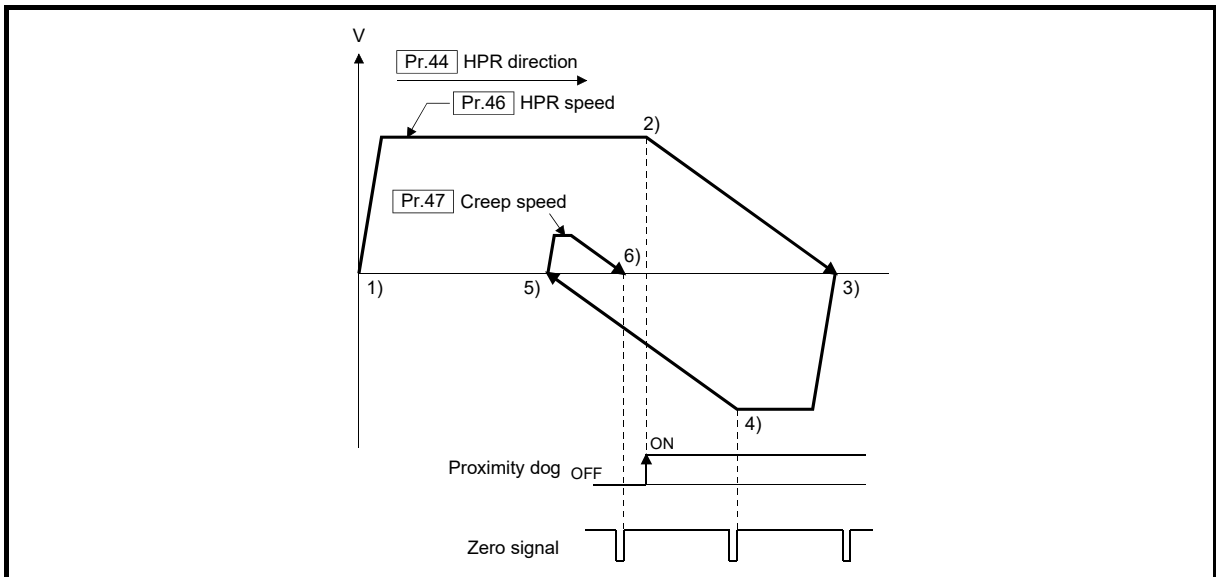

Fig. 8.12 Operation when the zero signal is detected again during deceleration with detection of zero signal

- (7) Do not use the scale origin signal detection method HPR with the backlash compensation function.
- (8) When using the direct drive motor, make it passed the Z phase once before reaching 3) of Fig. 8.10.

8.2.8 HPR method (6): Driver HPR method [CiA402 mode]

The HPR is executed based on the positioning pattern set on the driver (servo amplifier) side (hereafter called the "driver side"). Set the setting value of HPR in the parameters of the driver side. Refer to the manual of the driver because the HPR operation and parameters depend on the specification of the driver.

■ Operation chart

| | |
|----|---|
| 1) | The machine HPR is started. (The machine executes the HPR based on the positioning pattern set on the driver side.) |
| 2) | The HPR complete flag ([Md.31] Status: b4) turns from OFF to ON and the HPR request flag ([Md.31] Status: b3) turns from ON to OFF. |

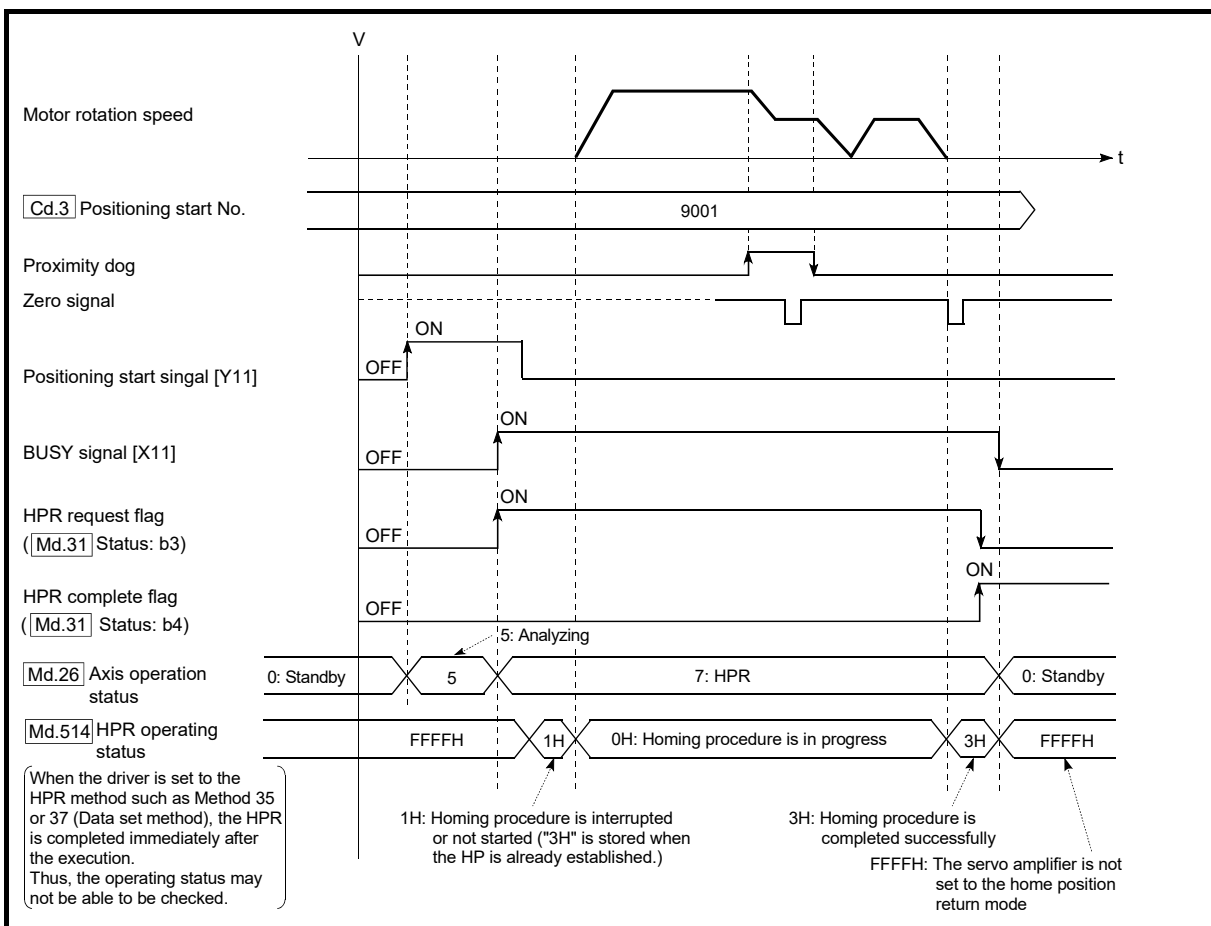

When the machine HPR is stopped

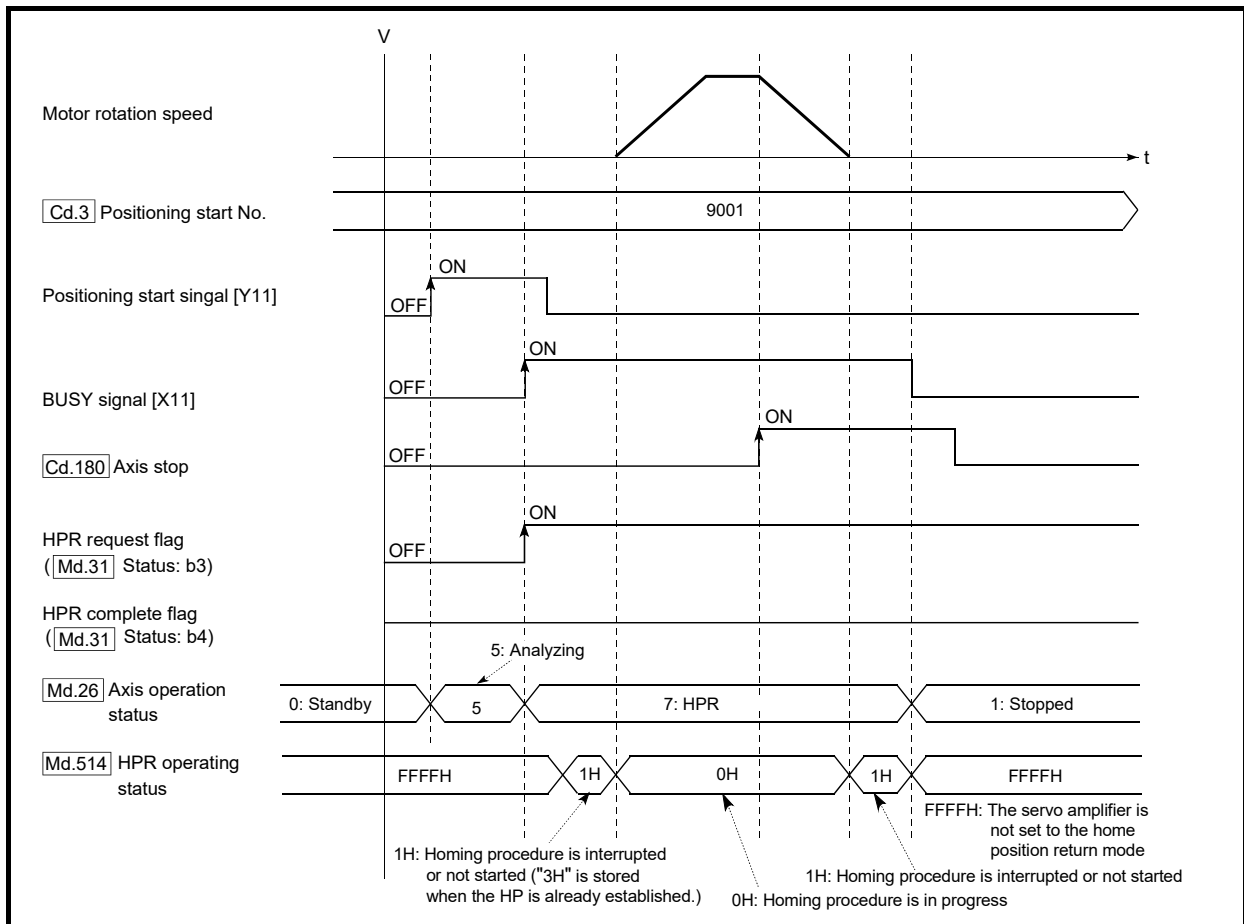

■ Setting the required parameters after driver HPR method

Refer to Section 5.1.3 "Setting items for HPR parameters".

■ Start of driver HPR method

The control mode of the servo amplifier is set to "Home mode" if "9001" is set in "[Cd.3] Positioning start No." and the axis is started.

If Zero speed ("[Md.108] Servo status" (low-order buffer memory address): b3) is not turned ON at start for the MR-J4-GF, the HPR operation does not start until Zero speed turns ON. Even in this case, "7: HPR" is set in "[Md.26] Axis operation status".

■ Axis stop of driver HPR method

When "[Cd.180] Axis stop" is turned ON during HPR, "HALT" signal is sent to the servo amplifier. If the servo amplifier which does not support the "HALT" signal is used, the axis is not stopped by this signal. Use the forced stop signal instead. Refer to the servo amplifier instruction manual for support information on the HALT signal and forced stop signal. The MR-J4-GF supports the HALT signal.

■ Backlash compensation after driver HPR method

When "[Pr.11] Backlash compensation amount" is set in the Simple Motion module, whether the backlash compensation is necessary or not is judged from "[Pr.44] HPR direction" of the Simple Motion module in the axis operation such as positioning after the driver HPR. When the positioning is executed in the same direction as "[Pr.44] HPR direction", the backlash compensation is not executed. However, when the positioning is executed in the reverse direction against "[Pr.44] HPR direction", the backlash compensation is executed.

Note that the HPR is executed based on the HPR direction of the parameter of the driver side during the driver HPR. Therefore, set the same direction to "[Pr.44] HPR direction" of the Simple Motion module and the last HPR direction of the driver side.

■ Restrictions of driver HPR method

- (1) The HPR cannot be started with the Simple Motion module during servo-off. Thus, the servo amplifier HPR method, Method 35 and 37 (Data set method), cannot be executed during servo-off.
- (2) The servo input axis cannot be used during the HPR. During the HPR, turn OFF "[Cd.380] Synchronous control start" of the output axis which is synchronized. When the HPR is used during the synchronous control, the axis operates as follows depending on the servo input axis type.

| [Pr.300] Servo input axis type | Output axis operation during synchronous control |
|--------------------------------|---|
| 1: Feed current value | The synchronous control axis does not operate. |
| 2: Real current value | |
| 3: Servo command value | The axis synchronizes with the input axis before the HPR is completed. However, the synchronous control is not executed at the end of the HPR and "Overspeed" (alarm No.: 31) or "Command frequency error" (alarm No.: 35) may occur. |
| 4: Feedback value | |

- (3) To use the HPR method which uses the proximity dog signal and is not based on the Z-phase, it is recommended to use the servo amplifier built-in DI.
- (4) Unlike other HPR methods, the HPR request flag ([Md.31] Status: b3) turns OFF and the HPR complete flag ([Md.31] Status: b4) turns ON before BUSY signal is turned OFF at HPR completion.

8.3 Fast HPR

8.3.1 Outline of the fast HPR operation

■ Fast HPR operation

After establishing HP by a machine HPR, positioning control to the HP is executed without using a proximity dog or a zero signal.

The following shows the operation during a basic fast HPR start.

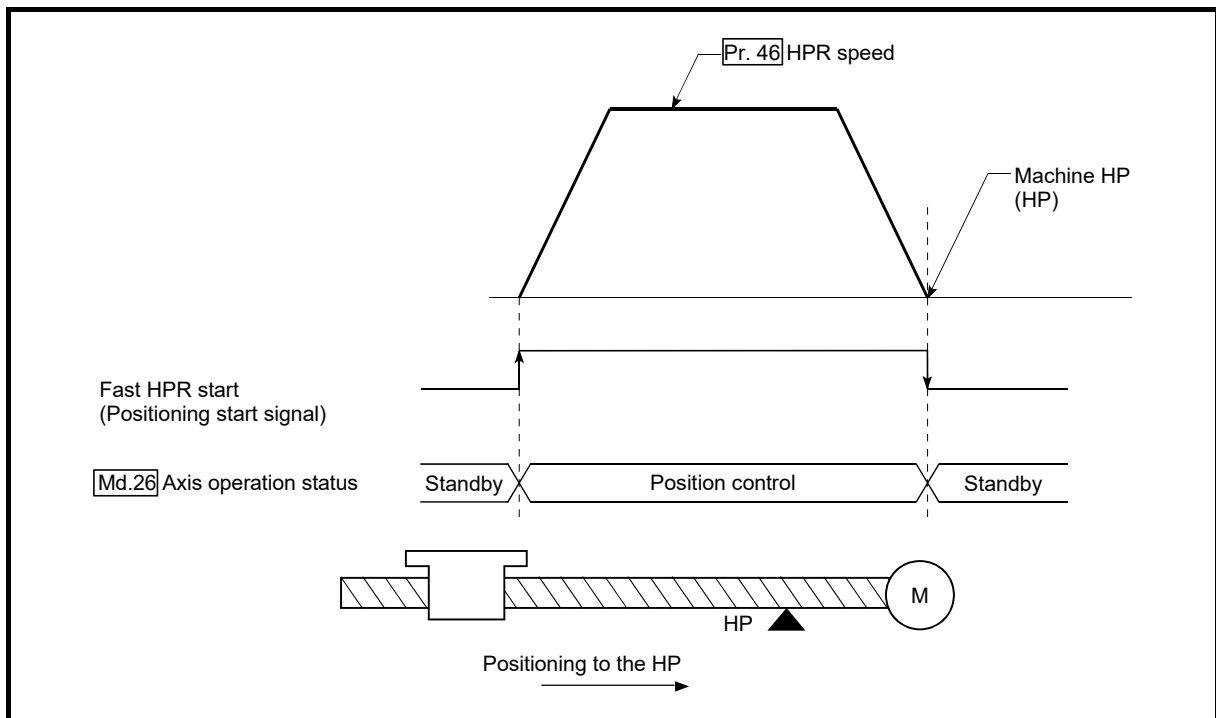

Fig. 8.13 Fast HPR

- 1) The fast HPR is started.
- 2) Positioning control to the HP established by a machine HPR begins at speed set in "[Pr.46] HPR speed".
- 3) The fast HPR is completed.

■ Operation timing and processing time of fast HPR

The following shows details about the operation timing and time during fast HPR.

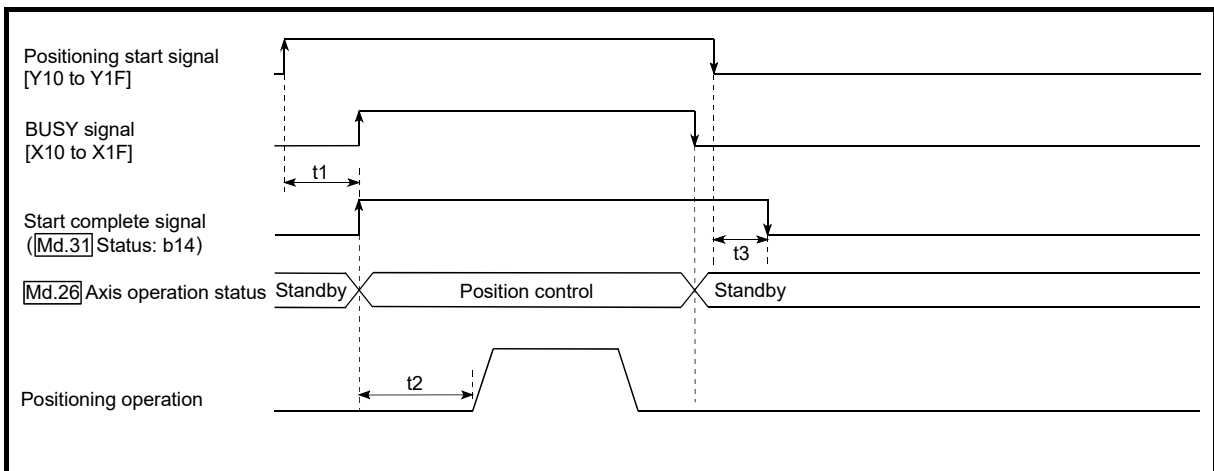

Fig. 8.14 Operation timing and processing time of fast HPR

| Normal timing time | | Unit: [ms] | | |
|---|-----------------|------------|--------------|----------|
| [Pr. 132] Communication mode setting | Operation cycle | t1 | t2 | t3 |
| MR-J4-B-RJ010 communication mode | 0.88 | 0.7 to 1.5 | 3.1 to 4.8 | 0 to 0.9 |
| | 1.77 | 0.8 to 1.9 | 4.4 to 6.8 | 0 to 1.8 |
| | 3.55 | 1.0 to 3.6 | 10.8 to 13.5 | 0 to 3.6 |
| Communication mode correspond to CiA402 | 1.00 | 0.9 to 1.8 | 3.1 to 4.8 | 0 to 1.0 |
| | 2.00 | 0.9 to 2.6 | 5.5 to 6.8 | 0 to 2.0 |
| | 4.00 | 1.2 to 4.8 | 11.5 to 13.5 | 0 to 4.0 |

- The t1 timing time could be delayed by the operation state of other axes.

■ Operating restrictions

- (1) The fast HPR can only be executed after the HP is established by executing the Machine HPR.
If not, the error "HPR request ON" (error code: 207) will occur.
(HPR request flag ([Md.31] Status: b3) must be turned OFF).
- (2) If the fraction pulse is cleared to zero using current value changing or fixed-feed control, execute the fast HPR and an error will occur by a cleared amount.
- (3) When unlimited length feed is executed by speed control and the feed machine value overflows or underflows once, the fast HPR cannot be executed normally.
- (4) The HPR complete flag ([Md.31] Status: b4) is not turned ON.
- (5) The axis operation status during fast HPR is "in position control".

8.4 Selection of the HPR setting condition

8.4.1 Outline of the HPR setting condition

If executing the home position return (HPR) when selecting "0: Need to pass servo motor Z-phase after power on" with the servo parameter of the servo amplifier "Function selection C-4 (PC17)", it is necessary that the servomotor has been rotated more than one revolution and passed the Z phase (Motor reference position signal) and that the zero point pass signal ([Md.108] Servo status (low-order buffer memory address): b0) has turned ON.

When selecting "1: Not need to pass servo motor Z-phase after power on" with "Function selection C-4 (PC17)", it is possible to turn the zero point pass signal ([Md.108] Servo status (low-order buffer memory address): b0) ON without passing the zero point.

| | Buffer memory address (low-order) |
|---------------------------|-----------------------------------|
| [Md.108] Servo status: b0 | 2476+100n |

n: Axis No.-1

■ Data setting

To select the "HPR setting condition", set the "servo parameter" shown in the following table.

Servo parameters are set for each axis.

The "HPR setting condition" is stored into the following buffer memory addresses.

| Setting item | Setting value | Setting details | Buffer memory address |
|-------------------------------|---------------|--|-----------------------|
| Function selection C-4 (PC17) | → | 0 : Need to pass servo motor Z-phase after power on 1 : Not need to pass servo motor Z-phase after power on | 28480+100n |

n: Axis No.-1

*: Refer to Section 5.2.8 "Servo parameters" for information on the storage details.

■ Precautions during operation

- (1) Set "Function selection C-4 (PC17)", and then turn off the power supply of the servo amplifier once and switch it on again to make that parameter setting valid.

Chapter 9 Major Positioning Control

The details and usage of the major positioning controls (control functions using the "positioning data") are explained in this chapter.

The major positioning controls include such controls as "positioning control" in which positioning is carried out to a designated position using the address information, "speed control" in which a rotating object is controlled at a constant speed, "speed-position switching control" in which the operation is shifted from "speed control" to "position control" and "position-speed switching control" in which the operation is shifted from "position control" to "speed control".

Execute the required settings to match each control.

| | | |
|--------|--|-------|
| 9.1 | Outline of major positioning controls..... | 9- 2 |
| 9.1.1 | Data required for major positioning control..... | 9- 4 |
| 9.1.2 | Operation patterns of major positioning controls..... | 9- 5 |
| 9.1.3 | Designating the positioning address..... | 9- 15 |
| 9.1.4 | Confirming the current value..... | 9- 16 |
| 9.1.5 | Control unit "degree" handling..... | 9- 18 |
| 9.1.6 | Interpolation control..... | 9- 21 |
| 9.2 | Setting the positioning data..... | 9- 26 |
| 9.2.1 | Relation between each control and positioning data..... | 9- 26 |
| 9.2.2 | 1-axis linear control..... | 9- 28 |
| 9.2.3 | 2-axis linear interpolation control..... | 9- 32 |
| 9.2.4 | 3-axis linear interpolation control..... | 9- 37 |
| 9.2.5 | 4-axis linear interpolation control..... | 9- 43 |
| 9.2.6 | 1-axis fixed-feed control..... | 9- 46 |
| 9.2.7 | 2-axis fixed-feed control (interpolation)..... | 9- 49 |
| 9.2.8 | 3-axis fixed-feed control (interpolation)..... | 9- 51 |
| 9.2.9 | 4-axis fixed-feed control (interpolation)..... | 9- 56 |
| 9.2.10 | 2-axis circular interpolation control with sub point designation..... | 9- 59 |
| 9.2.11 | 2-axis circular interpolation control with center point designation..... | 9- 65 |
| 9.2.12 | 1-axis speed control..... | 9- 73 |
| 9.2.13 | 2-axis speed control..... | 9- 76 |
| 9.2.14 | 3-axis speed control..... | 9- 80 |
| 9.2.15 | 4-axis speed control..... | 9- 84 |
| 9.2.16 | Speed-position switching control (INC mode)..... | 9- 89 |
| 9.2.17 | Speed-position switching control (ABS mode)..... | 9- 99 |
| 9.2.18 | Position-speed switching control..... | 9-108 |
| 9.2.19 | Current value changing..... | 9-117 |
| 9.2.20 | NOP instruction..... | 9-122 |
| 9.2.21 | JUMP instruction..... | 9-123 |
| 9.2.22 | LOOP..... | 9-125 |
| 9.2.23 | LEND..... | 9-127 |

9.1 Outline of major positioning controls

"Major positioning controls" are carried out using the "positioning data" stored in the Simple Motion module.

The basic controls such as position control and speed control are executed by setting the required items in this "positioning data", and then starting that positioning data.

The control method for the "major positioning controls" is set in setting item "[Da.2] Control method" of the positioning data.

Control defined as a "major positioning control" carries out the following types of control according to the "[Da.2] Control method" setting.

However, the position loop is included for commanding to servo amplifier in the speed control set in "[Da.2] Control method".

Use the "speed-torque control" (Refer to Section 12.1 "Speed-torque control") to execute the speed control not including position loop.

| Major positioning control | | [Da.2] Control method | | Details |
|---------------------------|--|--|--|---|
| | | | | |
| Position control | Linear control | 1-axis linear control | ABS Linear 1 INC Linear 1 | Positioning of the designated 1 axis is carried out from the start address (current stop position) to the designated position. |
| | | 2-axis linear interpolation control (Note-1) | ABS Linear 2 INC Linear 2 | Using the designated 2 axes, linear interpolation control is carried out from the start address (current stop position) to the designated position. |
| | | 3-axis linear interpolation control (Note-1) | ABS Linear 3 INC Linear 3 | Using the designated 3 axes, linear interpolation control is carried out from the start address (current stop position) to the designated position. |
| | | 4-axis linear interpolation control (Note-1) | ABS Linear 4 INC Linear 4 | Using the designated 4 axes, linear interpolation control is carried out from the start address (current stop position) to the designated position. |
| | Fixed-feed control | 1-axis fixed-feed control | Fixed-feed 1 | Positioning of the designated 1 axis is carried out for a designated movement amount from the start address (current stop position). (The "[Md.20] Feed current value" is set to "0" at the start.) |
| | | 2-axis fixed-feed control (Note-1) | Fixed-feed 2 | Using the designated 2 axes, linear interpolation control is carried out for a designated movement amount from the start address (current stop position). (The "[Md.20] Feed current value" is set to "0" at the start.) |
| | | 3-axis fixed-feed control (Note-1) | Fixed-feed 3 | Using the designated 3 axes, linear interpolation control is carried out for a designated movement amount from the start address (current stop position). (The "[Md.20] Feed current value" is set to "0" at the start.) |
| | | 4-axis fixed-feed control (Note-1) | Fixed-feed 4 | Using the designated 4 axes, linear interpolation control is carried out for a designated movement amount from the start address (current stop position). (The "[Md.20] Feed current value" is set to "0" at the start.) |
| | 2-axis circular interpolation control (Note-1) | Sub point designation | ABS Circular sub INC Circular sub | Using the designated 2 axes, positioning is carried out in an arc path to a position designated from the start point address (current stop position). |
| | | Center point designation | ABS Circular right ABS Circular left INC Circular right INC Circular left | |

| Major positioning control | | [Da.2] Control method | Details |
|----------------------------------|-------------------------------|--|---|
| Speed control | 1-axis speed control | Forward run speed 1 Reverse run speed 1 | The speed control of the designated 1 axis is carried out. |
| | 2-axis speed control (Note-1) | Forward run speed 2 Reverse run speed 2 | The speed control of the designated 2 axes is carried out. |
| | 3-axis speed control (Note-1) | Forward run speed 3 Reverse run speed 3 | The speed control of the designated 3 axes is carried out. |
| | 4-axis speed control (Note-1) | Forward run speed 4 Reverse run speed 4 | The speed control of the designated 4 axes is carried out. |
| Speed-position switching control | | Forward run speed/position Reverse run speed/position | The control is continued as position control (positioning for the designated address or movement amount) by turning ON the "speed-position switching signal" after first carrying out speed control. |
| Position-speed switching control | | Forward run position/speed Reverse run position/speed | The control is continued as speed control by turning ON the "position-speed switching signal" after first carrying out position control. |
| Other control | NOP instruction | NOP | A nonexecutable control method. When this instruction is set, the operation is transferred to the next data operation, and the instruction is not executed. |
| | Current value changing | Current value changing | "[Md.20] Feed current value" is changed to an address set in the positioning data. This can be carried out by either of the following 2 methods. (("[Md.21] Feed machine value" cannot be changed.) • Current value changing using the control method • Current value changing using the current value changing start No. (No. 9003). |
| | JUMP instruction | JUMP instruction | An unconditional or conditional JUMP is carried out to a designated positioning data No. |
| | LOOP | LOOP | A repeat control is carried out by repeat LOOP to LEND. |
| | LEND | LEND | Control is returned to the top of the repeat control by repeat LOOP to LEND. After the repeat operation is completed specified times, the next positioning data is run. |

(Note-1): Control is carried out so that linear and arc paths are drawn using a motor set in two or more axes directions. This kind of control is called "interpolation control". (Refer to Section 9.1.6 "Interpolation control" for details.)

9.1.1 Data required for major positioning control

The following table shows an outline of the "positioning data" configuration and setting details required to carry out the "major positioning controls".

| Setting item | | Setting details |
|------------------------|--|---|
| Positioning data No. 1 | [Da.1] Operation pattern | Set the method by which the continuous positioning data (Ex: positioning data No.1, No.2, No.3) will be controlled. (Refer to Section 9.1.2.) |
| | [Da.2] Control method | Set the control method defined as a "major positioning control". (Refer to Section 9.1.) |
| | [Da.3] Acceleration time No. | Select and set the acceleration time at control start. (Select one of the four values set in [Pr.9], [Pr.25], [Pr.26], and [Pr.27] for the acceleration time.) |
| | [Da.4] Deceleration time No. | Select and set the deceleration time at control stop. (Select one of the four values set in [Pr.10], [Pr.28], [Pr.29], and [Pr.30] for the deceleration time.) |
| | [Da.6] Positioning address/movement amount | Set the target value during position control. (Refer to Section 9.1.3.) |
| | [Da.7] Arc address | Set the sub point or center point address during circular interpolation control. |
| | [Da.8] Command speed | Set the speed during the control execution. |
| | [Da.9] Dwell time/JUMP destination positioning data No. | The time between the command pulse output is completed to the positioning completed signal is turned ON. Set it for absorbing the delay of the mechanical system to the instruction, such as the delay of the servo system (deviation). |
| | [Da.10] M code/Condition data No./Number of LOOP to LEND repetitions | Set this item when carrying out sub work (clamp and drill stops, tool replacement, etc.) corresponding to the code No. related to the positioning data execution. |
| | [Da.20] Axis to be interpolated No.1 | Set an axis to be interpolated during the 2- to 4-axis interpolation operation. (Refer to Section 9.1.6.) |
| | [Da.21] Axis to be interpolated No.2 | |
| | [Da.22] Axis to be interpolated No.3 | |

(Note): The settings and setting requirement for the setting details of [Da.1] to [Da.10] and [Da.20] to [Da.22] differ according to the "[Da.2] Control method". (Refer to Section 9.2 "Setting the positioning data".)

■ Major positioning control sub functions

Refer to Section 3.2.5 "Combination of QD77GF main functions and sub functions" for details on "sub functions" that can be combined with the major positioning control.

Also refer to Chapter 13 "Control Sub Functions" for details on each sub function.

■ Major positioning control from GX Works2

"Major positioning control" can be executed by test function of GX Works2.

Refer to "Simple Motion Module Setting Tool Help" of GX Works2 for details on carrying out major positioning control from the GX Works2.

REMARK

600 positioning data (positioning data No. 1 to 600) items can be set per axis.

9.1.2 Operation patterns of major positioning controls

In "major positioning control" (high-level positioning control), "[Da.1] Operation pattern" can be set to designate whether to continue executing positioning data after the started positioning data. The "operation pattern" includes the following 3 types.

- Positioning complete — (1) Independent positioning control (operation pattern: 00)
- Positioning continue — (2) Continuous positioning control (operation pattern: 01)
- (3) Continuous path control (operation pattern: 11)

The following shows examples of operation patterns when "1-axis linear control (ABS linear 1)" is set in positioning data No. 1 to No. 6 of axis 1. Details of each operation pattern are shown on the following pages.

< Operation example when "1-axis linear positioning" is set in the positioning data of axis 1 >

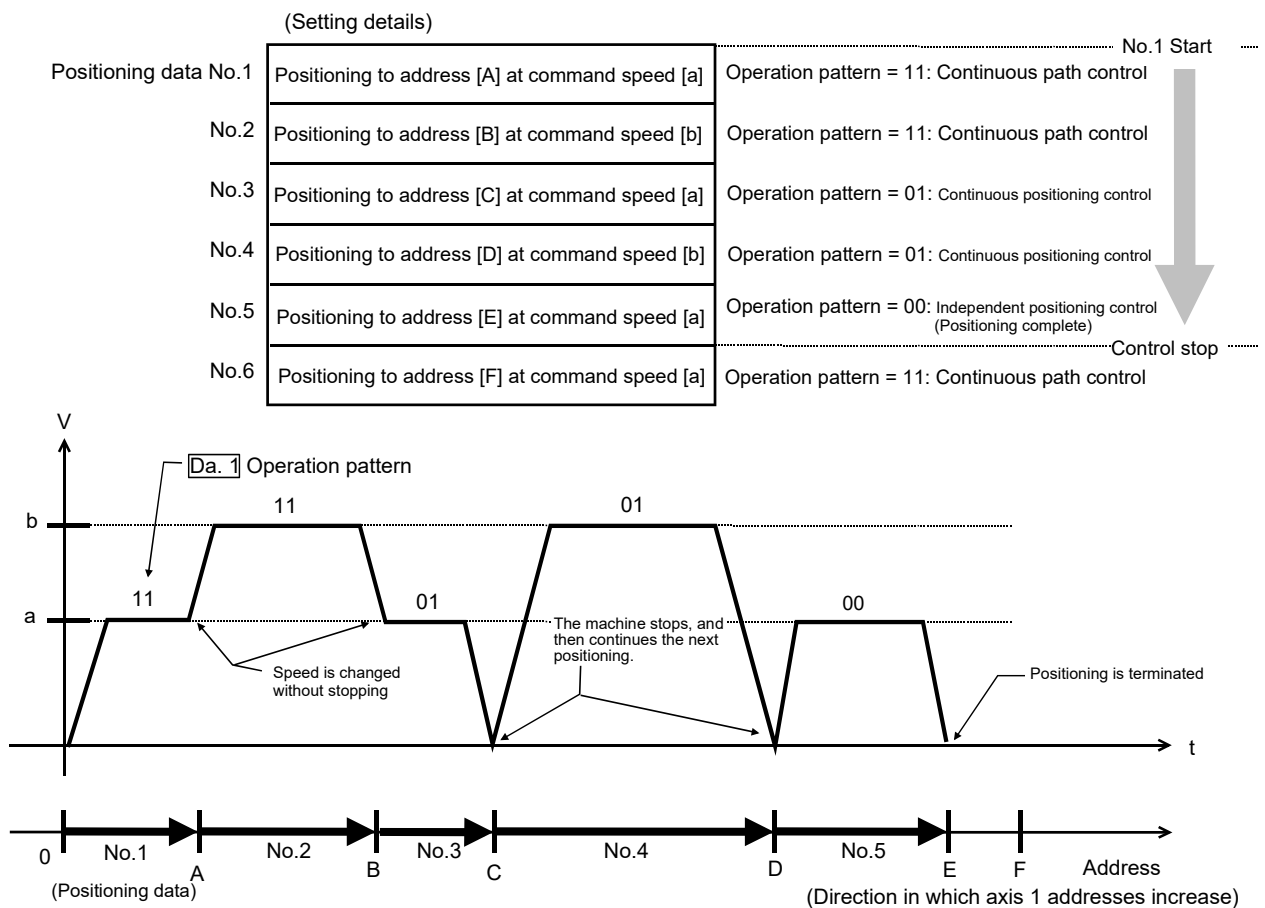

- | | |
|--------------|--|
| POINT | <p>(1) When the operation pattern is continuous positioning control or continuous path control, the same address as the last value is specified in absolute system or the movement amount 0 is specified in incremental system, positioning control of movement amount 0 is executed.</p> <p>(2) The BUSY signal turns ON even when position control of movement amount 0 is executed. However, since the ON time is short, the ON status may not be detected in the PLC program.</p> <p>(3) The positioning complete signal turns ON even when position control of movement amount 0 is executed. ON time is determined by "[Pr.40] Positioning complete signal output time".</p> |
|--------------|--|

[1] Independent positioning control (Positioning complete)

This control is set when executing only one designated data item of positioning. If a dwell time is designated, the positioning completes after the designated time elapses.

This data (operation pattern [00] data) becomes the end of block data when carrying out block positioning. (The positioning stops after this data is executed.)

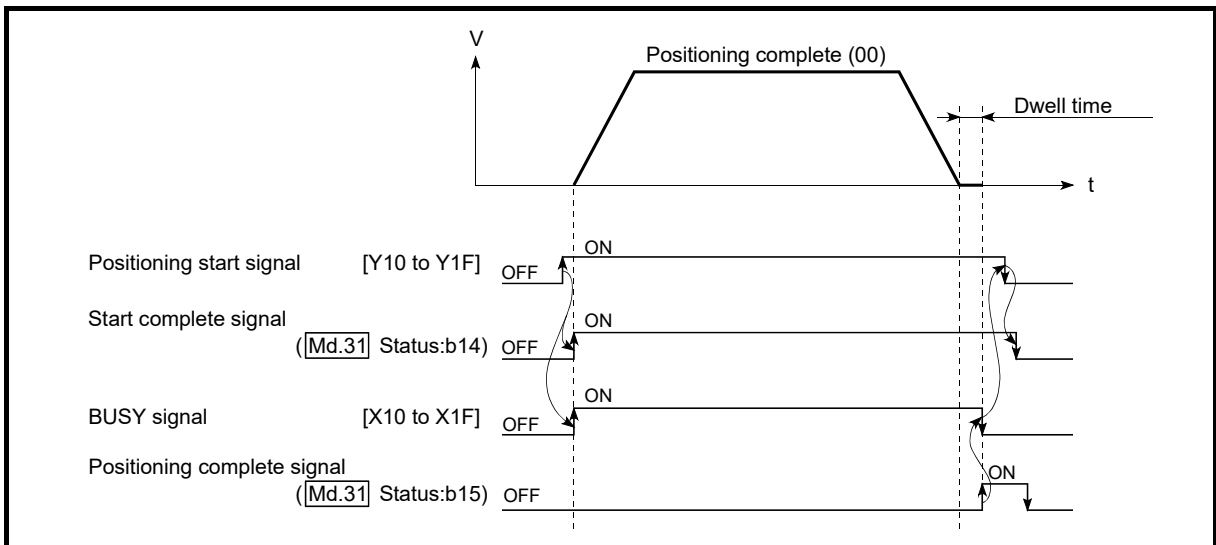

Fig. 9.1 Operation during independent positioning control

[2] Continuous positioning control

- (1) The machine always automatically decelerates each time the positioning is completed. Acceleration is then carried out after the Simple Motion module command speed reaches 0 to carry out the next positioning data operation. If a dwell time is designated, the acceleration is carried out after the designated time elapses.
- (2) In operation by continuous positioning control (operation pattern "01"), the next positioning No. is automatically executed. Always set operation pattern "00" in the last positioning data to complete the positioning. If the operation pattern is set to positioning continue ("01" or "11"), the operation will continue until operation pattern "00" is found. If the operation pattern "00" cannot be found, the operation may be carried out until the positioning data No. 600. If the operation pattern of the positioning data No. 600 is not completed, the operation will be started again from the positioning data No. 1.

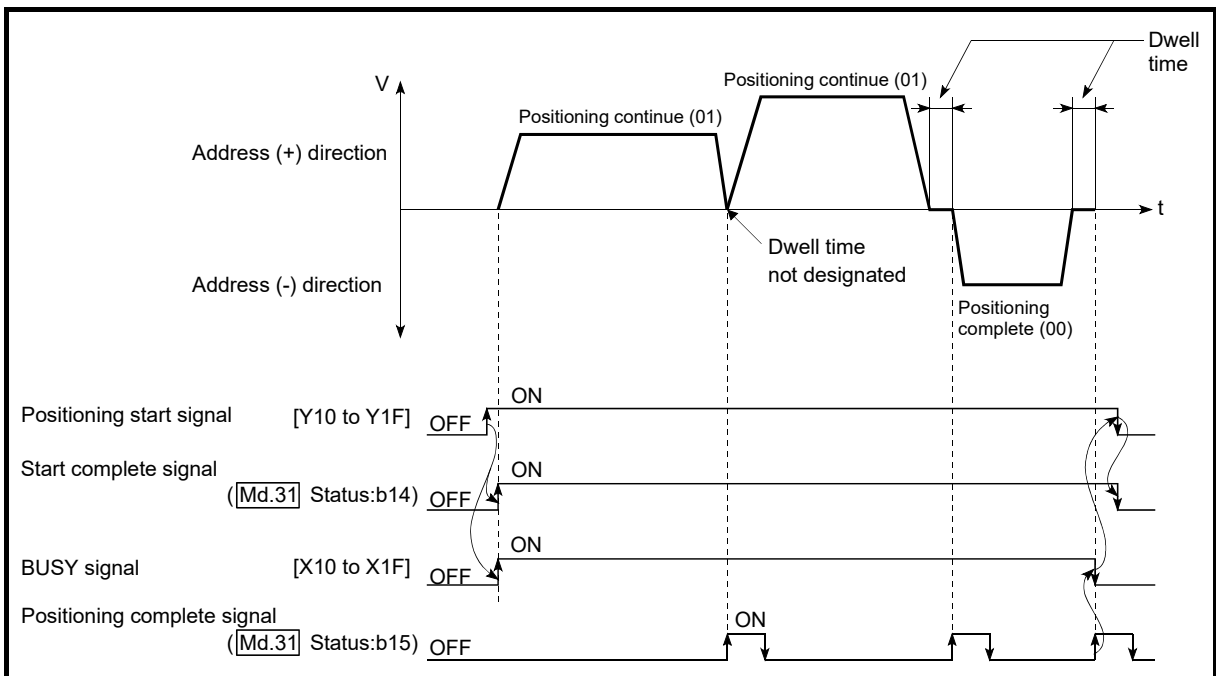

Fig. 9.2 Operation during continuous positioning control

[3] Continuous path control

(1) Continuous path control

- (a) The speed is changed without deceleration stop between the command speed of the "positioning data No. currently being executed" and the speed of the "positioning data No. to carry out the next operation".
The speed is not changed if the current speed and the next speed are equal.
- (b) The speed used in the previous positioning operation is continued when the command speed is set to "-1".
- (c) Dwell time is ignored, even if it is set.
- (d) The next positioning No. is executed automatically in operations by continuous path control (operation pattern "11"). Always complete the positioning by setting operation pattern "00" in the last positioning data. If the operation pattern is set to positioning continue ("01" or "11"), the operation will continue until operation pattern "00" is found. If the operation pattern "00" cannot be found, the operation may be carried out until the positioning data No. 600. If the operation pattern of the positioning data No. 600 is not complete, the operation will be started again from the positioning data No. 1.
- (e) The speed switching includes the "front-loading speed switching mode" in which the speed is changed at the end of the current positioning side, and the "standard speed switching mode" in which the speed is at the start of the next positioning side. (Refer to "[Pr.19] Speed switching mode".)
- (f) In the continuous path control, the positioning may be completed before the set address/movement amount and the current data may be switched to the "positioning data that will be run next". This is because a preference is given to the positioning at a command speed. In actuality, the positioning is completed before the set address/movement amount by an amount of remaining distance at speeds less than the command speed. The remaining distance ($\Delta \ell$) at speeds less than the command speed is $0 \leq \Delta \ell \leq$ (distance moved in operation cycle at a speed at the time of completion of the positioning).
The remaining distance ($\Delta \ell$) is output at the next positioning data No.

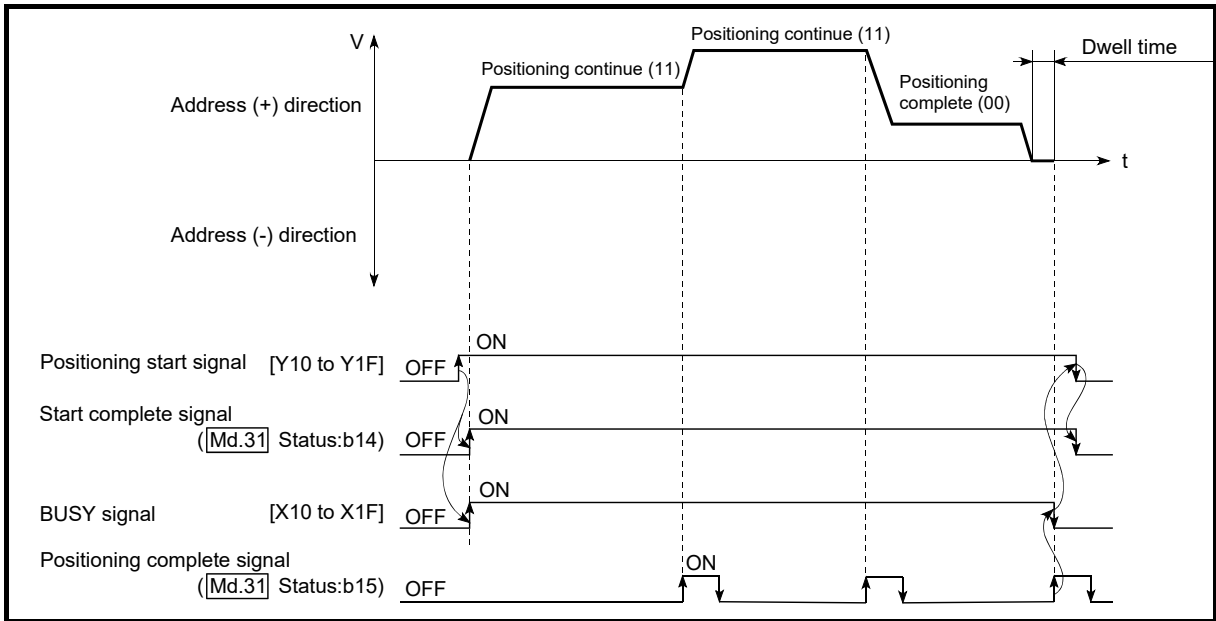

Fig. 9.3 Operation during continuous path control (Standard speed switching mode)

POINT

In the continuous path control, a speed variation will not occur using the near-pass function when the positioning data No. is switched (Refer to Section 13.3.3 "Near pass function").

(2) Deceleration stop conditions during continuous path control

Deceleration stops are not carried out in continuous path control, but the machine will carry out a deceleration stop to speed "0" in the following cases (a) to (c).

- (a) When the operation pattern of the positioning data currently being executed is "continuous path control: 11", and the movement direction of the positioning data currently being executed differs from that of the next positioning data. (Only for 1-axis positioning control (Refer to the "POINTS" in the next page.))

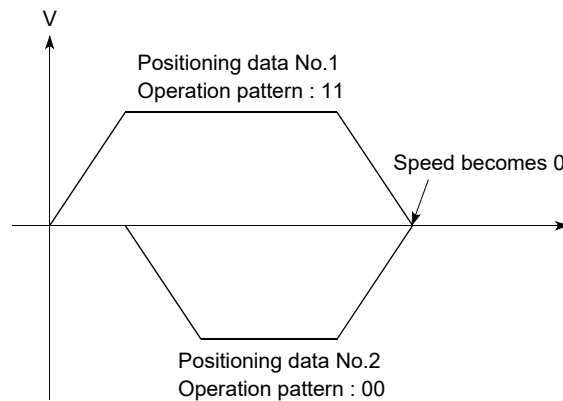

- (b) During operation by step operation. (Refer to Section 13.7.1 "Step function".)
- (c) When there is an error in the positioning data to carry out the next operation.

| POINTS |
|---|
| <p>(1) The movement direction is not checked during interpolation operations. Thus, automatic deceleration to a stop will not be carried out even if the movement direction is changed (See the figures below). Because of this, the interpolation axis may rapidly reverse direction. To avoid this rapid direction reversal in the interpolation axis, set the pass point to continuous positioning control "01" instead of setting it to continuous path control "11".</p> <div style="display: flex; justify-content: space-around; text-align: center;"> <div style="width: 30%;"> <p>[Positioning by interpolation]</p> </div> <div style="width: 30%;"> <p>[Reference axis operation]</p> </div> <div style="width: 30%;"> <p>[Interpolation axis operation]</p> </div> </div> <p>(2) When a "0" is set in the "[Da.6] Positioning address/movement amount" of the continuous path control positioning data, the command speed is reduced to 0 in an operation cycle. When a "0" is set in the "[Da.6] Positioning address/movement amount" to increase the number of speed change points in the future, change the "[Da.2] Control method" to the "NOP" to make the control nonexecutable. (Refer to Section 9.2.20 "NOP instruction".)</p> <p>(3) In the continuous path control positioning data, assure a movement distance so that the execution time with that data is 100 ms or longer, or lower the command speed.</p> |

(3) Speed handling

- (a) Continuous path control command speeds are set with each positioning data.
The Simple Motion module carries out the positioning at the speed designated with each positioning data.
- (b) The command speed can be set to "-1" in continuous path control.
The control will be carried out at the speed used in the previous positioning data No. if the command speed is set to "-1".
(The "current speed" will be displayed in the command speed when the positioning data is set with a GX Works2. The current speed is the speed of the positioning control being executed currently.)
 - 1) The speed does not need to be set in each positioning data when carrying out uniform speed control if "-1" is set beforehand in the command speed.
 - 2) If the speed is changed or the override function is executed, in the previous positioning data when "-1" is set in the command speed, the operation can be continued at the new speed.
 - 3) The error "No command speed" (error code: 503) occurs and positioning cannot be started if "-1" is set in the command speed of the first positioning data at start.

[Relation between the command speed and current speed]

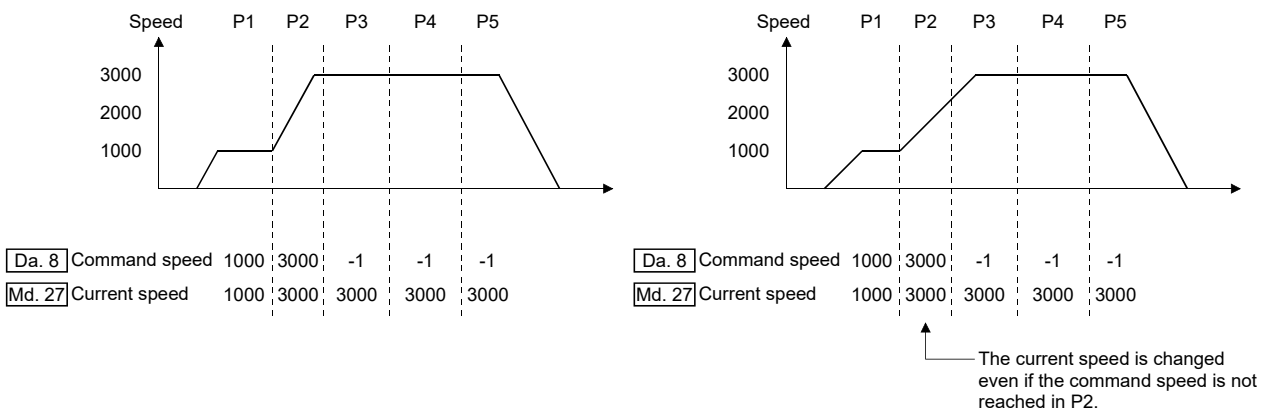

POINTS

- (1) In the continuous path control, a speed variation will not occur using the near-pass function when the positioning data is switched (Refer to Section 13.3.3 "Near pass function").
- (2) The Simple Motion module holds the command speed set with the positioning data, and the latest value of the speed set with the speed change request as the "[Md.27] Current speed". It controls the operation at the "current speed" when "-1" is set in the command speed.
(Depending on the relation between the movement amount and the speed, the feedrate may not reach the command speed value, but even then the current speed will be updated.)
- (3) When the address for speed change is identified beforehand, generate and execute the positioning data for speed change by the continuous path control to carry out the speed change without requesting the speed change with a sequence program.

(4) Speed switching
(Refer to "[Pr.19] Speed switching mode".)

The two modes for changing the speed are shown below.

- Standard speed switching.....Switch the speed when executing the next positioning data.
- Front-loading speed switching....The speed switches at the end of the positioning data currently being executed.

(a) Standard speed switching mode

- 1) If the respective command speeds differ in the "positioning data currently being executed" and the "positioning data to carry out the next operation", the machine will accelerate or decelerate after reaching the positioning point set in the "positioning data currently being executed" and the speed will change over to the speed set in the "positioning data to carry out the next operation".
- 2) The parameters used in acceleration/deceleration to the command speed set in the "positioning data to carry out the next operation" are those of the positioning data to carry out acceleration/deceleration.
Speed switching will not be carried out if the command speeds are the same.

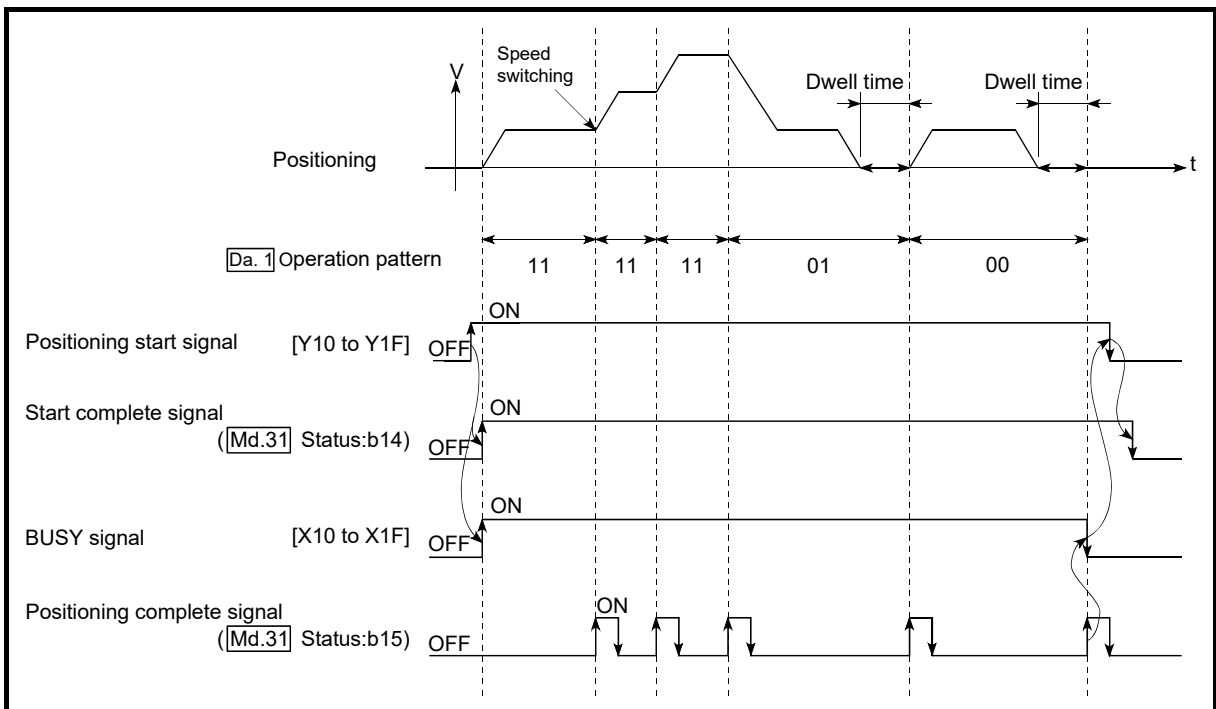

Fig. 9.4 Operation for the standard speed switching mode

3) Speed switching condition

If the movement amount is small in regard to the target speed, the current speed may not reach the target speed even if acceleration/deceleration is carried out. In this case, the machine is accelerated/decelerated so that it nears the target speed.

If the movement amount will be exceeded when automatic deceleration is required (Ex. Operation patterns "00", "01", etc.), the machine will immediately stop at the designated positioning address, and the warning "Insufficient movement amount" (warning code: 513) will occur.

[When the speed cannot change over in P2]

For the following relation of the speed

$$P1 = P4, P2 = P3, P1 < P2$$

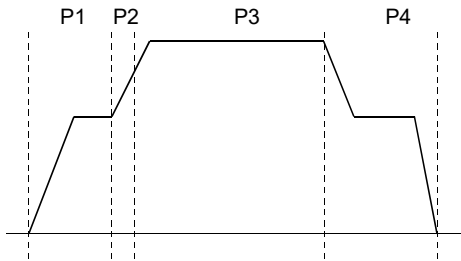

[When the movement amount is small during automatic deceleration]

The movement amount required to carry out the automatic deceleration cannot be secured, so the machine immediately stops in a speed $\neq 0$ status.

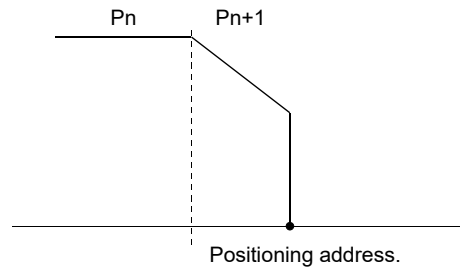

(b) Front-loading speed switching mode

- 1) If the respective command speeds differ in the "positioning data currently being executed" and the "positioning data to carry out the next operation", the speed will change over to the speed set in the "positioning data to carry out the next operation" at the end of the "positioning data currently being executed".
- 2) The parameters used in acceleration/deceleration to the command speed set in the "positioning data to carry out the next operation" are those of the positioning data to carry out acceleration/deceleration.
Speed switching will not be carried out if the command speeds are the same.

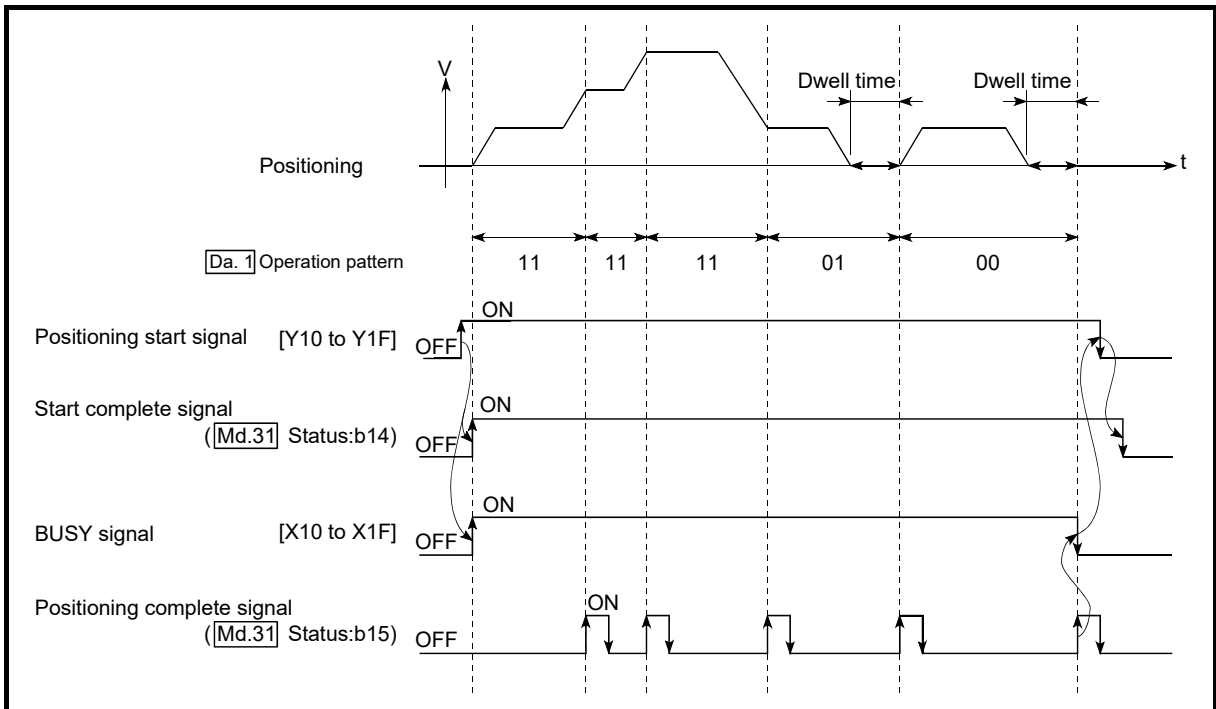

Fig. 9.5 Operation for the front-loading speed switching mode

3) Speed switching condition

If the movement amount is small in regard to the target speed, the current speed may not reach the target speed even if acceleration/deceleration is carried out. In this case, the machine is accelerated/decelerated so that it nears the target speed. If the movement amount will be exceeded when automatic deceleration is required (Ex. Operation patterns "00", "01", etc.), the machine will immediately stop at the designated positioning address, and the warning "Insufficient movement amount" (warning code: 513) will occur.

[When the speed cannot change over to the P2 speed in P1]

For the following relation of the speed
 $P1 = P4, P2 = P3, P1 < P2$

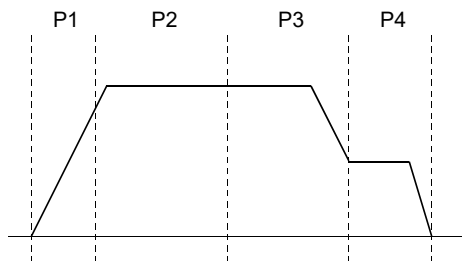

[When the movement amount is small during automatic deceleration]

The movement amount required to carry out the automatic deceleration cannot be secured, so the machine immediately stops in a speed $\neq 0$ status.

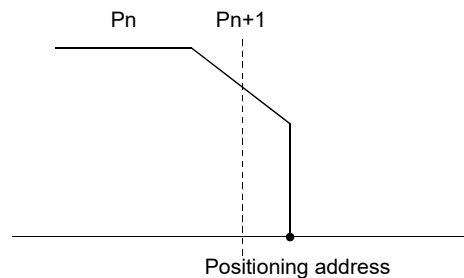

9.1.3 Designating the positioning address

The following shows the two methods for commanding the position in control using positioning data.

■ Absolute system

Positioning is carried out to a designated position (absolute address) having the HP as a reference. This address is regarded as the positioning address. (The start point can be anywhere.)

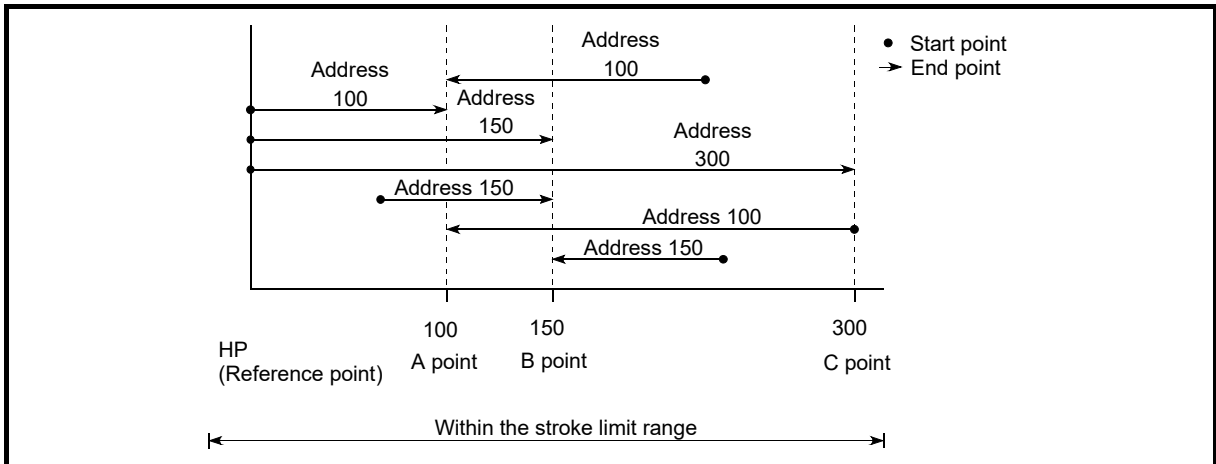

Fig. 9.6 Absolute system positioning

■ Incremental system

The position where the machine is currently stopped is regarded as the start point, and positioning is carried out for a designated movement amount in a designated movement direction.

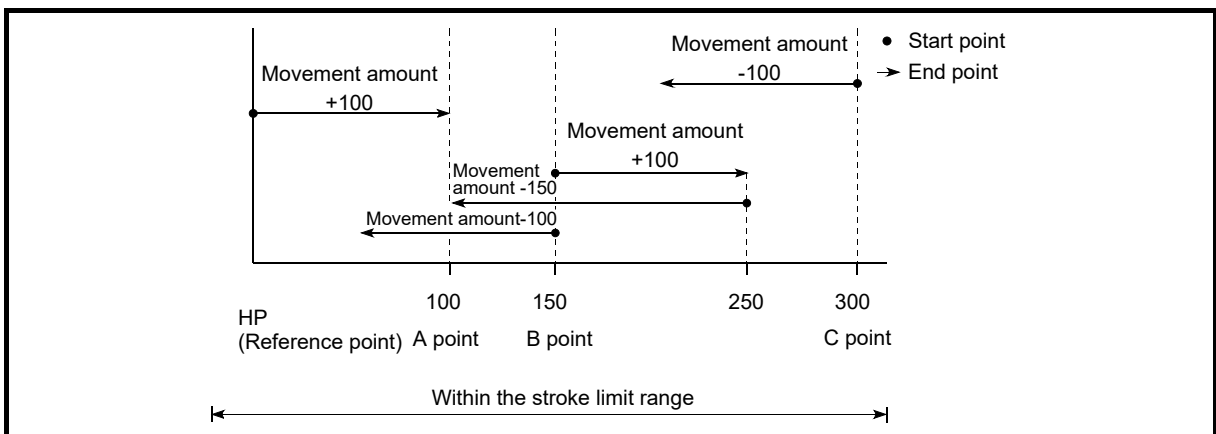

Fig. 9.7 Incremental system positioning

9.1.4 Confirming the current value

■ Values showing the current value

The following two types of addresses are used as values to show the position in the Simple Motion module.

These addresses ("feed current value" and "feed machine value") are stored in the monitor data area, and used in monitoring the current value display, etc.

| | |
|--------------------|--|
| Feed current value | <ul style="list-style-type: none"> • This is the value stored in "[Md.20] Feed current value". • This value has an address established with a "machine HPR" as a reference, but the address can be changed by changing the current value to a new value. |
| Feed machine value | <ul style="list-style-type: none"> • This is the value stored in "[Md.21] Feed machine value". • This value always has an address established with a "machine HPR" as a reference. The address cannot be changed, even if the current value is changed to a new value. |

The "feed current value" and "feed machine value" are used in monitoring the current value display, etc.

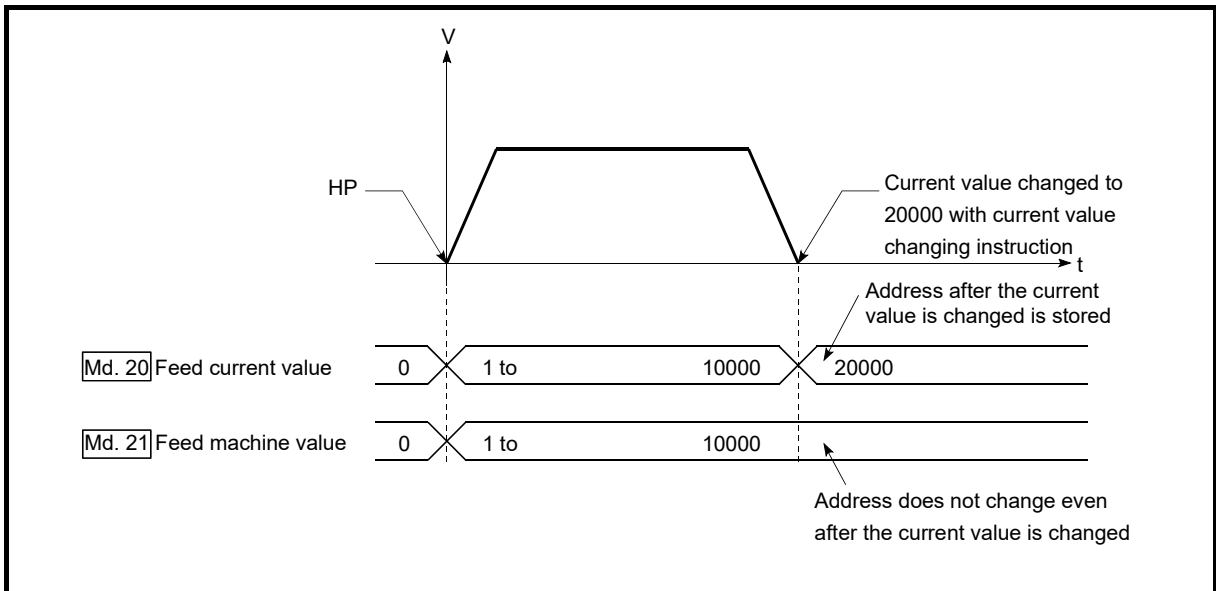

Fig. 9.8 Feed current value and feed machine value

■ Restrictions

- (1) Operation cycle error will occur in the current value refresh cycle when the stored "feed current value" and "feed machine value" are used in the control.

■ Monitoring the current value

The "feed current value" and "feed machine value" are stored in the following buffer memory addresses, and can be read using a "DFRO(P) instruction" or "DMOV(P) instruction" from the PLC CPU.

| | Buffer memory addresses |
|----------------------------|-------------------------|
| [Md.20] Feed current value | 2400+100n 2401+100n |
| [Md.21] Feed machine value | 2402+100n 2403+100n |

(1) The following shows the examples of programs to read out the feed current value of the QD77GF16 [axis 1] to D104 and D105 when X40 is turned ON.

(a) For the DFRO(P) instruction

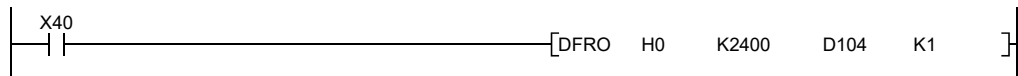

(b) For the DMOV(P) instruction

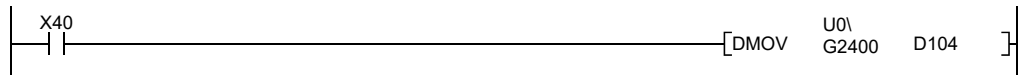

9.1.5 Control unit "degree" handling

When the control unit is set to "degree", the following items differ from when other control units are set.

[1] Feed current value and feed machine value addresses

The address of "[Md.20] Feed current value" becomes a ring address from 0 to 359.99999°. The address of "[Md.21] Feed machine value" will become a cumulative value. (They will not have a ring structure for values between 0 and 359.99999°.) However, "[Md.21] Feed machine value" is restored with cumulating the feed machine value before the power supply OFF (the rounded value within the range of 0 to 359.99999°) to the movement amount during the power supply OFF at the communication start with servo amplifier after the power supply ON or PLC CPU reset.

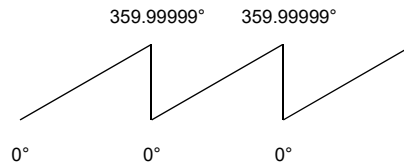

[2] Software stroke limit valid/invalid setting

With the control unit set to "degree", the software stroke limit upper and lower limit values are 0 to 359.99999°.

(a) Setting to validate software stroke limit

To validate the software stroke limit, set the software stroke limit lower limit value and the upper limit value in a clockwise direction.

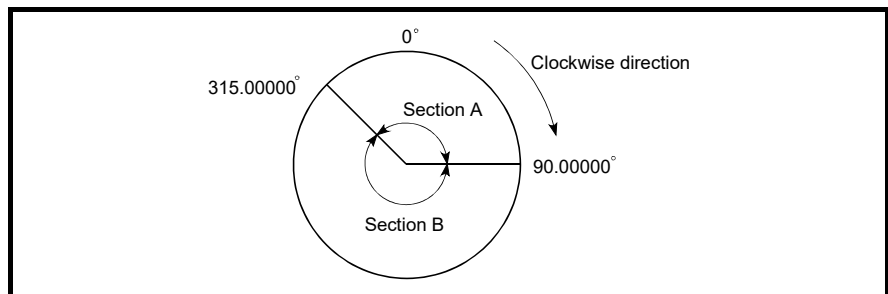

1) To set the movement range A, set as follows.

- Software stroke limit lower limit value.....315.00000°
- Software stroke limit upper limit value90.00000°

2) To set the movement range B, set as follows.

- Software stroke limit lower limit value.....90.00000°
- Software stroke limit upper limit value315.00000°

(b) Setting to invalidate software stroke limit

To invalidate the software stroke limit, set the software stroke limit lower limit value equal to the software stroke limit upper limit value.

The control can be carried out irrespective of the setting of the software stroke limit.

| |
|--|
| POINT |
| <p>(1) When the upper/lower limit value of the axis which set the software stroke limit as valid are changed, perform the machine HPR after that.</p> <p>(2) When the software stroke limit is set as valid in the incremental data system, perform the machine HPR after power supply on.</p> |

[3] Positioning control method when the control unit is set to "degree"

1) Absolute system

(a) When the software stroke limit is invalid

Positioning is carried out in the nearest direction to the designated address, using the current value as a reference.

(This is called "shortcut control".)

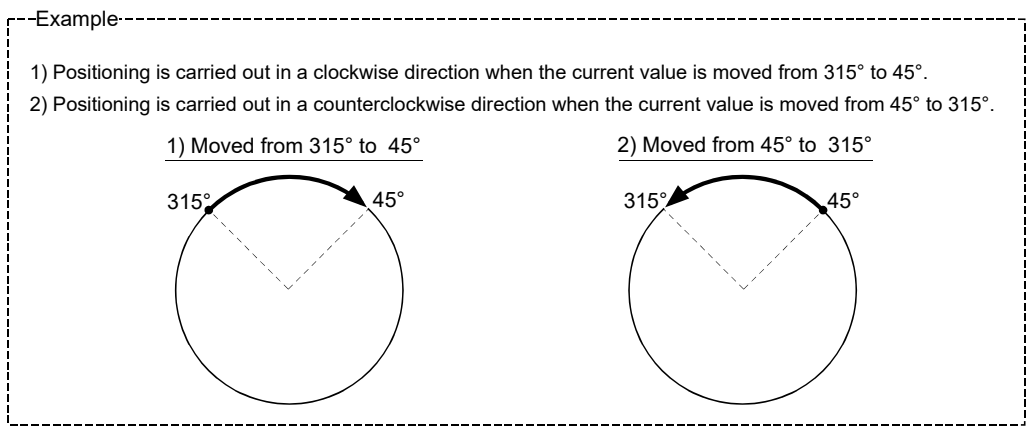

To designate the positioning direction (not carrying out the shortcut control), the shortcut control is invalidated and positioning in a designated direction is carried out by the "[Cd.40] ABS direction in degrees".

This function can perform only when the software stroke limit is invalid. When the software stroke limit is valid, the error "Illegal setting of ABS direction in unit of degree" (error code: 546) occurs and positioning is not started.

To designate the movement direction in the ABS control, a "1" or "2" is written to the "[Cd.40] ABS direction in degrees" of the buffer memory (initial value: 0).

The value written to the "[Cd.40] ABS direction in degrees" becomes valid only when the positioning control is started.

In the continuous positioning control and continuous path control, the operation is continued with the setting set at the time of start even if the setting is changed during the operation.

| Name | Function | Buffer memory address | Initial value |
|----------------------------------|---|-----------------------|---------------|
| [Cd.40] ABS direction in degrees | The ABS movement direction in the unit of degree is designated. 0: Shortcut (direction setting invalid) 1: ABS clockwise 2: ABS counterclockwise | 4350+100n | 0 |

(b) When the software stroke limit is valid

The positioning is carried out in a clockwise/counterclockwise direction depending on the software stroke limit range setting method.

Because of this, positioning with "shortcut control" may not be possible.

Example

When the current value is moved from 0° to 315°, positioning is carried out in the clockwise direction if the software stroke limit lower limit value is 0° and the upper limit value is 345°.

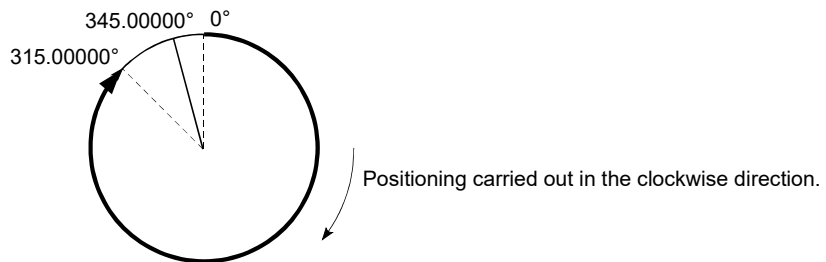

POINT

Positioning addresses are within a range of 0° to 359.99999°.
Use the incremental system to carry out positioning of one rotation or more.

2) Incremental system

Positioning is carried out for a designated movement amount in a designated movement direction when in the incremental system of positioning.

The movement direction is determined by the sign (+, -) of the movement amount.

- For a positive (+) movement directionClockwise
- For a negative (-) movement direction..... Counterclockwise

POINT

Positioning of 360° or more can be carried out with the incremental system.
At this time, set as shown below to invalidate the software stroke limit.

[Software stroke limit upper limit value = Software stroke limit lower limit value]

Set the value within the setting range (0° to 359.99999°).

9.1.6 Interpolation control

■ Meaning of interpolation control

In "2-axis linear interpolation control", "3-axis linear interpolation control", "4-axis linear interpolation control", "2-axis fixed-feed control", "3-axis fixed-feed control", "4-axis fixed-feed control", "2-axis speed control", "3-axis speed control", "4-axis speed control", and "2-axis circular interpolation control", control is carried out so that linear and arc paths are drawn using a motor set in two to four axis directions. This kind of control is called "interpolation control".

In interpolation control, the axis in which the control method is set is defined as the "reference axis", and the other axis is defined as the "interpolation axis".

The Simple Motion module controls the "reference axis" following the positioning data set in the "reference axis", and controls the "interpolation axis" corresponding to the reference axis control so that a linear or arc path is drawn.

The following table shows the reference axis and interpolation axis combinations.

| Axis definition Interpolation of "[Da.2] Control method " | QD77GF | |
|---|--------------------------------------|---|
| | Reference axis | Interpolation axis |
| 2-axis linear interpolation control 2-axis fixed-feed control 2-axis circular interpolation control 2-axis speed control | [QD77GF4] Any of axes 1 to 4 | "Axis to be interpolated No.1" set in reference axis |
| 3-axis linear interpolation control 3-axis fixed-feed control 3-axis speed control | [QD77GF8] Any of axes 1 to 8 | "Axis to be interpolated No.1" and "Axis to be interpolated No.2" set in reference axis |
| 4-axis linear interpolation control 4-axis fixed-feed control 4-axis speed control | [QD77GF16] Any of axes 1 to 16 | "Axis to be interpolated No.1", "Axis to be interpolated No.2" and "Axis to be interpolated No.3" set in reference axis |

■ Setting the positioning data during interpolation control

When carrying out interpolation control, the same positioning data Nos. are set for the "reference axis" and the "interpolation axis".

The following table shows the "positioning data" setting items for the reference axis and interpolation axis.

| Setting item | | Axis | Reference axis setting item | Interpolation axis setting item |
|---------------------------|---------|---|---|---|
| Same positioning data Nos | [Da.1] | Operation pattern | ◎ | — |
| | [Da.2] | Control method | Linear 2, 3, 4, Fixed-feed 2, 3, 4, Circular sub, Circular right, Circular left Forward run speed 2, 3, 4 Reverse run speed 2, 3, 4 | — |
| | [Da.3] | Acceleration time No. | ◎ | — |
| | [Da.4] | Deceleration time No. | ◎ | — |
| | [Da.6] | Positioning address/ movement amount | △ (Forward run speed 2, 3, and 4. Reverse run speed 2, 3, and 4 not required.) | △ (Forward run speed 2, 3, and 4. Reverse run speed 2, 3, and 4 not required.) |
| | [Da.7] | Arc address | △ (Only during circular sub, circular right, and circular left). | △ (Only during circular sub, circular right, and circular left). |
| | [Da.8] | Command speed | ◎ | △ (Only during forward run speed 2, 3, 4 and reverse run speed 2, 3, 4). |
| | [Da.9] | Dwell time/JUMP destination positioning data No. | ○ | — |
| | [Da.10] | M code/Condition data No./Number of LOOP to LEND repetitions | ○ | — |
| | [Da.20] | Axis to be interpolated No.1 | ○ *1 | — |
| | [Da.21] | Axis to be interpolated No.2 | ○ *1 | — |
| | [Da.22] | Axis to be interpolated No.3 | ○ *1 | — |

◎ : Setting always required

○ : Set according to requirements (Set to "—" when not used.)

△ : Setting restrictions exist

— : Setting not required (Use the initial value or a value within the setting range.)

*1: The axis No. is set to axis to be interpolated No.1 for 2-axis linear interpolation, to axis to be interpolated No.1 and No.2 for 3-axis linear interpolation, and to axis to be interpolated No.1 to No.3 for 4-axis linear interpolation.

If the self-axis is set, the error "Illegal interpolation description command" (error code: 521) will occur. The axes that are not used are not required.

(Note): Refer to Section 5.3 "List of positioning data" for information on the setting details.

■ Starting the interpolation control

The positioning data Nos. of the reference axis (axis in which interpolation control was set in "[Da.2] Control method") are started when starting the interpolation control. (Starting of the interpolation axis is not required.)

The following errors or warnings will occur and the positioning will not start if both reference axis and the interpolation axis are started.

- Reference axis : Interpolation while interpolation axis BUSY (error code: 519)
- Interpolation axis : Control method setting error (error code: 524), start during operation (warning code: 100).

■ Interpolation control continuous positioning

When carrying out interpolation control in which "continuous positioning control" and "continuous path control" are designated in the operation pattern, the positioning method for all positioning data from the started positioning data to the positioning data in which "positioning complete" is set must be set to interpolation control.

The number of the interpolation axes and axes to be interpolated cannot be changed from the intermediate positioning data. When the number of the interpolation axes and axes to be interpolated are changed, the error "Control method setting error" (error code: 524) will occur and the positioning will stop.

■ Speed during interpolation control

Either the "composite speed" or "reference axis speed" can be designated as the speed during interpolation control.

([Pr.20] Interpolation speed designation method)

Only the "Reference axis speed" can be designated in the following interpolation control.

When a "composite speed" is set and positioning is started, the error "Interpolation mode error" (error code: 523) occurs, and the system will not start.

- 4-axis linear interpolation
- 2-axis speed control
- 3-axis speed control
- 4-axis speed control

■ Cautions in interpolation control

- (1) If any axis exceeds "[Pr.8] Speed limit value" in the 2- to 4-axes speed control, the axis exceeding the speed limit value is controlled with the speed limit value. The speeds of the other axes being interpolated are suppressed by the command speed ratio.
- (2) If the reference axis exceeds "[Pr.8] Speed limit value" during 2-axis circular interpolation control, the reference axis is controlled at the speed limit value. (The speed limit does not function on the interpolation axis side.)
- (3) If any axis exceeds "[Pr.8] Speed limit value" during 2- to 4-axis linear interpolation control or 2- to 4-axis fixed-feed control, the axis exceeding the speed limit value is controlled with the speed limit value. The speeds of the other axes being interpolated are suppressed by the movement amount ratio.
- (4) In 2- to 4-axis interpolation, you cannot change the combination of interpolated axes midway through operation.

POINT

When the "reference axis speed" is set during interpolation control, set so the major axis side becomes the reference axis. If the minor axis side is set as the reference axis, the major axis side speed may exceed the "[Pr.8] Speed limit value".

■ Limits to interpolation control

There are limits to the interpolation control that can be executed and speed ([Pr.20] Interpolation speed designation method) that can be set, depending on the "[Pr.1] Unit setting" of the reference axis and interpolation axis. (For example, circular interpolation control cannot be executed if the reference axis and interpolation axis units differ.)

The following table shows the interpolation control and speed designation limits.

| "[Da.2] Control method" interpolation control | [Pr.20] Interpolation speed designation method | [Pr.1] Unit setting *1 | |
|--|--|---|---|
| | | Reference axis and interpolation axis units are the same, or a combination of "mm" and "inch". *3 | Reference axis and interpolation axis units differ *3 |
| Linear 2 (ABS, INC) Fixed-feed 2 | Composite speed | ○ | × |
| | Reference axis speed | ○ | ○ |
| Circular sub (ABS, INC) Circular right (ABS, INC) Circular left (ABS, INC) | Composite speed | ○*2 | × |
| | Reference axis speed | × | × |
| Linear 3 (ABS, INC) Fixed-feed 3 | Composite speed | ○ | × |
| | Reference axis speed | ○ | ○ |
| Linear 4 (ABS, INC) Fixed-feed 4 | Composite speed | × | × |
| | Reference axis speed | ○ | ○ |
| 2 to 4-axis speed control | Composite speed | × | × |
| | Reference axis speed | ○ | ○ |

○ : Setting possible, × : Setting not possible.

*1: "mm" and "inch" unit mix possible.

When "mm" and "inch" are mixed, convert as follows for the positioning.

- If interpolation control units are "mm", positioning is controlled by calculating position commands from the address, travel value, positioning speed and electronic gear, which have been converted to "mm" using the formula: inch setting value × 25.4 = mm setting value.
- If interpolation control units are "inch", positioning is controlled by calculating position commands from the address, travel value, positioning speed and electronic gear, which have been converted to "inch" using the formula: mm setting value ÷ 25.4 = inch setting value.

*2: "degree" setting not possible. The error "Circular interpolation not possible" (error code: 535) will occur and the positioning control does not start if circular interpolation control is set when the unit is "degree". The machine will carry out a deceleration stop if "degree" is set during positioning control.

*3: The unit set in the reference axis will be used for the speed unit during control if the units differ or if "mm" and "inch" are combined.

■ Axis operation status during interpolation control

"Interpolation" will be stored in the "[Md.26] Axis operation status" during interpolation control. "Standby" will be stored when the interpolation operation is terminated. Both the reference axis and interpolation axis will carry out a deceleration stop if an error occurs during control, and "Error" will be stored in the operation status.

9.2 Setting the positioning data

9.2.1 Relation between each control and positioning data

The setting requirements and details for the setting items of the positioning data to be set differ according to the "[Da.2] Control method".

The following table shows the positioning data setting items corresponding to the different types of control. Details and settings for the operation of each control are shown in Section 9.2.2 and subsequent sections.

(In this section, it is assumed that the positioning data setting is carried out using GX Works2.)

| Major positioning control | | | Position control | | | Speed control |
|--------------------------------|--|--|--|--|--|--|
| Positioning data setting items | | | 1-axis linear control | 1-axis fixed-feed control 2-axis fixed-feed control 3-axis fixed-feed control 4-axis fixed-feed control | 2-axis circular interpolation control | 1-axis, 2-axis, 3-axis, 4-axis Speed control |
| | | | 2-axis linear interpolation control | | | |
| | | | 3-axis linear interpolation control | | | |
| | | | 4-axis linear interpolation control | | | |
| [Da.1] | Operation pattern | Independent positioning control (Positioning complete) | ◎ | ◎ | ◎ | ◎ |
| | | Continuous positioning control | ◎ | ◎ | ◎ | × |
| | | Continuous path control | ◎ | × | ◎ | × |
| [Da.2] | Control method | Linear 1 Linear 2 Linear 3 Linear 4 * | Fixed-feed 1 Fixed-feed 2 Fixed-feed 3 Fixed-feed 4 | Circular sub Circular right Circular left * | Forward run speed 1 Reverse run speed 1 Forward run speed 2 Reverse run speed 2 Forward run speed 3 Reverse run speed 3 Forward run speed 4 Reverse run speed 4 | |
| [Da.3] | Acceleration time No. | ◎ | ◎ | ◎ | ◎ | |
| [Da.4] | Deceleration time No. | ◎ | ◎ | ◎ | ◎ | |
| [Da.6] | Positioning address/movement amount | ◎ | ◎ | ◎ | — | |
| [Da.7] | Arc address | — | — | ◎ | — | |
| [Da.8] | Command speed | ◎ | ◎ | ◎ | ◎ | |
| [Da.9] | Dwell time/JUMP destination positioning data No. | ○ | ○ | ○ | — | |
| [Da.10] | M code/Condition data No./Number of LOOP to LEND repetitions | ○ | ○ | ○ | ○ | |
| [Da.20] | Axis to be interpolated No.1 | ◎: 2, 3, 4-axis -: 1-axis | | | | |
| [Da.21] | Axis to be interpolated No.2 | ◎: 3, 4-axis -: 1, 2-axis | | | | |
| [Da.22] | Axis to be interpolated No.3 | ◎: 4-axis -: 1, 2, 3-axis | | | | |

| | Speed-position switching control | Position- speed switching control | Other control | | | | |
|--|--|--|-----------------|----------------------------|---------------------------------------|-----------------------------------|------|
| | | | NOP instruction | Current value changing | JUMP instruction | LOOP | LEND |
| | ◎ | ◎ | - | ◎ | - | - | - |
| | ◎ | × | - | ◎ | - | - | - |
| | × | × | - | × | - | - | - |
| | Forward run speed/position Reverse run speed/position * | Forward run position/speed Reverse run position/speed | NOP | Current value changing | JUMP instruction | LOOP | LEND |
| | ◎ | ◎ | - | - | - | - | - |
| | ◎ | ◎ | - | - | - | - | - |
| | ◎ | ◎ | - | Change destination address | - | - | - |
| | - | - | - | - | - | - | - |
| | ◎ | ◎ | - | - | - | - | - |
| | ○ | ○ | - | - | JUMP destination-positioning data No. | - | - |
| | ○ | ○ | - | ○ | Condition data No. at JUMP | Number of LOOP to LEND repetition | - |
| | - | - | - | - | - | - | - |
| | - | - | - | - | - | - | - |
| | - | - | - | - | - | - | - |

◎ : Always set

○ : Set according to requirements ("-" when not set)

× : Setting not possible (If setting is made, the error "Continuous path control not possible" (error code: 516) will occur at a start.)

- : Setting not required (Use the initial values or setting values within a range.)

* : The "ABS (absolute) system" or "INC (incremental) system" can be used for the control system.

REMARK

- It is recommended that the "positioning data" be set whenever possible with GX Works2. Execution by sequence program uses many sequence programs and devices. The execution becomes complicated, and the scan times will increase.

9.2.2 1-axis linear control

In "1-axis linear control" ("[Da.2] Control method" = ABS linear 1, INC linear 1), one motor is used to carry out position control in a set axis direction.

[1] 1-axis linear control (ABS linear 1)

■ Operation chart

In absolute system 1-axis linear control, positioning is carried out from the current stop position (start point address) to the address (end point address) set in "[Da.6] Positioning address/movement amount".

Example

When the start point address (current stop position) is 1000, and the end point address (positioning address) is 8000, positioning is carried out in the positive direction for a movement amount of 7000 (8000-1000).

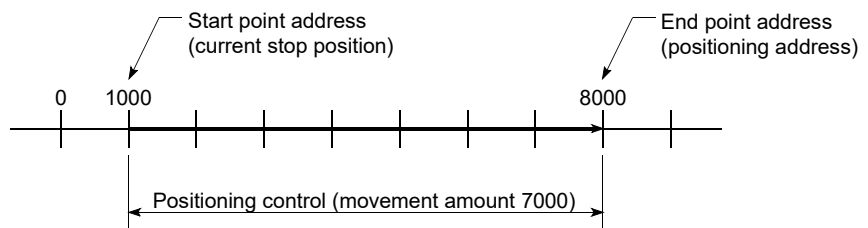

■ Positioning data setting example

[When "1-axis linear control (ABS linear 1)" is set in positioning data No. 1 of axis 1.]

| Setting item | | Setting example | Setting details |
|-------------------------------|---|----------------------|---|
| Axis 1 Positioning data No. 1 | [Da.1] Operation pattern | Positioning complete | Set "Positioning complete" assuming the next positioning data will not be executed. |
| | [Da.2] Control method | ABS linear 1 | Set absolute system 1-axis linear control. |
| | [Da.3] Acceleration time No. | 1 | Designate the value set in "[Pr.25] Acceleration time 1" as the acceleration time at start. |
| | [Da.4] Deceleration time No. | 0 | Designate the value set in "[Pr.10] Deceleration time 0" as the deceleration time at deceleration. |
| | [Da.6] Positioning address/ movement amount | 8000.0μm | Set the positioning address. (Assuming "mm" is set in "[Pr.1] Unit setting".) |
| | [Da.7] Arc address | – | Setting not required (setting value is ignored). |
| | [Da.8] Command speed | 6000.00mm/min | Set the speed during movement to the positioning address. |
| | [Da.9] Dwell time/JUMP destination positioning data No. | 500ms | Set the time the machine dwells after the positioning stop (command stop) to the output of the positioning complete signal. |
| | [Da.10] M code/Condition data No./Number of LOOP to LEND repetitions | 10 | Set this when other sub operation commands are issued in combination with the No.1 positioning data. |
| | [Da.20] Axis to be interpolated No.1 | – | Setting not required (setting value is ignored). |
| | [Da.21] Axis to be interpolated No.2 | – | |
| | [Da.22] Axis to be interpolated No.3 | – | |

(Note): Refer to Section 5.3 "List of positioning data" for information on the setting details.

[2] 1-axis linear control (INC linear 1)

■ Operation chart

In incremental system 1-axis linear control, positioning is carried out from the current stop position (start point address) to a position at the end of the movement amount set in "[Da.6] Positioning address/movement amount". The movement direction is determined by the sign of the movement amount.

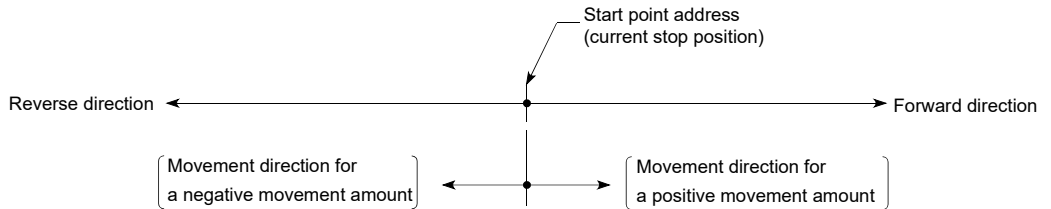

-Example-

When the start point address is 5000, and the movement amount is -7000, positioning is carried out to the -2000 position.

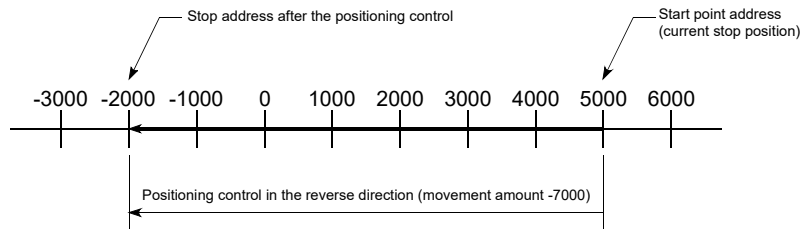

■ Positioning data setting example

[When "1-axis linear control (INC linear 1)" is set in positioning data No. 1 of axis 1]

| Setting item | | Setting example | Setting details | |
|-------------------------------|---------|---|----------------------|---|
| Axis 1 Positioning data No. 1 | [Da.1] | Operation pattern | Positioning complete | Set "Positioning complete" assuming the next positioning data will not be executed. |
| | [Da.2] | Control method | INC linear 1 | Set incremental system 1-axis linear control. |
| | [Da.3] | Acceleration time No. | 1 | Designate the value set in "[Pr.25] Acceleration time 1" as the acceleration time at start. |
| | [Da.4] | Deceleration time No. | 0 | Designate the value set in "[Pr.10] Deceleration time 0" as the deceleration time at deceleration. |
| | [Da.6] | Positioning address/ movement amount | -7000.0μm | Set the movement amount. (Assuming "mm" is set in "[Pr.1] Unit setting".) |
| | [Da.7] | Arc address | – | Setting not required (setting value is ignored). |
| | [Da.8] | Command speed | 6000.00mm/min | Set the speed during movement. |
| | [Da.9] | Dwell time/JUMP destination positioning data No. | 500ms | Set the time the machine dwells after the positioning stop (command stop) to the output of the positioning complete signal. |
| | [Da.10] | M code/Condition data No./Number of LOOP to LEND repetitions | 10 | Set this when other sub operation commands are issued in combination with the No.1 positioning data. |
| | [Da.20] | Axis to be interpolated No.1 | – | Setting not required (setting value is ignored). |
| | [Da.21] | Axis to be interpolated No.2 | – | |
| | [Da.22] | Axis to be interpolated No.3 | – | |

(Note): Refer to Section 5.3 "List of positioning data" for information on the setting details.

9.2.3 2-axis linear interpolation control

In "2-axis linear interpolation control" ("[Da.2] Control method" = ABS linear 2, INC linear 2), two motors are used to carry out position control in a linear path while carrying out interpolation for the axis directions set in each axis.

(Refer to Section 9.1.6 "Interpolation control" for details on interpolation control.)

[1] 2-axis linear interpolation control (ABS linear 2)

■ Operation chart

In absolute system 2-axis linear interpolation control, the designated 2 axes are used. Linear interpolation positioning is carried out from the current stop position (start point address) to the address (end point address) set in "[Da.6] Positioning address/movement amount".

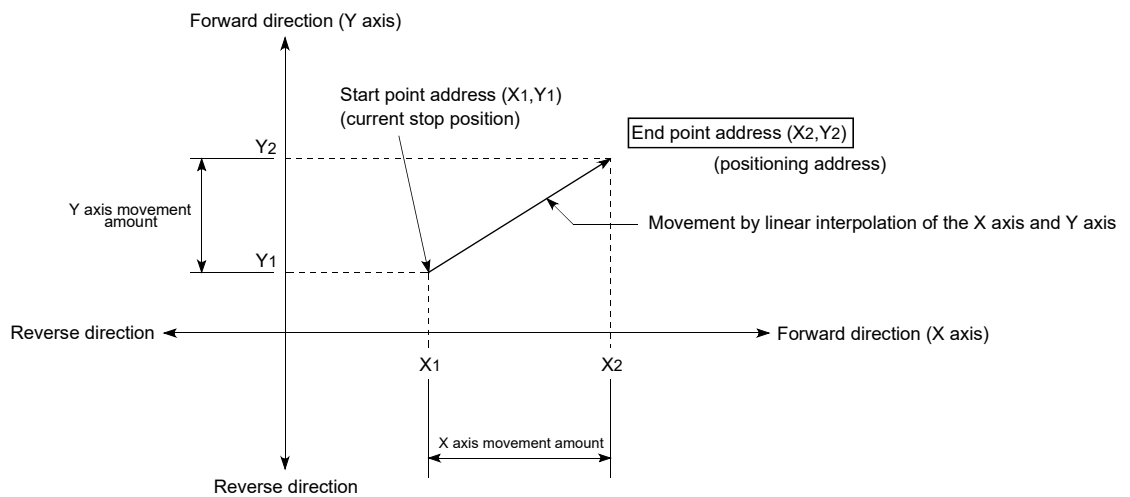

Example

When the start point address (current stop position) is (1000, 1000) and the end point address (positioning address) is (10000, 4000), positioning is carried out as follows.

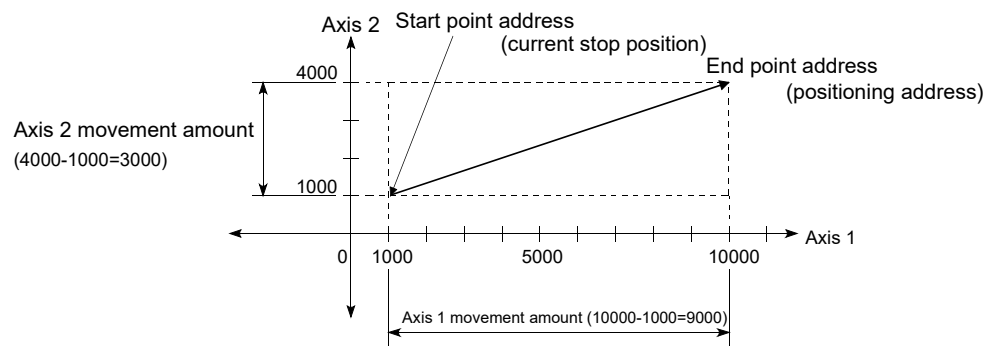

■ Restrictions

An error will occur and the positioning will not start in the following cases. The machine will immediately stop if the error is detected during a positioning control.

- If the movement amount of each axis exceeds "1073741824 (=2³⁰)" when "0: Composite speed" is set in "[Pr.20] Interpolation speed designation method" The error "Outside linear movement amount range" (error code: 504) occurs at a positioning start.
(The maximum movement amount that can be set in "[Da.6] Positioning address/movement amount" is "1073741824 (=2³⁰)".)

■ Positioning data setting example

[When "2-axis linear interpolation control (ABS linear 2)" is set in positioning data No. 1 of axis 1]

- Reference axis Axis 1
- Interpolation axis Axis 2 (The required values are also set in positioning data No. 1 of axis 2.)

| Setting item | Axis | Setting example | | Setting details |
|--|------|----------------------------|--------------------------------|---|
| | | Axis 1 (reference axis) | Axis 2 (interpolation axis) | |
| [Da.1] Operation pattern | | Positioning complete | — | Set "Positioning complete" assuming the next positioning data will not be executed. |
| [Da.2] Control method | | ABS linear 2 | — | Set absolute system 2-axis linear interpolation control. |
| [Da.3] Acceleration time No. | | 1 | — | Designate the value set in "[Pr.25] Acceleration time 1" as the acceleration time at start. |
| [Da.4] Deceleration time No. | | 0 | — | Designate the value set in "[Pr.10] Deceleration time 0" as the deceleration time at deceleration. |
| [Da.6] Positioning address/movement amount | | 10000.0 μm | 4000.0 μm | Set the end point address. (Assuming "mm" is set in "[Pr.1] Unit setting".) |
| [Da.7] Arc address | | — | — | Setting not required (setting value is ignored). |
| [Da.8] Command speed | | 6000.00 mm/min | — | Set the speed during movement to the end point address. |
| [Da.9] Dwell time/JUMP destination positioning data No. | | 500ms | — | Set the time the machine dwells after the positioning stop (command stop) to the output of the positioning complete signal. |
| [Da.10] M code/Condition data No./Number of LOOP to LEND repetitions | | 10 | — | Set this when other sub operation commands are issued in combination with the No.1 positioning data. |
| [Da.20] Axis to be interpolated No.1 | | Axis 2 | — | Set the axis to be interpolated. If the self-axis is set, an error will occur. |
| [Da.21] Axis to be interpolated No.2 | | — | — | Setting not required (setting value is ignored). |
| [Da.22] Axis to be interpolated No.3 | | — | — | |

(Note): Refer to Section 5.3 "List of positioning data" for information on the setting details.

POINT

- When the "reference axis speed" is set during 2-axis linear interpolation control, set so the major axis side becomes the reference axis. If the minor axis side is set as the reference axis, the major axis side speed may exceed the "[Pr.8] Speed limit value".

[2] 2-axis linear interpolation control (INC linear 2)

■ Operation chart

In incremental system 2-axis linear interpolation control, the designated 2 axes are used. Linear interpolation positioning is carried out from the current stop position (start point address) to a position at the end of the movement amount set in "[Da.6] Positioning address/movement amount". The movement direction is determined by the sign of the movement amount.

- Positive movement amount Positioning control to forward direction (Address increase direction)
- Negative movement amount..... Positioning control to reverse direction (Address decrease direction)

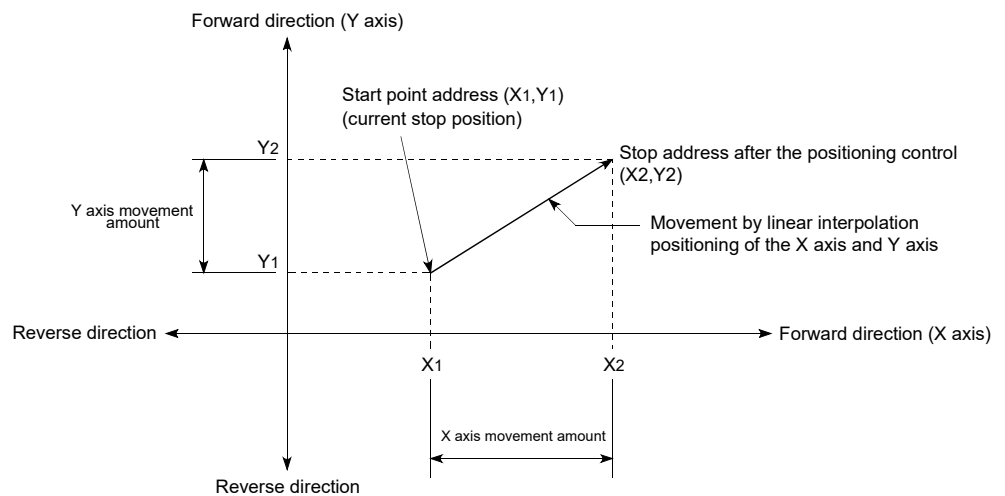

Example

When the axis 1 movement amount is 9000 and the axis 2 movement amount is -3000, positioning address (10000, 4000) is carried out as follows.

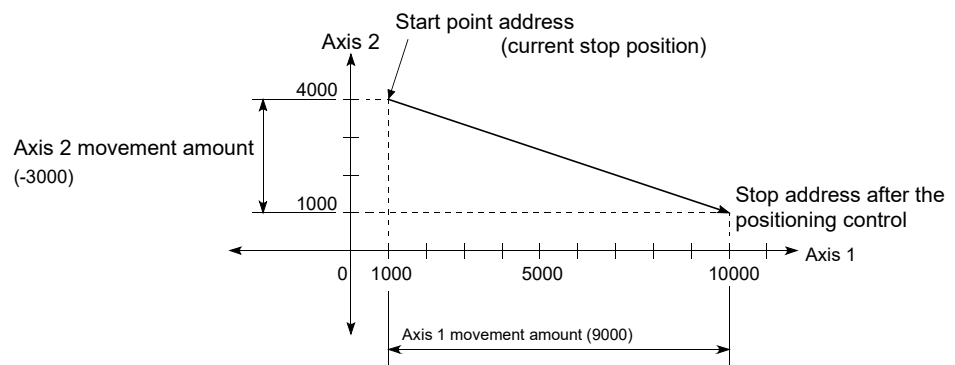

■ Restrictions

An error will occur and the positioning will not start in the following cases. The machine will immediately stop if the error is detected during a positioning operation.

- If the movement amount of each axis exceeds "1073741824 (=2³⁰)" when "0: Composite speed" is set in "[Pr.20] Interpolation speed designation method" The error "Outside linear movement amount range" (error code: 504) occurs at a positioning start.
(The maximum movement amount that can be set in "[Da.6] Positioning address/movement amount" is "1073741824 (=2³⁰).")

■ Positioning data setting example

[When "2-axis linear interpolation control (INC linear 2)" is set in positioning data No. 1 of axis 1]

- Reference axis Axis 1
- Interpolation axis Axis 2 (The required values are also set in positioning data No. 1 of axis 2.)

| Setting item | Axis | Setting example | | Setting details |
|-------------------------------|--|----------------------------|--------------------------------|---|
| | | Axis 1 (reference axis) | Axis 2 (interpolation axis) | |
| Axis 1 Positioning data No. 1 | [Da.1] Operation pattern | Positioning complete | - | Set "Positioning complete" assuming the next positioning data will not be executed. |
| | [Da.2] Control method | INC linear 2 | - | Set incremental system 2-axis linear interpolation control. |
| | [Da.3] Acceleration time No. | 1 | - | Designate the value set in "[Pr.25] Acceleration time 1" as the acceleration time at start. |
| | [Da.4] Deceleration time No. | 0 | - | Designate the value set in "[Pr.10] Deceleration time 0" as the deceleration time at deceleration. |
| | [Da.6] Positioning address/movement amount | 9000.0 μm | -3000.0 μm | Set the movement amount. (Assuming "mm" is set in "[Pr.1] Unit setting".) |
| | [Da.7] Arc address | - | - | Setting not required (setting value is ignored). |
| | [Da.8] Command speed | 6000.00 mm/min | - | Set the speed during movement. |
| | [Da.9] Dwell time/JUMP destination positioning data No. | 500ms | - | Set the time the machine dwells after the positioning stop (command stop) to the output of the positioning complete signal. |
| | [Da.10] M code/Condition data No./Number of LOOP to LEND repetitions | 10 | - | Set this when other sub operation commands are issued in combination with the No.1 positioning data. |
| | [Da.20] Axis to be interpolated No.1 | Axis 2 | - | Set the axis to be interpolated. If the self-axis is set, an error will occur. |
| | [Da.21] Axis to be interpolated No.2 | - | - | Setting not required (setting value is ignored). |
| | [Da.22] Axis to be interpolated No.3 | - | - | |

(Note): Refer to Section 5.3 "List of positioning data" for information on the setting details.

POINT

- When the "reference axis speed" is set during 2-axis linear interpolation control, set so the major axis side becomes the reference axis. If the minor axis side is set as the reference axis, the major axis side speed may exceed the "[Pr.8] Speed limit value".

9.2.4 3-axis linear interpolation control

In "3-axis linear interpolation control" ("[Da.2] Control method" = ABS linear 3, INC linear 3), three motors are used to carry out position control in a linear path while carrying out interpolation for the axis directions set in each axis.

(Refer to Section 9.1.6 "Interpolation control" for details on interpolation control.)

[1] 3-axis linear interpolation control (ABS linear 3)

■ Operation chart

In the absolute system 3-axis linear interpolation control, the designated 3 axes are used. Linear interpolation positioning is carried out from the current stop position (start point address) to the address (end point address) set in the "[Da.6] Positioning address/movement amount".

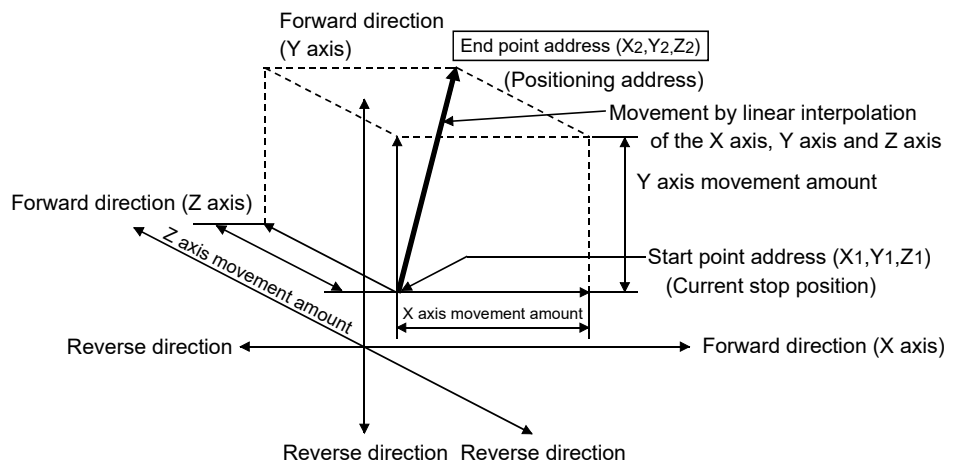

Example

When the start point address (current stop position) is (1000, 2000, 1000) and the end point address (positioning address) is (4000, 8000, 4000), positioning is carried out as follows.

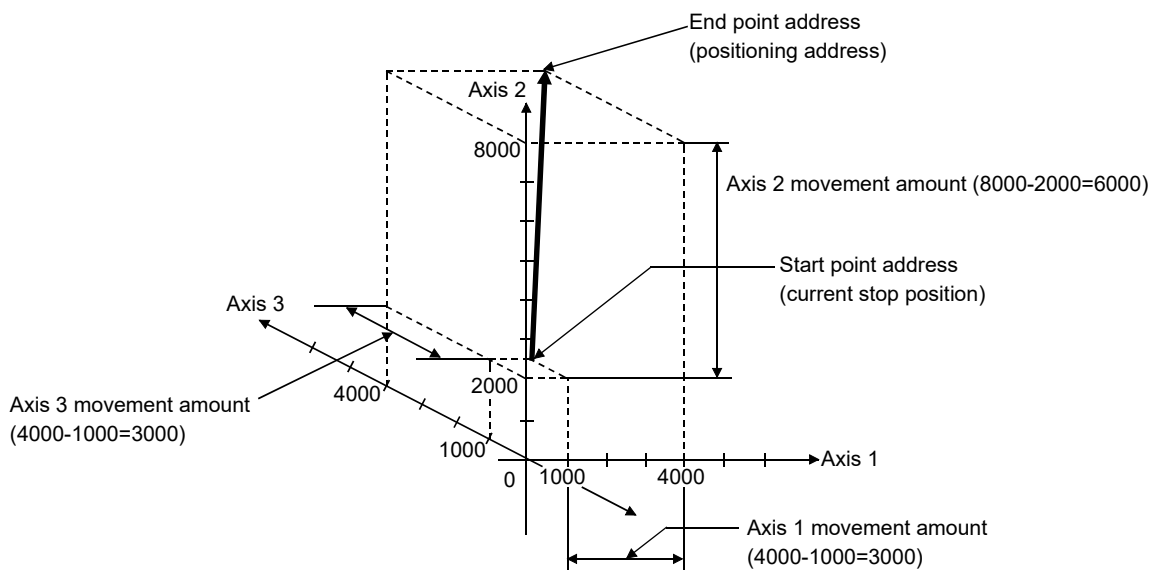

■ Restrictions

An error will occur and the positioning will not start in the following cases. The machine will immediately stop if the error is detected during a positioning control.

- If the movement amount of each axis exceeds "1073741824 (=2³⁰)" when "0: Composite speed" is set in "[Pr.20] Interpolation speed designation method" The error "Outside linear movement amount range" (error code: 504) occurs at a positioning start.
(The maximum movement amount that can be set in "[Da.6] Positioning address/movement amount" is "1073741824 (=2³⁰).")

■ Positioning data setting example

[When "3-axis linear interpolation control (ABS linear 3)" is set in positioning data No. 1 of axis 1]

- Reference axis Axis 1
- Interpolation axis Axis 2, Axis3 (The required values are also set in positioning data No. 1 of axis 2 and axis 3.)

| Setting item | | Axis | Setting example | | | Setting details |
|-------------------------------|---------|--|-------------------------|-----------------------------|-----------------------------|---|
| | | | Axis 1 (reference axis) | Axis 2 (interpolation axis) | Axis 3 (interpolation axis) | |
| Axis 1 Positioning data No. 1 | [Da.1] | Operation pattern | Positioning complete | - | - | Set "Positioning complete" assuming the next positioning data will not be executed. |
| | [Da.2] | Control method | ABS linear 3 | - | - | Set absolute system 3-axis linear interpolation control. |
| | [Da.3] | Acceleration time No. | 1 | - | - | Designate the value set in "[Pr.25] Acceleration time 1" as the acceleration time at start. |
| | [Da.4] | Deceleration time No. | 0 | - | - | Designate the value set in "[Pr.10] Deceleration time 0" as the deceleration time at deceleration. |
| | [Da.6] | Positioning address/movement amount | 4000.0 μm | 8000.0 μm | 4000.0 μm | Set the end point address. (Assuming "mm" is set in "[Pr.1] Unit setting".) |
| | [Da.7] | Arc address | - | - | - | Setting not required (setting value is ignored). |
| | [Da.8] | Command speed | 6000.00 mm/min | - | - | Set the speed during movement to the end point address. |
| | [Da.9] | Dwell time/JUMP destination positioning data No. | 500ms | - | - | Set the time the machine dwells after the positioning stop (command stop) to the output of the positioning complete signal. |
| | [Da.10] | M code/Condition data No./Number of LOOP to LEND repetitions | 10 | - | - | Set this when other sub operation commands are issued in combination with the No. 1 positioning data. |
| | [Da.20] | Axis to be interpolated No.1 | Axis 2 | - | - | Set the axis to be interpolated. If the self-axis is set, an error will occur. |
| | [Da.21] | Axis to be interpolated No.2 | Axis 3 | - | - | |
| | [Da.22] | Axis to be interpolated No.3 | - | - | - | Setting not required (setting value is ignored). |

(Note): Refer to Section 5.3 "List of positioning data" for information on the setting details.

POINTS

- When the "reference axis speed" is set during 3-axis linear interpolation control, set so the major axis side becomes the reference axis. If the minor axis side is set as the reference axis, the major axis side speed may exceed the "[Pr.8] Speed limit value".
- Refer to Section 9.1.6 "Interpolation control" for the reference axis and interpolation axis combinations.

[2] 3-axis linear interpolation control (INC linear 3)

■ Operation chart

In the incremental system 3-axis linear interpolation control, the designated 3 axes are used. Linear interpolation positioning is carried out from the current stop position (start point address) to a position at the end of the movement amount set in the "[Da.6] Positioning address/movement amount". The movement direction is determined the sign of the movement amount.

- Positive movement amount Positioning control to forward direction (Address increase direction)
- Negative movement amount..... Positioning control to reverse direction (Address decrease direction)

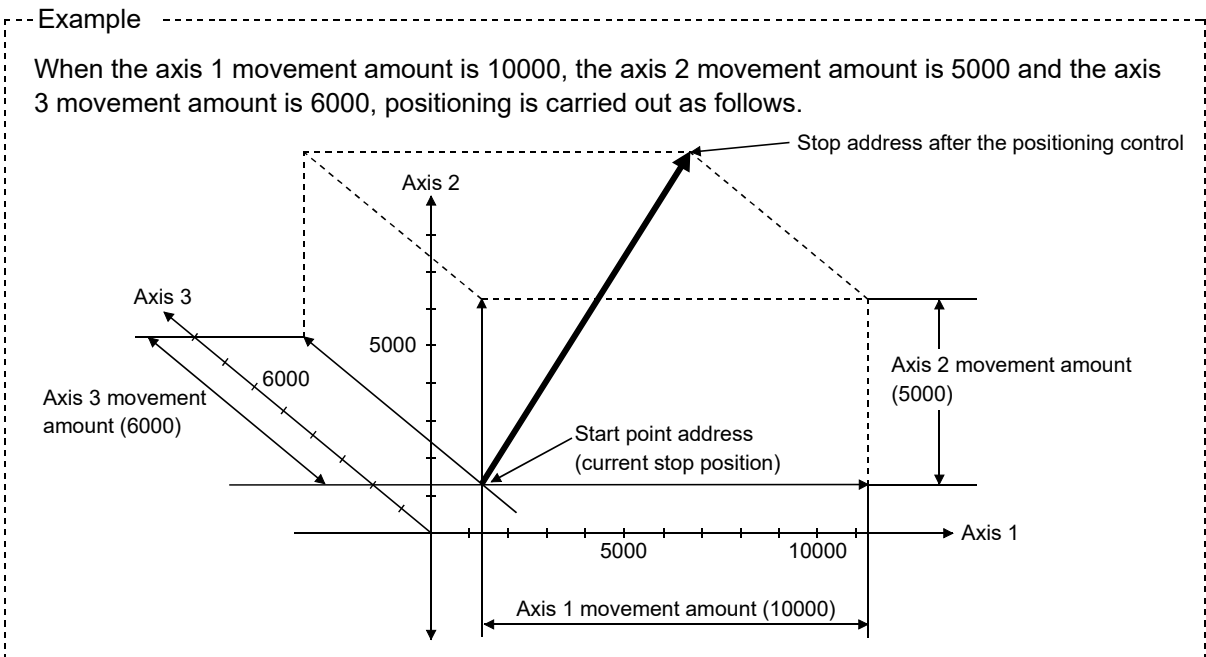
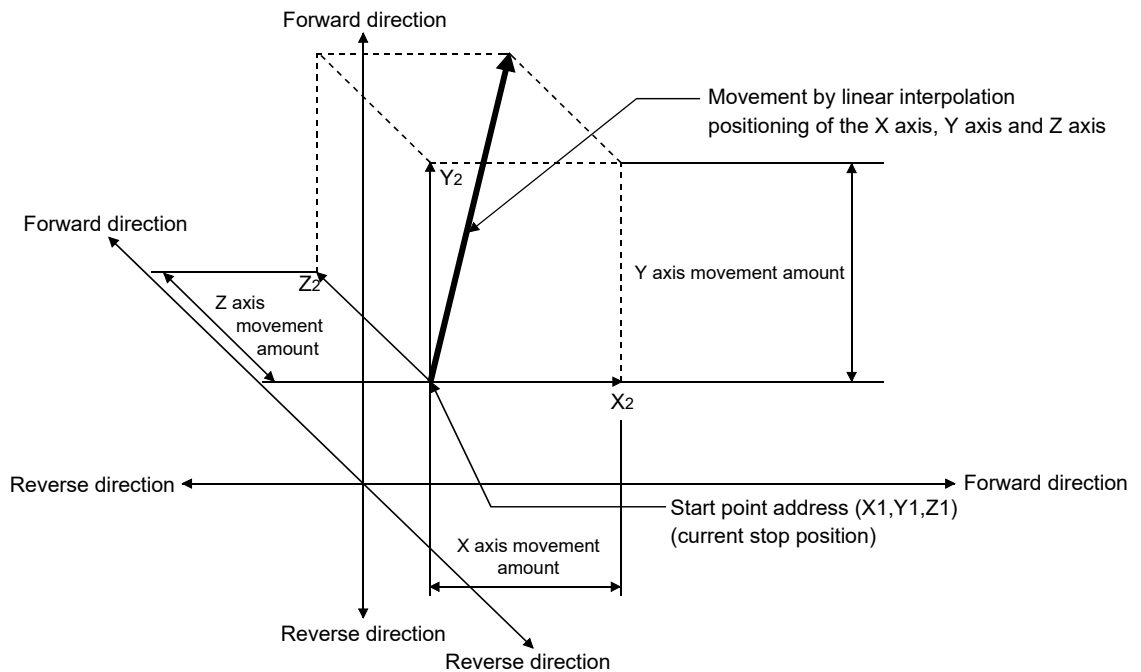

■ Restrictions

An error will occur and the positioning will not start in the following cases. The machine will immediately stop if the error is detected during a positioning operation.

- If the movement amount of each axis exceeds "1073741824 (=2³⁰)" when "0: Composite speed" is set in "[Pr.20] Interpolation speed designation method" The error "Outside linear movement amount range" (error code: 504) occurs at a positioning start.
(The maximum movement amount that can be set in "[Da.6] Positioning address/movement amount" is "1073741824 (=2³⁰).")

■ Positioning data setting example

[When "3-axis linear interpolation control (INC linear 3)" is set in positioning data No. 1 of axis 1]

- Reference axis..... Axis 1
- Interpolation axis Axis 2, Axis3 (The required values are also set in positioning data No. 1 of axis 2 and axis 3.)

| Setting item | | Setting example | | | Setting details |
|-------------------------------|--|----------------------------|--------------------------------|--------------------------------|---|
| | | Axis 1 (reference axis) | Axis 2 (interpolation axis) | Axis 3 (interpolation axis) | |
| Axis 1 Positioning data No. 1 | [Da.1] Operation pattern | Positioning complete | - | - | Set "Positioning complete" assuming the next positioning data will not be executed. |
| | [Da.2] Control method | INC linear 3 | - | - | Set incremental system 3-axis linear interpolation control. |
| | [Da.3] Acceleration time No. | 1 | - | - | Designate the value set in "[Pr.25] Acceleration time 1" as the acceleration time at start. |
| | [Da.4] Deceleration time No. | 0 | - | - | Designate the value set in "[Pr.10] Deceleration time 0" as the deceleration time at deceleration. |
| | [Da.6] Positioning address/movement amount | 10000.0 μm | 5000.0 μm | 6000.0 μm | Set the movement amount. (Assuming "mm" is set in "[Pr.1] Unit setting".) |
| | [Da.7] Arc address | - | - | - | Setting not required (setting value is ignored). |
| | [Da.8] Command speed | 6000.00 mm/min | - | - | Set the speed during movement to the end point address. |
| | [Da.9] Dwell time/JUMP destination positioning data No. | 500ms | - | - | Set the time the machine dwells after the positioning stop (command stop) to the output of the positioning complete signal. |
| | [Da.10] M code/Condition data No./Number of LOOP to LEND repetitions | 10 | - | - | Set this when other sub operation commands are issued in combination with the No. 1 positioning data. |
| | [Da.20] Axis to be interpolated No.1 | Axis 2 | - | - | Set the axis to be interpolated. |
| | [Da.21] Axis to be interpolated No.2 | Axis 3 | - | - | If the self-axis is set, an error will occur. |
| | [Da.22] Axis to be interpolated No.3 | - | - | - | Setting not required (setting value is ignored). |

(Note): Refer to Section 5.3 "List of positioning data" for information on the setting details.

POINTS

- When the "reference axis speed" is set during 3-axis linear interpolation control, set so the major axis side becomes the reference axis. If the minor axis side is set as the reference axis, the major axis side speed may exceed the "[Pr.8] Speed limit value".
- Refer to Section 9.1.6 "Interpolation control" for the reference axis and interpolation axis combinations.

9.2.5 4-axis linear interpolation control

In "4-axis linear interpolation control" ("[Da.2] Control method" = ABS linear 4, INC linear 4), four motors are used to carry out position control in a linear path while carrying out interpolation for the axis directions set in each axis.

(Refer to Section 9.1.6 "Interpolation control" for details on interpolation control.)

[1] 4-axis linear interpolation control (ABS linear 4)

In the absolute system 4-axis linear interpolation control, the designated 4 axes are used. Linear interpolation positioning is carried out from the current stop position (start point address) to the address (end point address) set in the "[Da.6] Positioning address/movement amount".

■ Positioning data setting example

[When "4-axis linear interpolation control (ABS linear 4)" is set in positioning data No. 1 of axis 1]

- Reference axis..... Axis 1
- Interpolation axis Axis 2, Axis3, Axis4 (The required values are also set in positioning data No. 1 of axis 2, axis 3 and axis 4.)

| Setting item | | Axis | Setting example | | | | Setting details |
|-------------------------------|--|----------------------|----------------------------|--------------------------------|--------------------------------|---|-----------------|
| | | | Axis 1 (reference axis) | Axis 2 (interpolation axis) | Axis 3 (interpolation axis) | Axis 4 (interpolation axis) | |
| Axis 1 Positioning data No. 1 | [Da.1] Operation pattern | Positioning complete | - | - | - | Set "Positioning complete" assuming the next positioning data will not be executed. | |
| | [Da.2] Control method | ABS linear 4 | - | - | - | Set absolute system 4-axis linear interpolation control. | |
| | [Da.3] Acceleration time No. | 1 | - | - | - | Designate the value set in "[Pr.25] Acceleration time 1" as the acceleration time at start. | |
| | [Da.4] Deceleration time No. | 0 | - | - | - | Designate the value set in "[Pr.10] Deceleration time 0" as the deceleration time at deceleration. | |
| | [Da.6] Positioning address/movement amount | 4000.0 μm | 8000.0 μm | 4000.0 μm | 3000.0 μm | Set the end point address. (Assuming "mm" is set in "[Pr.1] Unit setting".) | |
| | [Da.7] Arc address | - | - | - | - | Setting not required (setting value is ignored). | |
| | [Da.8] Command speed | 6000.00 mm/min | - | - | - | Set the speed during movement to the end point address. | |
| | [Da.9] Dwell time/JUMP destination positioning data No. | 500ms | - | - | - | Set the time the machine dwells after the positioning stop (command stop) to the output of the positioning complete signal. | |
| | [Da.10] M code/Condition data No./Number of LOOP to LEND repetitions | 10 | - | - | - | Set this when other sub operation commands are issued in combination with the No. 1 positioning data. | |
| | [Da.20] Axis to be interpolated No.1 | Axis 2 | - | - | - | Set the axis to be interpolated. If the self-axis is set, an error will occur. | |
| | [Da.21] Axis to be interpolated No.2 | Axis 3 | - | - | - | | |
| | [Da.22] Axis to be interpolated No.3 | Axis 4 | - | - | - | | |

(Note): Refer to Section 5.3 "List of positioning data" for information on the setting details.

POINTS

- When the "reference axis speed" is set during 4-axis linear interpolation control, set so the major axis side becomes the reference axis. If the minor axis side is set as the reference axis, the major axis side speed may exceed the "[Pr.8] Speed limit value".
- Refer to Section 9.1.6 "Interpolation control" for the reference axis and interpolation axis combinations.

[2] 4-axis linear interpolation control (INC linear 4)

In the incremental system 4-axis linear interpolation control, the designated 4 axes are used. Linear interpolation positioning is carried out from the current stop position (start point address) to a position at the end of the movement amount set in the "[Da.6] Positioning address/movement amount". The movement direction is determined by the sign of the movement amount.

■ Restrictions

An error will occur and the positioning will not start in the following cases. The machine will immediately stop if the error is detected during a positioning operation.

- When the movement amount for each axis exceeds "1073741824 (=2³⁰)"
The error "Outside linear movement amount range" (error code: 504) will occur at the positioning start.
(The maximum movement amount that can be set in "[Da.6] Positioning address/movement amount" is "1073741824 (=2³⁰).")

■ Positioning data setting example

[When "4-axis linear interpolation control (INC linear 4)" is set in positioning data No. 1 of axis 1]

- Reference axis..... Axis 1
- Interpolation axis Axis 2, Axis3, Axis4 (The required values are also set in positioning data No. 1 of axis 2, axis 3 and axis 4.)

| Setting item | | Axis | Setting example | | | | Setting details |
|--------------|------------------------|--|----------------------------|--------------------------------|--------------------------------|--------------------------------|---|
| | | | Axis 1 (reference axis) | Axis 2 (interpolation axis) | Axis 3 (interpolation axis) | Axis 4 (interpolation axis) | |
| Axis 1 | Positioning data No. 1 | [Da.1] Operation pattern | Positioning complete | - | - | - | Set "Positioning complete" assuming the next positioning data will not be executed. |
| | | [Da.2] Control method | INC linear 4 | - | - | - | Set incremental system 4-axis linear interpolation control. |
| | | [Da.3] Acceleration time No. | 1 | - | - | - | Designate the value set in "[Pr.25] Acceleration time 1" as the acceleration time at start. |
| | | [Da.4] Deceleration time No. | 0 | - | - | - | Designate the value set in "[Pr.10] Deceleration time 0" as the deceleration time at deceleration. |
| | | [Da.6] Positioning address/movement amount | 4000.0 μm | 8000.0 μm | 4000.0 μm | 3000.0 μm | Set the movement amount. (Assuming "mm" is set in "[Pr.1] Unit setting".) |
| | | [Da.7] Arc address | - | - | - | - | Setting not required (setting value is ignored). |
| | | [Da.8] Command speed | 6000.00 mm/min | - | - | - | Set the speed during movement. |
| | | [Da.9] Dwell time/JUMP destination positioning data No. | 500ms | - | - | - | Set the time the machine dwells after the positioning stop (command stop) to the output of the positioning complete signal. |
| | | [Da.10] M code/Condition data No./Number of LOOP to LEND repetitions | 10 | - | - | - | Set this when other sub operation commands are issued in combination with the No. 1 positioning data. |
| | | [Da.20] Axis to be interpolated No.1 | Axis 2 | - | - | - | Set the axis to be interpolated. If the self-axis is set, an error will occur. |
| | | [Da.21] Axis to be interpolated No.2 | Axis 3 | - | - | - | |
| | | [Da.22] Axis to be interpolated No.3 | Axis 4 | - | - | - | |

(Note): Refer to Section 5.3 "List of positioning data" for information on the setting details.

| |
|---|
| POINT |
| <ul style="list-style-type: none"> • When the "reference axis speed" is set during 4-axis linear interpolation control, set so the major axis side becomes the reference axis. If the minor axis side is set as the reference axis, the major axis side speed may exceed the "[Pr.8] Speed limit value". • Refer to Section 9.1.6 "Interpolation control" for the reference axis and interpolation axis combinations. |

9.2.6 1-axis fixed-feed control

In "1-axis fixed-feed control" ("[Da.2] Control method" = fixed-feed 1), one motor is used to carry out fixed-feed control in a set axis direction.

In fixed-feed control, any remainder of below control accuracy is rounded down to convert the movement amount designated in the positioning data into the command value to servo amplifier.

■ Operation chart

In 1-axis fixed-feed control, the address ([Md.20] Feed current value) of the current stop position (start point address) is set to "0". Positioning is then carried out to a position at the end of the movement amount set in "[Da.6] Positioning address/movement amount".

The movement direction is determined by the movement amount sign.

- Positive movement amount Positioning control to forward direction
(Address increase direction)
- Negative movement amount..... Positioning control to reverse direction
(Address decrease direction)

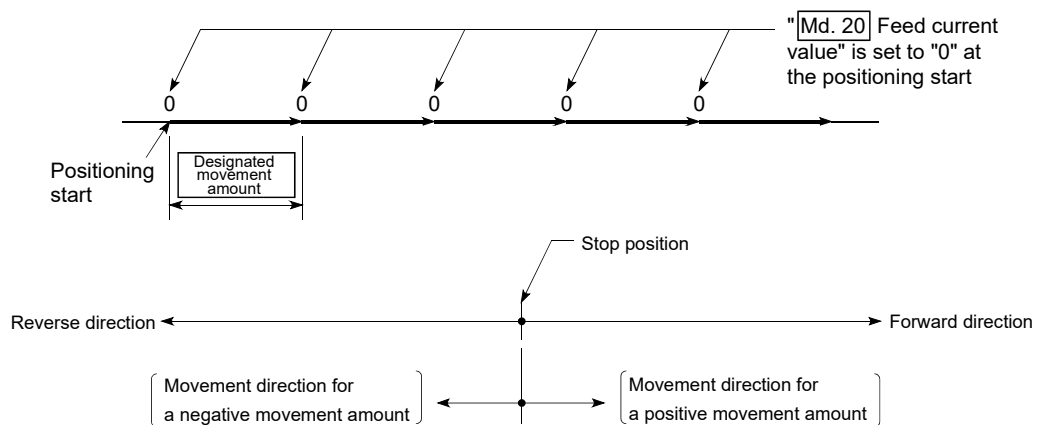

■ Restrictions

- (1) The error "Continuous path control not possible" (error code: 516) will occur and the operation cannot start if "continuous path control" is set in "[Da.1] Operation pattern". ("Continuous path control" cannot be set in fixed-feed control.)
- (2) "Fixed-feed" cannot be set in "[Da.2] Control method" in the positioning data when "continuous path control" has been set in "[Da.1] Operation pattern" of the immediately prior positioning data. (For example, if the operation pattern of positioning data No. 1 is "continuous path control", fixed-feed control cannot be set in positioning data No. 2.) The error "Continuous path control not possible" (error code: 516) will occur and the machine will carry out a deceleration stop if this type of setting is carried out.

POINT

- When the movement amount is converted to the actual number of command pulses, a fraction appears after the decimal point, according to the movement amount per pulse. This fraction is normally retained in the Simple Motion module and reflected at the next positioning.

For the fixed-feed control, since the movement distance is maintained constant (= the command number of pulses is maintained constant), the control is carried out after the fraction pulse is cleared to zero at start.

[Accumulation/cutoff for fractional pulses]

When movement amount per pulse is $1.0 \mu\text{m}$ and movement for $2.5 \mu\text{m}$ is executed two times.

→ Conversion to command pulses: $2.5 \mu\text{m} \div 1.0 = 2.5 \text{ [PLS]}$

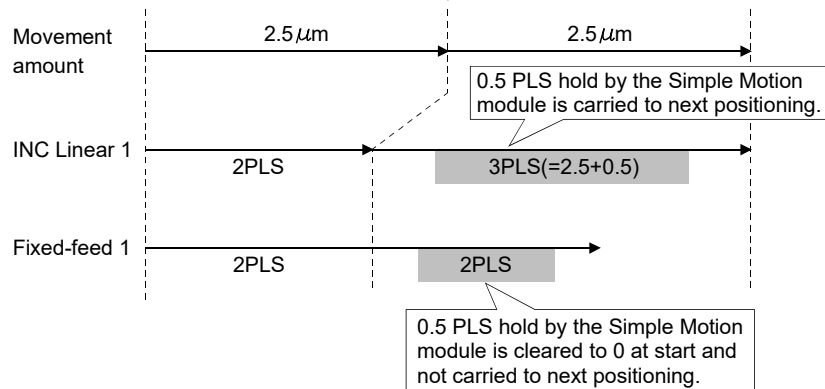

■ Positioning data setting example

[When "1-axis fixed-feed control (fixed-feed 1)" is set in positioning data No.1 of axis 1]

| Setting item | | Setting example | Setting details |
|-------------------------------|---|----------------------|---|
| Axis 1 Positioning data No. 1 | [Da.1] Operation pattern | Positioning complete | Set "Positioning complete" assuming the next positioning data will not be executed. |
| | [Da.2] Control method | Fixed-feed 1 | Set 1-axis fixed-feed control. |
| | [Da.3] Acceleration time No. | 1 | Designate the value set in "[Pr.25] Acceleration time 1" as the acceleration time at start. |
| | [Da.4] Deceleration time No. | 0 | Designate the value set in "[Pr.10] Deceleration time 0" as the deceleration time at deceleration. |
| | [Da.6] Positioning address/ movement amount | 8000.0μm | Set the positioning address. (Assuming "mm" is set in "[Pr.1] Unit setting".) |
| | [Da.7] Arc address | – | Setting not required (setting value is ignored). |
| | [Da.8] Command speed | 6000.00mm/min | Set the speed during movement to the positioning address. |
| | [Da.9] Dwell time/JUMP destination positioning data No. | 500ms | Set the time the machine dwells after the positioning stop (command stop) to the output of the positioning complete signal. |
| | [Da.10] M code/Condition data No./Number of LOOP to LEND repetitions | 10 | Set this when other sub operation commands are issued in combination with the No. 1 positioning data. |
| | [Da.20] Axis to be interpolated No.1 | – | Setting not required (setting value is ignored). |
| | [Da.21] Axis to be interpolated No.2 | – | |
| | [Da.22] Axis to be interpolated No.3 | – | |

(Note): Refer to Section 5.3 "List of positioning data" for information on the setting details.

9.2.7 2-axis fixed-feed control (interpolation)

In "2-axis fixed-feed control" ("[Da.2] Control method" = fixed-feed 2), two motors are used to carry out fixed-feed control in a linear path while carrying out interpolation for the axis directions set in each axis.

In fixed-feed control, any remainder of below control accuracy is rounded down to convert the movement amount designated in the positioning data into the command value to servo amplifier.

(Refer to Section 9.1.6 "Interpolation control" for details on interpolation control.)

■ Operation chart

In incremental system 2-axis fixed-feed control, the addresses ([Md.20] Feed current value) of the current stop position (start addresses) of both axes are set to "0". Linear interpolation positioning is then carried out from that position to a position at the end of the movement amount set in "[Da.6] Positioning address/movement amount". The movement direction is determined by the sign of the movement amount.

- Positive movement amount Positioning control to forward direction
(Address increase direction)
- Negative movement amount..... Positioning control to reverse direction
(Address decrease direction)

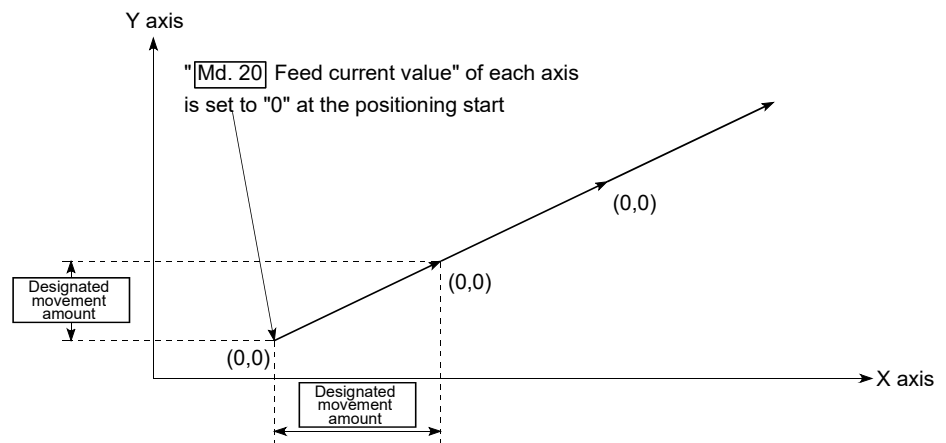

■ Restrictions

- (1) The error "Continuous path control not possible" (error code: 516) will occur and the operation cannot start if "continuous path control" is set in "[Da.1] Operation pattern". ("Continuous path control" cannot be set in fixed-feed control.)
- (2) If the movement amount of each axis exceeds "1073741824 (=2³⁰)" when "0: Composite speed" is set in "[Pr.20] Interpolation speed designation method", the error "Outside linear movement amount range" (error code: 504) occurs at a positioning start and positioning cannot be started. (The maximum movement amount that can be set in "[Da.6] Positioning address/movement amount" is "1073741824 (= 2³⁰)".)
- (3) "Fixed-feed" cannot be set in "[Da.2] Control method" in the positioning data when "continuous path control" has been set in "[Da.1] Operation pattern" of the immediately prior positioning data. (For example, if the operation pattern of positioning data No. 1 is "continuous path control", fixed-feed control cannot be set in positioning data No. 2.) The error "Continuous path control not possible" (error code: 516) will occur and the machine will carry out a deceleration stop if this type of setting is carried out.

■ Positioning data setting example

[When "2-axis fixed-feed control (fixed-feed 2)" is set in positioning data No. 1 of axis 1]

- Reference axis Axis 1
- Interpolation axis Axis 2 (The required values are also set in positioning data No. 1 of axis 2.)

| Setting item | | Axis | | Setting details |
|-------------------------------|--|----------------------------|--------------------------------|---|
| | | Axis 1 (reference axis) | Axis 2 (interpolation axis) | |
| Axis 1 Positioning data No. 1 | [Da.1] Operation pattern | Positioning complete | – | Set "Positioning complete" assuming the next positioning data will not be executed. |
| | [Da.2] Control method | Fixed-feed 2 | – | Set 2-axis fixed-feed control. |
| | [Da.3] Acceleration time No. | 1 | – | Designate the value set in "[Pr.25] Acceleration time 1" as the acceleration time at start. |
| | [Da.4] Deceleration time No. | 0 | – | Designate the value set in "[Pr.10] Deceleration time 0" as the deceleration time at deceleration. |
| | [Da.6] Positioning address/movement amount | 8000.0 μm | 6000.0 μm | Set the positioning address. (Assuming "mm" is set in "[Pr.1] Unit setting".) |
| | [Da.7] Arc address | – | – | Setting not required (setting value is ignored). |
| | [Da.8] Command speed | 6000.00 mm/min | – | Set the speed during movement. (Designate the composite speed of reference axis speed in "[Pr.20] Interpolation speed designation method".) |
| | [Da.9] Dwell time/JUMP destination positioning data No. | 500ms | – | Set the time the machine dwells after the positioning stop (command stop) to the output of the positioning complete signal. |
| | [Da.10] M code/Condition data No./Number of LOOP to LEND repetitions | 10 | – | Set this when other sub operation commands are issued in combination with the No. 1 positioning data. |
| | [Da.20] Axis to be interpolated No.1 | Axis 2 | – | Set the axis to be interpolated. If the self-axis is set, an error will occur. |
| | [Da.21] Axis to be interpolated No.2 | – | – | Setting not required (setting value is ignored). |
| | [Da.22] Axis to be interpolated No.3 | – | – | |

(Note): Refer to Section 5.3 "List of positioning data" for information on the setting details.

POINTS

- When the movement amount is converted to the actual number of command pulses, a fraction appears after the decimal point, according to the movement amount per pulse. This fraction is normally retained in the Simple Motion module and reflected at the next positioning.

For the fixed-feed control, since the movement distance is maintained constant (= the command number of pulses is maintained constant), the control is carried out after the fraction pulse is cleared to zero at start.

[Accumulation/cutoff for fractional pulses]

When movement amount per pulse is 1.0 [μm] and movement for 2.5 [μm] is executed two times.

→ Conversion to command pulses: $2.5 [\mu\text{m}] \div 1.0 = 2.5 [\text{PLS}]$

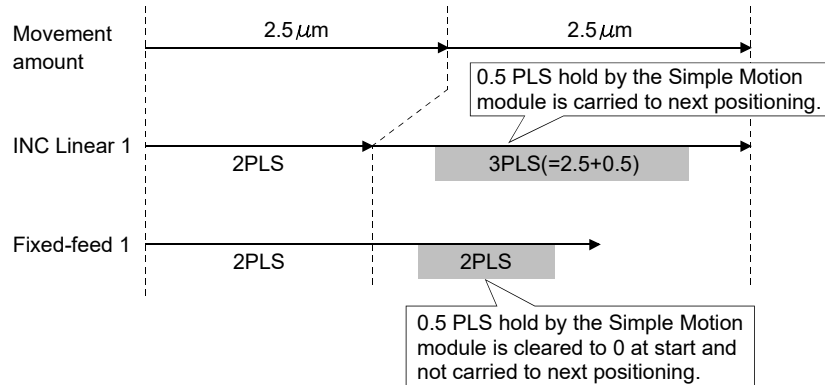

- When the "reference axis speed" is set during 2-axis fixed-feed control, set so the major axis side becomes the reference axis. If the minor axis side is set as the reference axis, the major axis side speed may exceed the "[Pr.8] Speed limit value".

9.2.8 3-axis fixed-feed control (interpolation)

In "3-axis fixed-feed control" ("[Da.2] Control method" = fixed-feed 3), three motors are used to carry out fixed-feed control in a linear path while carrying out interpolation for the axis directions set in each axis.

In fixed-feed control, any remainder of below control accuracy is rounded down to convert the movement amount designated in the positioning data into the command value to servo amplifier.

(Refer to Section 9.1.6 "Interpolation control" for details on interpolation control.)

■ Operation chart

In incremental system 3-axis fixed-feed control, the addresses ([Md.20] Feed current value) of the current stop position (start addresses) of every axes are set to "0". Linear interpolation positioning is then carried out from that position to a position at the end of the movement amount set in "[Da.6] Positioning address/movement amount". The movement direction is determined by the sign of the movement amount.

- Positive movement amount Positioning control to forward direction (Address increase direction)
- Negative movement amount..... Positioning control to reverse direction (Address decrease direction)

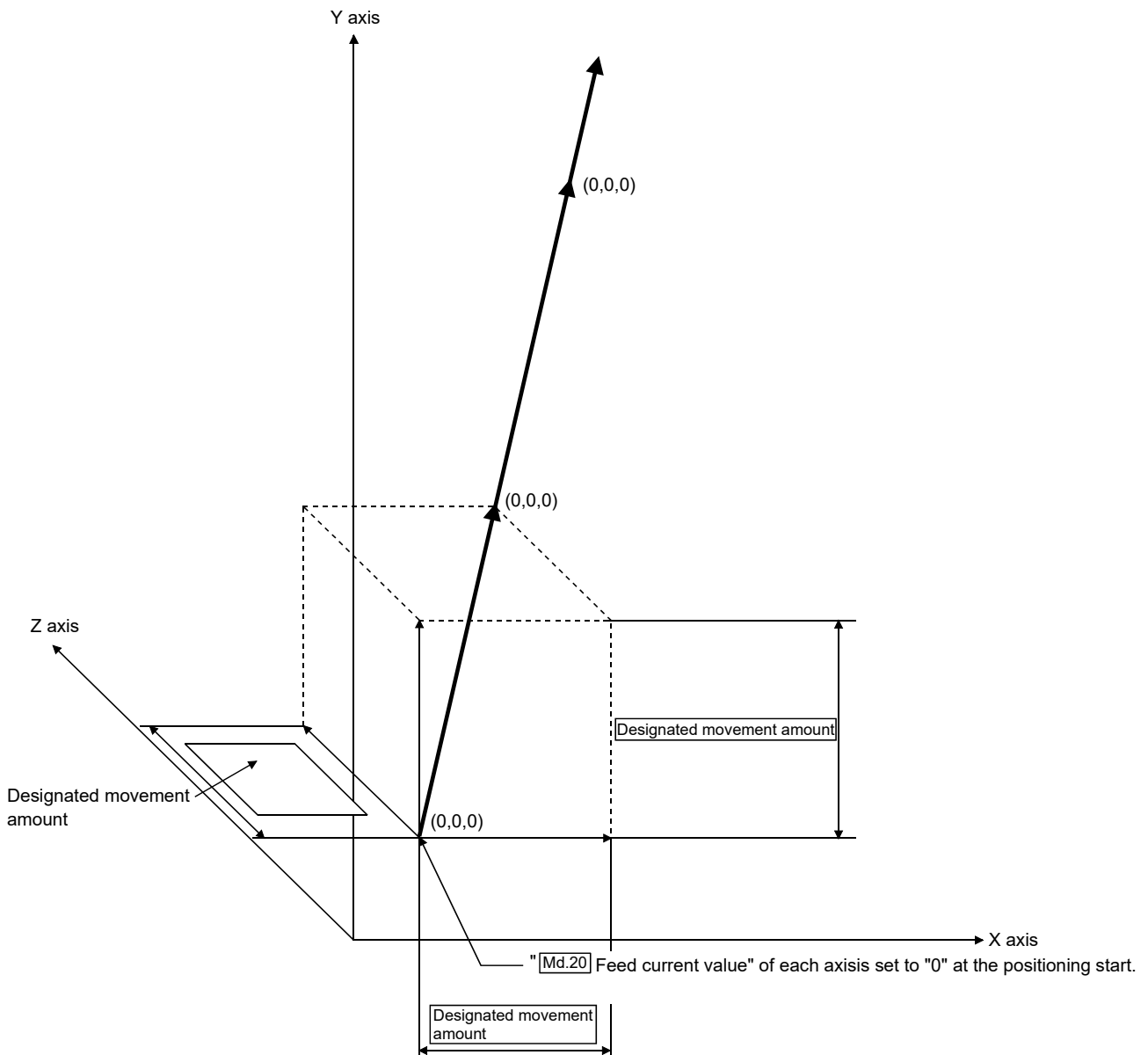

■ Restrictions

- (1) The error "Continuous path control not possible" (error code: 516) will occur and the operation cannot start if "continuous path control" is set in "[Da.1] Operation pattern". ("Continuous path control" cannot be set in fixed-feed control.)
- (2) If the movement amount of each axis exceeds "1073741824 (=2³⁰)" when "0: Composite speed" is set in "[Pr.20] Interpolation speed designation method", the error "Outside linear movement amount range" (error code: 504) occurs at a positioning start and positioning cannot be started. (The maximum movement amount that can be set in "[Da.6] Positioning address/movement amount" is "1073741824 (= 2³⁰)".)
- (3) "Fixed-feed" cannot be set in "[Da.2] Control method" in the positioning data when "continuous path control" has been set in "[Da.1] Operation pattern" of the immediately prior positioning data. (For example, if the operation pattern of positioning data No. 1 is "continuous path control", fixed-feed control cannot be set in positioning data No. 2.) The error "Continuous path control not possible" (error code: 516) will occur and the machine will carry out a deceleration stop if this type of setting is carried out.

■ Positioning data setting example

[When "3-axis fixed-feed control (fixed-feed 3)" is set in positioning data No. 1 of axis 1]

- Reference axis..... Axis 1
- Interpolation axis Axis 2, Axis3 (The required values are also set in positioning data No. 1 of axis 2 and axis 3.)

| Setting item | | Axis | Setting example | | | Setting details |
|-------------------------------|---------|--|----------------------------|--------------------------------|--------------------------------|---|
| | | | Axis 1 (reference axis) | Axis 2 (interpolation axis) | Axis 3 (interpolation axis) | |
| Axis 1 Positioning data No. 1 | [Da.1] | Operation pattern | Positioning complete | – | – | Set "Positioning complete" assuming the next positioning data will not be executed. |
| | [Da.2] | Control method | Fixed-feed 3 | – | – | Set 3-axis fixed-feed control. |
| | [Da.3] | Acceleration time No. | 1 | – | – | Designate the value set in "[Pr.25] Acceleration time 1" as the acceleration time at start. |
| | [Da.4] | Deceleration time No. | 0 | – | – | Designate the value set in "[Pr.10] Deceleration time 0" as the deceleration time at deceleration. |
| | [Da.6] | Positioning address/movement amount | 10000.0 μm | 5000.0 μm | 6000.0 μm | Set the positioning address. (Assuming "mm" is set in "[Pr.1] Unit setting".) |
| | [Da.7] | Arc address | – | – | – | Setting not required (setting value is ignored). |
| | [Da.8] | Command speed | 6000.00 mm/min | – | – | Set the speed during movement. |
| | [Da.9] | Dwell time/JUMP destination positioning data No. | 500ms | – | – | Set the time the machine dwells after the positioning stop (command stop) to the output of the positioning complete signal. |
| | [Da.10] | M code/Condition data No./Number of LOOP to LEND repetitions | 10 | – | – | Set this when other sub operation commands are issued in combination with the No. 1 positioning data. |
| | [Da.20] | Axis to be interpolated No.1 | Axis 2 | – | – | Set the axis to be interpolated. |
| | [Da.21] | Axis to be interpolated No.2 | Axis 3 | – | – | If the self-axis is set, an error will occur. |
| | [Da.22] | Axis to be interpolated No.3 | – | – | – | Setting not required (setting value is ignored). |

(Note): Refer to Section 5.3 "List of positioning data" for information on the setting details.

POINTS

- When the movement amount is converted to the actual number of command pulses, a fraction appears after the decimal point, according to the movement amount per pulse. This fraction is normally retained in the Simple Motion module and reflected at the next positioning.

For the fixed-feed control, since the movement distance is maintained constant (= the command number of pulses is maintained constant), the control is carried out after the fraction pulse is cleared to zero at start.

[Accumulation/cutoff for fractional pulses]

When movement amount per pulse is $1.0 \mu\text{m}$ and movement for $2.5 \mu\text{m}$ is executed two times.

→ Conversion to command pulses: $2.5 \mu\text{m} \div 1.0 = 2.5 \text{ [PLS]}$

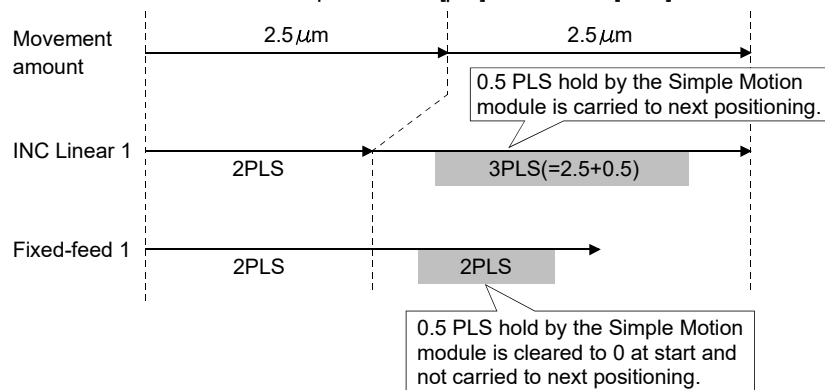

- When the "reference axis speed" is set during 3-axis fixed-feed control, set so the major axis side becomes the reference axis. If the minor axis side is set as the reference axis, the major axis side speed may exceed the "[Pr.8] Speed limit value".
- Refer to Section 9.1.6 "Interpolation control" for the reference axis and interpolation axis combinations.

9.2.9 4-axis fixed-feed control (interpolation)

In "4-axis fixed-feed control" ("[Da.2] Control method" = fixed-feed 4), four motors are used to carry out fixed-feed control in a linear path while carrying out interpolation for the axis directions set in each axis.

In fixed-feed control, any remainder of below control accuracy is rounded down to convert the movement amount designated in the positioning data into the command value to servo amplifier.

(Refer to Section 9.1.6 "Interpolation control" for details on interpolation control.)

■ Operation chart

In incremental system 4-axis fixed-feed control, the addresses ([Md.20] Feed current value) of the current stop position (start addresses) of every axes are set to "0". Linear interpolation positioning is then carried out from that position to a position at the end of the movement amount set in "[Da.6] Positioning address/movement amount". The movement direction is determined by the sign of the movement amount.

- Positive movement amount Positioning control to forward direction
(Address increase direction)
- Negative movement amount..... Positioning control to reverse direction
(Address decrease direction)

■ Restrictions

- (1) The error "Continuous path control not possible" (error code: 516) will occur and the operation cannot start if "continuous path control" is set in "[Da.1] Operation pattern". ("Continuous path control" cannot be set in fixed-feed control.)
- (2) "Fixed-feed" cannot be set in "[Da.2] Control method" in the positioning data when "continuous path control" has been set in "[Da.1] Operation pattern" of the immediately prior positioning data. (For example, if the operation pattern of positioning data No. 1 is "continuous path control", fixed-feed control cannot be set in positioning data No. 2.) The error "Continuous path control not possible" (error code: 516) will occur and the machine will carry out a deceleration stop if this type of setting is carried out.
- (3) Set "1: Reference axis speed" in "[Pr.20] Interpolation speed designation method". The error "Interpolation mode error" (error code: 523) will occur and the operation cannot start if "0: Composite speed" is set.

■ Positioning data setting example

[When "4-axis fixed-feed control (fixed-feed 4)" is set in positioning data No.1 of axis 1]

- Reference axis Axis 1
- Interpolation axis Axis 2, Axis3, Axis4 (The required values are also set in positioning data No. 1 of axis 2, axis 3 and axis 4.)

| Setting item | | Axis | Setting example | | | | Setting details |
|-------------------------------|---------|--|----------------------------|--------------------------------|--------------------------------|--------------------------------|---|
| | | | Axis 1 (reference axis) | Axis 2 (interpolation axis) | Axis 3 (interpolation axis) | Axis 4 (interpolation axis) | |
| Axis 1 Positioning data No. 1 | [Da.1] | Operation pattern | Positioning complete | - | - | - | Set "Positioning complete" assuming the next positioning data will not be executed. |
| | [Da.2] | Control method | Fixed-feed 4 | - | - | - | Set 4-axis fixed-feed control. |
| | [Da.3] | Acceleration time No. | 1 | - | - | - | Designate the value set in "[Pr.25] Acceleration time 1" as the acceleration time at start. |
| | [Da.4] | Deceleration time No. | 0 | - | - | - | Designate the value set in "[Pr.10] Deceleration time 0" as the deceleration time at deceleration. |
| | [Da.6] | Positioning address/movement amount | 4000.0 μm | 8000.0 μm | 4000.0 μm | 3000.0 μm | Set the positioning address. (Assuming "mm" is set in "[Pr.1] Unit setting".) |
| | [Da.7] | Arc address | - | - | - | - | Setting not required (setting value is ignored). |
| | [Da.8] | Command speed | 6000.00 mm/min | - | - | - | Set the speed during movement. |
| | [Da.9] | Dwell time/JUMP destination positioning data No. | 500ms | - | - | - | Set the time the machine dwells after the positioning stop (command stop) to the output of the positioning complete signal. |
| | [Da.10] | M code/Condition data No./Number of LOOP to LEND repetitions | 10 | - | - | - | Set this when other sub operation commands are issued in combination with the No. 1 positioning data. |
| | [Da.20] | Axis to be interpolated No.1 | Axis 2 | - | - | - | Set the axis to be interpolated. If the self-axis is set, an error will occur. |
| | [Da.21] | Axis to be interpolated No.2 | Axis 3 | - | - | - | |
| | [Da.22] | Axis to be interpolated No.3 | Axis 4 | - | - | - | |

(Note): Refer to Section 5.3 "List of positioning data" for information on the setting details.

POINTS

- When the movement amount is converted to the actual number of command pulses, a fraction appears after the decimal point, according to the movement amount per pulse. This fraction is normally retained in the Simple Motion module and reflected at the next positioning.

For the fixed-feed control, since the movement distance is maintained constant (= the command number of pulses is maintained constant), the control is carried out after the fraction pulse is cleared to zero at start.

[Accumulation/cutoff for fractional pulses]

When movement amount per pulse is $1.0\ \mu\text{m}$ and movement for $2.5\ \mu\text{m}$ is executed two times.

→ Conversion to command pulses: $2.5\ \mu\text{m} \div 1.0 = 2.5\ \text{[PLS]}$

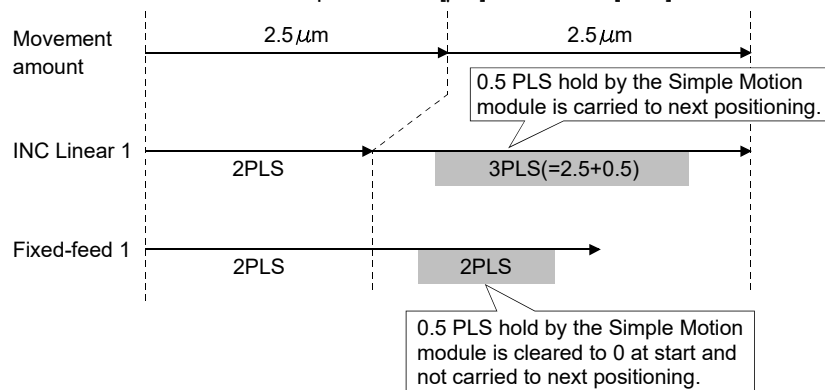

- When the "reference axis speed" is set during 4-axis fixed-feed control, set so the major axis side becomes the reference axis. If the minor axis side is set as the reference axis, the major axis side speed may exceed the "[Pr.8] Speed limit value".
- Refer to Section 9.1.6 "Interpolation control" for the reference axis and interpolation axis combinations.

9.2.10 2-axis circular interpolation control with sub point designation

In "2-axis circular interpolation control" ("[Da.2] Control method" = ABS circular sub, INC circular sub), two motors are used to carry out position control in an arc path passing through designated sub points, while carrying out interpolation for the axis directions set in each axis.

(Refer to Section 9.1.6 "Interpolation control" for details on interpolation control.)

[1] 2-axis circular interpolation control with sub point designation (ABS circular sub)

■ Operation chart

In the absolute system, 2-axis circular interpolation control with sub point designation, positioning is carried out from the current stop position (start point address) to the address (end point address) set in "[Da.6] Positioning address/ movement amount", in an arc path that passes through the sub point address set in "[Da.7] Arc address".

The resulting control path is an arc having as its center the intersection point of perpendicular bisectors of a straight line between the start point address (current stop position) and sub point address (arc address), and a straight line between the sub point address (arc address) and end point address (positioning address).

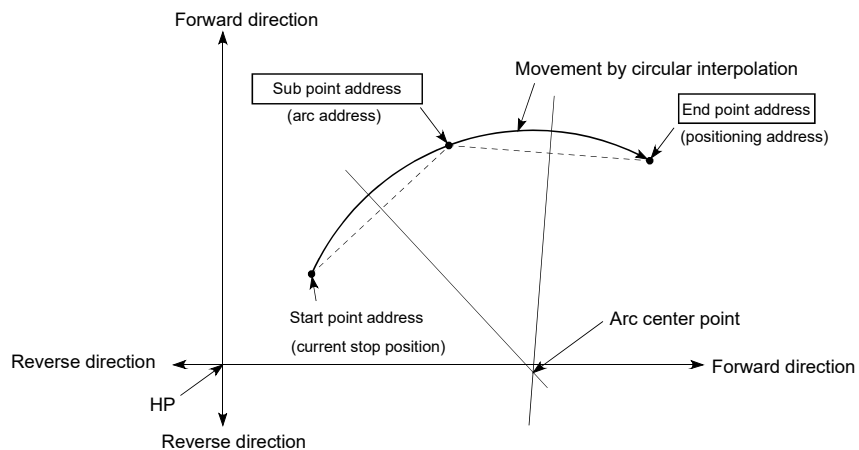

■ Restrictions

- (1) 2-axis circular interpolation control cannot be set in the following cases.
 - When "degree" is set in "[Pr.1] Unit setting"
 - When the units set in "[Pr.1] Unit setting" are different for the reference axis and interpolation axis. ("mm" and "inch" combinations are possible.)
 - When "reference axis speed" is set in "[Pr.20] Interpolation speed designation method"

- (2) An error will occur and the positioning start will not be possible in the following cases. The machine will immediately stop if the error is detected during positioning control.
 - When the radius exceeds "536870912 ($=2^{29}$)". (The maximum radius for which circular interpolation control is possible is "536870912 ($=2^{29}$)")
 - ... The error "Outside radius range" (error code: 544) will occur at positioning start.
 - When the center point address is outside the range of "-2147483648 (-2^{31}) to 2147483647 ($2^{31}-1$)"
 - ... The error "Sub point setting error" (error code: 525) will occur at positioning start.
 - When the start point address is the same as the end point address
 - ... The error "End point setting error" (error code: 526) will occur.
 - When the start point address is the same as the sub point address
 - ... The error "Sub point setting error" (error code: 525) will occur.
 - When the end point address is the same as the sub point address
 - ... The error "Sub point setting error" (error code: 525) will occur.
 - When the start point address, sub point address, and end point address are in a straight line
 - ... The error "Sub point setting error" (error code: 525) will occur.

■ Positioning data setting example

[When "2-axis circular interpolation control with sub point designation (ABS circular sub)" is set in positioning data No. 1 of axis 1]

- Reference axis..... Axis 1
- Interpolation axis Axis 2 (The required values are also set in positioning data No. 1 of axis 2.)

| Setting item | | Setting example | | Setting details |
|----------------------------------|--|----------------------------|--------------------------------|--|
| | | Axis 1 (reference axis) | Axis 2 (interpolation axis) | |
| Axis 1 Positioning data No. 1 | [Da.1] Operation pattern | Positioning complete | – | Set "Positioning complete" assuming the next positioning data will not be executed. |
| | [Da.2] Control method | ABS circular sub | – | Set absolute system, 2-axis circular interpolation control with sub point designation. |
| | [Da.3] Acceleration time No. | 1 | – | Designate the value set in "[Pr.25] Acceleration time 1" as the acceleration time at start. |
| | [Da.4] Deceleration time No. | 0 | – | Designate the value set in "[Pr.10] Deceleration time 0" as the deceleration time at deceleration. |
| | [Da.6] Positioning address/ movement amount | 8000.0 μm | 6000.0 μm | Set the positioning address. (Assuming "mm" is set in "[Pr.1] Unit setting".) |
| | [Da.7] Arc address | 4000.0 μm | 3000.0 μm | Set the sub point address. (Assuming that the "[Pr.1] Unit setting" is set to "mm".) |
| | [Da.8] Command speed | 6000.00 mm/min | – | Set the speed when moving to the end point address. (Designate the composite speed in "[Pr.20] Interpolation speed designation method".) |
| | [Da.9] Dwell time/JUMP destination positioning data No. | 500ms | – | Set the time the machine dwells after the positioning stop (command stop) to the output of the positioning complete signal. |
| | [Da.10] M code/Condition data No./Number of LOOP to LEND repetitions | 10 | – | Set this when other sub operation commands are issued in combination with the No. 1 positioning data. |
| | [Da.20] Axis to be interpolated No.1 | Axis 2 | – | Set the axis to be interpolated. If the self-axis is set, an error will occur. |
| | [Da.21] Axis to be interpolated No.2 | – | – | Setting not required (setting value is ignored). |
| | [Da.22] Axis to be interpolated No.3 | – | – | |

(Note): Refer to Section 5.3 "List of positioning data" for information on the setting details.

| |
|---|
| POINT |
| Set a value in "[Da.8] Command speed" so that the speed of each axis does not exceed the "[Pr.8] Speed limit value". (The speed limit does not function for the speed calculated by the Simple Motion module during interpolation control.) |

[2] 2-axis circular interpolation control with sub point designation (INC circular sub)

■ Operation chart

In the incremental system, 2-axis circular interpolation control with sub point designation, positioning is carried out from the current stop position (start point address) to a position at the end of the movement amount set in "[Da.6] Positioning address/movement amount" in an arc path that passes through the sub point address set in "[Da.7] Arc address". The movement direction depends on the sign (+ or -) of the movement amount.

The resulting control path is an arc having as its center the intersection point of perpendicular bisectors of the straight line between the start point address (current stop position) and sub point address (arc address) calculated from the movement amount to the sub point, and a straight line between the sub point address (arc address) and end point address (positioning address) calculated from the movement amount to the end point.

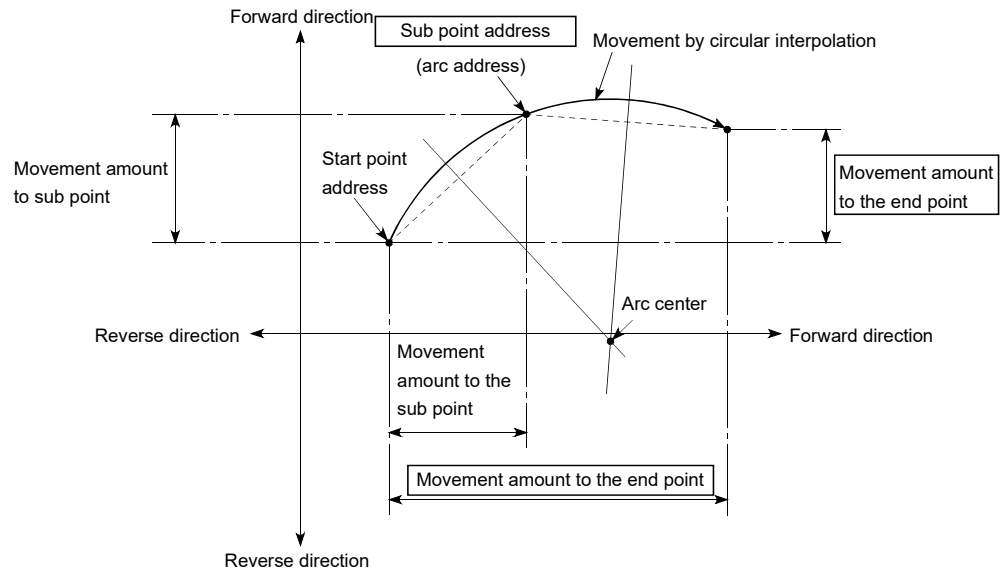

■ Restrictions

- (1) 2-axis circular interpolation control cannot be set in the following cases.
 - When "degree" is set in "[Pr.1] Unit setting"
 - When the units set in "[Pr.1] Unit setting" are different for the reference axis and interpolation axis. ("mm" and "inch" combinations are possible.)
 - When "reference axis speed" is set in "[Pr.20] Interpolation speed designation method"

- (2) An error will occur and the positioning start will not be possible in the following cases. The machine will immediately stop if the error is detected during positioning control.
 - When the radius exceeds "536870912 ($=2^{29}$)". (The maximum radius for which circular interpolation control is possible is "536870912 ($=2^{29}$)")
 - ... The error "Outside radius range" (error code: 544) will occur at positioning start.
 - When the sub point address is outside the range of " -2^{31} to $2^{31}-1$ "
 - ... The error "Sub point setting error" (error code: 525) will occur.
 - When the end point address is outside the range of " -2^{31} to $2^{31}-1$ "
 - ... The error "End point setting error" (error code: 526) will occur.
 - When the center point address is outside the range of " -2^{31} to $2^{31}-1$ "
 - ... The error "Sub point setting error" (error code: 525) will occur at positioning start.
 - When the start point address is the same as the end point address
 - ... The error "End point setting error" (error code: 526) will occur.
 - When the start point address is the same as the sub point address
 - ... The error "Sub point setting error" (error code: 525) will occur.
 - When the end point address is the same as the sub point address
 - ... The error "Sub point setting error" (error code: 525) will occur.
 - When the start point address, sub point address, and end point address are in a straight line
 - ... The error "Sub point setting error" (error code: 525) will occur.

■ Positioning data setting example

[When "2-axis circular interpolation control with sub point designation (INC circular sub)" is set in positioning data No. 1 of axis 1]

- Reference axis..... Axis 1
- Interpolation axis Axis 2 (The required values are also set in positioning data No. 1 of axis 2.)

| Setting item | | Axis | Setting example | | Setting details |
|-------------------------------|---------|--|----------------------------|--------------------------------|---|
| | | | Axis 1 (reference axis) | Axis 2 (interpolation axis) | |
| Axis 1 Positioning data No. 1 | [Da.1] | Operation pattern | Positioning complete | – | Set "Positioning complete" assuming the next positioning data will not be executed. |
| | [Da.2] | Control method | INC circular sub | – | Set incremental system, 2-axis circular interpolation control with sub point designation. |
| | [Da.3] | Acceleration time No. | 1 | – | Designate the value set in "[Pr.25] Acceleration time 1" as the acceleration time at start. |
| | [Da.4] | Deceleration time No. | 0 | – | Designate the value set in "[Pr.10] Deceleration time 0" as the deceleration time at deceleration. |
| | [Da.6] | Positioning address/ movement amount | 8000.0 μm | 6000.0 μm | Set the movement amount. (Assuming that the "[Pr.1] Unit setting" is set to "mm".) |
| | [Da.7] | Arc address | 4000.0 μm | 3000.0 μm | Set the sub point address. (Assuming that the "[Pr.1] Unit setting" is set to "mm".) |
| | [Da.8] | Command speed | 6000.00 mm/min | – | Set the speed during movement. (Designate the composite speed in "[Pr.20] Interpolation speed designation method".) |
| | [Da.9] | Dwell time/JUMP destination positioning data No. | 500ms | – | Set the time the machine dwells after the positioning stop (command stop) to the output of the positioning complete signal. |
| | [Da.10] | M code/Condition data No./Number of LOOP to LEND repetitions | 10 | – | Set this when other sub operation commands are issued in combination with the No. 1 positioning data. |
| | [Da.20] | Axis to be interpolated No.1 | Axis 2 | – | Set the axis to be interpolated. If the self-axis is set, an error will occur. |
| | [Da.21] | Axis to be interpolated No.2 | – | – | Setting not required (setting value is ignored). |
| | [Da.22] | Axis to be interpolated No.3 | – | – | |

(Note): Refer to Section 5.3 "List of positioning data" for information on the setting details.

| |
|---|
| POINT |
| Set a value in "[Da.8] Command speed" so that the speed of each axis does not exceed the "[Pr.8] Speed limit value". (The speed limit does not function for the speed calculated by the Simple Motion module during interpolation control.) |

9.2.11 2-axis circular interpolation control with center point designation

In "2-axis circular interpolation control" ("[Da.2] Control method" = ABS circular right, INC circular right, ABS circular left, INC circular left), two motors are used to carry out position control in an arc path having an arc address as a center point, while carrying out interpolation for the axis directions set in each axis.
 (Refer to Section 9.1.6 "Interpolation control" for details on interpolation control.)

The following table shows the rotation directions, arc center angles that can be controlled, and positioning paths for the different control methods.

| Control method | Rotation direction | Arc center angle that can be controlled | Positioning path |
|--------------------|--------------------|---|------------------|
| ABS circular right | Clockwise | $0^\circ < \theta \leq 360^\circ$ | |
| INC circular right | | | |
| ABS circular left | Counterclockwise | | |
| INC circular left | | | |

■ Circular interpolation error compensation

In circular interpolation control with center point designation, the arc path calculated from the start point address and center point address may deviate from the position of the end point address set in "[Da.6] Positioning address/movement amount".

(Refer to "[Pr.41] Allowable circular interpolation error width".)

- (1) Calculated error \leq "[Pr.41] Allowable circular interpolation error width"
Circular interpolation control to the set end point address is carried out while the error compensation is carried out. (This is called "spiral interpolation".)

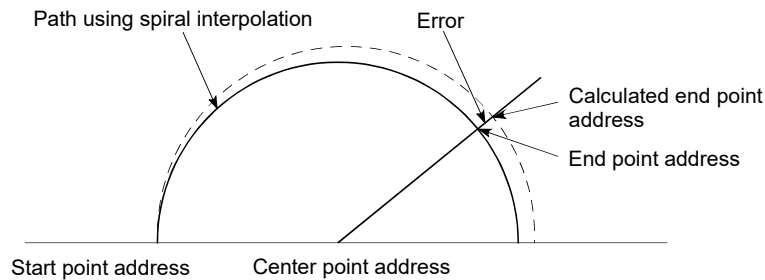

In circular interpolation control with center point designation, an angular velocity is calculated on the assumption that operation is carried out at a command speed on the arc using the radius calculated from the start point address and center point address, and the radius is compensated in proportion to the angular velocity deviated from that at the start point. Thus, when there is a difference (error) between a radius calculated from the start point address and center point address (start point radius) and a radius calculated from the end point address and center point address (end point radius), the composite speed differs from the command speed as follows.

- * Start point radius > End point radius: As compared with the speed without error, the speed becomes slower as end point address is reached.
- * Start point radius < End point radius: As compared with the speed without error, the speed becomes faster as end point address is reached.

- (2) Calculated error > "[Pr.41] Allowable circular interpolation error width"
At the positioning start, the error "Large arc error deviation" (error code: 506) will occur and the control will not start. The machine will immediately stop if the error is detected during positioning control.

[1] 2-axis circular interpolation control with center point designation
(ABS circular right, ABS circular left)

■ Operation chart

In the absolute system, 2-axis circular interpolation control with center point designation positioning is carried out from the current stop position (start point address) to the address (end point address) set in "[Da.6] Positioning address/movement amount", in an arc path having as its center the address (arc address) of the center point set in "[Da.7] Arc address".

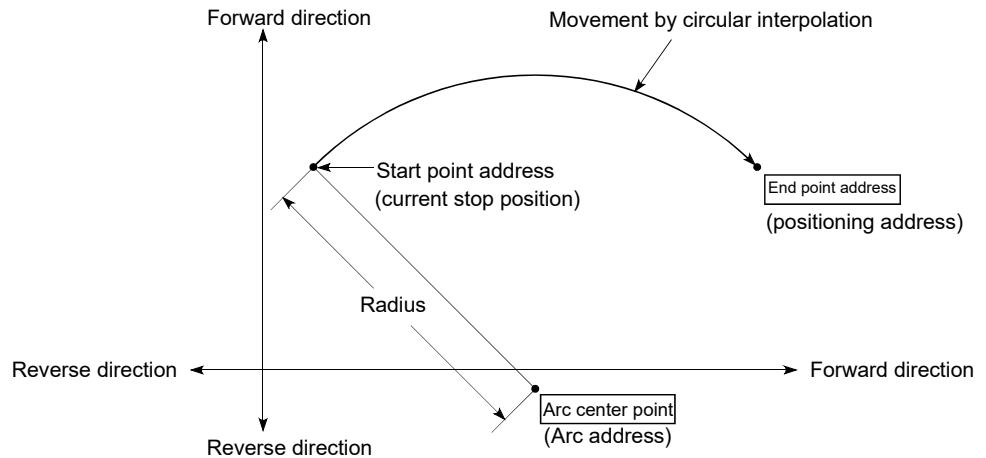

Positioning of a complete round with a radius from the start point address to the arc center point can be carried out by setting the end point address (positioning address) to the same address as the start point address.

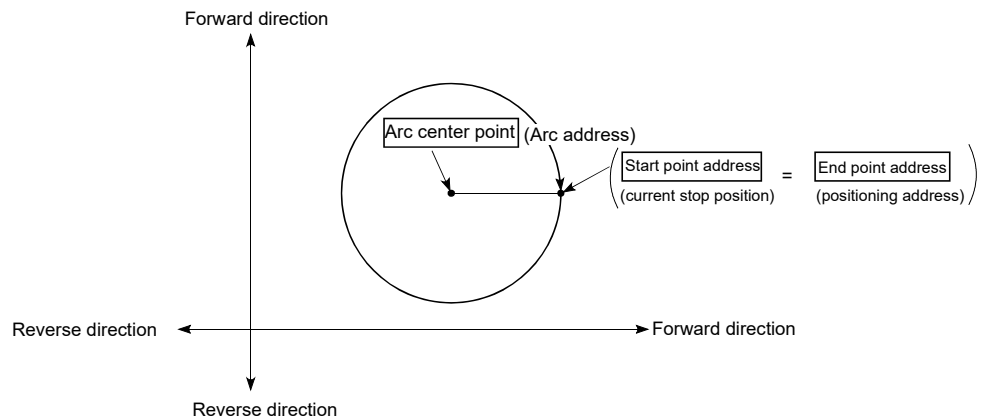

In circular interpolation control with center point designation, an angular velocity is calculated on the assumption that operation is carried out at a command speed on the arc using the radius calculated from the start point address and center point address, and the radius is compensated in proportion to the angular velocity deviated from that at the start point.

Thus, when there is a difference (error) between a radius calculated from the start point address and center point address (start point radius) and a radius calculated from the end point address and center point address (end point radius), the composite speed differs from the command speed as follows.

- * Start point radius > End point radius: As compared with the speed without error, the speed becomes slower as end point address is reached.
- * Start point radius < End point radius: As compared with the speed without error, the speed becomes faster as end point address is reached.

■ Restrictions

- (1) 2-axis circular interpolation control cannot be set in the following cases.
 - When "degree" is set in "[Pr.1] Unit setting"
 - When the units set in "[Pr.1] Unit setting" are different for the reference axis and interpolation axis. ("mm" and "inch" combinations are possible.)
 - When "reference axis speed" is set in "[Pr.20] Interpolation speed designation method"
- (2) An error will occur and the positioning start will not be possible in the following cases. The machine will immediately stop if the error is detected during positioning control.
 - When the radius exceeds "536870912 ($=2^{29}$)". (The maximum radius for which circular interpolation control is possible is "536870912 ($=2^{29}$)")
 - ... The error "Outside radius range" (error code: 544) will occur at positioning start.
 - When the start point address is the same as the center point address
 - ... The error "Center point setting error" (error code: 527) will occur.
 - When the end point address is the same as the center point address
 - ... The error "Center point setting error" (error code: 527) will occur.
 - When the center point address is outside the range of $-2147483648 (-2^{31})$ to $2147483647 (2^{31}-1)$
 - ... The error "Center point setting error" (error code: 527) will occur.

■ Positioning data setting examples

[When "2-axis circular interpolation control with center point designation (ABS circular right, ABS circular left)" is set in positioning data No. 1 of axis 1]

- Reference axis Axis 1
- Interpolation axis Axis 2 (The required values are also set in positioning data No. 1 of axis 2.)

| Setting item | | Setting example | | Setting details |
|-------------------------------|--|---|--------------------------------|--|
| | | Axis 1 (reference axis) | Axis 2 (interpolation axis) | |
| Axis 1 Positioning data No. 1 | [Da.1] Operation pattern | Positioning complete | – | Set "Positioning complete" assuming the next positioning data will not be executed. |
| | [Da.2] Control method | ABS circular right ABS circular left | – | Set absolute system, 2-axis circular interpolation control with center point designation. (Select clockwise or counterclockwise according to the control.) |
| | [Da.3] Acceleration time No. | 1 | – | Designate the value set in "[Pr.25] Acceleration time 1" as the acceleration time at start. |
| | [Da.4] Deceleration time No. | 0 | – | Designate the value set in "[Pr.10] Deceleration time 0" as the deceleration time at deceleration. |
| | [Da.6] Positioning address/ movement amount | 8000.0 μm | 6000.0 μm | Set the positioning address. (Assuming "mm" is set in "[Pr.1] Unit setting".) |
| | [Da.7] Arc address | 4000.0 μm | 3000.0 μm | Set the arc address (center point address). (Assuming that the "[Pr.1] Unit setting" is set to "mm".) |
| | [Da.8] Command speed | 6000.00 mm/min | – | Set the speed when moving to the end point address. (Designate the composite speed in "[Pr.20] Interpolation speed designation method".) |
| | [Da.9] Dwell time/JUMP destination positioning data No. | 500ms | – | Set the time the machine dwells after the positioning stop (command stop) to the output of the positioning complete signal. |
| | [Da.10] M code/Condition data No./Number of LOOP to LEND repetitions | 10 | – | Set this when other sub operation commands are issued in combination with the No. 1 positioning data. |
| | [Da.20] Axis to be interpolated No.1 | Axis 2 | – | Set the axis to be interpolated. If the self-axis is set, an error will occur. |
| | [Da.21] Axis to be interpolated No.2 | – | – | Setting not required (setting value is ignored). |
| | [Da.22] Axis to be interpolated No.3 | – | – | |

(Note): Refer to Section 5.3 "List of positioning data" for information on the setting details.

| |
|---|
| POINT |
| Set a value in "[Da.8] Command speed" so that the speed of each axis does not exceed the "[Pr.8] Speed limit value". (The speed limit does not function for the speed calculated by the Simple Motion module during interpolation control.) |

[2] 2-axis circular interpolation control with center point designation
(INC circular right, INC circular left)

■ Operation chart

In the incremental system, 2-axis circular interpolation control with center point designation, positioning is carried out from the current stop position (start point address) to a position at the end of the movement amount set in "[Da.6] Positioning address/movement amount", in an arc path having as its center the address (arc address) of the center point set in "[Da.7] Arc address".

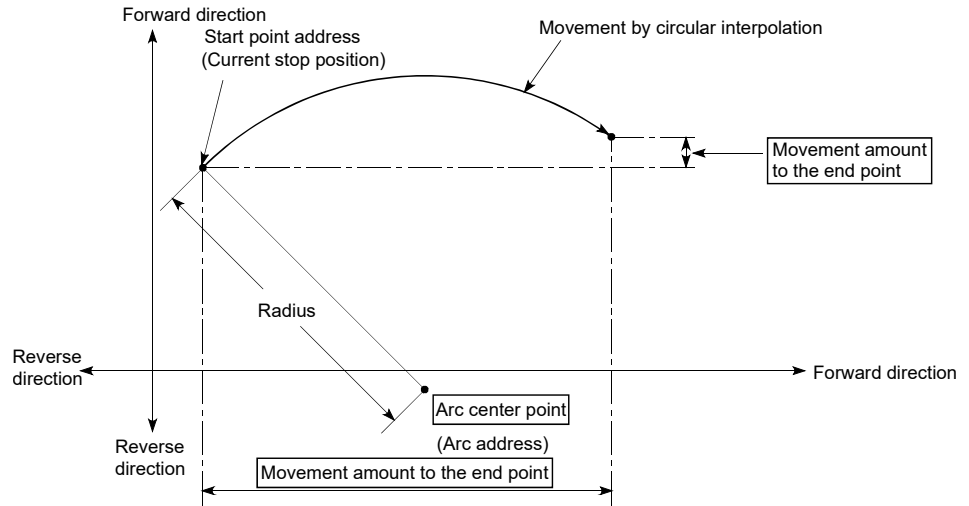

Positioning of a complete round with a radius of the distance from the start point address to the arc center point can be carried out by setting the movement amount to "0".

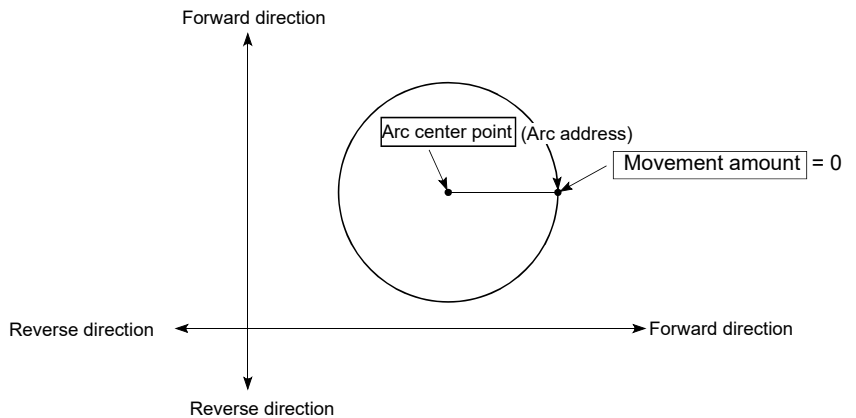

In circular interpolation control with center point designation, an angular velocity is calculated on the assumption that operation is carried out at a command speed on the arc using the radius calculated from the start point address and center point address, and the radius is compensated in proportion to the angular velocity deviated from that at the start point.

Thus, when there is a difference (error) between a radius calculated from the start point address and center point address (start point radius) and a radius calculated from the end point address and center point address (end point radius), the composite speed differs from the command speed as follows.

- * Start point radius > End point radius: As compared with the speed without error, the speed becomes slower as end point address is reached.
- * Start point radius < End point radius: As compared with the speed without error, the speed becomes faster as end point address is reached.

■ Restrictions

(1) 2-axis circular interpolation control cannot be set in the following cases.

- When "degree" is set in "[Pr.1] Unit setting"
- When the units set in "[Pr.1] Unit setting" are different for the reference axis and interpolation axis. ("mm" and "inch" combinations are possible.)
- When "reference axis speed" is set in "[Pr.20] Interpolation speed designation method"

(2) An error will occur and the positioning start will not be possible in the following cases. The machine will immediately stop if the error is detected during positioning control.

- When the radius exceeds "536870912 ($=2^{29}$)". (The maximum radius for which circular interpolation control is possible is "536870912 ($=2^{29}$)")
... The error "Outside radius range" (error code: 544) will occur at positioning start.
- When the end point address is outside the range of $-2147483648 (-2^{31})$ to $2147483647 (2^{31}-1)$
... The error "End point setting error" (error code: 526) will occur.
- When the start point address is the same as the center point address
... The error "Center point setting error" (error code: 527) will occur.
- When the end point address is the same as the center point address
... The error "Center point setting error" (error code: 527) will occur.
- When the center point address is outside the range of $-2147483648 (-2^{31})$ to $2147483647 (2^{31}-1)$
... The error "Center point setting error" (error code: 527) will occur.

■ Positioning data setting examples

[When "2-axis circular interpolation control with center point designation (INC circular right, INC circular left)" is set in positioning data No. 1 of axis 1]

- Reference axis Axis 1
- Interpolation axis Axis 2 (The required values are also set in positioning data No. 1 of axis 2.)

| Setting item | | Setting example | | Setting details |
|-------------------------------|--|---|--------------------------------|---|
| | | Axis 1 (reference axis) | Axis 2 (interpolation axis) | |
| Axis 1 Positioning data No. 1 | [Da.1] Operation pattern | Positioning complete | – | Set "Positioning complete" assuming the next positioning data will not be executed. |
| | [Da.2] Control method | INC circular right INC circular left | – | Set incremental system, 2-axis circular interpolation control with center point designation. (Select clockwise or counterclockwise according to the control.) |
| | [Da.3] Acceleration time No. | 1 | – | Designate the value set in "[Pr.25] Acceleration time 1" as the acceleration time at start. |
| | [Da.4] Deceleration time No. | 0 | – | Designate the value set in "[Pr.10] Deceleration time 0" as the deceleration time at deceleration. |
| | [Da.6] Positioning address/ movement amount | 8000.0 μm | 6000.0 μm | Set the movement amount. (Assuming that the "[Pr.1] Unit setting" is set to "mm".) |
| | [Da.7] Arc address | 4000.0 μm | 3000.0 μm | Set the center point address (center point address). (Assuming that the "[Pr.1] Unit setting" is set to "mm".) |
| | [Da.8] Command speed | 6000.00 mm/min | – | Set the speed when moving to the end point address. (Designate the composite speed in "[Pr.20] Interpolation speed designation method".) |
| | [Da.9] Dwell time/JUMP destination positioning data No. | 500ms | – | Set the time the machine dwells after the positioning stop (command stop) to the output of the positioning complete signal. |
| | [Da.10] M code/Condition data No./Number of LOOP to LEND repetitions | 10 | – | Set this when other sub operation commands are issued in combination with the No. 1 positioning data. |
| | [Da.20] Axis to be interpolated No.1 | Axis 2 | – | Set the axis to be interpolated. If the self-axis is set, an error will occur. |
| | [Da.21] Axis to be interpolated No.2 | – | – | Setting not required (setting value is ignored). |
| | [Da.22] Axis to be interpolated No.3 | – | – | |

(Note): Refer to Section 5.3 "List of positioning data" for information on the setting details.

| |
|---|
| POINT |
| Set a value in "[Da.8] Command speed" so that the speed of each axis does not exceed the "[Pr.8] Speed limit value". (The speed limit does not function for the speed calculated by the Simple Motion module during interpolation control.) |

9.2.12 1-axis speed control

In "1-axis speed control" ("[Da.2] Control method" = Forward run: speed 1, Reverse run: speed 1), control is carried out in the axis direction in which the positioning data has been set by continuously outputting pulses for the speed set in "[Da.8] Command speed" until the input of a stop command.

The two types of 1-axis speed control are "Forward run: speed 1" in which the control starts in the forward run direction, and "Reverse run: speed 1" in which control starts in the reverse run direction.

■ Operation chart

The following chart shows the operation timing for 1-axis speed control with axis 1 as the reference axis.

The "in speed control" flag ([Md.31] Status: b0) is turned ON during speed control.

The "Positioning complete signal" is not turned ON.

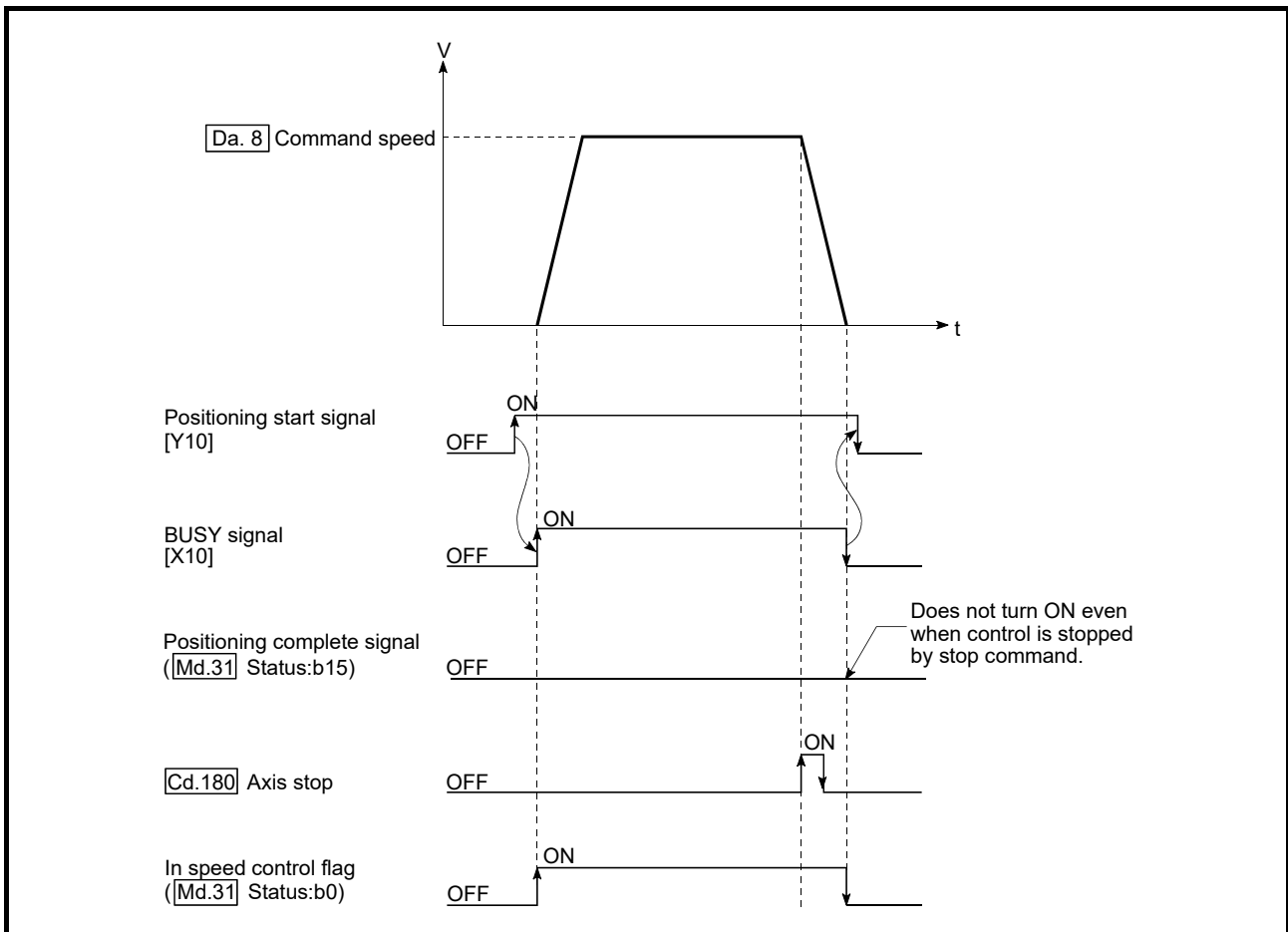
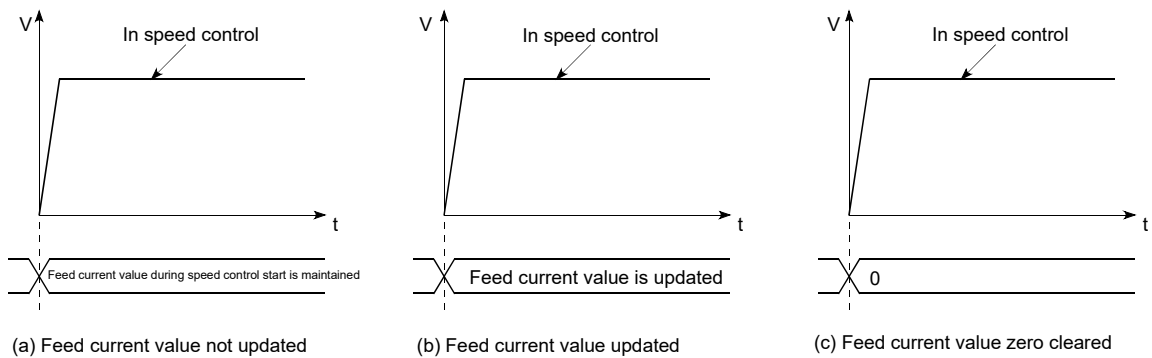

Fig.9.9 1-axis speed control operation timing

■ Feed current value during 1-axis speed control

The following table shows the "[Md.20] Feed current value" during 1-axis speed control corresponding to the "[Pr.21] Feed current value during speed control" settings.

| "[Pr.21] Feed current value during speed control" setting | [Md.20] Feed current value |
|---|--|
| 0: Do not update feed current value | The feed current value at speed control start is maintained. |
| 1: Update feed current value | The feed current value is updated. |
| 2: Zero clear feed current value | The feed current value is fixed at 0. |



■ Restrictions

- (1) Set "Positioning complete" in "[Da.1] Operation pattern". The error "Continuous path control not possible" (error code: 516) will occur and the operation cannot start if "continuous positioning control" or "continuous path control" is set in "[Da.1] Operation pattern". ("Continuous positioning control" and "continuous path control" cannot be set in speed control.)
- (2) Set the WITH mode in "[Pr.18] M code ON signal output timing" when using an M code. The M code will not be output, and the M code ON signal will not turn ON if the AFTER mode is set.
- (3) The error "No command speed" (error code: 503) will occur if the current speed (-1) is set in "[Da.8] Command speed".
- (4) The software stroke limit check is not carried out if the control unit is set to "degree".

■ Positioning data setting examples

[When "1-axis speed control (forward run: speed 1)" is set in the positioning data No. 1 of axis 1]

| Setting item | | Setting example | Setting details |
|-------------------------------|---|----------------------|--|
| Axis 1 Positioning data No. 1 | [Da.1] Operation pattern | Positioning complete | Setting other than "Positioning complete" is not possible in speed control. |
| | [Da.2] Control method | Forward run speed 1 | Set 1-axis speed control. |
| | [Da.3] Acceleration time No. | 1 | Designate the value set in "[Pr.25] Acceleration time 1" as the acceleration time at start. |
| | [Da.4] Deceleration time No. | 0 | Designate the value set in "[Pr.10] Deceleration time 0" as the deceleration time at deceleration. |
| | [Da.6] Positioning address/ movement amount | – | Setting not required (setting value is ignored). |
| | [Da.7] Arc address | – | Set the speed to be commanded. |
| | [Da.8] Command speed | 6000.00mm/min | |
| | [Da.9] Dwell time/JUMP destination positioning data No. | – | Setting not required (setting value is ignored). |
| | [Da.10] M code/Condition data No./Number of LOOP to LEND repetitions | 10 | Set this when other sub operation commands are issued in combination with the No. 1 positioning data. ("[Pr.18] M code ON signal output timing" setting only possible in the WITH mode.) |
| | [Da.20] Axis to be interpolated No.1 | – | Setting not required (setting value is ignored). |
| | [Da.21] Axis to be interpolated No.2 | – | |
| | [Da.22] Axis to be interpolated No.3 | – | |

(Note): Refer to Section 5.3 "List of positioning data" for information on the setting details.

9.2.13 2-axis speed control

In "2-axis speed control" ("[Da.2] Control method" = Forward run: speed 2, Reverse run: speed 2), control is carried out in the 2-axis direction in which the positioning data has been set by continuously outputting pulses for the speed set in "[Da.8] Command speed" until the input of a stop command.

The two types of 2-axis speed control are "Forward run: speed 2" in which the control starts in the forward run direction, and "Reverse run: speed 2" in which control starts in the reverse run direction.

(Refer to Section 9.1.6 "Interpolation control" for the combination of the reference axis with the interpolation axis.)

■ Operation chart

The following chart shows the operation timing for 2-axis (axes 1 and 2) speed control with axis 1 as the reference axis. The "in speed control" flag ([Md.31] Status: b0) is turned ON during speed control.

The "positioning complete signal" is not turned ON.

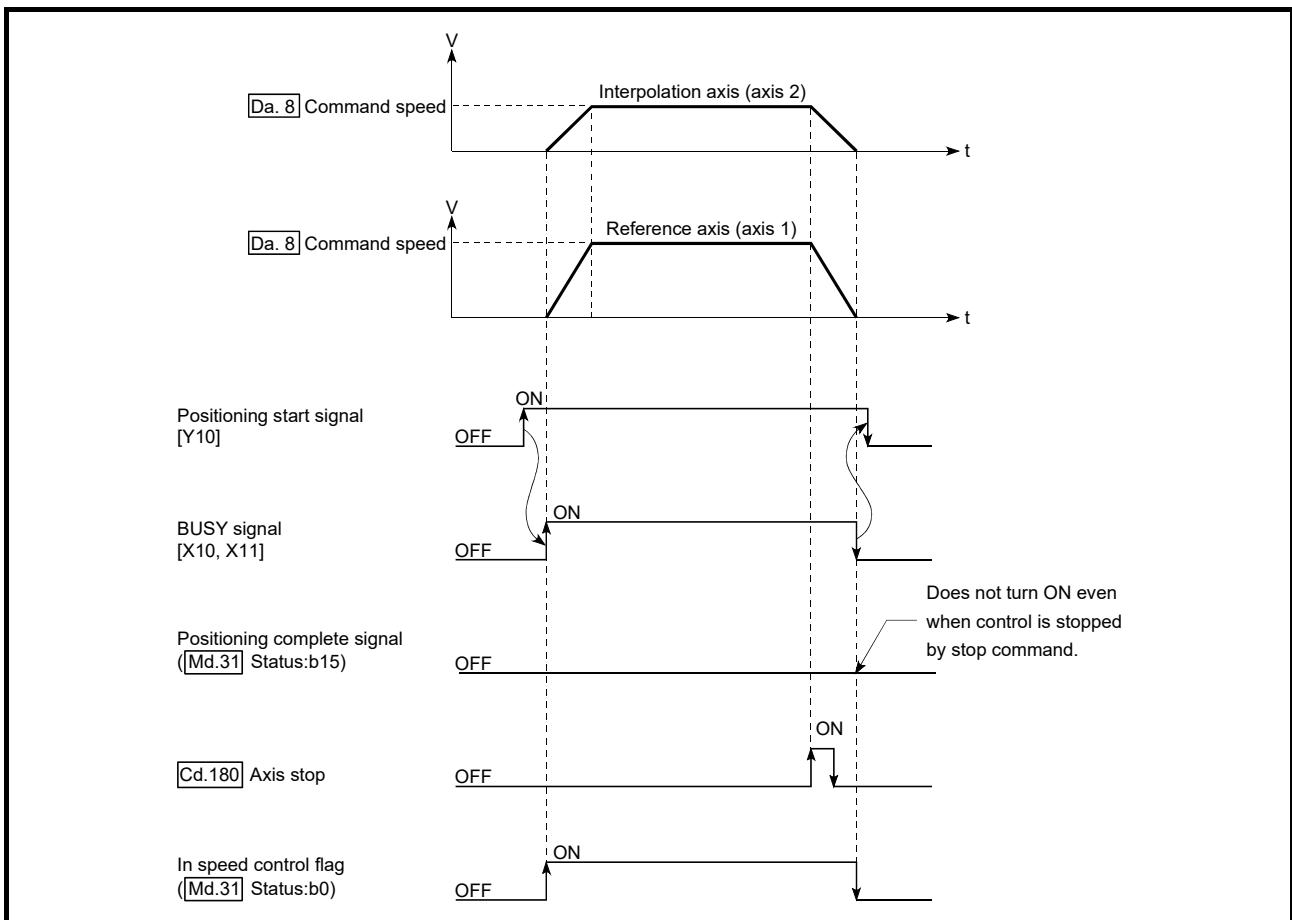
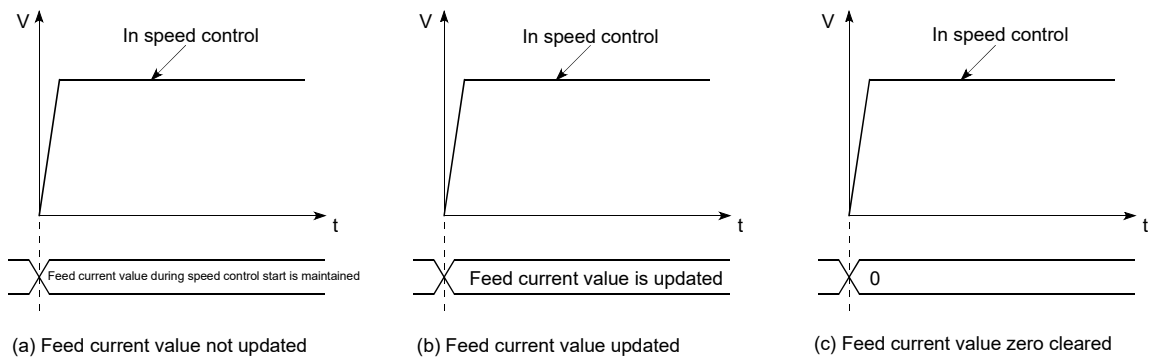

Fig. 9.10 2-axis speed control operation timing

■ Feed current value during 2-axis speed control

The following table shows the "[Md.20] Feed current value" during 2-axis speed control corresponding to the "[Pr.21] Feed current value during speed control" settings. (Note that the reference axis setting values are used for parameters.)

| "[Pr.21] Feed current value during speed control" setting | [Md.20] Feed current value |
|---|--|
| 0: Do not update feed current value | The feed current value at speed control start is maintained. |
| 1: Update feed current value | The feed current value is updated. |
| 2: Zero clear feed current value | The feed current value is fixed at 0. |



■ Restrictions

- (1) Set "Positioning complete" in "[Da.1] Operation pattern". The error "Continuous path control not possible" (error code: 516) will occur and the operation cannot start if "continuous positioning control" or "continuous path control" is set. ("Continuous positioning control" and "continuous path control" cannot be set in speed control.)
- (2) Set the WITH mode in "[Pr.18] M code ON signal output timing" when using an M code. The M code will not be output, and the M code ON signal will not turn ON if the AFTER mode is set.
- (3) Set the "reference axis speed" in "[Pr.20] Interpolation speed designation method". The error "Interpolation mode error" (error code: 523) will occur and the operation cannot start if a composite speed is set.

- (4) When either of two axes exceeds the speed limit, that axis is controlled with the speed limit value. The speeds of the other axes are limited at the ratios of "[Da.8] Command speed".

(Examples)

| Setting item | | Axis | |
|--------------|-------------------|----------------|----------------|
| | | Axis 1 setting | Axis 2 setting |
| [Pr.8] | Speed limit value | 4000.00mm/min | 5000.00mm/min |
| [Da.8] | Command speed | 8000.00mm/min | 6000.00mm/min |

With the settings shown above, the operation speed in speed control is as follows.

Axis 1: 4000.00 mm/min (Speed is limited by [Pr.8]).

Axis 2: 3000.00 mm/min (Speed is limited at a ratio of an axis 1 command speed to an axis 2 command speed).

(Note): Operation runs at speed 1 when a reference axis speed is less than 1 as a result of speed limit.

In addition, when "[Pr.7] Bias speed at start" is set, the set value will be the minimum speed.

- (5) The error "No command speed" (error code: 503) occurs if a current speed (-1) is set in "[Da.8] Command speed".
- (6) The software stroke limit check is not carried out when the control unit is set to "degree".

■ Positioning data setting examples

[When "2-axis speed control (forward run: speed 2)" is set in the positioning data No. 1 of axis 1]

- Reference axis Axis 1
- Interpolation axis Axis 2 (The required values are also set in positioning data No.1 of axis 2.)

| Setting item | | Axis | Setting example | | Setting details |
|-------------------------------|---------|--|----------------------------|--------------------------------|--|
| | | | Axis 1 (reference axis) | Axis 2 (interpolation axis) | |
| Axis 1 Positioning data No. 1 | [Da.1] | Operation pattern | Positioning complete | – | Setting other than "Positioning complete" is not possible in speed control. |
| | [Da.2] | Control method | Forward run speed 2 | – | Set 2-axis speed control. |
| | [Da.3] | Acceleration time No. | 1 | – | Designate the value set in "[Pr.25] Acceleration time 1" as the acceleration time at start. |
| | [Da.4] | Deceleration time No. | 0 | – | Designate the value set in "[Pr.10] Deceleration time 0" as the deceleration time at deceleration. |
| | [Da.6] | Positioning address/movement amount | – | – | Setting not required (setting value is ignored). |
| | [Da.7] | Arc address | – | – | Setting not required (setting value is ignored). |
| | [Da.8] | Command speed | 6000.00 mm/min | 3000.00 mm/min | Set the speed to be commanded. |
| | [Da.9] | Dwell time/JUMP destination positioning data No. | – | – | Setting not required (setting value is ignored). |
| | [Da.10] | M code/Condition data No./Number of LOOP to LEND repetitions | 10 | – | Set this when other sub operation commands are issued in combination with the No. 1 positioning data. ("[Pr.18] M code ON signal output timing" setting only possible in the WITH mode.) |
| | [Da.20] | Axis to be interpolated No.1 | Axis 2 | – | Set the axis to be interpolated. If the self-axis is set, an error will occur. |
| | [Da.21] | Axis to be interpolated No.2 | – | – | Setting not required (setting value is ignored). |
| | [Da.22] | Axis to be interpolated No.3 | – | – | |

(Note): Refer to Section 5.3 "List of positioning data" for information on the setting details.

9.2.14 3-axis speed control

In "3-axis speed control" ("[Da.2] Control method" = Forward run: speed 3, Reverse run: speed 3), control is carried out in the 3-axis direction in which the positioning data has been set by continuously outputting pulses for the speed set in "[Da.8] Command speed" until the input of a stop command.

The two types of 3-axis speed control are "Forward run: speed 3" in which the control starts in the forward run direction, and "Reverse run: speed 3" in which control starts in the reverse run direction.

(Refer to Section 9.1.6 "Interpolation control" for the combination of the reference axis with the interpolation axes.)

■ Operation chart

The following chart shows the operation timing for 3-axis (axes 1, 2, and 3) speed control with axis 1 as the reference axis.

The "in speed control" flag ([Md.31] Status: b0) is turned ON during speed control.

The "positioning complete signal" is not turned ON.

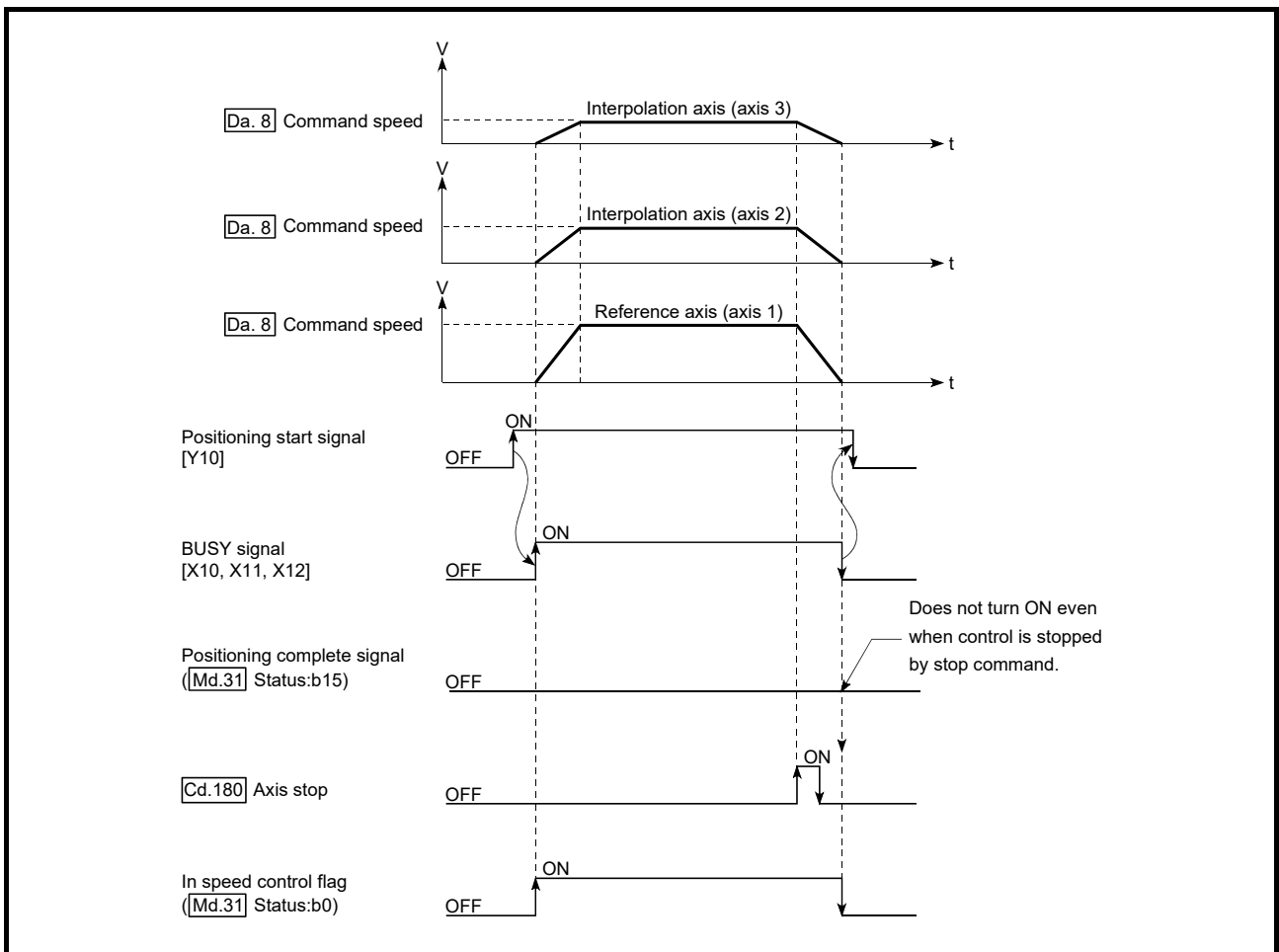
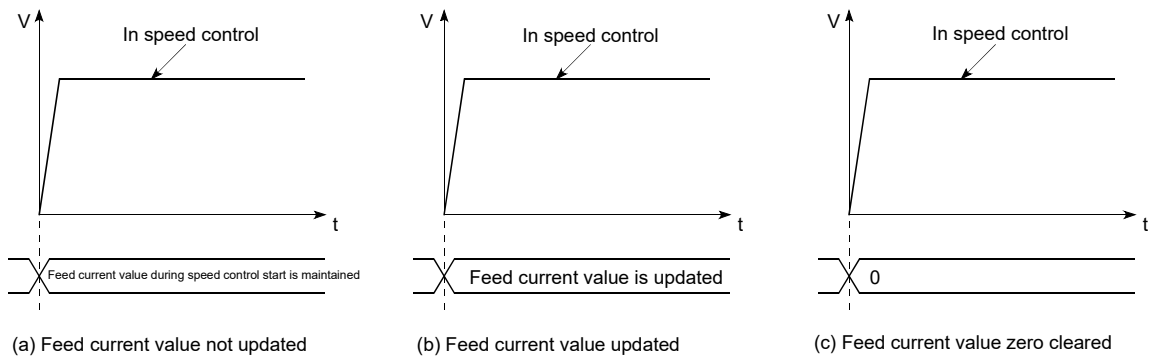

Fig. 9.11 3-axis speed control operation timing

■ Feed current value during 3-axis speed control

The following table shows the "[Md.20] Feed current value" during 3-axis speed control corresponding to the "[Pr.21] Feed current value during speed control" settings. (Note that the reference axis setting values are used for parameters.)

| "[Pr.21] Feed current value during speed control" setting | [Md.20] Feed current value |
|---|--|
| 0: Do not update feed current value | The feed current value at speed control start is maintained. |
| 1: Update feed current value | The feed current value is updated. |
| 2: Zero clear feed current value | The feed current value is fixed at 0. |



■ Restrictions

- (1) Set "Positioning complete" in "[Da.1] Operation pattern". The error "Continuous path control not possible" (error code: 516) will occur and the operation cannot start if "continuous positioning control" or "continuous path control" is set. ("Continuous positioning control" and "continuous path control" cannot be set in speed control.)
- (2) Set the WITH mode in "[Pr.18] M code ON signal output timing" when using an M code. The M code will not be output, and the M code ON signal will not turn ON if the AFTER mode is set.
- (3) Set the "reference axis speed" in "[Pr.20] Interpolation speed designation method". The error "Interpolation mode error" (error code: 523) will occur and the operation cannot start if a composite speed is set.

- (4) When either of three axes exceeds the speed limit, that axis is controlled with the speed limit value. The speeds of the other axes are limited at the ratios of "[Da.8] Command speed".

(Examples)

| Setting item | | Axis | | |
|--------------|-------------------|----------------|----------------|----------------|
| | | Axis 1 setting | Axis 2 setting | Axis 3 setting |
| [Pr.8] | Speed limit value | 4000.00mm/min | 5000.00mm/min | 6000.00mm/min |
| [Da.8] | Command speed | 8000.00mm/min | 6000.00mm/min | 4000.00mm/min |

With the settings shown above, the operation speed in speed control is as follows.

Axis 1: 4000.00 mm/min (Speed is limited by [Pr.8].)

Axis 2: 3000.00 mm/min (Speed is limited at ratios in axes 1, 2, and 3 command speeds.)

Axis 3: 2000.00 mm/min (Speed is limited at ratios in axes 1, 2, and 3 command speeds.)

(Note): Operation runs at speed 1 when a reference axis speed is less than 1 as a result of speed limit.

In addition, when "[Pr.7] Bias speed at start" is set, the set value will be the minimum speed.

- (5) The error "No command speed" (error code: 503) will occur if a current speed (-1) is set in "[Da.8] Command speed".
- (6) The software stroke limit check is not carried out when the control unit is set to "degree".

■ Positioning data setting examples

[When "3-axis speed control (forward run: speed 3)" is set in the positioning data No. 1 of axis 1]

- Reference axis..... Axis 1
- Interpolation axis Axis 2, Axis 3 (The required values are also set in positioning data No.1 of axis 2 and axis 3.)

| Setting item | | Axis | Setting example | | | Setting details |
|-------------------------------|---------|--|----------------------------|--------------------------------|--------------------------------|--|
| | | | Axis 1 (reference axis) | Axis 2 (interpolation axis) | Axis 3 (interpolation axis) | |
| Axis 1 Positioning data No. 1 | [Da.1] | Operation pattern | Positioning complete | – | – | Setting other than "Positioning complete" is not possible in speed control. |
| | [Da.2] | Control method | Forward run speed 3 | – | – | Set 3-axis speed control. |
| | [Da.3] | Acceleration time No. | 1 | – | – | Designate the value set in "[Pr.25] Acceleration time 1" as the acceleration time at start. |
| | [Da.4] | Deceleration time No. | 0 | – | – | Designate the value set in "[Pr.10] Deceleration time 0" as the deceleration time at deceleration. |
| | [Da.6] | Positioning address/ movement amount | – | – | – | Setting not required (setting value is ignored). |
| | [Da.7] | Arc address | – | – | – | |
| | [Da.8] | Command speed | 6000.00 mm/min | 3000.00 mm/min | 2000.00 mm/min | Set the speed to be commanded. |
| | [Da.9] | Dwell time/JUMP destination positioning data No. | – | – | – | Setting not required (setting value is ignored). |
| | [Da.10] | M code/Condition data No./Number of LOOP to LEND repetitions | 10 | – | – | Set this when other sub operation commands are issued in combination with the No. 1 positioning data. ("[Pr.18] M code ON signal output timing" setting only possible in the WITH mode.) |
| | [Da.20] | Axis to be interpolated No.1 | Axis 2 | – | – | Set the axis to be interpolated. If the self-axis is set, an error will occur. |
| | [Da.21] | Axis to be interpolated No.2 | Axis 3 | – | – | |
| | [Da.22] | Axis to be interpolated No.3 | – | – | – | Setting not required (setting value is ignored). |

(Note): Refer to Section 5.3 "List of positioning data" for information on the setting details.

9.2.15 4-axis speed control

In "4-axis speed control" ("[Da.2] Control method" = Forward run: speed 4, Reverse run: speed 4), control is carried out in the 4-axis direction in which the positioning data has been set by continuously outputting pulses for the speed set in "[Da.8] Command speed" until the input of a stop command.

The two types of 4-axis speed control are "Forward run: speed 4" in which the control starts in the forward run direction, and "Reverse run: speed 4" in which control starts in the reverse run direction.

(Refer to Section 9.1.6 "Interpolation control" for the combination of the reference axis with the interpolation axes.)

■ Operation chart

The following chart shows the operation timing for 4-axis speed control with axis 1 as the reference axis.

The "in speed control" flag ([Md.31] Status: b0) is turned ON during speed control.
 The "positioning complete signal" is not turned ON.

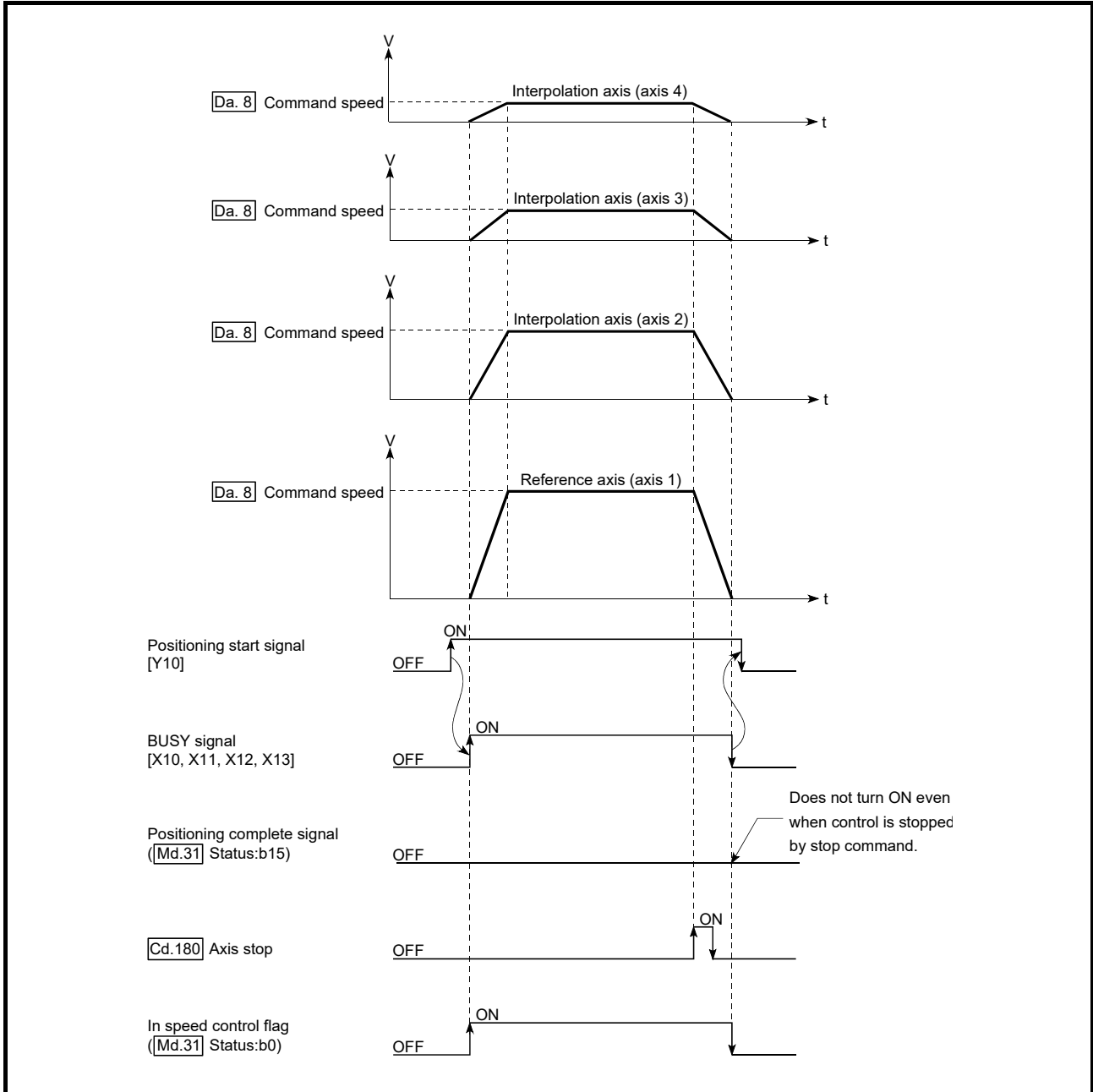
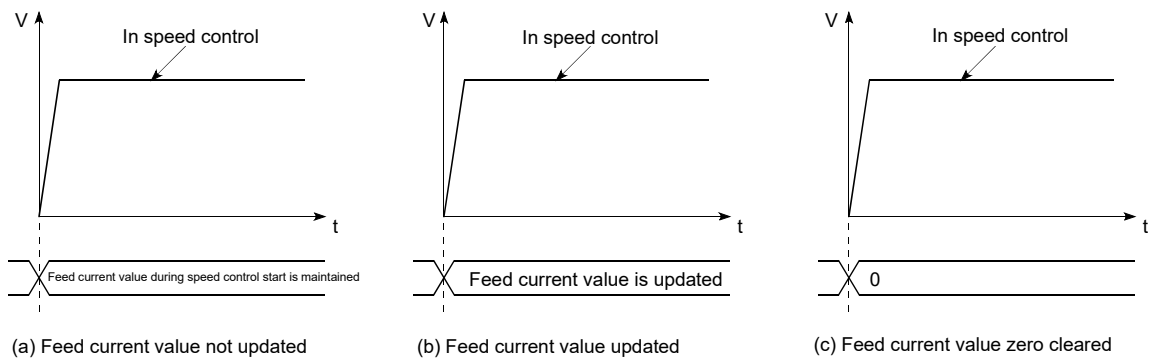

Fig. 9.12 4-axis speed control operation timing

■ Feed current value during 4-axis speed control

The following table shows the "[Md.20] Feed current value" during 4-axis speed control corresponding to the "[Pr.21] Feed current value during speed control" settings. (Note that the reference axis setting values are used for parameters.)

| "[Pr.21] Feed current value during speed control" setting | [Md.20] Feed current value |
|---|--|
| 0: Do not update feed current value | The feed current value at speed control start is maintained. |
| 1: Update feed current value | The feed current value is updated. |
| 2: Zero clear feed current value | The feed current value is fixed at 0. |



■ Restrictions

- (1) Set "Positioning complete" in "[Da.1] Operation pattern". The error "Continuous path control not possible" (error code: 516) will occur and the operation cannot start if "continuous positioning control" or "continuous path control" is set. ("Continuous positioning control" and "continuous path control" cannot be set in speed control.)
- (2) Set the WITH mode in "[Pr.18] M code ON signal output timing" when using an M code. The M code will not be output, and the M code ON signal will not turn ON if the AFTER mode is set.
- (3) Set the "reference axis speed" in "[Pr.20] Interpolation speed designation method". The error "Interpolation mode error" (error code: 523) will occur and the operation cannot start if a composite speed is set.

- (4) When either of four axes exceeds the speed limit, that axis is controlled with the speed limit value. The speeds of the other axes are limited at the ratios of "[Da.8] Command speed".

(Examples)

| Setting item | | Axis | | | |
|--------------|-------------------|----------------|----------------|----------------|----------------|
| | | Axis 1 setting | Axis 2 setting | Axis 3 setting | Axis 4 setting |
| [Pr.8] | Speed limit value | 4000.00mm/min | 5000.00mm/min | 6000.00mm/min | 8000.00mm/min |
| [Da.8] | Command speed | 8000.00mm/min | 6000.00mm/min | 4000.00mm/min | 1500.00mm/min |

With the settings shown above, the operation speed in speed control is as follows.

Axis 1: 4000.00 mm/min (Speed is limited by [Pr.8].)

Axis 2: 3000.00 mm/min (Speed is limited at ratios in axes 1, 2, 3 and 4 command speeds.)

Axis 3: 2000.00 mm/min (Speed is limited at ratios in axes 1, 2, 3 and 4 command speeds.)

Axis 4: 750.00 mm/min (Speed is limited at ratios in axes 1, 2, 3 and 4 command speeds.)

(Note): Operation runs at speed 1 when a reference axis speed is less than 1 as a result of speed limit.

In addition, when "[Pr.7] Bias speed at start" is set, the set value will be the minimum speed.

- (5) The error "No command speed" (error code: 503) will occur if a current speed (-1) is set in "[Da.8] Command speed".
- (6) The software stroke limit check is not carried out when the control unit is set to "degree".

■ Positioning data setting examples

[When "4-axis speed control (forward run: speed 4)" is set in the positioning data No. 1 of axis 1]

- Reference axis..... Axis 1
- Interpolation axis Axis 2 to Axis 4 (The required values are also set in positioning data No. 1 of axis 2 to axis 4.)

| Setting item | | Axis | Setting example | | | | Setting details |
|-------------------------------|---------|--|----------------------------|--------------------------------|--------------------------------|--------------------------------|--|
| | | | Axis 1 (reference axis) | Axis 2 (interpolation axis) | Axis 3 (interpolation axis) | Axis 4 (interpolation axis) | |
| Axis 1 Positioning data No. 1 | [Da.1] | Operation pattern | Positioning complete | – | – | – | Setting other than "Positioning complete" is not possible in speed control. |
| | [Da.2] | Control method | Forward run speed 4 | – | – | – | Set 4-axis speed control. |
| | [Da.3] | Acceleration time No. | 1 | – | – | – | Designate the value set in "[Pr.25] Acceleration time 1" as the acceleration time at start. |
| | [Da.4] | Deceleration time No. | 0 | – | – | – | Designate the value set in "[Pr.10] Deceleration time 0" as the deceleration time at deceleration. |
| | [Da.6] | Positioning address/movement amount | – | – | – | – | Setting not required (setting value is ignored). |
| | [Da.7] | Arc address | – | – | – | – | |
| | [Da.8] | Command speed | 6000.00 mm/min | 3000.00 mm/min | 2000.00 mm/min | 1000.00 mm/min | Set the speed to be commanded. |
| | [Da.9] | Dwell time/JUMP destination positioning data No. | – | – | – | – | Setting not required (setting value is ignored). |
| | [Da.10] | M code/Condition data No./Number of LOOP to LEND repetitions | 10 | – | – | – | Set this when other sub operation commands are issued in combination with the No. 1 positioning data. ("[Pr.18] M code ON signal output timing" setting only possible in the WITH mode.) |
| | [Da.20] | Axis to be interpolated No.1 | Axis 2 | – | – | – | Set the axis to be interpolated. If the self-axis is set, an error will occur. |
| | [Da.21] | Axis to be interpolated No.2 | Axis 3 | – | – | – | |
| | [Da.22] | Axis to be interpolated No.3 | Axis 4 | – | – | – | |

(Note): Refer to Section 5.3 "List of positioning data" for information on the setting details.

9.2.16 Speed-position switching control (INC mode)

In "speed-position switching control (INC mode)" ("[Da.2] Control method" = Forward run: speed/position, Reverse run: speed/position), the pulses of the speed set in "[Da.8] Command speed" are kept output on the axial direction set to the positioning data. When the "speed-position switching signal" is input, position control of the movement amount set in "[Da.6] Positioning address/movement amount" is exercised.

"Speed-position switching control (INC mode)" is available in two different types: "forward run: speed/position" which starts the axis in the forward run direction and "reverse run: speed/position" which starts the axis in the reverse run direction.

Use the detailed parameter 1 "[Pr.81] Speed-position function selection" with regard to the choice for "speed-position switching control (INC mode)".

| Setting item | | Setting value | Setting details | Buffer memory address |
|--------------|-----------------------------------|---------------|---|-----------------------|
| [Pr.81] | Speed-position function selection | 0 | Speed-position switching control (INC mode) | 34+150n |

(Note): If the set value is other than 0 and 2, it is regarded as 0 and operation is performed in the INC mode. For details of the setting, refer to Section 5.2 "List of parameters".

■ Switching over from speed control to position control

- (1) The control is selected the switching method from speed control to position control by the setting value of "[Cd.45] Speed-position switching device selection".

| Setting item | | Setting value | Setting details | Buffer memory address |
|--------------|---|---------------|--|-----------------------|
| [Cd.45] | Speed-position switching device selection | → | The device used for speed-position switching is selected. 0: Use the external command signal for switching from speed control to position control 1: Use the proximity signal for switching from speed control to position control 2: Use the "[Cd.46] Speed-position switching command" for switching from speed control to position control | 4366+100n |

The switching is performed by using the following device when "2" is set.

| Setting item | | Setting value | Setting details | Buffer memory address |
|--------------|----------------------------------|---------------|--|-----------------------|
| [Cd.46] | Speed-position switching command | 1 | 1: Switch from speed control to position control | 4367+100n |

- (2) "[Cd.24] Speed-position switching enable flag" must be turned ON to switch over from speed control to position control. (If the "[Cd.24] Speed-position switching enable flag" turns ON after the speed-position switching signal turns ON, the control will continue as speed control without switching over to position control. The control will be switched over from position control to speed control when the speed-position switching signal turns from OFF to ON again. Only position control will be carried out when the "[Cd.24] Speed-position switching enable flag" and speed-position switching signal are ON at the operation start.)

| Setting item | | Setting value | Setting details | Buffer memory address |
|--------------|--------------------------------------|---------------|--|-----------------------|
| [Cd.24] | Speed-position switching enable flag | 1 | Speed control will be taken over by position control when the external command signal [DI] comes ON. | 4328+100n |

■ Operation chart

The following chart (Fig.9.13) shows the operation timing for speed-position switching control (INC mode). The "in speed control flag" ([Md.31] Status: b0) is turned ON during speed control of speed-position switching control (INC mode).

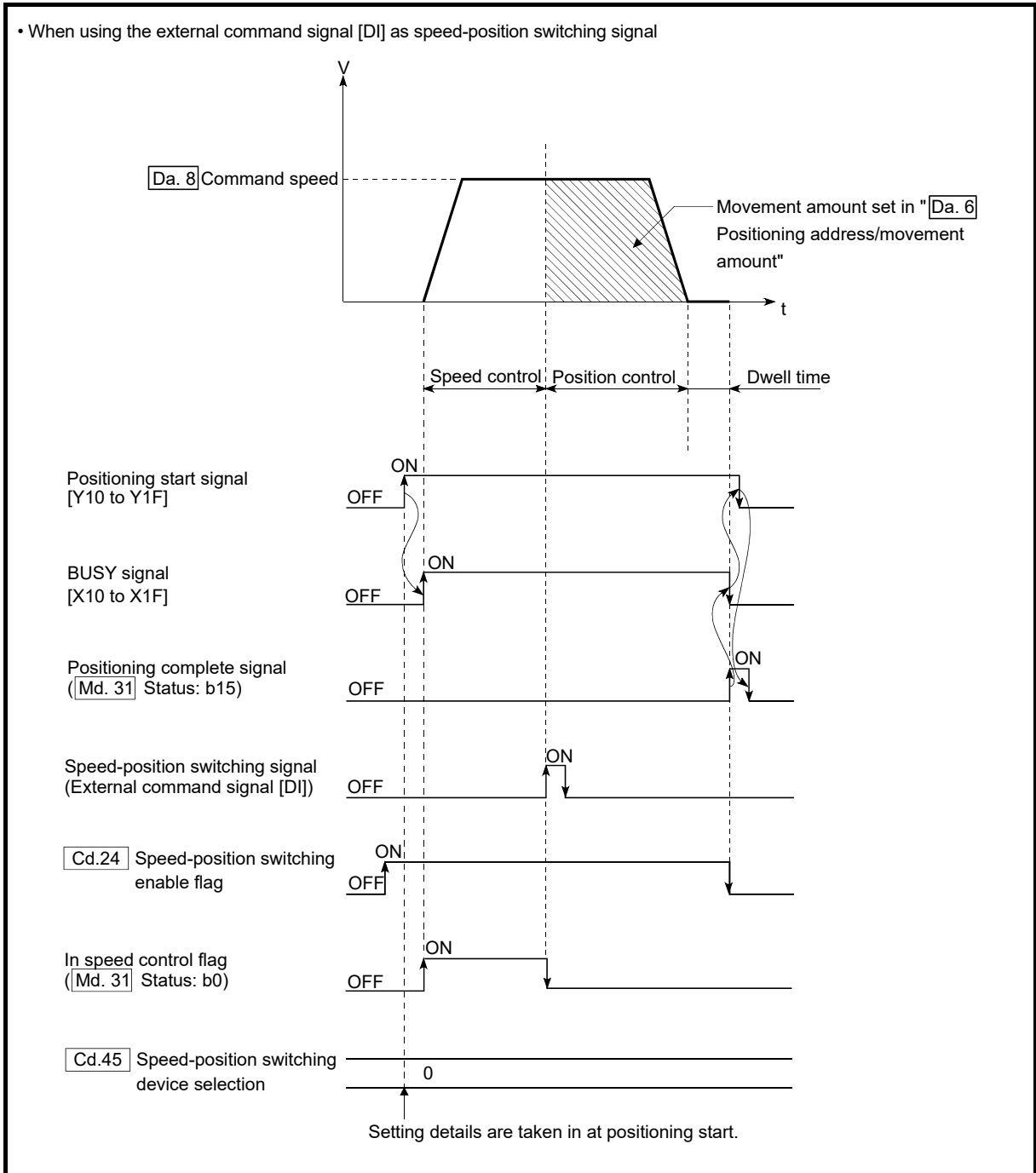
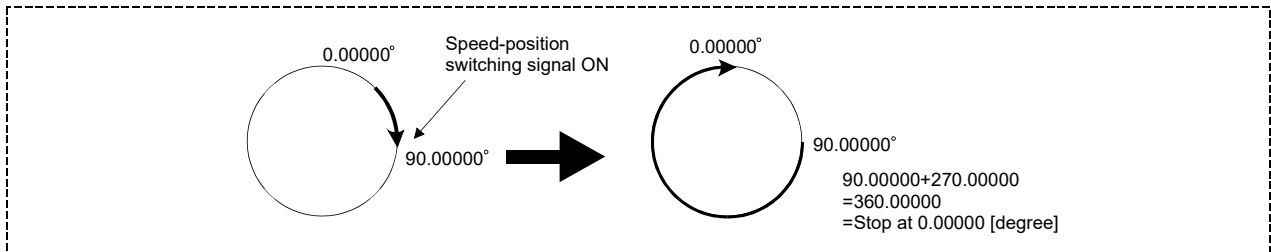

Fig. 9.13 Speed-position switching control (INC mode) operation timing

[Operation example]

The following operation assumes that the speed-position switching signal is input at the position of the feed current value of 90.00000 [degree] during execution of "[Da.2] Control method" "Forward run: speed/position" at "[Pr.1] Unit setting" of "2: degree" and "[Pr.21] Feed current value during speed control" setting of "1: Update feed current value".

(The value set in "[Da.6] Positioning address/movement amount" is 270.00000 [degree])



■ Operation timing and processing time during speed-position switching control (INC mode)

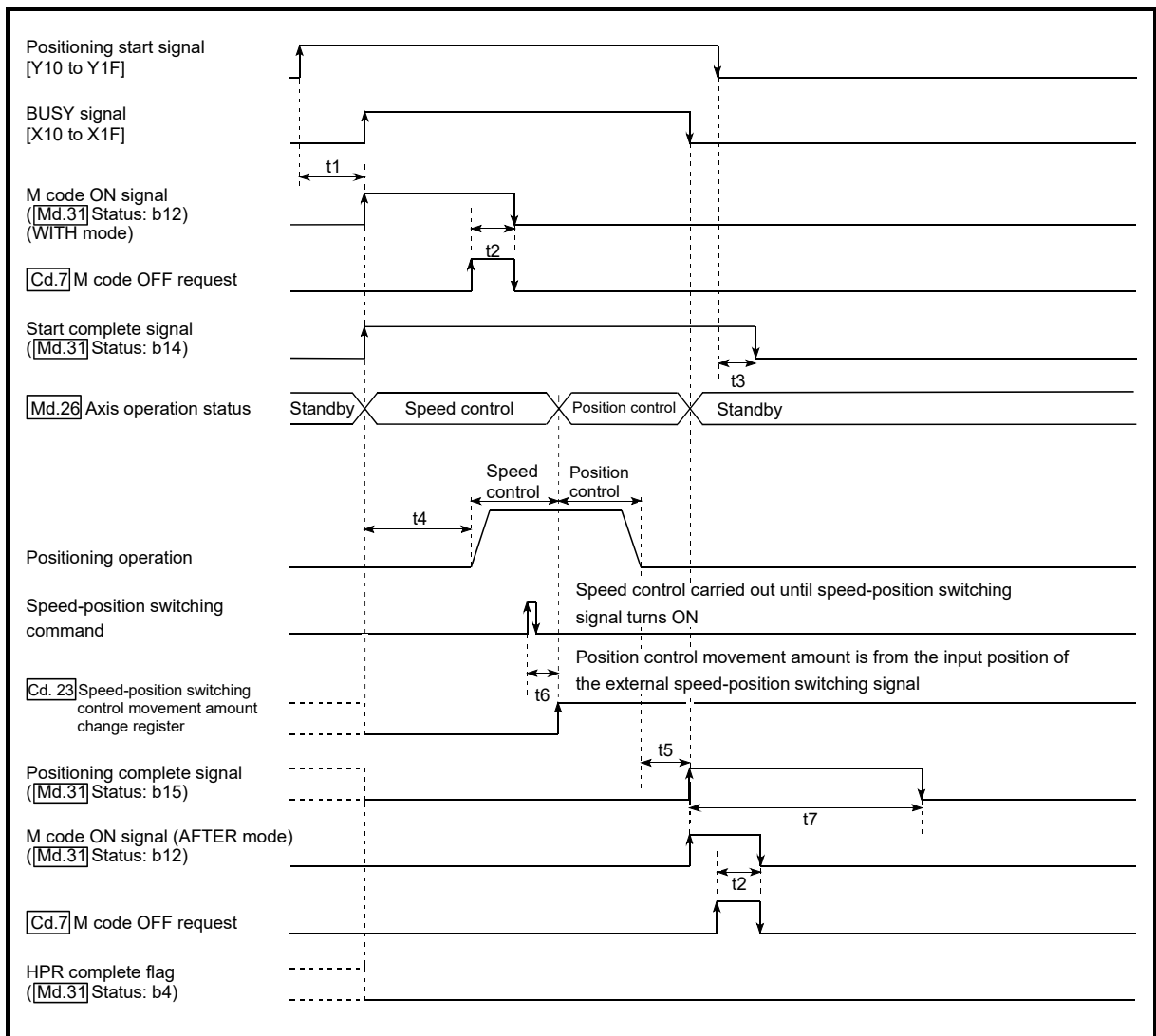

Fig. 9.14 Operation timing and processing time during speed-position switching control (INC mode)

Normal timing time

Unit: [ms]

| [Pr.132] Communication mode setting | Operation cycle | t1 | t2 | t3 | t4 | t5 | t6 | t7 |
|---|-----------------|------------|----------|----------|--------------|----------|------------|--------------------|
| MR-J4-B-RJ010 communication mode | 0.88 | 0.9 to 1.6 | 0 to 0.9 | 0 to 0.9 | 2.7 to 3.5 | 0 to 0.9 | 0.1 to 0.2 | Follows parameters |
| | 1.77 | 1.0 to 2.0 | 0 to 1.8 | 0 to 1.8 | 4.5 to 6.5 | 0 to 1.8 | 0.1 to 0.2 | Follows parameters |
| | 3.55 | 1.0 to 3.4 | 0 to 3.6 | 0 to 3.6 | 10.6 to 12.6 | 0 to 3.6 | 0.1 to 0.2 | Follows parameters |
| Communication mode correspond to CiA402 | 1.00 | 0.9 to 1.8 | 0 to 1.0 | 0 to 1.0 | 2.7 to 3.5 | 0 to 1.0 | 0.1 to 0.2 | Follows parameters |
| | 2.00 | 1.0 to 2.6 | 0 to 2.0 | 0 to 2.0 | 5.5 to 6.5 | 0 to 2.0 | 0.1 to 0.2 | Follows parameters |
| | 4.00 | 1.3 to 3.9 | 0 to 4.0 | 0 to 4.0 | 11.5 to 12.6 | 0 to 4.0 | 0.1 to 0.2 | Follows parameters |

- The t1 timing time could be delayed by the operation state of other axes.
- When using the proximity dog signal or "[Cd.46] Speed-position switching command", the t6 timing time could be delayed or vary influenced by the PLC scan time or communication with servo amplifier.

■ Feed current value during speed-position switching control (INC mode)

The following table shows the "[Md.20] Feed current value" during speed-position switching control (INC mode) corresponding to the "[Pr.21] Feed current value during speed control" settings.

| "[Pr.21] Feed current value during speed control" setting | [Md.20] Feed current value |
|---|---|
| 0: Do not update feed current value | The feed current value at control start is maintained during speed control, and updated from the switching to position control. |
| 1: Update feed current value | The feed current value is updated during speed control and position control. |
| 2: Zero clear feed current value | The feed current value is cleared (set to "0") at control start, and updated from the switching to position control. |

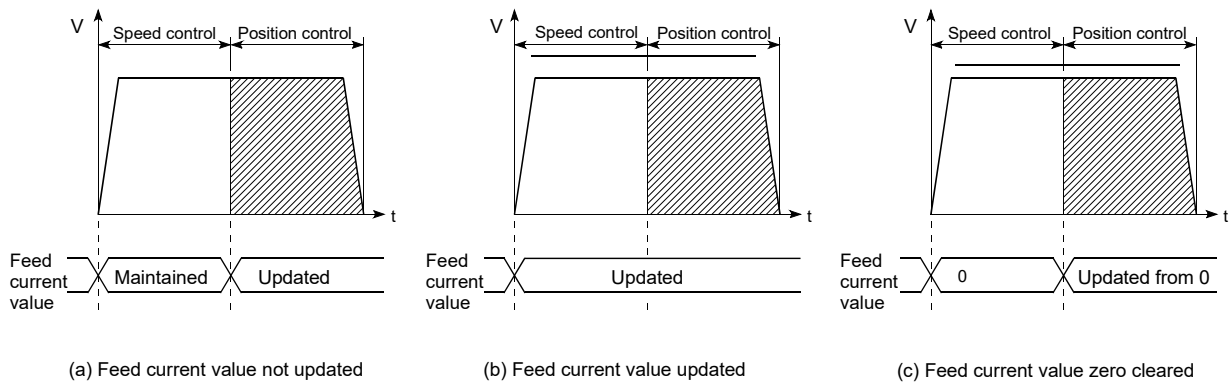

■ Switching time from speed control to position control

There is 1ms from the time the speed-position switching signal is turned ON to the time the speed-position switching latch flag ([Md.31] Status: b1) turns ON.

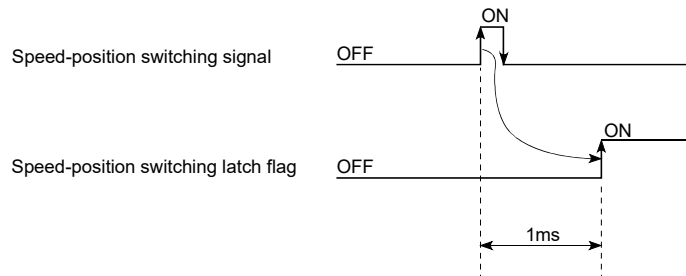

■ Speed-position switching signal setting

(1) The following table shows the items that must be set to use the external command signals [DI] as speed-position switching signals.

| Setting item | Setting value | Setting details | Buffer memory address |
|---|---------------|---|-----------------------|
| [Pr.42] External command function selection | 2 | Speed-position, position-speed switching request. | 62+150n |
| [Cd.8] External command valid | 1 | Validates an external command. | 4305+100n |
| [Cd.45] Speed-position switching device selection | 0 | Use the external command signal for switching from speed control to position control. | 4366+100n |

(Note): Set the external command signal [DI] in "[Pr.95] External command signal selection". Refer to Section 5.2 "List of parameters" and Section 5.7 "List of control data" for information on the setting details.

(2) The following table shows the items that must be set to use the proximity dog signal (DOG) as speed-position switching signals.

| Setting item | | Setting value | Setting details | Buffer memory address |
|--------------|---|---------------|---|-----------------------|
| [Cd.45] | Speed-position switching device selection | 1 | Use the proximity dog signal for switching from speed control to position control | 4366+100n |

(Note): The setting is not required for "[Pr.42] External command function selection" and "[Cd.8] External command valid".

Refer to Section 5.7 "List of control data" for information on the setting details.

(3) The following table shows the items that must be set to use "[Cd.46] Speed-position switching command" as speed-position switching signals.

| Setting item | | Setting value | Setting details | Buffer memory address |
|--------------|---|---------------|---|-----------------------|
| [Cd.45] | Speed-position switching device selection | 2 | Use the "[Cd.46] Speed-position switching command" for switching from speed control to position control | 4366+100n |

(Note): The setting is not required for "[Pr.42] External command function selection" and "[Cd.8] External command valid".

Refer to Section 5.7 "List of control data" for information on the setting details.

■ Changing the position control movement amount

In "speed-position switching control (INC mode)", the position control movement amount can be changed during the speed control section.

- (1) The position control movement amount can be changed during the speed control section of speed-position switching control (INC mode).

A movement amount change request will be ignored unless issued during the speed control section of the speed-position switching control (INC mode).

- (2) The "new movement amount" is stored in "[Cd.23] Speed-position switching control movement amount change register" by the sequence program during speed control.

When the speed-position switching signal is turned ON, the movement amount for position control is stored in "[Cd.23] Speed-position switching control movement amount change register".

- (3) The movement amount is stored in the "[Md.29] Speed-position switching control positioning movement amount" of the axis monitor area from the point where the control changes to position control by the input of a speed-position switching signal from an external device.

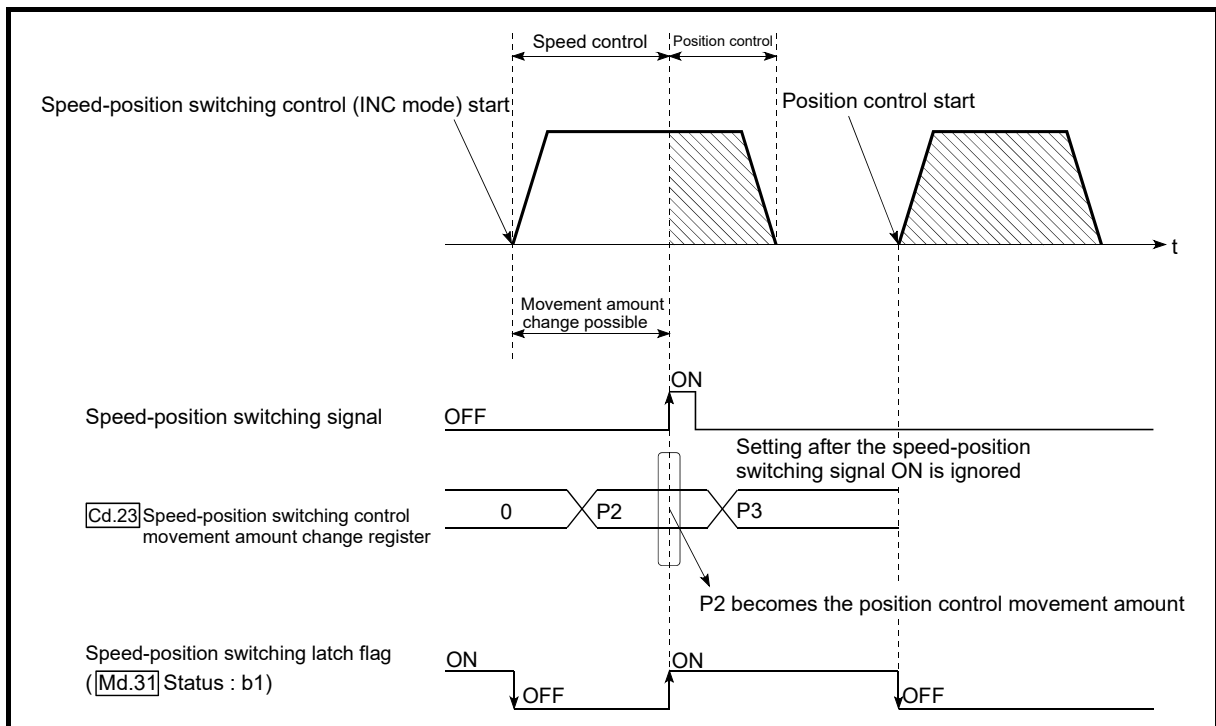

Fig. 9.15 Position control movement amount change timing

POINT

- The machine recognizes the presence of a movement amount change request when the data is written to "[Cd.23] Speed-position switching control movement amount change register" with the sequence program.
- The new movement amount is validated after execution of the speed-position switching control (INC mode), before the input of the speed-position switching signal.
- The movement amount change can be enable/disable with the interlock function in position control using the "speed-position switching latch flag" ([Md.31] Status: b1) of the axis monitor area.

■ Restrictions

- (1) The error "Continuous path control not possible" (error code: 516) will occur and the operation cannot start if "continuous positioning control" or "continuous path control" is set in "[Da.1] Operation pattern".
- (2) "Speed-position switching control" cannot be set in "[Da.2] Control method" of the positioning data when "continuous path control" has been set in "[Da.1] Operation pattern" of the immediately prior positioning data. (For example, if the operation pattern of positioning data No. 1 is "continuous path control", "speed-position switching control" cannot be set in positioning data No. 2.) The error "Continuous path control not possible" (error code: 516) will occur and the machine will carry out a deceleration stop if this type of setting is carried out.
- (3) The error "No command speed" (error code: 503) will occur if "current speed (-1)" is set in "[Da.8] Command speed".
- (4) The software stroke limit range check during speed control is made only when the following (a) and (b) are satisfied:
 - (a) "[Pr.21] Feed current value during speed control" is "1: Update feed current value".
If the movement amount exceeds the software stroke limit range during speed control in case of the setting of other than "1: Update feed current value", the error "Software stroke limit +" (error code: 507) or "Software stroke limit -" (error code: 508) will occur as soon as speed control is changed to position control and the axis will decelerate to a stop.
 - (b) When "[Pr.1] Unit setting" is other than "2: degree"
If the unit is "degree", the software stroke limit range check is not performed.
- (5) If the value set in "[Da.6] Positioning address/movement amount" is negative, the error "Outside address range" (error code: 530) will occur.
- (6) Deceleration processing is carried out from the point where the speed-position switching signal is input if the position control movement amount set in "[Da.6] Positioning address/movement amount" is smaller than the deceleration distance from the "[Da.8] Command speed".
- (7) Turn ON the speed-position switching signal in the speed stabilization region (constant speed status). The warning "Speed-position switching (during acceleration) signal ON" (warning code: 508) will occur because of large deviation in the droop pulse amount if the signal is turned ON during acceleration.
During use of the servo motor, the movement amount is "[Da.6] Positioning address/movement amount" from the assumed motor position based on "[Md.101] Real current value" at switching of speed control to position control. Therefore, if the signal is turned ON during acceleration/deceleration, the stop position will vary due to large variation of the droop pulse amount. Even though "[Md.29] Speed-position switching control positioning movement amount" is the same, the stop position will change due to a change in droop pulse amount when "[Da.8] Command speed" is different.

■ Positioning data setting examples

[When "speed-position switching control (INC mode) by forward run" is set in positioning data No. 1 of axis 1]

| Setting item | | Setting example | Setting details |
|-------------------------------|--|-----------------------------|---|
| Axis 1 Positioning data No. 1 | [Da.1] Operation pattern | Positioning complete | Set "Positioning complete" assuming the next positioning data will not be executed. ("Continuous path control" cannot be set in "speed-position switching control (INC mode)".) |
| | [Da.2] Control method | Forward run: speed/position | Set speed-position switching control by forward run. |
| | [Da.3] Acceleration time No. | 1 | Designate the value set in "[Pr.25] Acceleration time 1" as the acceleration time at start. |
| | [Da.4] Deceleration time No. | 0 | Designate the value set in "[Pr.10] Deceleration time 0" as the deceleration time at deceleration. |
| | [Da.6] Positioning address/movement amount | 10000.0μm | INC mode ([Pr.81] = 0) Set the movement amount after the switching to position control. (Assuming that the "[Pr.1] Unit setting" is set to "mm".) |
| | [Da.7] Arc address | – | Setting not required. (Setting value is ignored.) |
| | [Da.8] Command speed | 6000.00mm/min | Set the speed to be controlled. |
| | [Da.9] Dwell time/JUMP destination positioning data No. | 500ms | Set a time from the positioning stop (command stop) by position control until the positioning complete signal is output. When the system is stopped by speed control, ignore the setting value. |
| | [Da.10] M code/Condition data No./Number of LOOP to LEND repetitions | 10 | Set this when other sub operation commands are issued in combination with the No.1 positioning data. |
| | [Da.20] Axis to be interpolated No.1 | – | Setting not required (setting value is ignored). |
| | [Da.21] Axis to be interpolated No.2 | – | |
| | [Da.22] Axis to be interpolated No.3 | – | |

(Note): Refer to Section 5.3 "List of positioning data" for information on the setting details.

9.2.17 Speed-position switching control (ABS mode)

In case of "speed-position switching control (ABS mode)" ("[Da.2] Control method" = Forward run: speed/position, Reverse run: speed/position), the pulses of the speed set in "[Da.8] Command speed" are kept output in the axial direction set to the positioning data. When the "speed-position switching signal" is input, position control to the address set in "[Da.6] Positioning address/movement amount" is exercised.

"Speed-position switching control (ABS mode)" is available in two different types: "forward run: speed/position" which starts the axis in the forward run direction and "reverse run: speed/position" which starts the axis in the reverse run direction.

"Speed-position switching control (ABS mode)" is valid only when "[Pr.1] Unit setting" is "2: degree".

| | | | | |
|-----------------------------------|----|------|--------|-----|
| [Pr.1] Unit setting | mm | inch | degree | PLS |
| Speed-position function selection | | | | |
| INC mode | ○ | ○ | ○ | ○ |
| ABS mode | × | × | ○ | × |

○: Setting allowed,

×: Setting disallowed (If setting is made, the error "Speed-position function selection error" (error code: 935) will occur when the PLC READY signal [Y0] turns ON.)

Use the detailed parameter 1 "[Pr.81] Speed-position function selection" to choose "speed-position switching control (ABS mode)".

| Setting item | | Setting value | Setting details | Buffer memory address |
|--------------|-----------------------------------|---------------|---|-----------------------|
| [Pr.81] | Speed-position function selection | 2 | Speed-position switching control (ABS mode) | 34+150n |

(Note): If the set value is other than 0 and 2, it is regarded as 0 and operation is performed in the INC mode.

For details of the setting, refer to Section 5.2 "List of parameters".

■ Switching over from speed control to position control

- (1) The control is selected the switching method from speed control to position control by the setting value of "[Cd.45] Speed-position switching device selection".

| Setting item | | Setting value | Setting details | Buffer memory address |
|--------------|---|---------------|--|-----------------------|
| [Cd.45] | Speed-position switching device selection | → | The device used for speed-position switching is selected. 0: Use the external command signal for switching from speed control to position control 1: Use the proximity signal for switching from speed control to position control 2: Use the "[Cd.46] Speed-position switching command" for switching from speed control to position control | 4366+100n |

The switching is performed by using the following device when "2" is set.

| Setting item | | Setting value | Setting details | Buffer memory address |
|--------------|----------------------------------|---------------|--|-----------------------|
| [Cd.46] | Speed-position switching command | 1 | 1: Switch from speed control to position control | 4367+100n |

- (2) "[Cd.24] Speed-position switching enable flag" must be turned ON to switch over from speed control to position control. (If the "[Cd.24] Speed-position switching enable flag" turns ON after the speed-position switching signal turns ON, the control will continue as speed control without switching over to position control. The control will be switched over from speed control to position control when the speed-position switching signal turns from OFF to ON again. Only position control will be carried out when the "[Cd.24] Speed-position switching enable flag" and speed-position switching signal are ON at the operation start.)

| Setting item | | Setting value | Setting details | Buffer memory address |
|--------------|--------------------------------------|---------------|--|-----------------------|
| [Cd.24] | Speed-position switching enable flag | 1 | Speed control will be taken over by position control when the external command signal [DI] comes ON. | 4328+100n |

■ Operation chart

The following chart (Fig.9.16) shows the operation timing for speed-position switching control (ABS mode). The "in speed control flag" ([Md.31] Status: b0) is turned ON during speed control of speed-position switching control (ABS mode).

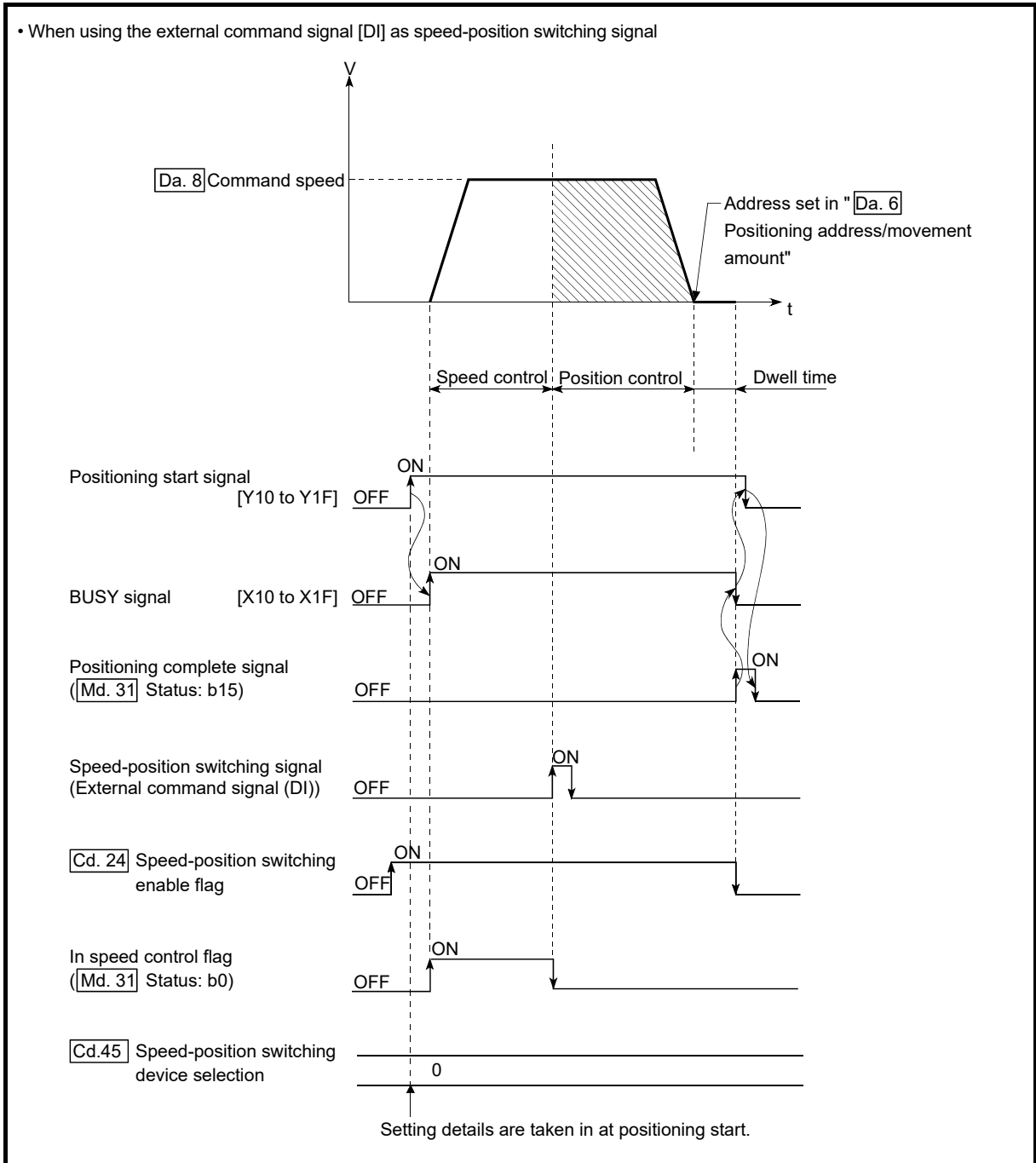
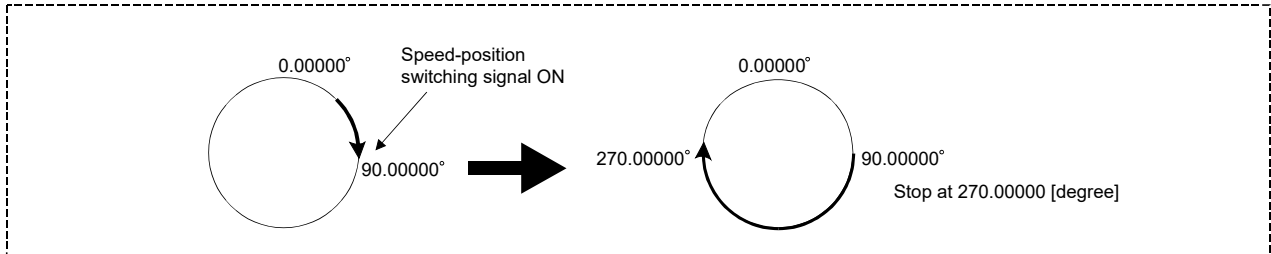

Fig. 9.16 Speed-position switching control (ABS mode) operation timing

[Operation example]

The following operation assumes that the speed-position switching signal is input at the position of the feed current value of 90.00000 [degree] during execution of "[Da.2] Control method" "Forward run: speed/position" at "[Pr.1] Unit setting" of "2: degree" and "[Pr.21] Feed current value during speed control" setting of "1: Update feed current value".

(The value set in "[Da.6] Positioning address/movement amount" is 270.00000 [degree])



■ Operation timing and processing time during speed-position switching control (ABS mode)

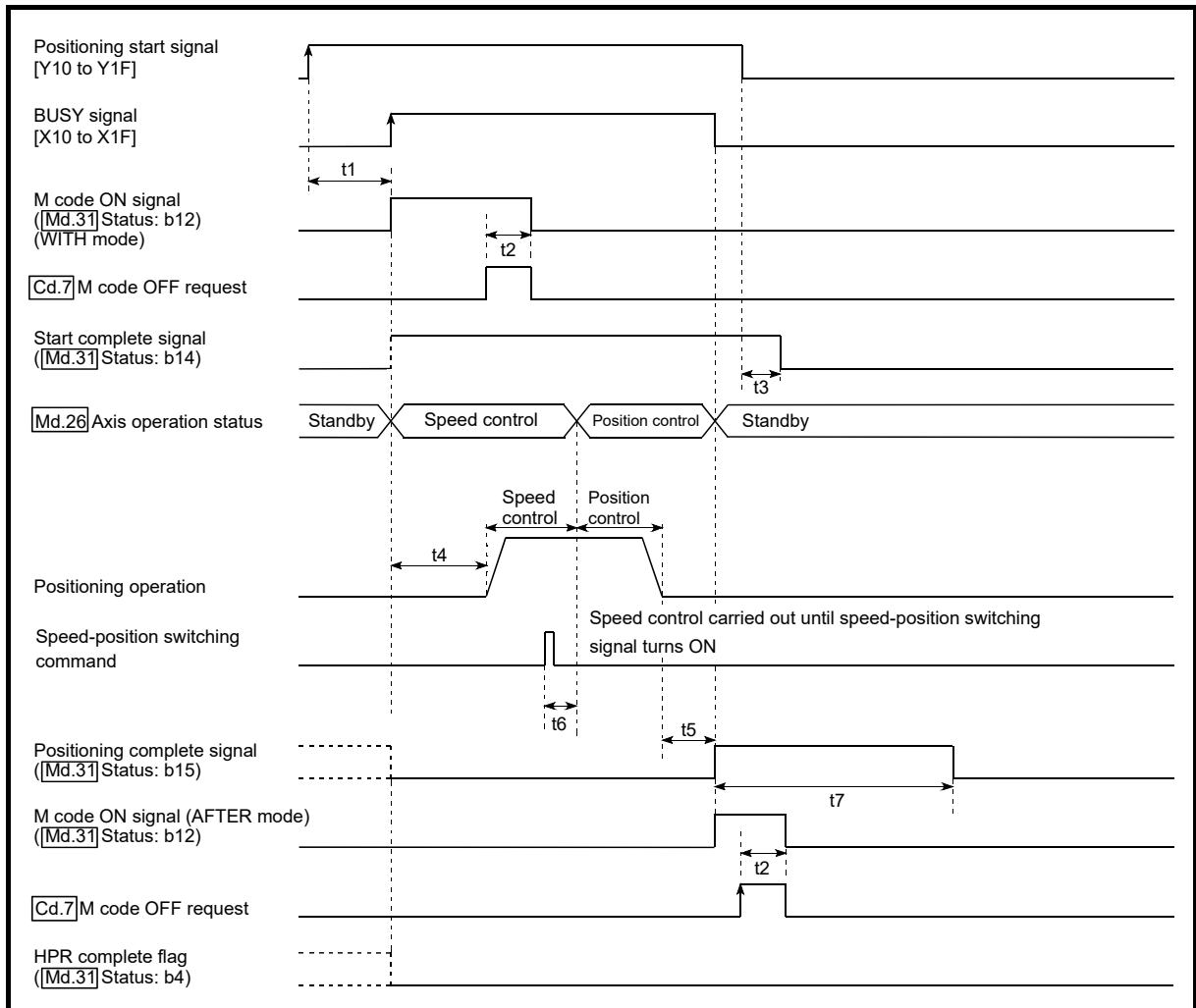

Fig. 9.17 Operation timing and processing time during speed-position switching control (ABS mode)

Normal timing time

Unit: [ms]

| [Pr.132] Communication mode setting | Operation cycle | t1 | t2 | t3 | t4 | t5 | t6 | t7 |
|--|--------------------|------------|----------|----------|----------------|----------|------------|-----------------------|
| MR-J4-B-RJ010 communication mode | 0.88 | 0.8 to 1.4 | 0 to 0.9 | 0 to 0.9 | 2.7 to 3.2 | 0 to 0.9 | 0.1 to 0.2 | Follows parameters |
| | 1.77 | 0.8 to 2.5 | 0 to 1.8 | 0 to 1.8 | 3.7 to 6.9 | 0 to 1.8 | 0.1 to 0.2 | Follows parameters |
| | 3.55 | 0.8 to 3.2 | 0 to 3.6 | 0 to 3.6 | 9.4 to 13.0 | 0 to 3.6 | 0.1 to 0.2 | Follows parameters |
| Communication mode correspond to CiA402 | 1.00 | 0.8 to 1.7 | 0 to 1.0 | 0 to 1.0 | 2.7 to 3.2 | 0 to 1.0 | 0.1 to 0.2 | Follows parameters |
| | 2.00 | 1.0 to 2.5 | 0 to 2.0 | 0 to 2.0 | 5.5 to 6.9 | 0 to 2.0 | 0.1 to 0.2 | Follows parameters |
| | 4.00 | 1.2 to 4.7 | 0 to 4.0 | 0 to 4.0 | 7.6 to 11.7 | 0 to 4.0 | 0.1 to 0.2 | Follows parameters |

- The t1 timing time could be delayed by the operation state of other axes.
- When using the proximity dog signal and "[Cd.46] Speed-position switching command", the t6 timing time could be delayed or vary influenced by the PLC scan time or communication with servo amplifier.

■ Feed current value during speed-position switching control (ABS mode)

The following table shows the "[Md.20] Feed current value" during speed-position switching control (ABS mode) corresponding to the "[Pr.21] Feed current value during speed control" settings.

| "[Pr.21] Feed current value during speed control" setting | [Md.20] Feed current value |
|---|--|
| 1: Update feed current value | The feed current value is updated during speed control and position control. |

Only "1: Update current value" is valid for the setting of "[Pr.21] Feed current value during speed control" in speed-position switching control (ABS mode).

The error "Speed-position function selection error" (error code: 935) will occur if the "[Pr.21] Feed current value during speed control" setting is other than 1.

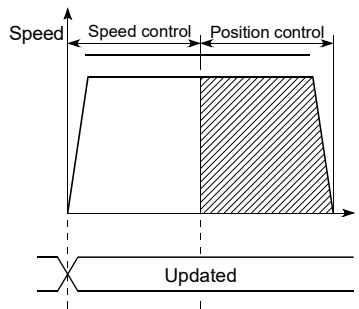

Feed current value updated

■ Switching time from speed control to position control

There is 1ms from the time the speed-position switching signal is turned ON to the time the speed-position switching latch flag ([Md.31] Status: b1) turns ON.

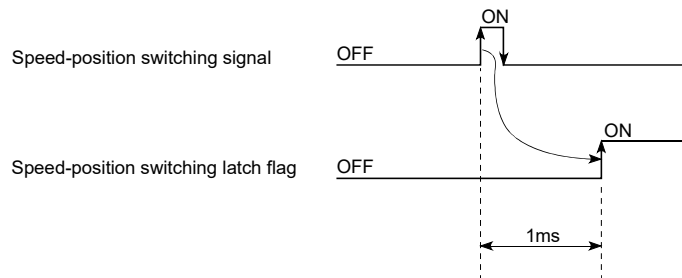

■ Speed-position switching signal setting

- (1) The following table shows the items that must be set to use the external command signals [DI] as speed-position switching signals.

| Setting item | | Setting value | Setting details | Buffer memory address |
|--------------|---|---------------|---|-----------------------|
| [Pr.42] | External command function selection | 2 | Speed-position, position-speed switching request. | 62+150n |
| [Cd.8] | External command valid | 1 | Validates an external command. | 4305+100n |
| [Cd.45] | Speed-position switching device selection | 0 | Use the external command signal for switching from speed control to position control. | 4366+100n |

(Note): Set the external command signal [DI] in "[Pr.95] External command signal selection".

Refer to Section 5.2 "List of parameters" and Section 5.7 "List of control data" for information on the setting details.

- (2) The following table shows the items that must be set to use the proximity dog signal (DOG) as speed-position switching signals.

| Setting item | | Setting value | Setting details | Buffer memory address |
|--------------|---|---------------|--|-----------------------|
| [Cd.45] | Speed-position switching device selection | 1 | Use the proximity dog signal for switching from speed control to position control. | 4366+100n |

(Note): The setting is not required for "[Pr.42] External command function selection" and "[Cd.8] External command valid".

Refer to Section 5.7 "List of control data" for information on the setting details.

- (3) The following table shows the items that must be set to use "[Cd.46] Speed-position switching command" as speed-position switching signals.

| Setting item | | Setting value | Setting details | Buffer memory address |
|--------------|---|---------------|--|-----------------------|
| [Cd.45] | Speed-position switching device selection | 2 | Use the "[Cd.46] Speed-position switching command" for switching from speed control to position control. | 4366+100n |

(Note): The setting is not required for "[Pr.42] External command function selection" and "[Cd.8] External command valid".

Refer to Section 5.7 "List of control data" for information on the setting details.

■ Restrictions

- (1) The error "Continuous path control not possible" (error code: 516) will occur and the operation cannot start if "continuous positioning control" or "continuous path control" is set in "[Da.1] Operation pattern".
- (2) "Speed-position switching control" cannot be set in "[Da.2] Control method" of the positioning data when "continuous path control" has been set in "[Da.1] Operation pattern" of the immediately prior positioning data. (For example, if the operation pattern of positioning data No. 1 is "continuous path control", "speed-position switching control" cannot be set in positioning data No. 2.) The error "Continuous path control not possible" (error code: 516) will occur and the machine will carry out a deceleration stop if this type of setting is carried out.
- (3) The error "No command speed" (error code: 503) will occur if "current speed (-1)" is set in "[Da.8] Command speed".
- (4) If the value set in "[Da.6] Positioning address/movement amount" is negative, the error "Outside address range" (error code: 530) will occur.
- (5) Even though the axis control data "[Cd.23] Speed-position switching control movement amount change register" was set in speed-position switching control (ABS mode), it would not function. The set value is ignored.
- (6) To exercise speed-position switching control (ABS mode), the following conditions must be satisfied:
 - (a) "[Pr.1] Unit setting" is "2: degree"
 - (b) The software stroke limit function is invalid (upper limit value = lower limit value)
 - (c) "[Pr.21] Feed current value during speed control" is "1: Update feed current value"
 - (d) The "[Da.6] Positioning address/movement amount" setting range is 0 to 359.99999 (degree)
If the value is outside of the range 0 to 359.99999 (degree), the error "Outside address range" (error code: 530) will occur at a start.
 - (e) The "[Pr.81] Speed-position function selection" setting is "2: Speed-position switching control (ABS mode)".
- (7) If any of the conditions in (6) (a) to (6) (c) is not satisfied in the case of (6) (e), the error "Speed-position function selection error" (error code: 935) will occur when the PLC READY signal [Y0] turns from OFF to ON.
- (8) If the axis reaches the positioning address midway through deceleration after automatic deceleration started at the input of the speed-position switching signal, the axis will not stop immediately at the positioning address. The axis will stop at the positioning address after N revolutions so that automatic deceleration can always be made. (N: Natural number)
In the following example, since making deceleration in the path of dotted line will cause the axis to exceed the positioning addresses twice, the axis will decelerate to a stop at the third positioning address.

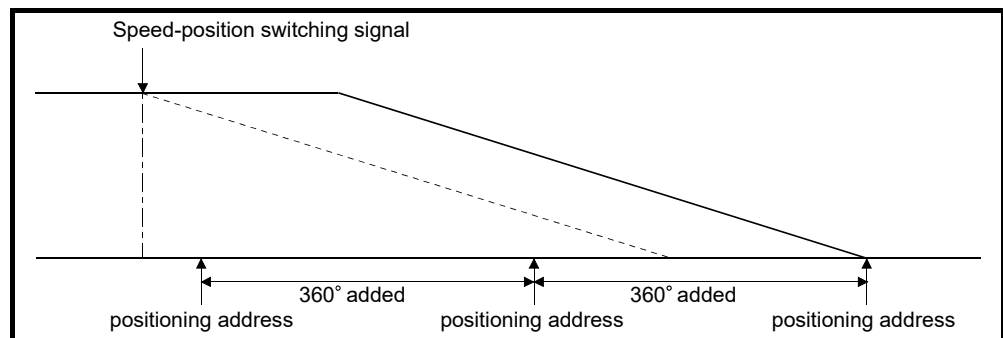

■ Positioning data setting examples

[When "speed-position switching control (ABS mode) by forward run" is set in positioning data No. 1 of axis 1]

| Setting item | | Setting example | Setting details |
|-------------------------------|---|--------------------------------|--|
| Axis 1 Positioning data No. 1 | [Da.1] Operation pattern | Positioning complete | Set "Positioning complete" assuming the next positioning data will not be executed. ("Continuous path control" cannot be set in "speed-position switching control (ABS mode)".) |
| | [Da.2] Control method | Forward run: speed/position | Set speed-position switching control by forward run. |
| | [Da.3] Acceleration time No. | 1 | Designate the value set in "[Pr.25] Acceleration time 1" as the acceleration time at start. |
| | [Da.4] Deceleration time No. | 0 | Designate the value set in "[Pr.10] Deceleration time 0" as the deceleration time at deceleration. |
| | [Da.6] Positioning address/ movement amount | 270.00000degree | ABS mode ([Pr.81] = 2) Set the address after the switching to position control. (Assuming that the "[Pr.1] Unit setting" is set to "degree".) |
| | [Da.7] Arc address | – | Setting not required. (Setting value is ignored.) |
| | [Da.8] Command speed | 6000.000degree/min | Set the speed to be controlled. |
| | [Da.9] Dwell time/JUMP destination positioning data No. | 500ms | Set a time from the positioning stop (command stop) by position control until the positioning complete signal is output. When the system is stopped by speed control, ignore the setting value. |
| | [Da.10] M code/Condition data No./Number of LOOP to LEND repetitions | 10 | Set this when other sub operation commands are issued in combination with the No. 1 positioning data. |
| | [Da.20] Axis to be interpolated No.1 | – | Setting not required (setting value is ignored). |
| | [Da.21] Axis to be interpolated No.2 | – | |
| | [Da.22] Axis to be interpolated No.3 | – | |

(Note): Refer to Section 5.3 "List of positioning data" for information on the setting details.

9.2.18 Position-speed switching control

In "position-speed switching control" ("[Da.2] Control method" = Forward run: position/speed, Reverse run: position/speed), before the position-speed switching signal is input, position control is carried out for the movement amount set in "[Da.6] Positioning address/movement amount" in the axis direction in which the positioning data has been set. When the position-speed switching signal is input, the position control is carried out by continuously outputting the pulses for the speed set in "[Da.8] Command speed" until the input of a stop command.

The two types of position-speed switching control are "Forward run: position/speed" in which the control starts in the forward run direction, and "Reverse run: position/speed" in which control starts in the reverse run direction.

■ Switching over from position control to speed control

- (1) The control is selected the switching method from position control to speed control by the setting value of "[Cd.45] Speed-position switching device selection".

| Setting item | | Setting value | Setting details | Buffer memory address |
|--------------|---|---------------|---|-----------------------|
| [Cd.45] | Speed-position switching device selection | → | <p>The device used for speed-position switching is selected.</p> <p>0: Use the external command signal for switching from position control to speed control</p> <p>1: Use the proximity signal for switching from position control to speed control</p> <p>2: Use the "[Cd.46] Speed-position switching command" for switching from position control to speed control</p> | 4366+100n |

The switching is performed by using the following device when "2" is set.

| Setting item | | Setting value | Setting details | Buffer memory address |
|--------------|----------------------------------|---------------|--|-----------------------|
| [Cd.46] | Speed-position switching command | 1 | 1: Switch from position control to speed control | 4367+100n |

- (2) "[Cd.26] Position-speed switching enable flag" must be turned ON to switch over from position control to speed control. (If the "[Cd.26] Position-speed switching enable flag" turns ON after the position-speed switching signal turns ON, the control will continue as position control without switching over to speed control. The control will be switched over from position control to speed control when the position-speed switching signal turns from OFF to ON again. Only speed control will be carried out when the "[Cd.26] Position-speed switching enable flag" and position-speed switching signal are ON at the operation start.)

| Setting item | | Setting value | Setting details | Buffer memory address |
|--------------|--------------------------------------|---------------|--|-----------------------|
| [Cd.26] | Position-speed switching enable flag | 1 | Position control will be taken over by speed control when the external command signal [DI] comes ON. | 4332+100n |

■ Operation chart

The following chart shows the operation timing for position-speed switching control. The "in speed control" flag ([Md.31] Status: b0) is turned ON during speed control of position-speed switching control.

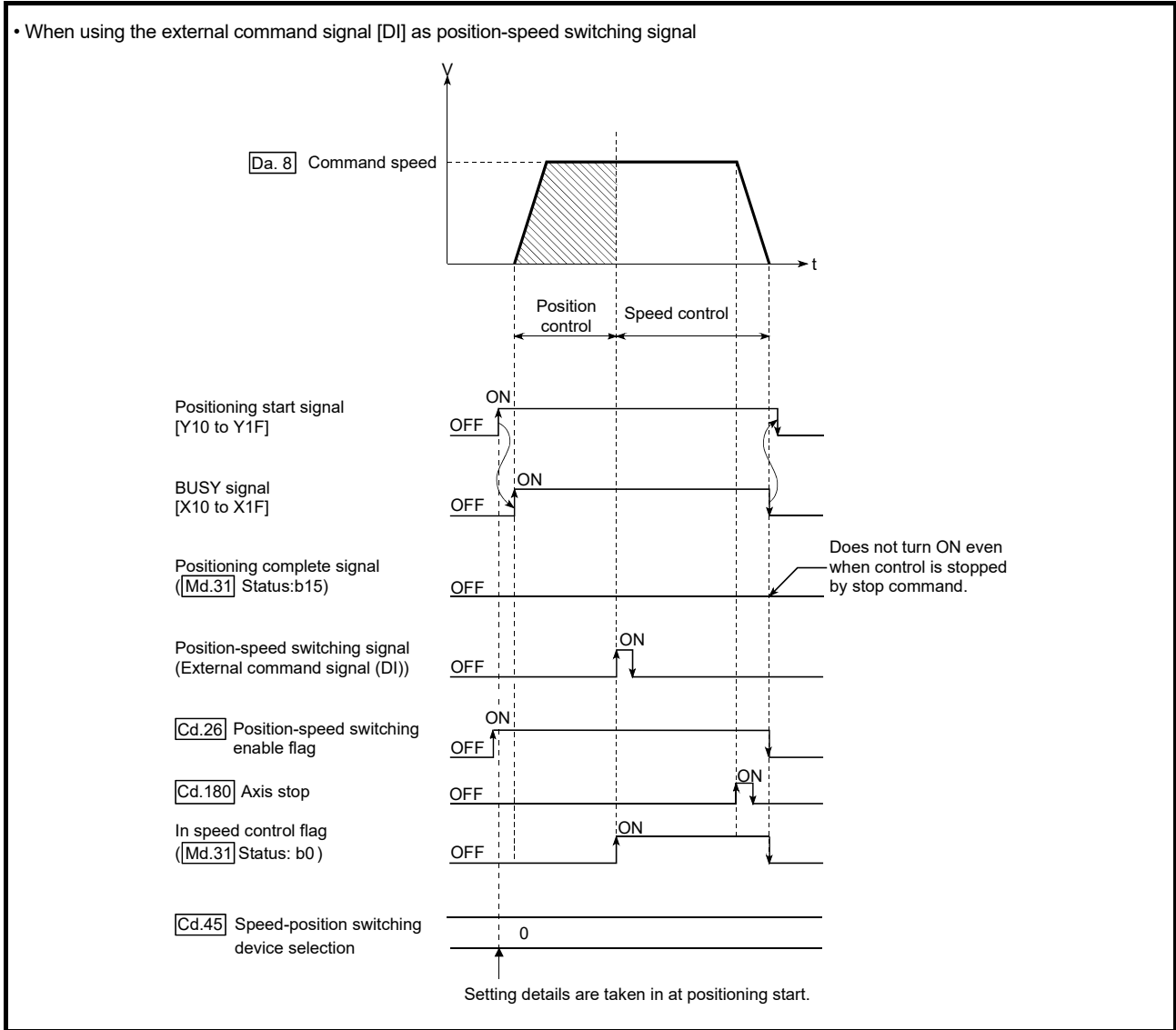

Fig. 9.18 Position-speed switching control operation timing

■ Operation timing and processing time during position-speed switching control

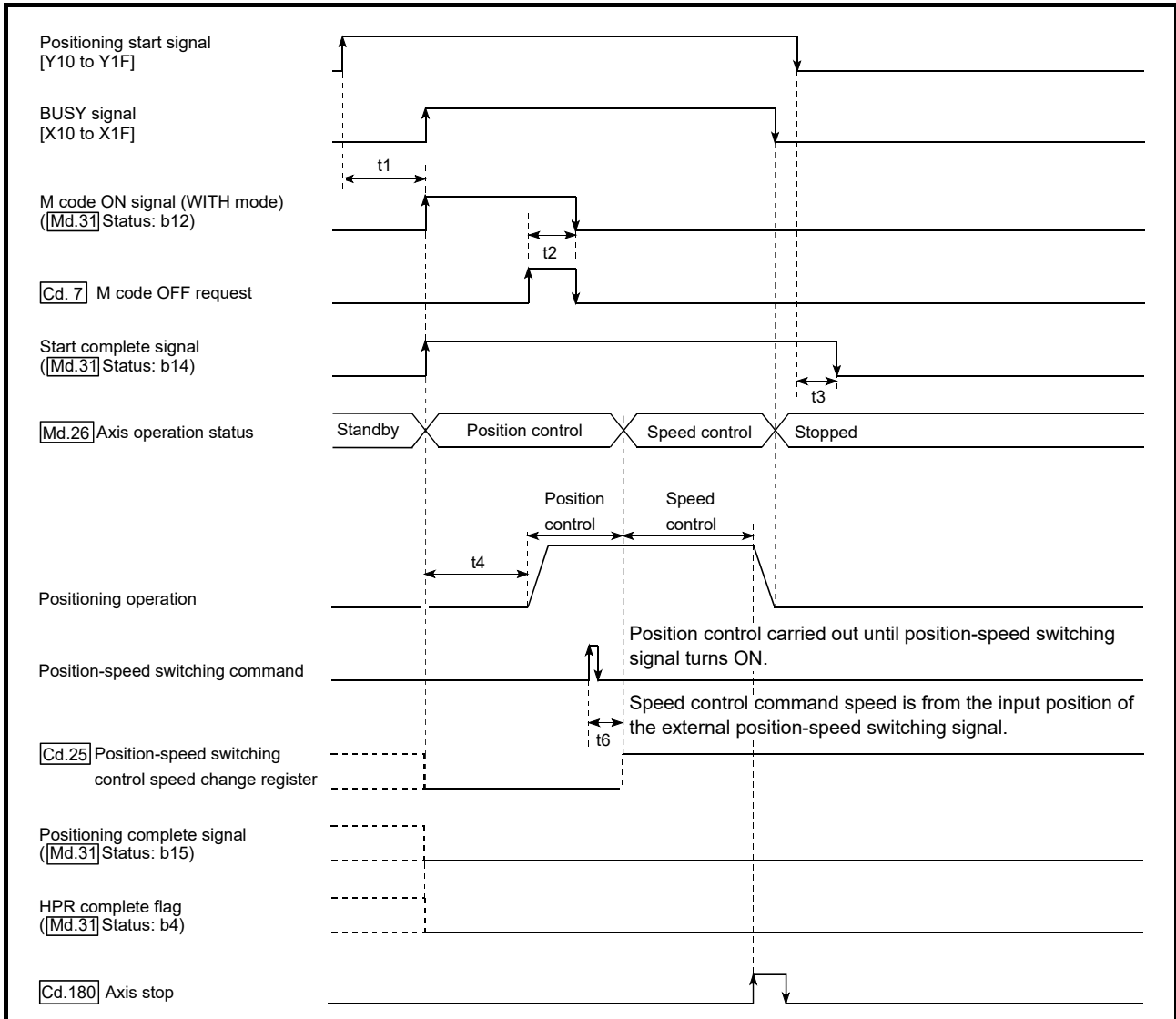

Fig. 9.19 Operation timing and processing time during position-speed switching control

Normal timing time

Unit: [ms]

| [Pr.132] Communication mode setting | Operation cycle | t1 | t2 | t3 | t4 | t5 | t6 |
|---|-----------------|------------|----------|----------|--------------|----|------------|
| MR-J4-B-RJ010 communication mode | 0.88 | 1.0 to 1.7 | 0 to 0.9 | 0 to 0.9 | 2.7 to 3.4 | – | 0.1 to 0.2 |
| | 1.77 | 1.1 to 2.5 | 0 to 1.8 | 0 to 1.8 | 5.6 to 6.9 | – | 0.1 to 0.2 |
| | 3.55 | 1.1 to 4.2 | 0 to 3.6 | 0 to 3.6 | 10.8 to 14.0 | – | 0.1 to 0.2 |
| Communication mode correspond to CiA402 | 1.00 | 1.0 to 1.9 | 0 to 1.0 | 0 to 1.0 | 2.7 to 3.4 | – | 0.1 to 0.2 |
| | 2.00 | 1.1 to 2.6 | 0 to 2.0 | 0 to 2.0 | 5.6 to 6.9 | – | 0.1 to 0.2 |
| | 4.00 | 1.1 to 4.2 | 0 to 4.0 | 0 to 4.0 | 11.4 to 14.0 | – | 0.1 to 0.2 |

- The t1 timing time could be delayed by the operation state of other axes.
- When using the proximity dog signal and "[Cd.46] Speed-position switching command", the t6 timing time could be delayed or vary influenced by the PLC scan time or communication with servo amplifier.

■ Feed current value during position-speed switching control

The following table shows the "[Md.20] Feed current value" during position-speed switching control corresponding to the "[Pr.21] Feed current value during speed control" settings.

| "[Pr.21] Feed current value during speed control" setting | [Md.20] Feed current value |
|---|--|
| 0: Do not update feed current value | The feed current value is updated during position control, and the feed current value at the time of switching is maintained as soon as position control is switched to speed control. |
| 1: Update feed current value | The feed current value is updated during position control and speed control. |
| 2: Zero clear feed current value | The feed current value is updated during position control, and the feed current value is cleared (to "0") as soon as position control is switched to speed control. |

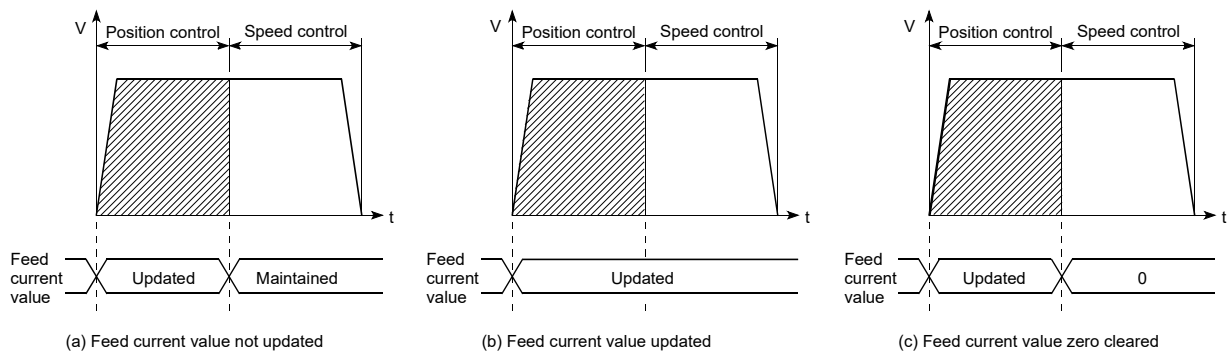

■ Switching time from position control to speed control

There is 1ms from the time the position-speed switching signal is turned ON to the time the position-speed switching latch flag ([Md.31] Status: b5) turns ON.



■ Position-speed switching signal setting

(1) The following table shows the items that must be set to use the external command signals [DI] as position-speed switching signals.

| Setting item | | Setting value | Setting details | Buffer memory address |
|--------------|---|---------------|---|-----------------------|
| [Pr.42] | External command function selection | 2 | Speed-position, position-speed switching request. | 62+150n |
| [Cd.8] | External command valid | 1 | Validates an external command. | 4305+100n |
| [Cd.45] | Speed-position switching device selection | 0 | Use the external command signal for switching from position control to speed control. | 4366+100n |

(Note): Set the external command signal [DI] in "[Pr.95] External command signal selection".

Refer to Section 5.2 "List of parameters" and Section 5.7 "List of control data" for information on the setting details.

(2) The following table shows the items that must be set to use the proximity dog signal (DOG) as position-speed switching signals.

| Setting item | | Setting value | Setting details | Buffer memory address |
|--------------|---|---------------|--|-----------------------|
| [Cd.45] | Speed-position switching device selection | 1 | Use the proximity dog signal for switching from position control to speed control. | 4366+100n |

(Note): The setting is not required for "[Pr.42] External command function selection" and "[Cd.8] External command valid".

Refer to Section 5.7 "List of control data" for information on the setting details.

(3) The following table shows the items that must be set to use "[Cd.46] Speed-position switching command" as position-speed switching signals.

| Setting item | | Setting value | Setting details | Buffer memory address |
|--------------|---|---------------|--|-----------------------|
| [Cd.45] | Speed-position switching device selection | 2 | Use the "[Cd.46] Speed-position switching command" for switching from position control to speed control. | 4366+100n |

(Note): The setting is not required for "[Pr.42] External command function selection" and "[Cd.8] External command valid".

Refer to Section 5.7 "List of control data" for information on the setting details.

■ Changing the speed control command speed

In "position-speed switching control", the speed control command speed can be changed during the position control.

- (1) The speed control command speed can be changed during the position control of position-speed switching control.

A command speed change request will be ignored unless issued during the position control of the position-speed switching control.

- (2) The "new command speed" is stored in "[Cd.25] Position-speed switching control speed change register" by the sequence program during position control.

This value then becomes the speed control command speed when the position-speed switching signal turns ON.

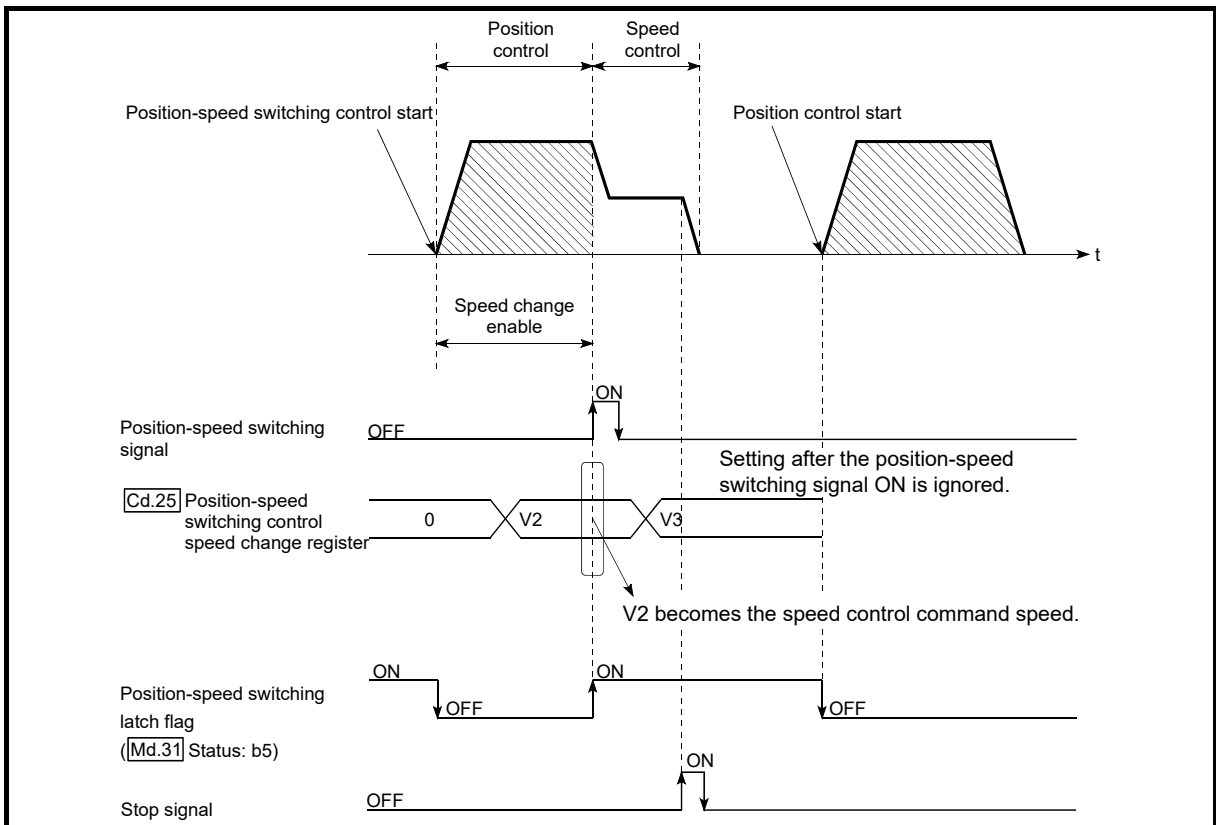

Fig. 9.20 Speed control speed change timing

POINTS

- The machine recognizes the presence of a command speed change request when the data is written to "[Cd.25] Position-speed switching control speed change register" with the sequence program.
- The new command speed is validated after execution of the position-speed switching control before the input of the position-speed switching signal.
- The command speed change can be enabled/disabled with the interlock function in speed control using the "position-speed switching latch flag" ([Md.31] Status: b5) of the axis monitor area.

■ Restrictions

- (1) The error "Continuous path control not possible" (error code: 516) will occur and the operation cannot start if "continuous positioning control" or "continuous path control" is set in "[Da.1] Operation pattern".
- (2) "Position-speed switching control" cannot be set in "[Da.2] Control method" of the positioning data when "continuous path control" has been set in "[Da.1] Operation pattern" of the immediately prior positioning data. (For example, if the operation pattern of positioning data No. 1 is "continuous path control", "position-speed switching control" cannot be set in positioning data No. 2.) The error "Continuous path control not possible" (error code: 516) will occur and the machine will carry out a deceleration stop if this type of setting is carried out.
- (3) The software stroke limit range is only checked during speed control if the "1: Update feed current value" is set in "[Pr.21] Feed current value during speed control".
The software stroke limit range is not checked when the control unit is set to "degree".
- (4) The error "Software stroke limit +" (error code: 507) or "Software stroke limit -" (error code: 508) will occur and the operation cannot start if the start point address or end point address for position control exceeds the software stroke limit range.
- (5) Deceleration stop will be carried out if the position-speed switching signal is not input before the machine is moved by a specified movement amount.
When the position-speed switching signal is input during automatic deceleration by positioning control, acceleration is carried out again to the command speed to continue speed control.
When the position-speed switching signal is input during deceleration to a stop with the stop signal, the control is switched to the speed control to stop the machine.
Restart is carried out by speed control using the restart command.
- (6) The warning "Speed limit value over" (warning code: 501) will occur and control is continued by "[Pr.8] Speed limit value" if a new speed exceeds "[Pr.8] Speed limit value" at the time of change of the command speed.
- (7) If the value set in "[Da.6] Positioning address/movement amount" is negative, the error "Outside address range" (error code: 530) will occur.
- (8) Set WITH mode in "[Pr.18] M code ON signal output timing" at M code use.
The M code will not be output, and the M code ON signal will not turn ON if the AFTER mode is set.

■ Positioning data setting examples

[When "position-speed switching control (forward run: position/speed)" is set in positioning data No. 1 of axis 1]

| Setting item | | Setting example | Setting details | |
|-------------------------------|---------|---|--------------------------------|---|
| Axis 1 Positioning data No. 1 | [Da.1] | Operation pattern | Positioning complete | Set "Positioning complete" assuming the next positioning data will not be executed. ("Continuous positioning control" and "Continuous path control" cannot be set in "position/speed changeover control".) |
| | [Da.2] | Control method | Forward run: position/speed | Set position-speed switching control. |
| | [Da.3] | Acceleration time No. | 1 | Designate the value set in "[Pr.25] Acceleration time 1" as the acceleration time at start. |
| | [Da.4] | Deceleration time No. | 0 | Designate the value set in "[Pr.10] Deceleration time 0" as the deceleration time at deceleration. |
| | [Da.6] | Positioning address/ movement amount | 10000.0 μ m | Set the movement amount at the time of position control before the switching to speed control. (Assuming that the "[Pr.1] Unit setting" is set to "mm".) |
| | [Da.7] | Arc address | – | Setting not required. (Setting value is ignored.) |
| | [Da.8] | Command speed | 6000.00mm/min | Set the speed to be controlled. |
| | [Da.9] | Dwell time/JUMP destination positioning data No. | 500ms | Set the time the machine dwells after the positioning stop (command stop) by position control to the output of the positioning complete signal. If the machine is stopped by speed control, the setting value is ignored. |
| | [Da.10] | M code/Condition data No./Number of LOOP to LEND repetitions | 10 | Set this when other sub operation commands are issued in combination with the No.1 positioning data. |
| | [Da.20] | Axis to be interpolated No.1 | – | Setting not required (setting value is ignored). |
| | [Da.21] | Axis to be interpolated No.2 | – | |
| | [Da.22] | Axis to be interpolated No.3 | – | |

(Note): Refer to Section 5.3 "List of positioning data" for information on the setting details.

9.2.19 Current value changing

When the current value is changed to a new value, control is carried out in which the "[Md.20] Feed current value" of the stopped axis is changed to a random address set by the user. (The "[Md.21] Feed machine value" is not changed when the current value is changed.)

The two methods for changing the current value are shown below.

- [1] Changing to a new current value using the positioning data
- [2] Changing to a new current value using the start No. (No. 9003) for a current value changing

The current value changing using method [1] is used during continuous positioning of multiple blocks, etc.

[1] Changing to a new current value using the positioning data

In "current value changing" ("[Da.2] Control method" = current value changing), "[Md.20] Feed current value" is changed to the address set in "[Da.6] Positioning address/movement amount".

■ Operation chart

The following chart shows the operation timing for a current value changing. The "[Md.20] Feed current value" is changed to the value set in "[Da.6] Positioning address/movement amount" when the positioning start signal turns ON.

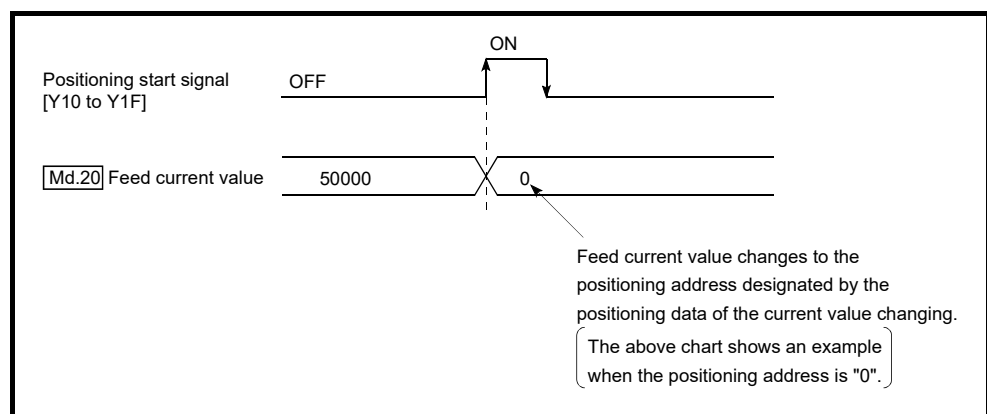

■ Restrictions

- (1) The error "New current value not possible" (error code: 515) will occur and the operation cannot start if "continuous path control" is set in "[Da.1] Operation pattern". ("Continuous path control" cannot be set in current value changing.)
- (2) "Current value changing" cannot be set in "[Da.2] Control method" of the positioning data when "continuous path control" has been set in "[Da.1] Operation pattern" of the immediately prior positioning data. (For example, if the operation pattern of positioning data No. 1 is "continuous path control", "current value changing" cannot be set in positioning data No. 2.) The error "New current value not possible" (error code: 515) will occur and the machine will carry out a deceleration stop if this type of setting is carried out.

- (3) The error "Outside new current value range" (error code: 514) will occur and the operation cannot start if "degree" is set in "[Pr.1] Unit setting" and the value set in "[Da.6] Positioning address/movement amount (0 to 359.99999 [degree])" is outside the setting range.
- (4) If the value set in "[Da.6] Positioning address/movement amount" is outside the software stroke limit ([Pr.12], [Pr.13]) setting range, the error "Software stroke limit +" (error code: 507) or "Software stroke limit -" (error code: 508) will occur at the positioning start, and the operation will not start.
- (5) The error "Software stroke limit +" (error code: 507) or "Software stroke limit -" (error code: 508) will occur if the new current value is outside the software stroke limit range.
- (6) The new current value using the positioning data (No.1 to 600) cannot be changed, if "0: Positioning control is not executed" is set in "[Pr.55] Operation setting for incompleteness of HPR" and "HPR request flag" ON. The error "Start at HPR incomplete" (error code: 547) will occur.
- (7) When an absolute position system is used, "[Md.20] Feed current value" returns to the same value as "[Md.21] Machine feed value" at the start of communication with the servo amplifier after the power supply ON or PLC CPU reset.

■ Positioning data setting examples

[When "current value changing" is set in the positioning data No. 1 of axis 1]

| Setting item | | Setting example | Setting details |
|-------------------------------|--|------------------------|---|
| Axis 1 Positioning data No. 1 | [Da.1] Operation pattern | Positioning complete | Set "Positioning complete" assuming that the next positioning data will be executed. ("Continuous path control" cannot be set by current value change.) |
| | [Da.2] Control method | Current value changing | Set the current value changing. |
| | [Da.3] Acceleration time No. | — | Setting not required (Setting value is ignored.) |
| | [Da.4] Deceleration time No. | — | |
| | [Da.6] Positioning address/movement amount | 10000.0 μ m | Set the address to which address change is desired. (Assuming that the "[Pr.1] Unit setting" is set to "mm".) |
| | [Da.7] Arc address | — | Setting not required (Setting value is ignored.) |
| | [Da.8] Command speed | — | |
| | [Da.9] Dwell time/JUMP destination positioning data No. | — | |
| | [Da.10] M code/Condition data No./Number of LOOP to LEND repetitions | 10 | Set this when other sub operation commands are issued in combination with the No.1 positioning data. |
| | [Da.20] Axis to be interpolated No.1 | — | Setting not required (setting value is ignored). |
| | [Da.21] Axis to be interpolated No.2 | — | |
| | [Da.22] Axis to be interpolated No.3 | — | |

(Note): Refer to Section 5.3 "List of positioning data" for information on the setting details.

[2] Changing to a new current value using the current value changing start No. (No. 9003)

In "current value changing" ("[Cd.3] Positioning start No." = 9003), "[Md.20] Feed current value" is changed to the address set in "[Cd.9] New current value".

■ Operation chart

The current value is changed by setting the new current value in the current value changing buffer memory "[Cd.9] New current value", setting "9003" in the "[Cd.3] Positioning start No.", and turning ON the positioning start signal.

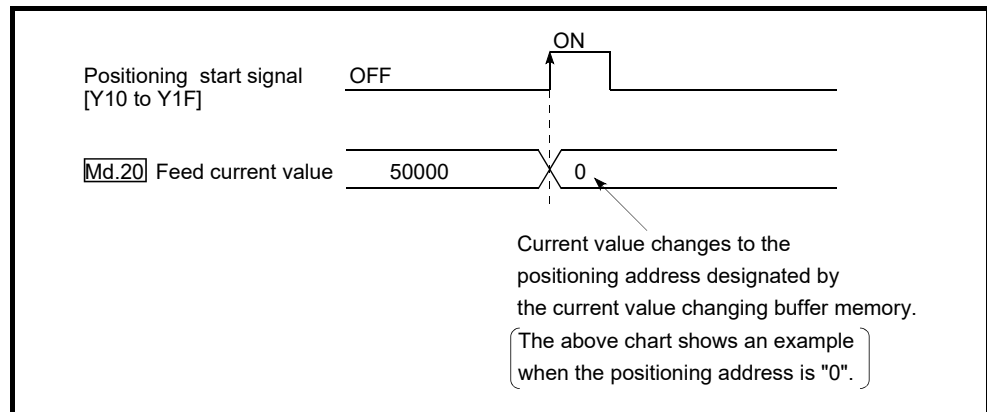

■ Restrictions

- (1) The error "Outside new current value range" (error code: 514) will occur if the designated value is outside the setting range when "degree" is set in "Unit setting".
- (2) The error "Software stroke limit +" (error code: 507) or "Software stroke limit -" (error code: 508) will occur if the designated value is outside the software stroke limit range.
- (3) The current value cannot be changed during stop commands and while the M code ON signal is ON.
- (4) The M code output function is made invalid.
- (5) When an absolute position system is used, "[Md.20] Feed current value" returns to the same value as "[Md.21] Machine feed value" at the start of communication with the servo amplifier after the power supply ON or PLC CPU reset.

POINTS

The current value can be changed using the current value changing start No. (No. 9003), if "0: Positioning control is not executed" is set in "[Pr.55] Operation setting for incompleteness of HPR" and HPR request flag is ON.

■ Current value changing procedure

The following shows the procedure for changing the current value to a new value.

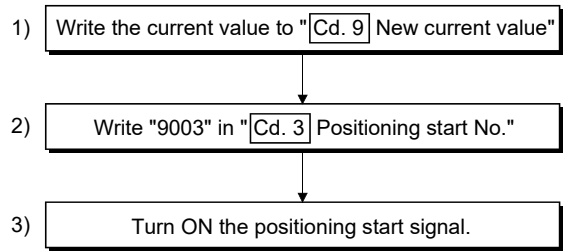

■ Setting method for the current value changing function

The following shows an example of a sequence program and data setting to change the current value to a new value with the positioning start signal. (The "[Md.20] Feed current value" value is changed to "5000.0µm" in the example shown.)

(1) Set the following data.

(Set with the sequence program shown in (3), while referring to the start time chart shown in (2).)

| Setting item | Setting value | Setting details | Buffer memory address |
|------------------------------|---------------|---|------------------------|
| [Cd.3] Positioning start No. | 9003 | Set the start No. "9003" for the new current value. | 4300+100n |
| [Cd.9] New current value | 50000 | Set the new "[Md.20] Feed current value". | 4306+100n 4307+100n |

(Note): Refer to Section 5.7 "List of control data" for details on the setting details.

(2) The following shows a start time chart.

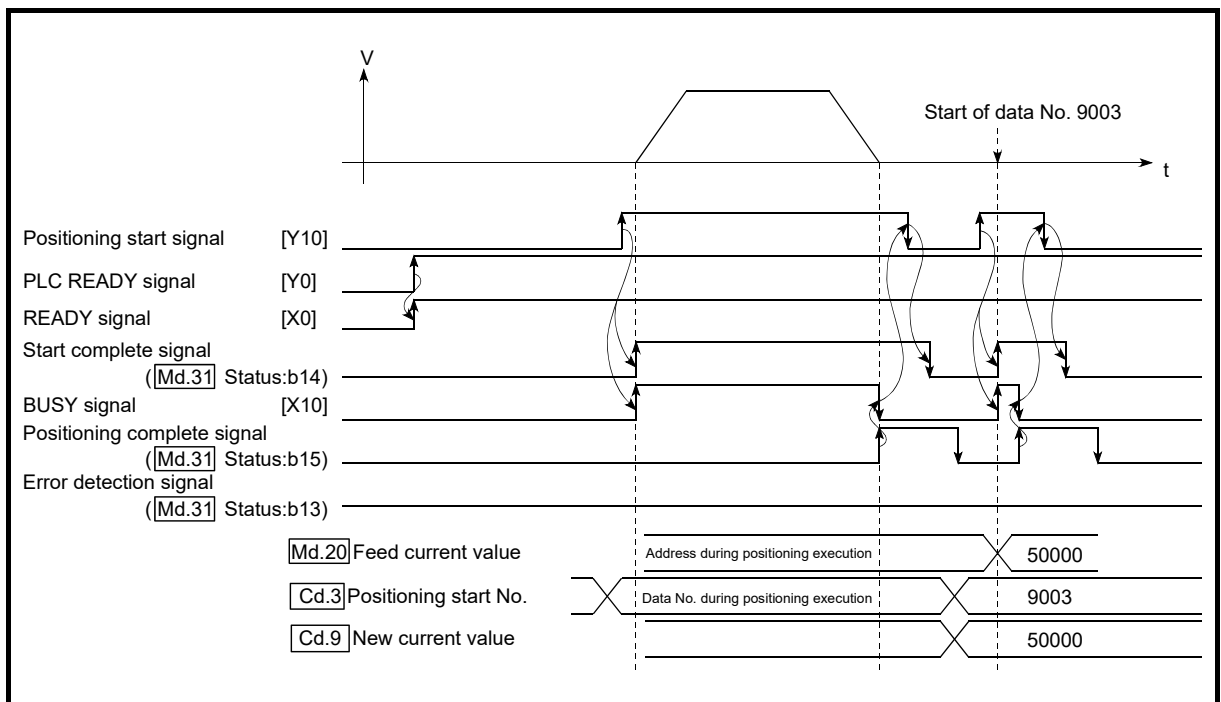
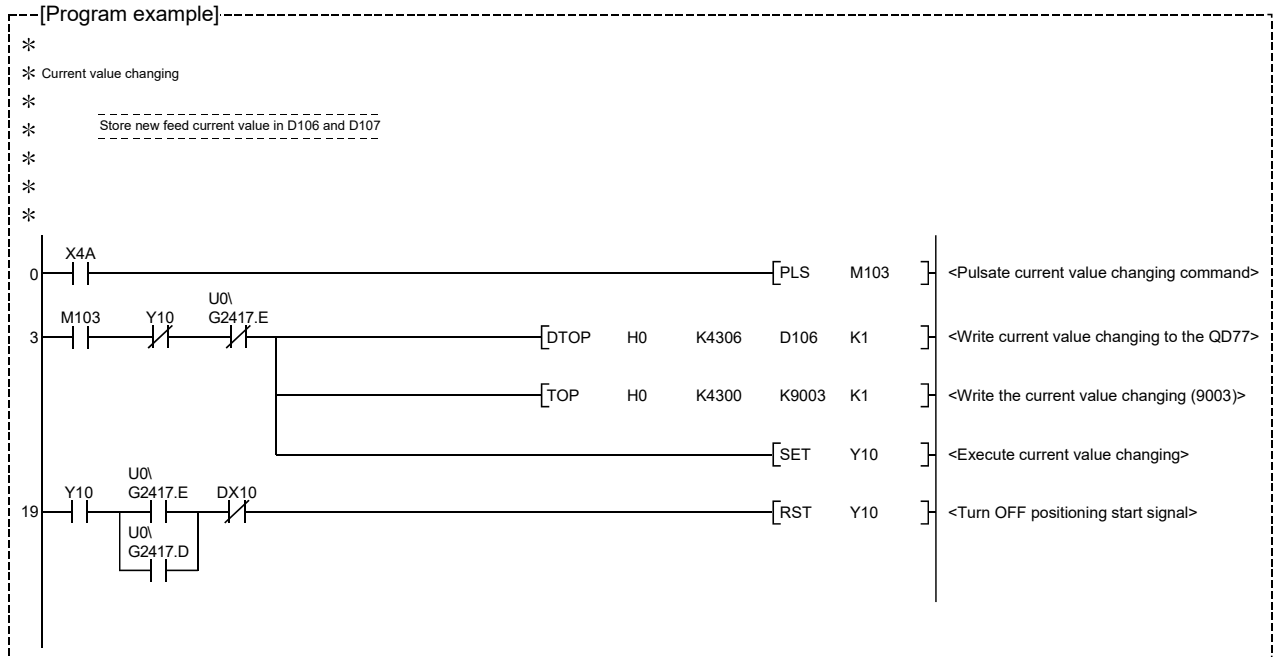

Fig. 9.21 Changing to a new current value using the start No. (No. 9003) for a current value changing

(3) Add the following sequence program to the control program, and write it to the PLC CPU.



9.2.20 NOP instruction

The NOP instruction is used for the nonexecutable control method.

■ Operation

The positioning data No. to which the NOP instruction is set transfers, without any processing, to the operation for the next positioning data No.

■ Positioning data setting examples

[When "NOP instruction" is set in positioning data No.1 of axis 1]

| Setting item | | Setting example | Setting details |
|-------------------------------|---|-----------------|--|
| Axis 1 Positioning data No. 1 | [Da.1] Operation pattern | – | Setting not required (Setting value is ignored.) |
| | [Da.2] Control method | NOP | Set the NOP instruction |
| | [Da.3] Acceleration time No. | – | Setting not required (Setting value is ignored.) |
| | [Da.4] Deceleration time No. | – | |
| | [Da.6] Positioning address/ movement amount | – | |
| | [Da.7] Arc address | – | |
| | [Da.8] Command speed | – | |
| | [Da.9] Dwell time/JUMP destination positioning data No. | – | |
| | [Da.10] M code/Condition data No./Number of LOOP to LEND repetitions | – | |
| | [Da.20] Axis to be interpolated No.1 | – | |
| | [Da.21] Axis to be interpolated No.2 | – | |
| | [Da.22] Axis to be interpolated No.3 | – | |

(Note): Refer to Section 5.3 "List of positioning data" for information on the setting details.

■ Restrictions

The error "Control method setting error" (error code: 524) will occur if the "NOP instruction" is set for the control method of the positioning data No. 600.

| POINT |
|---|
| <p><Use example of NOP instruction></p> <p>If there is a possibility of speed switching or temporary stop (automatic deceleration) at a point between two points during positioning, that data can be reserved with the NOP instruction to change the data merely by the replacement of the identifier.</p> |

9.2.21 JUMP instruction

The JUMP instruction is used to control the operation so it jumps to a positioning data No. set in the positioning data during "continuous positioning control" or "continuous path control".

JUMP instruction includes the following two types of JUMP.

- (1) Unconditional JUMP
When execution conditions are not set for the JUMP instruction
(When "0" is set to the condition data No.)
- (2) Conditional JUMP
When execution conditions are set for the JUMP instruction
(The conditions are set to the "condition data" used with "high-level positioning control".)

Using the JUMP instruction enables repeating of the same positioning control, or selection of positioning data by the execution conditions during "continuous positioning control" or "continuous path control".

■ Operation

- (1) Unconditional JUMP
The JUMP instruction is unconditionally executed. The operation jumps to the positioning data No. set in "[Da.9] Dwell time/JUMP destination positioning data No.".
- (2) Conditional JUMP
The block start condition data is used as the JUMP instruction execution conditions.
 - When block positioning data No. 7000 to 7004 is started:
Each block condition data is used.
 - When positioning data No. 1 to 600 is started:
Start block 0 condition data is used.
 - When the execution conditions set in "[Da.10] M code/Condition data No./Number of LOOP to LEND repetitions" of the JUMP instruction have been established:
the JUMP instruction is executed to jump the operation to the positioning data No. set in "[Da.9] Dwell time/JUMP destination positioning data No.".
 - When the execution conditions set in "[Da.10] M code/Condition data No./Number of LOOP to LEND repetitions" of the JUMP instruction have not been established:
the JUMP instruction is ignored, and the next positioning data No. is executed.

■ Restrictions

- (1) When using a conditional JUMP instruction, establish the JUMP instruction execution conditions by the 4th positioning data No. before the JUMP instruction positioning data No..
If the JUMP instruction execution conditions are not established by the time the 4th positioning control is carried out before the JUMP instruction positioning data No., the operation will be processed as an operation without established JUMP instruction execution conditions.
(During execution of continuous path control/continuous positioning control, the Simple Motion module calculates the positioning data of the positioning data No. four items ahead of the current positioning data.)

- (2) Set JUMP instruction to positioning data No. that "continuous positioning control" or "continuous path control" is set in operation pattern.
It cannot set to positioning data No. that "positioning complete" is set in operation pattern.
- (3) Positioning control such as loops cannot be executed by conditional JUMP instructions alone until the conditions have been established.
When loop control is executed using JUMP instruction, an axis operation status is "analyzing" during loop control, and the positioning data analysis (start) for other axes are not executed. As the target of the JUMP instruction, specify a positioning data that is controlled by other than JUMP and NOP instructions.

■ Positioning data setting example

[When "JUMP instruction" is set in positioning data No. 1 of axis 1]

| Setting item | | Setting example | Setting details |
|-------------------------------|---|------------------|---|
| Axis 1 Positioning data No. 1 | [Da.1] Operation pattern | – | Setting not required. (Setting value is ignored.) |
| | [Da.2] Control method | JUMP instruction | Set the JUMP instruction. |
| | [Da.3] Acceleration time No. | – | Setting not required. (Setting value is ignored.) |
| | [Da.4] Deceleration time No. | – | |
| | [Da.6] Positioning address/ movement amount | – | |
| | [Da.7] Arc address | – | |
| | [Da.8] Command speed | – | |
| | [Da.9] Dwell time/JUMP destination positioning data No. | 500 | Set the positioning data No. 1 to 600 for the JUMP destination. (The positioning data No. of the JUMP instruction cannot be set. Setting its own positioning data No. will result in the error "Illegal data No." (error code: 502).) |
| | [Da.10] M code/Condition data No./Number of LOOP to LEND repetitions | 1 | Set the JUMP instruction execution conditions with the condition data No. 0 : Unconditional JUMP 1 to 10 : Condition data No. ("Simultaneous start" condition data cannot be set.) |
| | [Da.20] Axis to be interpolated No.1 | – | Setting not required (setting value is ignored). |
| | [Da.21] Axis to be interpolated No.2 | – | |
| | [Da.22] Axis to be interpolated No.3 | – | |

(Note): Refer to Section 5.3 "List of positioning data" for information on the setting details.

9.2.22 LOOP

The LOOP is used for loop control by the repetition of LOOP to LEND.

■ Operation

The LOOP to LEND loop is repeated by set repeat cycles.

■ Positioning data setting examples

[When "LOOP" is set in positioning data No. 1 of axis 1]

| Setting item | | Setting example | Setting details | |
|----------------------------------|---------|---|-----------------|---|
| Axis 1 Positioning data No. 1 | [Da.1] | Operation pattern | – | Setting not required. (Setting value is ignored.) |
| | [Da.2] | Control method | LOOP | Set the LOOP. |
| | [Da.3] | Acceleration time No. | – | Setting not required. (Setting value is ignored.) |
| | [Da.4] | Deceleration time No. | – | |
| | [Da.6] | Positioning address/ movement amount | – | |
| | [Da.7] | Arc address | – | |
| | [Da.8] | Command speed | – | |
| | [Da.9] | Dwell time/JUMP destination positioning data No. | – | |
| | [Da.10] | M code/Condition data No./Number of LOOP to LEND repetitions | 5 | |
| | [Da.20] | Axis to be interpolated No.1 | – | Setting not required (setting value is ignored). |
| | [Da.21] | Axis to be interpolated No.2 | – | |
| | [Da.22] | Axis to be interpolated No.3 | – | |

(Note): Refer to Section 5.3 "List of positioning data" for information on the setting details.

■ Restrictions

- (1) The error "Control method LOOP setting error" (error code: 545) will occur if a "0" is set for the repeat cycles.
- (2) Even if LEND is absent after LOOP, no error will occur, but repeat processing will not be carried out.
- (3) Nesting is not allowed between LOOP-LEND's. If such setting is made, only the inner LOOP-LEND is processed repeatedly.

POINT

The setting by this control method is easier than that by the special start "FOR loop" of "High-level Positioning Control" (refer to Chapter 10).

- For special start: Positioning start data, special start data, condition data, and positioning data
- For control method: Positioning data

For the special start FOR to NEXT, the positioning data is required for each of FOR and NEXT points. For the control method, loop can be executed even only by one data.

Also, nesting is enabled by using the control method LOOP to LEND in combination with the special start FOR to NEXT.

However LOOP to LEND cannot be set across block. Always set LOOP to LEND so that the processing ends within one block.

(For details of the "block", refer to Section 10.1 "Outline of high-level positioning control".)

9.2.23 LEND

The LEND is used to return the operation to the top of the repeat (LOOP to LEND) loop.

■ Operation

When the repeat cycle designated by the LOOP becomes 0, the loop is terminated, and the next positioning data No. processing is started. (The operation pattern, if set to "Positioning complete", will be ignored.)

When the operation is stopped after the repeat operation is executed by designated cycles, the dummy positioning data (for example, incremental positioning without movement amount) is set next to LEND.

| Positioning data No. | Operation pattern | Control method | Conditions | Operation |
|----------------------|-------------------------|----------------|--------------------------|--|
| 1 | Continuous control | ABS2 | | Executed in the order of the positioning data No. 1 → 2 → 3 → 4 → 5 → 2 → 3 → 4 → 5 → 6. (The operation patterns of the positioning data Nos. 2 and 5 are ignored.) |
| 2 | Positioning complete | LOOP | Number of loop cycles: 2 | |
| 3 | Continuous path control | ABS2 | | |
| 4 | Continuous control | ABS2 | | |
| 5 | Positioning complete | LEND | | |
| 6 | Positioning complete | ABS2 | | |

■ Positioning data setting examples

[When "LEND" is set in positioning data No. 8 of axis 1]

| Setting item | | Setting example | Setting details |
|-------------------------------|--|-----------------|---|
| Axis 1 Positioning data No. 1 | [Da.1] Operation pattern | – | Setting not required. (Setting value is ignored.) |
| | [Da.2] Control method | LEND | Set the LEND. |
| | [Da.3] Acceleration time No. | – | Setting not required. (Setting value is ignored.) |
| | [Da.4] Deceleration time No. | – | |
| | [Da.6] Positioning address/ movement amount | – | |
| | [Da.7] Arc address | – | |
| | [Da.8] Command speed | – | |
| | [Da.9] Dwell time/JUMP destination positioning data No. | – | |
| | [Da.10] M code/Condition data No./Number of LOOP to LEND repetitions | – | |
| | [Da.20] Axis to be interpolated No.1 | – | |
| | [Da.21] Axis to be interpolated No.2 | – | |
| | [Da.22] Axis to be interpolated No.3 | – | |

(Note): Refer to Section 5.3 "List of positioning data" for information on the setting details.

■ Restrictions

- (1) Ignore the "LEND" before the "LOOP" is executed.
- (2) When the operation pattern "Positioning complete" has been set between LOOP and LEND, the positioning control is completed after the positioning data is executed, and the LOOP control is not executed.

Chapter 10 High-Level Positioning Control

The details and usage of high-level positioning control (control functions using the "block start data") are explained in this chapter.

High-level positioning control is used to carry out applied control using the "positioning data". Examples of applied control are using conditional judgment to control "positioning data" set with the major positioning control, or simultaneously starting "positioning data" for several different axes.

Read the execution procedures and settings for each control, and set as required.

| | | |
|--------|---|--------|
| 10.1 | Outline of high-level positioning control | 10- 2 |
| 10.1.1 | Data required for high-level positioning control..... | 10- 3 |
| 10.1.2 | "Block start data" and "condition data" configuration | 10- 4 |
| 10.2 | High-level positioning control execution procedure..... | 10- 6 |
| 10.3 | Setting the block start data | 10- 7 |
| 10.3.1 | Relation between various controls and block start data | 10- 7 |
| 10.3.2 | Block start (normal start)..... | 10- 8 |
| 10.3.3 | Condition start | 10- 10 |
| 10.3.4 | Wait start | 10- 11 |
| 10.3.5 | Simultaneous start | 10- 12 |
| 10.3.6 | Repeated start (FOR loop) | 10- 13 |
| 10.3.7 | Repeated start (FOR condition)..... | 10- 14 |
| 10.3.8 | Restrictions when using the NEXT start..... | 10- 15 |
| 10.4 | Setting the condition data | 10- 16 |
| 10.4.1 | Relation between various controls and the condition data | 10- 16 |
| 10.4.2 | Condition data setting examples | 10- 18 |
| 10.5 | Multiple axes simultaneous start control..... | 10- 19 |
| 10.6 | Start program for high-level positioning control | 10- 22 |
| 10.6.1 | Starting high-level positioning control..... | 10- 22 |
| 10.6.2 | Example of a start program for high-level positioning control | 10- 23 |

10.1 Outline of high-level positioning control

In "high-level positioning control" the execution order and execution conditions of the "positioning data" are set to carry out more applied positioning. (The execution order and execution conditions are set in the "block start data" and "condition data".) The following applied positioning controls can be carried out with "high-level positioning control".

| High-level positioning control | Details |
|---|---|
| Block ^(Note-1) start (Normal start) | With one start, executes the positioning data in a random block with the set order. |
| Condition start | Carries out condition judgment set in the "condition data" for the designated positioning data, and then executes the "block start data". <ul style="list-style-type: none"> • When the condition is established, the "block start data" is executed. • When not established, that "block start data" is ignored, and the next point's "block start data" is executed. |
| Wait start | Carries out condition judgment set in the "condition data" for the designated positioning data, and then executes the "block start data". <ul style="list-style-type: none"> • When the condition is established, the "block start data" is executed. • When not established, stops the control until the condition is established. (Waits.) |
| Simultaneous start (Note-2) | Simultaneously executes the positioning data having the No. for the axis designated with the "condition data". (Outputs command at the same timing.) |
| Repeated start (FOR loop) | Repeats the program from the "block start data" set with the "FOR loop" to the "block start data" set in "NEXT" for the designated number of times. |
| Repeated start (FOR condition) | Repeats the program from the "block start data" set with the "FOR condition" to the "block start data" set in "NEXT" until the conditions set in the "condition data" are established. |

■ High-level positioning control sub functions

"High-level positioning control" uses the "positioning data" set with the "major positioning control". Refer to Section 3.2.5 "Combination of QD77GF main functions and sub functions" for details on sub functions that can be combined with the major positioning control.

Note that the sub function Section 13.7.7 "Pre-reading start function" cannot be used together with "high-level positioning control".

■ High-level positioning control from GX Works2

"High-level positioning control" (start of the "block start data") can be executed using the test function of GX Works2.

Refer to the "Simple Motion Module Setting Tool Help" of GX Works2 for details on starting of the "block start data" using GX Works2.

REMARK

(Note-1): Block

"1 block" is defined as all the data continuing from the positioning data in which "continuous positioning control" or "continuous path control" is set in the "[Da.1] Operation pattern" to the positioning data in which "independent positioning control (Positioning complete)" is set.

(Note-2): Simultaneous start

Besides the simultaneous start of "block start data" system, the "simultaneous starts" include the "multiple axes simultaneous start control" of control method.

Refer to Section 10.5 "Multiple axes simultaneous start control" for details.

10.1.1 Data required for high-level positioning control

"High-level positioning control" is executed by setting the required items in the "block start data" and "condition data", then starting that "block start data". Judgment about whether execution is possible, etc., is carried out at execution using the "condition data" designated in the "block start data".

"Block start data" can be set for each No. from 7000 to 7004 (called "block Nos."), and up to 50 points can be set for each axis. (This data is controlled with Nos. called "points" to distinguish it from the positioning data. For example, the 1st block start data item is called the "1st point block start data" or "point No. 1 block start data".)

"Condition data" can be set for each No. from 7000 to 7004 (called "block Nos."), and up to 10 data items can be set for each axis.

The "block start data" and "condition data" are set as 1 set for each block No.

The following table shows an outline of the "block start data" and "condition data" stored in the Simple Motion module.

| Setting item | | Setting details |
|------------------|-----------------------------------|---|
| Block start data | [Da.11] Shape | Set whether to end the control after executing only the "block start data" of the shape itself, or continue executing the "block start data" set in the next point. |
| | [Da.12] Start data No. | Set the "positioning data No." to be executed. |
| | [Da.13] Special start instruction | Set the method by which the positioning data set in [Da.12] will be started. |
| | [Da.14] Parameter | Set the conditions by which the start will be executed according to the commands set in [Da.13]. (Designate the "condition data No." and "Number of repetitions".) |

| Setting item | | Setting details |
|---|--|--|
| Condition data | [Da.15] Condition target | Designate the "device", "buffer memory storage details", and "positioning data No." elements for which the conditions are set. |
| | [Da.16] Condition operator | Set the judgment method carried out for the target set in [Da.15]. |
| | [Da.17] Address | Set the buffer memory address in which condition judgment is carried out (only when the details set in [Da.15] are "buffer memory storage details"). |
| | [Da.18] Parameter 1 | Set the required conditions according to the details set in [Da.15], [Da.16] and [Da.23]. |
| | [Da.19] Parameter 2 | |
| | [Da.23] Number of simultaneous starting axes | Set the number of axes to be started simultaneously in the simultaneously start. |
| | [Da.24] Simultaneous starting axis No.1 | Set the simultaneous starting axis in the simultaneously start on 2 to 4 axes. |
| | [Da.25] Simultaneous starting axis No.2 | |
| [Da.26] Simultaneous starting axis No.3 | | |

10.1.2 "Block start data" and "condition data" configuration

The "block start data" and "condition data" corresponding to "block No. 7000" can be stored in the buffer memory.

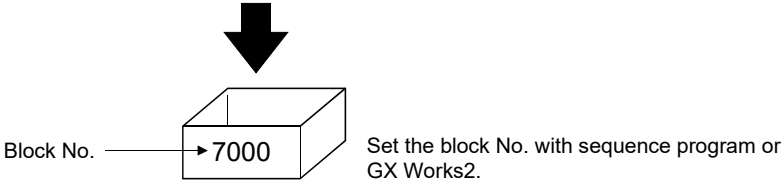
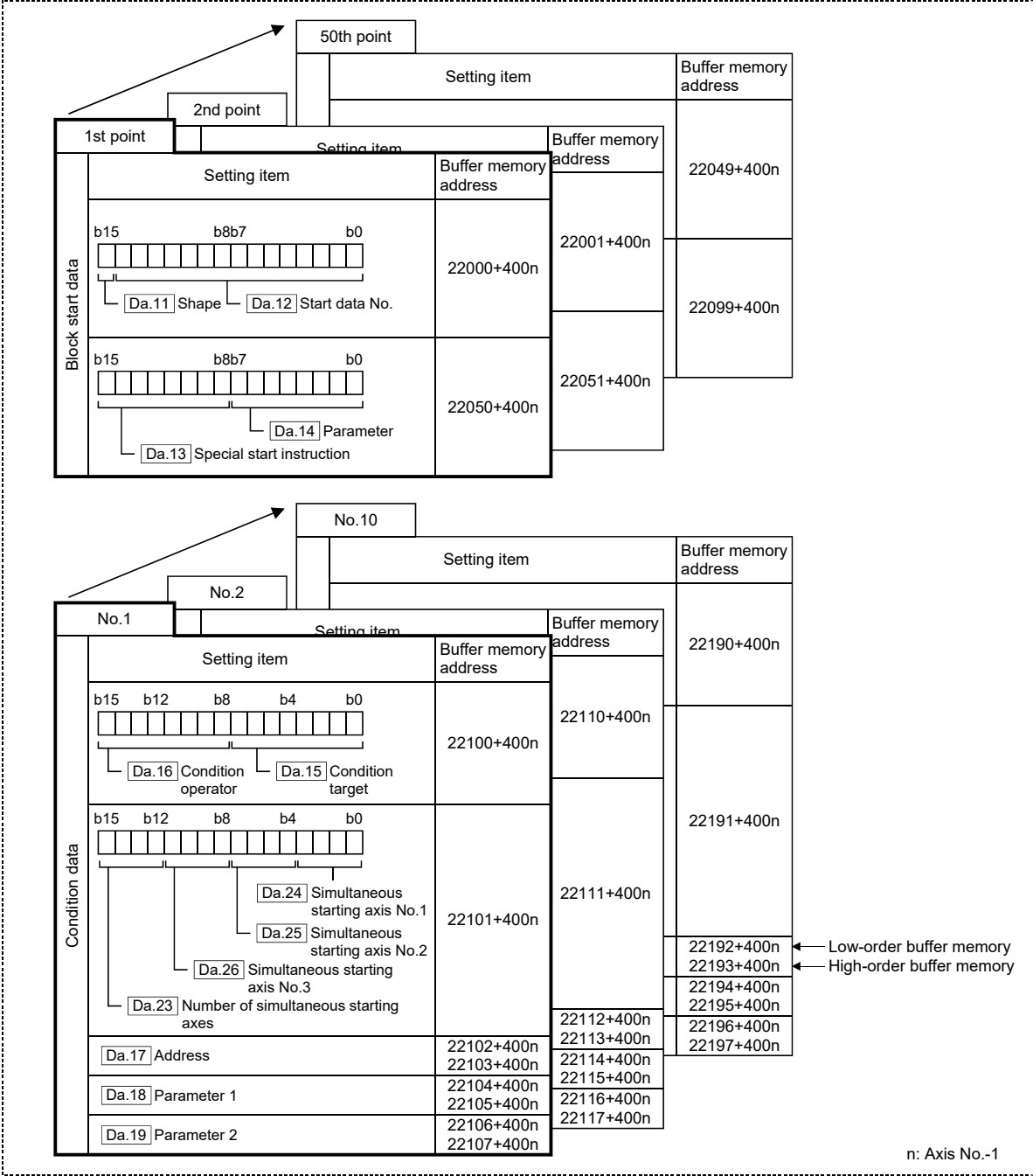

Set the "block start data" and "condition data" corresponding to the following "block Nos. 7001 to 7004" using sequence program or GX Works2 to Simple Motion module. The "block start data" and "condition data" corresponding to "block No. 7002 to 7004" are not allocated. Set the data with GX Works2.

10.2 High-level positioning control execution procedure

High-level positioning control is carried out using the following procedure.

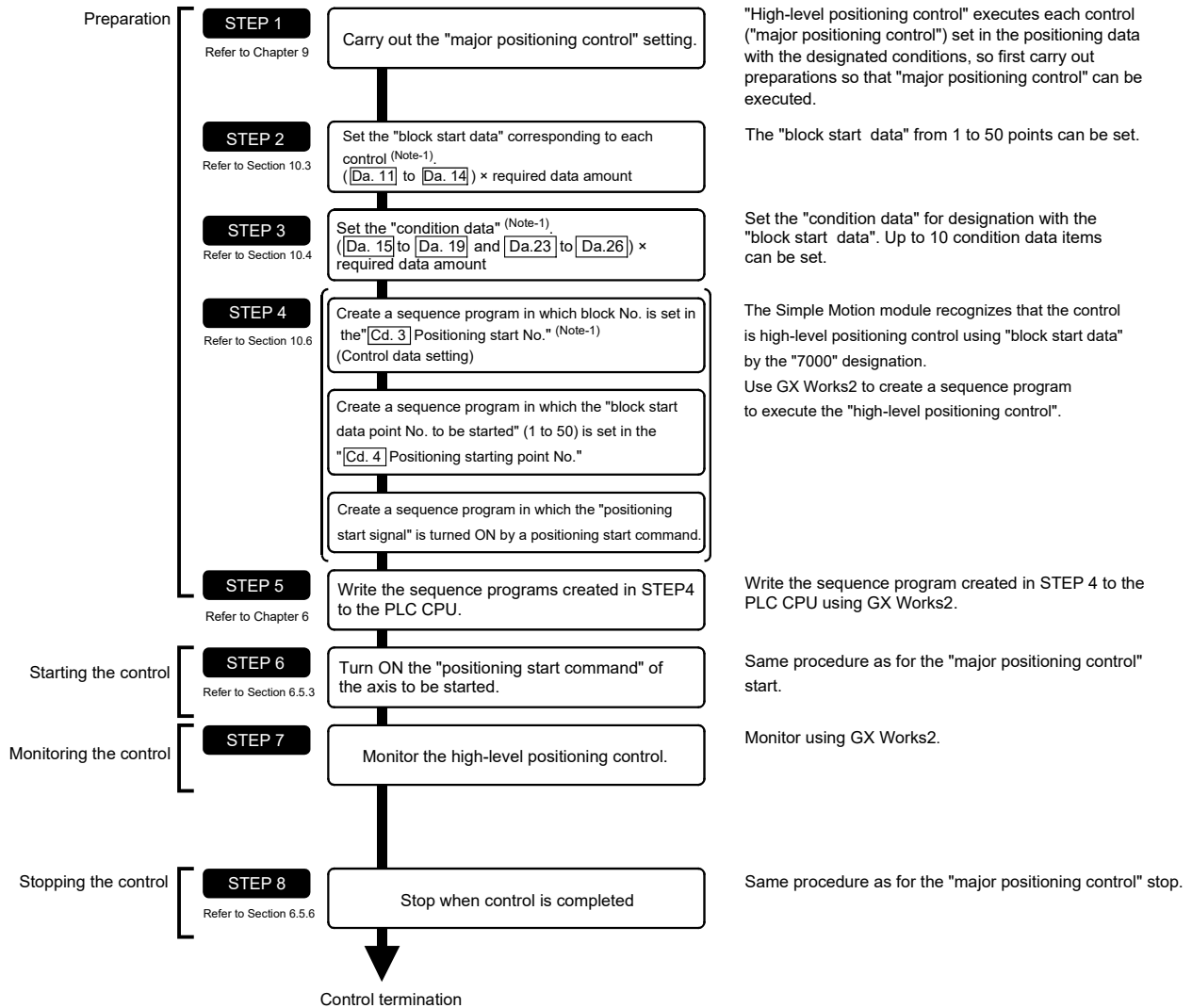

REMARK

(Note-1): Five sets of "block start data (50 points)" and "condition data (10 items)" corresponding to "block No. 7000 to 7004" are set with GX Works2 or sequence program.

When those are set with GX Works2 and written to the Simple Motion module, "7000 to 7004" can be set in "[Cd.3] Positioning start No." on STEP4.

10.3 Setting the block start data

10.3.1 Relation between various controls and block start data

The "block start data" must be set to carry out "high-level positioning control". The setting requirements and details of each "block start data" item to be set differ according to the "[Da.13] Special start instruction" setting.

The following shows the "block start data" setting items corresponding to various control methods. The operation details of each control type are explained starting in Section 10.3.2. Also refer to Section 10.4 "Setting the condition data" for details on "condition data" with which control execution is judged.

(The "block start data" settings in this chapter are assumed to be carried out using GX Works2.)

| High-level positioning control | | Block start (Normal start) | Condition start | Wait start | Simultaneous start | Repeated start (FOR loop) | Repeated start (FOR condition) | NEXT start * |
|--------------------------------|---------------------------|----------------------------|--------------------|------------|--------------------|---------------------------|--------------------------------|--------------|
| [Da.11] | Shape | 0 : End | ◎ | ◎ | ◎ | × | × | ◎ |
| | | 1 : Continue | ◎ | ◎ | ◎ | ◎ | ◎ | ◎ |
| [Da.12] | Start data No. | 1 to 600 | | | | | | |
| [Da.13] | Special start instruction | 0 | 1 | 2 | 3 | 4 | 5 | 6 |
| [Da.14] | Parameter | — | Condition data No. | | | Number of repetitions | Condition data No. | — |

◎ : One of the two setting items must be set.

○ : Set as required (Set to "—" when not used.)

× : Setting not possible

— : Setting not required (Use the initial value or a value within the setting range.)

* The "NEXT start" instruction is used in combination with "repeated start (FOR loop)" and "repeated start (FOR condition)". Control using only the "NEXT start" will not be carried out.

REMARK

It is recommended that the "block start data" be set whenever possible with GX Works2. Execution by sequence program uses many sequence programs and devices. The execution becomes complicated, and the scan times will increase.

10.3.2 Block start (normal start)

In a "block start (normal start)", the positioning data groups of a block starting from the positioning data set in "[Da.12] Start data No." are continuously executed with the set order by starting once.

Section [2] shows a control example where the "block start data" and "positioning data" are set as shown in section [1].

[1] Setting examples

(1) Block start data setting example

| Axis 1 block start data | [Da.11] Shape | [Da.12] Start data No. | [Da.13] Special start instruction | [Da.14] Parameter |
|-------------------------|---------------|------------------------|-----------------------------------|-------------------|
| 1st point | 1: Continue | 1 | 0: Block start | — |
| 2nd point | 1: Continue | 2 | 0: Block start | — |
| 3rd point | 1: Continue | 5 | 0: Block start | — |
| 4th point | 1: Continue | 10 | 0: Block start | — |
| 5th point | 0: End | 15 | 0: Block start | — |
| • | | | | |
| • | | | | |

(2) Positioning data setting example

| Axis 1 positioning data No. | [Da.1] Operation pattern | |
|-----------------------------|------------------------------------|--------------------|
| 1 | 00: Positioning complete | } 1 block (Note-1) |
| 2 | 11: Continuous path control | |
| 3 | 01: Continuous positioning control | |
| 4 | 00: Positioning complete | } 1 block |
| 5 | 11: Continuous path control | |
| 6 | 00: Positioning complete | |
| • | | |
| 10 | 00: Positioning complete | |
| • | | |
| 15 | 00: Positioning complete | |
| • | | |

REMARK

(Note-1): Block

"1 block" is defined as all the data continuing from the positioning data in which "continuous positioning control" or "continuous path control" is set in the "[Da.1] Operation pattern" to the positioning data in which "independent positioning control (Positioning complete)" is set.

[2] Control examples

The following shows the control executed when the "block start data" of the 1st point of axis 1 is set as shown in section [1] and started.

<1> The positioning data is executed in the following order before stopping.
 Axis 1 positioning data No. 1 → 2 → 3 → 4 → 5 → 6 → 10 → 15.

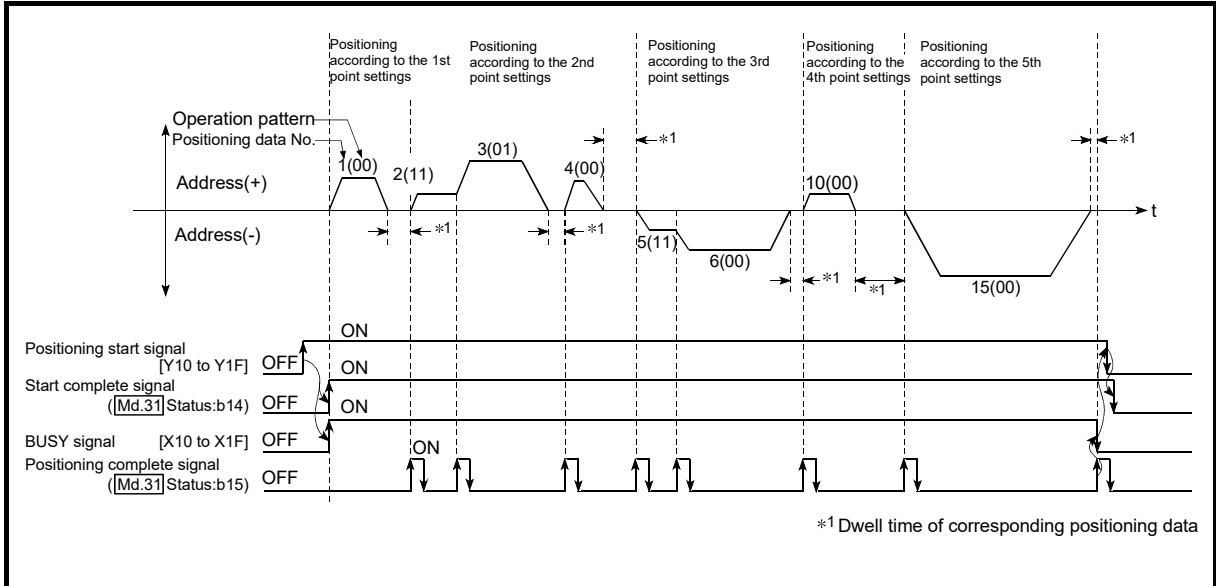

Fig. 10.1 Block start control example

10.3.3 Condition start

In a "condition start", the "condition data" conditional judgment designated in "[Da.14] Parameter" is carried out for the positioning data set in "[Da.12] Start data No.". If the conditions have been established, the "block start data" set in "1: condition start" is executed. If the conditions have not been established, that "block start data" will be ignored, and the "block start data" of the next point will be executed.

Section [2] shows a control example where the "block start data" and "positioning data" are set as shown in section [1].

[1] Setting examples

(1) Block start data setting example

| Axis 1 block start data | [Da.11] Shape | [Da.12] Start data No. | [Da.13] Special start instruction | [Da.14] Parameter |
|-------------------------|---------------|------------------------|-----------------------------------|-------------------|
| 1st point | 1: Continue | 1 | 1: Condition start | 1 |
| 2nd point | 1: Continue | 10 | 1: Condition start | 2 |
| 3rd point | 0: End | 50 | 0: Block start | – |
| • | | | | |
| • | | | | |

(Note): The "condition data Nos." have been set in "[Da.14] Parameter".

(2) Positioning data setting example

| Axis 1 positioning data No. | [Da.1] Operation pattern |
|-----------------------------|------------------------------------|
| 1 | 01: Continuous positioning control |
| 2 | 01: Continuous positioning control |
| 3 | 00: Positioning complete |
| • | |
| 10 | 11: Continuous path control |
| 11 | 11: Continuous path control |
| 12 | 00: Positioning complete |
| • | |
| 50 | 00: Positioning complete |
| • | |

[2] Control examples

The following shows the control executed when the "block start data" of the 1st point of axis 1 is set as shown in section [1] and started.

- <1> The conditional judgment set in "condition data No. 1" is carried out before execution of the axis 1 "positioning data No.1".
 → Conditions established → Execute positioning data No. 1, 2, and 3 → Go to <2>.
 → Conditions not established → Go to <2>.
- <2> The conditional judgment set in "condition data No.2" is carried out before execution of the axis 1 "positioning data No. 10".
 → Conditions established → Execute positioning data No.10, 11, and 12 → Go to <3>.
 → Conditions not established → Go to <3>.
- <3> Execute axis 1 "positioning data No.50" and stop the control.

10.3.4 Wait start

In a "wait start", the "condition data" conditional judgment designated in "[Da.14] Parameter" is carried out for the positioning data set in "[Da.12] Start data No.". If the conditions have been established, the "block start data" is executed. If the conditions have not been established, the control stops (waits) until the conditions are established.

Section [2] shows a control example where the "block start data" and "positioning data" are set as shown in section [1].

[1] Setting examples

(1) Block start data setting example

| Axis 1 block start data | [Da.11] Shape | [Da.12] Start data No. | [Da.13] Special start instruction | [Da.14] Parameter |
|-------------------------|---------------|------------------------|-----------------------------------|-------------------|
| 1st point | 1: Continue | 1 | 2: Wait start | 3 |
| 2nd point | 1: Continue | 10 | 0: Block start | – |
| 3rd point | 0: End | 50 | 0: Block start | – |
| • | | | | |
| • | | | | |

(Note): The "condition data Nos." have been set in "[Da.14] Parameter".

(2) Positioning data setting example

| Axis 1 positioning data No. | [Da.1] Operation pattern |
|-----------------------------|------------------------------------|
| 1 | 01: Continuous positioning control |
| 2 | 01: Continuous positioning control |
| 3 | 00: Positioning complete |
| • | |
| 10 | 11: Continuous path control |
| 11 | 11: Continuous path control |
| 12 | 00: Positioning complete |
| • | |
| 50 | 00: Positioning complete |
| • | |

[2] Control examples

The following shows the control executed when the "block start data" of the 1st point of axis 1 is set as shown in section [1] and started.

- <1> The conditional judgment set in "condition data No. 3" is carried out before execution of the axis 1 "positioning data No. 1".
- Conditions established → Execute positioning data No. 1, 2, and 3 → Go to <2>.
 - Conditions not established → Control stops (waits) until conditions are established → Go to <1>.
- <2> Execute the axis 1 "positioning data No. 10, 11, 12, and 50" and stop the control.

10.3.5 Simultaneous start

In a "simultaneous start", the positioning data set in the "[Da.12] Start data No." and positioning data of other axes set in the "condition data" are simultaneously executed (commands are output with the same timing).

(The "condition data" is designated with "[Da.14] Parameter".)

Section [2] shows a control example where the "block start data" and "positioning data" are set as shown in section [1].

[1] Setting examples

(1) Block start data setting example

| Axis 1 block start data | [Da.11] Shape | [Da.12] Start data No. | [Da.13] Special start instruction | [Da.14] Parameter |
|-------------------------|---------------|------------------------|-----------------------------------|-------------------|
| 1st point | 0: End | 1 | 3: Simultaneous start | 4 |
| • | | | | |
| • | | | | |
| • | | | | |
| • | | | | |

(Note): It is assumed that the "axis 2 positioning data" for simultaneous starting is set in the "condition data" designated with "[Da.14] Parameter".

(2) Positioning data setting example

| Axis 1 positioning data No. | [Da.1] Operation pattern |
|-----------------------------|------------------------------------|
| 1 | 01: Continuous positioning control |
| 2 | 01: Continuous positioning control |
| 3 | 00: Positioning complete |
| • | |
| • | |
| • | |
| • | |
| • | |

[2] Control examples

The following shows the control executed when the "block start data" of the 1st point of axis 1 is set as shown in section [1] and started.

<1> Check the axis operation status of axis 2 which is regarded as the simultaneous starting axis.

→ Axis 2 is standing by → Go to <2>.

→ Axis 2 is carrying out positioning. → An error occurs and simultaneous start will not be carried out.

<2> Simultaneously start the axis 1 "positioning data No. 1" and axis 2 positioning data set in "condition data No. 4.

[3] Precautions

Positioning data No. executed by simultaneous starting axes is set to condition data ("[Da.18] Parameter 1", "[Da.19] Parameter 2"), but the setting value of start axis (the axis which carries out positioning start) should be "0". If the setting value is set to other than "0", the positioning data set in "[Da.18] Parameter 1", "[Da.19] Parameter 2" is given priority to be executed rather than "[Da.12] Start data No."

(For details, refer to Section 5.5 "List of condition data".)

10.3.6 Repeated start (FOR loop)

In a "repeated start (FOR loop)", the data between the "block start data" in which "4: FOR loop" is set in "[Da.13] Special start instruction" and the "block start data" in which "6: NEXT start" is set in "[Da.13] Special start instruction" is repeatedly executed for the number of times set in "[Da.14] Parameter". An endless loop will result if the number of repetitions is set to "0".

(The number of repetitions is set in "[Da.14] Parameter" of the "block start data" in which "4: FOR loop" is set in "[Da.13] Special start instruction".)

Section [2] shows a control example where the "block start data" and "positioning data" are set as shown in section [1].

[1] Setting examples

(1) Block start data setting example

| Axis 1 block start data | [Da.11] Shape | [Da.12] Start data No. | [Da.13] Special start instruction | [Da.14] Parameter |
|-------------------------|---------------|------------------------|-----------------------------------|-------------------|
| 1st point | 1: Continue | 1 | 4: FOR loop | 2 |
| 2nd point | 1: Continue | 10 | 0: Block start | – |
| 3rd point | 0: End | 50 | 6: NEXT start | – |
| • | | | | |
| • | | | | |

(Note): The "condition data Nos." have been set in "[Da.14] Parameter".

(2) Positioning data setting example

| Axis 1 positioning data No. | [Da.1] Operation pattern |
|-----------------------------|------------------------------------|
| 1 | 01: Continuous positioning control |
| 2 | 01: Continuous positioning control |
| 3 | 00: Positioning complete |
| • | |
| 10 | 11: Continuous path control |
| 11 | 00: Positioning complete |
| • | |
| 50 | 01: Continuous positioning control |
| 51 | 00: Positioning complete |
| • | |

[2] Control examples

The following shows the control executed when the "block start data" of the 1st point of axis 1 is set as shown in section [1] and started.

<1> Execute the axis 1 "positioning data No.1, 2, 3, 10, 11, 50, and 51".

<2> Return to the axis 1 "1st point block start data". Again execute the axis 1 "positioning data No.1, 2, 3, 10, 11, 50 and 51", and then stop the control. (Repeat for the number of times (2 times) set in [Da.14].)

10.3.7 Repeated start (FOR condition)

In a "repeated start (FOR condition)", the data between the "block start data" in which "5: FOR condition" is set in "[Da.13] Special start instruction" and the "block start data" in which "6: NEXT start" is set in "[Da.13] Special start instruction" is repeatedly executed until the establishment of the conditions set in the "condition data". Conditional judgment is carried out as soon as switching to the point of "6: NEXT start" (before positioning of NEXT start point). (The "condition data" designation is set in "[Da.14] Parameter" of the "block start data" in which "5: FOR condition" is set in "[Da.13] Special start instruction".)

Section [2] shows a control example where the "block start data" and "positioning data" are set as shown in section [1].

[1] Setting examples

(1) Block start data setting example

| Axis 1 block start data | [Da.11] Shape | [Da.12] Start data No. | [Da.13] Special start instruction | [Da.14] Parameter |
|-------------------------|---------------|------------------------|-----------------------------------|-------------------|
| 1st point | 1: Continue | 1 | 5: FOR condition | 5 |
| 2nd point | 1: Continue | 10 | 0: Block start | – |
| 3rd point | 0: End | 50 | 6: NEXT start | – |
| • | | | | |
| • | | | | |

(Note): The "condition data Nos." have been set in "[Da.14] Parameter".

(2) Positioning data setting example

| Axis 1 positioning data No. | [Da.1] Operation pattern |
|-----------------------------|------------------------------------|
| 1 | 01: Continuous positioning control |
| 2 | 01: Continuous positioning control |
| 3 | 00: Positioning complete |
| • | |
| 10 | 11: Continuous path control |
| 11 | 00: Positioning complete |
| • | |
| 50 | 01: Continuous positioning control |
| 51 | 00: Positioning complete |
| • | |

[2] Control examples

The following shows the control executed when the "block start data" of the 1st point of axis 1 is set as shown in section [1] and started.

<1> Execute axis 1 "positioning data No.1, 2, 3, 10, and 11".

<2> Carry out the conditional judgment set in axis 1 "condition data No.5" (Note-1).

→ Conditions not established → Execute "Positioning data No.50, 51".
Go to <1>.

→ Conditions established → Execute "Positioning data No.50, 51" and complete the positioning.

(Note-1): Conditional judgment is carried out as soon as switching to NEXT start point (before positioning of NEXT start point).

10.3.8 Restrictions when using the NEXT start

The "NEXT start" is an instruction indicating the end of the repetitions when executing Section 10.3.6 "Repeated start (FOR loop)" and Section 10.3.7 "Repeated start (FOR condition)".

The following shows the restrictions when setting "6: NEXT start" in the "block start data".

- (1) The processing when "6: NEXT start" is set before execution of "4: FOR loop" or "5: FOR condition" is the same as that for a "0: block start".
- (2) Repeated processing will not be carried out if there is no "6: NEXT start" instruction after the "4: FOR loop" or "5: FOR condition" instruction. (Note that an "error" will not occur.)
- (3) Nesting is not possible between "4: FOR loop" and "6: NEXT start", or between "5: FOR condition" and "6: NEXT start". The warning "FOR to NEXT nest construction" (warning code: 506) will occur if nesting is attempted.

[Operating examples without nesting structure]

| Start block data | [Da.13] Special start instruction |
|------------------|--------------------------------------|
| 1st point | Normal start |
| 2nd point | FOR ← |
| 3rd point | Normal start |
| 4th point | NEXT — |
| 5th point | Normal start |
| 6th point | Normal start |
| 7th point | FOR ← |
| 8th point | Normal start |
| 9th point | NEXT — |
| • | |
| • | |

[Operating examples with nesting structure]

| Start block data | [Da.13] Special start instruction |
|------------------|--------------------------------------|
| 1st point | Normal start |
| 2nd point | FOR |
| 3rd point | Normal start |
| 4th point | FOR ← |
| 5th point | Normal start |
| 6th point | Normal start |
| 7th point | NEXT — |
| 8th point | Normal start |
| 9th point | NEXT |
| • | |
| • | |

A warning will occur when starting the 4th point "FOR". The JUMP destination of the 7th point "NEXT" is the 4th point. The 9th point "NEXT" is processed as normal start.

10.4 Setting the condition data

10.4.1 Relation between various controls and the condition data

"Condition data" is set in the following cases.

- (1) When setting conditions during execution of Section 9.2.21 "JUMP instruction" (major positioning control)
- (2) When setting conditions during execution of "high-level positioning control"

The "condition data" to be set includes the setting items from [Da.15] to [Da.19] and [Da.23] to [Da.26], but the setting requirements and details differ according to the control method and setting conditions.

The following shows the "condition data" "[Da.15] Condition target" corresponding to the different types of control.

(The "condition data" settings in this chapter are assumed to be carried out using GX Works2.)

| Control type [Da.15] Setting item | High-level positioning control | | | | Major positioning control |
|---|--------------------------------|------------|--------------------|--------------------------------|---------------------------|
| | Block start | Wait start | Simultaneous start | Repeated start (For condition) | JUMP instruction |
| 01H: Device X (Note-1) | ◎ | ◎ | × | ◎ | ◎ |
| 02H: Device Y (Note-1) | ◎ | ◎ | × | ◎ | ◎ |
| 03H: Buffer memory (1 word) | ◎ | ◎ | × | ◎ | ◎ |
| 04H: Buffer memory (2 words) | ◎ | ◎ | × | ◎ | ◎ |
| 05H: Positioning data No. | × | × | ◎ | × | × |

◎ : One of the setting items must be set.

× : Setting not possible

(Note-1): Refer to devices X/Y which belongs to Simple Motion module.

REMARK

It is recommended that the "condition data" be set whenever possible with GX Works2. Execution by sequence program uses many sequence programs and devices. The execution becomes complicated, and the scan times will increase.

The setting requirements and details of the following "condition data" [Da.16] to [Da.19] and [Da.23] setting items differ according to the "[Da.15] Condition target" setting. The following shows the [Da.16] to [Da.19] and [Da.23] setting items corresponding to the "[Da.15] Condition target".

| Other setting item [Da.15] Condition target | [Da.16] Condition operator | [Da.23] Number of simultaneous starting axes | [Da.17] Address | [Da.18] Parameter 1 | [Da.19] Parameter 2 |
|---|--|---|-----------------------|---|---|
| 01H: Device X | 07H: DEV=ON | — | — | X: 0H, 1H, 10H to 1FH | — |
| 02H: Device Y | 08H: DEV=OFF | | | Y: 0H, 1H, 10H to 1FH | |
| 03H: Buffer memory (1 word) (Note-1) | 01H: **=P1 02H: **≠P1 | — | Buffer memory address | P1 (numeric value) | P2 (numeric value) (Set only when "[Da.16]" is [05H] or [06H].) |
| 04H: Buffer memory (2 words) (Note-1) | 03H: **≤P1 04H: **≥P1 05H: P1≤**≤P2 06H: **≤P1, P2≤** | | | | |
| 05H: Positioning data No. | / | 2 | — | Low-order 16 bits: "[Da.24] Simultaneous starting axis No.1" positioning data No. High-order 16 bits: "[Da.25] Simultaneous starting axis No.2" positioning data No. | — Low-order 16 bits: "[Da.26] Simultaneous starting axis No.3" positioning data No. High-order 16 bits: Unusable (Set "0".) |
| | | 3 | | | |
| | | 4 | | | |

— : Setting not required (Use the initial value or a value within the setting range.)

** : Value stored in buffer memory designated in [Da.17]

(Note-1): Comparison of ≤ and ≥ is judged as signed values.

Refer to Section 5.5 "List of condition data" for the setting contents.

Judgment whether the condition operator is "=" or "≠" at the start of wait.
Judgment on data is carried out for each operation cycle of the Simple Motion module.
Thus, in the judgment on the data such as feed current value which varies continuously, the operator "=" may not be detected. If this occurs, use a range operator.

10.4.2 Condition data setting examples

The following shows the setting examples for "condition data".

(1) Setting the device ON/OFF as a condition

[Condition]

Device "X10" (Axis 1 BUSY signal) is OFF

| [Da.15] Condition target | [Da.16] Condition operator | [Da.17] Address | [Da.18] Parameter 1 | [Da.19] Parameter 2 | [Da.23] Number of simultaneous starting axes | [Da.24] Simultaneous starting axis No.1 | [Da.25] Simultaneous starting axis No.2 | [Da.26] Simultaneous starting axis No.3 |
|--------------------------------|----------------------------------|--------------------|------------------------|------------------------|---|--|--|--|
| 01H: Device X | 08H: DEV=OFF | — | 10H | — | — | — | — | — |

(2) Setting the numeric value stored in the "buffer memory" as a condition

[Condition]

The value stored in buffer memory addresses "2400, 2401" ([Md.20] Feed current value) is "1000" or larger.

| [Da.15] Condition target | [Da.16] Condition operator | [Da.17] Address | [Da.18] Parameter 1 | [Da.19] Parameter 2 | [Da.23] Number of simultaneous starting axes | [Da.24] Simultaneous starting axis No.1 | [Da.25] Simultaneous starting axis No.2 | [Da.26] Simultaneous starting axis No.3 |
|------------------------------------|----------------------------------|--------------------|------------------------|------------------------|---|--|--|--|
| 04H: Buffer memory (2 words) | 04H: * * ≥ P1 | 2400 | 1000 | — | — | — | — | — |

(3) Designating the axis and positioning data No. to be simultaneously started in "simultaneous start"

[Condition]

Simultaneously starting "axis 2 positioning data No.3"

| [Da.15] Condition target | [Da.16] Condition operator | [Da.17] Address | [Da.18] Parameter 1 | [Da.19] Parameter 2 | [Da.23] Number of simultaneous starting axes | [Da.24] Simultaneous starting axis No.1 | [Da.25] Simultaneous starting axis No.2 | [Da.26] Simultaneous starting axis No.3 |
|---------------------------------|----------------------------------|--------------------|---------------------------------|------------------------|---|--|--|--|
| 05H: Positioning data No. | — | — | Low-order 16 bits "0003H" | — | 2H: 2 axes | 1H: Axis 2 | 0H | 0H |

10.5 Multiple axes simultaneous start control

The "multiple axes simultaneous start" starts outputting the command to the specified simultaneous starting axis at the same timing as the started axis.

The maximum of four axes can be started simultaneously.

[1] Control details

The multiple axes simultaneous start control is carried out by setting the simultaneous start setting data to the multiple axes simultaneous start control buffer memory of the axis control data, and the "9004" to "[Cd.3] Positioning start No." of the start axis, and then turning ON the positioning start signal.

Set the number of axes to be started simultaneously and axis No. in "[Cd.43] Simultaneous starting axis", and the start data No. of simultaneous starting axis (positioning data No. to be started simultaneously for each axis) in "[Cd.30] Simultaneous starting own axis start data No." and "[Cd.31] Simultaneous starting axis start data No.1" to "[Cd.33] Simultaneous starting axis start data No.3".

[2] Restrictions

- (1) The error "Error before simultaneous start" (error code:501) will occur and all simultaneous starting axes will not start if the simultaneous starting axis start data No. is not set to the axis control data on the start axis or set outside the setting range.
- (2) The error "Error before simultaneous start" (error code:501) will occur and all simultaneous starting axes will not start if either of the simultaneous starting axes is BUSY.
- (3) The error "Error before simultaneous start" (error code:501) will occur and all simultaneous starting axes will not start if an error occurs during the analysis of the positioning data on the simultaneous starting axes.
- (4) No error or warning will occur if only the start axis is the simultaneous starting axis.
- (5) This function cannot be used with the sub function Section 13.7.7 "Pre-reading start function".

[3] Multiple axes simultaneous start control procedure

The procedure for multiple axes simultaneous start control is as follows.

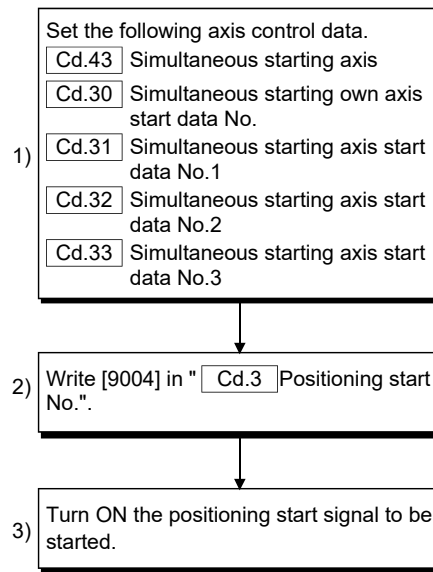

[4] Multiple axes simultaneous start control function setting method

The following shows the setting of the data used to execute the multiple axes simultaneous start control with positioning start signals (The axis control data on the start axis is set).

| Setting item | Setting value | Setting details | Buffer memory address |
|---|---------------|---|-----------------------|
| [Cd.3] Positioning start No. | 9004 | Set the multiple axes simultaneous start control start No. "9004". | 4300+100n |
| [Cd.43] Simultaneous starting axis | | Set the number of simultaneous starting axes and target axis. Set the simultaneous starting axis start data No. Set a "0" for the axis other than the simultaneous starting axes. | 4339+100n |
| [Cd.30] Simultaneous starting own axis start data No. | | | 4340+100n |
| [Cd.31] Simultaneous starting axis start data No.1 | | | 4341+100n |
| [Cd.32] Simultaneous starting axis start data No.2 | | | 4342+100n |
| [Cd.33] Simultaneous starting axis start data No.3 | | | 4343+100n |

n: Axis No.-1

(Note-1): Refer to Section 5.7 "List of control data" for information on setting details.

[5] Setting examples

- (1) The following shows the setting examples in which the QD77GF16 [axis 10] is used as the start axis and the simultaneous starting axes are used as the axes 12 and 14.

| Setting item | | Setting value | Setting details | Buffer memory address (Axis 10) |
|--------------|---|---------------|---|---------------------------------|
| [Cd.3] | Positioning start No. | 9004 | Set the multiple axes simultaneous start control start No. "9004". | 5200 |
| [Cd.43] | Simultaneous starting axis | 30DBH | Set the axis 12 (0BH) to the simultaneous starting axis No.1, and the axis 14 (0DH) to the simultaneous starting axis No.2. | 5239 |
| [Cd.30] | Simultaneous starting own axis start data No. | 100 | The axis 10 starts the positioning data No. 100. | 5240 |
| [Cd.31] | Simultaneous starting axis start data No.1 | 200 | Immediately after the start of the axis 10, the axis 12 starts the axis 12 positioning data No. 200. | 5241 |
| [Cd.32] | Simultaneous starting axis start data No.2 | 300 | Immediately after the start of the axis 10, the axis 14 starts the axis 14 positioning data No. 300. | 5242 |
| [Cd.33] | Simultaneous starting axis start data No.3 | 0 | Will not start simultaneously. | 5243 |

POINTS

- (1) The "multiple axes simultaneous start control" carries out an operation equivalent to the "simultaneous start" using the "block start data".
- (2) The setting of the "multiple axes simultaneous start control" is easier than that of the "simultaneous start" using the "block start data".
- Setting items for "simultaneous start" using "block start data"
Positioning start data, block start data, condition data, and positioning data
 - Setting items for "multiple axes simultaneous start control"
Positioning data and axis control data

10.6 Start program for high-level positioning control

10.6.1 Starting high-level positioning control

To execute high-level positioning control, a sequence program must be created to start the control in the same method as for major positioning control.

The following shows the procedure for starting the "1st point block start data" (regarded as block No. 7000) set in axis 1.

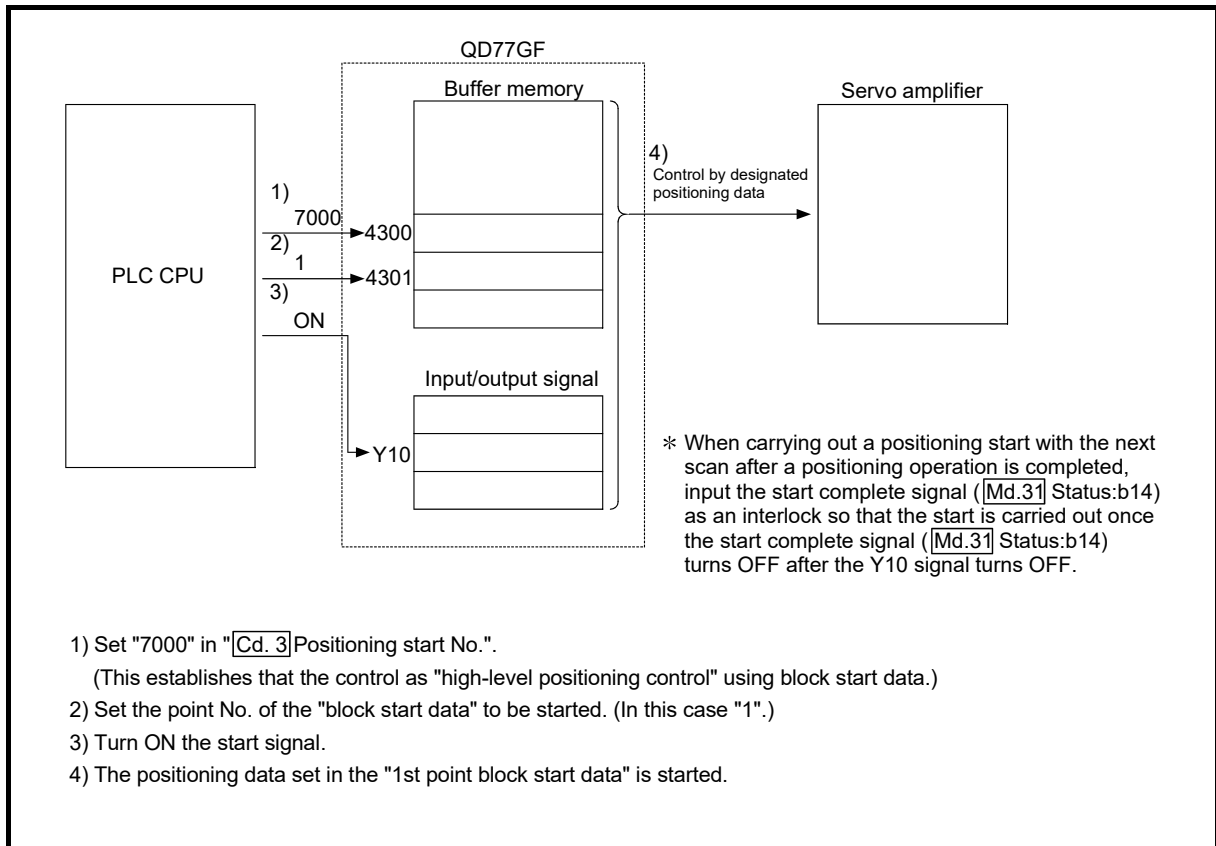

Fig. 10.2 High-level positioning control start procedure

10.6.2 Example of a start program for high-level positioning control

The following shows an example of a start program for high-level positioning control in which the 1st point "block start data" of axis 1 is started. (The block No. is regarded as "7000".)

■ Control data that require setting

The following control data must be set to execute high-level positioning control. The setting is carried out using a sequence program.

| Setting item | Setting value | Setting details | Buffer memory address |
|---------------------------------------|---------------|--|-----------------------|
| [Cd.3] Positioning start No. | 7000 | Set "7000" to indicate control using "block start data". | 4300+100n |
| [Cd.4] Positioning starting point No. | 1 | Set the point No. of the "block start data" to be started. | 4301+100n |

n: Axis No.-1

(Note): Refer to Section 5.7 "List of control data" for details on the setting details.

■ Start conditions

The following conditions must be fulfilled when starting the control. The required conditions must also be integrated into the sequence program, and configured so the control does not start unless the conditions are fulfilled.

| Signal name | Signal state | Signal state | Device | |
|------------------|--------------------------|--------------|---|---------------------|
| Interface signal | PLC READY signal | ON | PLC CPU preparation completed | Y0 |
| | READY signal | ON | QD77GF preparation completed | X0 |
| | All axis servo ON | ON | All axis servo ON | Y1 |
| | Synchronization flag | ON | QD77GF buffer memory The access is possible. | X1 |
| | Axis stop signal | OFF | Axis stop signal is OFF | [Cd.180] Axis stop |
| | Start complete signal | OFF | Start complete signal is OFF | [Md.31] Status: b14 |
| | BUSY signal | OFF | BUSY signal is OFF | X10 to X1F |
| | Error detection signal | OFF | There is no error | [Md.31] Status: b13 |
| | M code ON signal | OFF | M code ON signal is OFF | [Md.31] Status: b12 |
| External signal | Forced stop input signal | ON | There is no forced stop input | – |
| | Stop signal | OFF | Stop signal is OFF | – |
| | Upper limit (FLS) | ON | Within limit range | – |
| | Lower limit (RLS) | ON | Within limit range | – |

■ Start time chart

The following chart shows a time chart in which the positioning data No. 1, 2, 10, 11, and 12 of QD77GF16 [axis 1] are continuously executed as an example.

(1) Block start data setting example

| Axis 1 block start data | [Da.11] Shape | [Da.12] Start data No. | [Da.13] Special start instruction | [Da.14] Parameter |
|-------------------------|---------------|------------------------|-----------------------------------|-------------------|
| 1st point | 1: Continue | 1 | 0: Block start | — |
| 2nd point | 0: End | 10 | 0: Block start | — |
| • | | | | |
| • | | | | |

(2) Positioning data setting example

| Axis 1 positioning data No. | [Da.1] Operation pattern |
|-----------------------------|-----------------------------|
| 1 | 11: Continuous path control |
| 2 | 00: Positioning complete |
| • | |
| 10 | 11: Continuous path control |
| 11 | 11: Continuous path control |
| 12 | 00: Positioning complete |
| • | |

(3) Start time chart

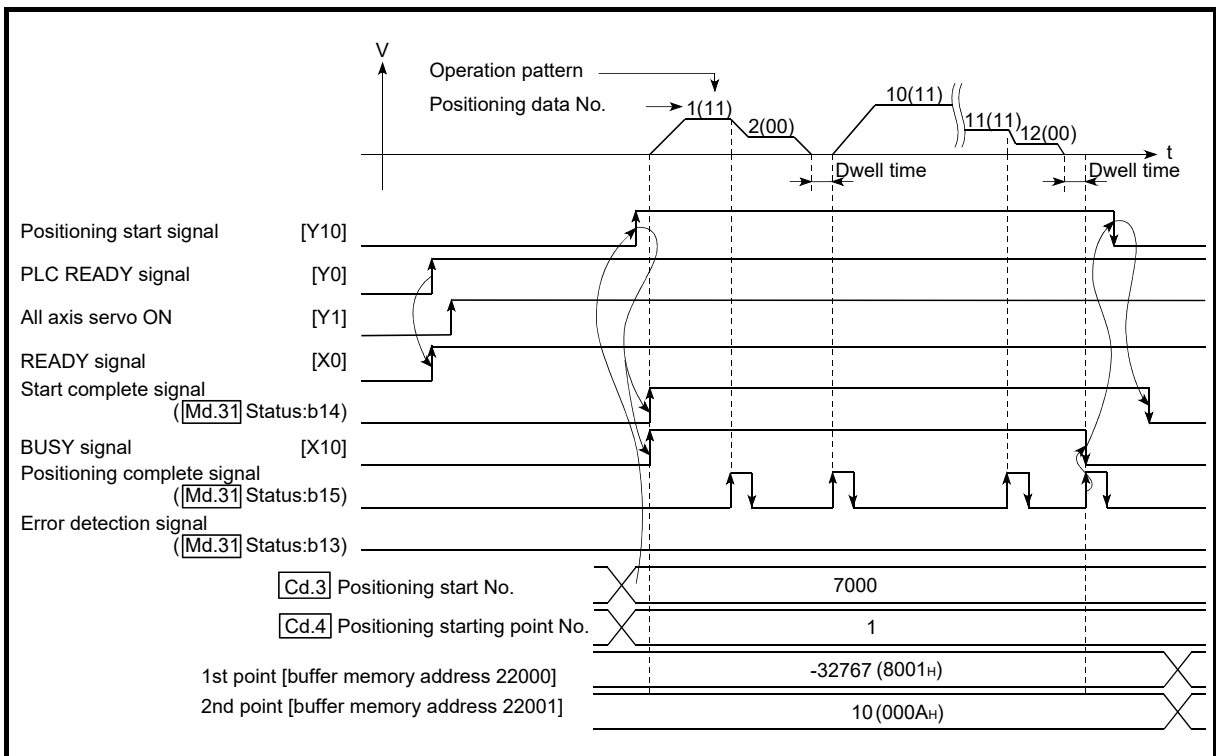
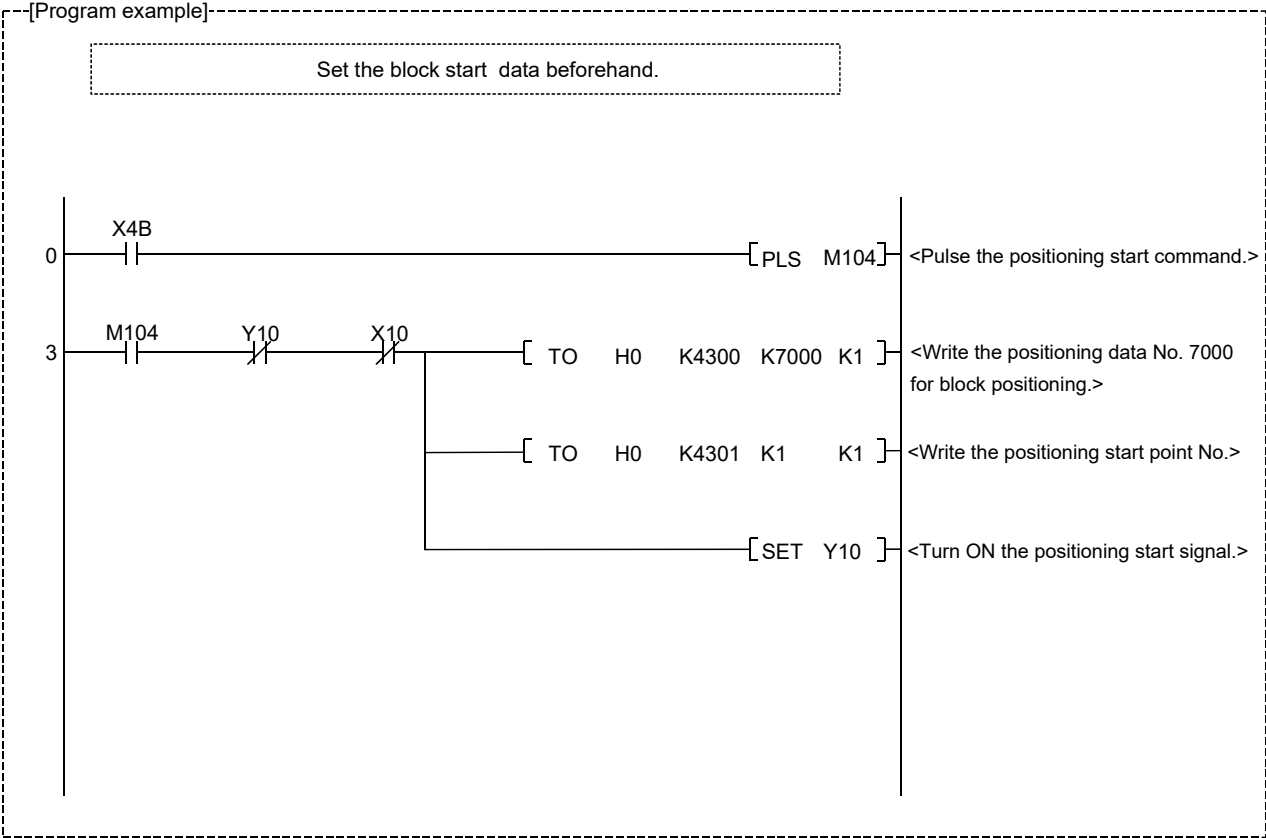

Fig. 10.3 Start time chart for high-level positioning control (block start)

■ Creating the program



Chapter 11 Manual Control

The details and usage of manual control are explained in this chapter. In manual control, commands are issued during a JOG operation and an inching operation executed by the turning ON of the JOG START signal, or from a manual pulse generator connected to the Simple Motion module.

Manual control using a sequence program from the PLC CPU is explained in this chapter. Refer to the "Simple Motion Module Setting Tool Help" of GX Works2 for an explanation of manual control (JOG operation, inching operation and manual pulse generator operation) using the GX Works2.

| | | |
|--------|---|--------|
| 11.1 | Outline of manual control | 11- 2 |
| 11.1.1 | Three manual control methods..... | 11- 2 |
| 11.2 | JOG operation..... | 11- 4 |
| 11.2.1 | Outline of JOG operation | 11- 4 |
| 11.2.2 | JOG operation execution procedure | 11- 7 |
| 11.2.3 | Setting the required parameters for JOG operation | 11- 8 |
| 11.2.4 | Creating start programs for JOG operation..... | 11- 10 |
| 11.2.5 | JOG operation example | 11- 12 |
| 11.3 | Inching operation | 11- 15 |
| 11.3.1 | Outline of inching operation | 11- 15 |
| 11.3.2 | Inching operation execution procedure | 11- 18 |
| 11.3.3 | Setting the required parameters for inching operation | 11- 19 |
| 11.3.4 | Creating a program to start the inching operation | 11- 20 |
| 11.3.5 | Inching operation example..... | 11- 22 |
| 11.4 | Manual pulse generator operation | 11- 24 |
| 11.4.1 | Outline of manual pulse generator operation..... | 11- 24 |
| 11.4.2 | Manual pulse generator operation execution procedure | 11- 28 |
| 11.4.3 | Setting the required parameters for manual pulse generator operation..... | 11- 29 |
| 11.4.4 | Creating a program to enable/disable the manual pulse generator operation..... | 11- 30 |

11.1 Outline of manual control

11.1.1 Three manual control methods

"Manual control" refers to control in which positioning data is not used, and a positioning operation is carried out in response to signal input from an external device. The three types of this "manual control" are explained below.

[1] JOG operation

"JOG operation" is a control method in which the machine is moved by only a movement amount (commands are continuously output while the JOG START signal is ON). This operation is used to move the workpiece in the direction in which the limit signal is ON, when the operation is stopped by turning the limit signal OFF to confirm the positioning system connection and obtain the positioning data address (refer to Section 13.7.4 "Teaching function").

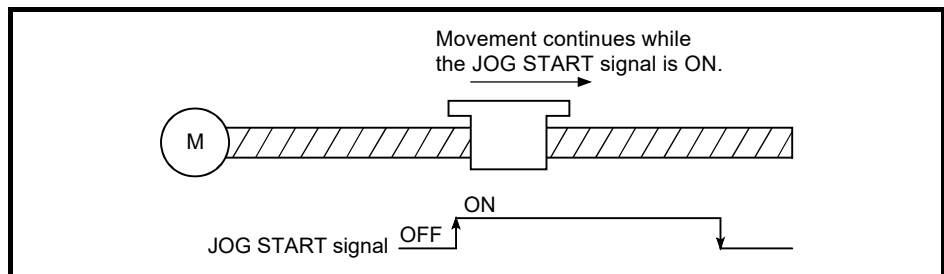

Fig. 11.1 JOG operation

[2] Inching operation

"Inching operation" is a control method in which a minute movement amount of command is output manually in operation cycle.

When the "inching movement amount" of the axis control data is set by JOG operation, the workpiece is moved by a set movement amount. (When the "inching movement amount" is set to "0", the machine operates as JOG operation.)

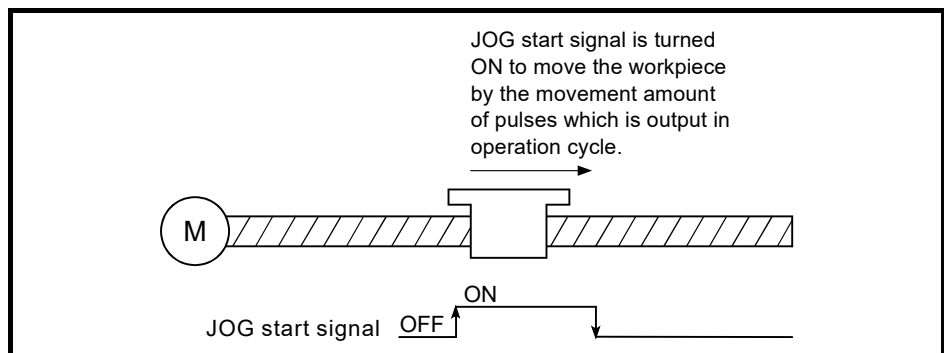

Fig. 11.2 Inching operation

[3] Manual pulse generator operation

"Manual pulse generator operation" is a control method in which positioning is carried out in response to the number of pulses input from a manual pulse generator (the number of input command is output). This operation is used for manual fine adjustment, etc., when carrying out accurate positioning to obtain the positioning address.

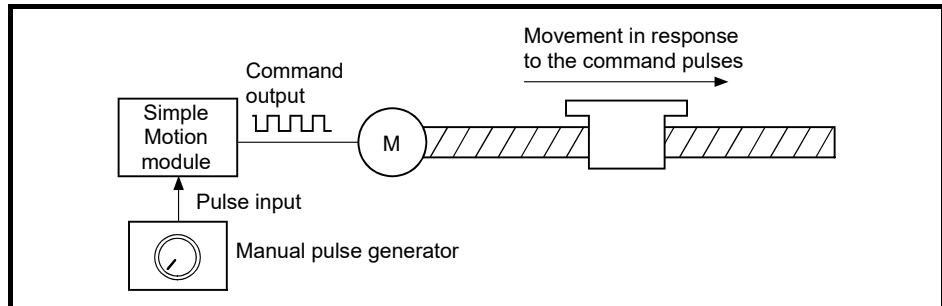

Fig. 11.3 Manual pulse generator control

■ Manual control sub functions

Refer to Section 3.2.5 "Combination of QD77GF main functions and sub functions" for details on "sub functions" that can be combined with manual control. Also refer to Chapter 13 "Control Sub Functions" for details on each sub function.

■ Carrying out manual control from GX Works2

"JOG operation", "Inching operation" and enabling/disabling of the "manual pulse generator operation" can be executed from GX Works2 test function. Refer to the "Simple Motion Module Setting Tool Help" of GX Works2 for details on manual control from GX Works2.

■ Monitoring manual control

Refer to Section 5.6 "List of monitor data" when directly monitoring the buffer memory using GX Works2. Also refer to the "Simple Motion Module Setting Tool Help" of GX Works2 when monitoring with the monitor functions of GX Works2.

11.2 JOG operation

11.2.1 Outline of JOG operation

■ JOG operation

In JOG operation, the forward run JOG start signal ([Cd.181]) or reverse run JOG start signal ([Cd.182]) turns ON, causing pulses to be output to the servo amplifier from the Simple Motion module while the signal is ON. The workpiece is then moved in the designated direction.

The following shows examples of JOG operation.

| | |
|----|---|
| 1) | When the START signal turns ON, acceleration begins in the direction designated by the START signal, and continues for the acceleration time designated in "[Pr.32] JOG operation acceleration time selection". At this time, the BUSY signal changes from OFF to ON. |
| 2) | When the workpiece being accelerated reaches the speed set in "[Cd.17] JOG speed", the movement continues at this speed. The constant speed movement takes place at 2) and 3). |
| 3) | When the START signal is turned OFF, deceleration begins from the speed set in "[Cd.17] JOG speed", and continues for the deceleration time designated in "[Pr.33] JOG operation deceleration time selection". |
| 4) | The operation stops when the speed becomes "0". At this time, the BUSY signal changes from ON to OFF. |

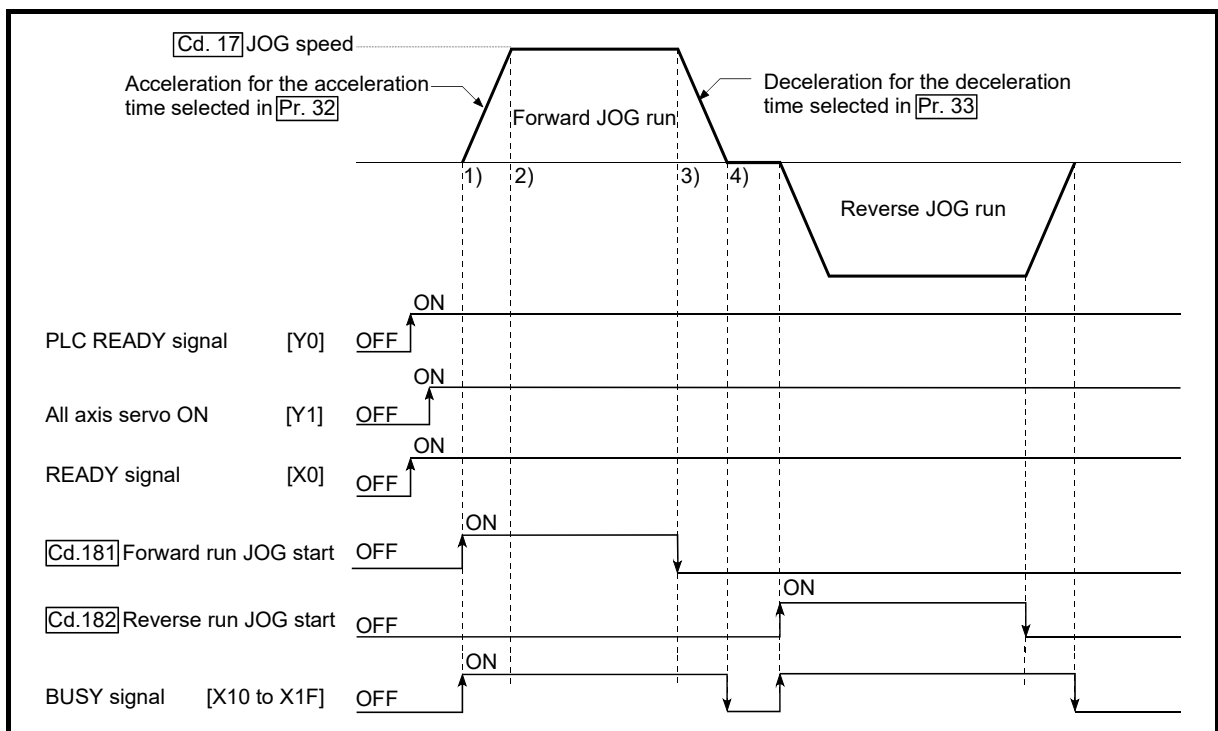

Fig. 11.4 JOG operation

Important

Use the hardware stroke limit function when carrying out JOG operation near the upper or lower limits. (Refer to Section "13.4.4".)

If the hardware stroke limit function is not used, the workpiece may exceed the moving range, causing an accident.

■ Precautions during operation

The following details must be understood before carrying out JOG operation.

- (1) For safety, first set "[Cd.17] JOG speed" to a smaller value and check the movement. Then gradually increase the value.
- (2) The error "Outside JOG speed range" (error code: 300) will occur and the operation will not start if the "JOG speed" is outside the setting range at the JOG start.
- (3) The error "JOG speed limit value error" (error code: 956) will occur and the operation will not start if "[Pr.31] JOG speed limit value" is set to a value larger than "[Pr.8] Speed limit value".
- (4) If "[Cd.17] JOG speed" exceeds the speed set in "[Pr.31] JOG speed limit value", the workpiece will move at the "[Pr.31] JOG speed limit value" and the warning "JOG speed limit value" (warning code: 301) will occur in the Simple Motion module.
- (5) The JOG operation can be continued even if an "Axis warning" has occurred.
- (6) Set a "0" in "[Cd.16] Inching movement amount". If a value other than "0" is set, the operation will become an inching operation (Refer to Section 11.3 "Inching operation").

■ Operations when stroke limit error occurs

When the operation is stopped by hardware stroke limit error or software stroke limit error, the JOG operation can execute in an opposite way (direction within normal limits) after an error reset. (An error will occur again if JOG start signal is turned ON in a direction to outside the stroke limit.)

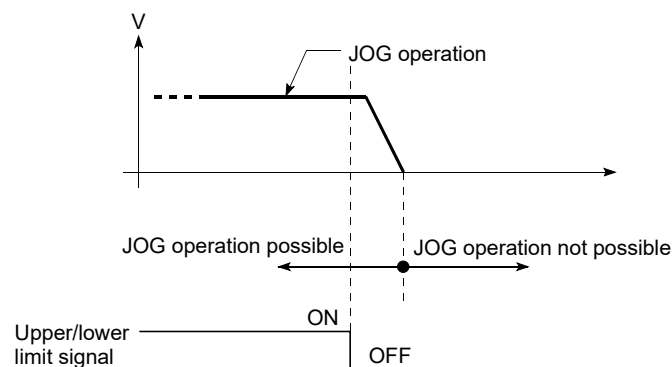

■ JOG operation timing and processing time

The following drawing shows details of the JOG operation timing and processing time.

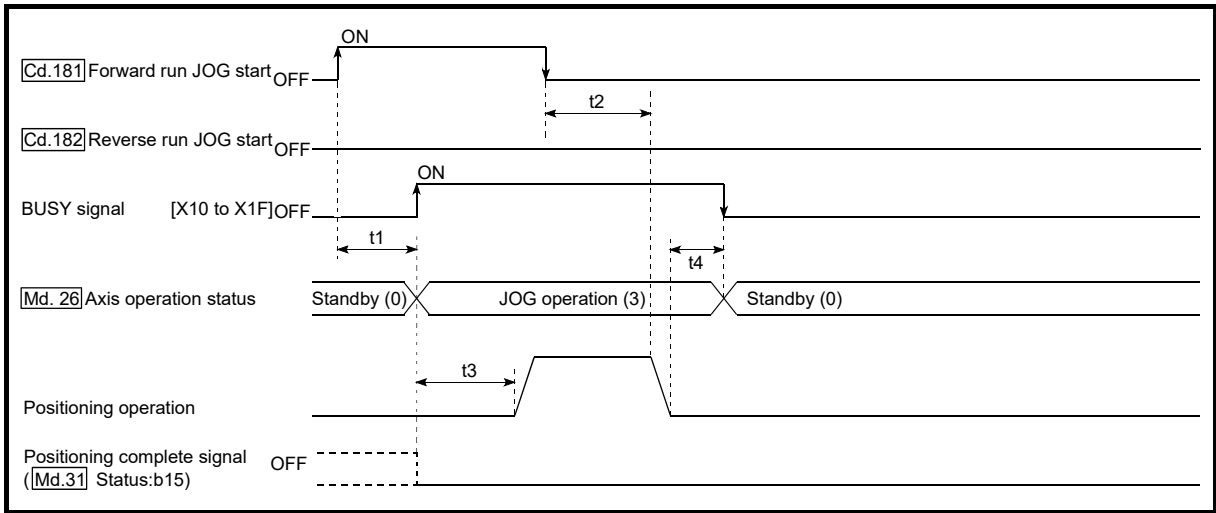

Fig. 11.5 JOG operation timing and processing times

Normal timing times

Unit: [ms]

| [Pr.132] Communication mode setting | Operation cycle | t1 | t2 | t3 | t4 |
|---|-----------------|------------|----------|--------------|----------|
| MR-J4-B-RJ010 communication mode | 0.88 | 0.7 to 1.5 | 0 to 0.9 | 2.5 to 3.4 | 0 to 0.9 |
| | 1.77 | 0.7 to 2.3 | 0 to 1.8 | 6.2 to 7.9 | 0 to 1.8 |
| | 3.55 | 1.3 to 4.0 | 0 to 3.6 | 11.2 to 13.7 | 0 to 3.6 |
| Communication mode correspond to CiA402 | 1.00 | 0.7 to 1.6 | 0 to 1.0 | 2.5 to 3.4 | 0 to 1.0 |
| | 2.00 | 0.7 to 2.6 | 0 to 2.0 | 6.2 to 7.9 | 0 to 2.0 |
| | 4.00 | 1.3 to 4.3 | 0 to 4.0 | 11.5 to 13.7 | 0 to 4.0 |

- Delays may occur in the t1 timing time due to the operation status of other axes.

11.2.2 JOG operation execution procedure

The JOG operation is carried out by the following procedure.

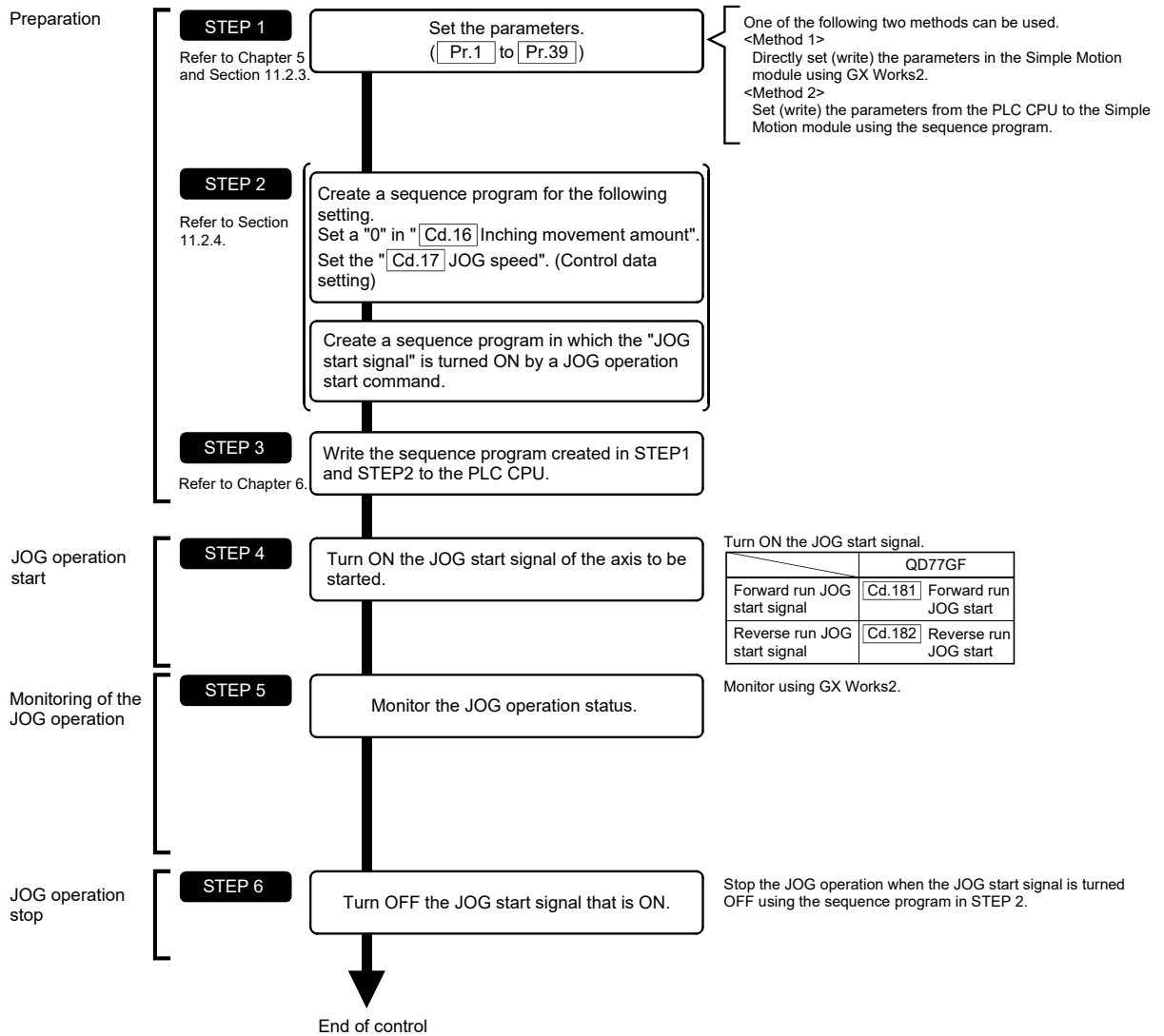

REMARK

- Mechanical elements such as limit switches are considered as already installed.
- Parameter settings work in common for all control using the Simple Motion module.

11.2.3 Setting the required parameters for JOG operation

The "Positioning parameters" must be set to carry out JOG operation.

The following table shows the setting items of the required parameters for carrying out JOG operation. Parameters not shown below are not required to be set for carrying out only JOG operation. (Set the initial value or a value within the setting range.)

| Setting item | | Setting requirement | Factory-set initial value (setting details) |
|------------------------|---|---------------------|--|
| Positioning parameters | [Pr.1] Unit setting | ◎ | 3 (PLS) |
| | [Pr.2] Number of pulses per rotation (AP) (Unit: PLS) | ◎ | 20000 |
| | [Pr.3] Movement amount per rotation (AL) (Unit: PLS) | ◎ | 20000 |
| | [Pr.4] Unit magnification (AM) | ◎ | 1 (1 times) |
| | [Pr.7] Bias speed at start (Unit: PLS/s) | ○ | 0 |
| | [Pr.8] Speed limit value (Unit: PLS/s) | ◎ | 200000 |
| | [Pr.9] Acceleration time 0 (Unit: ms) | ◎ | 1000 |
| | [Pr.10] Deceleration time 0 (Unit: ms) | ◎ | 1000 |
| | [Pr.11] Backlash compensation amount (Unit: PLS) | ○ | 0 |
| | [Pr.12] Software stroke limit upper limit value (Unit: PLS) | ○ | 2147483647 |
| | [Pr.13] Software stroke limit lower limit value (Unit: PLS) | ○ | -2147483648 |
| | [Pr.14] Software stroke limit selection | ○ | 0 (feed current value) |
| | [Pr.15] Software stroke limit valid/invalid setting | ○ | 0 (valid) |
| | [Pr.17] Torque limit setting value (Unit: %) | ○ | 300 |
| | [Pr.25] Acceleration time 1 (Unit: ms) | ○ | 1000 |
| | [Pr.26] Acceleration time 2 (Unit: ms) | ○ | 1000 |
| | [Pr.27] Acceleration time 3 (Unit: ms) | ○ | 1000 |
| | [Pr.28] Deceleration time 1 (Unit: ms) | ○ | 1000 |
| | [Pr.29] Deceleration time 2 (Unit: ms) | ○ | 1000 |
| | [Pr.30] Deceleration time 3 (Unit: ms) | ○ | 1000 |
| | [Pr.31] JOG speed limit value (Unit: PLS/s) | ◎ | 20000 |
| | [Pr.32] JOG operation acceleration time selection | ◎ | 0 (acceleration time 0) |
| | [Pr.33] JOG operation deceleration time selection | ◎ | 0 (deceleration time 0) |
| | [Pr.34] Acceleration/deceleration process selection | ○ | 0 (trapezoidal acceleration/ deceleration processing) |
| | [Pr.35] S-curve ratio (Unit: %) | ○ | 100 |
| | [Pr.36] Rapid stop deceleration time (Unit: ms) | ○ | 1000 |
| | [Pr.37] Stop group 1 rapid stop selection | ○ | 0 (deceleration stop) |
| | [Pr.38] Stop group 2 rapid stop selection | ○ | 0 (deceleration stop) |
| | [Pr.39] Stop group 3 rapid stop selection | ○ | 0 (deceleration stop) |

◎ : Setting always required.

○ : Set according to requirements (Set the initial value or a value within the setting range when not used.)

REMARK

- Parameter settings work in common for all controls using the Simple Motion module. When carrying out other controls ("major positioning control", "high-level positioning control", "HPR positioning control"), set the respective setting items as well.
- Parameters are set for each axis.
- Refer to Chapter 5 "Data Used for Positioning Control" for the setting details.

11.2.4 Creating start programs for JOG operation

A sequence program must be created to execute a JOG operation. Consider the "required control data setting", "start conditions" and "start time chart" when creating the program.

The following shows an example when a JOG operation is started for axis 1. ("[Cd.17] JOG speed" is set to "100.00mm/min" in the example shown.)

■ Required control data setting

The control data shown below must be set to execute a JOG operation. The setting is carried out with the sequence program.

| Setting item | Setting value | Setting details | Buffer memory address |
|---------------------------------|---------------|--|------------------------|
| [Cd.16] Inching movement amount | 0 | Set "0". | 4317+100n |
| [Cd.17] JOG speed | 10000 | Set a value equal to or below the "[Pr.31] JOG speed limit value". | 4318+100n 4319+100n |

n: Axis No.-1

*: Refer to Section 5.7 "List of control data" for details on the setting details.

■ Start conditions

The following conditions must be fulfilled when starting. The required conditions must also be assembled in the sequence program, and the sequence program must be configured so the operation will not start if the conditions are not fulfilled.

| | Signal name | Signal state | Device | |
|------------------|--------------------------|--------------|---|---------------------|
| Interface signal | PLC READY signal | ON | PLC CPU preparation completed | Y0 |
| | READY signal | ON | QD77GF preparation completed | X0 |
| | All axis servo ON | ON | All axis servo ON | Y1 |
| | Synchronization flag * | ON | QD77GF buffer memory The access is possible. | X1 |
| | Axis stop signal | OFF | Axis stop signal is OFF | [Cd.180] Axis stop |
| | Start complete signal | OFF | Start complete signal is OFF | [Md.31] Status: b14 |
| | BUSY signal | OFF | QD77GF is not operating | X10 to X1F |
| | Error detection signal | OFF | There is no error | [Md.31] Status: b13 |
| External signal | M code ON signal | OFF | M code ON signal is OFF | [Md.31] Status: b12 |
| | Forced stop input signal | ON | There is no forced stop input | – |
| | Stop signal | OFF | Stop signal is OFF | – |
| | Upper limit (FLS) | ON | Within limit range | – |
| | Lower limit (RLS) | ON | Within limit range | – |

*: If the PLC CPU is set to the asynchronous mode in the synchronization setting, this must be inserted in the program for interlocking. If it is set to the synchronous mode, it must not be inserted in the program for interlocking because it is turned ON when the PLC CPU executes calculation.

11.2.5 JOG operation example

■ When the "stop signal" is turned ON during JOG operation

When the "stop signal" is turned ON during JOG operation, the JOG operation will stop by the "deceleration stop" method.

If the JOG start signal is turned ON while the stop signal is ON, the error "Stop signal ON at start" (error code: 106) will occur.

The operation can be started by turning the stop signal OFF, and turning the JOG start signal from OFF to ON again.

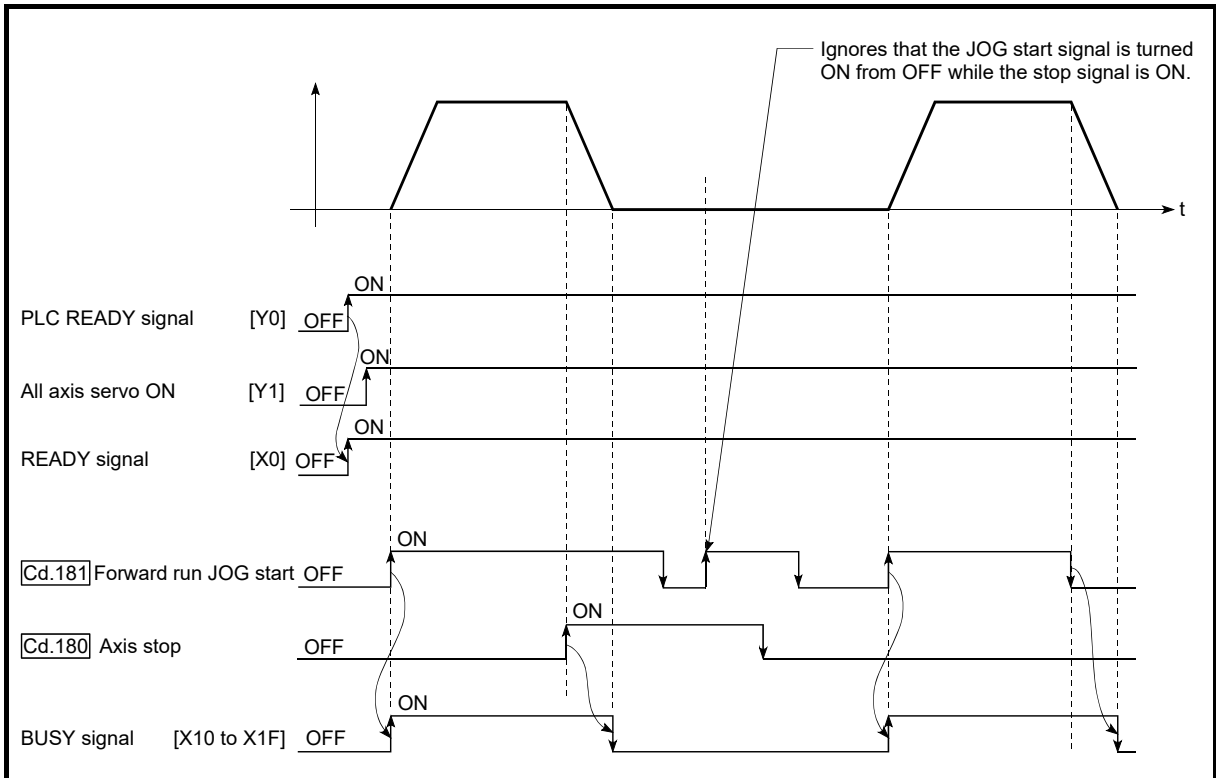

Fig. 11.7 Operation when the stop signal is turned ON during JOG operation

- When both the "forward run JOG start signal" and "reverse run JOG start signal" are turned ON simultaneously for one axis

When both the "forward run JOG start signal" and "reverse run JOG start signal" are turned ON simultaneously for one axis, the "forward run JOG start signal" is given priority. In this case, the "reverse run JOG start signal" is validated when the BUSY signal of Simple Motion module is turned OFF.

If the forward run JOG operation is stopped due to stop by a stop signal or axis error, the reverse run JOG operation will not be executed even if the "reverse run JOG start signal" turns ON.

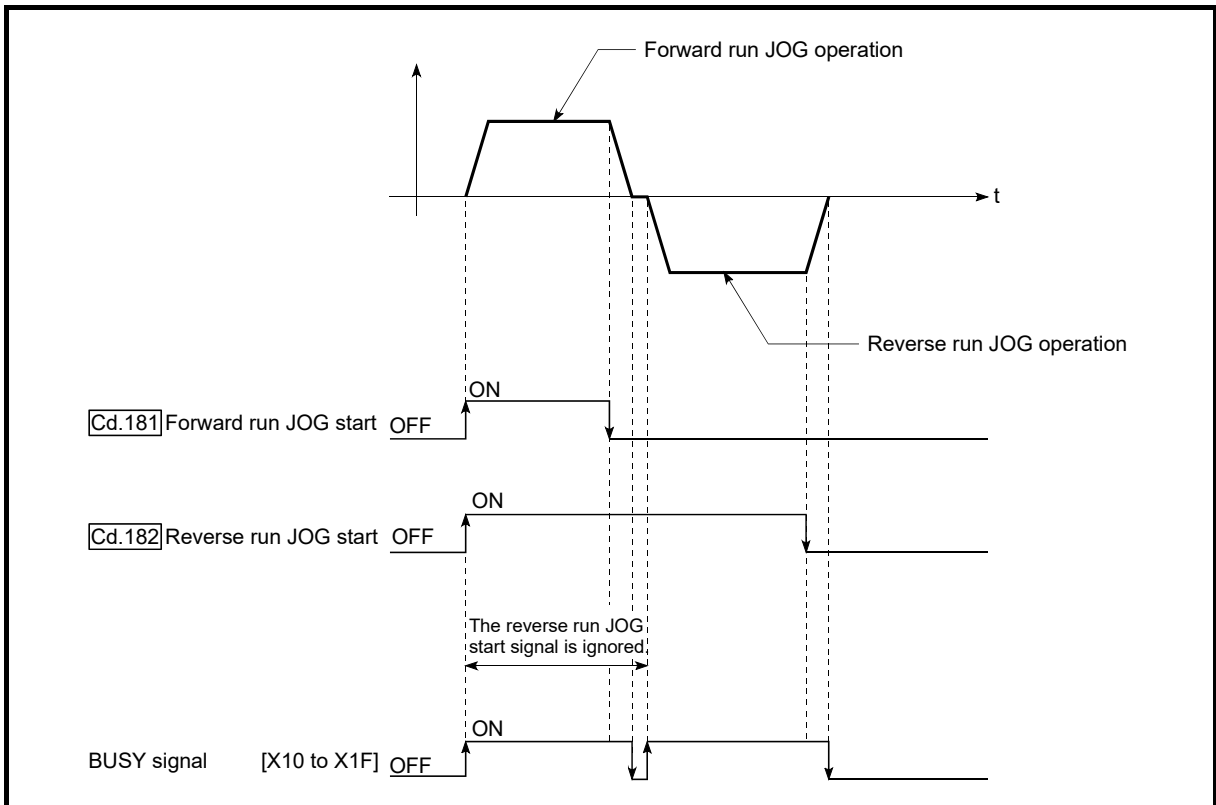

Fig. 11.8 Operation when both the forward run JOG start signal and reverse run JOG start signal are turned ON simultaneously

- When the "JOG start signal" is turned ON again during deceleration caused by the ON → OFF of the "JOG start signal"

When the "JOG start signal" is turned ON again during deceleration caused by the ON → OFF of the "JOG start signal", the JOG operation will be carried out from the time the "JOG start signal" is turned ON.

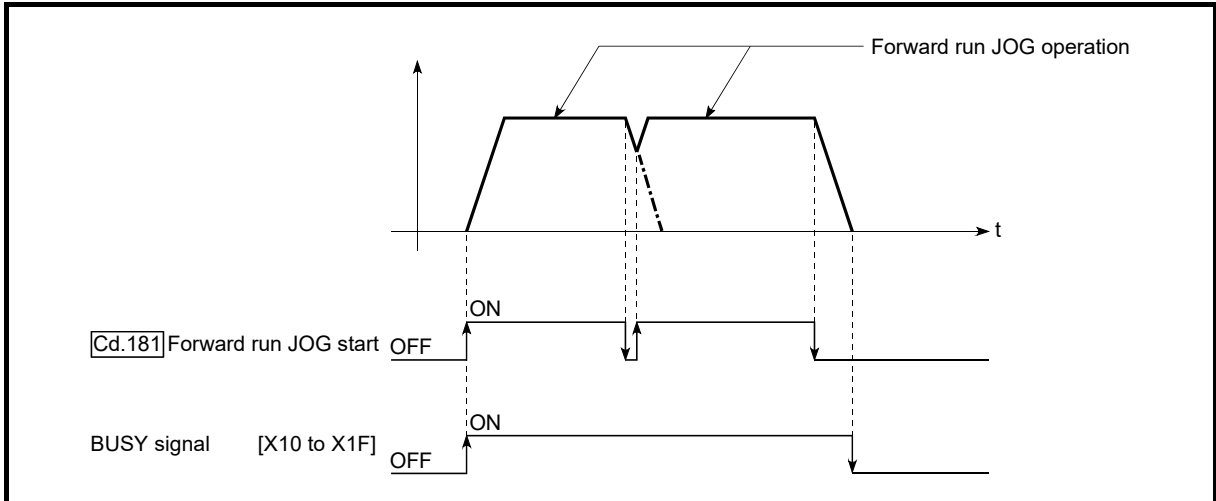

Fig. 11.9 Operation when the JOG start signal is turned ON during deceleration

- When the "JOG start signal" is turned ON while the test function of GX Works2 is used

When the "JOG start signal" is turned ON while the test function of GX Works2 is used, it will be ignored and the JOG operation will not be carried out.

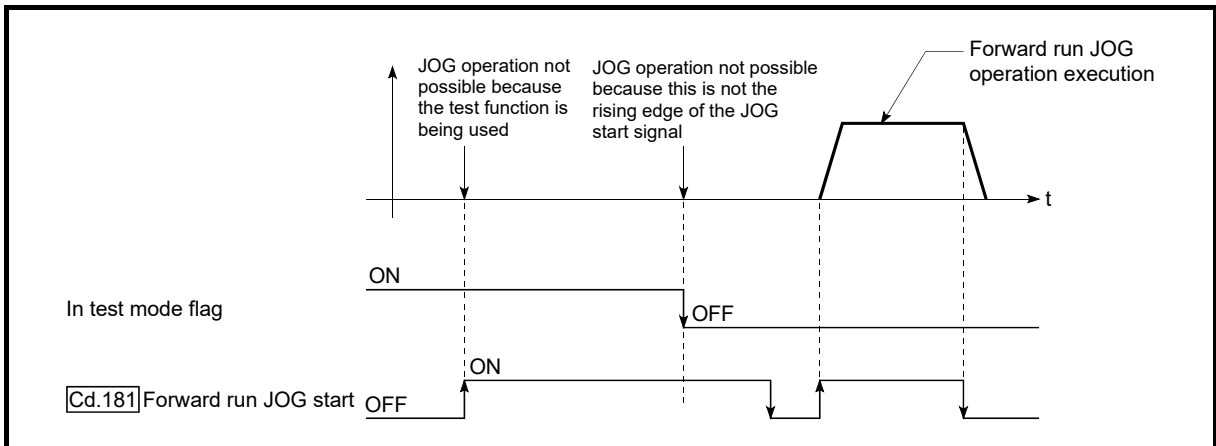

Fig. 11.10 Operation when the JOG start signal is turned ON while the test function is used

11.3 Inching operation

11.3.1 Outline of inching operation

■ Inching operation

In inching operation, pulses are output to the servo amplifier at operation cycle to move the workpiece by a designated movement amount after the forward run JOG start signal ([Cd.181]) or reverse JOG start signal ([Cd.182]) is turned ON.

The following shows the example of inching operation.

| | |
|----|---|
| 1) | When the start signal is turned ON, inching operation is carried out in the direction designated by the start signal. In this case, BUSY signal is turned from OFF to ON. |
| 2) | The workpiece is moved by a movement amount set in "[Cd.16] Inching movement amount". |
| 3) | The workpiece movement stops when the speed becomes "0". In this case, BUSY signal is turned from ON to OFF. The positioning complete signal is turned from OFF to ON. |
| 4) | The positioning complete signal is turned from ON to OFF after a time set in "[Pr.40] Positioning complete signal output time" has been elapsed. |

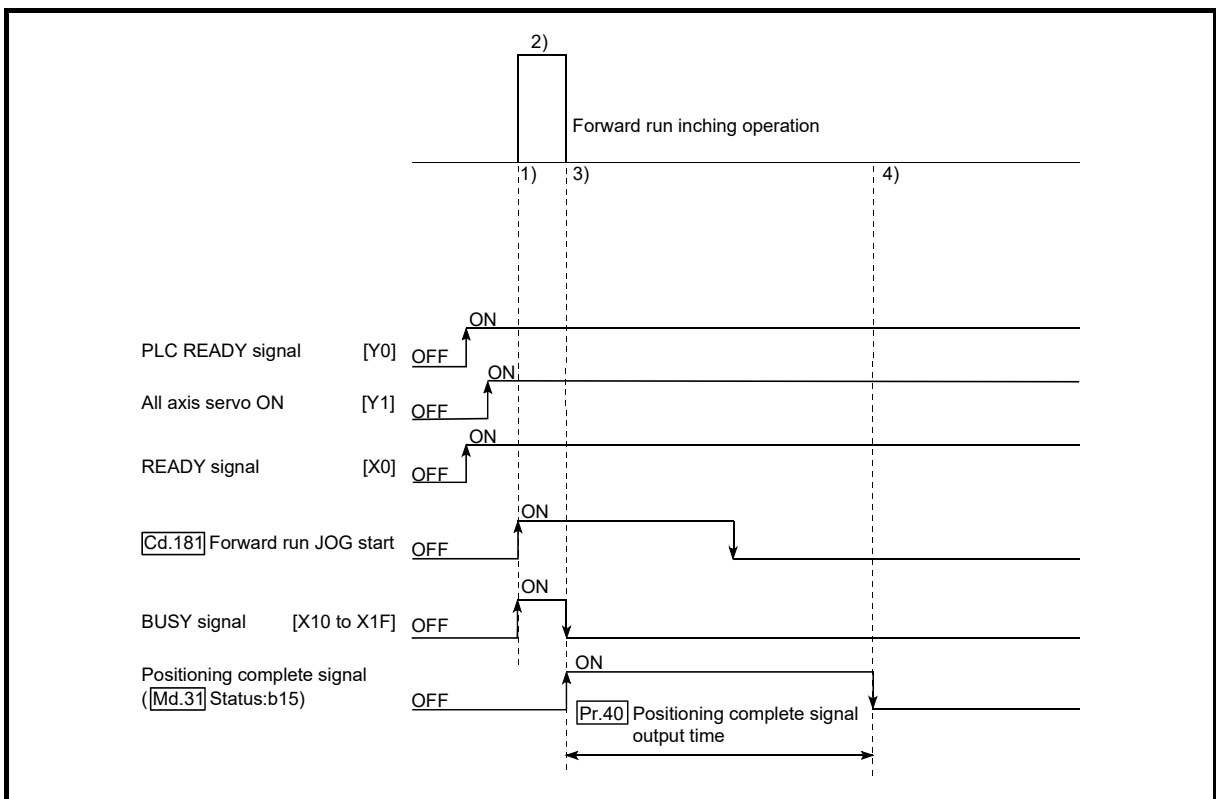

Fig. 11.11 Inching operation

Important

When the inching operation is carried out near the upper or lower limit, use the hardware stroke limit function (Refer to Section 13.4.4).

If the hardware stroke limit function is not used, the workpiece may exceed the movement range, and an accident may result.

■ Precautions during operation

The following details must be understood before inching operation is carried out.

- (1) Acceleration/deceleration processing is not carried out during inching operation.

(Commands corresponding to the designated inching movement amount are output at operation cycle. When the movement direction of inching operation is reversed and backlash compensation is carried out, the backlash compensation amount and inching movement amount are output at the same operation cycle.)

The "[Cd.17] JOG speed" is ignored even if it is set. The error "Inching movement amount error" (error code: 301) will occur in the following cases.
 $([Cd.16] \text{ Inching movement amount}) \times (A) > ([Pr.31] \text{ JOG speed limit value})$

However, (A) is as follows.

[RJ010 mode]

Unit: [ms]

| | Operation cycle | | |
|---|-----------------|-------|--------|
| | 0.88 | 1.77 | 3.55 |
| When unit is set to PLS | 1125 | 562.5 | 281.25 |
| When unit is set to degree and "[Pr.83] Speed control 10 x multiplier setting for degree axis" is valid | 67.5 | 33.75 | 16.88 |
| When unit setting is other than the above | 675 | 337.5 | 168.75 |

[CiA402 mode]

Unit: [ms]

| | Operation cycle | | |
|---|-----------------|------|------|
| | 1.00 | 2.00 | 4.00 |
| When unit is set to PLS | 1000 | 500 | 250 |
| When unit is set to degree and "[Pr.83] Speed control 10 x multiplier setting for degree axis" is valid | 60 | 30 | 15 |
| When unit setting is other than the above | 600 | 300 | 150 |

- (2) Set a value other than a "0" in "[Cd.16] Inching movement amount".
 If a "0" is set, the operation will become JOG operation (Refer to Section 11.2 "JOG operation").

■ Operations when stroke limit error occurs

When the operation is stopped by hardware stroke limit error or software stroke limit error, the inching operation can be performed in an opposite way (direction within normal limits) after an error reset.

(An error will occur again if JOG start signal is turned ON in a direction to outside the stroke limit.)

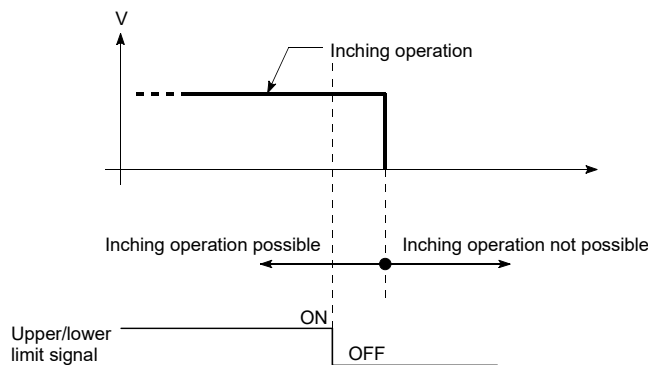

■ Inching operation timing and processing times

The following drawing shows the details of the inching operation timing and processing time.

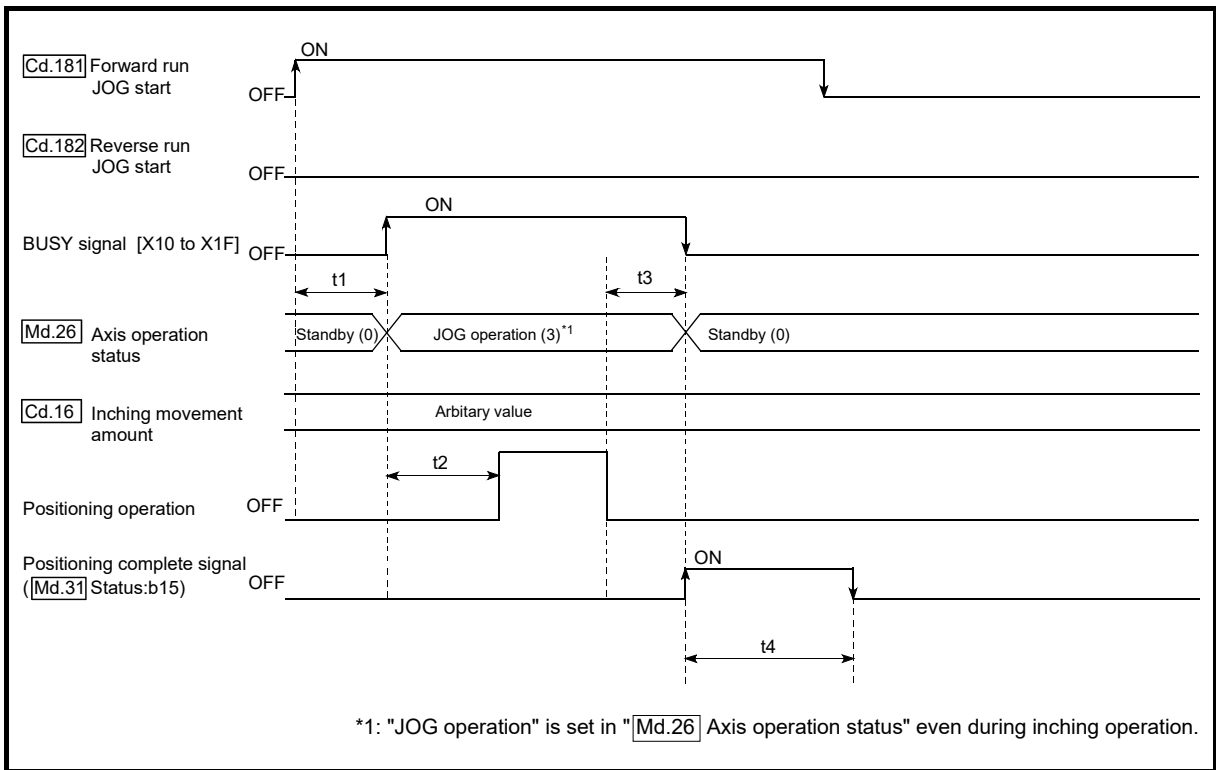

Fig. 11.12 Inching operation timing and processing times

Normal timing times

Unit: [ms]

| [Pr.132] Communication mode setting | Operation cycle | t1 | t2 | t3 | t4 |
|---|-----------------|------------|--------------|----------|--------------------|
| MR-J4-B-RJ010 communication mode | 0.88 | 0.6 to 1.3 | 2.4 to 3.2 | 0 to 0.9 | Follows parameters |
| | 1.77 | 0.9 to 2.2 | 6.4 to 7.7 | 0 to 1.8 | Follows parameters |
| | 3.55 | 0.9 to 4.1 | 10.6 to 13.9 | 0 to 3.6 | Follows parameters |
| Communication mode correspond to CiA402 | 1.00 | 0.6 to 1.4 | 2.4 to 3.2 | 0 to 1.0 | Follows parameters |
| | 2.00 | 0.9 to 2.7 | 6.4 to 7.7 | 0 to 2.0 | Follows parameters |
| | 4.00 | 0.9 to 4.6 | 11.5 to 13.9 | 0 to 4.0 | Follows parameters |

- Depending on the operating statuses of the other axes, delay may occur in the t1 timing time.

11.3.2 Inching operation execution procedure

The inching operation is carried out by the following procedure.

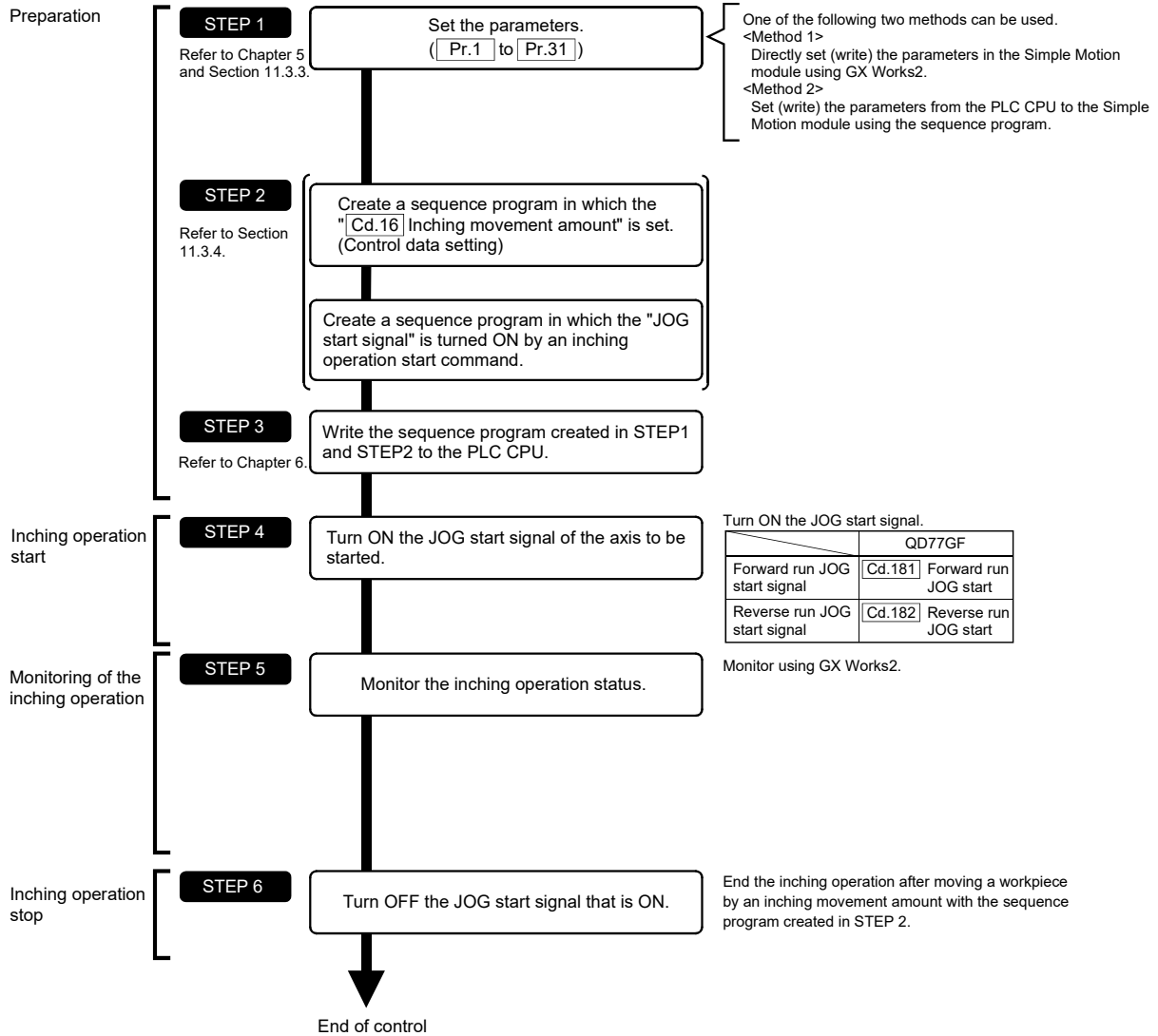

One of the following two methods can be used.
 <Method 1>
 Directly set (write) the parameters in the Simple Motion module using GX Works2.
 <Method 2>
 Set (write) the parameters from the PLC CPU to the Simple Motion module using the sequence program.

Turn ON the JOG start signal.

| | QD77GF | |
|------------------------------|----------|-----------------------|
| Forward run JOG start signal | [Cd.181] | Forward run JOG start |
| Reverse run JOG start signal | [Cd.182] | Reverse run JOG start |

Monitor using GX Works2.

End the inching operation after moving a workpiece by an inching movement amount with the sequence program created in STEP 2.

REMARK

- Mechanical elements such as limit switches are considered as already installed.
- Parameter settings work in common for all control using the Simple Motion module.

11.3.3 Setting the required parameters for inching operation

The "Positioning parameters" must be set to carry out inching operation.

The following table shows the setting items of the required parameters for carrying out inching operation. Parameters not shown below are not required to be set for carrying out only inching operation. (Set the initial value or a value within the setting range.)

| Setting item | | Setting requirement | Factory-set initial value (setting details) | |
|------------------------|---------|---|---|------------------------|
| Positioning parameters | [Pr.1] | Unit setting | ◎ | 3 (PLS) |
| | [Pr.2] | Number of pulses per rotation (AP) (Unit: PLS) | ◎ | 20000 |
| | [Pr.3] | Movement amount per rotation (AL) (Unit: PLS) | ◎ | 20000 |
| | [Pr.4] | Unit magnification (AM) | ◎ | 1 (1 times) |
| | [Pr.11] | Backlash compensation amount (Unit: PLS) | ○ | 0 |
| | [Pr.12] | Software stroke limit upper limit value (Unit: PLS) | ○ | 2147483647 |
| | [Pr.13] | Software stroke limit lower limit value (Unit: PLS) | ○ | -2147483648 |
| | [Pr.14] | Software stroke limit selection | ○ | 0 (feed current value) |
| | [Pr.15] | Software stroke limit valid/invalid setting | ○ | 0 (valid) |
| | [Pr.17] | Torque limit setting value (Unit: %) | ○ | 300 |
| | [Pr.31] | JOG speed limit value (Unit: PLS/s) | ◎ | 20000 |

◎ : Setting always required.

○ : Set according to requirements (Set the initial value or a value within the setting range when not used.)

REMARK

- Positioning parameter settings work in common for all controls using the Simple Motion module. When carrying out other controls ("major positioning control", "high-level positioning control", and "HPR control"), set the respective setting items as well.
- Parameters are set for each axis.
- Refer to Chapter 5 "Data Used for Positioning Control" for the setting details.

11.3.4 Creating a program to start the inching operation

A sequence program must be created to execute an inching operation. Consider the "required control data setting", "start conditions", and "start time chart" when creating the program.

The following shows an example when an inching operation is started for axis 1. (The example shows the inching operation when a "10.0 μm" is set in "[Cd.16] Inching movement amount".)

■ Required control data setting

The control data shown below must be set to execute an inching operation. The setting is carried out with the sequence program.

| Setting item | | Setting value | Setting details | Buffer memory address |
|--------------|-------------------------|---------------|---|-----------------------|
| [Cd.16] | Inching movement amount | 100 | Set the setting value so that the JOG speed limit value is not increased larger than the maximum output pulse | 4317+100n |

n: Axis No.-1

*: Refer to Section 5.7 "List of control data" for information on setting details.

■ Start conditions

The following conditions must be fulfilled when starting. The required conditions must also be assembled in the sequence program, and the sequence program must be configured so the operation will not start if the conditions are not fulfilled.

| Signal name | | Signal state | | Device |
|------------------|-----------------------------|--------------|------------------------------------|---------------------|
| Interface signal | PLC READY signal | ON | PLC CPU preparation completed | Y0 |
| | READY signal | ON | QD77GF preparation completed | X0 |
| | All axis servo ON | ON | All axis servo ON | Y1 |
| | Synchronization flag * | ON | Accessible to QD77GF buffer memory | X1 |
| | Axis stop signal | OFF | Axis stop signal is OFF | [Cd.180] Axis stop |
| | Start complete signal | OFF | Start complete signal is OFF | [Md.31] Status: b14 |
| | BUSY signal | OFF | QD77GF is not operating | X10 to X1F |
| | Positioning complete signal | OFF | Positioning complete signal is OFF | [Md.31] Status: b15 |
| | Error detection signal | OFF | There is no error | [Md.31] Status: b13 |
| External signal | M code ON signal | OFF | M code ON signal is OFF | [Md.31] Status: b12 |
| | Forced stop input signal | ON | There is no forced stop input | – |
| | Stop signal | OFF | Stop signal is OFF | – |
| | Upper limit (FLS) | ON | Within limit range | – |
| | Lower limit (RLS) | ON | Within limit range | – |

*: If the PLC CPU is set to the asynchronous mode in the synchronization setting, this must be inserted in the program for interlocking. If it is set to the synchronous mode, it must not be inserted in the program for interlocking because it is turned ON when the PLC CPU executes calculation.

■ Start time chart

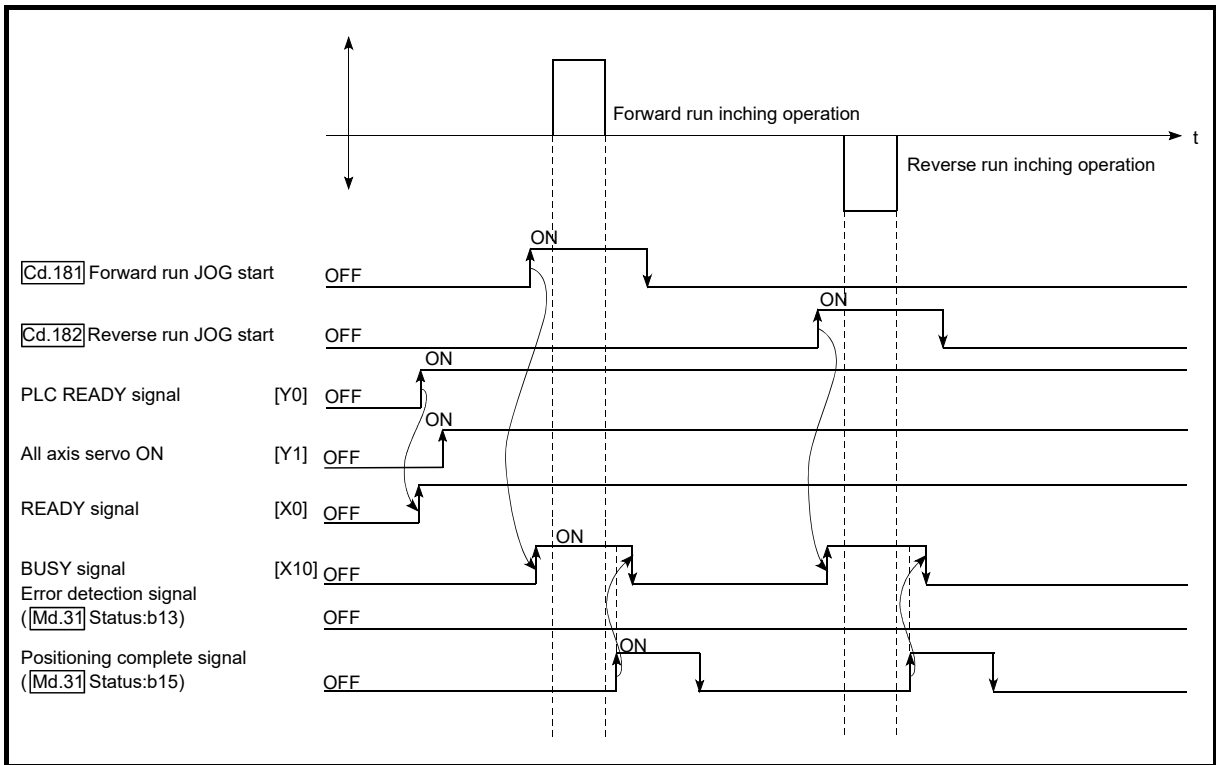
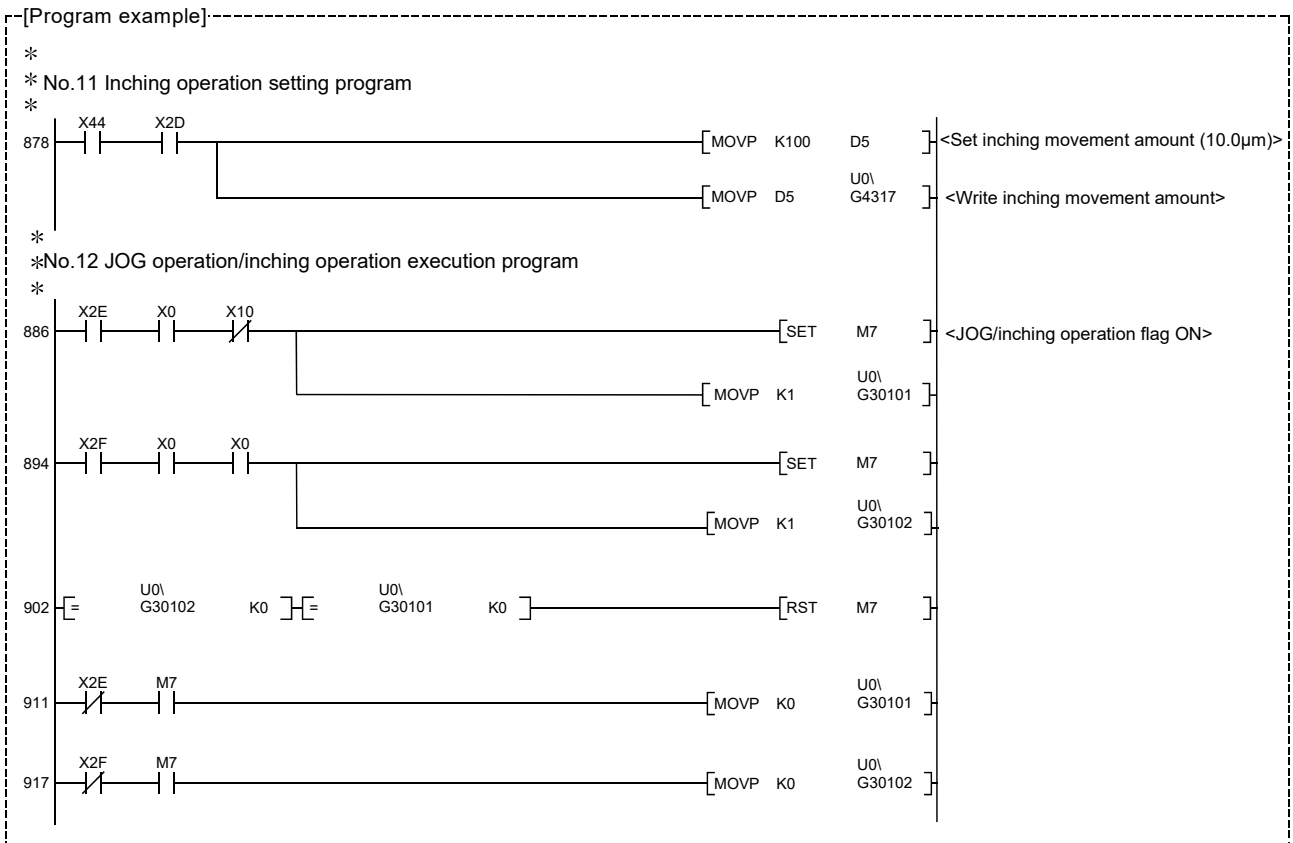

Fig. 11.13 Inching operation start time chart

■ Creating the program



11.3.5 Inching operation example

■ When executing inching operation while stop signal is turned ON

If the JOG start signal is turned ON while the stop signal is ON, the error "Stop signal ON at start" (error code: 106) will occur.

The inching operation can be re-started when the stop signal is turned OFF and then re-turned ON.

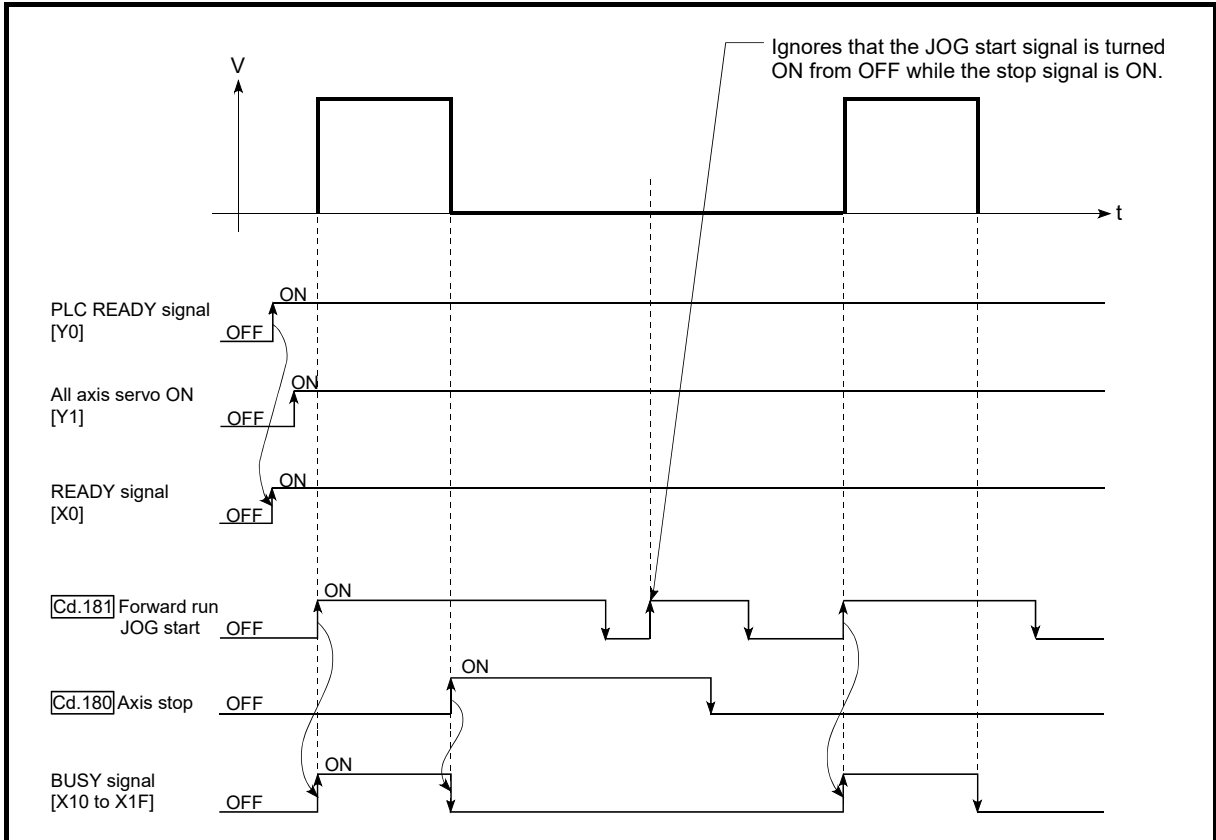

Fig. 11.14 Operation when executing inching operation while stop signal is turned ON

■ When the "JOG start signal" is turned ON while the test function of GX Works2 is used

When the "JOG start signal" is turned ON while the test function is used, it will be ignored and the inching operation will not be carried out.

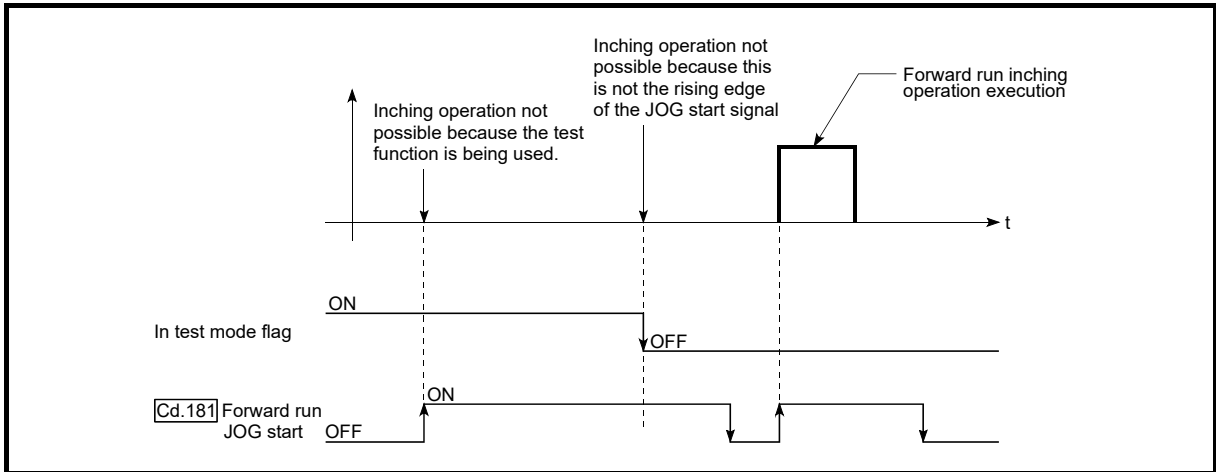

Fig. 11.15 Operation when the JOG start signal is turned ON while the test function is used

11.4 Manual pulse generator operation

11.4.1 Outline of manual pulse generator operation

Manual pulse generator operation

In manual pulse generator operations, pulses are input to the Simple Motion module from the manual pulse generator. This causes the same number of input command to be output from the Simple Motion module to the servo amplifier, and the workpiece is moved in the designated direction.

The following shows an example of manual pulse generator operation.

| | |
|----|--|
| 1) | When "[Cd.21] Manual pulse generator enable flag" is set to "1", the BUSY signal turns ON and the manual pulse generator operation is enabled. |
| 2) | The workpiece is moved corresponding to the number of pulses input from the manual pulse generator. |
| 3) | The workpiece movement stops when no more pulses are input from the manual pulse generator. |
| 4) | When "[Cd.21] Manual pulse generator enable flag" is set to "0", the BUSY signal turns OFF and the manual pulse generator operation is disabled. |

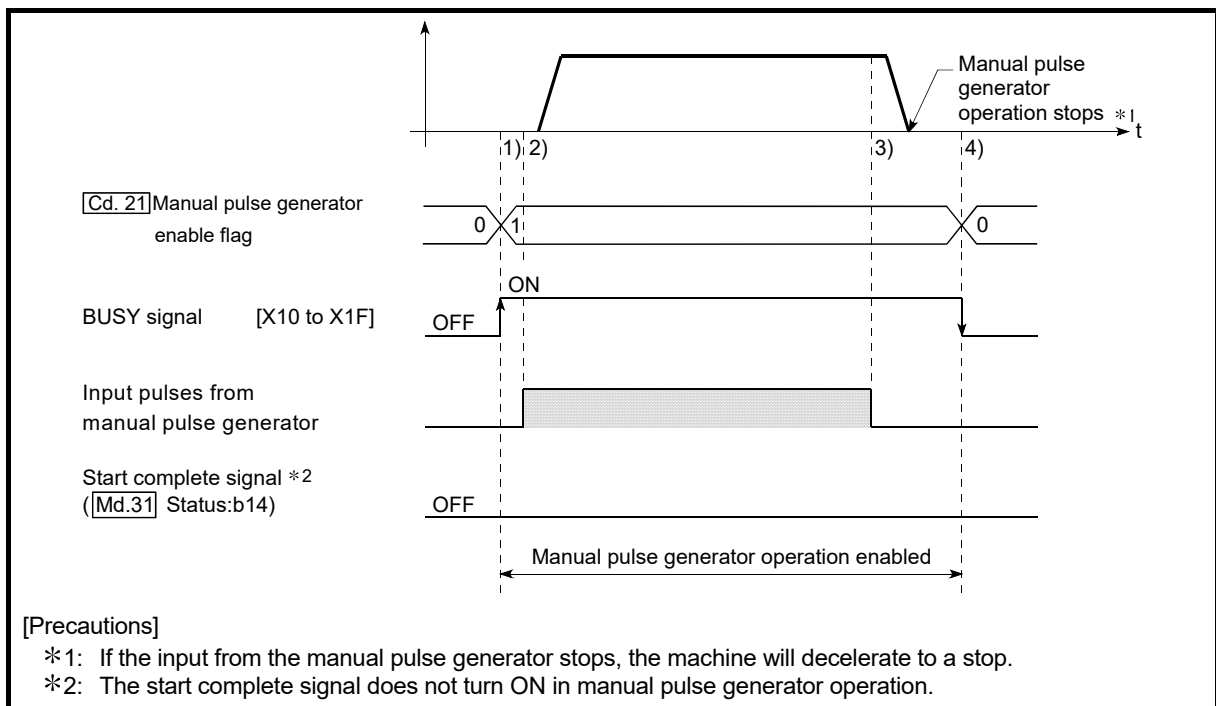

Fig. 11.16 Manual pulse generator operation

Important

Create the sequence program so that "[Cd.21] Manual pulse generator enable flag" is always set to "0" (disabled) when a manual pulse generator operation is not carried out.

Mistakenly touching the manual pulse generator when the "manual pulse generator enable flag" is set to "1" (enable) can cause accidents or incorrect positioning.

■ Restricted items

A manual pulse generator is required to carry out manual pulse generator operation.

■ Precautions during operation

The following details must be understood before carrying out manual pulse generator operation.

- (1) The speed during manual pulse generator operation is not limited by the "[Pr.8] Speed limit value".
- (2) If "[Cd.21] Manual pulse generator enable flag" is turned ON while the Simple Motion module is BUSY (BUSY signal ON), the warning "Start during operation" (warning code: 100) will occur.
- (3) If a stop factor occurs during manual pulse generator operation, the operation will stop, and the BUSY signal will turn OFF.
At this time, "[Cd.21] Manual pulse generator enable flag" will remain ON. However, manual pulse generator operation will not be possible. To carry out manual pulse generator operation again, measures must be carried out to eliminate the stop factor. Once eliminated, the operation can be carried out again by turning "[Cd.21] Manual pulse generator enable flag" ON → OFF → ON.
(Note that this excludes hardware/software stroke limit error.)
- (4) Command will not be output if an error occurs when the manual pulse generator operation starts.

Important

The speed command is issued according to the input from the manual pulse generator irrelevant of the speed limit setting.

When the speed command is larger than 62914560pps (63Mpps), the servo alarm "Command frequency error" (alarm No.: 35) will occur.

The following calculation formula is used to judge whether or not a servo alarm will occur.

$$(\text{Speed command}) = \left(\begin{array}{c} \text{Number of} \\ \text{input pulses} \\ \text{for one} \\ \text{second} \end{array} \right) \times \left(\begin{array}{c} \text{Manual pulse} \\ \text{generator 1} \\ \text{pulse input} \\ \text{magnification} \end{array} \right) \times \left(\begin{array}{c} \text{Manual pulse} \\ \text{generator 1} \\ \text{pulse movement} \\ \text{amount} \end{array} \right) \times \left(\begin{array}{c} \text{Number of pulses per rotation} \\ \text{Movement amount per rotation} \end{array} \right)$$

If a large value is set to the manual pulse generator 1 pulse input magnification, there is a high possibility of the servo alarm "Command frequency error" (alarm No.: 35) occurrence. Note that the servomotor does not work rapidly by rapid pulse input even if the servo alarm will not occur.

REMARK

- One Simple Motion module can be connected to one manual pulse generator.
- The QD77GF module can simultaneously command to multiple servo amplifiers by one manual pulse generator.
(Simultaneous operation is possible up to the maximum number of control axes.)

■ Operations when stroke limit error occurs

When the hardware stroke limit error or the software stroke limit error is detected (Note-1) during operation, the operation will decelerate to a stop. However, in case of "[Md.26] Axis operation status", "Manual pulse generator operation" will continue (Note-1). After stopping, input pulses from a manual pulse generator to the outside direction of the limit range are not accepted, but operation can be executed within the range.

(Note-1): Only when the feed current value or the feed machine value overflows or underflows during deceleration, the manual pulse generator operation will terminate as "error occurring". To carry out manual pulse generator operation again, "[Cd.21] Manual pulse generator enable flag" must be turned OFF once and turn ON.

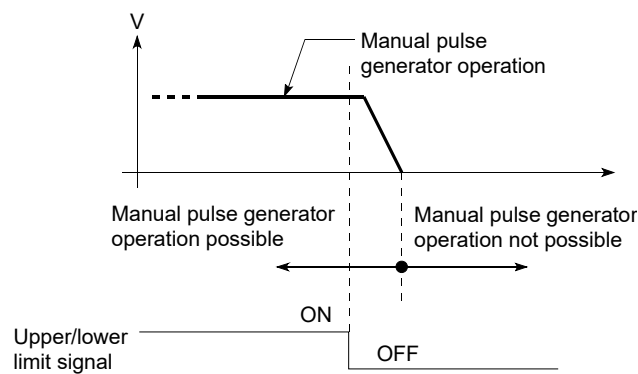

■ Manual pulse generator operation timing and processing time

The following drawing shows details of the manual pulse generator operation timing and processing time.

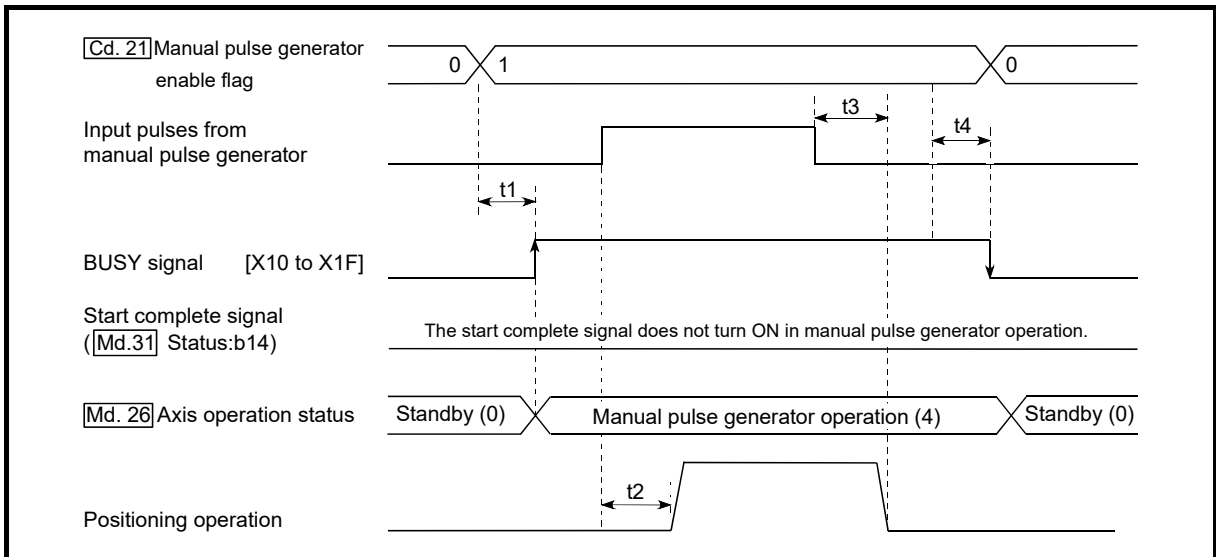

Fig. 11.17 Manual pulse generator operation timing and processing times

Normal timing times

Unit: [ms]

| [Pr.132] Communication mode setting | Operation cycle | t1 | t2 | t3 | t4 |
|---|--------------------|------------|--------------|--------------|--------------|
| MR-J4-B-RJ010 communication mode | 0.88 | 0.9 to 1.2 | 5.2 to 10.5 | 15.0 to 18.5 | 10.6 |
| | 1.77 | 1.7 to 1.8 | 5.2 to 11.5 | 18.8 to 21.0 | 10.4 |
| | 3.55 | 3.5 to 3.6 | 7.2 to 14.5 | 18.8 to 21.0 | 10.7 |
| Communication mode correspond to CiA402 | 1.00 | 0.9 to 1.2 | 6.9 to 13.0 | 17.2 to 22.9 | 13.2 to 13.4 |
| | 2.00 | 1.7 to 1.8 | 7.4 to 14.1 | 18.8 to 23.5 | 13.2 to 13.3 |
| | 4.00 | 3.5 to 3.6 | 11.2 to 16.8 | 18.8 to 23.5 | 13.2 to 13.3 |

- Delays may occur in the t1 timing time due to the operation status of other axes.

■ Position control by manual pulse generator operation

In manual pulse generator operation, the position is moved by a "manual pulse generator 1 pulse movement amount" per pulse. The feed current value in the positioning control by manual pulse generator operation can be calculated using the expression shown below.

$$\begin{aligned} \text{Feed current value} &= \text{Number of input pulses} \\ &\quad \times [\text{Cd.20}] \text{ Manual pulse generator 1 pulse input magnification} \\ &\quad \times \text{Manual pulse generator 1 pulse movement amount} \end{aligned}$$

| [Pr.1] Unit setting | mm | inch | degree | PLS |
|--|-------------|-------------|---------------|------|
| Manual pulse generator 1 pulse movement amount | 0.1 μ m | 0.00001inch | 0.00001degree | 1PLS |

For example, when "[Pr.1] Unit setting" is mm and "[Cd.20] Manual pulse generator 1 pulse input magnification" is 2, and 100 pulses are input from the manual pulse generator, the feed current value is as follows.

$$100 \times 2 \times 0.1 = 20 [\mu\text{m}] \quad (["\text{Md.20}] \text{ Feed current value} = 200)$$

The number of pulses output actually to the servo amplifier is "Manual pulse generator 1 pulse movement amount/movement amount per pulse".

The movement amount per pulse can be calculated using the expression shown below.

$$\text{Movement amount per pulse} = \frac{[\text{Pr.3}] \text{ Movement amount per rotation(AL)}}{[\text{Pr.2}] \text{ Number of pulses per rotation(AP)}} \times [\text{Pr.4}] \text{ Unit magnification(AM)}$$

For example, when "[Pr.1] Unit setting" is mm and the movement amount per pulse is 1 μ m, $0.1/1 = 1/10$, i.e., the output to the servo amplifier per pulse from the manual pulse generator is 1/10pulse. Thus, the Simple Motion module outputs 1pulse to the servo amplifier after receiving 10pulses from the manual pulse generator.

■ Speed control by manual pulse generation operation

The speed during positioning control by manual pulse generator operation is a speed corresponding to the number of input pulses per unit time, and can be obtained using the following equation.

$$\text{Output command frequency} = \text{Input frequency} \times [\text{Cd.20}] \text{ Manual pulse generator 1 pulse input magnification}$$

11.4.2 Manual pulse generator operation execution procedure

The manual pulse generator operation is carried out by the following procedure.

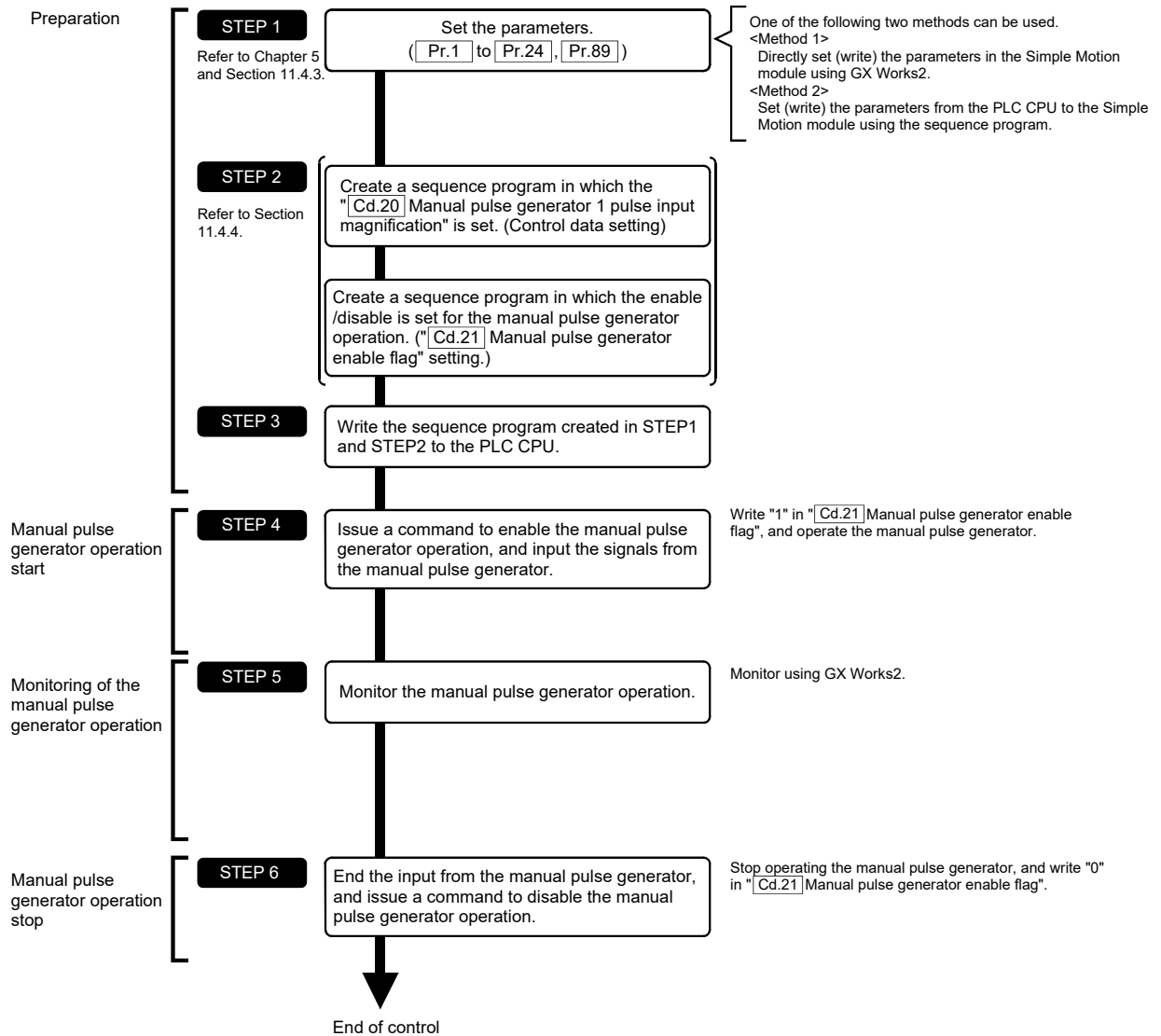

REMARK

- Mechanical elements such as limit switches are considered as already installed.
- Parameter settings work in common for all control using the Simple Motion module.

11.4.3 Setting the required parameters for manual pulse generator operation

The "Positioning parameters" must be set to carry out manual pulse generator operation.

The following table shows the setting items of the required parameters for carrying out manual pulse generator operation. Parameters not shown below are not required to be set for carrying out only manual pulse generator operation. (Set the initial value or a value within the setting range.)

| Setting item | | Setting requirement | Factory-set initial value (setting details) | |
|------------------------|---------|---|---|---|
| Positioning parameters | [Pr.1] | Unit setting | ⊙ | 3 (PLS) |
| | [Pr.2] | Number of pulses per rotation (AP) (Unit: PLS) | ⊙ | 20000 |
| | [Pr.3] | Movement amount per rotation (AL) (Unit: PLS) | ⊙ | 20000 |
| | [Pr.4] | Unit magnification (AM) | ⊙ | 1 (1 times) |
| | [Pr.8] | Speed limit value (Unit: PLS/s) | ⊙ | 200000 |
| | [Pr.11] | Backlash compensation amount (Unit: PLS) | ○ | 0 |
| | [Pr.12] | Software stroke limit upper limit value (Unit: PLS) | ○ | 2147483647 |
| | [Pr.13] | Software stroke limit lower limit value (Unit: PLS) | ○ | -2147483648 |
| | [Pr.14] | Software stroke limit selection | ○ | 0 (feed current value) |
| | [Pr.15] | Software stroke limit valid/invalid setting | ○ | 0 (valid) |
| | [Pr.17] | Torque limit setting value (Unit: %) | ○ | 300 |
| | [Pr.22] | Input signal logic selection | ○ | 0 (Manual pulse generator input is negative logic.) |
| | [Pr.24] | Manual pulse generator/Incremental synchronous encoder input selection | ○ | 0 (4 times multiplication of A phase/B phase) |
| | [Pr.89] | Manual pulse generator/Incremental synchronous encoder input type selection | ⊙ | 0 (Differential output type) |

⊙ : Setting always required.

○ : Set according to requirements (Set the initial value or a value within the setting range when not used.)

REMARK

- Positioning parameter settings work in common for all controls using the Simple Motion module. When carrying out other controls ("major positioning control", "high-level positioning control", "HPR control"), set the respective setting items as well.
- Parameters are set for each axis. But [Pr.22] Manual pulse generator input (b8), [Pr.24], [Pr.89] is set only for axis 1. (The setting for other than axis 1 is ignored.)
- Refer to Chapter 5 "Data Used for Positioning Control" for the setting details.

11.4.4 Creating a program to enable/disable the manual pulse generator operation

A sequence program must be created to execute a manual pulse generator operation. Consider the "required control data setting", "start conditions" and "start time chart" when creating the program.

The following shows an example when a manual pulse generator operation is started for axis 1.

■ Required control data setting

The control data shown below must be set to execute a manual pulse generator operation. The setting is carried out with the sequence program.

| Setting item | Setting value | Setting details | Buffer memory address |
|--|---------------|--|------------------------|
| [Cd.20] Manual pulse generator 1 pulse input magnification | 1 | Set the manual pulse generator 1 pulse input magnification. (1 to 10000 times) | 4322+100n 4323+100n |
| [Cd.21] Manual pulse generator enable flag | 1 (0) | Set "1: Enable manual pulse generator operation". (Set "0: Disable manual pulse generator operation" when finished with the manual pulse generator operation.) | 4324+100n |

n: Axis No.-1

*: Refer to Section 5.7 "List of control data" for details on the setting details.

■ Start conditions

The following conditions must be fulfilled when starting. The required conditions must also be assembled in the sequence program, and the sequence program must be configured so the operation will not start if the conditions are not fulfilled.

| Signal name | Signal state | Signal state | Device | |
|------------------|--------------------------|--------------|---|---------------------|
| Interface signal | PLC READY signal | ON | PLC CPU preparation completed | Y0 |
| | READY signal | ON | QD77GF preparation completed | X0 |
| | All axis servo ON | ON | All axis servo ON | Y1 |
| | Synchronization flag * | ON | QD77GF buffer memory The access is possible. | X1 |
| | Axis stop signal | OFF | Axis stop signal is OFF | [Cd.180] Axis stop |
| | Start complete signal | OFF | Start complete signal is OFF | [Md.31] Status: b14 |
| | BUSY signal | OFF | QD77GF is not operating | X10 to X1F |
| | Error detection signal | OFF | There is no error | [Md.31] Status: b13 |
| | M code ON signal | OFF | M code ON signal is OFF | [Md.31] Status: b12 |
| External signal | Forced stop input signal | ON | There is no forced stop input | – |
| | Stop signal | OFF | Stop signal is OFF | – |
| | Upper limit (FLS) | ON | Within limit range | – |
| | Lower limit (RLS) | ON | Within limit range | – |

*: If the PLC CPU is set to the asynchronous mode in the synchronization setting, this must be inserted in the program for interlocking. If it is set to the synchronous mode, it must not be inserted in the program for interlocking because it is turned ON when the PLC CPU executes calculation.

■ Start time chart

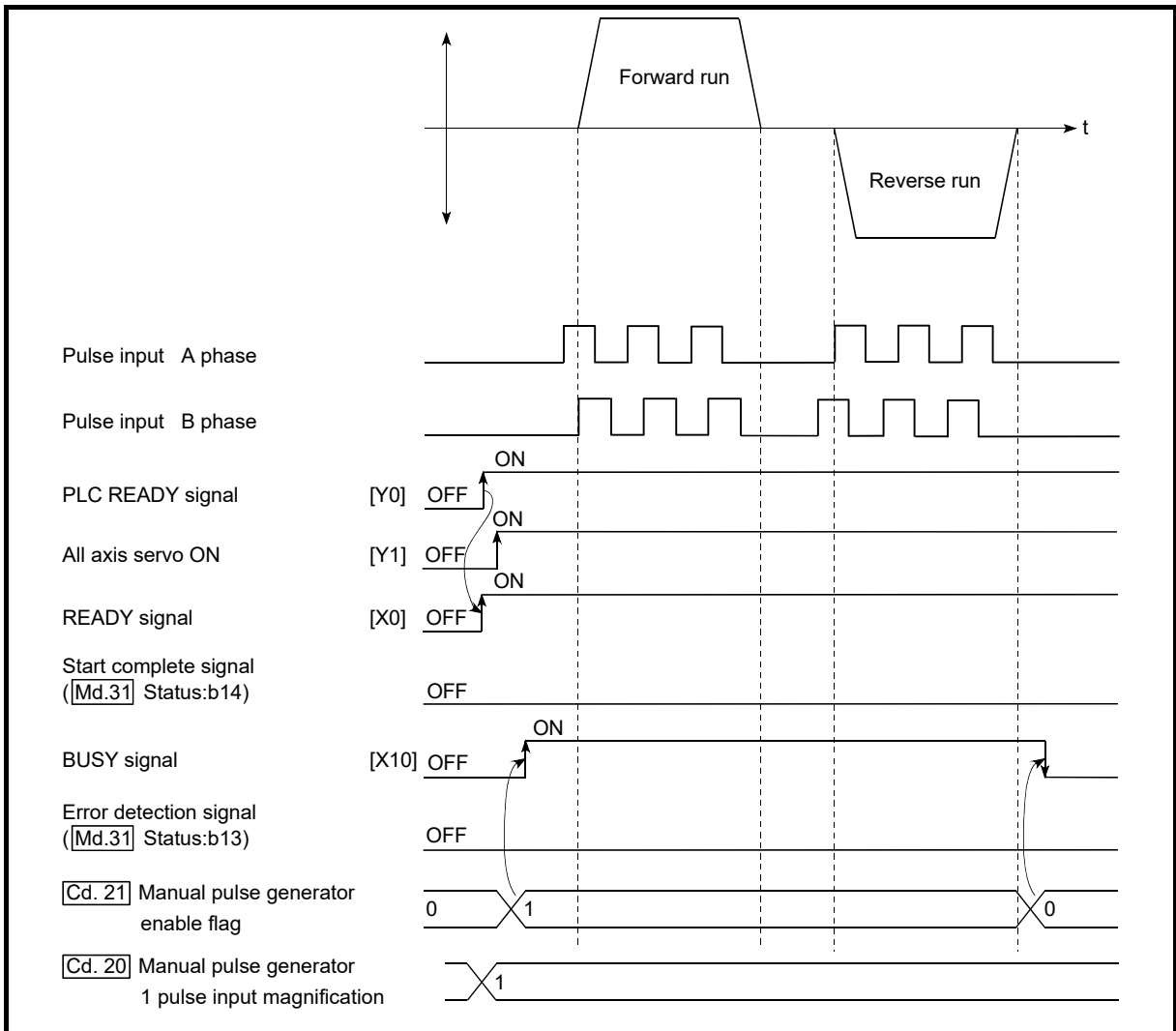
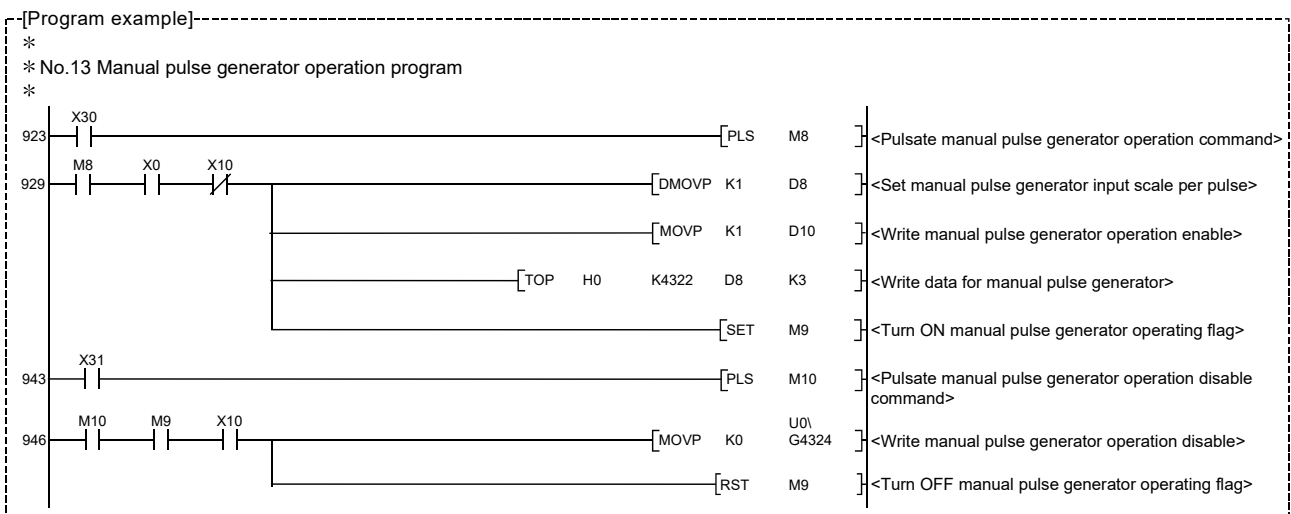

Fig. 11.18 Manual pulse generator operation start time chart

■ Creating the program



Chapter 12 Expansion Control

The details and usage of expansion control are explained in this chapter.

Expansion control includes the speed-torque control to execute the speed control and torque control not including position loop and the synchronous control to synchronize with input axis using software with "synchronous control parameter" instead of controlling mechanically with gear, shaft, speed change gear or cam, etc.

Execute the required settings to match each control.

| | | |
|--------|---|--------|
| 12.1 | Speed-torque control | 12- 2 |
| 12.1.1 | Outline of speed-torque control | 12- 2 |
| 12.1.2 | Setting the required parameters for speed-torque control..... | 12- 3 |
| 12.1.3 | Setting the required data for speed-torque control | 12- 4 |
| 12.1.4 | Operation of speed-torque control..... | 12- 5 |
| 12.2 | Synchronous control..... | 12- 18 |

12.1 Speed-torque control

12.1.1 Outline of speed-torque control

This function is used to execute the speed control or torque control that does not include the position loop for the command to servo amplifier.

Switch the control mode from "position control mode" to "speed control mode" or "torque control mode" to execute the "Speed-torque control".

| Control mode | Control | Remark |
|-----------------------|---|--|
| Position control mode | Positioning control, HPR control, JOG operation, Inching operation and Manual pulse generator operation | Control that include the position loop for the command to servo amplifier |
| Speed control mode | Speed-torque control | Control that does not include the position loop for the command to servo amplifier |
| Torque control mode | | |

Use the servo amplifiers whose software versions are compatible with each control mode to execute the "Speed-torque control".

Servo amplifier software versions that are compatible with each control mode are shown below. For the support information not listed in the table below, refer to the instruction manual of the servo amplifier to be used.

| Servo amplifier model | Software version | |
|------------------------------|---|----------------|
| | Speed control | Torque control |
| MR-J4-_B_-RJ010 | A1 or later | |
| MR-J4-GF_(-RJ) [CiA402 mode] | There is no restriction by the version. | |

POINT

When switching the control mode for the servo amplifier which does not support the speed-torque control, the operation varies by the SERIAL No. of the Simple Motion module.

| First five digits of SERIAL No. (Note-1) | Operation |
|--|--|
| before 15092 | The switching operation is ignored. |
| 15092 or later | The error "Speed-torque control not supported" (error code: 550) occurs. |

(Note-1): The serial number can be checked on the "Product Information List" screen in GX Works2.

⚠ CAUTION

- If operation that generates torque more than 100% of the rating is performed with an abnormally high frequency in a servomotor stop status (servo lock status) or in a 30r/min or less low-speed operation status, the servo amplifier may malfunction regardless of the electronic thermal relay protection.

12.1.2 Setting the required parameters for speed-torque control

The "Positioning parameters" must be set to carry out speed-torque control.

The following table shows the setting items of the required parameters for carrying out speed-torque control. Parameters not shown below are not required to be set for carrying out only speed-torque control. (Set the initial value or a value within the setting range.)

| Setting item | | Setting requirement |
|------------------------|---|---------------------|
| Positioning parameters | [Pr.1] Unit setting | ◎ |
| | [Pr.2] Number of pulses per rotation (AP) | ◎ |
| | [Pr.3] Movement amount per rotation (AL) | ◎ |
| | [Pr.4] Unit magnification (AM) | ◎ |
| | [Pr.8] Speed limit value | ◎ |
| | [Pr.12] Software stroke limit upper limit value | ○ |
| | [Pr.13] Software stroke limit lower limit value | ○ |
| | [Pr.14] Software stroke limit selection | ○ |
| | [Pr.22] Input signal logic selection | ◎ |
| | [Pr.82] Forced stop valid/invalid selection | ○ |
| | [Pr.83] Speed control 10 x multiplier setting for degree axis | ○ |
| | [Pr.90] Operation setting for speed-torque control mode | ○ |

◎ : Setting always required.

○ : Set according to requirements (Set the initial value or a value within the setting range when not used.)

REMARK

- Positioning parameter settings work in common for all controls using the Simple Motion module. When carrying out other controls ("major positioning control", "high-level positioning control", "HPR control"), set the respective setting items as well.
- Parameters are set for each axis.
- Refer to Chapter 5 "Data Used for Positioning Control" for the setting details.

12.1.3 Setting the required data for speed-torque control

■ Required control data setting for the control mode switching

The control data shown below must be set to execute the control mode switching.

| | Setting item | Setting value | Setting details | Buffer memory address |
|----------|--------------------------------|---------------|--|-----------------------|
| [Cd.138] | Control mode switching request | 1 | Set "1: Switching request" after setting "[Cd.139] Control mode setting". | 4374+100n |
| [Cd.139] | Control mode setting | → | Set the control mode to switch. 0: Position control mode 10: Speed control mode 20: Torque control mode | 4375+100n |

n: Axis No.-1

※: Refer to Section 5.7 "List of control data" for the setting details.

■ Required control data setting for the speed control mode

The control data shown below must be set to execute the speed control.

| | Setting item | Setting value | Setting details | Buffer memory address |
|----------|---|---------------|--|------------------------|
| [Cd.140] | Command speed at speed control mode | → | Set the command speed at speed control mode. | 4376+100n 4377+100n |
| [Cd.141] | Acceleration time at speed control mode | → | Set the acceleration time at speed control mode. | 4378+100n |
| [Cd.142] | Deceleration time at speed control mode | → | Set the deceleration time at speed control mode | 4379+100n |

n: Axis No.-1

※: Refer to Section 5.7 "List of control data" for the setting details.

■ Required control data setting for the torque control mode

The control data shown below must be set to execute the torque control.

| | Setting item | Setting value | Setting details | Buffer memory address |
|----------|--|---------------|---|------------------------|
| [Cd.143] | Command torque at torque control mode | → | Set the command torque at torque control mode. | 4380+100n |
| [Cd.144] | Torque time constant at torque control mode (Forward direction) | → | Set the time constant at driving during torque control mode. | 4381+100n |
| [Cd.145] | Torque time constant at torque control mode (Negative direction) | → | Set the time constant at regeneration during torque control mode. | 4382+100n |
| [Cd.146] | Speed limit value at torque control mode | → | Set the speed limit value at torque control mode. | 4384+100n 4385+100n |

n: Axis No.-1

※: Refer to Section 5.7 "List of control data" for the setting details.

12.1.4 Operation of speed-torque control

[1] Switching of control mode (Speed control/Torque control)

■ Switching method of control mode

To switch the control mode to the speed control or the torque control, set "1" in "[Cd.138] Control mode switching request" after setting the control mode in "[Cd.139] Control mode setting".

When the mode is switched to the speed control mode or the torque control mode, the control data used in each control mode must be set before setting "1" in "[Cd.138] Control mode switching request".

When the switching condition is satisfied at control mode switching request, "30: Control mode switch" is set in "[Md.26] Axis operation status", and the BUSY signal turns ON. "0" is automatically stored in "[Cd.138] Control mode switching request" by Simple Motion module after completion of switching.

The warning "Control mode switching during BUSY" (warning code: 120) or "Control mode switching during zero speed OFF" (warning code: 121) occurs if the switching condition is not satisfied, and the control mode is not switched.

The following shows the switching condition of each control mode.

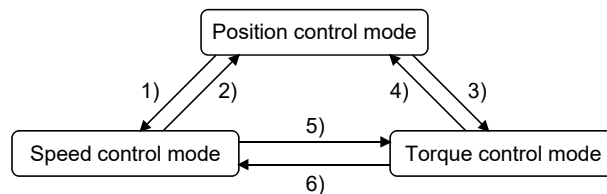

| Switching operation | | Switching condition |
|---------------------|---|--|
| 1) | Position control mode → Speed control mode | Not during positioning ^(Note-1) and during motor stop ^{(Note-2), (Note-3)} |
| 2) | Seed control mode → Position control mode | During motor stop ^{(Note-2), (Note-3)} |
| 3) | Position control mode → Torque control mode | Not during positioning ^(Note-1) and during motor stop ^{(Note-2), (Note-3)} |
| 4) | Torque control mode → Position control mode | During motor stop ^{(Note-2), (Note-3)} |
| 5) | Speed control mode → Torque control mode | None |
| 6) | Torque control mode → Speed control mode | |

(Note-1): BUSY signal is OFF.

(Note-2): ZERO speed (Low-order buffer memory address: b3 of "[Md.108] Servo status") is ON.

| | Buffer memory address (Low-order) |
|---------------------------|-----------------------------------|
| [Md.108] Servo status: b3 | 2476+100n |

n: Axis No.-1

(Note-3): Change the setting of "Condition selection at mode switching (b12 to b15)" in "[Pr.90] Operation setting for speed-torque control mode" when switching the control mode without waiting for the servo motor to stop. Note that it may cause vibration or impact at control switching. (Refer to Section 5.2.4 "Detailed parameters 2".)

The history of control mode switching is stored to the starting history at request of control mode switching. (Refer to Section 5.6.1 "System monitor data".)

Confirm the control mode with "control mode (high-order buffer memory address: b2, b3)" of "[Md.108] Servo status". (Refer to Section 5.6.2 "Axis monitor data".)

| | Buffer memory address (High-order) |
|-------------------------------|------------------------------------|
| [Md.108] Servo status: b2, b3 | 2477+100n |

n: Axis No.-1

■ Precautions at control mode switching

- (1) The start complete signal and the positioning complete signal do not turn ON at control mode switching.
- (2) When "30: Control mode switch", "31: Speed control", or "32: Torque control" is set in "[Md.26] Axis operation status", the BUSY signal turns ON.
- (3) The motor speed might change momentarily at switching from the speed control mode to the torque control mode. Therefore, it is recommended that the control mode is switched from the speed control to the torque control after the servomotors stop.
- (4) The operation to press with limited torque during the speed control cannot be used.
- (5) "In speed control flag" ([Md.31] Status: b0) does not turn ON during the speed control mode in the speed-torque control.

■ Operation for "Position control mode ↔ Speed control mode switching"

When the position control mode is switched to the speed control mode, the command speed immediately after the switching is the speed set in "speed initial value selection (b8 to b11)" of "[Pr.90] Operation setting for speed-torque control mode".

| | |
|---|---|
| Speed initial value selection ([Pr.90]: b8 to b11) | Command speed to servo amplifier immediately after switching from position control mode to speed control mode |
| 0: Command speed | The speed to servo amplifier immediately after switching is "0". |
| 1: Feedback speed | Motor speed received from servo amplifier at switching. |

When the speed control mode is switched to the position control mode, the command position immediately after the switching is the feed current value at switching.

The following chart shows the operation timing for axis 1.

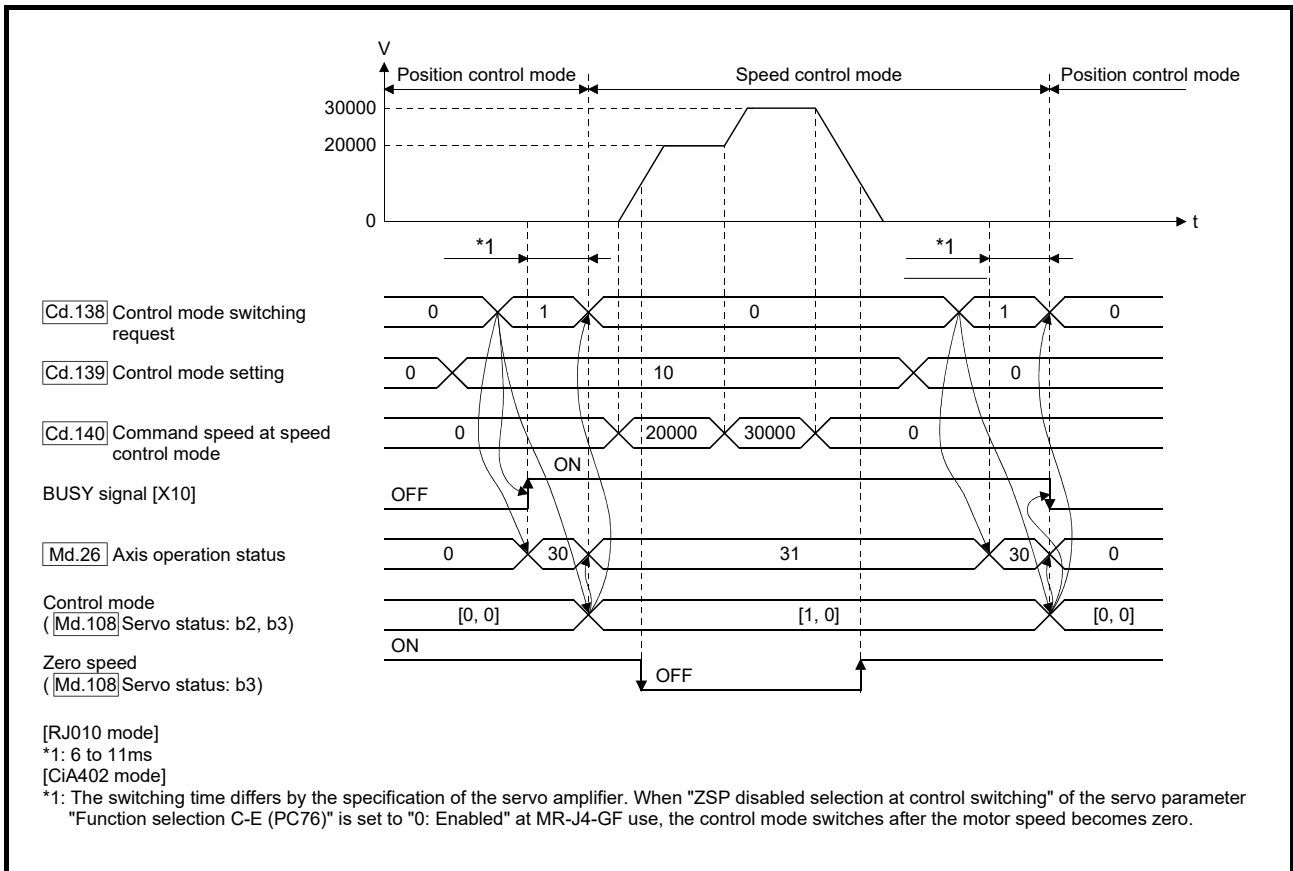

■ Operation for "Position control mode ↔ Torque control mode switching"

When the position control mode is switched to the torque control mode, the command torque immediately after the switching is the torque set in "Torque initial value selection (b4 to b7)" of "[Pr.90] Operation setting for speed-torque control mode".

| | |
|---|--|
| Torque initial value selection ([Pr.90]: b4 to b7) | Command torque to servo amplifier immediately after switching from position control mode to torque control mode |
| 0: Command torque | The value of "[Cd.143] Command torque at torque control mode" at switching. |
| 1: Feedback torque | Motor torque value at switching. |

POINT

When the servo parameter "Function selection C-B POL reflection selection at torque control (PC29)" is set to "0: Enabled" and "Torque initial value selection" is set to "1: Feedback torque", the warning "Torque initial value selection invalid" (warning code: 521) will occur at control mode switching, and the command value immediately after switching is the same as the case of selecting "0: Command torque". If the feedback torque is selected, set "1: Disabled" in the servo parameter "Function selection C-B POL reflection selection at torque control (PC29)".

When the torque control mode is switched to the position control mode, the command position immediately after the switching is the feed current value at switching.

The following chart shows the operation timing for axis 1.

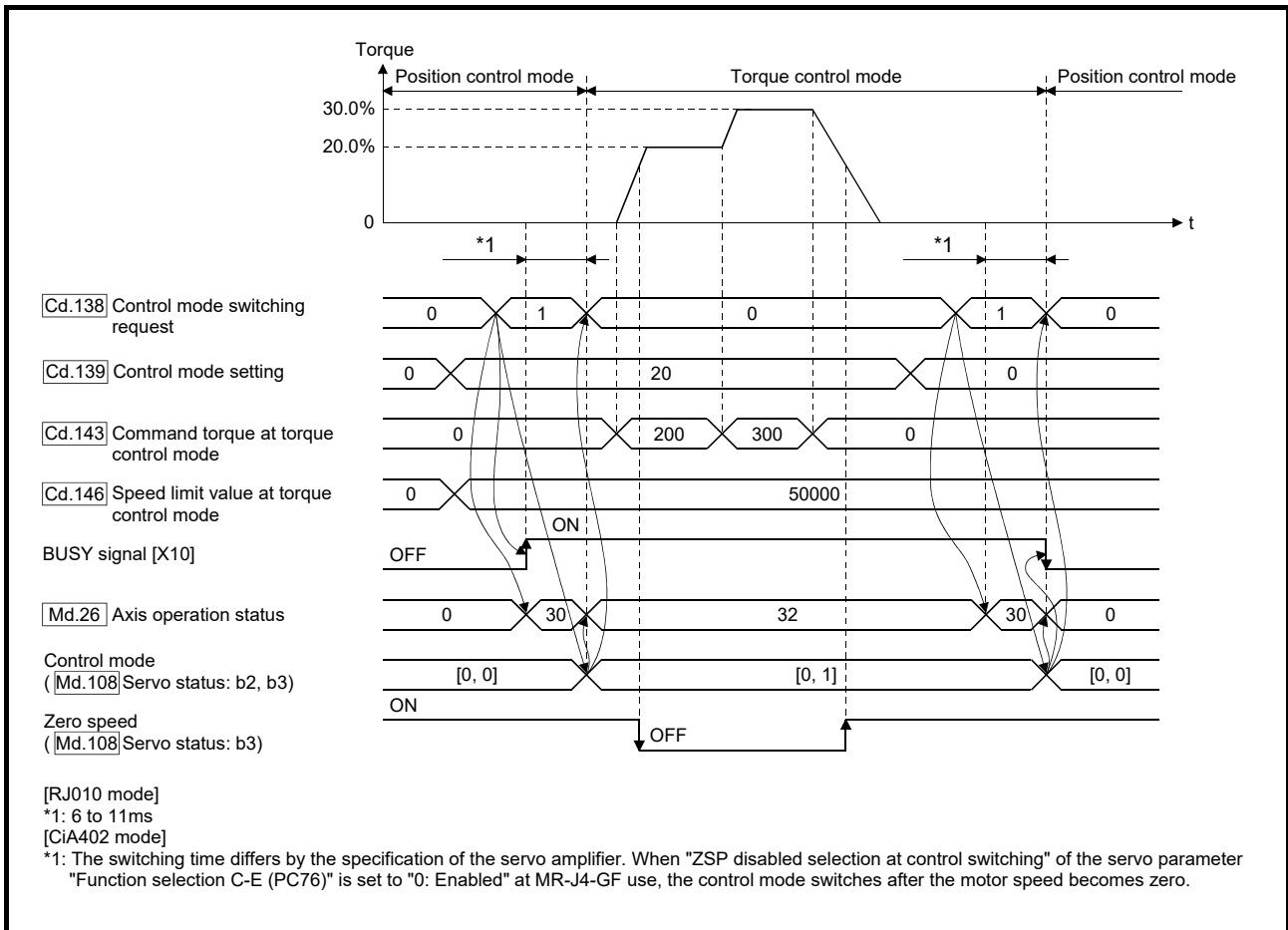

■ Operation for "Speed control mode ↔ Torque control mode switching"

When the speed control mode is switched to the torque control mode, the command torque immediately after the switching is the torque set in "Torque initial value selection (b4 to b7)" of "[Pr.90] Operation setting for speed-torque control mode".

| | |
|---|--|
| Torque initial value selection ([Pr.90]: b4 to b7) | Command torque to servo amplifier immediately after switching from speed control mode to torque control mode |
| 0: Command torque | The value of "[Cd.143] Command torque at torque control mode" at switching. |
| 1: Feedback torque | Motor torque value at switching. |

POINT

When the servo parameter "Function selection C-B POL reflection selection at torque control (PC29)" is set to "0: Enabled" and "Torque initial value selection" is set to "1: Feedback torque", the warning "Torque initial value selection invalid" (warning code: 521) will occur at control mode switching, and the command value immediately after switching is the same as the case of selecting "0: Command torque". If the feedback torque is selected, set "1: Disabled" in the servo parameter "Function selection C-B POL reflection selection at torque control (PC29)".

When the torque control mode is switched to the speed control mode, the command speed immediately after the switching is the motor speed at switching.

The following chart shows the operation timing for axis 1.

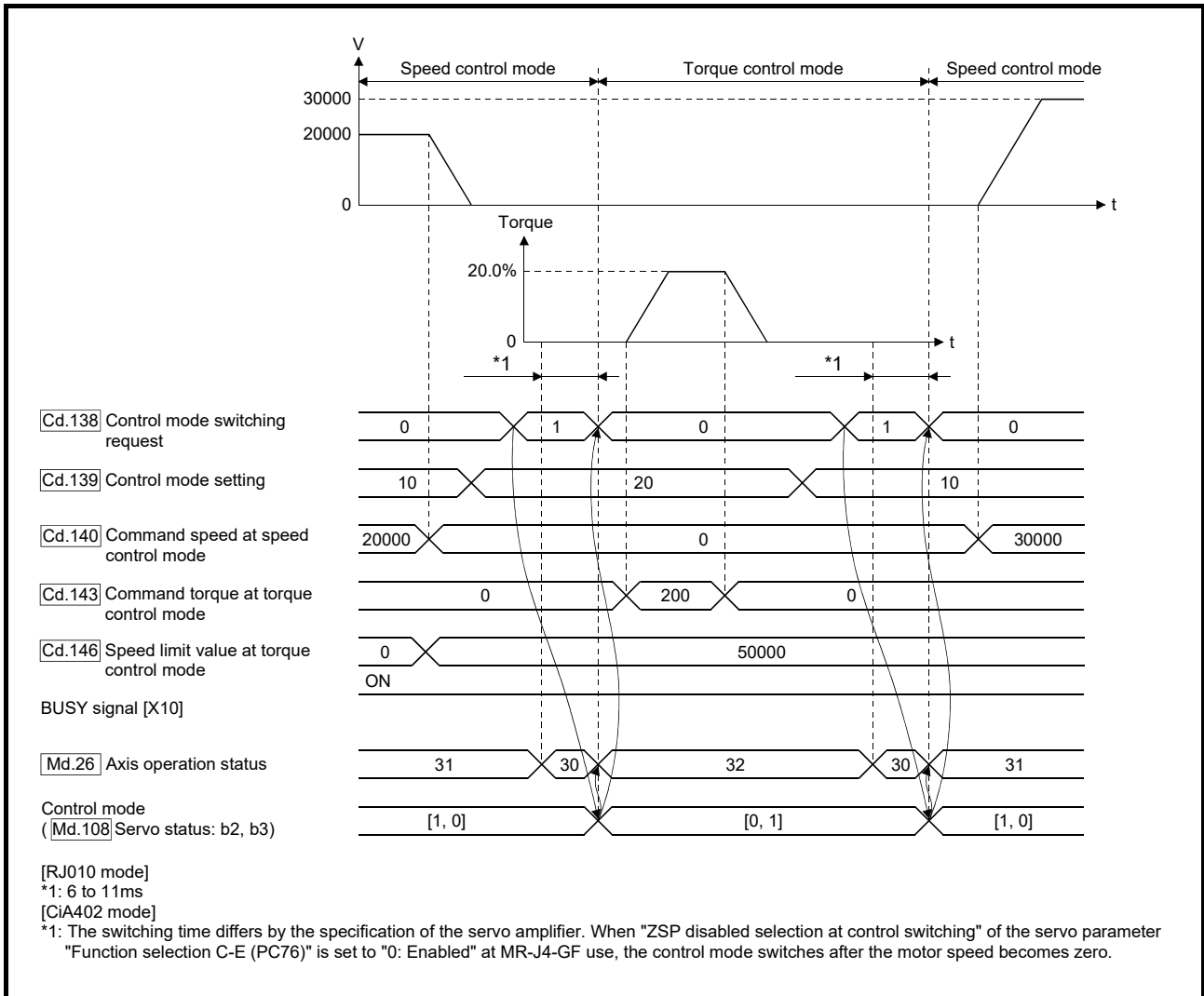

[2] Speed control mode

■ Operation for speed control mode

The speed control is executed at the speed set in "[Cd.140] Command speed at speed control mode" in the speed control mode. Set a positive value for forward rotation and a negative value for reverse rotation. "[Cd.140]" can be changed any time during the speed control mode.

Acceleration/deceleration is performed based on a trapezoidal acceleration/deceleration processing. Set acceleration/deceleration time toward "[Pr.8] Speed limit value" in "[Cd.141] Acceleration time at speed control mode" and "[Cd.142] Deceleration time at speed control mode". The value at speed control mode switching request is valid for "[Cd.141]" and "[Cd.142]".

The command speed during the speed control mode is limited with "[Pr.8] Speed limit value". If the speed exceeding the speed limit value is set, the warning "Speed limit value over" (warning code: 501) occurs, and the operation is controlled with the speed limit value.

Confirm the command speed to servo amplifier with "[Md.122] Speed during command".

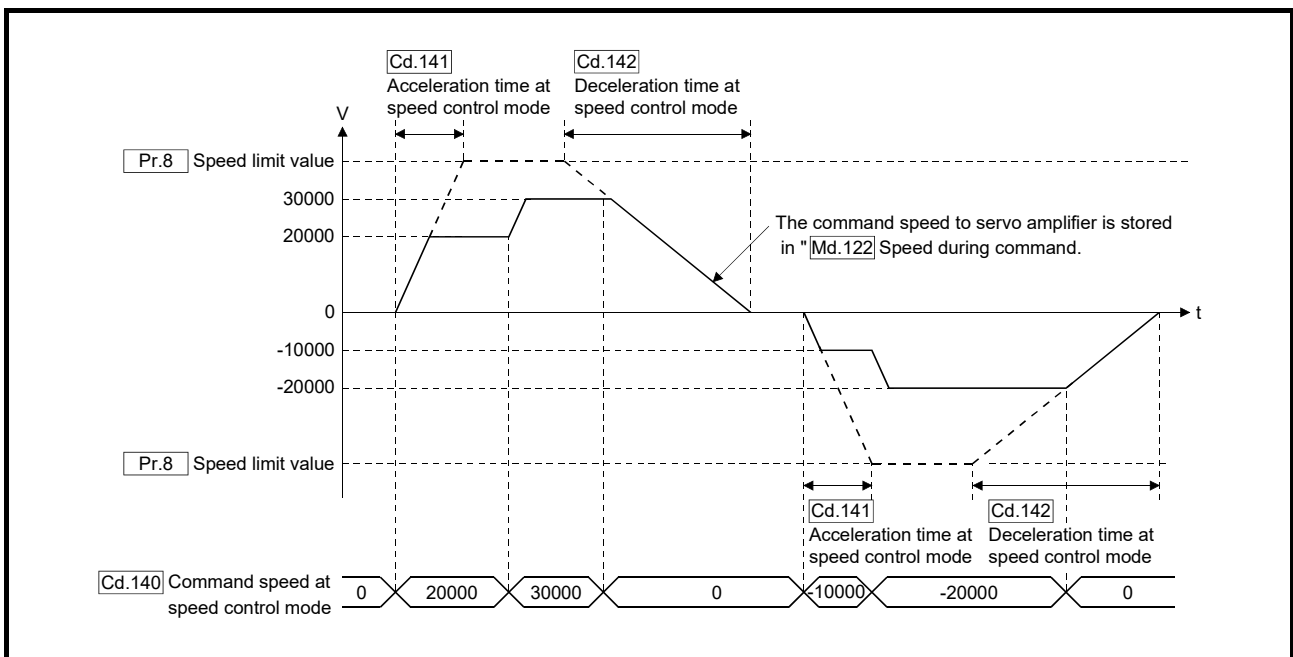

■ Feed current value during speed control mode

"[Md.20] Feed current value", "[Md.21] Feed machine value" and "[Md.101] Real current value" are updated even in the speed control mode.

If the feed current value exceeds the software stroke limit, the error "Software stroke limit +" (error code: 507) or "Software stroke limit -" (error code: 508) occurs, and the operation switches to the position control mode. Invalidate the software stroke limit to execute one-way feed.

■ Stop cause during speed control mode

The operation for stop cause during speed control mode is shown below.

| Item | Operation during speed control mode |
|--|--|
| "[Cd.180] Axis stop" turned ON. | The motor decelerates to speed "0" according to the setting value of "[Cd.142] Deceleration time at speed control mode". The mode switches to the position control mode when "Zero speed" of "[Md.108] Servo status" turns ON, and the operation stops. |
| Stop signal of "[Cd.44] External input signal operation device" turned ON. | |
| All axis servo ON [Y1] turned OFF. | The servo OFF is not executed during the speed control mode. The command status when the mode is switched to the position control mode becomes valid. |
| "[Cd.100] Servo OFF command" turned ON. | |
| The current value reached the software stroke limit. | An error (error code: 507, 508, 104, 105, or 101) occurs. The mode switches to the position control mode at the current position, and the operation immediately stops. (Deceleration processing is not executed.) |
| The position of the motor reached the hardware stroke limit. | |
| PLC READY [Y0] turned OFF. | |
| The forced stop input to Simple Motion module. | The mode switches to the position control mode when the servo OFF (Servo ON of "[Md.108] Servo status" turns OFF) is executed. (While the servo amplifier is servo OFF, even if the mode is switched to position control mode, the servomotor immediately stops. |
| The emergency stop input to servo amplifier. | |
| The servo alarm occurred. | |
| The servo amplifier's power supply turned OFF. | The motor immediately stops. (The mode is set to the position control mode at the servo amplifier's power supply ON again.) |

[3] Torque control mode

■ Operation for torque control mode

The torque control is executed at the command torque set in "[Cd.143] Command torque at torque control mode" in the torque control mode. "[Cd.143] Command torque at torque control mode" can be changed any time during torque control mode. The relation between the setting of command torque and the torque generation direction of servomotor varies depending on the setting of servo parameters "Rotation direction selection/travel direction selection (PA14)" and "Function selection C-B POL reflection selection at torque control (PC29)".

(1) When servo parameter "Function selection C-B POL reflection selection at torque control (PC29)" is set to "0: Enabled"

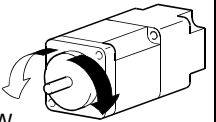
| "Rotation direction selection/travel direction selection (PA14)" | "[Cd.143] Command torque at torque control mode" | Torque generation direction of servo motor | |
|--|--|--|--|
| 0: Forward rotation (CCW) with the increase of the positioning address | Positive value (Forward direction) | CCW direction |  CCW direction CW direction |
| | Negative value (Reverse direction) | CW direction | |
| 1: Reverse rotation (CW) with the increase of the positioning address | Positive value (Forward direction) | CW direction | |
| | Negative value (Reverse direction) | CCW direction | |

(2) When servo parameter "Function selection C-B POL reflection selection at torque control (PC29)" is set to "1: Disabled"

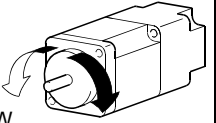
| "Rotation direction selection/travel direction selection (PA14)" | "[Cd.143] Command torque at torque control mode" | Torque generation direction of servo motor | |
|--|--|--|--|
| 0: Forward rotation (CCW) with the increase of the positioning address | Positive value (Forward direction) | CCW direction |  CCW direction CW direction |
| | Negative value (Reverse direction) | CW direction | |
| 1: Reverse rotation (CW) with the increase of the positioning address | Positive value (Forward direction) | CCW direction | |
| | Negative value (Reverse direction) | CW direction | |

Set time for the command torque to increase from 0% to "[Pr.17] Torque limit setting value" in "[Cd.144] Torque time constant at torque control mode (Forward direction)" and for the command torque to decrease from "[Pr.17] Torque limit setting value" to 0% in "[Cd.145] Torque time constant at torque control mode (Negative direction)". The value at torque control mode switching request is valid for "[Cd.144]" and "[Cd.145]".

The command torque during the torque control mode is limited with "[Pr.17] Torque limit setting value". If the torque exceeding the torque limit setting value is set, the warning "Torque limit value over" (warning code: 520) occurs, and the operation is controlled with the torque limit setting value.

Confirm the command torque to servo amplifier with "[Md.123] Torque during command".

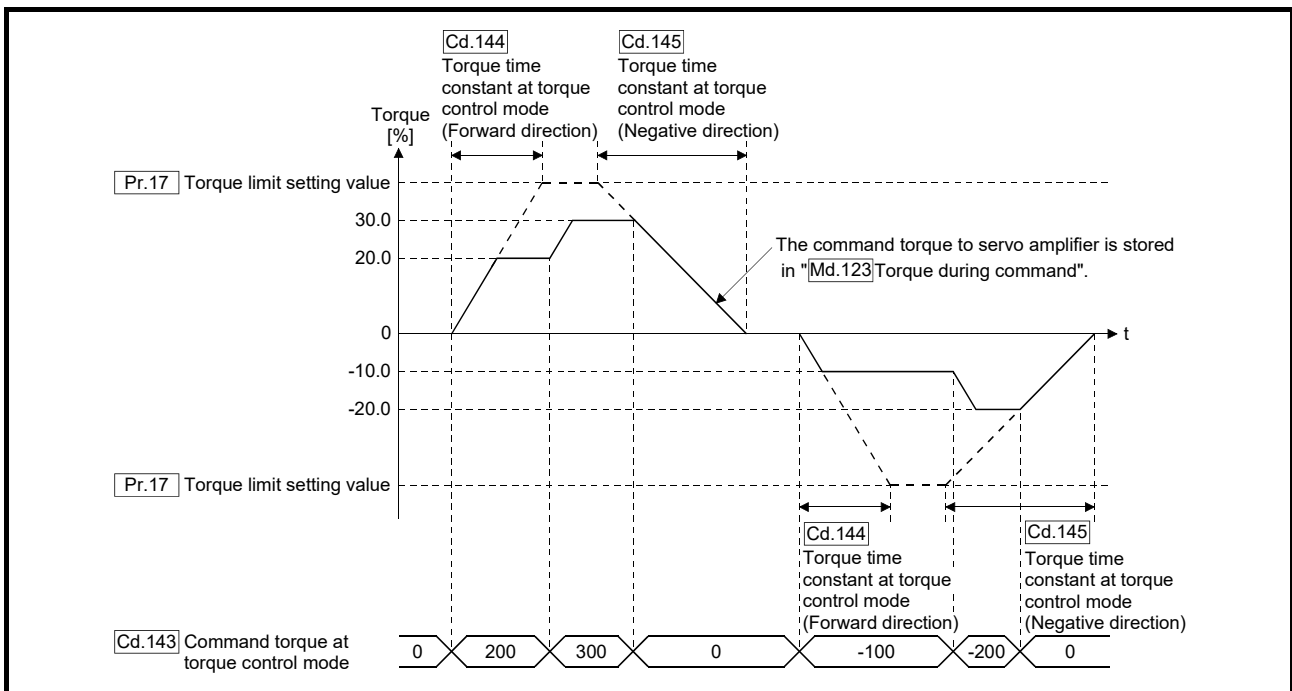

■ Speed during torque control mode

The speed during the torque control mode is controlled with "[Cd.146] Speed limit value at torque control mode". At this time, "Speed limit" ("[Md.108] Servo status" (low-order buffer memory address): b4) turns ON.

| | Buffer memory address (Low-order) |
|---------------------------|-----------------------------------|
| [Md.108] Servo status: b4 | 2476+100n |

n: Axis No.-1

"[Cd.146] Speed limit value at torque control mode" is set to a positive value regardless of the rotation direction. (Controlled by the same value for forward and reverse directions.)

In addition, "[Cd.146] Speed limit value at torque control mode" is limited with "[Pr.8] Speed limit value". If the speed exceeding the speed limit value is set, the warning "Speed limit value over" (warning code: 501) occurs, and the operation is controlled with the speed limit value.

The acceleration/deceleration processing is invalid for "[Cd.146] Speed limit value at torque control mode".

POINT

The actual motor speed may not reach the speed limit value depending on the machine load situation during the torque control.

■ Feed current value during torque control mode

"[Md.20] Feed current value", "[Md.21] Feed machine value" and "[Md.101] Real current value" are updated even in the torque control mode. If the feed current value exceeds the software stroke limit, the error "Software stroke limit +" (error code: 507) or "Software stroke limit -" (error code: 508) occurs, and the operation switches to the position control mode. Invalidate the software stroke limit to execute one-way feed.

■ Stop cause during torque control mode

The operation for stop cause during torque control mode is shown below.

| Item | Operation during torque control mode |
|--|---|
| "[Cd.180] Axis stop" turned ON. | The speed limit value commanded to servo amplifier is "0" regardless of the setting value of "[Cd.146] Speed limit value at torque control mode". The mode switches to the position control mode when "Zero speed" of "[Md.108] Servo status" turns ON, and the operation immediately stops. (Deceleration processing is not executed.) |
| Stop signal of "[Cd.44] External input signal operation device" turned ON. | The value of command torque is not changed. It might take time to reach the speed "0" depending on the current torque command value. |
| All axis servo ON [Y1] turned OFF. | The servo OFF is not executed during the torque control mode. |
| "[Cd.100] Servo OFF command" turned ON. | The command status when the mode is switched to the position control mode becomes valid. |
| The current value reached the software stroke limit. | An error (error code: 507, 508, 104, 105, or 101) occurs. The mode switches to the position control mode at the current position, and the operation immediately stops. (Deceleration processing is not executed.) |
| The position of the motor reached the hardware stroke limit. | |
| PLC READY [Y0] turned OFF. | |
| The forced stop input to Simple Motion module. | The mode switches to the position control mode when the servo OFF (Servo ON of "[Md.108] Servo status" turns OFF) is executed. (While the servo amplifier is servo OFF, even if the mode is switched to position control mode, the servomotor immediately stops.) |
| The emergency stop input to servo amplifier. | |
| The servo alarm occurred. | |
| The servo amplifier's power supply turned OFF. | The motor immediately stops. (The mode is set to the position control mode at the servo amplifier's power supply ON again.) |

12.2 Synchronous control

"Synchronous control" can be achieved using software instead of controlling mechanically with gear, shaft, speed change gear or cam, etc.

"Synchronous control" synchronizes movement with the input axis (servo input axis or synchronous encoder axis), by setting "the parameters for synchronous control" and starting synchronous control on each output axis.

Refer to "MELSEC-Q/L QD77MS/QD77GF/LD77MS/LD77MH Simple Motion Module User's Manual (Synchronous Control)" for details of synchronous control.

Chapter 13 Control Sub Functions

The details and usage of the "sub functions" added and used in combination with the main functions are explained in this chapter.

A variety of sub functions are available, including functions specifically for machine HPR and generally related functions such as control compensation, etc.

More appropriate, finer control can be carried out by using these sub functions.

Each sub function is used together with a main function by creating matching parameter settings and sequence programs. Read the execution procedures and settings for each sub function, and set as required.

| | | |
|---------|--|--------|
| 13.1 | Outline of sub functions | 13- 2 |
| 13.1.1 | Outline of sub functions | 13- 2 |
| 13.2 | Sub functions specifically for machine HPR | 13- 4 |
| 13.2.1 | HPR retry function [RJ010 mode]..... | 13- 4 |
| 13.2.2 | HP shift function [RJ010 mode]..... | 13- 8 |
| 13.3 | Functions for compensating the control..... | 13- 11 |
| 13.3.1 | Backlash compensation function..... | 13- 11 |
| 13.3.2 | Electronic gear function | 13- 13 |
| 13.3.3 | Near pass function | 13- 21 |
| 13.4 | Functions to limit the control..... | 13- 23 |
| 13.4.1 | Speed limit function..... | 13- 23 |
| 13.4.2 | Torque limit function..... | 13- 25 |
| 13.4.3 | Software stroke limit function..... | 13- 30 |
| 13.4.4 | Hardware stroke limit function | 13- 37 |
| 13.4.5 | Forced stop function | 13- 41 |
| 13.5 | Functions to change the control details | 13- 44 |
| 13.5.1 | Speed change function | 13- 44 |
| 13.5.2 | Override function..... | 13- 51 |
| 13.5.3 | Acceleration/deceleration time change function | 13- 54 |
| 13.5.4 | Torque change function | 13- 59 |
| 13.5.5 | Target position change function | 13- 63 |
| 13.6 | Absolute position system..... | 13- 67 |
| 13.7 | Other functions..... | 13- 69 |
| 13.7.1 | Step function | 13- 69 |
| 13.7.2 | Skip function..... | 13- 74 |
| 13.7.3 | M code output function..... | 13- 78 |
| 13.7.4 | Teaching function..... | 13- 82 |
| 13.7.5 | Command in-position function..... | 13- 88 |
| 13.7.6 | Acceleration/deceleration processing function | 13- 91 |
| 13.7.7 | Pre-reading start function | 13- 94 |
| 13.7.8 | Deceleration start flag function | 13- 96 |
| 13.7.9 | Stop command processing for deceleration stop function..... | 13- 99 |
| 13.7.10 | Speed control 10 x multiplier setting for degree axis function | 13-102 |
| 13.7.11 | Operation setting for incompleteness of HPR function..... | 13-104 |
| 13.8 | Servo ON/OFF | 13-106 |
| 13.8.1 | Servo ON/OFF | 13-106 |
| 13.8.2 | Follow up function | 13-108 |

13.1 Outline of sub functions

"Sub functions" are functions that compensate, limit, add functions, etc., to the control when the main functions are executed. These sub functions are executed by parameter settings, operation from GX Works2, sub function sequence programs, etc.

13.1.1 Outline of sub functions

The following table shows the types of sub functions available.

| Sub function | | Details |
|---|--|--|
| Functions characteristic to machine HPR | HPR retry function [RJ010 mode] | This function retries the HPR with the upper/lower limit switches during machine HPR. This allows machine HPR to be carried out even if the axis is not returned to before the proximity dog with JOG operation, etc. |
| | HP shift function [RJ010 mode] | After returning to the machine HP, this function offsets the position by the designated distance from the machine HP and sets that position as the HP address. |
| Functions that compensate control | Backlash compensation function | This function compensates the mechanical backlash. Feed command equivalent to the set backlash amount are output each time the movement direction changes. |
| | Electronic gear function | By setting the movement amount per pulse, this function can freely change the machine movement amount per commanded pulse. When the movement amount per pulse is set, a flexible positioning system that matches the machine system can be structured. |
| | Near pass function *1 | This function suppresses the machine vibration when the positioning data is switched during continuous path control in the interpolation control. |
| Functions that limit control | Speed limit function | If the command speed exceeds "[Pr.8] Speed limit value" during control, this function limits the commanded speed to within the "[Pr.8] Speed limit value" setting range. |
| | Torque limit function | If the torque generated by the servomotor exceeds "[Pr.17] Torque limit setting value" during control, this function limits the generated torque to within the "[Pr.17] Torque limit setting value" setting range. |
| | Software stroke limit function | If a command outside of the upper/lower limit stroke limit setting range, set in the parameters, is issued, this function will not execute positioning for that command. |
| | Hardware stroke limit function | This function carries out deceleration stop with the hardware stroke limit switch. |
| | Forced stop function | This function stops the all axes of the servo amplifier with the forced stop signal. |
| Functions that change control details | Speed change function | This function changes the speed during positioning. Set the changed speed in the speed change buffer memory ([Cd.14] New speed value), and change the speed with the speed change request ([Cd.15] Speed change request). |
| | Override function | This function changes the speed within a percentage of 1 to 300% during positioning. This is executed using "[Cd.13] Positioning operation speed override". |
| | Acceleration/deceleration time change function | This function changes the acceleration/deceleration time during speed change. (Functions added to the speed change function and override function.) |
| | Torque change function | This function changes the "torque limit value" during control. |
| | Target position change function | This function changes the target position during the execution of positioning. At the same time, this also can change the speed. |

*1: The near pass function is featured as standard and is valid only for setting continuous path control for position control. It cannot be set to be invalid with parameters.

| Sub function | | Details |
|--|--|--|
| Absolute position system function | | This function restores the absolute position of designated axis. By this function, the HPR after power ON from OFF is not required once the HPR is executed when the system operation is started. |
| Other functions | Step function | This function temporarily stops the operation to confirm the positioning operation during debugging, etc. The operation can be stopped at each "automatic deceleration" or "positioning data". |
| | Skip function | This function stops the positioning being executed (decelerates to a stop) when the skip signal is input, and carries out the next positioning. |
| | M code output function | This function issues a sub work (clamp or drill stop, tool change, etc.) according to the code No. (0 to 65535) set for each positioning data. |
| | Teaching function | This function stores the address positioned with manual control into the positioning address ([Da.6] Positioning address/movement amount) having the designated positioning data No. |
| | Command in-position function | At each automatic deceleration, this function calculates the remaining distance for the Simple Motion module to reach the positioning stop position, and when the value is less than the set value, sets the "command in-position flag". When using another sub work before ending the control, use this function as a trigger for the sub work. |
| | Acceleration/deceleration processing function | This function adjusts the control acceleration/deceleration. |
| | Pre-reading start function | This function shortens the virtual start time. |
| | Deceleration start flag function | Function that turns ON the flag when the constant speed status or acceleration status switches to the deceleration status during position control, whose operation pattern is "Positioning complete", to make the stop timing known. |
| | Stop command processing for deceleration stop function | Function that selects a deceleration curve when a stop cause occurs during deceleration stop processing to speed 0. |
| | Speed control 10 x multiplier setting for degree axis function | This function is executed the positioning control by the 10 x speed of the command speed and the speed limit value when the setting unit is "degree". |
| Operation setting for incompleteness of HPR function | This function is provided to select whether positioning control is operated or not, when HPR request flag is ON. | |
| Servo ON/OFF | Servo ON/OFF | This function executes servo ON/OFF of the servo amplifiers connected to the Simple Motion module. |
| | Follow up function | This function monitors the motor rotation amount with the servo turned OFF, and reflects it on the feed current value. |

13.2 Sub functions specifically for machine HPR

The sub functions specifically for machine HPR include the "HPR retry function" and "HP shift function". Each function is executed by parameter setting.

13.2.1 HPR retry function [RJ010 mode]

When the workpiece goes past the HP without stopping during positioning control, it may not move back in the direction of the HP although a machine HPR is commanded, depending on the workpiece position. This normally means the workpiece has to be moved to a position before the proximity dog by a JOG operation, etc., to start the machine HPR again. However, by using the HPR retry function, a machine HPR can be carried out regardless of the workpiece position.

The details shown below explain about the "HPR retry function".

- [1] Control details
- [2] Precautions during control
- [3] Setting the HPR retry function

[1] Control details

The following drawing shows the operation of the HPR retry function.

- (1) HPR retry point return retry operation when the workpiece is within the range between the upper and lower limits.

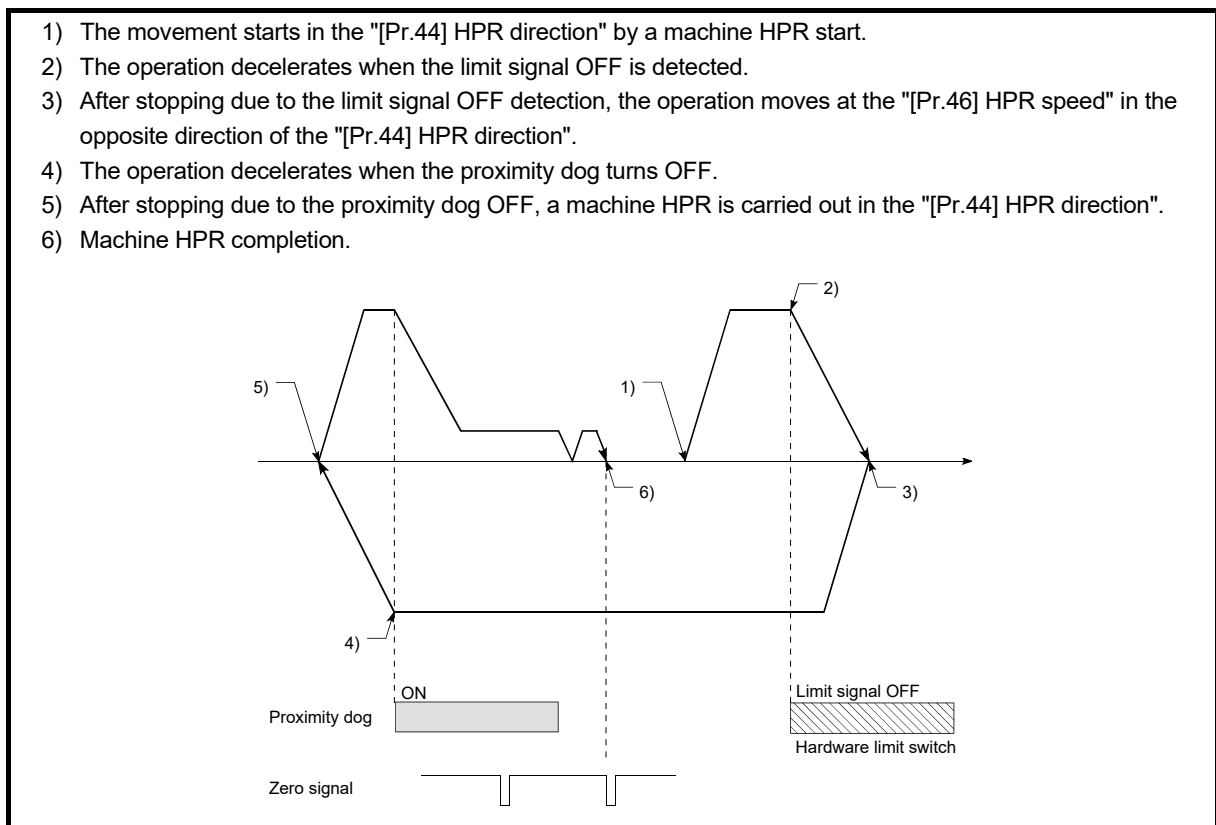
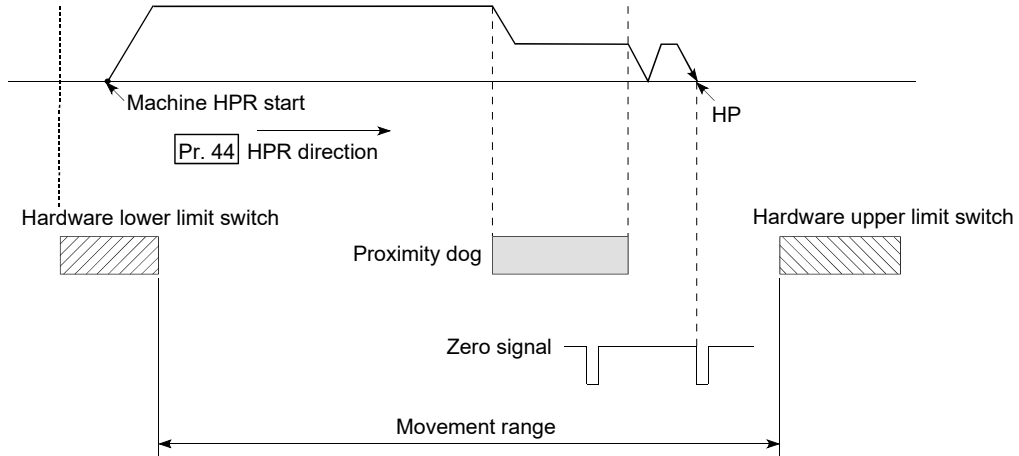

Fig. 13.1 HPR retry operation by limit signal detection

(2) HPR retry operation when the workpiece is outside the range between the upper and lower limits.

1) When the direction from the workpiece to the HP is the same as the "[Pr.44] HPR direction", a normal machine HPR is carried out.



2) When the direction from the workpiece to the HP is the opposite direction from the "[Pr.44] HPR direction", the operation carries out a deceleration stop when the proximity dog turns OFF, and then carries out a machine HPR in the direction set in "[Pr.44] HPR direction".

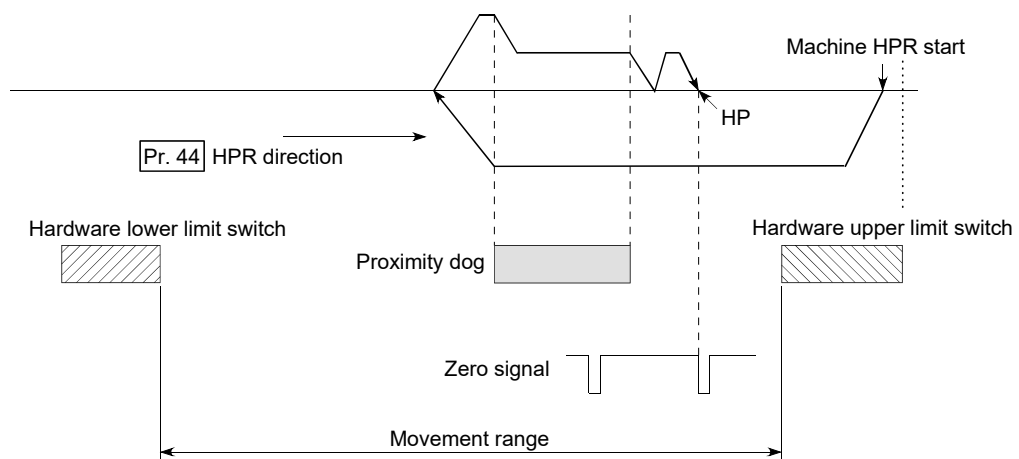

* In the above example 1) and 2), "0: Positive direction" is set in "[Pr.44] HPR direction"

REMARK

- When the "0: Positive direction" is selected in "[Pr.44] HPR direction", the upper limit switch is set to the limit switch in the HPR direction.
- When the "1: Negative direction" is selected in "[Pr.44] HPR direction", the lower limit switch is set to the limit switch in the HPR direction.
- If inverting the install positions of upper/lower limit switches, hardware stroke limit function cannot be operated properly.

If any problem is found for HPR operation, review "Rotation direction selection/travel direction selection (PA14)" and the wiring for the upper/lower limit switch.

Fig. 13.2 HPR retry operation from on limit (limit signal OFF)

(3) Setting the dwell time during an HPR retry

The HPR retry function can perform such function as the dwell time using "[Pr.57] Dwell time during HPR retry" when the reverse run operation is carried out due to detection by the limit signal for upper and lower limits and when the machine HPR is executed after the proximity dog is turned OFF to stop the operation.

"[Pr.57] Dwell time during HPR retry" is validated when the operation stops at the "A" and "B" positions in the following drawing. (The dwell time is the same value at both positions "A" and "B".)

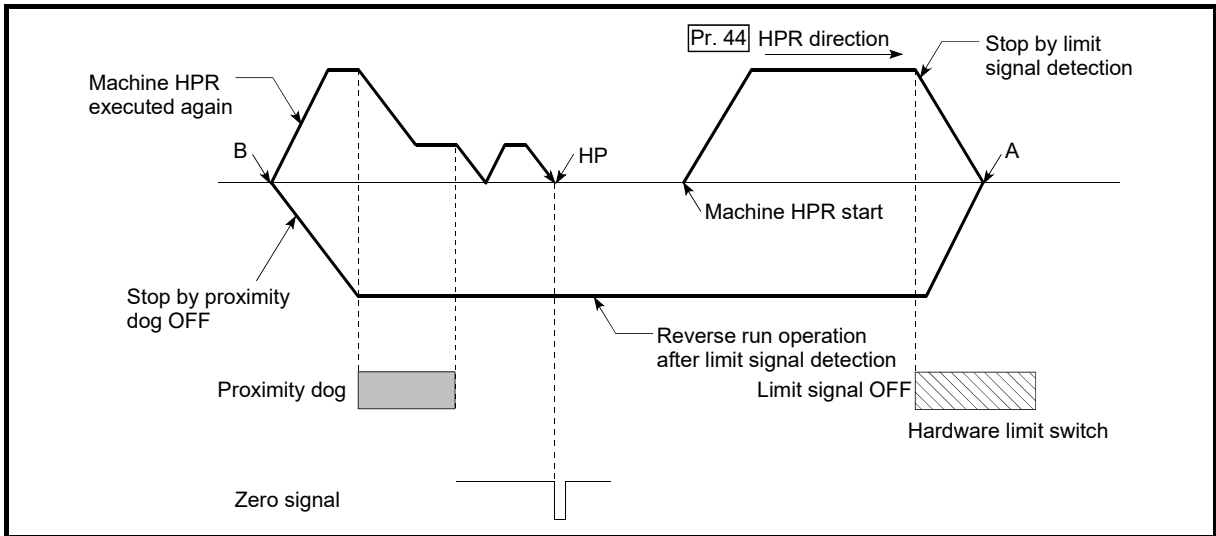

Fig. 13.3 Setting the dwell time during an HPR retry

[2] Precaution during control

(1) The following table shows whether the HPR retry function may be executed by the "[Pr.43] HPR method".

| [Pr.43] HPR method | | Execution status of HPR retry function |
|--------------------------------------|---------------|--|
| Proximity dog method | [RJ010 mode] | ○ : Execution possible |
| Count method 1) | | ○ : Execution possible |
| Count method 2) | | ○ : Execution possible |
| Data set method | | — |
| Scale origin signal detection method | | × : Execution not possible |
| Driver HPR method | [CiA402 mode] | — |

- (2) Always establish upper/lower limit switches at the upper/lower limit positions of the machine. If the HPR retry function is used without hardware stroke limit switches, the motor will continue rotation until a hardware stroke limit signal is detected.
- (3) Do not configure a system so that the servo amplifier power turns OFF by the upper/lower limit switches. If the servo amplifier power is turned OFF, the HPR retry cannot be carried out.
- (4) The operation decelerates upon detection of the hardware limit signal, and the movement starts in the opposite direction. In this case, however, the error "Hardware stroke limit (+)" (error code: 104) or "Hardware stroke limit (-)" (error code: 105) does not occur.

POINT

The settings of the upper/lower stroke limit signal are shown below. The HPR retry function can be used with either setting. (Refer to Section 13.4.4 "Hardware stroke limit function".)

- External input signal of servo amplifier
- External input signal via CPU (buffer memory of QD77GF)

[3] Setting the HPR retry function

To use the "HPR retry function", set the required details in the parameters shown in the following table, and write them to the Simple Motion module.

When the parameters are set, the HPR retry function will be added to the machine HPR control. The set details are validated at the rising edge (OFF → ON) of the PLC READY signal [Y0]. Set "[Pr.57] Dwell time during HPR retry" according to the user's requirements.

| Setting item | | Setting value | Setting details | Factory-set initial value |
|--------------|-----------------------------|---------------|--|---------------------------|
| [Pr.48] | HPR retry | 1 | Set "1: Carry out HPR retry by limit switch". | 0 |
| [Pr.57] | Dwell time during HPR retry | → | Set the deceleration stop time during HPR retry. (Random value between 0 and 65535 (ms)) | 0 |

*: Refer to Section 5.2 "List of parameters" for setting details.

REMARK

- Parameters are set for each axis.
- It is recommended that the parameters be set whenever possible with GX Works2. Execution by sequence program uses many sequence programs and devices. The execution becomes complicated, and the scan times will increase.

13.2.2 HP shift function [RJ010 mode]

When a machine HPR is carried out, the HP is normally established using the proximity dog or zero signal. However, by using the HP shift function, the machine can be moved a designated movement amount from the position where the zero signal was detected. A mechanically established HP can then be interpreted at that point.

The details shown below explain about the "HP shift function".

- [1] Control details
- [2] Setting range for the HP shift amount
- [3] Movement speed during HP shift
- [4] Precautions during control
- [5] Setting the HP shift function

[1] Control details

The following drawing shows the operation of the HP shift function.

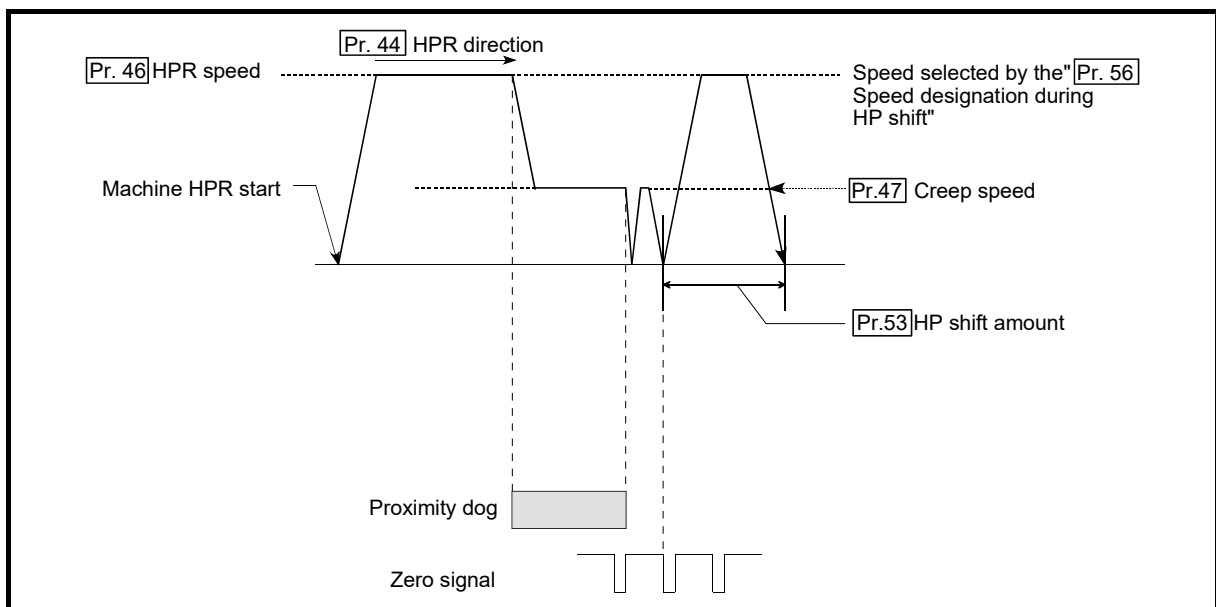

Fig. 13.4 HP shift operation

[2] Setting range for the HP shift amount

Set the HP shift amount within the range from the detected zero signal to the upper/lower limit switches.

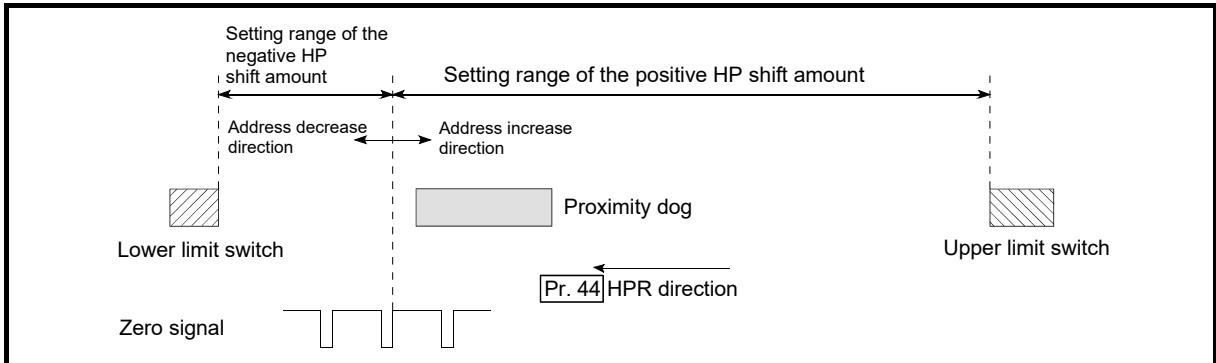

Fig. 13.5 Setting range for the HP shift amount

[3] Movement speed during HP shift

When using the HP shift function, the movement speed during the HP shift is set in "[Pr.56] Speed designation during HP shift". The movement speed during the HP shift is selected from either the "[Pr.46] HPR speed" or the "[Pr.47] Creep speed".

The following drawings show the movement speed during the HP shift when a mechanical HPR is carried out by the proximity dog method. For the acceleration/deceleration time, the value specified in "[Pr.51] HPR acceleration time selection" or "[Pr.52] HPR deceleration time selection" is used.

(1) HP shift operation at the "[Pr.46] HPR speed"

(When "[Pr.56] Speed designation during HP shift" is 0)

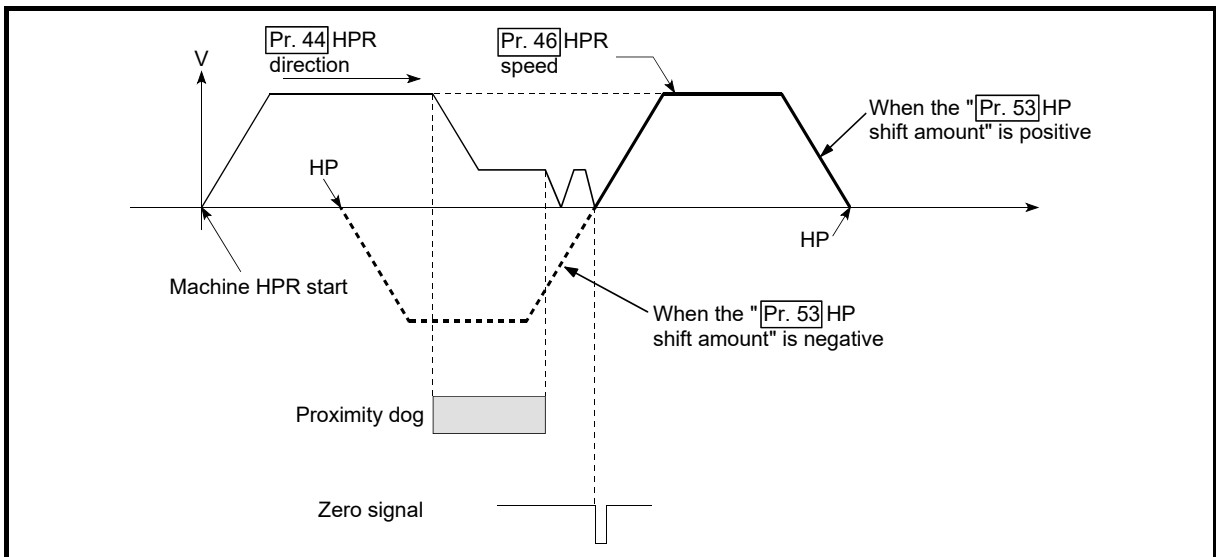

Fig. 13.6 HP shift operation at the HPR speed

- (2) HP shift operation at the "[Pr.47] Creep speed"
 (When "[Pr.56] Speed designation during HP shift" is 1)

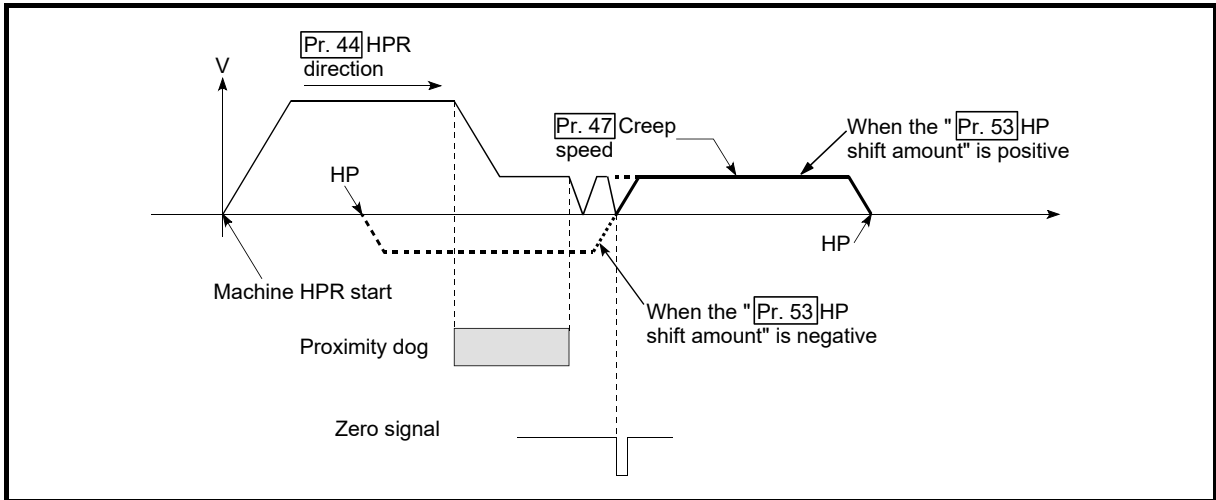

Fig. 13.7 HP shift operation at the creep speed

[4] Precautions during control

- (1) The following data are set after the HP shift amount is complete.

- HPR complete flag ([Md.31] Status: b4)
- [Md.20] Feed current value
- [Md.21] Feed machine value
- [Md.26] Axis operation status

HPR request flag ([Md.31] Status: b3) is reset after completion of the HP shift.

- (2) "[Pr.53] HP shift amount" is not added to "[Md.34] Movement amount after proximity dog ON". The movement amount immediately before the HP shift operation, considering proximity dog ON as "0", is stored.

[5] Setting the HP shift function

To use the "HP shift function", set the required details in the parameters shown in the following table, and write them to the Simple Motion module.

When the parameters are set, the HP shift function will be added to the machine HPR control. The set details are validated at the rising edge (OFF → ON) of the PLC READY signal [Y0].

| Setting item | Setting value | Setting details | Factory-set initial value |
|---|---------------|--|---------------------------|
| [Pr.53] HP shift amount | → | Set the shift amount during the HP shift. | 0 |
| [Pr.56] Speed designation during HP shift | → | Select the speed during the HP shift 0: [Pr.46] HPR speed 1: [Pr.47] Creep speed | 0 |

*: Refer to Section 5.2 "List of parameters" for setting details.

REMARK

- Parameters are set for each axis.
- It is recommended that the parameters be set whenever possible with GX Works2. Execution by sequence program uses many sequence programs and devices. The execution becomes complicated, and the scan times will increase.

13.3 Functions for compensating the control

The sub functions for compensating the control include the "backlash compensation function", "electronic gear function", and "near pass function". Each function is executed by parameter setting or sequence program creation and writing.

13.3.1 Backlash compensation function

The "backlash compensation function" compensates the backlash amount in the mechanical system.

The details shown below explain about the "backlash compensation function".

- [1] Control details
- [2] Precautions during control
- [3] Setting the backlash compensation function

[1] Control details

When the backlash compensation amount is set, an extra amount of command equivalent to the set backlash amount is output every time the movement direction changes.

The following drawing shows the operation of the backlash compensation function.

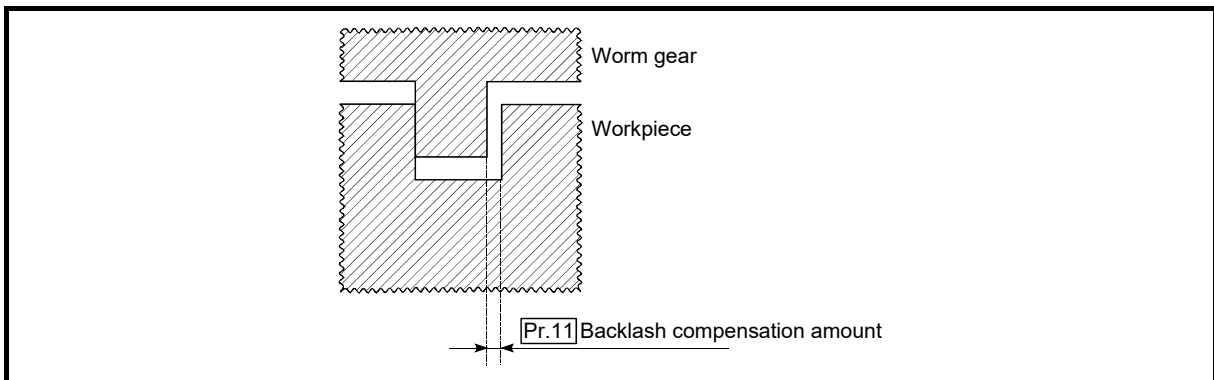

Fig. 13.8 Backlash compensation amount

[2] Precautions during control

- (1) The feed command of the backlash compensation amount are not added to the "[Md.20] Feed current value" or "[Md.21] Feed machine value".
- (2) Always carry out a machine HPR before starting the control when using the backlash compensation function (when "[Pr.11] Backlash compensation amount" is set). The backlash in the mechanical system cannot be correctly compensated if a machine HPR is not carried out.
- (3) Backlash compensation, which includes the movement amount and "[Pr.11] Backlash compensation amount", is output the moment at the moving direction changes.
- (4) Backlash compensation cannot be made during the speed control mode or torque control mode.
- (5) Whether the backlash compensation is necessary or not is judged from "[Pr.44] HPR direction" of the Simple Motion module in the axis operation such as positioning after the HPR.
When the positioning is executed in the same direction as "[Pr.44] HPR direction", the backlash compensation is not executed. However, when the positioning is executed in the reverse direction against "[Pr.44] HPR direction", the backlash compensation is executed.

[3] Setting the backlash compensation function

To use the "backlash compensation function", set the "backlash compensation amount" in the parameter shown in the following table, and write it to the Simple Motion module.

The set details are validated at the rising edge (OFF → ON) of the PLC READY signal [Y0].

| Setting item | | Setting value | Setting details | Factory-set initial value |
|--------------|------------------------------|---------------|---|---------------------------|
| [Pr.11] | Backlash compensation amount | → | Set the backlash compensation amount. | 0 |
| [Pr.44] | HPR direction | → | Set the same direction as the last HPR direction set in the servo amplifier when using the driver HPR. [CiA402 mode] | 0 |

*: Refer to Section 5.2 "List of parameters" for setting details.

REMARK

- Parameters are set for each axis.
- It is recommended that the parameters be set whenever possible with GX Works2. Execution by sequence program uses many sequence programs and devices. The execution becomes complicated, and the scan times will increase.

13.3.2 Electronic gear function

The "electronic gear function" adjusts the actual machine movement amount and number of pulse output to servo amplifier according to the parameters set in the Simple Motion module.

The "electronic gear function" has the following three functions ([A] to [C]).

- [A] During machine movement, the function increments in the Simple Motion module values less than one pulse that could not be output, and outputs the incremented amount when the total incremented value reached one pulse or more.
- [B] When machine HPR is completed, current value changing is completed, speed control is started (except when feed current value change is present), or fixed-feed control is started, the function clears to "0" the cumulative values of less than one pulse which could not be output. (If the cumulative value is cleared, an error will occur by a cleared amount in the feed machine value. Control can be constantly carried out at the same machine movement amount, even when the fixed-feed control is continued.)
- [C] The function compensates the mechanical system error of the command movement amount and actual movement amount by adjusting the "electronic gear".
(The "movement amount per pulse" value is defined by "[Pr.2] Number of pulses per rotation (AP)", "[Pr.3] Movement amount per rotation (AL)" and "[Pr.4] Unit magnification (AM)".)

The Simple Motion module automatically carries out the processing for [A] and [B].

The details shown below explain about the "electronic gear function", including the method for compensating the error in [C] above, etc.

- [1] Basic concept of the electronic gear
- [2] The method for compensating the error

[1] Basic concept of the electronic gear

The electronic gear is an item which determines how many rotations (rotations by how many pulses) the motor must make in order to move the machine according to the programmed movement amount.

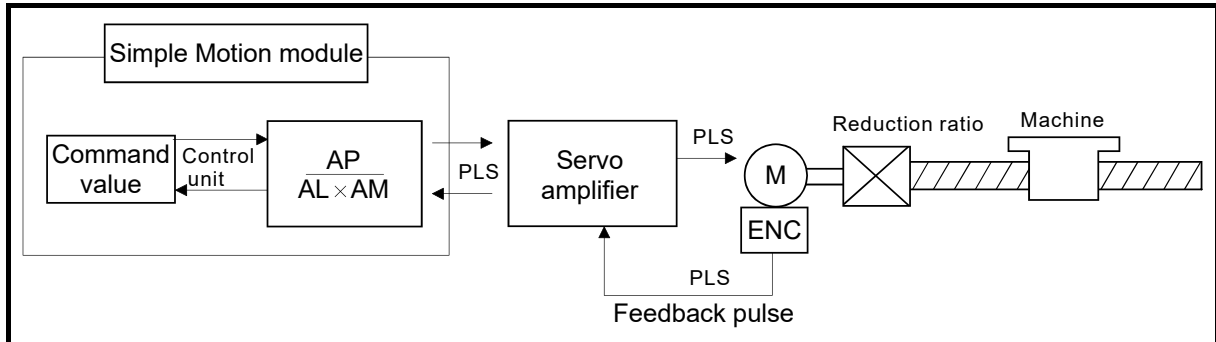

The basic concept of the electronic gear is represented by the following expression.

- [Pr.2] (Number of pulses per rotation) = AP
- [Pr.3] (Movement amount per rotation) = AL
- [Pr.4] (Unit magnification) = AM
- Movement amount per rotation that considered unit magnification = ΔS

$$\text{Electronic gear} = \frac{AP}{\Delta S} = \frac{AP}{AL \times AM} \dots(1)$$

Set values for AP, AL and AM so that this related equation is established.

However, because values to be set for AP, AL and AM have the settable range, values calculated (reduced) from the above related equation must be contained in the setting range for AP, AL and AM.

(1) For "Ball screw" + "Reduction gear"

When the ball screw pitch is 10mm, the motor is the HG-KR (4194304 PLS/rev) and the reduction ratio is 9/44.

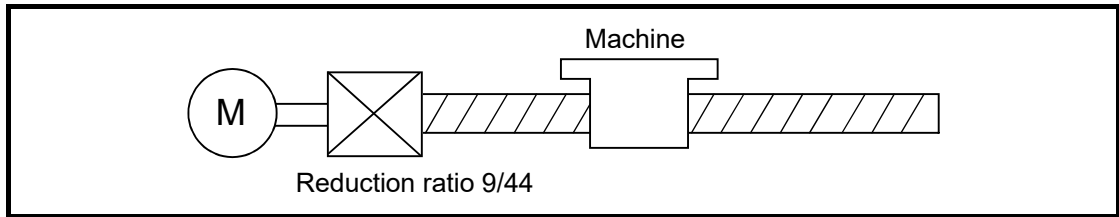

First, find how many millimeters the load (machine) will travel (ΔS) when the motor turns one revolution (AP).

- AP (Number of pulses per rotation) = 4194304 [PLS]
- ΔS (Movement amount per rotation)
 - = Ball screw pitch \times Reduction ratio
 - = 10 [mm] \times 9/44
 - = 10000.0 [μ m] \times 9/44

Substitute this for the above expression (1).

At this time, make calculation with the reduction ratio 9/44 remaining as a fraction.

$$\begin{aligned}
 \frac{AP}{\Delta S} &= \frac{4194304 \text{ [PLS]}}{10000.0 \text{ [\mu m]} \times 9/44} \\
 &= \frac{4194304 \times 44}{10000.0 \times 9} \\
 &= \frac{184549376}{90000.0} \\
 &= \frac{23068672}{11250.0} = \frac{23068672 \text{ (AP)}}{11250.0 \text{ (AL)} \times 1 \text{ (AM)}} \\
 &= \frac{23068672 \text{ (AP)}}{1125.0 \text{ (AL)} \times 10 \text{ (AM)}}
 \end{aligned}$$

Thus, AP, AL and AM to be set are as follows.

$$\begin{aligned}
 AP &= 23068672 \dots [\text{Pr.2}] & AP &= 23068672 \dots [\text{Pr.2}] \\
 AL &= 11250.0 \dots [\text{Pr.3}] & \text{or} & AL &= 1125.0 \dots [\text{Pr.3}] \\
 AM &= 1 \dots [\text{Pr.4}] & AM &= 10 \dots [\text{Pr.4}]
 \end{aligned}$$

Note): These two examples of settings are only examples. There are settings other than these examples.

(2) When "PLS (pulse)" is set as the control unit

When using PLS (pulse) as the control unit, set the electronic gear as follows.

- AP = "Number of pulses per rotation"
- AL = "Movement amount per rotation"
- AM = 1

Example) When the motor is the HG-KR (4194304PLS/rev)

- AP = 4194304 .. [Pr.2]
- AL = 4194304 .. [Pr.3]
- AM = 1 [Pr.4]

(3) When "degree" is set as the control unit for a rotary axis

When the rotary axis is used, the motor is HG-KR (4194304PLS/rev) and the reduction ratio is 3/11.

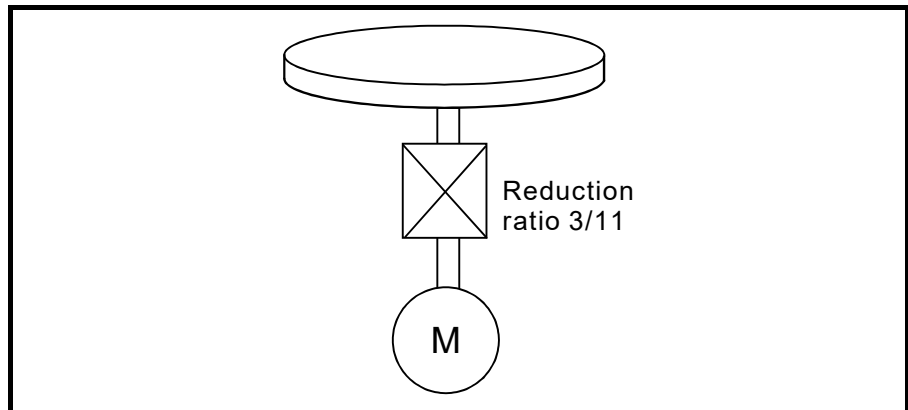

First, find how many degrees the load (machine) will travel (ΔS) when the motor turns one revolution (AP).

- AP (Number of pulses per rotation) = 4194304 [PLS]
- ΔS (Movement amount per rotation)
 - = 360.00000 [degree] \times Reduction ratio
 - = 360.00000 \times 3/11

Substitute this for the above expression (1).

$$\begin{aligned}
 \frac{AP}{\Delta S} &= \frac{4194304 \text{ [PLS]}}{360.00000 \text{ [degree]} \times 3/11} \\
 &= \frac{4194304 \text{ [PLS]} \times 11}{360.00000 \times 3} \\
 &= \frac{46137344}{1080.00000} \\
 &= \frac{2883584}{67.50000} = \frac{2883584 \text{ (AP)}}{67.50000(\text{AL}) \times 1 \text{ (AM)}} \\
 &= \frac{2883584 \text{ (AP)}}{0.06750 \text{ (AL)} \times 1000 \text{ (AM)}}
 \end{aligned}$$

Thus, AP, AL and AM to be set are as follows.

$$\begin{array}{ll}
 AP = 2883584 \dots\dots[\text{Pr.2}] & AP = 2883584 \dots\dots[\text{Pr.2}] \\
 AL = 67.50000 \dots[\text{Pr.3}] & \text{or } AL = 0.06750 \dots\dots[\text{Pr.3}] \\
 AM = 1 \dots\dots\dots[\text{Pr.4}] & AM = 1000 \dots\dots\dots[\text{Pr.4}]
 \end{array}$$

Note): These two examples of settings are only examples. There are settings other than these examples.

(4) When "mm" is set as the control unit for conveyor drive (calculation including π)

When the belt conveyor drive is used, the conveyor diameter is 135mm, the pulley ratio is 1/3, the motor is HG-KR (4194304PLS/rev) and the reduction ratio is 7/53.

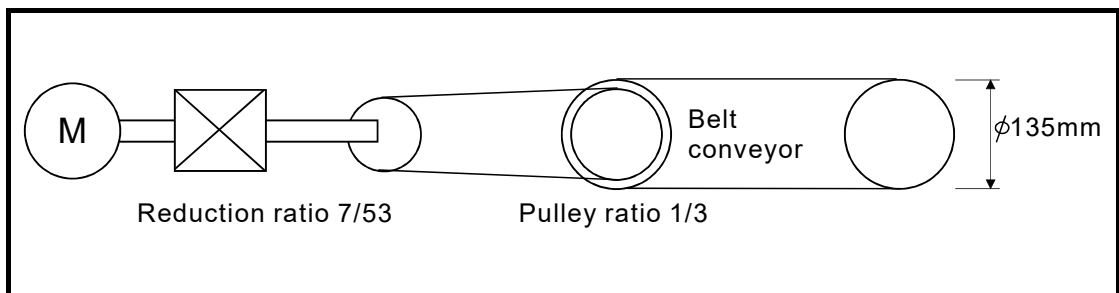

As the travel value of the conveyor is used to exercise control, set "mm" as the control unit.

First, find how many millimeters the load (machine) will travel (ΔS) when the motor turns one revolution (AP).

- AP (Number of pulses per rotation) = 4194304 [PLS]
- ΔS (Movement amount per rotation)
 - = 135000.0 [μm] $\times \pi \times$ Reduction ratio
 - = 135000.0 [μm] $\times \pi \times 7/53 \times 1/3$

Substitute this for the above expression (1).

At this time, make calculation with the reduction ratio $7/53 \times 1/3$ remaining as a fraction.

$$\begin{aligned}
 \frac{AP}{\Delta S} &= \frac{AP}{AL \times AM} = \frac{4194304 \text{ [PLS]}}{135000.0 \text{ [\mu m]} \times \pi \times 7/53 \times 1/3} \\
 &= \frac{4194304 \times 53 \times 3}{135000.0 \times \pi \times 7} \\
 &= \frac{166723584}{236250 \times \pi}
 \end{aligned}$$

Here, make calculation on the assumption that π is equal to 3.141592654.

$$\frac{AP}{\Delta S} = \frac{AP}{AL \times AM} = \frac{166723584}{742201.2645075}$$

AL has a significant number to first decimal place, round down numbers to two decimal places.

$$\frac{AP}{\Delta S} = \frac{AP}{AL \times AM} = \frac{166723584}{742201.2} = \frac{166723584 (AP)}{742201.2 (AL) \times 1(AM)}$$

Thus, AP, AL and AM to be set are as follows.

$$AP = 166723584 \quad \text{.....[Pr.2]}$$

$$AL = 742201.2 \quad \text{.....[Pr.3]}$$

$$AM = 1 \quad \text{.....[Pr.4]}$$

This setting will produce an error for the true machine value, but it cannot be helped. This error is as follows.

$$\left(\frac{7422012/166723584}{2362500 \pi/166723584} - 1 \right) \times 100 = -8.69 \times 10^{-6} [\%]$$

- AP (Number of pulses per rotation) = 4194304 [PLS]
- ΔS (Movement amount per rotation)
 - = 135000.0 [μm] $\times \pi \times$ Reduction ratio
 - = 135000.0 [μm] $\times \pi \times 7/53 \times 1/3$

It is equivalent to an about 86.9 [μm] error in continuous 1km feed.

(5) Number of pulses/ movement amount at linear servo use

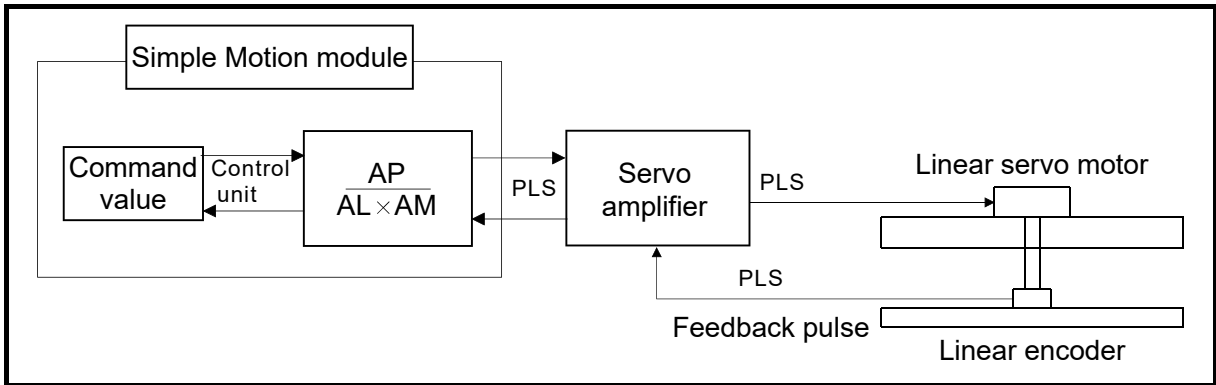

Calculate the number of pulses (AP) and movement amount (AL × AM) for the linear encoder in the following conditions.

$$\text{Linear encoder resolution} = \frac{\text{Number of pulses (AP)}}{\text{Movement amount (AL} \times \text{AM)}}$$

Linear encoder resolution: 0.05 [μm] per PLS

$$\frac{1 \text{ [PLS]}}{0.05 \text{ [}\mu\text{m]}} = \frac{\text{Number of pulses (AP) [PLS]}}{\text{Movement amount (AL} \times \text{AM) [}\mu\text{m]}} = \frac{20}{1.0}$$

Set the number of pulses in "[Pr.2] Number of pulses per rotation (AP)", the movement amount in "[Pr.3] Movement amount per rotation (AL)", and the unit magnification in "[Pr.4] Unit magnification (AM)" in the actual setting.

*: When MR-J4(W)-GF use, set the same value in AP, AL, and AM as the value set in the servo parameter "Linear encoder resolution - Numerator (PL02)" and "Linear encoder resolution - Denominator (PL03)".

Refer to each servo amplifier instruction manual for details.

When "Linear encoder resolution - Numerator (PL02)" is set to 1 [μm] and "Linear encoder resolution - Denominator (PL03)" is set to 20 [μm], the values of AP, AL and AM are shown below.

- AP = 20 [Pr.2]
- AL = 1.0 [Pr.3]
- AM = 1 [Pr.4]

[2] The method for compensating the error

When the position control is carried out using the "Electronic gear" set in a parameter, this may produce an error between the command movement amount (L) and the actual movement amount (L'). With Simple Motion module, this error is compensated by adjusting the electronic gear. The "Error compensation amount", which is used for error compensation, is defined as follows:

$$\text{Error compensation amount} = \frac{\text{Command movement amount (L)}}{\text{Actual movement amount (L')}} \times \frac{\text{AP}}{\text{AL} \times \text{AM}}$$

The electronic gear including an error compensation amount is shown below.

$$\frac{\text{AP}}{\text{AL} \times \text{AM}} \times \frac{\text{L}}{\text{L}'} = \frac{\text{AP}'}{\text{AL}' \times \text{AM}'}$$

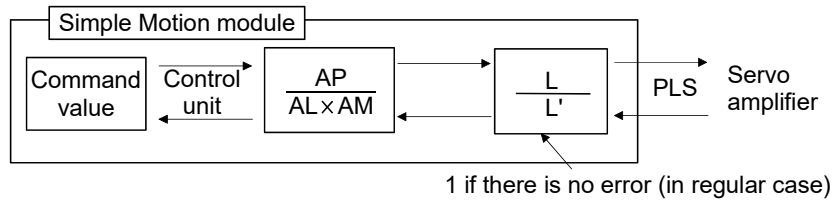

Electronic gear taking an error into consideration

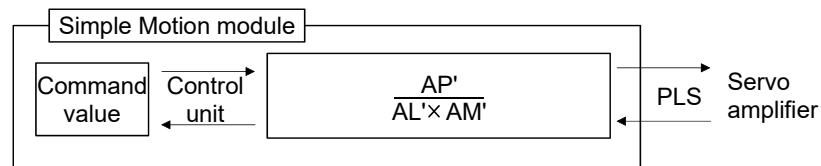

--- Calculation example ---

(Conditions)

- Number of pulses per rotation (AP) : 4194304 [PLS]
- Movement amount per rotation (AL) : 5000.0 [μm]
- Unit magnification (AM) : 1

(Positioning results)

- Command movement amount (L) : 100 [mm]
- Actual movement amount (L') : 101 [mm]

(Compensation value)

$$\frac{\text{AP}}{\text{AL} \times \text{AM}} \times \frac{\text{L}}{\text{L}'} = \frac{4194304}{5000.0 \times 1} \times \frac{100}{101} = \frac{4194304 (\text{AP}')}{5050 (\text{AL}') \times 1 (\text{AM}')}$$

- Number of pulses per rotation (AP') : 4194304[Pr.2]
- Movement amount per rotation (AL') : 5050.0[Pr.3]
- Unit magnification (AM') : 1[Pr.4]

Set the post-compensation "[Pr.2] Number of pulses per rotation (AP')", "[Pr.3] Movement amount per rotation (AL')", and "[Pr.4] Unit magnification (AM')" in the parameters, and write them to the Simple Motion module. The set details are validated at the rising edge (OFF → ON) of the PLC READY signal [Y0].

13.3.3 Near pass function

When continuous pass control is carried out using interpolation control, the near pass function is carried out.

The "near pass function" is a function to suppress the mechanical vibration occurring at the time of switching the positioning data when continuous pass control is carried out using interpolation control.

[Near pass function]

The extra movement amount occurring at the end of each positioning data unit being continuously executed is carried over to the next positioning data unit. Alignment is not carried out, and thus the output speed drops are eliminated, and the mechanical vibration occurring during speed changes can be suppressed. Because alignment is not carried out, the operation is controlled on a path that passes near the position set in "[Da.6] Positioning address".

The details shown below explain about the "near pass function".

- [1] Control details
- [2] Precautions during control

[1] Control details

The following drawing shows the path of the continuous path control by the 2-axis linear interpolation control.

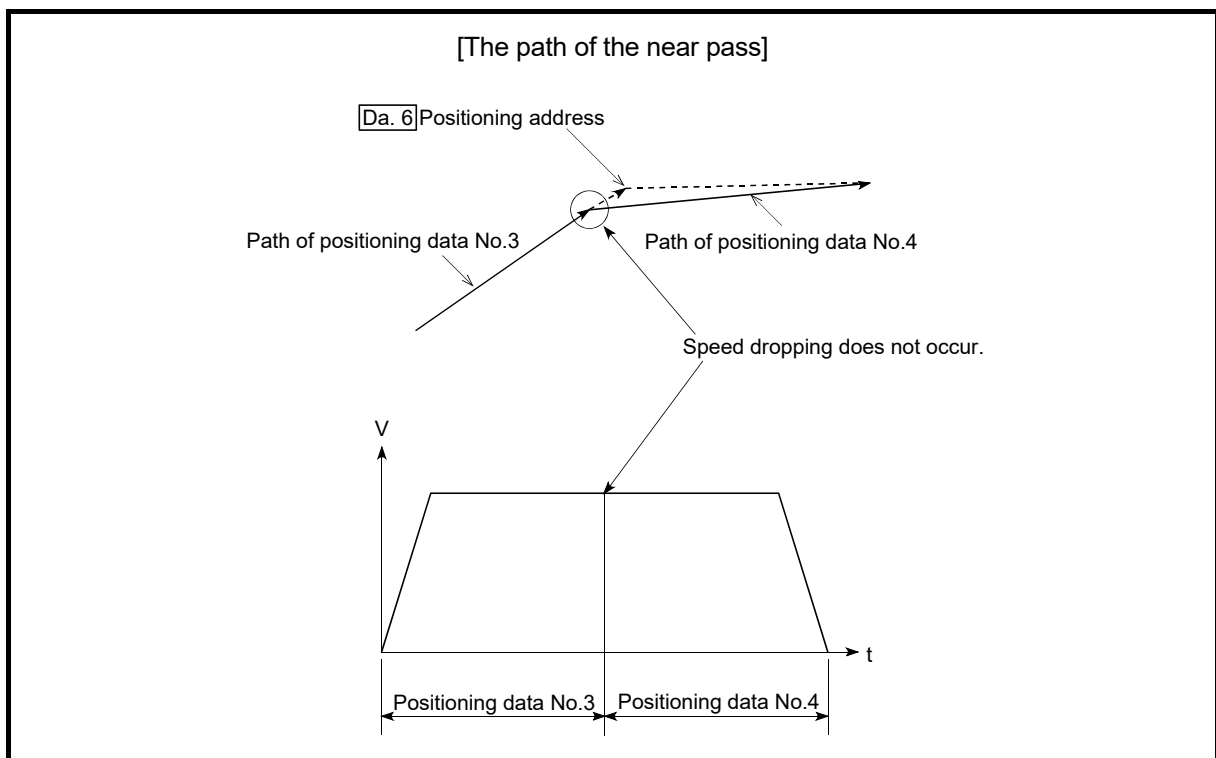

Fig. 13.9 The path of the continuous path control

[2] Precautions during control

- (1) If the movement amount designated by the positioning data is small when the continuous path control is executed, the output speed may not reach the designated speed.
- (2) The movement direction is not checked during interpolation operation. Therefore, a deceleration stops are not carried out even if the movement direction changes. (See below) For this reason, the output will rapidly reverse when the reference axis movement direction changes. To prevent the rapid output reversal, assign not the continuous path control "11", but the continuous positioning control "01" to the positioning data of the passing point.

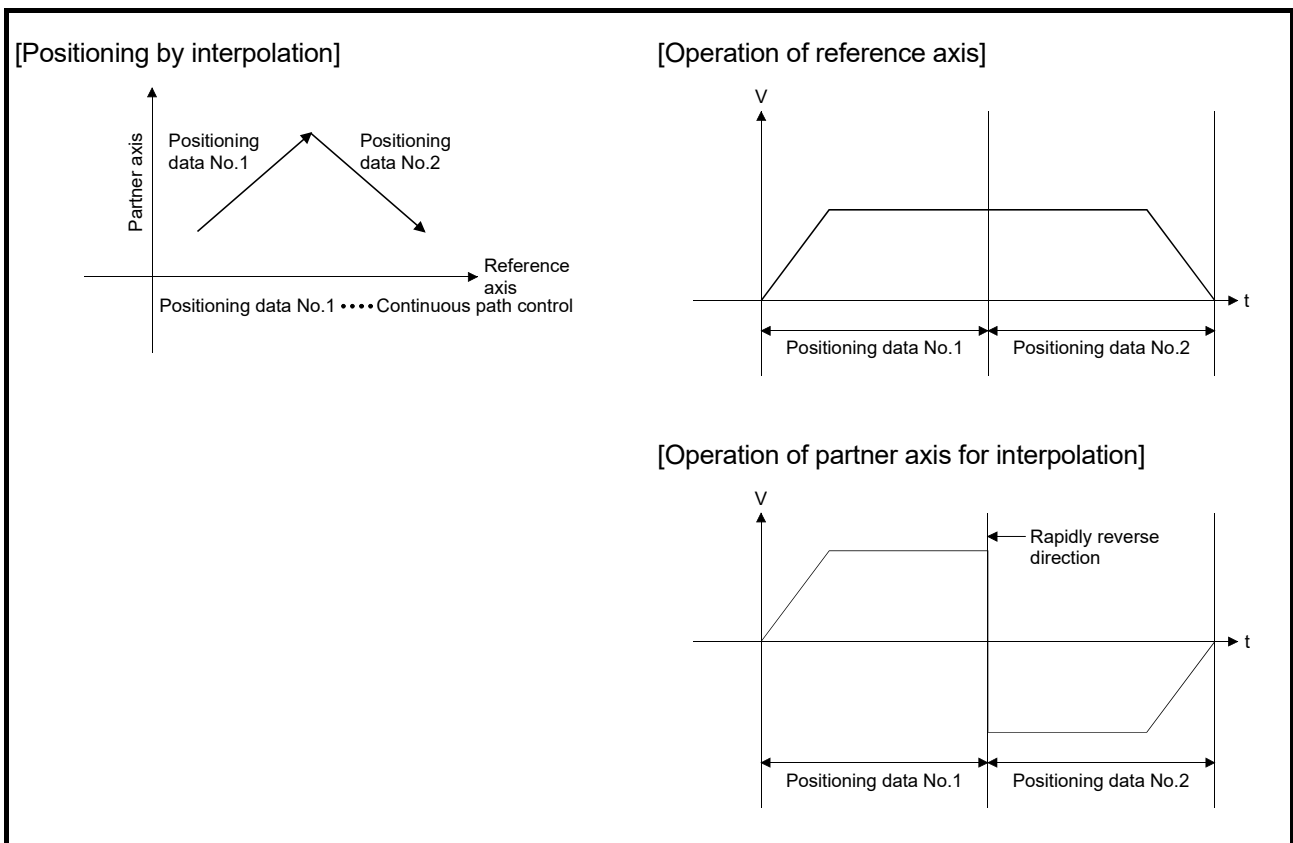

Fig. 13.10 Path and output speed of various axes when movement direction varies during continuous path control

13.4 Functions to limit the control

Functions to limit the control include the "speed limit function", "torque limit function", "software stroke limit function", "hardware stroke limit function", and "forced stop function". Each function is executed by parameter setting or sequence program creation and writing.

13.4.1 Speed limit function

The speed limit function limits the command speed to a value within the "speed limit value" setting range when the command speed during control exceeds the "speed limit value".

The details shown below explain about the "speed limit function".

- [1] Relation between the speed limit function and various controls
- [2] Precautions during control
- [3] Setting the speed limit function

[1] Relation between the speed limit function and various controls

The following table shows the relation of the "speed limit function" and various controls.

| Control type | | Speed limit function | Speed limit value | |
|---|--|--|--|-----------------------|
| HPR control | Machine HPR control | ◎ | [Pr.8] Speed limit value [CiA402 mode] The speed limit value follows the setting of the driver (servo amplifier) when using the driver HPR method. | |
| | Fast HPR control | ◎ | [Pr.8] Speed limit value | |
| Major positioning control | Position control | 1-axis linear control | | ◎ |
| | | 2 to 4-axes linear interpolation control | | ◎ |
| | | 1-axis fixed-feed control | | ◎ |
| | | 2 to 4-axes fixed-feed control (interpolation) | | ◎ |
| | | 2-axis circular interpolation control | | ◎ |
| | 1 to 4-axes Speed control | ◎ | | |
| | Speed-position switching control, Position-speed switching control | ◎ | | |
| | Other control | Current value changing | — | Setting value invalid |
| JUMP instruction, NOP instruction, LOOP to LEND | | — | | |
| Manual control | JOG operation, Inching operation | ◎ | [Pr.31] JOG speed limit value | |
| | Manual pulse generator operation | — | Setting is invalid | |
| Expansion control | Speed-torque control | ◎ | [Pr.8] Speed limit value | |

◎ : Always set

— : Setting not required (Use the initial value or a value within the setting range.)

[2] Precautions during control

- (1) If any axis exceeds "[Pr.8] Speed limit value" during 2- to 4-axis speed control, the axis in excess of the speed limit value is controlled at the speed limit value. The speeds of the other axes interpolated are suppressed depending on their command speed ratios.
- (2) If the reference axis exceeds "[Pr.8] Speed limit value" during 2-axis circular interpolation control, the reference axis is controlled at the speed limit value (The speed limit does not function on the interpolation axis side.)
- (3) If any axis exceeds "[Pr.8] Speed limit value" during 2- to 4-axis linear interpolation control or 2- to 4-axis fixed-feed control, the axis exceeding the speed limit value is controlled with the speed limit value. The speeds of the other axes being interpolated are suppressed by the movement amount ratio.

POINT

When the "reference axis speed" is set during interpolation control, set so the major axis side becomes the reference axis. If the minor axis side is set as the reference axis, the major axis side speed may exceed the "[Pr.8] Speed limit value".

[3] Setting the speed limit function

To use the "speed limit function", set the "speed limit value" in the parameters shown in the following table, and write them to the Simple Motion module.

The set details are validated at the next start after they are written to the Simple Motion module.

| Setting item | | Setting value | Setting details | Factory-set initial value |
|--------------|-----------------------|---------------|--|---------------------------|
| [Pr.8] | Speed limit value | → | Set the speed limit value (max. speed during control). | 200000 |
| [Pr.31] | JOG speed limit value | → | Set the speed limit value during JOG operation (max. speed during control). (Note that "[Pr.31] JOG speed limit value" shall be less than or equal to "[Pr.8] Speed limit value".) | 20000 |

*: Refer to Section 5.2 "List of parameters" for setting details.

REMARK

- Parameters are set for each axis.
- It is recommended that the parameters be set whenever possible with GX Works2. Execution by sequence program uses many sequence programs and devices. The execution becomes complicated, and the scan times will increase.

13.4.2 Torque limit function

The "torque limit function" limits the generated torque to a value within the "torque limit value" setting range when the torque generated in the servomotor exceeds the "torque limit value".

The "torque limit function" protects the deceleration function, limits the power of the operation pressing against the stopper, etc. It controls the operation so that unnecessary force is not applied to the load and machine.

The details shown below explain about the "torque limit function".

- [1] Relation between the torque limit function and various controls
- [2] Control details
- [3] Precautions during control
- [4] Setting the torque limit function

[1] Relation between the torque limit function and various controls

The following table shows the relation of the "torque limit function" and various controls.

| Control type | | Torque limit function | Torque limit value *1 |
|---|--|--|--|
| HPR control | Machine HPR control | ○ | [RJ010 mode] "[Pr.17] Torque limit setting value" or "[Cd.101] Torque output setting value". (After the "[Pr.47] Creep speed" is reached, this value becomes the "[Pr.54] HPR torque limit value".) [CiA402 mode] "[Pr.17] Torque limit setting value" or "[Cd.101] Torque output setting value". *2 The HPR method that can change the torque limit value during the HPR is set in HPR parameters of the servo amplifier. *3 |
| | Fast HPR control | ○ | |
| Major positioning control | Position control | 1-axis linear control | ○ |
| | | 2 to 4-axes linear interpolation control | ○ |
| | | 1-axis fixed-feed control | ○ |
| | | 2 to 4-axes fixed-feed control (interpolation) | ○ |
| | | 2-axis circular interpolation control | ○ |
| | 1 to 4-axes speed control | ○ | |
| | Speed-position switching control Position-speed switching control | ○ | |
| | Other control | Current value changing | — |
| JUMP instruction, NOP instruction, LOOP to LEND | | — | |
| Manual control | JOG operation, Inching operation | ○ | "[Pr.17] Torque limit setting value" or "[Cd.101] Torque output setting value". |
| | Manual pulse generator operation | ○ | |
| Expansion control | Speed-torque control | ○ | Torque limit value before switching control mode is continued. |

○ : Set when required (Set to " — " when not used.)

— : Setting not required (Use the initial value or a value within the setting range.)

*1: Shows the torque limit value when "[Cd.22] New torque value/forward new torque value" or "[Cd.113] New reverse torque value" is set to "0".

*2: Valid for the value set at start only. It cannot be changed during the HPR.

*3: Refer to the servo amplifier instruction manual for the setting method.

[2] Control details

The following drawing shows the operation of the torque limit function.

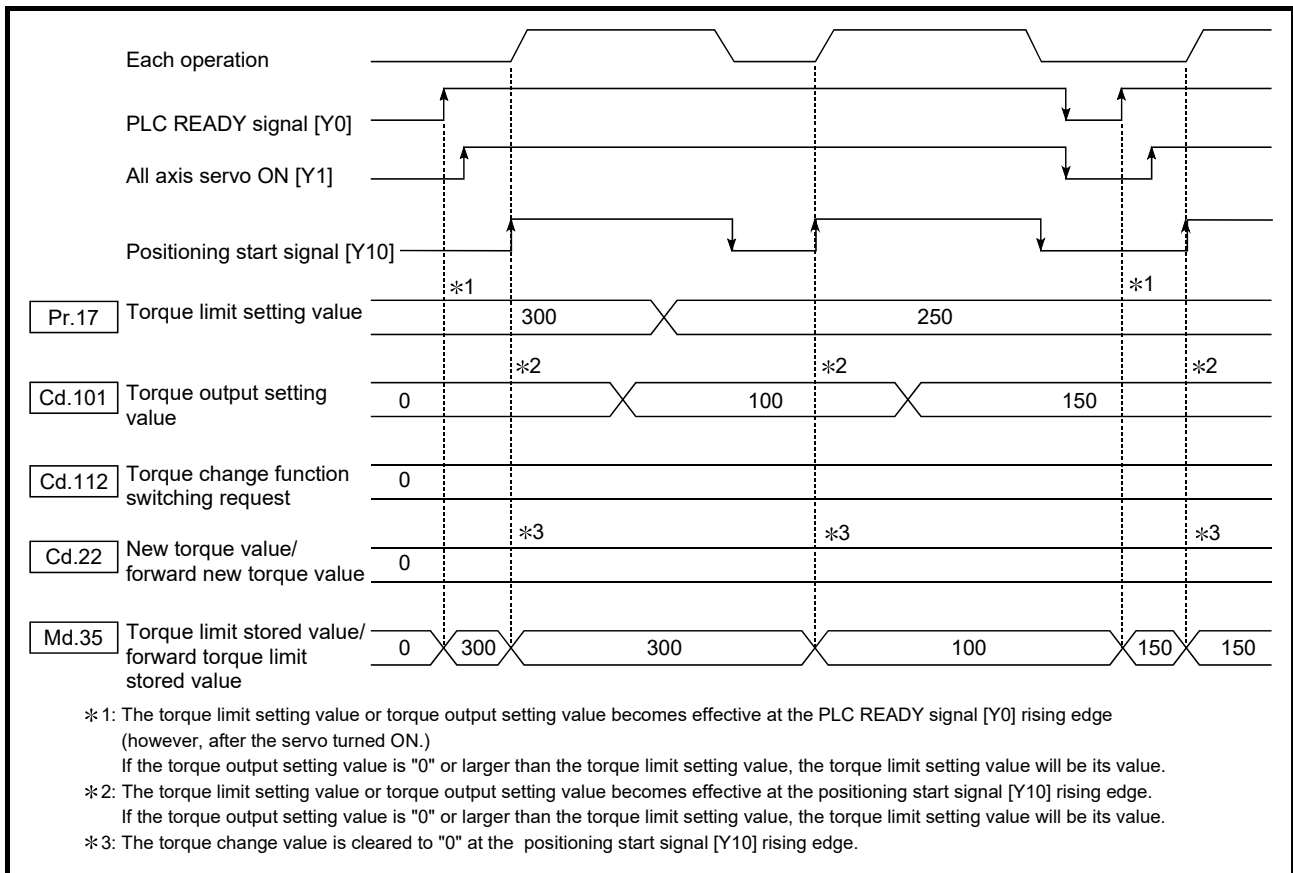

Fig. 13.11 Torque limit function operation

[3] Precautions during control

- (1) When limiting the torque at the "[Pr.17] Torque limit setting value", confirm that "[Cd.22] New torque value/forward new torque value" or "[Cd.113] New reverse torque value" is set to "0". If this parameter is set to a value besides "0", the setting value will be validated, and the torque will be limited at that value. (Refer to Section 13.5.4 "Torque change function" for details about the "new torque value".)
- (2) When the "[Pr.54] HPR torque limit value" exceeds the "[Pr.17] Torque limit setting value", the error "HPR torque limit value error" (error code: 995) occurs.
- (3) When the operation is stopped by torque limiting, the droop pulse will remain in the deviation counter. If the load torque is eliminated, operation for the amount of droop pulses will be carried out. Note that the movement might start rapidly as soon as the load torque is eliminated.

[4] Setting the torque limit function

(1) To use the "torque limit function", set the "torque limit value" in the parameters shown in the following table, and write them to the Simple Motion module.

a) The set details are validated at the rising edge (OFF → ON) of the PLC READY signal [Y0].

| Setting item | Setting value | Setting details | Factory-set initial value |
|------------------------------------|---------------|---|---------------------------|
| [Pr.17] Torque limit setting value | → | Set the torque limit value as a percentage. | 300 |
| [Pr.54] HPR torque limit value | → | [RJ010 mode] Set the torque limit value after the "[Pr.47] Creep speed" is reached. Set as a percentage. [CiA402 mode] The setting value is ignored. | 300 |

b) The set details are validated at the rising edge (OFF → ON) of the positioning start signal [Y10].

| Setting item | Setting value | Setting details | Factory-set initial value |
|--------------------------------------|---------------|--|---------------------------|
| [Cd.101] Torque output setting value | → | Set the torque output value as a percentage. | 0 |

- *: Refer to Section 5.2 "List of parameters" or Section 5.7 "List of control data" for setting details.
- *: Torque limit value: Will be an upper limit value of the torque change value. Even if a larger value has been mistakenly input for the torque change value, it is restricted within the torque limit setting values to prevent an erroneous entry. (Even if a value larger than the torque limit setting value has been input to the torque change value, the torque value is not changed.)
- *: Torque output setting value: to be taken at the start of positioning, and used as a torque limit value. If the value is "0" or larger than the torque limit setting value, the parameter "torque limit setting value" is taken at the start.

(2) The "torque limit value" set in the Simple Motion module is set in the "[Md.35] Torque limit stored value/forward torque limit stored value" or "[Md.120] Reverse torque limit stored value".

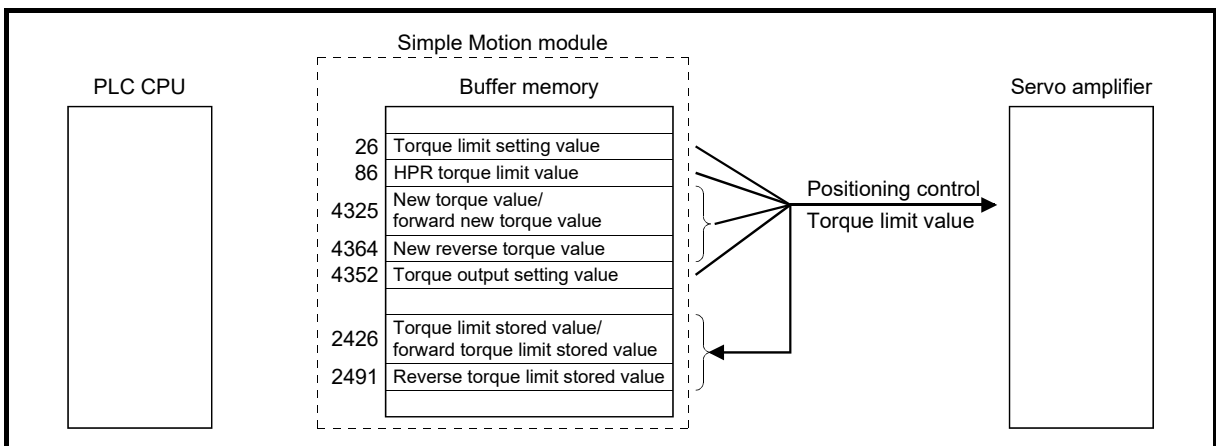

Fig. 13.12 Limiting the torque to the servo amplifier (Axis 1)

- (3) The following table shows the "[Md.35] Torque limit stored value/forward torque limit stored value" and "[Md.120] Reverse torque limit stored value" of the buffer memory address.

| Monitor item | | Monitor value | Storage details | Buffer memory address |
|--------------|---|---------------|--|-----------------------|
| [Md.35] | Torque limit stored value/forward torque limit stored value | → | The "torque limit value/forward torque limit stored value" valid at that time is stored. ([Pr.17], [Pr.54], [Cd.22] or [Cd.101]) | 2426+100n |
| [Md.120] | Reverse torque limit stored value | → | The "reverse torque limit stored value" is stored depending on the control status. ([Pr.17], [Pr.54], [Cd.22], [Cd.101] or [Cd.113]) | 2491+100n |

n: Axis No.-1

*: Refer to Section 5.6 "List of monitor data" for information on the storage details.

REMARK

- Parameters are set for each axis.
- It is recommended that the parameters be set whenever possible with GX Works2. Execution by sequence program uses many sequence programs and devices. The execution becomes complicated, and the scan times will increase.
- Use "[Md.120] Reverse torque limit stored value" and "[Cd.113] New reverse torque value" only when "1: Forward/reverse torque limit value individual setting" is set in "[Cd.112] Torque change function switching request". (Refer to Section 13.5.4 "Torque change function".)

13.4.3 Software stroke limit function

In the "software stroke limit function" the address established by a machine HPR is used to set the upper and lower limits of the moveable range of the workpiece. Movement commands issued to addresses outside that setting range will not be executed.

In the Simple Motion module, the "feed current value" and "feed machine value" are used as the addresses indicating the current position. However, in the "software stroke limit function", the address used to carry out the limit check is designated in the "[Pr.14] Software stroke limit selection". (Refer to Section 9.1.4 "Confirming the current value" or details on the "feed current value" and "feed machine value".)

The upper and lower limits of the moveable range of the workpiece are set in "[Pr.12] Software stroke limit upper limit value"/"[Pr.13] Software stroke limit lower limit value".

The details shown below explain about the "software stroke limit function".

- [1] Differences in the moveable range when "feed current value" and "feed machine value" are selected.
- [2] Software stroke limit check details
- [3] Relation between the software stroke limit function and various controls
- [4] Precautions during software stroke limit check
- [5] Setting the software stroke limit function
- [6] Invalidating the software stroke limit
- [7] Setting when the control unit is "degree"

- [1] Differences in the moveable range when "feed current value" and "feed machine value" are selected.

The following drawing shows the moveable range of the workpiece when the software stroke limit function is used.

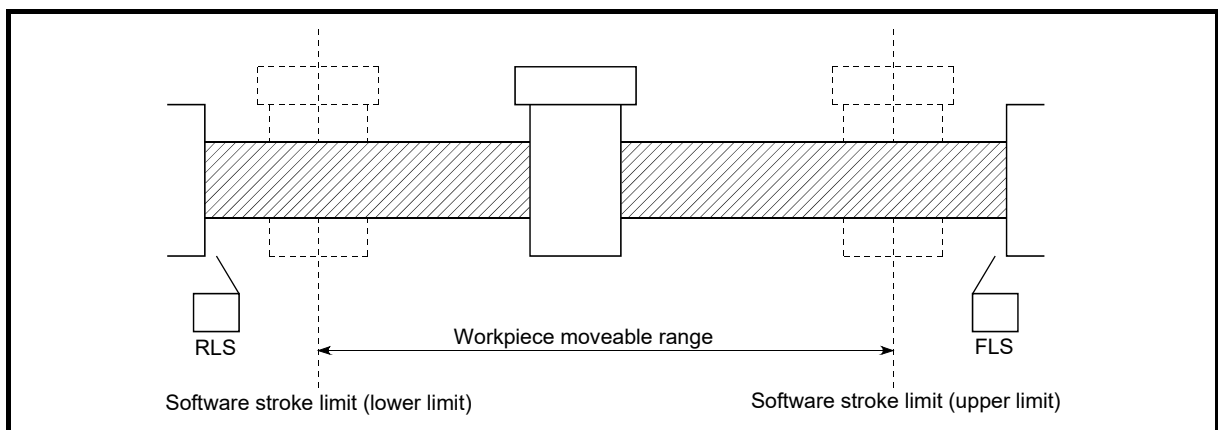

Fig. 13.13 Workpiece moveable range

The following drawing shows the differences in the operation when "[Md.20] Feed current value" and "[Md.21] Feed machine value" are used in the moveable range limit check.

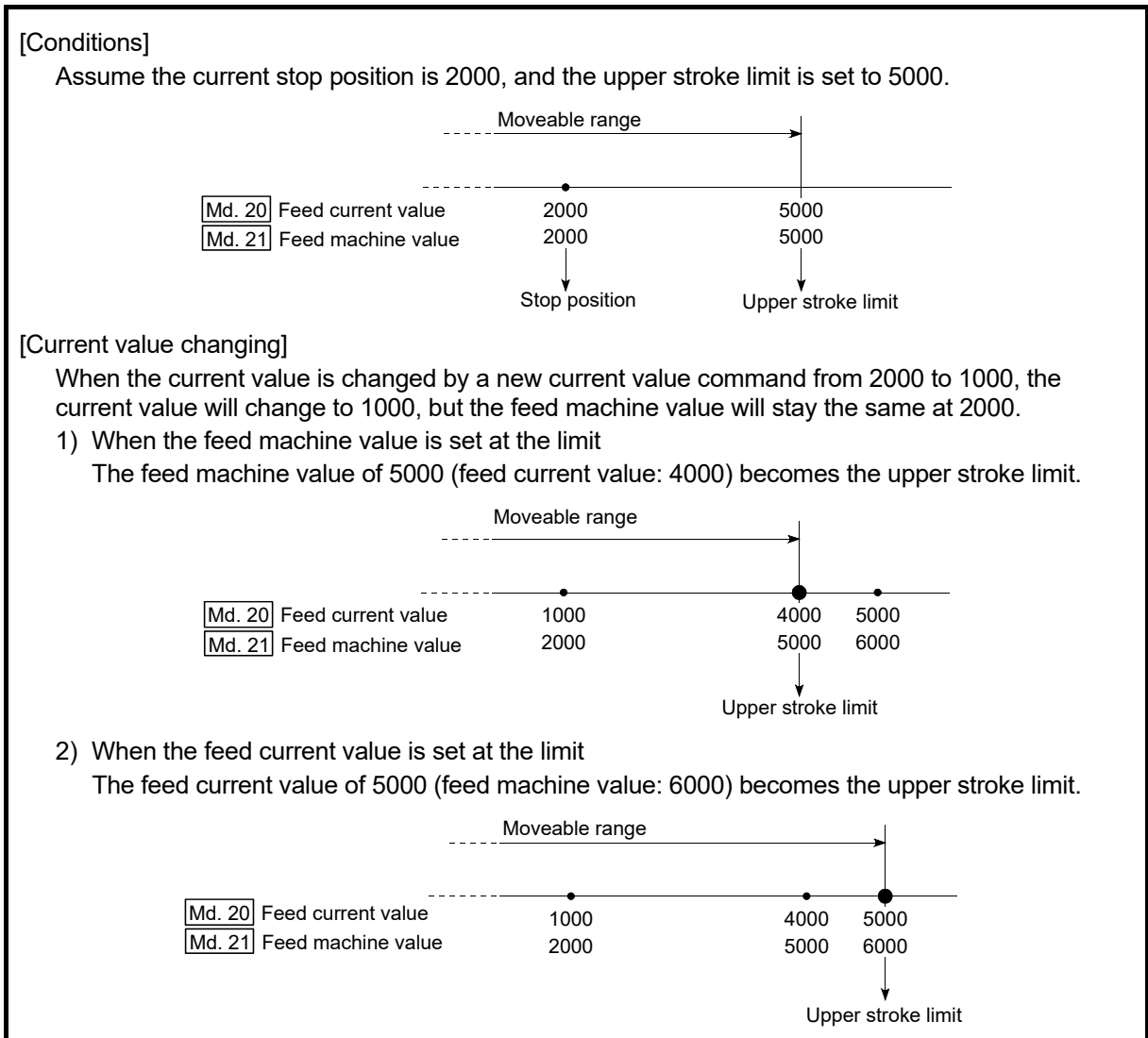

Fig. 13.14 Software stroke limits of the feed current value and feed machine value

POINT
When "feed machine value" is set in "[Pr.14] Software stroke limit selection", the moveable range becomes an absolute range referenced on the HP. When "feed current value" is set, the moveable range is the relative range from the "feed current value".

[2] Software stroke limit check details

| Check details | | Processing when an error occurs |
|---------------|---|--|
| 1) | An error shall occur if the current value ^{*1} is outside the software stroke limit range ^{*2} . (Check "[Md.20] Feed current value" or "[Md.21] Feed machine value".) | The error "Software stroke limit +" (error code: 507) or "Software stroke limit -" (error code: 508) will occur. |
| 2) | An error shall occur if the command address is outside the software stroke limit range. (Check "[Da.6] Positioning address/movement amount".) | The error "Software stroke limit +" (error code: 507) or "Software stroke limit -" (error code: 508) will occur. |

*1: Check whether the "[Md.20] Feed current value" or "[Md.21] Feed machine value" is set in "[Pr.14] Software stroke limit selection".

*2: Moveable range from the "[Pr.12] Software stroke limit upper limit value" to the "[Pr.13] Software stroke limit lower limit value".

[3] Relation between the software stroke limit function and various controls

| Control type | | Limit check | Processing at check | |
|---|--|--|------------------------|---|
| HPR control | Machine HPR control | Data set method | ⊙ | The HPR control will not be executed if the HP address is outside the software stroke limit range. |
| | | Other than "Data set method" | — | Check not carried out. |
| | Fast HPR control | | — | |
| Major positioning control | Position control | 1-axis linear control | ⊙ | Checks 1) and 2) in the previous section [2] are carried out. For speed control: The axis decelerates to a stop when it exceeds the software stroke limit range. For position control: The axis comes to an immediate stop when it exceeds the software stroke limit range. |
| | | 2 to 4-axes axis linear interpolation control | ⊙ | |
| | | 1-axis fixed-feed control | ⊙ | |
| | | 2 to 4-axes fixed-feed control (interpolation) | ⊙ | |
| | | 2-axis circular interpolation control | ⊙ | |
| | 1 to 4-axes speed control | | ○ *1, *2 | |
| | Speed-position switching control Position-speed switching control | | ○ *1, *2 | |
| | Other control | Current value changing | ⊙ | |
| JUMP instruction, NOP instruction, LOOP to LEND | | — | Check not carried out. | |
| Manual control | JOG operation, Inching operation | | △*3 | Check 1) in the previous section [2] is carried out. The machine will carry out a deceleration stop when the software stroke limit range is exceeded. If the address is outside the software stroke limit range, the operation can only be started toward the moveable range. |
| | Manual pulse generator operation | | △*3 | |
| Expansion control | Speed-torque control | | ⊙ | Check 1) in the previous section [2] is carried out. The mode switches to the position control mode when the software stroke limit range is exceeded, and the operation immediately stops. |

⊙ : Check valid

○ : Check is not made when the feed current value is not updated (Refer to [Pr.21]) at the setting of "feed current value" in "[Pr.14] Software stroke limit selection" during speed control.

— : Check not carried out (check invalid).

△ : Valid only when "0: valid" is set in the "[Pr.15] Software stroke limit valid/invalid setting".

*1: The value in "[Md.20] Feed current value" will differ according to the "[Pr.21] Feed current value during speed control" setting.

*2: When the unit is "degree", check is not made during speed control.

*3: When the unit is "degree", check is not carried out.

[4] Precautions during software stroke limit check

- (1) A machine HPR must be executed beforehand for the "software stroke limit function" to function properly.
- (2) During interpolation control, a stroke limit check is carried out for the every current value of both the reference axis and the interpolation axis. Every axis will not start if an error occurs, even if it only occurs in one axis.
- (3) During circular interpolation control, the "[Pr.12] Software stroke limit upper limit value"/"[Pr.13] Software stroke limit lower limit value" may be exceeded. In this case, a deceleration stop will not be carried out even if the stroke limit is exceeded. Always install an external limit switch if there is a possibility the stroke limit will be exceeded.

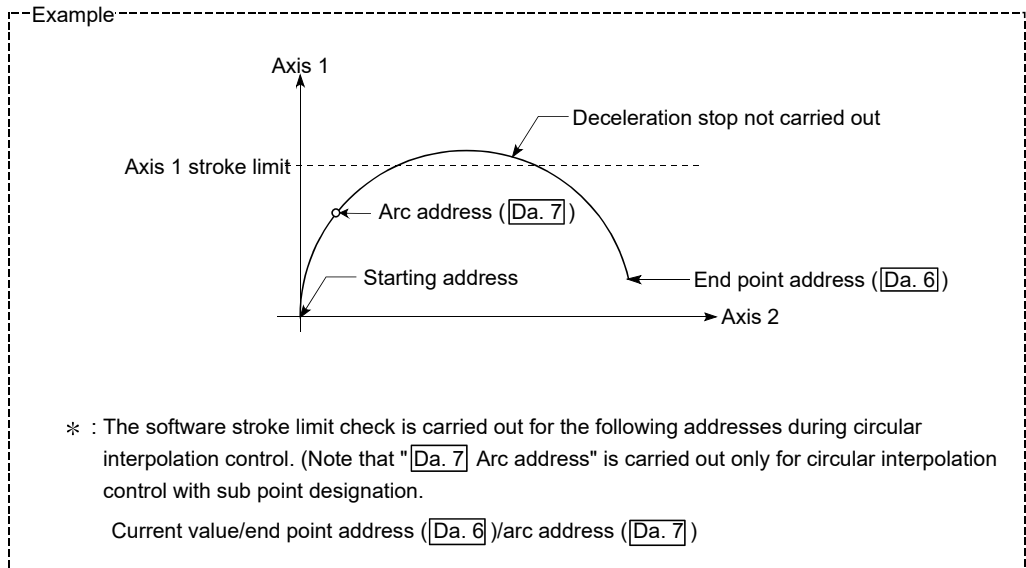

- (4) If an error is detected during continuous path control, the axis stops immediately on completion of execution of the positioning data located right before the positioning data in error.

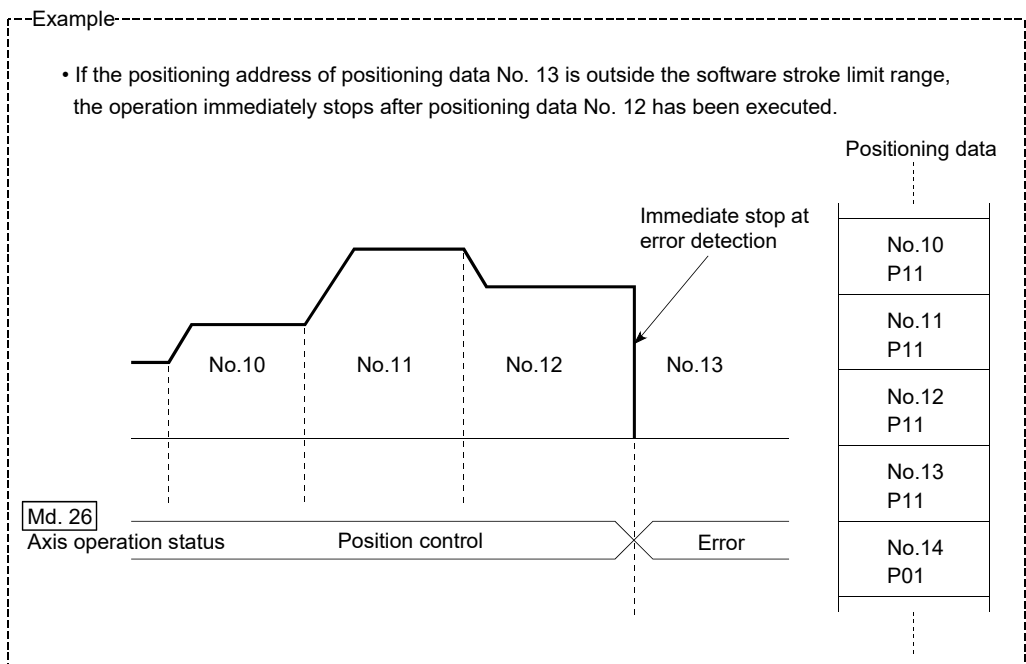

- (5) During simultaneous start, a stroke limit check is carried out for the current values of every axis to be started. Every axis will not start if an error occurs, even if it only occurs in one axis.

[5] Setting the software stroke limit function

To use the "software stroke limit function", set the required values in the parameters shown in the following table, and write them to the Simple Motion module.

The set details are validated at the rising edge (OFF → ON) of the PLC READY signal [Y0].

| Setting item | | Setting value | Setting details | Factory-set initial value |
|--------------|---|---------------|---|---------------------------|
| [Pr.12] | Software stroke limit upper limit value | → | Set the upper limit value of the moveable range. | 2147483647 |
| [Pr.13] | Software stroke limit lower limit value | → | Set the lower limit value of the moveable range. | -2147483648 |
| [Pr.14] | Software stroke limit selection | → | Set whether to use the "[Md.20] Feed current value" or "[Md.21] Feed machine value" as the "current value". | 0: Feed current value |
| [Pr.15] | Software stroke limit valid/invalid setting | 0:Valid | Set whether the software stroke limit is validated or invalidated during manual control (JOG operation, Inching operation, manual pulse generator operation). | 0: Valid |

*: Refer to Section 5.2 "List of parameters" for setting details.

[6] Invalidating the software stroke limit

To invalidate the software stroke limit, set the following parameters as shown, and write them to the Simple Motion module. (Set the value within the setting range.)

$$\boxed{\begin{array}{|l|l|} \hline \text{[Pr.12]} & \text{Software stroke limit upper limit value} \\ \hline \end{array}} = \boxed{\begin{array}{|l|l|} \hline \text{[Pr.13]} & \text{Software stroke limit lower limit value} \\ \hline \end{array}}$$

(To invalidate only the manual operation, set "1: software stroke limit invalid" in the "[Pr.15] Software stroke limit valid/invalid setting".)

The set details are validated at the rising edge (OFF → ON) of the PLC READY signal [Y0].

When the unit is "degree", the software stroke limit check is not performed during speed control (including speed control in speed-position switching control or position-speed switching control) or during manual control, independently of the values set in [Pr.12], [Pr.13] and [Pr.15].

REMARK

- Parameters are set for each axis.
- It is recommended that the parameters be set whenever possible with GX Works2. Execution by sequence program uses many sequence programs and devices. The execution becomes complicated, and the scan times will increase.

[7] Setting when the control unit is "degree"

■ Current value address

The "[Md.20] Feed current value" address is a ring address between 0 and 359.99999° .

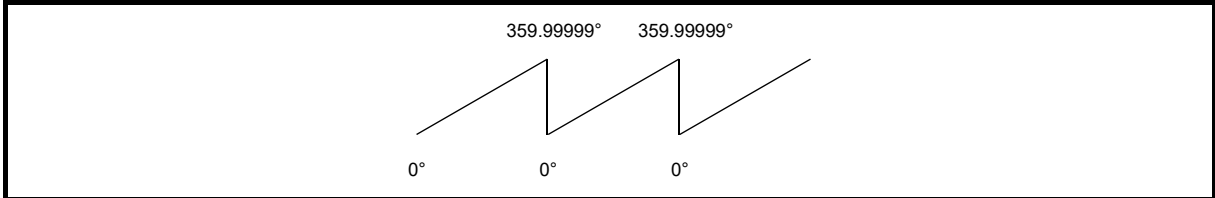

Fig. 13.15 Current value address when the control unit is "degree".

■ Setting the software stroke limit

The upper limit value/lower limit value of the software stroke limit is a value between 0 and 359.99999° .

(1) Setting when the software stroke limit is to be validated.

When the software stroke limit is to be validated, set the upper limit value in a clockwise direction from the lower limit value.

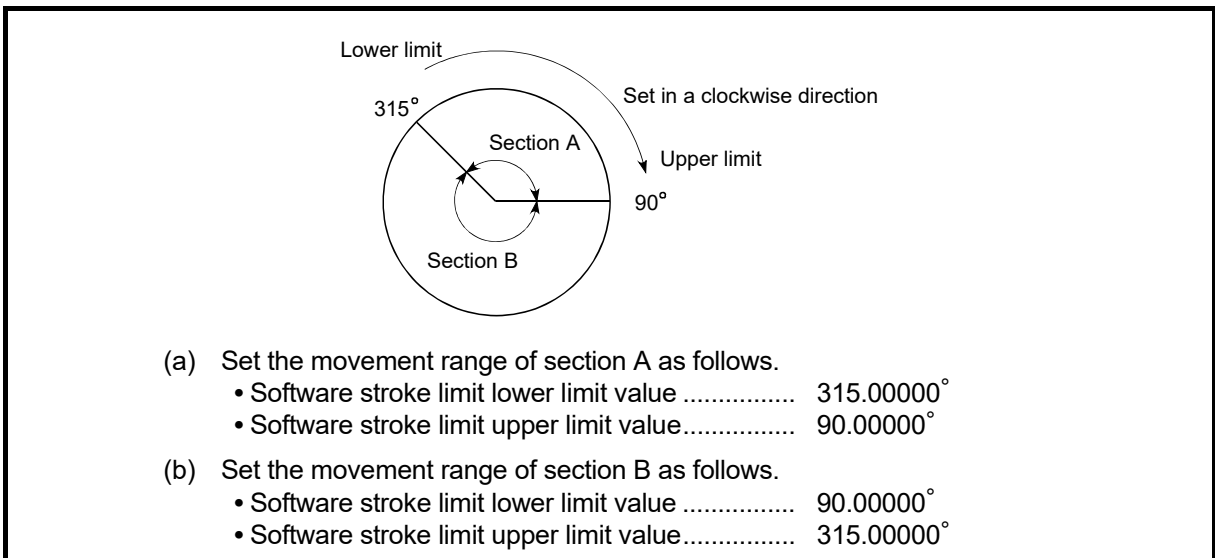

Fig. 13.16 Software stroke limit when the control unit is "degree"

13.4.4 Hardware stroke limit function

 **DANGER**

- When the hardware stroke limit is required to be wired, ensure to wire it in the negative logic using b-contact. If it is set in positive logic using a-contact, a serious accident may occur.

In the "hardware stroke limit function", limit switches are set at the upper/lower limit of the physical moveable range, and the control is stopped (by deceleration stop) by the input of a signal from the limit switch. Damage to the machine can be prevented by stopping the control before the upper/lower limit of the physical moveable range is reached.

The hardware stroke limit is able to use the following signals. (Refer to the "[Pr.80] External input signal selection".)

- External input signal of servo amplifier
- External input signal via CPU (buffer memory of QD77GF)

The details shown below explain about the "hardware stroke limit function".

[1] Control details

[2] Wiring the hardware stroke limit

[3] Precautions during control

[4] When the hardware stroke limit function is not used

[1] Control details

The following drawing shows the operation of the hardware stroke limit function.

(1) External input signal of servo amplifier

For the operation when the servo amplifier stroke limit is detected, confirm the specifications of the servo amplifier to be used. The following shows the case of MR-J4-GF use.

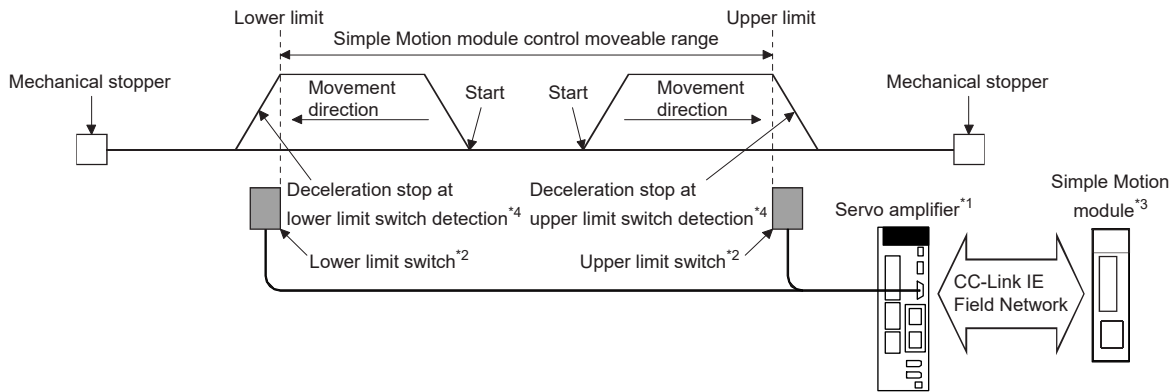

- *1: Set the following servo parameters properly. (Refer to "[5] Servo parameter setting" for details.)
 - Set "0: Input from servo amplifier" to "Sensor input type selection" of the servo parameter "Function selection D-4 (PD41)".
 - Set "1: Enabled only for home position return mode" to "Stroke limit enabling condition selection" of the servo parameter "Function selection D-4 (PD41)".
 - Assign the LSP/LSN signal with the servo parameter "Input device selection 1 to 3 (PD03 to 05)".
- *2: The signal to be wired differs by the servo parameter "Rotation direction selection/travel direction selection (PA14)".

| Setting value of "Rotation direction selection/travel direction selection (PA14)" | Signal name of servo amplifier | |
|---|--------------------------------|-------------|
| | Lower limit | Upper limit |
| 0: Forward rotation (CCW) with the increase of the positioning address | LSN | LSP |
| 1: Reverse rotation (CW) with the increase of the positioning address | LSP | LSN |

- *3: Set the same value in "[Pr.22] Input signal logic selection" as the value set in the input logic setting of the servo amplifier. For the input logic specification of the servo amplifier, refer to the instruction manual of the servo amplifier to be used.
- *4: The Simple Motion module executes the stop process.

(2) External input signal via CPU (buffer memory of QD77GF)

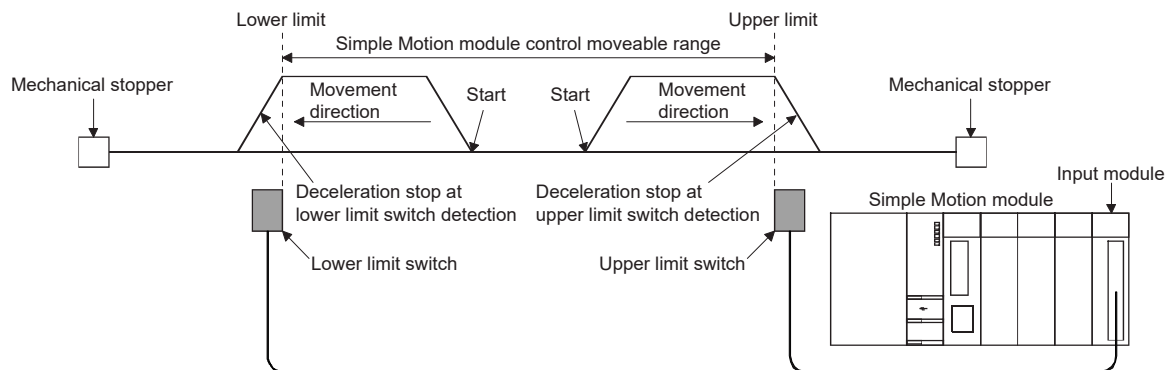

Set the servo parameter properly. (Refer to "[5] Servo parameter setting" for details.)

Fig. 13.17 Hardware stroke limit function operation

[2] Wiring the hardware stroke limit

Refer to the instruction manual of the servo amplifier to be used for details on input and wiring of the signal.

When using MR-J4-GF, execute the parameter setting and wiring related to the LSP/LSN signal. (Refer to "[1] Control details".)

When using the hardware stroke limit function, wire the terminals of the servo amplifier upper/lower limit stroke limit as shown in the following drawing. As for the 24VDC power supply, the direction of current can be switched.

(When "[Pr.22] Input signal logic selection" is set to the initial value)

When using the hardware stroke limit function with the external input signal via CPU (buffer memory of QD77GF), wiring differs depending on the input module.

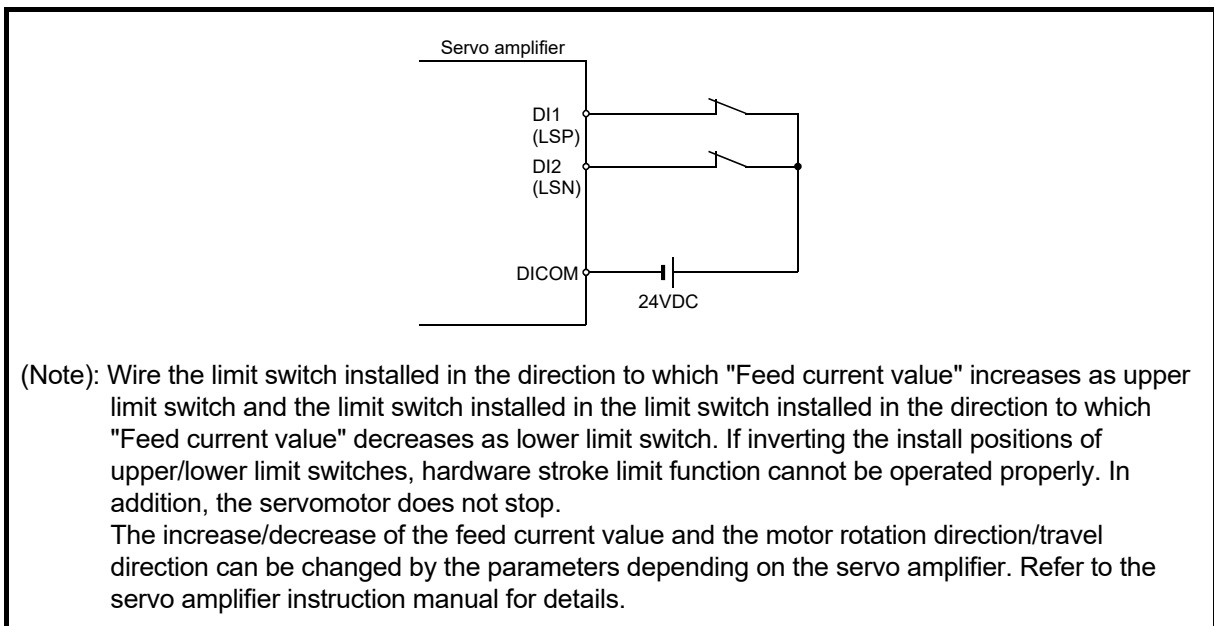

Fig. 13.18 Wiring when using the hardware stroke limit

[3] Precautions during control

- (1) If the machine is stopped outside the Simple Motion module control range (outside the upper/lower limit switches), or if stopped by hardware stroke limit detection, the starting for the "HPR control", "major positioning control", and "high-level positioning control" and the control mode switching cannot be executed. To carry out these types of control again, return the workpiece to the Simple Motion module control range by a "JOG operation", "inching operation" or "manual pulse generator operation".
- (2) When "[Pr.22] Input signal logic selection" is set to the initial value, the Simple Motion module cannot carry out the positioning control if FLS (limit switch for upper limit) is separated from DICOM or RLS (limit switch for lower limit) is separated from DICOM (including when wiring is not carried out).

[4] When the hardware stroke limit function is not used

When not using the hardware stroke limit function, set the logic of FLS and RLS to the "negative logic" (initial value) with "[Pr.22] Input signal logic selection" and input the signal which always turns ON. Otherwise, set the logic of FLS and RLS to the "positive logic" with "[Pr.22] Input signal logic selection" and always turn OFF the input.

[5] Servo parameter setting [CiA402 mode]

Set "Sensor input type selection" of the servo parameter "Function selection D-4 (PD41)" properly at MR-J4-GF use. Otherwise, the stroke limit signal cannot be released. The operation at stroke limit detection according to each setting is as follows.

| Control details | Controller setting [Pr.80] External input signal selection | Servo parameter setting Sensor input type selection of Function selection D-4 (PD41) | Actual signal input | Stop process |
|-------------------|---|--|---------------------|-----------------|
| Other than HPR | 1: External input signal of servo amplifier | 0: Input from servo amplifier | Servo amplifier | _ *1 |
| | | | | Controller *3 |
| | 2: Buffer memory of QD77GF | 1: Input from controller | Servo amplifier | _ *1 |
| | | 0: Input from servo amplifier | Servo amplifier | _ *1 |
| | | | Controller | _ *1 |
| | | 1: Input from controller | Servo amplifier | _ *2 |
| Controller | Controller | | | |
| HPR | 1: External input signal of servo amplifier | 0: Input from servo amplifier | Servo amplifier | Servo amplifier |
| | | 1: Input from controller | Servo amplifier | _ *1 |
| | 2: Buffer memory of QD77GF | 0: Input from servo amplifier | Servo amplifier | _ *1 |
| | | | Controller | _ *1 |
| | | 1: Input from controller | Servo amplifier | _ *2 |
| | | | Controller | Servo amplifier |

*1 : The error "Servo parameter PD41 setting error" (error code: 1005) occurs. The cyclic transmission is not performed.

*2 : The stroke limit signal cannot be released.

*3 : When "1: Enabled only for HPR mode" is set to "Stroke limit enabling condition selection" of the servo parameter "Function selection D-4 (PD41)"

POINT

The consistency between "[Pr.80] External input signal selection" and the servo parameter "Function selection D-4 (PD41)" is checked at the start of connection with the servo amplifier. At the diagnostic error, the error "Servo parameter PD41 setting error" (error code: 1005) occurs and the cyclic transmission with the servo amplifier of the target axis is not performed.

13.4.5 Forced stop function

⚠ DANGER

- When the forced stop is required to be wired, ensure to wire it in the negative logic using b-contact.
- Provided safety circuit outside the Simple Motion module so that the entire system will operate safety even when the "[Pr.82] Forced stop valid/invalid selection" is set "1: Invalid". Be sure to use the forced stop signal (EMI) of the servo amplifier.

This function stops all axes of the servo amplifier with the forced stop signal. (The initial value is "0: Valid (External input signal)".)

The forced stop input valid/invalid is selected by "[Pr.82] Forced stop valid/invalid selection".

The details shown below explain about the "forced stop function".

- [1] Control details
- [2] Wiring the forced stop
- [3] Setting the forced stop
- [4] How to check the forced stop
- [5] Precautions during control

[1] Control details

When the "[Pr.82] Forced stop valid/invalid selection" is set to other than "1: Invalid", the forced stop signal is sent to all axes after the forced stop input signal is turned on. Refer to the servo amplifier instruction manual for the operation of the servo amplifier after the forced stop signal is sent.

The outline of the forced stop process is shown below.

| Stop cause | | Stop axis | M code ON signal after stop | Axis operation status ([Md.26]) after stopping | Stop process | | | | | |
|-------------|--|-----------|-----------------------------|--|---------------------|------------------|---------------------------|--------------------------------|-----------------------|----------------------------------|
| | | | | | HPR control | | Major positioning control | High-level positioning control | Manual control | |
| | | | | | Machine HPR control | Fast HPR control | | | JOG/Inching operation | Manual pulse generator operation |
| Forced stop | "Forced stop input signal" OFF from an external device | All axes | No change | Servo OFF | Immediate stop | | | | | — |

The following drawing shows the operation of the forced stop function.

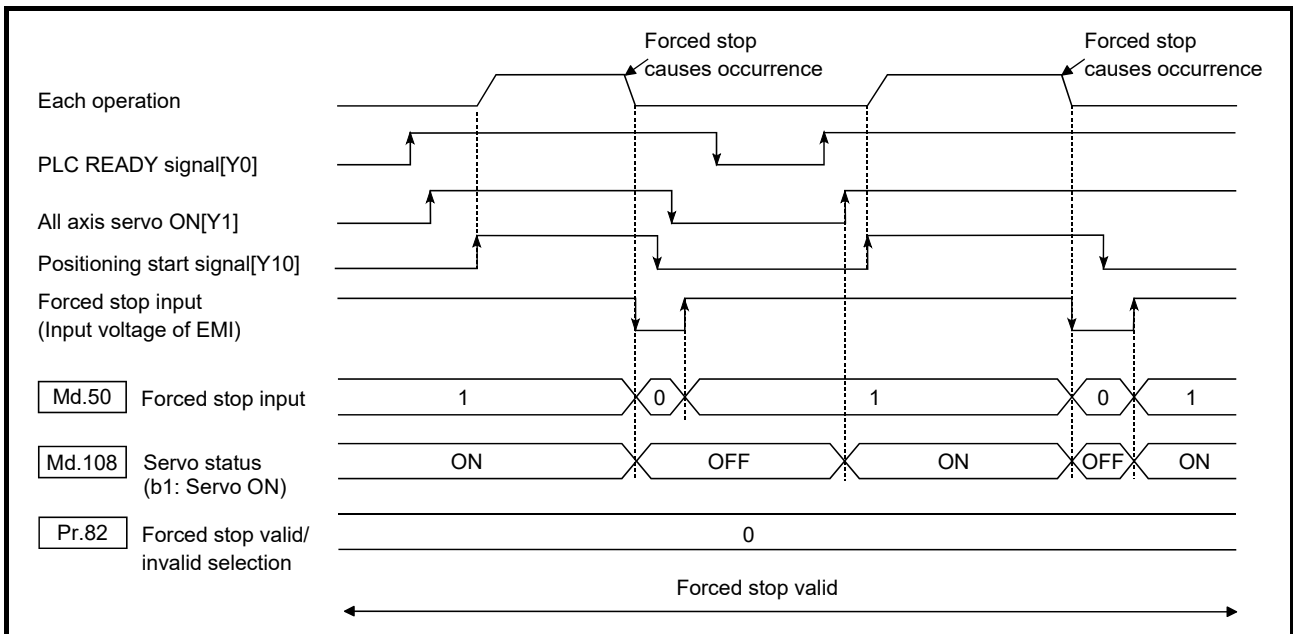

Fig. 13.20 Operation for the forced stop function

[2] Wiring the forced stop

When using the forced stop function, wire the terminals of the Simple Motion module forced stop input as shown in the following drawing. As for the 24VDC power supply, the direction of current can be switched.

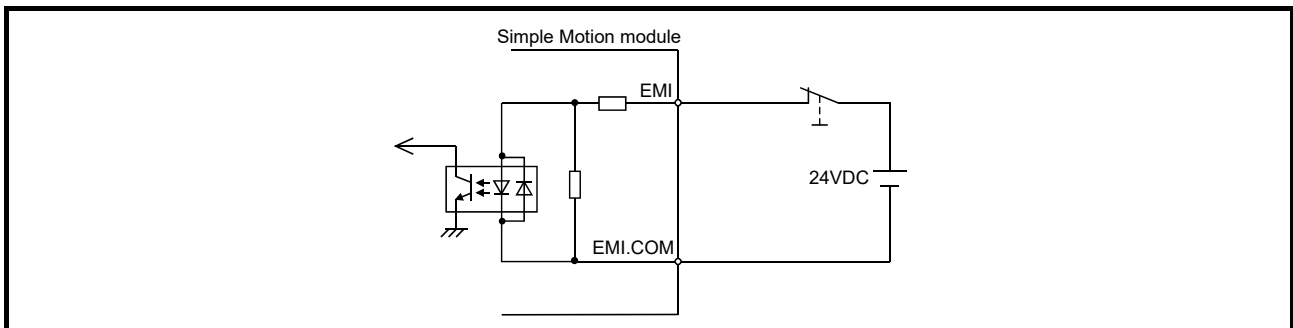

Fig. 13.21 Wiring when using the forced stop

[3] Setting the forced stop

To use the "Forced stop function", set the following data using a sequence program.

"[Pr.82] Forced stop valid/invalid selection" is validated at the rising edge (OFF → ON) of the PLC READY signal [Y0] and the forced stop input checks in the operation cycle.

| Setting item | Setting value | Setting details | Buffer memory address |
|--|---------------|---|-----------------------|
| [Pr.82] Forced stop valid/ invalid selection | → | Set the forced stop function. 0: Valid (External input signal)Forced stop is used 1: Invalid.....Forced stop is not used | 35 |

*: Refer to Section 5.2.3 "Detailed parameters 1" for details on the setting details.

[4] How to check the forced stop

To use the states (ON/OFF) of forced stop input, set the parameters shown in the following table.

| Monitor item | Monitor value | Storage details | Buffer memory address |
|---------------------------|---------------|---|-----------------------|
| [Md.50] Forced stop input | → | Stores the states (ON/OFF) of forced stop input. 0: Forced stop input ON (Forced stop) 1: Forced stop input OFF (Forced stop release) | 4231 |

*: Refer to Section 5.6.1 "System monitor data" for details on the storage details.

[5] Precautions during control

- (1) After the "Forced stop input" is released, the servo ON/OFF is valid for the status of all axis servo ON [Y1].
- (2) If the setting value of "[Pr.82] Forced stop valid/invalid selection" is outside the range, the error "Forced stop valid/invalid setting error" (error code: 937) occurs.
- (3) The "[Md.50] Forced stop input" is stored "1" by setting "[Pr.82] Forced stop valid/invalid selection" to "1: invalid".
- (4) When the "Forced stop input" is turned ON during operation, the error "Servo READY signal OFF during operation" (error code: 102) will not occur.
- (5) Errors cannot be cleared by "[Cd.5] Axis error reset" during forced stop. Clear errors after forced stop is released. [CiA402 mode]

13.5 Functions to change the control details

Functions to change the control details include the "speed change function", "override function", "acceleration/deceleration time change function", "torque change function" and "target position change function". Each function is executed by parameter setting or sequence program creation and writing.

Refer to Section 3.2.5 "Combination of QD77GF main functions and sub functions" for combination with main function.

Both the "speed change function" or "override function" change the speed, but the differences between the functions are shown below. Use the function that corresponds to the application.

"Speed change function"

- The speed is changed at any time, only in the control being executed.
- The new speed is directly set.

"Override function"

- The speed is changed for all control to be executed.
- The new speed is set as a percent (%) of the command speed.

| |
|--|
| POINT |
| "Speed change function" and "Override function" cannot be used in the manual pulse generator operation and speed-torque control. |

13.5.1 Speed change function

The speed control function is used to change the speed during control to a newly designated speed at any time.

The new speed is directly set in the buffer memory, and the speed is changed by a speed change command ([Cd.15] Speed change request) or external command signal. During the machine HPR, a speed change to the creep speed cannot be carried out after deceleration start because the proximity dog ON is detected. When the speed change function is enabled and the speed is slower than the creep speed, the speed change is disabled and the speed accelerates to the creep speed after the proximity dog ON is detected.

The details shown below explain about the "speed change function".

[1] Control details

[2] Precautions during control

[3] Setting the speed change function from the PLC CPU

[4] Setting the speed change function using an external command signal

[1] Control details

The following drawing shows the operation during a speed change.

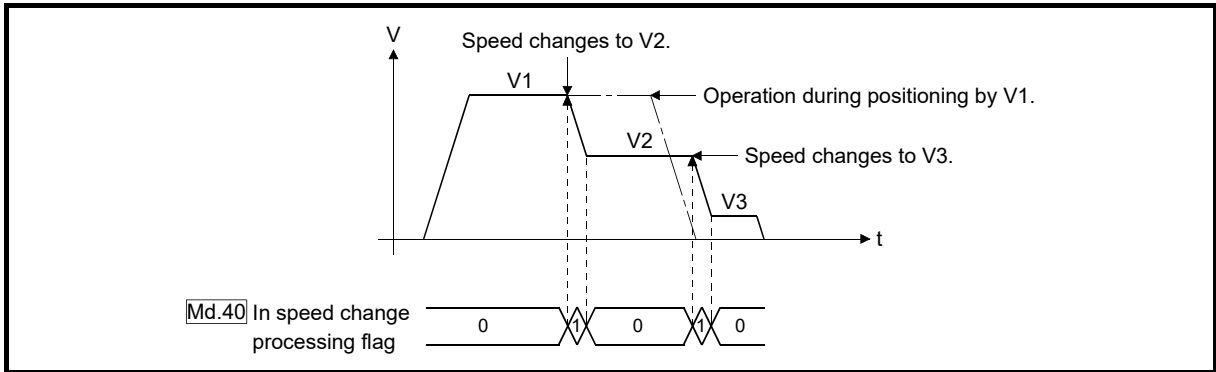

Fig. 13.22 Speed change operation

[2] Precautions during control

(1) Control is carried out as follows at the speed change during continuous path control.

- a) When no speed designation (current speed) is provided in the next positioning data:
 - The next positioning data is controlled at the "[Cd.14] New speed value".
- b) When a speed designation is provided in the next positioning data:
 - The next positioning data is controlled at its "[Da.8] Command speed".

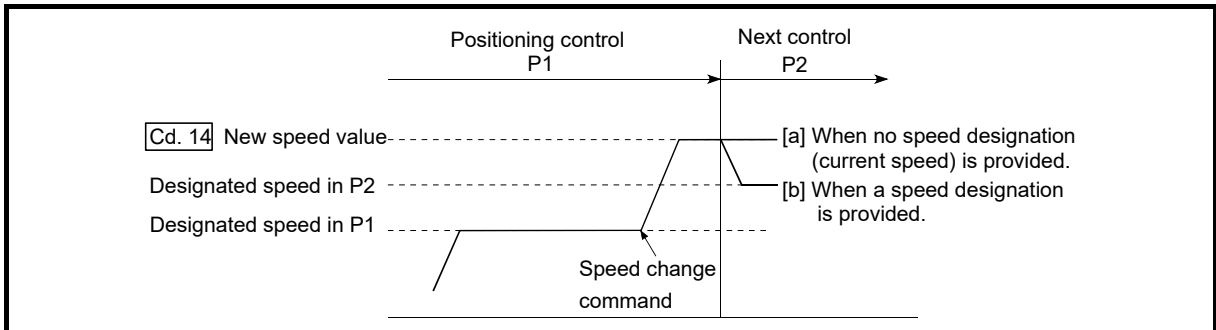

Fig. 13.23 Speed change during continuous path control

(2) When changing the speed during continuous path control, the speed change will be ignored if there is not enough distance remaining to carry out the change.

- (3) When the stop command was given to make a stop after a speed change that had been made during position control, the restarting speed depends on the "[Cd.14] New speed value".

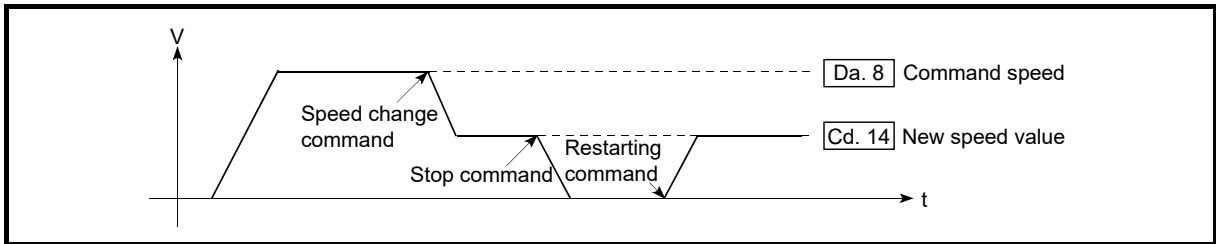

Fig. 13.24 Restarting speed after speed change made during position control

- (4) When the speed is changed by setting "[Cd.14] New speed value" to "0", the operation is carried out as follows.
- When "[Cd.15] Speed change request" is turned ON, the speed change 0 flag ([Md.31] Status: b10) turns ON.
(During interpolation control, the speed change 0 flag on the reference axis side turns ON.)
 - The axis stops, but "[Md.26] Axis operation status" does not change, and the BUSY signal remains ON. (If a stop signal is input, the BUSY signal will turn OFF, and "[Md.26] Axis operation status" will change to "stopped".)

In this case, setting the "[Cd.14] New speed value" to a value besides "0" will turn OFF the speed change 0 flag ([Md.31] Status: b10), and enable continued operation.

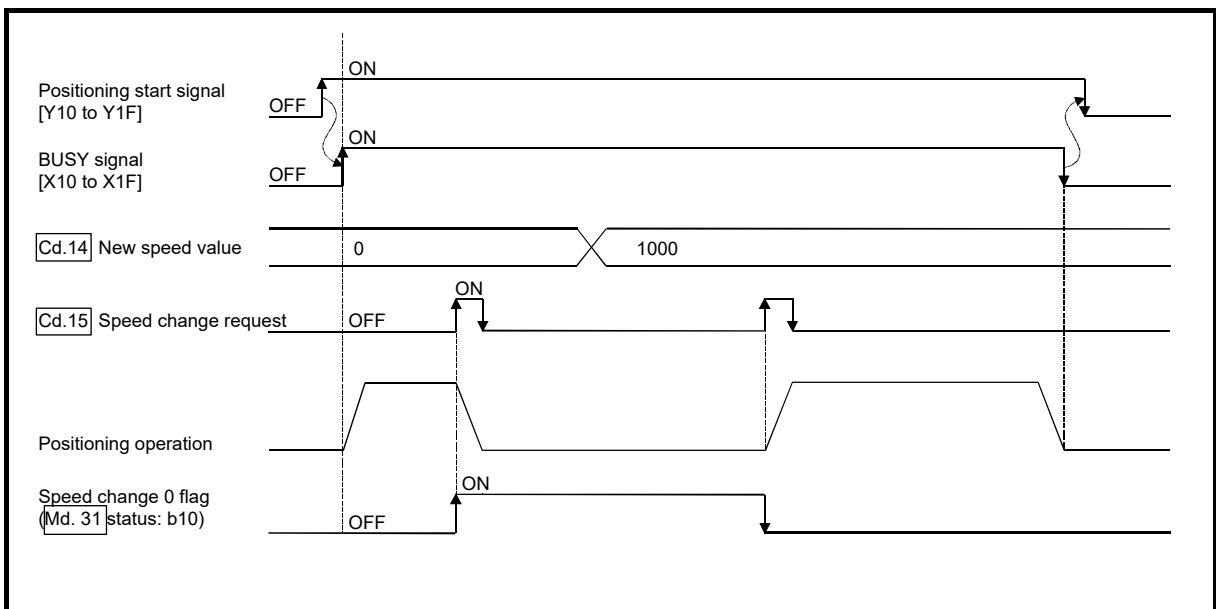

Fig. 13.25 Speed change at new speed value "0"

- (5) The warning "Deceleration/stop speed change" (warning code: 500) occurs and the speed cannot be changed in the following cases.
 - During deceleration by a stop command
 - During automatic deceleration during positioning control
- (6) The warning "Speed limit value over" (warning code: 501) occurs and the speed is controlled at the "[Pr.8] Speed limit value" when the value set in "[Cd.14] New speed value" is larger than the "[Pr.8] Speed limit value".
- (7) When the speed is changed during interpolation control, the required speed is set in the reference axis.
- (8) When carrying out consecutive speed changes, be sure there is an interval between the speed changes of 100ms or more.
(If the interval between speed changes is short, the Simple Motion module will not be able to track, and it may become impossible to carry out commands correctly.)
- (9) When a speed change is requested simultaneously for multiple axes, change the speed one by one.
Therefore, the start timing of speed change is different for each axis.
- (10) Speed change cannot be carried out during the machine HPR. A request for speed change is ignored.
- (11) When deceleration is started by the speed change function, the deceleration start flag does not turn ON.
- (12) The speed change function cannot be used during speed control mode or torque control mode. Refer to Section 12.1 "Speed-torque control" for the speed change during speed control mode.

[3] Setting the speed change function from the PLC CPU

The following shows the data settings and sequence program example for changing the control speed of axis 1 from the PLC CPU. (In this example, the control speed is changed to "20.00mm/min".)

- (1) Set the following data.
(Use the speed change time chart shown in section (2) below as a reference, and set using the sequence program shown in section (3).)

| Setting item | | Setting value | Setting details | Buffer memory address |
|--------------|----------------------|---------------|----------------------------|------------------------|
| [Cd.14] | New speed value | 2000 | Set the new speed. | 4314+100n 4315+100n |
| [Cd.15] | Speed change request | 1 | Set "1: Change the speed". | 4316+100n |

n: Axis No.-1

*: Refer to Section 5.7 "List of control data" for details on the setting details.

(2) The following shows the speed change time chart.

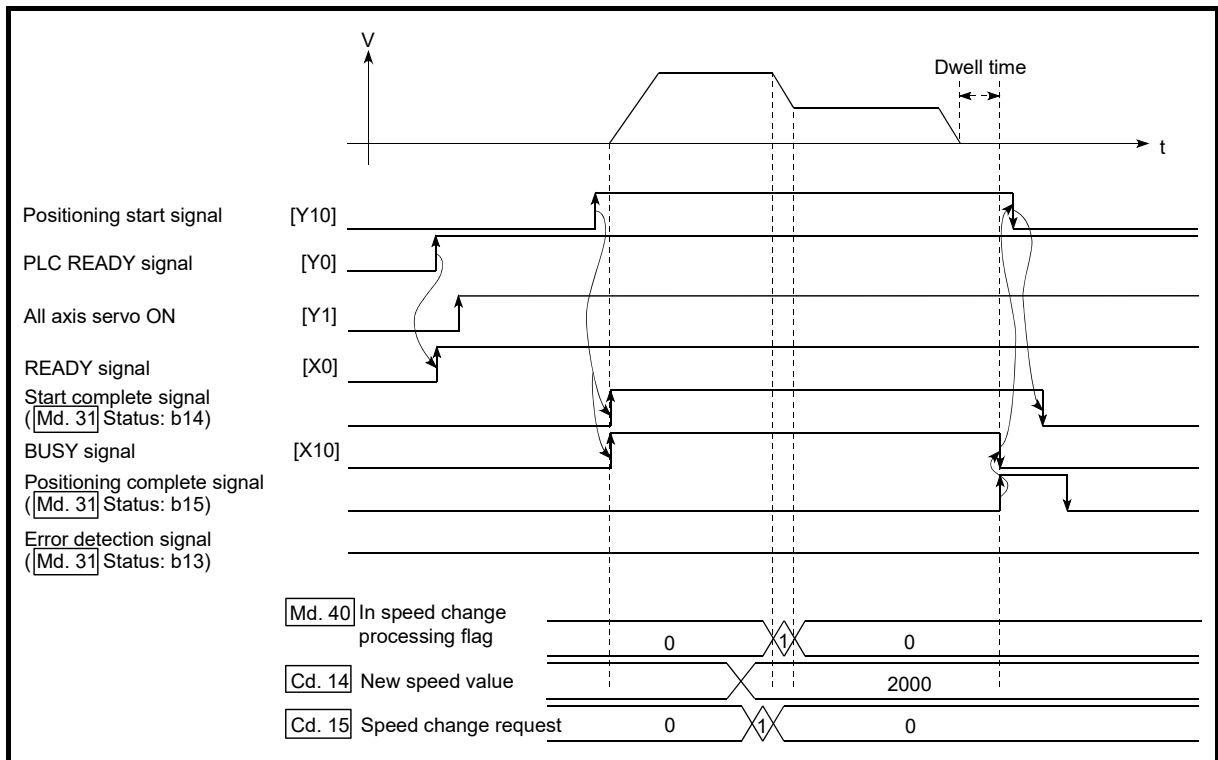
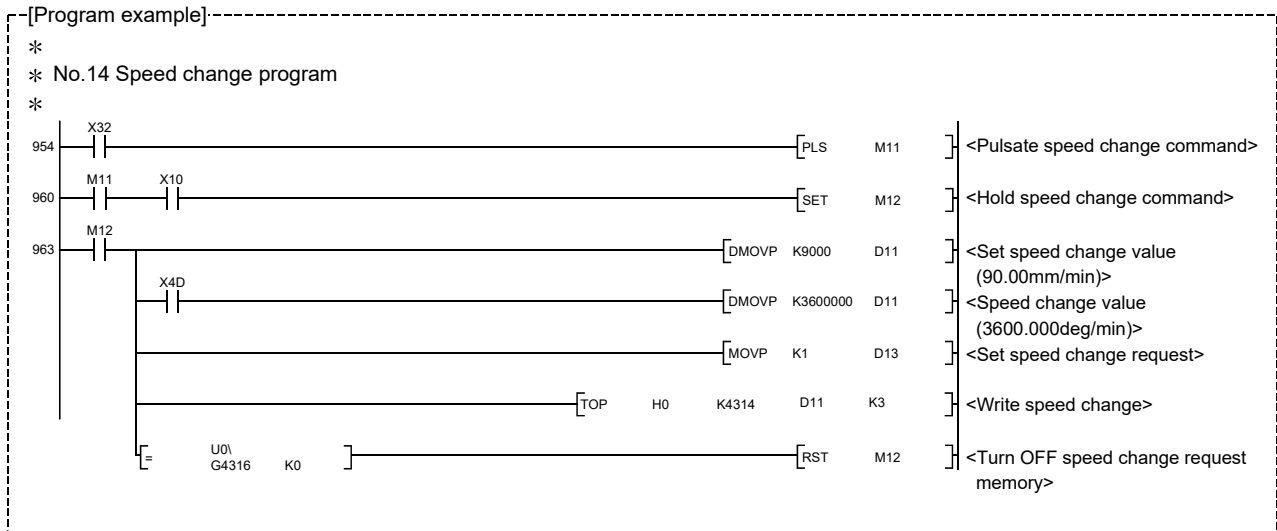

Fig. 13.26 Time chart for changing the speed from the PLC CPU

(3) Add the following sequence program to the control program, and write it to the PLC CPU.



[4] Setting the speed change function using an external command signal

The speed can also be changed using an "external command signal".

The following shows the data settings and sequence program example for changing the control speed of axis 1 using an "external command signal". (In this example, the control speed is changed to "10000.00mm/min".)

- (1) Set the following data to change the speed using an external command signal.
(Use the speed change time chart shown in section (2) below as a reference, and set using the sequence program shown in section (3).)

| Setting item | Setting value | Setting details | Buffer memory address |
|---|---------------|--|------------------------|
| [Pr.42] External command function selection | 1 | Set "1: External speed change request". | 62+150n |
| [Cd.8] External command valid | 1 | Set "1: Validates an external command.". | 4305+100n |
| [Cd.14] New speed value | 1000000 | Set the new speed. | 4314+100n 4315+100n |

n: Axis No.-1

※: Set the external command signal (DI) to be used in "[Pr.95] External command signal selection".
Refer to Section 5.2 "List of parameters" and Section 5.7 "List of control data" for details on the setting details.

(2) The following shows the speed change time chart.

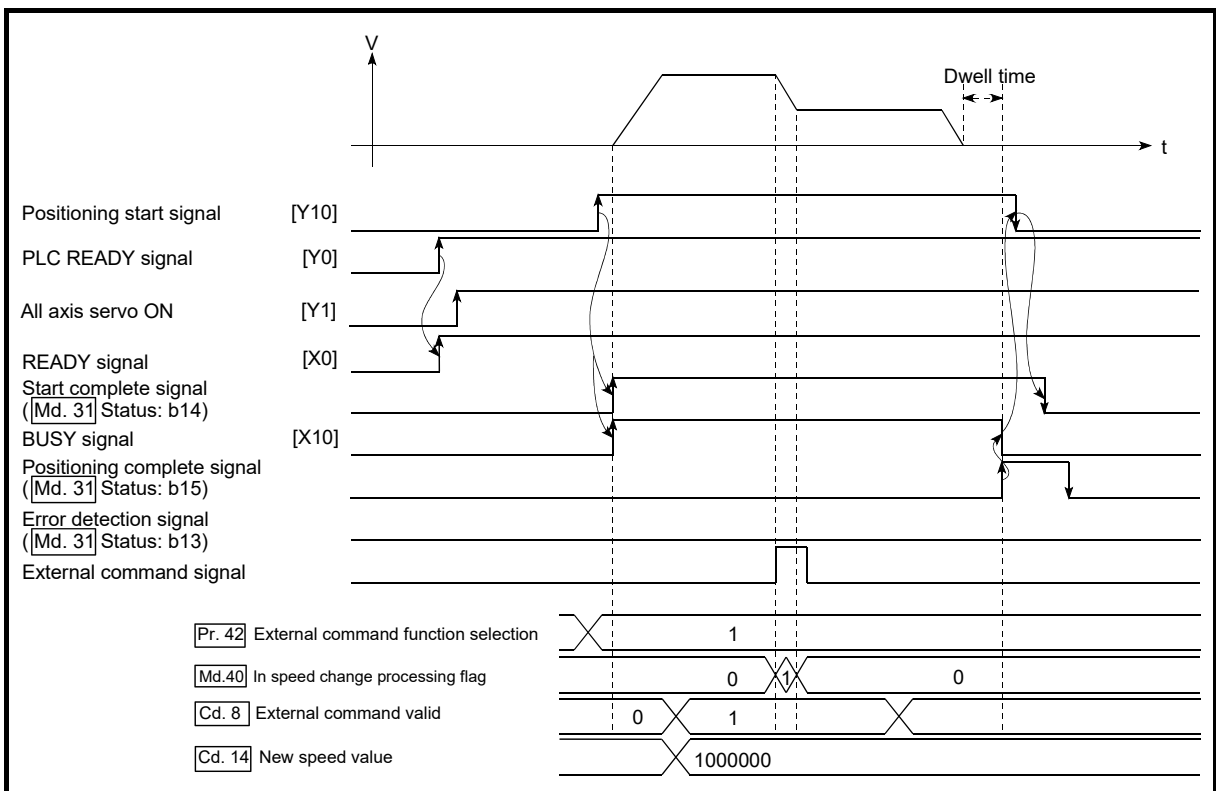
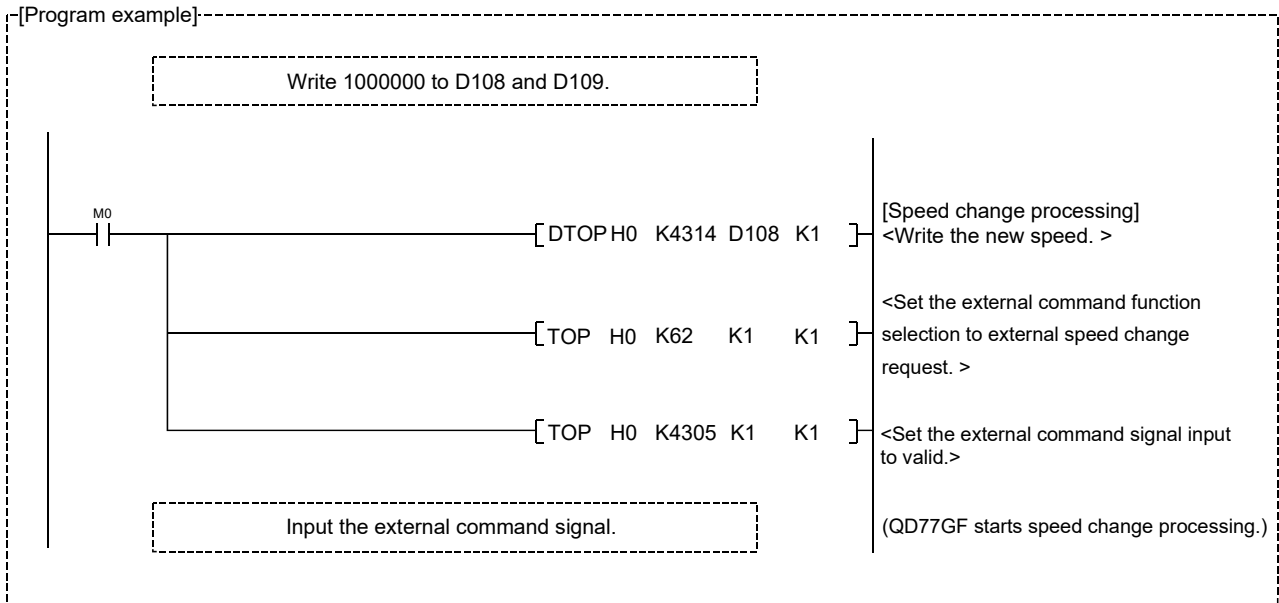

Fig. 13.27 Time chart for changing the speed using an external command signal

- (3) Add the following sequence program to the control program, and write it to the PLC CPU.



13.5.2 Override function

The override function changes the command speed by a designated percentage (1 to 300%) for all control to be executed.

The speed can be changed by setting the percentage (%) by which the speed is changed in "[Cd.13] Positioning operation speed override".

- [1] Control details
- [2] Precautions during control
- [3] Setting the override function

[1] Control details

The following shows that operation of the override function.

- 1) A value changed by the override function is monitored by "[Md.22] Feedrate".
- 2) If "[Cd.13] Positioning operation speed override" is set to 100 %, the speed will not change.
- 3) If "[Cd.13] Positioning operation speed override" is set with a value less than "100 (%)" and "[Md.22] Feedrate" is less than "1", the warning "Less than minimum speed" (warning code: 110) occurs and "[Md.22] Feedrate" is set with "1" in any speed unit.
- 4) If there is not enough remaining distance to change the speed due to the "override function", when the speed is changed during the position control of speed-position switching control or position-speed switching control, the operation will be carried out at the speed that could be changed.
- 5) If the speed changed by the override function is greater than the "[Pr.8] Speed limit value", the warning "Speed limit value over" (warning code: 501) will occur and the speed will be controlled at the "[Pr.8] Speed limit value". The "[Md.39] In speed limit flag" will turn ON.

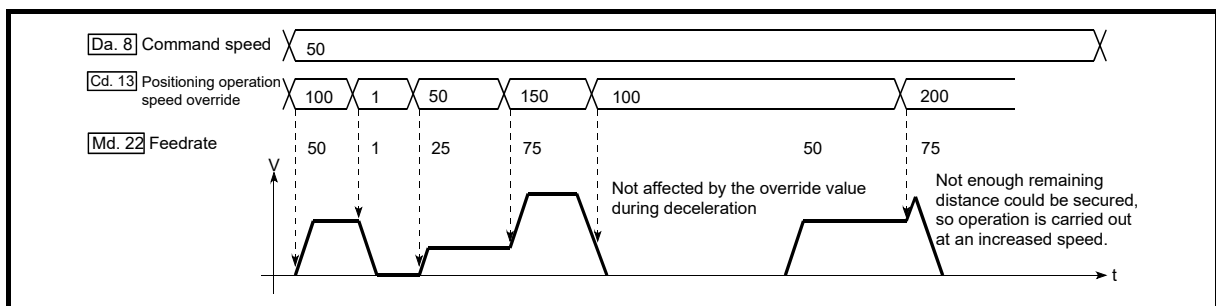

Fig. 13.28 Override function operation

[2] Precaution during control

- (1) When changing the speed by the override function during continuous path control, the speed change will be ignored if there is not enough distance remaining to carry out the change.
- (2) The warning "Deceleration/stop speed change" (warning code: 500) occurs and the speed cannot be changed by the override function in the following cases.
(The value set in "[Cd.13] Positioning operation speed override" is validated after a deceleration stop.)
 - During deceleration by a stop command
 - During automatic deceleration during positioning control
- (3) When the speed is changed by the override function during interpolation control, the required speed is set in the reference axis.
- (4) When carrying out consecutive speed changes by the override function, be sure there is an interval between the speed changes of 100ms or more. (If the interval between speed changes is short, the Simple Motion module will not be able to track, and it may become impossible to carry out commands correctly.)
- (5) When a machine HPR is performed, the speed change by the override function cannot be carried out after a deceleration start to the creep speed following the detection of proximity dog ON. When the override is enabled during HPR and the speed is changed, the override is disabled and the speed accelerates to the creep speed after the proximity dog ON is detected.
- (6) When deceleration is started by the override function, the deceleration start flag does not turn ON.
- (7) The override function cannot be used during speed control mode or torque control mode.
- (8) The override function cannot be used during the driver HPR. [CiA402 mode]

[3] Setting the override function

The following shows the data settings and sequence program example for setting the override value of axis 1 to "200%".

- (1) Set the following data. (Use the speed change time chart shown in section (2) below as a reference, and set using the sequence program shown in section (3).)

| Setting item | | Setting value | Setting details | Buffer memory address |
|--------------|--------------------------------------|---------------|--|-----------------------|
| [Cd.13] | Positioning operation speed override | 200 | Set the new speed as a percentage (%). | 4313+100n |

n: Axis No.-1

*: Refer to Section 5.7 "List of control data" for details on the setting details.

13.5.3 Acceleration/deceleration time change function

The "acceleration/deceleration time change function" is used to change the acceleration/deceleration time during a speed change to a random value when carrying out the speed change by the "speed change function" and "override function". In a normal speed change (when the acceleration/deceleration time is not changed), the acceleration/deceleration time previously set in the parameters ([Pr.9], [Pr.10], and [Pr.25] to [Pr.30] values) is set in the positioning parameter data items [Da.3] and [Da.4], and control is carried out with that acceleration/deceleration time. However, by setting the new acceleration/deceleration time ([Cd.10], [Cd.11]) in the control data, and issuing an acceleration/deceleration time change enable command ([Cd.12] Acceleration/deceleration time change value during speed change, enable/disable) to change the speed when the acceleration/deceleration time change is enabled, the speed will be changed with the new acceleration/deceleration time ([Cd.10], [Cd.11]).

The details shown below explain about the "acceleration/deceleration time change function".

[1] Control details

[2] Precautions during control

[3] Setting the acceleration/deceleration time change function

[1] Control details

After setting the following two items, carry out the speed change to change the acceleration/deceleration time during the speed change.

- Set change value of the acceleration/deceleration time ("[Cd.10] New acceleration time value", "[Cd.11] New deceleration time value")
- Setting acceleration/deceleration time change to enable ("[Cd.12] Acceleration/deceleration time change value during speed change, enable/disable")

The following drawing shows the operation during an acceleration/deceleration time change.

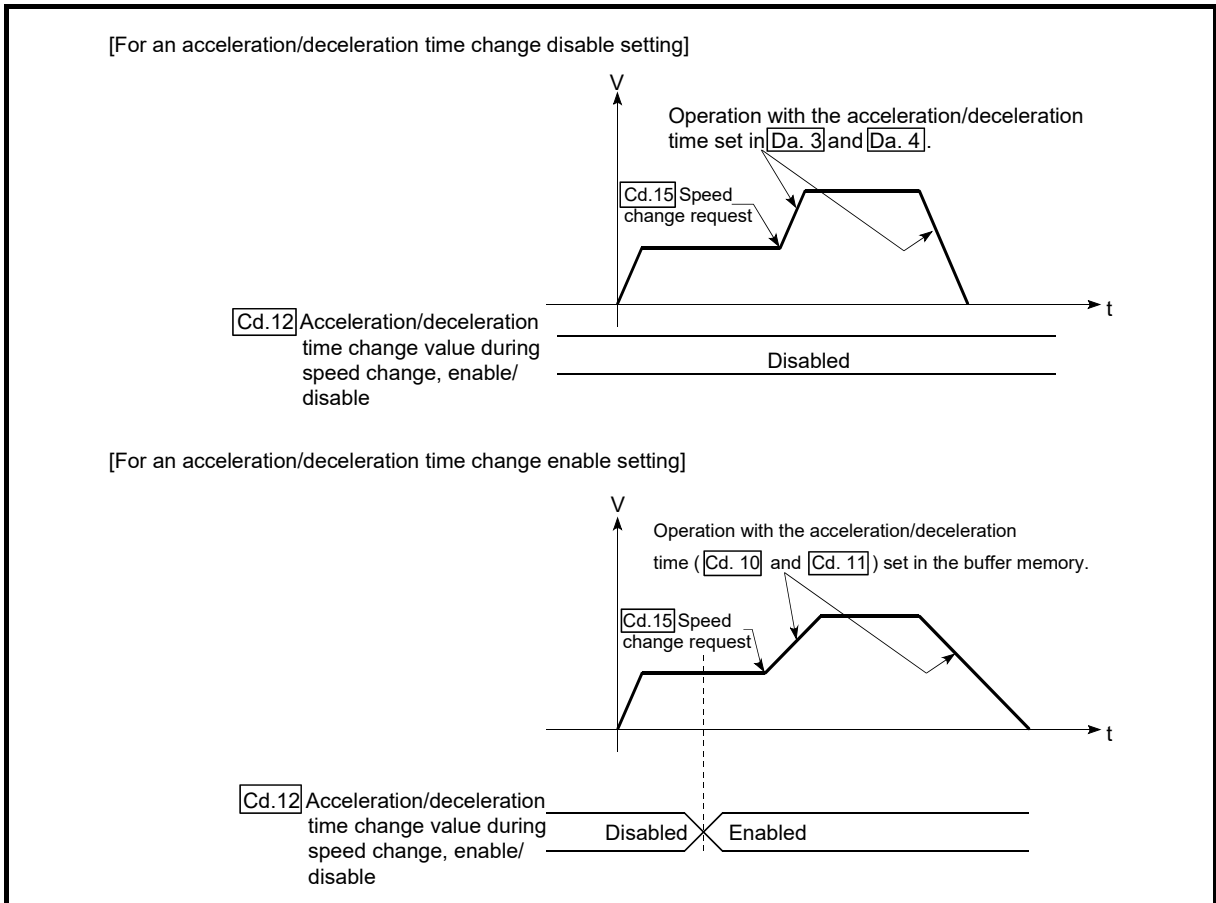
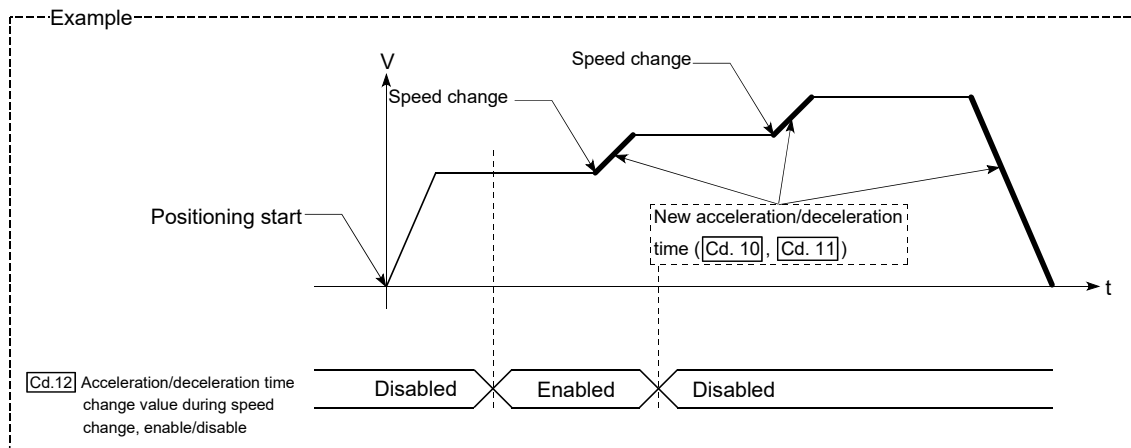

Fig. 13.30 Operation during an acceleration/deceleration time change

[2] Precautions during control

- (1) When "0" is set in "[Cd.10] New acceleration time value" and "[Cd.11] New deceleration time value", the acceleration/deceleration time will not be changed even if the speed is changed. In this case, the operation will be controlled at the acceleration/deceleration time previously set in the parameters.
- (2) The "new acceleration/deceleration time" is valid during execution of the positioning data for which the speed was changed. In continuous positioning control and continuous path control, the speed is changed and control is carried out with the previously set acceleration/deceleration time at the changeover to the next positioning data, even if the acceleration/deceleration time is changed to the "new acceleration/deceleration time ([Cd.10], [Cd.11])".
- (3) Even if the acceleration/deceleration time change is set to disable after the "new acceleration/deceleration time" is validated, the positioning data for which the "new acceleration/deceleration time" was validated will continue to be controlled with that value. (The next positioning data will be controlled with the previously set acceleration/deceleration time.)



- (4) If the "new acceleration/deceleration time" is set to "0" and the speed is changed after the "new acceleration/deceleration time" is validated, the operation will be controlled with the previous "new acceleration/deceleration time".

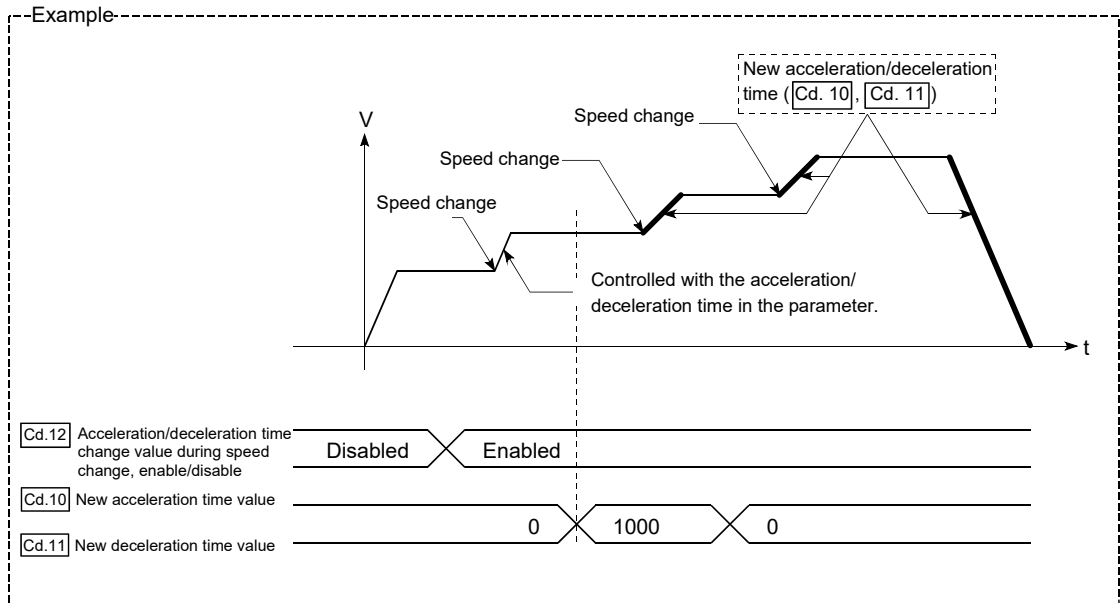

- (5) The acceleration/deceleration change function cannot be used during speed control mode or torque control mode. Refer to Section 12.1 "Speed-torque control" for the acceleration/deceleration processing during speed control mode.

POINT

If the speed is changed when an acceleration/deceleration change is enabled, the "new acceleration/deceleration time" will become the acceleration/deceleration time of the positioning data being executed. The "new acceleration/deceleration time" remains valid until the changeover to the next positioning data. (The automatic deceleration processing at the completion of the positioning will also be controlled by the "new acceleration/deceleration time".)

[3] Setting the acceleration/deceleration time change function

To use the "acceleration/deceleration time change function", write the data shown in the following table to the Simple Motion module using the sequence program.

The set details are validated when a speed change is executed after the details are written to the Simple Motion module.

| Setting item | | Setting value | Setting details | Buffer memory address |
|--------------|--|---------------|--|------------------------|
| [Cd.10] | New acceleration time value | → | Set the new acceleration time. | 4308+100n 4309+100n |
| [Cd.11] | New deceleration time value | → | Set the new deceleration time. | 4310+100n 4311+100n |
| [Cd.12] | Acceleration/ deceleration time change value during speed change, enable/disable | 1 | Set "1: Acceleration/deceleration time change enable". | 4312+100n |

n: Axis No.-1

*: Refer to Section 5.7 "List of control data" for details on the setting details.

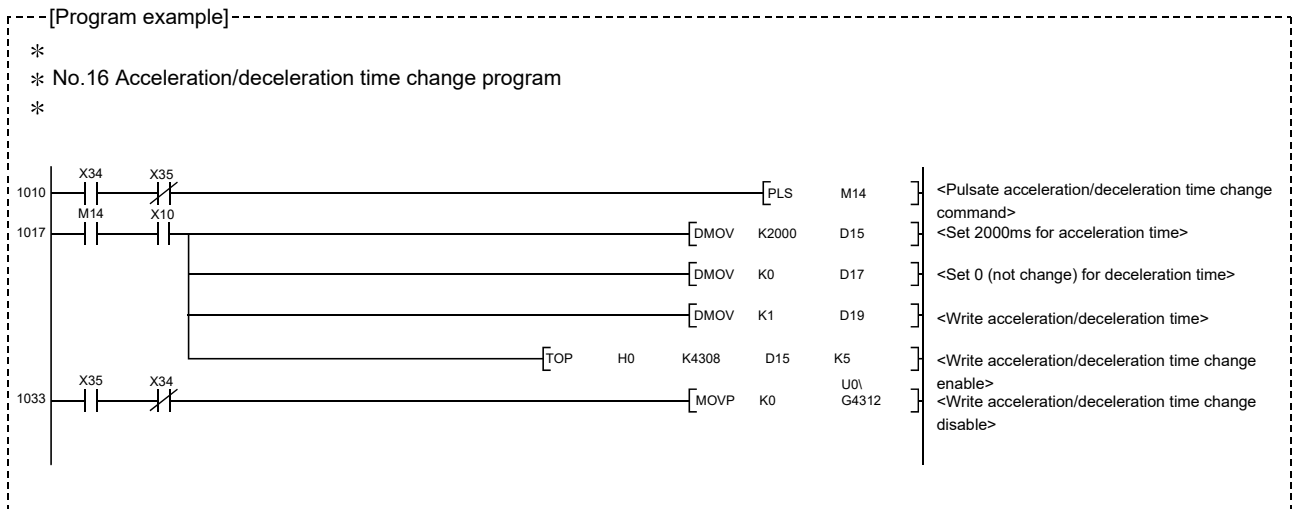

13.5.4 Torque change function

The "torque change function" is used to change the torque limit value during torque limiting.

The torque limit value at the control start is the value set in the "[Pr.17] Torque limit setting value" or "[Cd.101] Torque output setting value".

The following two change methods in the torque change function.

| Torque change function | Details |
|---|---|
| Forward/reverse torque limit value same setting | The forward torque limit value and reverse torque limit value are changed to the same value by the new torque value. (Use this method when they need not be separately set.) |
| Forward/reverse torque limit value individual setting | The forward torque limit value and reverse torque limit value are individually changed respectively by the forward new torque value and new reverse torque value. |

*: Forward torque limit value: The limit value to the generated torque during CW regeneration at the CCW driving of the servo motor.

Reverse torque limit value: The limit value to the generated torque during CCW regeneration at the CW driving of the servo motor.

Set previously "same setting" or "individual setting" of the forward/reverse torque limit value in "[Cd.112] Torque change function switching request". Set the new torque value (forward new torque value or new reverse torque value) in the axis control data ([Cd.22] or [Cd.113]) shown below.

| Torque change function | Setting items | |
|---|--|--|
| | Torque change function switching request ([Cd.112]) | New torque value ([Cd.22], [Cd.113]) |
| Forward/reverse torque limit value same setting | 0: Forward/reverse torque limit value same setting | [Cd.22] New torque value/ forward new torque value |
| | | [Cd.113] Setting invalid |
| Forward/reverse torque limit value individual setting | 1: Forward/reverse torque limit value individual setting | [Cd.22] New torque value/ forward new torque value |
| | | [Cd.113] New reverse torque value |

The details shown below explain about the "torque change function".

[1] Control details

[2] Precautions during control

[3] Setting the torque change function start signal

[1] Control details

The torque value (forward new torque value/new reverse torque value) of the axis control data can be changed at all times. The torque can be limited with a new torque value from the time the new torque value has been written to the Simple Motion module.

Note that the delay time until a torque control is executed is max. operation cycle after torque change value was written.

The torque limiting is not carried out from the time the power supply is turned ON to the time the PLC READY signal [Y0] is turned ON.

The new torque value ([Cd.22], [Cd.113]) is cleared to zero at the leading edge (OFF to ON) of the positioning start signal [Y10], JOG operation start, and synchronous control start.

The torque setting range is from 0 to "[Pr.17] Torque limit setting value".

(When the setting value is 0, a torque change is considered not to be carried out, and it becomes to the value set in "[Pr.17] Torque limit setting value" or "[Cd.101] Torque output setting value".)

The torque change range is 1 to "[Pr.17] Torque limit setting value".

The following drawing shows the operation at the same setting (Figure 13.31) and the operation at the individual setting (Figure 13.32) for the forward new torque value and new reverse torque value.

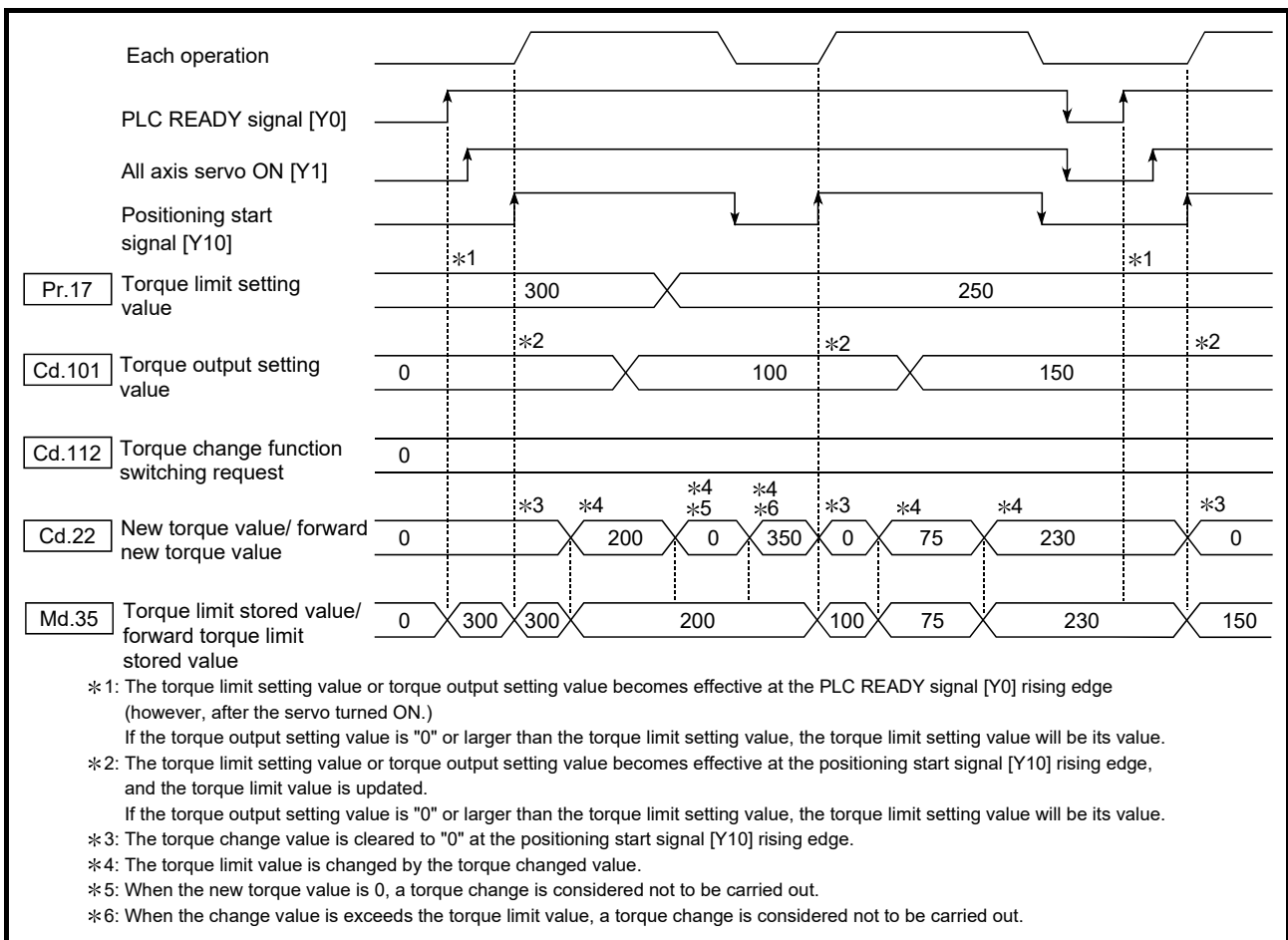

Fig. 13.31 Torque change operation (forward/reverse torque limit value same setting) (Axis 1)

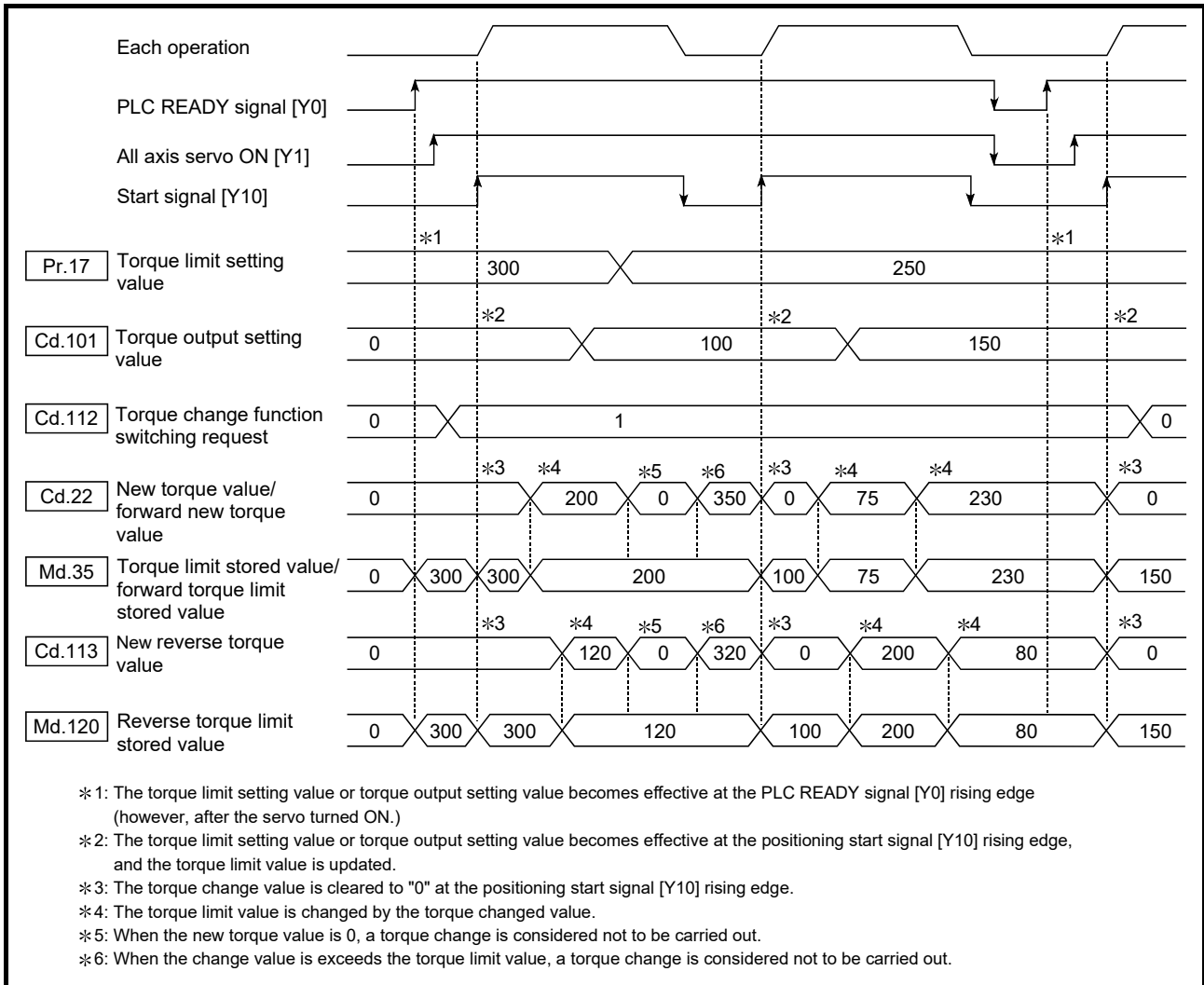

Fig. 13.32 Torque change operation (forward/reverse torque limit value individual setting) (Axis 1)

[2] Precautions during control

- (1) If a value besides "0" is set in the new torque value, the torque generated by the servomotor will be limited by the setting value. To limit the torque with the value set in "[Pr.17] Torque limit setting value" or "[Cd.101] Torque output setting value", set "0" to the new torque value.

| Setting value of "[Cd.112] Torque change function switching request" | Setting item (New Torque value) |
|--|---|
| 0: Forward/reverse torque limit value same setting | [Cd.22] New torque value/forward new torque value |
| 1: Forward/reverse torque limit value individual setting | [Cd.22] New torque value/forward new torque value |
| | [Cd.113] New reverse torque value |

- (2) The "[Cd.22] New torque value/forward new torque value" or "[Cd.113] New reverse torque value" is validated when written to the Simple Motion module. (Note that it is not validated from the time the power supply is turned ON to the time the PLC READY signal [Y0] is turned ON.)
- (3) If the setting value of "[Cd.22] New torque value/forward new torque value" is outside the setting range, the warning "Outside new torque value range/outside forward new torque value range" (warning code: 113) will occur and the torque will not be changed.
If the setting value of "[Cd.113] New reverse torque value" is outside the setting range, the warning "Outside new reverse torque value range" (warning code: 115) will occur and the torque will not be changed.
- (4) If the time to hold the new torque value is not more than 100ms, a torque change may not be executed.
- (5) When changing from "0: Forward/reverse torque limit value same setting" to "1: Forward/reverse torque limit value individual setting" by the torque change function, set "0" or same value set in "[Cd.22] New torque value/forward new torque value" in "[Cd.113] New reverse torque value" before change.

[3] Setting the torque change function start signal

To use the "torque change function", write the data shown in the following table to the Simple Motion module using the sequence program.

The set details are validated when written to the Simple Motion module.

| Setting item | Setting value | Setting details | Buffer memory address |
|--|--|--|-----------------------|
| [Cd.112] Torque change function switching request | 0: Forward/reverse torque limit value same setting 1: Forward/reverse torque limit value individual setting | Sets "same setting/individual setting" of the forward torque limit value and reverse torque limit value. *: Set "0" normally. (When the forward torque limit value and reverse torque limit value are not divided.) *: When a value except "1" is set, it operates as "forward/reverse torque limit value same setting." | 4363+100n |
| [Cd.22] New torque value/forward new torque value | 0 to [Pr.17] Torque limit setting value | When "0" is set to "[Cd.112] Torque change function switching request", a new torque limit value is set. (This value is set to the forward torque limit value and reverse torque limit value.) When "1" is set to "[Cd.112] Torque change function switching request", a new forward torque limit value is set. | 4325+100n |
| [Cd.113] New reverse torque value | 0 to [Pr.17] Torque limit setting value | "1" is set in "[Cd.112] Torque change function switching request", a new reverse torque limit value is set. *: When "0" is set in "[Cd.112] Torque change function switching request", the setting value is invalid. | 4364+100n |

n: Axis No.-1

*: Refer to Section 5.7 "List of control data" for details on the setting details.

13.5.5 Target position change function

The "target position change function" is a function to change a target position to a newly designated target position at any timing during the position control (1-axis linear control). A command speed can also be changed simultaneously.

The target position and command speed changed are set directly in the buffer memory, and the target position change is executed by "[Cd.29] Target position change request flag".

The following shows the details of the "target position change function".

[1] Details of control

[2] Precaution during operation

[3] Method of setting target position change function from PLC CPU

[1] Details of control

The following charts show the details of control of the target position change function.

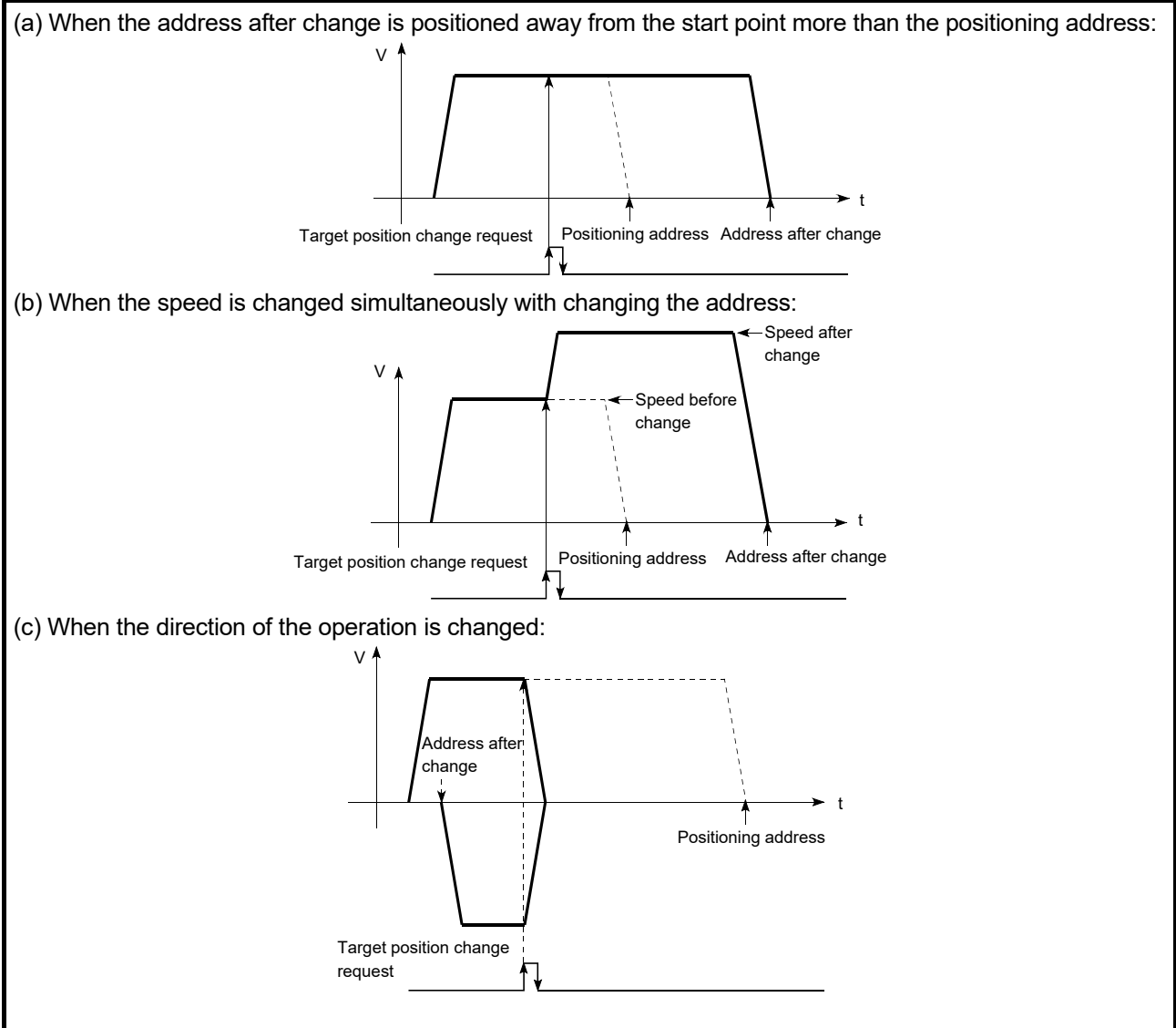

Fig. 13.33 Target position change operation

[2] Precautions during operation

- (1) If the positioning movement direction from the stop position to a new target position is reversed, stop the operation once and then position to the new target position. (Refer to Fig. 13.33 (c).)
- (2) If a command speed exceeding the speed limit value is set to change the command speed, the warning "Speed limit value over" (warning code: 501) will occur and the new command speed will be the speed limit value. Also, if the command speed change disables the remaining distance to the target value from being assured, the warning "Insufficient remaining distance" (warning code: 509) will occur.
- (3) In the following cases, a target position change request given is ignored and the warning "Target position change not possible" (warning code: 518) occurs.
 - During interpolation control
 - A new target position value (address) is outside the software stroke limit range.
 - The axis is decelerating to a stop by a stop cause.
 - While the positioning data whose operation pattern is continuous path control is executed.
 - When the speed change 0 flag ([Md.31] Status: b10) is ON.
- (4) When a command speed is changed, the current speed is also changed. When the next positioning speed uses the current speed in the continuous positioning, the next positioning operation is carried out at the new speed value. When the speed is set with the next positioning data, the speed becomes the current speed and the operation is carried out at the current speed.
- (5) When a target position change request is given during automatic deceleration in position control, positioning control to a new position is exercised after the axis has stopped once if the moving direction is reversed. If the moving direction is not reversed, the axis is accelerated to the command speed again and positioned to the new position.
- (6) If the constant speed status is regained or the output is reversed by a target position change made while "[Md.48] Deceleration start flag" is ON, the deceleration start flag remains ON. (For details, refer to Section 13.7.8.)
- (7) Carrying out the target position change to the ABS linear 1 in degrees may carry out the positioning to the new target position after the operation decelerates to stop once, even the movement direction is not reversed.

POINT

When carrying out the target position change continuously, take an interval of 100 ms or longer between the times of the target position changes. Also, take an interval of 100 ms or longer when the speed change and override is carried out after changing the target position or the target position change is carried out after the speed change and override.

[3] Method of setting target position change function from PLC CPU

The following table and chart show the example of a data setting and sequence program used to change the target position of the axis 1 by the command from the PLC CPU, respectively. (example in which the target position value and command speed are changed to a new target position of "300.0 μm" and a new command speed of "10000.00 mm/min".)

(1) The following data is set.

(Referring to the target position change time chart shown in item (2) below, carry out the setting with the sequence program shown in item (3).)

| Setting item | Setting value | Setting details | Buffer memory address |
|--|---------------|---|------------------------|
| [Cd.27] Target position change value (New address) | 3000 | Set the new address. | 4334+100n 4335+100n |
| [Cd.28] Target position change value (New speed) | 1000000 | Set the new speed. | 4336+100n 4337+100n |
| [Cd.29] Target position change request flag | 1 | Set "1": Requests a change in the target position". | 4338+100n |

n: Axis No.-1

*: Refer to Section 5.7 "List of control data" for details on the setting details.

(2) The following shows the time chart for target position change.

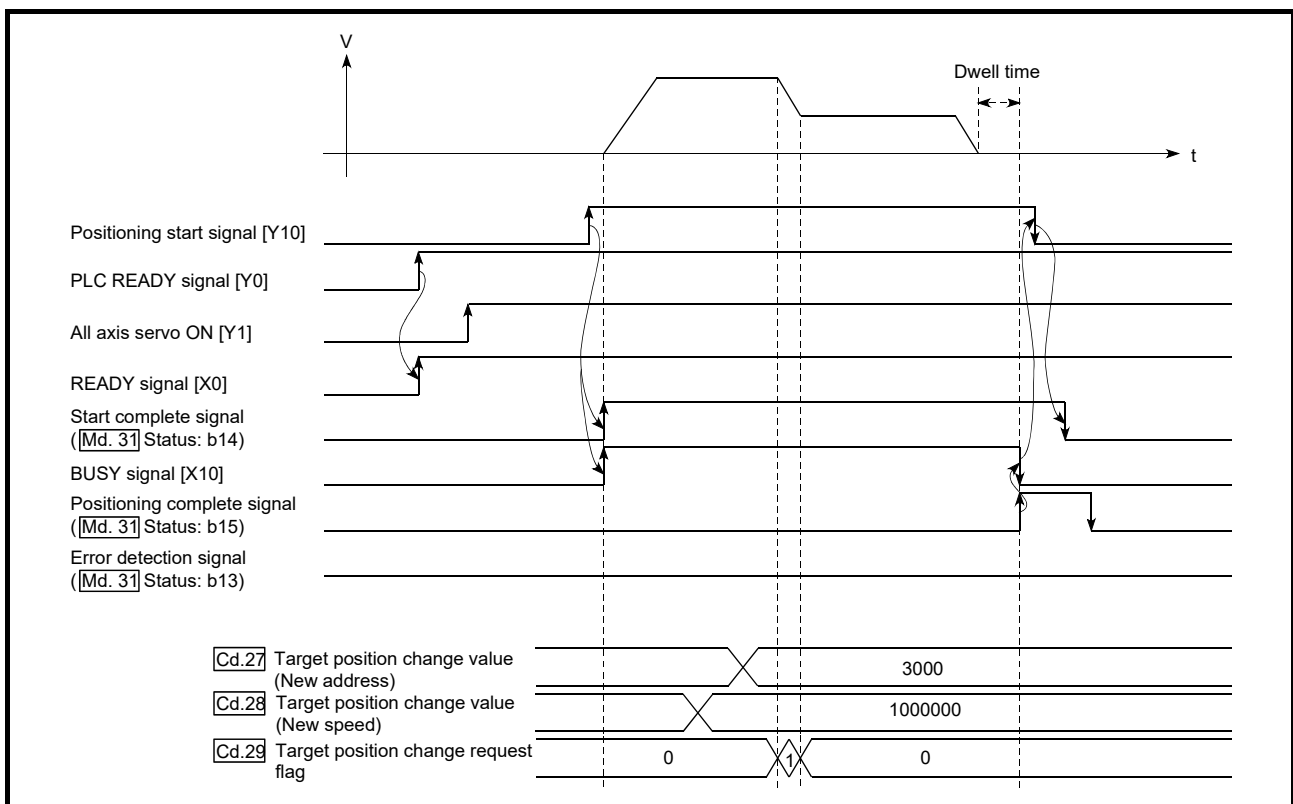

Fig. 13.34 Time chart for target position change from PLC CPU

13.6 Absolute position system

The Simple Motion module can construct an absolute position system.
 The following describes precautions when constructing the absolute position system.

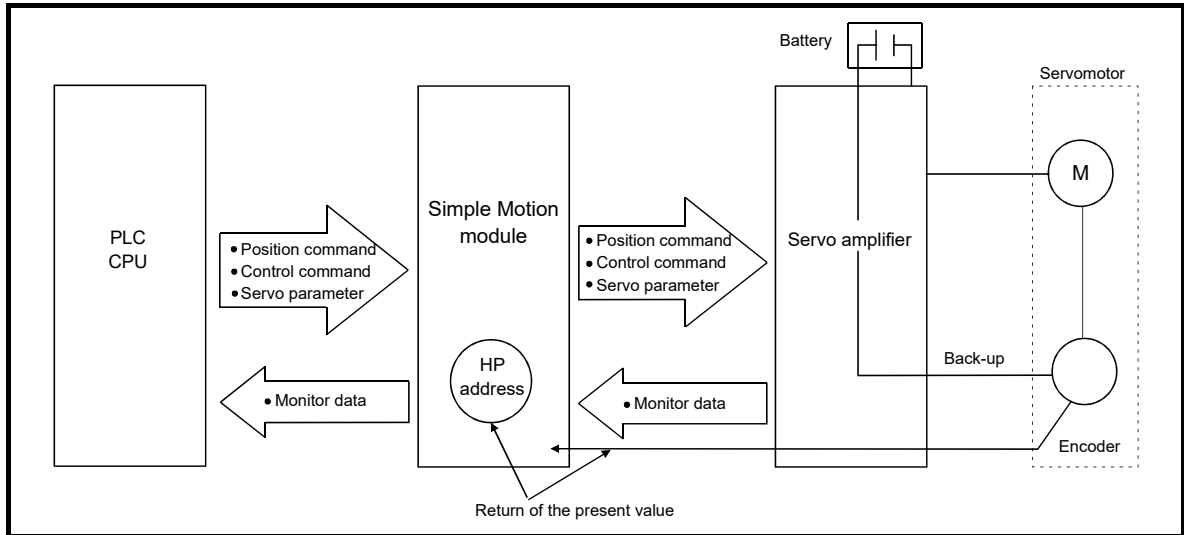

Fig. 13.35 Configuration of absolute position system

[1] Setting for absolute positions

For constructing an absolute position system, use a servo amplifier and a servomotor which enable absolute position detection.

It is also necessary to install a battery for retaining the location of the HPR in the servo amplifier.

To use the absolute position system, set "1: Enabled (absolute position detection system)" for the parameter shown in the following table.

| Servo series | Parameter | Buffer memory address |
|---|---|-----------------------|
| MR-J4-B (For CC-Link IE Field Motion) or MR-J4-GF | Absolute position detection system (PA03) | — |

In addition, select "0: Invalid" in "Absolute position counter warning (AL.E3) selection (PC18)" for the MR-J4-GF.

Refer to each servo amplifier instruction manual for details of the absolute position system.

[2] HPR

In the absolute position system, a home position can be determined through HPR. In the "Data set method" HPR method, the location to which the location of the HP is moved by manual operation (JOG operation/manual pulse generator operation) is treated as the HP.

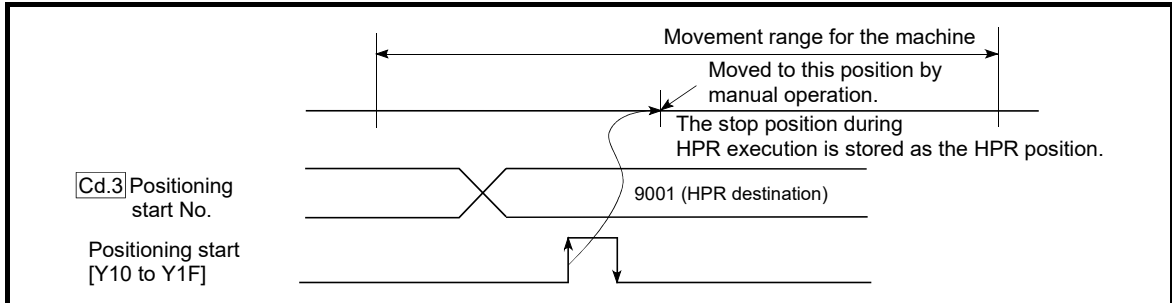

Fig. 13.36 Operation of the HPR execution

13.7 Other functions

Other functions include the "step function", "skip function", "M code output function", "teaching function", "command in-position function", "acceleration/deceleration processing function", "pre-reading start function", "deceleration start flag function", "stop command processing for deceleration stop function", "follow up processing function", "speed control 10 × multiplier setting for degree axis function" and "operation setting for incompleteness of HPR function". Each function is executed by parameter setting or sequence program creation and writing.

13.7.1 Step function

The "step function" is used to confirm each operation of the positioning control one by one.

It is used in debugging work for major positioning control, etc.

A positioning operation in which a "step function" is used is called a "step operation". In step operations, the timing for stopping the control can be set. (This is called the "step mode".) Control stopped by a step operation can be continued by setting "step continues (to continue the control)" in the "step start information".

The details shown below explain about the "step function".

- [1] Relation between the step function and various controls
- [2] Step mode
- [3] Step start information
- [4] Using the step operation
- [5] Control details
- [6] Precautions during control
- [7] Step function settings

[1] Relation between the step function and various controls

The following table shows the relation between the "step function" and various controls.

| Control type | | Step function | Step applicability |
|----------------------------------|---|---|-----------------------------|
| HPR control | Machine HPR control | × | Step operation not possible |
| | Fast HPR control | × | |
| Major positioning control | Position control | 1-axis linear control | ○ |
| | | 2 to 4-axes linear interpolation control | ○ |
| | | 1-axis fixed-feed control | ○ |
| | | 2 to 4- axes fixed-feed control (interpolation) | ○ |
| | | 2-axis circular interpolation control | ○ |
| | 1 to 4- axes Speed control | × | Step operation not possible |
| | Other control | Speed-position switching control | ○ |
| Position-speed switching control | | ○ | |
| Manual control | Current value changing | ○ | Step operation not possible |
| | JUMP instruction, NOP instruction, LOOP to LEND | × | |
| Expansion control | JOG operation, Inching operation | × | Step operation not possible |
| | Manual pulse generator operation | × | |
| Expansion control | Speed-torque control | × | |

○: Set when required

×: Setting not possible

[2] Step mode

In step operations, the timing for stopping the control can be set. This is called the "step mode". (The "step mode" is set in the control data "[Cd.34] Step mode".)

The following shows the two types of "step mode" functions.

(1) Deceleration unit step

The operation stops at positioning data requiring automatic deceleration. (A normal operation will be carried out until the positioning data requiring automatic deceleration is found. Once found, that positioning data will be executed, and the operation will then automatically decelerate and stop.)

(2) Data No. unit step

The operation automatically decelerates and stops for each positioning data. (Even in continuous path control, an automatic deceleration and stop will be forcibly carried out.)

[3] Step start information

Control stopped by a step operation can be continued by setting "step continues" (to continue the control) in the "step start information". (The "step start information" is set in the control data "[Cd.36] Step start information".)

The following table shows the results of starts using the "step start information" during step operation.

| Stop status in the step operation | [Md.26] Axis operation status | [Cd.36] Step start information | Step start results |
|--|-------------------------------|--------------------------------|--|
| 1 step of positioning stopped normally | Step standby | 1: Continues step operation | The next positioning data is executed. |

The warning "Step not possible" (warning code: 511) will occur if the "[Md.26] Axis operation status" is as shown below or the step valid flag is OFF when step start information is set.

| [Md.26] Axis operation status | Step start results |
|--|-------------------------------|
| Standby | Step not continued by warning |
| Stopped | |
| Interpolation | |
| JOG operation | |
| Manual pulse generator operation | |
| Analyzing | |
| Special start standby | |
| HPR | |
| Position control | |
| Speed control | |
| Speed control in speed-position switching control | |
| Position control in speed-position switching control | |
| Speed control in position-speed switching control | |
| Position control in position-speed switching control | |
| Synchronous control | |
| Control mode switch | |
| Speed control | |
| Torque control | |

[4] Using the step operation

The following shows the procedure for checking positioning data using the step operation.

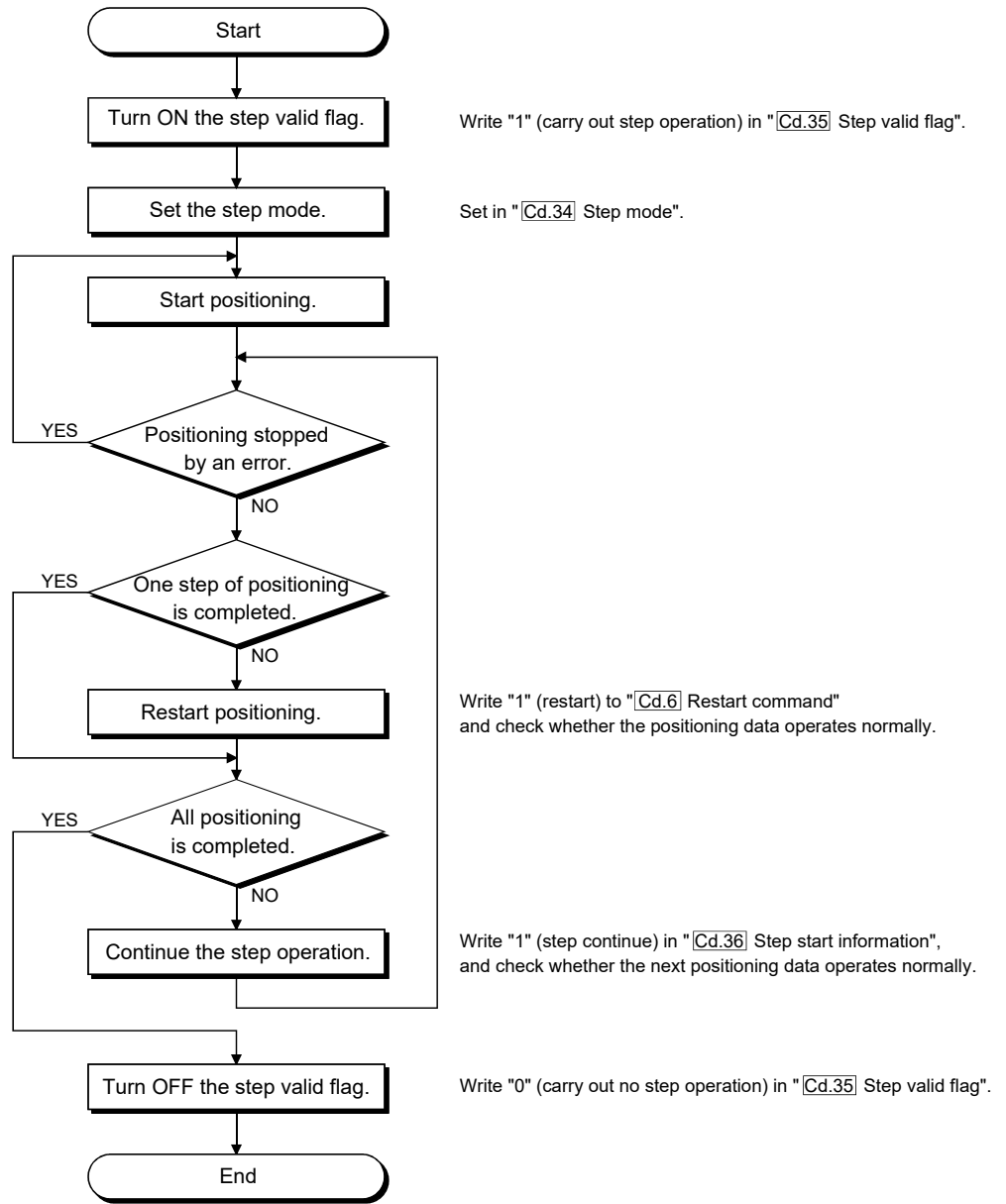

[5] Control details

(1) The following drawing shows a step operation during a "deceleration unit step".

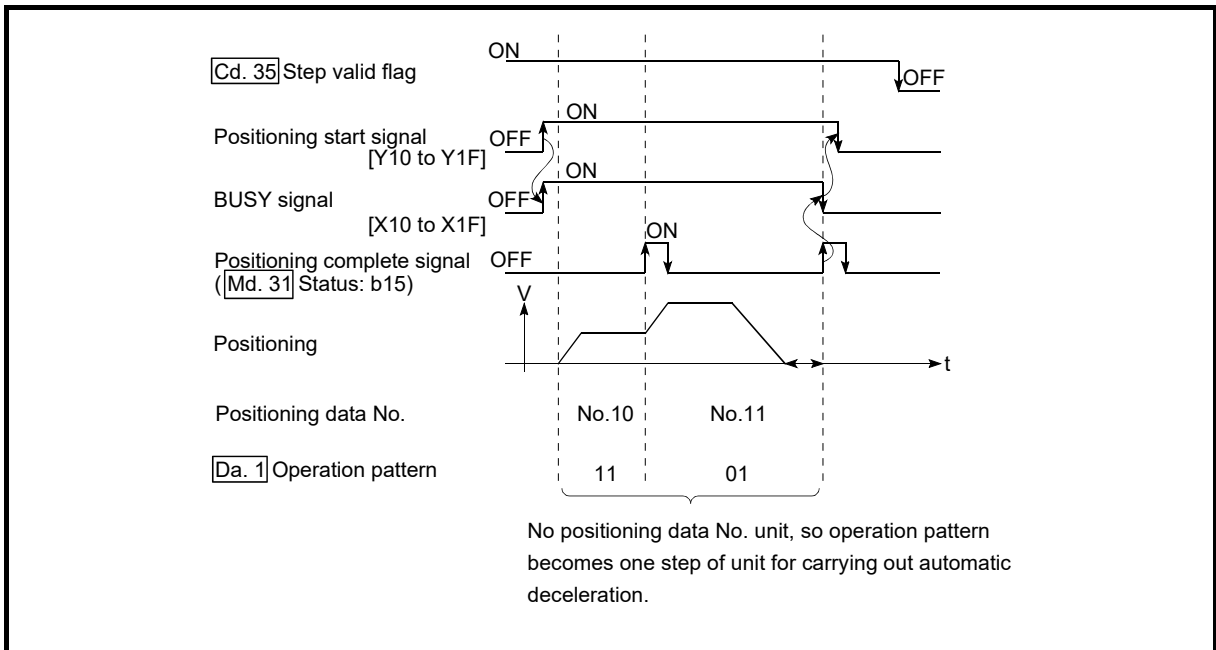

Fig. 13.37 Operation during step execution by deceleration unit step

(2) The following drawing shows a step operation during a "data No. unit step".

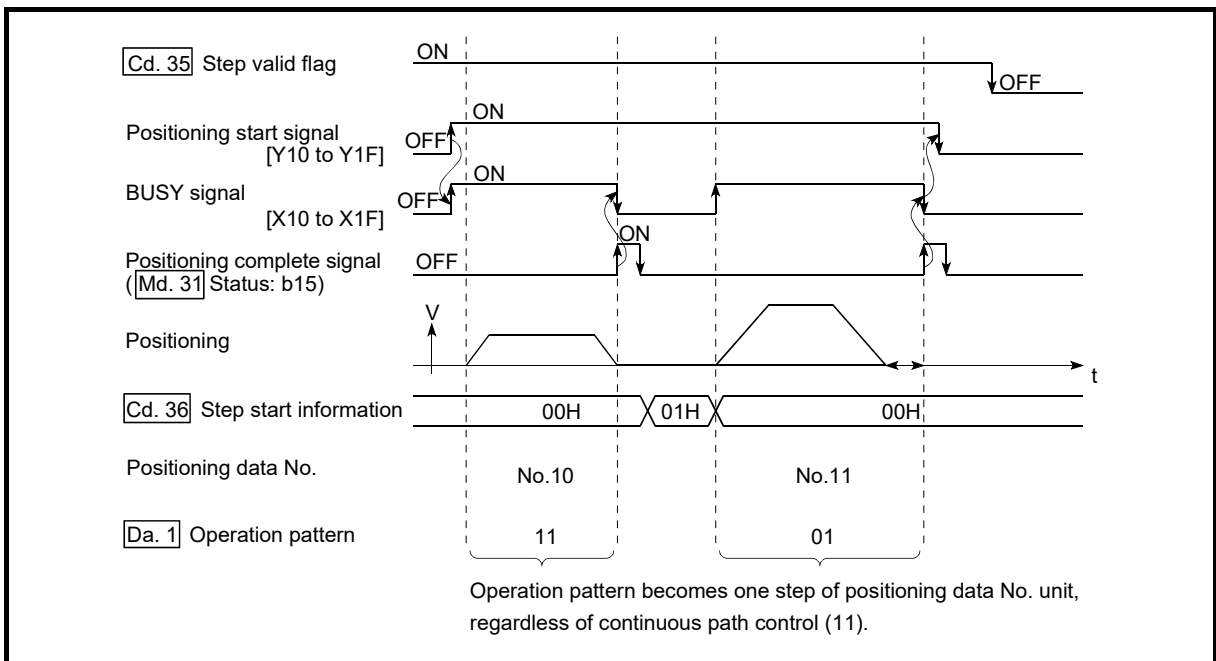

Fig. 13.38 Operation during step execution positioning data No. unit step

[6] Precautions during control

- (1) When step operation is carried out using interpolation control positioning data, the step function settings are carried out for the reference axis.
- (2) When the step valid flag is ON, the step operation will start from the beginning if the positioning start signal is turned ON while "[Md.26] Axis operation status" is "step standby". (The step operation will be carried out from the positioning data set in "[Cd.3] Positioning start No.".)

[7] Step function settings

To use the "step function", write the data shown in the following table to the Simple Motion module using the sequence program. Refer to section [4] "Using the step operation" for the timing of the settings.

The set details are validated when written to the Simple Motion module.

| Setting item | Setting value | Setting details | Buffer memory address |
|--------------------------------|---------------|---|-----------------------|
| [Cd.34] Step mode | → | Set "0: Stepping by deceleration units" or "1: Stepping by data No. units". | 4344+100n |
| [Cd.35] Step valid flag | 1 | Set "1: Validates step operations". | 4345+100n |
| [Cd.36] Step start information | → | Set "1: Continues step operation", depending on the stop status. | 4346+100n |

n: Axis No.-1

*: Refer to Section 5.7 "List of control data" for details on the setting details.

13.7.2 Skip function

The "skip function" is used to stop (deceleration stop) the control of the positioning data being executed at the time of the skip signal input, and execute the next positioning data.

A skip is executed by a skip command ([Cd.37] Skip command) or external command signal.

The "skip function" can be used during control in which positioning data is used.

The details shown below explain about the "skip function".

[1] Relation between the skip function and various controls

[2] Control details

[3] Precautions during control

[4] Setting the skip function from the PLC CPU

[5] Setting the skip function using an external command signal

[1] Relation between the skip function and various controls

The following table shows the relation between the "skip function" and various controls.

| Control type | | Skip function | Skip applicability |
|----------------------------------|---|--|-----------------------------|
| HPR control | Machine HPR control | × | Skip operation not possible |
| | Fast HPR control | × | |
| Major positioning control | Position control | 1-axis linear control | ○ |
| | | 2 to 4-axes linear interpolation control | ○ |
| | | 1-axis fixed-feed control | ○ |
| | | 2 to 4-axes fixed-feed control (interpolation) | ○ |
| | 2-axis circular interpolation control | ○ | Skip operation possible |
| | 1 to 4-axes Speed control | × | Skip operation not possible |
| | Speed-position switching control | ○ | Skip operation possible |
| Position-speed switching control | × | Skip operation not possible | |
| Other control | Current value changing | ○ | Skip operation possible |
| | JUMP instruction, NOP instruction, LOOP to LEND | × | Skip operation not possible |
| Manual control | JOG operation, Inching operation | × | Skip operation not possible |
| | Manual pulse generator operation | × | |
| Expansion control | Speed-torque control | × | Skip operation not possible |

○: Set when required, ×: Setting not possible

[2] Control details

The following drawing shows the skip function operation.

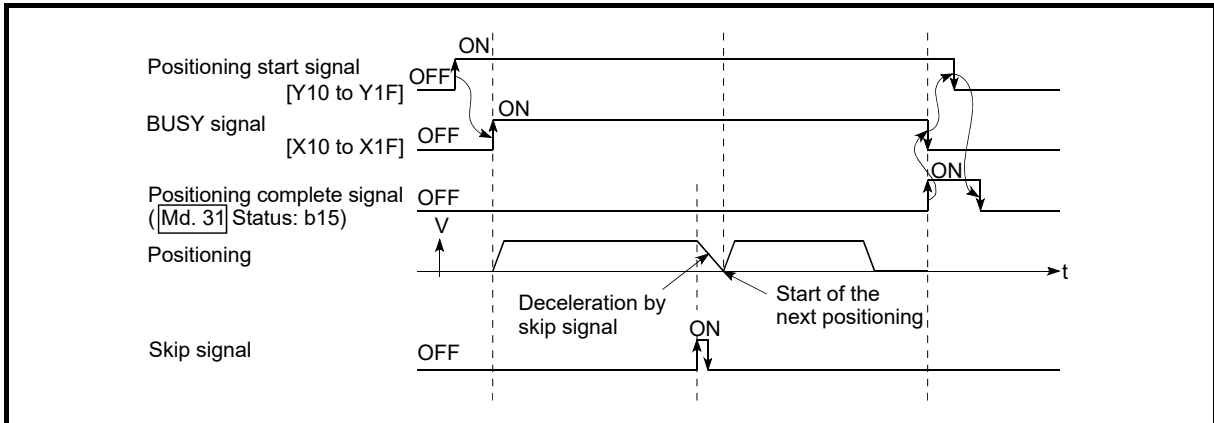

Fig. 13.39 Operation when a skip signal is input during positioning control

[3] Precautions during control

- (1) If the skip signal is turned ON at the last of an operation, a deceleration stop will occur and the operation will be terminated.
- (2) When a control is skipped (when the skip signal is turned ON during a control), the positioning complete signals will not turn ON.
- (3) When the skip signal is turned ON during the dwell time, the remaining dwell time will be ignored, and the next positioning data will be executed.
- (4) When a control is skipped during interpolation control, the reference axis skip signal is turned ON. When the reference axis skip signal is turned ON, a deceleration stop will be carried out for every axis, and the next reference axis positioning data will be executed.
- (5) The M code ON signals will not turn ON when the M code output is set to the AFTER mode (when "1: AFTER mode" is set in "[Pr.18] M code ON signal output timing").
(In this case, the M code will not be stored in "[Md.25] Valid M code".)
- (6) The skip cannot be carried out by the speed control and position-speed switching control.
- (7) If the skip signal is turned ON with the M code signal turned ON, the transition to the next data is not carried out until the M code signal is turned OFF.

[4] Setting the skip function from the PLC CPU

The following shows the settings and sequence program example for skipping the control being executed in axis 1 with a command from the PLC CPU.

(1) Set the following data.

(The setting is carried out using the sequence program shown below in section (2)).

| Setting item | Setting value | Setting details | Buffer memory address |
|----------------------|---------------|------------------------|-----------------------|
| [Cd.37] Skip command | 1 | Set "1: Skip request". | 4347+100n |

n: Axis No.-1

*: Refer to Section 5.7 "List of control data" for details on the setting details.

(2) Add the following sequence program to the control program, and write it to the PLC CPU.

1) When the "skip command" is input, the value "1" (skip request) set in "[Cd.37] Skip command" is written to the buffer memory of Simple Motion module.

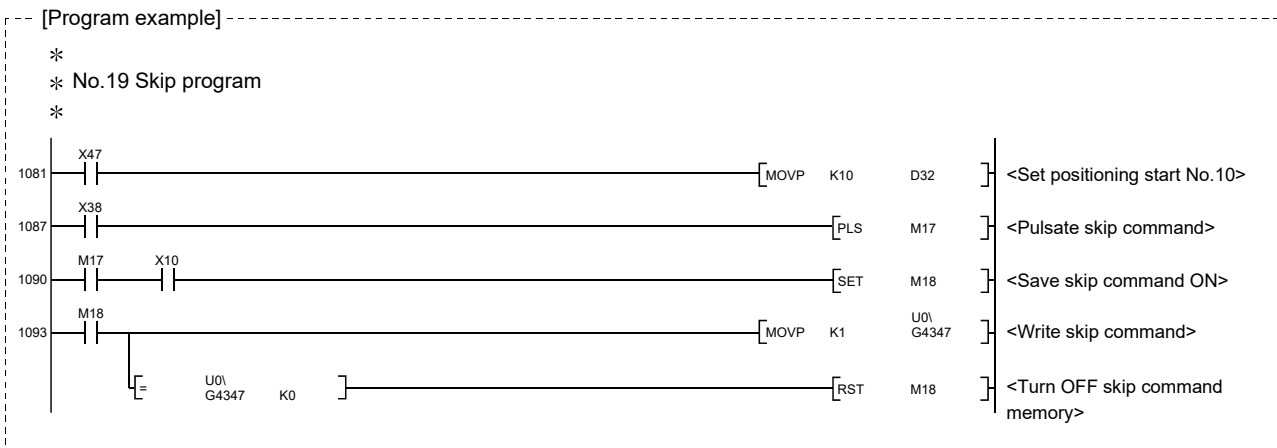

[5] Setting the skip function using an external command signal

The skip function can also be executed using an "external command signal". The following shows the settings and sequence program example for skipping the control being executed in axis 1 using an "external command signal".

(1) Set the following data to execute the skip function using an external command signal.

(The setting is carried out using the sequence program shown below in section (2)).

| Setting item | Setting value | Setting details | Buffer memory address |
|---|---------------|-------------------------------------|-----------------------|
| [Pr.42] External command function selection | 3 | Set "3: Skip request". | 62+150n |
| [Pr.95] External command signal selection | 1 | Set "1: DI1". | 69+150n |
| [Cd.8] External command valid | 1 | Set "1: Validate external command". | 4305+100n |

n: Axis No.-1

*: Refer to Section 5.2 "List of parameter" or Section 5.7 "List of control data" for details on the setting details.

(2) Add the following sequence program to the control program, and write it to the PLC CPU.

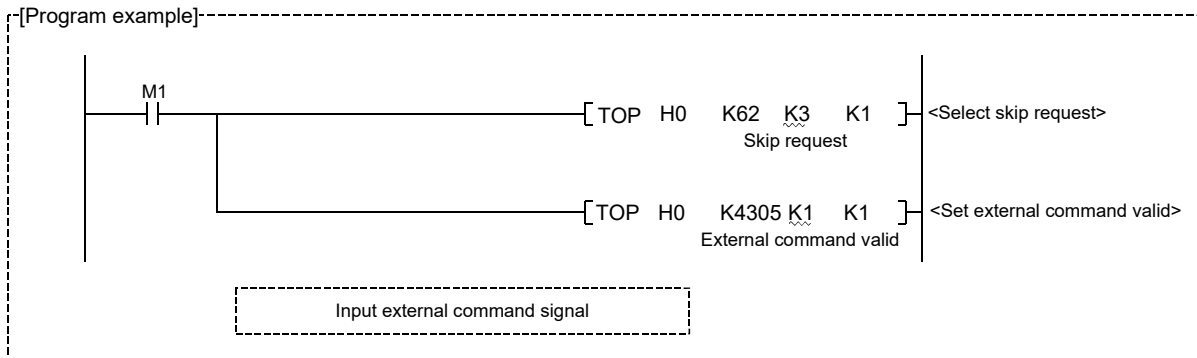

13.7.3 M code output function

The "M code output function" is used to command sub work (clamping, drill rotation, tool replacement, etc.) related to the positioning data being executed.

When the M code ON signal ([Md.31] Status: b12) is turned ON during positioning execution, a No. called the M code is stored in "[Md.25] Valid M code". These "[Md.25] Valid M code" are read from the PLC CPU, and used to command auxiliary work. M codes can be set for each positioning data. (Set in setting item "[Da.10] M code/Condition data No./Number of LOOP to LEND repetitions" of the positioning data.)

The timing for outputting (storing) the M codes can also be set in the "M code output function".

The details shown below explain about the "M code output function".

- [1] M code ON signal output timing
- [2] M code ON signal OFF request
- [3] Precautions during control
- [4] Setting the M code output function
- [5] Reading M codes

[1] M code ON signal output timing

The timing for outputting (storing) the M codes can be set in the "M code output function". (The M code is stored in "[Md.25] Valid M code" when the M code ON signal is turned ON.)

The following shows the two types of timing for outputting M codes: the "WITH mode" and the "AFTER mode".

(1) WITH mode

The M code ON signal is turned ON at the positioning start, and the M code is stored in "[Md.25] Valid M code".

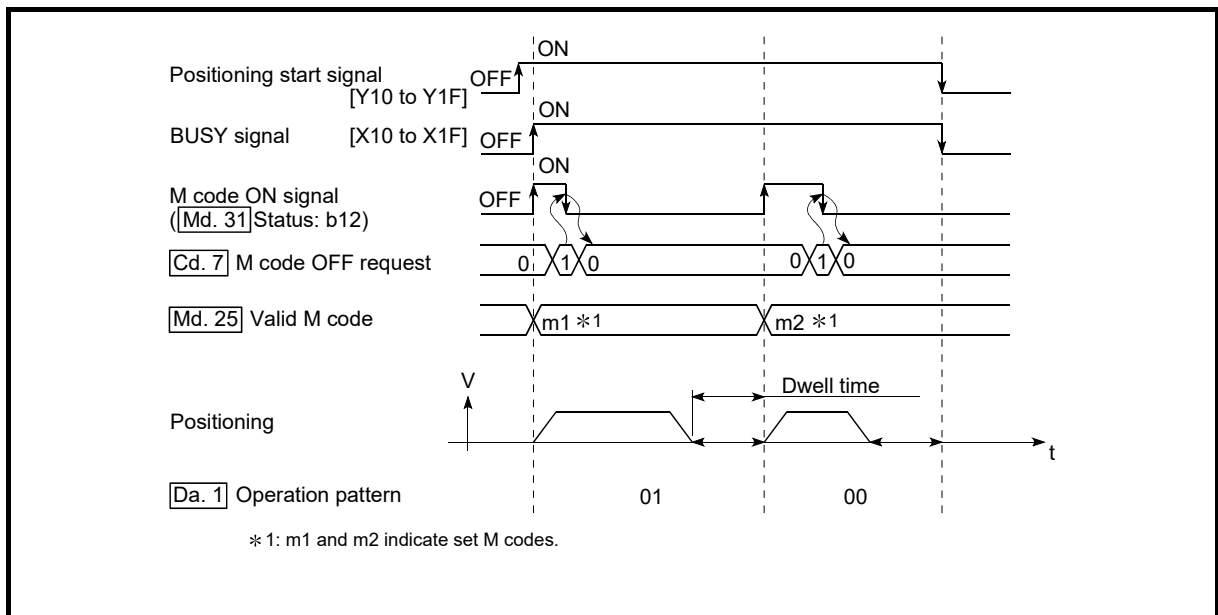

Fig. 13.40 M code ON/OFF timing (WITH mode)

(2) AFTER mode

The M code ON signal is turned ON at the positioning completion, and the M code is stored in "[Md.25] Valid M code".

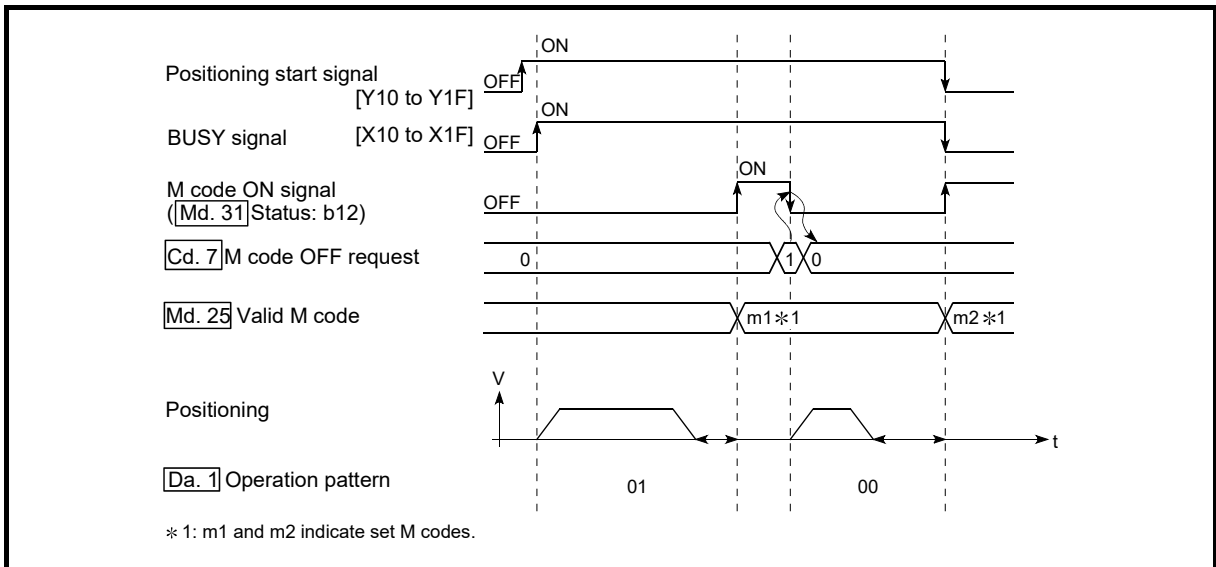

Fig. 13.41 M code ON/OFF timing (AFTER mode)

[2] M code ON signal OFF request

When the M code ON signal is ON, it must be turned OFF by the sequence program.

To turn OFF the M code ON signal, set "1" (turn OFF the M code signal) in "[Cd.7] M code OFF request".

| Setting item | Setting value | Setting details | Buffer memory address |
|---------------------------|---------------|---|-----------------------|
| [Cd.7] M code OFF request | 1 | Set "1: Turn OFF the M code ON signal". | 4304+100n |

n: Axis No.-1

*: Refer to Section 5.7 "List of control data" for details on the setting details.

The next positioning data will be processed as follows if the M code ON signal is not turned OFF. (The processing differs according to the "[Da.1] Operation pattern".)

| [Da.1] Operation pattern | Processing |
|--|--|
| 00 Independent positioning control (Positioning control) | The next positioning data will not be executed until the M code ON signal is turned OFF. |
| 01 Continuous positioning control | |
| 11 Continuous path control | The next positioning data will be executed. If the M code is set to the next positioning data, the warning "M code ON signal ON" (warning code: 503) will occur. |

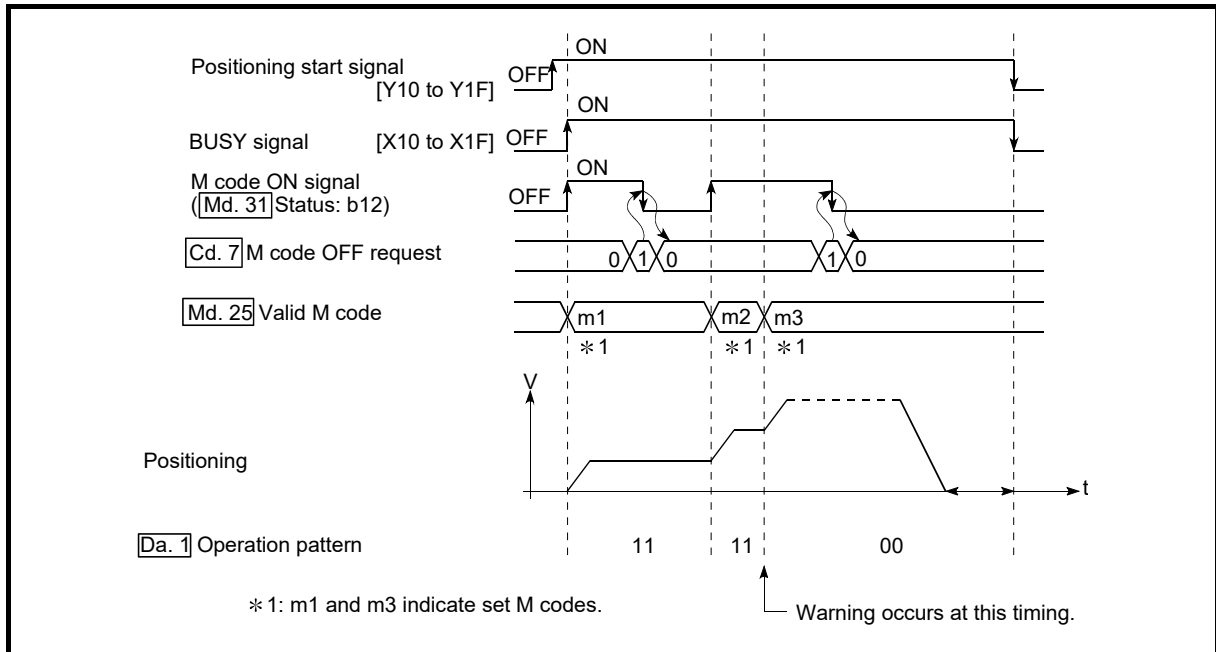

Fig. 13.42 Warning due to an M code ON signal during continuous path control

POINT

If the M code output function is not required, set a "0" in setting item "[Da.10] M code /Condition data No./Number of LOOP to LEND repetitions" of the positioning data.

[3] Precautions during control

- (1) During interpolation control, the reference axis M code ON signal is turned ON.
- (2) The M code ON signal will not turn ON if "0" is set in "[Da.10] M code/Condition data No./Number of LOOP to LEND repetitions". (The M code will not be output, and the previously output value will be held in "[Md.25] Valid M code".)
- (3) If the M code ON signal is ON at the positioning start, the error "M code ON signal start" (error code: 536) will occur, and the positioning will not start.
- (4) If the PLC READY signal [Y0] is turned OFF, the M code ON signal will turn OFF and "0" will be stored in "[Md.25] Valid M code".
- (5) If the positioning operation time is short during continuous path control, there will not be enough time to turn OFF the M code ON signal, and the warning "M code ON signal ON" (warning code: 503) may occur. In this case, set a "0" in the "[Da.10] M code/Condition data No./Number of LOOP to LEND repetitions" of that section's positioning data.
- (6) In the AFTER mode during speed control, the M code is not output and the M code ON signal does not turn ON.
- (7) If current value changing where "9003" has been set to "[Cd.3] Positioning start No." is performed, the M code output function is made invalid.

[4] Setting the M code output function

The following shows the settings to use the "M code output function".

- (1) Set the M code No. in the positioning data "[Da.10] M code/Condition data No./Number of LOOP to LEND repetitions".
- (2) Set the timing to output the M code ON signal.

Set the required value in the following parameter, and write it to the Simple Motion module.

The set details are validated at the rising edge (OFF → ON) of the PLC READY signal [Y0].

| Setting item | | Setting value | Setting details | Buffer memory address |
|--------------|--------------------------------|---------------|---|-----------------------|
| [Pr.18] | M code ON signal output timing | → | Set the timing to output the M code ON signal. 0: WITH mode 1: AFTER mode | 27+150n |

n: Axis No.-1

*: Refer to Section 5.2 "List of parameters" for setting details.

[5] Reading M codes

"M codes" are stored in the following buffer memory when the M code ON signal turns ON.

| Monitor item | | Monitor value | Storage details | Buffer memory address |
|--------------|--------------|---------------|--|-----------------------|
| [Md.25] | Valid M code | → | The M code No. ([Da.10] M code/Condition data No./Number of LOOP to LEND repetitions) set in the positioning data is stored. | 2408+100n |

n: Axis No.-1

*: Refer to Section 5.6 "List of monitor data" for information on the storage details.

The following shows a sequence program example for reading the "[Md.25] Valid M code" to the PLC CPU data register (D110). (The read value is used to command the sub work.)

Read M codes not as "rising edge commands", but as "ON execution commands".

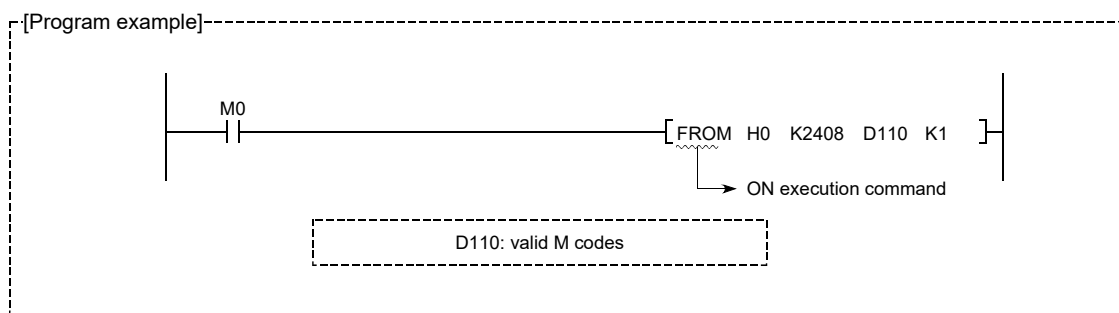

13.7.4 Teaching function

The "teaching function" is used to set addresses aligned using the manual control (JOG operation, inching operation manual pulse generator operation) in the positioning data addresses ("[Da.6] Positioning address/movement amount", "[Da.7] Arc address").

The details shown below explain about the "teaching function".

- [1] Control details
- [2] Precautions during control
- [3] Data used in teaching
- [4] Teaching procedure
- [5] Teaching program example

[1] Control details

(1) Teaching timing

Teaching is executed using the sequence program when the BUSY signal [X10 to X1F] is OFF. (During manual control, teaching can be carried out as long as the axis is not BUSY, even when an error or warning has occurred.)

(2) Addresses for which teaching is possible

The addresses for which teaching is possible are "feed current values" ([Md.20] Feed current value) having the HP as a reference. The settings of the "movement amount" used in incremental system positioning cannot be used. In the teaching function, these "feed current values" are set in the "[Da.6] Positioning address/movement amount" or "[Da.7] Arc address".

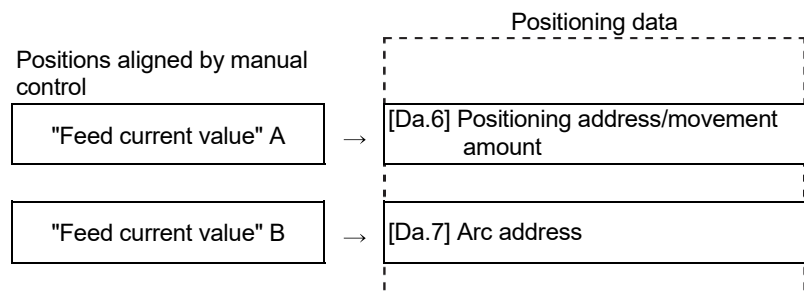

[2] Precautions during control

- (1) Before teaching, a "machine HPR" must be carried out to establish the HP. (When a current value changing, etc., is carried out, "[Md.20] Feed current value" may not show absolute addresses having the HP as a reference.)
- (2) Teaching cannot be carried out for positions to which movement cannot be executed by manual control (positions to which the workpiece cannot physically move). (During center point designation circular interpolation control, etc., teaching of "[Da.7] Arc address" cannot be carried out if the center point of the arc is not within the moveable range of the workpiece.)
- (3) Writing to the flash ROM can be executed up to 100,000 times. If writing to the flash ROM exceeds 100,000 times, the writing may become impossible (assured value is up to 100,000 times). If the error "Flash ROM write number error" (error code: 805) occurs when writing to the flash ROM has been completed, check whether or not the program is created so as to write continuously to the flash ROM.

[3] Data used in teaching

The following control data is used in teaching.

| Setting item | | Setting value | Setting details | Buffer memory address |
|--------------|-------------------------------|---------------|--|-----------------------|
| [Cd.1] | Flash ROM write request | 1 | Write the set details to the flash ROM (backup the changed data). | 5900 |
| [Cd.38] | Teaching data selection | → | Sets to which "feed current value" is written. 0: Written to "[Da.6] Positioning address/movement amount". 1: Written to "[Da.7] Arc address". | 4348+100n |
| [Cd.39] | Teaching positioning data No. | → | Designates the data to be taught. (Teaching is carried out when the setting value is 1 to 600.) When teaching has been completed, this data is zero cleared. | 4349+100n |

n: Axis No.-1

*: Refer to Section 5.7 "List of control data" for details on the setting details.

[4] Teaching procedure

The following shows the procedure for a teaching operation.

- (1) When teaching to the "[Da.6] Positioning address/movement amount"
(Teaching example on QD77GF16 [axis 1])

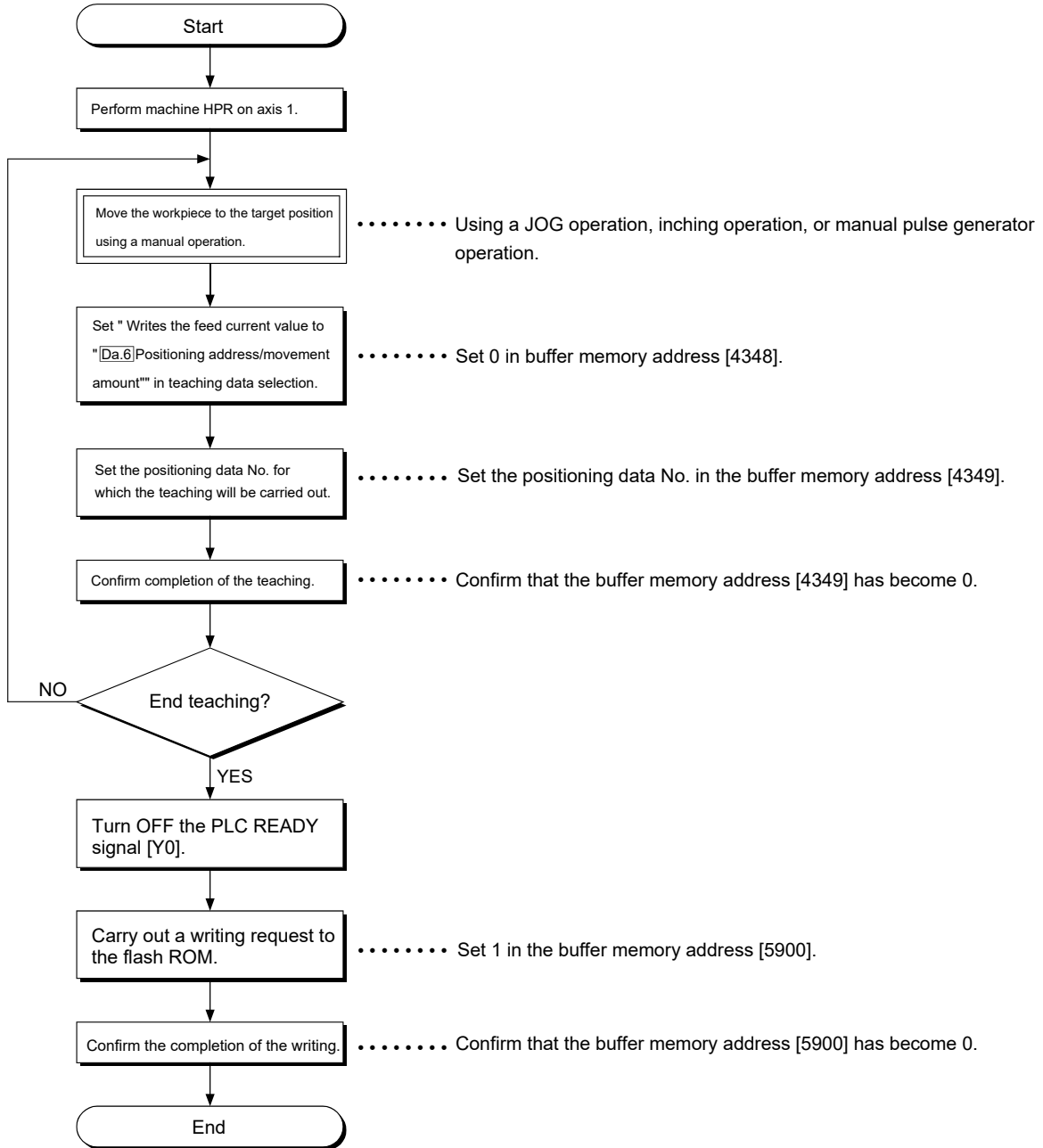

- (2) When teaching to the "[Da.7] Arc address", then teaching to the "[Da.6] Positioning address/movement amount"
 (Teaching example for 2-axis circular interpolation control with sub point designation on QD77GF16 [axis 1] and [axis 2])

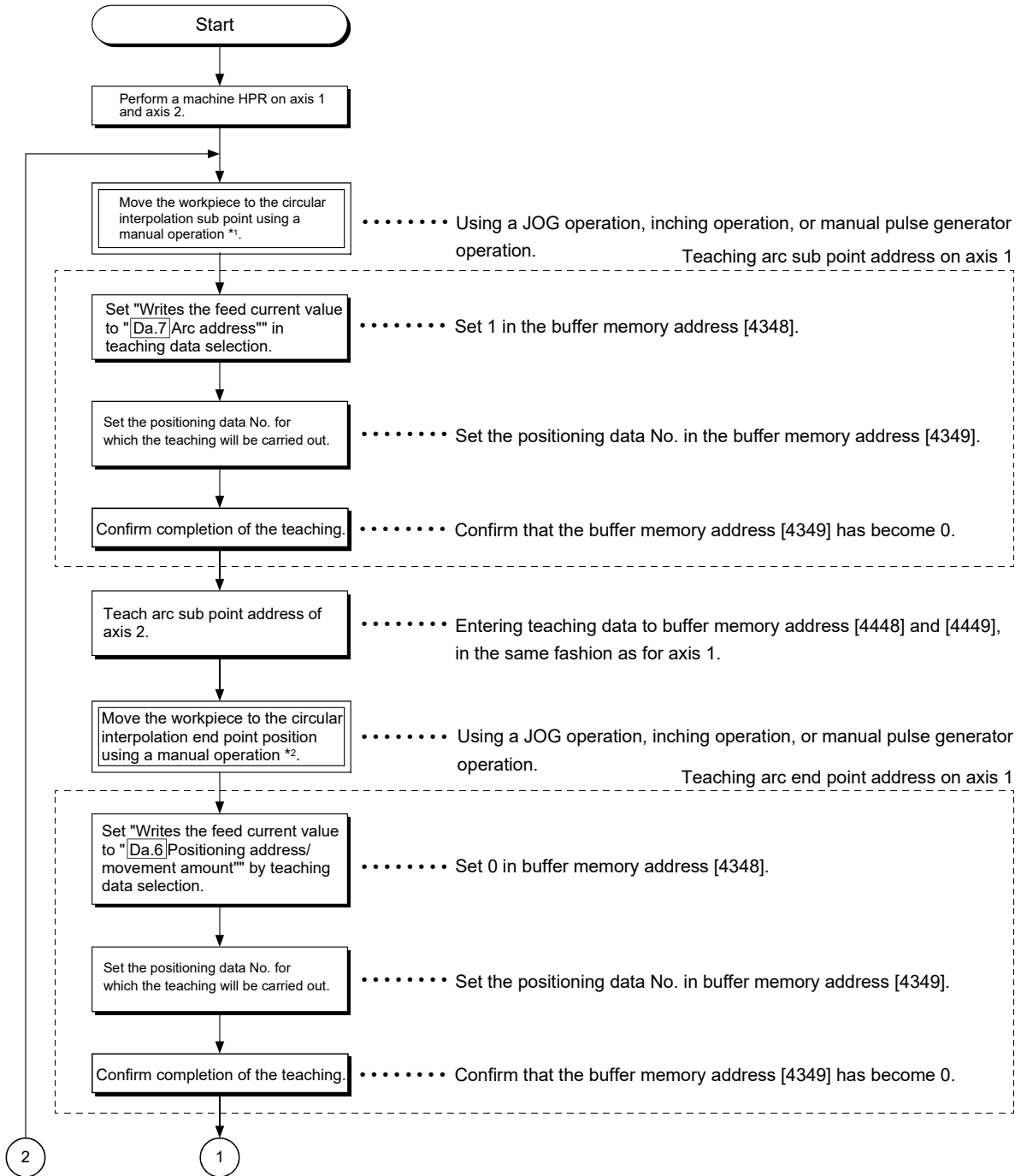

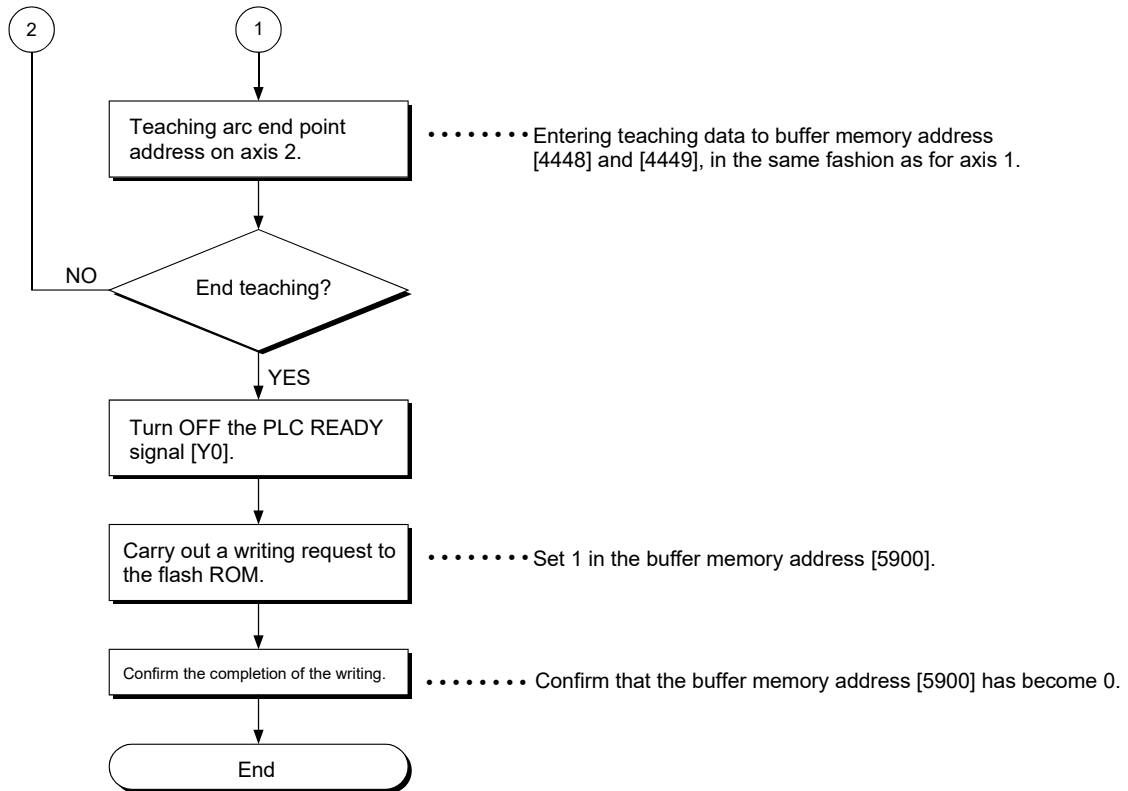

[Motion path]

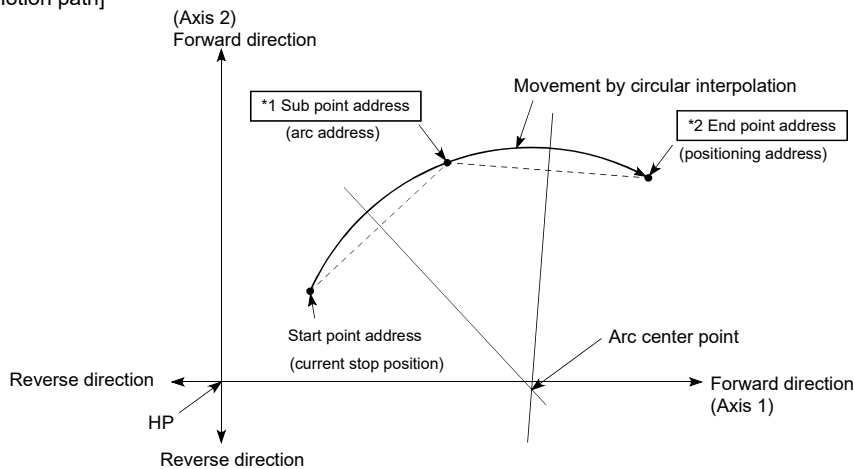

- *1: The sub point address is stored in the arc address.
- *2: The end point address is stored in the positioning address.

[5] Teaching program example

The following shows a sequence program example for setting (writing) the positioning data obtained with the teaching function to the Simple Motion module.

(1) Setting conditions

- When setting the feed current value as the positioning address, write it when the BUSY signal is OFF.

(2) Program example

- The following example shows a program to carry out the teaching of axis 1.
 - 1) Move the workpiece to the target position using a JOG operation (or an inching operation, a manual pulse generator operation).

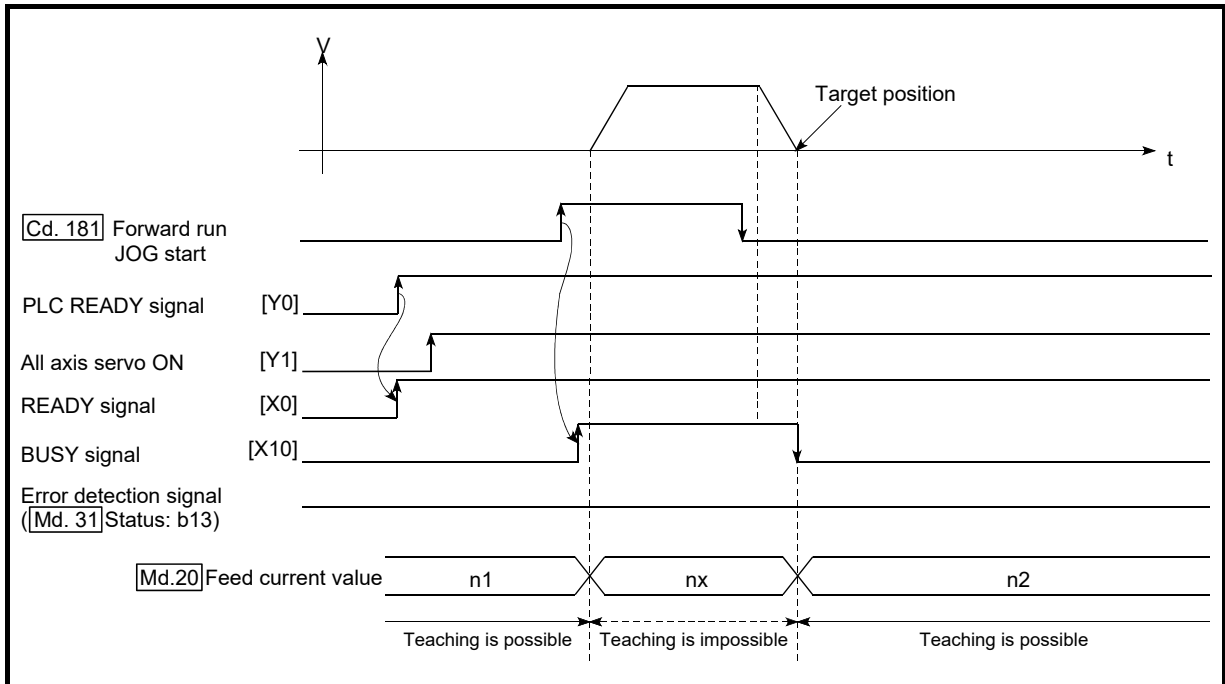

2) Carry out the teaching operation with the following program.

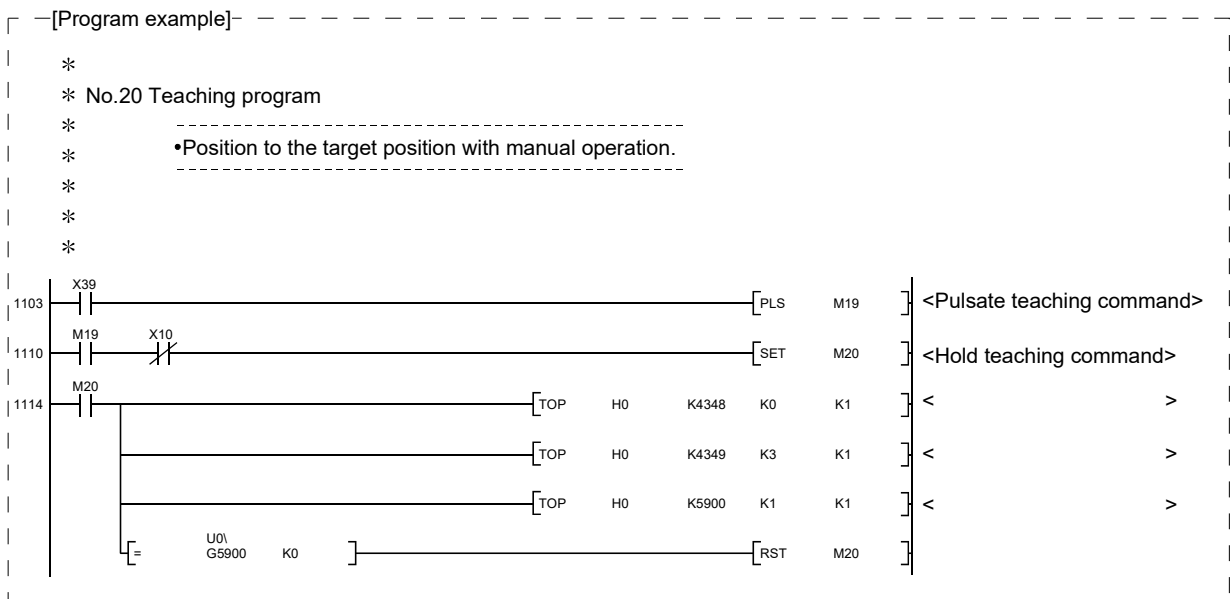

POINT

- (1) Confirm the teaching function and teaching procedure before setting the positioning data.
- (2) The positioning addresses that are written are absolute address (ABS) values.
- (3) The positioning data written by the teaching function overwrites the data of the buffer memory only. Therefore, read from the buffer memory and write to the flash ROM before turning OFF as necessary.

13.7.5 Command in-position function

The "command in-position function" checks the remaining distance to the stop position during the automatic deceleration of positioning control, and sets "1". This flag is called the "command in-position flag". The command in-position flag is used as a front-loading signal indicating beforehand the completion of the position control.

The details shown below explain about the "command in-position function".

- [1] Control details
- [2] Precautions during control
- [3] Setting the command in-position function
- [4] Confirming the command in-position flag

[1] Control details

The following shows control details of the command in-position function.

- (1) When the remaining distance to the stop position during the automatic deceleration of positioning control becomes equal to or less than the value set in "[Pr.16] Command in-position width", "1" is stored in the command in-position flag ([Md.31] Status: b2).

(Command in-position width check)

$$\text{Remaining distance} \leq \text{"[Pr.16] Command in-position width" setting value}$$

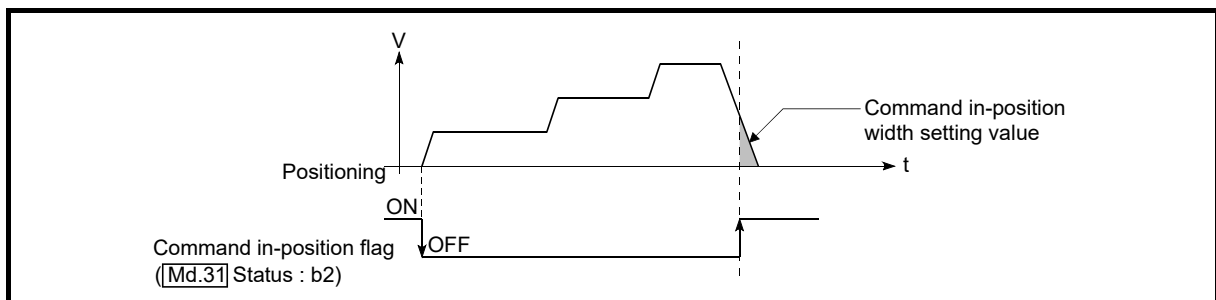

Fig. 13.43 Command in-position operation

- (2) A command in-position width check is carried out every operation cycle.

[2] Precautions during control

(1) A command in-position width check will not be carried out in the following cases.

- During speed control
- During speed control in speed-position switching control
- During speed control in position-speed switching control
- During speed control mode
- During torque control mode

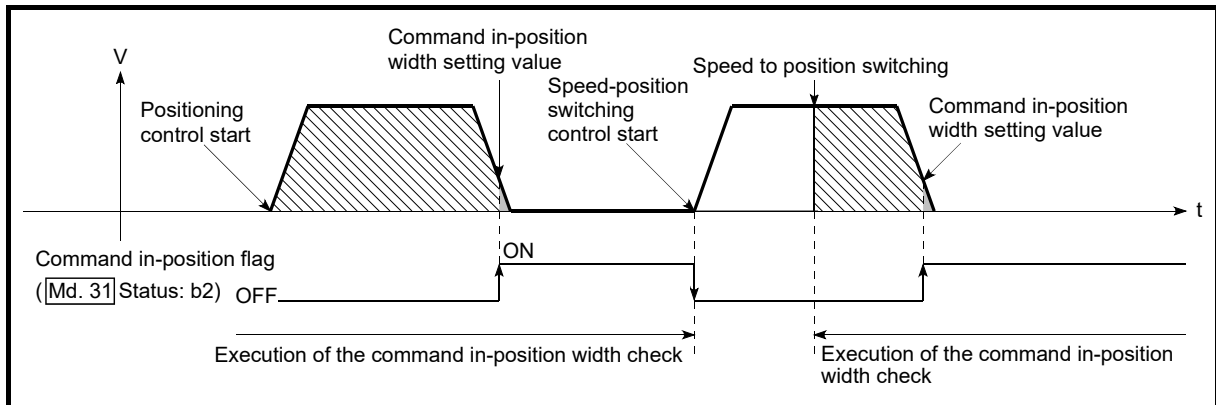

Fig. 13.44 Command in-position width check

(2) The command in-position flag will be turned OFF in the following cases.

("0" will be stored in "[Md.31] Status: b2".)

- At the positioning control start
- At the speed control start
- At the speed-position switching control, position-speed switching control start
- At the HPR control start
- At the JOG operation start
- At the inching operation start
- When the manual pulse generator operation is enabled

(3) The "[Pr.16] Command in-position width" and command in-position flag ([Md.31] Status: b2) of the reference axis are used during interpolation control.

When the "[Pr.20] Interpolation speed designation method" is "Composite speed", the command in-position width check is carried out in the remaining distance on the composite axis (line/arc connecting the start point address and end point address).

[3] Setting the command in-position function

To use the "command in-position function", set the required value in the parameter shown in the following table, and write it to the Simple Motion module. The set details are validated at the rising edge (OFF → ON) of the PLC READY signal [Y0].

| Setting item | | Setting value | Setting details | Factory-set initial value |
|--------------|---------------------------|---------------|--|---------------------------|
| [Pr.16] | Command in-position width | → | Turn ON the command in-position flag, and set the remaining distance to the stop position of the position control. | 100 |

*: Refer to Section 5.2 "List of parameters" for setting details.

[4] Confirming the command in-position flag

The "command in-position flag" is stored in the following buffer memory.

| Monitor item | | Monitor value | Storage details | Buffer memory address |
|--------------|--------|---------------|--|-----------------------|
| [Md.31] | Status | → | The command in-position flag is stored in the "b2" position. | 2417+100n |

n: Axis No.-1

*: Refer to Section 5.6 "List of monitor data" for information on the storage details.

REMARK

- Parameters are set for each axis.
- It is recommended that the parameters be set whenever possible with GX Works2. Execution by sequence program uses many sequence programs and devices. The execution becomes complicated, and the scan times will increase.

13.7.6 Acceleration/deceleration processing function

The "acceleration/deceleration processing function" adjusts the acceleration/deceleration of each control to the acceleration/deceleration curve suitable for device.

Setting the acceleration/deceleration time changes the slope of the acceleration/deceleration curve.

The following two methods can be selected for the acceleration/deceleration curve:

- Trapezoidal acceleration/deceleration
- S-curve acceleration/deceleration

Refer to Section 12.1 "Speed-torque control" for acceleration/deceleration processing of speed-torque control.

The details shown below explain about the "acceleration/deceleration processing function".

[1] "Acceleration/deceleration time 0 to 3" control details and setting

[2] "Acceleration/deceleration method setting" control details and setting

[1] "Acceleration/deceleration time 0 to 3" control details and setting

In the Simple Motion module, four types each of acceleration time and deceleration time can be set. By using separate acceleration/deceleration times, control can be carried out with different acceleration/deceleration times for positioning control, JOG operation, HPR, etc.

Set the required values for the acceleration/deceleration time in the parameters shown in the following table, and write them to the Simple Motion module.

The set details are validated when written to the Simple Motion module.

| Setting item | Setting value | Setting details | Factory-set initial value |
|-----------------------------|---------------|---|---------------------------|
| [Pr.9] Acceleration time 0 | → | Set the acceleration time at a value within the range of 1 to 8388608 ms. | 1000 |
| [Pr.25] Acceleration time 1 | → | | 1000 |
| [Pr.26] Acceleration time 2 | → | | 1000 |
| [Pr.27] Acceleration time 3 | → | | 1000 |
| [Pr.10] Deceleration time 0 | → | Set the deceleration time at a value within the range of 1 to 8388608 ms. | 1000 |
| [Pr.28] Deceleration time 1 | → | | 1000 |
| [Pr.29] Deceleration time 2 | → | | 1000 |
| [Pr.30] Deceleration time 3 | → | | 1000 |

*: Refer to Section 5.2 "List of parameters" for setting details.

[2] "Acceleration/deceleration method setting" control details and setting

In the "acceleration/deceleration method setting", the acceleration/deceleration processing method is selected and set. The set acceleration/deceleration processing is applied to all acceleration/deceleration. (except for inching operation, manual pulse generator operation and speed-torque control.)

The two types of "acceleration/deceleration processing method" are shown below.

(1) Trapezoidal acceleration/deceleration processing method

This is a method in which linear acceleration/deceleration is carried out based on the acceleration time, deceleration time, and speed limit value set by the user.

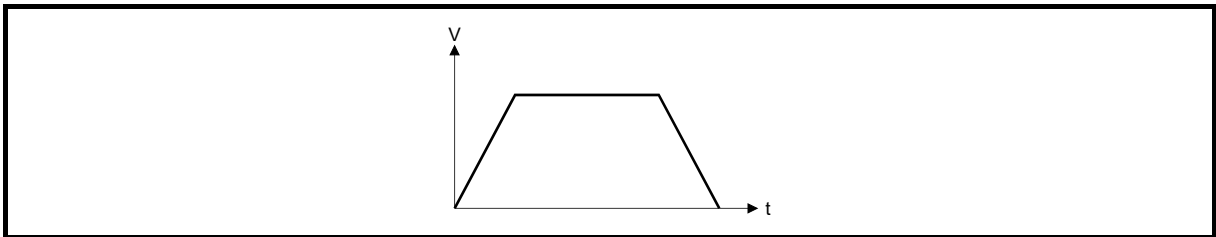

Fig. 13.45 Trapezoidal acceleration/deceleration processing method

(2) S-curve acceleration/deceleration processing method

In this method, the motor burden is reduced during starting and stopping.

This is a method in which acceleration/deceleration is carried out gradually, based on the acceleration time, deceleration time, speed limit value, and "[Pr.35] S-curve ratio" (1 to 100%) set by the user.

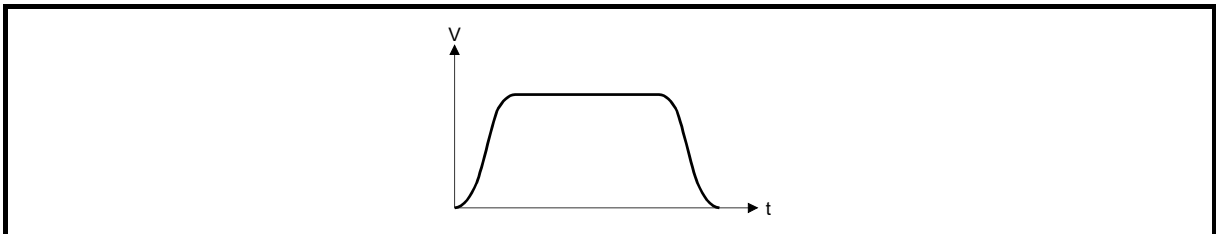

Fig. 13.46 S-curve acceleration/deceleration processing method

When a speed change request or override request is given during S-curve acceleration/ deceleration processing, S-curve acceleration/deceleration processing begins at a speed change request or override request start.

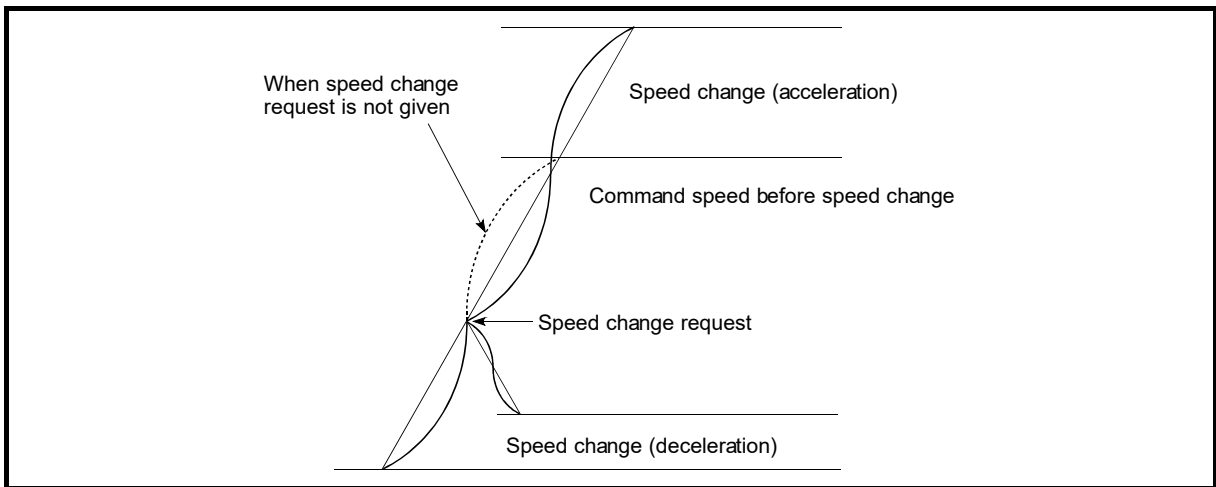

Fig. 13.47 Speed change during S-curve acceleration/deceleration processing

Set the required values for the "acceleration/deceleration method setting" in the parameters shown in the following table, and write them to the Simple Motion module.

The set details are validated when written to the Simple Motion module.

| Setting item | Setting value | Setting details | Factory-set initial value |
|--|---------------|---|---------------------------|
| [Pr.34] Acceleration/ deceleration process selection | → | Set the acceleration/deceleration method. 0: Trapezoidal acceleration/deceleration processing 1: S-curve acceleration/deceleration processing | 0 |
| [Pr.35] S-curve ratio | → | Set the acceleration/deceleration curve when "1" is set in "[Pr.34] Acceleration/deceleration process selection". | 100 |

*: Refer to Section 5.2 "List of parameters" for setting details.

REMARK

- Parameters are set for each axis.
- It is recommended that the parameters be set whenever possible with GX Works2. Execution by sequence program uses many sequence programs and devices. The execution becomes complicated, and the scan times will increase.

13.7.7 Pre-reading start function

The "pre-reading start function" does not start servo while the execution prohibition flag is ON if a positioning start request is given with the execution prohibition flag ON, and starts servo within operation cycle after OFF of the execution prohibition flag is detected. The positioning start request is given when the axis is in a standby status, and the execution prohibition flag is turned OFF at the axis operating timing.

The "pre-reading start function" will be explained below.

- [1] Controls
- [2] Precautions during control
- [3] Program examples

[1] Controls

The pre-reading start function is performed by turning ON the positioning start signal with the execution prohibition flag ([Cd.183]) ON. However, if positioning is started with the execution prohibition flag ON, the positioning data is analyzed but servo start is not provided. While the execution prohibition flag is ON, "[Md.26] Axis operation status" remains unchanged from "5: Analyzing". The servo starts within operation cycle after the execution prohibition flag has turned OFF, and "[Md.26] Axis operation status" changes to the status (e.g. position control, speed control) that matches the control method. (Refer to Fig.13.48)

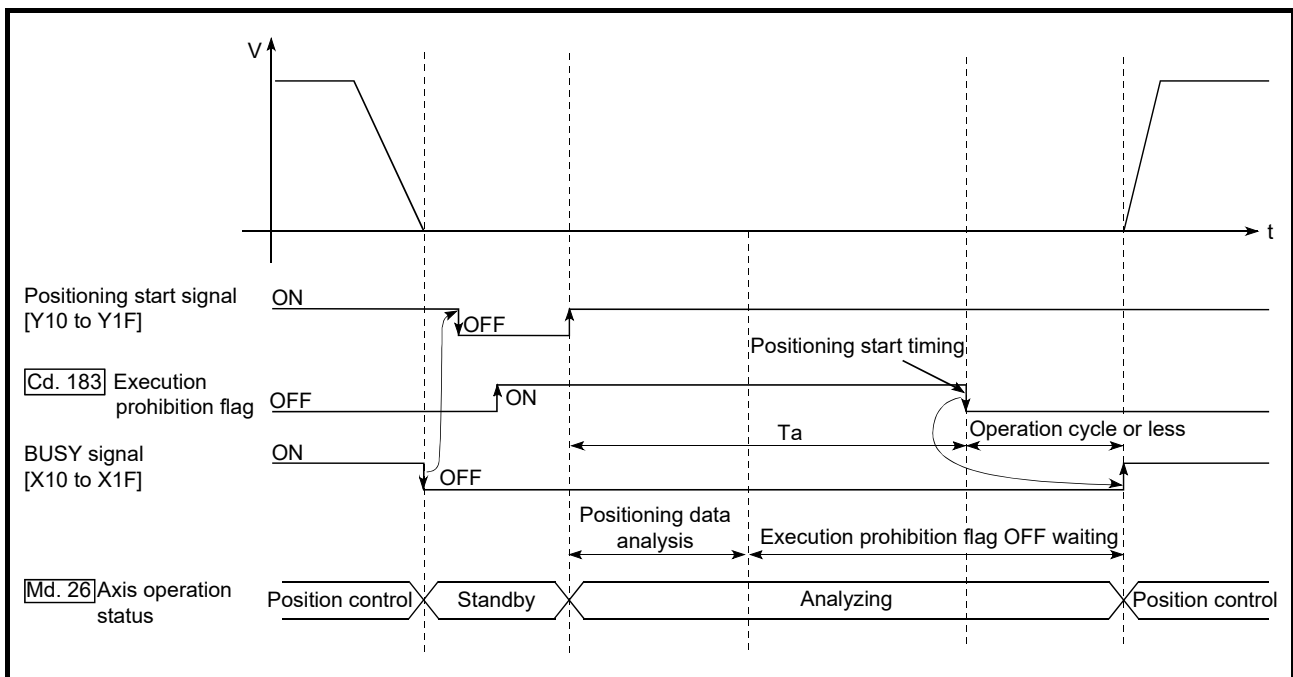

Fig. 13.48 Operations of pre-reading start function

[2] Precautions during control

- (1) The time required to analyze the positioning data is up to one operation cycle.
- (2) After positioning data analysis, the system is put in an execution prohibition flag OFF waiting status. Any change made to the positioning data in the execution prohibition flag OFF waiting status is not reflected on the positioning data. Change the positioning data before turning ON the positioning start signal.
- (3) The pre-reading start function is invalid if the execution prohibition flag is turned OFF between when the positioning start signal has turned ON and when positioning data analysis is completed (Ta < start time, Ta: Refer to Fig. 13.48).
- (4) The data No. which can be executed positioning start using "[Cd.3] Positioning start No." with the pre-reading start function are No. 1 to 600 only. Performing the pre-reading start function at the setting of No. 7000 to 7004 or 9001 to 9004 will result in the error "Outside start No. range" (error code: 543).
- (5) Always turn ON the execution prohibition flag at the same time or before turning ON the positioning start signal. Pre-reading may not be started if the execution prohibition flag is turned ON during Ta after the positioning start signal is turned ON. The pre-reading start function is invalid if the execution prohibition flag is turned ON after positioning start with the execution prohibition flag OFF. (It is made valid at the next positioning start.)

[3] Program examples

[Program example]

- * Pre-reading start program (when positioning start signal Y10 is used)

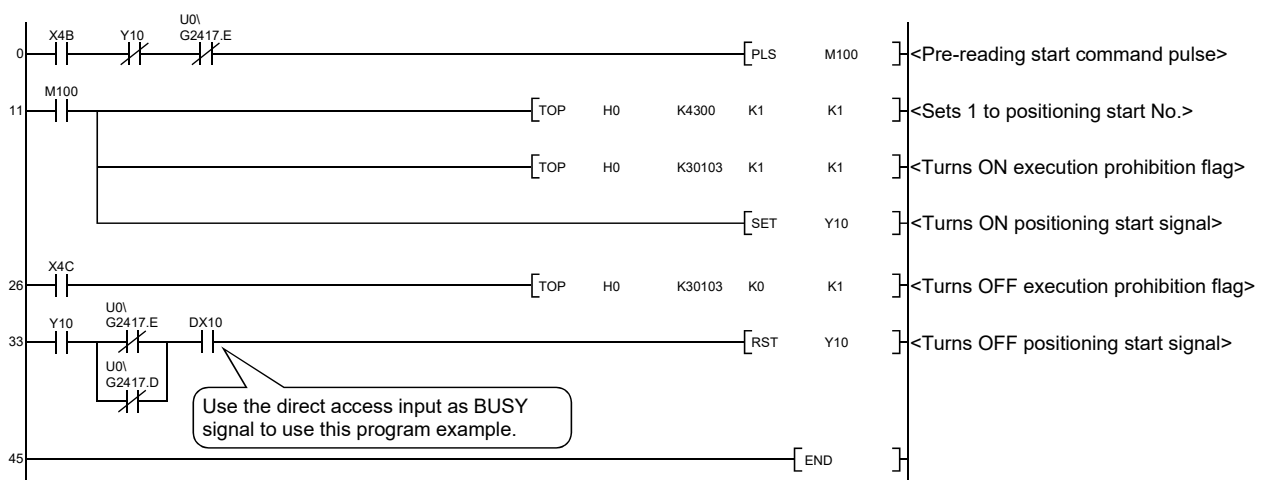

13.7.8 Deceleration start flag function

The "deceleration start flag function" turns ON the flag when the constant speed status or acceleration status switches to the deceleration status during position control whose operation pattern is "Positioning complete". This function can be used as a signal to start the operation to be performed by other equipment at each end of position control or to perform preparatory operation, etc. for the next position control.

For the "deceleration start flag function", the following will be explained.

- [1] Control details
- [2] Precautions during control
- [3] Deceleration start flag function setting method
- [4] Checking of deceleration start flag

[1] Control details

When deceleration for a stop is started in the position control whose operation pattern is "Positioning complete", "1" is stored into "[Md.48] Deceleration start flag". When the next operation start is made or the manual pulse generator operation enable status is gained, "0" is stored. (Refer to Fig. 13.49.)

(1) Start made with positioning data No. specified

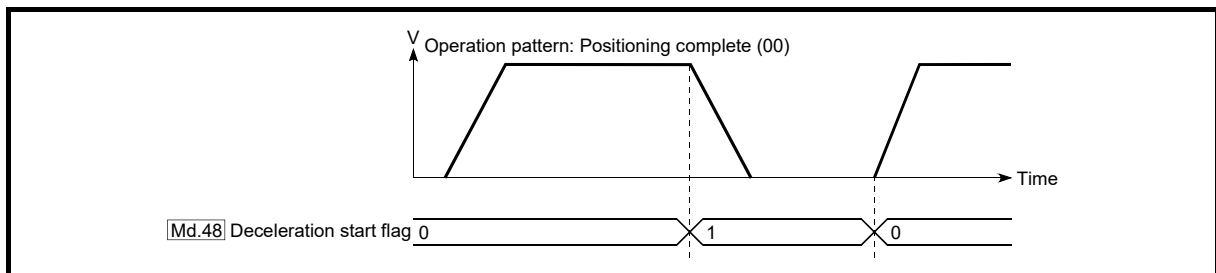

Fig. 13.49 Operation of deceleration start flag

(2) Block start

At a block start, this function is valid for only the position control whose operation pattern is "Positioning complete" at the point whose shape has been set to "End". (Refer to Fig. 13.50.)

The following table indicates the operation of the deceleration start flag in the case of the following block start data and positioning data.

| Block start data | [Da.11] Shape | [Da.12] Start data No. | [Da.13] Special start instruction |
|------------------|---------------|------------------------|-----------------------------------|
| 1st point | 1: Continue | 1 | 0: Block start |
| 2nd point | 1: Continue | 3 | 0: Block start |
| 3rd point | 0: End | 4 | 0: Block start |
| • | | | |
| • | | | |

| Positioning Data No. | [Da.1] Operation pattern |
|----------------------|------------------------------------|
| 1 | 01: Continuous positioning control |
| 2 | 00: Positioning complete |
| 3 | 00: Positioning complete |
| 4 | 11: Continuous path control |
| 5 | 00: Positioning complete |
| • | |
| • | |

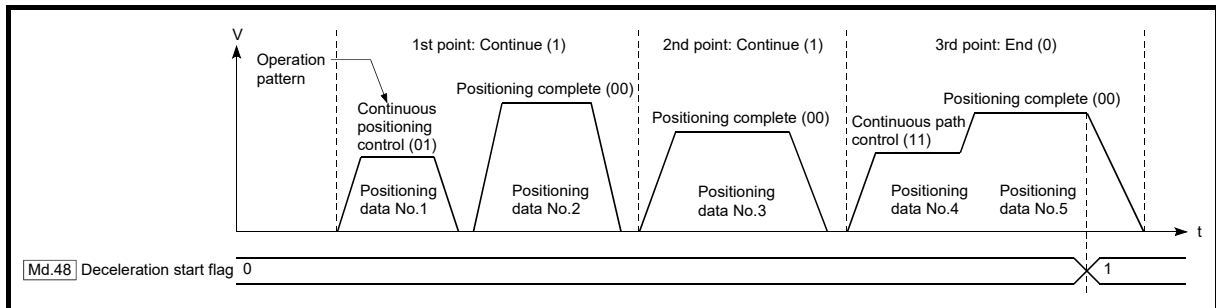
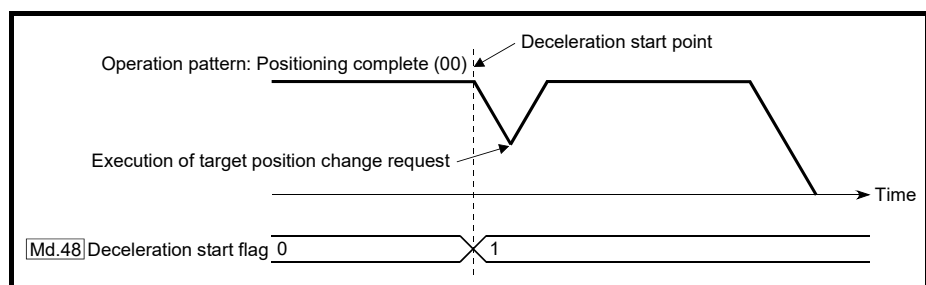

Fig. 13.50 Operation of deceleration start flag at block start

[2] Precautions during control

- (1) The deceleration start flag function is valid for the control method of "1-axis linear control", "2-axis linear interpolation control", "3-axis linear interpolation control", "4-axis linear interpolation control", "speed-position switching control" or "position-speed switching control". (In the case of linear interpolation control, the function is valid for only the reference axis.) Refer to Section 3.2.5 "Combination of QD77GF main functions and sub functions".
- (2) The deceleration start flag does not turn ON when the operation pattern is "continuous positioning control" or "continuous path control".
- (3) The deceleration start flag function is invalid for an HPR, JOG operation, inching operation, manual pulse generator operation, speed-torque control and deceleration made with a stop signal.
- (4) The deceleration start flag does not turn ON when a speed change or override is used to make deceleration.
- (5) If a target position change is made while the deceleration start flag is ON, the deceleration start flag remains ON.



- (6) When the movement direction is reversed by a target position change, the deceleration start flag turns ON.

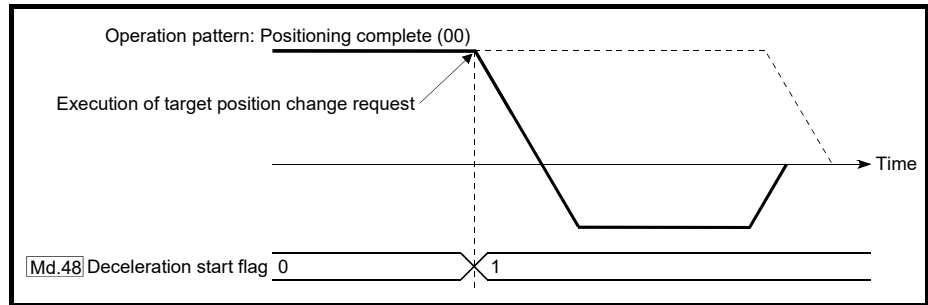

- (7) During position control of position-speed switching control, the deceleration start flag is turned ON by automatic deceleration. The deceleration start flag remains ON if position control is switched to speed control by the position-speed switching signal after the deceleration start flag has turned ON.
- (8) If the condition start of a block start is not made since the condition is not satisfied, the deceleration start flag turns ON when the shape is "End".
- (9) When an interrupt request during continuous operation is issued, the deceleration start flag turns ON at a start of deceleration in the positioning data being executed.

[3] Deceleration start flag function setting method

To use the "deceleration start flag function", set "1" to the following control data using a sequence program.

The set data is made valid on the rising edge (OFF to ON) of the PLC READY signal [Y0].

| Setting item | Setting value | Setting details | Buffer memory address |
|---------------------------------------|---------------|--|-----------------------|
| [Cd.41] Deceleration start flag valid | → | Set whether the deceleration start flag function is made valid or invalid. 0: Deceleration start flag invalid 1: Deceleration start flag valid | 5905 |

*: Refer to Section 5.7 "List of control data" for details on the setting details.

[4] Checking of deceleration start flag

The "deceleration start flag" is stored into the following buffer memory addresses.

| Monitor item | Monitor value | Storage details | Buffer memory address |
|---------------------------------|---------------|--|-----------------------|
| [Md.48] Deceleration start flag | → | 0: Status other than below 1: Status from deceleration start to next operation start or manual pulse generator operation enable | 2499+100n |

n: Axis No.-1

*: Refer to Section 5.6 "List of monitor data" for information on the storage details.

13.7.9 Stop command processing for deceleration stop function

The "stop command processing for deceleration stop function" is provided to set the deceleration curve if a stop cause occurs during deceleration stop processing (including automatic deceleration).

This function is valid for both trapezoidal and S-curve acceleration/deceleration processing methods.

(For the stop cause, refer to Section 1.2.3 "Outline of stopping".)

The "stop command processing for deceleration stop function" performs the following two operations:

- (1) **Deceleration curve re-processing**
Re-processes a deceleration curve starting from the speed at stop cause occurrence until at a stop, according to the preset deceleration time.
- (2) **Deceleration curve continuation**
Continues the current deceleration curve after a stop cause has occurred.

This section explains the "stop command processing for deceleration stop function" as follows:

- [1] Control
- [2] Precautions for control
- [3] Setting method

[1] Control

The operation of "stop command processing for deceleration stop function" is explained below.

(1) Deceleration curve re-processing

A deceleration curve is re-processed starting from the speed at stop cause occurrence until at a stop, according to the preset deceleration time.

If a stop cause occurs during automatic deceleration of position control, the deceleration stop processing stops as soon as the target has reached the positioning address specified in the positioning data that is currently executed.

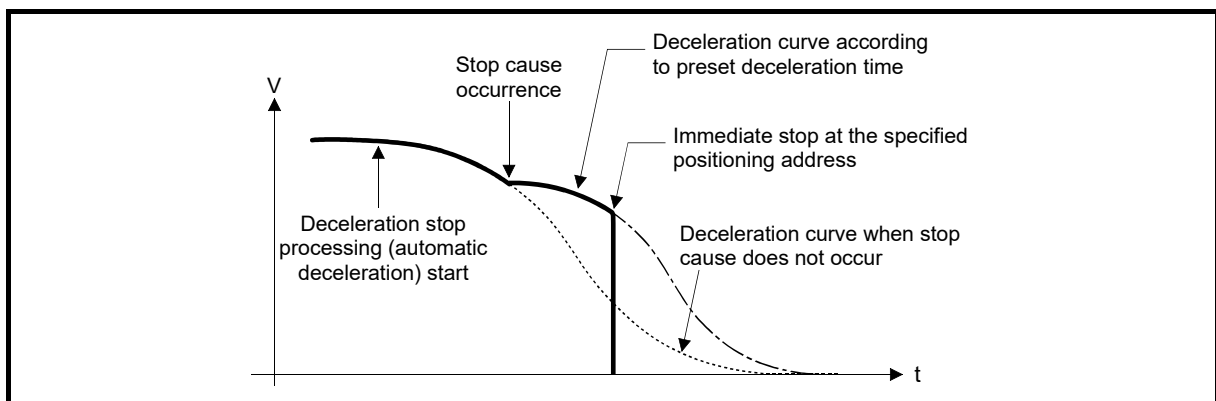

Fig. 13.51 Deceleration curve re-processing operation (for position control or S-curve acceleration/deceleration processing)

(2) Deceleration curve continuation

The current deceleration curve is continued after a stop cause has occurred. If a stop cause occurs during automatic deceleration of position control, the deceleration stop processing may be complete before the target has reached the positioning address specified in the positioning data that is currently executed.

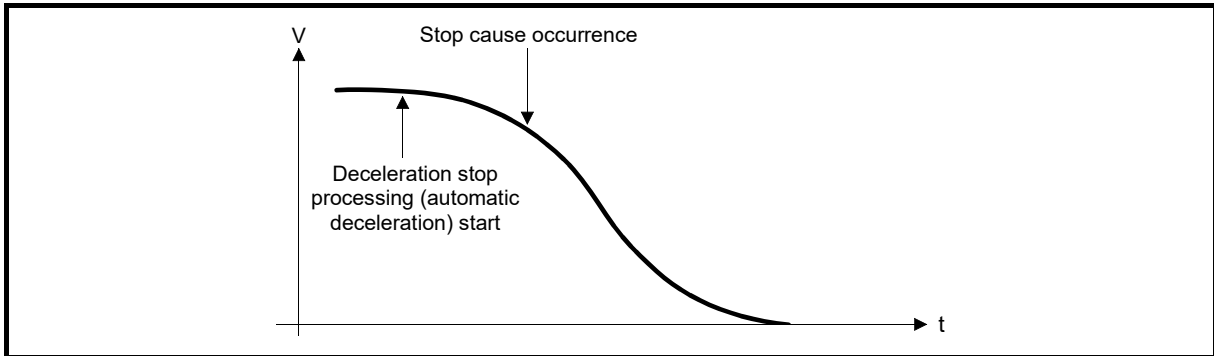

Fig. 13.52 Deceleration curve continuation operation (for position control or S-curve acceleration/deceleration processing)

[2] Precautions for control

- (1) In manual control (JOG operation, inching operation, manual pulse generator operation) and speed-torque control, the stop command processing for deceleration stop function is invalid.
- (2) The stop command processing for deceleration stop function is valid when "0: Normal deceleration stop" is set in "[Pr.37] Stop group 1 rapid stop selection" to "[Pr.39] Stop group 3 rapid stop selection" as the stopping method for stop cause occurrence.
- (3) The stop command processing for deceleration stop function is invalid when "1: Rapid stop" is set in "[Pr.37] Stop group 1 rapid stop selection" to "[Pr.39] Stop group 3 rapid stop selection". (A deceleration curve is re-processed starting from the speed at stop cause occurrence until at a stop, according to the "[Pr.36] Rapid stop deceleration time".)

In the position control (including position control of speed/position changeover control or position/speed changeover control) mode, positioning may stop immediately depending on the stop cause occurrence timing and "[Pr.36] Rapid stop deceleration time" setting.

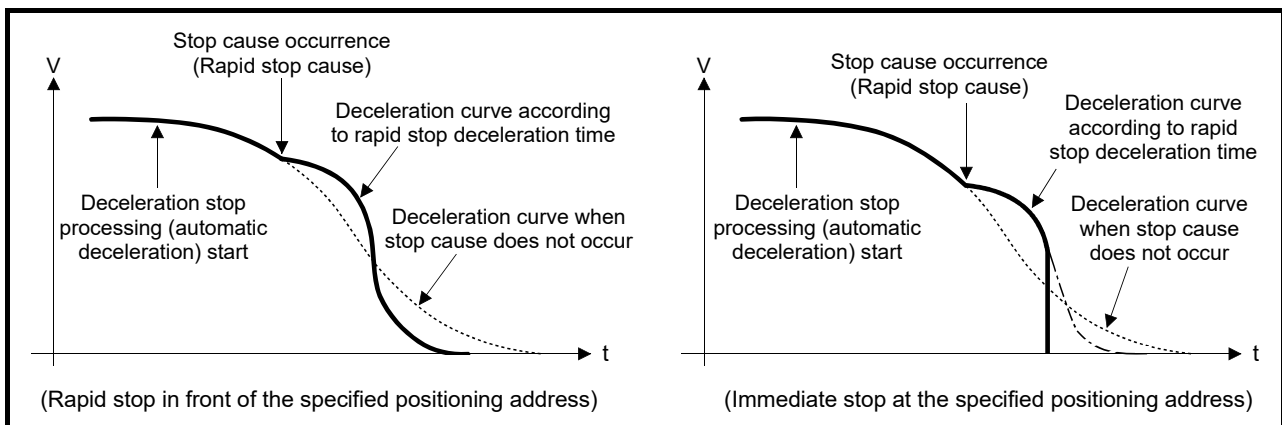

Fig. 13.53 Rapid stop operation (for position control or S-curve acceleration/deceleration processing)

[3] Setting method

To use the "stop command processing for deceleration stop function", set the following control data in a sequence program.

The set data are made valid as soon as they are written to the buffer memory.

The PLC ready signal [Y0] is irrelevant.

| Setting item | | Setting value | Setting details | Buffer memory address |
|--------------|---|---------------|--|-----------------------|
| [Cd.42] | Stop command processing for deceleration stop selection | → | Set the stop command processing for deceleration stop function. 0: Deceleration curve re-processing 1: Deceleration curve continuation | 5907 |

*: For details of the setting details, refer to Section 5.7 "List of control data".

13.7.10 Speed control 10 x multiplier setting for degree axis function

The "Speed control 10 x multiplier setting for degree axis function" is provided to execute the positioning control by 10 x speed of the setting value in the command speed and the speed limit value when the setting unit is "degree".

This section explains the "speed control 10 multiplier specifying function for degree axis" as follows:

[1] Control details

[2] Setting method of "Speed control 10 x multiplier setting for degree axis function"

[1] Control details

When "Speed control 10 multiplier specifying function for degree axis" is valid, this function related to the command speed, monitor data, speed limit value, is shown below.

(1) Command speed

(a) Parameters

- "[Pr.7] Bias speed at start"
- "[Pr.46] HPR speed"
- "[Pr.47] Creep speed"
- "[Cd.14] New speed value"
- "[Cd.17] JOG speed"
- "[Cd.25] Position-speed switching control speed change register"
- "[Cd.28] Target position change value (New speed)"
- "[Cd.140] Command speed at speed control mode"
- "[Da.8] Command speed"

(b) Major positioning control

- 1) For "2 to 4 axis linear interpolation control" and "2 to 4 axis fixed-feed control", the positioning control is performed at decuple speed of command speed, when "[Pr.83] Speed control 10 x multiplier setting for degree axis" of reference axis is valid.
- 2) For "2 to 4 axis speed control", "[Pr.83] Speed control 10 x multiplier setting for degree axis" is evaluated whether it is valid for each axis. If valid, the positioning control will be performed at decuple speed of command speed.

(2) Monitor data

- "[Md.22] Feedrate"
- "[Md.27] Current speed"
- "[Md.28] Axis feedrate"
- "[Md.33] Target speed"
- "[Md.122] Speed during command"

*: For the above monitoring data, "[Pr.83] Speed control 10 x multiplier setting for degree axis" is evaluated whether it is valid for each axis. If valid, unit conversion value is changed ($\times 10^{-3} \rightarrow \times 10^{-2}$). The unit conversion table of monitor value is shown below.

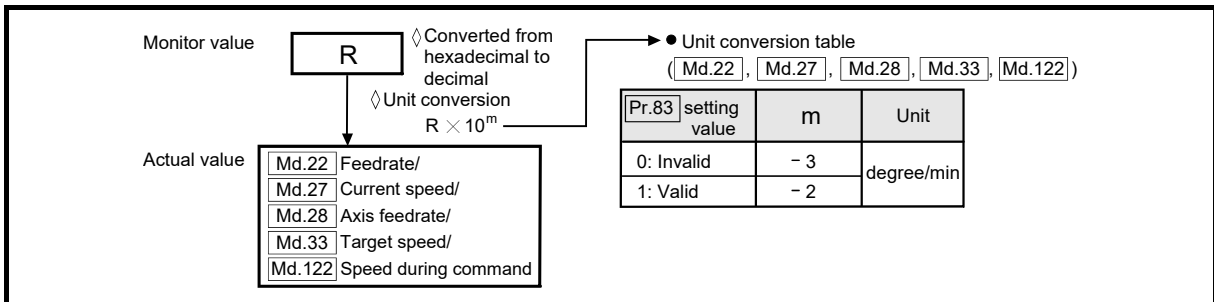

(3) Speed limit value

- "[Pr.8] Speed limit value"
- "[Pr.31] JOG speed limit value"
- "[Cd.146] Speed limit value at torque control mode"

*: For the speed limit value, "[Pr.83] Speed control 10 x multiplier setting for degree axis" is evaluated whether it is valid for each axis. If valid, the positioning control will be performed at decuple speed of setting value (max. speed).

[2] Setting method of "Speed control 10 x multiplier setting for degree axis function"

Normally, the speed specification range is 0.001 to 2000000.000[degree/min], but it will be decupled and become 0.01 to 20000000.00[degree/min] by setting "[Pr.83] Speed control 10 x multiplier setting for degree axis" to valid.

To use the "Speed control 10 x multiplier setting for degree axis function", set the parameters shown in the following table.

| Setting item | Setting value | Setting details | Buffer memory address |
|---|---------------|--|-----------------------|
| [Pr.83] Speed control 10 x multiplier setting for degree axis | → | Set the speed control 10 x multiplier setting for degree axis. 0: Invalid 1: Valid | 63+150n |

n: Axis No.-1

*: Refer to Section 5.2.4 "Detailed parameters 2" for details on the setting details.

13.7.11 Operation setting for incompleteness of HPR function

The "Operation setting for incompleteness of HPR function" is provided to select whether positioning control is operated or not, when HPR request flag is ON.

This section explains the "Operation setting for incompleteness of HPR function" as follows:

- [1] Control details
- [2] Precautions during control
- [3] Setting method of "Operation setting for incompleteness of HPR function"

[1] Control details

When "[Pr.55] Operation setting for incompleteness of HPR" is valid, this function related to the command speed, monitor data, speed limit value, is shown below.

| Item | [Pr.55] Operation setting for incompleteness of HPR | |
|---|---|---|
| | "0: Positioning control is not executed." and "HPR request flag ON" | "1: Positioning control is executed." and "HPR request flag ON" |
| <ul style="list-style-type: none"> • Machine HPR • JOG operation • Inching operation • Manual pulse generator operation • Current value changing using current value changing start No. (No. 9003). | ○*1 | ○*1 |
| The positioning control is impossible to start/restart in the following case. <ul style="list-style-type: none"> • 1-axis linear control • 2/3/4-axis linear interpolation control • 1/2/3/4-axis fixed-feed control • 2-axis circular interpolation control with sub point designation • 2-axis circular interpolation control with center point designation • 1/2/3/4-axis speed control • Speed-position switching control (INC mode/ ABS mode) • Position-speed switching control • Current value changing using positioning data No. (No.1 to 600). | × | ○*1 |
| Control mode switching | × | ○*1 |

○: Positioning start possible (Execution possible)

×: Positioning start impossible (Execution not possible)

*1: There may be restrictions in the operation for incompleteness of HPR depending on the setting or specifications of the servo amplifier. Refer to the servo amplifier instruction manual for details.

[2] Precautions during control

- (1) The error "Start at HPR incomplete" (error code: 547) occurs if HPR request flag ([Md.31] Status: b3) is executed the positioning control by turning on, when "0: Positioning control is not executed" is selected the operation setting for incompleteness of HPR setting, and positioning control will not be performed. At this time, operation with the manual control (JOG operation, inching operation, manual pulse generator operation) is available.

(2) When HPR request flag ([Md.31] Status: b3) is ON, starting Fast HPR will result in the error "HPR request ON" (error code: 207) despite the setting value of "[Pr.55] Operation setting for incompleation of HPR", and Fast HPR will not be performed.

[3] Setting method of "Operation setting for incompleation of HPR"

To use the "Operation setting for incompleation of HPR", set the following parameters using a sequence program.

| Setting item | | Setting value | Setting details | Buffer memory address |
|--------------|--|---------------|---|-----------------------|
| [Pr.55] | Operation setting for incompleation of HPR | → | Set the operation setting for incompleation of HPR. 0: Positioning control is not executed. 1: Positioning control is executed. | 87+150n |

n: Axis No.-1

*: Refer to Section 5.2.6 "HPR detailed parameters" for details on the setting details.

13.8 Servo ON/OFF

13.8.1 Servo ON/OFF

This function executes servo ON/OFF of the servo amplifiers connected to the Simple Motion module.

By establishing the servo ON status with the servo ON command, servo motor operation is enabled.

Use the following two signals to execute servo ON/OFF.

- All axis servo ON [Y1]
- [Cd.100] Servo OFF command (Buffer memory addresses: 4351+100n)

A list of the "All axis servo ON [Y1]" and "[Cd.100] Servo OFF command" is given below.

| | | [Cd.100] Servo OFF command | | | |
|-----------------------|-----|----------------------------|--|----------------------------|--|
| | | Setting value "0" | | Setting value "1" | |
| | | Command to servo amplifier | | Command to servo amplifier | |
| All axis servo ON: Y1 | OFF | × | Servo ON command: OFF Ready ON command: OFF | × | Servo ON command: OFF Ready ON command: OFF |
| | ON | ○ | Servo ON command: ON Ready ON command: ON | × | Servo ON command: OFF Ready ON command: ON |

○: Servo ON (Servo operation enabled), ×: Servo OFF (Servo operation disabled)

POINT

When the delay time of "Electromagnetic brake sequence output (PC02)" is used, execute the servo ON to OFF by "[Cd.100] Servo OFF command". (When all axis servo ON [Y1] is turned ON to OFF, set "1" in "[Cd.100] Servo OFF command" and execute the servo OFF. Then, turn off [Y1] after delay time passes.)

Refer to each servo amplifier instruction manual for details of servo ON command OFF and ready ON command OFF from Simple Motion module.

[1] Servo ON (Servo operation enabled)

The following shows the procedure for servo ON.

- (1) Make sure that the servo LED indicates "b_".
(The initial value for "All axis servo ON [Y1]" is "OFF".)
- (2) Set "0" for "[Cd.100] Servo OFF command".
- (3) Turn ON "All axis servo ON [Y1]".

Now the servo amplifier turns ON the servo (servo operation enabled state).
(The servo LED indicates "d_".)

[2] Servo OFF (Servo operation disabled)

The following shows the procedure for servo OFF.

- (1) Set "1" for "[Cd.100] Servo OFF command". (The servo LED indicates "c_".)
(If the "[Cd.100] Servo OFF command" set "0" again, after the servo operation enabled.)
- (2) Turn OFF "All axis servo ON [Y1]".
(The servo LED indicates "b_".)

POINT

- If the servomotor is rotated by external force during the servo OFF status, follow up processing is performed.
- Change between servo ON or OFF status while operation is stopped (position control mode).

The servo OFF command of during positioning in position control mode, manual pulse control, HPR, speed control mode and torque control mode will be ignored.

- When the servo OFF is given to all axes, "All axis servo ON [Y1]" is applied even if all axis servo ON command is turned ON to OFF with "[Cd.100] Servo OFF command" set "0".

13.8.2 Follow up function

(1) Follow up function

The follow up function monitors the number of motor rotations (actual present value) with the servo OFF and reflects the value in the present feed value.

If the servomotor rotates during the servo OFF, the servomotor will not just rotate for the amount of droop pulses at switching the servo ON next time, so that the positioning can be performed from the stop position.

(2) Execution of follow up

Follow up function is executed continually during the servo OFF status.

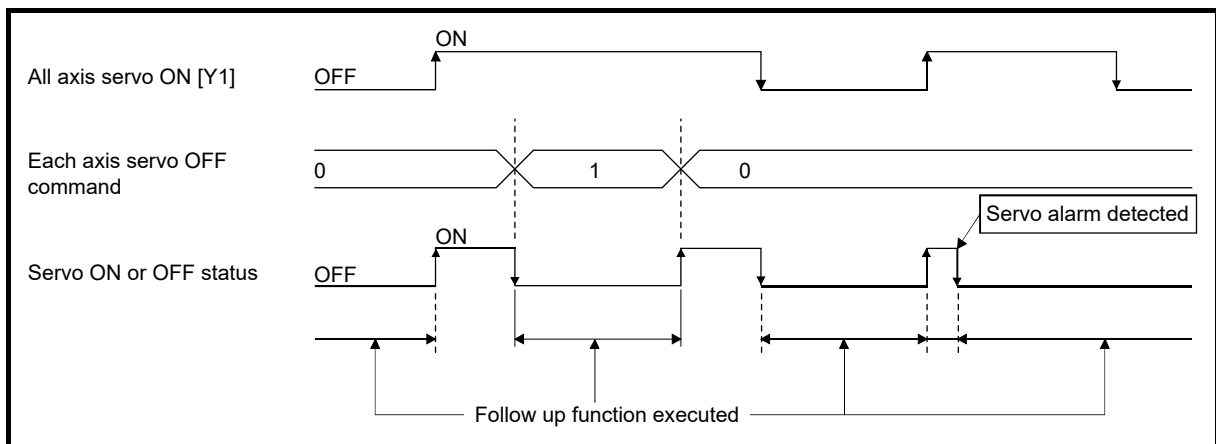

Fig. 13.54 Operation timings of follow up function

POINT

- The follow-up function performs the process if the "Simple Motion module and the servo amplifier is turned ON" and "servo OFF" regardless of the presence of the absolute position system.

Chapter 14 Common Functions

The details and usage of the "common functions" executed according to the user's requirements are explained in this chapter.

Common functions include functions required when using the Simple Motion module, such as parameter initialization and execution data backup.
Read the setting and execution procedures for each common function indicated in this chapter thoroughly, and execute the appropriate function where required.

| | | |
|------|---|--------|
| 14.1 | Outline of common functions..... | 14- 2 |
| 14.2 | Parameter initialization function | 14- 3 |
| 14.3 | Execution data backup function | 14- 5 |
| 14.4 | External signal selection function..... | 14- 7 |
| 14.5 | External I/O signal logic switching function..... | 14- 12 |
| 14.6 | History monitor function..... | 14- 14 |
| 14.7 | Virtual servo amplifier function | 14- 18 |
| 14.8 | Mark detection function | 14- 21 |
| 14.9 | Module error collection function | 14- 32 |

14.1 Outline of common functions

"Common functions" are executed according to the user's requirements, regardless of the control method, etc. These common functions are executed by GX Works2 or sequence programs.

The following table shows the functions included in the "common functions".

| Common function | Details | Means | |
|--|--|------------------|-----------|
| | | Sequence program | GX Works2 |
| Parameter initialization function | This function returns the parameter stored in the buffer memory/internal memory and flash ROM/internal memory (nonvolatile) of Simple Motion module to the factory-set initial value. | ○ | ○ |
| Execution data backup function | This function writes the "execution data", currently being used for control, to the flash ROM/internal memory (nonvolatile). | ○ | ○ |
| External signal selection function | This function is used to select from the following signals when using the upper/lower limit signal and the proximity dog signal. <ul style="list-style-type: none"> • External input signal of servo amplifier • External input signal via CPU (the buffer memory of QD77GF) | ○ | ○ |
| External I/O signal logic switching function | This function switches I/O signal logic according to the equipment connected to the Simple Motion module. For the system in which with b-contact, upper limit switch, and lower limit switch are not used, the parameter logic setting can be controlled without wiring if it is changed to a "positive logic". | ○ | ○ |
| History monitor function | This function monitors start history, error history, warning history, and current value history of all axes. | — | ○ |
| Virtual servo amplifier function | This function executes the operation as the axis (virtual servo amplifier axis) that operates only command (instruction) virtually without servo amplifiers. | ○ | ○ |
| Mark detection function | This function is used to latch any data at the input timing of the mark detection signal (DI1 to DI4). | ○ | ○ |
| Module error collection function | This function collects errors occurred in the Simple Motion module in the PLC CPU. Holding the error contents in the PLC CPU, this function enables to check the error history even after the PLC CPU in powered off or reset. | — | ○ |

14.2 Parameter initialization function

The "parameter initialization function" is used to return the setting data set in the buffer memory/internal memory and flash ROM/internal memory (nonvolatile) of Simple Motion module to their factory-set initial values.

The details shown below explain about the "parameter initialization function".

[1] Parameter initialization means

[2] Control details

[3] Precautions during control

[4] Parameter initialization method

[1] Parameter initialization means

- Initialization is executed with a sequence program.
- Initialization is executed by GX Works2.

Refer to the "Simple Motion Module Setting Tool Help" of GX Works2 for the execution method by GX Works2.

[2] Control details

The following table shows the setting data initialized by the "parameter initialization function".

(The data initialized are "buffer memory/internal memory" and " flash ROM/internal memory (nonvolatile)" setting data.)

| Setting data |
|--|
| Basic parameters ([Pr.1] to [Pr.10]) |
| Detailed parameters ([Pr.11] to [Pr.42], [Pr.80] to [Pr.90], [Pr.95]) |
| HPR basic parameters ([Pr.43] to [Pr.48]) |
| HPR detailed parameters ([Pr.50] to [Pr.57]) |
| Expansion parameters ([Pr.96], [Pr.113], [Pr.132]) |
| Servo parameters ([Pr.101], MR-J4-B use: PA, PB, PC, PD, PE, PS, PF, Po, PL) *1 |
| Positioning data (No.1 to 600) |
| Block start data (No.7000 to 7004) |

*1: Initialized regardless of the status of "[Pr.132] Communication mode setting" at the parameter initialization.

[3] Precautions during control

- (1) Parameter initialization is only executed when the positioning control is not carried out (when the PLC READY signal [Y0] is OFF).
The warning "In PLC READY" (warning code: 111) will occur if executed when the PLC READY signal [Y0] is ON.
- (2) Writing to the flash ROM is up to 100,000 times. If writing to the flash ROM exceeds 100,000 times, the writing may become impossible, and the error "Flash ROM write error" (error code: 801) will occur.
- (3) A "PLC CPU reset" or "PLC CPU power restart" must be carried out after the parameters are initialized.
- (4) If an error occurs on the parameter set in the Simple Motion module when the PLC READY signal [Y0] is turned ON, the READY signal [X0] will not be turned ON and the control cannot be carried out.

Important

Parameter initialization takes about 16 seconds. (Up to 30 seconds are sometimes required.)

Do not turn the power ON/OFF or reset the PLC CPU during parameter initialization. If the power is turned OFF or the PLC CPU module is reset to forcibly end the process, the data backed up in the flash ROM/internal memory (nonvolatile) will be lost.

[4] Parameter initialization method

- (1) Parameter initialization is carried out by the writing of the data shown in the table below to the buffer memory of Simple Motion module using the TO command/intelligent function device.

The initialization of the parameter is executed at the time point the data is written to the buffer memory of Simple Motion module.

| Setting item | Setting value | Setting details | Buffer memory address |
|---|---------------|---|-----------------------|
| [Cd.2] Parameter initialization request | 1 | Set "1: Requests parameter initialization." | 5901 |

*: Refer to Section 5.7 "List of control data" for details on the setting details.

When the initialization is complete, "0" will be set in "[Cd.2] Parameter initialization request" by the Simple Motion module automatically.

14.3 Execution data backup function

When the buffer memory data of Simple Motion module is rewritten from the PLC CPU, "the data backed up in the flash ROM/internal memory (nonvolatile)" of Simple Motion module may differ from "the execution data being used for control (buffer memory data)".

In this case, the execution data will be lost when the PLC power is turned OFF. (Refer to Chapter 7 "Memory Configuration and Data Process".)

The "execution data backup function" is used to back up the execution data by writing to the flash ROM/internal memory (nonvolatile). The data backed up will be written to the buffer memory when the power is turned ON next time.

The details shown below explain about the "execution data backup function".

- [1] Execution data backup (written to flash ROM) means
- [2] Control details
- [3] Precautions during control
- [4] Execution data backup method

| |
|--|
| POINT |
| When the Simple Motion module is replaced, all the data in the Simple Motion module including absolute position data can be backed up (read to) in the personal computer and restored to (written to) the Simple Motion module again by using the backup/restore function of GX Works2. Refer to the "Simple Motion Module Setting Tool Help" for details. |

[1] Execution data backup (written to flash ROM) means

- The backup is executed with a sequence program.
- The backup is written to the flash ROM by GX Works2.

Refer to the "Simple Motion Module Setting Tool Help" of GX Works2 for the flash ROM write method by GX Works2.

[2] Control details

The following shows the data that can be written to the flash ROM/internal memory (nonvolatile) using the "execution data backup function".

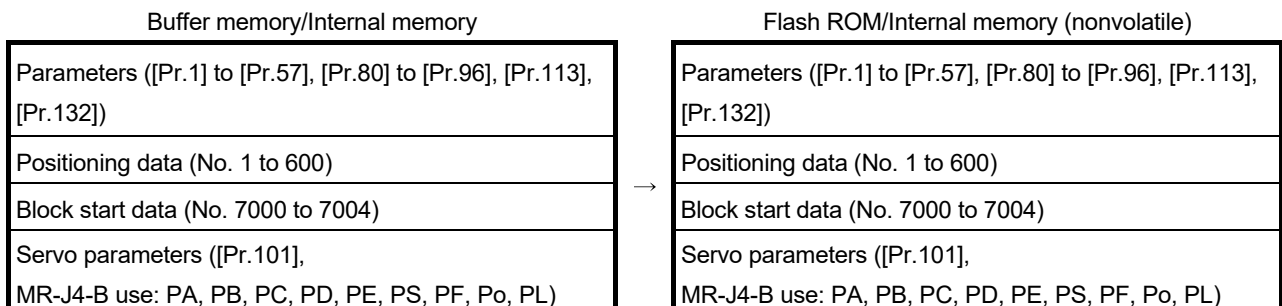

[3] Precautions during control

- (1) Data can only be written to the flash ROM when the positioning control is not carried out (when the PLC READY signal [Y0] is OFF).
The warning "In PLC READY" (warning code: 111) will occur if executed when the PLC READY signal [Y0] is ON.
- (2) Writing to the flash ROM can be executed up to 100,000 times.
If writing to the flash ROM exceeds 100,000 times, the writing may become impossible, and the error "Flash ROM write error" (error code: 801) will occur.
- (3) After one power ON/PLC CPU reset operation, writing to the flash ROM using a sequence program is limited to up to 25 times.
If the 26th writing is executed, the error "Flash ROM write number error" (error code: 805) will occur. If this error occurs, carry out the error reset or power OFF→ON/PLC CPU reset operation again.
Refer to "[Md.19] Number of write accesses to flash ROM" of Section 5.1.9 "Types and roles of monitor data" for details.

Important

Do not turn the power ON/OFF or reset the PLC CPU during executing the flash ROM writing. If the power is turned OFF or the PLC CPU module is reset to forcibly end the process, the data backed up in the flash ROM/internal memory (nonvolatile) will be lost.

[4] Execution data backup method

- (1) Refer to Section 7.2 "Data transmission process" for the data transmission processing at the backup of the execution data.
- (2) Execution data backup is carried out by the writing of the data shown in the table below to the buffer memory of Simple Motion module using the TO command/intelligent function device.
The writing to the flash ROM/internal memory (nonvolatile) is executed at the time point the data is written to the buffer memory of Simple Motion module.

| Setting item | Setting value | Setting details | Buffer memory address |
|--------------------------------|---------------|--|-----------------------|
| [Cd.1] Flash ROM write request | 1 | Set "1: Requests write access to flash ROM." | 5900 |

*: Refer to Section 5.7 "List of control data" for details on the setting details.

When the writing to the flash ROM/internal memory (nonvolatile) is complete, "0" will be set in "[Cd.1] Flash ROM write request" by the Simple Motion module automatically.

14.4 External signal selection function

The "external signal selection function" is used to select from the following signals when using the upper/lower limit signal and proximity dog signal.

- External input signal of servo amplifier
- External input signal via CPU (buffer memory of QD77GF)

When the external input signal via CPU (the buffer memory of QD77GF) is used, the external input signal status of Simple Motion module can be operated by connecting the limit switch to input module and by operating the buffer memory of sequence program. When the external input signal via CPU (the buffer memory of QD77GF) is used, operation is affected by the PLC scan time.

The details shown below explain about the "External signal selection function".

- [1] Parameter setting details
- [2] Precautions during parameter setting
- [3] Control details
- [4] Program example

[1] Parameter setting details

The setting details of the "External signal selection function" are shown in the following table.

| Setting item | Setting value | Setting details | Buffer memory address |
|---|---------------|---|-----------------------|
| [Pr.80] External input signal selection | 1 | Set the external signal selection. 1: External input signal of servo amplifier 2: Buffer memory of QD77GF | 32+150n |

n: Axis No.-1

- (1) When "1: External input signal of servo amplifier" is set, set the Pin No. of external input signal of servo amplifier shown in the following table.

For using a servo amplifier other than the following, refer to each equipment manual for details on specifications.

| Pin No.*1 | Signal name |
|-----------------|-------------|
| CN3-19 (DI3) | DOG |
| CN3-12 (DI2) | LSN |
| CN3-2 (DI1) | LSP |
| Buffer memory*2 | STOP |

*1: Refer to the "Servo Amplifier Instruction Manual" for details on the pin No. of servo amplifier.

*2: The stop signal cannot be input from the external input signal of servo amplifier. To input the stop signal, set "[Cd.44] External input signal operation device". For setting details, refer to Section 5.7.1 "System control data".

- (2) When "2: Buffer memory of QD77GF" is set, use the following control data to operate the external input signal (upper/lower limit signal, proximity dog signal and stop signal).

| Setting item | | Setting value | Setting details | Buffer memory address |
|--------------|--|---------------|---|-----------------------|
| [Cd.44] | External input signal operation device | → | Set the status of the upper/lower limit signal, the proximity dog signal and the stop signal. | 5928 to 5931 |

*: Refer to Section 5.7 "List of control data" for details on the setting details.

[2] Precautions during parameter setting

- (1) When the value which cannot be used is set, the error "External input signal selection error" (error code: 936) occurs at turning the PLC READY signal [Y0] ON, and the READY signal [X0] is not turned ON.
- (2) When "1: External input signal of servo amplifier" is set, use a servo amplifier which enables input of the external input signal.
- (3) When "2: Buffer memory of QD77GF" is set, operation is affected by the PLC scan time.
- (4) When using MR-J4-GF, the servo parameter "Function selection D-4 (PD41)" is required to be set as shown in the following table. [CiA402 mode]
Refer to Section 13.4.4 "Hardware stroke limit function".

| [Pr.80] External input signal selection | Setting of servo parameter "Function selection D-4 (PD41)" |
|---|--|
| 1: External input signal of servo amplifier | 01__H |
| 2: Buffer memory of QD77GF | 11__H |

[3] Control details

The following table shows the external signal that becomes valid by setting "[Pr.80] External input signal selection".

| "[Pr.80] External input signal selection" | External signal that becomes valid |
|--|---|
| External input signal of servo amplifier (Setting value: 1) | Upper/lower stroke limit signal : External input signal of servo amplifier (LSP, LSN) Proximity dog signal : External input signal of servo amplifier (DOG) Stop signal : Buffer memory of QD77GF (STOP) External command/switching signal: External input signal of QD77GF (DI) |
| Buffer memory of QD77GF (Setting value: 2) | Upper/lower stroke limit signal : Buffer memory of QD77GF (FLS, RLS) Proximity dog signal : Buffer memory of QD77GF (DOG) Stop signal : Buffer memory of QD77GF (STOP) External command/switching signal: External input signal of QD77GF (DI) |

[4] Program example

The following shows the program example that is used to operate "[Cd.44] External input signal operation device" of axis 1, axis 4, axis 8, and axis 16 using the limit switch connected to the input module when "2: Buffer memory of QD77GF" is set in "[Pr.80] External input signal selection".

■ System configuration

The following shows the system configuration that is used with the program example.

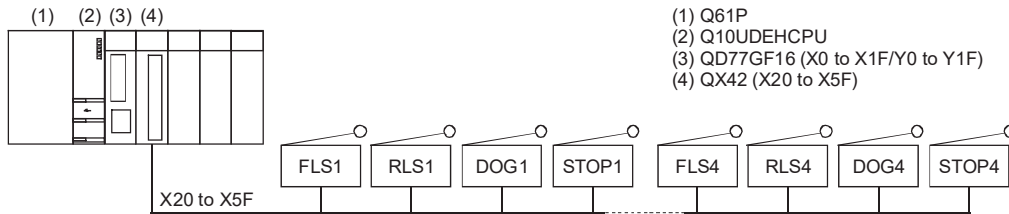

■ List of devices to be used

The following shows the device list that is used with the program example.

| Device name | Device | Limit switch to be connected | Purpose | Description at device ON |
|--------------------------|--------|------------------------------|------------------------|---|
| External input (command) | X20 | FLS 1 | Axis1 FLS ON command | When "[Pr.22] Input signal logic selection" is negative logic: ON When "[Pr.22] Input signal logic selection" is positive logic: OFF |
| | X21 | RLS 1 | Axis1 RLS ON command | |
| | X22 | DOG 1 | Axis1 DOG ON command | |
| | X23 | STOP 1 | Axis1 STOP ON command | |
| | X24 | FLS 2 | Axis4 FLS ON command | |
| | X25 | RLS 2 | Axis4 RLS ON command | |
| | X26 | DOG 2 | Axis4 DOG ON command | |
| | X27 | STOP 2 | Axis4 STOP ON command | |
| | X28 | FLS 3 | Axis8 FLS ON command | |
| | X29 | RLS 3 | Axis8 RLS ON command | |
| | X2A | DOG 3 | Axis8 DOG ON command | |
| | X2B | STOP 3 | Axis8 STOP ON command | |
| | X2C | FLS 4 | Axis16 FLS ON command | |
| | X2D | RLS 4 | Axis16 RLS ON command | |
| | X2E | DOG 4 | Axis16 DOG ON command | |
| | X2F | STOP 4 | Axis16 STOP ON command | |

■ Program example [RJ010 mode]

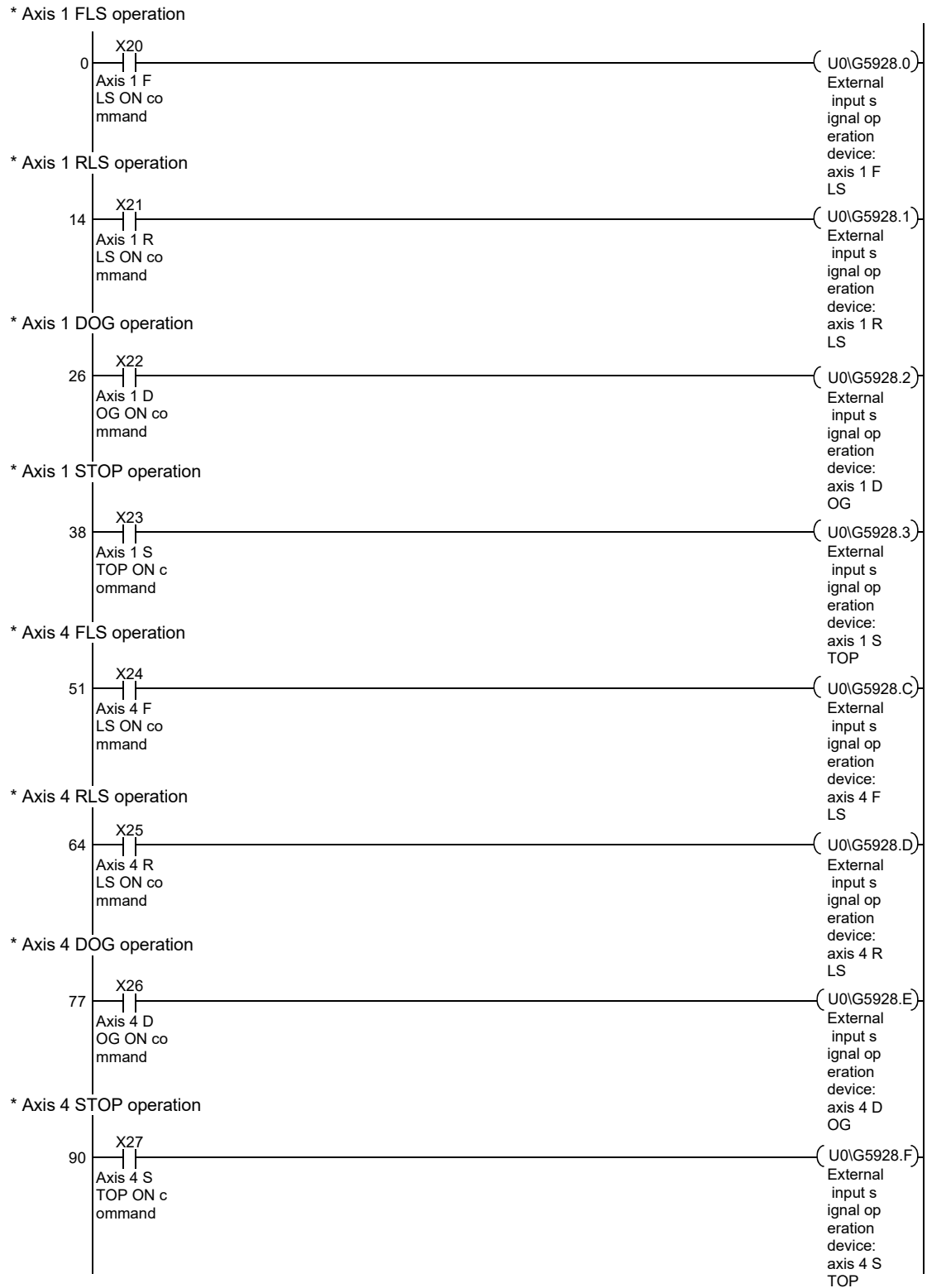

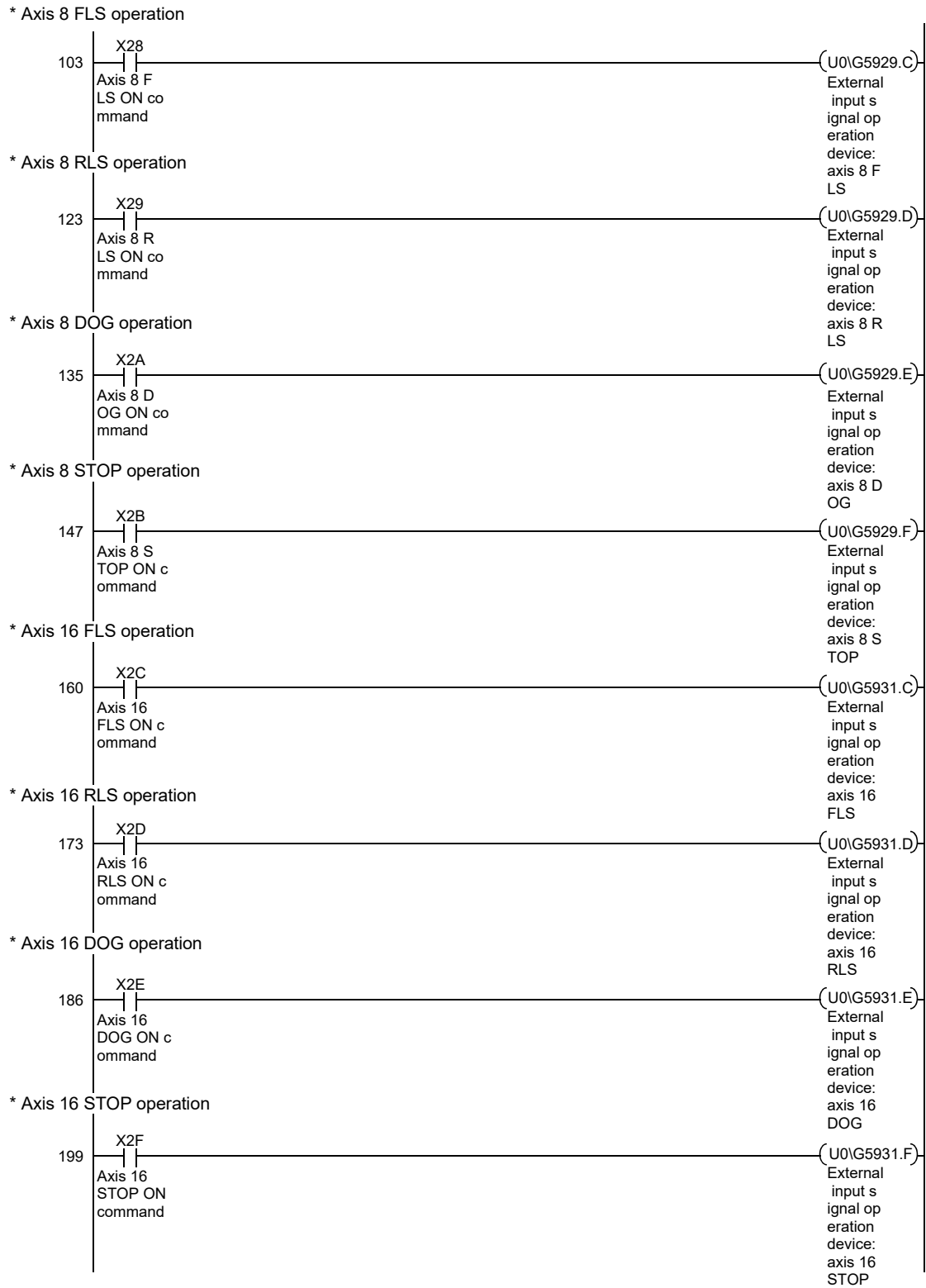

14.5 External I/O signal logic switching function

This function switches the signal logic according to the following signals.

- External equipment connected to the Simple Motion module
- [Cd.44] External input signal operation device
- External input signal of servo amplifier (upper/lower limit switch or proximity dog)

For the system in which b-contact, upper limit switch, and lower limit switch are not used, the parameter logic setting can be controlled without wiring if it is changed to a "positive logic".

When the upper limit switch, and lower limit switch are used, ensure to use them with negative logic (b-contact).

Important

When the MR-J4-GF is connected, set the logic of the upper/lower limit signal (FLS/RLS) and proximity dog signal (DOG) as shown below. If the setting is incorrect, the external input signal may be detected incorrectly during the HPR or positioning operation. For the input logic specification of the servo amplifier, refer to the instruction manual of the servo amplifier to be used.

- When the external input signal of the servo amplifier is used
Set the same value in "[Pr.22] Input signal logic selection" as the value set in the input logic setting of the servo amplifier to be connected.
- When other than the external input signal of the servo amplifier is used.
Change the servo parameter "Function selection T-3 (PT29)" to "1: Dog detection with on".

The details shown below explain about the "External I/O signal logic switching function".

[1] Parameter setting details

[2] Precautions on parameter setting

[1] Parameter setting details

To use the "External I/O signal logic switching function", set the parameters shown in the following table.

| Setting item | | Setting details | | Factory-set initial value | Buffer memory address | |
|--------------|------------------------------|--|---------------------------------------|---------------------------|-----------------------|---|
| [Pr.22] | Input signal logic selection | • Selection of logic of signals input from external device to Simple Motion module | | 0 | 31+150n | |
| | | b0 | Lower limit *2 | | | 0: Negative logic, 1: Positive logic |
| | | b1 | Upper limit *2 | | | |
| | | b2 | Not used | | | Set "0". |
| | | b3 | Stop signal | | | 0: Negative logic, 1: Positive logic |
| | | b4 | External command/ switching signal | | | 0: Negative logic, 1: Positive logic |
| | | b5 | Not used | | | Set "0". |
| | | b6 | Proximity dog signal *2 | | | 0: Negative logic, 1: Positive logic |
| | | b7 | Not used | | | Set "0". |
| | | b8 | Manual pulse generator input *1 | | | 0: Negative logic, 1: Positive logic |
| b9 to b15 | Not used | Set "0". | | | | |

n: Axis No.-1

*1: Only the value specified against the axis 1 is valid for the logic selection of manual pulse generator input (b8).

*2: When a servo amplifier is used and HPR is being executed, the setting is ignored. For the input logic specification of the servo amplifier, refer to the instruction manual of the servo amplifier to be used. [CiA402 mode]

*: Refer to Section 5.2 "List of parameters" for the information on detail settings.

[2] Precautions on parameter setting

- (1) The external I/O signal logic switching parameters are validated when the PLC READY signal [Y0] is turned OFF to ON. (The logic is negative right after power-on.)
- (2) If the logic of each signal is set erroneously, the operation may not be carried out correctly.
Before setting, check the specifications of the equipment to be used.
- (3) When the same external input signal is set to use to the multiple axes in "[Pr.80] External input signal selection" or "[Pr.95] External command signal selection", "Input signal logic selection" of those axes should be the same. Otherwise, the error "Input signal logic selection setting error" (error code: 938) occurs when the PLC READY signal [Y0] is turned ON, and the READY signal [X0] will not be turned ON.

14.6 History monitor function

This function monitors start history, error history, warning history, and current history stored in the buffer memory of the Simple Motion module on the operation monitor of GX Works2.

[1] Starting history

Sixteen starting history logs of operations such as positioning operation, JOG operation, and manual pulse generator operation can be monitored. The latest history 16 logs can be monitored all the time. This function allows users to check the operation sequence (whether the operations have been started in a predetermined sequence) at system start-up.

For the starting history check method, refer to the "Simple Motion Module Setting Tool Help" of GX Works2.

[2] Error history, warning history

The error and warning history logs can be monitored.
The latest history 16 logs can be monitored all the time.

For the error and warning history check method, refer to the "Simple Motion Module Setting Tool Help" of GX Works2.

| |
|--------------|
| POINT |
|--------------|

| |
|---|
| Set the clock of PLC CPU. Refer to the "GX Works2 Version1 Operating Manual (Common)" for setting method. |
|---|

[3] Current value history

The current value history data of each axis can be monitored. The following shows about the current value history data of each axis.

| Monitor details | Monitor item |
|---|---|
| Latest backup data The number of backup: Once | Feed current value |
| | Servo command value |
| | Encoder single revolution position |
| | Encoder multiple revolution counter |
| | Time 1 (Year: month) *1 |
| | Time 2 (Day: hour) *1 |
| | Time 3 (Minute: second) *1 |
| | Latest backup data pointer |
| Backup data at the power disconnection The number of backup: 4 times | Feed current value |
| | Servo command value |
| | Encoder single revolution position |
| | Encoder multiple revolution counter |
| | Time 1 (Year: month) *1 |
| | Time 2 (Day: hour) *1 |
| | Time 3 (Minute: second) *1 |
| | Backup data pointer |
| Backup data at the power on The number of backup: 4 times | Feed current value |
| | Servo command value |
| | Encoder single revolution position |
| | Encoder multiple revolution counter |
| | Time 1 (Year: month) *1 |
| | Time 2 (Day: hour) *1 |
| | Time 3 (Minute: second) *1 |
| | Error code at current value restoration |
| Home position return data The number of backup: Once | Feed current value |
| | Servo command value |
| | Encoder single revolution position |
| | Encoder multiple revolution counter |
| | Time 1 (Year: month) *1 |
| | Time 2 (Day: hour) *1 |
| | Time 3 (Minute: second) *1 |

*1: Displays a value set by the clock function of the CPU module.

■ Latest backup data

The latest backup data outputs the following data saved in the fixed cycle to the buffer memory.

- Feed current value
- Servo command value
- Encoder single revolution position
- Encoder multiple revolution counter
- Time 1 (Year: month) data
- Time 2 (Day: hour) data
- Time 3 (Minute: second) data
- Latest backup data pointer

The latest backup data starts outputting the data after the power on.

After the home position is established in the absolute system, the data becomes valid and outputs the current value.

The following servo amplifier and servo motor are connected artificially during amplifier-less operation. Therefore, the encoder single revolution position and encoder multiple revolution counter made virtually by the command value are output.

[CiA402 mode]

Servo amplifier type: MR-J4-10GF

Motor type : HG-KR053 (Resolution per servo motor rotation: 4194304 PLS/rev)

■ Backup data at the power disconnection

The detail of the latest backup data right before the power disconnection is output to the buffer memory.

The backup data at the power on starts being output after the power on.

The backup data at the power disconnection starts being output after the power on.

The detail of the latest backup data right before the power disconnection used in the absolute system setting is output, regardless of the setting of the absolute system or incremental system.

If the data has never been used in the absolute system in the incremental system setting, "0" is output in all storage items.

■ Backup data at the power on

After the power on, the detail of the data which restored the current value is output to the buffer memory.

The backup data at the power on starts being output after the power on.

If the current value cannot be restored in the absolute system, "0" is set to the feed current value and servo command value.

The error "HPR data incorrect" (error code: 1201) is set in the error code at current value restoration.

When the incremental system is set, the detail of the backup data at the power on used in the absolute system setting is output. If the data has never been used in the absolute system, "0" is output in all storage items.

■ Home position return data

The following data saved at home position return completion to the buffer memory.

- Feed current value at home position return completion
- Servo command value at home position return completion
- Encoder single revolution position of absolute position reference point data
- Encoder multiple revolution counter of absolute position reference point data
- Time 1 (Year: month) data
- Time 2 (Day: hour) data
- Time 3 (Minute: second) data

The data becomes valid only when the absolute system is set.

If the data has never been used in the absolute system in the incremental system setting,

"0" is output in all storage items.

14.7 Virtual servo amplifier function

This function executes the operation virtually without connecting servo amplifiers (regarded as connected) by setting "1" in servo amplifier setting parameter "[Pr.101] Virtual servo amplifier setting". The synchronous control with virtually input command is possible by using the virtual servo amplifier axis as servo input axis of synchronous control. Also, it can be used as simulation operation for axes without servo amplifiers.

The details shown below explain about the "Virtual servo amplifier function".

[1] Control details

[2] Restrictions

[1] Control details [RJ010 mode]

- (1) The virtual servo amplifier function can be used by the following methods.
 - (a) When the virtual servo amplifier is used, do not set the axis (station) as use station in the network parameter of GX Works2.
 - (b) When "1" is set in "[Pr.101] Virtual servo amplifier setting" set in the flash ROM, it operates as virtual servo amplifier immediately after power supply ON. (However, when the station is set as use station in the network parameter of GX Works2, the error "Virtual servo amplifier setting error" (error code: 1004) will occur and the READY signal [X0] will not be turned ON if the PLC READY signal [Y0] is turned OFF to ON.)
 - (c) When other than "1" is set in "[Pr.101] Virtual servo amplifier setting" set in the flash ROM, it does not operate as virtual servo amplifier even if "1" is set in "[Pr.101] Virtual servo amplifier setting" of buffer memory after power supply ON and the PLC READY signal [Y0] is turned OFF to ON.
 - (d) The servo amplifier is not recognized even if the actual servo amplifier is connected to axis (station) set as virtual servo amplifier.
 - (e) When the virtual servo amplifier is set in the system setting of GX Works2, "0: Disabled (used in incremental system)" is set in "Absolute position detection system (PA03)".
Set "1: Enabled (absolute position detection system)" to the buffer memory to use as absolute position system.
 - (f) The virtual servo amplifier operates with "0: MR-J4-B-RJ010 communication mode" even if "1: Communication mode correspond to CiA402" is set in "[Pr.132] Communication mode setting".

| POINT |
|--|
| Do not make to operate by switching between the actual servo amplifier and virtual servo amplifier. When the station is set as use station in the network parameter of GX Works2, the servo amplifier cannot be used as virtual servo amplifier even if the "[Pr.101] Virtual servo amplifier setting" of buffer memory is changed after power supply ON and then the PLC READY signal [Y0] is turned OFF to ON. |

(2) The feed current value and feed machine value of virtual servo amplifier are as follows.

(a) When the absolute position system is not in use

The both of feed current value and feed machine value are set to "0".

(b) When the absolute position system is in use

HP is established: Address at latest power supply OFF

HP is not established: "0" (Feed current value and feed machine value)

[2] Restrictions

(1) The following monitor data of virtual servo amplifier differ from the actual servo amplifier.

| Storage item | | Storage details | Buffer memory address |
|--------------|---------------------------------------|---|------------------------|
| [Md.102] | Deviation counter value | Always "0". | 2452+100n 2453+100n |
| [Md.107] | Parameter error No. | Always "0". | 2470+100n |
| | | <ul style="list-style-type: none"> • Zero point pass (b0) : Always ON • Zero speed (b3) : Changed depending on the command speed • Speed limit (b4) : Always ON when a value other than "0" is set to the command torque at torque control mode. Otherwise, always OFF. • PID control (b8) : Always OFF | 2476+100n |
| [Md.108] | Servo status | <ul style="list-style-type: none"> • READY ON (b0), Servo ON (b1) : Changed depending on the all axis servo ON signal [Y1] and "[Cd.100] Servo OFF command" • Control mode (b2, b3) : Indicates control mode. • Gain switching (b4) : Always OFF • Fully closed loop control switching (b5) : Always OFF • Servo alarm (b7) : Always OFF • In-position (b12) : Always ON • Torque limit (b13) : Changed depending on "[Md.104] Motor current value". (Refer to "Restrictions (2) and (3)" for details.) • Absolute position lost (b14) : Always OFF • Servo warning (b15) : Always OFF | 2477+100n |
| [Md.109] | Regenerative load ratio | Always "0". | 2478+100n |
| [Md.110] | Effective load torque | Always "0". | 2479+100n |
| [Md.111] | Peak torque ratio | Always "0". | 2480+100n |
| [Md.514] | HPR operating status [CiA402 mode] | Always "FFFFH". | 2457+100n |

n: Axis No.-1

(2) The operation of the following function of virtual servo amplifier differs from the actual servo amplifier.

| Function | Operation |
|------------------------------------|---|
| External signal selection function | <p>When "1: External input signal of servo amplifier" is set in "[Pr.80] External input signal selection", the external signal status immediately after power supply ON is shown below.</p> <ul style="list-style-type: none"> • Upper/lower limit signal (FLS, RLS): ON • Proximity dog signal (DOG): OFF <p>Change the signal status in "[Md.30] External input signal". (Refer to "Restrictions (3)" for details.)</p> <p>When "2: Buffer memory of QD77GF" is set in "[Pr.80] External input signal selection", the upper/lower limit signal (FLS, RLS) and the proximity dog signal (DOG) follow the buffer memory status of the Simple Motion module even in the virtual servo amplifier.</p> |
| Torque limit function | <p>Turns ON/OFF the torque limit ("[Md.108] Servo status" high-order buffer memory address: b13) depending on "[Md.104] Motor current value". (Refer to "Restrictions (3)" for details.)</p> |

(3) The following monitor data of virtual servo amplifier differ from the actual servo amplifiers. The writing operation is possible in the virtual servo amplifier.

| Storage item | Storage details | Buffer memory address |
|-------------------------------|---|-----------------------|
| [Md.30] External input signal | <p>When "1: External input signal of servo amplifier" is set in "[Pr.80] External input signal selection", the external input signal status can be operated by turning ON/OFF the following signals.</p> <ul style="list-style-type: none"> • b0: Lower limit signal • b1: Upper limit signal • b6: Proximity dog signal | 2416+100n |
| [Md.104] Motor current value | <p>"0" is set after immediately power supply ON. The motor current value can be emulated by changing this monitor data in user side.</p> | 2456+100n |

n: Axis No.-1

14.8 Mark detection function

Any data can be latched at the input timing of the mark detection signal (DI1 to DI4). Also, only data within a specific range can be latched by specifying the data detection range.

The following three modes are available for execution of mark detection.

1) Continuous detection mode

The latched data is always stored to the first of mark detection data storage area at mark detection.

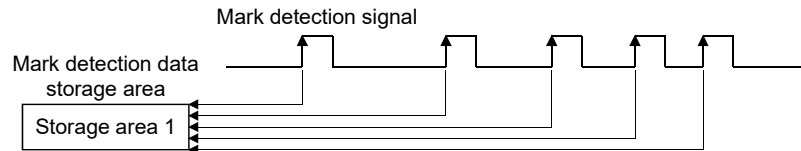

2) Specified number of detections mode

The latched data from a specified number of detections is stored.

The detected position for a specified number of detections can be collected when the mark detection signal is continuously input at high speed.

Example) Number of detections: 3

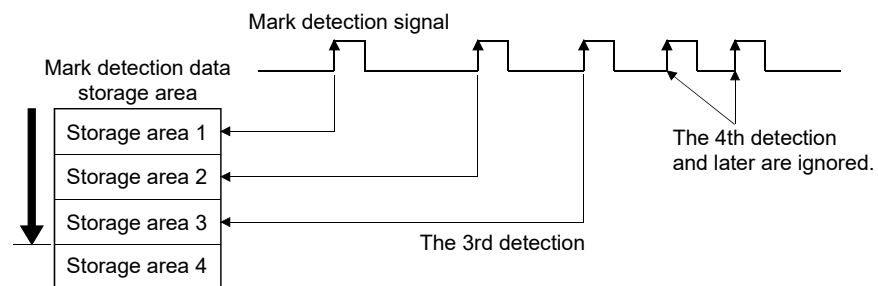

3) Ring buffer mode

The latched data is stored in a ring buffer for a specified number of detections.

The latched data is always stored at mark detection.

Example) Number of detections: 4

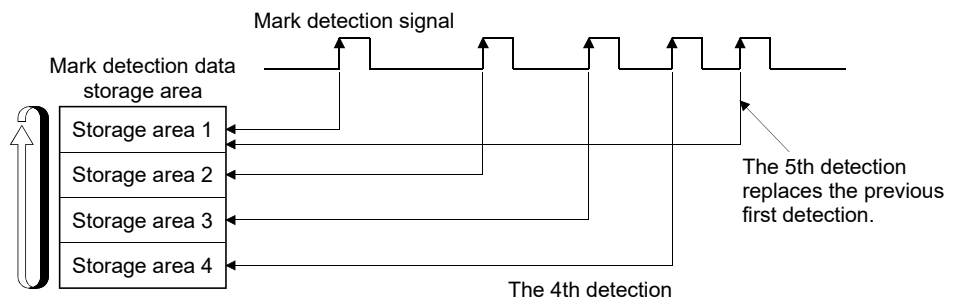

| Item | Performance specifications | | |
|---|--|--|---|
| | QD77GF4 | QD77GF8 | QD77GF16 |
| Number of mark detection settings | Up to 16 | | |
| Input signal | Axis 1 to Axis 4 External input signal (DI1 to DI4) | Axis 1 to Axis 8 External input signal (DI1 to DI4) | Axis 1 to Axis 16 External input signal (DI1 to DI4) |
| Input signal detection direction | Selectable for leading edge or trailing edge in logic setting of external input signal | | |
| Input signal compensation time | Correctable within the range of -32768 to 32767 μ s | | |
| Detection accuracy | 10 μ s | | |
| Latch data | 11 types + Optional buffer memory data (2 word) (Feed current value, Feed machine value, Real current value, Servo input axis current value, Synchronous encoder axis current value, Synchronous encoder axis current value per cycle, Current value after composite main shaft gear, Current value per cycle after main shaft gear, Current value per cycle after auxiliary shaft gear, Cam axis current value per cycle, Cam axis current value per cycle (real position)) | | |
| Number of continuous latch data storage | Up to 32 | | |
| Latched data range | Settable in the range of -2147483648 to 2147483647 | | |

The details shown below explain about the "Mark detection function".

- [1] Operation for mark detection function
- [2] How to use mark detection function
- [3] List of buffer memory
- [4] Precautions

[1] Operation for mark detection function

Operations done at mark detection are shown below.

- Calculations for the mark detection data are estimated at leading edge/trailing edge of the mark detection signal.
However, when the specified number of detections mode is set, the current number of mark detection is checked, and then it is judged whether to execute the mark detection.
- When a mark detection data range is set, it is first confirmed whether the mark detection data is within the range or not. Data outside the range are not detected.
- The mark detection data is stored in the mark detection data storage area according to the mark detection mode, and then the number of mark detection is updated.

(1) Continuous detection mode

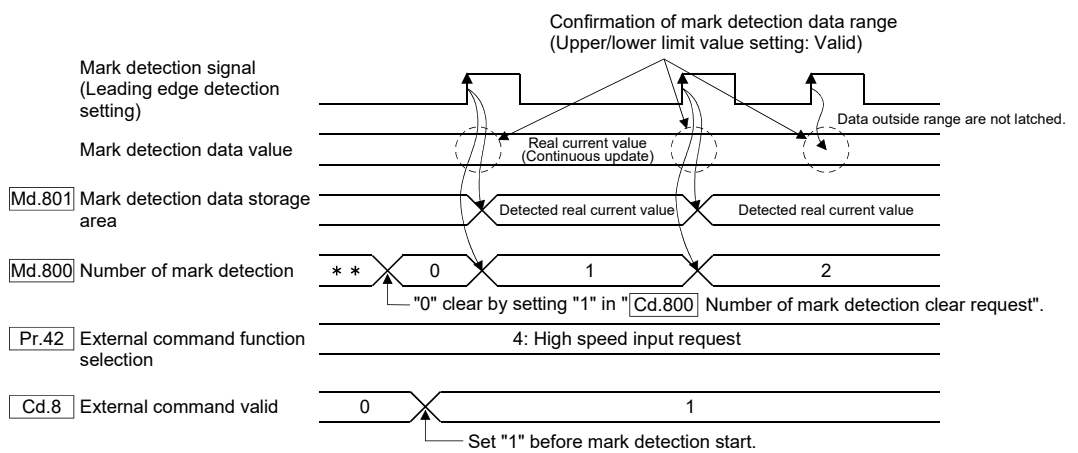

(2) Specified number of detection mode (Number of detections: 2)

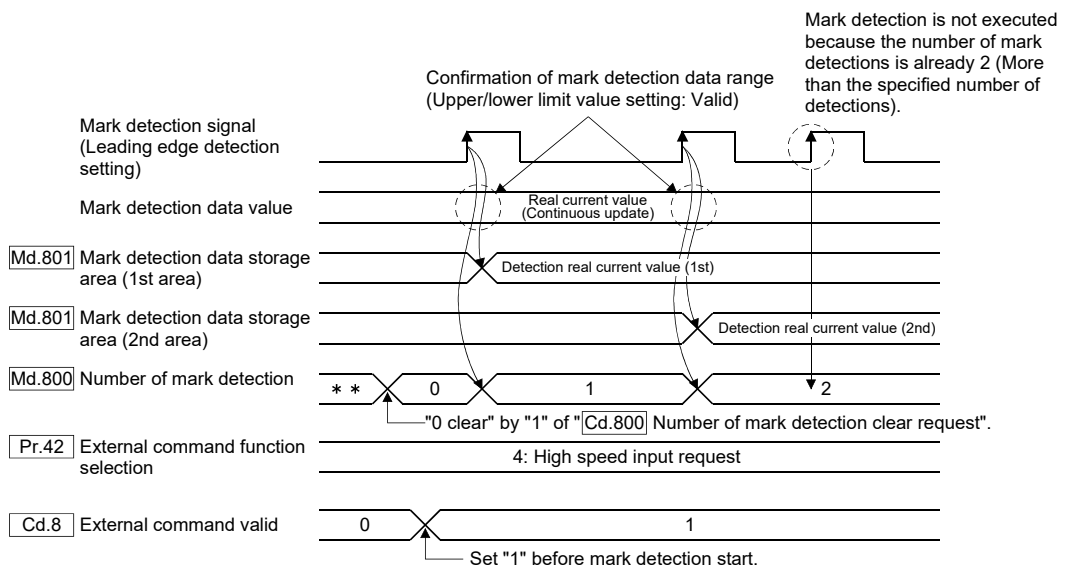

[2] How to use mark detection function

The following shows an example for mark detection by the external command signal (DI2) of axis 2.

The mark detection target is axis 1 real current value, and the all range is detected in continuous detection mode.

- (1) Allocate the input signal (DI2) to the external command signal of axis 2, and set the "high speed input request" for mark detection.

| Setting item | | Setting value | Setting details/setting value | Buffer memory address |
|--------------|-------------------------------------|---------------|--|-----------------------|
| [Pr.95] | External command signal selection | 2 | Set "2: DI2" to the external command signal of axis 2. | 219(69+150n) |
| [Pr.42] | External command function selection | 4 | Set "4: High speed input request" as the function used in the external command signal of axis 2. | 212 (62+150n) |

n: Axis No.-1

- (2) Set the following mark detection setting parameters. The optional mark detection setting No. can be set.

| Setting item | | Setting value | Setting details/setting value | Buffer memory address |
|--------------|---|---------------|---|------------------------|
| [Pr.800] | Mark detection signal setting | 2 | Set "2: Axis 2" to the external input signal for mark detection. | 54000+20k |
| [Pr.801] | Mark detection signal compensation time | 0 | Set "0: (No compensation)" to the compensation time such as delay of sensor. | 54001+20k |
| [Pr.802] | Mark detection data type | 2 | Set "2: Real current value" to the target data for mark detection. | 54002+20k |
| [Pr.803] | Mark detection data axis No. | 1 | Set "1: Axis 1" to the axis No. of target data for mark detection. | 54003+20k |
| [Pr.805] | Latch data range upper limit value | 0 | Set "0" to the valid upper limit value for latch data at mark detection. (Mark detection for all range is executed by setting the same value as lower limit value.) | 54006+20k 54007+20k |
| [Pr.806] | Latch data range lower limit value | 0 | Set "0" to the valid lower limit value for latch data at mark detection. (Mark detection for all range is executed by setting the same value as upper limit value.) | 54008+20k 54009+20k |
| [Pr.807] | Mark detection mode setting | 0 | Set "0: Continuous detection mode" to the mark detection mode. | 54010+20k |

k: Mark detection setting No.-1

- (3) Turn the power supply OFF or reset of PLC CPU to validate the setting parameters.
- (4) The mark detection starts by setting "1: Validates an external command." in "[Cd.8] External command valid" of axis 2 with the sequence program. Refer to "[Md.800] Number of mark detection" or "[Md.801] Mark detection data storage area" of mark detection setting No. set in this section (2) for the number of mark detections and mark detection data.

[3] List of buffer memory

The following shows the configuration of buffer memory for mark detection function.

| Buffer memory address | Number of word | Item | Mark detection setting No. |
|-----------------------|----------------|--|----------------------------|
| 54000 to 54019 | 20 | Mark detection setting parameter [Pr.800] to [Pr.807] | Mark detection setting 1 |
| 54020 to 54039 | 20 | | Mark detection setting 2 |
| 54040 to 54059 | 20 | | Mark detection setting 3 |
| to | to | | to |
| 54300 to 54319 | 20 | | Mark detection setting 16 |
| 54640 to 54649 | 10 | Mark detection control data [Cd.800], [Cd.801] | Mark detection setting 1 |
| 54650 to 54659 | 10 | | Mark detection setting 2 |
| 54660 to 54669 | 10 | | Mark detection setting 3 |
| to | to | | to |
| 54790 to 54799 | 10 | | Mark detection setting 16 |
| 54960 to 55039 | 80 | Mark detection monitor data [Md.800], [Md.801] | Mark detection setting 1 |
| 55040 to 55119 | 80 | | Mark detection setting 2 |
| 55120 to 55199 | 80 | | Mark detection setting 3 |
| to | to | | to |
| 56160 to 56239 | 80 | | Mark detection setting 16 |

- Guide to buffer memory address

In the buffer memory address, "k" in "54002+20k", etc. indicates a value corresponding to mark detection setting No. such as the following table.

| Mark detection setting No. | k | Mark detection setting No. | k | Mark detection setting No. | k | Mark detection setting No. | k |
|----------------------------|---|----------------------------|---|----------------------------|----|----------------------------|----|
| 1 | 0 | 5 | 4 | 9 | 8 | 13 | 12 |
| 2 | 1 | 6 | 5 | 10 | 9 | 14 | 13 |
| 3 | 2 | 7 | 6 | 11 | 10 | 15 | 14 |
| 4 | 3 | 8 | 7 | 12 | 11 | 16 | 15 |

(Note): Calculate as follows for the buffer memory address corresponding to each mark detection setting No.

(Example) For mark detection setting 16

$54002+20k$ ([Pr.802] Mark detection data type)= $54002+20 \times 15=54302$

The following shows the buffer memory used in the mark detection function.

(1) Mark detection setting parameters

| Setting item | | Setting details/setting value | Default value | Buffer memory address |
|--------------|---|---|---------------|------------------------|
| [Pr.800] | Mark detection signal setting | Set the external input signal (high speed input request) for mark detection. 0 : Invalid 1 to 4 : External command signal of axis 1 to axis 4 (at 4-axis module use) 1 to 8 : External command signal of axis 1 to axis 8 (at 8-axis module use) 1 to 16 : External command signal of axis 1 to axis 16 (at 16-axis module use) Fetch cycle: Power supply ON | 0 | 54000+20k |
| [Pr.801] | Mark detection signal compensation time | Set the compensation time such as delay of sensor. Set a positive value to compensate for a delay. -32768 to 32767[μs] Fetch cycle: Power supply ON or PLC READY signal [Y0] OFF to ON | 0 | 54001+20k |
| [Pr.802] | Mark detection data type | Set the target data for mark detection. 0 to 12 : Data type -1 : Optional 2 word buffer memory Fetch cycle: Power supply ON | 0 | 54002+20k |
| [Pr.803] | Mark detection data axis No. | Set the axis No. of target data for mark detection. 1 to 4 : Axis 1 to axis 4 (at 4-axis module use) 1 to 8 : Axis 1 to axis 8 (at 8-axis module use) 1 to 16 : Axis 1 to axis 16 (at 16-axis module use) 801 to 804 : Synchronous encoder axis 1 to axis 4 Fetch cycle: Power supply ON | 0 | 54003+20k |
| [Pr.804] | Mark detection data buffer memory No. | Set the optional buffer memory No. Set this parameter as an even number. 0 to 65534: Optional buffer memory Fetch cycle: Power supply ON | 0 | 54004+20k 54005+20k |
| [Pr.805] | Latch data range upper limit value | Set the valid upper limit value for latch data at mark detection. -2147483648 to 2147483647 Fetch cycle: Power supply ON or PLC READY signal [Y0] OFF to ON | 0 | 54006+20k 54007+20k |
| [Pr.806] | Latch data range lower limit value | Set the valid lower limit value for latch data at mark detection -2147483648 to 2147483647 Fetch cycle: Power supply ON or PLC READY signal [Y0] OFF to ON | 0 | 54008+20k 54009+20k |
| [Pr.807] | Mark detection mode setting | Set the continuous detection mode or specified number of detection mode. 0 : Continuous detection mode 1 to 32 : Specified number of detection mode (Set the number of detections.) -1 to -32 : Ring buffer mode (Set the value that made the number of buffers into negative value.) Fetch cycle: Power supply ON or PLC READY signal [Y0] OFF to ON | 0 | 54010+20k |

k: Mark detection setting No.-1

POINT

The above parameters are valid with the value set in the flash ROM of the Simple Motion module when the power ON or the CPU module reset. Except for a part, the value is not fetched by turning the PLC READY signal ON from OFF. Therefore, write to the flash ROM after setting the value in the buffer memory to change.

[Pr.800] Mark detection signal setting

Set the input signal for mark detection.

- 0 : Invalid
- 1 to 4 : External command signal (DI) of axis 1 to axis 4 (at 4-axis module use)
- 1 to 8 : External command signal (DI) of axis 1 to axis 8 (at 8-axis module use)
- 1 to 16 : External command signal (DI) of axis 1 to axis 16 (at 16-axis module use)

If a value other than the above is set, the warning "Outside mark detection signal setting range" (warning code: 130) occurs and the target mark detection is not available.

Set "4: High speed input request" in "[Pr.42] External command function selection" and set "1: Validates an external command." in "[Cd.8] External command valid".

[Pr.801] Mark detection signal compensation time

Compensate the input timing of the mark detection signal.

Set this parameter to compensate such as delay of sensor input. (Set a positive value to compensate for a delay.)

[Pr.802] Mark detection data type

Set the data that latched at mark detection.

The target data is latched by setting "0 to 12". Set the axis No. in "[Pr.803] Mark detection data axis No.".

Optional 2 word buffer memory is latched by setting "-1". Set the buffer memory No. in "[Pr.804] Mark detection data buffer memory No.".

- 0 : Feed current value
- 1 : Feed machine value
- 2 : Real current value
- 3 : Servo input axis current value
- 6 : Synchronous encoder axis current value
- 7 : Synchronous encoder axis current value per cycle
- 8 : Current value after composite main shaft gear
- 9 : Current value per cycle after main shaft gear
- 10 : Current value per cycle after auxiliary shaft gear
- 11 : Cam axis current value per cycle
- 12 : Cam axis current value per cycle (Real position)
- 1 : Optional 2 words buffer memory

If a value other than the above is set, the warning "Outside mark detection data type setting range" (warning code: 131) occurs and the target mark detection is not available.

[Pr.803] Mark detection data axis No.

Set the axis No. of data that latched at mark detection.

| [Pr.802] Mark detection data type | | | [Pr.803] Mark detection data axis No. | | |
|-----------------------------------|---|---|---------------------------------------|---------|----------|
| Setting value | Data name | Unit | QD77GF4 | QD77GF8 | QD77GF16 |
| 0 | Feed current value | 10 ⁻¹ [μm], 10 ⁻⁵ [inch], 10 ⁻⁵ [degree], [PLS] | 1 to 4 | 1 to 8 | 1 to 16 |
| 1 | Feed machine value | | | | |
| 2 | Real current value | | | | |
| 3 | Servo input axis current value | | | | |
| 6 | Synchronous encoder axis current value | Synchronous encoder axis position unit | 801 to 804 | | |
| 7 | Synchronous encoder axis current value per cycle | | | | |
| 8 | Current value after composite main shaft gear | Main input axis position unit | 1 to 4 | 1 to 8 | 1 to 16 |
| 9 | Current value per cycle after main shaft gear | Cam axis cycle unit | | | |
| 10 | Current value per cycle after auxiliary shaft gear | | | | |
| 11 | Cam axis current value per cycle | | | | |
| 12 | Cam axis current value per cycle (Real position) ^(Note) | | | | |

(Note): Cam axis current value per cycle that considered delay of the servo system.

If a value other than the above is set, the warning "Outside mark detection data axis No. setting range" (warning code: 132) occurs and the target mark detection is not available.

[Pr.804] Mark detection data buffer memory No.

Set the No. of optional 2 words buffer memory that latched at mark detection.

Set this No. as an even No.

If a value other than the above is set, the warning "Outside mark detection data buffer memory No. setting range" (warning code: 133) occurs and the target mark detection is not available.

[Pr.805] Latch data range upper limit value, [Pr.806] Latch data range lower limit value

Set the upper limit value and lower limit value of the latch data at mark detection. When the data at mark detection is within the range, they are stored in "[Md.801] Mark detection data storage area" (1 to 32) and the "[Md.800] Number of mark detection" is incremented by 1. The mark detection processing is not executed.

- Upper limit value > Lower limit value

The mark detection is executed when the mark detection data is "greater or equal to the lower limit value and less than the upper limit value".

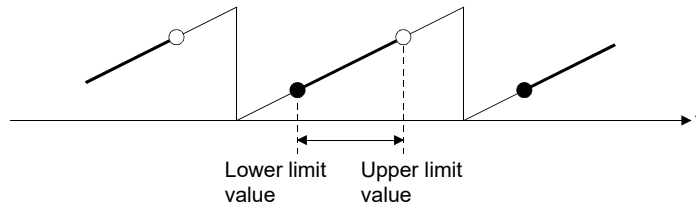

- Upper limit value < Lower limit value

The mark detection is executed when the mark detection data is "greater or equal to the lower limit value or less than the upper limit value".

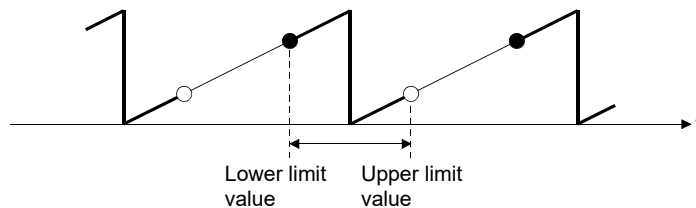

- Upper limit value = Lower limit value

The mark detection range is not checked. The mark detection is executed for all range.

[Pr.807] Mark detection mode setting

Set the data storage method of mark detection.

| Mode | Setting value | Operation for mark detection | Mark detection data storage method |
|------------------------------------|---------------|---|---|
| Continuous detection mode | 0 | Always | The data is updated in the mark detection data storage area 1. |
| Specified number of detection mode | 1 to 32 | Number of detections (If the number of mark detection is the number of detections or more, the mark detection is not executed.) | The data is stored to the mark detection data storage area "n". |
| Ring buffer mode | -1 to -32 | Always (The mark detection data storage area 1 to 32 is used as a ring buffer for the number of detections.) | n = (1+ Number of mark detection) |

(2) Mark detection control data

| Setting item | | Setting details/setting value | Default value | Buffer memory address |
|--------------|--|---|---------------|-----------------------|
| [Cd.800] | Number of mark detection clear request | Set "1" to execute "0" clear of number of mark detections. "0" is automatically set after completion by "0" clear of number of mark detections. 1: 0 clear of number of mark detections <u>Fetch cycle: Operation cycle</u> | 0 | 54640+10k |
| [Cd.801] | Mark detection invalid flag | Set this flag to invalidate mark detection temporarily. 1 : Mark detection: Invalid Others : Mark detection: Valid <u>Fetch cycle: Operation cycle</u> | 0 | 54641+10k |

k: Mark detection setting No.-1

[Cd.800] Number of mark detection clear request

Set "1" to execute "0" clear of "[Md.800] Number of mark detection". "0" is automatically set after completion by "0" clear of "[Md.800] Number of mark detection".

[Cd.801] Mark detection invalid flag

Set "1" to invalidate mark detection temporarily. The mark detection signal during invalidity is ignored.

(3) Mark detection monitor data

| Storage item | | Storage details/storage value | Buffer memory address |
|--------------|---|---|--|
| [Md.800] | Number of mark detection | The number of mark detections is stored. "0" clear is executed at power supply ON. Continuous detection mode: 0 to 65535 (Ring counter) Specified number of detection mode: 0 to 32 Ring buffer mode: 0 to (number of buffers - 1) Refresh cycle: At mark detection | 54960+80k |
| [Md.801] | Mark detection data storage area 1 to Mark detection data storage area 32 | The latch data at mark detection is stored. Data for up to 32 times are stored in the specified number of detection mode. Data are stored as a ring buffer for number of detections in the ring buffer mode. -2147483648 to 2147483647 Refresh cycle: At mark detection | 54962+80k, 54963+80k to 55024+80k, 55025+80k |

k: Mark detection setting No.-1

[Md.800] Number of mark detection

The counter value is incremented by 1 at mark detection. Preset "0" clear in "[Cd.800] Number of mark detection clear request" to execute the mark detection in specified number of detections mode or ring buffer mode.

[Md.801] Mark detection data storage area 1 to 32

The latch data at mark detection is stored. Data for up to 32 times can be stored in the specified number of detection mode or ring buffer mode.

[4] Precautions

When the data of "[Pr.802] Mark detection data type" or "[Pr.803] Mark detection data axis No." is selected incorrectly, the incorrect latch data is stored.

For the data of "[Pr.802] Mark detection data type", set the item No. instead of specifying the buffer memory No. directly. When "8: Current value after composite main shaft gear" to "12: Cam axis current value per cycle (real position)" are set to "[Pr.802] Mark detection data type" and the mark detection is executed other than during synchronous control, the value different from the actual output monitor data may be latched.

14.9 Module error collection function

This function collects errors occurred in the Simple Motion module in the PLC CPU. Those errors are stored in a memory (latch area) of the PLC CPU as module error logs. The stored error logs are retained even when the PLC CPU is powered off or reset.

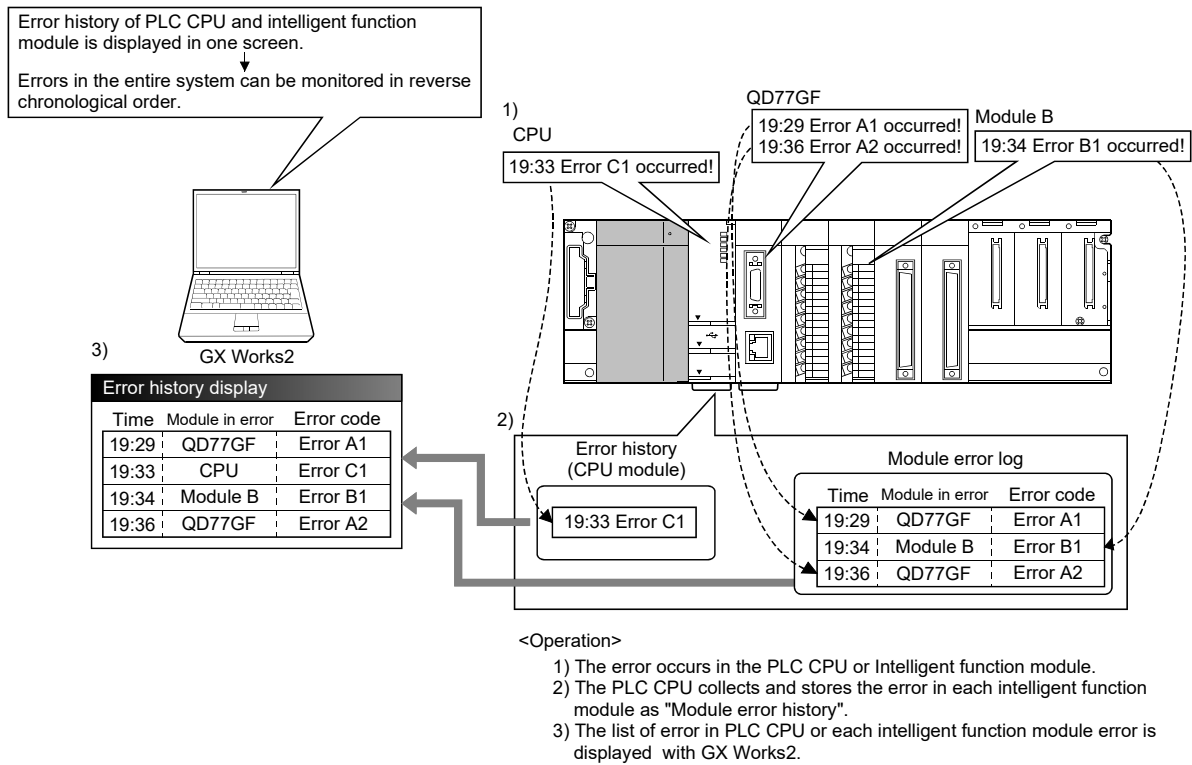

For details on the module error collection function, refer to Section 16.1 "Checking errors using GX Works2".

Chapter 15 Dedicated Instructions

The dedicated instructions of Simple Motion module are explained in this chapter.

These instructions are used to facilitate the programming for the use of the functions of the intelligent function module.

Using the dedicated instructions, the programming can be carried out without being aware of the buffer memory address of Simple Motion module and interlock signal.

15.1 List of dedicated instructions 15- 2

15.1 List of dedicated instructions

The dedicated instructions are listed in Table 15.1.

Refer to "MELSEC-Q QD77GF Simple Motion Module User's Manual (Network)" for details of each dedicated instruction.

Table 15.1 List of dedicated instructions

| Dedicated instruction | Outline of functions |
|-----------------------|--|
| READ | Reads data from the device of another station. (In units of words) |
| SREAD | For the SREAD instruction, when data read is completed, the device on the other station is turned on. Data reading from the other station by the SREAD instruction can be checked. |
| WRITE | Writes data in the device of another station. (In units of words) |
| SWRITE | For the SWRITE instruction, when data write is completed, the other station's device is turned on. It can be confirmed that data was written to the other station by the SWRITE instruction. |
| REMF | Reads data from the buffer memory in the target station. (In units of words) |
| REMT | Writes data to the buffer memory in the target station. (In units of words) |

Chapter 16 Troubleshooting

The "errors" and "warnings" detected by the Simple Motion module are explained in this chapter.

Errors can be confirmed with the LED display of Simple Motion module and GX Works2. When an error or warning is detected, confirm the detection details and carry out the required measures.

| | | |
|------|--------------------------------------|--------|
| 16.1 | Checking errors using GX Works2..... | 16- 2 |
| 16.2 | Troubleshooting..... | 16- 5 |
| 16.3 | Error and warning details | 16- 6 |
| 16.4 | List of errors | 16- 12 |
| 16.5 | List of warnings | 16- 44 |

16.1 Checking errors using GX Works2

Error codes corresponding to the errors occurred in the Simple Motion module can be checked either on the following screen of GX Works2.

Select the screen according to the purpose and usage.

- "Module's Detailed Information" screen
- "Error History" screen

(1) Checking errors on the "Module's Detailed Information" screen

Select [Diagnostics] → [System Monitor] on GX Works2.

Select "QD77GF" for "Main block" and click the [Detailed information] button.

The "Module's Detailed Information" screen for the QD77GF appears and error code, error details, and corrective actions can be checked.

(2) Checking errors on the "Error History" screen.

| POINT |
|--|
| The PLC CPU and GX Works2 that support the module error collection function are required to confirm errors on the "Error History" screen. Refer to each PLC CPU manual for the version of the PLC CPU or GX Works2 that supports the module error collection function. |

On the "Error History" screen, the error logs of the QD77GF are displayed in a list together with the error logs of other modules. The logs can be output to a CSV format file. The error codes and the time of error occurrence can be checked even after the PLC CPU is powered off and then on or reset.

Select [Diagnostics] → [System Monitor] → [System Error History] button on GX Works2.

(a) Error History List

Module error logs are displayed in a list.

(b) Error and Solution, Intelligent Module Information

• Error and Solution

Details of the selected in the "Error History List" and its corrective action are displayed.

• Intelligent Module Information

The status of Simple Motion module when the error selected in the "Error History List" occurred is displayed.

1) Error code (other than D000H to DFFFH)

| Item | Description |
|--|---|
| Start axis | The axis No. requested to start is stored. |
| Positioning start No. | The start No. at positioning start is stored. (Note-1) |
| Axis in which the error occurred | The axis No. in which the error occurred is stored. |
| Axis error occurrence (Data No.) | The positioning data No. currently being executed in which the error occurred is stored. (Note-1), (Note-2) |
| Feed current value | The feed current value of the axis in which the error occurred (at error occurrence) is stored. |
| State of the input signal [X0 to XF] | The status of input signals [X0 to XF] (at error occurrence) is stored (in binary). |
| State of the input signal [X10 to X1F] | The status of input signals [X10 to X1F] (at error occurrence) is stored (in binary). |
| State of the output signal [Y0 to YF] | The status of output signals [Y0 to YF] (at error occurrence) is stored (in binary). |
| State of the output signal [Y10 to Y1F] | The status of output signals [Y10 to Y1F] (at error occurrence) is stored (in binary). |
| <ul style="list-style-type: none"> • Axis in which the error occurred (Upper limit signal) • Axis in which the error occurred (Lower limit signal) • Axis in which the error occurred (Stop signal) • Axis in which the error occurred (External command signal/switching signal) • Axis in which the error occurred (Proximity dog signal) | The status of external input signals of the axis in which the error occurred (at error occurrence) is stored. |
| Servo alarm | The alarm code detected by servo amplifier is stored. (Note-3) |
| Driver operation alarm | The driver operation alarm detected by servo amplifier is stored. (Note-4) |

(Note-1): "0" is stored at the servo alarm occurrence.

(Note-2): The current cam data No. is displayed for output axis of synchronous control.

(Note-3): "0" is stored unless the servo alarm occurs.

(Note-4): "0" is stored unless the driver operation alarm occurs.

2) Error code (D000H to DFFFH)

| Item | Description |
|---|---|
| Communication status (own station) | The communication status of own station (at error occurrence) is stored. |
| Cause of communication interruption | The cause of communication interruption is stored. |
| Cause of data link stop | The cause of data link stop is stored. |
| Connection status (own station) | The connection status of own station (at error occurrence) is stored. |
| Baton pass status (each station) (station No.1 to 16) | The baton pass status of station No.1 to 16 (at error occurrence) is stored (in binary). |
| Baton pass status (each station) (station No.17 to 32) | The baton pass status of station No.17 to 32 (at error occurrence) is stored (in binary). |
| Baton pass status (each station) (station No.33 to 48) | The baton pass status of station No.33 to 48 (at error occurrence) is stored (in binary). |
| Baton pass status (each station) (station No.49 to 64) | The baton pass status of station No.49 to 64 (at error occurrence) is stored (in binary). |
| Baton pass status (each station) (station No.65 to 80) | The baton pass status of station No.65 to 80 (at error occurrence) is stored (in binary). |
| Baton pass status (each station) (station No.81 to 96) | The baton pass status of station No.81 to 96 (at error occurrence) is stored (in binary). |
| Baton pass status (each station) (station No.97 to 112) | The baton pass status of station No.97 to 112 (at error occurrence) is stored (in binary). |
| Baton pass status (each station) (station No.113 to 120) | The baton pass status of station No.113 to 120 (at error occurrence) is stored (in binary). |
| Dedicated instruction name in which the error occurred | The name of dedicated instruction in which the error occurred is stored. |
| Dedicated instruction CH in which the error occurred | The CH No. of dedicated instruction in which the error occurred is stored. |
| Target network No. in which the error occurred | The target network No. in which the error occurred is stored. |
| Target station No. in which the error occurred | The target station No. in which the error occurred is stored. |

(c) [Create CSV File] button

The module error logs are output to a CSV format file.

POINT

(1) If errors frequently occur in the Simple Motion module, **"*HST.LOSS*"** (instead of an actual error code) may be displayed in the Error Code column.
(Display example)

| No. | Error Code |
|-------|------------|
| 00100 | 012C |
| 00099 | *HST.LOSS* |
| 00098 | 0387 |
| 00097 | 0386 |
| 00096 | 0385 |

If **"*HST.LOSS*"** is frequently displayed, set a larger value for the number of errors collected per scan in the PLC RAS tab of the PLC Parameter dialog box.
For the setting, refer to the "User's Manual (Function Explanation, Program Fundamentals)" of the CPU module in use.

(2) If the error occurred at the simultaneous start, the axis No. in which the error is detected is stored in the "Starting axis" in Error History.

16.2 Troubleshooting

(1) Troubleshooting using the LEDs

Check items and corrective actions for troubleshooting using the indicator LEDs of the Simple Motion module are described below.

Refer to "MELSEC-Q QD77GF Simple Motion Module User's Manual (Network)" together.

(a) When the RUN LED turns off.

| Check item | Action |
|--|--|
| Is the power supplied? | Check that the voltage supplied to the power supply module is within the rated range. |
| Is the power supply capacity sufficient? | Calculate the total current consumption of the connected modules (PLC CPU module, I/O modules, and intelligent function modules) and check that the power supply capacity is not insufficient. |
| Is the module connected correctly? | Check the state of connection with the module. |

If there is no problem on the above check items, a watchdog timer error may have occurred. Reset the PLC CPU and check that the RUN LED turns on. If not, the possible cause is a hardware failure. Please consult your local Mitsubishi representative, explaining a detailed description of the problem.

(b) When the ERR.LED turns on

| Check item | Action |
|--------------------------|---|
| Is there a system error? | An error may have occurred in the PLC CPU. Check the error code and take a corrective action. |

(c) When the ERR. LED and axis LED flash

| Check item | Action |
|-------------------------|---|
| Is there an axis error? | Check the error code and take the action described in Section 16.4. |

(d) When the ERR.LED flashes

| Check item | Action |
|--|---|
| Is there a synchronous encoder axis error? | Check the error code and take the action described in Section 16.4. |

(e) When all LEDs turn on

Reset the PLC CPU and check that the module is in the normal status. If all LEDs still turn on, the possible cause is a hardware failure. Please consult your local Mitsubishi representative, explaining a detailed description of the problem.

16.3 Error and warning details

[1] Errors

■ Types of errors

Errors detected by the Simple Motion module include parameter setting range errors, errors at the operation start or during operation and errors detected by servo amplifier.

(1) Errors detected by the Simple Motion module include parameter setting range errors

The parameters are checked when the power is turned ON and at the rising edge (OFF → ON) of the PLC READY signal [Y0]. An error will occur if there is a mistake in the parameter setting details at that time.

When this kind of error occurs, the READY signal [X0] does not turn ON.

To cancel this kind of error, set the correct value in the parameter for which the error occurred, and then turn ON the PLC READY signal [Y0].

| POINT |
|---|
| Re-set the parameters after parameter initialization (refer to Section 14.2) if errors (error code: 900 to 999) frequently occur and the Simple Motion module does not start. |

(2) Errors at the operation start or during operation (Simple Motion module detection errors)

These are errors that occur at the operation start or during operation when the positioning control, JOG operation, or inching operation is used. If an axis error occurs during interpolation operation, the error code will be stored in both the reference axis and the interpolation axis.

Note that, in the following cases (a) and (b), the axis error No. will be stored only in the reference axis during analysis of the positioning data set in each point of the positioning start data table.

(a) When the interpolation axis is BUSY.

(b) When the error occurs in positioning data or parameters unrelated to interpolation control.

If the error occurs at the simultaneous start of a positioning operation, the axis error storage details will differ depending on whether the error occurred before or after the simultaneous start.

- If the error (illegal axis No. or other axis BUSY, etc.) occurs before the simultaneous start, the error "Error before simultaneous start" (error code: 501) will occur.
- If the error (positioning data error or software stroke limit error, etc.) occurs after the simultaneous start, an error code corresponding to the axis in which the error occurred will be stored. Because a simultaneous start cannot be carried out due to this, the error "Simultaneous start not possible" (error code: 532) will be stored in all axes in which an error has not occurred.

The axis operation status will be displayed as "error occurring" for axes in which an error occurred.

If an error occurs during operation, any moving axes will deceleration stop, and their operation status will be displayed as "error occurring".

All axes will decelerate to a stop during interpolation operations, even if the error occurs in only one axis.

(3) Servo amplifier detection errors

These are errors that occur at the hardware error such as servo amplifier and servomotor or the servo parameter error.

Servo is turned off at the error occurrence, and axis stop.

Remove the error factor and reset the error, reset the controller, or turn the servo amplifier power supply ON again from OFF.

(4) Types of error codes

| Error code | Classification of errors |
|----------------|---|
| 001 to 009 | Fatal errors |
| 100 to 199 | Common errors |
| 200 to 299 | HPR errors |
| 300 to 399 | JOG operation errors |
| 400 to 499 | Manual pulse generator operation errors |
| 500 to 599 | Positioning operation errors |
| 600 to 699 | Synchronous control input axis errors |
| 700 to 799 | Synchronous control output axis errors |
| 800 to 899 | I/F (Interface) errors |
| 900 to 1099 | Parameter setting range errors |
| 1201 to 1209 | Encoder errors |
| 2000 | Servo amplifier errors |
| 53248 to 57343 | CC-Link IE Field Network communication errors |

■ Error storage

When an error occurs, the error detection signal turns ON, and the error code corresponding to the error details is stored in the following buffer memory address ([Md.23] Axis error No.) for axis error No. storage. Note that there is a delay of up to operation cycle after the error detection signal turns ON until the error code is stored.

| Axis No. | Error detection signal | Buffer memory address |
|----------|------------------------|-----------------------|
| 1 | [Md.31] Status: b13 | 2406 |
| 2 | | 2506 |
| 3 | | 2606 |
| 4 | | 2706 |
| 5 | | 2806 |
| to | | to |
| 16 | | 3906 |

A new error code is stored in the buffer memory address ([Md.23] Axis error No.) for axis error storage every time an error occurs.

POINT

When any of the following errors that are independent of an axis is detected, it is stored in the axis error No. of axis 1. (These errors are stored in the axis error No. of axis 1 for the system which not use the axis 1.)

Error code: 001, 002, 107, 190, 800, 802, 805, 999

When an error occurs on servo amplifier, the error "Servo amplifier error" (error code: 2000) is stored in "[Md.23] Axis error No.", and the alarm code of servo amplifier is stored in the following buffer memory address ([Md.114] Servo alarm). Check the error details and remedies by this servo alarm details.

| Axis No. | Buffer memory address |
|----------|-----------------------|
| 1 | 2488 |
| 2 | 2588 |
| 3 | 2688 |
| 4 | 2788 |
| 5 | 2888 |
| to | to |
| 16 | 3988 |

[2] Warnings

■ Types of warnings

Warnings detected by the Simple Motion module include system warnings, axis warnings and warnings detected by servo amplifier.

(1) Simple Motion module detection system warnings

The types of system warnings are shown below.

- System control data setting warnings

An axis warning for axis 1 will occur.

- Positioning data setting warnings

An axis warning for each axis will occur.

Note that a warning will occur for the reference axis when an interpolation designation or axis setting warning occurs.

(2) Simple Motion module detection axis warnings

- Axis warnings occur due to setting warnings from operations such as positioning operations, JOG operations or manual pulse generator operations.
- Axis warnings occur due to system warnings.

The axis operation status does not change even if an axis warning occurs.

(3) Servo amplifier detection warnings

These are warning that occur at the hardware error such as servo amplifier and servomotor or the inapplicable servo parameters.

Error or normality operation can't be executed by warning when warning is left as it is though servo off isn't executed.

When the warning cause is removed, warning is automatically released in servo amplifier. However, the state of generating warning is continued in Simple Motion module.

Reset it if necessary.

(4) Types of warning codes

| Warning code | Classification of warnings |
|--------------|--|
| 100 to 199 | Common warnings |
| 200 to 299 | HPR warnings |
| 300 to 399 | JOG operation warnings |
| 400 to 499 | Manual pulse generator operation warnings |
| 500 to 599 | Positioning operation warnings |
| 600 to 699 | Synchronous control input axis warnings |
| 700 to 799 | Synchronous control output axis warnings |
| 800 to 899 | Cam data operation warnings |
| 900 to 999 | System control data setting range check warnings |
| 2000 | Servo amplifier warnings (The contents of warnings vary in the model of servo amplifier.) |

■ Warning storage

- (1) When an axis warning occurs, the warning code corresponding to the warning details is stored in the following buffer memory ([Md.24] Axis warning No.) for axis warning No. storage.

| Axis No. | Buffer memory address |
|----------|-----------------------|
| 1 | 2407 |
| 2 | 2507 |
| 3 | 2607 |
| 4 | 2707 |
| 5 | 2807 |
| to | to |
| 16 | 3907 |

A new warning code is stored in the buffer memory address ([Md.24] Axis warning No.) for axis warning storage every time a warning occurs.

- (2) When an axis warning occurs in a positioning operation, etc., "axis warning detection ([Md.31] Status: b9)" of the following buffer memory for axis status storage turns ON.

| Axis No. | Buffer memory address |
|----------|-----------------------|
| 1 | 2417 |
| 2 | 2517 |
| 3 | 2617 |
| 4 | 2717 |
| 5 | 2817 |
| to | to |
| 16 | 3917 |

When a warning occurs on servo amplifier, the warning "Servo amplifier warning" (warning code: 2000) is stored in "[Md.24] Axis warning No.", and the warning code of servo amplifier is stored in the following buffer memory address ([Md.114] Servo alarm). Check the warning details and remedies by this servo alarm details.

| Axis No. | Buffer memory address |
|----------|-----------------------|
| 1 | 2488 |
| 2 | 2588 |
| 3 | 2688 |
| 4 | 2788 |
| 5 | 2888 |
| to | to |
| 16 | 3988 |

[3] Resetting errors and warnings

Remove the cause of error or warning following the actions described in Section 16.4 and 16.5, before cancel an error or warning state by resetting the error.

■ How to clear errors or warnings

An error or warning state is canceled after the following processing is carried out by setting "1" in the address of the buffer memory for resetting axis error ([Cd.5] Axis error reset).

- Axis error detection signal is turned OFF.
- "[Md.23] Axis error No." is cleared.
- "[Md.24] Axis warning No." is cleared.
- "[Md.114] Servo alarm" is cleared.
- "[Md.26] Axis operation status" is changed from "Error" to "Standby".
- "Axis warning detection ([Md.31] Status: b9)" is turned OFF.

POINT

When servo amplifier alarms cannot be reset even if error reset is requested, "0" is not stored in "[Cd.5] Axis error reset" by Simple Motion module. It remains "1". Set "0" in "[Cd.5] Axis error reset" and then set "1" to execute the error reset again by user side.

[4] Confirming the error and warning definitions

The error and warning definitions can be confirmed with the error codes and warning codes. Confirming them requires GX Works2.

■ Confirming the error definitions

- System monitor of GX Works2 (Refer to Section 16.1.)
- Error history screen of GX Works2 (Simple Motion Module Setting Tool) (Refer to the Simple Motion Module Setting Tool Help.)

■ Confirming the warning definitions

- Warning history screen of GX Works2 (Simple Motion Module Setting Tool) (Refer to the Simple Motion Module Setting Tool Help.)

16.4 List of errors

The following table shows the error details and remedies to be taken when an error occurs.

| Classification of errors | Error code | Error name | Error | Operation status at error occurrence | |
|---|-------------------------|---|---|--|--|
| — | 000 | (Normal status) | — | — | |
| Fatal errors | 001 | Faults | Hardware is faulty. | The system stops. | |
| | 002 | Internal circuit fault | | | |
| Common errors | 101 | PLC READY OFF during operation | The PLC READY signal [Y0] is turned OFF during operation. | The system stops with the setting (deceleration stop/rapid stop) of the detailed parameter 2 rapid stop selection (stop group 2). (Note that the deceleration stop only occurs during the manual pulse generator operation.) | |
| | 102 | Servo READY signal OFF during operation | The servo READY signal is turned OFF during operation. | During operation: The system stops immediately. | |
| | 103 | Test mode faults during operation | The personal computer cannot communicate with the CPU module. | The system stops with the setting (deceleration stop/rapid stop) of the detailed parameter 2 rapid stop selection (stop group 2). (Note that the deceleration stop only occurs during the manual pulse generator operation.) | |
| | 104 | Hardware stroke limit (+) | The hardware stroke limit (upper limit signal FLS) is turned OFF during operation. | During operation: The system stops with the setting (deceleration stop/rapid stop) of the detailed parameter 2 rapid stop selection (stop group 1). (Note that the deceleration stop only occurs during the manual pulse generator operation.) At start : The system does not start. | |
| | | | Start is requested when the hardware stroke limit (upper limit signal FLS) is turned OFF. | | |
| | 105 | Hardware stroke limit (-) | The hardware stroke limit (lower limit signal RLS) is turned OFF during operation. | During operation: The system stops with the setting (deceleration stop/rapid stop) of the detailed parameter 2 rapid stop selection (stop group 1). (Note that the deceleration stop only occurs during the manual pulse generator operation.) At start : The system does not start. | |
| Start is requested when the hardware stroke limit (lower limit signal RLS) is turned OFF. | | | | | |
| 106 | Stop signal ON at start | Start is requested when a stop signal is turned ON. | The system does not start. | | |

| Related buffer memory address | Set range (Setting with sequence program) | Remedy |
|-------------------------------|--|--|
| — | — | — |
| — | — | Check that there is no influence from noise. |
| — | — | Review the program which turns ON/OFF PLC READY signal [Y0]. |
| — | — | Check the servo amplifier power, wiring with the servo amplifier, and connection of connectors. |
| — | — | Check that there is no error on the personal computer side I/F to which a cable is connected. |
| — | — | After making an axis error reset (refer to [3] in Section 16.3), perform manual control operation (refer to Chapter 11) to move the axis to the other position in order that the upper limit signal (FLS) will not turn OFF. |
| — | — | <ul style="list-style-type: none"> • Check the wiring of upper limit signal FLS. • Check if the specification of the limit switch and the setting of the "[Pr.22] Input signal logic selection" match. • If hardware stroke limit (limit switch) is unnecessary system for installation, wire to always turn ON the upper limit signal (FLS) input of the Simple Motion module. |
| — | — | After making an axis error reset (refer to [3] in Section 16.3), perform manual control operation (refer to Chapter 11) to move the axis to the other position in order that the lower limit signal (RLS) will not turn OFF. |
| — | — | <ul style="list-style-type: none"> • Check the wiring of lower limit signal RLS. • Check if the specification of the limit switch and the setting of the "[Pr.22] Input signal logic selection" match. • If hardware stroke limit (limit switch) is unnecessary system for installation, wire to always turn ON the lower limit signal (RLS) input of the Simple Motion module. |
| — | — | After confirming the stop command status, then review the timing of start. |

| Classification of errors | Error code | Error name | Error | Operation status at error occurrence | |
|----------------------------|------------|------------------------------------|--|---|--|
| Common errors | 107 | READY OFF → ON during BUSY | The PLC READY signal is turned from OFF to ON when BUSY signal is turned ON. | The READY signal [X0] is not turned ON. | |
| | 108 | Start not possible | Start is requested when start is not possible in the axis operation state. | The system does not start positioning. | |
| | 190 | Operation cycle time over error | The calculation process time of the positioning etc. exceeds the operation cycle. | The operation continues. Note that the communication might not be executed if the operation cycle is exceeded excessively. | |
| Home position return (HPR) | 201 | Start at HP | <ul style="list-style-type: none"> When the HPR retry invalid is set, the proximity dog method machine HPR is started with the HPR complete flag turned ON. Scale origin signal detection method machine HPR is started with the HPR complete flag turned ON and the proximity dog signal turned ON. | The machine HPR does not start. | |
| | 203 | Dog detection timing fault | The proximity dog signal is turned OFF during the deceleration from an HPR speed to a creep speed by the proximity dog method machine HPR. | The system stops with the setting (deceleration stop/rapid stop) of the detailed parameter 2 rapid stop selection (stop group 3). (Note that the deceleration stop only occurs during the manual pulse generator operation.) | |
| | 206 | Count method movement amount fault | In the count method 1) and 2) machine HPR, a parameter "Setting for the movement amount after proximity dog ON" is smaller than a distance necessary for deceleration stop from an HPR speed. | At start : The system does not operate. During operation: The system stops with the setting (deceleration stop/rapid stop) of the detailed parameter 2 rapid stop selection (stop group 3). | |
| | 207 | HPR request ON | The HPR request flag is turned ON when a fast-HPR is started (positioning start No. 9002). | The fast-HPR does not start. | |
| | 209 | HPR restart not possible | The restart command is turned ON after the machine HPR is stopped using a stop signal. | The restart is not carried out. | |
| | 210 | HPR zero point not passed | The zero point is not passed when the dog method, count method or scale origin signal detection method HPR is re-started, or data set method HPR is executed. | The HPR does not complete. | |
| | 211 | ZCT read error | The data is not loaded from the servo amplifier properly upon the HPR. | | |
| | 212 | ABS reference point read error | <ul style="list-style-type: none"> The data is not loaded from the servo amplifier properly upon the HPR. The in-position signal is not turned ON within 1.5 seconds after moving an axis to the HP. | | |

| | Related buffer memory address | Set range (Setting with sequence program) | Remedy |
|--|-------------------------------|--|---|
| | — | — | Turn ON the PLC READY signal [Y0] with the BUSY signals of all axes OFF. |
| | — | — | Do not request the start when the axis operation state is other than "standby", "stop", and "step standby". |
| | 105 | — | Review the content of the positioning or "[Pr.96] Operation cycle setting" longer than the current setting. |
| | 78+150n | <HPR retry> 0, 1 | <ul style="list-style-type: none"> • Validate the HPR retry function (set value: 1). (Refer to Section 13.2.1). • Move the work piece from the current position (on HP) using the manual control operation (refer to Chapter 11), then carry out a machine HPR again. |
| | 74+150n 75+150n | <HPR speed> 1 to 1000000000 [PLS/s] 1 to 2000000000 [$\times 10^{-2}$ mm/min or others] | <ul style="list-style-type: none"> • Lower the HPR speed. • Increase the dog signal input time. (Refer to Section 8.2.3) |
| | 80+150n 81+150n | <Movement amount setting after proximity dog ON> 0 to 2147483647 | <ul style="list-style-type: none"> • Calculate the movement distance using a speed limit, HPR speed, and deceleration time, and set the movement amount after proximity dog ON so that the distance becomes a deceleration distance or longer. • Lower the HPR speed. • Adjust the proximity dog position so that the movement amount after proximity dog ON becomes longer. (Refer to Section 8.2.4, 8.2.5) |
| | 74+150n 75+150n | <HPR speed> 1 to 1000000000 [PLS/s] 1 to 2000000000 [$\times 10^{-2}$ mm/min] | |
| | 4300+100n | <Positioning start No.> 1 to 600, 7000 to 7004, 9001 to 9004 | Execute the machine HPR (positioning start No. 9001). (Refer to Section 8.2) |
| | 4300+100n | <Positioning start No.> 1 to 600, 7000 to 7004, 9001 to 9004 | Start the machine HPR (positioning start No. 9001) again. (Refer to Section 8.2) |
| | — | — | Turn the motor more than one revolution using JOG or positioning operation. |
| | — | — | <ul style="list-style-type: none"> • Execute HPR again. • When the servo parameter "Function selection C-4 (PC17)" is changed to "1: Not need to pass motor Z-phase after the power supply is switched on", transfer the parameter from the Simple Motion module to the servo amplifier and turn the power supply of the servo amplifier OFF. Then, turn it ON and execute HPR again. |
| | — | — | <ul style="list-style-type: none"> • Execute HPR again. • Adjust the servo gain and in-position range, and execute HPR again. |

| Classification of errors | Error code | Error name | Error | Operation status at error occurrence | | | | | | | | | | | | | | | | | | | | | | | | | | | | | | | | | | | | | | |
|---|-----------------|-----------------------------------|--|--|-----------------|--|--|------|------|------|-------------------------|------|-------|--------|---|------|-------|-------|---|-----|-------|--------|--|-----------------|--|--|------|------|------|-------------------------|------|-----|-----|---|----|----|----|---|-----|-----|-----|---|
| Home position return (HPR) | 231 | Z-phase passing parameter invalid | Servo parameter "Function selection C-4 (PC17)" is not set to "0: Need to pass servo motor Z-phase after power on" in the machine HPR of scale origin signal detection method. | The HPR does not start. | | | | | | | | | | | | | | | | | | | | | | | | | | | | | | | | | | | | | | |
| | 232 | HPR method invalid | Started the HPR method that did not support a communication mode. | The HPR does not start. | | | | | | | | | | | | | | | | | | | | | | | | | | | | | | | | | | | | | | |
| JOG operation or inching operation errors | 300 | Outside JOG speed range | At the time of JOG starting, the JOG speed comes out of a specified range. | The JOG operation is not carried out when the JOG speed is outside the setting range at the time of JOG start. | | | | | | | | | | | | | | | | | | | | | | | | | | | | | | | | | | | | | | |
| | 301 | Inching movement amount error | <p>The inching movement amount does not satisfy the setting conditions. (The setting value is large.)</p> <p>Setting condition: "Inching movement amount × (A) ≤ JOG speed limit value" Use the following values for (A). [RJ010 mode] Unit: [ms]</p> <table border="1"> <thead> <tr> <th rowspan="2"></th> <th colspan="3">Operation cycle</th> </tr> <tr> <th>0.88</th> <th>1.77</th> <th>3.55</th> </tr> </thead> <tbody> <tr> <td>When unit is set to PLS</td> <td>1125</td> <td>562.5</td> <td>281.25</td> </tr> <tr> <td>When unit is set to degree and "[Pr.83] Speed control 10 x multiplier setting for degree axis" is valid</td> <td>67.5</td> <td>33.75</td> <td>16.88</td> </tr> <tr> <td>When unit setting is other than the above</td> <td>675</td> <td>337.5</td> <td>168.75</td> </tr> </tbody> </table> <p>[CiA402 mode] Unit: [ms]</p> <table border="1"> <thead> <tr> <th rowspan="2"></th> <th colspan="3">Operation cycle</th> </tr> <tr> <th>1.00</th> <th>2.00</th> <th>4.00</th> </tr> </thead> <tbody> <tr> <td>When unit is set to PLS</td> <td>1000</td> <td>500</td> <td>250</td> </tr> <tr> <td>When unit is set to degree and "[Pr.83] Speed control 10 x multiplier setting for degree axis" is valid</td> <td>60</td> <td>30</td> <td>15</td> </tr> <tr> <td>When unit setting is other than the above</td> <td>600</td> <td>300</td> <td>150</td> </tr> </tbody> </table> | | Operation cycle | | | 0.88 | 1.77 | 3.55 | When unit is set to PLS | 1125 | 562.5 | 281.25 | When unit is set to degree and "[Pr.83] Speed control 10 x multiplier setting for degree axis" is valid | 67.5 | 33.75 | 16.88 | When unit setting is other than the above | 675 | 337.5 | 168.75 | | Operation cycle | | | 1.00 | 2.00 | 4.00 | When unit is set to PLS | 1000 | 500 | 250 | When unit is set to degree and "[Pr.83] Speed control 10 x multiplier setting for degree axis" is valid | 60 | 30 | 15 | When unit setting is other than the above | 600 | 300 | 150 | The inching operation is not carried out when the inching movement amount exceeds a JOG speed limit at the time of inching start. |
| | Operation cycle | | | | | | | | | | | | | | | | | | | | | | | | | | | | | | | | | | | | | | | | | |
| | 0.88 | 1.77 | 3.55 | | | | | | | | | | | | | | | | | | | | | | | | | | | | | | | | | | | | | | | |
| When unit is set to PLS | 1125 | 562.5 | 281.25 | | | | | | | | | | | | | | | | | | | | | | | | | | | | | | | | | | | | | | | |
| When unit is set to degree and "[Pr.83] Speed control 10 x multiplier setting for degree axis" is valid | 67.5 | 33.75 | 16.88 | | | | | | | | | | | | | | | | | | | | | | | | | | | | | | | | | | | | | | | |
| When unit setting is other than the above | 675 | 337.5 | 168.75 | | | | | | | | | | | | | | | | | | | | | | | | | | | | | | | | | | | | | | | |
| | Operation cycle | | | | | | | | | | | | | | | | | | | | | | | | | | | | | | | | | | | | | | | | | |
| | 1.00 | 2.00 | 4.00 | | | | | | | | | | | | | | | | | | | | | | | | | | | | | | | | | | | | | | | |
| When unit is set to PLS | 1000 | 500 | 250 | | | | | | | | | | | | | | | | | | | | | | | | | | | | | | | | | | | | | | | |
| When unit is set to degree and "[Pr.83] Speed control 10 x multiplier setting for degree axis" is valid | 60 | 30 | 15 | | | | | | | | | | | | | | | | | | | | | | | | | | | | | | | | | | | | | | | |
| When unit setting is other than the above | 600 | 300 | 150 | | | | | | | | | | | | | | | | | | | | | | | | | | | | | | | | | | | | | | | |
| Positioning operation errors | 500 | Illegal condition data No. | The condition data No. is outside the setting range when a block using the condition data is started by a special starting (conditional start, wait start, simultaneous start, FOR (condition)). (1 ≤ Condition data No. ≤ 10) | The operation is terminated. | | | | | | | | | | | | | | | | | | | | | | | | | | | | | | | | | | | | | | |

| Related buffer memory address | Set range (Setting with sequence program) | Remedy |
|--|--|--|
| 28480+100n | — | Set "0: Need to pass servo motor Z-phase after power on" in the servo parameter "Function selection C-4 (PC17)". |
| 70+150n | [RJ010 mode] 0, 4, 5, 6, 7 [CiA402 mode] 8 | Correct to the available HPR method. |
| 4318+100n 4319+100n | <JOG speed> 1 to 1000000000 [PLS/s] 1 to 2000000000 [$\times 10^{-2}$ mm/min or others] | Bring the JOG speed into the setting range. (Refer to Section 11.2) |
| 4317+100n | <Inching movement amount> 0 to 65535 | Set a smaller inching movement amount so that the setting condition is satisfied. (Refer to Section 11.3) |
| Refer to Section 5.4 "List of block start data" | <Condition data No.> 1 to 10 | Review the condition data No. (Refer to Section 5.4 [Da.14]) |

| Classification of errors | Error code | Error name | Error | Operation status at error occurrence | |
|------------------------------|------------------|--|--|---|--|
| Positioning operation errors | 501 | Error before simultaneous start | <p><When blocks are started simultaneously></p> <ul style="list-style-type: none"> The partner axis for simultaneous start is BUSY. | <p>At start : The system does not operate.</p> <p>During operation: The system stops immediately.</p> | |
| | | | <p><When multiple axes are started and controlled simultaneously></p> <ul style="list-style-type: none"> The same axis number is set to multiple simultaneous start axes. The own axis number is set to a simultaneous start axis. The number of simultaneous start axes is outside the setting range of 2 to 4. The partner axis for simultaneous start is BUSY. The "Simultaneous starting axis start data No." of the start axis and the partner axis for simultaneous start is 0 or is outside the setting range. | | |
| | 502 | Illegal data No. | <ul style="list-style-type: none"> The positioning data No. tried to be executed is outside the ranges of 1 to 600, 7000 to 7004, and 9001 to 9004. The designation of a JUMP destination is executed currently. The designation of a JUMP destination is outside the ranges of 1 to 600. | The positioning data is not executed. | |
| 503 | No command speed | <ul style="list-style-type: none"> At the start of positioning, a current speed (-1) is set for the command speed of the positioning data to be initially executed. The current speed is set by speed control. The current speed is set for speed-position or position-speed switching control. | The operation does not start at positioning start. | | |

| Related buffer memory address | Set range (Setting with sequence program) | Remedy |
|--|---|--|
| 4339+100n | <Simultaneous starting axis> b12 to b15 : 2 to 4 b8 to b11 : 0h to Fh b4 to b7 : 0h to Fh b0 to b3 : 0h to Fh | Normalize the simultaneous start axis. |
| 4339+100n | <Simultaneous starting axis> b12 to b15 : 2 to 4 b8 to b11 : 0h to Fh b4 to b7 : 0h to Fh b0 to b3 : 0h to Fh | Normalize the simultaneous starting own axis start data No. and the simultaneous starting axis start data No.(1 to 3). (Refer to Section 10.5) |
| 4340+100n | <Simultaneous starting own axis start data No.> 1 to 600 | |
| 4341+100n | Simultaneous starting axis start data No.1 | |
| 4342+100n | Simultaneous starting axis start data No.2 | |
| 4343+100n | Simultaneous starting axis start data No.3 | |
| 4300+100n | <Positioning start No.> 1 to 600, 7000 to 7004, 9001 to 9004 | Normalize the positioning start No., positioning start data (in block start), and positioning data (in JUMP instruction). |
| | <JUMP destination> 1 to 600 | |
| Refer to Section 5.3 "List of positioning data" | <Command speed> 1 to 1000000000 [PLS/s] 1 to 2000000000 [$\times 10^{-2}$ mm/min or others] | Normalize the positioning data. |

n: Axis No.-1

| Classification of errors | Error code | Error name | Error | Operation status at error occurrence | |
|------------------------------|------------|--------------------------------------|--|---|--|
| Positioning operation errors | 504 | Outside linear movement amount range | <ul style="list-style-type: none"> When the parameter "interpolation speed designation method" performs a linear interpolation in setting a "composite speed", the axis movement amount for each positioning data exceeds 1073741824(2³⁰). The positioning address is -360.00000 or less or 360.00000 or more using INC instruction, where the control unit is set to "degree" and software stroke limit upper limit is not equal to the software stroke limit lower limit. | <p>At start : The system does not operate.</p> <p>During operation: The system stops immediately.</p> | |
| | 506 | Large arc error deviation | When an arc is interpolated by the designation of the center point, a difference between a radius of start point-center point and a radius of end point-center point exceeds the parameter "Circular interpolation error allowable limit". | <p>At start : The circular interpolation control by center point designation is not executed.</p> <p>During operation: The system stops immediately.</p> | |
| | 507 | Software stroke limit+ | <ul style="list-style-type: none"> The positioning is executed at a position exceeding the upper limit of the software stroke limit. The positioning address and the new current value exceed the upper limit of the software stroke limit. In the circular interpolation with sub points designated, the sub point exceeds the upper limit of the software stroke limit. During the speed control mode/the torque control mode, the feed current value exceeded the upper limit of the software stroke limit. | <p>At operation start: The system does not operate.</p> <p>In the analysis of new current value: Current value is not changed.</p> <p>During operation:</p> <ul style="list-style-type: none"> The system stops immediately when the positioning address during position control (including position control in speed-position switching control or position-speed switching control) is switched to the data outside the software stroke limit range. During speed control (including speed control in speed-position switching control or position-speed switching control), the system stops at the setting (normal deceleration stop only) of rapid stop selection (stop group 3) in the detailed parameter 2 when the feed current value or feed machine value during manual control is outside the software stroke limit range. | |
| | 508 | Software stroke limit- | <ul style="list-style-type: none"> The positioning is executed at a position exceeding the lower limit of the software stroke limit. The positioning address and the new current value exceed the lower limit of the software stroke limit. In the circular interpolation with sub points designated, the sub point exceeds the lower limit of the software stroke limit. During the speed control mode/the torque control mode, the feed current value exceeded the lower limit of the software stroke limit. | <p>At the speed control mode/ the torque control mode: The system switches to the position control mode and stops immediately when the feed current value is outside the software stroke limit range.</p> | |

| Related buffer memory address | Set range (Setting with sequence program) | Remedy |
|---|--|---|
| <p>Refer to Section 5.3 "List of positioning data"</p> | <p><Positioning address/movement amount></p> <ul style="list-style-type: none"> • ABS unit [mm] [inch] [PLS] -2147483648 to 2147483647 Unit [degree] 0 to 35999999 • INC (When software stroke limits are valid) Unit [mm], [inch] [PLS]: -2147483648 to 2147483647 Unit [degree]: -35999999 to 35999999 (When software stroke limits are invalid) -2147483648 to 2147483647 • Speed-position switching INC mode: 0 to 2147483647 ABS mode: 0 to 35999999 ([degree] only) • Position-speed switching 0 to 2147483647 <Arc address> -2147483648 to 2147483647 | <p>Review the positioning address.</p> |
| | <p>60+150n 61+150n</p> | <p><Circular interpolation error allowable limit> 0 to 1000000</p> |
| <p>New current value</p> <hr/> <p>4306+100n 4307+100n</p> <hr/> <p>Software stroke limit upper limit</p> <hr/> <p>18+150n 19+150n</p> <hr/> <p>Software stroke limit lower limit</p> <hr/> <p>20+150n 21+150n</p> | <p><New current value></p> <p><Software stroke upper and lower limits></p> <ul style="list-style-type: none"> • [mm] [inch] [PLS] -2147483648 to 2147483647 • [degree] 0 to 35999999 | <p>At operation start :</p> <ul style="list-style-type: none"> • Set the feed current value within the software stroke limit by the manual control operation. (Refer to Chapter 11) • Correct the positioning address. (At circular interpolation with sub points designated, also check the arc address.) <p>New current value: Set the new current value within the software stroke limit. (Refer to Section 9.2.19)</p> <p>During operation : Correct the positioning address. (For the positioning and arc addresses, refer to [Da.6] and [Da.7] in Section 5.3)</p> <p>At the speed control mode/the torque control mode: Review the operation so that the feed current value does not exceed the software stroke limit.</p> |

n: Axis No.-1

| Classification of errors | Error code | Error name | Error | Operation status at error occurrence | |
|------------------------------|------------|---|---|--|--|
| Positioning operation errors | 514 | Outside new current value range | The new current address is outside the ranges of 0 to 359.99999, where the control unit is set to "degree". | Current value is not changed. | |
| | 515 | New current value not possible | <ul style="list-style-type: none"> The control method sets an operation pattern (continuous path control) using new current positioning data. The operation pattern sets a "new current value" in the control method using the data following the "continuous path control" positioning data. | | |
| | 516 | Continuous path control not possible | <ul style="list-style-type: none"> The continuous path control is designated using a control method which is not allowed to use for continuous path control such as speed control, speed-position switching control, position-speed switching control, fixed-feed, and current value changing. The previous data such as those on speed control, speed-position switching control, position-speed switching control, fixed-feed, and current value changing shows a continuous path control. The continuous positioning control is designated for speed control or position-speed switching control. | The system does not operate at start. | |
| | 518 | Outside operation pattern range | The operation pattern set value is 2. | At start : The system does not operate. During operation: The system stops with the setting (deceleration stop/rapid stop) of the detailed parameter 2 rapid stop selection (stop group 3). (Note that the deceleration stop only occurs during the manual pulse generator operation.) | |
| | 519 | Interpolation while interpolation axis BUSY | Interpolation is started during the operation of the interpolation axis. | | |
| | 520 | Unit group unmatched | The reference and interpolation axis units are different at the parameter "interpolation speed designation method" setting of "composite speed". | | |
| | 521 | Illegal interpolation description command | In 2-axis interpolation, the axis to be interpolated is the self axis or an axis not present. | | |
| | 522 | Command speed setting error | The command speed is outside the setting range. Linear interpolation, circular interpolation: Reference axis is outside the setting range. Speed control interpolation: Either of reference axis and interpolation axis is outside the speed range. | | |

| Related buffer memory address | Set range (Setting with sequence program) | Remedy |
|---|--|---|
| 4306+100n 4307+100n | <New current value> [degree] 0 to 35999999 | Bring the new current value into the setting range. (Refer to Section 9.2.19) |
| Refer to Section 5.3 "List of positioning data" | <Control method> 01H to 1EH, 80H to 84H • 03H, 0CH, 17H, 1CH: 1 to 4 axis fixed-feed control • 04H, 05H, 13H, 14H, 18H, 19H, 1DH, 1EH: 1 to 4 axis speed control • 81H: current value changing • Speed-position switching control: 06H, 07H • Position-speed switching control: 08H, 09H <Operation pattern> 00, 01, 11 • 01: Continuous positioning control • 11: Continuous path control | <ul style="list-style-type: none"> Do not designate a current value changing using the positioning data following the continuous path control. Do not designate positioning data following continuous path control using a "current value changing". (Refer to Section 9.2.19) Do not designate a speed control, fixed-feed, speed-position switching control, position-speed switching control, and current value changing using the positioning data following the continuous path control data. Do not carry out the fixed-feed, speed control, speed-position switching control, position-speed switching control, and current value changing using the continuous path control operation pattern. Do not carry out the speed control and position-speed switching control using the continuous path control operation pattern. (Refer to Chapter 9) |
| | Same as error codes 515 to 516 | Correct the operation pattern. (Refer to Section 5.3 [Da.1]) |
| | | Correct the control method. (Refer to Section 5.3 [Da.2]) |
| 0+150n | <Unit setting> 0, 1, 2, 3 | Correct the positioning data or change the parameter "Unit setting" of the axis to be interpolated. (Refer to Section 9.1.6) |
| | Same as error codes 515 to 516 | <ul style="list-style-type: none"> Correct the control method. (Refer to Section 5.3 [Da.2]) Correct the axis to be interpolated. (Refer to Section 5.3 [Da.20] to [Da.22]) |
| Command speed storage addresses of positioning data No. 1 to 600 | <Command speed> 1 to 1000000000 [PLS/s] 1 to 2000000000 [$\times 10^{-2}$ mm/min or others] | Correct the command speed. (Refer to Section 5.3 [Da.8]) |

n: Axis No.-1

| Classification of errors | Error code | Error name | Error | Operation status at error occurrence | |
|------------------------------|------------|------------------------------|---|--|--|
| Positioning operation errors | 523 | Interpolation mode error | <ul style="list-style-type: none"> For starting, a composite speed is designated in the reference axis parameter "Interpolation speed designation method" using the speed interpolation control or 4-axis linear interpolation control. For starting, a reference axis speed is designated in the reference axis parameter "Interpolation speed designation method" using the circular interpolation control. | At start : The system does not operate. During operation: The system stops with the setting (deceleration stop/rapid stop) of the detailed parameter 2 rapid stop selection (stop group 3). (Note that the deceleration stop only occurs during the manual pulse generator operation.) | |
| | 524 | Control method setting error | <ul style="list-style-type: none"> The control method setting value is outside the setting range. The number of control axes or the axis to be interpolated differs from the previous data when continuous positioning control or continuous path control is to be exercised for continuously. The NOP instruction was set to the control method of positioning data No. 600. | | |
| | 525 | Sub point setting error | Either of the following applies in the circular interpolation with sub points designated. <ul style="list-style-type: none"> Start point = sub point End point = sub point Start point, end point, and sub point are in line with each other. Sub point address and center point address are outside the range of -2147483648 to 2147483647. | At start : The system does not operate. During operation: The system stops immediately. | |
| | 526 | End point setting error | <ul style="list-style-type: none"> Start point is equal to end point in the circular interpolation with sub points designated. End point address is outside the range of -2147483648 to 2147483647 in the circular interpolation with auxiliary point designation and center point designation. | | |
| | 527 | Center point setting error | Circular interpolation with center point designation applicable to one of the followings. <ul style="list-style-type: none"> Start point = Center point End point = Center point Center point address is outside the range of -2147483648 to 2147483647. | | |

| Related buffer memory address | Set range (Setting with sequence program) | Remedy |
|--|--|--|
| 29+150n | <Interpolation speed designation method> 0: Composite speed 1: Reference axis speed | Set the "Interpolation speed designation method" correctly. (Refer to Section 9.1.6) |
| Same as error codes 515 to 516 | | Correct the control method, axis to be interpolated or parameter. (Refer to Section 9.1.6, 9.2.20) |
| Refer to Section 5.3 "List of positioning data" | <Positioning address/movement amount> • Unit [mm] [PLS] [inch] -2147483648 to 2147483647 (Unit [degree]) cannot be set. <Arc address> -2147483648 to 2147483647 | Correct the sub address (arc address). (Refer to Section 9.2.10) Correct the end address (positioning address). (Refer to Section 9.2.10) |
| Same as in error codes 525 to 526. | | Correct the center point address (arc address). (Refer to Section 9.2.11) |

n: Axis No.-1

| Classification of errors | Error code | Error name | Error | Operation status at error occurrence | |
|------------------------------|------------|-------------------------------------|--|--|--|
| Positioning operation errors | 530 | Outside address range | <ul style="list-style-type: none"> In the speed-position switching control and the position-speed switching control, the setting value of a positioning address is negative. In ABS1, ABS2, ABS3 and ABS4, the setting value of a positioning address is outside the range of 0 to 359.99999 degrees. | <p>At start : The system does not operate.</p> <p>During operation: The system stops immediately with the setting (deceleration stop/rapid stop) of the detailed parameter 2 rapid stop selection (stop group 3). (Note that the deceleration stop only occurs during the manual pulse generator operation.)</p> | |
| | 532 | Simultaneous start not possible | Among the axes to be started simultaneously, there is an axis on which an error other than this error occurs. | | |
| | 533 | Condition data error | <ul style="list-style-type: none"> The condition setting values are not set or outside the setting range. The condition operator setting values are not set or outside the setting range. The condition operator is a bit operator, and the parameter 1 is 32 or more. An unusable condition operator is set for the set condition. The conditional operator has been [parameter 1 is greater than to parameter 2] with 05H ($P1 \leq ** \leq P2$). The setting value of "address" is outside the setting range when the condition target is set to "Buffer memory (1-word/2-word)". (1-word: 0 to 32767, 2-word: 0 to 32766) The setting value of "simultaneous starting axis" is outside the setting range when the condition target is set to "positioning data No.". | The operation is terminated. | |
| | 534 | Special start instruction error | No applicable special start instruction is present. | | |
| | 535 | Circular interpolation not possible | Circular interpolation is carried out on an axis in the unit of degree. | | |
| | 536 | M code ON signal start | The positioning start is carried out when an M code ON signal is turned ON. | | |
| | 537 | PLC READY OFF start | The positioning start is carried out when the PLC READY signal [Y0] is turned OFF. | | |
| | 538 | READY OFF start | The positioning start is carried out when the READY signal [X0] is turned OFF. | | |
| | 543 | Outside start No. range | <ul style="list-style-type: none"> At the start of positioning, the setting value of the "positioning start No." of the axis control data is outside the ranges of 1 to 600, 7000 to 7004, and 9001 to 9004. At a Pre-reading start, the "positioning start No." setting of the axis control data is other than 1 to 600. | The system does not operate at start. | |

| Related buffer memory address | Set range (Setting with sequence program) | Remedy |
|---|---|--|
| | Same as in error codes 504, 506. | Correct the positioning address. (Refer to Section 9.2.16, 9.2.17, or 9.2.18) |
| Refer to Section 5.3 "List of positioning data" and Section 5.4 "List of block start data" | — | In the error history, check the axis where the error other than this error occurred, and remove the error factor. Correct the block start data and positioning data. |
| Refer to Section 5.4 "List of block start data" | — | Normalize the block start data. |
| | <Special start instruction> 00H to 06H | Correct the instruction code of the special start. (Refer to Section 5.4 [Da.13]) |
| Refer to Section 5.3 "List of positioning data" | — | Correct the control method. (Refer to Section 5.3 [Da.2]) |
| 4304+100n | <M code OFF request> 1: M code ON signal is turned OFF | After turning OFF the M code ON signal, start the system. (Refer to Section 13.7.3) |
| — | — | Check the program which turns ON/OFF the PLC READY signal [Y0], and turn ON the PLC READY signal. Then start the system. |
| — | — | Check the READY ON signal, and then start the system. (Refer to Section 3.3.2) |
| 4300+100n | <Positioning start No.> 1 to 600, 7000 to 7004, 9001 to 9004 | Normalize the positioning start No. (Refer to Section 13.7.7) |

n: Axis No.-1

| Classification of errors | Error code | Error name | Error | Operation status at error occurrence | |
|------------------------------|------------|--|--|---|--|
| Positioning operation errors | 544 | Outside radius range | The arc radius exceeds 536870912. | At start : The system does not operate. During operation: The system stops immediately. | |
| | 545 | Control method LOOP setting error | A "0" is set in the repeating times of the control method "LOOP". | The operation is terminated. | |
| | 546 | Illegal setting of ABS direction in unit of degree | The setting value of ABS direction in the unit of degree is as follows. • Set outside the setting range. • A figure other than "0" is set when the software stroke limit is valid. | At start : The system does not operate. During operation: The system decelerates to a stop. (Note that, in the continuous positioning control and continuous path control, the system continues operating with the setting set at the time of start even if the setting is changed during the operation.) | |
| | 547 | Start at HPR incomplete | • When executing operation setting at HPR incomplete, positioning was started at HPR request ON. • When executing operation setting at HPR incomplete, control mode switching was executed at HPR request ON. | At start : The system does not operate. At control mode switching: The mode does not change. | |
| | 550 | Speed-torque control not supported | Switching to the speed-torque control mode is requested to a servo amplifier which does not support the speed-torque control. | During positioning control: The system stops with the setting of the detailed parameter 2 rapid stop selection (stop group 3). During speed control mode: The system switches to the position control mode and stops immediately. | |
| I/F errors | 800 | Hold error | In the CPU module parameter "Output at error stop", the setting for the Simple Motion module is "Hold". | At start : The system does not operate. During operation: The system stops with the setting (deceleration stop/rapid stop) of the detailed parameter 2 rapid stop selection (stop group 3). (Note that the deceleration stop only occurs during the manual pulse generator operation.) | |
| | 801 | Flash ROM write error | Data is not written to the flash ROM. | | |
| | 802 | Flash ROM sum check error | While data is written to the flash ROM, the power is turned OFF. | At start: The system does not operate. | |

| | Related buffer memory address | Set range (Setting with sequence program) | Remedy |
|--|--|---|---|
| | Refer to Section 5.3 "List of positioning data" | <Maximum radius> 536870912 | Correct the positioning data. (Refer to Section 9.2.10 or 9.2.11) |
| | | <LOOP to LEND> 1 to 65535 | Set 1 to 65535 in the repeating time of LOOP. (Refer to Section 9.2.22) |
| | ABS setting direction in the unit of degree | 0: Shortcut 1: Clockwise 2: Counterclockwise | <ul style="list-style-type: none"> Set the ABS setting direction in the unit of degree within the setting range. Set "0" when the software stroke limits are valid. (Refer to Section 9.1.5) |
| | 4350+100n | | |
| | Software stroke limit upper limit | <ul style="list-style-type: none"> [mm] [inch] [PLS] -2147483648 to 2147483647 [degree] 0 to 35999999 | <ul style="list-style-type: none"> Invalidate the software stroke limit. (To invalidate, set the software stroke limit upper limit value to the software stroke limit lower limit value.) (Refer to Section 9.1.5) |
| | 18+150n 19+150n | | |
| | Software stroke limit lower limit | | |
| | 20+150n 21+150n | | |
| | | | |
| | Operation setting for incompleteness of HPR | <Operation setting for incompleteness of HPR> 0, 1 | <ul style="list-style-type: none"> Start after the HPR is executed. Switch the control mode after the HPR is executed. For systems which can operate the positioning control and speed-torque control though the HPR request is ON, set "1" to the setting value of the operation setting at HPR incomplete. |
| | 87+150n | | |
| | — | — | Use a servo amplifier which supports the speed-torque control. |
| | — | — | Clear the setting of the CPU module parameter "Output at error stop". |
| | — | — | The flash ROM is expected to be at the end of its writable life. |
| | 5901 | <Parameter initialization request> 1: Parameter initialization is requested | Return the parameter to that set at the time of delivery from the plant. (Refer to Section 14.2) |

n: Axis No.-1

| Classification of errors | Error code | Error name | Error | Operation status at error occurrence | |
|--------------------------------|------------|--|--|--|--|
| I/F errors | 803 | PLC CPU error | The CPU module resulted in an error. | At start : The system does not operate. During operation: The system stops with the setting (deceleration stop/rapid stop) of the detailed parameter 2 rapid stop selection (stop group 2). (Note that the deceleration stop only occurs during the manual pulse generator operation.) | |
| | 805 | Flash ROM write number error | Data is written to the flash ROM continuously 25 times or more from the program. | At start: The system does not operate. | |
| Parameter setting range errors | 900 | Outside unit setting range | The set value of the basic parameter 1 "Unit setting" is outside the setting range. | The READY signal [X0] is not turned ON. | |
| | 901 | Outside pulse number per rotation range | The set value of the basic parameter 1 "Number of pulses per rotation" is outside the setting range. | | |
| | 902 | Outside movement amount per rotation range | The set value of the basic parameter 1 "Movement amount per rotation" is outside the setting range. | | |
| | 903 | Outside unit magnification range | <ul style="list-style-type: none"> The set value of the basic parameter 1 "Unit magnification" is outside the setting range. "Movement amount per rotation (AL)" × "Unit magnification (AM)" exceeds 2147483648. | | |
| | 906 | Outside bias speed range | <ul style="list-style-type: none"> The set value of the basic parameter 1 "Bias speed at start" is outside the setting range. The bias speed exceeds the speed limit. | The READY signal [X0] is not turned ON. | |
| | 907 | Outside electronic gear setting range | The set value of the electronic gear is outside the setting range. | | |

| Related buffer memory address | Set range (Setting with sequence program) | Remedy |
|---|--|---|
| — | — | Check the error code in CPU module. (Refer to the "QCPU User's Manual (Hardware Design, Maintenance and Inspection)".) |
| — | — | Review the program so that data is not written continuously to the flash ROM. (Using "[Md.19]" in Section 5.6.1, the number of flash ROM write times can be monitored.) (If this error has occurred in a proper using method, writing is enabled by resetting the error, switching power OFF, then ON, or resetting the CPU module.) |
| 0+150n | 0, 1, 2, 3 | With the setting brought into the setting range, turn the PLC READY signal [Y0] from OFF to ON. |
| 2+150n 3+150n | 1 to 200000000 | |
| 4+150n 5+150n | 1 to 200000000 | |
| 1+150n | 1,10,100,1000 | <ul style="list-style-type: none"> Set AL and AM values which make "Movement amount per rotation (AL)" × "Unit magnification (AM)" within 2147483647, and then turn the PLC READY signal [Y0] from OFF to ON. With the setting brought into the setting range, turn the PLC READY signal [Y0] from OFF to ON. |
| 6+150n 7+150n | 0 [PLS/s] 0 [$\times 10^{-2}$ mm/min or others] | <ul style="list-style-type: none"> Set the bias speed to not more than the speed limit value. With the setting brought into the setting range, turn the PLC READY signal [Y0] from OFF to ON. |
| Unit magnification 1+150n | $0.001 \leq \text{Electronic gear} \leq 320000$ $\text{Electronic gear} = \frac{[\text{Pr.2}]}{[\text{Pr.3}] \times [\text{Pr.4}]}$ | "[Pr.2] Number of pulses per rotation (AP)", "[Pr.3] Movement amount per rotation (AL)", "[Pr.4] Unit magnification (AM)" Review these parameters. (Refer to Section 5.2.1) |
| Number of pulses per rotation 2+150n 3+150n | | |
| Movement amount per rotation 4+150n 5+150n | | |

n: Axis No.-1

| Classification of errors | Error code | Error name | Error | Operation status at error occurrence | |
|--------------------------------|------------|---|---|---|--|
| Parameter setting range errors | 910 | Outside speed limit value range | <ul style="list-style-type: none"> The set value of the basic parameter 2 "Speed limit value" is outside the setting range. The speed limit value is smaller than the HPR speed. | When the PLC READY signal [Y0] is turned from OFF to ON : READY signal [X0] is not turned ON. At start : The system does not operate. | |
| | 911 | Outside acceleration time 0 range | The set value of the basic parameter 2 "Acceleration time 0" is outside the setting range. | | |
| | 912 | Outside deceleration time 0 range | The set value of the basic parameter 2 "Deceleration time 0" is outside the setting range. | | |
| | 920 | Backlash compensation amount error | The calculation result of the following equation is smaller than 0 or larger than 4194304. $0 \leq \frac{[Pr.11] \times [Pr.2]}{[Pr.3] \times [Pr.4]} \leq 4194303$ | The READY signal [X0] is not turned ON. | |
| | 921 | Software stroke limit upper limit | <ul style="list-style-type: none"> In the unit of "degree", the set value of the detailed parameter 1 "Software stroke limit upper limit value" is outside the setting range. In a unit other than "degree", the software stroke limit upper limit value is smaller than the software stroke limit lower limit value. | | |
| | 922 | Software stroke limit lower limit | <ul style="list-style-type: none"> In the unit of "degree", the set value of the detailed parameter 1 "Software stroke limit lower limit value" is outside the setting range. In a unit other than "degree", the software stroke limit upper limit value is smaller than the software stroke limit lower limit value. | | |
| | 923 | Software stroke limit selection | <ul style="list-style-type: none"> The set value of the detailed parameter 1 "Software stroke limit selection" is outside the setting range. In the unit of "degree", "1: Apply software stroke limit on feed machine value" is set. | | |
| | 924 | Software stroke limit valid/invalid setting | The set value of the detailed parameter 1 "Software stroke limit valid/invalid setting" is outside the setting range. | | |

| | Related buffer memory address | Set range (Setting with sequence program) | Remedy |
|--|-------------------------------|---|---|
| | 10+150n 11+150n | <Speed limit value> 1 to 1000000000 [PLS/s] 1 to 2000000000 [$\times 10^{-2}$ mm/min or others] | <ul style="list-style-type: none"> Set a value which is not less than the HPR speed. With the setting brought into the setting range, turn the PLC READY signal [Y0] from OFF to ON. |
| | 12+150n 13+150n | 1 to 8388608 | With the setting brought into the setting range, turn the PLC READY signal [Y0] from OFF to ON. |
| | 14+150n 15+150n | 1 to 8388608 | |
| | 17+150n | $0 \leq \frac{[\text{Pr.11}] \times [\text{Pr.2}]}{[\text{Pr.3}] \times [\text{Pr.4}]} \leq 4194303$ | "[Pr.2] Number of pulses per rotation (AP)", "[Pr.3] Movement amount per rotation (AL)", "[Pr.4] Unit magnification (AM)" "[Pr.11] Backlash compensation amount" Review the items above. (Refer to Section 5.2.1 or Section 5.2.3) |
| | 18+150n 19+150n | <ul style="list-style-type: none"> [mm] [inch] [PLS] -2147483648 to 2147483647 [degree] 0 to 35999999 | <ul style="list-style-type: none"> Bring the setting into the setting range. In a unit other than degree, set so that the lower limit value is smaller than the upper limit value. |
| | 20+150n 21+150n | <ul style="list-style-type: none"> [mm] [inch] [PLS] -2147483648 to 2147483647 [degree] 0 to 35999999 | |
| | 22+150n | 0, 1 | <ul style="list-style-type: none"> Bring the setting into the setting range. In the unit of "degree", set "0: Apply software stroke limit on feed current value". |
| | 23+150n | 0, 1 | With the setting brought into the setting range, turn the PLC READY signal [Y0] from OFF to ON. |

n: Axis No.-1

| Classification of errors | Error code | Error name | Error | Operation status at error occurrence | |
|--------------------------------|------------|--|--|---|---|
| Parameter setting range errors | 925 | Command in-position width | The set value of the detailed parameter 1 "Command in-position width" is outside the setting range. | The READY signal [X0] is not turned ON. | |
| | 926 | Illegal torque limit setting value | The set value of the detailed parameter 1 "Torque limit setting value" is outside the setting range. | | |
| | 927 | M code ON timing error | The set value of the detailed parameter 1 "M code ON signal output timing" is outside the setting range. | | |
| | 928 | Speed switching mode error | The set value of the detailed parameter 1 "Speed switching mode" is outside the setting range. | | |
| | 929 | Interpolation speed designation method error | The set value of the detailed parameter 1 "Interpolation speed designation method" is outside the setting range. | | |
| | 930 | Current value update request error | The set value of the detailed parameter 1 "Feed current value during speed control" is outside the setting range. | | |
| | 932 | Manual pulse generator input mode error | The set value of the detailed parameter 1 "Manual pulse generator/Incremental synchronous encoder input selection" is outside the setting range. | | |
| | 935 | Speed-position function selection error | The detailed parameter 1 "Speed-position function selection" is preset to 2 and the following three conditions are not satisfied: 1) Unit is "degree". 2) Software stroke limits are invalid. 3) Update feed current value. | | |
| | 936 | External input signal selection error | The set value of the detailed parameter 1 "External input signal selection" is outside the setting range. | | |
| | 937 | Forced stop valid/invalid setting error | The set value of the detailed parameter 1 "Forced stop valid/invalid setting" is outside the setting range. | | |
| | 938 | Input signal logic selection setting error | The set values of the detailed parameter 1 "Input signal logic selection" are different in the axis that uses the same input signal. | | |
| | 950 | Acceleration time 1 setting error | The set value of the detailed parameter 2 "Acceleration time 1" is outside the setting range. | | When the PLC READY signal [Y0] is turned from OFF to ON: The READY signal [X0] is not turned ON. At start : The system does not start. During operation : The system stops with the setting (deceleration stop/rapid stop) of the detailed parameter 2 rapid stop selection (stop group 3). (Note that the deceleration stop only occurs during the manual pulse generator operation.) |
| | 951 | Acceleration time 2 setting error | The set value of the detailed parameter 2 "Acceleration time 2" is outside the setting range. | | |
| | 952 | Acceleration time 3 setting error | The set value of the detailed parameter 2 "Acceleration time 3" is outside the setting range. | | |

| | Related buffer memory address | Set range (Setting with sequence program) | Remedy |
|--|-------------------------------|--|---|
| | 24+150n 25+150n | 1 to 2147483647 | With the setting brought into the setting range, turn the PLC READY signal [Y0] from OFF to ON. |
| | 26+150n | 1 to 1000 | |
| | 27+150n | 0, 1 | |
| | 28+150n | 0, 1 | |
| | 29+150n | 0, 1 | |
| | 30+150n | 0, 1, 2 | |
| | 33 | 0, 1, 2, 3 | |
| | 34+150n | 0, 2 | <ul style="list-style-type: none"> • Speed-position switching control (ABS mode) should satisfy the conditions 1) to 3) given on the left. • When speed-position switching control (ABS mode) is not to be exercised, set 0 to speed-position function selection and turn the PLC READY signal [Y0] from OFF to ON. |
| | 32+150n | 0, 1, 2, 3, 4, 5, 6 | With the setting brought into the setting range, turn the PLC READY signal [Y0] from OFF to ON. |
| | 35 | 0, 1 | |
| | 31+150n | 0, 1 | With the setting of the axis is matched, turn the PLC READY signal [Y0] from OFF to ON. |
| | 36+150n 37+150n | 1 to 8388608 | With the setting brought into the setting range, turn the PLC READY signal [Y0] from OFF to ON. |
| | 38+150n 39+150n | 1 to 8388608 | |
| | 40+150n 41+150n | 1 to 8388608 | |

n: Axis No.-1

| Classification of errors | Error code | Error name | Error | Operation status at error occurrence | |
|--------------------------------|------------|--|---|---|--|
| Parameter setting range errors | 953 | Deceleration time 1 setting error | The set value of the detailed parameter 2 "Deceleration time 1" is outside the setting range. | When the PLC READY signal [Y0] is turned from OFF to ON: The READY signal [X0] is not turned ON. At start : The system does not start. During operation : The system stops with the setting (deceleration stop/rapid stop) of the detailed parameter 2 rapid stop selection (stop group 3). (Note that the deceleration stop only occurs during the manual pulse generator operation.) | |
| | 954 | Deceleration time 2 setting error | The set value of the detailed parameter 2 "Deceleration time 2" is outside the setting range. | | |
| | 955 | Deceleration time 3 setting error | The set value of the detailed parameter 2 "Deceleration time 3" is outside the setting range. | | |
| | 956 | JOG speed limit value error | <ul style="list-style-type: none"> The set value of the detailed parameter 2 "JOG speed limit value" is outside the setting range. The set value of the detailed parameter 2 "JOG speed limit value" exceeds the speed limit. | | |
| | 957 | JOG acceleration time selection setting error | The set value of the detailed parameter 2 "JOG operation acceleration time selection" is outside the setting range. | | |
| | 958 | JOG deceleration time selection setting error | The set value of the detailed parameter 2 "JOG operation deceleration time selection" is outside the setting range. | | |
| | 959 | Acceleration/ deceleration process selection setting error | The set value of the detailed parameter 2 "Acceleration/deceleration process selection" is outside the setting range. | | |
| | 960 | S-curve ratio setting error | The set value of the detailed parameter 2 "S-curve ratio" is outside the setting range. | | |
| | 961 | Illegal rapid stop deceleration time | The set value of the detailed parameter 2 "Rapid stop deceleration time" is outside the setting range. | | |
| | 962 | Stop group 1 rapid stop selection error | The set value of the detailed parameter 2 "Stop group 1 rapid stop selection" is outside the setting range. | | |
| | 963 | Stop group 2 rapid stop selection error | The set value of the detailed parameter 2 "Stop group 2 rapid stop selection" is outside the setting range. | | |
| | 964 | Stop group 3 rapid stop selection error | The set value of the detailed parameter 2 "Stop group 3 rapid stop selection" is outside the setting range. | | |
| | 966 | Outside allowance circular interpolation error width | The set value of the detailed parameter 2 "Allowance circular interpolation error width" is outside the setting range. | | |
| | 967 | External command function selection error | The set value of the detailed parameter 2 "External command function selection" is outside the setting range. | | |

| | Related buffer memory address | Set range (Setting with sequence program) | Remedy |
|--|-------------------------------|--|---|
| | 42+150n 43+150n | 1 to 8388608 | With the setting brought into the setting range, turn the PLC READY signal [Y0] from OFF to ON. |
| | 44+150n 45+150n | 1 to 8388608 | |
| | 46+150n 47+150n | 1 to 8388608 | |
| | 48+150n 49+150n | <JOG speed limit value> 1 to 1000000000 [PLS/s] 1 to 2000000000 [$\times 10^{-2}$ mm/min or others] | <ul style="list-style-type: none"> • With the setting brought into the setting range, turn the PLC READY signal [Y0] from OFF to ON. • Bring the setting into the speed limit value or below. |
| | 50+150n | 0, 1, 2, 3 | With the setting brought into the setting range, turn the PLC READY signal [Y0] from OFF to ON. |
| | 51+150n | 0, 1, 2, 3 | |
| | 52+150n | 0, 1 | |
| | 53+150n | 1 to 100 | |
| | 54+150n 55+150n | 1 to 8388608 | |
| | 56+150n | 0, 1 | |
| | 57+150n | 0, 1 | |
| | 58+150n | 0, 1 | |
| | 60+150n 61+150n | 0 to 100000 | |
| | 62+150n | 0, 1, 2, 3, 4 | |

n: Axis No.-1

| Classification of errors | Error code | Error name | Error | Operation status at error occurrence | |
|--------------------------------|------------|---|--|---|--|
| Parameter setting range errors | 970 | Restart allowable range error | The set value of the detailed parameter 2 "Restart allowable range when servo OFF to ON" is outside the setting range. | The READY signal [X0] is not turned ON. | |
| | 971 | Speed control 10 x multiplier setting for degree axis error | The set value of the detailed parameter 2 "Speed control 10 x multiplier setting for degree axis" is outside the setting range. | | |
| | 976 | Manual pulse generator/Incremental synchronous encoder input type selection error | The set value of the detailed parameter 2 "Manual pulse generator/Incremental synchronous encoder input type selection" is outside the setting range. | | |
| | 977 | Operation setting for speed-torque control mode error | The set value of the detailed parameter 2 "Operation setting for speed-torque control mode" is outside the setting range. | | |
| | 978 | External command signal selection error | The set value of the detailed parameter 2 "External command signal selection" is outside the setting range. | | |
| | 979 | Synchronous encoder via servo amplifier invalid error | <ul style="list-style-type: none"> • In system construction, the unset up servo amplifier axis is set as the synchronous encoder via servo amplifier. • The servo amplifier axis set as synchronous encoder via servo amplifier is not supported with scale measurement mode. • The servo amplifier axis set as synchronous encoder via servo amplifier is connected to the linear scale. | | |
| | 980 | HPR method error | The set value of the HPR basic parameter "HPR method" is outside the setting range. | | |
| | 981 | HPR direction error | The set value of the HPR basic parameter "HPR direction" is outside the setting range. | | |
| | 982 | HP address setting error | The set value of the HPR basic parameter "HP address" is outside the setting range. | | |
| | 983 | HPR speed error | <ul style="list-style-type: none"> • The set value of the HPR basic parameter "HPR speed" is outside the setting range. • The set value of the HPR basic parameter "HPR speed" is smaller than the bias speed at start. | | |

| | Related buffer memory address | Set range (Setting with sequence program) | Remedy |
|--|-------------------------------|--|---|
| | 64+150n 65+150n | 0 to 327680 | With the setting brought into the setting range, turn the PLC READY signal [Y0] from OFF to ON. |
| | 63+150n | 0, 1 | |
| | 67 | 0, 1 | |
| | 68+150n | <Torque initial value selection (b4 to b7)> 0, 1 | |
| | | <Speed initial value selection (b8 to b11)> 0, 1, 2 | |
| | | <Condition selection at mode switching (b12 to b15)> 0, 1 | |
| | 69+150n | 0, 1, 2, 3, 4 | |
| | — | — | With remove causes, switch the power on again or reset the PLC. |
| | 70+150n | [RJ010 mode] 0, 4, 5, 6, 7 [CiA402 mode] 8 | With the setting brought into the setting range, turn the PLC READY signal [Y0] from OFF to ON. |
| | 71+150n | 0, 1 | |
| | 72+150n 73+150n | • [mm] [inch] [PLS] -2147483648 to 2147483647 • [degree] 0 to 35999999 | |
| | 74+150n 75+150n | <HPR speed> 1 to 1000000000 [PLS/s] 1 to 2000000000 [$\times 10^{-2}$ mm/min or others] | <ul style="list-style-type: none"> Bring the setting into the setting range. Set the speed to the bias speed at start or higher. (Refer to Section 5.2.5) |

n: Axis No.-1

| Classification of errors | Error code | Error name | Error | Operation status at error occurrence | | |
|--------------------------------|------------|--|---|---|---|--|
| Parameter setting range errors | 984 | Creep speed error | <ul style="list-style-type: none"> The set value of the HPR basic parameter "Creep speed" is outside the setting range. The set value of the HPR basic parameter "Creep speed" is larger than the HPR speed. The set value of the HPR basic parameter "Creep speed" is smaller than the bias speed at start. | The READY signal [X0] is not turned ON. | | |
| | 985 | HPR retry error | The set value of the HPR basic parameter "HPR retry" is outside the setting range. | | | |
| | 991 | Setting for the movement amount after proximity dog ON error | The set value of the HPR detailed parameter "Setting for the movement amount after proximity dog ON" is outside the setting range. | | | |
| | 992 | HPR acceleration time selection error | The set value of the HPR detailed parameter "HPR acceleration time selection" is outside the setting range. | | | |
| | 993 | HPR deceleration time selection error | The set value of the HPR detailed parameter "HPR deceleration time selection" is outside the setting range. | | | |
| | 995 | HPR torque limit value error | <ul style="list-style-type: none"> The set value of the HPR detailed parameter "HPR torque limit value" is outside the setting range. The HPR detailed parameter "HPR torque limit value" has exceeded the detailed parameter 1 "Torque limit setting value". | | | |
| | 997 | Speed designation during HP shift error | The set value of the HPR detailed parameter "Speed designation during HP shift" is outside the setting range. | | | |
| | 998 | Operation setting for incompletion of HPR error | The set value of the HPR detailed parameter "Operation setting at HPR Incomplete" is outside the setting range. | | | |
| | 999 | Operation cycle setting error | <ul style="list-style-type: none"> The set value of the expansion parameter "Operation cycle setting" is outside the setting range. The set values of the expansion parameter "Communication mode setting" and the expansion parameter "Operation cycle setting" are mismatch. | | | |
| | 1004 | Virtual servo amplifier setting error | "1: Use for the virtual servo amplifier" is set to the axis to which the station No. is set on the network parameter. | | | |
| | 1005 | Servo parameter PD41 setting error | Servo parameter "Function selection D-4 (PD41)" (Stroke limit enabling condition selection) is not set to "1: Enabled only for HPR mode". | | The communication with the applicable servo amplifiers is not executed. | |
| | 1006 | Connection servo amplifier SI unit velocity setting error | SI unit velocity that is set to the servo amplifier is not supported. | | | |

| Related buffer memory address | Set range (Setting with sequence program) | Remedy |
|-------------------------------|--|---|
| 76+150n 77+150n | <Creep speed> 1 to 1000000000 [PLS/s] 1 to 2000000000 [$\times 10^{-2}$ mm/min or others] | <ul style="list-style-type: none"> • Bring the setting into the setting range. • Set the speed to that below the HPR speed. • Set the value to the bias speed at start or higher. (Refer to Section 5.2.5) |
| 78+150n | 0, 1 | With the setting brought into the setting range, turn the PLC READY signal [Y0] from OFF to ON. |
| 80+150n 81+150n | 0 to 2147483647 | |
| 82+150n | 0, 1, 2, 3 | |
| 83+150n | 0, 1, 2, 3 | |
| 86+150n | 1 to 1000 | |
| 88+150n | 0, 1 | |
| 87+150n | 0, 1 | |
| 105 132+150n | <Operation cycle setting> [RJ010 mode] 0, 1, 2 [CiA402 mode] 1000H, 1001H, 1002H <Communication mode setting> 0, 1 | With the setting brought into the setting range, write to the flash ROM and switch the power on again or reset the PLC. |
| 28401+100n | 0, 1 | With the setting brought into "0: Use for the actual servo amplifier", write to the flash ROM and switch the power on again or reset the PLC. Or, the setting of the station No. on the network parameter is changed. |
| — | — | Set "1: Enabled only for HPR mode" in the servo parameter "Function selection D-4 (PD41)" (Stroke limit enabling condition selection). |
| — | — | Refer to the servo amplifier instruction manual for details, please change the SI unit velocity to (0.01r/min) or (0.01mm/s). |

| Classification of errors | Error code | Error name | Error | Operation status at error occurrence | |
|--------------------------|------------|-----------------------|---|--------------------------------------|--|
| Encoder errors | 1201 | HPR data incorrect | <ul style="list-style-type: none"> • The backup data for absolute position restoration is illegal. • The home position return has never been executed after the system starts. • The home position return is started, but not completed correctly. • The servo alarm "Absolute position erased" (alarm No.: 25) or the servo warning "Absolute position counter warning" (warning No.: E3) occurred. • "Rotation direction selection/travel direction selection (PA14)" of the servo parameter is changed. | The operation continues. | |
| Servo amplifier | 2000 | Servo amplifier error | Alarm occurs on the servo amplifier. | The operation stops. | |

| Related buffer memory address | Set range (Setting with sequence program) | Remedy |
|-------------------------------|--|--|
| — | — | Execute HPR. |
| 2488+100n | — | Confirm the alarm code by "[Md.114] servo alarm", and refer to the servo amplifier instruction manual for details. |

n: Axis No.-1

16.5 List of warnings

The following table shows the warning details and remedies to be taken when a warning occurs.

| Classification of warnings | Warning code | Warning name | Warning | Operation status at warning occurrence | |
|----------------------------|--|--|--|--|--|
| — | 000 | (Normal status) | — | — | |
| Common warnings | 100 | Start during operation | <ul style="list-style-type: none"> The start request is issued while the axis is BUSY. Positioning was started during speed control mode/torque control mode. | Position control mode: The operation continues. Speed control mode/torque control mode: The operation continues. (Positioning start is not executed.) | |
| | 104 | Restart not possible | The restart command is issued when the axis operation status is not "Stopped". | Continue the operation. | |
| | 109 | Teaching in BUSY | The teaching request is issued while the axis is BUSY. | The warning is issued for the axis designated at the time of the teaching request. | |
| | 110 | Less than minimum speed | The overridden speed becomes "0". | The system is controlled with the currently executing unit of 1. | |
| | 111 | In PLC READY | The request for writing to the flash ROM is issued when the PLC READY is turned ON. | The warning for axis 1 is issued. | |
| | 112 | Illegal override value | A value other than 1 to 300 is set for the override value. | <ul style="list-style-type: none"> When a setting value is 0: Controlled at 100. When a setting value is 301 or more: Controlled at 300. | |
| | 113 | Outside new torque value range/outside forward new torque value range | A new torque value/forward new torque value is exceeded the torque limit setting value. (Note): When the individual setting is used for new torque value and new reverse torque value, it indicates outside forward new torque value. | The torque change is not carried out. | |
| | 114 | Below bias speed | The command speed is below the bias speed at start. | Operate by the bias speed at start. | |
| 115 | Outside new reverse torque value range | A new reverse torque value is exceeded the torque limit setting value. | The torque change is not carried out. | | |

| Related buffer memory address | Set range (Setting with sequence program) | Remedy |
|--|---|---|
| — | — | — |
| — | — | <ul style="list-style-type: none"> • Normalize the start request ON timing. • When in speed control mode/torque control mode, start positioning after switching to the position control mode. |
| 4303+100n | <Restart command> 1: Restart | Normalize the start request ON timing. (Refer to Section 6.5.5) (Do not issue the restart command when the axis operation is not stopped.) |
| 4348+100n 4349+100n | <Teaching data selection> 0, 1 <Teaching positioning data No.> 1 to 600 | Carry out the teaching request when the axis is not BUSY. (Refer to Section 13.7.4) |
| 4313+100n | <Positioning operation speed override> 1 to 300 | Prevent the overridden speed from being reduced to 0. (Refer to Section 13.5.2) |
| Same as warning code 109 | | Request to write when the PLC READY signal [Y0] is OFF. |
| 4313+100n | <Positioning operation speed override> 1 to 300 | Set a value within the setting range. |
| 4325+100n | <New torque value/forward new torque value > 0 to [Torque limit setting value] | Set a new torque value or a forward new torque value less than the torque limit setting value. |
| 26+150n | <Torque limit setting value> 1 to 1000 | |
| Refer to Section 5.3 "List of positioning data" for command speed Bias speed at start 6+150n 7+150n | <Command speed> 1 to 1000000000 [PLS/s] 1 to 2000000000 [$\times 10^{-2}$ mm/min or another] | Re-set the command speed/bias speed at start so that the command speed is equal to or larger than the bias speed at start. |
| | <Bias speed at start> 0 [PLS/s] 0 [$\times 10^{-2}$ mm/min or another] | |
| 4364+100n | <New reverse torque value> 0 to [Torque limit setting value] | Set a value which does not exceed the torque limit setting value as the new reverse torque value. |
| 26+150n | <Torque limit setting value> 1 to 1000 | |

n: Axis No.-1

| Classification of warnings | Warning code | Warning name | Warning | Operation status at warning occurrence | |
|---|--------------|---|---|--|--|
| Common warnings | 120 | Control mode switching during BUSY | Control mode switching was executed from the position control mode to the speed control mode/torque control mode while BUSY was turned ON. | The control mode is not switched. (Positioning during operation continues.) | |
| | 121 | Control mode switching during zero speed OFF | Control mode was changed when "Zero speed" ([Md.108] Servo status) was turned OFF. | The control mode is not switched. (Current operation continues.) | |
| | 122 | Outside control mode range | Control mode switching request was performed by specifying a value outside the range for "[Cd.139] Control mode setting". | | |
| | 123 | Control mode switching | Control mode switching request was performed during the control mode switching. | Control mode switching request is not accepted. | |
| | 130 | Outside mark detection signal setting range | The mark detection signal setting is outside the range. | All mark detections are not operated. | |
| | 131 | Outside mark detection data type setting range | The mark detection data type setting is outside the range. | | |
| | 132 | Outside mark detection data axis No. setting range | When the mark detection data type setting is not "Optional 2 word buffer memory", the mark detection data type setting is outside the range. | | |
| | 133 | Outside mark detection data buffer memory No. setting range | When the mark detection data type setting is "Optional 2 word buffer memory", the mark detection data buffer memory No. is outside the range or odd number. | All mark detections are not operated. | |
| JOG operation warnings | 300 | Speed change during deceleration | The speed change request is issued during deceleration stop with JOG start signal OFF. | The speed change is not carried out. | |
| | 301 | JOG speed limit value | <ul style="list-style-type: none"> The JOG speed (Note-1) is exceeded the speed limit value at start. The new speed value (Note-1) exceeds the JOG speed limit value when the speed is changed during JOG operation. (Note-1): This speed is a value in which override value is considered when override function is used. ("[Cd.13] Positioning operation speed override" is set other than 100[%].) | <ul style="list-style-type: none"> When the speed exceeds the JOG speed limit, the JOG operation is carried out with the JOG speed limit value. While the speed is limited by the JOG speed limit value, the "[Md.39] In speed limit flag" is turned ON. | |
| Manual pulse generator operation warnings | 401 | Outside manual pulse generator input magnification range | The manual pulse generator 1 pulse input magnification is set to 0, 10001 or more, or negative value. | <ul style="list-style-type: none"> When input magnification is set at 10001 or more, or negative value: Re-set to 10000. When input magnification is set at 0: Re-set to 1. | |

| | Related buffer memory address | Set range (Setting with sequence program) | Remedy |
|--|---|---|--|
| | — | — | Switch the control mode after turning BUSY OFF. |
| | — | — | Switch the control mode after turning "Zero speed" ([Md.108] Servo status) ON. |
| | 4375+100n | <Control mode setting> 0, 10, 20 | Switch the control mode after setting a value within the range for "[Cd.139] Control mode setting". |
| | — | — | Carry out the control mode switching request after completing the control mode switching. |
| | 54000+20k | < Mark detection signal setting > 0 to 16 | Set a value within the setting range. |
| | 54002+20k | < Mark detection data type > -1 to 12 | |
| | 54003+20k | < Mark detection data axis No.> 1 to 16, 801 to 804 | Set a value within the setting range. |
| | 54004+20k 54005+20k | <Mark detection data buffer memory No.> 0 to 65534 | Set a value with an even number within the setting range. |
| | JOG speed 4318+100n 4319+100n | <JOG speed> 1 to 1000000000 [PLS/s] 1 to 2000000000 [$\times 10^{-2}$ mm/min or another] | Do not carry out the JOG speed change during deceleration with the JOG start signal OFF. |
| | New speed value 4314+100n 4315+100n | <New speed value> 0 to 1000000000 [PLS/s] 0 to 2000000000 [$\times 10^{-2}$ mm/min or another] | |
| | JOG speed limit value 48+150n 49+150n | <JOG speed limit value> 1 to 1000000000 [PLS/s] 1 to 2000000000 [$\times 10^{-2}$ mm/min or another] | Set a value within the setting range. |
| | Positioning operation speed override 4313+100n | < Positioning operation speed override > 1 to 300 [%] | |
| | 4322+100n 4323+100n | <Manual pulse generator 1 pulse input magnification> 1 to 1000 | Set the manual pulse generator 1 pulse input magnification to within the setting range. |

n: Axis No.-1

k: Mark detection setting No.-1

| Classification of warnings | Warning code | Warning name | Warning | Operation status at warning occurrence | |
|--------------------------------|--------------|--|--|---|--|
| Positioning operation warnings | 500 | Deceleration/stop speed change | The speed change request is issued during deceleration stop. | The speed change is not carried out. | |
| | 501 | Speed limit value over | <ul style="list-style-type: none"> Setting speeds ^(Note-2) exceed the speed limit value when starting/restarting the positioning or when changing the speed at the positioning ^(Note-1). (At the interpolation control, either of reference axes or interpolation axes exceeds the speed limit value.) "[Cd.140] Command speed at speed control mode" exceeds "[Pr.8] Speed limit value" during the speed control mode. "[Cd.146] Speed limit value at torque control mode" exceeds "[Pr.8] Speed limit value" during the torque control mode. <p>(Note-1): The speed change by position-speed switching control, target position change function, or override function is contained.</p> <p>(Note-2): This speed is a value in which override value is considered when override function is used. ("[Cd.13] Positioning operation speed override" is set other than 100[%].)</p> | <p>Position control mode:</p> <ul style="list-style-type: none"> The speed is controlled with the speed limit value. The "[Md.39] In speed limit flag" is turned ON. <p>Speed control mode/torque control mode: The speed is controlled with the speed limit value. ("[Md.39] In speed limit flag" is not turned ON.)</p> | |
| | 503 | M code ON signal ON | The M code ON signal is turned ON when the positioning data is executed. | Continue executing the positioning data. | |
| | 505 | No operation termination setting | In the positioning by block starting, the 50th point of the positioning start data is set to CONTINUE. | The operation is terminated. | |
| | 506 | FOR to NEXT nest construction | FOR to NEXT is nested. | | |
| | 508 | Speed-position switching (during acceleration) signal ON | The switching signal for speed-position switching control (INC mode) is turned ON during acceleration. | The operation is continued. | |

| | Related buffer memory address | Set range (Setting with sequence program) | Remedy | |
|--|---|--|---|---|
| | 4316+100n | <Speed change request> 1: Speed change is requested | Do not carry out the speed change during deceleration with a stop command, during stoppage, or during automatic deceleration with position control. | |
| | HPR speed 74+150n 75+150n | <HPR speed> 1 to 1000000000 [PLS/s] 1 to 2000000000 [$\times 10^{-2}$ mm/min or another] | Review each speed so that setting speeds do not exceed the speed limit value. | |
| | Command speed Refer to Section 5.3 "List of positioning data" | <Command speed> 1 to 1000000000 [PLS/s] 1 to 2000000000 [$\times 10^{-2}$ mm/min or another] | | |
| | New speed value 4314+100n 4315+100n | <New speed value> 0 to 1000000000 [PLS/s] 0 to 2000000000 [$\times 10^{-2}$ mm/min or another] | | |
| | Position-speed switching control speed change register 4330+100n 4331+100n | <Position-speed switching control speed change register> 0 to 1000000000 [PLS/s] 0 to 2000000000 [$\times 10^{-2}$ mm/min or another] | | |
| | Target position change value (New speed) 4336+100n 4337+100n | <Target position change value (New speed)> 0 to 1000000000 [PLS/s] 0 to 2000000000 [$\times 10^{-2}$ mm/min or another] | | |
| | Speed limit value 10+150n 11+150n | <JOG speed limit value> 1 to 1000000000 [PLS/s] 1 to 2000000000 [$\times 10^{-2}$ mm/min or another] | | |
| | Positioning operation speed override 4313+100n | <Positioning operation speed override> 1 to 300[%] | | |
| | Command speed at speed control mode 4376+100n 4377+100n | <Command speed at speed control mode> -1000000000 to 1000000000 [PLS/s] -2000000000 to 2000000000 [$\times 10^{-2}$ mm/min or another] | | |
| | Speed limit value at torque control mode 4384+100n 4385+100n | <Speed limit value at torque control mode> 0 to 1000000000 [PLS/s] 0 to 2000000000 [$\times 10^{-2}$ mm/min or another] | | |
| | 4304+100n | <M code OFF request> 1: M code ON signal is turned OFF | | Normalize the ON and OFF timings of the "M code OFF request". (Refer to Section 13.7.3) |
| | Refer to Section 5.3 "List of positioning data" | <Operation pattern> 00: Positioning end 01: Continuous positioning control 11: Continuous path control | | Set the operation termination to the 50th point. (Refer to Chapter 10) |
| | — | — | | Make 1 nest construction for FOR to NEXT. (Refer to Section 10.3.8) |
| | — | — | | Do not turn ON the speed-position switching signal during acceleration. (Refer to Section 9.2.16) |

n: Axis No.-1

| Classification of warnings | Warning code | Warning name | Warning | Operation status at warning occurrence | |
|--------------------------------|--------------|-----------------------------------|--|---|--|
| Positioning operation warnings | 509 | Insufficient remaining distance | <ul style="list-style-type: none"> At a continuous operation interrupt request, the distance required deceleration stop is not long enough. At a speed change request, the remaining distance is shorter than the distance required for speed change. | <ul style="list-style-type: none"> When a command speed is changed: Change to a value as near a new speed value as possible. When a target position is changed: Adjust the speed to a value as near the command speed as possible, and then change to a target position. (When the operation pattern is a continuous path control, ignore the operations stated above.) | |
| | 511 | Step not possible | Code 1 is set for the step start information when the step is outside standby. | The step will not start. | |
| | 512 | Illegal external command function | The detailed parameter 2 "External command function selection" setting range is exceeded. | Even if the external command signal is turned ON, the system will not perform anything. | |
| | 513 | Insufficient movement amount | The movement amount is not large enough for automatic deceleration. | The system stops immediately after it reaches the positioning address. | |
| | 514 | Outside command speed range | <ul style="list-style-type: none"> The speed change value is outside the setting range when changing the speed during operation. (Note-1) "[Cd.140] Command speed at speed control mode" is outside the setting range during the speed control mode. "[Cd.146] Speed limit value at torque control mode" is outside the setting range during the torque control mode. (Note-1): The speed change by position-speed switching control or target position change function is contained. | <ul style="list-style-type: none"> The speed change value is controlled as the "maximum value within the setting range". The "[Md.39] In speed limit flag" is turned ON. | |
| | 516 | Illegal teaching data No. | The positioning data No. is set outside the setting range. | Teaching is not carried out when the set value is 0 or 601 or more. (The set value is automatically reset to "0" by the Simple Motion module even when a "0" or "601" or more is set.) | |
| | 517 | Illegal teaching data selection | The teaching data selection set value is outside the setting range. | Teaching is not carried out. | |

| | Related buffer memory address | Set range (Setting with sequence program) | Remedy | |
|--|--|---|---|--|
| | — | — | Give a request at the position where there is an enough remaining distance. | |
| | 4346+100n | <Step start information> 1: Step is continued 2: Re-start is carried out | Do not set a "1" to the step start information when the step is not in standby state. (Refer to Section 13.7.1) | |
| | 62+150n | <External command function selection> 0, 1, 2, 3, 4 | Set the detailed parameter 2 "External command function selection" to within the setting range. | |
| | Refer to Section 5.3 "List of positioning data" | — | Set a decelerating address or a movement amount to the positioning data. | |
| | New speed value 4314+100n 4315+100n | <New speed value> 0 to 1000000000 [PLS/s] 0 to 2000000000 [$\times 10^{-2}$ mm/min or another] | <ul style="list-style-type: none"> • Set the speed change value to within the setting range. • Set "[Cd.140] Command speed at speed control mode" to within the setting range during the speed control mode. • Set "[Cd.146] Speed limit value at torque control mode" to within the setting range during the torque control mode. | |
| | Position-speed switching control speed change register 4330+100n 4331+100n | <Position-speed switching control speed change register> 0 to 1000000000 [PLS/s] 0 to 2000000000 [$\times 10^{-2}$ mm/min or another] | | |
| | Target position change value (New speed) 4336+100n 4337+100n | <Target position change value (New speed)> 0 to 1000000000 [PLS/s] 0 to 2000000000 [$\times 10^{-2}$ mm/min or another] | | |
| | Command speed at speed control mode 4376+100n 4377+100n | <Command speed at speed control mode> -1000000000 to 1000000000 [PLS/s] -2000000000 to 2000000000 [$\times 10^{-2}$ mm/min or another] | | |
| | Speed limit value at torque control mode 4384+100n 4385+100n | <Speed limit value at torque control mode> 0 to 1000000000 [PLS/s] 0 to 2000000000 [$\times 10^{-2}$ mm/min or another] | | |
| | 4349+100n | <Teaching positioning data No.> 1 to 600 | | Set the positioning data No. to within the setting range. |
| | 4348+100n | <Teaching data selection> 0, 1 | | Set the teaching data selection set value to within the setting range. |

n: Axis No.-1

| Classification of warnings | Warning code | Warning name | Warning | Operation status at warning occurrence | |
|--------------------------------|--------------|--|--|---|--|
| Positioning operation warnings | 518 | Target position change not possible | <ul style="list-style-type: none"> • A target position change request was given for the control method other than ABS1 and INC1. • A target position change request is turned ON during continuous path control. • A new target position address is outside the software stroke limit range. • A target position change request was given during deceleration to a stop. • A target position change request was issued when speed change 0 flag ([Md.31] Status: b10) was ON. | The target position change is not carried out. | |
| | 520 | Torque limit value over | <ul style="list-style-type: none"> • A value exceeding "[Pr.17] Torque limit setting value" is set to "[Cd.143] Command torque at torque control mode" at torque control mode. | The torque is controlled with the torque limit setting value. | |
| | 521 | Torque initial value selection invalid | <ul style="list-style-type: none"> • At switching the control mode, the servo parameter "Function selection C-B POL reflection selection at torque control (PC29)" is "0: Enabled" on the axis that set feedback torque into the torque initial value selection. | The torque initial value selection is controlled as the command torque. | |
| Servo amplifier | 2000 | Servo amplifier warning | Warning occurs on the servo amplifier. | The operation continues. | |

| Related buffer memory address | Set range (Setting with sequence program) | Remedy |
|--|---|---|
| 4338+100n | <Target position change request flag> 1: Target position change request | <ul style="list-style-type: none"> • Do not turn ON the target position change request in the following cases. <ol style="list-style-type: none"> 1) An operating pattern "continuous path control" is used. 2) A control method other than ABS1, and INC1 is used. 3) During deceleration stop. 4) When speed change 0 flag ([Md.31] Status: b10) is ON. 5) During speed control mode 6) During torque control mode • When the target position change address is outside the software stroke limit range, correct the target position change address. (Refer to Section 13.5.5) |
| Command torque at torque control mode 4380+100n Torque limit setting value 26+150n | <Command torque at torque control mode> -10000 to 10000 [$\times 10^{-1}\%$] <Torque limit setting value> 1 to 1000[%] | Review the setting value so that the setting torque is not exceeded the torque limit setting value. |
| Operation setting for speed-torque control mode 68+150n POL reflection setting at torque control 28492+100n | <Torque initial value selection (b4 to b7)> 0, 1 <POL reflection setting at torque control> 0, 1 | <ul style="list-style-type: none"> • Use a servo amplifier which supports the servo parameter "Function selection C-B POL reflection selection at torque control (PC29)" and set the servo parameter "Function selection C-B POL reflection selection at torque control (PC29)" to "1: Disabled". • At switching the control mode, use the command torque by the torque initial value selection. |
| 2488+100n | — | Confirm the warning code by "[Md.114] servo alarm", and refer to the servo amplifier instruction manual for details. |

n: Axis No.-1

Appendices

| | |
|--|--------------|
| Appendix 1 List of buffer memory addresses | Appendix- 2 |
| Appendix 2 Connection with servo amplifiers..... | Appendix- 14 |
| Appendix 3 Connection with external device..... | Appendix- 17 |
| Appendix 3.1 Connector..... | Appendix- 17 |
| Appendix 3.2 External input signal cable | Appendix- 20 |
| Appendix 3.3 Manual pulse generator (MR-HDP01) | Appendix- 26 |
| Appendix 4 When using GX Works2 | Appendix- 27 |
| Appendix 5 External dimension drawing | Appendix- 28 |

Appendix 1 List of buffer memory addresses

The following shows the relation between the buffer memory addresses and the various items.

(Note-1): Do not use the buffer memory address that not been described here for a "Maker setting".

(Note-2): For the list of buffer memory addresses for positioning data, refer to the "Simple Motion Module Setting Tool Help" of GX Works2.

(Note-3): For the list of buffer memory addresses used in synchronous control, refer to the "MELSEC-Q/L QD77MS/QD77GF/LD77MS/LD77MH Simple Motion Module User's Manual (Synchronous Control)".

(Note-4): Guide to buffer memory address

- In the buffer memory address, "n" in "1+150n", etc. indicates a value corresponding to axis No.

Calculate as follows for the buffer memory address corresponding to each axis.

(Example) For axis No. 16

$$1+150n \text{ ([Pr.4] Unit magnification (AM))} = 1+150 \times 16 = 2251$$

- In the buffer memory address, "p" in "4012+5p", etc. indicates a pointer No. Calculate as follows for the buffer memory address corresponding to each pointer No.

(Example) For pointer No. 15

$$4012+5p \text{ ([Md.3] Start information)} = 4012+5 \times 15 = 4087$$

| Buffer memory address | Item | Memory area |
|-----------------------|---|------------------------|
| 0+150n | [Pr.1] Unit setting | Positioning parameters |
| 1+150n | [Pr.4] Unit magnification (AM) | |
| 2+150n 3+150n | [Pr.2] Number of pulses per rotation (AP) | |
| 4+150n 5+150n | [Pr.3] Movement amount per rotation (AL) | |
| 6+150n 7+150n | [Pr.7] Bias speed at start | |
| 10+150n 11+150n | [Pr.8] Speed limit value | |
| 12+150n 13+150n | [Pr.9] Acceleration time 0 | |
| 14+150n 15+150n | [Pr.10] Deceleration time 0 | |
| 17+150n | [Pr.11] Backlash compensation amount | |
| 18+150n 19+150n | [Pr.12] Software stroke limit upper limit value | |
| 20+150n 21+150n | [Pr.13] Software stroke limit lower limit value | |
| 22+150n | [Pr.14] Software stroke limit selection | |
| 23+150n | [Pr.15] Software stroke limit valid/invalid setting | |
| 24+150n 25+150n | [Pr.16] Command in-position width | |

n: Axis No.-1

| Buffer memory address | Item | Memory area | |
|-----------------------|---|-----------------------|------------------------|
| 26+150n | [Pr.17] Torque limit setting value | Detailed parameters 1 | Positioning parameters |
| 27+150n | [Pr.18] M code ON signal output timing | | |
| 28+150n | [Pr.19] Speed switching mode | | |
| 29+150n | [Pr.20] Interpolation speed designation method | | |
| 30+150n | [Pr.21] Feed current value during speed control | | |
| 31+150n | [Pr.22] Input signal logic selection | | |
| 32+150n | [Pr.80] External input signal selection | | |
| 33 | [Pr.24] Manual pulse generator/Incremental synchronous encoder input selection | | |
| 34+150n | [Pr.81] Speed-position function selection | | |
| 35 | [Pr.82] Forced stop valid/invalid selection | | |
| 36+150n 37+150n | [Pr.25] Acceleration time 1 | Detailed parameters 2 | Positioning parameters |
| 38+150n 39+150n | [Pr.26] Acceleration time 2 | | |
| 40+150n 41+150n | [Pr.27] Acceleration time 3 | | |
| 42+150n 43+150n | [Pr.28] Deceleration time 1 | | |
| 44+150n 45+150n | [Pr.29] Deceleration time 2 | | |
| 46+150n 47+150n | [Pr.30] Deceleration time 3 | | |
| 48+150n 49+150n | [Pr.31] JOG speed limit value | | |
| 50+150n | [Pr.32] JOG operation acceleration time selection | | |
| 51+150n | [Pr.33] JOG operation deceleration time selection | | |
| 52+150n | [Pr.34] Acceleration/deceleration process selection | | |
| 53+150n | [Pr.35] S-curve ratio | | |
| 54+150n 55+150n | [Pr.36] Rapid stop deceleration time | | |
| 56+150n | [Pr.37] Stop group 1 rapid stop selection | | |
| 57+150n | [Pr.38] Stop group 2 rapid stop selection | | |
| 58+150n | [Pr.39] Stop group 3 rapid stop selection | | |
| 59+150n | [Pr.40] Positioning complete signal output time | | |
| 60+150n 61+150n | [Pr.41] Allowable circular interpolation error width | | |
| 62+150n | [Pr.42] External command function selection | | |
| 63+150n | [Pr.83] Speed control 10 x multiplier setting for degree axis | | |
| 64+150n 65+150n | [Pr.84] Restart allowable range when servo OFF to ON | | |
| 67 | [Pr.89] Manual pulse generator/incremental synchronous encoder input type selection | | |
| 68+150n | [Pr.90] Operation setting for speed-torque control mode | | |
| 69+150n | [Pr.95] External command signal selection | | |

n: Axis No.-1

| Buffer memory address | Item | Memory area | |
|-----------------------|--|----------------------|----------------|
| 70+150n | [Pr.43] HPR method | HPR basic parameters | HPR parameters |
| 71+150n | [Pr.44] HPR direction | | |
| 72+150n 73+150n | [Pr.45] HP address | | |
| 74+150n 75+150n | [Pr.46] HPR speed | | |
| 76+150n 77+150n | [Pr.47] Creep speed | | |
| 78+150n | [Pr.48] HPR retry | | |
| 80+150n 81+150n | [Pr.50] Setting for the movement amount after proximity dog ON | | |
| 82+150n | [Pr.51] HPR acceleration time selection | | |
| 83+150n | [Pr.52] HPR deceleration time selection | | |
| 84+150n 85+150n | [Pr.53] HP shift amount | | |
| 86+150n | [Pr.54] HPR torque limit value | | |
| 87+150n | [Pr.55] Operation setting for incompleteness of HPR | | |
| 88+150n 89+150n | [Pr.56] Speed designation during HP shift [Pr.57] Dwell time during HPR retry | | |
| 105 | [Pr.96] Operation cycle setting | Expansion parameter | |
| 113+150n | [Pr.113] Servo parameter transfer | | |
| 132+150n | [Pr.132] Communication mode setting | | |

n: Axis No.-1

| Buffer memory address | Item | Memory area | | |
|-----------------------|--|---------------------|--------------|-----------------|
| 4000 | [Md.1] In test mode flag | System monitor data | Monitor data | |
| 4006 4007 | [Md.130] OS version | | | |
| 4008 | [Md.134] Operation time | | | |
| 4009 | [Md.135] Maximum operation time | | | |
| 4011 | [Md.131] Digital oscilloscope running flag | | | |
| 4012+5p | [Md.3] Start information | | | Start history |
| 4013+5p | [Md.4] Start No. | | | |
| 4240+p | [Md.54] Start Year: month | | | |
| 4014+5p | [Md.5] Start Day: hour | | | |
| 4015+5p | [Md.6] Start Minute: second | | | |
| 4016+5p | [Md.7] Error judgment | | | |
| 4092 | [Md.8] Start history pointer | | | |
| 4093+4p | [Md.9] Axis in which the error occurred | | | Error history |
| 4094+4p | [Md.10] Axis error No. | | | |
| 31300+p | [Md.57] Servo alarm | | | |
| 4256+p | [Md.55] Axis error occurrence (Year: month) | | | |
| 4095+4p | [Md.11] Axis error occurrence (Day: hour) | | | |
| 4096+4p | [Md.12] Axis error occurrence (Minute: second) | | | |
| 4157 | [Md.13] Error history pointer | | | |
| 4158+4p | [Md.14] Axis in which the warning occurred | | | Warning history |
| 4159+4p | [Md.15] Axis warning No. | | | |
| 31316+p | [Md.58] Servo warning | | | |
| 4272+p | [Md.56] Axis warning occurrence (Year: month) | | | |
| 4160+4p | [Md.16] Axis warning occurrence (Day: hour) | | | |
| 4161+4p | [Md.17] Axis warning occurrence (Minute: second) | | | |
| 4222 | [Md.18] Warning history pointer | | | |
| 4224 4225 | [Md.19] Number of write accesses to flash ROM | | | |
| 4231 | [Md.50] Forced stop input | | | |
| 4235 | [Md.59] Module information | | | |
| 4238 | [Md.132] Operation cycle setting | | | |
| 4239 | [Md.133] Operation cycle over flag | | | |

p: Pointer No.-1

| Buffer memory address | Item | Memory area | |
|------------------------|--|-------------------|--------------|
| 2400+100n 2401+100n | [Md.20] Feed current value | Axis monitor data | Monitor data |
| 2402+100n 2403+100n | [Md.21] Feed machine value | | |
| 2404+100n 2405+100n | [Md.22] Feedrate | | |
| 2406+100n | [Md.23] Axis error No. | | |
| 2407+100n | [Md.24] Axis warning No. | | |
| 2408+100n | [Md.25] Valid M code | | |
| 2409+100n | [Md.26] Axis operation status | | |
| 2410+100n 2411+100n | [Md.27] Current speed | | |
| 2412+100n 2413+100n | [Md.28] Axis feedrate | | |
| 2414+100n 2415+100n | [Md.29] Speed-position switching control positioning movement amount | | |
| 2416+100n | [Md.30] External input signal | | |
| 2417+100n | [Md.31] Status | | |
| 2418+100n 2419+100n | [Md.32] Target value | | |
| 2420+100n 2421+100n | [Md.33] Target speed | | |
| 2424+100n 2425+100n | [Md.34] Movement amount after proximity dog ON | | |
| 2426+100n | [Md.35] Torque limit stored value/forward torque limit stored value | | |
| 2427+100n | [Md.36] Special start data instruction code setting value | | |
| 2428+100n | [Md.37] Special start data instruction parameter setting value | | |
| 2429+100n | [Md.38] Start positioning data No. setting value. | | |
| 2430+100n | [Md.39] In speed limit flag | | |
| 2431+100n | [Md.40] In speed change processing flag | | |
| 2432+100n | [Md.41] Special start repetition counter | | |
| 2433+100n | [Md.42] Control system repetition counter | | |
| 2434+100n | [Md.43] Start data pointer being executed | | |
| 2435+100n | [Md.44] Positioning data No. being executed | | |
| 2436+100n | [Md.45] Block No. being executed | | |
| 2437+100n | [Md.46] Last executed positioning data No. | | |

n: Axis No.-1

| Buffer memory address | Item | Memory area | |
|-----------------------|--|-------------------|-------------------------|
| 2438+100n | [Md.47] Positioning data being executed | Axis monitor data | |
| 2439+100n | | | Positioning identifier |
| 2440+100n | | | M code |
| 2441+100n | | | Dwell time |
| 2442+100n | | | Axis to be interpolated |
| 2443+100n | | | Command speed |
| 2444+100n | | | Positioning address |
| 2445+100n | | | Arc address |
| 2446+100n | | Monitor data | |
| 2447+100n | | | |
| 2448+100n | [Md.100] HPR re-travel value | | |
| 2449+100n | | | |
| 2450+100n | [Md.101] Real current value | | |
| 2451+100n | | | |
| 2452+100n | [Md.102] Deviation counter value | | |
| 2453+100n | | | |
| 2454+100n | [Md.103] Motor rotation speed | | |
| 2455+100n | | | |
| 2456+100n | [Md.104] Motor current value | | |
| 2457+100n | | | |
| 2458+100n | [Md.514] HPR operating status | | |
| 2459+100n | | | |
| 2470+100n | [Md.107] Parameter error No. | | |
| 2471+100n | | | |
| 2476+100n | [Md.108] Servo status | | |
| 2477+100n | | | |
| 2478+100n | [Md.109] Regenerative load ratio | | |
| 2479+100n | | | |
| 2480+100n | [Md.110] Effective load torque | | |
| 2481+100n | | | |
| 2482+100n | [Md.111] Peak torque ratio | | |
| 2483+100n | | | |
| 2487+100n | [Md.117] Statusword | | |
| 2488+100n | | | |
| 2489+100n | [Md.113] Semi/Fully closed loop status | | |
| 2490+100n | | | |
| 2488+100n | [Md.114] Servo alarm | | |
| 2491+100n | | | |
| 2492+100n | [Md.120] Reverse torque limit stored value | | |
| 2493+100n | | | |
| 2492+100n | [Md.122] Speed during command | | |
| 2493+100n | | | |
| 2494+100n | [Md.123] Torque during command | | |
| 2495+100n | | | |
| 2499+100n | [Md.48] Deceleration start flag | | |

n: Axis No.-1

| Buffer memory address | Item | Memory area | |
|------------------------|---|-------------------|--------------|
| 4300+100n | [Cd.3] Positioning start No. | Axis control data | Control data |
| 4301+100n | [Cd.4] Positioning starting point No. | | |
| 4302+100n | [Cd.5] Axis error reset | | |
| 4303+100n | [Cd.6] Restart command | | |
| 4304+100n | [Cd.7] M code OFF request | | |
| 4305+100n | [Cd.8] External command valid | | |
| 4306+100n 4307+100n | [Cd.9] New current value | | |
| 4308+100n 4309+100n | [Cd.10] New acceleration time value | | |
| 4310+100n 4311+100n | [Cd.11] New deceleration time value | | |
| 4312+100n | [Cd.12] Acceleration/deceleration time change value during speed change, enable/disable | | |
| 4313+100n | [Cd.13] Positioning operation speed override | | |
| 4314+100n 4315+100n | [Cd.14] New speed value | | |
| 4316+100n | [Cd.15] Speed change request | | |
| 4317+100n | [Cd.16] Inching movement amount | | |
| 4318+100n 4319+100n | [Cd.17] JOG speed | | |
| 4320+100n | [Cd.18] Interrupt request during continuous operation | | |
| 4321+100n | [Cd.19] HPR request flag OFF request | | |
| 4322+100n 4323+100n | [Cd.20] Manual pulse generator 1 pulse input magnification | | |
| 4324+100n | [Cd.21] Manual pulse generator enable flag | | |
| 4325+100n | [Cd.22] New torque value/forward new torque value | | |
| 4326+100n 4327+100n | [Cd.23] Speed-position switching control movement amount change register | | |
| 4328+100n | [Cd.24] Speed-position switching enable flag | | |
| 4330+100n 4331+100n | [Cd.25] Position-speed switching control speed change register | | |
| 4332+100n | [Cd.26] Position-speed switching enable flag | | |
| 4334+100n 4335+100n | [Cd.27] Target position change value (New address) | | |
| 4336+100n 4337+100n | [Cd.28] Target position change value (New speed) | | |
| 4338+100n | [Cd.29] Target position change request flag | | |
| 4339+100n | [Cd.43] Simultaneous starting axis | | |

n: Axis No.-1

| Buffer memory address | Item | Memory area | |
|------------------------|--|-------------------|--------------|
| 4340+100n | [Cd.30] Simultaneous starting own axis start data No. | Axis control data | Control data |
| 4341+100n | [Cd.31] Simultaneous starting axis start data No.1 | | |
| 4342+100n | [Cd.32] Simultaneous starting axis start data No.2 | | |
| 4343+100n | [Cd.33] Simultaneous starting axis start data No.3 | | |
| 4344+100n | [Cd.34] Step mode | | |
| 4345+100n | [Cd.35] Step valid flag | | |
| 4346+100n | [Cd.36] Step start information | | |
| 4347+100n | [Cd.37] Skip command | | |
| 4348+100n | [Cd.38] Teaching data selection | | |
| 4349+100n | [Cd.39] Teaching positioning data No. | | |
| 4350+100n | [Cd.40] ABS direction in degrees | | |
| 4351+100n | [Cd.100] Servo OFF command | | |
| 4352+100n | [Cd.101] Torque output setting value | | |
| 4358+100n | [Cd.133] Semi/Fully closed loop switching request | | |
| 4359+100n | [Cd.108] Gain switching command flag | | |
| 4363+100n | [Cd.112] Torque change function switching request | | |
| 4364+100n | [Cd.113] New reverse torque value | | |
| 4365+100n | [Cd.136] PI-PID switching request | | |
| 4366+100n | [Cd.45] Speed-position switching device selection | | |
| 4367+100n | [Cd.46] Speed-position switching command | | |
| 4374+100n | [Cd.138] Control mode switching request | | |
| 4375+100n | [Cd.139] Control mode setting | | |
| 4376+100n 4377+100n | [Cd.140] Command speed at speed control mode | | |
| 4378+100n | [Cd.141] Acceleration time at speed control mode | | |
| 4379+100n | [Cd.142] Deceleration time at speed control mode | | |
| 4380+100n | [Cd.143] Command torque at torque control mode | | |
| 4381+100n | [Cd.144] Torque time constant at torque control mode (Forward direction) | | |
| 4382+100n | [Cd.145] Torque time constant at torque control mode (Negative direction) | | |
| 4384+100n 4385+100n | [Cd.146] Speed limit value at torque control mode | | |
| 30100+10n | [Cd.180] Axis stop | | |
| 30101+10n | [Cd.181] Forward run JOG start | | |
| 30102+10n | [Cd.182] Reverse run JOG start | | |
| 30103+10n | [Cd.183] Execution prohibition flag | | |

: Axis No.-1

| Buffer memory address | Item | Memory area | | |
|--------------------------------|---|------------------------|--------------|-------------------------|
| 5900 | [Cd.1] Flash ROM write request | System control data | Control data | |
| 5901 | [Cd.2] Parameter initialization request | | | |
| 5905 | [Cd.41] Deceleration start flag valid | | | |
| 5907 | [Cd.42] Stop command processing for deceleration stop selection | | | |
| 5928 5929 5930 5931 | [Cd.44] External input signal operation device (Axis 1 to 16) | | | |
| 6000+1000n | [Da.1] Operation pattern | Positioning identifier | No.1 | |
| | [Da.2] Control method | | | |
| | [Da.3] Acceleration time No. | | | |
| | [Da.4] Deceleration time No. | | | |
| 6001+1000n | [Da.10] M code/condition data No. /Number of LOOP to LEND repetitions | Positioning data | | |
| 6002+1000n | [Da.9] Dwell time/JUMP destination positioning data No. | | | |
| 6003+1000n | [Da.20] Axis to be interpolated No.1 | | | Axis to be interpolated |
| | [Da.21] Axis to be interpolated No.2 | | | |
| | [Da.22] Axis to be interpolated No.3 | | | |
| 6004+1000n 6005+1000n | [Da.8] Command speed | | | Positioning data |
| 6006+1000n 6007+1000n | [Da.6] Positioning address/movement amount | | | |
| 6008+1000n 6009+1000n | [Da.7] Arc address | | | |
| 6010+1000n to 6019+1000n | No.2 | | | |
| 6020+1000n to 6029+1000n | No.3 | | | |
| to | to | | | |
| 6990+1000n to 6999+1000n | No.100 | | | |
| Set with GX Works2 | No.101 | | | |
| | to | | | |
| | No.600 | | | |

n: Axis No.-1

| Buffer memory address | | Item | Memory area | | |
|--------------------------------|---------------------|--|-------------|------------------|--|
| 22000+400n | / | [Da.11] Shape [Da.12] Start data No. | 1st point | Block start data | Positioning data (Starting block data) |
| | | 22050+400n | | | |
| 22001+400n | 22051+400n | 2nd point | | | |
| 22002+400n | 22052+400n | 3rd point | | | |
| to | | to | | | |
| 22049+400n | 22099+400n | 50th point | | | |
| 22100+400n | | [Da.15] Condition target | No.1 | Condition data | |
| | | [Da.16] Condition operator | | | |
| 22101+400n | | [Da.23] Number of simultaneous starting axes | | | |
| | | [Da.24] Simultaneous starting axis No.1 | | | |
| | | [Da.25] Simultaneous starting axis No.2 | | | |
| | | [Da.26] Simultaneous starting axis No.3 | | | |
| 22102+400n 22103+400n | [Da.17] Address | | | | |
| 22104+400n 22105+400n | [Da.18] Parameter 1 | | | | |
| 22106+400n 22107+400n | [Da.19] Parameter 2 | | | | |
| 22110+400n to 22119+400n | No.2 | | | | |
| 22120+400n to 22129+400n | No.3 | | | | |
| to | | to | | | |
| 22190+400n to 22199+400n | No.10 | | | | |
| 22200+400n to 22299+400n | Block start data | Starting block 1 | | | |
| 22300+400n to 22399+400n | Condition data | | | | |

n: Axis No.-1

| Buffer memory address | Item | Memory area | |
|-----------------------|------------------|------------------|--|
| Set with GX Works2 | Block start data | Starting block 2 | Positioning data (Starting block data) |
| | Condition data | | |
| | Block start data | Starting block 3 | |
| | Condition data | | |
| | Block start data | Starting block 4 | |
| | Condition data | | |

n: Axis No.-1

The following shows the relation between the buffer memory addresses of servo parameter and the various items.

(Note): The setting range is different depending on the servo amplifier model. Refer to each servo amplifier instruction manual for details.

| Buffer memory address | Item | Memory area |
|-----------------------|--|------------------|
| 28401+100n | [Pr.101] Virtual servo amplifier setting | Servo parameters |

n: Axis No.-1

The following shows the relation between the buffer memory addresses for mark detection function and the various items.

(Note): Do not use the buffer memory address that not been described here for a "Maker setting".

| Buffer memory address | Item | Memory area | |
|------------------------|---|-----------------------------------|-----------------------------|
| 54000+20k | [Pr.800] Mark detection signal setting | Mark detection setting parameters | |
| 54001+20k | [Pr.801] Mark detection signal compensation time | | |
| 54002+20k | [Pr.802] Mark detection data type | | |
| 54003+20k | [Pr.803] Mark detection data axis No. | | |
| 54004+20k 54005+20k | [Pr.804] Mark detection data buffer memory No. | | |
| 54006+20k 54007+20k | [Pr.805] Latch data range upper limit value | | |
| 54008+20k 54009+20k | [Pr.806] Latch data range lower limit value | | |
| 54010+20k | [Pr.807] Mark detection mode setting | | |
| 54640+10k | [Cd.800] Number of mark detection clear request | | Mark detection control data |
| 54641+10k | [Cd.801] Mark detection invalid flag | | |
| 54960+80k | [Md.800] Number of mark detection | Mark detection monitor data | |
| 54962+80k 54963+80k | [Md.801] Mark detection data storage area (1 to 32) | | 1 |
| 54964+80k 54965+80k | | | 2 |
| 54966+80k 54967+80k | | | 3 |
| to | | | to |
| 55024+80k 55025+80k | | | 32 |

k: Mark detection setting No.-1

Appendix 2 Connection with servo amplifiers

The connection between the Simple Motion module and our servo amplifiers is explained.

CC-Link IE Field Network cable connects with Simple Motion module and servo amplifiers.

[RJ010 mode]

The connectable our servo amplifier is MR-J4-_B_-RJ010 connected with MR-J3-T10. MR-J3-T10 enables an MR-J4-_B_-RJ010 to connect to the CC-Link IE Field Network by being attached to the MR-J4-_B_-RJ010.

[CiA402 mode]

The connectable our servo amplifier is MR-J4-GF.

The CC-Link IE Field Network communication function is exclusive of the CC-Link communication function. It cannot be used with the CC-Link communication function at the same time.

Refer to the servo amplifier instruction manual (CC-Link IE Field Network interface) for details.

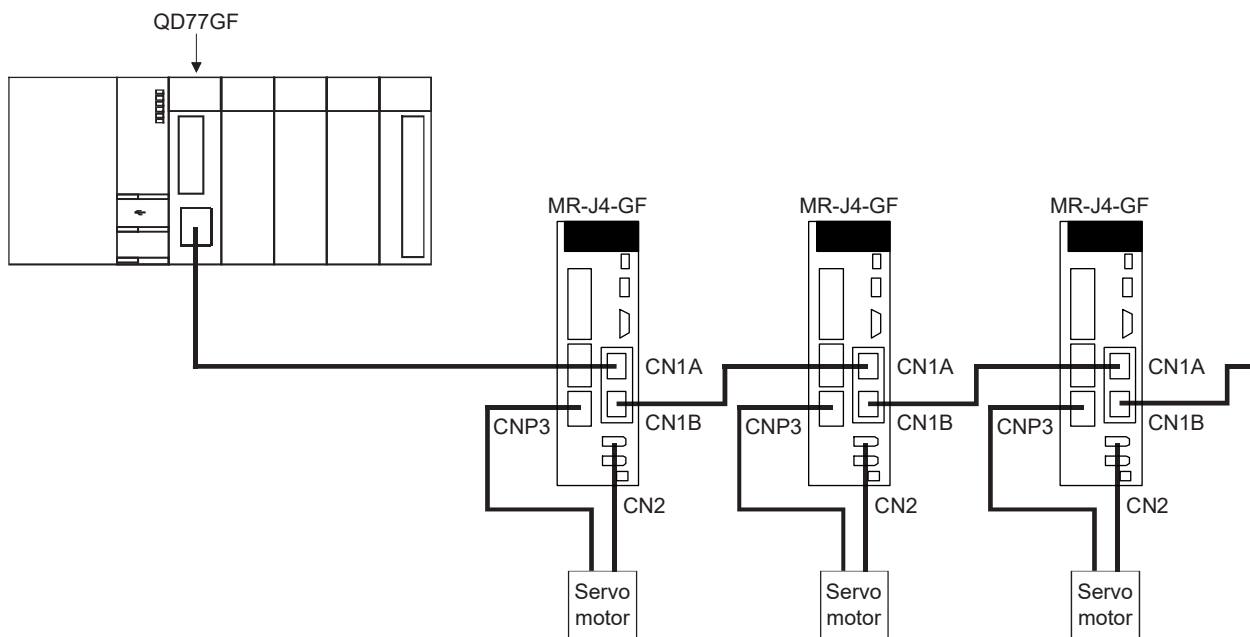

(Note): It cannot communicate with that the connection of CN1A and CN1B is mistaken.

| POINT | |
|---|--|
| When using linear servo motor control mode, direct drive motor control mode and fully closed loop control mode, set the followings. | |
| Operation mode | Setting |
| Linear servo motor control mode | <ul style="list-style-type: none"> Set "4: Linear servo motor control mode" in the "operation mode selection" of the servo parameter "Operation mode (PA01)". |
| Direct drive motor control mode | <ul style="list-style-type: none"> Set "6: DD motor control mode" in the "operation mode selection" of the servo parameter "Operation mode (PA01)". |
| Fully closed loop control mode | <ul style="list-style-type: none"> Set "1: Fully closed loop control mode" in the "operation mode selection" of the servo parameter "Operation mode (PA01)". Set "1: Fully closed loop control" in "[Cd.133] Semi/Fully closed loop switching request". The switching status of semi closed loop control/fully closed loop control is indicated in "[Md.113] Semi/Fully closed loop status". |

For wiring the CC-Link IE Field Network cable, use the 1000BASE-T compliant Ethernet cables.

| Ethernet cable | Connector | Type |
|---|-----------------|---|
| Category 5e or higher (Double shielded/STP) Straight cable | RJ-45 connector | The following conditioning cables: <ul style="list-style-type: none"> IEEE802.3 (1000BASE-T) ANSI/TIA/EIA-568-B (Category 5e) |

| POINT |
|---|
| <ul style="list-style-type: none"> For CC-Link IE Field Network wiring, use the recommended wiring components by CC-Link Partner Association. Cables for CC-Link IE Controller Network cannot be used for CC-Link IE Field Network. |

(1) Product

Cables for CC-Link IE Field Network are available from Mitsubishi Electric System & Service Co., Ltd. (Catalogs for cable are also available.)

Also, the connector processing of cable length is available for your preference.

Please consult your local Mitsubishi representative.

| Type | Model (manufacturer) |
|--------------------------------|--|
| CC-Link IE Field Network cable | SC-E5EW series (Mitsubishi Electric System & Service Co., Ltd.) |

REMARK

• Cable types

The following cable types are available depending on the operating environment:

- Standard type: Cables for inside the control panel and indoor connection
- L type: Cables for outdoor connection

Cables and relay adapters of flame retardant or waterproof type are also available.

Please contact your local Mitsubishi representative.

⚠ CAUTION

- Connect the CC-Link IE Field Network cable to the CC-Link IE Field Network cable connector. If the connection is incorrect, failure may be caused.
- Do not remove the CC-Link IE Field Network cable while the power of Simple Motion module or servo amplifiers is supplied.

Appendix 3 Connection with external device

Appendix 3.1 Connector

Mounted onto an external input connection connector of the Simple Motion module and used for wiring an external device. The "external device connector" includes the following 3 types.

(1) Connector type

| Type | | Type | |
|--------------------------------------|--------------------------------|--------------|----------------|
| | | Connector | Connector case |
| Soldering type (LD77MHIOCON) | Quick release metal latch type | 10126-3000PE | 10326-52F0-008 |
| Soldering type ^(Note) | Threaded type | 10126-3000PE | 10326-52A0-008 |
| Pressure-displacement type (Note) | Quick release metal latch type | 10126-6000EL | 10326-3210-000 |

(Note): These connectors are not options. Please purchase them by customer.

(2) Specifications of the connector

| Part name | Specification | |
|----------------------|--|--|
| Applicable connector | Soldering type (Quick release metal latch type/ Threaded type) | Pressure-displacement type (Quick release metal latch type) |
| Applicable wire size | AWG30 to AWG24 (0.05 to 0.2mm ²) | AWG28 (Stranded, 0.08mm ²) |

(Note): The external input wiring connector has been prepared. Please purchase them by customer.

Specialized tool

- MDR assembly press for pressure-displacement type
 Model name: 10960 (Hand press)
 : 10962 (Fixture unit)
 : 10963 (Fixture block)
 : 10964-1 (Cable clamp (black) 14 - 50 position)
- Contact for the specialized tool:
 Sumitomo 3M <http://www.3m.com>

(3) External dimension drawing

(a) Soldering type (Quick release metal latch type) (LD77MHIOCON)

[Unit: mm(inch)]

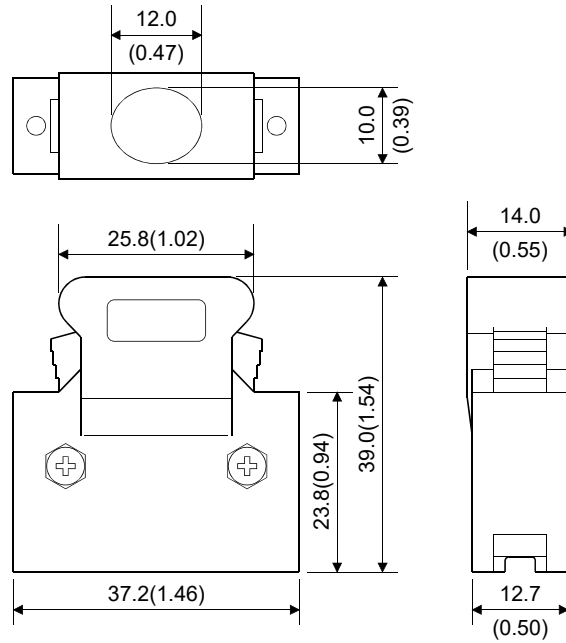

(b) Soldering type (Threaded type)

[Unit: mm(inch)]

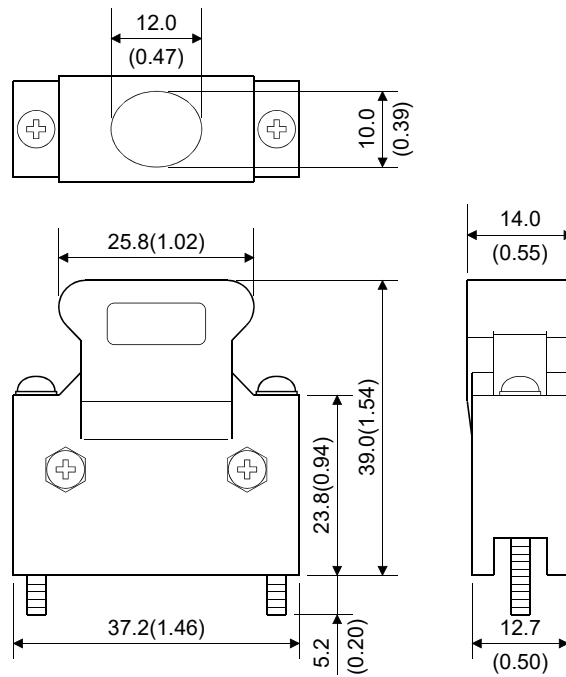

(c) Pressure-displacement type (Quick release metal latch type)

[Unit: mm(inch)]

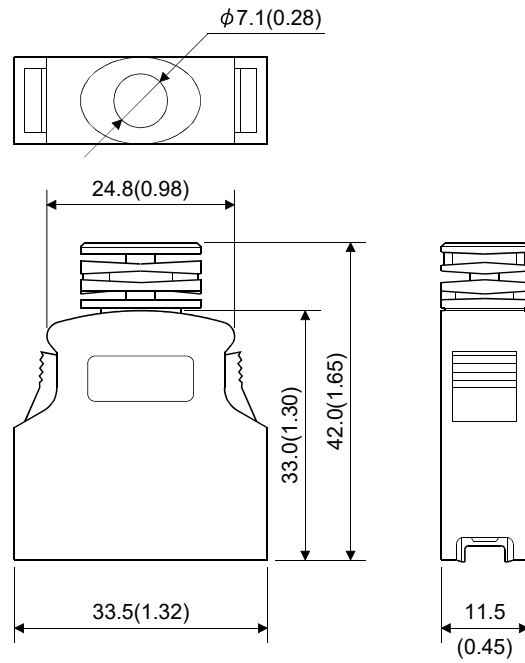

Appendix 3.2 External input signal cable

The external input signal cable is not prepared as an option. Fabricate the cable on the customer side.

(1) Connection diagram

The connection diagram differs depending on the type of the manual pulse generator/incremental synchronous encoder to be used and the connected power supply.

Make the cable as shown in the following connection diagram.

(a) Differential-output type
Make the cable within 30m (98.43ft.).

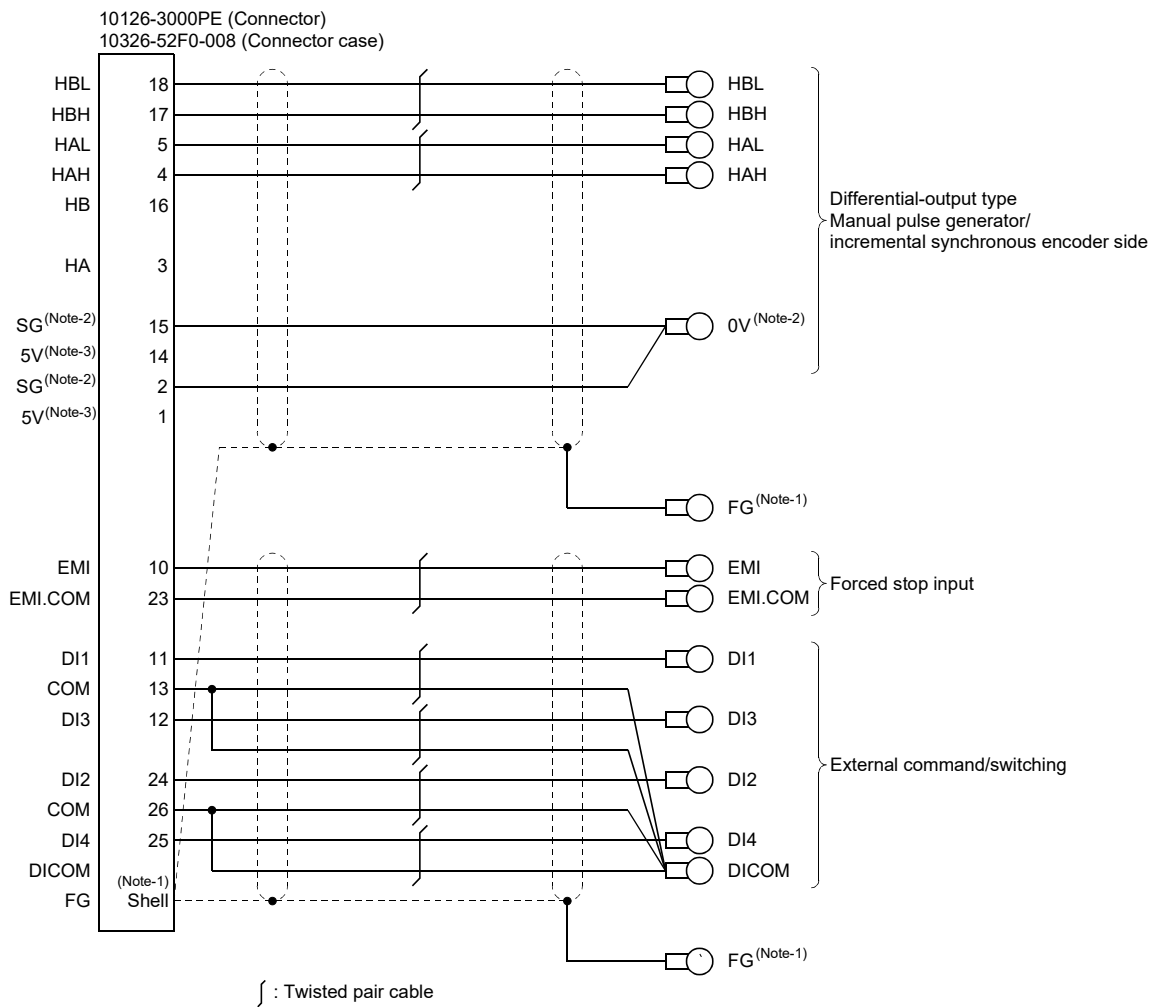
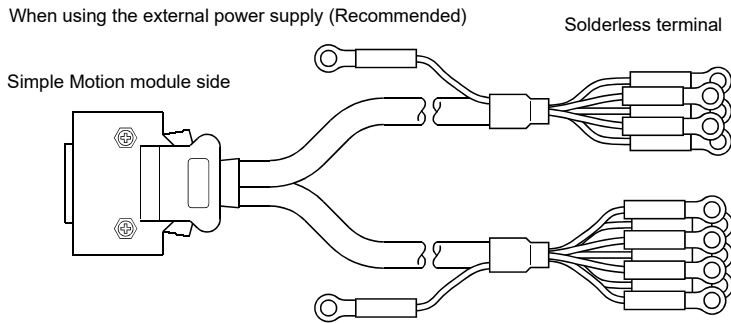

When using the internal power supply

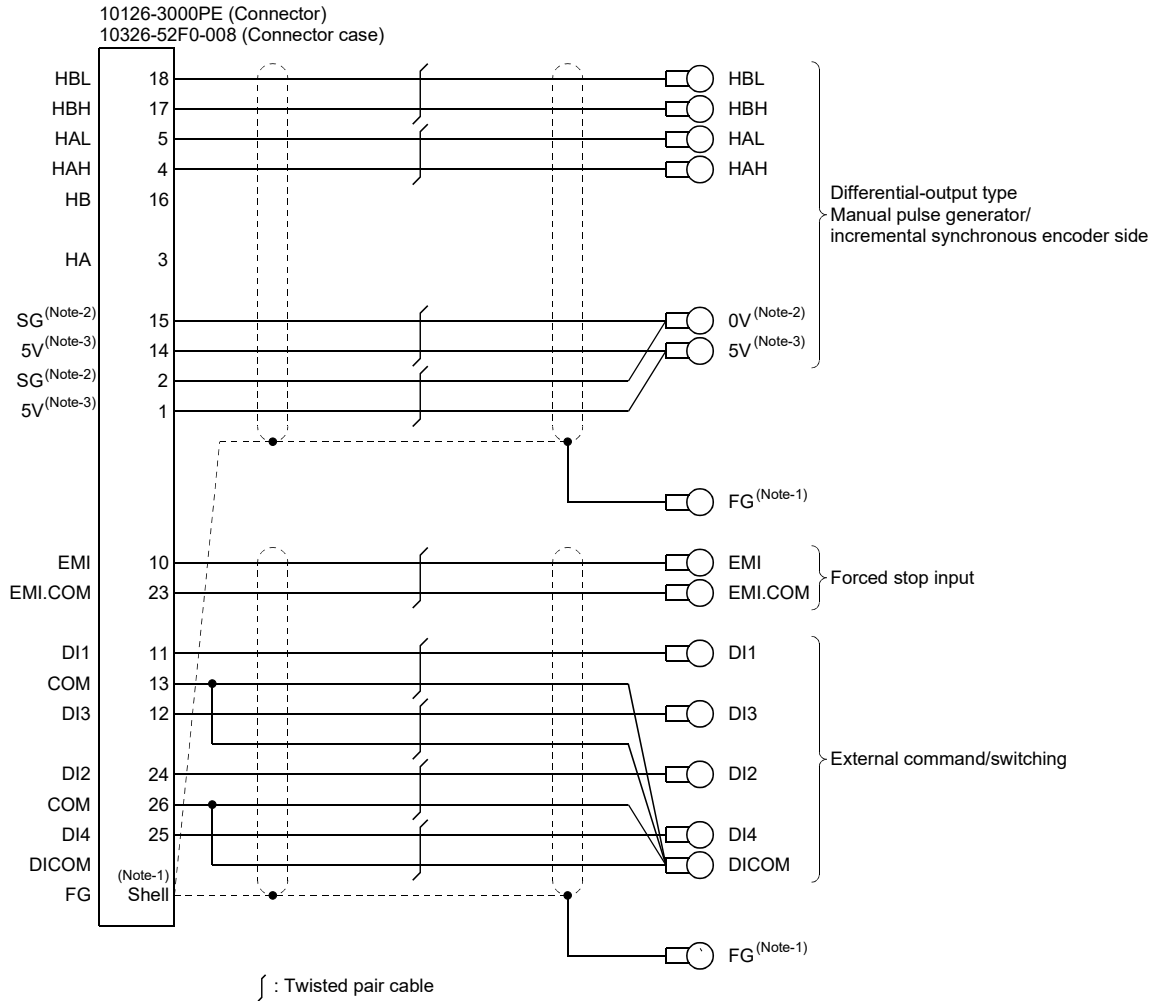
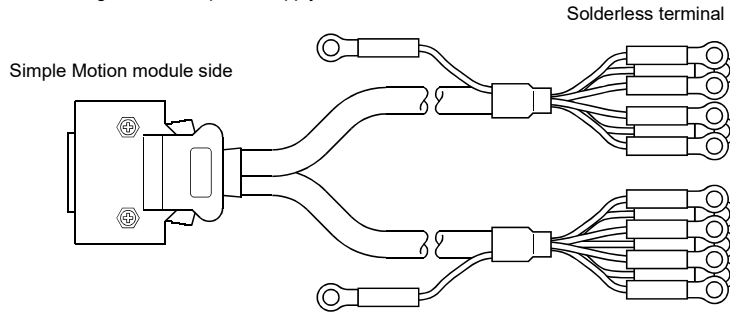

(b) Voltage-output/Open-collector type
 Make the cable within 10m (32.81ft.).

When using the external power supply (Recommended)

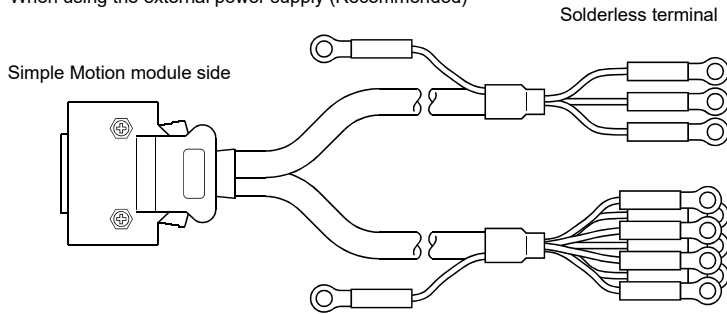

10126-3000PE (Connector)
 10326-52F0-008 (Connector case)

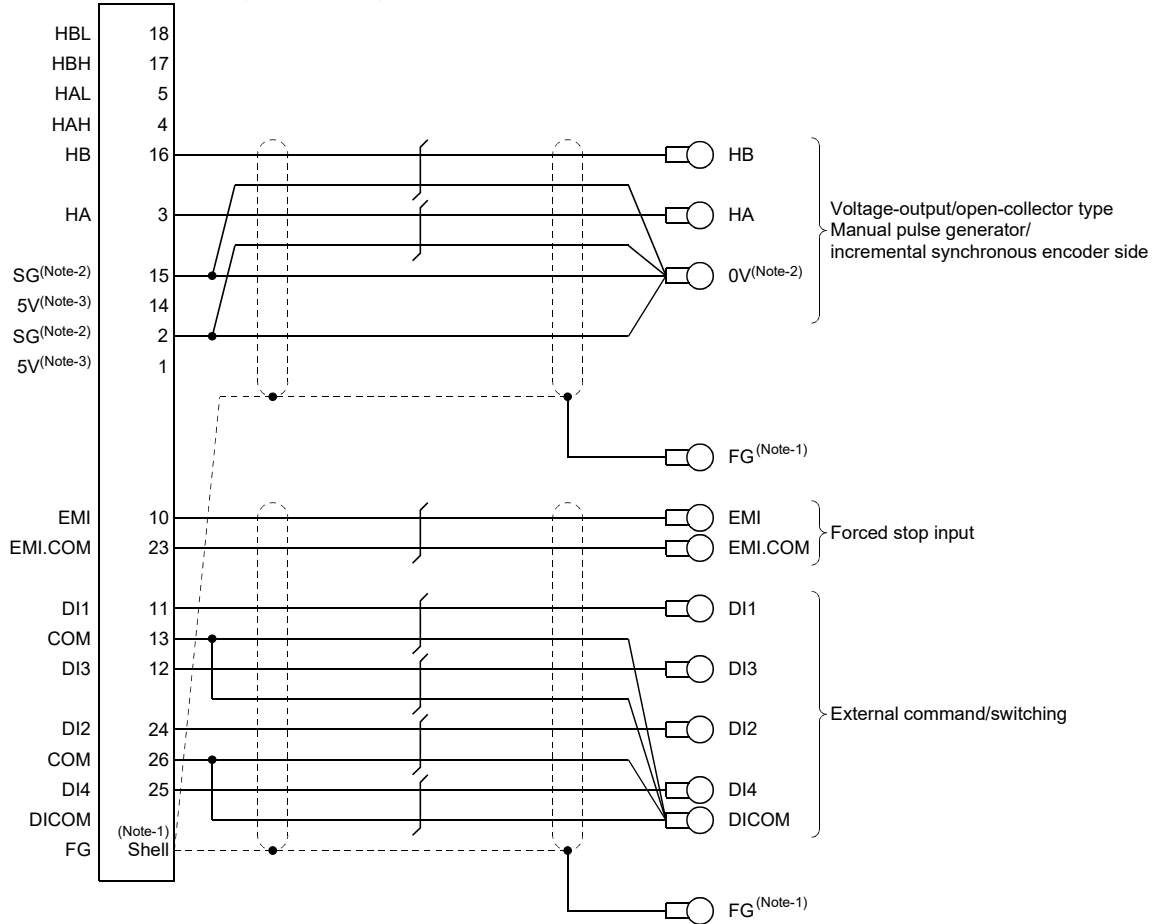

∩ : Twisted pair cable

(Note-1): Ground FG terminal on the used equipment side. Also, connect it to the shell of connector side.

(Note-2): Be sure to connect the 0 V (-) of the manual pulse generator/incremental synchronous encoder and the SG of the Simple Motion module.

(Note-3): The 5VDC power supply from the Simple Motion module must not be used.

- 1) The following table indicates the external input wiring cables used with motion controller and the manual pulse generator. Make selection according to your operating conditions.

Table 3.1 Table of wire specifications

| Wire model | Core size [mm ²] | Number of cores | Characteristics of one core | | | Finish OD [mm] ^(Note-2) |
|------------------------|------------------------------|-----------------|--------------------------------|--------------------------------------|--|------------------------------------|
| | | | Structure [Number of wires/mm] | Conductor resistance [Ω /km] | Insulating sheath OD d[mm] ^(Note-1) | |
| 20276FACBL 7/0.18mm×4P | AWG25 (0.16mm ²) | 8 (4 pairs) | 7/0.18TA | 115 | 1.0 | 6.8 |
| 20276FACBL 7/0.18mm×5P | AWG25 (0.16mm ²) | 10 (5 pairs) | 7/0.18TA | 115 | 1.0 | 7.3 |

(Note-1): d is as shown below.

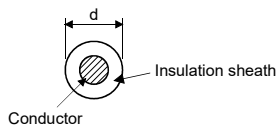

(Note-2): Standard OD. Max. OD is about 10% larger.

⚠ CAUTION

- When fabricating the cable, do not make incorrect connection. Wrong connection will cause runaway or explosion.

Appendix 3.3 Manual pulse generator (MR-HDP01)

(1) External dimension drawing

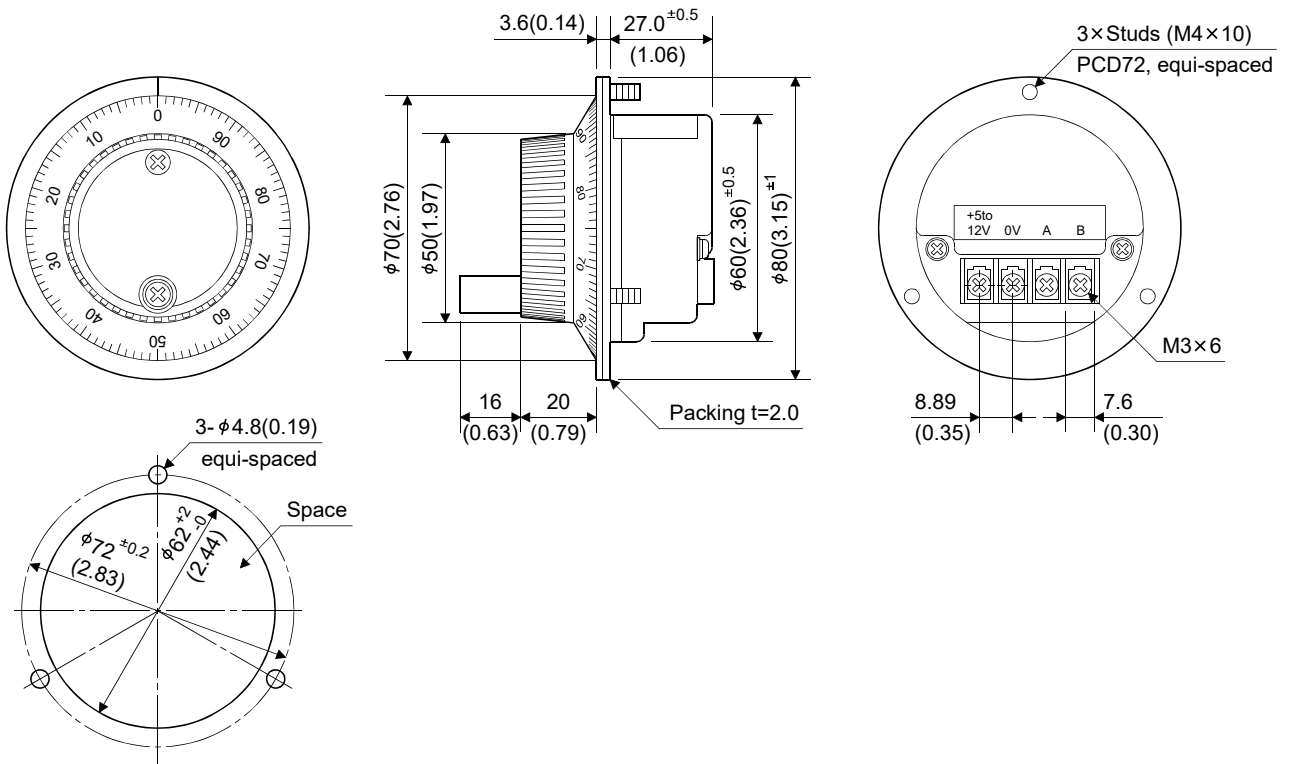

The figure of processing a disc

Appendix 4 When using GX Works2

Use the "Simple Motion Module Setting Tool" for Simple Motion module various setting.
The following shows the procedure for positioning operation when GX Works2 is used.

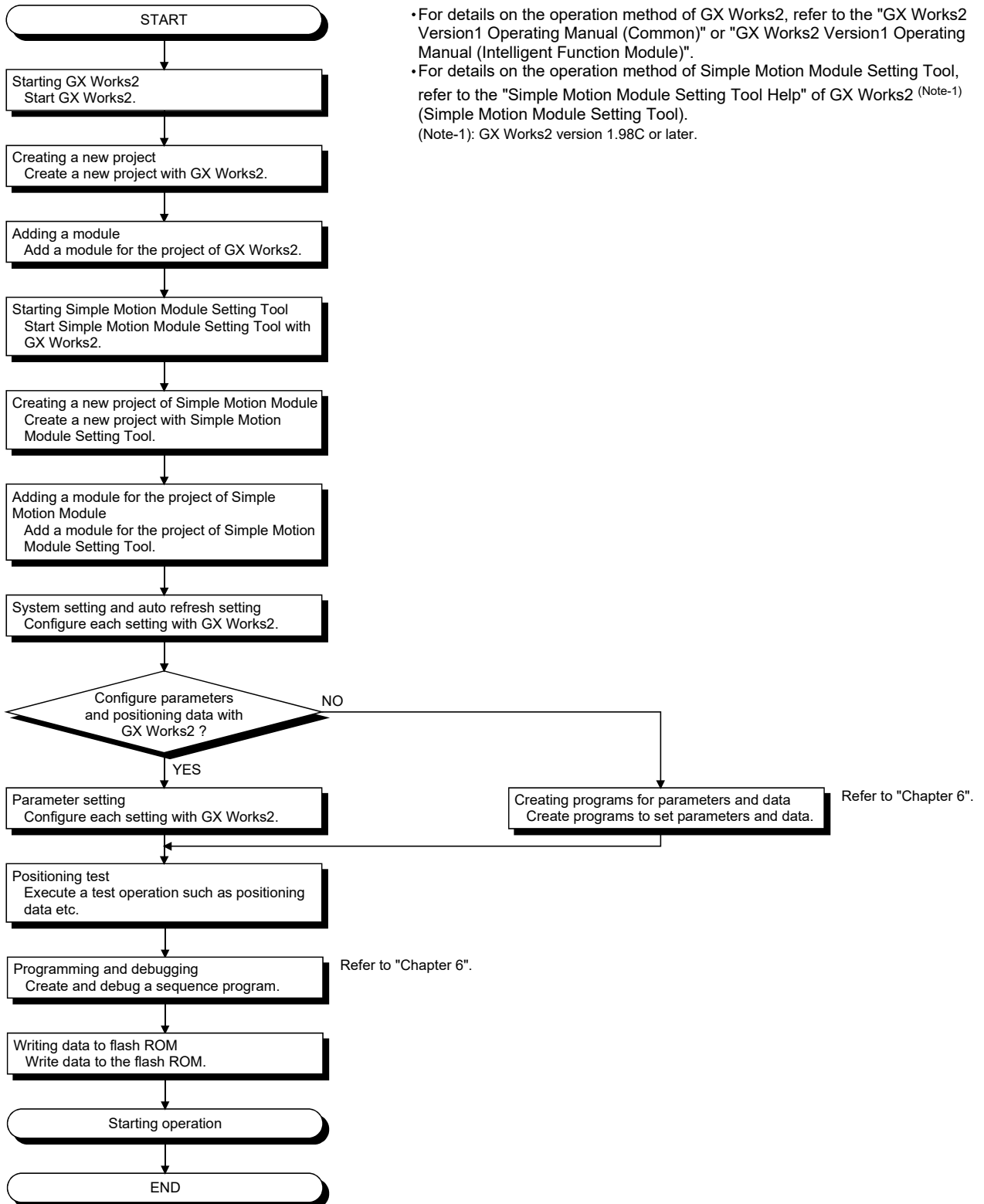

Appendix 5 External dimension drawing

[1] QD77GF4

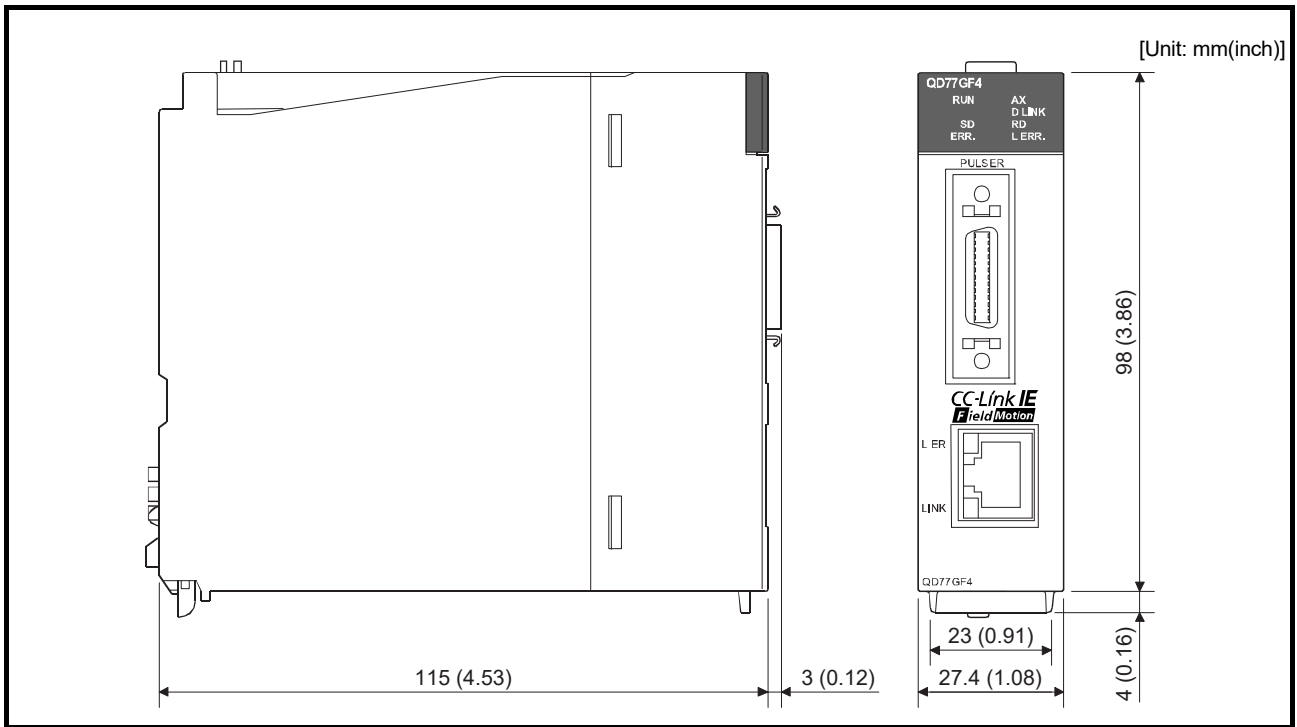

[2] QD77GF8

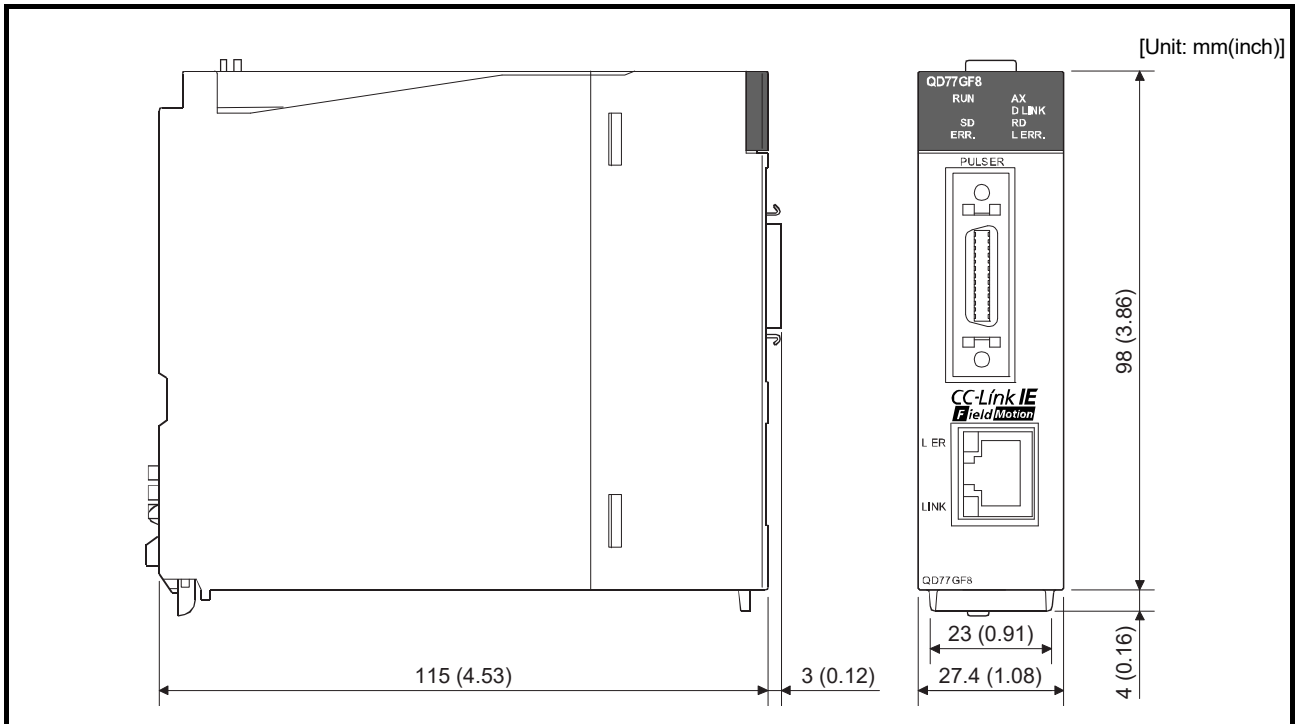

[3] QD77GF16

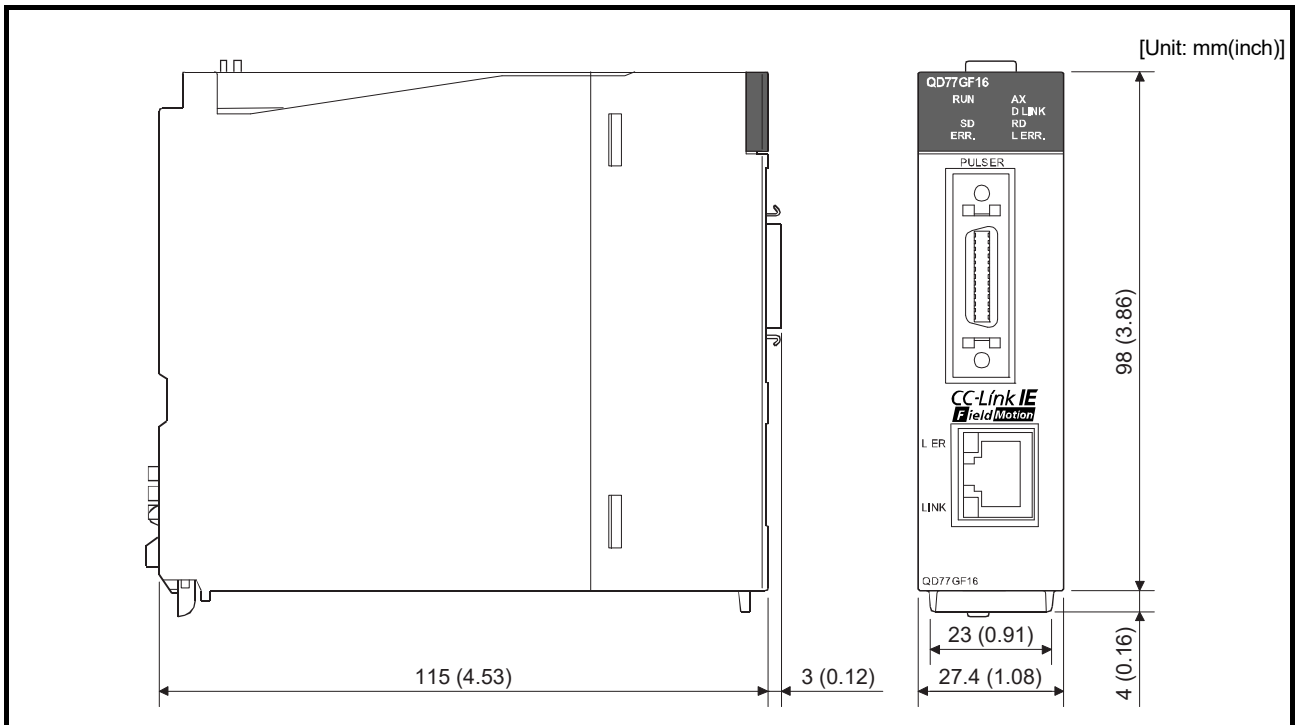

WARRANTY

Warranty

1. Warranty period and coverage

We will repair any failure or defect hereinafter referred to as "failure" in our FA equipment hereinafter referred to as the "Product" arisen during warranty period at no charge due to causes for which we are responsible through the distributor from which you purchased the Product or our service provider. However, we will charge the actual cost of dispatching our engineer for an on-site repair work on request by customer in Japan or overseas countries. We are not responsible for any on-site readjustment and/or trial run that may be required after a defective unit is repaired or replaced.

[Term]

For terms of warranty, please contact your original place of purchase.

[Limitations]

(1) You are requested to conduct an initial failure diagnosis by yourself, as a general rule.

It can also be carried out by us or our service company upon your request and the actual cost will be charged. However, it will not be charged if we are responsible for the cause of the failure.

(2) This limited warranty applies only when the condition, method, environment, etc. of use are in compliance with the terms and conditions and instructions that are set forth in the instruction manual and user manual for the Product and the caution label affixed to the Product.

(3) Even during the term of warranty, the repair cost will be charged on you in the following cases;

1. a failure caused by your improper storing or handling, carelessness or negligence, etc., and a failure caused by your hardware or software problem
2. a failure caused by any alteration, etc. to the Product made on your side without our approval
3. a failure which may be regarded as avoidable, if your equipment in which the Product is incorporated is equipped with a safety device required by applicable laws and has any function or structure considered to be indispensable according to a common sense in the industry
4. a failure which may be regarded as avoidable if consumable parts designated in the instruction manual, etc. are duly maintained and replaced
5. any replacement of consumable parts (battery, fan, smoothing capacitor, etc.)
6. a failure caused by external factors such as inevitable accidents, including without limitation fire and abnormal fluctuation of voltage, and acts of God, including without limitation earthquake, lightning and natural disasters
7. a failure generated by an unforeseeable cause with a scientific technology that was not available at the time of the shipment of the Product from our company
8. any other failures which we are not responsible for or which you acknowledge we are not responsible for

2. Term of warranty after the stop of production

(1) We may accept the repair at charge for another seven (7) years after the production of the product is discontinued. The announcement of the stop of production for each model can be seen in our Sales and Service, etc.

(2) Please note that the Product (including its spare parts) cannot be ordered after its stop of production.

3. Service in overseas countries

Our regional FA Center in overseas countries will accept the repair work of the Product. However, the terms and conditions of the repair work may differ depending on each FA Center. Please ask your local FA center for details.

4. Exclusion of loss in opportunity and secondary loss from warranty liability

Regardless of the gratis warranty term, Mitsubishi shall not be liable for compensation to:

- (1) Damages caused by any cause found not to be the responsibility of Mitsubishi.
- (2) Loss in opportunity, lost profits incurred to the user by Failures of Mitsubishi products.
- (3) Special damages and secondary damages whether foreseeable or not, compensation for accidents, and compensation for damages to products other than Mitsubishi products.
- (4) Replacement by the user, maintenance of on-site equipment, start-up test run and other tasks.

5. Change of Product specifications

Specifications listed in our catalogs, manuals or technical documents may be changed without notice.

6. Application and use of the Product

(1) For the use of our Simple Motion module, its applications should be those that may not result in a serious damage even if any failure or malfunction occurs in the Simple Motion module, and a backup or fail-safe function should operate on an external system to the Simple Motion module when any failure or malfunction occurs.

(2) Our Simple Motion module is designed and manufactured as a general purpose product for use at general industries. Therefore, applications substantially influential on the public interest for such as atomic power plants and other power plants of electric power companies, and also which require a special quality assurance system, including applications for railway companies and government or public offices are not recommended, and we assume no responsibility for any failure caused by these applications when used.

In addition, applications which may be substantially influential to human lives or properties for such as airlines, medical treatments, railway service, incineration and fuel systems, man-operated material handling equipment, entertainment machines, safety machines, etc. are not recommended, and we assume no responsibility for any failure caused by these applications when used. We will review the acceptability of the above mentioned applications, if you agree not to require a specific quality for a specific application. Please contact us for consultation.

(3) Mitsubishi shall have no responsibility or liability for any problems involving programmable controller trouble and system trouble caused by DoS attacks, unauthorized access, computer viruses, and other cyberattacks.

TRADEMARKS

Microsoft and Windows are either registered trademarks or trademarks of Microsoft Corporation in the United States and/or other countries.

The company names, system names and product names mentioned in this manual are either registered trademarks or trademarks of their respective companies.

In some cases, trademark symbols such as [™] or [®] are not specified in this manual.

IB(NA)-0300202-E(2211)MEE

MODEL: QD77GF-U-S-E

MODEL CODE: 1XB956

mitsubishi electric corporation

HEAD OFFICE : TOKYO BUILDING, 2-7-3 MARUNOUCHI, CHIYODA-KU, TOKYO 100-8310, JAPAN
NAGOYA WORKS : 1-14, YADA-MINAMI 5-CHOME, HIGASHI-KU, NAGOYA, JAPAN

When exported from Japan, this manual does not require application to the
Ministry of Economy, Trade and Industry for service transaction permission.

Specifications subject to change without notice.