



Programmable Controller

MELSEC iQ-F
series

MELSEC iQ-F



FX5 Predefined Protocol Support for Positioning
Function Block Reference (for IAI)



SAFETY PRECAUTIONS

(Read these precautions before use.)

Before using this product, please read this reference and the relevant manuals introduced in this reference carefully and pay full attention to safety in order to handle the product correctly.

Precautions shown in this reference are only for this product. For safety precautions on the programmable controller system, refer to the user's manual (hardware) of the CPU module to be used.

This reference classifies the safety precautions into two categories: [ WARNING] and [ CAUTION].

 WARNING	Indicates that incorrect handling may cause hazardous conditions, resulting in death or severe injury.
 CAUTION	Indicates that incorrect handling may cause hazardous conditions, resulting in minor or moderate injury or property damage.

Depending on the circumstances, procedures indicated by [ CAUTION] may also cause severe injury.

It is important to follow all precautions for personal safety.

Make sure that the end users read this manual and then keep the manual in a safe place for future reference.

INTRODUCTION

Thank you for purchasing the MELSEC iQ-F series.

This reference describes the module FBs for the applicable modules listed below.

Before using this product, please read this reference and the manuals of relevant products carefully and develop familiarity with the specifications to handle the product correctly.

Please make sure that the end users read this reference.

Applicable modules

- FX5U
- FX5UC

Regarding use of this product

- This product has been manufactured as a general-purpose part for general industries, and has not been designed or manufactured to be incorporated in a device or system used in purposes related to human life.
- Before using the product for special purposes such as nuclear power, electric power, aerospace, medicine, or passenger movement vehicles, consult Mitsubishi Electric.
- This product has been manufactured under strict quality control. However, when installing the product where major accidents or losses could occur if the product fails, install appropriate backup or failsafe functions in the system.

Note

- If in doubt at any stage during the installation of the product, always consult a professional electrical engineer who is qualified and trained in the local and national standards. If in doubt about the operation or use, please consult the nearest Mitsubishi Electric representative.
- Since the examples indicated by this reference, technical bulletin, catalog, etc. are used as a reference, please use it after confirming the function and safety of the equipment and system. Mitsubishi Electric will accept no responsibility for actual use of the product based on these illustrative examples.
- This reference content, specification etc. may be changed without a notice for improvement.
- The information in this reference has been carefully checked and is believed to be accurate; however, if you notice a doubtful point, an error, etc., please contact the nearest Mitsubishi Electric representative. When doing so, please provide the manual number given at the end of this reference.

CONTENTS

SAFETY PRECAUTIONS	1
INTRODUCTION	2
RELEVANT MANUALS	5
TERMS	6
GENERIC TERM/ABBREVIATION	6
CHAPTER 1 OVERVIEW	7
1.1 Specification Overview	7
1.2 FB List	8
1.3 System Configuration	9
CHAPTER 2 DETAILS OF THE FB LIBRARY	10
2.1 Common Specifications	10
Global label	10
Structure list	10
Precautions on FB combinations	12
Precautions	13
2.2 M+IAIStartHomePositioning_F (Home Position Return)	14
Overview	14
Label	14
Function overview	15
Parameter setting	18
Performance value	18
Error code	19
2.3 M+IAIJogInching_F (JOG/Inching Operation)	20
Overview	20
Label	20
Function overview	21
Parameter setting	32
Performance value	32
Error code	32
2.4 M+IAIReadPositioningTable_F (Position Table Read)	33
Overview	33
Label	33
Function overview	34
Parameter setting	37
Performance value	37
Error code	37
2.5 M+IAISetPositioningTable_F (Position Table Setting)	38
Overview	38
Label	38
Function overview	40
Parameter setting	44
Application example	44
Performance value	44
Error code	44
Version upgrade history	44
2.6 M+IAIStartPositioning_F (Positioning Operation)	45

Overview	45
Label	45
Function overview	46
Parameter setting	49
Application example	49
Performance value	49
Error code	50
2.7 M+IAIMonitoring_F (Operation Monitor)	51
Overview	51
Label	51
Function overview	52
Parameter setting	55
Performance value	55
Error code	55
2.8 M+IAIServoControl_F (Servo ON/OFF)	56
Overview	56
Label	56
Function overview	57
Parameter setting	60
Application example	60
Performance value	60
Error code	61
CHAPTER 3 FB LIBRARY USE PROCEDURE	62
<hr/>	
3.1 Position Table Setting and Positioning Operation	62
Overview of program example	63
Operation flow	64
System configuration	64
Wiring	65
Pre-setting	65
Parameter setting	65
FB library registration	65
Enhanced use of FB library	65
Program contents	66
3.2 JOG Operation and Current Position Reading	77
Overview of program example	77
Operation flow	77
System configuration	77
Wiring	77
Pre-setting	77
Parameter setting	77
FB library registration	78
Enhanced use of FB library	78
Program contents	78
INSTRUCTION INDEX	83
<hr/>	
REVISIONS	85
TRADEMARKS	86

RELEVANT MANUALS

Manual name	Description
MELSEC iQ-F FX5S/FX5UJ/FX5U/FX5UC User's Manual (Hardware) [SH-082452ENG]	Describes the details of hardware of the CPU module, including performance specifications, wiring, installation, and maintenance.
MELSEC iQ-F FX5 User's Manual (Application) [JY997D55401]	Basic knowledge required for program design, functions of the CPU module, devices/labels, and descriptions of parameters.
MELSEC iQ-F FX5 User's Manual (Communication) [SH-082625ENG]	Describes the communication function of the built-in CPU module and the Ethernet module.
MELSEC iQ-F FX5 Programming Manual (Instructions, Standard Functions/Function Blocks) [JY997D55801]	Specifications of instructions and functions that can be used in programs.
MELSEC iQ-F FX5 Programming Manual (Program Design) [JY997D55701]	Specifications of ladders, ST, FBD/LD, and other programs and labels.
GX Works3 Operating Manual [SH-081215ENG]	System configuration, parameter settings, and online function operations of GX Works3.
Predefined Protocol Support Tool For Positioning Operating Manual [SH-082176ENG]	System configuration, operation method of functions, and troubleshooting of Predefined Protocol Support Tool For Positioning.
ERC2 Actuator with Integrated Controller (PIO Type) Operation Manual [ME0158-5H]	How to use the ERC2 actuator with integrated controller (PIO type) and its structure and maintenance.
ERC2 Actuator with Integrated Controller (SIO Type) Operation Manual [ME0159-7F]	How to use the ERC2 actuator with integrated controller (SIO type) and its structure and maintenance.
ERC3 Actuator with Integrated Controller Instruction Manual [ME0297-13]	How to use the ERC3 actuator with integrated controller and its structure and maintenance.
PCON, ACON, SCON, RCP6 (PLC Unit) ERC2, ERC3 Serial Communication [Modbus Version] Operation Manual [ME0162-10B]	How to use the serial communication (Modbus).
ACON-CY Controller Solenoid Valve Type Operation Manual [ME0167-13D]	How to use the ACON-CY controller solenoid valve type and its structure and maintenance.
PCON-C/CG/CF Controller Positioner Type Operation Manual [ME0170-18C]	How to use the PCON-C/CG/CF controller positioner type and its structure and maintenance.
PC Software RCM-101-MW, RCM-101-USB Operation Manual [ME0155-30I]	How to use the PC software.

TERMS

Unless otherwise specified, this reference uses the following terms.

Terms	Description
Engineering tool	A tool for configuring settings and performing programming, debugging, and maintenance for programmable controllers.
Inching operation	Pulses for minute movement amount are output to the drive unit by manual operation.
JOG operation	Pulses are output to the drive unit only while the JOG start signal is on.

GENERIC TERM/ABBREVIATION

Unless otherwise specified, this reference uses the following generic term and abbreviation.

Generic term/abbreviation	Description
FB	FB is the abbreviation for Function Block. The FB is a generalized circuit block that is repeatedly used in a sequence program and designed to be diverted in the sequence program. This improves the efficiency of the program development and reduces the programming errors, resulting in the improvement in the program quality.
FX5	A generic term for FX5UJ, FX5U, and FX5UC programmable controllers.
FX5 CPU module	A generic term for FX5UJ, FX5U, and FX5UC CPU modules.
FX5U CPU module	A generic term for FX5U-32MR/ES, FX5U-32MT/ES, FX5U-32MT/ESS, FX5U-64MR/ES, FX5U-64MT/ES, FX5U-64MT/ESS, FX5U-80MR/ES, FX5U-80MT/ES, FX5U-80MT/ESS, FX5U-32MR/DS, FX5U-32MT/DS, FX5U-32MT/DSS, FX5U-64MR/DS, FX5U-64MT/DS, FX5U-64MT/DSS, FX5U-80MR/DS, FX5U-80MT/DS, and FX5U-80MT/DSS.
FX5UC CPU module	A generic term for FX5UC-32MT/D, FX5UC-32MT/DSS, FX5UC-64MT/D, FX5UC-64MT/DSS, FX5UC-96MT/D, FX5UC-96MT/DSS, FX5UC-32MT/DS-TS, and FX5UC-32MT/DSS-TS.

1 OVERVIEW

The FBs in this reference are the FB libraries for connecting the MELSEC iQ-F FX5U or FX5UC series and IAI ROBO Cylinder through the MODBUS RTU connection, and using them.

1.1 Specification Overview

The following shows the features of this function.

Optimal system for low-price devices

In the easy drive control, easy and low-price system construction can be achieved by using Predefined Protocol Support Function For Positioning and the IAI ROBO Cylinder together.

Easy startup

Using the program application example described in this reference enables the positioning operation without modifying a program.

The following shows an example of using this function in an electrical parts assembly device. Use three ROBO Cylinders to perform the positioning control.

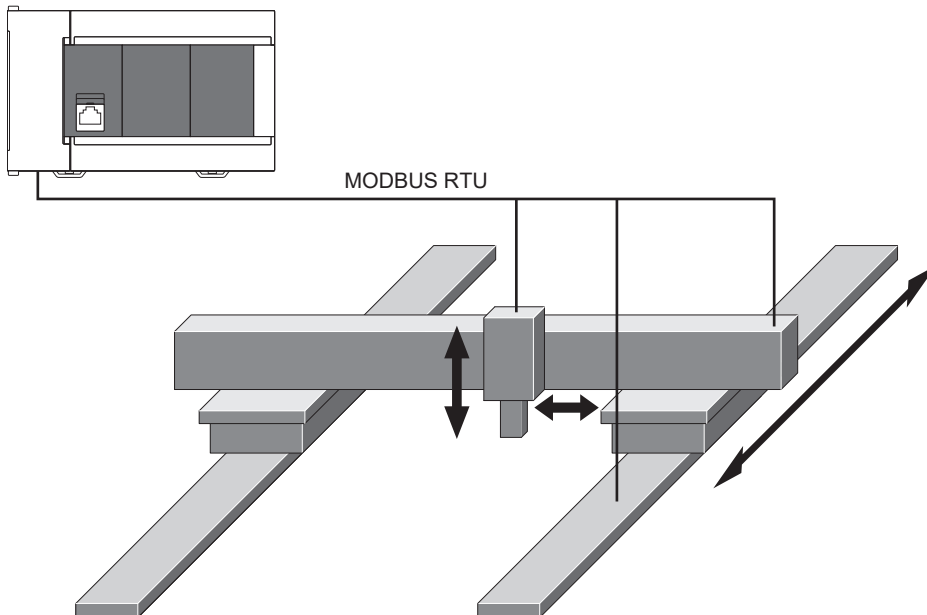

1.2 FB List

The following table lists the FB libraries in this reference.

Point 

Note that this reference does not describe the FB version information which is displayed such as "_00A" at the end of FB name.

○: Necessary, —: Unnecessary

FB name	Description	Parameter setting necessity
M+IAIStartHomePositioning_F	Executes the home position return.	○
M+IAIJogInching_F	Performs the JOG operation or inching operation.	○
M+IAIReadPositioningTable_F	Reads the specified position table data.	○
M+IAISetPositioningTable_F	Sets the specified position table data.	○
M+IAIStartPositioning_F	Starts the positioning operation.	○
M+IAIMonitoring_F	Monitors the current position and alarms, and performs the alarm reset.	○
M+IAIServoControl_F	Controls the servo ON/OFF.	○

1.3 System Configuration

The following shows a system configuration example for using the FB described in this reference.

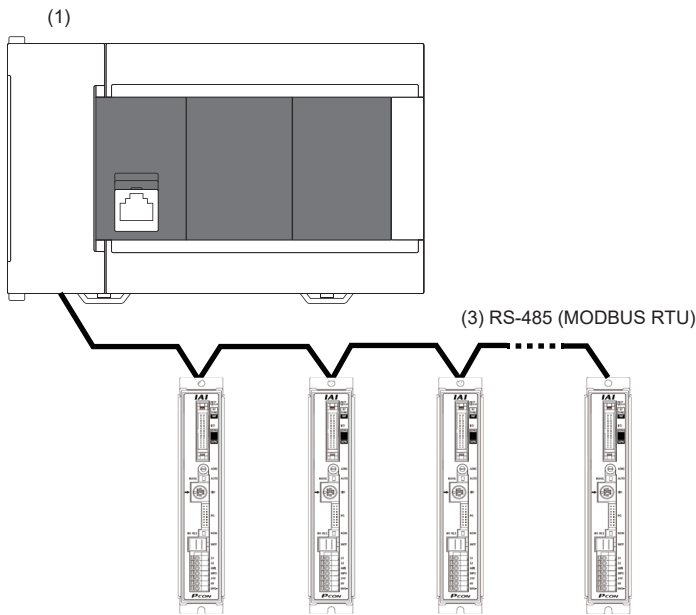

(2) Maximum number of connected modules: 16

No.	Device		Remarks
(1)	FX5U, FX5UC	Built-in RS-485 port	CH1
		FX5-485-BD	CH2
		FX5-485ADP	CH3, CH4
		FX5-232-BD	CH2
		FX5-232ADP	CH3, CH4
(2)	IAI ROBO Cylinder	PCON series	C/CA/CB/CFA/CFB/CF/CY/CYB/SE
		ACON series	C/CA/CB/CY/CYB/SE
		SCON series	C/CA/CAL/CB (excluding the servo press specification)
		DCON series	CA/CB/CYB
		RCP6S	RCP6S*1
		ERC2 series	Controller integrated ROBO Cylinder
		ERC3 series*2	Controller integrated ROBO Cylinder
(3)	Serial communication	RS-485 connection	—
		RS-232 connection	Converting from RS-232 to RS-485 is required. RCB-TU-SIO-A and RCB-TU-SIO-B of IAI Corporation are recommended for conversion.

*1 In the specifications of the RCP6S series, reading and writing of the position table information register (positioning data) with MODBUS RTU are prohibited. Therefore, the positioning data cannot be read and written in this FB library as well. When using RCP6S, use the teaching box or PC software of IAI Corporation.

*2 For the ERC3 series with the controller type set to the MEC mode, connection is not available.

2 DETAILS OF THE FB LIBRARY

2.1 Common Specifications

This section describes the common specifications in this FB library.

Global label

The following table lists the global labels to be used in this FB library.

Label name	Data type	Purpose
None	None	—

Structure list

The following table lists the structures to be used in this FB library.

Position table

Label	Label name	Data type	Setting range	Description
dTargetPosition	Target position	Double word [Signed]/Bit string [32-bit]	-999999 to 999999	The target position [unit: 0.01 mm] set in the specified position table No. is stored.
udPositioningWidth	Positioning width	Double word [Unsigned]/Bit string [32-bit]	1 to 999999	The positioning width [unit: 0.01 mm] set in the specified position table No. is stored.
udSpeed	Speed	Double word [Unsigned]/Bit string [32-bit]	1 to 999999	The speed [unit: 0.01 mm/s] set in the specified position table No. is stored.
dZoneBoundaryPlus	Individual zone boundary plus side	Double word [Signed]/Bit string [32-bit]	-999999 to 999999	The individual zone boundary plus side [unit: 0.01 mm] set in the specified position table No. is stored.
dZoneBoundaryMinus	Individual zone boundary minus side	Double word [Signed]/Bit string [32-bit]	-999999 to 999999	The individual zone boundary minus side [unit: 0.01 mm] set in the specified position table No. is stored.
uAcceleration	Acceleration	Word [Unsigned]/Bit string [16-bit]	0001H to 012CH	The acceleration [unit: 0.01 G] set in the specified position table No. is stored in hexadecimal.
uDeceleration	Deceleration	Word [Unsigned]/Bit string [16-bit]	0001H to 012CH	The deceleration [unit: 0.01 G] set in the specified position table No. is stored in hexadecimal.
uPressingCurrentLimit	Current limit value when pushed	Word [Unsigned]/Bit string [16-bit]	0033H to 01FEH ^{*1} (0033H to 00B3H)	The current limit value when pushed set in the specified position table No. is stored in hexadecimal. ^{*2}
uLoadCurrentThreshold	Load current threshold value	Word [Unsigned]/Bit string [16-bit]	0 or larger (depends on the setting range of the actuator)	The load current threshold value set in the specified position table No. is stored in hexadecimal. ^{*2}
uControlFlag	Control flag specification	Word [Unsigned]/Bit string [16-bit]	0000H to 30FEH Bit 1: Push operation Bit 2: Forward (Reverse) rotation after approach Bit 3: Pitch feed Bit 4, 5: Parameter set Bit 6, 7: Acceleration pattern Bit 12, 13: Damping control Others: Not used	The control flag set in the specified position table No. is stored in hexadecimal.

*1 The range may differ depending on the actuator type.

*2 The following formula shows the relation between the rate of output (A [%]) and read value: Read value = 255 × A ÷ 100 (digits after the decimal point are rounded off).

Monitor table

Label	Label name	Data type	Setting range	Description
uAlmDetailCode	Alarm detail code	Word [Unsigned]/Bit string [16-bit]	0000H to FFFFH	The alarm detail code that occurred last is stored in hexadecimal. When no error has occurred, "0x0000" is stored in hexadecimal.
uAlmAddress	Alarm address	Word [Unsigned]/Bit string [16-bit]	0000H to FFFFH	The alarm address that occurred last is stored in hexadecimal. When no error has occurred, "0xFFFF" is stored in hexadecimal.
uAlmCode	Alarm code	Word [Unsigned]/Bit string [16-bit]	0000H to FFFFH	The alarm code that occurred last is stored in hexadecimal. When no error has occurred, "0x0000" is stored in hexadecimal.
udAlmTime	Alarm occurrence time	Double word [Unsigned]/Bit string [32-bit]	0 to 4294967295	The occurrence time of the alarm that occurred last is stored in hexadecimal. (Elapsed time [s] from reference time or power-on)
dCurrentPosition	Current position monitor	Double word [Signed]/Bit string [32-bit]	-999999 to 999999	The current position is stored in units of 0.01 mm.
uCurrentAlmCode	Currently occurring alarm code	Word [Unsigned]/Bit string [16-bit]	0000H to FFFFH	The alarm code that is currently occurring is stored in hexadecimal. When no error has occurred, "0x0000" is stored.
uInputPort	Input port	Word [Unsigned]/Bit string [16-bit]	0000H to FFFFH	The port input value of the RC controller is stored in hexadecimal.
uOutputPort	Output port	Word [Unsigned]/Bit string [16-bit]	0000H to FFFFH	The port output value of the RC controller is stored in hexadecimal.
uStatus1	Device status 1	Word [Unsigned]/Bit string [16-bit]	0000H to FFFFH	The status of the controller is stored in hexadecimal.
uStatus2	Device status 2	Word [Unsigned]/Bit string [16-bit]	0000H to FFFFH	The status of the controller is stored in hexadecimal.
uExtendedDeviceStatus	Extended device status	Word [Unsigned]/Bit string [16-bit]	0000H to FFFFH	The status of the controller (extended device) is stored in hexadecimal.
udSystemStatus	System status	Double word [Unsigned]/Bit string [32-bit]	0000H to FFFFH	The internal operation status of the controller is stored in hexadecimal.
dCurrentSpeed	Current speed	Double word [Signed]/Bit string [32-bit]	-999999 to 999999	The monitor data of the actual motor speed is stored in units of 0.01 mm/s.
dElectricCurrentValue	Current value	Double word [Signed]/Bit string [32-bit]	-2147483648 to 2147483647	The monitor data of the motor current (torque current command value) is stored in units of 1 mA.
dDeviation	Deviation	Double word [Signed]/Bit string [32-bit]	-2147483648 to 2147483647	The deviation amount between the position command value and the feedback value (actual position) per 1 ms cycle is stored in units of 1 pulse.
udSystemOpeTime	System operation time	Double word [Unsigned]/Bit string [32-bit]	0 to 4294967295	The cumulative time from controller power-on is stored in units of 1 ms.
uSpecialInputPort	Special input port	Word [Unsigned]/Bit string [16-bit]	0000H to FFFFH	The status of an input port other than the normal ones is stored in hexadecimal.
uZoneStatus	Zone status	Word [Unsigned]/Bit string [16-bit]	0000H to FFFFH	The status of the zone output is stored in hexadecimal.
uDoneOrRunProgramNo	Positioning complete position No. status/ Running program No.	Word [Unsigned]/Bit string [16-bit]	0 to 1023	The complete position number or running program number is stored.
uExpansionSystemStatus	Expansion system status	Word [Unsigned]/Bit string [16-bit]	0000H to FFFFH	The internal operation status of the controller (extended device) is stored in hexadecimal.

Precautions on FB combinations

The following describes the influences when using multiple FBs of this FB library in combination.

Influence matrix of the communication channel and target axis

The following shows the influence matrices of the communication channel and target axis.

○: Simultaneous processing available, △: FB operation delayed

		Target axis	
		Same axis	Other axis
Communication channel	Same channel	Refer to the influence matrix when the same axis and channel are specified.	△
	Other channel	○	○

Influence matrix when the same axis and channel are specified

The following shows the influence matrices when the same axis and channel are specified.

△: FB operation delayed, ●: Depends on the controller

		Target FB						
		M+IAIStartHomePositioning_F (Home position return)	M+IAIJogInching_F (JOG/Inching operation)	M+IAIReadPositioningTable_F (Position table read)	M+IAISetPositioningTable_F (Position table setting)	M+IAIStartPositioning_F (Positioning operation)	M+IAIMonitoring_F (Operation monitoring)	M+IAIServoControl_F (Servo ON/OFF)
Target FB	M+IAIStartHomePositioning_F (Home position return)	●	●	△	△	●	△	●
	M+IAIJogInching_F (JOG/Inching operation)	●	●	△	△	●	△	●
	M+IAIReadPositioningTable_F (Position table read)	△	△	△	△	△	△	△
	M+IAISetPositioningTable_F (Position table setting)	△	△	△	△	△	△	△
	M+IAIStartPositioning_F (Positioning operation)	●	●	△	△	●	△	●
	M+IAIMonitoring_F (Operation monitoring)	△	△	△	△	△	△	△
	M+IAIServoControl_F (Servo ON/OFF)	●	●	△	△	●	△	●

Precautions

Check the following precautions before using this FB library.

No.	Condition
1	The external device for serial communication and the IAI controller support MODBUS RTU.
2	The MELSEC iQ-F series product and IAI controller are connected by the serial communication.
3	R0 to R2335 (2336 points) of the file register (R) are used in this FB library.
4	Set the channel to be used in Predefined Protocol Support Tool For Positioning. For details, refer to Predefined Protocol Support Tool For Positioning Operating Manual (6.4 Writing Predefined Protocol Information) .
5	When using the following FBs, be careful not to use them at the same time with the same target axis specified in <code>i_uAxis</code> (Target axis) or with the same communication channel specified in <code>i_uCh</code> (Target channel). Otherwise, they may not operate normally. <ul style="list-style-type: none">• M+IAIStartHomePositioning_F (Home position return)• M+IAIJogInching_F (JOG/Inching operation)• M+IAIStartPositioning_F (Positioning operation)• M+IAIServoControl_F (Servo ON/OFF)
6	When FBs are executed at the same time, specifying the same communication channel in <code>i_uCh</code> (Target axis) delays the FB operation.
7	The FBs check the device name set in the IAI controller. Do not change the set device name.
8	Change the number of timeouts or retries of the communication in Predefined Protocol Support Tool For Positioning. For details of the settings, refer to Predefined Protocol Support Tool For Positioning Operating Manual (6.2 Setting a Connected Model) . If the communication interval for the same channel is short, commands cannot be received depending on the connected controller, and a serial communication timeout (CPU error) may occur. In this case, increasing the "Sending waiting time" in the protocol sending/receiving setting for the connected model setting can avoid the above error.

2.2 M+IAIStartHomePositioning_F (Home Position Return)

Overview

This FB sets the PIO/MODBUS switching to the MODBUS communication and executes the home position return.

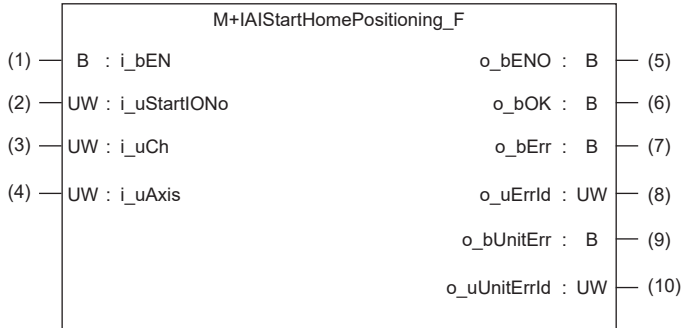

Label

Input label

No.	Label	Label name	Data type	Setting range	Description
(1)	i_bEN	Execution command	Bit	ON, OFF	ON: The FB is activated. OFF: The FB is not activated.
(2)	i_uStartIONo	Start I/O No.	Word [Unsigned]/Bit string [16-bit]	—	Setting this label is not required since it is not used in the program in this FB.
(3)	i_uCh	Target CH	Word [Unsigned]/Bit string [16-bit]	1 to 4	Specify the channel number. 1: Built-in RS485 port 2: FX5-485-BD, FX5-232-BD 3, 4: FX5-485ADP, FX5-232ADP
(4)	i_uAxis	Target axis	Word [Unsigned]/Bit string [16-bit]	1 to 16	Specify the axis number set in the ROBO Cylinder incremented by one.*1 Example: When setting 0 for the axis number of the ROBO Cylinder, set 1 in i_uAxis (Target axis).

*1 The axis number corresponds to the slave station number of MODBUS.

Output label

No.	Label	Label name	Data type	Default value	Description
(5)	o_bENO	Execution status	Bit	OFF	ON: The execution command is on. OFF: The execution command is off.
(6)	o_bOK	Normal completion	Bit	OFF	When this label is on, it indicates that the home position return has been completed.
(7)	o_bErr	Error completion	Bit	OFF	When this label is on, it indicates that an error has occurred in the FB.
(8)	o_uErrld	Error code	Word [Unsigned]/Bit string [16-bit]	0	The error code that occurred in the FB is stored.
(9)	o_bUnitErr	Module error completion	Bit	OFF	When this label is on, it indicates that an error has occurred in the module.
(10)	o_uUnitErrld	Module error code	Word [Unsigned]/Bit string [16-bit]	0	The error code that occurred in the module is stored.

Function overview

Applicable hardware and software



■ Predefined Protocol Support FB For Positioning

Applicable module	Firmware version	Engineering tool
FX5U CPU	1.200 or later	GX Works3 Version 1.060N or later
FX5UC CPU	1.200 or later	GX Works3 Version 1.060N or later

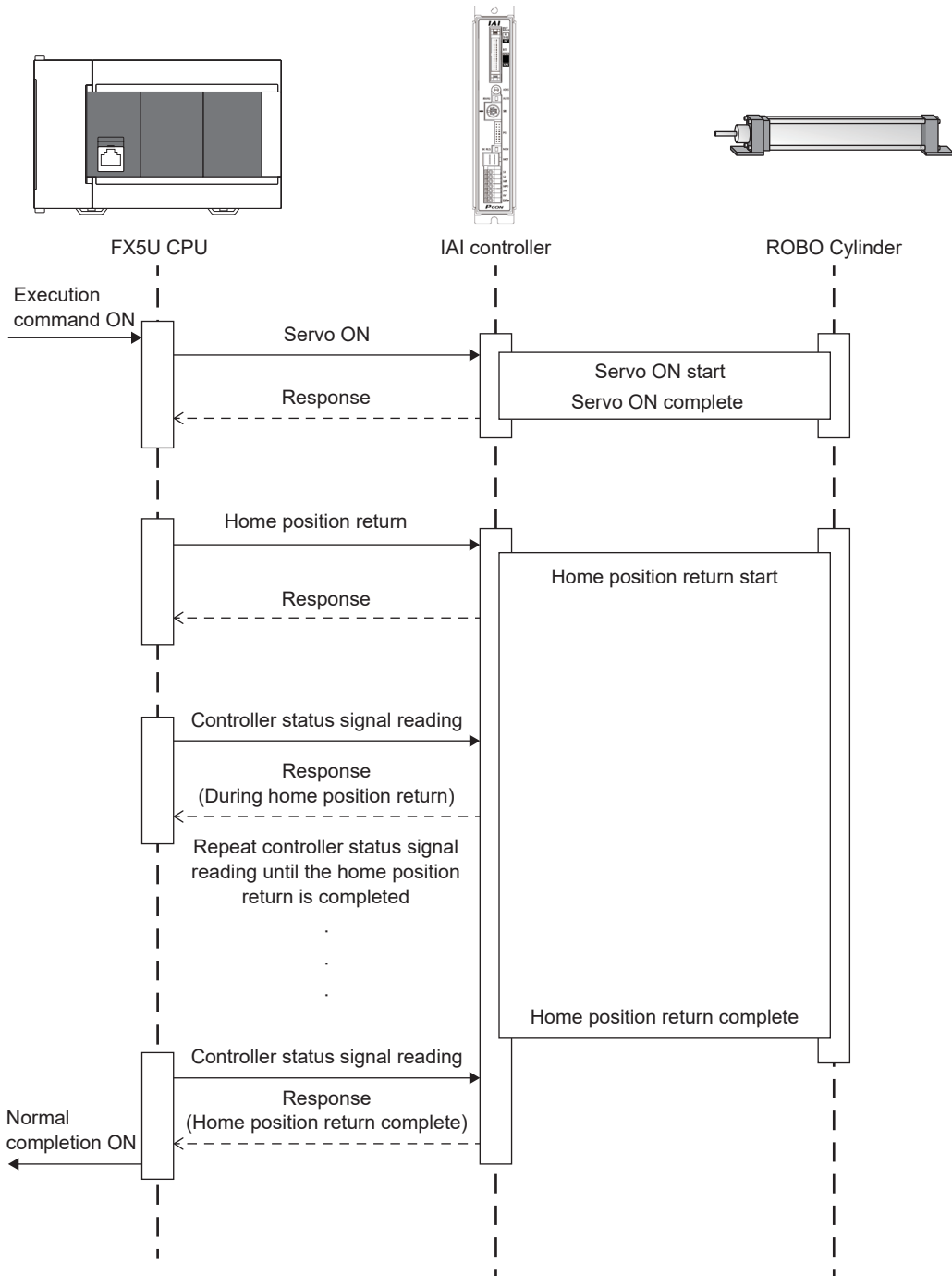

Sequence diagram



Basic specifications

Item	Description
Programming language	- (The program in this FB is not open to the public.)
Number of steps	6208 steps The number of steps of the FB in a program depends on the CPU module used, input and output definition, and option settings of GX Works3. For the option settings of GX Works3, refer to  GX Works3 Operating Manual (2.9 Option Setting for Each Function).
Label amount used	<ul style="list-style-type: none"> Label: 0.06K points (Word) Latch label: 0K points (Word) The label amount used in a program depends on the CPU module used, device specified in the argument, and option settings of GX Works3. For the option settings of GX Works3, refer to  GX Works3 Operating Manual (2.9 Option Setting for Each Function).
Number of index register points used	<ul style="list-style-type: none"> Index register: 0 points Long index register: 0 points
File register amount used	File register: 2336 points (Word) (R0 to R2335)
FB dependence	M+IAIStartHomePositioning_F LM+IAIServoControl_F
FB compiling method	Subroutine type
FB operation type	Pulsed execution (multiple scan execution type)

Function description

- Set the axis number of the operation target in `i_uAxis` (Target axis).
- At rising edge of `i_bEN` (Execution command), this FB sets the PIO/MODBUS switching to the MODBUS communication and executes the home position return.
- `o_bOK` (Normal completion) turns on when the home position return is completed.
- When this FB is executed, the servo is automatically turned on.
- If an error occurs while sending/receiving a predefined protocol, `o_bErr` (Error completion) turns on and the processing of the FB is interrupted. The error code is stored in `o_uErrId` (Error code). For details of the error code, refer to  MELSEC iQ-F FX5 User's Manual (Communication).
- If an error occurs in the ROBO Cylinder and this FB receives an error code, `o_bUnitErr` (Module error completion) turns on and the processing of the FB is interrupted. The received error code is stored in `o_uUnitErrId` (Module error code). For details of the error code, refer to the manuals described in "RELEVANT MANUALS".
- If any other error occurs, `o_bErr` (Error completion) turns on and the processing of the FB is interrupted. For details of the error code, refer to  Page 19 Error code.

Timing chart of I/O signals

Normal completion

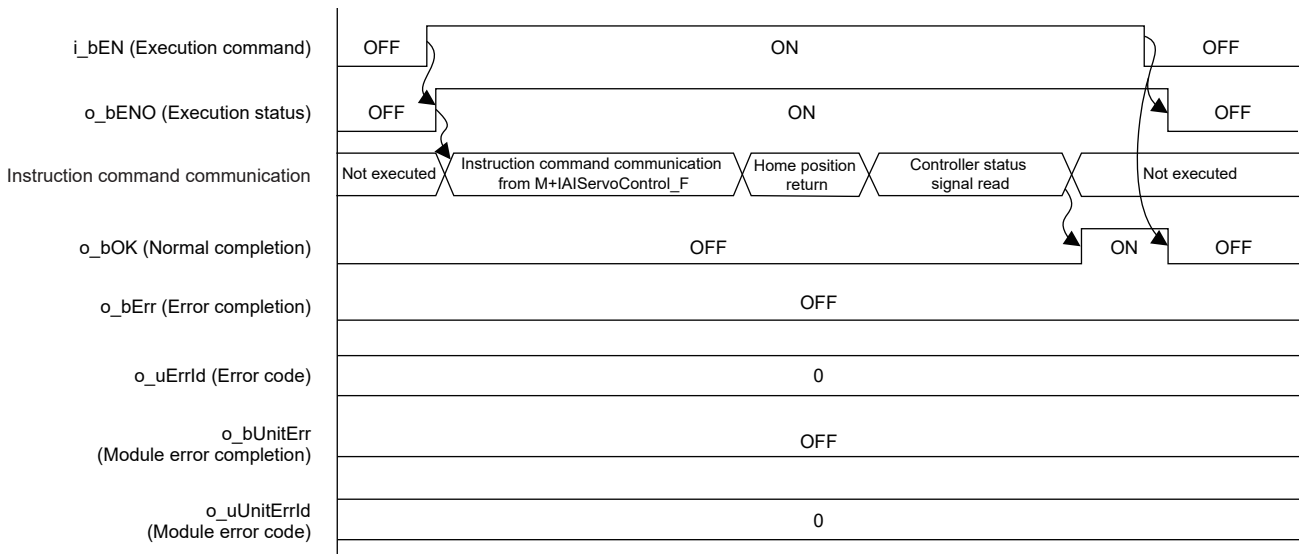

Error completion

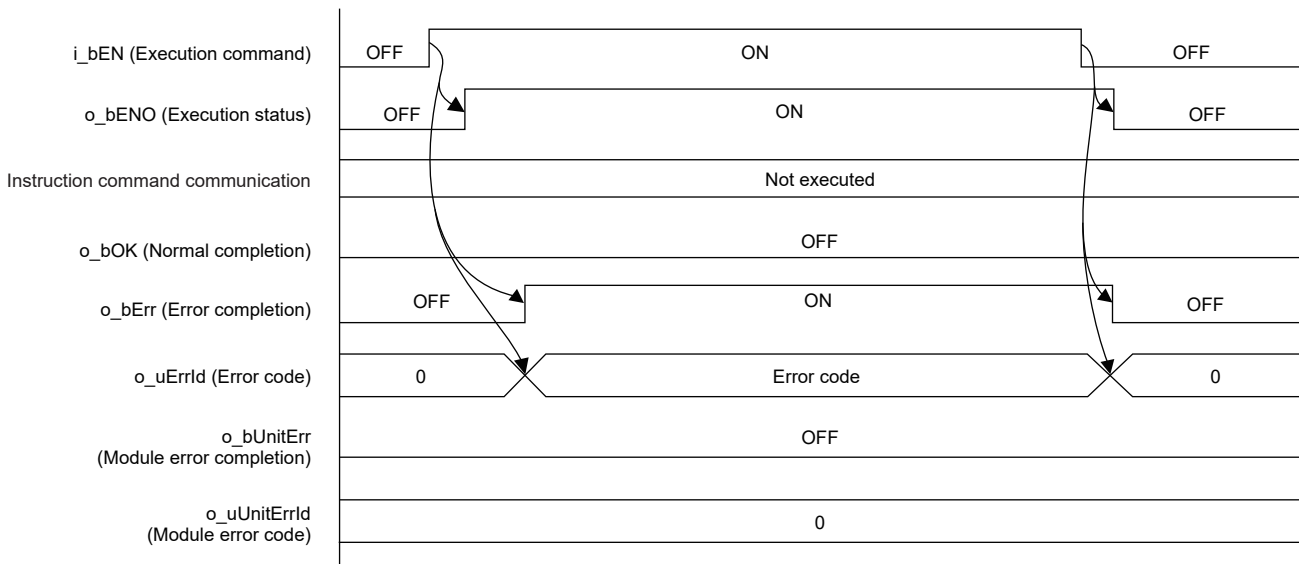

Restrictions and precautions

- This FB does not include error recovery processing. Program the error recovery processing separately in accordance with the required system operation.
- This FB cannot be used in an interrupt program.
- Using the FB in a program that is to be executed only once, such as a subroutine program or a FOR-NEXT loop, has a problem that i_bEN (Execution command) can no longer be turned off and normal operation is not possible; Always use the FB in a program that is capable of turning off the execution command.
- This FB requires the ladder to be configured for every input label.
- In this FB, if i_bEN (Execution command) is turned off after the home position return operation is started and before o_bOK (Normal completion), o_bErr (Error completion), or o_bUnitErr (Module error completion) turns on, the operation of the cylinder does not stop until the home position return operation is completed.
- This FB uses the CPRTCL instruction. For details, refer to MELSEC iQ-F FX5 User's Manual (Communication).
- To operate the IAI ROBO Cylinder, set the protocol type to the predefined protocol support function with the module parameter of GX Works3. For details of the parameter settings, refer to Page 18 Parameter setting.

Parameter setting

Set the protocol type to the predefined protocol support function.

Configure the settings by selecting the following menu items in GX Works3.

[Navigation window] ⇒ [Parameter] ⇒ Communication port to be used ⇒ [Basic Settings] For the protocol type setting, select "Predefined Protocol Support Function" for "Communication Protocol Type".

Configure the following settings in the detail settings.

- Data Length: 8 (Default value: 7)
- Parity Bit: None (Default value: Odd)
- Stop Bit: 1bit (Default value: 1bit)
- Baud Rate: 38400bps (Default value: 115200bps)

Set the other parameters to the default values.

For details of the parameter settings, refer to MELSEC iQ-F FX5 User's Manual (Communication).

In addition, set the channel to be used and write the data in Predefined Protocol Support Tool For Positioning.

For details, refer to Predefined Protocol Support Tool For Positioning Operating Manual (6.4 Writing Predefined Protocol Information).

Performance value

CPU	Measurement condition ^{*3}	Processing time	Maximum scan time	Number of scans
FX5U, FX5UC ^{*1*2}	Axis 1	1760 ms	1.07 ms	5472 scans

*1 When the program capacity is set to 128K steps, the process speed may be decreased.

*2 The standard area is used for the labels.

*3 The current position at the start of the measurement is 1000. Perform the positioning operation in advance so that the current position becomes 1000.

Error code

Error code (hexadecimal)	Description	Action
101H	The setting value of i_uCh (Target CH) is out of range. The target channel is not within the range of 1 to 4.	Review and correct the setting and then execute the FB again.
102H	The setting value of i_uAxis (Target axis) is out of range. The target axis is not within the range of 1 to 16.	Review and correct the setting and then execute the FB again.
200H	An unsupported device is connected.	Review and correct the connected device and then execute the FB again.
201H	The execution command has turned off during the processing.	Keep the ON state of the execution command until the normal completion, error completion, or module error completion turns on.*1
203H	The controller is in the emergency stop state or a major failure has occurred.	Check the status of the controller using M+IAIMonitoring_F. After checking the status, eliminate the error cause and then execute the FB again.
Predefined protocol error code	This error code occurs during communication.	Refer to  MELSEC iQ-F FX5 User's Manual (Communication).

*1 It is output only during one scan.

2.3 M+IAIJogInching_F (JOG/Inching Operation)

Overview

This FB sets the PIO/MODBUS switching to the MODBUS communication and turns on the servo after *i_udJogSpeed* (JOG speed) and *i_udInchingMovingDistance* (Inching movement distance) are written to the parameter data of the ROBO Cylinder.

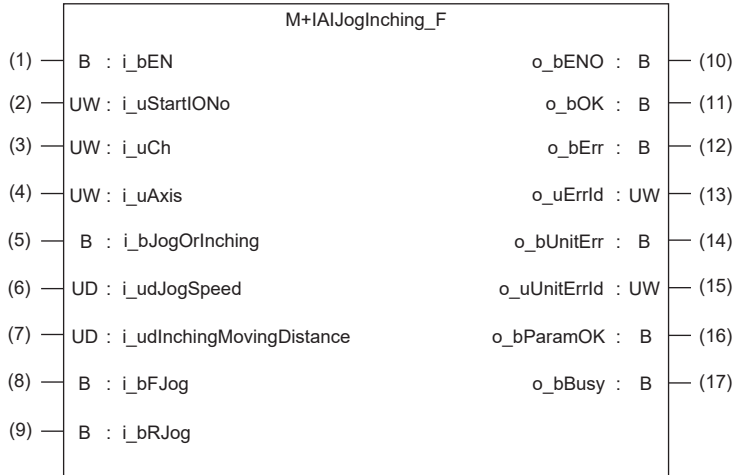

Label

Input label

No.	Label	Label name	Data type	Setting range	Description
(1)	<i>i_bEN</i>	Execution command	Bit	ON, OFF	ON: The FB is activated. OFF: The FB is not activated.
(2)	<i>i_uStartIONo</i>	Start I/O No.	Word [Unsigned]/Bit string [16-bit]	—	Setting this label is not required since it is not used in the program in this FB.
(3)	<i>i_uCh</i>	Target CH	Word [Unsigned]/Bit string [16-bit]	1 to 4	Specify the channel number. 1: Built-in RS485 port 2: FX5-485-BD, FX5-232-BD 3, 4: FX5-485ADP, FX5-232ADP
(4)	<i>i_uAxis</i>	Target axis	Word [Unsigned]/Bit string [16-bit]	1 to 16	Specify the axis number set in the ROBO Cylinder incremented by one. ^{*1} Example: When setting 0 for the axis number of the ROBO Cylinder, set 1 in <i>i_uAxis</i> (Target axis).
(5)	<i>i_bJogOrInching</i>	JOG/inching switching	Bit	ON, OFF	ON: The inching operation is specified. OFF: The JOG operation is specified.
(6)	<i>i_udJogSpeed</i>	JOG speed	Double word [Unsigned]/Bit string [32-bit]	1 to 999999	Specify the JOG speed. ^{*2} The setting is ignored for the inching operation.
(7)	<i>i_udInchingMovingDistance</i>	Inching movement distance	Double word [Unsigned]/Bit string [32-bit]	1 to 999999	Specify the inching movement distance. ^{*3} The setting is ignored for the JOG operation.
(8)	<i>i_bFJog</i>	JOG+ command	Bit	ON, OFF	Turn on this label to perform the forward JOG operation or forward inching operation.
(9)	<i>i_bRJog</i>	JOG- command	Bit	ON, OFF	Turn on this label to perform the reverse JOG operation or reverse inching operation.

*1 The axis number corresponds to the slave station number of MODBUS.

*2 The unit is 0.01 mm/s.

*3 The unit is 0.01 mm.

Output label

No.	Label	Label name	Data type	Default value	Description
(10)	o_bENO	Execution status	Bit	OFF	ON: The execution command is on. OFF: The execution command is off.
(11)	o_bOK	Normal completion	Bit	OFF	When this label is on, it indicates that the execution of the JOG operation has started without error or the execution of the inching operation has been completed without error.
(12)	o_bErr	Error completion	Bit	OFF	When this label is on, it indicates that an error has occurred in the FB.
(13)	o_uErrId	Error code	Word [Unsigned]/Bit string [16-bit]	0	The error code that occurred in the FB is stored.
(14)	o_bUnitErr	Module error completion	Bit	OFF	When this label is on, it indicates that an error has occurred in the module.
(15)	o_uUnitErrId	Module error code	Word [Unsigned]/Bit string [16-bit]	0	The error code that occurred in the module is stored.
(16)	o_bParamOK	Setting completion flag	Bit	OFF	When this label is on, it indicates that configuring the initial settings to enable the cylinder operation has been completed.
(17)	o_bBusy	Busy signal	Bit	OFF	When this label is on, it indicates that the cylinder is operating.

Function overview

Applicable hardware and software

■ Predefined Protocol Support FB For Positioning

Applicable module	Firmware version	Engineering tool
FX5U CPU	1.200 or later	GX Works3 Version 1.060N or later
FX5UC CPU	1.200 or later	GX Works3 Version 1.060N or later

Sequence diagram

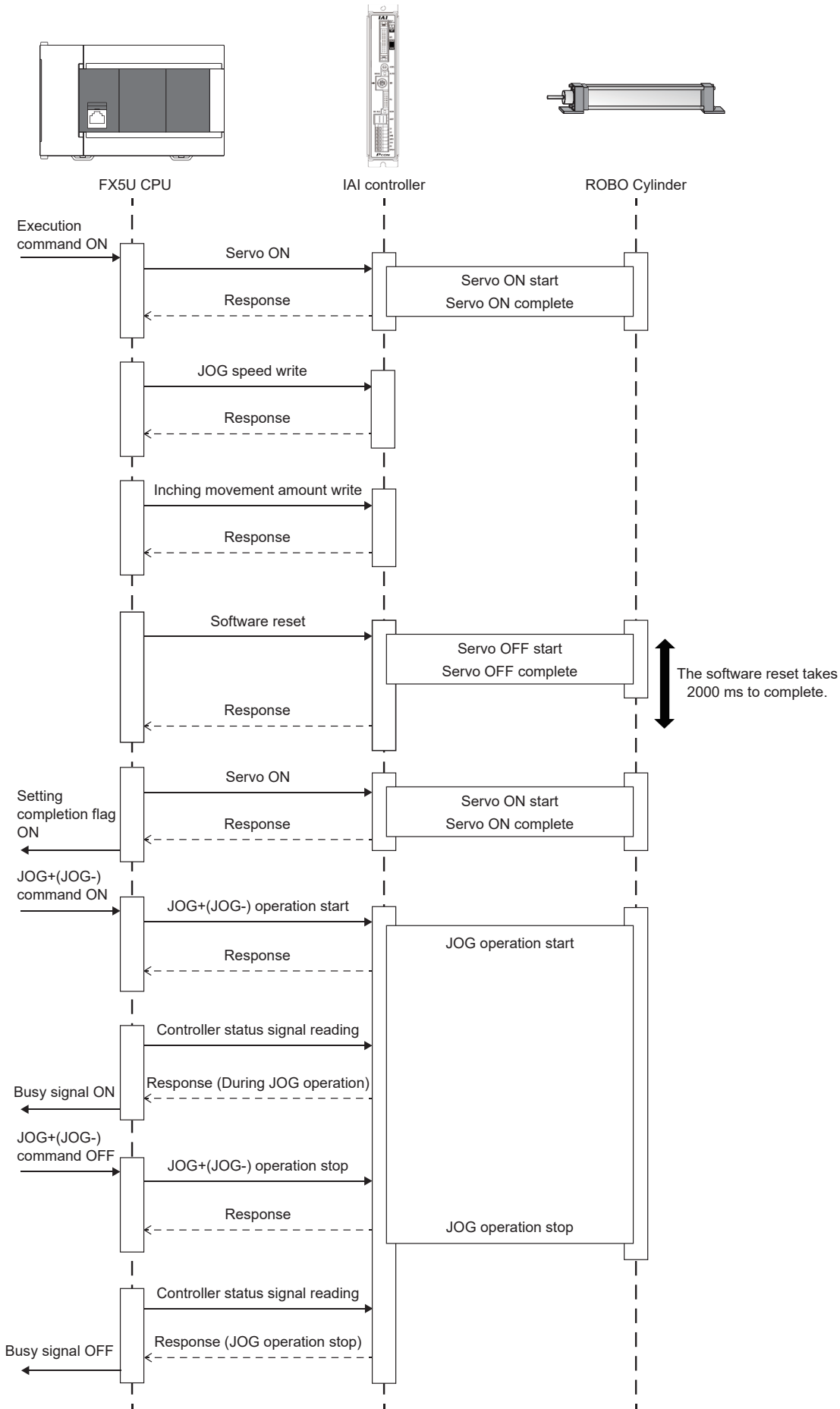

Basic specifications

Item	Description
Programming language	- (The program in this FB is not open to the public.)
Number of steps	10.83K steps The number of steps of the FB in a program depends on the CPU module used, input and output definition, and option settings of GX Works3. For the option settings of GX Works3, refer to GX Works3 Operating Manual (2.9 Option Setting for Each Function) .
Label amount used	<ul style="list-style-type: none"> • Label: 0.08K points (Word) • Latch label: 0K points (Word) The label amount used in a program depends on the CPU module used, device specified in the argument, and option settings of GX Works3. For the option settings of GX Works3, refer to GX Works3 Operating Manual (2.9 Option Setting for Each Function) .
Number of index register points used	<ul style="list-style-type: none"> • Index register: 0 points • Long index register: 0 points
File register amount used	File register: 2336 points (Word) (R0 to R2335)
FB dependence	M+IAIJogInching_F LM+IAIServoControl_F
FB compiling method	Subroutine type
FB operation type	Real-time execution

Function description

- Set the axis number of the operation target in `i_uAxis` (Target axis).
- At rising edge of `i_bEN` (Execution command), this FB sets the PIO/MODBUS switching to the MODBUS communication and turns on the servo after `i_udJogSpeed` (JOG speed) and `i_udInchingMovingDistance` (Inching movement distance) are written to the parameter data of the ROBO Cylinder.
- The software is reset after the parameter data is written, and `o_bParamOK` (Setting completion flag) turns on when the JOG/inching operation is enabled.
- While the cylinder is operating, `o_bBusy` (Busy signal) is on.
- The inching operation command is executed until the operation is completed at rising edge of `i_bFJog` (JOG+ command) or `i_bRJog` (JOG- command) while `i_bJogOrInching` (JOG/inching switching) is on. `o_bOK` (Normal completion) turns on when the operation is completed.
- For the inching operation, the operation decelerates to stop when the command of the operation in the opposite direction turns on while the cylinder is operating.
- The JOG operation command is executed while `i_bJogOrInching` (JOG/inching switching) is off and `i_bFJog` (JOG+ command) or `i_bRJog` (JOG- command) is on. `o_bOK` (Normal completion) turns on when the operation starts. The operation decelerates to stop and `o_bOK` (Normal completion) turns off when `i_bFJog` (JOG+ command) or `i_bRJog` (JOG- command) is switched off from ON.
- For the JOG operation, the operation decelerates to stop when both `i_bFJog` (JOG+ command) and `i_bRJog` (JOG- command) are turned on. If either of these commands is turned off, the operation which remains on is started.
- The operation decelerates to stop when `i_bJogOrInching` (JOG/inching switching) is changed during the operation of `i_bFJog` (JOG+ command) or `i_bRJog` (JOG- command).
- If an error occurs while sending/receiving a predefined protocol, `o_bErr` (Error completion) turns on and the processing of the FB is interrupted. The error code is stored in `o_uErrId` (Error code). For details of the error code, refer to [MELSEC iQ-F FX5 User's Manual \(Communication\)](#).
- If an error occurs in the ROBO Cylinder and this FB receives an error code, `o_bUnitErr` (Module error completion) turns on and the processing of the FB is interrupted. The received error code is stored in `o_uUnitErrId` (Module error code). For details of the error code, refer to the manuals described in "RELEVANT MANUALS".
- If any other error occurs, `o_bErr` (Error completion) turns on and the processing of the FB is interrupted. For details of the error code, refer to [Page 32 Error code](#).

Timing chart of I/O signals

■ Normal completion

- From rising edge of the execution command ON to the second servo ON

The following processing is executed only once at rising edge of the execution command ON.

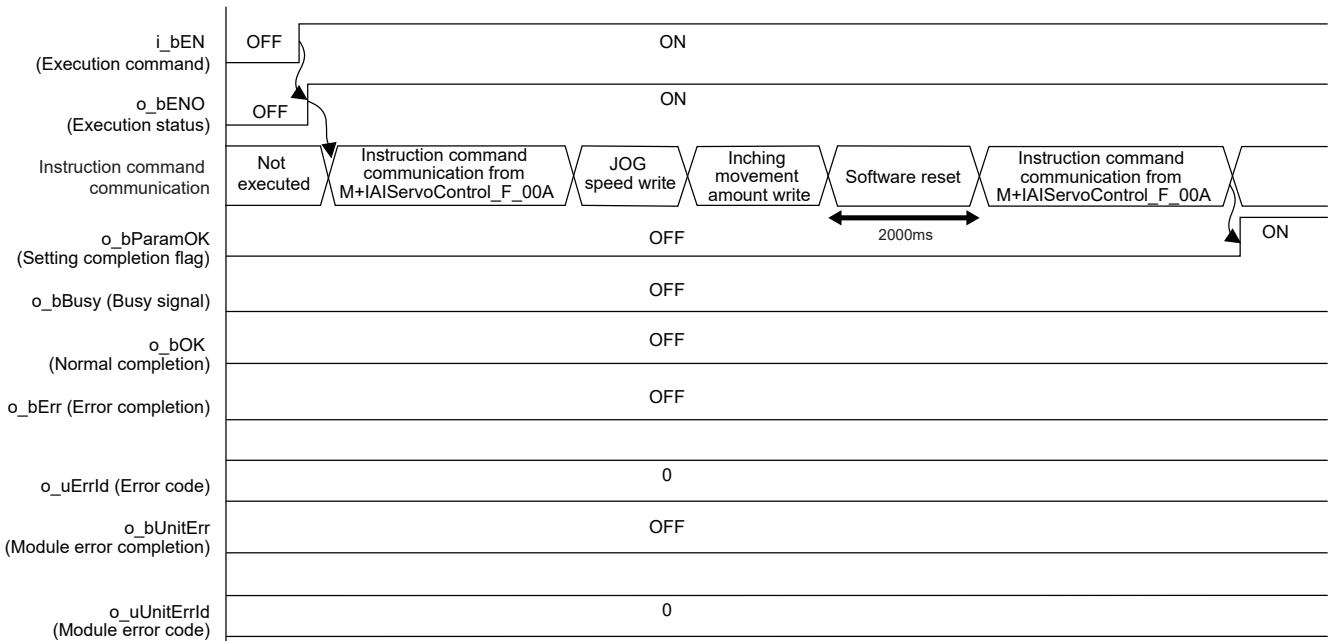

- From the JOG/inching switching command to execution command OFF (Example: JOG operation)

The following processing is repeatedly executed while i_bEN (Execution command) is on.

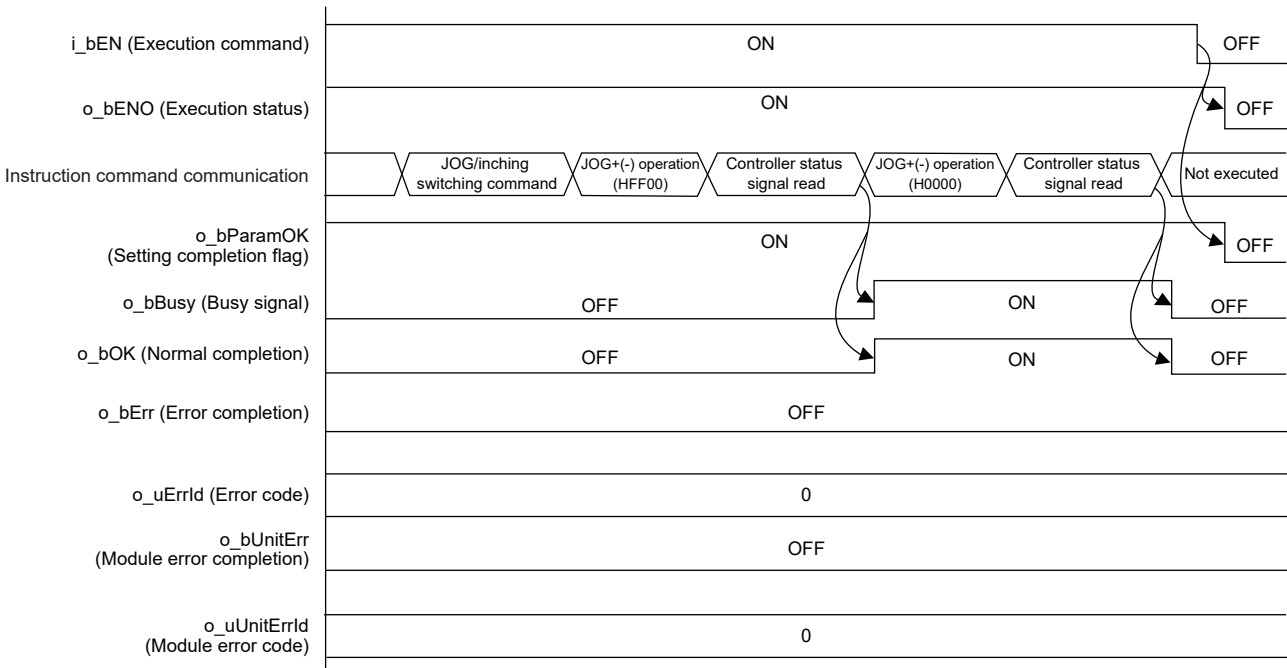

• JOG operation (JOG+ command)

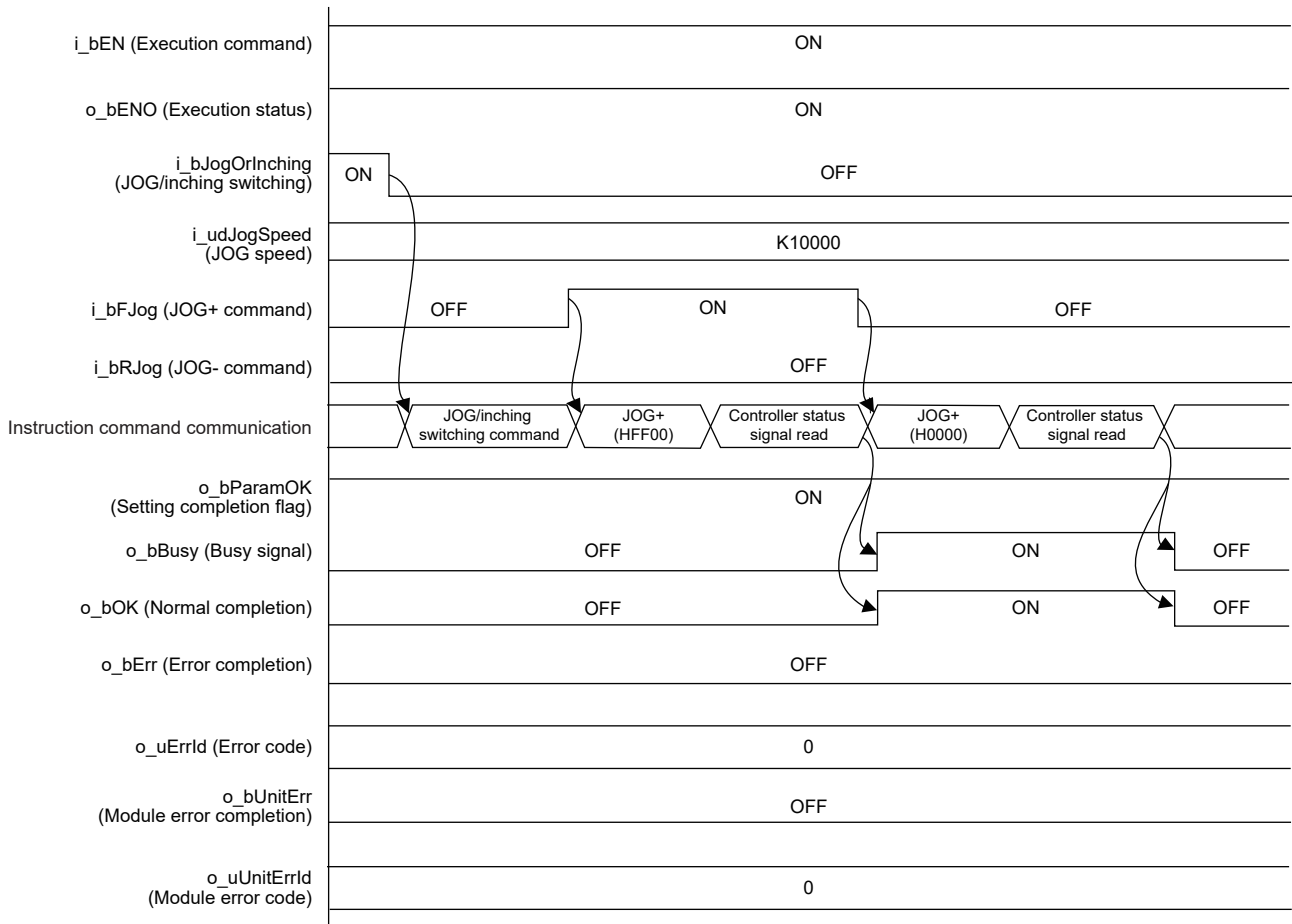

• JOG operation (JOG- command)

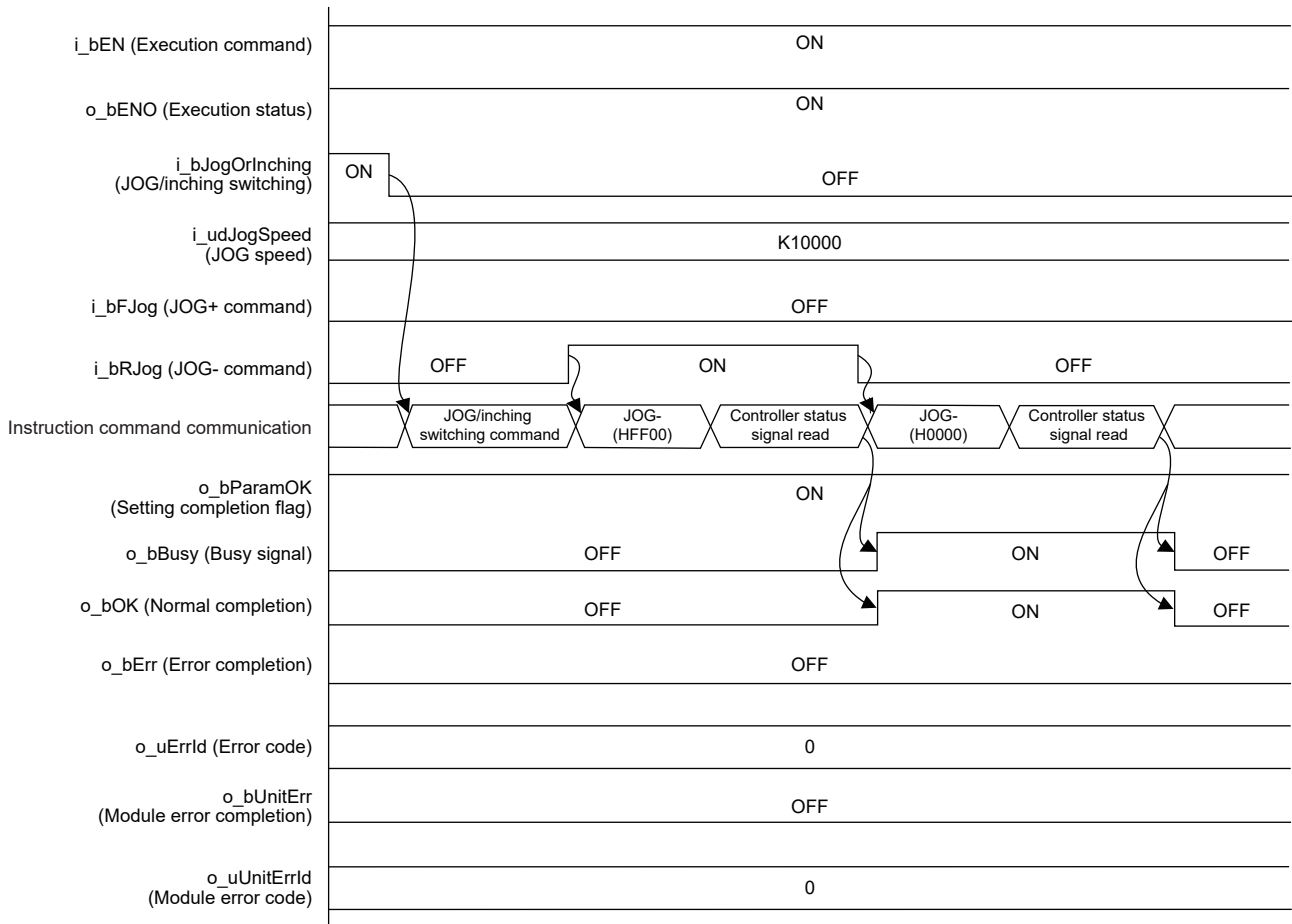

• JOG operation (when both JOG+ command and JOG- command are simultaneously turned on)

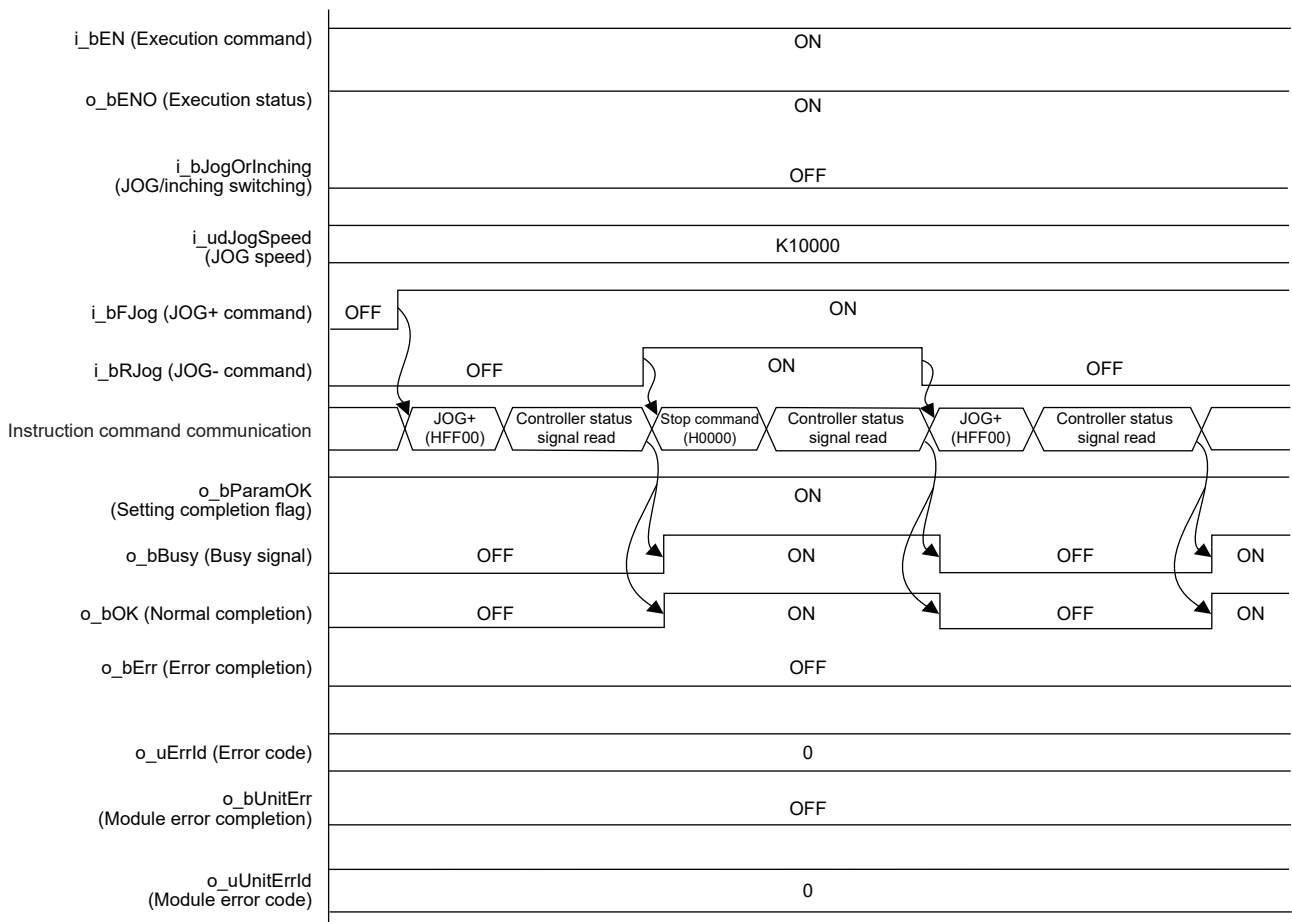

- Inching operation (JOG+ command)

When i_bFJog (JOG+ command) is turned off before o_bOK (Normal completion) turns on, o_bOK (Normal completion) is on only during one scan.

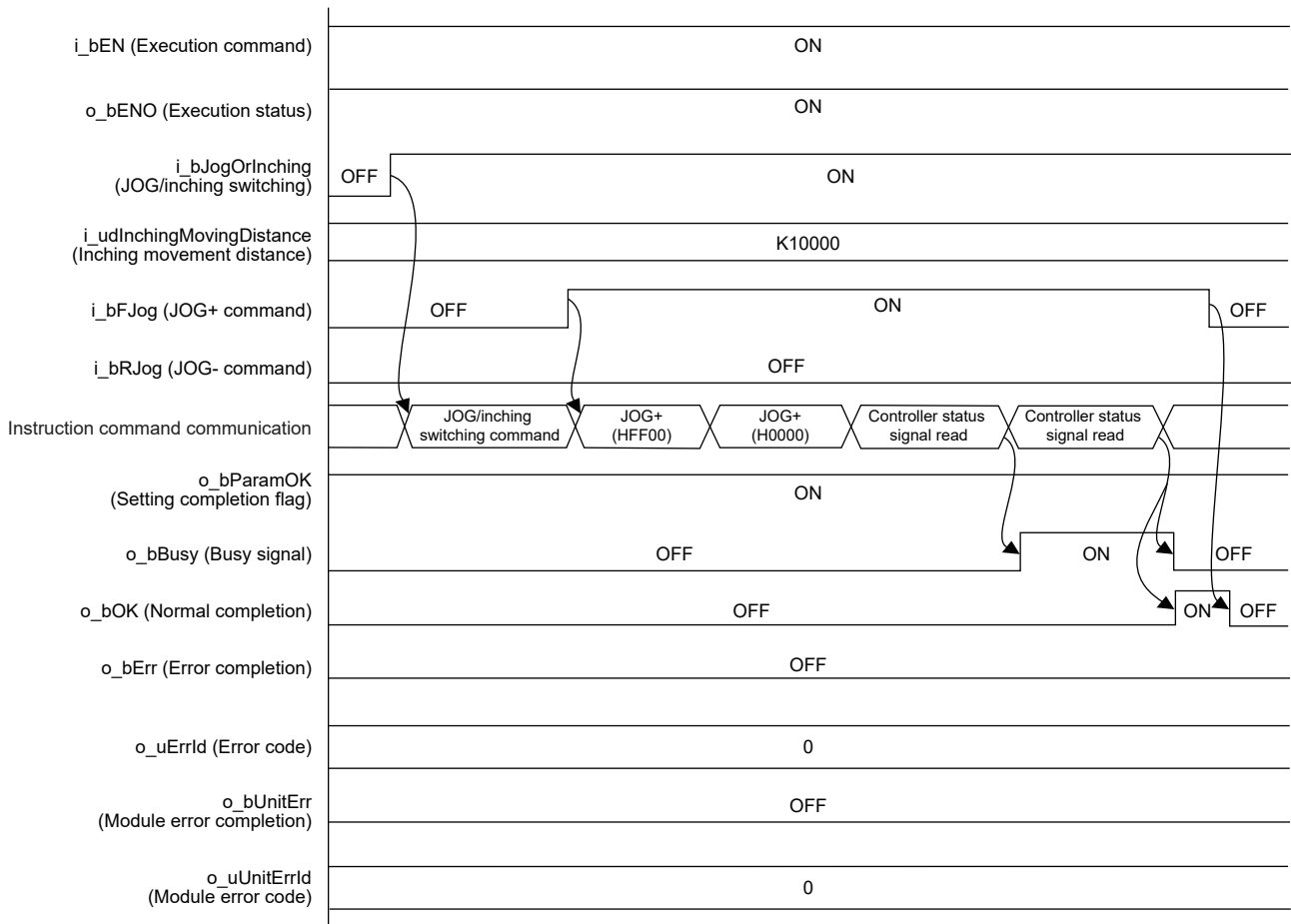

• Inching operation (JOG- command)

When i_bRJog (JOG- command) is turned off before o_bOK (Normal completion) turns on, o_bOK (Normal completion) is on only during one scan.

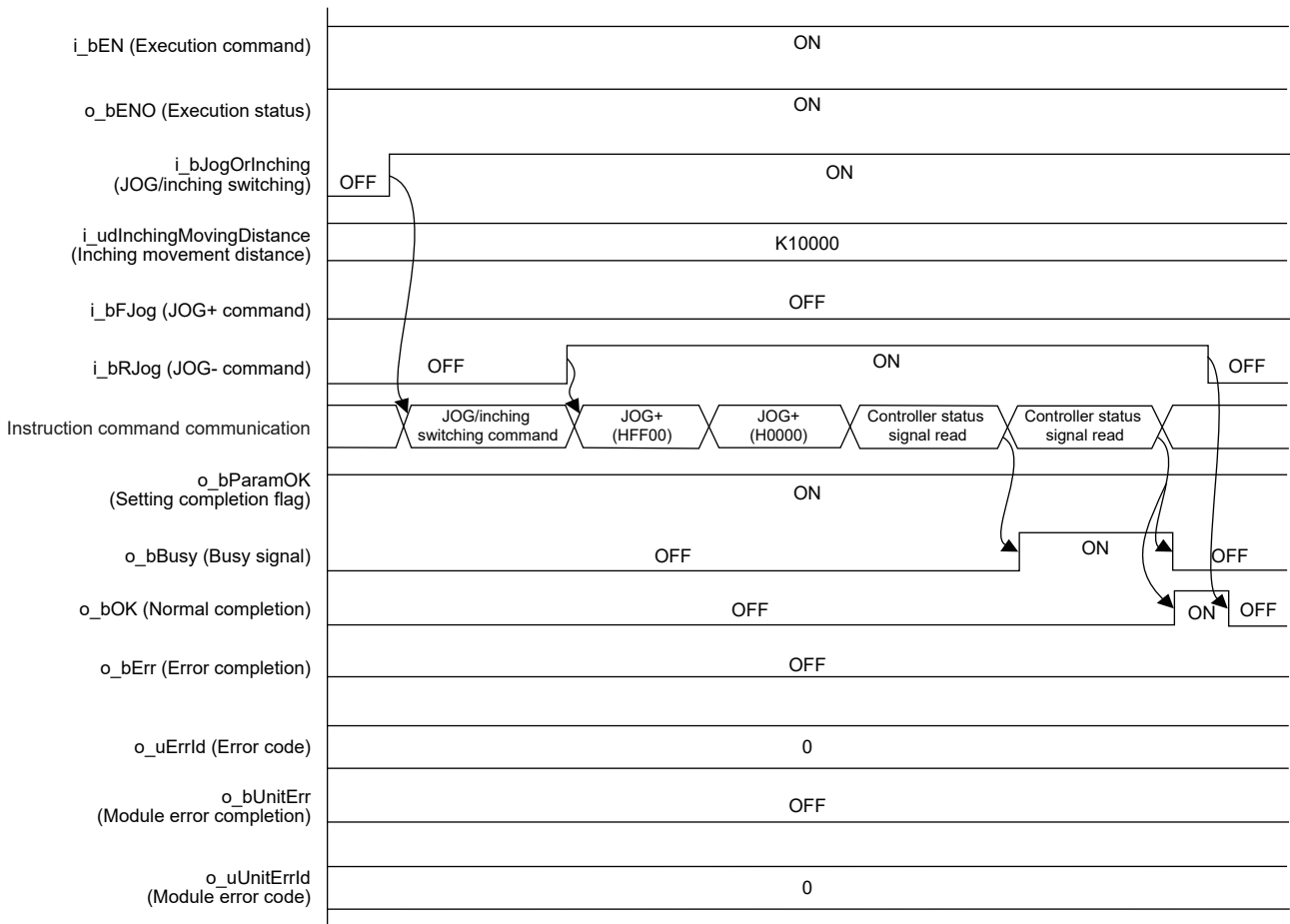

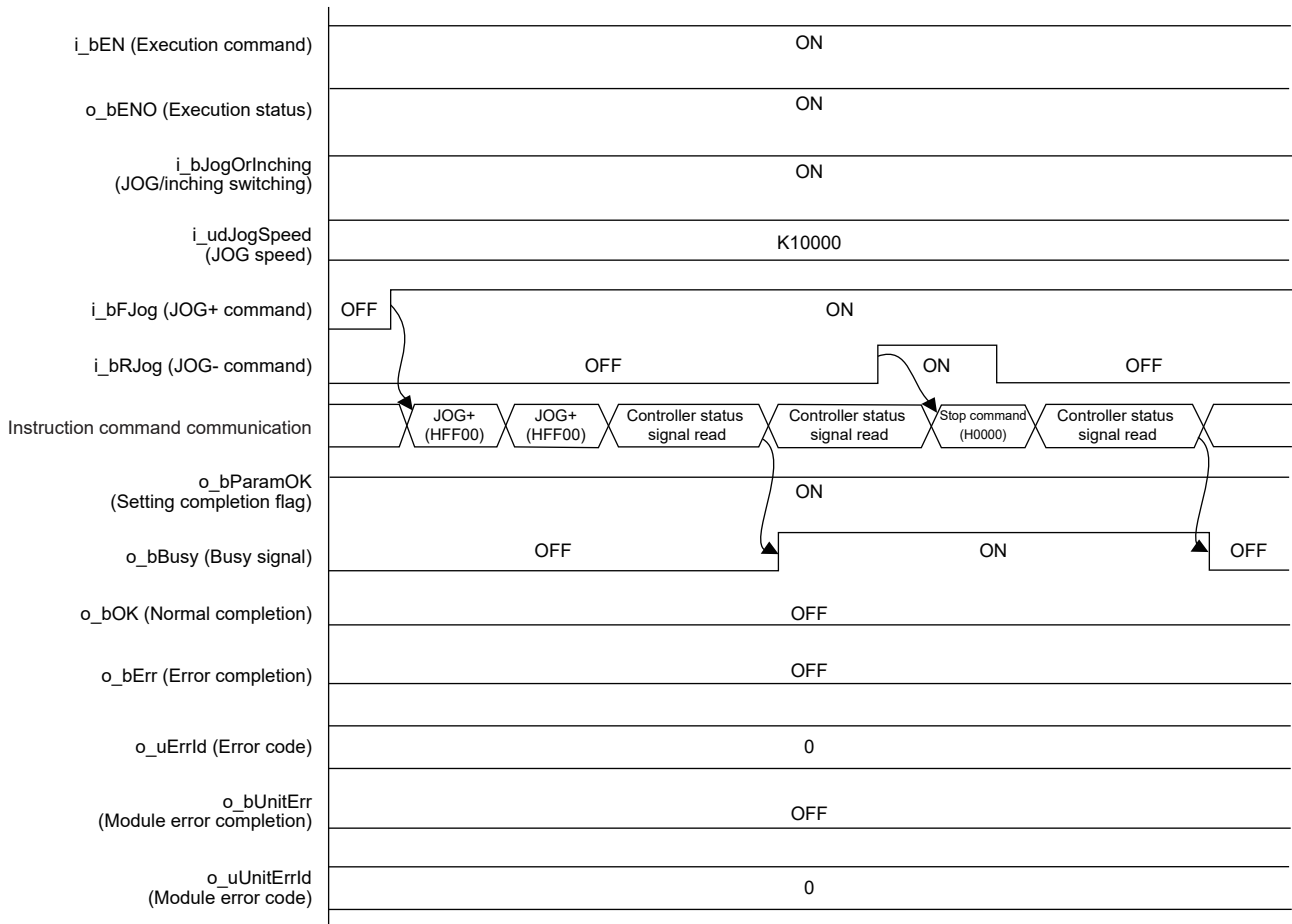

- Inching operation (when both JOG+ command and JOG- command are simultaneously turned on)

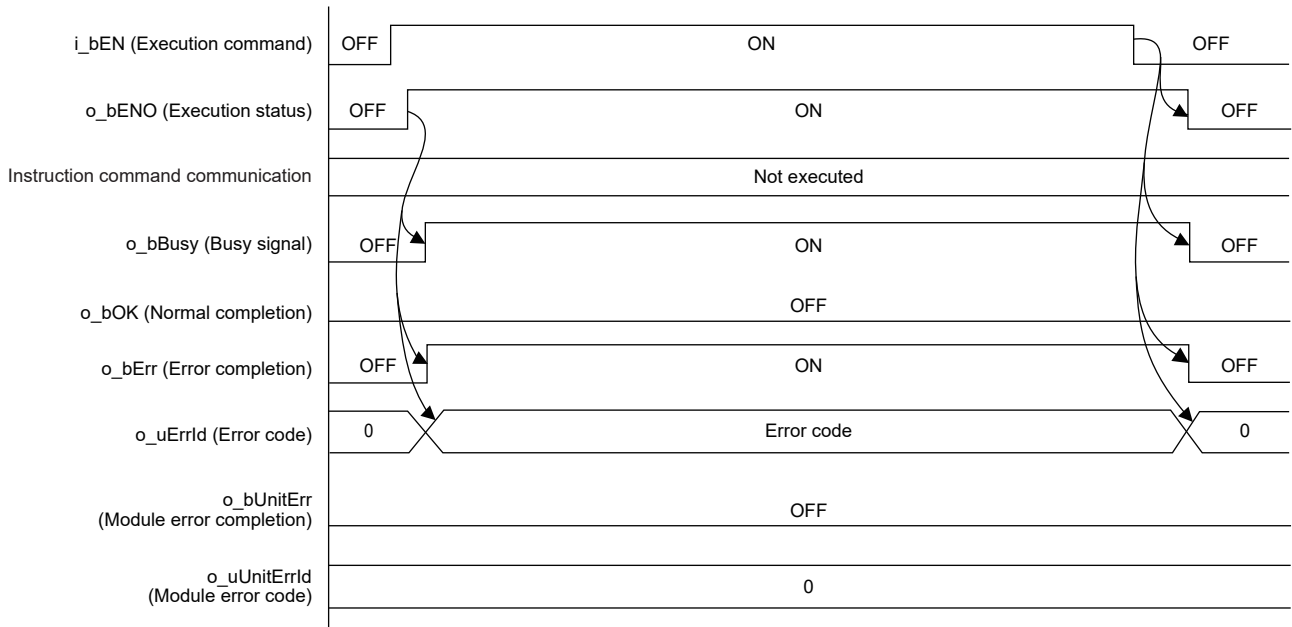

■ Error completion



Restrictions and precautions

- This FB does not include error recovery processing. Program the error recovery processing separately in accordance with the required system operation.
- This FB cannot be used in an interrupt program.
- Using the FB in a program that is to be executed only once, such as a subroutine program or a FOR-NEXT loop, has a problem that i_bEN (Execution command) can no longer be turned off and normal operation is not possible; Always use the FB in a program that is capable of turning off the execution command.
- This FB requires the ladder to be configured for every input label.
- This FB writes data to the nonvolatile memory. For details, refer to  PCON, ACON, SCON, RCP6 (PLC Unit) ERC2, ERC3 Serial Communication [Modbus Version] Operation Manual.
- By turning on i_bEN (Execution command), this FB restarts the controller after turning off the servo. Restart takes 2000 ms.
- When 2100 ms or more is taken from the restart of the controller until the communication is enabled, this FB is completed with an error. In such a case, set the time from the restart until the communication is enabled in the file register (R2335). The waiting time of this FB is $R2335 \times 100$ ms. When the set waiting time is 2100 ms or shorter, it is automatically set to 2100 ms.
- The JOG speed or inching movement distance cannot be changed while i_bEN (Execution command) is on. When changing either of them, execute the FB again.
- Execute the home position return after o_bParamOK (Setting completion flag) turns on. Otherwise, a major error occurs when the cylinder exceeds the operation limit value.
- When the cylinder stops at the operation limit value, no error occurs in this FB.
- When i_bFJog (JOG+ command) or i_bRJog (JOG- command) is turned on before o_bParamOK (Setting completion flag) turns on, the JOG+(-) command is ignored. Turn on the JOG+(-) command again after o_bParamOK (Setting completion flag) turns on.
- When i_bEN (Execution command) is turned off while the cylinder is operating, the cylinder operation does not stop. Program the processing separately in accordance with the required system operation.
- This FB uses the CPRTCL instruction. For details, refer to  MELSEC iQ-F FX5 User's Manual (Communication).
- To operate the IAI ROBO Cylinder, set the protocol type to the predefined protocol support function with the module parameter of GX Works3. For details of the parameter settings, refer to  Page 18 Parameter setting.
- Since the controller is restarted at the execution of this FB, the control by the following FBs is stopped.

 Page 14 M+IAIStartHomePositioning_F (Home Position Return)

 Page 45 M+IAIStartPositioning_F (Positioning Operation)

Parameter setting

For details of the parameter settings, refer to  Page 18 Parameter setting.

Performance value

CPU	Measurement condition				Processing time	Maximum scan time	Number of scans
	JOG/inching operation	+ command/- command	JOG speed (Unit: 0.01 mm/s)	Inching movement distance (Unit: 0.01 mm)			
FX5U, FX5UC ^{*1} *2	JOG operation	JOG+ command	100	—	14.0 ms	1.08 ms	40 scans
			1000	—	14.1 ms	1.10 ms	40 scans
			10000	—	14.2 ms	1.15 ms	40 scans
		JOG- command	100	—	14.0 ms	1.13 ms	40 scans
			1000	—	14.2 ms	1.09 ms	40 scans
			10000	—	14.3 ms	1.08 ms	40 scans
	Inching operation	Inching+ command	100	10	41.8 ms	1.07 ms	126 scans
			100	100	960 ms	1.11 ms	2885 scans
			100	1000	9950 ms	1.44 ms	30473 scans
		Inching- command	100	10	45.9 ms	1.10 ms	128 scans
			100	100	946 ms	1.27 ms	2853 scans
			100	1000	10000 ms	1.43 ms	30492 scans

*1 When the program capacity is set to 128K steps, the process speed may be decreased.

*2 The standard area is used for the labels.

Error code

Error code (hexadecimal)	Description	Action
101H	The setting value of i_uCh (Target CH) is out of range. The target channel is not within the range of 1 to 4.	Review and correct the setting and then execute the FB again.
102H	The setting value of i_uAxis (Target axis) is out of range. The target axis is not within the range of 1 to 16.	Review and correct the setting and then execute the FB again.
103H	The setting value of i_udJogSpeed (JOG speed) is out of range. The JOG speed is not within the range of 1 to 999999.	Review and correct the setting and then execute the FB again.
104H	The setting value of i_udInchingMovingDistance (Inching movement distance) is out of range. The inching movement distance is not within the range of 1 to 999999.	Review and correct the setting and then execute the FB again.
200H	An unsupported device is connected.	Review and correct the connected device and then execute the FB again.
201H	The execution command has turned off during the processing.	Keep the ON state until the setting completion flag turns on. ^{*1}
203H	The controller is in the emergency stop state or a major failure has occurred.	Check the status of the controller using M+IAIMonitoring_F. After checking the status, eliminate the error cause and then execute the FB again.
Predefined protocol error code	This error code occurs during communication.	Refer to  MELSEC iQ-F FX5 User's Manual (Communication).

*1 It is output only during one scan.

2.4 M+IAIReadPositioningTable_F (Position Table Read)

Overview

This FB sets the PIO/MODBUS switching to the MODBUS communication and reads the position table information for the specified position table No. of the IAI ROBO Cylinder.

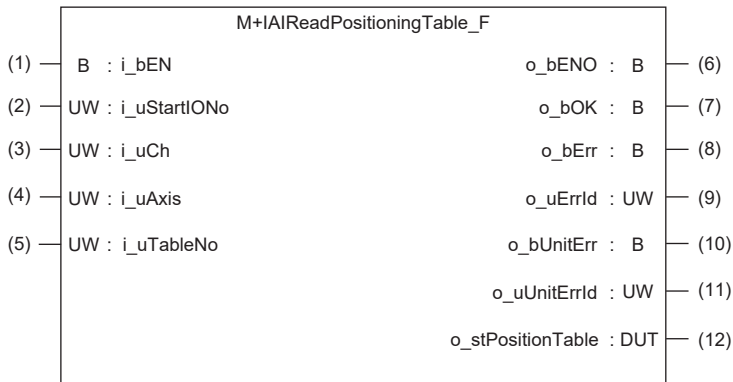

Label

Input label

No.	Label	Label name	Data type	Setting range	Description
(1)	i_bEN	Execution command	Bit	ON, OFF	ON: The FB is activated. OFF: The FB is not activated.
(2)	i_uStartIOno	Start I/O No.	Word [Unsigned]/Bit string [16-bit]	—	Setting this label is not required since it is not used in the program in this FB.
(3)	i_uCh	Target CH	Word [Unsigned]/Bit string [16-bit]	1 to 4	Specify the channel number. 1: Built-in RS485 port 2: FX5-485-BD, FX5-232-BD 3, 4: FX5-485ADP, FX5-232ADP
(4)	i_uAxis	Target axis	Word [Unsigned]/Bit string [16-bit]	1 to 16	Specify the axis number set in the ROBO Cylinder incremented by one.*1 Example: When setting 0 for the axis number of the ROBO Cylinder, set 1 in i_uAxis (Target axis).
(5)	i_uTableNo	Position table No.	Word [Unsigned]/Bit string [16-bit]	0 to 999	Specify the position table No. from which the setting values are read.

*1 The axis number corresponds to the slave station number of MODBUS.

Output label

No.	Label	Label name	Data type	Default value	Description
(6)	o_bENO	Execution status	Bit	OFF	ON: The execution command is on. OFF: The execution command is off.
(7)	o_bOK	Normal completion	Bit	OFF	When this label is on, it indicates that reading the position table data has been completed.
(8)	o_bErr	Error completion	Bit	OFF	When this label is on, it indicates that an error has occurred in the FB.
(9)	o_uErrId	Error code	Word [Unsigned]/Bit string [16-bit]	0	The error code that occurred in the FB is stored.
(10)	o_bUnitErr	Module error completion	Bit	OFF	When this label is on, it indicates that an error has occurred in the module.
(11)	o_uUnitErrId	Module error code	Word [Unsigned]/Bit string [16-bit]	0	The error code that occurred in the module is stored.
(12)	o_stPositionTable	Position table	Structure	—	The position table information is stored. For details of the structure, refer to Page 10 Position table.

Function overview

Applicable hardware and software

■Predefined Protocol Support FB For Positioning

Applicable module	Firmware version	Engineering tool
FX5U CPU	1.200 or later	GX Works3 Version 1.060N or later
FX5UC CPU	1.200 or later	GX Works3 Version 1.060N or later

Sequence diagram

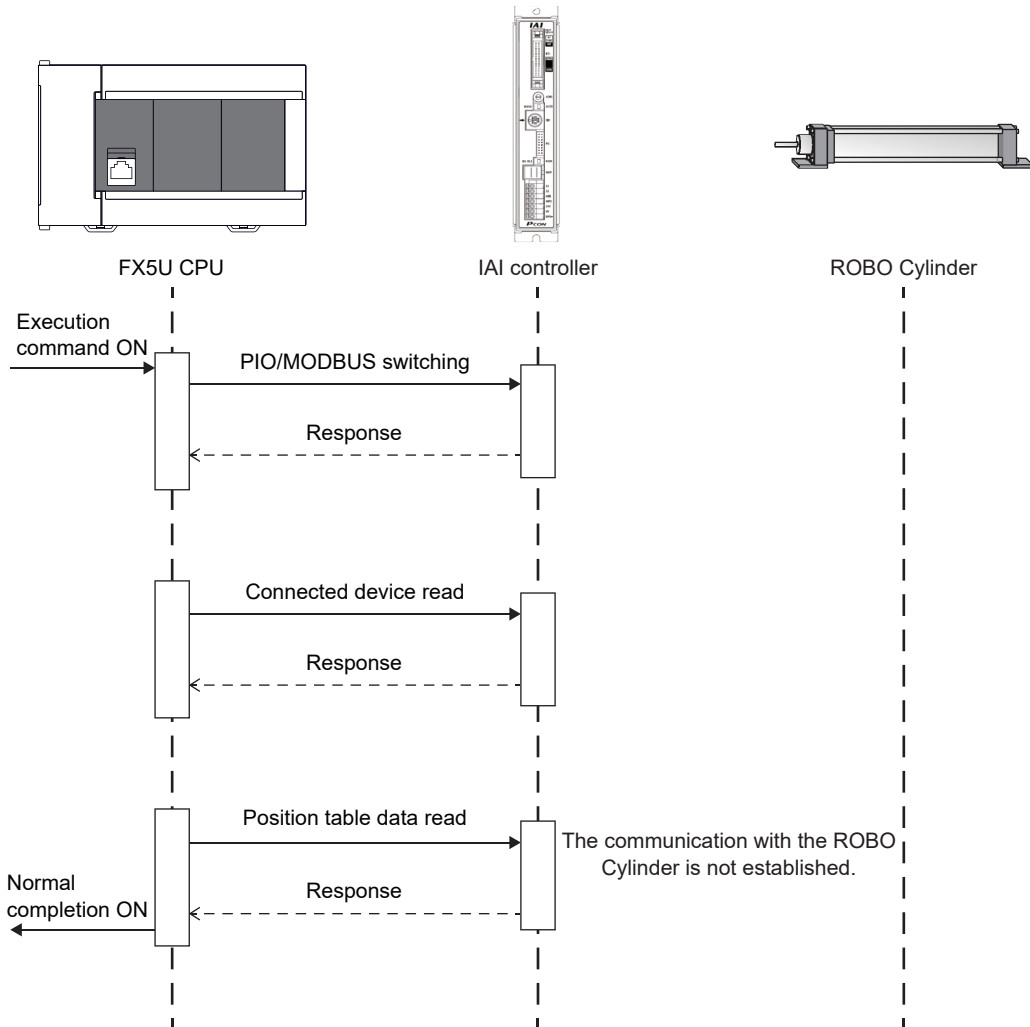

Basic specifications

Item	Description
Programming language	- (The program in this FB is not open to the public.)
Number of steps	3688 steps The number of steps of the FB in a program depends on the CPU module used, input and output definition, and option settings of GX Works3. For the option settings of GX Works3, refer to GX Works3 Operating Manual (2.9 Option Setting for Each Function).
Label amount used	<ul style="list-style-type: none"> Label: 0.05K points (Word) Latch label: 0K points (Word) The label amount used in a program depends on the CPU module used, device specified in the argument, and option settings of GX Works3. For the option settings of GX Works3, refer to GX Works3 Operating Manual (2.9 Option Setting for Each Function).
Number of index register points used	<ul style="list-style-type: none"> Index register: 0 points Long index register: 0 points
File register amount used	File register: 2336 points (Word) (R0 to R2335)
FB dependence	No dependence
FB compiling method	Subroutine type
FB operation type	Pulsed execution (multiple scan execution type)

Function description

- Set the axis number of the operation target in `i_uAxis` (Target axis).
- At rising edge of `i_bEN` (Execution command), this FB sets the PIO/MODBUS switching to the MODBUS communication and reads the set data in the specified position table No. of the IAI ROBO Cylinder.
- `o_bOK` (Normal completion) turns on when reading the position table is completed.
- If an error occurs while sending/receiving a predefined protocol, `o_bErr` (Error completion) turns on and the processing of the FB is interrupted. The error code is stored in `o_uErrId` (Error code). For details of the error code, refer to MELSEC iQ-F FX5 User's Manual (Communication).
- If an error occurs in the ROBO Cylinder and this FB receives an error code, `o_bUnitErr` (Module error completion) turns on and the processing of the FB is interrupted. The received error code is stored in `o_uUnitErrId` (Module error code). For details of the error code, refer to the manuals described in "RELEVANT MANUALS".
- If any other error occurs, `o_bErr` (Error completion) turns on and the processing of the FB is interrupted. For details of the error code, refer to Page 37 Error code.

Timing chart of I/O signals

■ Normal completion

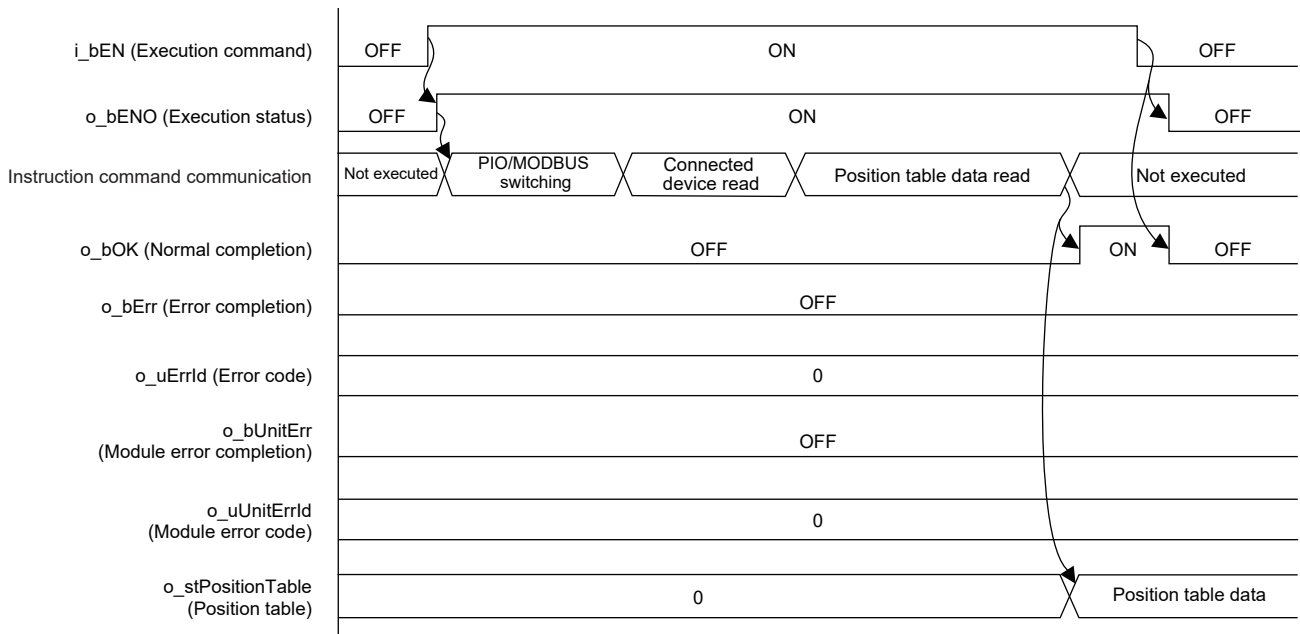

■ Error completion

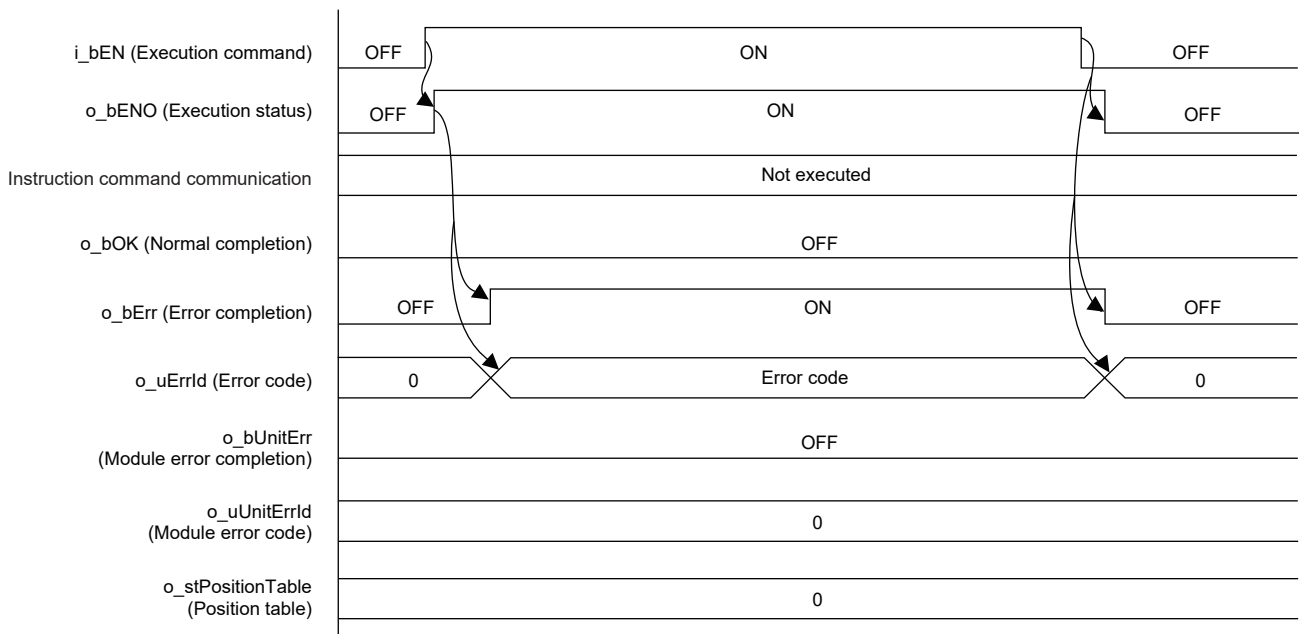

Restrictions and precautions

- This FB does not include error recovery processing. Program the error recovery processing separately in accordance with the required system operation.
- This FB cannot be used in an interrupt program.
- Using the FB in a program that is to be executed only once, such as a subroutine program or a FOR-NEXT loop, has a problem that i_bEN (Execution command) can no longer be turned off and normal operation is not possible; Always use the FB in a program that is capable of turning off the execution command.
- This FB requires the ladder to be configured for every input label.
- This FB uses the CPRTCL instruction. For details, refer to MELSEC iQ-F FX5 User's Manual (Communication).
- To operate the IAI ROBO Cylinder, set the protocol type to the predefined protocol support function with the module parameter of GX Works3. For details of the parameter settings, refer to Page 18 Parameter setting.

Parameter setting

For details of the parameter settings, refer to Page 18 Parameter setting.

Performance value

CPU	Measurement condition	Processing time	Maximum scan time	Number of scans
FX5U, FX5UC ^{*1*2}	Axis 1, position table No. 0	49.9 ms	0.933 ms	173 scans

*1 When the program capacity is set to 128K steps, the process speed may be decreased.

*2 The standard area is used for the labels.

Error code

Error code (hexadecimal)	Description	Action
101H	The setting value of i_uCh (Target CH) is out of range. The target channel is not within the range of 1 to 4.	Review and correct the setting and then execute the FB again.
102H	The setting value of i_uAxis (Target axis) is out of range. The target axis is not within the range of 1 to 16.	Review and correct the setting and then execute the FB again.
105H	The setting value of i_uTableNo (Position table No.) is out of range. The position table No. is not within the range of 0 to 999.	Review and correct the setting and then execute the FB again.
200H	An unsupported device is connected.	Review and correct the connected device and then execute the FB again.
201H	The execution command has turned off during the processing.	Keep the ON state of the execution command until the normal completion, error completion, or module error completion turns on. ^{*1}
Predefined protocol error code	This error code occurs during communication.	Refer to MELSEC iQ-F FX5 User's Manual (Serial Communication)/7.9 Troubleshooting/Checking absence/presence of errors).

*1 It is output only during one scan.

2.5 M+IAISetPositioningTable_F (Position Table Setting)

Overview

This FB writes the position table information to the specified position table No. of the IAI ROBO Cylinder.

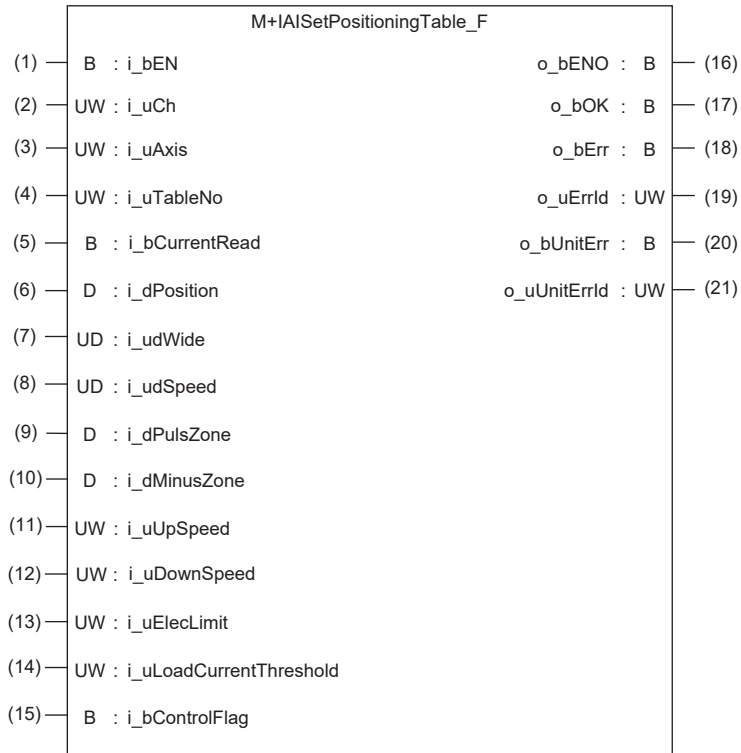

Label

Input label

No.	Label	Label name	Data type	Setting range	Description
(1)	i_bEN	Execution command	Bit	ON, OFF	ON: The FB is activated. OFF: The FB is not activated.
(2)	i_uCh	Target CH	Word [Unsigned]/Bit string [16-bit]	1 to 4	Specify the channel number. 1: Built-in RS485 port 2: FX5-485-BD, FX5-232-BD 3, 4: FX5-485ADP, FX5-232ADP
(3)	i_uAxis	Target axis	Word [Unsigned]/Bit string [16-bit]	1 to 16	Specify the axis number set in the ROBO Cylinder incremented by one.*1 Example: When setting 0 for the axis number of the ROBO Cylinder, set 1 in i_uAxis (Target axis).
(4)	i_uTableNo	Position table No.	Word [Unsigned]/Bit string [16-bit]	0 to 999	Specify the table No. to which the setting value is written.
(5)	i_bCurrentRead	Current position read	Bit	ON, OFF	ON: The current position of the ROBO Cylinder is set as the target position. OFF: Each setting value is written to the ROBO Cylinder.
(6)	i_dPosition	Target position	Double word [Signed]	-999999 to 999999	Specify the positioning target position.*2
(7)	i_udWide	Positioning width	Double word [Unsigned]/Bit string [32-bit]	1 to 999999	When the control flag is specified by the normal operation, specify the allowable difference between the target position used for detecting the operation completion and the current position. When the control flag is specified by the push operation, specify the push width.*2
(8)	i_udSpeed	Speed	Double word [Unsigned]/Bit string [32-bit]	1 to 999999	Specify the movement speed.*3

No.	Label	Label name	Data type	Setting range	Description
(9)	i_dPulsZone	Individual zone boundary plus side	Double word [Signed]	-999999 to 999999	Specify the plus side boundary value of the current position.*2
(10)	i_dMinusZone	Individual zone boundary minus side	Double word [Signed]	-999999 to 999999	Specify the minus side boundary value of the current position.*2
(11)	i_uUpSpeed	Acceleration	Word [Unsigned]/Bit string [16-bit]	1 to 300	Specify the acceleration when the position moves.*4
(12)	i_uDownSpeed	Deceleration	Word [Unsigned]/Bit string [16-bit]	1 to 300	Specify the deceleration when the position moves.*4
(13)	i_uElecLimit	Current limit value when pushed	Word [Unsigned]/Bit string [16-bit]	• 0033H to 00B3H • 0033H to 01FEH	Specify the current limit value when the push operation is performed.*5*6
(14)	i_uLoadCurrentThreshold	Load current threshold value	Word [Unsigned]/Bit string [16-bit]	• 0033H to 00B3H • 0033H to 01FEH	Specify the current threshold value. The setting range is the same as that of the current limit value when pushed.*6 Specify 0 when not making a judgment.
(15)	i_bControlFlag	Control flag specification	Bit	ON, OFF	ON: The push operation is specified. OFF: The normal operation is specified.

*1 The axis number corresponds to the slave station number of MODBUS.

*2 The unit is 0.01 mm.

*3 The unit is 0.01 mm/s.

*4 The unit is 0.01 G.

*5 The setting range differs depending on the actuator. For actuators other than the RCS2-RA13R, specify the value in the range of 0033H to 00B3H. For the RCS2-RA13R, specify the value in the range of 0033H to 01FEH.

*6 When it is set for A [%] of the output, the setting value is calculated by the following formula: $255 \times A + 100$ (digits after the decimal point are rounded off).

Output label

No.	Label	Label name	Data type	Default value	Description
(16)	o_bENO	Execution status	Bit	ON, OFF	ON: The FB is activated. OFF: The FB is not activated.
(17)	o_bOK	Normal completion	Bit	OFF	When this label is on, it indicates that the position table information setting has been completed.
(18)	o_bErr	Error completion	Bit	OFF	When this label is on, it indicates that an error has occurred in the FB.
(19)	o_uErrId	Error code	Word [Unsigned]/Bit string [16-bit]	0	The error code that occurred in the FB is stored.
(20)	o_bUnitErr	Module error flag	Bit	OFF	When this label is on, it indicates that an error has occurred in the module.
(21)	o_uUnitErrId	Module error code	Word [Unsigned]/Bit string [16-bit]	0	The error code that occurred in the module is stored.

Function overview

Applicable hardware and software



■Predefined Protocol Support FB For Positioning

Applicable module	Firmware version	Engineering tool
FX5U CPU	1.200 or later	GX Works3 Version 1.060N or later
FX5UC CPU	1.200 or later	GX Works3 Version 1.060N or later

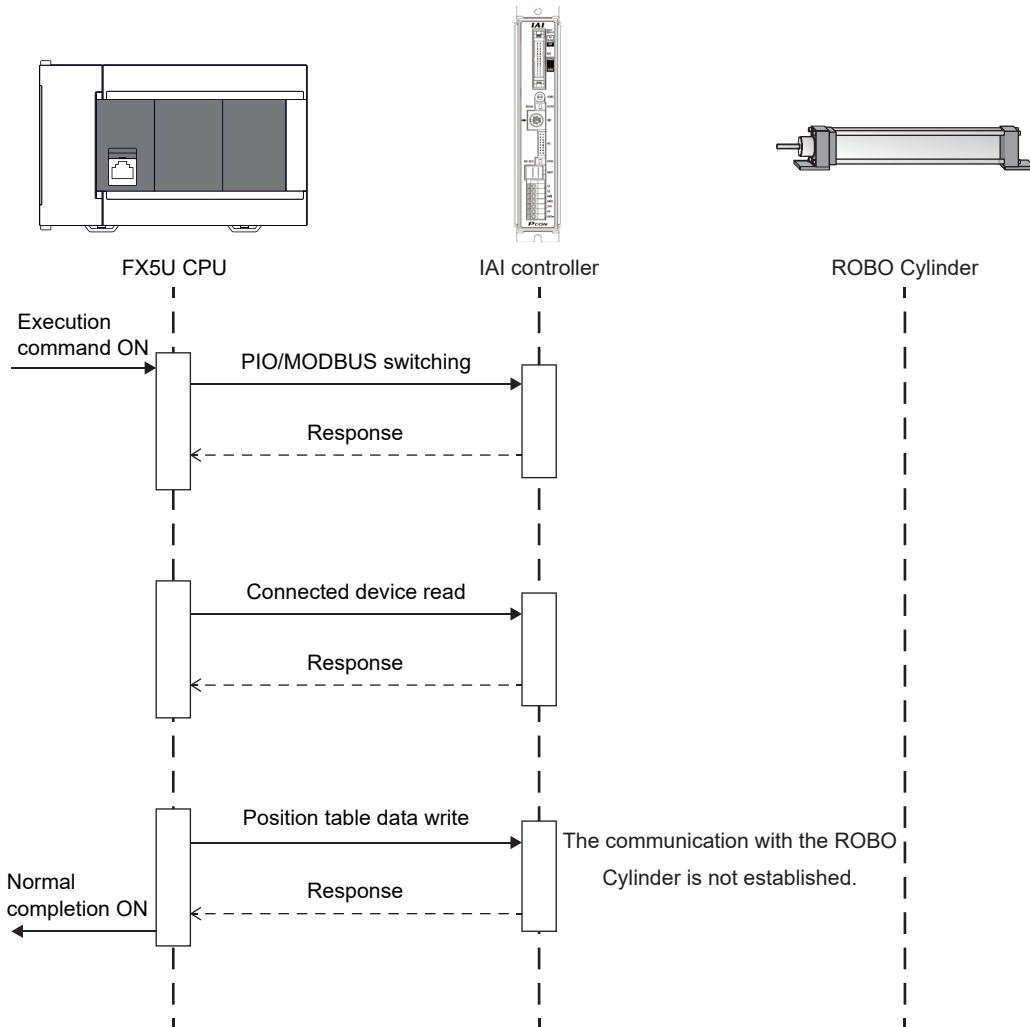

Sequence diagram



Basic specifications

Item	Description
Programming language	- (The program in this FB is not open to the public.)
Number of steps	2722 steps The number of steps of the FB in a program depends on the CPU module used, input and output definition, and option settings of GX Works3. For the option settings of GX Works3, refer to  GX Works3 Operating Manual (2.9 Option Setting for Each Function).
Label amount used	<ul style="list-style-type: none"> • Label: 0.05K points (Word) • Latch label: 0K points (Word) The label amount used in a program depends on the CPU module used, device specified in the argument, and option settings of GX Works3. For the option settings of GX Works3, refer to  GX Works3 Operating Manual (2.9 Option Setting for Each Function).
Number of index register points used	<ul style="list-style-type: none"> • Index register: 0 points • Long index register: 0 points
File register amount used	File register: 2336 points (Word) (R0 to R2335)
FB dependence	No dependence
FB compiling method	Macro type
FB operation type	Pulsed execution (multiple scan execution type)

Function description

- By turning on i_bEN (Execution command), PIO and MODBUS are switched, the MODBUS communication is performed, and the control of the IAI ROBO Cylinder is enabled from this FB.
- By turning on i_bEN (Execution command), this FB writes the settings of the position table information for the IAI ROBO Cylinder to the specified position table No. For details of the position table information, refer to  PC Software RCM-101-MW, RCM-101-USB Operation Manual.
- When i_bCurrentRead (Current value read) is on, set the current position as the target position.
- If an error occurs while sending/receiving a message to/from the IAI ROBO Cylinder, o_bUnitErr (Module error flag) turns on and an error code is stored in o_uUnitErrId (Module error code). For details of the error code, refer to the manuals described in "RELEVANT MANUALS".
- If any other error occurs, o_bErr (Error completion) turns on and the processing of the FB is interrupted. For details of the error code, refer to  Page 44 Error code.

Timing chart of I/O signals

■ Normal completion

- When the current position read is off

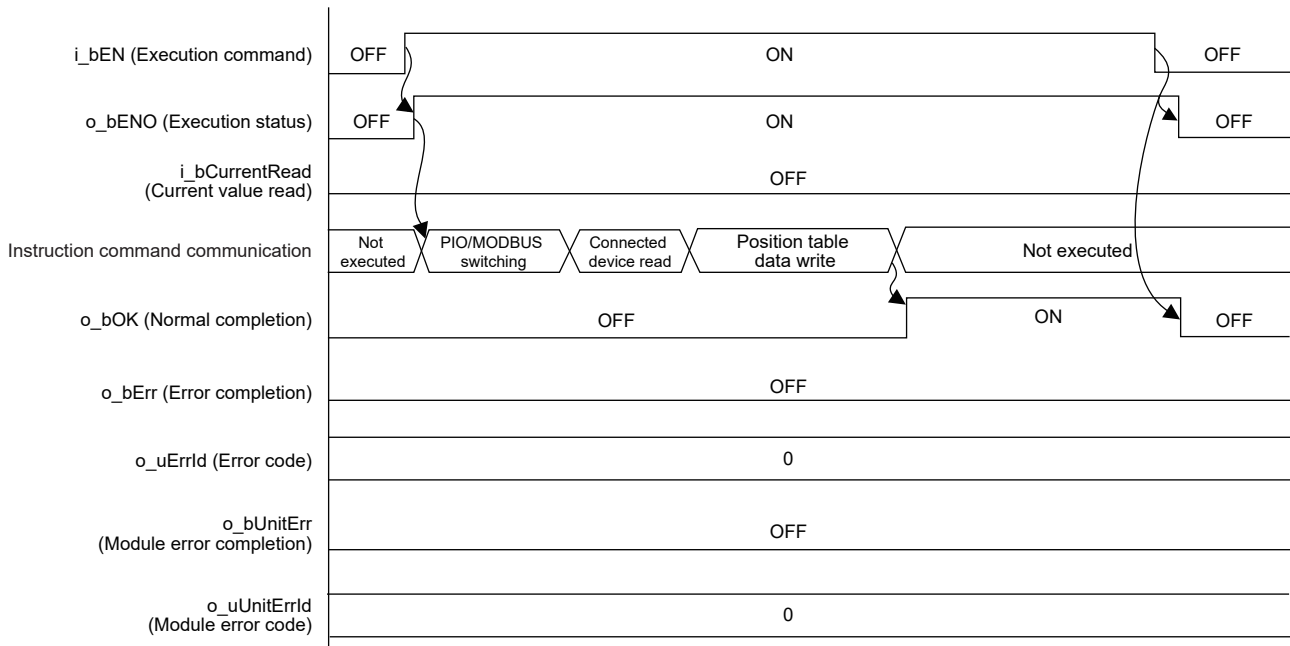

- When the current position read is on

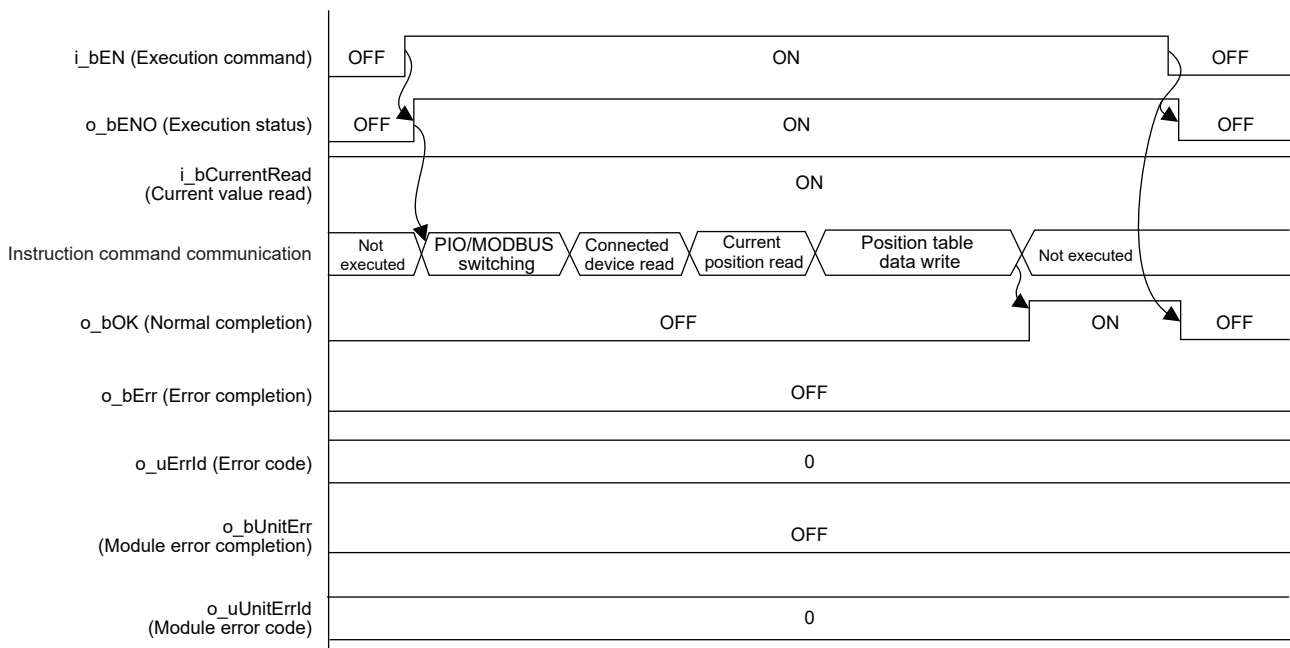

■ Error completion

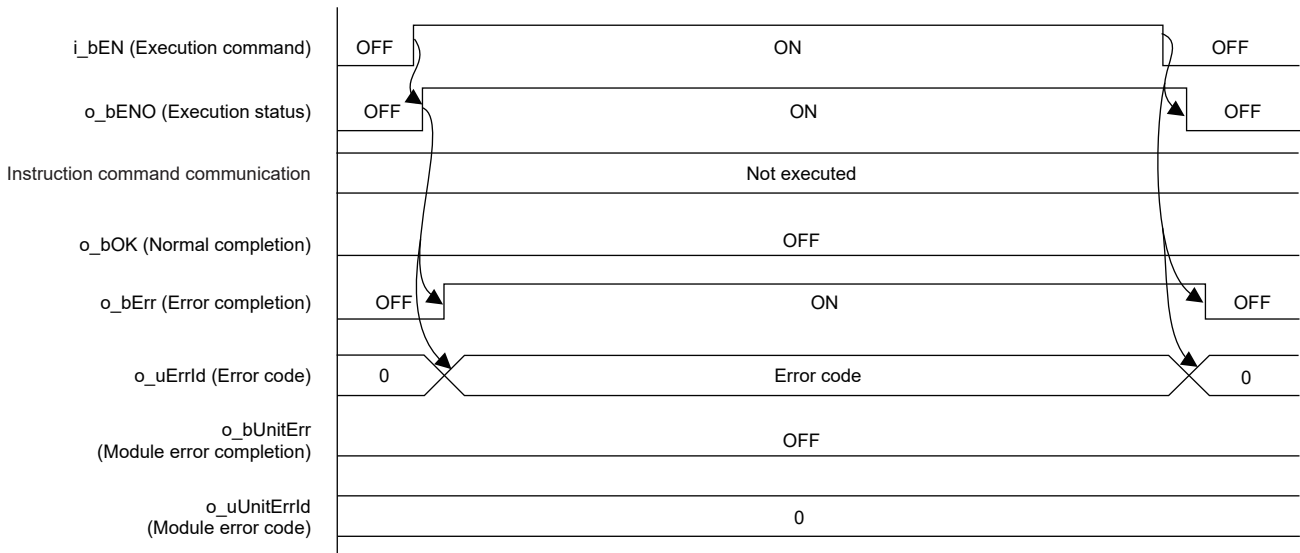

Restrictions and precautions

- This FB does not include error recovery processing. Program the error recovery processing separately in accordance with the required system operation.
- This FB uses the CPRTCL instruction.
- This FB cannot be used in an interrupt program.
- Using the FB in a program that is to be executed only once, such as a subroutine program or a FOR-NEXT loop, has a problem that i_bEN (Execution command) can no longer be turned off and normal operation is not possible; Always use the FB in a program that is capable of turning off the execution command.
- A duplicated coil warning may occur during conversion or total conversion. However, this is not a problem and the FB will operate without an error.

Parameter setting

For details of the parameter settings, refer to  Page 18 Parameter setting.

Application example

For details of the application example, refer to  Page 62 FB LIBRARY USE PROCEDURE.

Performance value

CPU	Measurement condition ^{*3*4}		Processing time ^{*5}	Maximum scan time	Number of scans
FX5U, FX5UC ^{*1*2}	Current position read: ON	Axis 1, table No. 0	80.8 ms	1.020 ms	274 scans
	Current position read: OFF	Axis 1, table No. 0	66.7 ms	0.901 ms	229 scans

*1 When the program capacity is set to 128K steps, the process speed may be decreased.

*2 The standard area is used for the labels.

*3 The position table data is as follows. The current position at the start of the measurement is 0 when the current position read is off and 1000 when the current position read is on.

Target position	Positioning width	Speed	Individual zone boundary plus side	Individual zone boundary minus side	Acceleration	Deceleration	Pushed current limit value	Load current threshold value	Control flag specification
1000	50	500	2000	2000	100	100	0	0	OFF

*4 When the current position read is on, perform the positioning operation in advance so that the current position becomes 1000.

*5 The processing time is the period from the execution command is turned on until the normal completion turns on.

Error code

Error code (hexadecimal)	Description	Action
100H	The setting value of i_uAxis (Target axis) is out of range. The target axis is not within the range of 1 to 16.	Review and correct the setting and then execute the FB again.
101H	The setting value of i_uPointNo (Point No.) is out of range. The point No. is not within the range of 0 to 999.	Review and correct the setting and then execute the FB again.
102H	An unsupported device is connected.	Review and correct the connected device and then execute the FB again.
103H	The setting value of i_uCh (Target CH) is out of range. The target channel is not within the range of 1 to 4.	Review and correct the setting and then execute the FB again.
Module error code	This error code occurs in the module.	Refer to  MELSEC iQ-F FX5 User's Manual (Communication).

Version upgrade history

Version	Date	Description
00A	December 2019	First edition
01A	October 2020	i_bControlFlag (Control flag specification) has been changed so that the other control flags are retained. ^{*1}

*1 Upgrade the FB in the program to the latest version as necessary. (The version is not automatically upgraded.)

2.6 M+IAIStartPositioning_F (Positioning Operation)

Overview

This FB sets the PIO/MODBUS switching to the MODBUS communication and starts the positioning operation.

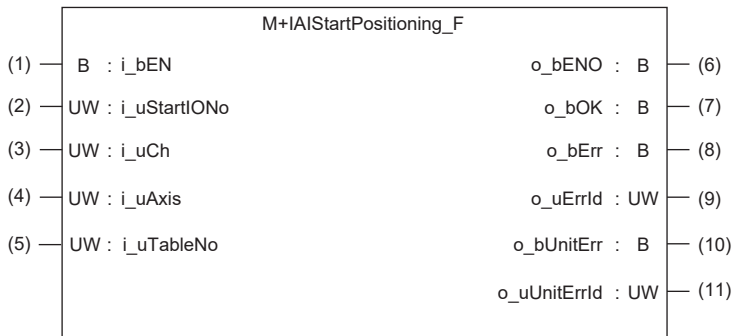

Label

Input label

No.	Label	Label name	Data type	Setting range	Description
(1)	i_bEN	Execution command	Bit	ON, OFF	ON: The FB is activated. OFF: The FB is not activated.
(2)	i_uStartIONo	Start I/O No.	Word [Unsigned]/Bit string [16-bit]	—	Setting this label is not required since it is not used in the program in this FB.
(3)	i_uCh	Target CH	Word [Unsigned]/Bit string [16-bit]	1 to 4	Specify the channel number. 1: Built-in RS485 port 2: FX5-485-BD, FX5-232-BD 3, 4: FX5-485ADP, FX5-232ADP
(4)	i_uAxis	Target axis	Word [Unsigned]/Bit string [16-bit]	1 to 16	Specify the axis number set in the ROBO Cylinder incremented by one. ^{*1} Example: When setting 0 for the axis number of the ROBO Cylinder, set 1 in i_uAxis (Target axis).
(5)	i_uTableNo	Position table No.	Word [Unsigned]/Bit string [16-bit]	0 to 999	Specify the positioning table No. that performs the positioning operation.

*1 The axis number corresponds to the slave station number of MODBUS.

Output label

No.	Label	Label name	Data type	Default value	Description
(6)	o_bENO	Execution status	Bit	OFF	ON: The execution command is on. OFF: The execution command is off.
(7)	o_bOK	Normal completion	Bit	OFF	When this label is on, it indicates that the positioning operation has been completed.
(8)	o_bErr	Error completion	Bit	OFF	When this label is on, it indicates that an error has occurred in the FB.
(9)	o_uErrId	Error code	Word [Unsigned]/Bit string [16-bit]	0	The error code that occurred in the FB is stored.
(10)	o_bUnitErr	Module error completion	Bit	OFF	When this label is on, it indicates that an error has occurred in the module.
(11)	o_uUnitErrId	Module error code	Word [Unsigned]/Bit string [16-bit]	0	The error code that occurred in the module is stored.

Function overview

Applicable hardware and software

■Predefined Protocol Support FB For Positioning

Applicable module	Firmware version	Engineering tool
FX5U CPU	1.200 or later	GX Works3 Version 1.060N or later
FX5UC CPU	1.200 or later	GX Works3 Version 1.060N or later

Sequence diagram

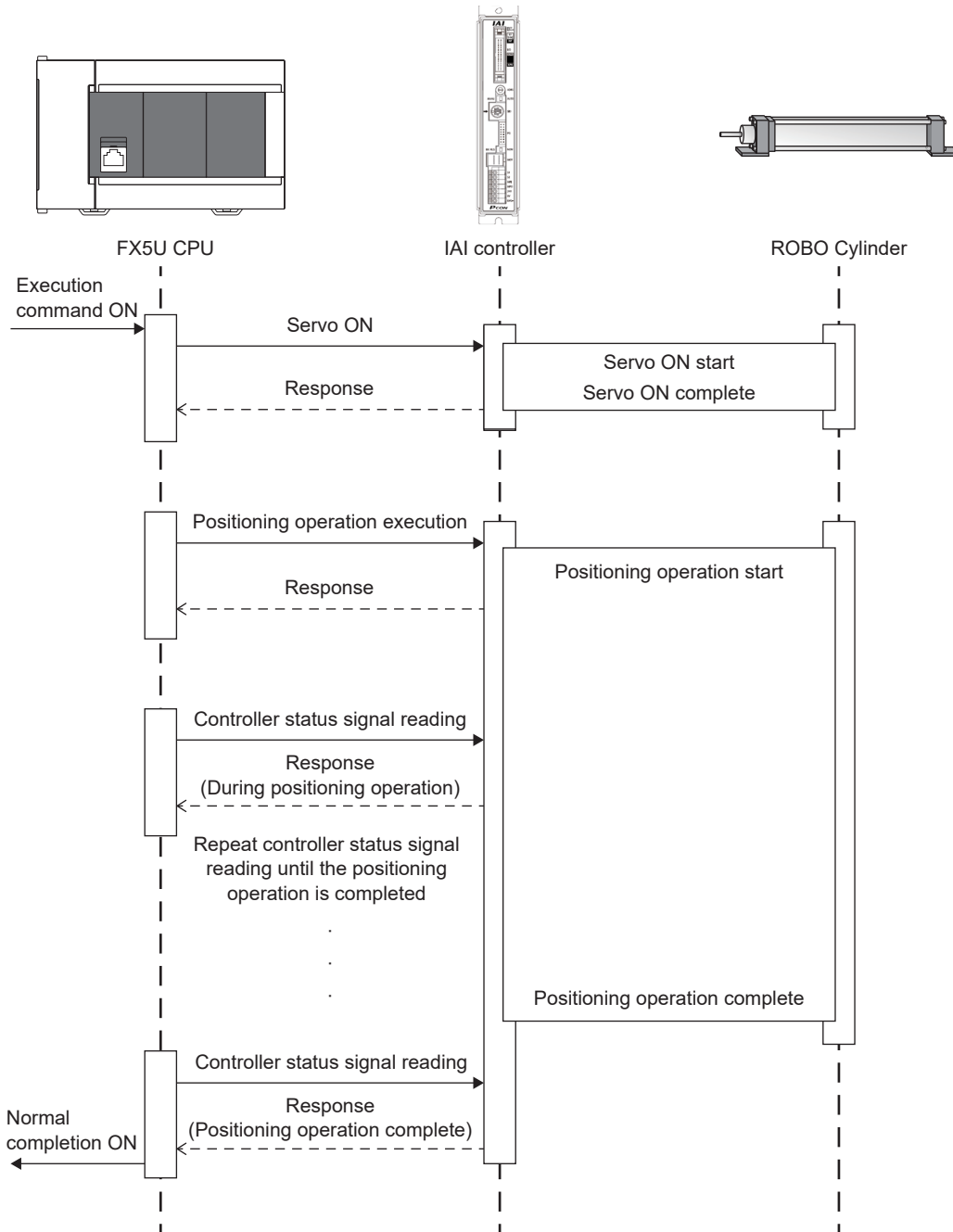

Basic specifications

Item	Description
Programming language	- (The program in this FB is not open to the public.)
Number of steps	7777 steps The number of steps of the FB in a program depends on the CPU module used, input and output definition, and option settings of GX Works3. For the option settings of GX Works3, refer to GX Works3 Operating Manual (2.9 Option Setting for Each Function).
Label amount used	<ul style="list-style-type: none"> • Label: 0.07K points (Word) • Latch label: 0K points (Word) The label amount used in a program depends on the CPU module used, device specified in the argument, and option settings of GX Works3. For the option settings of GX Works3, refer to GX Works3 Operating Manual (2.9 Option Setting for Each Function).
Number of index register points used	<ul style="list-style-type: none"> • Index register: 0 points • Long index register: 0 points
File register amount used	File register: 2336 points (Word) (R0 to R2335)
FB dependence	M+IAIStartPositioning_F LM+IAIServoControl_F
FB compiling method	Subroutine type
FB operation type	Pulsed execution (multiple scan execution type)

Function description

- Set the axis number of the operation target in `i_uAxis` (Target axis).
- Set the position table No. to be executed in `i_uTableNo` (Position table No.).
- At rising edge of `i_bEN` (Execution command), this FB sets the PIO/MODBUS switching to the MODBUS communication and starts the positioning operation.
- `o_bOK` (Normal completion) turns on when the positioning operation is completed.
- When this FB is executed, the servo is automatically turned on.
- If an error occurs while sending/receiving a communication protocol, `o_bErr` (Error completion) turns on and the processing of the FB is interrupted. The error code is stored in `o_uErrId` (Error code). For details of the error code, refer to MELSEC iQ-F FX5 User's Manual (Communication).
- If an error occurs in the ROBO Cylinder and this FB receives an error code, `o_bUnitErr` (Module error completion) turns on and the processing of the FB is interrupted. The received error code is stored in `o_uUnitErrId` (Module error code). For details of the error code, refer to the manuals described in "RELEVANT MANUALS".
- If any other error occurs, `o_bErr` (Error completion) turns on and the processing of the FB is interrupted. For details of the error code, refer to Page 50 Error code.

Timing chart of I/O signals

■ Normal completion

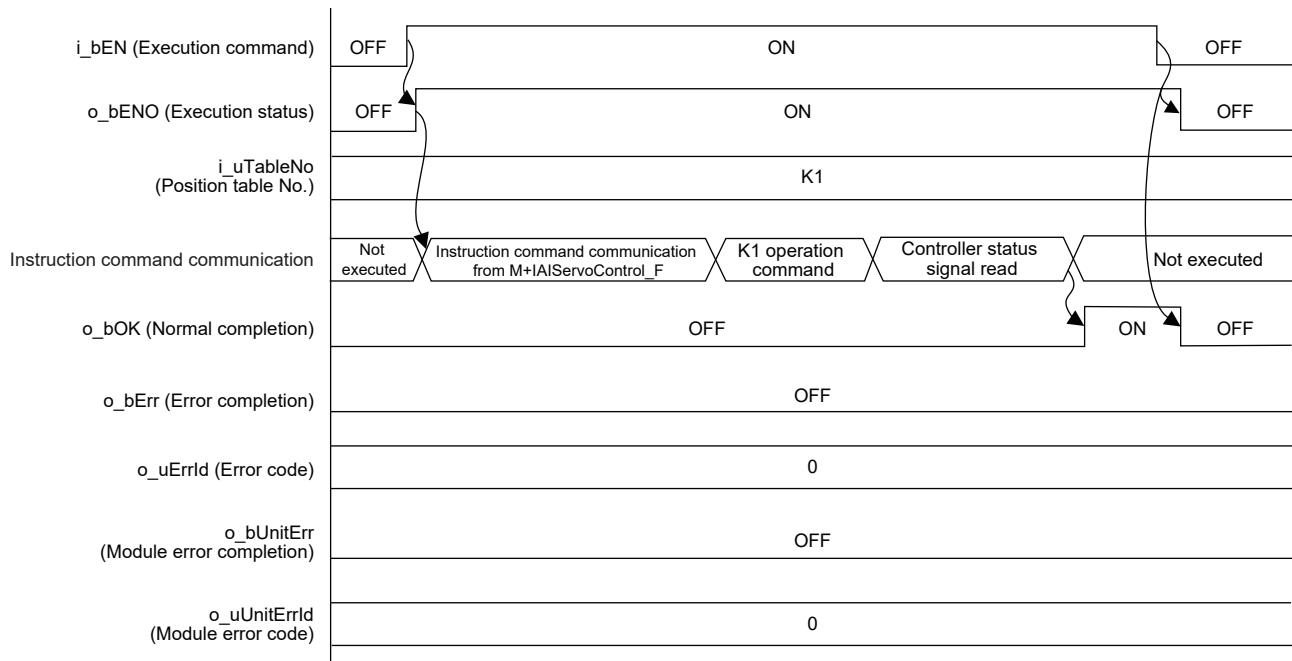

■ Error completion

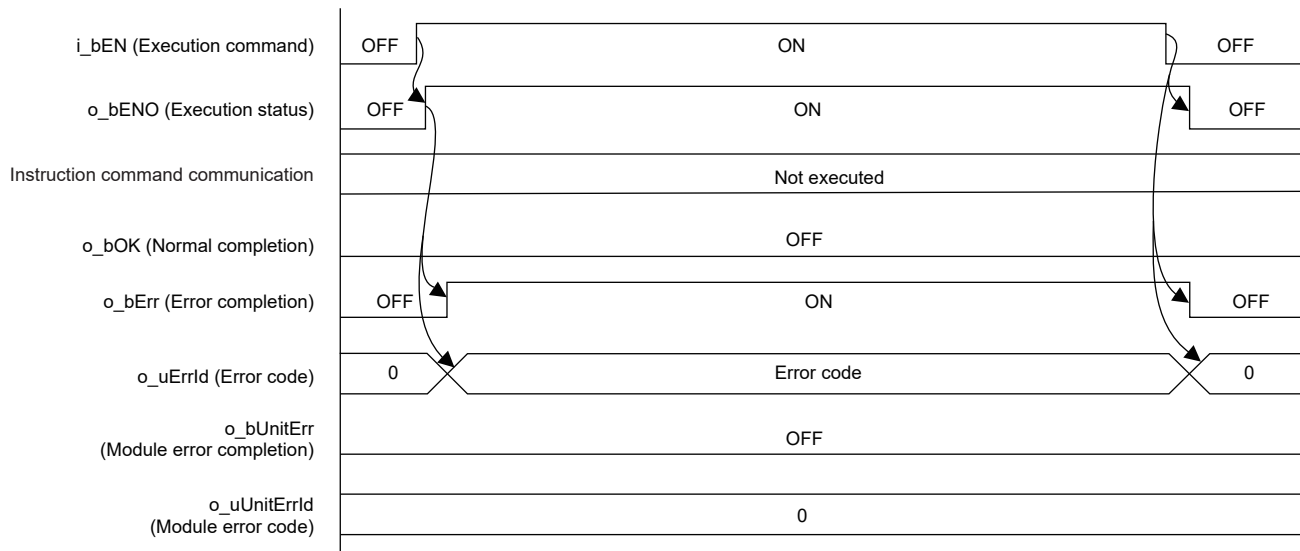

Restrictions and precautions

- The completion of the positioning operation or push operation is determined by the ON state of the positioning completion status (Device status 1 bit 3). For details, refer to PCON, ACON, SCON, RCP6 (PLC Unit) ERC2, ERC3 Serial Communication [Modbus Version] Operation Manual.
- This FB does not include error recovery processing. Program the error recovery processing separately in accordance with the required system operation.
- This FB cannot be used in an interrupt program.
- Using the FB in a program that is to be executed only once, such as a subroutine program or a FOR-NEXT loop, has a problem that i_bEN (Execution command) can no longer be turned off and normal operation is not possible; Always use the FB in a program that is capable of turning off the execution command.
- This FB requires the ladder to be configured for every input label.
- Set the memory/device setting in the CPU parameter so that the capacity required for using this FB is reserved. Otherwise, an error may occur in GX Works3.
- In this FB, if i_bEN (Execution command) is turned off after the positioning operation is started and before o_bOK (Normal completion), o_bErr (Error completion), or o_bUnitErr (Module error completion) turns on, the operation of the cylinder does not stop until the positioning operation is completed.
- This FB uses the CPRTCL instruction. For details, refer to MELSEC iQ-F FX5 User's Manual (Communication).
- To operate the IAI ROBO Cylinder, set the protocol type to the predefined protocol support function with the module parameter of GX Works3. For details of the parameter settings, refer to Page 18 Parameter setting.

Parameter setting

For details of the parameter settings, refer to Page 18 Parameter setting.

Application example

For details of the application example, refer to Page 62 FB LIBRARY USE PROCEDURE.

Performance value

CPU	Measurement condition ^{*3}	Processing time	Maximum scan time	Number of scans
FX5U, FX5UC ^{*1*2}	Axis 1, position table No. 0	2130 ms	1.24 ms	5126 scans

*1 When the program capacity is set to 128K steps, the process speed may be decreased.

*2 The standard area is used for the labels.

*3 The position table data is as follows. The current position at the start of the measurement is 0.

Target position	Positioning width	Speed	Individual zone boundary plus side	Individual zone boundary minus side	Acceleration	Deceleration	Pushed current limit value	Load current threshold value	Control flag specification
1000	50	500	2000	2000	100	100	0	0	OFF

Error code

Error code (hexadecimal)	Description	Action
101H	The setting value of i_uCh (Target CH) is out of range. The target channel is not within the range of 1 to 4.	Review and correct the setting and then execute the FB again.
102H	The setting value of i_uAxis (Target axis) is out of range. The target axis is not within the range of 1 to 16.	Review and correct the setting and then execute the FB again.
105H	The setting value of i_uTableNo (Position table No.) is out of range. The position table No. is not within the range of 0 to 999.	Review and correct the setting and then execute the FB again.
200H	An unsupported device is connected.	Review and correct the connected device and then execute the FB again.
201H	The execution command has turned off during the processing.	Keep the ON state of the execution command until the normal completion, error completion, or module error completion turns on.*1
203H	The controller is in the emergency stop state or a major failure has occurred.	Check the status of the controller using M+IAIMonitoring_F. After checking the status, eliminate the error cause and then execute the FB again.
Predefined protocol error code	This error code occurs during communication.	Refer to  MELSEC iQ-F FX5 User's Manual (Communication).

*1 It is output only during one scan.

2.7 M+IAIMonitoring_F (Operation Monitor)

Overview

This FB sets the PIO/MODBUS switching to the MODBUS communication and starts monitoring the target axis of the IAI ROBO Cylinder.

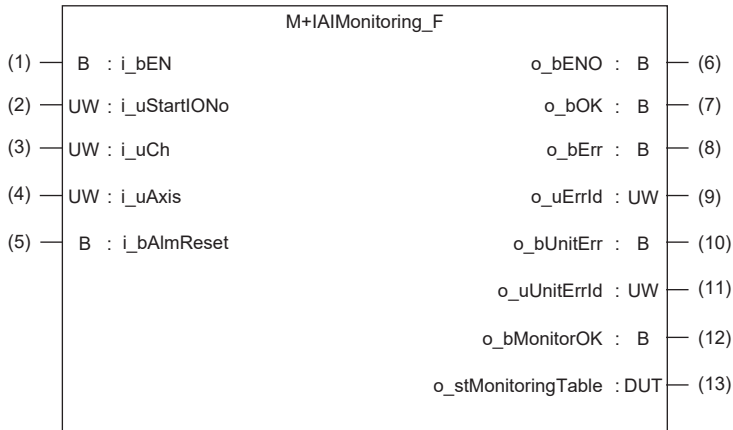

Label

Input label

No.	Label	Label name	Data type	Setting range	Description
(1)	i_bEN	Execution command	Bit	ON, OFF	ON: The FB is activated. OFF: The FB is not activated.
(2)	i_uStartIONo	Start I/O No.	Word [Unsigned]/Bit string [16-bit]	—	Setting this label is not required since it is not used in the program in this FB.
(3)	i_uCh	Target CH	Word [Unsigned]/Bit string [16-bit]	1 to 4	Specify the channel number. 1: Built-in RS485 port 2: FX5-485-BD, FX5-232-BD 3, 4: FX5-485ADP, FX5-232ADP
(4)	i_uAxis	Target axis	Word [Unsigned]/Bit string [16-bit]	1 to 16	Specify the axis number set in the ROBO Cylinder incremented by one.*1 Example: When setting 0 for the axis number of the ROBO Cylinder, set 1 in i_uAxis (Target axis).
(5)	i_bAlmReset	Alarm reset	Bit	ON, OFF	ON: The alarm is reset. OFF: No operation is performed.

*1 The axis number corresponds to the slave station number of MODBUS.

Output label

No.	Label	Label name	Data type	Default value	Description
(6)	o_bENO	Execution status	Bit	OFF	ON: The execution command is on. OFF: The execution command is off.
(7)	o_bOK	Normal completion	Bit	OFF	When this label is on, it indicates that the alarm has been cleared without error.
(8)	o_bErr	Error completion	Bit	OFF	When this label is on, it indicates that an error has occurred in the FB.
(9)	o_uErrId	Error code	Word [Unsigned]/Bit string [16-bit]	0	The error code that occurred in the FB is stored.
(10)	o_bUnitErr	Module error completion	Bit	OFF	When this label is on, it indicates that an error has occurred in the module.
(11)	o_uUnitErrId	Module error code	Word [Unsigned]/Bit string [16-bit]	0	The error code that occurred in the module is stored.
(12)	o_bMonitorOK	Monitoring status	Bit	OFF	When this label is on, it indicates that the operation is being monitored without error.

No.	Label	Label name	Data type	Default value	Description
(13)	o_stMonitoringTable	Monitor table	Structure	—	The monitor table information is stored. For details of the structure, refer to  Page 11 Monitor table.

Function overview

Applicable hardware and software

■Predefined Protocol Support FB For Positioning

Applicable module	Firmware version	Engineering tool
FX5U CPU	1.200 or later	GX Works3 Version 1.060N or later
FX5UC CPU	1.200 or later	GX Works3 Version 1.060N or later

Sequence diagram

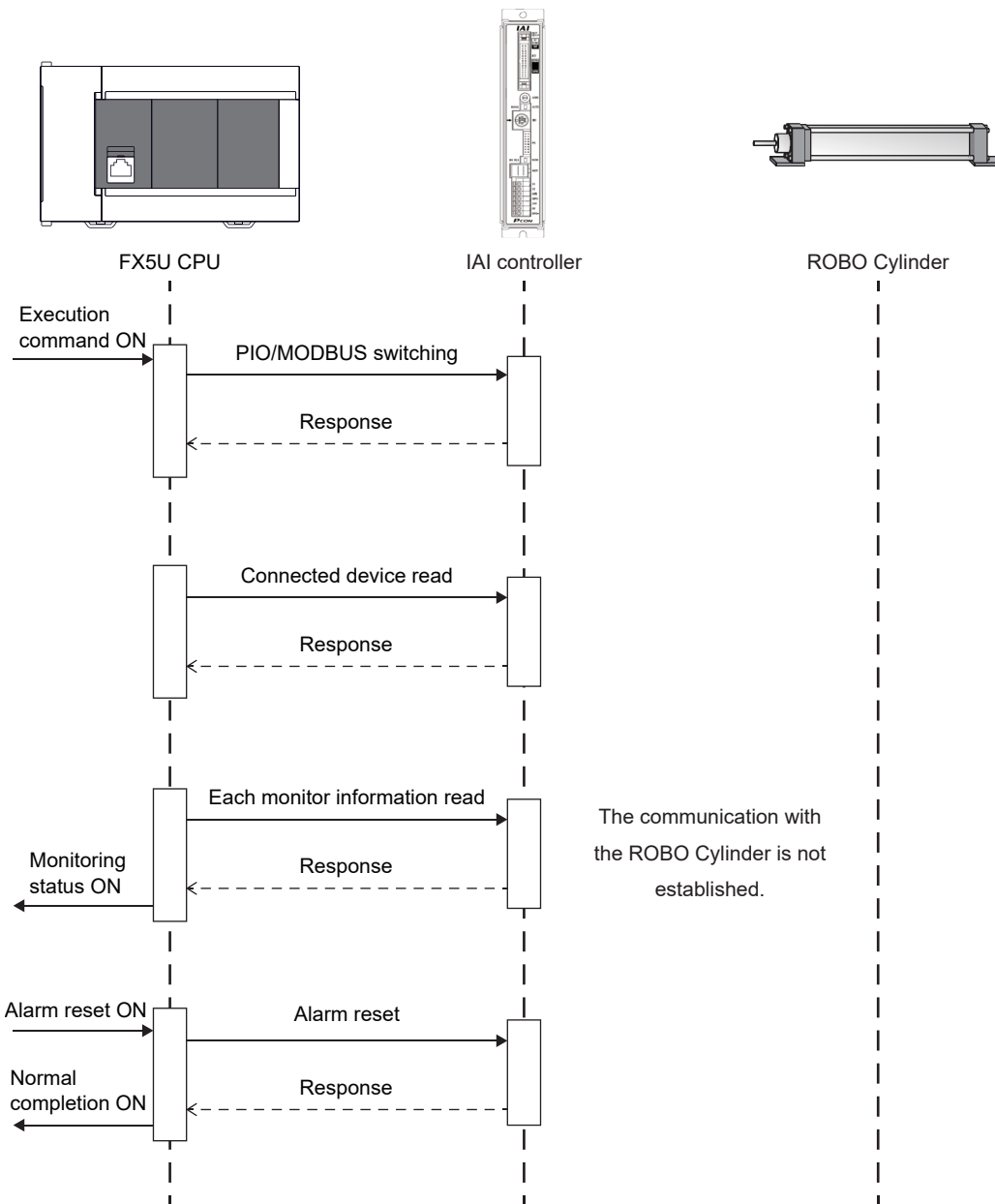

Basic specifications

Item	Description
Programming language	- (The program in this FB is not open to the public.)
Number of steps	4739 steps The number of steps of the FB in a program depends on the CPU module used, input and output definition, and option settings of GX Works3. For the option settings of GX Works3, refer to GX Works3 Operating Manual (2.9 Option Setting for Each Function).
Label amount used	<ul style="list-style-type: none"> • Label: 0.06K points (Word) • Latch label: 0K points (Word) The label amount used in a program depends on the CPU module used, device specified in the argument, and option settings of GX Works3. For the option settings of GX Works3, refer to GX Works3 Operating Manual (2.9 Option Setting for Each Function).
Number of index register points used	<ul style="list-style-type: none"> • Index register: 0 points • Long index register: 0 points
File register amount used	File register: 2336 points (Word) (R0 to R2335)
FB dependence	No dependence
FB compiling method	Subroutine type
FB operation type	Real-time execution

Function description

- Set the axis number of the operation target in `i_uAxis` (Target axis).
- At rising edge of `i_bEN` (Execution command), this FB sets the PIO/MODBUS switching to the MODBUS communication and starts monitoring the target axis of the IAI ROBO Cylinder. The monitoring data (such as the current position and alarm code) is stored in `o_stMonitoringTable` (Monitor table).
- While the target axis is being monitored, `o_bMonitorOK` (Monitoring status) is on.
- After `i_bEN` (Execution command) is turned on, the alarm is reset by turning on `i_bAlmReset` (Alarm reset command) while the alarm is occurring.
- `o_bOK` (Normal completion) turns on when the alarm reset is completed.
- If an error occurs while sending/receiving a communication protocol, `o_bErr` (Error completion) turns on and the processing of the FB is interrupted. The error code is stored in `o_uErrId` (Error code). For details of the error code, refer to MELSEC iQ-F FX5 User's Manual (Communication).
- If an error occurs in the ROBO Cylinder and this FB receives an error code, `o_bUnitErr` (Module error completion) turns on and the processing of the FB is interrupted. The received error code is stored in `o_uUnitErrId` (Module error code). For details of the error code, refer to the manuals described in "RELEVANT MANUALS".
- If any other error occurs, `o_bErr` (Error completion) turns on and the processing of the FB is interrupted. For details of the error code, refer to Page 55 Error code.

Timing chart of I/O signals

■ Normal completion

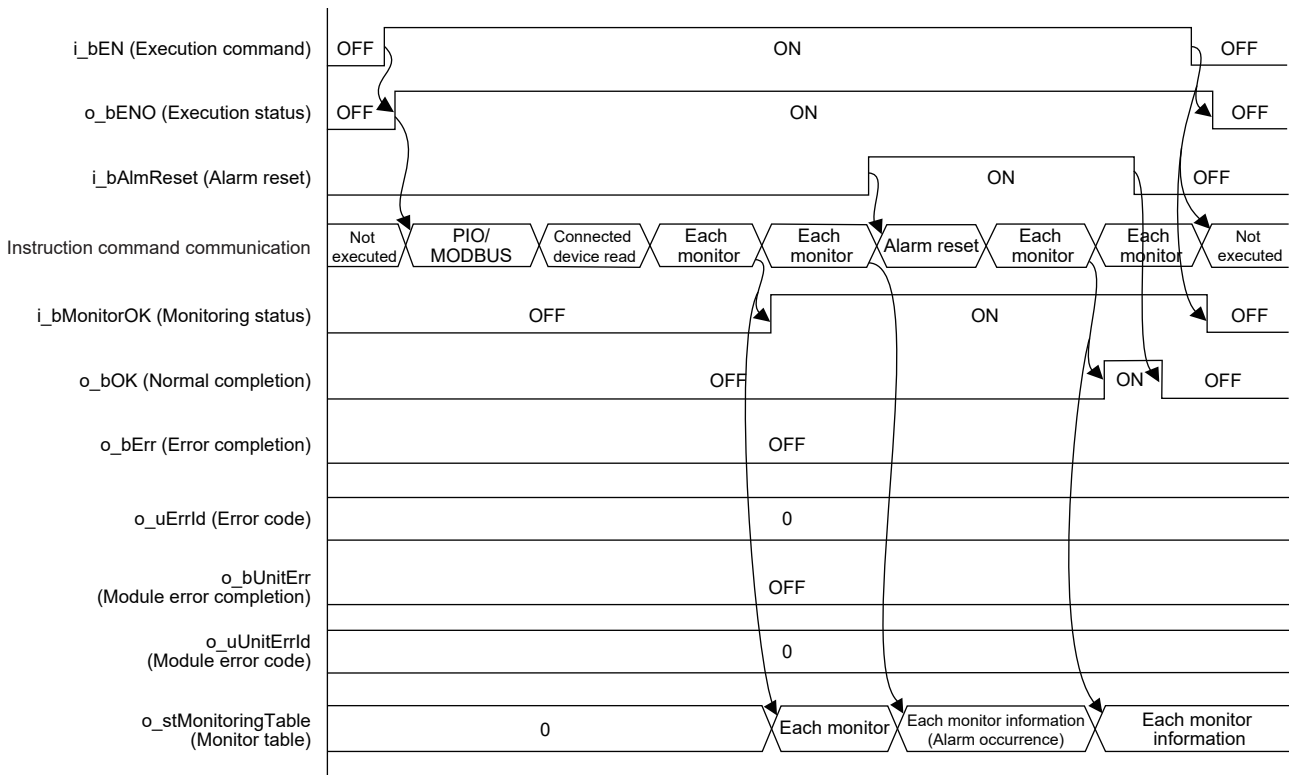

■ Error completion

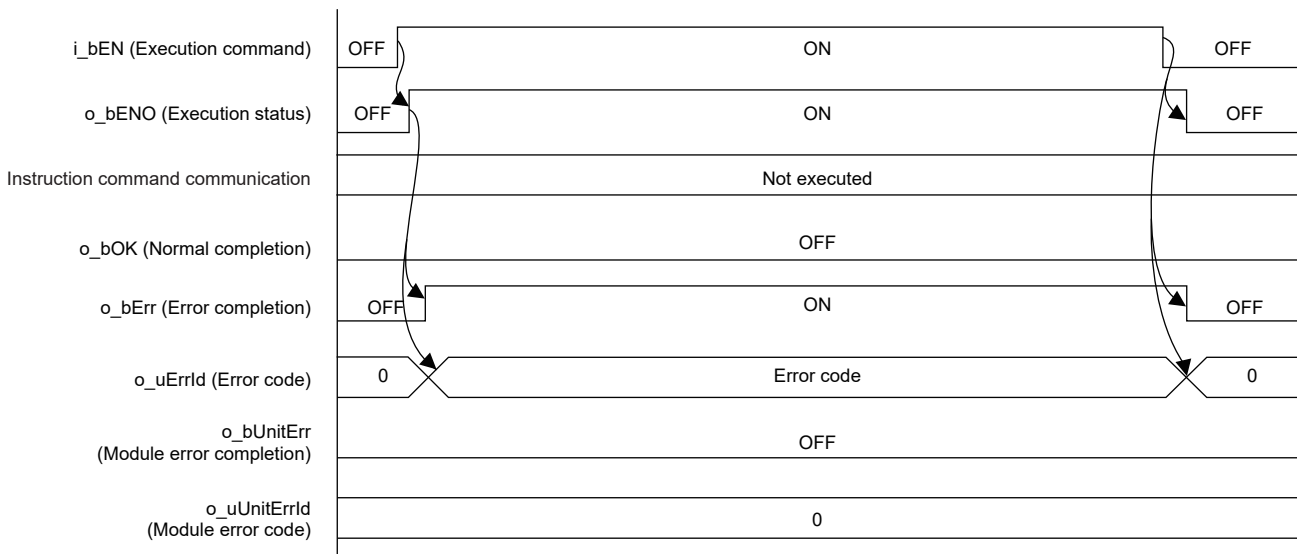

Restrictions and precautions

- This FB does not include error recovery processing. Program the error recovery processing separately in accordance with the required system operation.
- This FB cannot be used in an interrupt program.
- Using the FB in a program that is to be executed only once, such as a subroutine program or a FOR-NEXT loop, has a problem that i_bEN (Execution command) can no longer be turned off and normal operation is not possible; Always use the FB in a program that is capable of turning off the execution command.
- This FB requires the ladder to be configured for every input label.
- This FB uses the CPRTCL instruction. For details, refer to MELSEC iQ-F FX5 User's Manual (Communication).
- To operate the IAI ROBO Cylinder, set the protocol type to the predefined protocol support function with the module parameter of GX Works3. For details of the parameter settings, refer to Page 18 Parameter setting.

Parameter setting

For details of the parameter settings, refer to Page 18 Parameter setting.

Performance value

CPU	Measurement condition		Processing time	Maximum scan time	Number of scans
FX5U, FX5UC ^{*1*2}	Axis 1, CH1	From execution command ON to monitoring status ON	68.1 ms	1.30 ms	238 scans
		From alarm reset ON to normal completion	43.5 ms	1.36 ms	110 scans

*1 When the program capacity is set to 128K steps, the process speed may be decreased.

*2 The standard area is used for the labels.

Error code

Error code (hexadecimal)	Description	Action
101H	The setting value of i_uCh (Target CH) is out of range. The target channel is not within the range of 1 to 4.	Review and correct the setting and then execute the FB again.
102H	The setting value of i_uAxis (Target axis) is out of range. The target axis is not within the range of 1 to 16.	Review and correct the setting and then execute the FB again.
200H	An unsupported device is connected.	Review and correct the connected device and then execute the FB again.
201H	The execution command has turned off during the processing.	Keep the ON state of the execution command until the normal completion, error completion, or module error completion turns on.*1
Predefined protocol error code	This error code occurs during communication.	Refer to MELSEC iQ-F FX5 User's Manual (Communication).

*1 It is output only during one scan.

2.8 M+IAIServoControl_F (Servo ON/OFF)

Overview

This FB sets the PIO/MODBUS switching to the MODBUS communication and issues a servo ON request when i_bServo (Servo ON/OFF) is on or a servo OFF request when the label is off.

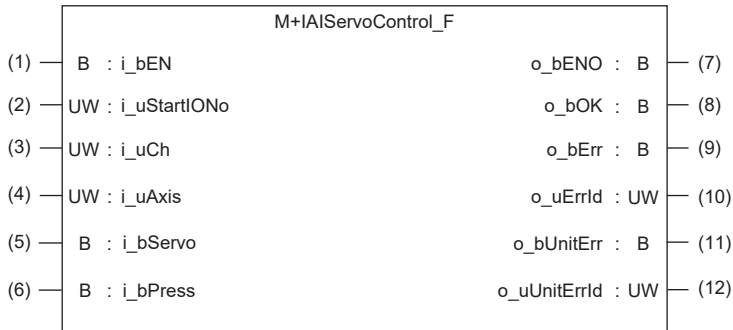

Label

Input label

No.	Label	Label name	Data type	Setting range	Description
(1)	i_bEN	Execution command	Bit	ON, OFF	ON: The FB is activated. OFF: The FB is not activated.
(2)	i_uStartIONo	Start I/O No.	Word [Unsigned]/Bit string [16-bit]	—	Setting this label is not required since it is not used in the program in this FB.
(3)	i_uCh	Target CH	Word [Unsigned]/Bit string [16-bit]	1 to 4	Specify the channel number. 1: Built-in RS485 port 2: FX5-485-BD, FX5-232-BD 3, 4: FX5-485ADP, FX5-232ADP
(4)	i_uAxis	Target axis	Word [Unsigned]/Bit string [16-bit]	1 to 16	Specify the axis number set in the ROBO Cylinder incremented by one.*1 Example: When setting 0 for the axis number of the ROBO Cylinder, set 1 in i_uAxis (Target axis).
(5)	i_bServo	Servo ON/OFF switching	Bit	ON, OFF	ON: Servo ON OFF: Servo OFF
(6)	i_bPress	Servo press ON/OFF switching	Bit	ON, OFF	ON: Servo press ON OFF: Servo press OFF

*1 The axis number corresponds to the slave station number of MODBUS.

Output label

No.	Label	Label name	Data type	Default value	Description
(7)	o_bENO	Execution status	Bit	OFF	ON: The execution command is on. OFF: The execution command is off.
(8)	o_bOK	Normal completion	Bit	OFF	When this label is on, it indicates that the servo ON/OFF (servo press ON/OFF) switching has been completed.
(9)	o_bErr	Error completion	Bit	OFF	When this label is on, it indicates that an error has occurred in the FB.
(10)	o_uErrId	Error code	Word [Unsigned]/Bit string [16-bit]	0	The error code that occurred in the FB is stored.
(11)	o_bUnitErr	Module error completion	Bit	OFF	When this label is on, it indicates that an error has occurred in the module.
(12)	o_uUnitErrId	Module error code	Word [Unsigned]/Bit string [16-bit]	0	The error code that occurred in the module is stored.

Function overview

Applicable hardware and software



■Predefined Protocol Support FB For Positioning

Applicable module	Firmware version	Engineering tool
FX5U CPU	1.200 or later	GX Works3 Version 1.060N or later
FX5UC CPU	1.200 or later	GX Works3 Version 1.060N or later

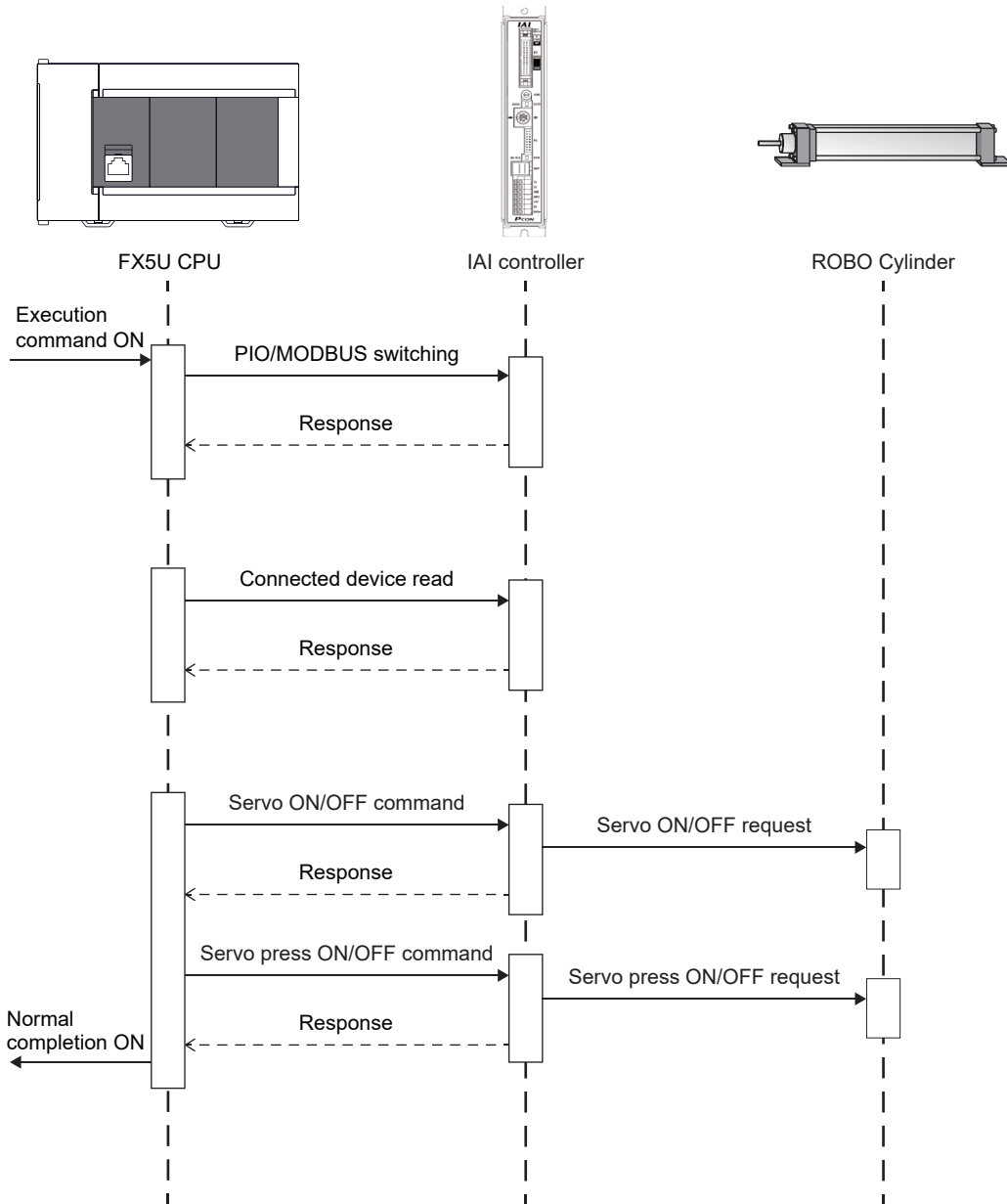

Sequence diagram



Basic specifications

Item	Description
Programming language	- (The program in this FB is not open to the public.)
Number of steps	3229 steps The number of steps of the FB in a program depends on the CPU module used, input and output definition, and option settings of GX Works3. For the option settings of GX Works3, refer to  GX Works3 Operating Manual (2.9 Option Setting for Each Function).
Label amount used	<ul style="list-style-type: none"> • Label: 0.03K points (Word) • Latch label: 0K points (Word) The label amount used in a program depends on the CPU module used, device specified in the argument, and option settings of GX Works3. For the option settings of GX Works3, refer to  GX Works3 Operating Manual (2.9 Option Setting for Each Function).
Number of index register points used	<ul style="list-style-type: none"> • Index register: 0 points • Long index register: 0 points
File register amount used	File register: 2336 points (Word) (R0 to R2335)
FB dependence	No dependence
FB compiling method	Subroutine type
FB operation type	Pulsed execution (multiple scan execution type)

Function description

- Set the axis number of the operation target in `i_uAxis` (Target axis).
- At rising edge of `i_bEN` (Execution command), this FB sets the PIO/MODBUS switching to the MODBUS communication and issues a servo ON request when `i_bServo` (Servo ON/OFF) is on or a servo OFF request when the label is off. It issues a servo press ON request when `i_bPress` (Servo press ON/OFF) is on or a servo press OFF request when the label is off. (Only for cylinders with the servo press specifications) This FB does not check whether the servo is turned on or off. Check the servo status in  Page 61 Error code.
- `o_bOK` (Normal completion) turns on when the execution is completed.
- If an error occurs while sending/receiving a communication protocol, `o_bErr` (Error completion) turns on and the processing of the FB is interrupted. The error code is stored in `o_uErrId` (Error code). For details of the error code, refer to  MELSEC iQ-F FX5 User's Manual (Communication).
- If an error occurs in the ROBO Cylinder and this FB receives an error code, `o_bUnitErr` (Module error completion) turns on and the processing of the FB is interrupted. The received error code is stored in `o_uUnitErrId` (Module error code). For details of the error code, refer to the manuals described in "RELEVANT MANUALS".
- If any other error occurs, `o_bErr` (Error completion) turns on and the processing of the FB is interrupted. For details of the error code, refer to  Page 61 Error code.

Timing chart of I/O signals

Normal completion

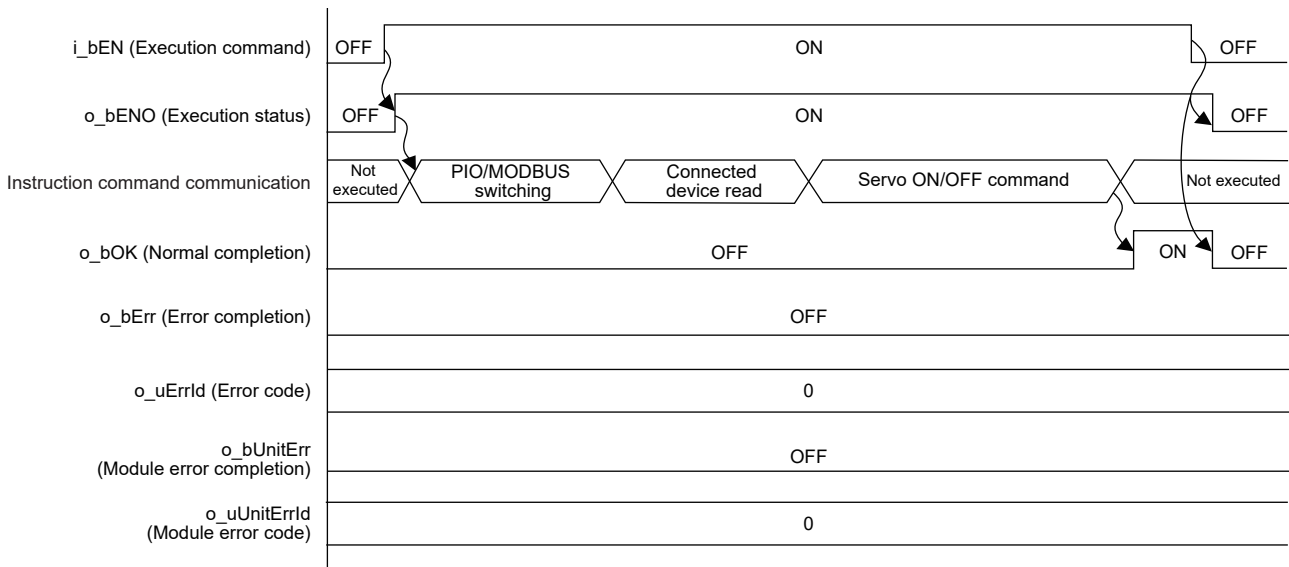

Error completion

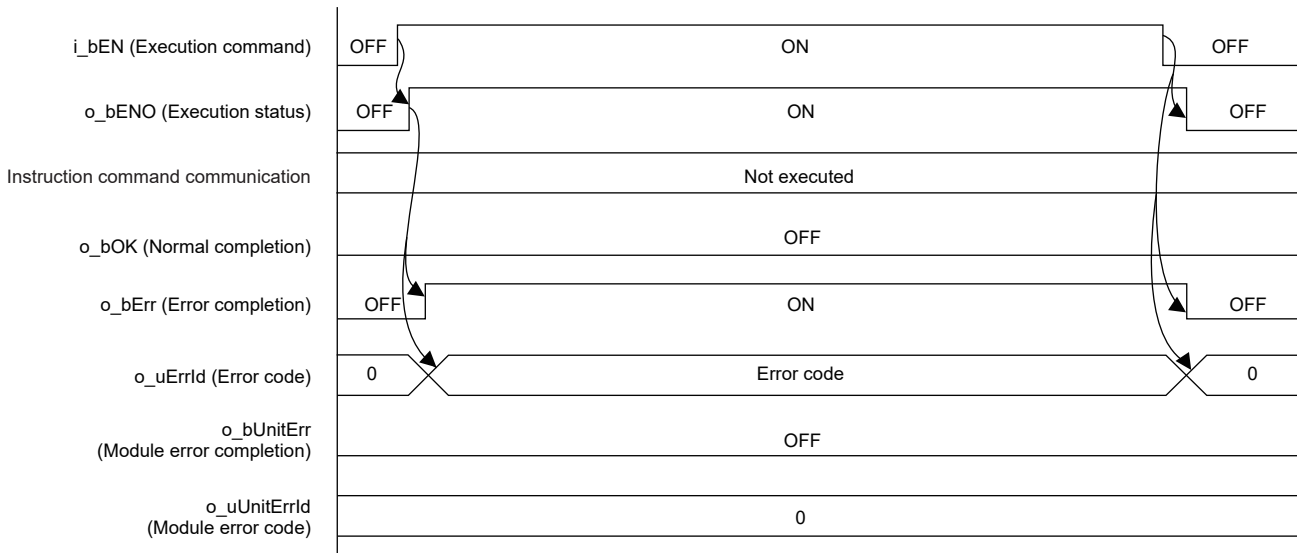

Restrictions and precautions

- This FB does not include error recovery processing. Program the error recovery processing separately in accordance with the required system operation.
- This FB cannot be used in an interrupt program.
- Using the FB in a program that is to be executed only once, such as a subroutine program or a FOR-NEXT loop, has a problem that i_bEN (Execution command) can no longer be turned off and normal operation is not possible; Always use the FB in a program that is capable of turning off the execution command.
- This FB requires the ladder to be configured for every input label.
- This FB uses the CPRTCL instruction. For details, refer to MELSEC iQ-F FX5 User's Manual (Communication).
- This FB needs to satisfy the following conditions in the monitor table.
 - Bit 10 of the device status 1 (Major failure status): 0
 - Bit 15 of the device status 1 (EMG status): 0
 - Bit 15 of the device status 2 (Enable status): 1
 - Bit 17 of the system status (Auto servo-off status): 0

When the above conditions are not satisfied, the servo is not turned on or off although o_bOK (Normal completion) turns on in this FB. For details, refer to PCON, ACON, SCON, RCP6 (PLC Unit) ERC2, ERC3 Serial Communication [Modbus Version] Operation Manual.

- To operate the IAI ROBO Cylinder, set the protocol type to the predefined protocol support function with the module parameter of GX Works3. For details of the parameter settings, refer to Page 18 Parameter setting.

Parameter setting

For details of the parameter settings, refer to Page 18 Parameter setting.

Application example

For details of the application example, refer to Page 62 FB LIBRARY USE PROCEDURE.

Performance value

CPU	Measurement condition	Processing time	Maximum scan time	Number of scans	
FX5U, FX5UC*1*2	Axis 1, CH1	Switching the servo ON state to the servo OFF state	41.4 ms	0.960 ms	144 scans
		Switching the servo OFF state to the servo ON state	42.0 ms	0.937 ms	148 scans

*1 When the program capacity is set to 128K steps, the process speed may be decreased.

*2 The standard area is used for the labels.

Error code

Error code (hexadecimal)	Description	Action
101H	The setting value of i_uCh (Target CH) is out of range. The target channel is not within the range of 1 to 4.	Review and correct the setting and then execute the FB again.
102H	The setting value of i_uAxis (Target axis) is out of range. The target axis is not within the range of 1 to 16.	Review and correct the setting and then execute the FB again.
200H	An unsupported device is connected.	Review and correct the connected device and then execute the FB again.
201H	The execution command has turned off during the processing.	Keep the ON state of the execution command until the normal completion, error completion, or module error completion turns on.*1
Predefined protocol error code	This error code occurs during communication.	Refer to MELSEC iQ-F FX5 User's Manual (Communication) .

*1 It is output only during one scan.

3 FB LIBRARY USE PROCEDURE

3.1 Position Table Setting and Positioning Operation

The following shows an example of using this FB library for configuring the position table setting and performing the home position return and positioning operation for the IAI controller. The following FBs are used in this example.

- M+IAIMonitoring_F (Operation monitor)
- M+IAIWritePositioningTable_F (Position table setting)
- M+IAIStartHomePositioning_F (Home position return)
- M+IAIStartPositioning_F (Positioning operation)
- M+IAIServoControl_F (Servo ON/OFF)

Overview of program example

Perform monitoring to check the status of the IAI controller. Then, write the position table information to the position table No. 0 of axis 1 and the position table No. 0 of axis 2 of the IAI controller with the following settings. After writing the data, perform the home position return, then move the electric actuator to the position which is 100mm away from the home position. If the error code 203H occurs during the operation, reset the alarm that has occurred in the IAI controller.

- Target position: 100 mm ($0.01 \text{ mm} \times 10000$)
- Positioning width: 1 mm ($0.01 \text{ mm} \times 100$)
- Acceleration: 0.01 G
- Speed: 10 mm/s
- Deceleration: 0.01 G

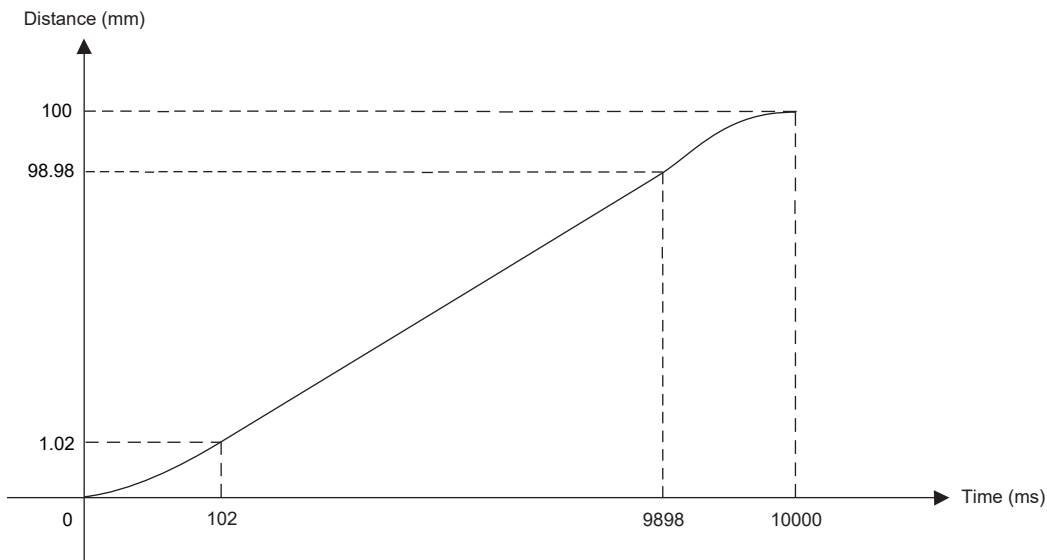
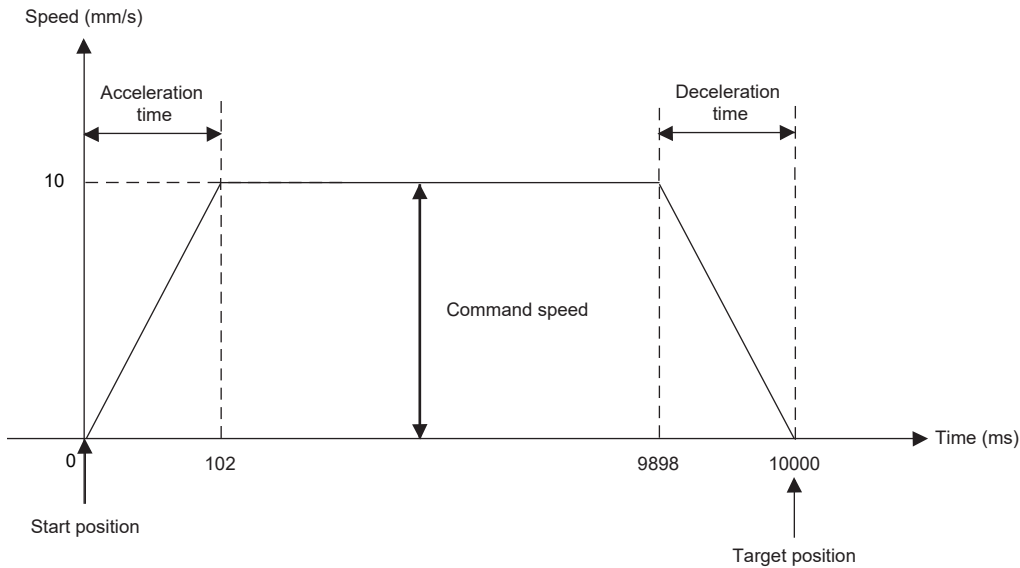

Operation flow

The following shows the operation flow from the parameter setting and wiring of the ROBO Cylinder and programmable controller to using Predefined Protocol Support FB For Positioning.

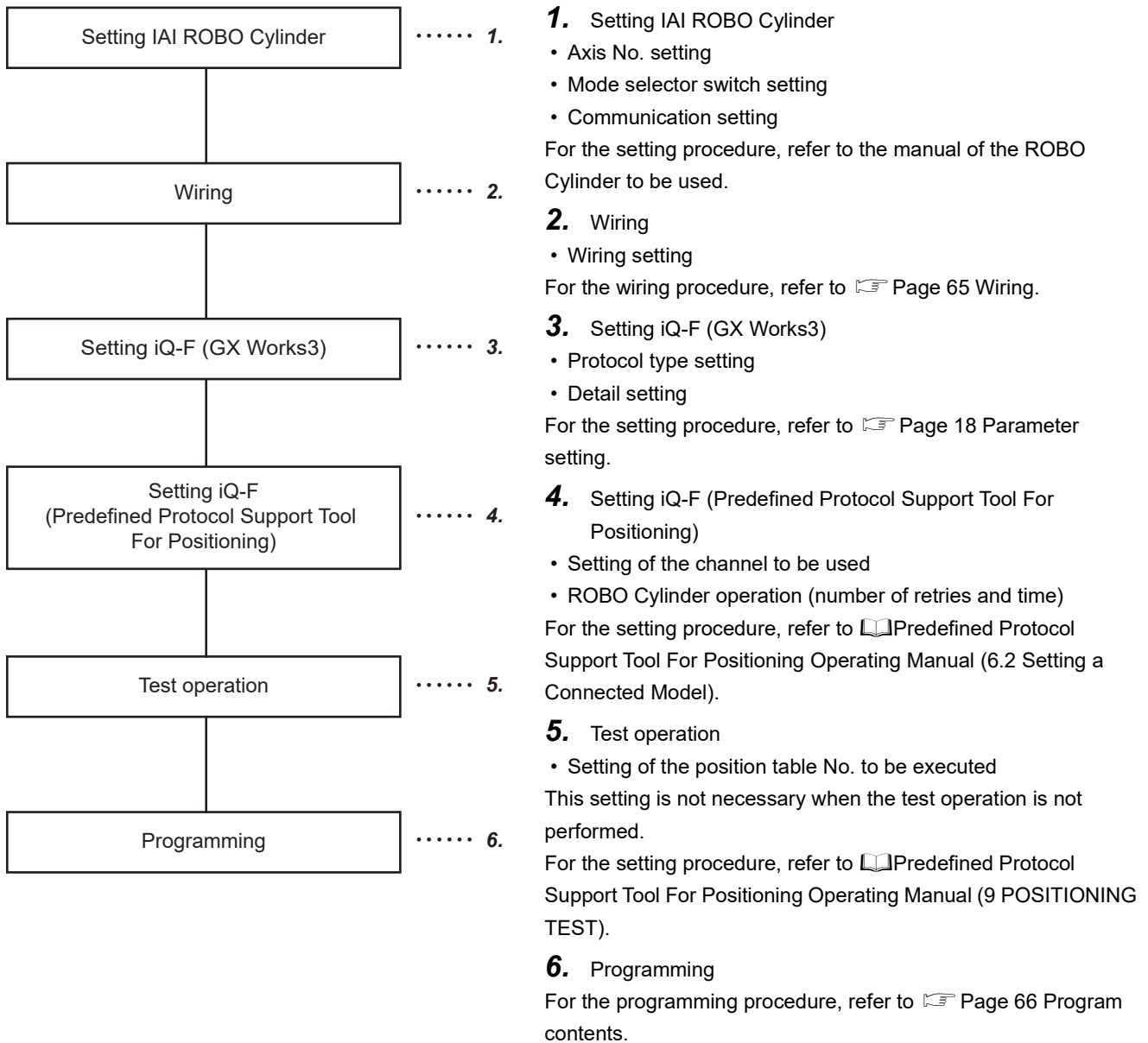

System configuration

For the system configuration example, refer to Page 9 System Configuration.

Wiring

In this example, perform wiring as follows.

For details, refer to [IAI ROBO Cylinder Series MITSUBISHI ELECTRIC MELSEC iQ-F Series MODBUS/RTU Connection Quick Start Guide](#).

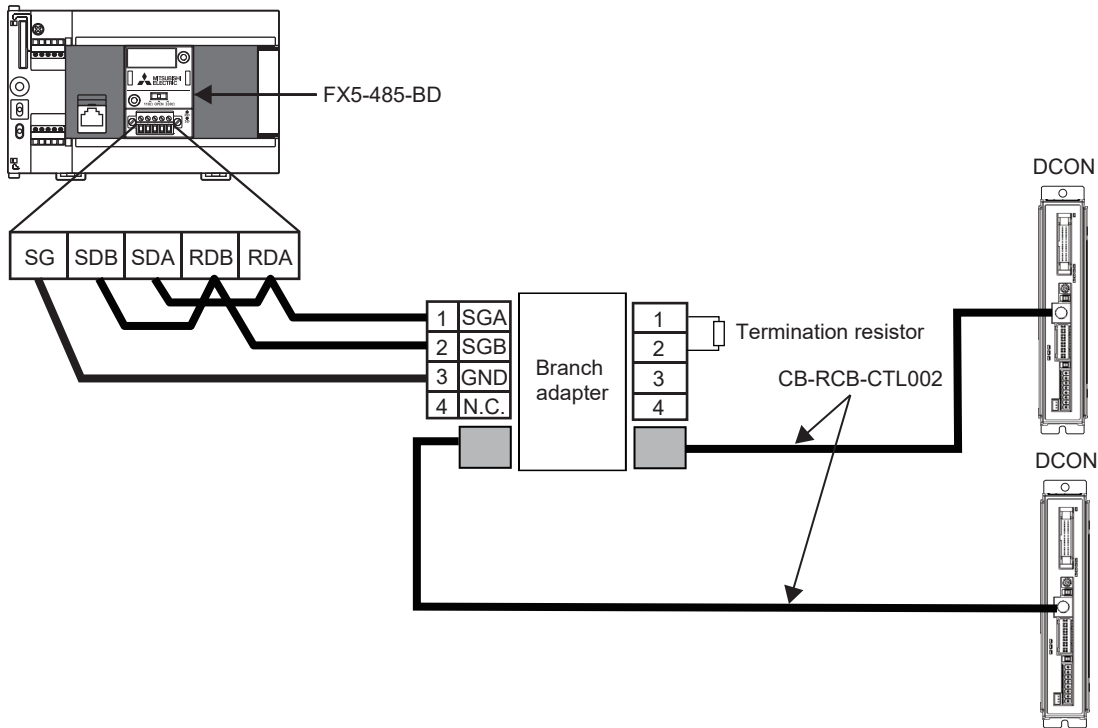

Pre-setting

Set the termination resistor in the FX5U CPU module. Set the termination resistor to 110 Ω using the termination resistor selector switch.

Parameter setting

For details of the parameter settings, refer to [Page 18 Parameter setting](#).

FB library registration

For the operating procedure to register the FB library to GX Works3, refer to [GX Works3 Operating Manual \(10.4 Enhanced Use of Application Library/MELSOFT Library\)](#).

Enhanced use of FB library

For the operating procedure to use FBs and structures included in the registered FB library in the program, refer to [GX Works3 Operating Manual \(10.3 Enhancing Use of User Library/Enhanced use of libraries/Utilizing an element\)](#).

Program contents

Target channel setting

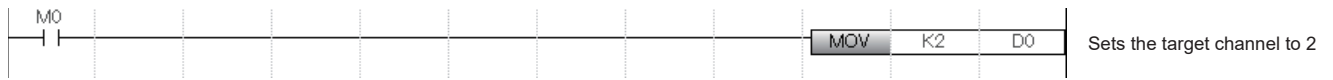

Axis No. setting

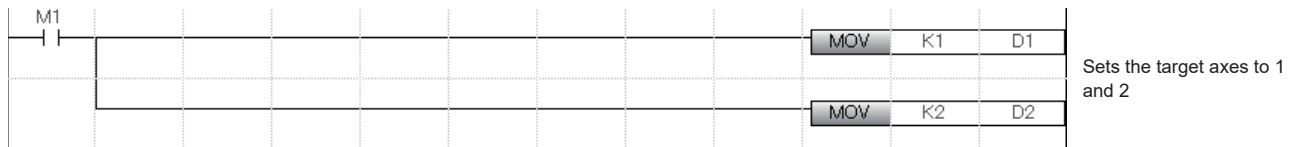

Position table No. setting

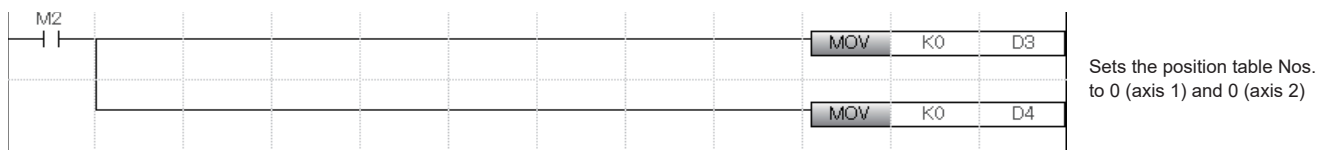

IAI controller monitoring

By turning on i_bEN (Execution command), the status of the IAI controller is monitored by M+IAIMonitoring_F (Operation monitoring).

When o_bMonitorOK (Monitoring status) is on, the monitoring table information of the IAI controller is stored in o_stMonitoringTable (Monitoring table).

For how to access the local labels stLabel4 and stLabel5 of the structure type (stMonitoringTable), refer to [Page 74](#) Acquiring the alarm that has occurred in the IAI controller.

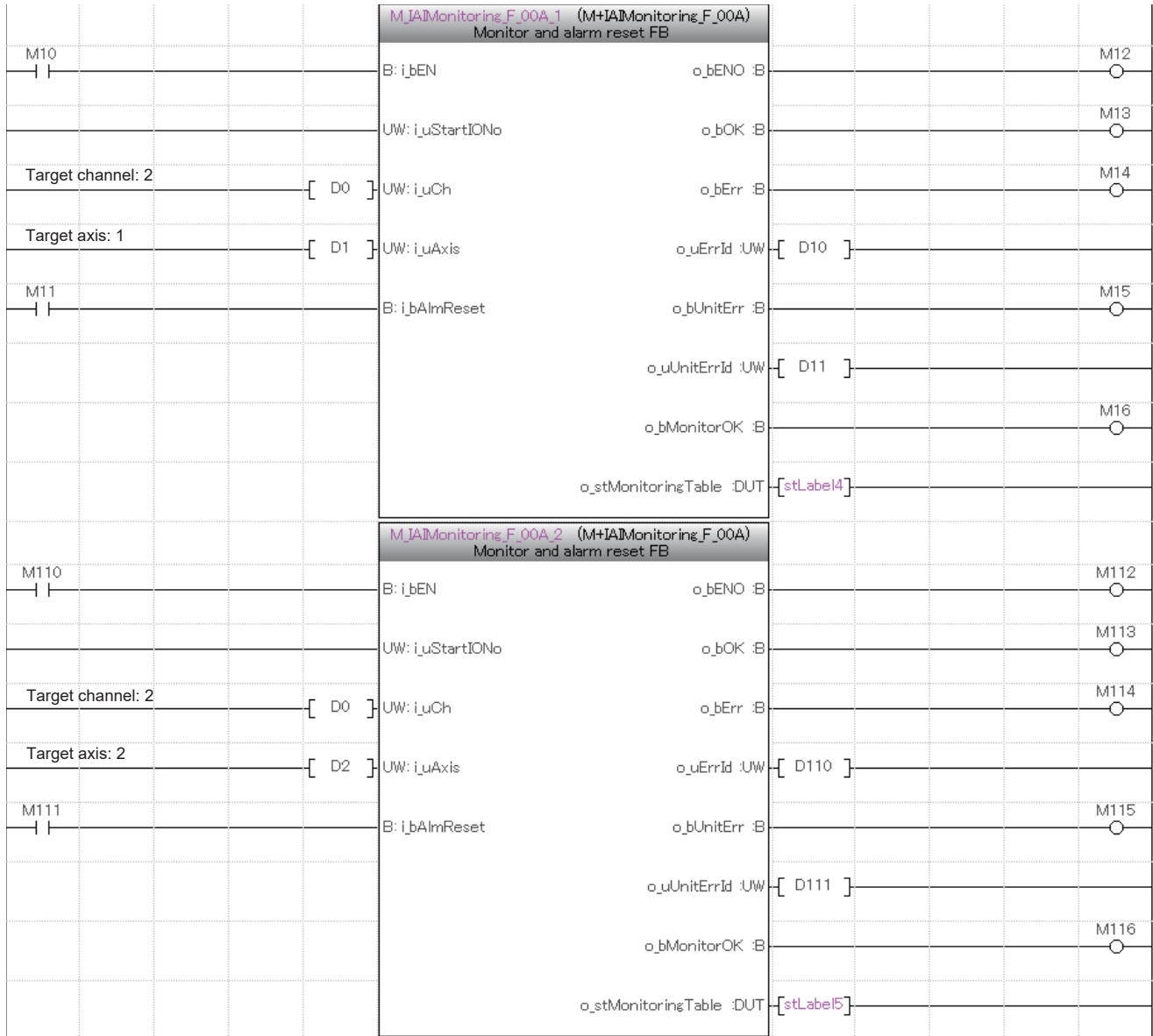

For o_stMonitoringTable (Monitoring table), refer to [Page 10](#) Structure list.

Position table (input label) setting

The following shows an example of setting the input labels for axes 1 and 2 of M+IAIsetPositioningTable_F (Position table setting) by turning on M19 and M119.

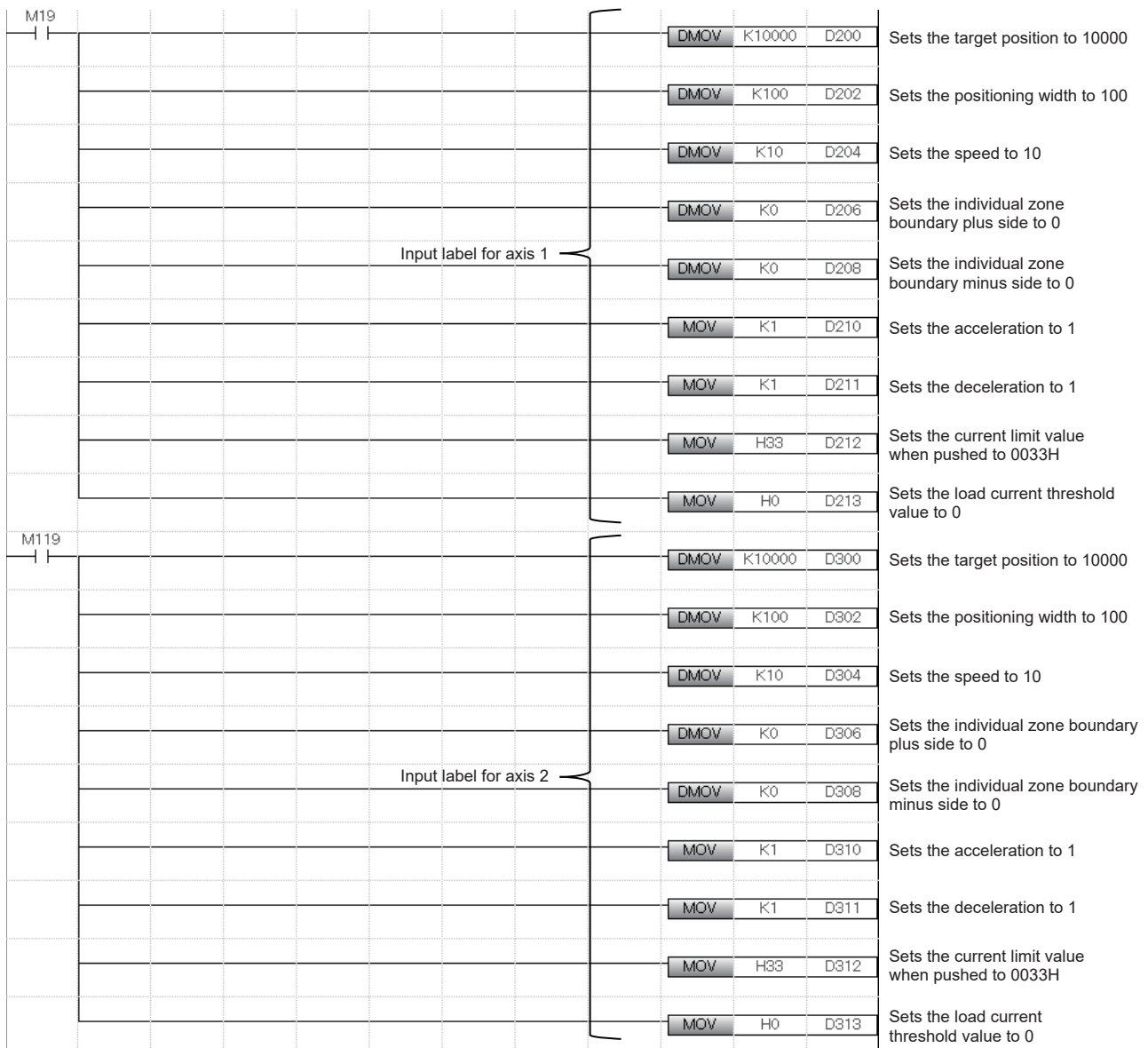

Setting the position table

By turning on i_bEN (Execution command), the information on the positioning operation is set in the positioning table of the target axis by M+IAISetPositioningTable_F (Position table setting).

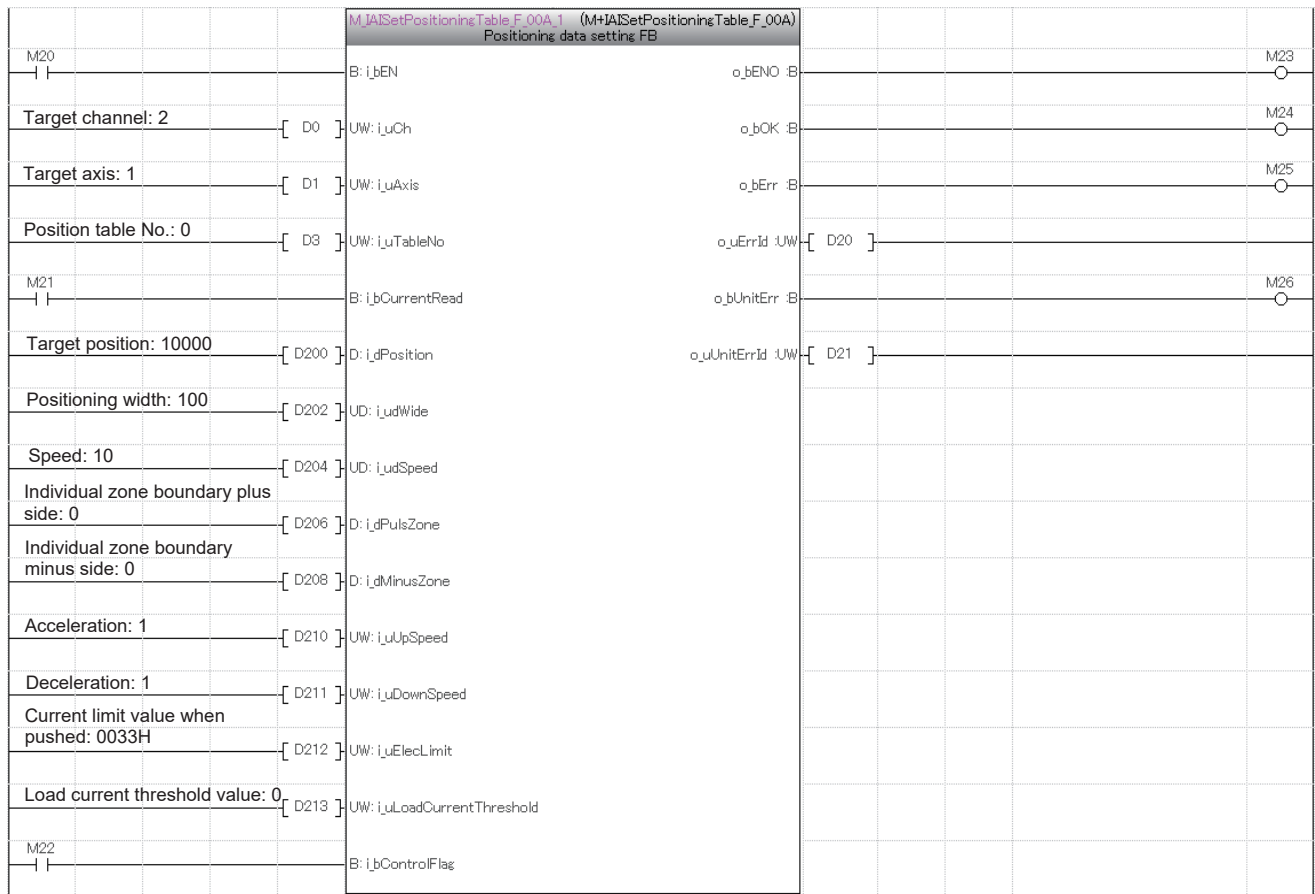

		M+IAIsetPositioningTable_F_00A.2 (M+IAIsetPositioningTable_F_00A)			
		Positioning data setting FB			
M120		B: i_bEN		o_bENO :B	M123
Target channel: 2	[D0]	UW: i_uCh		o_bOK :B	M124
Target axis: 2	[D2]	UW: i_uAxis		o_bErr :B	M125
Position table No.: 0	[D4]	UW: i_uTableNo		o_uErrId :UW [D120]	
M121		B: i_bCurrentRead		o_bUnitErr :B	M126
Target position: 10000	[D300]	D: i_dPosition		o_uUnitErrId :UW [D121]	
Positioning width: 100	[D302]	UD: i_udWide			
Speed: 10	[D304]	UD: i_udSpeed			
Individual zone boundary plus side: 0	[D306]	D: i_dPulsZone			
Individual zone boundary minus side: 0	[D308]	D: i_dMinusZone			
Acceleration: 1	[D310]	UW: i_uUpSpeed			
Deceleration: 1	[D311]	UW: i_uDownSpeed			
Current limit value when pushed: 0033H	[D312]	UW: i_uElecLimit			
Load current threshold value: 0	[D313]	UW: i_uLoadCurrentThreshold			
M122		B: i_bControlFlag			

Point 

The positioning table can be configured by using Predefined Protocol Support Tool For Positioning as well. In that case, setting by M+IAIsetPositioningTable_F (Position table setting) is not necessary. For details of setting by tools, refer to the following.

 Predefined Protocol Support Tool For Positioning Operating Manual (7.2 Setting and Editing Positioning Data)

Performing the home position return

By turning on i_bEN (Execution command), the home position return is performed by M+IAIStartHomePositioning_F (Home position return). When the home position return is performed, the servo is automatically turned on.

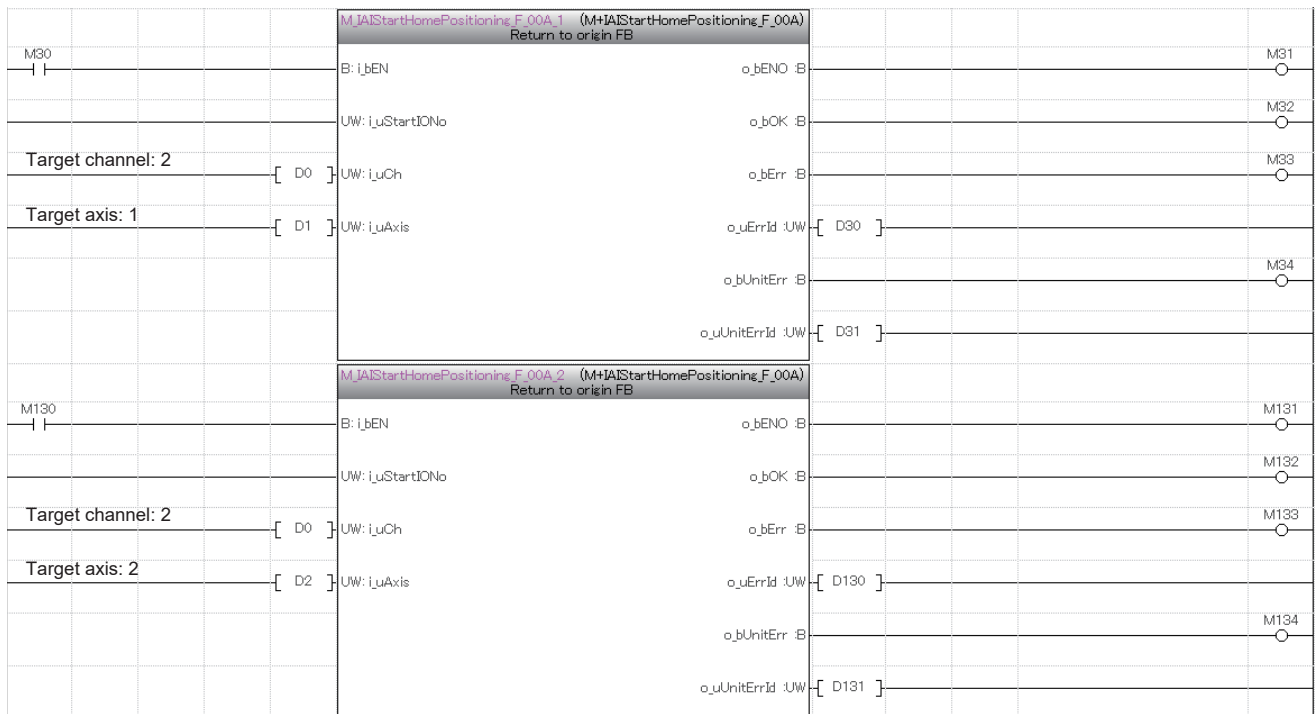

Performing the positioning operation

By turning on i_bEN (Execution command), the positioning operation of the set position table No. is performed by M+IAIStartPositioning_F (Positioning operation). When the positioning operation is performed, the servo is automatically turned on.

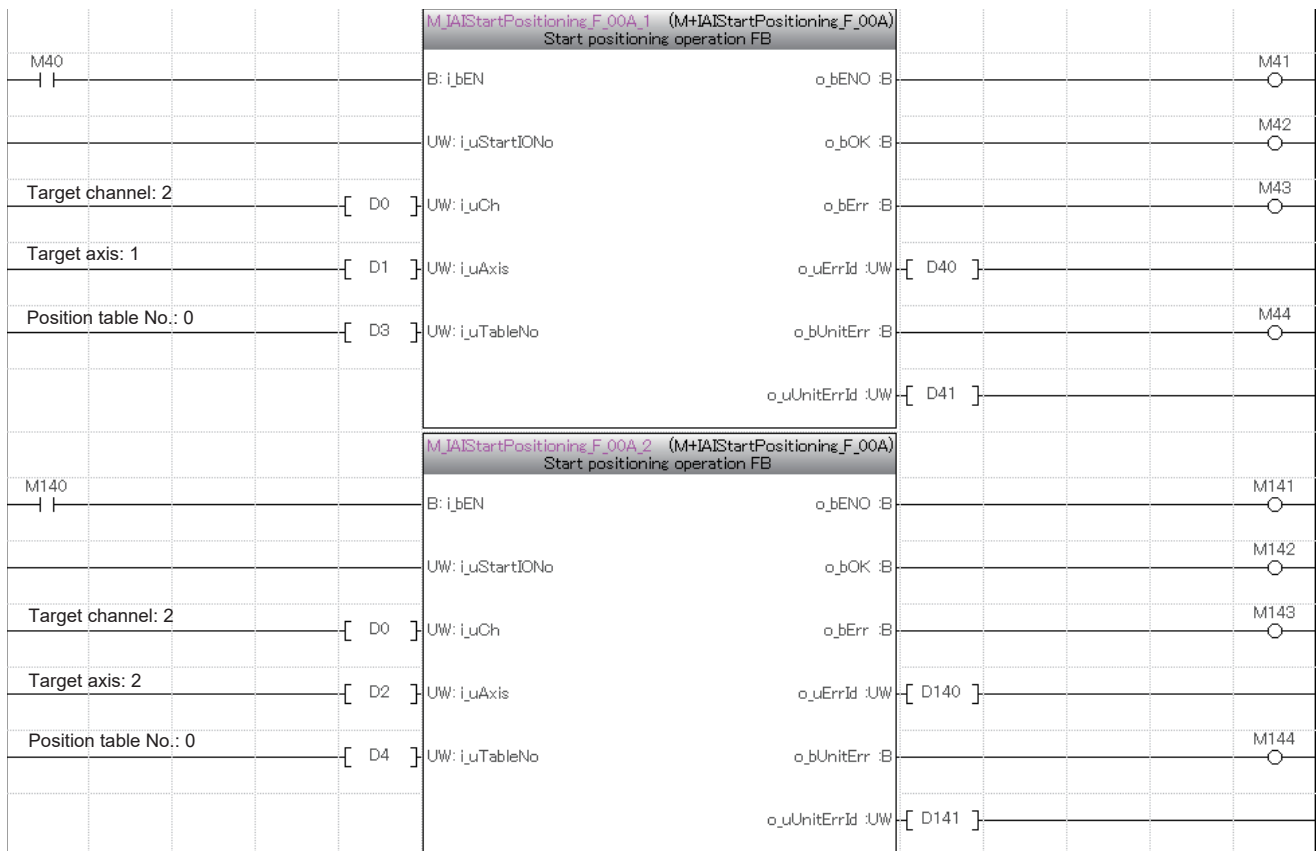

Servo OFF

When performing maintenance of the target axis, turn off the servo by M+IAIServoControl_F (Servo ON/OFF).
After normal completion of the FB, turn off i_bEN (Execution command).

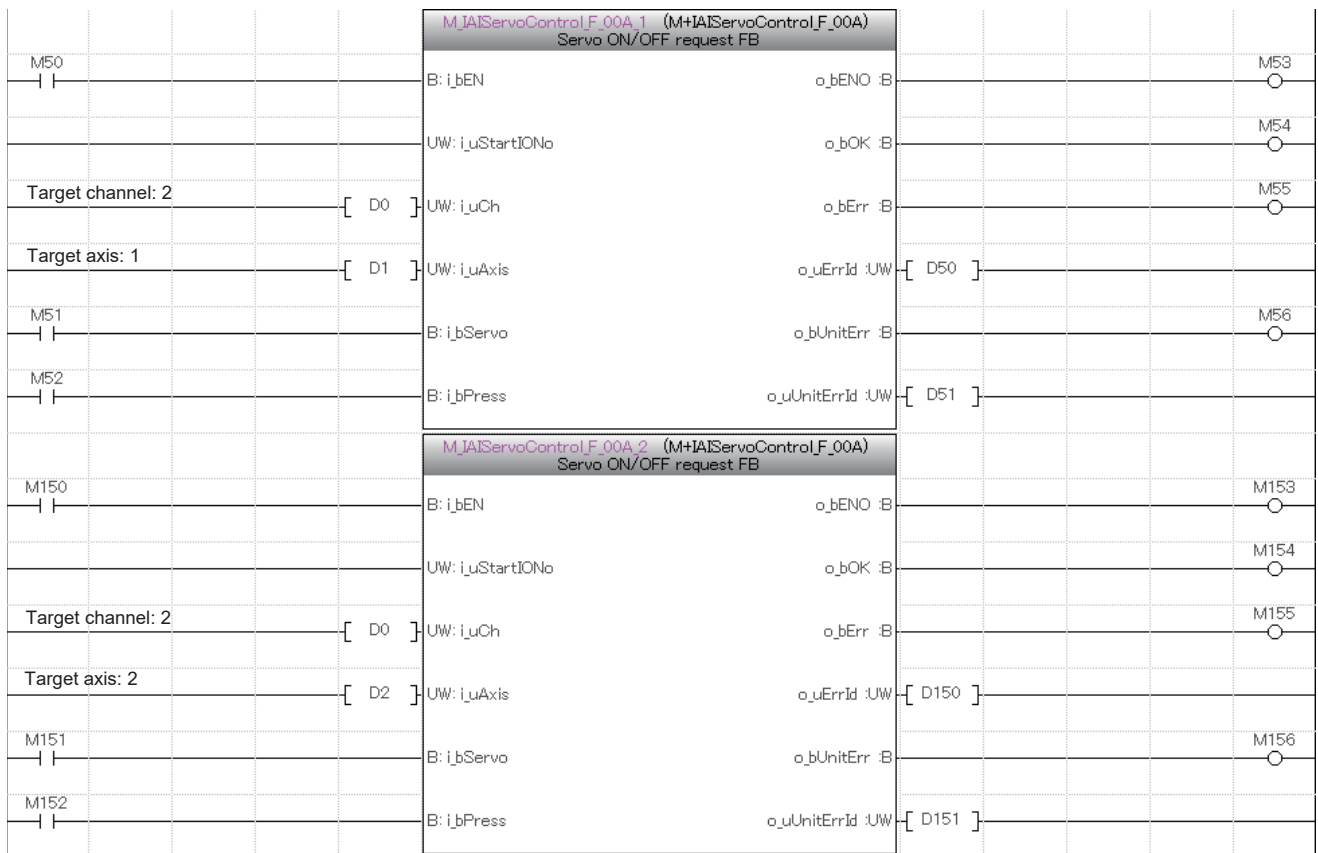

Acquiring the alarm that has occurred in the IAI controller

If the 203H error occurs in the home position return or positioning operation, an alarm has occurred in the IAI controller. The following shows an example of storing the data in the local labels stLabel4 and stLabel5 of the structure type (stMonitoringTable) in the data register (D) by turning on M60 and M160.



Address	Operation	Source	Destination	Description
M160	MOV	stLabel5.uAlarmDetailCode	D160	Stores the alarm detail code in D160
	MOV	stLabel5.uAlarmAddress	D161	Stores the alarm address in D161
	MOV	stLabel5.uAlarmCode	D162	Stores the alarm code in D162
	DMOV	stLabel5.udAlarmTime	D163	Stores the alarm occurrence time in D163
	DMOV	stLabel5.dCurrentPosition	D165	Stores the current position monitor in D165
	MOV	stLabel5.uCurrentAlarmCode	D167	Stores the currently occurring alarm code in D167
	MOV	stLabel5.uInputPort	D168	Stores the input port in D168
	MOV	stLabel5.uOutputPort	D169	Stores the output port in D169
	MOV	stLabel5.uStatus1	D170	Stores the device status 1 in D170
	MOV	stLabel5.uStatus2	D171	Stores the device status 2 in D171
	MOV	stLabel5.uExtendedDeviceStatus	D172	Stores the extended device status in D172
	DMOV	stLabel5.udSystemStatus	D173	Stores the system status in D173
	DMOV	stLabel5.dCurrentSpeed	D175	Stores the current speed in D175
	DMOV	stLabel5.dElectricCurrentValue	D177	Stores the current value in D177
	DMOV	stLabel5.dDeviation	D179	Stores the deviation in D179
	DMOV	stLabel5.udSystemOpTime	D181	Stores the system operation time in D181
	MOV	stLabel5.uSpecialInputPort	D183	Stores the special input port in D183
	MOV	stLabel5.uZoneStatus	D184	Stores the zone status in D184
	MOV	stLabel5.uDoneOrRunProgramNo	D185	Stores the positioning complete position No. status/ Running program No. in D185
	MOV	stLabel5.uExpansionSystemStatus	D186	Stores the expansion system status in D186

Data in stLabel5

Resetting the alarm that has occurred in the IAI controller

When an alarm code is stored in D62 or D162, the alarm that has occurred in the IAI controller is reset by M+IAIMonitoring_FB (Operation monitor) by turning on i_bAlmReset (Alarm reset).

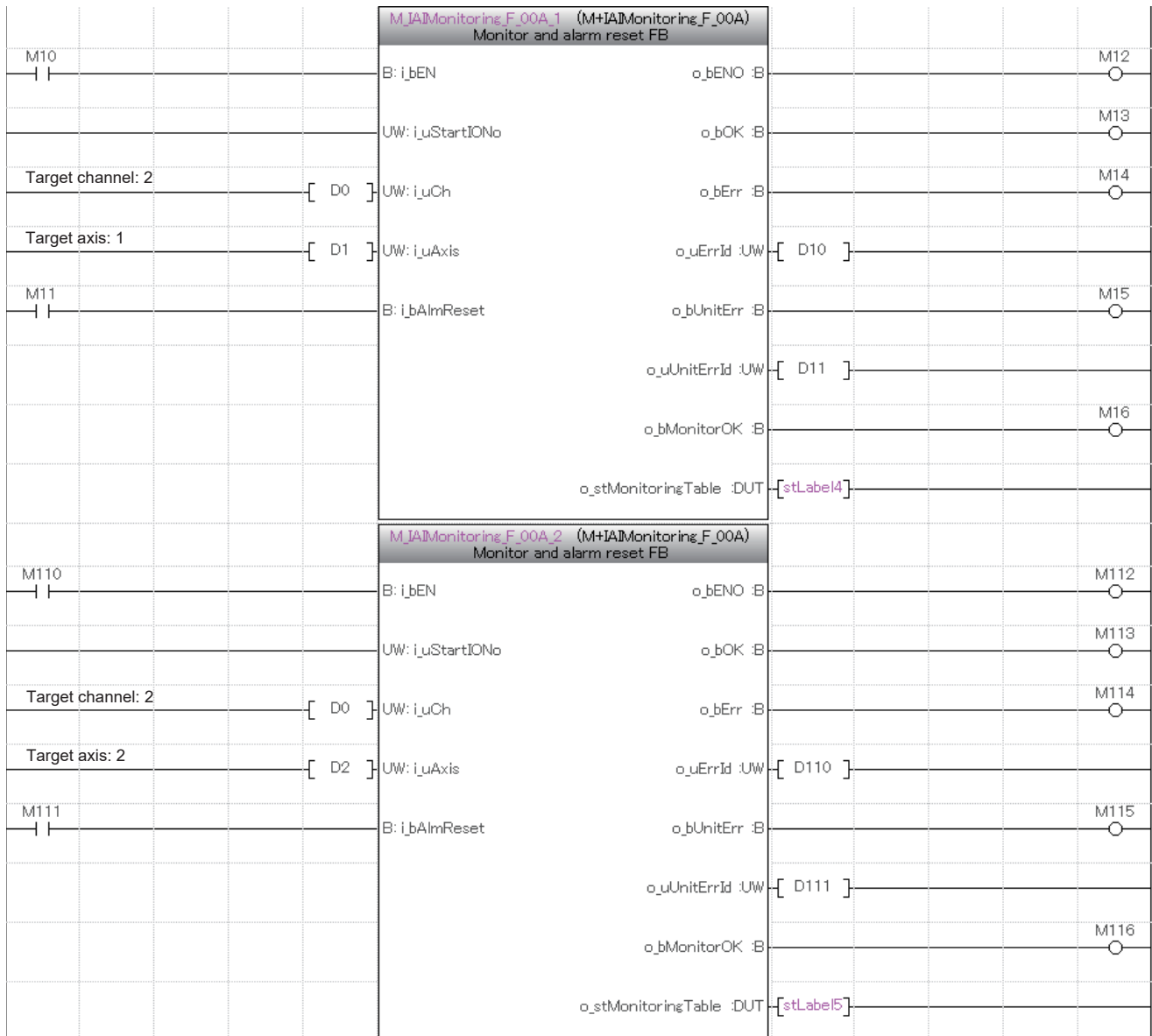

3.2 JOG Operation and Current Position Reading

The following shows an example of using this FB library for performing the JOG/inching operation and reading the current position after the operation. The following FBs are used in this example.

- M+IAIMonitoring_F (Operation monitor)
- M+IAIStartHomePositioning_F (Home position return)
- M+IAIJogInching_F (JOG/Inching operation)
- M+IAIWritePositioningTable_F (Position table setting)
- M+IAIReadPositioningTable_F (Position table read)
- M+IAIServoControl_F (Servo ON/OFF)

Overview of program example

Perform monitoring to check the status of the IAI controller. Then, perform the home position return, and perform the JOG operation on the axis 1 of the IAI controller by the parameter set for the IAI controller. The current position after the movement by JOG operation is read and set to the position of the position table No. 0. The position of the set position table is read.

Operation flow

Refer to [Page 64 Operation flow](#).

System configuration

Refer to [Page 9 System Configuration](#).

Wiring

In this example, perform wiring as follows.

For details, refer to [IAI ROBO Cylinder Series MITSUBISHI ELECTRIC MELSEC iQ-F Series MODBUS/RTU Connection Quick Start Guide](#).

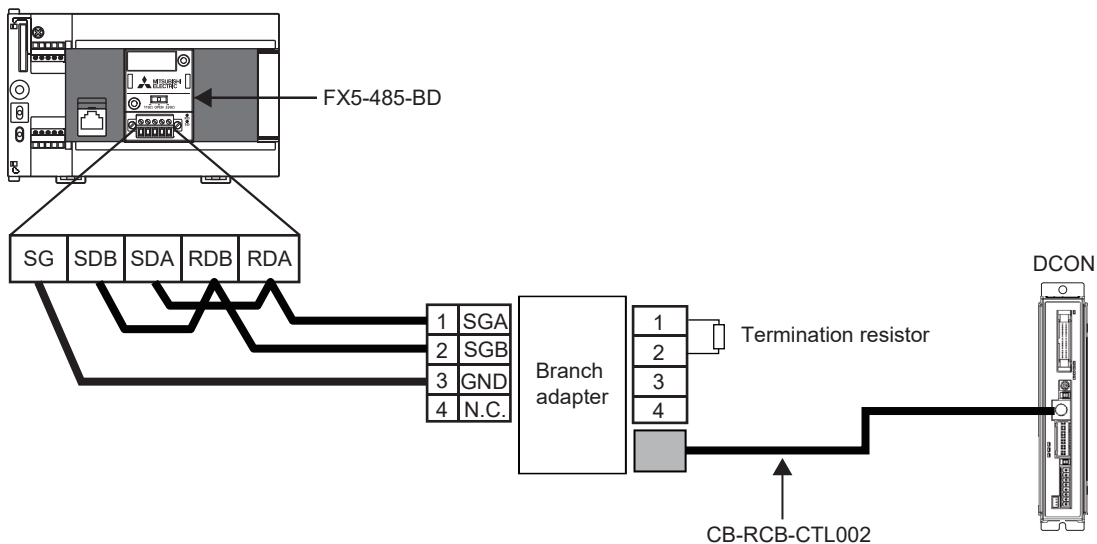

Pre-setting

Set the termination resistor in the FX5U CPU module. Set the termination resistor to 110 Ω using the termination resistor selector switch.

Parameter setting

For details of the parameter settings, refer to [Page 18 Parameter setting](#).

FB library registration

For the operating procedure to register the FB library to GX Works3, refer to [GX Works3 Operating Manual \(10.4 Enhanced Use of Application Library/MELSOFT Library\)](#).

Enhanced use of FB library

For the operating procedure to use FBs and structures included in the registered FB library in the program, refer to [GX Works3 Operating Manual \(10.3 Enhancing Use of User Library/Enhanced use of libraries/Utilizing an element\)](#).

Program contents

Target channel setting



Target axis setting



Position table No. setting



JOG speed setting



Inching movement amount setting



IAI controller monitoring

By turning on `i_bEN` (Execution command), the status of the IAI controller is monitored by `M+IAIMonitoring_F` (Operation monitoring).

When `o_bMonitorOK` (Monitoring status) is on, the monitoring table information of the IAI controller is stored in `o_stMonitoringTable` (Monitoring table).

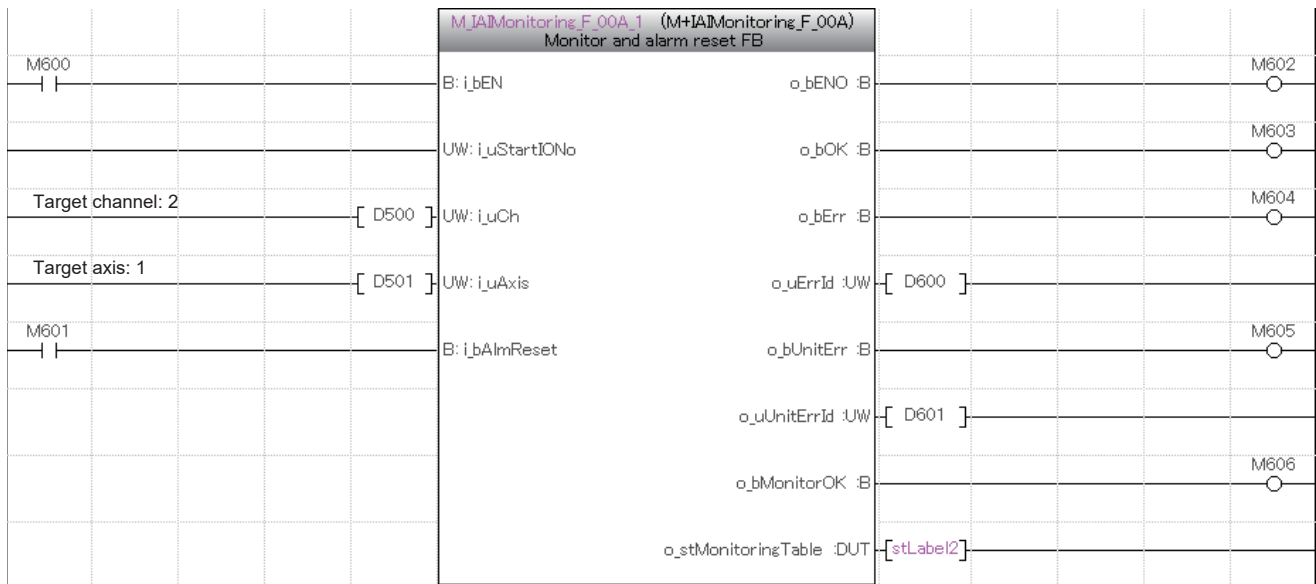

For `o_stMonitoringTable` (Monitoring table), refer to [Page 10 Structure list](#).

The following shows an example of storing the data in the local label `stLabel2` of the structure type (`stMonitoringTable`) in the data register (D) by turning on `M607`.

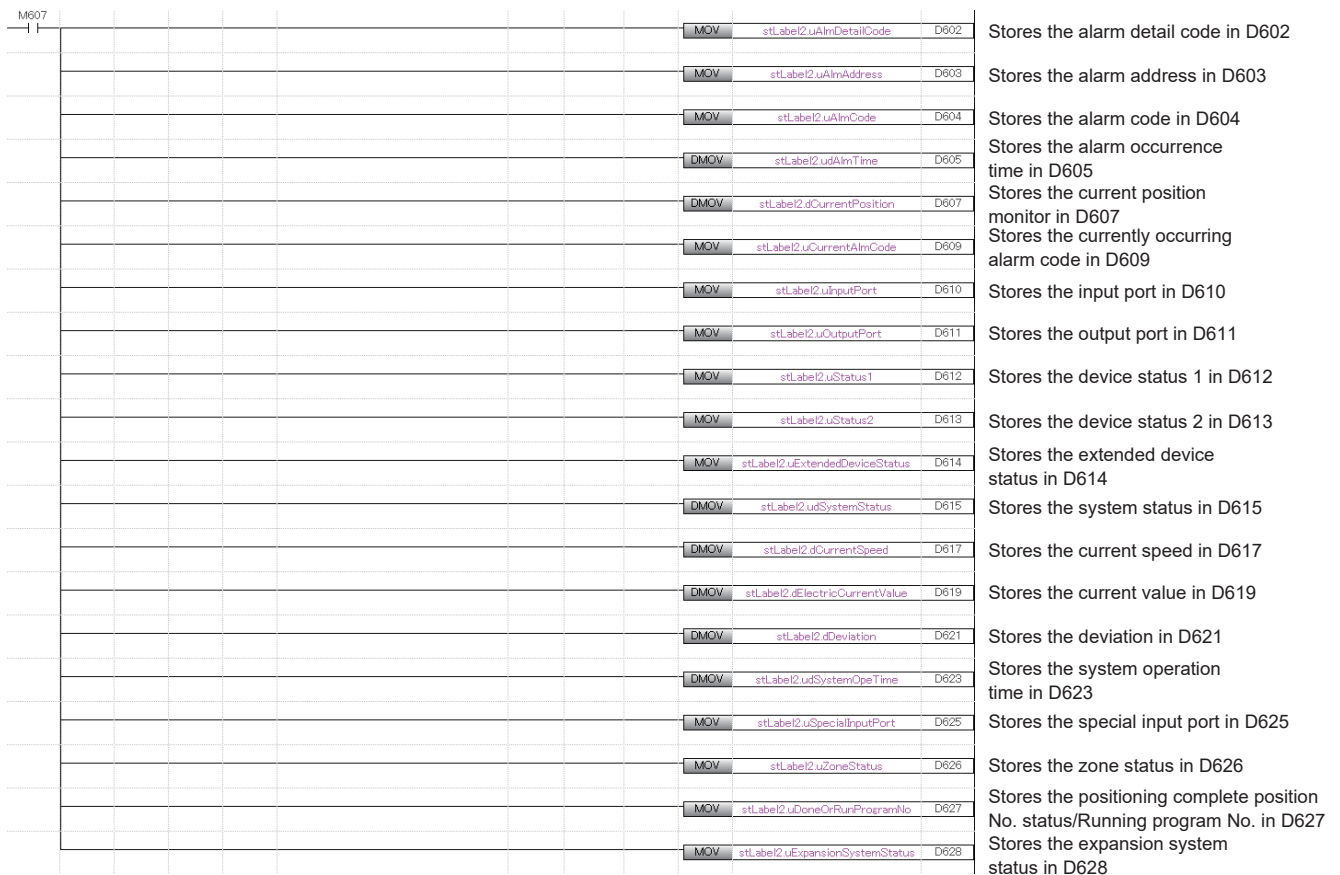

Performing the home position return

By turning on i_bEN (Execution command), the home position return is performed by M+IAIStartHomePositioning_F (Home position return). When the home position return is performed, the servo is automatically turned on.



Performing the JOG operation

Turn on i_bEN (Execution command) and execute M+IAIJogInching_F (JOG/inching operation). When the JOG/inching operation is performed, the servo is automatically turned on.

After o_bParamOK (Setting completion flag) is turned on, turn on i_bFJog (JOG+ command) or i_bRJog (JOG- command) to perform JOG operation.

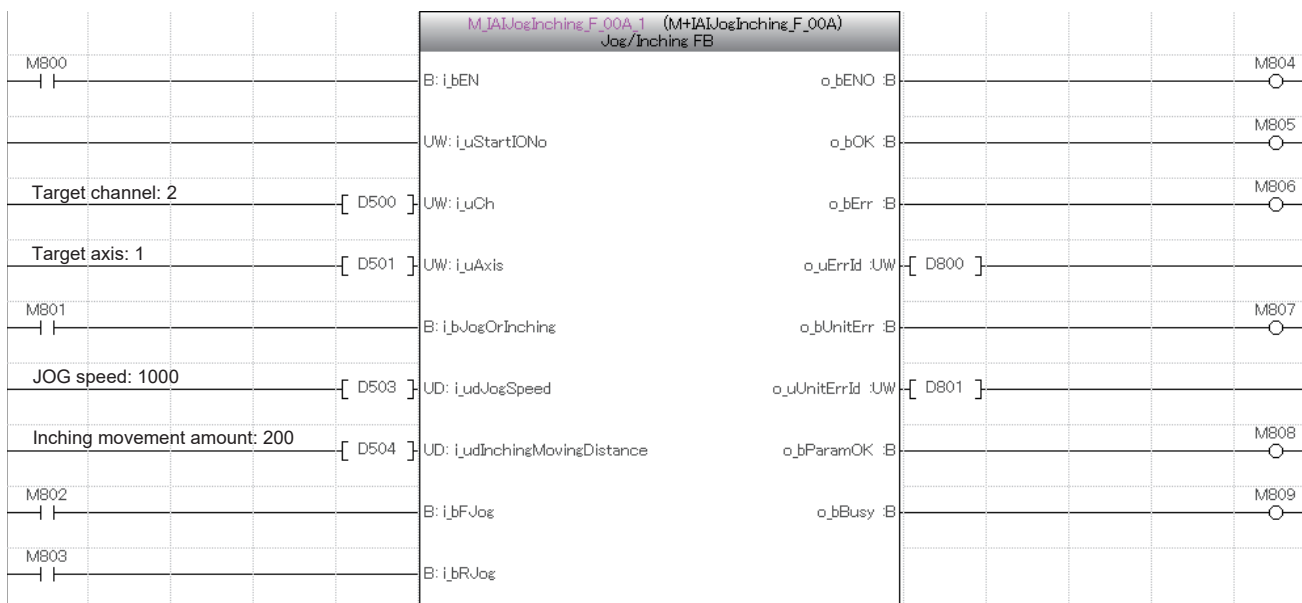

Setting the position table

The following shows an example of setting the input label of M+IAISetPositioningTable_F (Position table setting) by turning on M810.

M810		DMOV	K500	D510	Sets the target position to 500
		DMOV	K10	D512	Sets the positioning width to 10
		DMOV	K10000	D514	Sets the speed to 10000
		DMOV	K0	D516	Sets the individual zone boundary plus side to 0
		DMOV	K0	D518	Sets the individual zone boundary minus side to 0
		MOV	K30	D520	Sets the acceleration to 30
		MOV	K30	D521	Sets the deceleration to 30
		MOV	H33	D522	Sets the current limit value when pushed to 0033H
		MOV	H0	D523	Sets the load current threshold value to 0

By turning on i_bEN (Execution command) after turning on i_bCurrentRead (Current position reading), the current position after the JOG operation is set to the position table No. by M+IAISetPositioningTable_F (Position table setting). Because i_bCurrentRead (Current position reading) is turned on, the value of i_dPosition (Position) is ignored.

		M+IAISetPositioningTable_F_00A.1 (M+IAISetPositioningTable_F_00A) Positioning data setting FB			
M900		B: i_bEN		o_bENO :B	M903
Target channel: 2	[D500]	UW: i_uCh		o_bOK :B	M904
Target axis: 1	[D501]	UW: i_uAxis		o_bErr :B	M905
Position table No.: 0	[D502]	UW: i_uTableNo		o_uErrId :UW	[D900]
M901		B: i_bCurrentRead		o_bUnitErr :B	M906
Target position: 500	[D510]	D: i_dPosition		o_uUnitErrId :UW	[D902]
Positioning width: 10	[D512]	UD: i_udWide			
Speed: 10000	[D514]	UD: i_udSpeed			
Individual zone boundary plus side: 0	[D516]	D: i_dPulsZone			
Individual zone boundary minus side: 0	[D518]	D: i_dMinusZone			
Acceleration: 30	[D520]	UW: i_uUpSpeed			
Deceleration: 30	[D521]	UW: i_uDownSpeed			
Current limit value when pushed: 0033H	[D522]	UW: i_uElecLimit			
Load current threshold value: 0	[D523]	UW: i_uLoadCurrentThreshold			
M902		B: i_bControlFlag			

Reading the position table

By turning on i_bEN (Execution command), the position table information of the set position table No. is read by M+IAIReadPositioningTable_F (Position table read). The read position table information is stored in the local label stLabel7 of the structure type (stPositionTable).

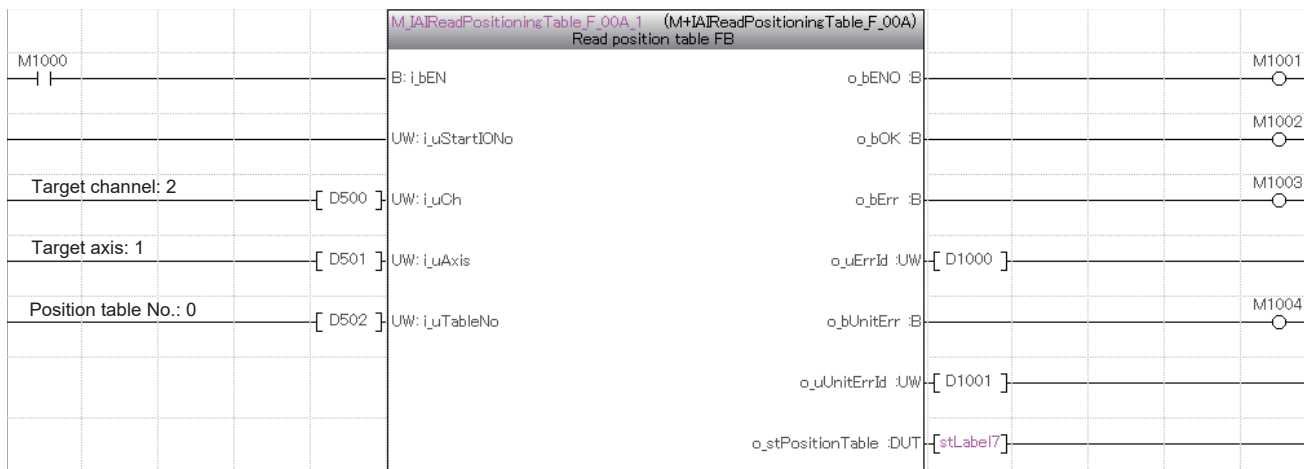

The following shows an example of storing the data in the local label stLabel7 of the structure type (stPositionTable) in the data register (D) by turning on M1005.

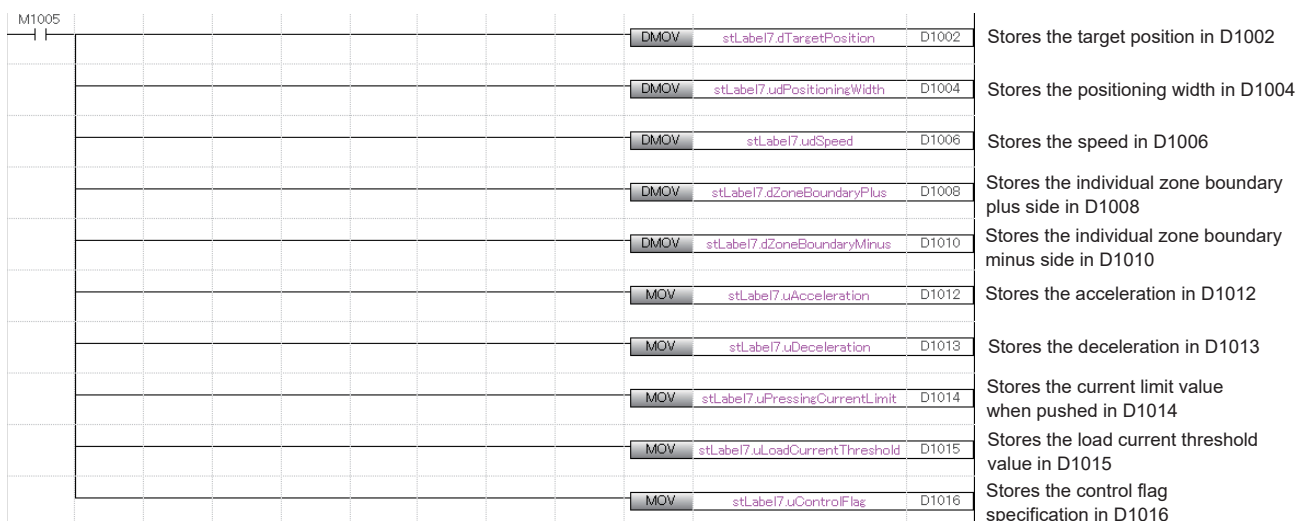

Servo OFF

When performing maintenance of the target axis, turn off the servo by M+IAIServoControl_F (Servo ON/OFF).

After normal completion of the FB, turn off i_bEN (Execution command).

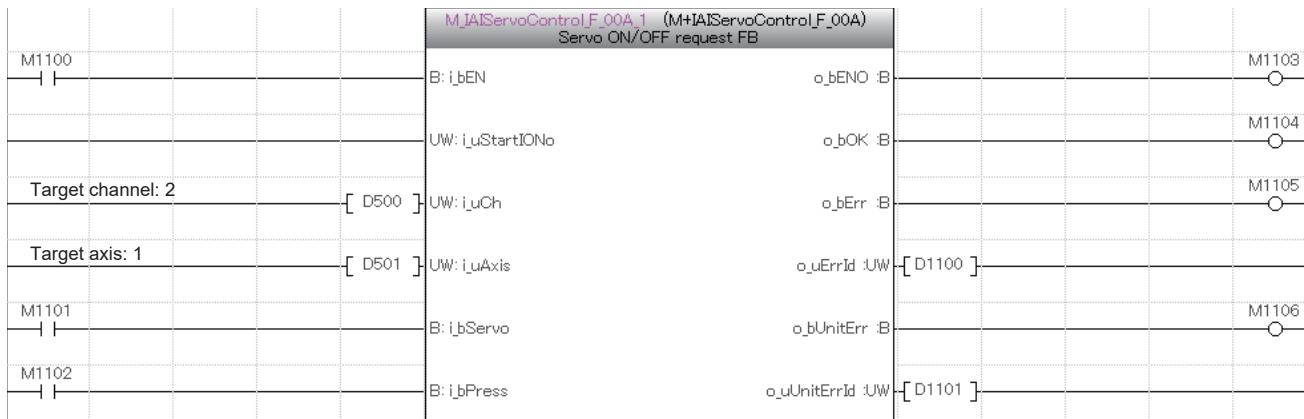

INSTRUCTION INDEX

M

M+IAIJogInching_F	20
M+IAIMonitoring_F	51
M+IAIReadPositioningTable_F	33
M+IAIServoControl_F	56
M+IAISetPositioningTable_F	38
M+IAIStartHomePositioning_F	14
M+IAIStartPositioning_F	45



MEMO

REVISIONS

*The manual number is given on the bottom left of the back cover.

Revision date	*Manual number	Description
February 2020	SH(NA)-082262ENG-A	First edition
October 2020	SH(NA)-082262ENG-B	■Added or modified parts RELEVANT MANUALS, Section 1.4, Chapter 2, Appendix 1
April 2022	SH(NA)-082262ENG-C	■Added or modified parts RELEVANT MANUALS, Section 1.3, Chapter 2, Chapter 3 ■Deleted parts Appendix 1
April 2023	SH(NA)-082262ENG-D	■Added or modified parts GENERIC TERM/ABBREVIATION, Section 2.5
July 2023	SH(NA)-082262ENG-E	■Added or modified parts RELEVANT MANUALS, Chapter 2

Japanese manual number: SH-082261-E

This manual confers no industrial property rights of any other kind, nor does it confer any patent licenses. Mitsubishi Electric Corporation cannot be held responsible for any problems involving industrial property rights which may occur as a result of using the contents noted in this manual.

© 2020 MITSUBISHI ELECTRIC CORPORATION

TRADEMARKS

The company names, system names, and product names mentioned in this manual are either registered trademarks or trademarks of their respective companies.

In some cases, trademark symbols such as [™] or [®] are not specified in this manual.

Manual number: SH(NA)-082262ENG-E

mitsubishi electric corporation

HEAD OFFICE: TOKYO BLDG., 2-7-3, MARUNOUCHI, CHIYODA-KU, TOKYO 100-8310, JAPAN
NAGOYA WORKS: 1-14, YADA-MINAMI 5-CHOME, HIGASHI-KU, NAGOYA 461-8670, JAPAN

When exported from Japan, this manual does not require application to the
Ministry of Economy, Trade and Industry for service transaction permission.

Specifications subject to change without notice.