

Programmable Controller

**MELSEC iQ-F**  
series

# MELSEC iQ-F FX5 Safety Extension Module User's Manual

---

Safety main module

-FX5-SF-MU4T5

Safety input expansion module

-FX5-SF-8DI4

Powered by  
**SICK**

This product was jointly developed and manufactured by Mitsubishi and SICK AG, Industrial Safety Systems in Germany.  
\* Note that the warranty on this product differs from that on other programmable controllers.  
(Refer to "WARRANTY" written in this manual.)



# PRECAUTIONS REGARDING WARRANTY

This product is jointly developed and manufactured by Mitsubishi Electric Corporation and SICK AG. Note that there are differences in warranty.

## ● Warranty

Item	Safety extension module	Other programmable controller products (e.g. MELSEC iQ-F series)
Free warranty period	12 months after delivery	36 months after delivery or 42 months after manufacture
Repair term after discontinuation of production	4 years	7 years



# SAFETY PRECAUTIONS

(Read these precautions before using this product.)

Before using this product, please read this manual, the relevant manuals, and the safety standards carefully, and pay full attention to safety to handle the product correctly.

The precautions given in this manual are concerned with this product only. For the safety precautions of the programmable controller system, refer to the user's manual for the CPU module used.

In this manual, the safety precautions are classified into two levels: "⚠ WARNING" and "⚠ CAUTION".

 <b>WARNING</b>	Indicates that incorrect handling may cause hazardous conditions, resulting in death or severe injury.
 <b>CAUTION</b>	Indicates that incorrect handling may cause hazardous conditions, resulting in minor or moderate injury or property damage.

Under some circumstances, failure to observe the precautions given under "⚠ CAUTION" may lead to serious consequences.

Observe the precautions of both levels because they are important for personal and system safety.

Make sure that the end users read this manual and then keep the manual in a safe place for future reference.

## [Design Precautions]

---

### **WARNING**

---

- When the safety extension module detects a fault in an external power supply or itself, it turns off the outputs. Configure an external circuit so that the connected devices are powered off according to the output status (off) of the safety extension module. Incorrect configuration may result in an accident.
  - Configure safety circuits external to a programmable controller to ensure that the entire system operates safely even when a fault occurs in an external power supply or a programmable controller. Failure to do so may result in an accident due to an incorrect output or malfunction.
    - (1) Emergency stop circuits, protection circuits, and protective interlock circuits for conflicting operations (such as forward/reverse rotations or upper/lower limit positioning) must be configured external to the programmable controller.
    - (2) Outputs may remain on or off due to the failure of components such as a relay, transistor, and a triac in an output circuit. For output signals that may lead to serious accidents, external circuits and mechanisms should be designed to ensure safe machinery operation in such a case.
  - In an output circuit, when a load current exceeding a rated current or an over current caused by a load short-circuit flows for a long time, it may cause smoke and fire. To prevent this, configure an external safety circuit, such as a fuse.
  - When changing data of a running programmable controller, configure an interlock circuit in the program to ensure that the entire system will always operate safely.

For other forms of control (such as program modification, parameter change, forced output, or operating status change) of a running programmable controller, read the relevant manuals carefully and ensure that the operation is safe before proceeding.

Improper operation may damage machines or cause accidents.
  - For safety relays, configure an external circuit using a device such as a fuse or breaker to protect a short-circuit current.
  - Create an interlock program using a reset button to prevent the safety extension module from restarting automatically after the safety function is activated and the safety extension module turns off the outputs.
-

### CAUTION

---

- During the control of an inductive load such as a lamp, heater, or solenoid valve, a large current (approximately ten times greater than normal) may flow when the output is turned from off to on. Take proper measures so that the flowing current does not exceed the value corresponding to the maximum load specification of the resistance load.
  - Turn on the power supply of an FX5 CPU module and a safety extension module simultaneously. When a connection error still occurs even if the power supplies are turned on simultaneously, review the power supply environment of the FX5 CPU module and the safety extension module. When the power is supplied for a programmable controller and other devices from the same power supply system, wire the system separately so that the programmable controller and the other devices can turn on and off individually. When a connection error occurs, check the error code, turn OFF the power supply of the CPU module and the safety extension module once, and then turn ON the power supplies simultaneously.
  - Ensure that an entire system using a safety extension module meets the requirements for the corresponding safety category.
  - Leave the following space between a programmable controller and equipments (such as a contactor and relay), external device wiring, or power cables to avoid the effect of radiated noise and heat.
    - Wiring: 100 mm or more
    - Device: 50 mm or more
  - If a mechanical switch such as a relay is connected to an input terminal of the safety extension module, consider contact bounce.
-

## [Design Precautions]

---

### **CAUTION**

---

- Observe the protective notes and measures.

Observe the following items in order to ensure the proper use of the safety extension module.

- (1) When mounting, installing and using the safety extension module, observe the standards and directives applicable in your country.
  - (2) When using the safety extension module in EU member states, comply with the following standards:
    - Machinery Directive 2006/42/EC
    - EMC Directive 2004/108/EC
    - Provision and Use of Work Equipment Directive 89/655/EC
    - The work safety regulations/safety rules
  - (3) Manufacturers and owners of the machine whose the safety extension modules are used are responsible for obtaining and observing all applicable safety regulations and rules.
  - (4) The notices, in particular the test notices of this manual (e.g. on use, mounting, installation or integration into the existing machine controller), must be observed.
  - (5) The test must be carried out by specialized personnel or specially qualified and authorized personnel, and must be recorded and documented so that a third party can reconstruct and retrace the test at any time.
  - (6) The external power supply of the device must be resistance to a momentary power failure lasting 20 ms as specified in IEC 60204-1.
  - (7) The safety extension module conforms to Class A, Group 1, in accordance with EN 55011. Group 1 encompasses all the ISM devices in which intentionally generated and/or used conductor-bound RF energy that is required for the inner function of the device itself occurs.
- The safety extension module is complied with the "Interference emission" basic specification and fulfills the requirements of Class A (for industrial use).  
Therefore, it is only suitable for use in an industrial environment and not for private use.
  - Wiring and replacement of this product must be performed by qualified maintenance personnel who is familiar with protection against electric shock.
- 

## [Installation Precautions]

---

### **WARNING**

---

- Make sure to cut off all phases of a power supply externally before attempting installation or wiring work. Failure to do so may cause electric shock or damage to the product.
  - Use the product within the generic environment specifications described in the user's manual (hardware) of the CPU module used.  
Do not use the product in areas with excessive dust, oily smoke, conductive dusts, corrosive gas (salt air, Cl<sub>2</sub>, H<sub>2</sub>S, SO<sub>2</sub>, or NO<sub>2</sub>), flammable gas, vibration or impacts, or expose it to high temperature, condensation, or rain and wind.  
If the product is used in such conditions, electric shock, fire, malfunctions, deterioration or damage may occur.
-

## [Installation Precautions]

---

### CAUTION

- Do not touch the conductive parts of the product directly. Doing so may cause device failures or malfunctions.
  - When drilling screw holes or wiring, make sure that cutting and wiring debris do not enter the ventilation slits of a programmable controller. Failure to do so may cause fire, equipment failures or malfunctions.
  - For the product supplied together with a dust proof sheet, the sheet should be affixed to the ventilation slits before the installation and wiring work to prevent foreign objects such as cutting and wiring debris.  
However, when the installation work is completed, make sure to remove the sheet to provide adequate ventilation. Failure to do so may cause fire, equipment failures, or malfunctions.
  - Install the product on a flat surface. If the mounting surface is rough, undue force will be applied to the PC board, thereby causing nonconformities.
  - Install the product securely using a DIN rail or mounting screws.
  - Work carefully when installing the product using a screwdriver. Failure to do so may cause damage to the product or accidents.
  - Connect extension cables, peripheral device cables, input/output cables and battery connecting cables securely to their designated connectors. Loose connections may cause malfunctions.
  - Always turn off the power before attaching or detaching the following devices. Failure to do so may cause failure or malfunction.
    - (1) Peripheral devices, expansion boards, and expansion adapters
    - (2) Extension modules and connector conversion modules
    - (3) Battery
  - The safety extension module is only suitable for mounting in a control panel with at least IP 54 degree of protection.  
Failure to meet the installation method may cause the module to fail or malfunction due to the deposition of dust or the adhesion of water.
  - Wiring and replacement of this product must be performed by qualified maintenance personnel who is familiar with protection against electric shock.
-

## [Wiring Precautions]

---

### **WARNING**

- Make sure to cut off all phases of a power supply externally before attempting installation or wiring work. Failure to do so may cause electric shock or damage to the product.
  - Make sure to attach the terminal cover, provided as an accessory, before turning on the power or initiating operation after installation or wiring work. Failure to do so may cause electric shock.
  - The temperature rating of the cable should be 80°C or more.
  - Make sure to properly wire to the spring clamp terminal block in accordance with the following precautions. Failure to do so may cause electric shock, equipment failures, a short-circuit, wire breakage, malfunctions, or damage to the product.
    - (1) The termination size of the cable end should follow the dimensions described in the manual.
    - (2) Twist the ends of stranded wires and make sure that there are no loose wires.
    - (3) Do not solder-plate the electric wire ends.
    - (4) Do not connect more than the specified number of wires or electric wires of unspecified size.
    - (5) Affix the electric wires so that neither the terminal block nor the connected parts are directly stressed.
- 

## [Wiring Precautions]

---

### **CAUTION**

- Perform class D grounding (grounding resistance: 100 Ω or less) of the grounding terminal on the CPU module and extension modules with a wire 2 mm<sup>2</sup> or thicker.
  - Connect power supply wiring to the dedicated terminals described in this manual. If an AC power supply is connected to a DC input/output terminal or DC power supply terminal, the programmable controller will burn out.
  - Do not wire vacant terminals externally. Doing so may damage the product.
  - Install modules so that excessive force will not be applied to terminal blocks, power connectors, I/O connectors, communication connectors, or communication cables. Failure to do so may result in wire damage/breakage or programmable controller failure.
  - If abnormal data is written to a programmable controller due to the effect of noise, malfunction of the programmable controller may occur which may damage machines or cause accidents. To prevent this, observe the following precautions:
    - (1) Do not bundle a power line, control line, and communication cables together with or lay them close to the main circuit, a high-voltage line, load line, or power line. As a guideline, lay the power line, control line, and connection cables at least 100 mm away from the main circuit, high-voltage line, load line or power line.
  - Check the interface type and correctly connect a cable. Incorrect wiring or connecting a cable to an incorrect interface may cause failure of the module and external device.
-



## [Wiring Precautions]

---

### CAUTION

---

- Connect circuits isolated from hazardous voltage by double/reinforced insulation to terminal blocks or power connectors.
  - Individually ground the GND wires of the safety extension module with a ground resistance of 100  $\Omega$  or less.  
Failure to do so may result in electric shock or malfunction.
  - Check the rated voltage and terminal layout before wiring to the module, and connect the cables correctly.  
Connecting a power supply with a different voltage rating or incorrect wiring may cause a fire or failure.
  - Tighten a terminal screw within the specified torque range.  
Undertightening can cause short circuit, fire, or malfunction. Overtightening can damage the screw and/or module, resulting in drop, short circuit, or malfunction.
  - Mitsubishi safety extension module must be installed in control panels. Connect the main power supply to the safety extension module through a relay terminal block.  
Wiring and replacement of an external power supply must be performed by qualified maintenance personnel who is familiar with protection against electric shock. For wiring methods, refer to Page 89 WIRING.
  - When using the safety extension module under the severe noise environment, take noise reduction measures such as using a surge absorber and a ferrite core.
-

## [Startup and Maintenance Precautions]

---

### **WARNING**

---

- Do not touch any terminals while the programmable controller's power is on. Doing so may cause electric shock or malfunctions.
  - Before cleaning or retightening terminals, cut off all phases of the power supply externally. Failure to do so in the power ON status may cause electric shock.
  - Before modifying a program in operation, forcible output, running or stopping a programmable controller, read through this manual carefully, and ensure that the operation is safe before proceeding. An operation error may damage the machinery or cause accidents.
  - Do not change the program in a programmable controller from two or more peripheral equipment devices such as an engineering tool or a GOT at the same time. Doing so may cause destruction or malfunction of the programmable controller program.
  - Safety-oriented devices must be suitable for safety related signals.  
A function interruption of safety outputs results in a loss of the safety functions so that the risk of serious injury exists.  
Do not connect any loads that exceed the rated values of the safety outputs.  
Wire the safety extension module so that 24 VDC signals cannot unintentionally contact safety outputs.  
Connect the GND wires (ground cable) of a power supply to earth so that the devices do not switch on when the safety output line is applied to the frame potential.  
Use suitable components or devices that fulfill all the applicable regulations and standards.  
Actuators at the outputs can be wired as single channel. In order to maintain the respective safety integrity levels, the lines have to be routed in such a manner that cross circuits to other live signals can be excluded, for example by routing them within protected areas such as in a control panel or in separate sheathed cables.
  - If an error occurs due to an accident or damage, stop the system operation immediately and ensure the safety. Investigate and resolve the causes to run the system again.
-

## [Startup and Maintenance Precautions]

---

### CAUTION

- Do not disassemble or modify the programmable controller. Doing so may cause failure, malfunction, or fire.
  - For repair, please contact your local Mitsubishi Electric sales office.
  - Turn off the power to the programmable controller before connecting or disconnecting any extension cable. Failure to do so may cause device failures or malfunctions.
  - Always turn off the power before attaching or detaching the following devices. Failure to do so may cause failure or malfunction.
    - (1) Peripheral devices, expansion boards, and expansion adapters
    - (2) Extension modules and connector conversion modules
    - (3) Battery
  - Before handling the module, touch a conducting object such as a grounded metal to discharge the static electricity from the human body. Failure to do so may cause the module to fail or malfunction.
  - Restrict the installation and removal of the module and terminal block up to 50 times (IEC 61131-2/JIS B 3502 compliant), after the first use of the product.  
Exceeding the limit may cause malfunction.
  - Startup and maintenance of a control panel must be performed by qualified maintenance personnel who is familiar with protection against electric shock.
- 

## [Operating Precautions]

---

### CAUTION

- When changing data of a running programmable controller, configure an interlock circuit in the program to ensure that the entire system will always operate safely. For other forms of control (such as program modification, parameter change, forced output, or operating status change) of a running programmable controller, read the relevant manuals carefully and ensure that the operation is safe before proceeding. Improper operation may damage machines or cause accidents.
- 

## [Disposal Precautions]

---

### CAUTION

- When disposing of this product, treat it as industrial waste.
- 

## [Transportation Precautions]

---

### CAUTION

- The programmable controller is a precision device. During transportation, avoid impacts larger than those specified in the general specifications of the user's manual (hardware) of the CPU module used by using dedicated packaging boxes and shock-absorbing pallets. Failure to do so may cause failures in the programmable controller. After transportation, verify operation of the programmable controller and check for damage of the mounting part, etc.
-



# PRÉCAUTIONS DE SÉCURITÉ

---

(Lire ces précautions avant toute utilisation du produit.)

Avant d'utiliser ce produit, lire attentivement ce manuel, les manuels auxquels il renvoie ainsi que les normes de sécurité, et toujours considérer la sécurité comme de la plus haute importance en manipulant le produit correctement.

Les précautions de sécurité indiquées dans ce manuel concernent uniquement ce produit. Pour les précautions de sécurité relatives au contrôleur programmable, voir le Manuel de l'Utilisateur du module CPU utilisé.

Dans ce chapitre, les précautions de sécurité sont regroupées en deux catégories : [ AVERTISSEMENT] et [ ATTENTION].

---

 <b>WARNING</b>	Indicates that incorrect handling may cause hazardous conditions, resulting in death or severe injury.
--	--

---

 <b>CAUTION</b>	Indicates that incorrect handling may cause hazardous conditions, resulting in minor or moderate injury or property damage.
--	---

---

Dans certaines circonstances, le non-respect d'une précaution de sécurité introduite sous le titre [ ATTENTION] peut avoir des conséquences graves.

Les précautions de ces deux niveaux doivent être observées dans leur intégralité car elles ont trait à la sécurité des personnes et aussi du système.

Veiller à ce que les utilisateurs finaux lisent ce manuel qui doit être conservé soigneusement à portée de main pour s'y référer autant que de besoin.

## [PRÉCAUTIONS DE CONCEPTION]

---

### **AVERTISSEMENT**

---

- Lorsque le module d'extension de sécurité détecte un problème d'alimentation externe ou une panne du module d'extension de sécurité lui-même, la sortie est désactivée. Configurez un circuit externe afin d'arrêter de façon certaine toute alimentation dangereuse en cas de désactivation de la sortie du module d'extension de sécurité. Faute de quoi, il y a un risque d'accident.
  - Assurez-vous de configurer les circuits de sécurité suivants en dehors du contrôleur programmable pour assurer un fonctionnement sûr du système, même pendant les problèmes d'alimentation externe ou la panne du contrôleur programmable. Faute de quoi, des dysfonctionnements peuvent causer des accidents graves.
    - (1) Configurez surtout ce qui suit : un circuit d'arrêt d'urgence, un circuit de protection, un circuit de verrouillage pour les mouvements opposés (tels que la rotation normale ou inversée) et un circuit de verrouillage (pour éviter d'endommager l'équipement aux niveaux supérieur et inférieur de limites de positionnement).
    - (2) Notez que lorsqu'une erreur se produit dans un relais, un transistor ou un triac d'un circuit de sortie, la sortie peut rester activée ou désactivée. Pour les signaux de sortie susceptibles d'entraîner des accidents graves, des circuits et des mécanismes externes doivent être conçus pour assurer le fonctionnement sûr des machines dans un tel cas.
  - Dans un circuit de sortie, si le courant de charge excède la valeur nominale ou si une surintensité causée par un court-circuit à la charge persiste longtemps, il peut en résulter un dégagement de fumée avec départ de feu. Pour éviter cela, il faut configurer un circuit de sécurité externe tel qu'un fusible.
  - Construire un circuit de verrouillage dans le programme afin que l'ensemble du système fonctionne toujours sur le côté sûr avant d'exécuter le contrôle (pour le changement de données) du contrôleur programmable en fonctionnement.

Lisez attentivement le manuel et assurez-vous une sécurité complète avant d'exécuter d'autres commandes (pour le changement de programme, le changement de paramètre, la sortie forcée et le changement d'état d'opération) du contrôleur programmable en cours de fonctionnement.

Faute de quoi, la machine peut être endommagée et des accidents peuvent se produire en raison d'opérations erronées.
  - Configurez un circuit de protection externe au module d'extension de sécurité, comprenant notamment une protection du relais de sécurité contre les courants de court-circuit, des fusibles et un disjoncteur.
  - Configurez un programme de verrouillage, utilisant un bouton de réinitialisation ou un dispositif similaire, afin que le système ne redémarre pas sans opération manuelle après l'activation de la fonction de sécurité et la désactivation de la sortie.
-

## [PRÉCAUTIONS DE CONCEPTION]

---

### **ATTENTION**

---

- À la commande d'une charge inductive comme une lampe, un réchauffeur ou une électrovanne, un fort courant (environ 10 fois supérieur à l'intensité normale) peut traverser la sortie quand celle-ci passe de OFF à ON. Prenez les mesures appropriées pour que l'intensité de courant ne dépasse pas la valeur correspondant à la spécification de charge maximale de la charge de résistance.
  - Mettez le module FX5 CPU et le module d'extension de sécurité sous tension en même temps. Si une erreur de connexion se produit après avoir mis les deux modules sous tension en même temps, vérifiez l'alimentation des deux modules.  
Dans le cas où un même circuit serait utilisé pour alimenter le contrôleur programmable et un autre appareil, il sera nécessaire de séparer le circuit afin de pouvoir mettre les appareils sous et hors tension indépendamment.  
Si une erreur de connexion se produit, vérifiez le code de l'erreur, puis mettez le module CPU et le module d'extension de sécurité hors tension avant de remettre les deux modules sous tension en même temps.
  - La catégorie de sécurité est définie par l'évaluation de l'équipement dans son ensemble. Procédez à toutes les vérifications nécessaires avant d'utiliser l'équipement.
  - Afin d'éviter la génération de bruit et de chaleur, maintenez les distances suivantes entre les appareils (contacteur, relais, etc.) et le contrôleur programmable, ainsi qu'entre les câbles des dispositifs externes et d'alimentation et les câbles du contrôleur programmable.
    - Distance entre les câbles: 100 mm ou plus
    - Distance entre les appareils: 50 mm ou plus
  - Lorsqu'un contact mécanique, tel qu'un relais, est connecté à l'entrée du module d'extension de sécurité, un cliquetis peut parfois entrer en tant que signal.
-

## [PRÉCAUTIONS DE CONCEPTION]

---

### **ATTENTION**

- Les précautions et les mesures de sécurité doivent être respectées.  
Respectez les précautions suivantes afin d'utiliser correctement le module d'extension de sécurité.
    - (1) Soyez sûr de respecter les normes et les directives qui s'appliquent dans le pays où le module d'extension de sécurité est installé et utilisé.
    - (2) Vous devez vous conformer aux directives ci-dessous lorsque vous utilisez le module d'extension de sécurité dans un Etat membre de l'Union européenne.
      - Directive 2006/42/CE relative aux machines
      - Directive 2004/108/CE relative à la CEM
      - Directive 89/655/CE concernant l'utilisation d'équipements de travail
      - Les autres lois et règlements relatifs à la sécurité au travail
    - (3) Les fabricants et les propriétaires d'équipements utilisés avec le module d'extension de sécurité sont responsables de la connaissance et du respect de toutes les lois et de tous les règlements qui s'appliquent.
    - (4) Il est extrêmement important de respecter le contenu de ce manuel, en particulier le contenu concernant les essais indiqué dans ce manuel.
    - (5) Les essais doivent être réalisés par des techniciens experts en sécurité ou par un responsable détenant les qualifications et les habilitations nécessaires. La mise en œuvre de ces essais doit être consignée et documentée afin qu'ils puissent être reproduits et vérifiés par un tiers.
    - (6) Conformément à la norme CEI 60204-1, l'alimentation externe de l'équipement doit pouvoir résister à une coupure de 20 ms.
    - (7) Le module d'extension de sécurité est un appareil de classe A groupe 1 conformément à la norme EN 55011. Le groupe 1 inclut tous les appareils industriels, scientifiques et médicaux (ISM) qui génèrent ou utilisent de façon délibérée des radiations électromagnétiques suffisantes pour utiliser les fonctions internes de l'appareil.
  - Le module d'extension de sécurité est conforme aux spécifications de base concernant l'immunité aux rayonnements électromagnétiques et remplit les conditions des appareils de classe A (à usage industriel).  
Par conséquent, le module d'extension de sécurité ne peut être utilisé que dans un environnement industriel. Il ne peut pas être utilisé dans un environnement résidentiel.
  - Le produit doit être utilisé par un technicien de maintenance suffisamment formé.
- 

## [PRÉCAUTIONS D'INSTALLATION]

---

### **AVERTISSEMENT**

- Assurez-vous de couper toutes les phases de l'alimentation externe avant d'essayer l'installation ou le câblage. Faute de quoi, il y a risque d'électrocution ou d'endommagement du produit.
  - Utilisez le produit dans un environnement conforme aux spécifications générales indiquées dans le Manuel de l'Utilisateur (Matériel) du module CPU utilisé.  
Ne jamais utiliser le produit dans les zones à poussières excessives, à fumées grasses, à poussières conductrices, à gaz corrosifs (air salé, Cl<sub>2</sub>, H<sub>2</sub>S, SO<sub>2</sub> ou NO<sub>2</sub>), à gaz inflammables, à vibrations ou à impacts, ou l'exposer à haute température, à condensation ou à pluie et vent.  
Si le produit est utilisé dans de telles conditions, l'électrocution, le feu, des dysfonctionnements, des détériorations ou des dommages peuvent se produire.
-

## [PRÉCAUTIONS D'INSTALLATION]

---

### **ATTENTION**

---

- Ne pas toucher directement les parties conductrices du produit. Cela pourrait être à l'origine d'une panne ou d'un dysfonctionnement.
  - Lors du perçage des trous de vis ou du câblage, assurez-vous que les débris de coupe et de câblage ne pénètrent pas dans les fentes de ventilation du contrôleur programmable. Faute de quoi, il y a risque de départ de feu, de panne ou de dysfonctionnement de l'équipement.
  - Pour le produit fourni avec une feuille anti-poussière, la feuille doit être fixée aux fentes de ventilation avant l'installation et le câblage pour éviter les objets étrangers tels que les débris de coupe et de câblage.  
Cependant, lorsque les travaux d'installation sont terminés, assurez-vous d'enlever la feuille pour assurer une ventilation adéquate. Faute de quoi, il y a risque de départ de feu, de panne ou de dysfonctionnement de l'équipement.
  - Installez le produit sur une surface plane. Si la surface de montage est rugueuse, une force excessive sera appliquée à la carte PC, ce qui entraînera des non-conformités.
  - Installez le produit solidement à l'aide d'un rail DIN ou de vis de montage.
  - Travailler soigneusement lorsque vous utilisez un tournevis comme pour l'installation du produit. Faute de quoi, il y a risque d'endommagement du produit ou des accidents.
  - Connectez les câbles d'extension, les câbles de périphériques, les câbles d'entrée/sortie et le câble de connexion de la batterie solidement à leurs connecteurs désignés. Les connexions lâches peuvent provoquer des dysfonctionnements.
  - Coupez l'alimentation du contrôleur programmable avant d'attacher ou de détacher les appareils suivants. Faute de quoi, il y a risque de panne ou de dysfonctionnement des équipements.
    - (1) Périphériques, carte d'extension, adaptateur d'extension
    - (2) Module d'extension, module de conversion de connecteur
    - (3) Batterie
  - Le module d'extension de sécurité doit être installé sur un boîtier de commutation avec un indice de protection IP54 ou supérieur.  
La poussière et l'eau peuvent provoquer des dysfonctionnements et une panne du module.
  - Le produit doit être utilisé par un technicien de maintenance suffisamment formé.
-



## [PRÉCAUTIONS DE CABLAGE]

---

### **AVERTISSEMENT**

- Assurez-vous de couper toutes les phases de l'alimentation externe avant d'essayer l'installation ou le câblage. Faute de quoi, il y a risque d'électrocution ou d'endommagement du produit.
  - Assurez-vous d'attacher le couvercle de borne, fourni en tant qu'accessoire, avant d'alimentation ou d'opération de lancement après installation ou câblage. Faute de quoi, il y a risque d'électrocution.
  - La température nominale du câble doit être de 80°C ou plus.
  - Assurez-vous de bien câbler la plaque à bornes avec bride à ressort conformément aux précautions suivantes. Faute de quoi, il y a le risque d'électrocutions, de pannes d'équipement, de court-circuit, de rupture du fil, de dysfonctionnements ou de dommages au produit.
    - (1) La taille des extrémités du câble lors de la mise au rebut doit suivre les dimensions décrites dans le manuel.
    - (2) Tordre les extrémités des fils échoués et s'assurer qu'il n'y a pas de fils lâches.
    - (3) Ne pas souder et plaquer les extrémités des fils électriques.
    - (4) Ne pas connecter plus que le nombre spécifié de fils ou fils électriques de taille non spécifiée.
    - (5) Fixez les fils électriques de sorte que ni le bornier ni les pièces connectées ne soient directement soumis à une contrainte.
- 

## [PRÉCAUTIONS DE CABLAGE]

---

### **ATTENTION**

- Effectuer la mise à la terre classe D (résistance à la mise à la terre : 100  $\Omega$  ou moins) de la borne de mise à la terre sur le module CPU et les modules d'extension avec un fil de 2 mm<sup>2</sup> ou plus épais.
  - Connectez le câblage d'alimentation aux bornes dédiées décrites dans ce manuel. Quand l'alimentation AC est connectée à une borne d'E/S ou à une borne d'alimentation DC, le contrôleur programmable s'éteindra.
  - Ne pas câbler les bornes vides à l'extérieur. Cela pourrait endommager le produit.
  - Installer le module afin que la force excessive ne soit pas appliquée aux borniers, aux connecteurs d'alimentation, aux connecteurs E/S, aux connecteurs de communication ou aux câbles de communication. Faute de quoi, il y a risque d'endommagement ou de rupture ou de panne du contrôleur programmable.
  - Assurez-vous d'observer les précautions suivantes afin d'éviter tout endommagement aux machines ou les accidents dues au dysfonctionnement du contrôleur programmable causé par des données anormales écrites sur le contrôleur programmable en raison d'effets du bruit.
    - (1) Ne pas regrouper la ligne d'alimentation, la ligne de commande et les câbles de communication, ou ni les placer près du circuit principal, la ligne à haute tension, la ligne de charge ou la ligne d'alimentation. À titre indicatif, posez la ligne d'alimentation, la ligne de commande et les câbles de communication au moins à 100 mm du circuit principal, de la ligne à haute tension, de la ligne de charge ou de la ligne d'alimentation.
  - Les câbles doivent être connectés après avoir vérifié le type de l'interface de connexion. Connecter les câbles à une mauvaise interface ou connecter les câbles de façon incorrecte peut provoquer une panne du module ou des dispositifs externes.
-

## [PRÉCAUTIONS DE CABLAGE]

---

### **ATTENTION**

---

- Connectez le connecteur d'alimentation et le bornier à un circuit isolé des tensions dangereuses au moyen d'une isolation double ou renforcée.
  - Effectuez une mise à la terre de classe D (résistance à la mise à la terre : 100  $\Omega$  ou moins) du module d'extension de sécurité.  
Faute de quoi, il y a un risque d'électrocution et de dysfonctionnement.
  - Vérifiez la tension nominale et la disposition des bornes avant d'effectuer le câblage afin de connecter le module correctement.  
Connecter le module de façon incorrecte ou à une tension différente peut provoquer un feu ou une panne.
  - Serrez les vis des bornes au couple de serrage indiqué.  
Des vis de bornes mal serrées peuvent provoquer un court-circuit, un feu ou un dysfonctionnement.  
Des vis de bornes trop serrées peuvent endommager les vis et le module et provoquer une chute, un court-circuit ou un dysfonctionnement.
  - Le module d'extension de sécurité doit être installé et utilisé dans un boîtier de commutation. Le câble d'alimentation principal connecté au module d'extension de sécurité installé dans le boîtier de commutation doit passer par un bornier relais.  
Le remplacement de l'alimentation et le câblage doivent être réalisés par un technicien de maintenance suffisamment formé à la prévention des risques d'électrocution. Voir Page 89 WIRING pour la méthode de câblage.
  - Dans les environnements stricts concernant les niveaux de bruit, prenez des mesures externes de prévention du bruit, telles que l'installation d'un parasurtenseur ou d'un cœur de ferrite.
-

## [PRÉCAUTIONS DE MISE EN SERVICE ET DE MAINTENANCE]

---

### **AVERTISSEMENT**

---

- Ne toucher aucune borne quand le contrôleur programmable est sous tension. Cela pourrait être à l'origine d'électrocutions ou de dysfonctionnements.
  - Avant de nettoyer ou de resserrer les bornes, couper toutes les phases de l'alimentation externe. Faute de quoi, il y a risque d'électrocution avec les bornes sous tension.
  - Avant d'effectuer une modification au programme en cours, une sortie forcée, ou une exécution ou un arrêt du contrôleur programmable, lisez attentivement ce manuel et assurez-vous une sécurité complète. Une opération erronée peut endommager la machine ou provoquer des accidents.
  - Ne pas modifier le programme dans le contrôleur programmable à partir de deux ou plusieurs périphériques en même temps (c'est-à-dire à partir d'un outil d'ingénierie et d'un GOT). Cela pourrait être à l'origine des destructions ou des dysfonctionnement du programme du contrôleur programmable.
  - Utilisez un dispositif de sécurité adapté aux signaux de sécurité.  
Les problèmes dans les fonctions liées à la sortie de sécurité peuvent provoquer une perte des fonctions de sécurité et entraîner des blessures graves.  
Ne connectez pas le produit à une charge supérieure aux valeurs nominales de la sortie de sécurité.  
Branchez le module d'extension de sécurité de manière à ce que le courant continu de 24 V n'entre pas en contact par erreur avec la sortie de sécurité.  
Reliez la ligne de terre à la terre et de manière à ce que l'appareil ne se mette pas en tension lorsque le câble de la sortie de sécurité entre en contact avec le potentiel de la masse.  
Utilisez uniquement des pièces et des appareils conformes à la législation et aux normes qui s'appliquent.  
L'actionneur de la borne de sortie peut être branché en monovoie. Afin de maintenir les niveaux de sécurité, gainez les câbles de signal séparément ou installez-les dans un espace protégé comme à l'intérieur du boîtier de commutation afin d'éviter des courts-circuits avec les autres signaux.
  - En cas de problème, tel qu'un accident ou des dommages sur un appareil, arrêtez immédiatement le système et assurez la sécurité. Recherchez et supprimez la cause du problème avant de refaire fonctionner le système.
-

## [PRÉCAUTIONS DE MISE EN SERVICE ET DE MAINTENANCE]

---

### ATTENTION

- Ne pas démonter ni modifier le contrôleur programmable. Cela pourrait causer un départ de feu, une panne ou un dysfonctionnement des équipements.
  - Pour réparation, contactez votre représentant local de Mitsubishi Electric.
  - Coupez l'alimentation du contrôleur programmable avant de connecter ou déconnecter les câbles d'extension. Faute de quoi, il y a risque de panne ou de dysfonctionnement des équipements.
  - Coupez l'alimentation du contrôleur programmable avant d'attacher ou de détacher les appareils suivants. Faute de quoi, il y a risque de panne ou de dysfonctionnement des équipements.
    - (1) Périphériques, carte d'extension, adaptateur d'extension
    - (2) Module d'extension, module de conversion de connecteur
    - (3) Batterie
  - Avant de toucher le module, touchez un conducteur électrique, tel qu'un morceau de métal relié à la terre, afin de décharger l'électricité statique de votre corps. Si vous ne déchargez pas cette électricité statique, vous risquez de provoquer une panne ou un dysfonctionnement du module.
  - Après l'utilisation du produit, n'installez pas et ne retirez pas le module ou le bornier plus de 50 fois. (Conformément aux normes JIS B 3502 et CEI 61131-2)  
Au-delà de cette limite, il y a un risque de dysfonctionnement.
  - Le produit doit être utilisé par un technicien de maintenance suffisamment formé.
- 

## [PRECAUTIONS D'OPÉRATION]

---

### ATTENTION

- Construire un circuit de verrouillage dans le programme afin que l'ensemble du système fonctionne toujours sur le côté sûr avant d'exécuter le contrôle (pour le changement de données) du contrôleur programmable en fonctionnement. Lisez attentivement le manuel et assurez-vous une sécurité complète avant d'exécuter d'autres commandes (pour le changement de programme, le changement de paramètre, la sortie forcée et le changement d'état d'opération) du contrôleur programmable en cours de fonctionnement. Sinon, la machine peut être endommagée et des accidents peuvent se produire à cause des opérations erronées.
- 

## [PRÉCAUTIONS DE MISE AU REBUT]

---

### ATTENTION

- Veuillez contacter une société certifiée de mise au rebut des déchets électroniques pour le recyclage et la mise au rebut écologique de votre équipement.
-

## [PRÉCAUTIONS DE TRANSPORT]

---

### **ATTENTION**

---

- Le contrôleur programmable est un instrument de précision. Pendant le transport, évitez de dépasser le niveau de choc indiqué dans les spécifications générales mentionnées dans le Manuel de l'Utilisateur (Matériel) du module CPU, notamment en plaçant le contrôleur dans une boîte spéciale ou en utilisant une palette amortisseuse. Faute de quoi, il y a un risque de panne. Après le transport, vérifiez que le contrôleur programmable fonctionne correctement et que les pièces de montage ne sont pas endommagées.
-

# INTRODUCTION

Thank you for purchasing MELSEC iQ-F series programmable controllers.

This manual describes the handling of MELSEC iQ-F series safety extension modules.

Before using this product, please read this manual and relevant manuals carefully and develop familiarity with the specifications to handle the product correctly.

Please make sure that the end users read this manual.

## Conditions of use for the product

Although Mitsubishi Electric has obtained the certification for Product's compliance to the international safety standards IEC61508 and ISO13849-1 from TUV Rheinland, this fact does not guarantee that Product will be free from any malfunction or failure. The user of this Product shall comply with any and all applicable safety standard, regulation or law and take appropriate safety measures for the system in which the Product is installed or used and shall take the second or third safety measures other than the Product. Mitsubishi Electric is not liable for damages that could have been prevented by compliance with any applicable safety standard, regulation or law.

## Regarding use of this product

- This product has been manufactured as a general-purpose part for general industries, and has not been designed or manufactured to be incorporated in a device or system used in purposes related to human life.
- Before using the product for special purposes such as nuclear power, electric power, aerospace, medical, or passenger movement vehicles, please contact Mitsubishi Electric sales office.
- This product has been manufactured under strict quality control. However, when installing the product where major accidents or losses could occur if the product fails, install appropriate backup or failsafe functions in the system.

## Note

- If in doubt at any stage during the installation of the product, always consult a professional electrical engineer who is qualified and trained in the local and national standards. If in doubt about the operation or use, please contact your local Mitsubishi Electric representative.
- Since the examples indicated by this manual, technical bulletin, catalog, etc. are used as a reference, please use the product after confirming the function and safety of the equipment and system.
- This manual content, specification etc. may be changed, without a notice, for improvement.
- The information in this manual has been carefully checked and is believed to be accurate; however, if you notice a doubtful point, an error, etc., please contact your local Mitsubishi Electric representative. When doing so, please provide the manual number given at the end of this manual.

# CONTENTS

PRECAUTIONS REGARDING WARRANTY .....	1
SAFETY PRECAUTIONS .....	1
PRÉCAUTIONS DE SÉCURITÉ .....	10
INTRODUCTION .....	20
RELEVANT MANUALS .....	23
TERMS .....	24
<b>CHAPTER 1 OVERVIEW</b> .....	<b>25</b>
<b>CHAPTER 2 SPECIFICATIONS</b> .....	<b>27</b>
2.1 General Specifications .....	27
Dielectric withstand voltage test and insulation resistance test .....	27
2.2 Safety Specifications .....	27
2.3 Power Supply Specifications .....	28
2.4 Performance Specifications .....	29
2.5 Safety Output Derating Curve .....	31
2.6 Parts Names .....	32
<b>CHAPTER 3 PROCEDURES BEFORE OPERATION</b> .....	<b>36</b>
<b>CHAPTER 4 FUNCTIONS</b> .....	<b>38</b>
4.1 List of Functions .....	38
4.2 Built-In Program Selection Function .....	39
4.3 Off Delay Delay Setting Function .....	67
4.4 Muting Function .....	69
4.5 AND link .....	71
4.6 OR link .....	74
4.7 Bypass .....	76
4.8 Restart Interlock .....	77
4.9 External Device Monitoring (EDM) .....	78
4.10 Retriggering of the Delayed OSSDs .....	79
4.11 ENABLE Input (XS0 Terminal) .....	80
4.12 Two-Hand Operation/Jog Mode .....	81
4.13 Error History .....	82
4.14 Safety Information Monitoring Function .....	85
<b>CHAPTER 5 SYSTEM CONFIGURATION</b> .....	<b>87</b>
<b>CHAPTER 6 WIRING</b> .....	<b>89</b>
6.1 Spring Clamp Terminal Block .....	89
6.2 Terminal Arrangement .....	92
6.3 Grounding .....	96
6.4 External Wiring Example .....	97
Considerations on wiring external devices .....	106
6.5 Installation of Muting Sensors .....	108
<b>CHAPTER 7 PARAMETER SETTINGS</b> .....	<b>111</b>
7.1 Refresh Setting .....	111

<b>CHAPTER 8 PROGRAMMING</b>	<b>113</b>
8.1 Programming Procedure	113
8.2 Programming Method (for FX5-SF-MU4T5/FX5-SF-8DI4)	114
Applying a setting	114
8.3 Programming Method (for FX5 CPU module)	115
<b>CHAPTER 9 COMMISSIONING</b>	<b>117</b>
9.1 Validation of Application	117
9.2 Considerations for Inspection	117
<b>CHAPTER 10 TROUBLESHOOTING</b>	<b>119</b>
10.1 Checking Errors with LEDs	119
10.2 Checking Errors with an Engineering Tool	122
10.3 Troubleshooting by Symptom	125
POWER LED on a safety extension module turns OFF	125
ERROR LED on an FX5 CPU module flashes	125
ERROR LED on a safety extension module flashes	125
Turning ON the power of a system including a safety extension module	126
10.4 List of Error Codes	127
<b>APPENDIX</b>	<b>133</b>
Appendix 1 External Dimensions	133
Appendix 2 Standards	134
Certification of UL, cUL standards	134
Compliance with EC directive (CE marking)	134
Requirement for compliance with EMC directive	134
Considerations for complying with EC directive	135
Machinery directive	135
Compliance with UKCA marking	136
Appendix 3 Checklist for Manufacturer	137
Appendix 4 Module Labels	138
Appendix 5 Buffer Memory	140
List of buffer memory	140
Details of buffer memory addresses	143
Appendix 6 How to Use MELSEC iQ-F Series Safety Extension Module Configuration Guide	155
Confirmed browsers	155
Procedure to use	157
Screen configuration	158
Operation	165
Troubleshooting	170
Appendix 7 Software Licenses and Copyrights	172
<b>INDEX</b>	<b>178</b>
REVISIONS	180
WARRANTY	181
TRADEMARKS	182
COPYRIGHTS	182



# RELEVANT MANUALS

Manual name <manual number>	Description
MELSEC iQ-F FX5S/FX5UJ/FX5U/FX5UC User's Manual (Hardware) <SH-082452ENG>	Describes the details of hardware of the CPU module, including performance specifications, wiring, installation, and maintenance.
MELSEC iQ-F FX5 User's Manual (Application) <JY997D55401>	Describes the basic knowledge required for program design, functions of the CPU module, devices/ labels, and parameters.
MELSEC iQ-F FX5 Programming Manual (Program Design) <JY997D55701>	Describes the specifications of ladder, ST, FBD/LD, and SFC programs, and labels.
MELSEC iQ-F FX5 Programming Manual (Instructions, Standard Functions/Function Blocks) <JY997D55801>	Describes the specifications of instructions and functions that can be used in programs.
MELSEC iQ-F FX5 Safety Extension Module User's Manual <SH-082078ENG> (This manual)	Describes the safety extension module.
GX Works3 Operating Manual <SH-081215ENG>	Describes the system configuration, parameter settings, and online operations of GX Works3.

# TERMS

Unless otherwise specified, this manual uses the following terms.

Term	Description
<b>■Devices</b>	
FX5	A generic term for FX5UJ, FX5U, and FX5UC programmable controllers.
FX5 CPU module	A generic term for FX5UJ CPU modules, FX5U CPU modules, and FX5UC CPU modules.
FX5UJ CPU module	A generic term for FX5UJ-24MR/ES, FX5UJ-24MT/ES, FX5UJ-24MT/ESS, FX5UJ-40MR/ES, FX5UJ-40MT/ES, FX5UJ-40MT/ESS, FX5UJ-60MR/ES, FX5UJ-60MT/ES, and FX5UJ-60MT/ESS.
FX5U CPU module	A generic term for FX5U-32MR/ES, FX5U-32MT/ES, FX5U-32MT/ESS, FX5U-64MR/ES, FX5U-64MT/ES, FX5U-64MT/ESS, FX5U-80MR/ES, FX5U-80MT/ES, FX5U-80MT/ESS, FX5U-32MR/DS, FX5U-32MT/DS, FX5U-32MT/DSS, FX5U-64MR/DS, FX5U-64MT/DS, FX5U-64MT/DSS, FX5U-80MR/DS, FX5U-80MT/DS, and FX5U-80MT/DSS.
FX5UC CPU module	A generic term for FX5UC-32MT/D, FX5UC-32MT/DSS, FX5UC-64MT/D, FX5UC-64MT/DSS, FX5UC-96MT/D, FX5UC-96MT/DSS, FX5UC-32MT/DS-TS, FX5UC-32MT/DSS-TS, and FX5UC-32MR/DS-TS.
Extension module	A generic term for FX5 extension modules and FX3 extension modules.
FX5 extension module	A generic term for I/O modules, FX5 extension power supply modules, and FX5 intelligent function modules.
Extension power supply module	A generic term for FX5 extension power supply modules and FX3 extension power supply modules.
FX5 extension power supply module	A generic term for FX5 extension power supply modules (extension cable type) and FX5 extension power supply modules (extension connector type).
FX5 extension power supply module (extension cable type)	Another term for FX5-1PSU-5V.
FX5 extension power supply module (extension connector type)	Another term for FX5-C1PS-5V.
Intelligent function module	A generic term for FX5 intelligent function modules and FX3 intelligent function modules.
FX5 intelligent function module	A generic term for FX5-4AD, FX5-4DA, FX5-8AD, FX5-4LC, FX5-20PG-P, FX5-20PG-D, FX5-40SSC-S, FX5-80SSC-S, FX5-ENET, FX5-CCLIEF, FX5-CCL-MS, FX5-ASL-M, and FX5-DP-M.
Safety expansion module	A generic term for expansion modules attached to a safety main module.
Safety main module	Another term for FX5-SF-MU4T5.
Safety extension module	A generic term for safety main modules and safety expansion modules.
Safety input expansion module	Another term for FX5-SF-8DI4
Connector conversion module	A generic term for connector conversion modules (extension cable type) and connector conversion modules (extension connector type).
Connector conversion module (extension cable type)	Another term for FX5-CNV-IF.
Connector conversion module (extension connector type)	Another term for FX5-CNV-IFC.
Peripheral device	A generic term for engineering tools and GOTs.
GOT	A generic term for Mitsubishi Electric Graphic Operation Terminal GOT1000 and GOT2000 series.
<b>■Software packages</b>	
Engineering tool	A generic product name of software packages for the MELSEC programmable controllers.
GX Works3	A generic product name for SWnDND-GXW3. ('n' indicates its version.)
<b>■Safety control</b>	
EDM	An abbreviation for the external device monitoring function.
ESPE	An abbreviation for the electro-sensitive protective equipment.
N/C	An abbreviation for normally closed.
N/O	An abbreviation for normally open.
OSSD	An abbreviation for the output signal switching device.
PFHd	An abbreviation for the probability of dangerous failure per hour.
SIL	An abbreviation for the safety integrity level.

# 1 OVERVIEW

Safety extension module is a module that can configure a safety control system with an FX5 CPU module.

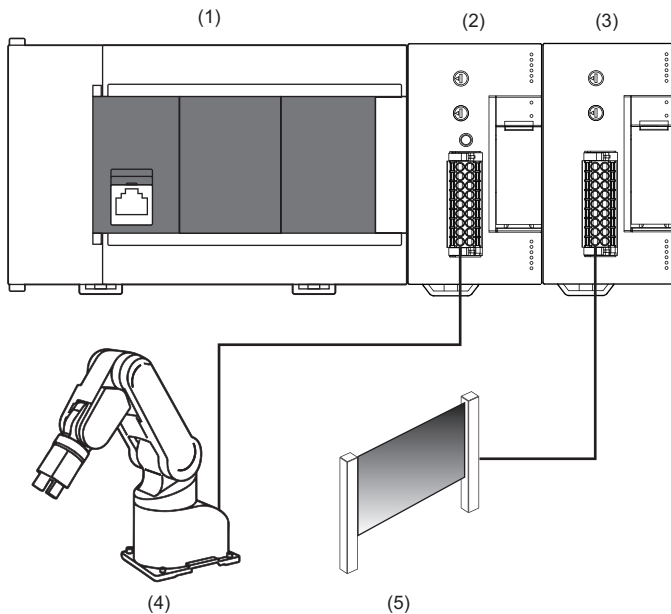

- (1) FX5 CPU module
- (2) Safety main module (FX5-SF-MU4T5)
- (3) Safety input expansion module (FX5-SF-8DI4)
- (4) Robots
- (5) Light curtains

## Features

The following explains the features of a safety extension module.

### ■ Easy to construct a safety control system

A safety extension module can be attached directly to the iQ-F bus.

Therefore, only by connecting a safety extension module to a general control system, the conventional system can be expanded to a safety control system.

Additionally, each status of the safety control (such as safety inputs/outputs and error statuses) can be monitored.

### ■ Construct a safety system without programming

A safety control system can be constructed by selecting a built-in program of a safety extension module.

No sequence program for the safety control is required.

### ■ Easy to troubleshoot

When an error occurred on a safety control side, the error status can be easily checked in the monitor of GX Works3 or the module diagnostic screen; therefore, troubleshooting can be done easily.

Additionally, unlike a general safety relay and a safety controller, the safety wiring or setting of a communication gateway module to monitor the safety control status is not required because a safety extension module can be attached directly to the iQ-F bus.

# MEMO

---

# 2 SPECIFICATIONS

This chapter explains the specifications of a safety extension module.

## 2.1 General Specifications

The following shows the specifications of a safety extension module.

The general specifications other than below are the same as those of the CPU module to be connected.

For the general specifications, refer to the following:

📖 MELSEC iQ-F FX5S/FX5UJ/FX5U/FX5UC User's Manual (Hardware)

Item	Specification
Electromagnetic Compatibility (EMC)	EN 61000-6-2, EN 61131-2, EN 61326-3-1, EN 55011 (classA)
Protection degree	IP20

### Dielectric withstand voltage test and insulation resistance test

Perform dielectric withstand voltage test and insulation resistance test at the following voltages between each terminal and the safety extension module ground terminal.

Wire the terminals with caution since each terminal is not insulated.

Between terminals	Dielectric withstand voltage	Insulation resistance
Between the power supply terminal of safety extension module (DC power supply) and CPU module ground terminal	500 VAC for one minute	10 M $\Omega$ or higher by 500 VDC insulation resistance tester.
Between safety extension module input terminal and CPU module ground terminal		
Between safety extension module output terminal and CPU module ground terminal		

## 2.2 Safety Specifications

The following shows the safety-related parameters of a safety extension module.

Item	Specification
Safety integrity level	SIL3 (IEC 61508, EN IEC 62061)
Category	Category 4 (EN ISO 13849-1)
Performance level	PL e (EN ISO 13849-1)
PFHd	$1.5 \times 10^{-8}$
T <sub>M</sub> (mission time)	20 years (EN ISO 13849-1)

## 2.3 Power Supply Specifications

### Power supply specifications of an FX5-SF-MU4T5

Item	Specification
Internal power supply	5 VDC 200 mA, 24 VDC 5 mA
External power supply	24 VDC (+20%, -15%) 125 mA
Power supply voltage circuit system	PELV or SELV <sup>*1</sup> , max. 6 A <sup>*2</sup>
Rated input current <sup>*3</sup>	5.2 A

\*1 PELV (protective extra low voltage) and SELV (safety extra low voltage) are circuits that are protected by voltage limit or insulation.

\*2 The current of the power supply that powers the module must be limited to a maximum of 6 A, either through the power supply itself or a fuse.

\*3 The maximum current supplied from the external power supply when using all output terminals in the maximum configuration that can be configured (attaching FX5-SF-MU4T5 (one module) and FX5-SF-8DI4 (two modules)).

### Power supply specifications of an FX5-SF-8DI4

Item	Specification
Internal power supply <sup>*1</sup>	24 VDC (+20%, -15%) 125 mA

\*1 Electric power provided from the external power supply of FX5-SF-MU4T5.

## 2.4 Performance Specifications

The following shows the performance specifications.

### Safety inputs of an FX5-SF-MU4T5

Item	Specification	
Number of inputs	4 points	
Input voltage (ON)	13 VDC or more (13 VDC to 30 VDC)	
Input voltage (OFF)	5 VDC or less (-5 VDC to 5 VDC)	
Input current (ON)	3 mA (2.4 mA to 3.8 mA)	
Input current (OFF)	2.1 mA or less (-2.5 mA to 2.1 mA)	
Input response time (filter delay)	2 ms	
Indication of input operation	LED lights when an input is ON.	
Minimum switch-off time <sup>*1,*2</sup> (I0/I1)	Program 1, 2, 4, 5, 6, and 9	24 ms
	Program 3.1, 7, and 8	4 ms
	Program 3.2	76 ms/24 ms
Minimum switch-off time <sup>*1,*2</sup> (I2/I3)	Program 4, 5, and 6	24 ms
	Program 1, 2, 3, 7, 8, and 9	4 ms
Synchronous time monitoring	Program 1 and 2	1500 ms
	Program 4 and 5	500 ms
Muting ON <sup>*3</sup>	Program 3	61 ms
Muting OFF	Program 3	61 ms (165 ms <sup>*4</sup> )
Muting gap suppression <sup>*5</sup>	Program 3	94 ms to 100 ms
Reset time		106 ms
Maximum teach-in time of the ENTER button <sup>*6</sup>		3 s
Duration of actuation of a reset button (X0 and X1)		50 ms to 5 s

\*1 The minimum switch-off time is the minimum time takes until a switch-off condition is detected after a module is switched off.

\*2 A response time without any sensors. When sensors are connected, the data of the connected sensors is applied and the minimum switch-off time is extended.

\*3 The time from when a muting condition is enabled (I2/I3 are turned ON) until the muting function is activated.

\*4 Indicates the maximum switch-off time when a muting error occurs.

\*5 A muting input (I2 or I3) keeps OFF for the specified period of time.

\*6 A time from when an ERROR LED starts flashing.

### General inputs of an FX5-SF-MU4T5

Item	Specification
Number of inputs	4 points (3 general inputs/1 ENABLE input)
Input voltage (ON)	13 VDC or more (13.0 VDC to 30.0 VDC)
Input voltage (OFF)	5 VDC or less (-5.0 VDC to 5.0 VDC)
Input current (ON)	3 mA (2.4 mA to 3.8 mA)
Input current (OFF)	2.1 mA or less (-2.5 mA to 2.1 mA)
Indication of input operation	LED lights when an input is ON.
Minimum switch-off time (XS0)	4 ms

## Test outputs of an FX5-SF-MU4T5

Item	Specification	
Number of outputs	2 points	
Output method	PNP output (source output), short-circuit protection, cross-circuit detection <sup>*1</sup>	
Output voltage	16 VDC to 30 VDC	
Output current <sup>*2</sup>	120 mA	
Test cycle (T0 and T1)	Program 1, 2, 4, 5, 6, and 9	40 ms
	Program 3.2	T0 = 400 ms T1 = 40 ms

\*1 A cross-circuit detection is performed only in the module.

\*2 All the output current in a system is limited. Observe the following limit values.

Supply current for all sensors connected to an FX5-SF-MU4T5 (T0/T1) and FX5-SF-8DI4 (T0 to T7):  $I < 600 \text{ mA}$

## Safety outputs of an FX5-SF-MU4T5

Item	Specification	
Number of outputs	4 points	
Output method	PNP output (source output), short-circuit protection, cross-circuit detection <sup>*1</sup>	
Output voltage	18.4 VDC to 30.0 VDC	
Output current	2.0A(@ $T_A \leq 45^\circ\text{C}$ ) 1.5A(@ $T_A \leq 55^\circ\text{C}$ )	
Total current $I_{\text{sum}}$	4.0A(@ $T_A \leq 45^\circ\text{C}$ ) 3.0A(@ $T_A \leq 55^\circ\text{C}$ )	
Leak current (in the switch OFF status)	1 mA or less	
Indication of output operation	LED lights when an output is ON.	
Response time <sup>*2</sup> (I0/I1)	Program 1, 2, 4, 5, 6, and 9	29 ms
	Program 3.1, 7, and 8	9 ms
	Program 3.2	81 ms/29 ms <sup>*3</sup>
Response time <sup>*2</sup> (I2/I3)	Program 4, 5, and 6	29 ms
	Program 1, 2, 3, 7, 8, and 9	9 ms
Response time (XS0)	9 ms	
Off delay time	0 / 0.5 / 1 / 1.5 / 2 / 2.5 / 3 / 3.5 / 4 / 5 s	

\*1 A cross-circuit detection is performed only in the module.

\*2 A response time without any sensors. When sensors are connected, the data of the connected sensors is applied and the minimum switch-off time is extended.

\*3 In the program 3.2, either one of the I0 and I1 terminal is connected to an available sensor and the other terminal is connected to the T0 or T1 terminal depending on the sensor specifications.

When a sensor is connected to I0, the response time is 81 ms. For I1, the response time is 29 ms.

## Number of occupied points in FX5-SF-MU4T5

Item	Specification
Number of occupied I/O points	8 points



## Safety inputs of an FX5-SF-8DI4

Item		Specification
Number of inputs		8 points
Input voltage (ON)		13 VDC or more (13 VDC to 30 VDC)
Input voltage (OFF)		5 VDC or less (-5 VDC to 5 VDC)
Input current (ON)		3 mA (2.4 mA to 3.8 mA)
Input current (OFF)		2.1 mA or less (-2.5 mA to 2.1 mA)
Indication of input operation		LED lights when an input is ON.
Minimum switch-off time	Program 1, 2, 3, 4, 5, and 8	24 ms
	Program 6 and 7	4 ms
Synchronous time monitoring	Program 3 and 5	1500 ms

## Test outputs of an FX5-SF-8DI4

Item		Specification
Number of outputs		8 points
Output method		PNP output (source output), short-circuit protection, cross-circuit detection <sup>*1</sup>
Output voltage		16 VDC to 30 VDC
Output current		30 mA
Test cycle		40 ms

\*1 A cross-circuit detection is performed only in the module.

## Response time of FX5-SF-8DI4

Item		Specification
Response time	Program 1, 2, 3, 4, 5, and 8	33 ms
	Program 6 and 7	13 ms

## Number of occupied I/O points in FX5-SF-8DI4

Item		Specification
Number of occupied I/O points		0 points

# 2.5 Safety Output Derating Curve

The following figure shows the derating curve for safety outputs (Q0 to Q3) of an FX5-SF-MU4T5.

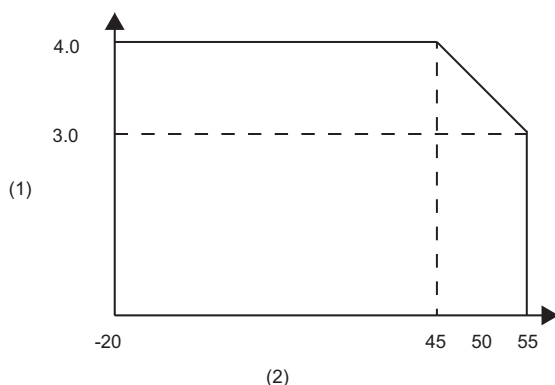

(1) Load current (A)

(2) Ambient temperature (°C)

## 2.6 Parts Names

The following shows the names of parts on a safety extension module.

### FX5-SF-MU4T5

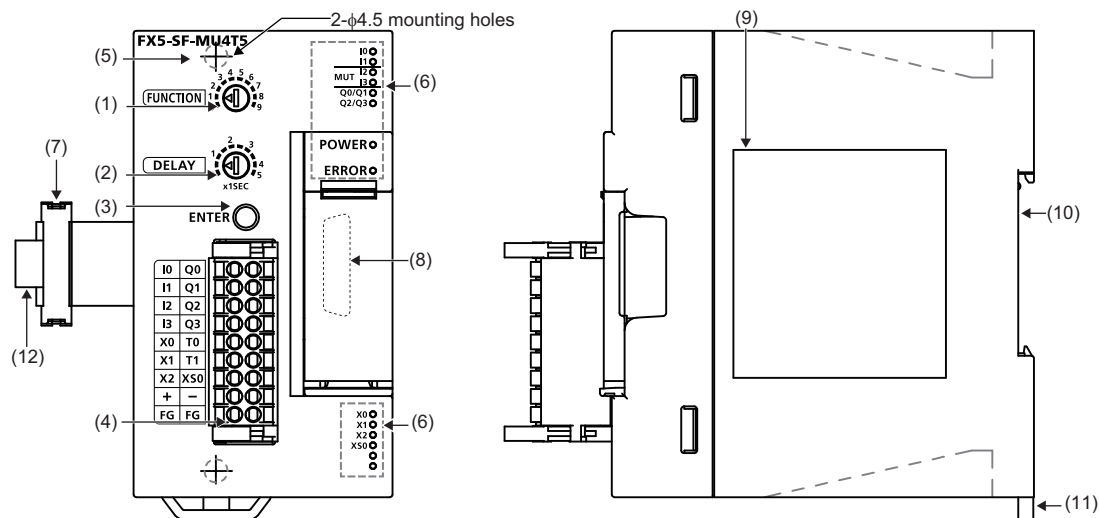

No.	Name	Description
(1)	FUNCTION rotary switch	To select a built-in program. For details on the functions to select a built-in program, refer to the following: ☞ Page 39 Built-In Program Selection Function
(2)	DELAY rotary switch	To set a delay time for off delay.
(3)	ENTER button	To apply settings.
(4)	Terminal block (spring clamp terminal block)	A spring clamp terminal block. For details on the signal array, refer to the following: ☞ Page 92 Terminal Arrangement
(5)	Direct mounting hole	Screw holes (2-φ4.5, mounting screw: M4 screw) for direct installation.
(6)	Operations status display LEDs	To indicate the operating status of the module. (☞ Page 34 LED indication)
(7)	Extension cable	A cable for connecting a preceding module.
(8)	Extension connector	A connector for connecting the extension cable of an extension module.
(9)	Name plate	The product model name and manufacturer's serial number are shown.
(10)	DIN rail mounting groove	The module can be installed on DIN46277 rail (35 mm wide).
(11)	DIN rail mounting hook	A hook for mounting the module on a DIN rail of DIN46277 (35 mm wide).
(12)	Pull out tab	To use for drawing out an extension cable.

## FX5-SF-8DI4

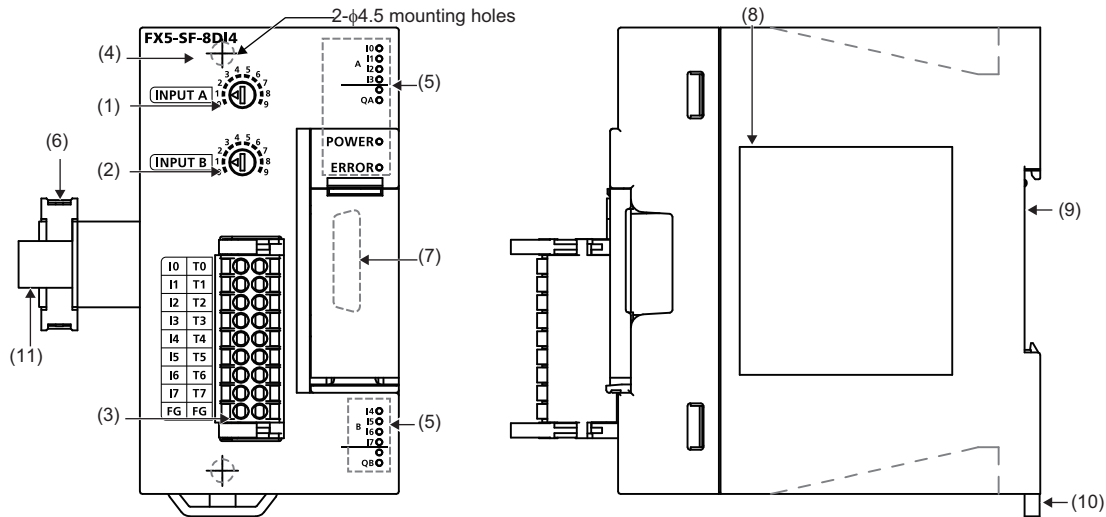

No.	Name	Description
(1)	INPUT A rotary switch	To select a program. For details on the functions to select a program, refer to the following:
(2)	INPUT B rotary switch	☞ Page 39 Built-In Program Selection Function
(3)	Terminal block (spring clamp terminal block)	A spring clamp terminal block. For details on the signal array, refer to the following:
(4)	Direct mounting hole	Screw holes (2- $\phi$ 4.5, mounting screw: M4 screw) for direct installation.
(5)	Operations status display LEDs	To indicate the operating status of the module. (☞ Page 34 LED indication)
(6)	Extension cable	A cable for connecting a preceding module.
(7)	Extension connector	A connector for connecting the extension cable of an extension module.
(8)	Name plate	The product model name and manufacturer's serial number are shown.
(9)	DIN rail mounting groove	The module can be installed on DIN46277 rail (35 mm wide).
(10)	DIN rail mounting hook	A hook for mounting the module on a DIN rail of DIN46277 (35 mm wide).
(11)	Pull out tab	To use for drawing out an extension cable.

## LED indication

### ■FX5-SF-MU4T5

The following shows the indications of the LEDs on an FX5-SF-MU4T5.

LED name	LED color	Description
POWER LED	Green	Indicates the power supply status. ON: Normal operation Flashing: The rotary switch setting was changed during operation. OFF: Powered OFF
ERROR LED*1	Red	Indicates an error status. ON: An error occurred in any one of the safety extension modules. Flashing (two times): Failed to apply the settings to the safety extension module. Flashing (three times): The rotary switch setting was changed during operation. Flashing (four times): Any of the following errors occurred. <ul style="list-style-type: none"> <li>• The input statuses of any of X0, X1, or X2 are incorrect.</li> <li>• The module was powered ON after the rotary switch setting has been changed in the power OFF state.</li> <li>• The ENTER button is pressed for three seconds or more.</li> <li>• A setting is not applied after changing the position of a module.</li> </ul> Flashing (five times): A power supply error occurred. Flashing (six times): A self-monitoring error or an internal error occurred. OFF: No error
I0 LED	Green	Indicates the input status of I0. ON: Input ON Flashing: A process error, or synchronization time/concurrence error occurring. Flashing (I0 and I1 flash in phase): A cross-circuit occurred between I0 and I1. OFF: Input OFF
I1 LED	Green	Indicates the input status of I1. ON: Input ON Flashing: A process error, or synchronization time/concurrence error occurring. Flashing (I0 and I1 flash in phase): A cross-circuit occurred between I0 and I1. OFF: Input OFF
I2 LED	Green	Indicates the input status of I2. ON: Input ON Flashing: A process error, or synchronization time/concurrence error occurring. Flashing (I2 and I3 flash in phase): A cross-circuit occurred between I2 and I3. OFF: Input OFF
I3 LED	Green	Indicates the input status of I3. ON: Input ON Flashing: A process error, or synchronization time/concurrence error occurring. Flashing (I2 and I3 flash in phase): A cross-circuit occurred between I2 and I3. OFF: Input OFF
Q0/Q1 LED	Green	Indicates the output statuses of Q0 and Q1. ON: Output ON OFF: Output OFF
Q2/Q3 LED	Green	Indicates the output statuses of Q2 and Q3. ON: Output ON Flashing: In lapse of off delay time OFF: Output OFF
X0 LED	Green	Indicates the input status of X0. ON: Input ON Flashing: Input OFF (by restart interlock or EDM) OFF: Input OFF
X1 LED	Green	Indicates the input status of X1. ON: Input ON Flashing: Input OFF (by restart interlock or EDM) OFF: Input OFF
X2 LED	Green	Indicates the input status of X2. ON: Input ON Flashing: Input OFF (by restart interlock or EDM) OFF: Input OFF
XS0 LED	Green	Indicates the input status of XS0. ON: Input ON OFF: Input OFF

\*1 The ERROR LED flashes rapidly and repeatedly at regular intervals.

## ■FX5-SF-8DI4

The following shows the indications of the LEDs on an FX5-SF-8DI4.

LED name	LED color	Description
POWER	Green	Indicates the power supply status. ON: Normal operation Flashing: The rotary switch setting was changed during operation. OFF: Powered OFF
ERROR*1	Red	Indicates an error status. ON: An error occurred in any one of the safety extension modules. Flashing (two times): Failed to apply the settings to the safety extension module. Flashing (three times): The rotary switch setting was changed during operation. Flashing (four times): Any of the following errors occurred. <ul style="list-style-type: none"> <li>• The module was powered ON after the rotary switch setting has been changed in the power OFF state.</li> <li>• The ENTER button is pressed for three seconds or more.</li> <li>• A setting is not applied after changing the position of a module.</li> </ul> Flashing (five times): A power supply error occurred. Flashing (six times): A self-monitoring error or an internal error occurred. OFF: No error
I0 LED	Green	Indicates the input status of I0. ON: Input ON Flashing: A process error occurred or synchronous time (1500ms) was exceeded. Flashing (I0 and I1 flash in phase): A cross-circuit occurred between I0 and I1. OFF: Input OFF
I1 LED	Green	Indicates the input status of I1. ON: Input ON Flashing: A process error occurred or synchronous time (1500ms) was exceeded. Flashing (I0 and I1 flash in phase): A cross-circuit occurred between I0 and I1. OFF: Input OFF
I2 LED	Green	Indicates the input status of I2. ON: Input ON Flashing: A process error occurred or synchronous time (1500ms) was exceeded. Flashing (I2 and I3 flash in phase): A cross-circuit occurred between I2 and I3. OFF: Input OFF
I3 LED	Green	Indicates the input status of I3. ON: Input ON Flashing: A process error occurred or synchronous time (1500ms) was exceeded. Flashing (I2 and I3 flash in phase): A cross-circuit occurred between I2 and I3. OFF: Input OFF
I4 LED	Green	Indicates the input status of I4. ON: Input ON Flashing: A process error occurred or synchronous time (1500ms) was exceeded. Flashing (I4 and I5 flash in phase): A cross-circuit occurred between I4 and I5. OFF: Input OFF
I5 LED	Green	Indicates the input status of I5. ON: Input ON Flashing: A process error occurred or synchronous time (1500ms) was exceeded. Flashing (I4 and I5 flash in phase): A cross-circuit occurred between I4 and I5. OFF: Input OFF
I6 LED	Green	Indicates the input status of I6. ON: Input ON Flashing: A process error occurred or synchronous time (1500ms) was exceeded. Flashing (I6 and I7 flash in phase): A cross-circuit occurred between I6 and I7. OFF: Input OFF
I7 LED	Green	Indicates the input status of I7. ON: Input ON Flashing: A process error occurred or synchronous time (1500ms) was exceeded. Flashing (I6 and I7 flash in phase): A cross-circuit occurred between I6 and I7. OFF: Input OFF
QA LED	Green	Indicates if the input conditions of INPUT A from input I0 to I3 are satisfied. ON: Input conditions are satisfied. OFF: Input OFF
QB LED	Green	Indicates if the input conditions of INPUT B from input I4 to I7 are satisfied. ON: Input conditions are satisfied. OFF: Input OFF

\*1 The ERROR LED flashes rapidly and repeatedly at regular intervals.

# 3 PROCEDURES BEFORE OPERATION

---

This chapter explains the procedures before operation.

## 1. Checking the specifications of a safety extension module

Check the specifications of a safety extension module. (☞ Page 27 SPECIFICATIONS)

The system configuration can be checked in advance using MELSEC iQ-F Series Safety Extension Module Configuration Guide. (☞ Page 155 How to Use MELSEC iQ-F Series Safety Extension Module Configuration Guide)

## 2. Attaching a safety extension module

Attach a safety extension module to a CPU module. For details, refer to the following:

📖 MELSEC iQ-F FX5S/FX5UJ/FX5U/FX5UC User's Manual (Hardware)

## 3. Selecting a program of the safety extension module

Select a built-in program using the rotary switch(es). (☞ Page 114 Programming Method (for FX5-SF-MU4T5/FX5-SF-8DI4))

## 4. Wiring

Wire external devices to the safety extension module.

## 5. Programming (for FX5-SF-MU4T5/FX5-SF-8DI4)

Apply the setting. (☞ Page 114 Applying a setting)

## 6. Adding a module

Add a safety extension module to the module configuration in GX Works3.

## 7. Setting parameters

Configure the automatic refresh setting in GX Works3 as necessary. (☞ Page 111 PARAMETER SETTINGS)

## 8. Programming (for FX5 CPU module)

Create sequential programs in GX Works3 as necessary. (☞ Page 115 Programming Method (for FX5 CPU module))

---

### Point

When turning the power of the target system OFF and ON after performing the procedure 5, turn OFF the power of all modules. After that, turn the powers ON again simultaneously.

If a time lag occurs when turning the power ON, turn the powers ON in order of modules other than a safety extension module and a CPU module (powered input/output module, extension power supply module, expansion adapter, and intelligent function module), CPU module, and safety extension module.

When the above conditions are not satisfied, an error (error code: 3052H) may occur in the safety extension module.

For the wiring diagram, refer to the following:

☞ Page 126 Turning ON the power of a system including a safety extension module

---



# 4 FUNCTIONS

This chapter explains the details of functions that can be used for a safety extension module, and their setting methods. For details on the buffer memory, refer to the following:

☞ Page 140 Buffer Memory

## 4.1 List of Functions

The following lists the functions of a safety extension module.

Category	Item	Description	Reference
Safety control	Built-in program selection function	To select a built-in program to run using the rotary switch(es) on the front of a module.	Page 39 Built-In Program Selection Function
	Off delay delay setting function	To set off delay time to a desired output using the rotary switch on the front of a module.	Page 67 Off Delay Delay Setting Function
	Muting function	To temporarily disable the protection function of a safety device.	Page 69 Muting Function
	AND link	To activate the logic path of safety functions according to the input from an FX5-SF-8DI4.	Page 71 AND link
	OR link	To bridge logic path A or B of safety functions according to the input from an FX5-SF-8DI4.	Page 74 OR link
	Bypass	To bridge logic path A or B of safety functions according to the input from an FX5-SF-8DI4, and forcibly turn ON the safety output for 60 seconds.	Page 76 Bypass
	Restart interlock	To prevent a system from restarting until safety is verified and a reset signal is input after safety outputs are turned OFF.	Page 77 Restart Interlock
	External device monitoring (EDM)	To monitor if a contactor is OFF when the module is reset.	Page 78 External Device Monitoring (EDM)
	Retriggering of the delayed OSSDs	To reset a delay time to keep a machine operating when safety inputs are in the safe state by the time off delay time elapses.	Page 79 Retriggering of the Delayed OSSDs
	ENABLE input (XS0 terminal)	XS0 is a terminal to enable safety outputs. The terminal can be used to cascade safety circuits.	Page 80 ENABLE Input (XS0 Terminal)
Diagnosis	Two-hand operation/jog mode	To control a safety system using a two-hand control device connected to an FX5-SF-MU4T5. Jog mode limits the duration time that keeps safety outputs Q2 and Q3 ON for five seconds by the operation of a two-hand control device.	Page 81 Two-Hand Operation/Jog Mode
	Error history function	To store the history of errors occurred in a safety extension module to the buffer memory.	Page 82 Error History
	Safety information monitoring function	To store information including the I/Os, settings, and error codes of a safety extension module to the buffer memory. The safety information can be referenced by user programs and built-in functions (such as Web server) of a CPU module or the monitoring screen of GX Works3.	Page 85 Safety Information Monitoring Function



## 4.2 Built-In Program Selection Function

This function selects a built-in program by the rotary switch(es) on the front of an FX5-SF-MU4T5 and FX5-SF-8DI4.

### Setting method

A built-in program can be selected by the following rotary switch(es).

- FUNCTION (FX5-SF-MU4T5)
- INPUT A (FX5-SF-8DI4)
- INPUT B (FX5-SF-8DI4)

After selecting a built-in program, the program runs by applying the settings.

For the method for applying the settings, refer to the following:

☞ Page 114 Applying a setting

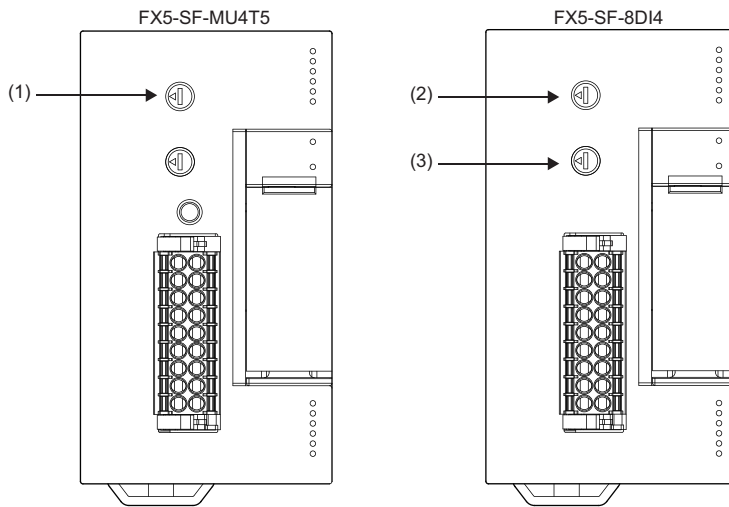

- (1) FUNCTION rotary switch
- (2) INPUT A rotary switch
- (3) INPUT B rotary switch

## Operation

One out of nine kinds of programs can be set for each of FX5-SF-MU4T5 and FX5-SF-8DI4.

### ■Programs that can be set for an FX5-SF-MU4T5

Each program of an FX5-SF-MU4T5 consists of logic path A and B.

Each program (logic path A and B) are logic circuits that turn ON and OFF each safety output depending on the ON/OFF status of respective safety inputs.

The list of built-in programs that can be set for an FX5-SF-MU4T5 is as follows.

(1) Cross-circuit detection

(2) Synchronous time monitoring

○: Supported, ×: Not supported, —: Not available

Program	Overview	Description	Logic path A (I0/I1)			Logic path B (I2/I3)			Program overview
			Input device	(1)	(2)	Input device	(1)	(2)	
0	Inactive	FX5-SF-MU4T5 is inactive. A program is not executed.	—	—	—	—	—	—	—
1	OR control (1)	Programs to output Q0 to Q3 according to the input result of logic path A and B calculated by OR logic.	N/C + N/C	○	○	N/C + N/C	×	×	
2	OR control (2)		N/C + N/O	○	○	N/C + N/C	×	×	
3	Muting control	A program for muting control. For details on the muting, refer to the following: ☞ Page 69 Muting Function	N/C + N/C	×	×	For muting sensors.	—	—	
4	Two-hand control (1)	A program for two-hand control devices. For details on the two-hand operation, refer to the following: ☞ Page 81 Two-Hand Operation/ Jog Mode	N/C + N/O	○	×	N/C + N/O	○	×	
5	Two-hand control (2)		N/C + N/C	○	×	N/C + N/C	○	×	
6	AND control (1)	Programs to output Q0 and Q1 according to the input of logic path A. Additionally, Q2 and Q3 are output according to the result of logic path A and B inputs calculated by AND logic.	N/C + N/C	○	×	N/C + N/C	○	×	
7	AND control (2)		N/C + N/C	×	×	N/C + N/C	×	×	

Program	Overview	Description	Logic path A (I0/I1)			Logic path B (I2/I3)			Program overview
			Input device	(1)	(2)	Input device	(1)	(2)	
8	Independent control	<p>A program to execute two types of safety control that are mutually independent.</p> <p>A program to output Q0 and Q1 according to the input of logic path A.</p> <p>Additionally, Q2 and Q3 are output according to the input of logic path B.</p>	N/C + N/C	×	×	N/C + N/C	×	×	<p>The diagram shows two parallel logic paths. Path A starts with input I0 and I1 connected to relay A, which is wired to outputs Q0 and Q1. Path B starts with input I2 and I3 connected to relay B, which is wired to outputs Q2 and Q3. A timer symbol is present in the second rung of path B.</p>
9	AND control (3)	<p>A program to output Q0 and Q1 according to the input of logic path A.</p> <p>Additionally, Q2 and Q3 are output according to the results of logic path A and B inputs calculated by AND logic.</p>	N/C + N/C	○	×	N/C + N/C	×	×	<p>The diagram shows two parallel logic paths. Path A starts with input I0 and I1 connected to relay A, which is wired to outputs Q0 and Q1. Path B starts with input I2 and I3 connected to relay B, which is wired to an AND gate (&amp;). The output of the AND gate is connected to outputs Q2 and Q3. A timer symbol is present in the second rung of path B.</p>

## ■ Programs that can be set for an FX5-SF-8DI4

Eight safety inputs of an FX5-SF-8DI4 are grouped into two safety inputs: INPUT A (safety input I0 to I3) and INPUT B (safety input I4 to I7) of the rotary switch.

A program to link the four safety inputs to logic path A or B of an FX5-SF-MU4T5 can be selected by the rotary switch.

The list of built-in programs that can be set for an FX5-SF-8DI4 is as follows.

(1) Cross-circuit detection

(2) Synchronous time monitoring

○: Supported, ×: Not supported, —: Not available

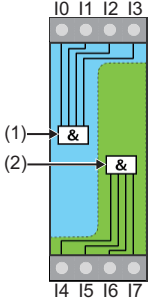
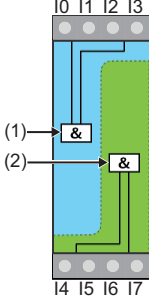
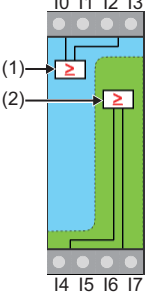
Program	Overview	Description	Logic path A connection (I0/I1, I2/I3)			Logic path B connection (I4/I5, I6/I7)			Program overview
			Input device	(1)	(2)	Input device	(1)	(2)	
0	Inactive	FX5-SF-8DI4 is inactive. The input signals are ignored.	—	—	—	—	—	—	
1	AND link (single-channel)	Connect four safety inputs of INPUT A or INPUT B in single-channel, and link them to logic path A and B of an FX5-SF-MU4T5 using AND logic. Unused safety inputs are required to be connected to a plus terminal or T terminals.	N/C	×	×	N/C	×	×	 <p>(1) Connect logic path A with AND link (2) Connect logic path B with AND link</p>
2	AND link (dual-channel) (1)	Connect four safety inputs of INPUT A or INPUT B in dual-channel, and link them to logic path A and B of an FX5-SF-MU4T5 using AND logic. Unused safety inputs are required to be connected to a plus terminal or T terminals.	N/C + N/C	○	×	N/C + N/C	○	×	 <p>(1) Connect logic path A with AND link (2) Connect logic path B with AND link</p>
3	AND link (dual-channel) (2)		N/C + N/C	○	○	N/C + N/C	○	○	
4	AND link (dual-channel) (3)		N/C + N/O	○	×	N/C + N/O	○	×	
5	AND link (dual-channel) (4)		N/C + N/O	○	○	N/C + N/O	○	○	
6	AND link (dual-channel) (5)		N/C + N/C	×	×	N/C + N/C	×	×	
7	OR link (dual-channel)	Connect four safety inputs of INPUT A or INPUT B in dual-channel, and link them to logic path A and B of an FX5-SF-MU4T5 using OR logic.	N/C + N/C	×	×	N/C + N/C	×	×	 <p>(1) Connect logic path A with OR link (2) Connect logic path B with OR link</p>

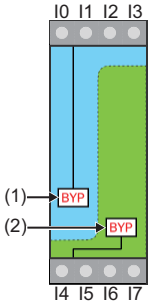
Program	Overview	Description	Logic path A connection (I0/I1, I2/I3)			Logic path B connection (I4/I5, I6/I7)			Program overview
			Input device	(1)	(2)	Input device	(1)	(2)	
8	Bypass	Connect two safety inputs (I0/I1 or I4/I5) of either INPUT A or INPUT B in dual-channel, and link them to logic path A or B of an FX5-SF-MU4T5 as the trigger of a bypass function. For details, refer to the following: ☞ Page 76 Bypass	N/C + N/C	○	×	N/C + N/C	○	×	 <p>(1) Connect logic path A with bypass (2) Connect logic path B with bypass</p>
9	All paths batch connection	Centralize all safety inputs of INPUT A and INPUT B into one AND logic, OR logic, or bypass, and connect it to either logic path A or B of an FX5-SF-MU4T5.	—	—	—	—	—	—	<p>A program overview differs depending on the combination of INPUT A and INPUT B rotary switch settings. For details, refer to the following: ☞ Page 44 Details of FX5-SF-8DI4 program 9</p>

## ■Details of FX5-SF-8DI4 program 9

The combinations of settings when INPUT A or INPUT B rotary switch is set to '9' are as follows.

Rotary switch (INPUT A)	Rotary switch (INPUT B)	Description	Program overview
1	9	Connect eight inputs in single-channel, and link them to logic path A of an FX5-SF-MU4T5 using AND logic.	<p>(1) Connect logic path A with AND link</p>
2 to 6	9	Connect eight inputs in dual-channel, and link them to logic path A of an FX5-SF-MU4T5 using AND logic.	<p>(1) Connect logic path A with AND link</p>
7	9	Connect eight inputs in dual-channel, and link them to logic path A of an FX5-SF-MU4T5 using OR logic.	<p>(1) Connect logic path A with OR link</p>

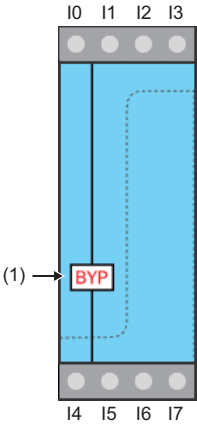
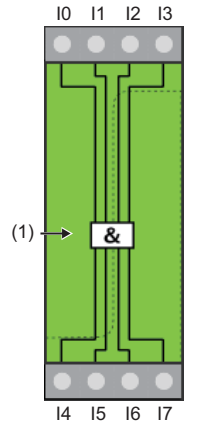
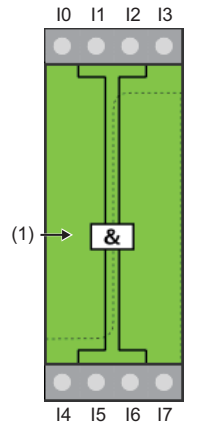
Rotary switch (INPUT A)	Rotary switch (INPUT B)	Description	Program overview
8	9	Connect I0/I1 and I4/I5 in dual-channel, and link them to logic path A using AND logic as the trigger of a bypass function.	 <p>(1) Connect logic path A with bypass</p>
9	9	When both INPUT A and INPUT B are set to '9', a configuration error will occur.	—
9	1	Connect eight inputs in single-channel, and link them to logic path B of an FX5-SF-MU4T5 using AND logic.	 <p>(1) Connect logic path B with AND link</p>
9	2 to 6	Connect eight inputs in dual channel, and link them to logic path B of an FX5-SF-MU4T5 using AND logic.	 <p>(1) Connect logic path B with AND link</p>

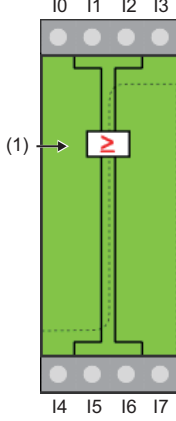
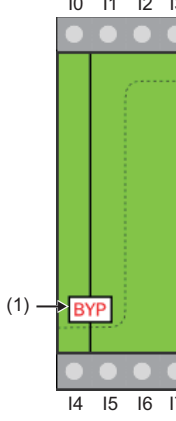
Rotary switch (INPUT A)	Rotary switch (INPUT B)	Description	Program overview
9	7	Connect eight inputs in dual-channel, and link them to logic path B of an FX5-SF-MU4T5 using OR logic.	 <p>(1) Connect logic path B with OR link</p>
9	8	Connect I0/I1 and I4/I5 in dual-channel, and link them to logic path B using AND logic as the trigger of a bypass function.	 <p>(1) Connect logic path B with bypass</p>



## Connectable devices and ladder symbols

### ■Connectable devices

The connectable inputs and sensors, and the corresponding programs are as follows.

Inputs and sensors	Description	Corresponding program number (rotary switch setting)			
		FX5-SF-MU4T5		FX5-SF-8DI4	
		Input of logic path A (I0, I1)	Input of logic path B (I2, I3)	Input (I0 to I3)	Input (I4 to I7)
<ul style="list-style-type: none"> <li>• : Potential free contact</li> <li>• : Emergency stop button</li> <li>• : Safety door switch</li> </ul>	Single-channel N/C contact	3, 7, 8	1, 2, 7, 8, 9	1, 6, 7	1, 6, 7
<ul style="list-style-type: none"> <li>• : Potential free contact</li> <li>• : Emergency stop button</li> <li>• : Safety door switch</li> </ul>	Dual-channel equivalent N/C contact	3, 7, 8	1, 2, 7, 8, 9	6, 7	6, 7
: Potential free contact	Dual-channel equivalent N/C contact (with cross-circuit detection)	1, 5, 6, 9	6	2, 3, 8	2, 3, 8
<ul style="list-style-type: none"> <li>• : Emergency stop button</li> <li>• : Safety door switch</li> </ul>	Dual-channel equivalent N/C contact (with cross-circuit detection)	1, 5, 6, 9	6	2, 3	2, 3
: Potential free contact	Dual-channel complementary N/C / N/O contact (with cross-circuit detection)	—	—	4	4
Safety mat	Pressure sensitive mat (four-wire system)	1	—	2	2
: Electro-sensitive protective equipment (ESPE)	Electro-sensitive protective equipment (ESPE) with semiconductor output	3, 7, 8	1, 2, 7, 8, 9	6, 7	6, 7
: Two-hand control switches	Two-hand operation (III C)	4	4	—	—
: Two-hand control switches	Two-hand operation (III A) without jog mode	—	5.2	—	—
: Two-hand control switches	Two-hand operation (III A) with jog mode (time limit 5 seconds)	—	5.1	—	—
: Non-contact safety switch	Dual-channel complementary N/C / N/O contact (with cross-circuit detection and synchronous time monitoring)	2	—	5	5
: Non-contact safety switch	Dual-channel equivalent N/O contact <sup>*1</sup>	1, 5, 6, 9	6	2, 3	2, 3
: Inductive switch	Sensors with semiconductor output	3	—	—	—
: Inductive switch	Sensor with semiconductor output (OSSD output)	3, 7, 8	1, 2, 7, 8, 9	6, 7	6, 7
: Single-beam photoelectric safety sensor	Single-channel N/C contact	3	—	1	1
: Single-beam photoelectric safety sensor	Dual-channel equivalent N/C contact	3, 7, 8	1, 2, 3, 7, 8, 9	6, 7	6, 7
: Single-beam photoelectric safety sensor	Dual-channel equivalent N/C contact (with cross-circuit detection)	1, 5, 6, 9	6	2, 3	2, 3

\*1 A connectable non-contact safety switch is a product with specifications that a circuit is opened under the condition where an actuator does not exist nearby the safety switch. This open status is considered to be normal and is represented as N/O.

### ■Ladder symbols

Ladder symbols used in the programs are as follows:

- : OR link
- : AND link
- : Restart interlock
- : Retriggering
- : Off delay
- : Muting lamp





## Details of the program 1 for FX5-SF-MU4T5s

The following explains the program when the FUNCTION rotary switch is set to '1'.

For details on the connectable devices and ladder symbols in the program, refer to the following:

☞ Page 47 Connectable devices and ladder symbols

Link a sensor and logic path A or B as follows.

Input for logic path A	Assignment	Input for logic path B	Assignment
Dual-channel equivalent N/C contact, cross-circuit detection, synchronous time monitoring 1500 ms		T0 to I0 T1 to I1	Dual-channel non-isolated semiconductor  + to I2 + to I3
			Dual-channel N/C contact, three-wire  + to I2 + to I3
Four-wire cross-circuit detection (cross-circuit detection switching mats)		T0 to I0 T1 to I1	Single-channel N/C contact  + to I2 + to I3

The details of the program 1 are as follows.

One logic path

Inputs/  
sensors

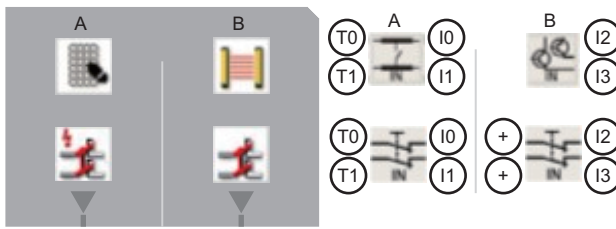

A:

Dual-channel equivalent N/C contact  
Cross-circuit detecting control signals, synchronous time monitoring 1500 ms  
Pressure sensitive mat (four-wire system)

B:

Single-channel N/C contact  
Dual-channel equivalent N/C contact (without cross-circuit detection)  
ESPE (sensors with semiconductor output)

OR



OR with FX5-SF-8DI4 (switch position 7)

AND



AND with FX5-SF-8DI4 (switch position 1 to 6)

Restart  
interlock

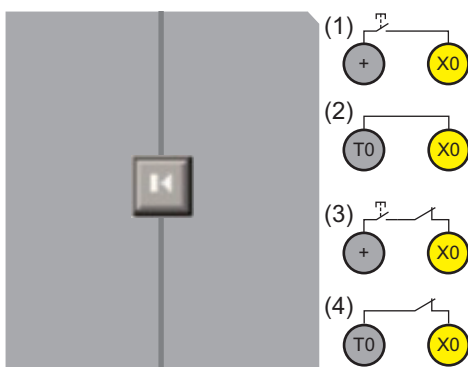

Connection of X0:

- (1): Q0/Q1, with restart interlock, without EDM
- (2): Q0/Q1, without restart interlock, without EDM
- (3): Q0/Q1, with restart interlock, with EDM
- (4): Q0/Q1, without restart interlock, with EDM

Connection of X1:

(5): Do not connect X1.

Bypass



OR limited 60 seconds with FX5-SF-8DI4 (switch position 8)

ENABLE



Always wire ENABLE (XS0). (24 VDC is required.)  
When the ENABLE is LOW, Q0 to Q3 are always LOW.

Off delay



Off delay acts on Q2 and Q3.

Retriggering

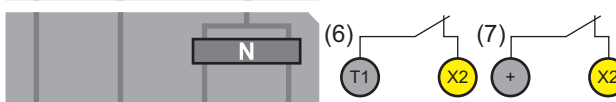

Connection of X2:

- (6): Q2/Q3, with/without EDM
- (7): Q2/Q3, with/without EDM
- Retriggering ON
- Retriggering OFF

Outputs

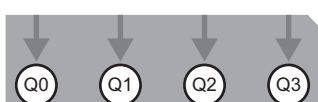

Q0/Q1, undelayed OSSDs  
Q2/Q3, delayable OSSDs





## Details of the program 2 for FX5-SF-MU4T5s

The following explains the program when the FUNCTION rotary switch is set to '2'.

For details on the connectable devices and ladder symbols in the program, refer to the following:

☞ Page 47 Connectable devices and ladder symbols

Link a sensor and logic path A or B as follows.

Input for logic path A	Assignment	Input for logic path B	Assignment
Dual-channel complementary N/C / N/O contact, cross-circuit detection, synchronous time monitoring 1500 ms		T0 to I0 T1 to I1	Dual-channel non-isolated semiconductor  + to I2 + to I3
			Dual-channel N/C contact, three-wire  + to I2 + to I3
Dual-channel complementary N/C / N/O contact, cross-circuit detection, synchronous time monitoring 1500 ms		T0 to I0 T1 to I1	Single-channel N/C contact  + to I2 + to I3

The details of the program 2 are as follows.

One logic path

Inputs/  
sensors

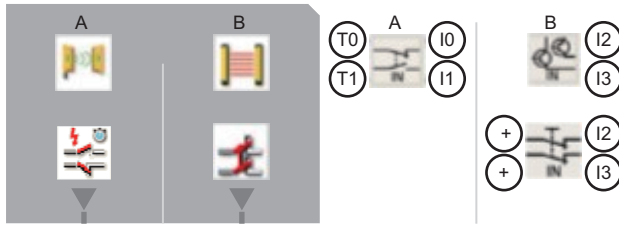

A:  
Dual-channel complementary  
N/C / N/O contact  
ESPE  
Cross-circuit detecting control  
signals, synchronous time  
monitoring 1500 ms

B:  
Single-channel N/C contact  
Dual-channel equivalent N/C  
contact (without cross-circuit  
detection)  
ESPE (sensors with  
semiconductor output)

OR



OR with FX5-SF-8DI4 (switch position 7)

AND



AND with FX5-SF-8DI4 (switch position 1 to 6)

Restart  
interlock

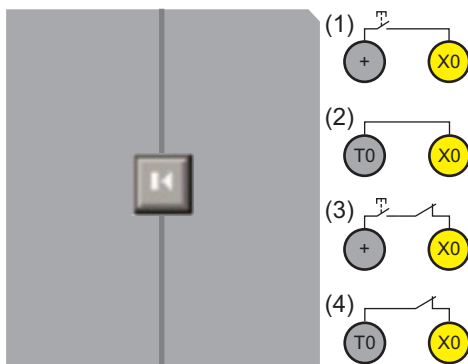

Connection of X0:

- (1): Q0/Q1, with restart interlock, without EDM
- (2): Q0/Q1, without restart interlock, without EDM
- (3): Q0/Q1, with restart interlock, with EDM
- (4): Q0/Q1, without restart interlock, with EDM

Connection of X1:

(5): Do not connect X1.

Bypass



OR limited 60 seconds with FX5-SF-8DI4 (switch position 8)

ENABLE



Always wire ENABLE (XS0). (24 VDC is required.)  
When the ENABLE is LOW, Q0 to Q3 are always LOW.

Off delay



Off delay acts on Q2 and Q3.

Retriggering

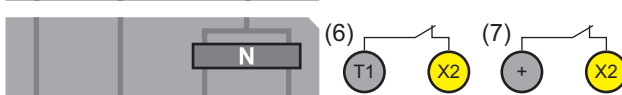

Connection of X2:

- (6): Q2/Q3, with/without EDM • Retriggering ON
- (7): Q2/Q3, with/without EDM • Retriggering OFF

Outputs

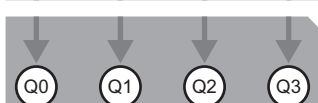

Q0/Q1, undelayed OSSDs  
Q2/Q3, delayable OSSDs



## Details of the program 3 for FX5-SF-MU4T5s

The following explains the program when the FUNCTION rotary switch is set to '3'.

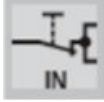
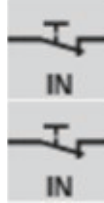

For details on the connectable devices and ladder symbols in the program, refer to the following:

☞ Page 47 Connectable devices and ladder symbols

In the program 3.1, link a sensor and logic path A or B as follows.

Input for logic path A	Assignment	Input for logic path B	Assignment
Single-channel N/C contact	 + to I0 + to I1	Two muting sensors, two single-channel N/C contacts or dual-channel non-isolated semiconductor	 + to I2 + to I3
Dual-channel N/C contact, three-wire	 + to I0 + to I1		
Dual-channel non-isolated semiconductor	 + to I0 + to I1		

In the program 3.2, link a sensor and logic path A or B as follows.

Input for logic path A	Assignment	Input for logic path B	Assignment
ESPE (sensors with semiconductor output)	 T1 to I1 (bridge T0 and I0)	Two muting sensors, two single-channel N/C contacts or dual-channel non-isolated semiconductor	 + to I2 + to I3
Inductive switch with semiconductor output	 T0 to I0 (bridge between T1 and I1)		

### Precautions

- When using the muting function, connect a muting sensor to I2 and I3.
- The connection method varies depending on a sensor to connect on the I0 and I1 side.  
For using a sensor in the program 3.1, connect the sensor to both of the I0 and I1 terminals as well as the plus terminal of X1.  
For using a sensor in the program 3.2, connect the sensor to either one of the I0 or I1 terminal (connect the other terminal to the T0 or T1 terminal). The X1 terminal does not need to be connected.

The details of the program 3.1 and program 3.2 are as follows.

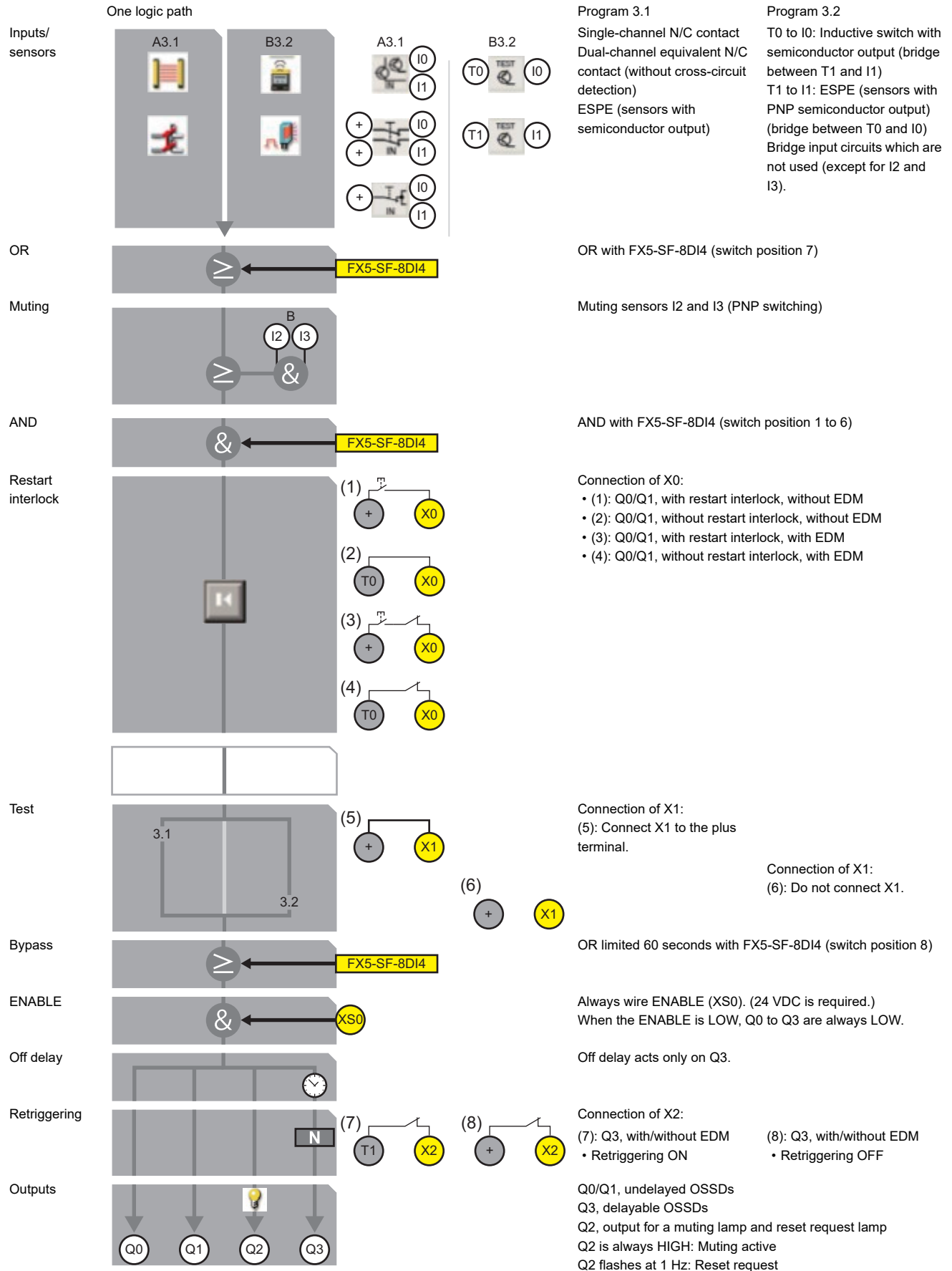

## Details of the program 4 for FX5-SF-MU4T5s

The following explains the program when the FUNCTION rotary switch is set to '4'.

For details on the connectable devices and ladder symbols in the program, refer to the following:

☞ Page 47 Connectable devices and ladder symbols

Link a sensor and logic path A or B as follows.

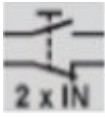
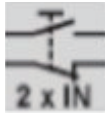
Input for logic path A	Assignment	Input for logic path B	Assignment
Two-hand control switches (T0 to I0 with N/O contact; T0 to I1 with N/C contact)	 T0 to I0 T0 to I1	Two-hand control switches (T1 to I2 with N/O contact; T1 to I3 with N/C contact)	 T1 to I2 T1 to I3



The details of the program 4 are as follows.

One logic path

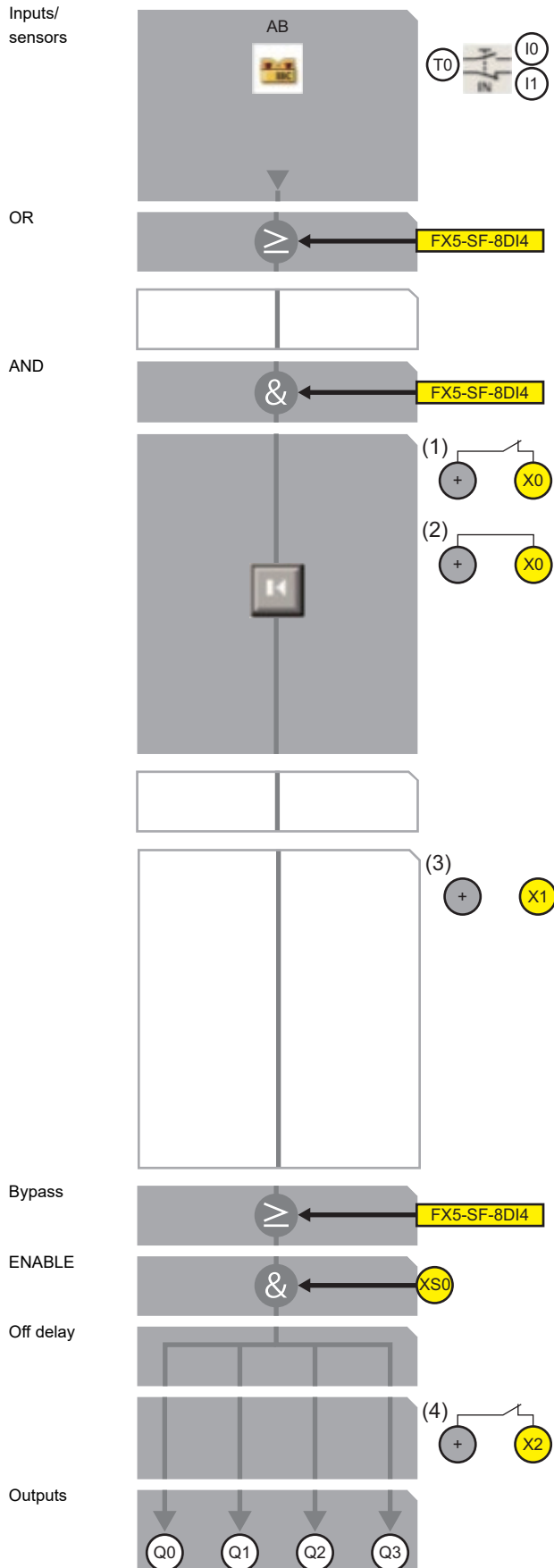

Two dual-channel complementary N/C / N/O contacts  
Two-hand operation (EN 574 III C compliant)  
Cross-circuit detecting control signals

OR with FX5-SF-8DI4 (switch position 7)

AND with FX5-SF-8DI4 (switch position 1 to 6)

Connection of X0:  
without restart interlock/with start-up testing  
Two-hand operation (EN 574 III C compliant)  
• (1): Q0/Q1, with EDM  
• (2): Q0/Q1, without EDM

Connection of X1:  
(3): Do not connect X1.

OR limited 60 seconds with FX5-SF-8DI4 (switch position 8)

Always wire ENABLE (XS0). (24 VDC is required.)  
When the ENABLE is LOW, Q0 to Q3 are always LOW.

No off delay (DELAY is set to '0')  
Do not set an off delay.

Connection of X2:  
(4): Q2/Q3, with/without EDM

Q0 to Q3, undelayed OSSDs  
No delayable OSSDs (two-hand standard)



## Details of the program 5 for FX5-SF-MU4T5s

The following explains the program when the FUNCTION rotary switch is set to '5'.

For details on the connectable devices and ladder symbols in the program, refer to the following:

 Page 47 Connectable devices and ladder symbols

Link a sensor and logic path A or B as follows.

Input for logic path A	Assignment	Input for logic path B	Assignment	
Dual-channel equivalent N/C contact, cross-circuit detection	 IN	T0 to I0 T1 to I1	 IN IN	T0 to I2 T1 to I3

The details of the program 5 are as follows.

Two logic paths have already been connected.

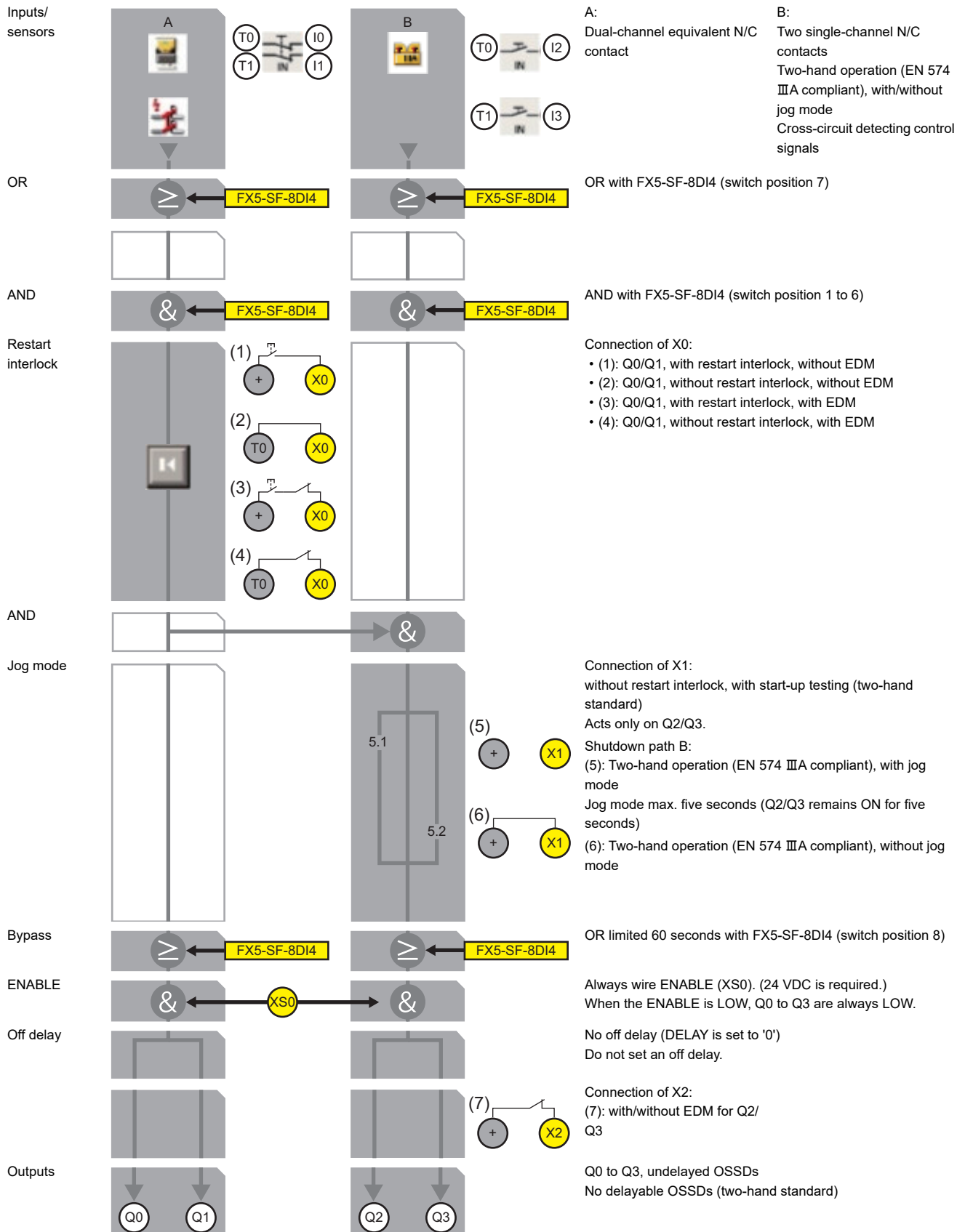

## Details of the program 6 for FX5-SF-MU4T5s

The following explains the program when the FUNCTION rotary switch is set to '6'.

For details on the connectable devices and ladder symbols in the program, refer to the following:

☞ Page 47 Connectable devices and ladder symbols

Link a sensor and logic path A or B as follows.

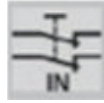
Input for logic path A	Assignment	Input for logic path B	Assignment
Dual-channel equivalent N/C contact, cross-circuit detection	 T0 to I0 T1 to I1	Dual-channel equivalent N/C contact, cross-circuit detection	 T0 to I2 T1 to I3

The details of the program 6 are as follows.

Two logic paths have already been connected.

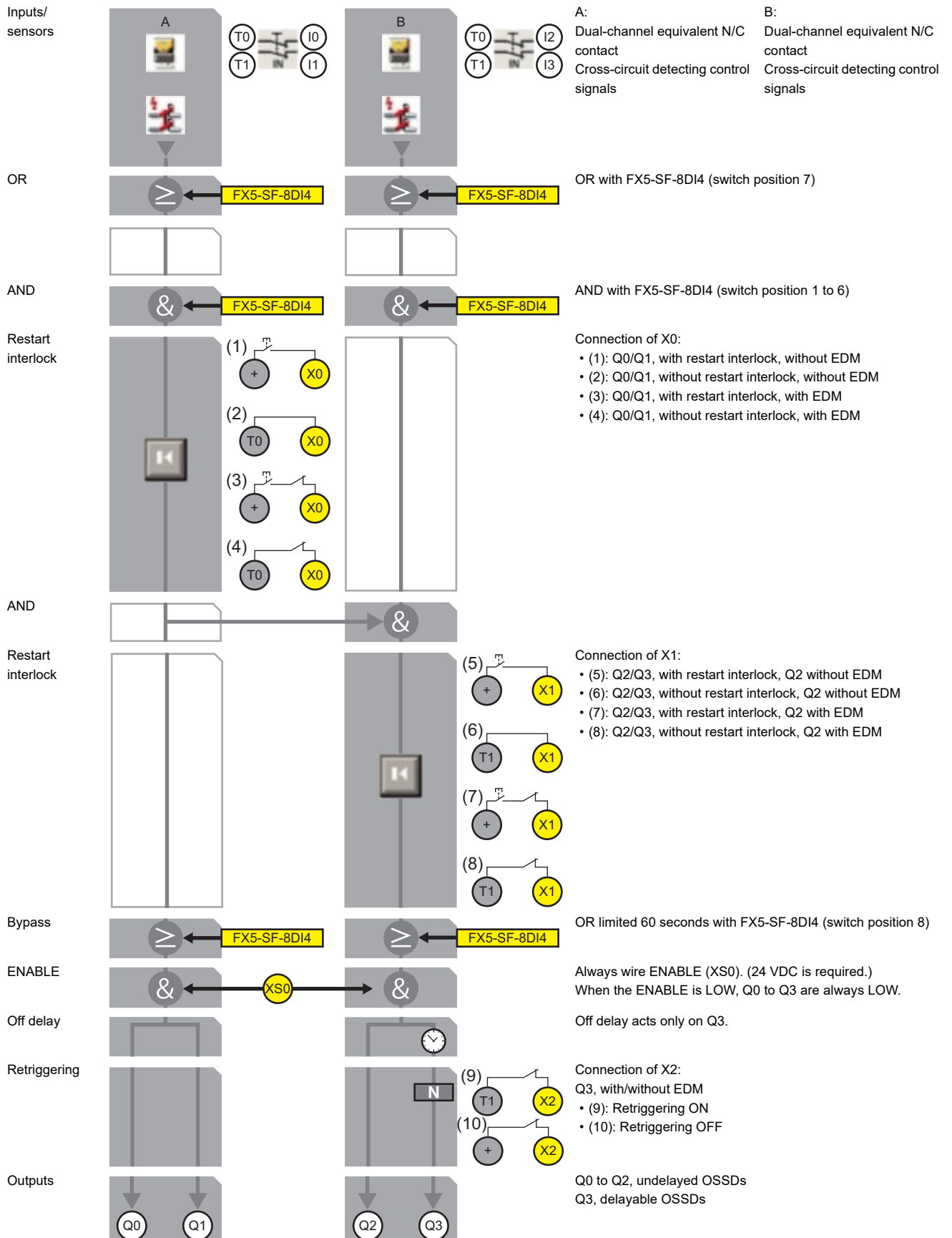







## Details of the program 7 for FX5-SF-MU4T5s

The following explains the program when the FUNCTION rotary switch is set to '7'.

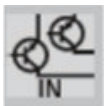
For details on the connectable devices and ladder symbols in the program, refer to the following:

☞ Page 47 Connectable devices and ladder symbols

Link a sensor and logic path A or B as follows.

Input for logic path A	Assignment	Input for logic path B	Assignment
Dual-channel non-isolated semiconductor	 + to I0 + to I1	Dual-channel non-isolated semiconductor	 + to I2 + to I3
Dual-channel N/C contact, three-wire	 + to I0 + to I1	Dual-channel N/C contact, three-wire	 + to I2 + to I3
Single-channel N/C contact	 + to I0 + to I1	Single-channel N/C contact	 + to I2 + to I3

The details of the program 7 are as follows.

Two logic paths have already been connected.

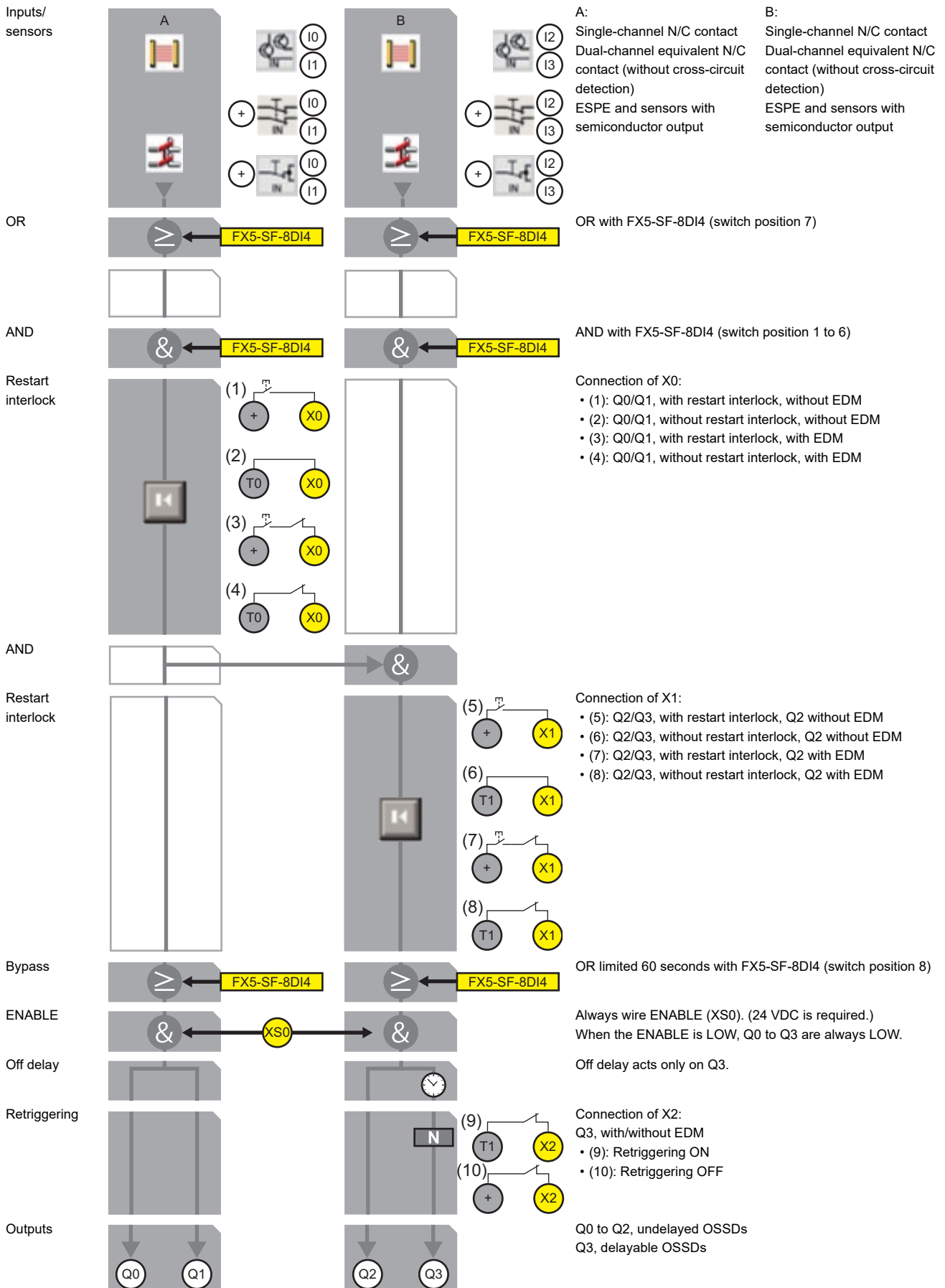





## Details of the program 8 for FX5-SF-MU4T5s

The following explains the program when the FUNCTION rotary switch is set to '8'.

For details on the connectable devices and ladder symbols in the program, refer to the following:

 Page 47 Connectable devices and ladder symbols

Link a sensor and logic path A or B as follows.

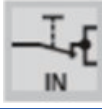
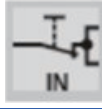
Input for logic path A	Assignment	Input for logic path B	Assignment
Dual-channel non-isolated semiconductor	 + to I0 + to I1	Dual-channel non-isolated semiconductor	 + to I2 + to I3
Dual-channel N/C contact, three-wire	 + to I0 + to I1	Dual-channel N/C contact, three-wire	 + to I2 + to I3
Single-channel N/C contact	 + to I0 + to I1	Single-channel N/C contact	 + to I2 + to I3



The details of the program 8 are as follows.

Two independent logic paths

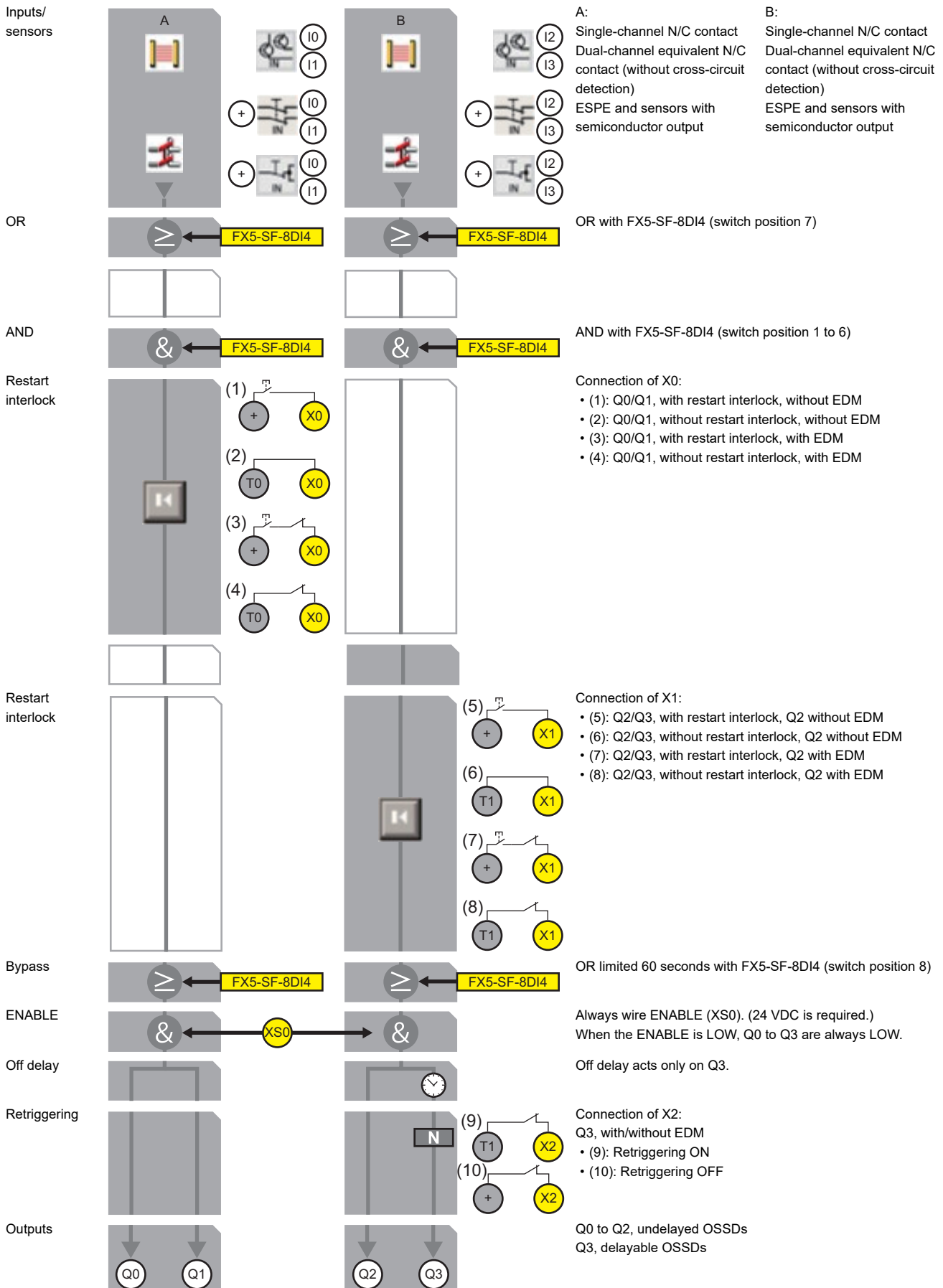



## Details of the program 9 for FX5-SF-MU4T5s

The following explains the program when the FUNCTION rotary switch is set to '9'.

For details on the connectable devices and ladder symbols in the program, refer to the following:

☞ Page 47 Connectable devices and ladder symbols

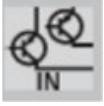
Link a sensor and logic path A or B as follows.

Input for logic path A	Assignment	Input for logic path B	Assignment		
Dual-channel equivalent N/C contact, cross-circuit detection		T0 to I0 T1 to I1		+ to I2 + to I3	
			Dual-channel N/C contact, three-wire		+ to I2 + to I3
			Single-channel N/C contact		+ to I2 + to I3

The details of the program 9 are as follows.

Two logic paths have already been connected.

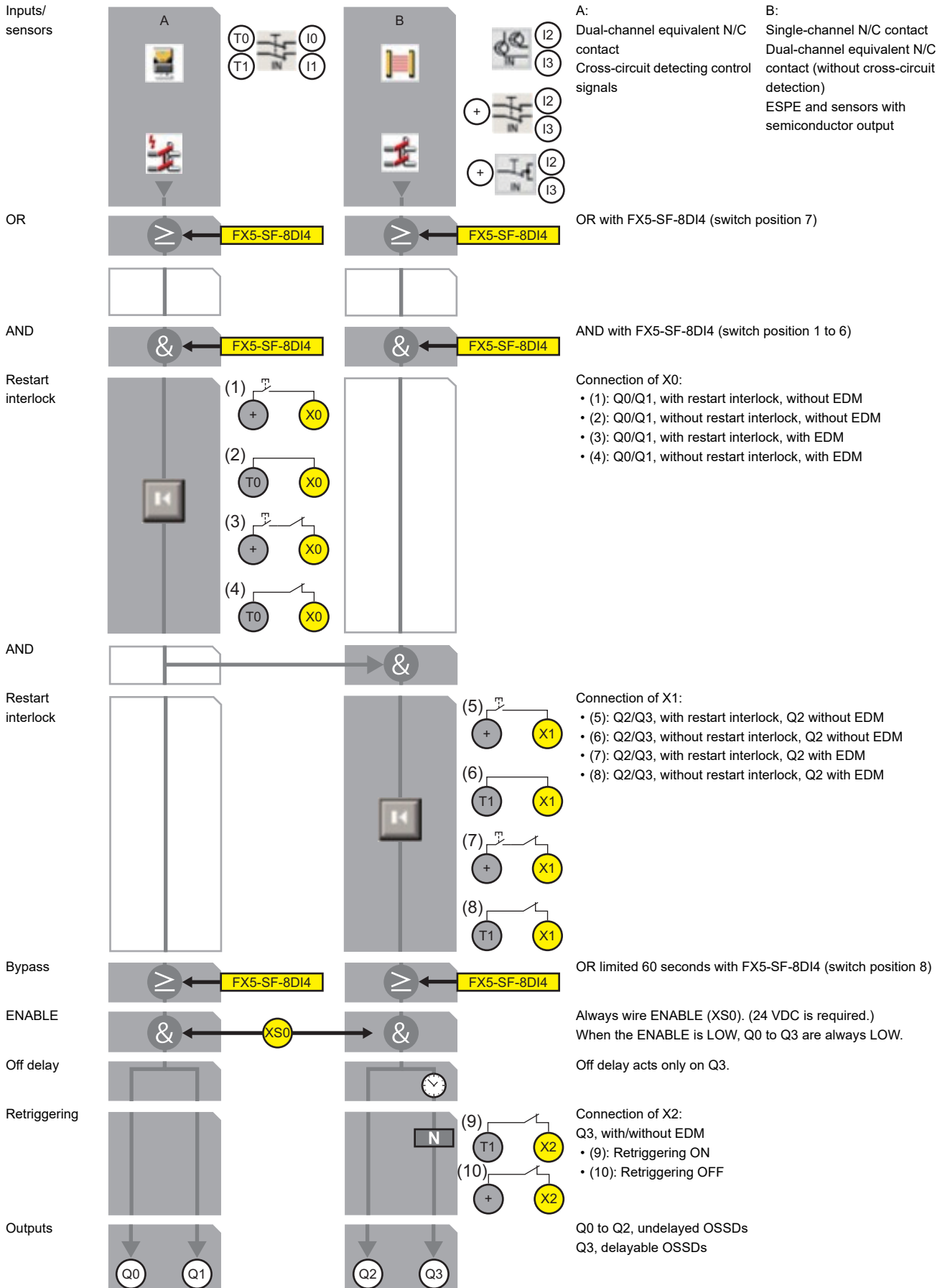

## Considerations

### ■Applying a setting

The program does not run only by selecting a built-in program using the rotary switch(es).

To run the selected built-in program, settings must be applied.

For the procedure for applying the settings, refer to the following:

☞ Page 114 Applying a setting

Rearranging the wiring of X0, X1, and X2 after the settings have been applied will cause an error.

### ■Setting a control function

Depending on the wiring status of X0, X1, and X2, set an appropriate control function (restart interlock, external device monitoring (EDM), or retriggering of the delayed OSSDs).

### ■Inspection of the connected device

Before changing the program, check if the connected devices operate properly.

For the inspection, refer to the following section.

☞ Page 117 COMMISSIONING

## 4.3 Off Delay Delay Setting Function

This function sets off delay for predefined outputs by setting the rotary switch on the front of an FX5-SF-MU4T5. By setting off delay, when a danger has been detected, the safety output is turned OFF after a user-defined period of time. When using a motor, the module turns OFF after the motor has been completely stopped.

### Setting method

Off delay can be set by the DELAY rotary switch. This function is enabled by applying the setting after off delay is set. For the procedure for applying the settings, refer to the following:

☞ Page 114 Applying a setting

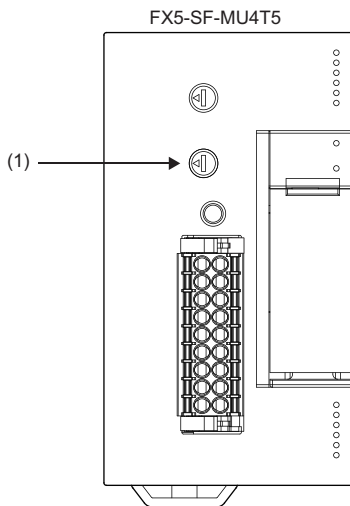

(1) DELAY rotary switch

### Operation

Depending on the program set with the FUNCTION rotary switch, an output to which the off delay is applied differs. The relationship among a program, an output to which off delay is applied, and settable delay time is as follows.

Program	Outputs	Delay time
Program 1	Q2 and Q3	0.0s, 0.5s, 1.0s, 1.5s, 2.0s, 2.5s, 3.0s, 3.5s, 4.0s, 5.0s
Program 2		
Program 3.1 Program 3.2	Q3	
Program 4*1	—	—
Program 5.1*1 Program 5.2*1		
Program 6	Q3	0.0s, 0.5s, 1.0s, 1.5s, 2.0s, 2.5s, 3.0s, 3.5s, 4.0s, 5.0s
Program 7		
Program 8		
Program 9		

\*1 Set the DELAY rotary switch to '0'.

## Precautions

### ■Applying a setting

The program does not run only by selecting a built-in program using the rotary switch(es).

To run the selected built-in program, settings must be applied.

For the procedure for applying the settings, refer to the following:

☞ Page 114 Applying a setting

Rearranging the wiring of X0, X1, and X2 after the settings have been applied will cause an error.

### ■Setting a control function

Depending on the wiring status of X0, X1, and X2, set an appropriate control function (restart interlock, external device monitoring (EDM), or retriggering of the delayed OSSDs).

### ■Inspection of the connected device

Before changing the program, check if the connected devices operate properly.

For the inspection, refer to the following:

☞ Page 117 COMMISSIONING

## 4.4 Muting Function

This function temporarily disables the protection function of a safety device while a conveyance pallet passes through the detection area of electro-sensitive protective equipment (ESPE).

This means that material can be transported to or from a machine or system without any disruption to the working process. Muting sensors monitor the existence of materials being transported. Depending on the type and installation position of the sensors, an object and a person can be distinguished.

By using the function and muting sensors, the device stops operation only when a person is detected in a hazardous area. When non-human objects are detected, the system continues operation.

### Setting method

Apply the program 3.1 or program 3.2 by setting the FUNCTION rotary switch of an FX5-SF-MU4T5 to '3'.

Connect muting sensors to I2 and I3 of an FX5-SF-MU4T5.

Connect a muting lamp to Q2 of an FX5-SF-MU4T5.

For details of the installation method of muting sensors, refer to the following:

☞ Page 108 Installation of Muting Sensors

For wiring muting sensors with a safety extension module, refer to the following section or MELSEC iQ-F Series Safety Extension Module Configuration Guide.

☞ Page 97 External Wiring Example

### Operation

The following shows an operation example for performing the muting function by connecting two muting sensors.

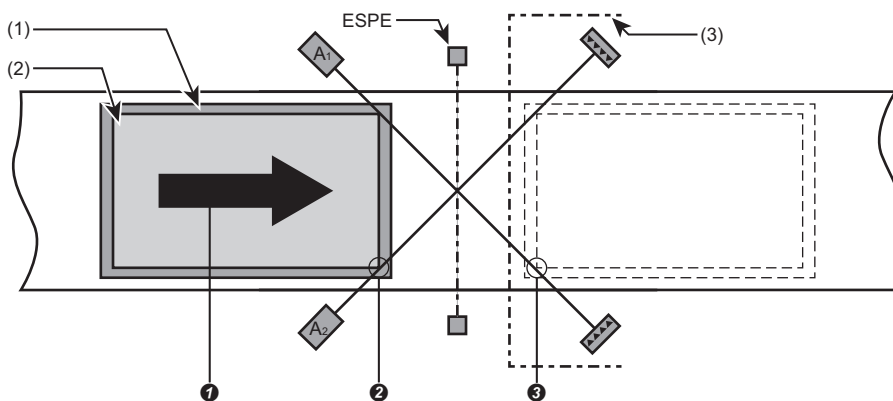

- (1): Conveyance equipment
- (2): Material
- (3): Hazardous area

The operation is as follows.

- ❶: A material moves from left to right on the conveyance equipment (conveyor belt).
- ❷: As soon as the material is detected by the muting sensors A1 and A2, ESPE is temporarily disabled so that the material can enter the hazardous area.
- ❸: When the material is not detected by the muting sensors A1 and A2, ESPE will be enabled again.

Sensors and input signals available for the muting sensors A1 and A2 are as follows:

- Optical sensors
- Inductive sensors
- Mechanical switches

## Considerations

- The muting function is allowed to be activated only when transporting a material to the hazardous area.
- The muting function should be triggered by at least two independently wired signals (which are received from muting sensors) and should not depend entirely on software signals (from a programmable controller).
- After a material has been transported to the hazardous area, the safety device should be immediately enabled.
- The material to be transported must be detected by muting sensors over its entire length and there must be no interruption during the transportation.
- Always position sensors so that the minimum distance to the protective equipment is observed. For details on the minimum distance, refer to the following:

☞ Page 108 Minimum distance to the light beams on the ESPE

- To prevent unintentional triggering of the muting function by a person, install sensors in the appropriate position.

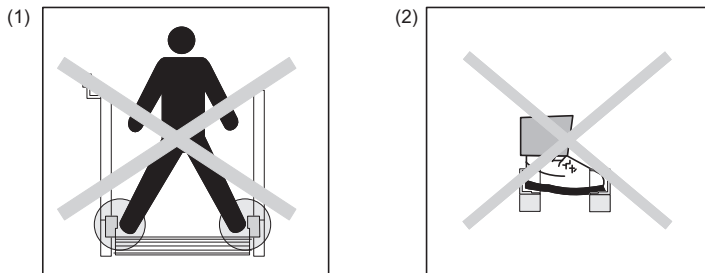

(1) Ensure the sensors installed in both sides are not activated simultaneously.

(2) Ensure the adjacent sensors are not activated simultaneously.

- The outputs on the muting sensors should be OFF when powering an FX5-SF-MU4T5; otherwise, an error occurs.
- The duration of the muting function is indefinite.
- A muting lamp turns ON continuously, then muting is active.
- A muting lamp flashes at 1 Hz, then the reset request is enabled.
- Always install a muting lamp where it can be clearly seen. A muting lamp must be clearly visible from all sides of the hazardous area and for the system operator.



# 4.5 AND link

This function connects each input of an FX5-SF-MU4T5 and FX5-SF-8DI4 using AND logic.

## Setting method

### ■For FX5-SF-MU4T5

Set the FUNCTION rotary switch to '5', '6', '7', or '9'.

Sensors that can be connected to an FX5-SF-MU4T5 are as follows.

○: Connectable, —: Not connectable

FX5-SF-MU4T5 (Program)	Inputs and sensors	Description	Input of logic path A (I0, I1)	Input of logic path B (I2, I3)
5	: Potential free contact	Dual-channel equivalent N/C contact (with cross-circuit detection)	○	—
	: Emergency stop button : Safety door switch	Dual-channel equivalent N/C contact (with cross-circuit detection)	○	—
	: Two-hand control switches	Two-hand operation (ⅢA) without jog mode	—	○
	: Two-hand control switches	Two-hand operation (ⅢA) with jog mode (time limit 5 seconds)	—	○
	: Non-contact safety switch	Dual-channel equivalent N/O contact*1	○	—
	: Single-beam photoelectric safety sensor	Dual-channel equivalent N/C contact (with cross-circuit detection)	○	—
6	: Potential free contact	Dual-channel equivalent N/C contact (with cross-circuit detection)	○	○
	: Emergency stop button : Safety door switch	Dual-channel equivalent N/C contact (with cross-circuit detection)	○	○
	: Non-contact safety switch	Dual-channel equivalent N/O contact*1	○	○
	: Single-beam photoelectric safety sensor	Dual-channel equivalent N/C contact (with cross-circuit detection)	○	○
7	: Potential free contact : Emergency stop button : Safety door switch	Single-channel N/C contact	○	○
	: Potential free contact : Emergency stop button : Safety door switch	Dual-channel equivalent N/C contact	○	○
	: Electro-sensitive protective equipment (ESPE)	Electro-sensitive protective equipment (ESPE) with semiconductor output	○	○
	: Inductive switch	Sensor with semiconductor output (OSSD output)	○	○
	: Single-beam photoelectric safety sensor	Dual-channel equivalent N/C contact	○	○
9	: Potential free contact : Emergency stop button : Safety door switch	Single-channel N/C contact	—	○
	: Potential free contact : Emergency stop button : Safety door switch	Dual-channel equivalent N/C contact	—	○
	: Potential free contact	Dual-channel equivalent N/C contact (with cross-circuit detection)	○	—
	: Emergency stop button : Safety door switch	Dual-channel equivalent N/C contact (with cross-circuit detection)	○	—
	: Electro-sensitive protective equipment (ESPE)	Electro-sensitive protective equipment (ESPE) with semiconductor output	—	○
	: Non-contact safety switch	Dual-channel equivalent N/O contact*1	○	—
	: Inductive switch	Sensor with semiconductor output (OSSD output)	—	○
	: Single-beam photoelectric safety sensor	Dual-channel equivalent N/C contact	—	○
: Single-beam photoelectric safety sensor	Dual-channel equivalent N/C contact (with cross-circuit detection)	○	—	

\*1 A connectable non-contact safety switch is a product with specifications that a circuit is opened under the condition where an actuator does not exist nearby the safety switch. This open status is considered to be normal and is represented as N/O.

☞ Page 56 Details of the program 5 for FX5-SF-MU4T5s

☞ Page 58 Details of the program 6 for FX5-SF-MU4T5s

☞ Page 60 Details of the program 7 for FX5-SF-MU4T5s

☞ Page 64 Details of the program 9 for FX5-SF-MU4T5s

### ■For FX5-SF-MU4T5 and FX5-SF-8DI4

Set the FUNCTION rotary switch of an FX5-SF-MU4T5 as necessary.

Set a rotary switch to any one of 1 to 6 depending on the sensor connected to the FX5-SF-8DI4.

Sensors that can be connected to an FX5-SF-8DI4 are as follows.

○: Connectable, —: Not connectable

FX5-SF-8DI4 (Program)	Inputs and sensors	Description	Input (I0 to I3)	Input (I4 to I7)
1	<ul style="list-style-type: none"> <li>• : Potential free contact</li> <li>• : Emergency stop button</li> <li>• : Safety door switch</li> </ul>	Single-channel N/C contact	○	○
	: Single-beam photoelectric safety sensor	Single-channel N/C contact	○	○
2	: Potential free contact	Dual-channel equivalent N/C contact (with cross-circuit detection)	○	○
	<ul style="list-style-type: none"> <li>• : Emergency stop button</li> <li>• : Safety door switch</li> </ul>	Dual-channel equivalent N/C contact (with cross-circuit detection)	○	○
	: Safety mat	Pressure sensitive mat (four-wire system)	○	○
	: Non-contact safety switch	Dual-channel equivalent N/O contact*1	○	○
	: Single-beam photoelectric safety sensor	Dual-channel equivalent N/C contact (with cross-circuit detection)	○	○
3	: Potential free contact	Dual-channel equivalent N/C contact (with cross-circuit detection)	○	○
	<ul style="list-style-type: none"> <li>• : Emergency stop button</li> <li>• : Safety door switch</li> </ul>	Dual-channel equivalent N/C contact (with cross-circuit detection)	○	○
	: Non-contact safety switch	Dual-channel equivalent N/O contact*1	○	○
	: Single-beam photoelectric safety sensor	Dual-channel equivalent N/C contact (with cross-circuit detection)	○	○
4	: Potential free contact	Dual-channel complementary N/C / N/O contact (with cross-circuit detection)	○	○
5	: Non-contact safety switch	Dual-channel complementary N/C / N/O contact (with cross-circuit detection and synchronous time monitoring)	○	○
6	<ul style="list-style-type: none"> <li>• : Potential free contact</li> <li>• : Emergency stop button</li> <li>• : Safety door switch</li> </ul>	Single-channel N/C contact	○	○
	<ul style="list-style-type: none"> <li>• : Potential free contact</li> <li>• : Emergency stop button</li> <li>• : Safety door switch</li> </ul>	Dual-channel equivalent N/C contact	○	○
	: Electro-sensitive protective equipment (ESPE)	Electro-sensitive protective equipment (ESPE) with semiconductor output	○	○
	: Inductive switch	Sensor with semiconductor output (OSSD output)	○	○
	: Single-beam photoelectric safety sensor	Dual-channel equivalent N/C contact	○	○

\*1 A connectable non-contact safety switch is a product with specifications that a circuit is opened under the condition where an actuator does not exist nearby the safety switch. This open status is considered to be normal and is represented as N/O.

## Operation

### ■For FX5-SF-MU4T5

Connect I0/I1 and I2/I3 of an FX5-SF-MU4T5 using AND logic.

### ■For FX5-SF-MU4T5 and FX5-SF-8DI4

Connect a logic path of an FX5-SF-MU4T5 to an input of the FX5-SF-8DI4 using AND logic.

## Precautions

To prevent the AND logic to always be '0', connect unused input terminal to a plus terminal.

# 4.6 OR link

This function connects each input of an FX5-SF-MU4T5 and FX5-SF-8DI4 using OR logic.

## Setting method

### ■For FX5-SF-MU4T5

Set the FUNCTION rotary switch to '1' or '2'.

Sensors that can be connected to an FX5-SF-MU4T5 are as follows.

○: Connectable, —: Not connectable

FX5-SF-MU4T5 (Program)	Inputs and sensors	Description	Input of logic path A (I0, I1)	Input of logic path B (I2, I3)
1	<ul style="list-style-type: none"> <li>: Potential free contact</li> <li>: Emergency stop button</li> <li>: Safety door switch</li> </ul>	Single-channel N/C contact	—	○
	<ul style="list-style-type: none"> <li>: Potential free contact</li> <li>: Emergency stop button</li> <li>: Safety door switch</li> </ul>	Dual-channel equivalent N/C contact	—	○
	: Potential free contact	Dual-channel equivalent N/C contact (with cross-circuit detection)	○	—
	<ul style="list-style-type: none"> <li>: Emergency stop button</li> <li>: Safety door switch</li> </ul>	Dual-channel equivalent N/C contact (with cross-circuit detection)	○	—
	: Safety mat	Pressure sensitive mat (four-wire system)	○	—
	: Electro-sensitive protective equipment (ESPE)	Electro-sensitive protective equipment (ESPE) with semiconductor output	—	○
	: Non-contact safety switch	Dual-channel equivalent N/O contact*1	○	—
	: Inductive switch	Sensor with semiconductor output (OSSD output)	—	○
	: Single-beam photoelectric safety sensor	Dual-channel equivalent N/C contact	—	○
	: Single-beam photoelectric safety sensor	Dual-channel equivalent N/C contact (with cross-circuit detection)	○	—
2	<ul style="list-style-type: none"> <li>: Potential free contact</li> <li>: Emergency stop button</li> <li>: Safety door switch</li> </ul>	Single-channel N/C contact	—	○
	<ul style="list-style-type: none"> <li>: Potential free contact</li> <li>: Emergency stop button</li> <li>: Safety door switch</li> </ul>	Dual-channel equivalent N/C contact	—	○
	: Electro-sensitive protective equipment (ESPE)	Electro-sensitive protective equipment (ESPE) with semiconductor output	—	○
	: Non-contact safety switch	Dual-channel complementary N/C / N/O contact (with cross-circuit detection and synchronous time monitoring)	○	—
	: Inductive switch	Sensor with semiconductor output (OSSD output)	—	○
	: Single-beam photoelectric safety sensor	Dual-channel equivalent N/C contact	—	○

\*1 A connectable non-contact safety switch is a product with specifications that a circuit is opened under the condition where an actuator does not exist nearby the safety switch. This open status is considered to be normal and is represented as N/O.

Page 48 Details of the program 1 for FX5-SF-MU4T5s

Page 50 Details of the program 2 for FX5-SF-MU4T5s









### ■For FX5-SF-MU4T5 and FX5-SF-8DI4

Set the FUNCTION rotary switch of an FX5-SF-MU4T5 as necessary.

Set the rotary switch of an FX5-SF-8DI4 to '7'.

Sensors that can be connected to an FX5-SF-8DI4 are as follows.

○: Connectable, —: Not connectable

FX5-SF-8DI4 (Program)	Inputs and sensors	Description	Input (I0 to I3)	Input (I4 to I7)
7	<ul style="list-style-type: none"> <li>• : Potential free contact</li> <li>• : Emergency stop button</li> <li>• : Safety door switch</li> </ul>	Single-channel N/C contact	○	○
	<ul style="list-style-type: none"> <li>• : Potential free contact</li> <li>• : Emergency stop button</li> <li>• : Safety door switch</li> </ul>	Dual-channel equivalent N/C contact	○	○
	 : Electro-sensitive protective equipment (ESPE)	Electro-sensitive protective equipment (ESPE) with semiconductor output	○	○
	 : Inductive switch	Sensor with semiconductor output (OSSD output)	○	○
	 : Single-beam photoelectric safety sensor	Dual-channel equivalent N/C contact	○	○

## Operation

### ■For FX5-SF-MU4T5

Connect I0/I1 and I2/I3 of an FX5-SF-MU4T5 using OR logic.

### ■For FX5-SF-MU4T5 and FX5-SF-8DI4

Connect the inputs of an FX5-SF-MU4T5 and the inputs of the OR function\*<sup>1</sup> of an FX5-SF-8DI4 using OR logic.

\*<sup>1</sup> When the INPUT A rotary switch of an FX5-SF-8DI4 is set to '7', I0/I1 and I2/I3 will be the input of the OR function. When the INPUT B rotary switch of an FX5-SF-8DI4 is set to '7', I4/I5 and I6/I7 will be the input of the OR function.

## Precautions

- The output of the FX5-SF-MU4T5 is kept ON while the OR function is enabled and any of the safety inputs are turned ON.
- During the OR function is active, make sure that there is no danger to people or parts of the machine by using other protective equipments. For example, when using the OR function for a setup mode, make sure that the protective equipments, such as a safety setup mode of a machine, are forcibly enabled.

# 4.7 Bypass

This function forcibly turns ON the outputs of an FX5-SF-MU4T5 for up to 60 seconds while the inputs of an FX5-SF-8DI4 turn ON, by connecting the inputs of the FX5-SF-8DI4 and a logic path of FX5-SF-MU4T5 with OR link.

## Setting method

Set the rotary switch of an FX5-SF-8DI4 to '8'.

Sensors that can be connected to an FX5-SF-8DI4 are as follows.

○: Connectable, —: Not connectable

FX5-SF-8DI4 (Program)	Inputs and sensors	Description	Input (I0 to I3)	Input (I4 to I7)
8	 : Potential free contact	Dual-channel equivalent N/C contact (with cross-circuit detection)	○	○

## Operation

### ■INPUT A rotary switch of an FX5-SF-8DI4 is set to '8'

While I0 and I1 of an FX5-SF-8DI4 turn ON, Q0 and Q1 of an FX5-SF-MU4T5 are forcibly turned ON for 60 seconds.

### ■INPUT B rotary switch of an FX5-SF-8DI4 is set to '8'

While I4 and I5 of an FX5-SF-8DI4 turn ON, Q2 and Q3 of an FX5-SF-MU4T5 are forcibly turned ON for 60 seconds.

## Considerations

- Do not wire I2, I3, I6, and I7 of an FX5-SF-8DI4. They are not used.
- While the bypass function is enabled, the safety outputs of an FX5-SF-MU4T5 are ON. During bypass operation, make sure that there is no danger to people, parts of the machine, or system.
- A bypass signal should be created using a dual-channel key switch (open contact).
- The bypass function should only be activated by a key switch with an automatic reset with two levels, or by two input signals that are independent of each other, such as two position switches.
- Using organizational measures, ensure that a key switch for the bypass function is actuated one time in a certain interval. This is necessary so that the FX5-SF-MU4T5 can identify an error condition of the key switch for the bypass function, or an error condition of its connection cable. The interval should be defined to suit the specific case dependent on the application.
- Constantly check if the bypass function can be enabled and disabled in the operation mode which was set for the bypass function.
- A key switch for the bypass function should be actuated in the place where the entire hazardous area can be surveyed.
- A key switch for the bypass function should not be handled in a hazardous area.
- When an error occurs, the FX5-SF-MU4T5 automatically ends the bypass function.
- A safety device is disabled by the bypass function; therefore, the bypass function should only be consciously activated by an operator in the place where the entire hazardous area can be surveyed.

# 4.8 Restart Interlock

When a danger is detected and a control output is turned OFF, a restart interlock prevents a system from restarting by keeping the safety output OFF status until safety is verified and a reset signal is turned ON.

## Setting method

The function is available by wiring terminals.

Connect a reset button between a plus terminal and an X terminal.

The outline of the wiring diagram is as follows:

Wiring	Without external device monitoring (EDM)	With external device monitoring (EDM)
X0	Manual reset (with restart interlock)	
	Auto-reset (without restart interlock)	
X1	Manual reset (with restart interlock)	
	Auto-reset (without restart interlock)	

For details on the wiring, refer to the following:

☞ Page 39 Built-In Program Selection Function

☞ Page 97 External Wiring Example

## Operation

When an output is suspended, it is not restarted unless the interlock is disabled.

To disable the restart interlock, current should be applied for all the connected terminals within X0, X1, and X2 after the reset button is pressed.

For an operation with no restart interlock, when logic in a logic path are all '1', outputs turn ON immediately.

## Precautions

- Always connect X0 and X2. Connect X1 depending on the program.
- Rearranging the wiring of X0, X1, and X2 after the settings have been applied will cause an error.
- When wiring the reset button to reset manually, the corresponding X terminal must be open or be connected to a high resistance output such as a programmable controller. If the potential is HIGH or LOW, a configuration error will occur.

## 4.9 External Device Monitoring (EDM)

This function monitors if the contactors are turned OFF during a reset.  
An external device failure and adherence of parts can be detected.

### Setting method

The function is available by wiring terminals.

For the outline of the wiring diagram, refer to the following:

☞ Page 77 Restart Interlock

For details on the wiring, refer to the following:

☞ Page 39 Built-In Program Selection Function

☞ Page 97 External Wiring Example

### Operation

The ON/OFF statuses of the contactors connected to Q0 to Q3 are monitored.

When the contactors are ON, no input for X0, X1, and X2 are detected. When they are OFF, inputs for X0, X1, and X2 are detected.

### Precautions

- Always connect X0 and X2 when using this function. Connect X1 depending on the program.
- Rearranging the wiring of X0, X1, and X2 after the settings have been applied will cause an error.
- When wiring the reset button to reset manually, the corresponding X terminal must be open or be connected to a high resistance output such as a programmable controller. If the potential is HIGH or LOW, a configuration error will occur.
- To monitor contactors that are externally connected to the safety output Q0 to Q3, connect the close contacts of each contactor to any of the inputs from X0 to X2 in direct connection.



# 4.10 Retriggering of the Delayed OSSDs

This function disables off delay when an input is in the safe state.

## Setting method

The function is available by wiring terminals.

To enable the function, wire the X2 terminal and the T1 terminal.

## Operation

The following shows the retriggering timing charts when off delay is set to a value longer than zero second.

Retriggering	Restart interlock	Timing chart	Description
ON	With/without restart interlock	<p>(1) Input (2) Output Qx (3) Output delay can be set up to x seconds.</p>	When all the inputs are turned ON before the lapse of off delay time, the output is not turned OFF.
OFF	With restart interlock	<p>(1) Input (2) Reset button (3) Output Qx (4) Output delay can be set up to x seconds.</p>	The output turns OFF when the delay time elapsed after the input was turned OFF. Pressing the reset button during the delay time does not affect the input/output. The output turns ON by pressing the reset button after the output is turned OFF.
OFF	Without restart interlock	<p>■When the input turns OFF</p> <p>(1) Input (2) Output Qx (3) Output delay can be set up to x seconds.</p> <p>■When the input turns ON during off delay</p> <p>(1) Input (2) Output Qx (3) Output delay can be set up to x seconds.</p>	<p>The output turns OFF when the delay time elapsed after the input was turned OFF.</p> <p>When a safety input is turned ON during the delay time, the output turns OFF for 400 ms after the lapse of the delay time. The output turns ON again after 400 ms.</p>

## Precautions

- Always connect X0 and X2. Connect X1 depending on the program.
- Rearranging the wiring of X0, X1, and X2 after the settings have been applied will cause an error.
- When wiring the reset button to reset manually, the corresponding X terminal must be open or be connected to a high resistance output such as a programmable controller. If the potential is HIGH or LOW, a configuration error will occur.

## 4.11 ENABLE Input (XS0 Terminal)

---

ENABLE input (XS0 terminal) is a terminal to enable safety outputs.

### Setting method

---

Connect the XS0 terminal of an FX5-SF-MU4T5 to the same power supply as the plus terminal.

### Operation

---

When the XS0 terminal goes LOW (0 V), the safety outputs Q0 to Q3 always go LOW. The input signals such as a reset and muting are not detected until the XS0 terminal goes HIGH again.

### Precautions

- When the XS0 terminal goes LOW, the corresponding module does not need to be reset for switching the XS0 terminal to HIGH again.
- If off delay has been set on Q2 and Q3, the delay time is counted after the XS0 terminal goes LOW.

## 4.12 Two-Hand Operation/Jog Mode

Two-hand operation can be used by connecting a two-hand control device that complies with EN 574 (Two-hand control device - Functional aspects and design principles) IIIA or IIIC to an FX5-SF-MU4T5.

Jog mode can limit the duration time which keeps the safety outputs Q2 and Q3 ON to five seconds by using a two-hand control device. An application which can supply works during the two-hand control device operation can be constructed easily.

### Setting method

Set the FUNCTION rotary switch of an FX5-SF-MU4T5 to '4' or '5'.

The jog mode is available only when '5' is set to the FUNCTION rotary switch.

Rotary switch	Jog mode	Settings
4	Unavailable	A two-hand control device (two dual-channel complementary N/C / N/O contacts) which complies with EN 574 IIIC is connected as follows. <ul style="list-style-type: none"> <li>• Cross-circuit detecting control signals (I0 to I1 and T0, I2 to I3 and T1)</li> </ul>
5	Disabled	A two-hand control device (two single-channel N/C contacts) which complies with EN 574 IIIA is connected as follows. Additionally, X1 is connected to a plus terminal. <ul style="list-style-type: none"> <li>• Cross-circuit detecting control signals (I2 and T0, I3 and T1)</li> </ul>
	Enabled	A two-hand control device (two single-channel N/C contacts) which complies with EN 574 IIIA is connected as follows. Additionally, X1 is disconnected from a plus terminal. <ul style="list-style-type: none"> <li>• Cross-circuit detecting control signals (I2 and T0, I3 and T1)</li> </ul>

For details of the wiring method, refer to the following:

☞ Page 54 Details of the program 4 for FX5-SF-MU4T5s

☞ Page 56 Details of the program 5 for FX5-SF-MU4T5s

### Operation

Rotary switch	Jog mode	Operation
4	Unavailable	Safety inputs of I0 to I3 turn ON only when two-hand control switches (IIIC) are pressed simultaneously within 0.5 seconds.
5	Disabled	Safety inputs of I2 to I3 turn ON only when two-hand control switches (IIIA) are pressed simultaneously within 0.5 seconds.
	Enabled	Safety inputs of I2 to I3 turn ON only when two-hand control switches (IIIA) are pressed down simultaneously within 0.5 seconds. *1

\*1 The duration for which the safety outputs turn ON is limited to five seconds. The duration can be reset by releasing the two-hand control switches.

**Ex.**

Output examples when safety inputs are turned ON

Rotary switch	Jog mode	Safety inputs				Safety outputs			
		I0	I1	I2	I3	Q0	Q1	Q2	Q3
4	Unavailable	ON	ON	ON	ON	ON	ON	ON	ON
5	Disabled	—	—	ON	ON	—	—	ON	ON
	Enabled	—	—	ON	ON	—	—	ON	ON

# 4.13 Error History

An error history occurred in the safety main module can be saved in the error history saving area in the buffer memory. Up to 16 error history records can be saved.

## Operation

An error occurred in a safety extension module is stored in the buffer memory as error history.

Up to 16 error history records can be saved for each device.

When an error occurs, the error code and the error time are stored from 'Error history No.1' (Un\G700) in ascending order.

The configuration of the buffer memory is as follows.

- Details of buffer memory assignment

	b15	to	b8	b7	to	b0
Un\G700	Error code					
Un\G701	First two digits of the year			Last two digits of the year		
Un\G702	Month			Day		
Un\G703	Hour			Minute		
Un\G704	Second			Day of the week		
Un\G705	Millisecond (upper)			(Millisecond (lower)		
Un\G706	System area					
to						
Un\G709						

**Ex.**

Storage example of error history

Item	Description	Storage example <sup>*1</sup>
First two digits of the year/ Last two digits of the year	A value is stored in BCD code.	2017H
Month/Day		0131H
Hour/Minute		1035H
Second		40H
Day of the week	One of the following values is stored in BCD code. <ul style="list-style-type: none"> <li>• Sunday: 0</li> <li>• Monday: 1</li> <li>• Tuesday: 2</li> <li>• Wednesday: 3</li> <li>• Thursday: 4</li> <li>• Friday: 5</li> <li>• Saturday: 6</li> </ul>	2H
Millisecond (upper)	A value is stored in BCD code.	6H
Millisecond (lower)		28H

\*1 These values assume that an error occurred at 10:35 and 40.628 milliseconds on Tuesday, January 31st, 2017.

The start address of error history where the latest error is stored can be found in 'Latest address of error history' (Un\G1).

**Ex.**

When the third error occurred:

The third error is stored in an error history No.3 and 720 (start address of the error history No.3) is stored in 'Latest address of error history' (Un\G1).

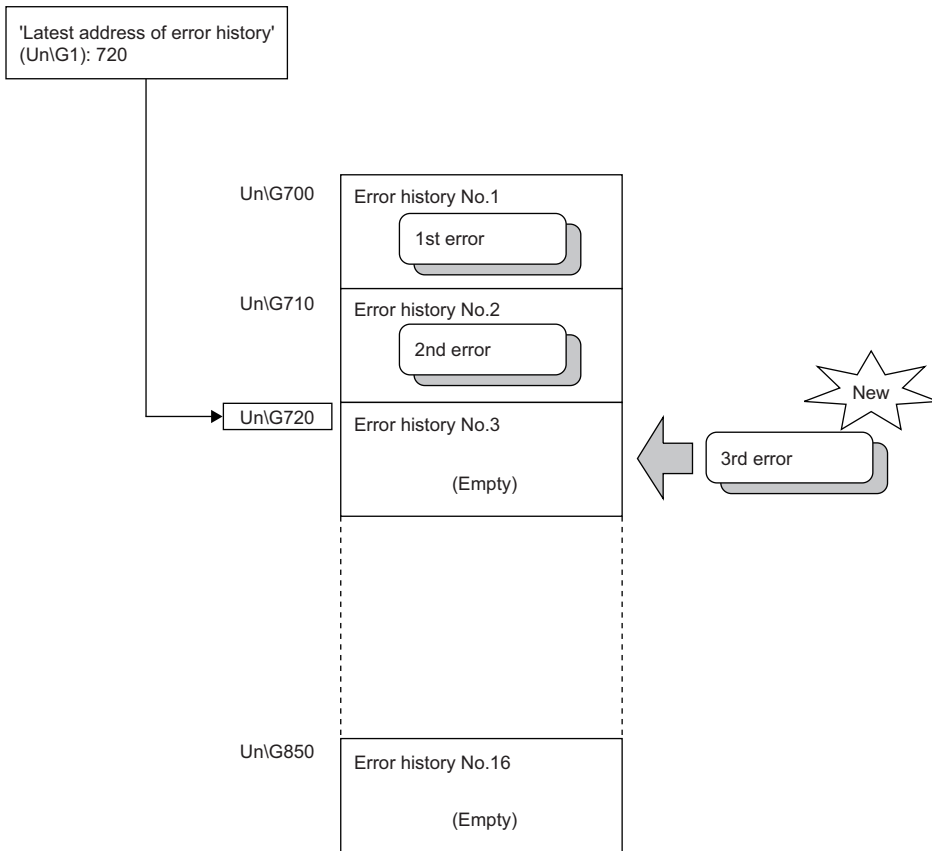

**Ex.**

When the 17th error occurred:

The 17th error is stored in an error history No.1 and 700 (start address of the error history No.1) is stored in 'Latest address of error history' (Un\G1).

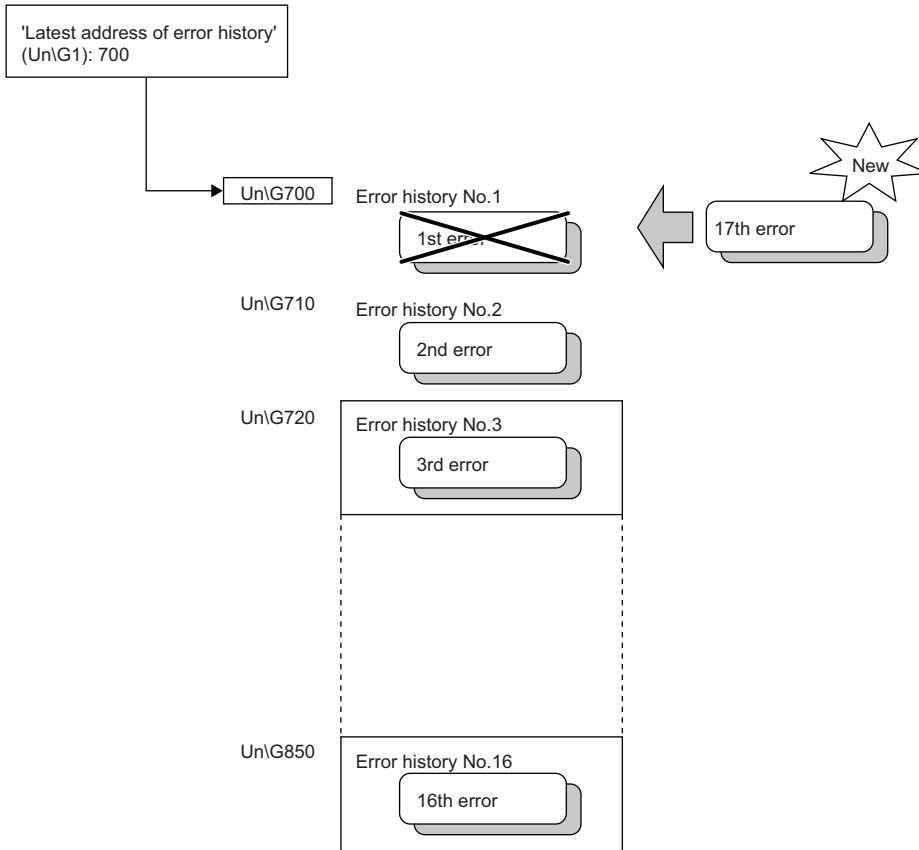

**Point**

- Once the error history storage area becomes full, the existing data is overwritten in order, starting with 'Error history No.1' (Un\G700). The overwritten history is deleted.
- The recorded error history is cleared by turning OFF the power.

# 4.14 Safety Information Monitoring Function

To store information including the I/Os, settings, and error codes of a safety extension module to the buffer memory. The safety information can be referenced by user programs and built-in functions (such as Web server) of a CPU module or the monitoring screen of GX Works3.

## Operation

This function stores information including the I/Os, settings, and error codes of a safety extension module to a buffer memory of a safety main module.

Not only the information of a safety main module, but also the information of a safety extension module are stored in the buffer memory.

## Buffer memory to be used

The buffer memory used for this function are as shown below.

For details on the buffer memory, refer to the following:

 Page 140 Buffer Memory

Address (decimal)	Address (hexadecimal)	Buffer memory name	Data type	Auto-refresh
71	47H	Number of units connected	Monitor	<input type="radio"/>
100	64H	1st Module Input signal	Monitor	<input type="radio"/>
101	65H	1st Module Output signal and Module state	Monitor	<input type="radio"/>
102	66H	1st Module Output signal and Internal error	Monitor	<input type="radio"/>
103	67H	1st Module System CRC	Monitor	<input type="radio"/>
104	68H	1st Module Input terminal error	Monitor	<input type="radio"/>
105	69H	1st Module Error code 1	Monitor	<input type="radio"/>
106	6AH	1st Module Error code 2	Monitor	<input type="radio"/>
108	6CH	1st Module Lower Rotary Switch state	Monitor	<input type="radio"/>
109	6DH	1st Module Upper Rotary Switch state	Monitor	<input type="radio"/>
110	6EH	1st Module X0 terminal state	Monitor	<input type="radio"/>
111	6FH	1st Module X1 terminal state	Monitor	<input type="radio"/>
112	70H	1st Module X2 terminal state	Monitor	<input type="radio"/>
113	71H	1st Module Module name identifier	Monitor	<input type="radio"/>
115	73H	1st Module Lower Rotary Switch startup state	Monitor	<input type="radio"/>
116	74H	1st Module Upper Rotary Switch startup state	Monitor	<input type="radio"/>
117	75H	1st Module X0 terminal startup state	Monitor	<input type="radio"/>
118	76H	1st Module X1 terminal startup state	Monitor	<input type="radio"/>
119	77H	1st Module X2 terminal startup state	Monitor	<input type="radio"/>
120	78H	1st Module Off delay time	Monitor	<input type="radio"/>
140	8CH	2nd Module Input signal	Monitor	<input type="radio"/>
141	8DH	2nd Module Output signal	Monitor	<input type="radio"/>
144	90H	2nd Module Input terminal error	Monitor	<input type="radio"/>
145	91H	2nd Module Error code 1	Monitor	<input type="radio"/>
146	92H	2nd Module Error code 2	Monitor	<input type="radio"/>
148	94H	2nd Module Lower Rotary Switch state	Monitor	<input type="radio"/>
149	95H	2nd Module Upper Rotary Switch state	Monitor	<input type="radio"/>
150	96H	2nd Module X0 terminal state	Monitor	<input type="radio"/>
151	97H	2nd Module X1 terminal state	Monitor	<input type="radio"/>
152	98H	2nd Module X2 terminal state	Monitor	<input type="radio"/>
153	99H	2nd Module Module name identifier	Monitor	<input type="radio"/>
155	9BH	2nd Module Lower Rotary Switch startup state	Monitor	<input type="radio"/>
156	9CH	2nd Module Upper Rotary Switch startup state	Monitor	<input type="radio"/>
157	9DH	2nd Module X0 terminal startup state	Monitor	<input type="radio"/>

Address (decimal)	Address (hexadecimal)	Buffer memory name	Data type	Auto-refresh
158	9EH	2nd Module X1 terminal startup state	Monitor	<input type="radio"/>
159	9FH	2nd Module X2 terminal startup state	Monitor	<input type="radio"/>
160	A0H	2nd Module Off delay time	Monitor	<input type="radio"/>
180	B4H	3rd Module Input signal	Monitor	<input type="radio"/>
181	B5H	3rd Module Output signal	Monitor	<input type="radio"/>
184	B8H	3rd Module Input terminal error	Monitor	<input type="radio"/>
185	B9H	3rd Module Error code 1	Monitor	<input type="radio"/>
186	BAH	3rd Module Error code 2	Monitor	<input type="radio"/>
188	BCH	3rd Module Lower Rotary Switch state	Monitor	<input type="radio"/>
189	BDH	3rd Module Upper Rotary Switch state	Monitor	<input type="radio"/>
190	BEH	3rd Module X0 terminal state	Monitor	<input type="radio"/>
191	BFH	3rd Module X1 terminal state	Monitor	<input type="radio"/>
192	C0H	3rd Module X2 terminal state	Monitor	<input type="radio"/>
193	C1H	3rd Module Module name identifier	Monitor	<input type="radio"/>
195	C3H	3rd Module Lower Rotary Switch startup state	Monitor	<input type="radio"/>
196	C4H	3rd Module Upper Rotary Switch startup state	Monitor	<input type="radio"/>
197	C5H	3rd Module X0 terminal startup state	Monitor	<input type="radio"/>
198	C6H	3rd Module X1 terminal startup state	Monitor	<input type="radio"/>
199	C7H	3rd Module X2 terminal startup state	Monitor	<input type="radio"/>
200	C8H	3rd Module Off delay time	Monitor	<input type="radio"/>



# 5 SYSTEM CONFIGURATION

A safety control system can be configured by attaching a safety extension module to a general control system. A system configuration example is as follows.

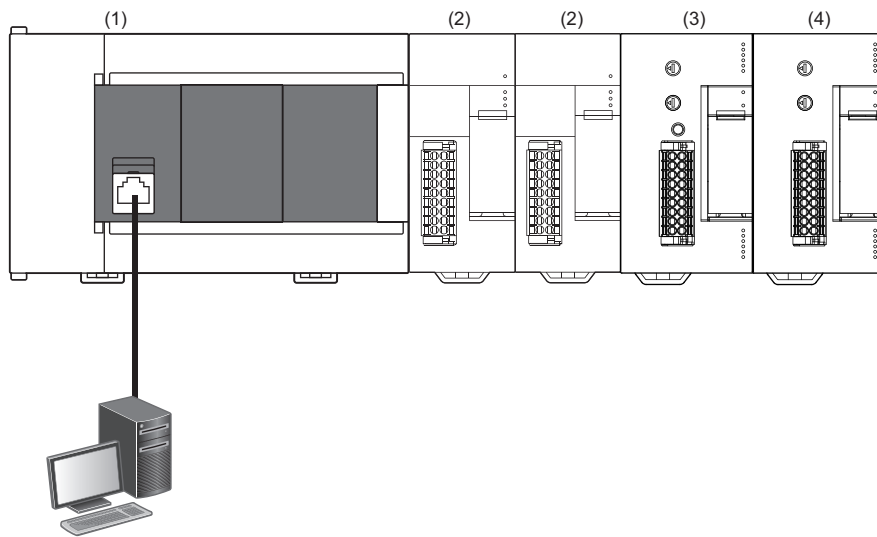

- (1) FX5 CPU module
- (2) Input/output module, powered input/output module, and intelligent function module
- (3) Safety main module (FX5-SF-MU4T5)
- (4) Safety input expansion module (FX5-SF-8DI4)

## Number of connectable modules and position to connect

Safety extension module	Max. number of connectable modules	Position to connect
FX5-SF-MU4T5	1	Rightmost of the system
FX5-SF-8DI4	2	Right side of an FX5-SF-MU4T5

### ■Bus conversion module

A safety extension module cannot be used in the system configuration where a bus conversion module is used. Additionally, a bus conversion module cannot be used in a system where a safety extension module is used.

### ■Motion module

When using a safety extension module and a motion module (FX5-40SSC-G or FX5-80SSC-G) together, connect the motion module the firmware version of which is '1.001' or later.

Additionally, when using the following intelligent function modules with a safety extension module and a motion module, use the respective firmware versions as follows:

- FX5-20PG-P: '1.011' or later
- FX5-20PG-D: '1.011' or later
- FX5-CCLGN-MS: '1.002' or later
- FX5-DP-M: '1.001' or later

# MEMO

---

# 6 WIRING

This chapter explains the wiring for connecting a safety extension module.

## 6.1 Spring Clamp Terminal Block

This section explains the wiring for a spring clamp terminal block.

### Applicable wire

A wire that can be connected to a spring clamp terminal block is as follows.

Number of wires per terminal	Wire size	
	Single wire, strand wire	Ferrule with insulation sleeve
Single wiring	AWG 24 to 16 (0.2 to 1.5 mm <sup>2</sup> )	AWG 23 to 19 (0.25 to 0.75 mm <sup>2</sup> )

### Wire end treatment

Strip the cable jacket approximately 10 mm from the tip, and connect a wire ferrule to the stripped part.

If the stripped part is too long, the exposed wire may touch a material part of the terminal, and it may result in electric shock or short-circuit among the adjacent terminals.

On the other side, if the stripped part is too short, it may cause contact failure to the spring clamp terminal.

Depending on the thickness of a sheath, it may be difficult to insert into an insulation sleeve. Select the wires by referring to the external dimensions.

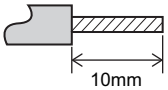
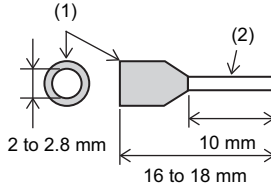
Strand wire/single wire	Ferrule with insulation sleeve
	 <p>(1) Insulation sleeve (2) Contact area (crimp area)</p>

The following table shows wire ferrules and tools for the wire ferrules that are suitable for terminal blocks. If the items other than those are used, the wire ferrule may not be able to remove. Before using a wire ferrule, check that it can be removed.

<Recommended products>

Manufacturer	Model	Wire size	Crimp tool
PHOENIX CONTACT GmbH & Co. KG	Al 0.5-10 WH	0.5 mm <sup>2</sup>	CRIMPFOX 6
	Al 0.75-10 GY	0.75mm <sup>2</sup>	
	A 1.0-10	1.0mm <sup>2</sup>	
	A 1.5-10	1.5mm <sup>2</sup>	

## Removal and installation of a terminal block

The following shows the method for removing and installing a terminal block.

### ■Lever position to lock and release

A three-step stopper is attached to prevent the lever from rotating, facilitating installation and removal of the terminal block. When removing or installing the terminal block, move the lever to the corresponding position.

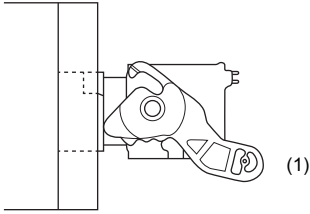

(1) Lever position to release

#### ■Lever position to release

The figure left shows the lever position when the terminal block has been completely removed from the module.

Rotate the lever from the lock position to the release position, and lift the terminal block from the module.

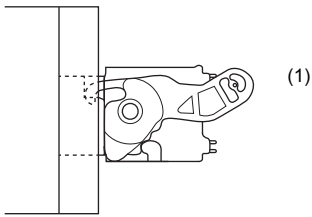

(1) Lever position to lock

#### ■Lever position to lock

The figure left shows the lever position when the terminal block is completely engaged with the module.

Check that the lever is at the lock position, and pull the terminal block slightly to check that the module and terminal block are completely engaged.

### ■Removal procedure

Rotate the lever to the release position, and remove the terminal block from the module.

### ■Installation procedure

Move the lever to the release position, and insert the terminal block. When the terminal block is inserted sufficiently, the lever latch engages with the module and the terminal block is engaged with the module.

#### Point

After inserting the terminal block, check that the lever is at the lock position.

### Precautions

When installing the terminal block, check that the lever is in the release position. If installation is performed while the lever is in the lock position, it may cause damage to the lever.

## Wiring of an electric wire

### ■When using a ferrule with insulation sleeve

Insert a wire to which a ferrule with insulation sleeve is cramped into the wire insertion opening.

### ■When using a single wire or strand wire

Using a flathead screwdriver, push the open/close button on the terminal block. While pushing the open/close button, insert the wire securely until it reaches the end. After the wire is fully inserted to the end, release the open/close button.

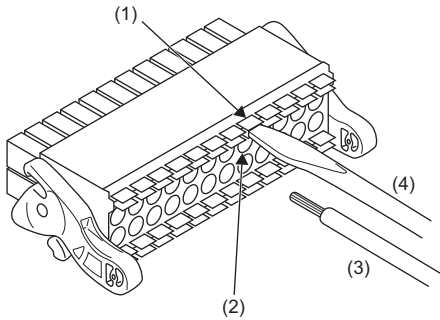

- (1) Open/close button
- (2) Wire insertion opening
- (3) Wire
- (4) Flathead screwdriver

<Reference>

Manufacturer	Model
PHOENIX CONTACT GmbH & Co. KG	SZS 0.4 × 2.5 VDE

## Precautions

After wiring, pull the wire slightly to check that the wire is securely clamped.

## Disconnection of a wire

Using a flathead screwdriver, push the open/close button of the wire to be disconnected. While pushing the open/close button, pull out the wire.

## 6.2 Terminal Arrangement

This section explains the terminal arrangement of a safety extension module.

### FX5-SF-MU4T5

The terminal arrangement of an FX5-SF-MU4T5 is as follows.

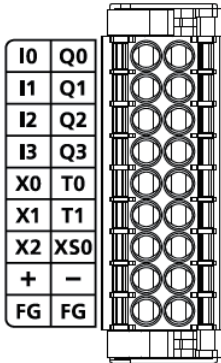

Left side of terminal arrangement		Right side of terminal arrangement	
Name	Description	Name	Description
I0	Safety input 0	Q0	Safety output 0
I1	Safety input 1	Q1	Safety output 1
I2	Safety input 2	Q2	Safety output 2
I3	Safety input 3	Q3	Safety output 3
X0	General input 0	T0	Test output 0
X1	General input 1	T1	Test output 1
X2	General input 2	XS0	ENABLE input
+	External 24 V +24 V terminal	-	External 24 V Ground terminal
FG	Frame ground	FG	Frame ground

#### Point

The following combinations of input terminals should be considered when wiring input terminals redundantly.

- I0 terminal and I1 terminal
- I2 terminal and I3 terminal

The following combinations of output terminals should be considered when wiring output terminals redundantly.

- Q0 terminal and Q1 terminal
- Q2 terminal and Q3 terminal

## Internal circuit overview

The following shows an external wiring example for connecting an emergency stop button between 'I' input terminal and 'T' output terminal.

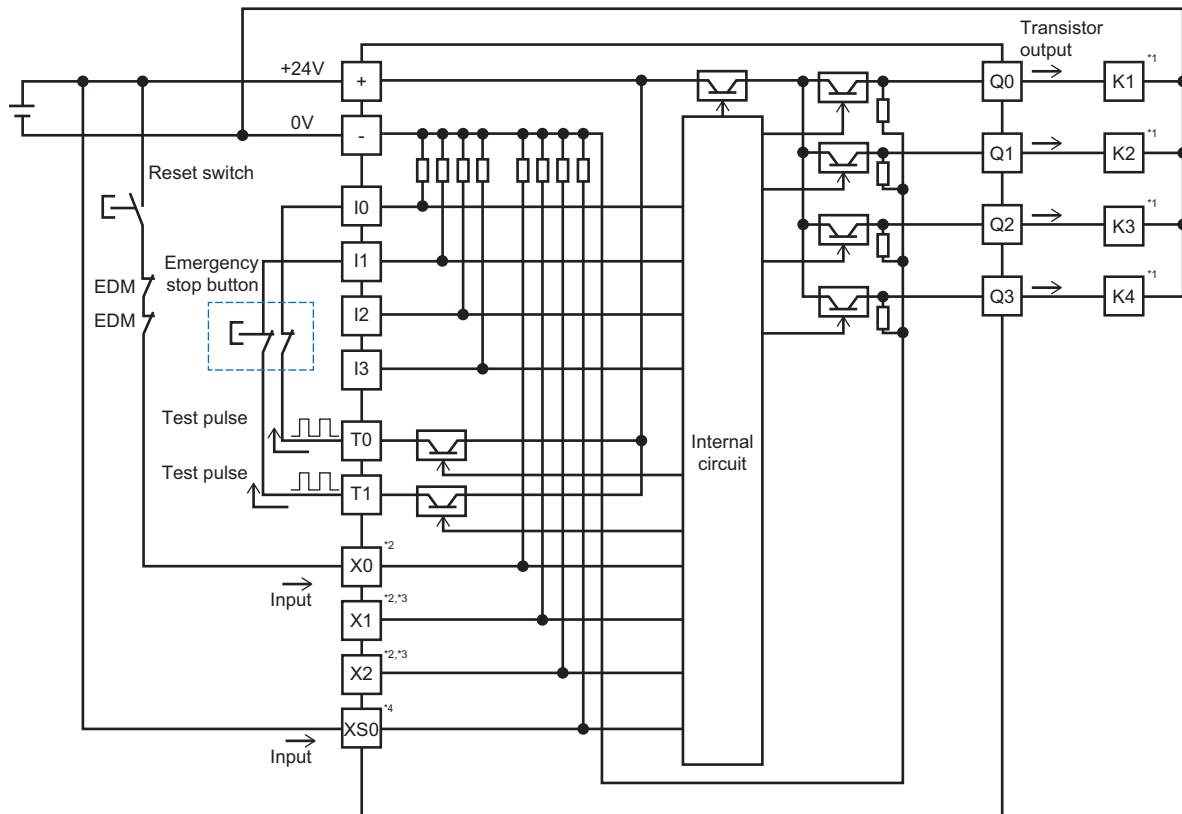

- \*1 'K1' to 'K4' indicate contactors.
- \*2 Any from X0 to X2 may be wired to T0 or T1 depending on a program.
- \*3 The connection method for X1 and X2 is the same as that of X0. (It depends on a program.)
- \*4 XS0 is an ENABLE input.

## FX5-SF-8DI4

The terminal arrangement of an FX5-SF-8DI4 is as follows.

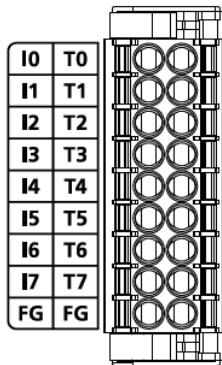

Left side of terminal arrangement		Right side of terminal arrangement	
Name	Description	Name	Description
I0	Safety input 0	T0	Test output 0
I1	Safety input 1	T1	Test output 1
I2	Safety input 2	T2	Test output 2
I3	Safety input 3	T3	Test output 3
I4	Safety input 4	T4	Test output 4
I5	Safety input 5	T5	Test output 5
I6	Safety input 6	T6	Test output 6
I7	Safety input 7	T7	Test output 7
FG	Frame ground	FG	Frame ground

### Point

The following combinations of input terminals should be considered when wiring input terminals redundantly.

- I0 terminal and I1 terminal
- I2 terminal and I3 terminal
- I4 terminal and I5 terminal
- I6 terminal and I7 terminal



## Internal circuit overview

The following shows an external wiring example for connecting an emergency stop button between 'I' input terminal and 'T' output terminal.

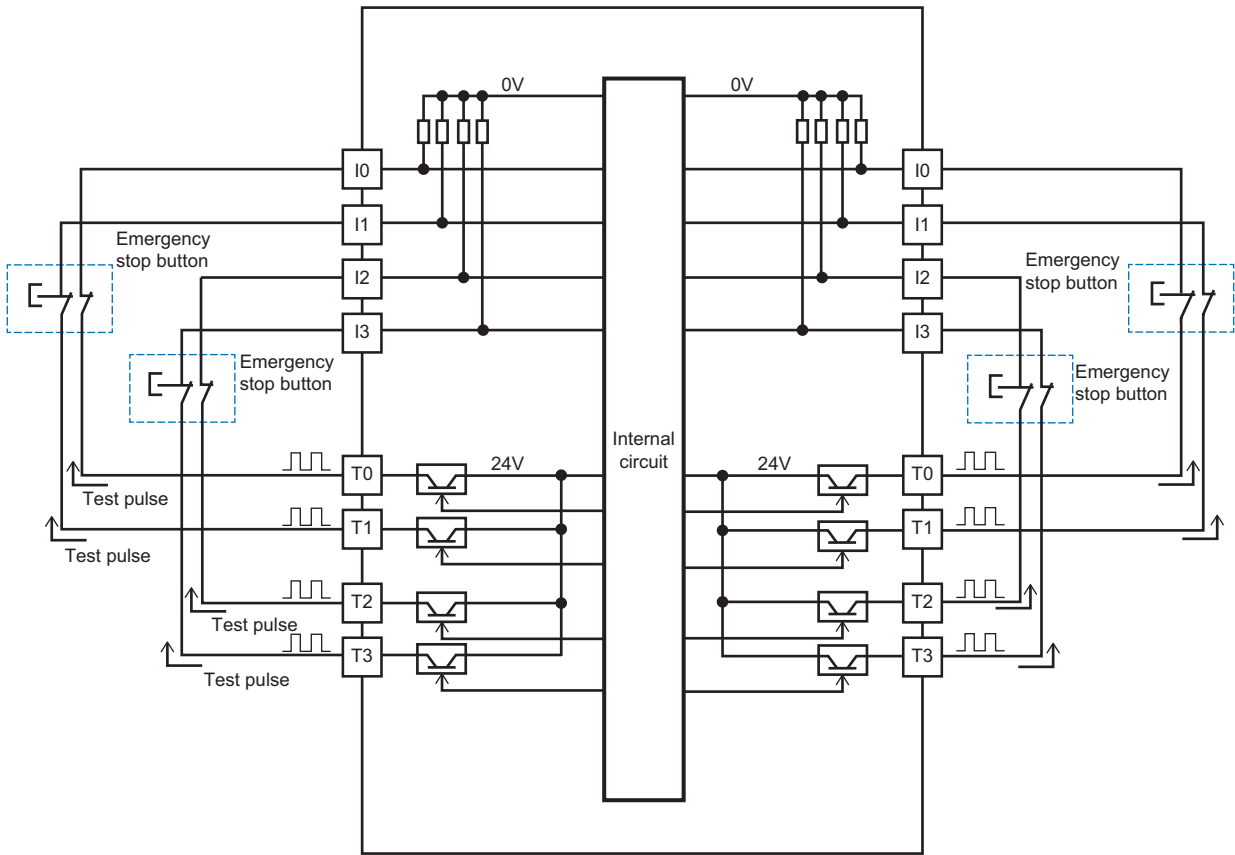

## 6.3 Grounding

Observe the following:

- Provide class D grounding. (Grounding resistance:  $100\ \Omega$  or less)
- Provide independent grounding when possible.
- If independent grounding cannot be provided, employ "Shared grounding" shown below.

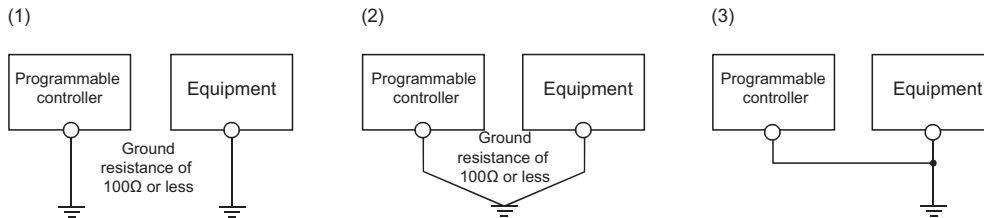

(1) Independent grounding: Recommended

(2) Shared grounding: Allowed

(3) Common grounding: Not allowed

- Bring the grounding point close to the programmable controller as much as possible so that the ground cable can be shortened.

## 6.4 External Wiring Example

---

This section explains examples for wiring external devices.

For details on functions and programs, refer to the following section.

☞ Page 38 FUNCTIONS

For details on the products including safety relay and universal output expansion module manufactured by SICK AG, refer to the SICK manuals.

Check the wiring example including an FX5-SF-8DI4 in MELSEC iQ-F Series Safety Extension Module Configuration Guide.

For details on MELSEC iQ-F Series Safety Extension Module Configuration Guide, refer to the following:

☞ Page 155 How to Use MELSEC iQ-F Series Safety Extension Module Configuration Guide

### Wiring devices

---

Preparation of the following safety devices to connect with a safety extension module is required.

- Single-beam photoelectric safety sensor
- Non-contact safety switches
- Safety light curtains and multiple-beam photoelectric safety sensor
- Muting lamps and cables
- Two-hand control switches

## Wiring an emergency stop button

The following shows an example of the program 1 with a restart interlock and EDM.

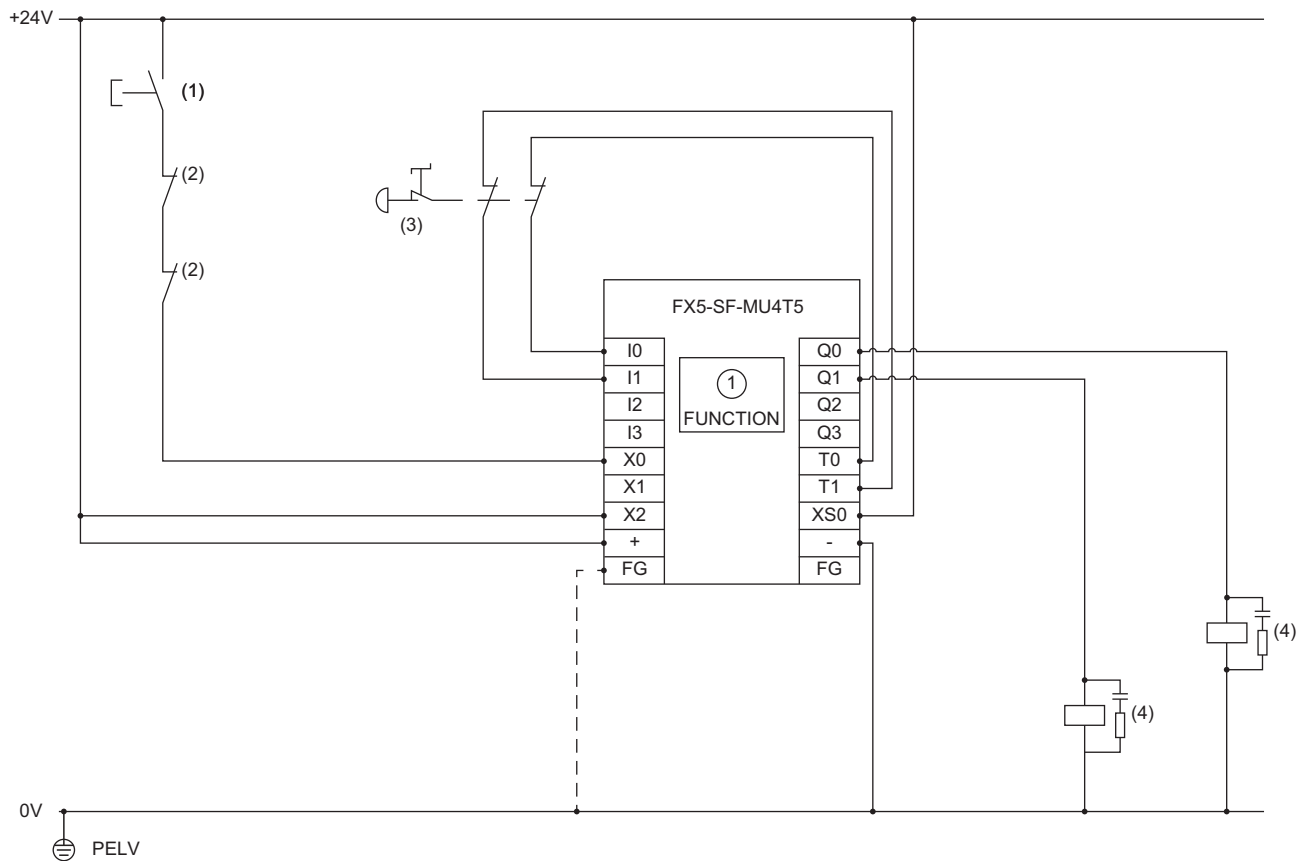

- (1) Reset switch, start switch
- (2) Contactor contact point
- (3) An emergency stop button
- (4) Contactor

## Wiring a magnetic safety switch

The following shows an example of the program 2 with a restart interlock and EDM.

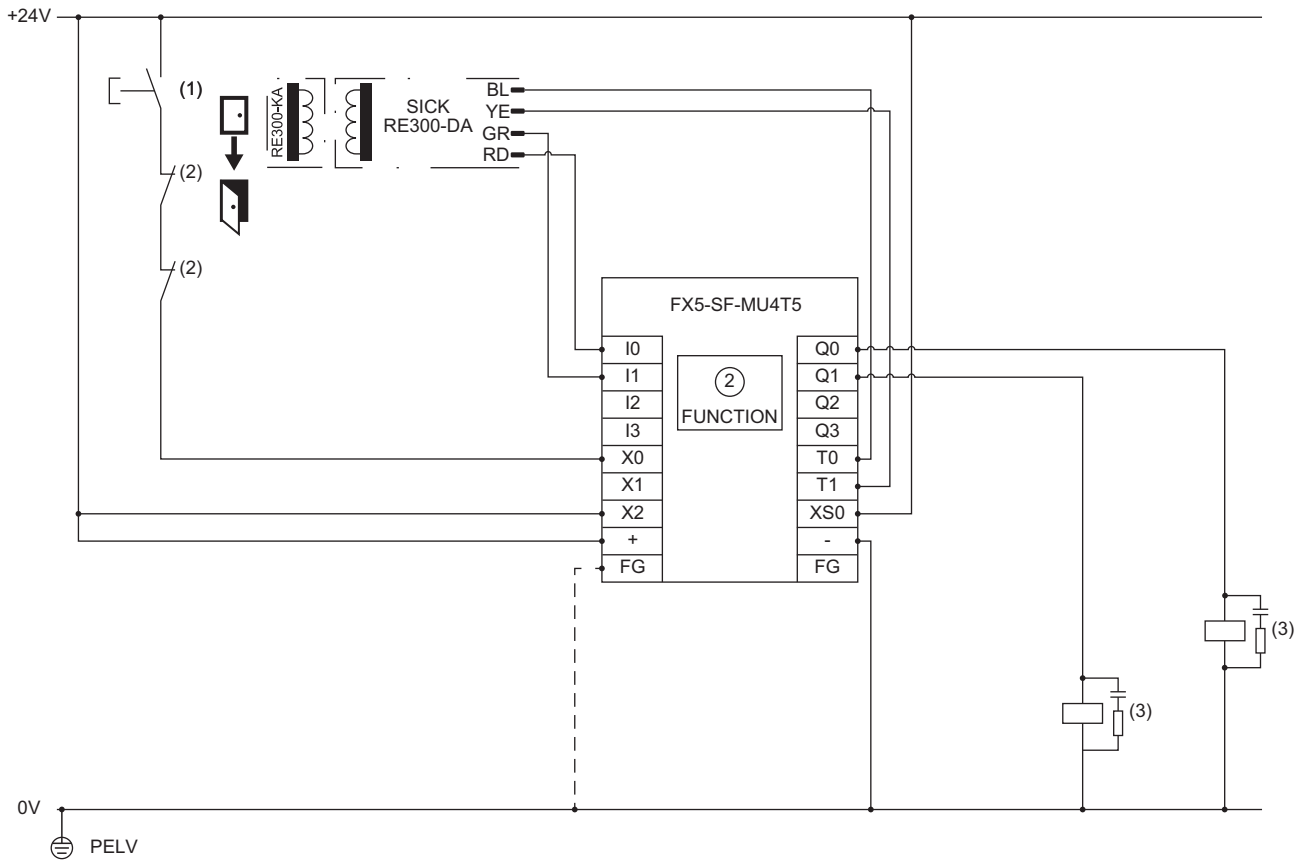

- (1) Reset switch, start switch
- (2) Contactor contact point
- (3) Contactor

## Wiring light curtains and muting sensors

The following shows an example of the program 3.1 with a restart interlock and EDM.

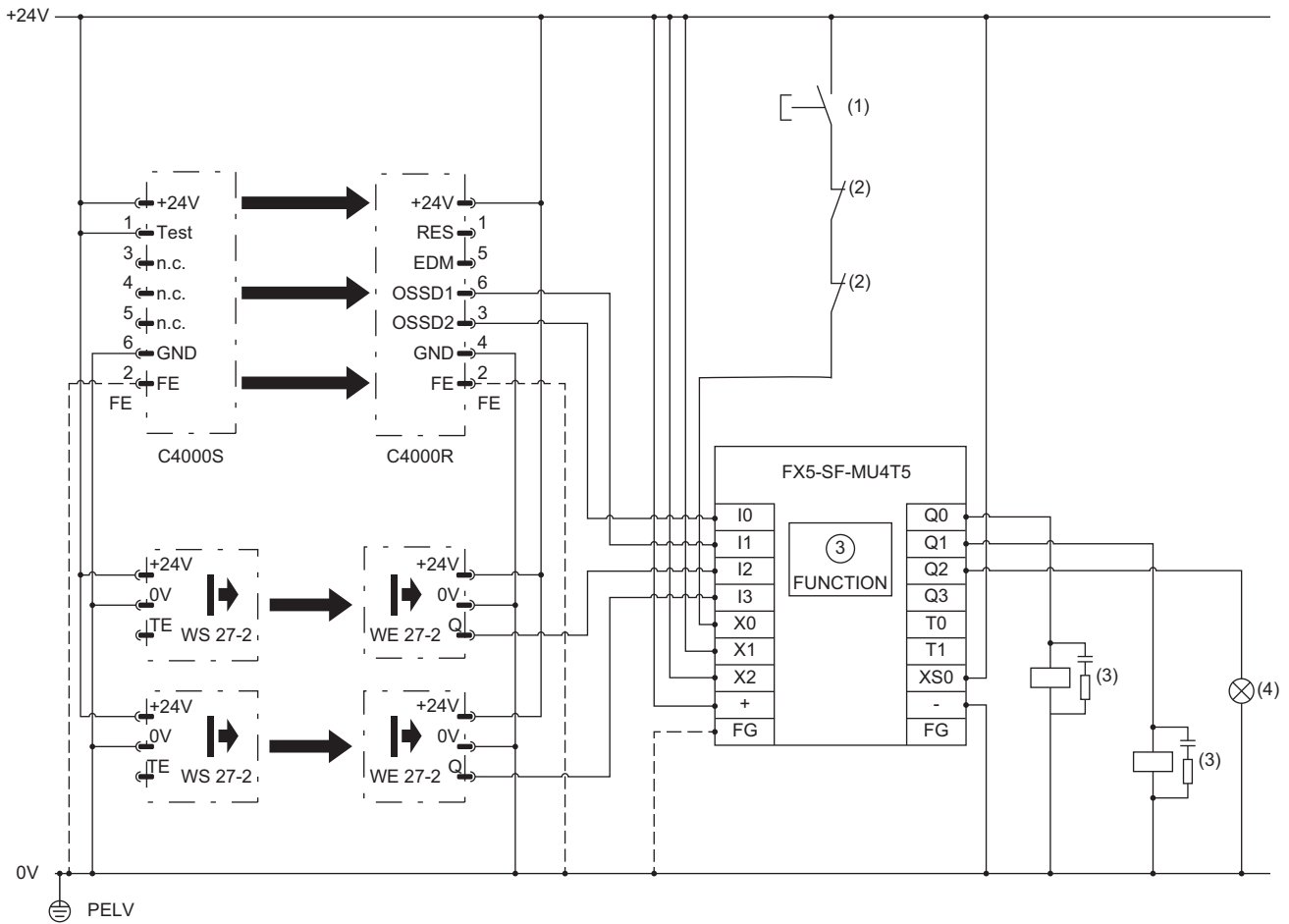

- (1) Reset switch, start switch
- (2) Contactor contact point
- (3) Contactor
- (4) Muting lamp

### Precautions

C4000 - FE must be grounded.

## Wiring a non-contact switch

The following shows an example of the program 3.2 with a restart interlock and EDM.

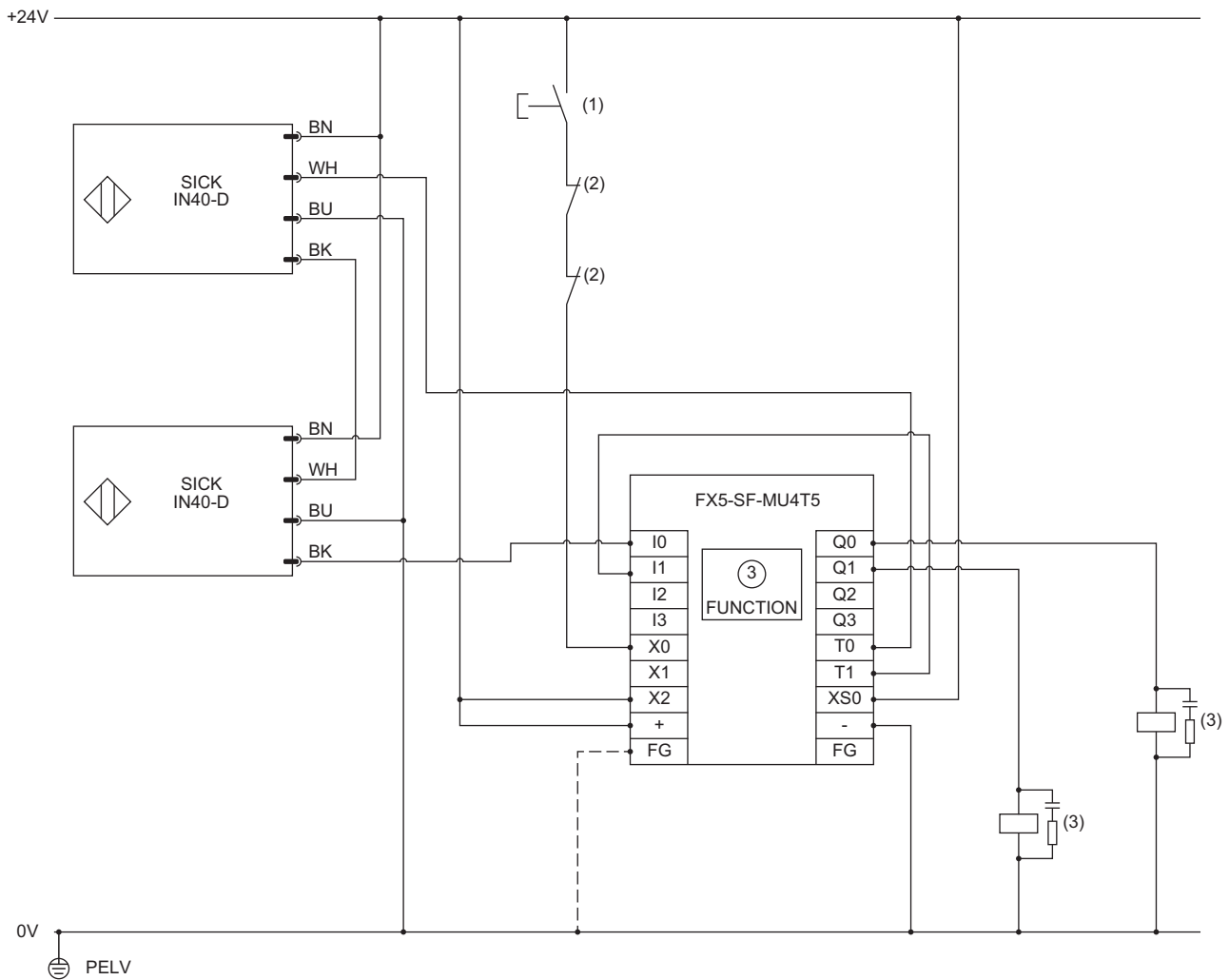

- (1) Reset switch, start switch
- (2) Contactor contact point
- (3) Contactor

## Wiring a transmissive photoelectric switch and an universal output expansion module

The following shows an example of the program 3.2 with a restart interlock and EDM.

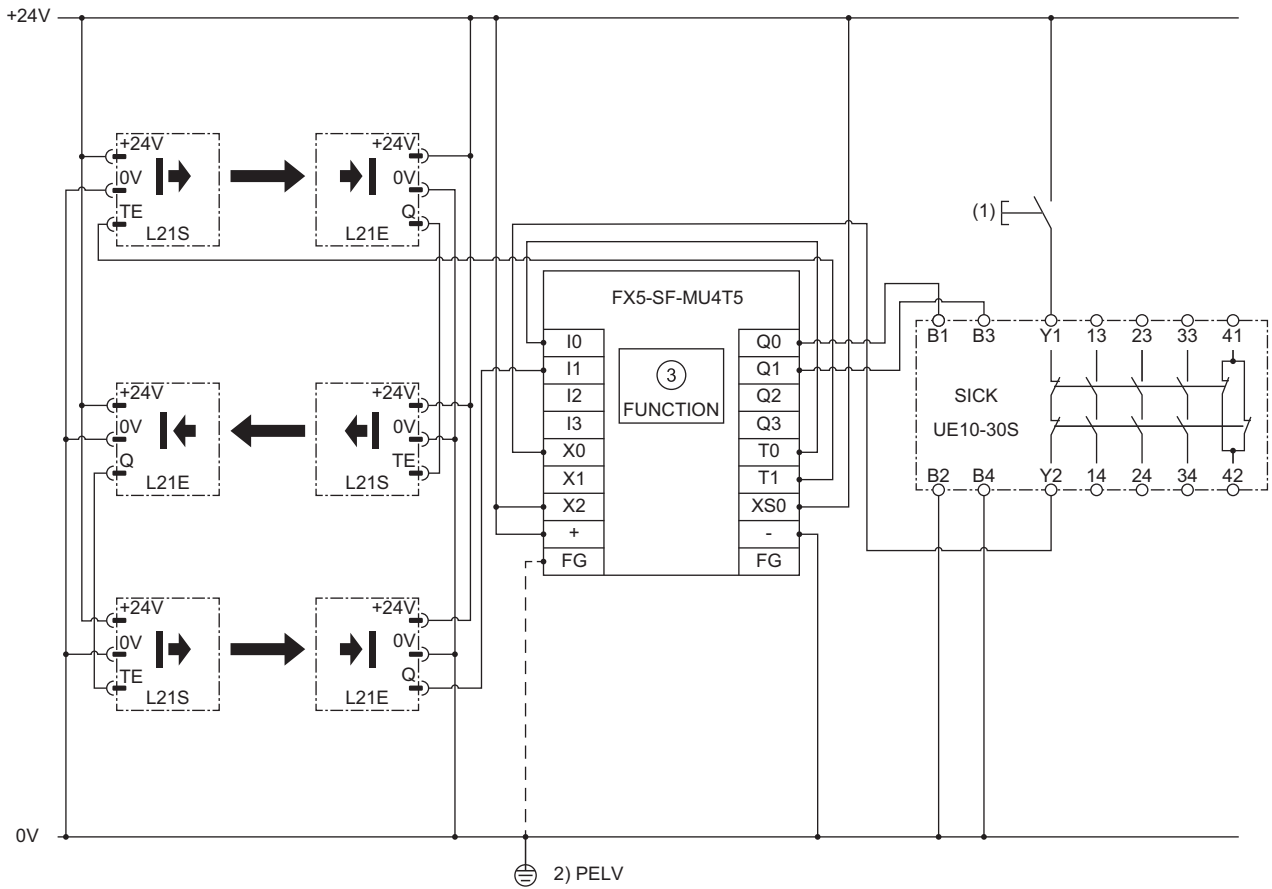



## Wiring a two-hand control

The following shows an example of the program 4 without a restart interlock and with EDM.

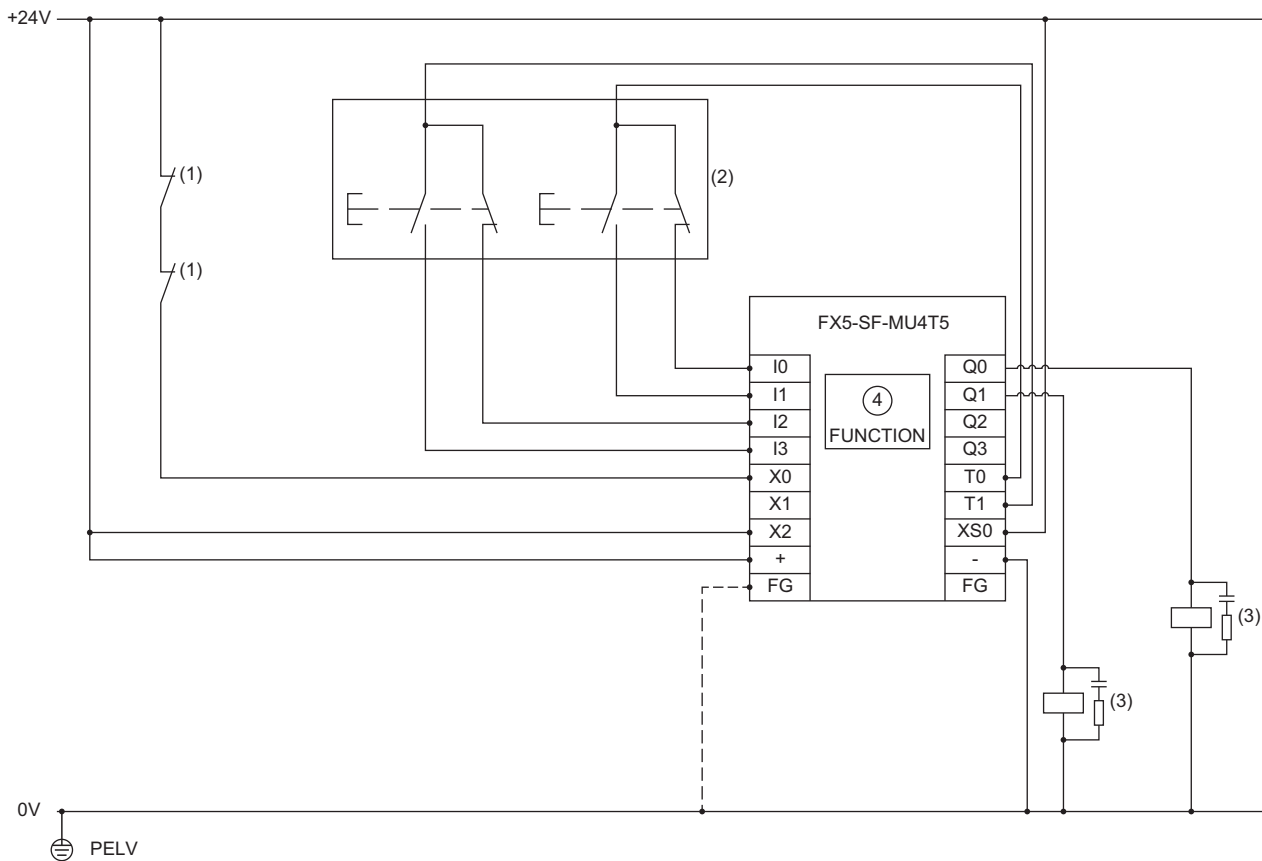

- (1) Contactor contact point
- (2) Two-hand switches III C
- (3) Contactor

## Wiring light curtains

The following shows an example of the program 7 with a restart interlock and EDM.

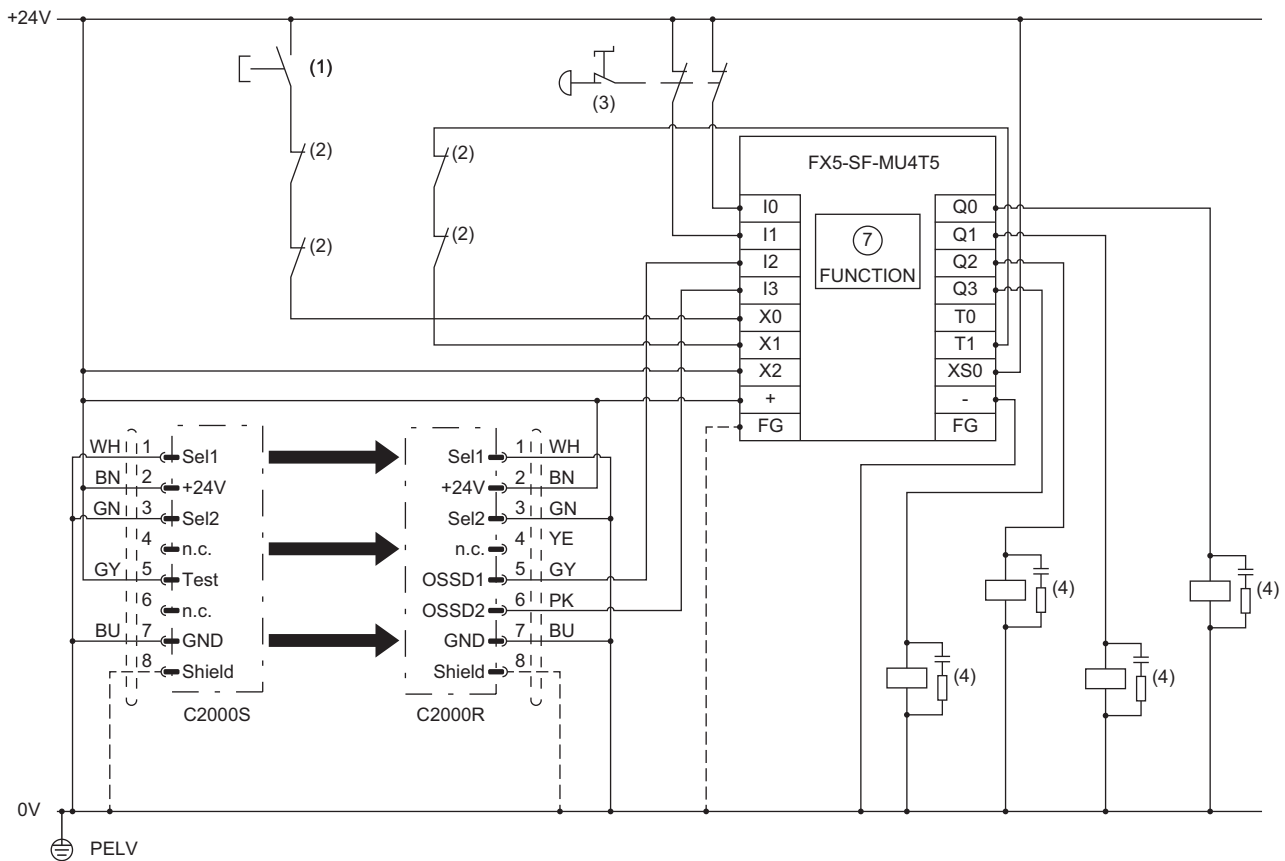

- (1) Reset switch, start switch
- (2) Contactor contact point
- (3) An emergency stop button
- (4) Contactor

## Wiring two switches

The following shows an example of the program 8 with a restart interlock and EDM.

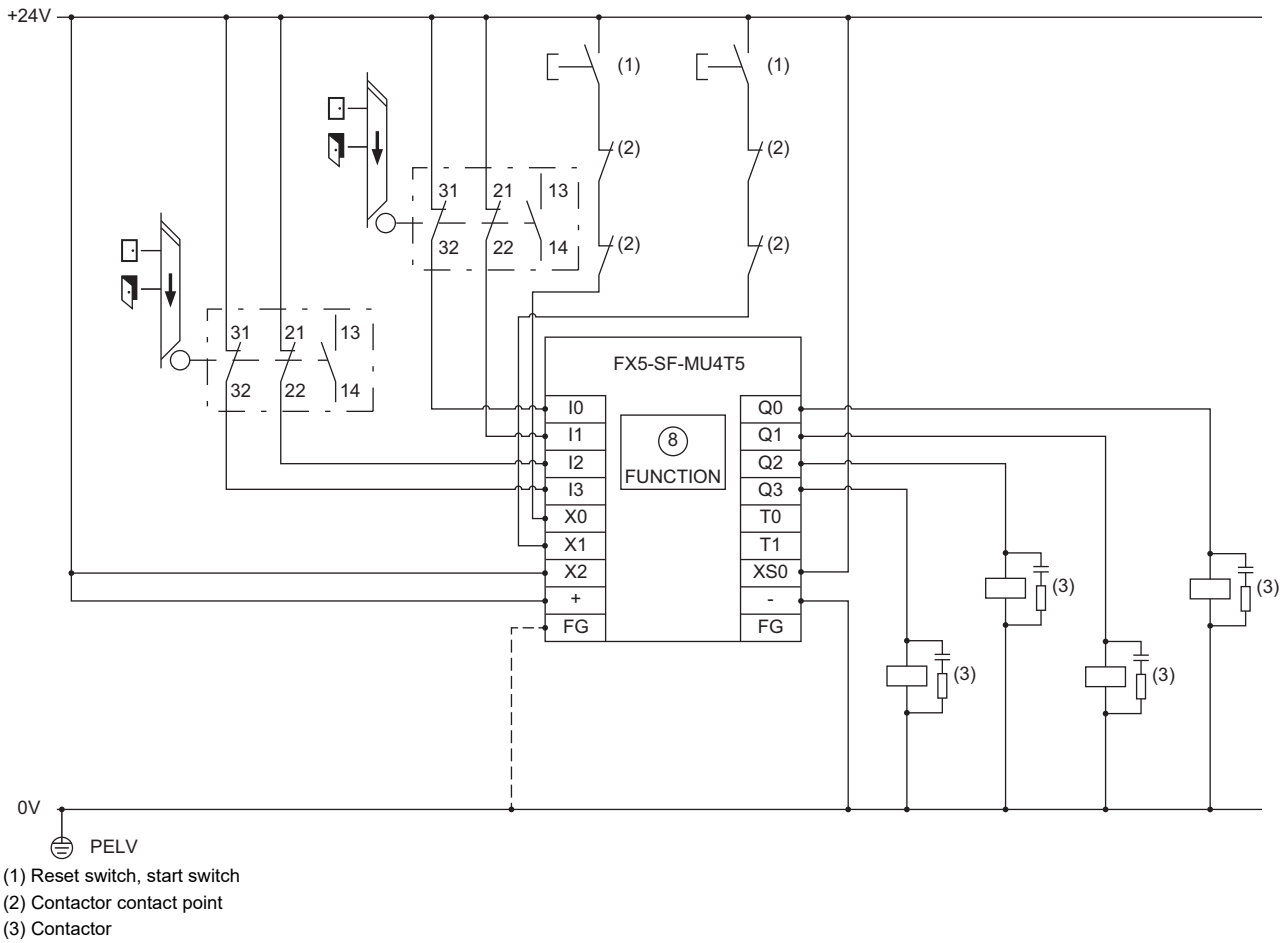

# Considerations on wiring external devices

The following shows the wiring considerations.

## Installation precautions

- Safety extension modules fulfill the EMC requirements in accordance with the basic specification IEC 61000-6-2 and EN 61131-2 for industrial use.
- Mitsubishi industrial safety devices are designed only for DC power supply applications which have one power supply and one power supply destination. For example, if the device is used in power supply networks that comply with IEC 61326-3-1 and use one power supply and multiple power supply destinations, additional protective measures have to be taken.
- When installing devices under the environment of overvoltage category III, an external protection element must be used. Required protection levels based on EN 62305-1 can be achieved by constructing an external protection circuit. The installed surge protective device (SPD) should meet the requirements according to EN 61643-11.
- The power supply as well as all signals connected have to fulfill the regulations for extra-low voltages with safe separation (SELV, PELV) in accordance with IEC 60664 and EN 50178 (equipment of electrical power installation with electronic devices).
- The installation must prevent common mode disturbances according to IEC 61000-4-16 in the frequency range from 0 Hz to 150 kHz.
- When using the safety extension modules under the severe noise environment, attach a ferrite core to the cable of a safety extension module and make 3 turns around the ferrite core. (Ferrite core used in our test: E04SR401938 manufactured by SEIWA ELECTRIC MFG. CO., LTD). The features of the ferrite core E04SR401938.

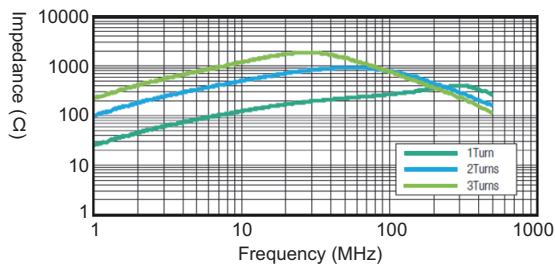

- A safety extension module should be installed in a control panel with at least IP54 (IEC 60529) enclosure classification.
- To ensure full EMC compatibility, the FG terminal has to be connected to functional earth (FE).
- To meet the requirements of the relevant product standards (IEC 61496-1), the external power supply for the devices (SELV) must, among other aspects, be able to bridge a momentary power failure lasting 20 ms.
- All safety related parts (cables, connected sensors and actuators, configuration settings, and EDM) must be according to the relevant safety standards (EN IEC 62061 or EN ISO 13849-1). This may mean that safety related signals need to be redundant or that single channel signals need protected wiring or short-circuit detection by using test pulse outputs and/or periodical function tests.
- Install a reset button on the outside of a hazardous area so that it cannot be actuated by a person in the area. When pressing the reset button, the operator must have full visual command of the hazardous area.

## Wiring precautions

- Power OFF the entire system while wiring. Otherwise, the system may be activated unexpectedly while connecting to devices.
- Electrical installation should be designed in accordance with IEC 60204-1.
- All connected sensors and downstream controllers and wiring/installation must correspond to the required category according to EN ISO 13849-1 and to the SIL according to EN IEC 62061 (protected installation, single plastic-sheathed cable with shielding).
- A safety extension module should be connected to the same power supply as the one connected to the protective equipment.
- When several power supplies are used, all mass connections (GND) must be connected to each other.
- Depending on the external loads, especially for inductive loads, additional external protective elements, such as varistors and RC elements, may be necessary in order to protect the safety outputs. Take into account that the response times may increase, depending on the type of protective element.
- The wiring of single-channel safety outputs as well as the external device monitoring (EDM) and XS0 (ENABLE input) must be performed inside the control panel.
- The possibility of an external error (cross-circuit) between a safety extension module and an external device in a safety control system has to be excluded by means of appropriate cabling measures (such as independent wiring and independent sheathed cable).
- Take into account that short-circuits between test pulse outputs and the corresponding inputs cannot be detected.
- An FX5-SF-8DI4 has two test pulse generators. One test pulse generator is responsible for the odd-numbered test outputs (T1, T3, T5, and T7), the other for the even-numbered test outputs (T0, T2, T4, and T6). A short circuit between T0 and T1 can be detected; however, a short-circuit between common test outputs (odd-numbered test outputs and even-numbered test outputs) is not detected. Take this into consideration during the wiring, such as applying separate routing and sheathed cables.
- Wire cables for reset buttons independently with each other using a sheathed cable.

## 6.5 Installation of Muting Sensors

This section explains the installation position of muting sensors.

Always place muting sensors so that only materials are detected and not the conveyance equipment (pallet or vehicle).

Additionally, they should be placed in the position where materials can pass unhindered, but people are reliably detected.

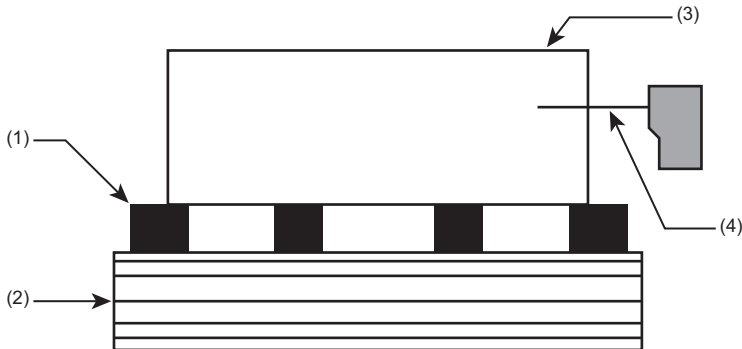

- (1): Conveyance equipment
- (2): Conveying surface
- (3): Material
- (4): Muting sensor

### Minimum distance to the light beams on the ESPE

Always install muting sensors such that, on the detection of a material, a minimum distance to the light beams on the protective equipment (ESPE) is maintained.

The minimum distance provides the processing time necessary until muting is activated.

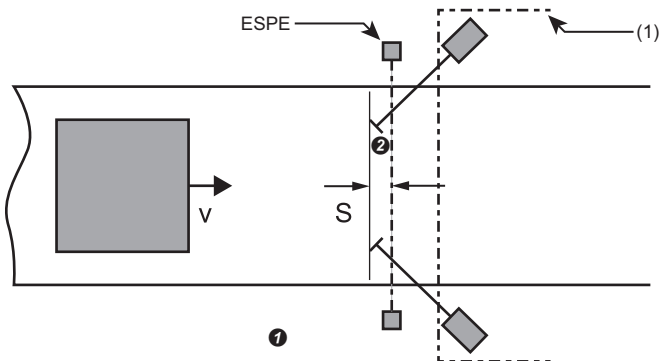

- (1): Hazardous area
- ①: Detection of a material
- ②: Light beams on the ESPE

The minimum distance can be obtained by the following formula.

$$S \geq v \times 61(\text{ms})$$

S: Minimum distance (mm)

v: Velocity of the material (conveyor) (m/s)

## Optical sensors

When optical sensors are used for muting sensors, install the sensors with background suppression so that only materials to be transported can meet the muting condition.

By using the optical sensors with background suppression, these can detect material only up to a specific distance. Objects that are further than the material to be detected are not detected.

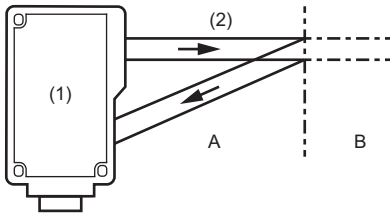

(1): Optical sensors with background suppression

(2): Detection zone

A: Material is detected.

B: Material is not detected.

## Cross muting

In the following example, the material moves from left to right or, alternatively, from right to left.

As soon as the muting sensors A1 and A2 are activated, a protection function provided by the protective equipment (ESPE) is temporally disabled.

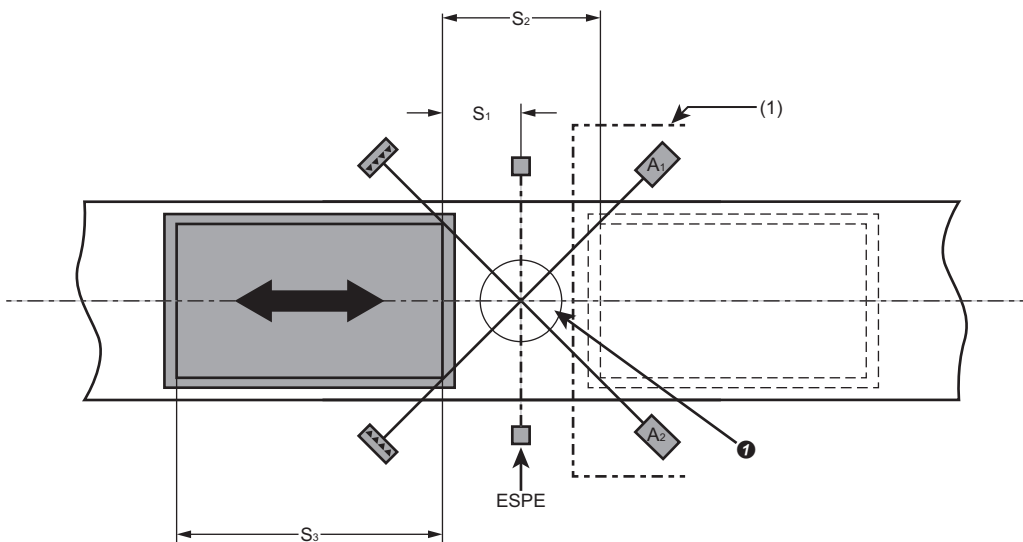

(1): Hazardous area

S1: Minimum distance between the detection line of the ESPE and the detection line of the muting sensors A1 and A2

S2: Distance between two detection lines of the muting sensors

S3: Length of the material

The following conditions are required to be met.

Condition	
1	A1 & A2: Muting applies as long as this condition is met.
2	Minimum distance: $S1^{*1} \geq v^{*2} \times 61$ (ms)

\*1 S1: Minimum distance between the light beams on the ESPE and the detection by the muting sensors (mm)

\*2 v: Velocity of the material (conveyor) (m/s)

In order for materials to be conveyed in both directions, place the muting sensors so that the intersection of the muting sensors (1) is exactly on the course of the light beams on the protective equipment (ESPE).

In order for materials to be conveyed in only one direction, place the muting sensors so that the intersection of the muting sensors is behind the light beams on the protective equipment (ESPE) seen from the conveyor direction.

This placement is suitable for through-beam photoelectric switches and photoelectric reflex switches.

## Sequential muting

In the following example, the material moves from left to right.

As soon as the muting sensors A1 and A2 are activated, a protection function provided by the protective equipment (ESPE) is temporarily disabled.

The protection function remains disabled until one of the sensors within the muting sensors B1 and B2 is enabled again.

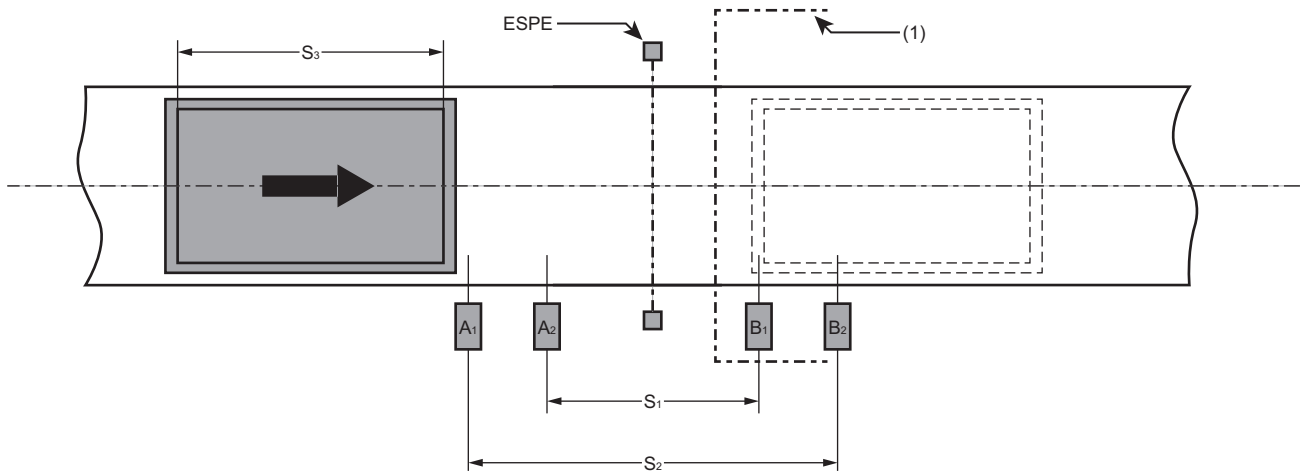

(1): Hazardous area

S1: Distance between internal sensors (the sensors are placed symmetry within the ESPE detection line)

S2: Distance between external sensors (the sensors are placed symmetry within the ESPE detection line)

S3: Length of the material

## Precautions

- When using four muting sensors, connect two muting sensors each to an input of the FX5-SF-MU4T5. Take into account that the muting sensors are combined as follows: A1 and B2, A2 and B1.
- Only high-side switching sensors can be used for four muting sensors. Check that "HIGH" always overwrites "LOW". Additionally, use the muting sensors after analyzing risks and errors properly.



# 7 PARAMETER SETTINGS

Set parameters for a safety extension module.

## 7.1 Refresh Setting

Set the buffer memory area of a safety extension module for refreshing the area automatically.

By configuring the refresh setting, reading/writing data from/to the buffer memory by a program becomes unnecessary.

### Setting method

1. Set the module parameter in GX Works3.

[Navigation window] ⇒ [Parameter] ⇒ [Module Information] ⇒ [(target module)] ⇒ [Module Parameter] ⇒ [Refresh]

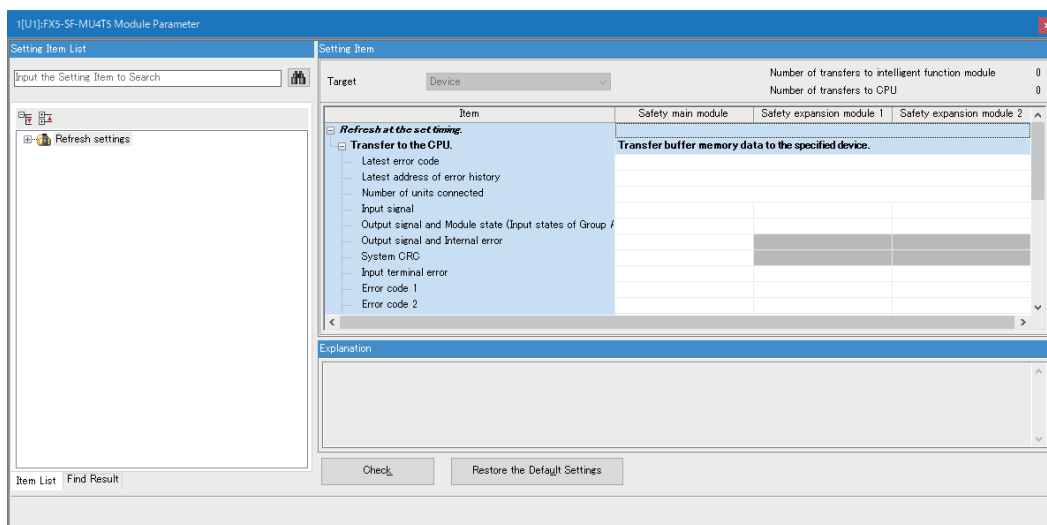

2. Double-click an item to be set, and enter a refresh target device.



# 8 PROGRAMMING

This chapter explains the programming procedure for a safety control system.

## System configuration example

In this chapter, program examples based on the following system configuration are explained.

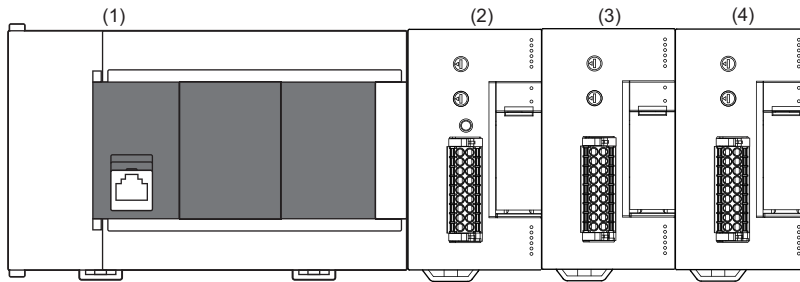

- (1) CPU module (FX5 CPU module)
- (2) Safety main module (FX5-SF-MU4T5)
- (3) Safety input expansion module (FX5-SF-8DI4)
- (4) Safety input expansion module (FX5-SF-8DI4)

## 8.1 Programming Procedure

The following shows the procedure for creating programs for running a safety control system.

1. Select a program to run on the safety extension module using a rotary switch.
2. Create a sequential program to run on the CPU module.

## 8.2 Programming Method (for FX5-SF-MU4T5/FX5-SF-8DI4)

Select a program by turning the rotary switch on the safety extension module.

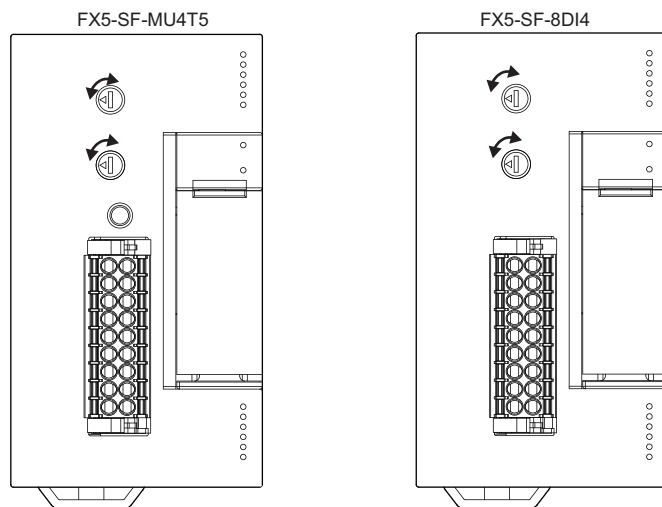

For details on the programs, refer to the following section.

☞ Page 39 Built-In Program Selection Function

The settings can be checked in MELSEC iQ-F Series Safety Extension Module Configuration Guide

☞ Page 155 How to Use MELSEC iQ-F Series Safety Extension Module Configuration Guide

After wiring external devices and selecting a program, apply the setting.

### Applying a setting

1. Wire external devices to the safety extension module.
2. While pressing the ENTER button on FX5-SF-MU4T5, turn ON the power of the FX5 CPU module and the safety extension module simultaneously.
3. When the ERROR LED of FX5-SF-MU4T5 begins to flash, release the ENTER button within three seconds.
4. Turn OFF the power of the FX5 CPU module and the safety extension module, and turn the powers ON again simultaneously.

Confirm that no error occurs.

When an error occurs, check the wiring and apply the setting again.

#### Point

The setting can be applied by turning ON an external power supply of the safety extension module. When an error occurred by turning ON the power supply of an FX5 CPU module and the safety extension module simultaneously, the error details can be checked in the GX Works3 module diagnostics screen.

### Precautions

- While applying the settings, do not press the reset button connected to any of the X0, X1, or X2 terminal.
- Set a control function (restart interlock, external device monitoring (EDM), or retriggering) depending on the wiring of an X0, X1, or X2 terminal. (☞ Page 97 External Wiring Example)
- When the ERROR LED begins to flash, release the ENTER button within three seconds. Otherwise, all the safety extension modules will be in error.
- If the wiring status of the X0, X1, or X2 terminal is changed after applying the settings, an error will occur.
- Before changing the applied settings, check if the function of a protective equipment works properly. Observe the considerations for inspection of a connected protective equipment.

## 8.3 Programming Method (for FX5 CPU module)

A sequential program is not required because a program for a safety control can be selected using a rotary switch. When using safety control information in a general control program, use the buffer memory of an FX5-SF-MU4T5 where the safety control information is stored.

### Program example

The following shows a program example when using safety control information in a general control program.

#### ■ Buffer memory of an FX5-SF-MU4T5 used in the program example

Buffer memory name	Device	Purpose	Status when the device is ON
Input signals	U1/G69.0	Module READY	FX5-SF-MU4T5 initial processing is completed.
	U1/G69.1	Module Safety READY	Safety control works properly.
	U1/G69.F	Error flag	An error occurred.
1st Module error code 1	U1/G105	Storing the error code 1 of FX5-MU FX5-SF-MU4T5	The error code 1 is stored.
1st Module error code 2	U1/G106	Storing the error code 2 of FX5-MU FX5-SF-MU4T5	The error code 2 is stored.
1st Module Output signal and Internal error	U1/G102.0	Output statuses from Q2 and Q3 on an FX5-SF-MU4T5	Outputs from Q2 and Q3 are ON.
	U1/G102.1	Output statuses from Q0 and Q1 on an FX5-SF-MU4T5	Outputs from Q0 and Q1 are ON.

#### ■ A program example that sets an interlock depending on the status of a safety control

The following shows the example of a program that checks the safety control status and interlocks a part of the program when a safety main module is in the error status.

It does not show the specific example of the program to provide interlocks with the safety control status.

The method is used when starting operation after completing safety check using the safety control.

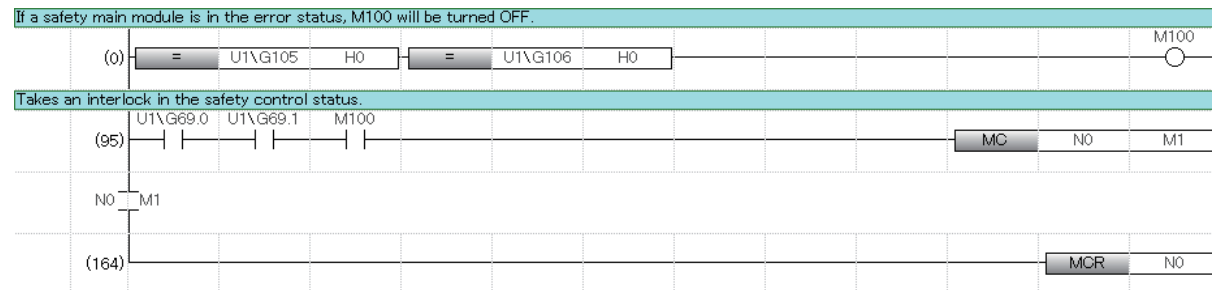

## ■A program example that manages output status of a safety control with an annunciator

The following shows a program example for a general control that manages safety output status with an annunciator (F). If the FX5-SF-MU4T5 detects a danger and any of the safety outputs are turned OFF, the annunciator number 5 turns ON in the ladder program.

When all the safety outputs are turned ON, the annunciator number 5 is turned OFF.

When starting the safety extension module, a CPU module program may start before the safety outputs turn ON. Add a wait processing program as necessary, as shown in the following program example.

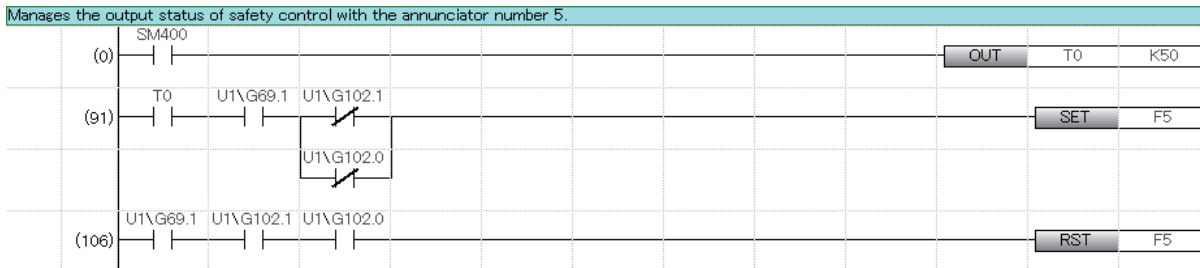

## Precautions

- When the safety control diagnostic information is not updated with the correct information, Module Safety READY (Un\G69.1) is turned OFF. To refer to the safety control diagnostic information, create a program that provides interlocks using 'Un\G69.1' as shown in the above program example.

This chapter shows the considerations when checking the entire system and performing periodic inspection.

## 9.1 Validation of Application

System commissioning can be performed only when the validation of the whole system was successful.

Validation may only be performed by professionals trained accordingly.

Additionally, regular testing is required after the commissioning.

Check the following items for validation. The result and system configuration should be recorded in a document.

- Check if the wiring of components for outputs corresponds to the required performance level (PL) in accordance with EN ISO 13849-1, SIL in accordance with IEC 61508, or SIL in accordance with EN IEC 62061.
- Check the devices connected to the FX5-SF-MU4T5/FX5-SF-8DI4 in accordance with the considerations for inspection described in the respective manuals.
- Clearly mark all connection cables and plugs of the FX5-SF-MU4T5/FX5-SF-8DI4.
- Perform a complete verification of the safety functions of the system in each operating mode and an error simulation. Observe the response times of the individual applications in particular.

## 9.2 Considerations for Inspection

### Tests before the first commissioning

Check the protective equipment as described below and in accordance with the applicable standards and regulations.

- Check the effectiveness of the protective equipment installed to the machine, using all selectable operating modes and functions.
- Ensure that the operating personnel of the machine fitted with FX5-SF-MU4T5/FX5-SF-8DI4 are instructed by the qualified safety personnel of the machine owner before beginning work. Instructing the operating personnel is the responsibility of the machine owner.

### Regular testing

In order to reach SIL in accordance with EN IEC 62061, the following test must be made at least every 365 days.

- Turn OFF the power of the FX5-SF-MU4T5/FX5-SF-8DI4.
- Turn ON the power of the FX5-SF-MU4T5/FX5-SF-8DI4.
- Check all the safety functions of the connected sensors.

### Regular inspection for a protective equipment

- Protection equipment should be inspected by a mechanic who is qualified to carry out safety inspections.
- Check the system following the inspection intervals specified in the national rules and regulations. Any changes on the machine and illegal manipulations of the protective equipment after the first commissioning can be detected.
- Safety functions should be checked at the specified period of time. The effectiveness of the protective equipment must be tested by qualified personnel.
- If any modifications have been made to the machine or the protective equipment, or if the safety extension module has been changed or repaired, check the system again as specified in "Checklist for Manufacturer". (☞ Page 137 Checklist for Manufacturer)
- Conduct regular or daily inspections to keep the safety extension module in an optimal operation mode.
- Check that the implementation of the safety extension module fulfills all the technical data of the device.
- Check that the installation condition and wiring of the safety extension module are correct.
- Regularly verify that the safety functions fulfill the requirements of the application as well as all relevant regulations and standards to ensure the reliability of the safety functions.

# MEMO

---



# 10 TROUBLESHOOTING

This chapter explains errors that may occur in a safety extension module and their troubleshooting methods. To resolve an error immediately, determining the cause and applying appropriate corrective actions are essential. The troubleshooting methods are as follows.

Checking method	Description	Reference
Checking errors visually (by LEDs)	A method for checking the module status by LEDs. Primary diagnosis can be performed without an engineering tool.	Page 119 Checking Errors with LEDs
Checking errors with an engineering tool	Check an error occurred in the module and error history, and identify the cause using an engineering tool (including GOT). The detailed information such as error cause and corrective actions obtained from an engineering tool is more helpful than those obtained by a visual inspection.	Page 122 Checking Errors with an Engineering Tool

## 10.1 Checking Errors with LEDs

Checking the LED status is the primary diagnostics without GX Works3. It narrows down the causes of the error. The status of a safety extension module can be verified by checking the POWER LED, ERROR LED, and LEDs for each I/O. The correspondence relation between LEDs and safety extension module statuses is shown below.

### LEDs on an FX5-SF-MU4T5

LED name	LED color	Description
POWER LED	Green	Indicates the power supply status. ON: Normal operation Flashing: The rotary switch setting was changed during operation. OFF: Powered OFF
ERROR LED*1	Red	Indicates an error status. ON: An error occurred in any one of the safety extension modules. Flashing (two times): Failed to apply the settings to the safety extension module. Flashing (three times): The rotary switch setting was changed during operation. Flashing (four times): Any of the following errors occurred. <ul style="list-style-type: none"> <li>• The input statuses of any of X0, X1, or X2 are incorrect.</li> <li>• The module was powered ON after the rotary switch setting has been changed in the power OFF state.</li> <li>• The ENTER button is pressed for three seconds or more.</li> <li>• A setting was not applied after changing the position of a module.</li> </ul> Flashing (five times): A power supply error occurred. Flashing (six times): A self-monitoring error or an internal error occurred. OFF: No error
I0 LED	Green	Indicates the input status of I0. ON: Input ON Flashing: A process error, or synchronization time/concurrence error occurring. Flashing (I0 and I1 flash in phase): A cross-circuit occurred between I0 and I1. OFF: Input OFF
I1 LED	Green	Indicates the input status of I1. ON: Input ON Flashing: A process error, or synchronization time/concurrence error occurring. Flashing (I0 and I1 flash in phase): A cross-circuit occurred between I0 and I1. OFF: Input OFF
I2 LED	Green	Indicates the input status of I2. ON: Input ON Flashing: A process error, or synchronization time/concurrence error occurring. Flashing (I2 and I3 flash in phase): A cross-circuit occurred between I2 and I3. OFF: Input OFF
I3 LED	Green	Indicates the input status of I3. ON: Input ON Flashing: A process error, or synchronization time/concurrence error occurring. Flashing (I2 and I3 flash in phase): A cross-circuit occurred between I2 and I3. OFF: Input OFF
Q0/Q1 LED	Green	Indicates the output statuses of Q0 and Q1. ON: Output ON OFF: Output OFF

LED name	LED color	Description
Q2/Q3 LED	Green	Indicates the output statuses of Q2 and Q3. ON: Output ON Flashing: In lapse of off delay time OFF: Output OFF
X0 LED	Green	Indicates the input status of X0. ON: Input ON Flashing: Input OFF (by restart interlock or EDM) OFF: Input OFF
X1 LED	Green	Indicates the input status of X1. ON: Input ON Flashing: Input OFF (by restart interlock or EDM) OFF: Input OFF
X2 LED	Green	Indicates the input status of X2. ON: Output ON Flashing: Input OFF (by restart interlock or EDM) OFF: Input OFF
XS0 LED	Green	Indicates the input status of XS0. ON: Input ON OFF: Input OFF

\*1 The ERROR LED flashes rapidly and repeatedly at regular intervals.

## LEDs on an FX5-SF-8DI4

LED name	LED color	Description
POWER LED	Green	Indicates the power supply status. ON: Normal operation Flashing: The rotary switch setting was changed during operation. OFF: Powered OFF
ERROR LED <sup>*1</sup>	Red	Indicates an error status. ON: An error occurred in any one of the safety extension modules. Flashing (two times): Failed to apply the settings to the safety extension module. Flashing (three times): The rotary switch setting was changed during operation. Flashing (four times): Any of the following errors occurred. <ul style="list-style-type: none"> <li>• The module was powered ON after the rotary switch setting has been changed in the power OFF state.</li> <li>• The ENTER button is pressed for three seconds or more.</li> <li>• A setting was not applied after changing the position of a module.</li> </ul> Flashing (five times): A power supply error occurred. Flashing (six times): A self-monitoring error or an internal error occurred. OFF: No error
I0 LED	Green	Indicates the input status of I0. ON: Input ON Flashing: A process error occurred or synchronous time (1500ms) was exceeded. Flashing (I0 and I1 flash in phase): A cross-circuit occurred between I0 and I1. OFF: Input OFF
I1 LED	Green	Indicates the input status of I1. ON: Input ON Flashing: A process error occurred or synchronous time (1500ms) was exceeded. Flashing (I0 and I1 flash in phase): A cross-circuit occurred between I0 and I1. OFF: Input OFF
I2 LED	Green	Indicates the input status of I2. ON: Input ON Flashing: A process error occurred or synchronous time (1500ms) was exceeded. Flashing (I2 and I3 flash in phase): A cross-circuit occurred between I2 and I3. OFF: Input OFF
I3 LED	Green	Indicates the input status of I3. ON: Input ON Flashing: A process error occurred or synchronous time (1500ms) was exceeded. Flashing (I2 and I3 flash in phase): A cross-circuit occurred between I2 and I3. OFF: Input OFF
I4 LED	Green	Indicates the input status of I4. ON: Input ON Flashing: A process error occurred or synchronous time (1500ms) was exceeded. Flashing (I4 and I5 flash in phase): A cross-circuit occurred between I4 and I5. OFF: Input OFF

LED name	LED color	Description
I5 LED	Green	Indicates the input status of I5. ON: Input ON Flashing: A process error occurred or synchronous time (1500ms) was exceeded. Flashing (I4 and I5 flash in phase): A cross-circuit occurred between I4 and I5. OFF: Input OFF
I6 LED	Green	Indicates the input status of I6. ON: Input ON Flashing: A process error occurred or synchronous time (1500ms) was exceeded. Flashing (I6 and I7 flash in phase): A cross-circuit occurred between I6 and I7. OFF: Input OFF
I7 LED	Green	Indicates the input status of I7. ON: Input ON Flashing: A process error occurred or synchronous time (1500ms) was exceeded. Flashing (I6 and I7 flash in phase): A cross-circuit occurred between I6 and I7. OFF: Input OFF
QA LED	Green	Indicates if the input conditions of INPUT A from input I0 to I3 are satisfied. ON: Input conditions are satisfied. OFF: Input OFF
QB LED	Green	Indicates if the input conditions of INPUT B from input I4 to I7 are satisfied. ON: Input conditions are satisfied. OFF: Input OFF

\*1 The ERROR LED flashes rapidly and repeatedly at regular intervals.

# 10.2 Checking Errors with an Engineering Tool

Check an error occurred in the module and error history, and identify the cause using an engineering tool. The detailed information such as error cause and corrective actions obtained from an engineering tool is more helpful than those obtained from LEDs.

An engineering tool has the following function that helps troubleshoot.

Function	Description
System monitor	To diagnose the current statuses of a CPU module and a safety extension module.
Module diagnostics	To diagnose (check the latest error and its detailed information) a target module.

For details on an engineering tool, refer to the following:

 GX Works3 Operating Manual

## Module diagnostics

The module information of a safety main module can be checked in the module diagnostic screen of an engineering tool.

The statuses of all the safety extension modules attached after an FX5-SF-MU4T5 can be checked in the module diagnostics screen displayed by selecting an FX5-SF-MU4T5.

 [Diagnostics] ⇒ [System monitor], and double-click FX5-SF-MU4T5

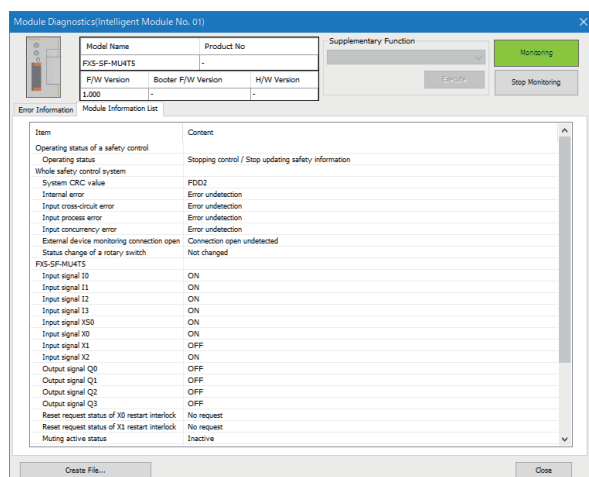
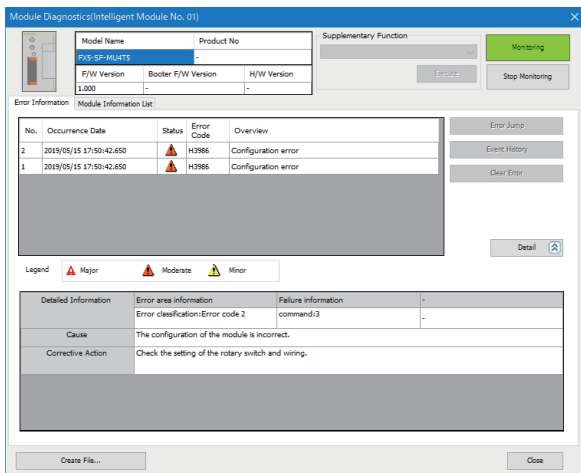

## ■Common information

The common items of FX5-SF-MU4T5 are displayed and the details of monitor can be checked.

Item	Description
Model Name	To display the module name "FX5-SF-MU4T5".
Product No	Hidden
F/W Version	To display the firmware version.
Booter F/W Version	Hidden
H/W version	Hidden

## ■Error information

Up to 16 errors occurred in FX5-SF-MU4T5 can be displayed. Additionally, the detailed information which is necessary for troubleshooting can be checked.

For safety extension modules other than FX5-SF-MU4T5, errors cannot be displayed in the error information of the module diagnostics screen. Check error codes from the module information list.

Item	Description
Occurrence Date	To display the occurrence date and time.
Status	To display the error level with an icon.
Error Code	To display the error number of each module.
Overview	To display the error overview.
Clear Error	No correspondence
Error Jump	No correspondence
Event History	No correspondence
Detailed information	To display information to determine the area of an error occurred as there are two error area information: error code 1 and error code 2. For failure information, information for a manufacturer to investigate the cause is displayed.
Cause	To display an error cause in detail.
Corrective action	To display a corrective action to eliminate the cause.

## ■Module information list

The common information of modules such as H/W information including LEDs and switches, and the information specific to each module can be checked.

Item		Description
Operating status of a safety control	Operating status	To display the operating status of a safety control.
Whole safety control system	System CRC value	To display the system CRC value of a safety control.
	Internal error	To display an error internally occurred in a safety control.
	Input cross-circuit error	To display the status of an input cross-circuit error in a safety control.
	Input process error	To display the status of an input process error in a safety control.
	Input concurrence error	To display the status of an input concurrence error in a safety control.
	External device monitoring connection open	To indicate the connection open status for monitoring external devices for a safety control.
	Status change of a rotary switch	To indicate the change status of a safety control rotary switch.
FX5-SF-MU4T5	Input signals I0 to I3	To display the status of inputs from I0 to I3 of an FX5-SF-MU4T5.
	Input signal XS0	To display the status of the input XS0 of an FX5-SF-MU4T5.
	Input signals X0 to X2	To display the status of inputs from X0 to X2 of an FX5-SF-MU4T5.
	Output signals Q0 to Q3	To display the status of outputs from Q0 to Q3 of an FX5-SF-MU4T5.
	X0 restart interlock reset request	To display the X0 restart interlock reset request status of an FX5-SF-MU4T5.
	X1 restart interlock reset request	To display the X1 restart interlock reset request status of an FX5-SF-MU4T5.
	Muting active status	To display the muting status of an FX5-SF-MU4T5.
	Bypass active status	To display the bypass status of an FX5-SF-MU4T5.
	Error code 1	To display an error code of an error occurring in an FX5-SF-MU4T5.
	Error code 2	
	FUNCTION setting	To display the setting of the FUNCTION rotary switch on an FX5-SF-MU4T5.
	DELAY setting	To display the setting of DELAY rotary switch on an FX5-SF-MU4T5.
	X0 to X2 settings	To display the setting of inputs from X0 to X2 of an FX5-SF-MU4T5.
Safety expansion module n: FX5-SF-8DI4	Input signals I0 to I7	To display the status of inputs from I0 to I7 of the nth safety expansion module.
	Output signals QA and QB	To display the status of outputs from QA and QB of the nth safety expansion module.
	Error code 1	To display an error code of an error occurring in the nth safety expansion module.
	Error code 2	
	INPUT A setting	To display the setting of INPUT A rotary switch on the nth safety expansion module.
	INPUT B setting	To display the setting of INPUT B rotary switch on the nth safety expansion module.

## Precautions

The information of an FX5-SF-8DI4 is integrated and displayed in the module diagnostics screen of an FX5-SF-MU4T5. When checking the status of an FX5-SF-8DI4, check the module diagnostic screen of the FX5-SF-MU4T5.

## 10.3 Troubleshooting by Symptom

When the function of a safety extension module does not work properly, check the following items and take appropriate corrective action.

### POWER LED on a safety extension module turns OFF

10

#### FX5-SF-MU4T5

Check item	Corrective action
Check if the power is supplied.	Check that the supply voltage from the power connected to the safety extension module is within the rated range.
Other than above	Reset the power of the whole system, and check if the POWER LED on the FX5-SF-MU4T5 turns ON. If the POWER LED does not turn ON, it is possible that the module is malfunctioning. Please contact your local Mitsubishi Electric sales office or representative.

#### FX5-SF-8DI4

Check item	Corrective action
Check if the modules are attached properly.	Check the condition of the modules.
Other than above	Reset the power of the whole system, and check if the POWER LED on the FX5-SF-8DI4 turns ON. If the POWER LED does not turn ON, it is possible that the module is malfunctioning. Please contact your local Mitsubishi Electric sales office or representative.

### ERROR LED on an FX5 CPU module flashes

Check item	Corrective action
Check if an error occurred.	Check the latest error code of the CPU module, and take corrective actions described in the error code list.* <sup>1</sup>

\*<sup>1</sup> "1200H: module moderate error" is notified in the CPU module only when an error whose SREADY (Un\G69.1) is turned OFF occurred.

### ERROR LED on a safety extension module flashes

#### FX5-SF-MU4T5

Check item	Corrective action
Check if an error occurred.	Check 'Latest error code' (Un/G0) of the FX5-SF-MU4T5, and take corrective actions described in the error code list.

#### FX5-SF-8DI4

Check item	Corrective action
Check if an error occurred.	Check the error code 1 and 2* <sup>1</sup> of the FX5-SF-8DI4 and take corrective actions described in the error code list.

\*<sup>1</sup> The buffer memory address of error code 1 and 2 differs depending on the attachment position of the FX5-SF-8DI4 ( the first or second module).

#### Point

If an error occurred, the ERROR LEDs on all the safety extension module turn ON or flash.  
For the safety extension module where an error occurred, the ERROR LED on the module flashes.

# Turning ON the power of a system including a safety extension module

The following shows a power supply wiring example including a safety extension module.

If an error (error code: 3052H) occurs in a safety extension module, turn the power ON in order of B, A, and C.

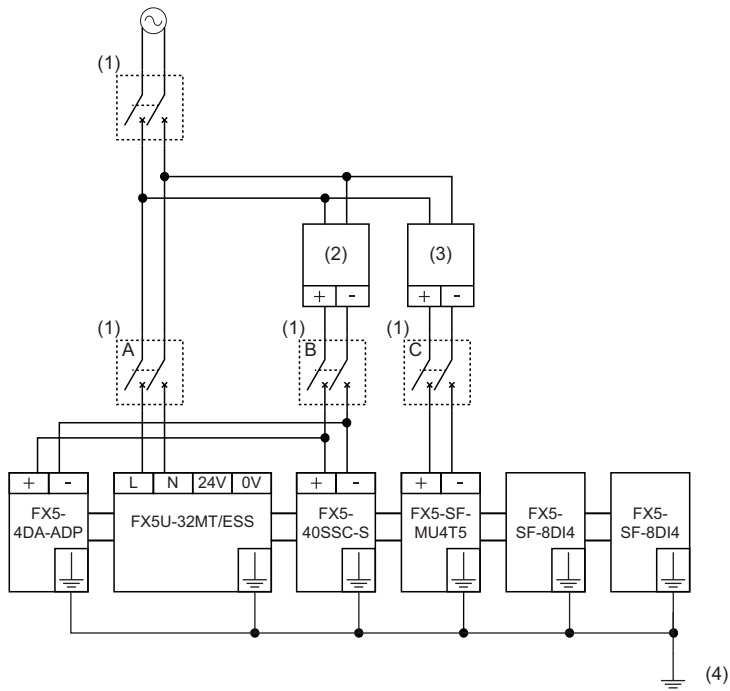

- (1) Breaker
- (2) DC power
- (3) DC power (PELV/SELV)
- (4) D grounding (Grounding resistance: 100Ω or less)



# 10.4 List of Error Codes

When an error occurs in a running safety extension module, the error code is stored to 'Latest error code' (Un\G0) in the buffer memory, and 'Error flag' (Un\G69.15) turns ON.

The following shows the error code list that will be stored in 'Latest error code' (Un\G0).

Error code	Error name	Description	Corrective action
0000H	—	There is no error.	—
3001H	Hardware error	A hardware error occurred.	Turn the power OFF and ON. If the error occurs again, there is a possibility that the module is malfunctioning. Please contact your local Mitsubishi Electric sales office or representative.
3030H	Flash memory error	Data in the flash memory is abnormal.	Turn the power OFF and ON. If the error occurs again, there is a possibility that the module is malfunctioning. Please contact your local Mitsubishi Electric sales office or representative.
3051H	Safety extension module initializing communication error	Unable to read data from a safety extension module when it is initialized.	Turn OFF the power of the CPU module and the safety extension module and turn ON the power again simultaneously. <sup>1</sup> If an error occurs after powering ON at the same time, check if the POWER LED on the safety extension module turns ON. If the POWER LED of the safety extension module does not turn ON, there is a possibility that the module is malfunctioning. Please contact your local Mitsubishi Electric sales office or representative.
3052H	Safety extension module communication error	Unable to read data in the safety extension module.	Turn OFF the power of the CPU module and the safety extension module and turn ON the power again simultaneously. If an error occurs during operation, check if the POWER LED on the safety extension module turns ON. If the LED does not turn ON, reset the power of the whole system. If the error is not resolved, there is a possibility that the module is malfunctioning. Please contact your local Mitsubishi Electric sales office or representative.
3053H	Number of connectable safety extension modules excess error	The number of connected safety extension modules exceeds the maximum number of connectable modules.	Connect the safety extension modules within the connectable limit. If this error occurs even when the number of connected modules are below the limit, check the parameter and the actual connected module. If they are different, adjust the parameter and the module configuration.
3054H	CRC error	An error occurred in CRC check.	Remove dirt and dust on the connector, and check if there is poor contact of the cable. Check the setting and wiring, and reset the power of the whole system. If the error is not resolved, there is a possibility that the module is malfunctioning. Please contact your local Mitsubishi Electric sales office or representative.
3100H	Safety extension module communication data error	Failed to read data in the safety extension module.	Remove dirt and dust on the connector, and check if there is poor contact of the cable. Check the setting and wiring, and reset the power of the whole system. If the error is not resolved, there is a possibility that the module is malfunctioning. Please contact your local Mitsubishi Electric sales office or representative.
3106H	Bus error	A bus error occurred.	Remove dirt and dust on the connector, and check if there is poor contact of the cable. Check the setting and wiring, and reset the power of the whole system. If the error is not resolved, there is a possibility that the module is malfunctioning. Please contact your local Mitsubishi Electric sales office or representative.

Error code	Error name	Description	Corrective action
3107H	Bus error	A bus error occurred.	Remove dirt and dust on the connector, and check if there is poor contact of the cable. Additionally, there is a possibility that the module is affected by noise. Take measure to reduce noise, check the setting and wiring, and reset the power of the whole system. If the error occurs after measures to reduce noise are taken, there is a possibility that the module is malfunctioning. Please contact your local Mitsubishi Electric sales office or representative.
3108H	Bus error	A bus error occurred.	Remove dirt and dust on the connector, and check if there is poor contact of the cable. Check the setting and wiring, and reset the power of the whole system. If the error is not resolved, there is a possibility that the module is malfunctioning. Please contact your local Mitsubishi Electric sales office or representative.
3109H	Bus error	A bus error occurred.	Remove dirt and dust on the connector, and check if there is poor contact of the cable. Check the setting and wiring, and reset the power of the whole system. If the error is not resolved, there is a possibility that the module is malfunctioning. Please contact your local Mitsubishi Electric sales office or representative.
310AH	Bus error	A bus error occurred.	Remove dirt and dust on the connector, and check if there is poor contact of the cable. Check the setting and wiring between modules, and reset the power of the whole system. If the problem is not resolved, there is a possibility that the module is malfunctioning. Please contact your local Mitsubishi Electric sales office or representative.
3110H	Bus error	A bus error occurred.	Remove dirt and dust on the connector, and check if there is poor contact of the cable. Check the setting and wiring, and reset the power of the whole system. If the error is not resolved, there is a possibility that the module is malfunctioning. Please contact your local Mitsubishi Electric sales office or representative.
3111H to 3112H	Bus error	A bus error occurred.	Remove dirt and dust on the connector, and check if there is poor contact of the cable. Check the setting and wiring, and reset the power of the whole system. If the error is not resolved, there is a possibility that the module is malfunctioning. Please contact your local Mitsubishi Electric sales office or representative.
3114H to 3118H	Bus error	A bus error occurred.	Remove dirt and dust on the connector, and check if there is poor contact of the cable. Check the setting and wiring, and reset the power of the whole system. If the error is not resolved, there is a possibility that the module is malfunctioning. Please contact your local Mitsubishi Electric sales office or representative.
3201H to 3208H	Internal error	An internal error occurred.	Check the setting and wiring, and reset the power of the whole system. If the error is not resolved, there is a possibility that the module is malfunctioning. Please contact your local Mitsubishi Electric sales office or representative.

Error code	Error name	Description	Corrective action
3341H to 3342H	Memory error	A memory error occurred.	Check the setting and wiring, and reset the power of the whole system. If the error is not resolved, there is a possibility that the module is malfunctioning. Please contact your local Mitsubishi Electric sales office or representative.
3401H to 3408H	Self-diagnostic error	A self-diagnostic error occurred.	Check the setting and wiring, and reset the power of the whole system. If the error is not resolved, there is a possibility that the module is malfunctioning. Please contact your local Mitsubishi Electric sales office or representative.
341BH	Self-diagnostic error	A self-diagnostic error occurred.	Check the setting and wiring, and reset the power of the whole system. If the error is not resolved, there is a possibility that the module is malfunctioning. Please contact your local Mitsubishi Electric sales office or representative.
3501H to 35FFH	An error occurred in the internal circuit of an input terminal Ix corresponding to the bits which are ON. 35□□H • b0: I0 • b1: I1 • b2: I2 • b3: I3 • b4: I4 • b5: I5 • b6: I6 • b7: I7		Check the setting and wiring, and reset the power of the whole system. If the error is not resolved, there is a possibility that the module is malfunctioning. Please contact your local Mitsubishi Electric sales office or representative.
3601H to 36FFH	No external test pulse of an input terminal Ix corresponding to the bits which are ON is detected. 36□□H • b0: I0 • b1: I1 • b2: I2 • b3: I3 • b4: I4 • b5: I5 • b6: I6 • b7: I7		Check the wiring between the corresponding input terminal and the test output.
3701H	T0 unstopable error	Unable to turn OFF the test output T0.	Check the wiring of I/Os if there is a cross-circuit.
3702H	T1 unstopable error	Unable to turn OFF the test output T1.	Check the wiring of I/Os if there is a cross-circuit.
3703H	Qx cross-circuit error	A cross-circuit was detected among Q0 to Q3.	Check the wiring of I/Os if there is a cross-circuit.
3704H	T2 unstopable error	Unable to turn OFF the test output T2.	Check the wiring of I/Os if there is a cross-circuit.
3705H to 3707H	Short-circuit error	A short-circuit is detected in some outputs.	Check the wiring of I/Os if there is a cross-circuit.
3708H	T3 unstopable error	Unable to turn OFF the test output T3.	Check the wiring of I/Os if there is a cross-circuit.
3709H to 370FH	Output circuit short-circuit error	A short-circuit is detected in some outputs.	Check the wiring of I/Os if there is a cross-circuit.
3710H	T0 unstartable error	Unable to turn ON the test output T0.	Check the wiring of I/Os if there is a cross-circuit.
3711H to 371FH	Output circuit short-circuit error	A short-circuit is detected in some outputs.	Check the wiring of I/Os if there is a cross-circuit.
3720H	T1 unstartable error	Unable to turn ON the test output T1.	Check the wiring of I/Os if there is a cross-circuit.
3721H to 373FH	Output circuit short-circuit error	A short-circuit is detected in some outputs.	Check the wiring of I/Os if there is a cross-circuit.
3740H	T2 unstartable error	Unable to turn ON the output T2.	Check the wiring of I/Os if there is a cross-circuit.
3741H to 377FH	Output circuit short-circuit error	A short-circuit is detected in some outputs.	Check the wiring of I/Os if there is a cross-circuit.
3780H	T3 unstartable error	Unable to turn ON the output T3.	Check the wiring of I/Os if there is a cross-circuit.
3781H to 37FFH	Output circuit short-circuit error	A short-circuit is detected in some outputs.	Check the wiring of I/Os if there is a cross-circuit.

Error code	Error name	Description	Corrective action
3801H to 38FFH		Each of the following bits indicate an error. 38□□H Lower bits: Overvoltage/undervoltage monitoring (0: no error, 1: with error) • b0: Bit for undervoltage I/O error • b1: Bit for undervoltage power supply error • b2: Bit for overvoltage I/O error • b3: Bit for overvoltage power supply error Upper bits: Power supply monitoring (0: no error, 1: with error) • b4: Bit for power supply monitoring and flag monitoring error • b5: Bit for power supply monitoring error • b6: — • b7: Bit for master restarting error due to low voltage power supply and I/O error	Check the power supply voltage, and reset the power of the whole system. If the error is not resolved, there is a possibility that the module is malfunctioning. Please contact your local Mitsubishi Electric sales office or representative.
3901H	Module discrepancy error	Module discrepancy is detected.	Check the module version and system requirements.
3902H	Configuration change detected	A configuration change is detected.	Review the configuration of the safety extension module. If the configuration has not been applied (press the ENTER button) after changing the configuration, apply the configuration.
3909H	Setting and diagnostic error	Setting and diagnostic error occurred.	Check the setting and wiring, and reset the power of the whole system. If the error is not resolved, there is a possibility that the module is malfunctioning. Please contact your local Mitsubishi Electric sales office or representative.
390AH to 390BH	Setting and diagnostic error	Setting and diagnostic error occurred.	Check the setting and wiring, and reset the power of the whole system. If the error is not resolved, there is a possibility that the module is malfunctioning. Please contact your local Mitsubishi Electric sales office or representative.
390CH	Module detection error	The module cannot be detected.	Review the system configuration, and reset the power of the whole system. If the error occurs after the power of the whole system is reset, review the configuration of the safety extension module. If the error is not resolved, there is a possibility that the module is malfunctioning. Please contact your local Mitsubishi Electric sales office or representative.
390EH	Rotary switch setting error	The setting of the rotary switch is invalid.	Check the setting of the rotary switch.
390FH	Rotary switch setting error	The setting of the rotary switch is invalid.	Check the setting of the rotary switch.
3910H to 3912H	Setting and diagnostic error	Setting and diagnostic error occurred.	Reset the power of the whole system.
3914H	Setting and diagnostic error	An error occurred in a safety expansion module.	For details, refer to the error codes of the safety expansion module.
3915H	Setting and diagnostic error	An error occurred in a safety main module.	For details, refer to the error codes of the safety main module.
3917H	Extension module configuration error	The configuration of the extension module is incorrect.	Check the setting, wiring, and system configuration, and reset the power of the whole system. If the error is not resolved, there is a possibility that the module is malfunctioning. Please contact your local Mitsubishi Electric sales office or representative.
3919H	Setting and diagnostic error	Setting and diagnostic error occurred.	Check the setting, wiring, and system configuration, and reset the power of the whole system. If the error is not resolved, there is a possibility that the module is malfunctioning. Please contact your local Mitsubishi Electric sales office or representative.
391AH	ENTER button holding down period excess error	When applying a setting, the duration for holding down the ENTER button was too long.	Apply the setting again. Note that, release the ENTER button within three seconds after the ERROR LED flashes.

Error code	Error name	Description	Corrective action
391CH to 391FH	Setting and diagnostic error	Setting and diagnostic error occurred.	Check the setting and wiring, and reset the power of the whole system. If the error is not resolved, there is a possibility that the module is malfunctioning. Please contact your local Mitsubishi Electric sales office or representative.
3921H	Setting and diagnostic error	Setting and diagnostic error occurred.	Check the setting and wiring, and reset the power of the whole system. If the error is not resolved, there is a possibility that the module is malfunctioning. Please contact your local Mitsubishi Electric sales office or representative.
3922H	Setting and diagnostic error	Setting and diagnostic error occurred.	Review the system configuration, check the setting and wiring, and reset the power of the whole system.
3941H to 3942H	Setting and diagnostic error	Setting and diagnostic error occurred.	Check the setting and wiring, and reset the power of the whole system. If the error is not resolved, there is a possibility that the module is malfunctioning. Please contact your local Mitsubishi Electric sales office or representative.
3981H	Number of connected modules excess error	The modules exceeding the maximum number of connectable modules are detected.	Configure a system using the predefined number of safety extension modules or less.
3982H	Setting and diagnostic error	Setting and diagnostic error occurred.	Check the setting and wiring, and reset the power of the whole system. If the error is not resolved, there is a possibility that the module is malfunctioning. Please contact your local Mitsubishi Electric sales office or representative.
3983H	X0 wiring error	Invalid jumper is detected in X0.	Check the wiring of the X0.
3984H	X1 wiring error	Invalid jumper is detected in X1.	Check the wiring of the X1.
3985H	X2 wiring error	Invalid jumper is detected in X2.	Check the wiring of the X2.
3986H	Configuration error	The configuration of the module is incorrect.	Check the setting of the rotary switch and wiring.
3987H	Rotary switch change error	The rotary switch setting was changed during operation.	Return the rotary switch to the original setting, and then cycle the power of the module or apply the setting.
3988H	Setting and diagnostic error	Setting and diagnostic error occurred.	Check the setting, wiring, and system configuration, and reset the power of the whole system. If the error is not resolved, there is a possibility that the module is malfunctioning. Please contact your local Mitsubishi Electric sales office or representative.
3A01H to 3AFFH	Each of the following bits indicate an error. 3A□□H Lower bits: Logic path A (0: no error, 1: with error) • b0: Bit for input logic error • b1: Bit for start function logic error • b2: Bit for output logic error • b3: Bit for bypass error Upper bits: Logic path B (0: no error, 1: with error) • b4: Bit for input logic error • b5: Bit for start function logic error • b6: Bit for output logic error • b7: Bit for bypass error		Check the wiring of inputs for the corresponding logic paths.
3B01H	I0/I1 synchronization time/concurrence error	A synchronization time/concurrence error occurred in I0/I1.	Inconsistency in the double input state is detected. Turn the input signals I0/I1 OFF and ON again. If the error is not resolved, check the wiring of the corresponding input terminals.
3B02H	I0/I1 process error	A process error occurred in I0/I1.	Inconsistency in the double input state is detected. Turn the input signals I0/I1 OFF and ON again. If the error is not resolved, check the wiring of the corresponding input terminals.
3B03H	I0/I1 cross-circuit error	A cross-circuit error occurred in I0/I1.	A cross-circuit is detected in the double input state. Turn the input signals I0/I1 OFF and ON again. If the error is not resolved, check the wiring of the corresponding input terminals.

Error code	Error name	Description	Corrective action
3B04H	I2/I3 synchronization time/concurrence error	A synchronization time/concurrence error occurred in I2/I3.	Inconsistency in the double input state is detected. Turn the input signals I2/I3 OFF and ON again. If the error is not resolved, check the wiring of the corresponding input terminals.
3B05H	I2/I3 process error	A process error occurred in I2/I3.	Inconsistency in the double input state is detected. Turn the input signals I2/I3 OFF and ON again. If the error is not resolved, check the wiring of the corresponding input terminals.
3B06H	I2/I3 cross-circuit error	A cross-circuit error occurred in I2/I3.	A cross-circuit is detected in the double input state. Turn the input signals I2/I3 OFF and ON again. If the error is not resolved, check the wiring of the corresponding input terminals.
3B07H	I4/I5 synchronization time/concurrence error	A synchronization time/concurrence error occurred in I4/I5.	Inconsistency in the double input state is detected. Turn the input signals I4/I5 OFF and ON again. If the error is not resolved, check the wiring of the corresponding input terminals.
3B08H	I4/I5 process error	A process error occurred in I4/I5.	Inconsistency in the double input state is detected. Turn the input signals I4/I5 OFF and ON again. If the error is not resolved, check the wiring of the corresponding input terminals.
3B09H	I4/I5 cross-circuit error	A cross-circuit error occurred in I4/I5.	A cross-circuit is detected in the double input state. Turn the input signals I4/I5 OFF and ON again. If the error is not resolved, check the wiring of the corresponding input terminals.
3B0AH	I6/I7 synchronization time/concurrence error	A synchronization time/concurrence error occurred in I6/I7.	Inconsistency in the double input state is detected. Turn the input signals I6/I7 OFF and ON again. If the error is not resolved, check the wiring of the corresponding input terminals.
3B0BH	I6/I7 process error	A process error occurred in I6/I7.	Inconsistency in the double input state is detected. Turn the input signals I6/I7 OFF and ON again. If the error is not resolved, check the wiring of the corresponding input terminals.
3B0CH	I6/I7 cross-circuit error	A cross-circuit error occurred in I6/I7.	A cross-circuit is detected in the double input state. Turn the input signals I6/I7 OFF and ON again. If the error is not resolved, check the wiring of the corresponding input terminals.
3B0DH	Feedback error	An error occurred in the feedback circuit X0.	Check the wiring and input state of the X0. If the error is not resolved, there is a possibility that the safety input and output devices are malfunctioning.
3B0EH	Feedback error	An error occurred in the feedback circuit X1.	Check the wiring and input state of the X1. If the error is not resolved, there is a possibility that the safety input and output devices are malfunctioning.
3B0FH	Feedback error	An error occurred in the feedback circuit X2.	Check the wiring and input state of the X2. If the error is not resolved, there is a possibility that the safety input and output devices are malfunctioning.

\*1 If a time lag occurs between when turning ON the power of the CPU module and the safety extension unit, 3051H may occur.  
In this case, turn ON the power of the safety extension module within five seconds after turning ON the power of the CPU module.

# APPENDIX

## Appendix 1 External Dimensions

The following figure shows the external dimensions of a safety extension module.

### FX5-SF-MU4T5

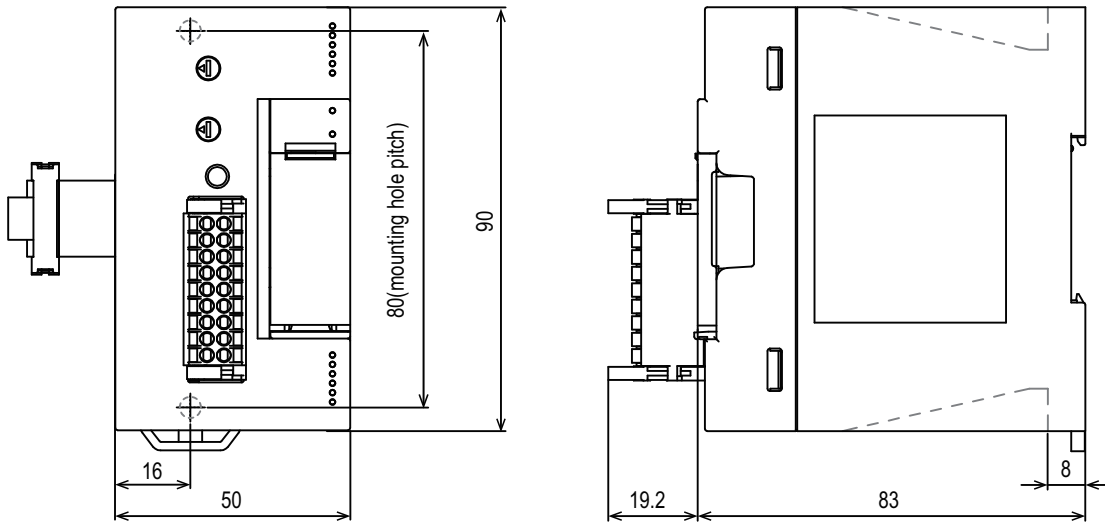

(Unit: mm)

- Mass (weight): Approx 0.3 kg

### FX5-SF-8DI4

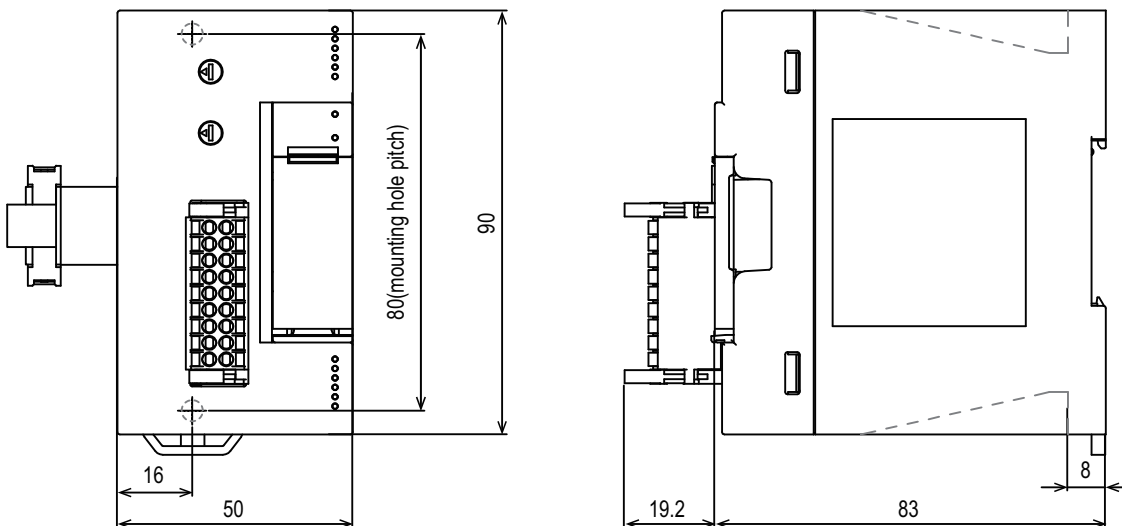

(Unit: mm)

- Mass (weight): Approx 0.25 kg

A

# Appendix 2 Standards

## Certification of UL, cUL standards

FX5-SF-MU4T5s and FX5-SF-8DI4s support UL (UL, cUL) standards.

UL file number: E336245

Safety functions of a safety extension module are not evaluated by UL. The safety extension module is certified based on the UL 508 general application standard.

## Compliance with EC directive (CE marking)

The EC directive does not guarantee that an entire machine produced in accordance with the contents of this note will comply with the following standards.

Compliance to EMC directive and the low voltage directive (LVD) of the entire mechanical module should be checked by the manufacturer. For more details, please contact your local Mitsubishi Electric sales office.

## Requirement for compliance with EMC directive

The following products have shown compliance through direct testing (of the identified standards below) and design analysis (through the creation of a technical construction file) to the European Directive for Electromagnetic Compatibility (2014/30/EU) when used as directed by the appropriate documentation.

### Considerations

This product is designed for use in industrial applications.

### Product compatibility

Type: Programmable controller (open type equipment)

Models: FX5 manufactured after the following date

September 1st, 2019	FX5-SF-MU4T5	FX5-SF-8DI4
Electromagnetic compatibility (EMC) directive	Remarks	
EN61131-2:2007 programmable controllers - Equipment requirements and tests	Compliance with all relevant aspects of the standard. EMI • Radiated emission • Conducted emission EMS • Radiated electromagnetic field • Fast transient burst • Electrostatic discharge • High-energy surge • Voltage drops and interruptions • Conducted RF • Power frequency magnetic field	



# Considerations for complying with EC directive

## Considerations when using FX5-SF-MU4T5 or FX5-SF-8DI4

When using FX5-SF-MU4T5 or FX5-SF-8DI4, attach a ferrite core to the power cable of a CPU module.

Make 3 turns around the ferrite core and attach within approximately 200 mm from the terminal block and connectors of the power cable. (Ferrite core used in Mitsubishi Electric's test: E04SR401938 manufactured by SEIWA ELECTRIC MFG. CO., LTD.)

## Machinery directive

Compliance with the Machinery Directive, which is one of the EU directives, has been mandatory for safety products sold within EU member states since 1995. Based on the certification by a third-party certification organization, TUV SUD, we declare that FX5-SF-MU4T5s and FX5-SF-8DI4s comply with the Machinery Directive and affix the CE marking on them.

The sales representative in EU member states is:

Company: MITSUBISHI ELECTRIC EUROPE B.V.

Address: Mitsubishi-Electric-Platz 1, 40882 Ratingen, Germany

## Measures to comply with the machinery directive

The Machinery Directive (2006/42/EC) requires that machinery satisfy the three pillars of safety: mechanical safety, electrical safety, and worker safety. FX5-SF-MU4T5s and FX5-SF-8DI4s comply with the Machinery Directive. Before using this product, please read this manual, the relevant manuals, and the safety standards carefully and pay full attention to safety to handle the product correctly. The descriptions are based on the requirements of the Machinery Directive and the harmonized standards. However, they do not guarantee that the entire machinery constructed according to the descriptions complies with the Machinery Directive. The manufacturer of the machinery must determine the testing method for compliance and declare conformity to the Machinery Directive.

### ■Machinery Directive related standards

Immunity requirements

Standard: EN61326-3-1:2008

Test item	Test description	Value specified in standard
EN61000-4-2 Electrostatic discharge immunity* <sup>1</sup>	An electrostatic discharge is applied to the enclosure of the equipment.	<ul style="list-style-type: none"> <li>• 8 kV air discharge</li> <li>• 4 kV contact discharge</li> </ul>
EN61000-4-3 Radiated, radio-frequency, electromagnetic field immunity* <sup>1</sup>	An electric field is radiated to the product.	80% AM modulation @1 kHz <ul style="list-style-type: none"> <li>• 80 M to 1 GHz: 10 V/m</li> <li>• 1.4 G to 2.0 GHz: 3 V/m</li> <li>• 2.0 G to 2.7 GHz: 1 V/m</li> </ul>
EN61000-4-4 Fast transient/burst immunity* <sup>1</sup>	Burst noise is applied to power lines and signal lines.	<ul style="list-style-type: none"> <li>• AC power: 3 kV</li> <li>• DC power: 3 kV</li> <li>• I/O signal/control: 2 kV</li> <li>• Functional earth: 2 kV</li> </ul>
EN61000-4-5 Surge immunity* <sup>1</sup>	Lightning surge is applied to power lines and signal lines.	<ul style="list-style-type: none"> <li>• AC power: 2 kV/cm, 4 kV/cm</li> <li>• DC power: 1 kV/cm, 2 kV/cm</li> <li>• I/O signal/control: 2 kV/cm</li> </ul>
EN61000-4-6 Conducted RF immunity* <sup>1</sup>	High-frequency noise is applied to power lines and signal lines.	0.15 M to 80 MHz 80% AM modulation @1 kHz, 10 V rms
EN61000-4-8 Power-frequency magnetic field immunity* <sup>1</sup>	The product is immersed in the magnetic field of an induction coil.	50Hz/60Hz, 30A/m
EN61000-4-11 Voltage dips and interruptions immunity* <sup>1</sup>	Power voltage is momentarily interrupted.	<ul style="list-style-type: none"> <li>• 0%, 1 period</li> <li>• 0%, 250/300 periods (50/60 Hz)</li> <li>• 40%, 10/12 periods (50/60 Hz)</li> <li>• 70%, 25/30 periods (50/60 Hz)</li> </ul>
EN61000-4-29 Voltage dips and interruptions immunity* <sup>1</sup>	Power voltage is momentarily interrupted.	<ul style="list-style-type: none"> <li>• 40% UT 10ms</li> <li>• 0% UT 20ms</li> </ul>

Test item	Test description	Value specified in standard
EN61000-4-16 Immunity to conducted, common mode disturbances*1	Low-frequency noise is applied to power lines and signal lines.	<ul style="list-style-type: none"> <li>• AC power</li> <li>1.5 k to 15 kHz: 1 to 10 V, 20 dB/Dec.</li> <li>15 k to 150 kHz: 10 V</li> <li>• DC power</li> <li>1.5 k to 15 kHz: 1 to 10 V, 20 dB/Dec.</li> <li>15 k to 150 kHz: 10 V</li> <li>DC, 16 2/3 Hz, 50/60 Hz: 10 V continuous, 100 V for a short time (1s)</li> <li>150/180 Hz: 10 V continuous</li> <li>• I/O signal/control</li> <li>1.5 k to 15 kHz: 1 to 10 V, 20 dB/Dec.</li> <li>15 k to 150 kHz: 10 V</li> <li>DC, 16 2/3 Hz, 50/60 Hz: 10 V continuous, 100 V for a short time (1s)</li> <li>150/180 Hz: 10 V continuous</li> </ul>

\*1 FX5-SF-MU4T5s and FX5-SF-8DI4s are open-type devices (devices designed to be housed inside other equipment) intended to be placed in a conductive control panel. The tests were conducted with the device installed in a control panel.

## Compliance with UKCA marking

The requirements for compliance with UKCA marking are the same as that with EC directive (CE marking).

# Appendix 3 Checklist for Manufacturer

---

The specifications in the following list must be available at least for the initial commissioning.

They are dependent on the application, whose requirement must be checked by the manufacturer/installer.

This checklist should be retained/stored with the machine documentation so that you can use it as a reference for periodical tests.

- |  |                              |                             |
|--|------------------------------|-----------------------------|
| <b>1.</b> Have the safety rules and regulations been observed in compliance with the directives/ standards applicable to the machine?  | Yes <input type="checkbox"/> | No <input type="checkbox"/> |
| <b>2.</b> Are the applied directives and standards listed in the declaration of conformity?  | Yes <input type="checkbox"/> | No <input type="checkbox"/> |
| <b>3.</b> Does the protective equipment comply with the required category?   | Yes <input type="checkbox"/> | No <input type="checkbox"/> |
| <b>4.</b> Are the required protective measures against electric shock in effect (protection class)?  | Yes <input type="checkbox"/> | No <input type="checkbox"/> |
| <b>5.</b> Has the protective function been checked in compliance with the test notes in this manual? Especially:   | Yes <input type="checkbox"/> | No <input type="checkbox"/> |
| <ul style="list-style-type: none"><li>• Functional check of the command devices, sensors and actuators connected to the safety extension module</li><li>• Test of all switch-off paths</li></ul> |                              |                             |
| <b>6.</b> Are you sure that the safety extension module was tested fully for safety functionality after each configuration change?   | Yes <input type="checkbox"/> | No <input type="checkbox"/> |

This checklist does not replace a system commissioning and regular inspections by a mechanic who is qualified to carry out safety inspections.

# Appendix 4 Module Labels

The functions of a safety extension module can be set using module labels.

## Module labels

A module label name consists of the following elements:

"Module name"\_"Number of modules"."Data type""Label name"

"Module name"\_"Number of modules"."Data type""Label name"\_D

Ex.

FX5\_SF\_MU4T5\_1.bModuleREADY\_D

### ■Module name

It indicates a module name.

### ■Number of modules

It indicates the number of modules.

The buffer memory values in safety expansion modules are centralized to a safety main module. Only one safety main module can be connected in each system; therefore the number of modules is fixed to one. Even if the two safety expansion modules are connected, the number of modules will be equal to that of the safety main modules.

### ■Data type

It indicates a data size of the buffer memory. It is categorized as follows.

Data type	Description
b	Bit
u	Word [Unsigned]/Bit String [16-bit]

### ■Label name

It indicates a unique label name for each module.

### ■\_D

It indicates that the module label is for direct access input.

## Module labels of the buffer memory

A module label name of the buffer memory consists of the following elements.

"Module name"\_"Number of modules"."Construction name"["(construction number)"]."Data type""Label name"

"Module name"\_"Number of modules"."Construction name"\_D["(construction number)"]."Data type""Label name"\_D

**Ex.**

FX5\_SF\_MU4T5\_1.stnMonitor\_D[0].zReserveArea00121\_D

### ■Module name

It indicates a module name.

### ■Number of modules

It indicates the number of modules.

The buffer memory values in safety expansion modules are centralized to a safety main module. Only one safety main module can be connected in each system; therefore the number of modules is fixed to one. Even if the two safety expansion modules are connected, the number of modules will be equal to that of the safety main modules.

### ■Construction name

It indicates a unique construction name for each module.

Construction name	Description
stnMonitor	Monitor
stnExpandedMonitor	Monitor

### ■Structure number

It indicates the structure number.

### ■Data type

It indicates a data size of the buffer memory. It is categorized as follows.

Data type	Description
u	Word [Unsigned]/Bit String [16-bit]

### ■Label name

It indicates a unique label name for each module.

### ■\_D

It indicates that the module label is for direct access. The value written to or read from the module label is immediately applied to the module.

# Appendix 5 Buffer Memory

## List of buffer memory

This section lists the buffer memory of a safety extension module. For details on the buffer memory, refer to the following section.

 Page 143 Details of buffer memory addresses

The buffer memory areas of a safety extension module are classified into the data types in the following table.

Data type	Description	
Monitor data	Description	Data used for checking the status of a safety extension module.
	Read and write attributes	Read only and unable to write.
	Setting method	—
	Setting timing	—

### Point

Do not write data to the system areas and areas whose data type is 'monitor'. Writing data into these areas can cause the malfunction of the module.

## Un\G0 to Un\G699

○: With refresh setting, ×: Without refresh setting

Address (decimal)	Address (hexadecimal)	Name	Data type	Auto-refresh
0	0	Latest error code	Monitor	○
1	1	Latest address of error history	Monitor	○
2 to 29	2 to 1D	System area	—	—
30	1E	Module information	Monitor	×
31	1F	Firmware version	Monitor	×
32 to 68	20 to 44	System area	—	—
69	45	Input signals	Monitor	×
70	46	System area	—	—
71	47	Number of units connected	Monitor	○
72 to 99	48 to 63	System area	—	—
100	64	1st Module Input signal	Monitor	○
101	65	1st Module Output signal and Module state	Monitor	○
102	66	1st Module Output signal and Internal error	Monitor	○
103	67	1st Module System CRC	Monitor	○
104	68	1st Module Input terminal error	Monitor	○
105	69	1st Module Error code 1	Monitor	○
106	6A	1st Module Error code 2	Monitor	○
107	6B	System area	—	—
108	6C	1st Module Lower Rotary Switch state	Monitor	○
109	6D	1st Module Upper Rotary Switch state	Monitor	○
110	6E	1st Module X0 terminal state	Monitor	○
111	6F	1st Module X1 terminal state	Monitor	○
112	70	1st Module X2 terminal state	Monitor	○
113	71	1st Module Module name identifier	Monitor	○
114	72	System area	—	—
115	73	1st Module Lower Rotary Switch startup state	Monitor	○
116	74	1st Module Upper Rotary Switch startup state	Monitor	○
117	75	1st Module X0 terminal startup state	Monitor	○
118	76	1st Module X1 terminal startup state	Monitor	○
119	77	1st Module X2 terminal startup state	Monitor	○

Address (decimal)	Address (hexadecimal)	Name	Data type	Auto-refresh
120	78	1st Module Off delay time	Monitor	○
121 to 139	79 to 8B	System area	—	—
140	8C	2nd Module Input signal	Monitor	○
141	8D	2nd Module Output signal	Monitor	○
142 to 143	8E to 8F	System area	—	—
144	90	2nd Module Input terminal error	Monitor	○
145	91	2nd Module Error code 1	Monitor	○
146	92	2nd Module Error code 2	Monitor	○
147	93	System area	—	—
148	94	2nd Module Lower Rotary Switch state	Monitor	○
149	95	2nd Module Upper Rotary Switch state	Monitor	○
150	96	2nd Module X0 terminal state	Monitor	○
151	97	2nd Module X1 terminal state	Monitor	○
152	98	2nd Module X2 terminal state	Monitor	○
153	99	2nd Module Module name identifier	Monitor	○
154	9A	System area	—	—
155	9B	2nd Module Lower Rotary Switch startup state	Monitor	○
156	9C	2nd Module Upper Rotary Switch startup state	Monitor	○
157	9D	2nd Module X0 terminal startup state	Monitor	○
158	9E	2nd Module X1 terminal startup state	Monitor	○
159	9F	2nd Module X2 terminal startup state	Monitor	○
160	A0	2nd Module Off delay time	Monitor	○
161 to 179	A1 to B3	System area	—	—
180	B4	3rd Module Input signal	Monitor	○
181	B5	3rd Module Output signal	Monitor	○
182 to 183	B6 to B7	System area	—	—
184	B8	3rd Module Input terminal error	Monitor	○
185	B9	3rd Module Error code 1	Monitor	○
186	BA	3rd Module Error code 2	Monitor	○
187	BB	System area	—	—
188	BC	3rd Module Lower Rotary Switch state	Monitor	○
189	BD	3rd Module Upper Rotary Switch state	Monitor	○
190	BE	3rd Module X0 terminal state	Monitor	○
191	BF	3rd Module X1 terminal state	Monitor	○
192	C0	3rd Module X2 terminal state	Monitor	○
193	C1	3rd Module Module name identifier	Monitor	○
194	C2	System area	—	—
195	C3	3rd Module Lower Rotary Switch startup state	Monitor	○
196	C4	3rd Module Upper Rotary Switch startup state	Monitor	○
197	C5	3rd Module X0 terminal startup state	Monitor	○
198	C6	3rd Module X1 terminal startup state	Monitor	○
199	C7	3rd Module X2 terminal startup state	Monitor	○
200	C8	3rd Module Off delay time	Monitor	○
201 to 699	C9 to 2BB	System area	—	—



## Error history (Un\G700 to Un\G859)

○: With refresh setting, ×: Without refresh setting

Address (decimal)	Address (hexadecimal)	Name	Data type	Auto-refresh	
700	2BC	Error history 1	Error code	Monitor	×
701	2BD		Error time: First two digits of the year/ Last two digits of the year	Monitor	×
702	2BE		Error time: Month/Day	Monitor	×
703	2BF		Error time: Hour/Minute	Monitor	×
704	2C0		Error time: Second/Day of the week	Monitor	×
705	2C1		Error time: Millisecond	Monitor	×
706 to 709	2C2 to 2C5	System area	—	—	
710 to 715	2C6 to 2CB	Error history 2	Same as error history 1	Monitor	×
716 to 719	2CC to 2CF	System area	—	—	
720 to 725	2D0 to 2D5	Error history 3	Same as error history 1	Monitor	×
726 to 729	2D6 to 2D9	System area	—	—	
730 to 735	2DA to 2DF	Error history 4	Same as error history 1	Monitor	×
736 to 739	2E0 to 2E3	System area	—	—	
740 to 745	2E4 to 2E9	Error history 5	Same as error history 1	Monitor	×
746 to 749	2EA to 2ED	System area	—	—	
750 to 755	2EE to 2F3	Error history 6	Same as error history 1	Monitor	×
756 to 759	2F4 to 2F7	System area	—	—	
760 to 765	2F8 to 2FD	Error history 7	Same as error history 1	Monitor	×
766 to 769	2FE to 301	System area	—	—	
770 to 775	302 to 307	Error history 8	Same as error history 1	Monitor	×
776 to 779	308 to 30B	System area	—	—	
780 to 785	30C to 311	Error history 9	Same as error history 1	Monitor	×
786 to 789	312 to 315	System area	—	—	
790 to 795	316 to 31B	Error history 10	Same as error history 1	Monitor	×
796 to 799	31C to 31F	System area	—	—	
800 to 805	320 to 325	Error history 11	Same as error history 1	Monitor	×
806 to 809	326 to 329	System area	—	—	
810 to 815	32A to 32F	Error history 12	Same as error history 1	Monitor	×
816 to 819	330 to 333	System area	—	—	
820 to 825	334 to 339	Error history 13	Same as error history 1	Monitor	×
826 to 829	33A to 33D	System area	—	—	
830 to 835	33E to 343	Error history 14	Same as error history 1	Monitor	×
836 to 839	344 to 347	System area	—	—	
840 to 845	348 to 34D	Error history 15	Same as error history 1	Monitor	×
846 to 849	34E to 351	System area	—	—	
850 to 855	352 to 357	Error history 16	Same as error history 1	Monitor	×
856 and above	358 and above	System area	—	—	



# Details of buffer memory addresses

This section shows the details of the buffer memory in a safety extension module.

## Latest error code

The latest error code detected in a safety extension module is stored. For details, refer to the following section.

 Page 127 List of Error Codes

### ■Buffer memory address

The buffer memory address of this area is as follows.

Buffer memory name	Address
Latest error code	0

## Latest address of error history

The buffer memory address where the latest error code has been stored is stored.

### ■Buffer memory address

The buffer memory address of this area is as follows.

Buffer memory name	Address
Latest address of error history	1

## Module information

The module information of a safety extension module is stored. 7FE9H (fixed hexadecimal value) is stored.

### ■Buffer memory address

The buffer memory address of this area is as follows.

Buffer memory name	Address
Module information	30

A

## Firmware version

A firmware version is stored. It is stored in four-digit decimal number.

### ■Buffer memory address

The buffer memory address of this area is as follows.

Buffer memory name	Address
Firmware version	31

## Input signals

The status of a safety extension module can be checked in the buffer memory.

### ■ Buffer memory address

The buffer memory address of this area is as follows.

Buffer memory name	Address
Input signals	69

### ■ List of input signals

Buffer memory	Description
b0	Module READY
b1	Module Safety READY
b2 to 14	Unavailable
b15	Error flag

### ■ Module READY

It turns ON after the completion of the initial processing of the CPU module when the power of the module is turned ON or reset.

### ■ Module Safety READY

It turns ON after the completion of the initial processing of the safety extension module when the power of the module is turned ON or reset.

When the safety control diagnostic information is not updated correctly, Module READY is turned OFF.

### ■ Error flag

It turns ON when an error occurs in a safety extension module (including a safety expansion module).

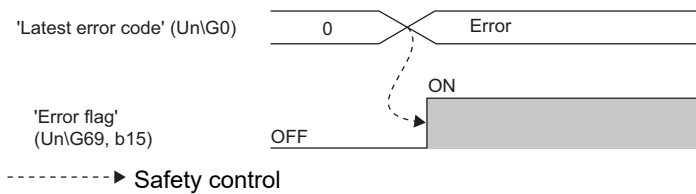

## Number of units connected

The number of connected safety extension modules is stored.

### ■ Buffer memory address

The buffer memory address of this area is as follows.

Buffer memory name	Address
Number of units connected	71

## Input signals

The information of the input terminals of a safety module is stored.

### ■Buffer memory address

The buffer memory address of this area is as follows.

Buffer memory name	Address
1st Module Input signal	100
2nd Module Input signal	140
3rd Module Input signal	180

### ■List of input signals

FX5-SF-MU4T5

Bit	Input terminal of FX5-SF-MU4T5	Operation
b0	Input signal I0	0: No input 1: Input
b1	Input signal I1	
b2	Input signal I2	
b3	Input signal I3	
b4	Input signal XS0	
b5	Input signal X0	
b6	Input signal X1	
b7	Input signal X2	
b8 to b15	—	Fixed to 0

FX5-SF-8DI4

Bit	Input terminal of FX5-SF-8DI4	Operation
b0	Input signal I0	0: No input 1: Input
b1	Input signal I1	
b2	Input signal I2	
b3	Input signal I3	
b4	Input signal I4	
b5	Input signal I5	
b6	Input signal I6	
b7	Input signal I7	
b8 to b15	—	Fixed to 0

A

## Output signals and module status

The information on the output terminals of a module and the statuses of each function are stored.

### ■ Buffer memory address

The buffer memory address of this area is as follows.

Buffer memory name	Address
1st Module Output signal and Module state	101
2nd Module Output signal	141
3rd Module Output signal	181

### ■ Output signals and statuses of each function

FX5-SF-MU4T5

Bit	Output terminal or function of FX5-SF-MU4T5	Operation
b0	Output signal Q0	0: No output 1: Output
b1	Output signal Q1	
b2	Output signal Q2	
b3	Output signal Q3	
b4	X0 restart interlock reset request	0: No reset request 1: Reset request
b5	X1 restart interlock reset request	
b6	Muting function	0: Inactive 1: Active
b7	Bypass function	0: Inactive 1: Active
b8 to b15	—	Fixed to 0

FX5-SF-8DI4

Bit	Output terminal or function of FX5-SF-8DI4	Operation
b0	—	—
b1	Output signal QA	0: No output 1: Output
b2	—	—
b3	Output signal QB	0: No output 1: Output
b4	—	—
b5	—	—
b6	—	—
b7	—	—
b8 to b15	—	Fixed to 0

## Output signal and internal error

Error information of the whole system is stored.

### ■Buffer memory address

The buffer memory address of this area is as follows.

Buffer memory name	Address
1st Module Output signal and Internal error	102

### ■List of output signals and internal errors

Bit	Output status or input error	Operation
b0	Output signals Q2/3	0: No output
b1	Output signals Q0/1	1: Output
b2	Status change of a rotary switch	0: Not changed 1: Changed
b3	External device monitoring connection open	0: Not detected 1: Detected
b4	Input concurrence error	0: Not detected 1: Detected
b5	Input process error	0: Not detected 1: Detected
b6	Input cross-circuit error	0: Not detected 1: Detected
b7	Internal error	0: Not detected 1: Detected
b8 to b15	—	Fixed to 0

## System CRC

A CRC value for checking configuration and setting is stored.

### ■Buffer memory address

The buffer memory address of this area is as follows.

Buffer memory name	Address
1st Module System CRC	103

### ■List of system CRCs

Buffer memory	Name	Description
b0 to 7	System CRC (lower)	CRC_L for checking configuration and settings
b8 to b15	System CRC (upper)	CRC_H for checking configuration and settings

## Input terminal errors

The input terminal status is stored. A value to be stored is as follows.

### ■Buffer memory address

The buffer memory address of this area is as follows.

Buffer memory name	Address
1st Module Input terminal error	104
2nd Module Input terminal error	144
3rd Module Input terminal error	184

### ■List of input terminal errors

FX5-SF-MU4T5

Bit	Input terminal of FX5-SF-MU4T5	Operation
b0	Input terminals I0/I1	00: No error 01: Synchronization time/concurrence error 10: Process error 11: Cross-circuit error
b1		
b2	Input terminals I2/I3	
b3		
b4	—	—
b5	Input terminal X0	0: Open circuit connected to X terminal not detected 1: Open circuit connected to X terminal detected
b6	Input terminal X1	
b7	Input terminal X2	
b8 to b15	—	Fixed to 0

FX5-SF-8DI4

Bit	Input terminal of FX5-SF-8DI4	Operation
b0	Input terminals I0/I1	00: No error 01: Synchronization time/concurrence error 10: Process error 11: Cross-circuit error
b1		
b2	Input terminals I2/I3	
b3		
b4	Input terminals I4/I5	
b5		
b6	Input terminals I6/I7	
b7		
b8 to b15	—	Fixed to 0

## Error code 1

The code of an error occurred in a module is stored. For error codes to be stored, refer to the following section.

 Page 127 List of Error Codes

### ■Buffer memory address

The buffer memory address of this area is as follows.

Buffer memory name	Address
1st Module Error code 1	105
2nd Module Error code 1	145
3rd Module Error code 1	185

## Error code 2

The code of an error occurred in a module is stored. For error codes to be stored, refer to the following section.

☞ Page 127 List of Error Codes

### ■Buffer memory address

The buffer memory address of this area is as follows.

Buffer memory name	Address
1st Module Error code 2	106
2nd Module Error code 2	146
3rd Module Error code 2	186

## Statuses of lower rotary switches

The current setting values of the rotary switches are stored.

### ■Buffer memory address

The buffer memory address of this area is as follows.

Buffer memory name	Address
1st Module Lower Rotary Switch state	108
2nd Module Lower Rotary Switch state	148
3rd Module Lower Rotary Switch state	188

### ■Switch status

Bit	Name	Description
b0	Lower rotary switch settings	0 to 9
b1		
b2		
b3		
b4 to b15	—	Fixed to 0

## Statuses of upper rotary switches

The current setting values of the rotary switches are stored.

### ■Buffer memory address

The buffer memory address of this area is as follows.

Buffer memory name	Address
1st Module Upper Rotary Switch state	109
2nd Module Upper Rotary Switch state	149
3rd Module Upper Rotary Switch state	189

### ■Switch status

Bit	Name	Description
b0	Upper rotary switch settings	0 to 9
b1		
b2		
b3		
b4 to b15	—	Fixed to 0

## X0 state

The connection information of an X0 terminal is stored.

### ■Buffer memory address

The buffer memory address of this area is as follows.

Buffer memory name	Address
1st Module X0 terminal state	110
2nd module X0 terminal state	150
3rd module X0 terminal state	190

### ■Status of an X0 terminal

Bit	Name	Description
b0	X0 state	00: Open
b1		01: Connected to T0 10: Connected to T1 11: Connected to plus terminal
b2 to b15	—	Fixed to 0

## X1 state

The connection information of an X1 terminal is stored.

### ■Buffer memory address

The buffer memory address of this area is as follows.

Buffer memory name	Address
1st Module X1 terminal state	111
2nd module X1 terminal state	151
3rd module X1 terminal state	191

### ■Status of an X1 terminal

Bit	Name	Description
b0	X1 state	00: Open
b1		01: Connected to T0 10: Connected to T1 11: Connected to plus terminal
b2 to b15	—	Fixed to 0

## X2 state

The connection information of an X2 terminal is stored.

### ■Buffer memory address

The buffer memory address of this area is as follows.

Buffer memory name	Address
1st Module X2 terminal state	112
2nd module X2 terminal state	152
3rd module X2 terminal state	192

### ■Status of an X2 terminal

Bit	Name	Description
b0	X2 state	00: Open
b1		01: Connected to T0 10: Connected to T1 11: Connected to plus terminal
b2 to b15	—	Fixed to 0



## Module name identifier

A module name identifier is stored.

### ■Buffer memory address

The buffer memory address of this area is as follows.

Buffer memory name	Address
1st Module Module name identifier	113
2nd Module Module name identifier	153
3rd Module Module name identifier	193

### ■Module name identifier

Bit	Name	Description
b0	Module name identifier	1: FX5-SF-MU4T5 3: FX5-SF-8DI4
b1		
b2		
b3		
b4		
b5		
b6		
b7		
b8 to b15	—	Fixed to 0

## Lower rotary switch startup state

The information of the rotary switches that have been set at startup is stored.

### ■Buffer memory address

The buffer memory address of this area is as follows.

Buffer memory name	Address
1st Module Lower Rotary Switch startup state	115
2nd Module Lower Rotary Switch startup state	155
3rd Module Lower Rotary Switch startup state	195

### ■Startup state

FX5-SF-MU4T5

Bit	Name	Description
b0	DELAY setting	0: 0s
b1		1: 0.5s
b2		2: 1s
b3		3: 1.5s
		4: 2s
		5: 2.5s
		6: 3s
		7: 3.5s
		8: 4s
		9: 5s
b4 to b15	—	Fixed to 0

FX5-SF-8DI4

Bit	Name	Description
b0	INPUT B	0: Disabled (Input signals are ignored.)
b1		1 to 9: 1 to 9 logic
b2		
b3		
b4 to b15	—	Fixed to 0

## Upper rotary switch startup state

The information of the rotary switches that have been set at startup is stored.

### ■Buffer memory address

The buffer memory address of this area is as follows.

Buffer memory name	Address
1st Module Upper Rotary Switch startup state	116
2nd Module Upper Rotary Switch startup state	156
3rd Module Upper Rotary Switch startup state	196

### ■Startup state

FX5-SF-MU4T5

Bit	Name	Description
b0	FUNCTION setting	0: Disabled 1 to 9: program 1 to 9
b1		
b2		
b3		
b4 to b15	—	Fixed to 0

FX5-SF-8DI4

Bit	Name	Description
b0	INPUT A	0: Disabled (Input signals are ignored.) 1 to 9: 1 to 9 logic
b1		
b2		
b3		
b4 to b15	—	Fixed to 0

## X0 startup state

The connection information of the X0 terminal at startup is stored.

### ■Buffer memory address

The buffer memory address of this area is as follows.

Buffer memory name	Address
1st Module X0 terminal startup state	117
2nd Module X0 terminal startup state	157
3rd Module X0 terminal startup state	197

### ■Status of an X0 terminal

FX5-SF-MU4T5

Bit	Name	Description
b0	X0 state	00: Open 01: Connected to T0 10: Connected to T1 11: Connected to plus terminal
b1		
b2 to b15	—	Fixed to 0

FX5-SF-8DI4

Bit	Name	Description
b0 to b15	—	Fixed to 0

## X1 startup state

The connection information of the X1 terminal at startup is stored.

### ■Buffer memory address

The buffer memory address of this area is as follows.

Buffer memory name	Address
1st Module X1 terminal startup state	118
2nd Module X1 terminal startup state	158
3rd Module X1 terminal startup state	198

### ■Status of an X1 terminal

FX5-SF-MU4T5

Bit	Name	Description
b0	X1 state	00: Open
b1		01: Connected to T0 10: Connected to T1 11: Connected to plus terminal
b2 to b15	—	Fixed to 0

FX5-SF-8DI4

Bit	Name	Description
b0 to b15	—	Fixed to 0

## X2 startup state

The connection information of the X2 terminal at startup is stored.

### ■Buffer memory address

The buffer memory address of this area is as follows.

Buffer memory name	Address
1st Module X2 terminal startup state	119
2nd Module X2 terminal startup state	159
3rd Module X2 terminal startup state	199

### ■Status of an X2 terminal

FX5-SF-MU4T5

Bit	Name	Description
b0	X2 state	00: Open
b1		01: Connected to T0 10: Connected to T1 11: Connected to plus terminal
b2 to b15	—	Fixed to 0

FX5-SF-8DI4

Bit	Name	Description
b0 to b15	—	Fixed to 0

## Off delay time

For the models which can set an off delay, the value indicating the settable time unit is stored.

### ■Buffer memory address

The buffer memory address of this area is as follows.

Buffer memory name	Address
1st Module Off delay time	120
2nd Module Off delay time	160
3rd Module Off delay time	200

### ■Off delay time

FX5-SF-MU4T5

Bit	Name	Description
b0	Off delay time	11: ×1 second
b1		
b2 to b15	—	Fixed to 0

FX5-SF-8DI4

Bit	Name	Description
b0 to b15	—	Fixed to 0

## Error history

Up to 16 errors (error history No.1 to No.16) occurred in a safety extension module are stored.

### ■Buffer memory address

The buffer memory address of this area is as follows.

Buffer memory name	Address (No.1 to No.16)
Error history	700 to 859

The configuration of the buffer memory is as follows.

	b15	to	b8	b7	to	b0
Un\G700	Error code					
Un\G701	First two digits of the year			Last two digits of the year		
Un\G702	Month			Day		
Un\G703	Hour			Minute		
Un\G704	Second			Day of the week		
Un\G705	Millisecond (upper)			(Millisecond (lower))		
Un\G706	System area					
to						
Un\G709						

Item	Description	Storage example <sup>*1</sup>
First two digits of the year/ Last two digits of the year	A value is stored in BCD code.	2017H
Month/Day		0131H
Hour/Minute		1035H
Second		40H
Day of the week	One of the following values is stored in BCD code. <ul style="list-style-type: none"> <li>• Sunday: 0</li> <li>• Monday: 1</li> <li>• Tuesday: 2</li> <li>• Wednesday: 3</li> <li>• Thursday: 4</li> <li>• Friday: 5</li> <li>• Saturday: 6</li> </ul>	2H
Millisecond (upper)	A value is stored in BCD code.	6H
Millisecond (lower)		28H

\*1 These values assume that an error occurred at 10:35 and 40.628 milliseconds on Tuesday, January 31st, 2017.

# Appendix 6 How to Use MELSEC iQ-F Series Safety Extension Module Configuration Guide

MELSEC iQ-F Series Safety Extension Module Configuration Guide is a tool for checking methods, settings and electric wiring to install a safety extension module safely.

The features of the configuration guide are as follows:

- Available to visually check how to connect each input and output device according to the specific safety extension module configuration or the rotary switch setting. (Terminals which can connect to each device can be checked.)
- Available to check how internal logic of the module varies by changing each rotary switch setting.
- Available to check and print ladder diagrams for arranging the wiring of set configurations.
- Available to save the set configurations and open them again as necessary.

Use MELSEC iQ-F Series Safety Extension Module Configuration Guide as necessary to use a safety extension module.

## Confirmed browsers

MELSEC iQ-F Series Safety Extension Module Configuration Guide is a web-based tool.

Operation of the following browsers has been confirmed:

- Google Chrome (recommended)
- Internet Explorer 11

## For using Google Chrome

For using MELSEC iQ-F Series Safety Extension Module Configuration Guide on Google Chrome, close all the running Google Chrome and execute 'start\_chrome.bat' which is included in the configuration guide installation folder to start the browser again.

When MELSEC iQ-F Series Safety Extension Module Configuration Guide does not start normally, refer to the following:

☞ Page 170 Version 1.01B or later

## Precautions

- 'start\_chrome.bat' supports the 'Windows (64-bit version) Google Chrome default installation location.' When Google Chrome does not start even if 'start\_chrome.bat' is executed, correct the Google Chrome installation folder path that is addressed in the batch file by using the text editor.

### ■Windows (32-bit version) Google Chrome default installation location

```
start "" "%programfiles%\Google\Chrome\Application\chrome.exe" --allow-file-access-from-files http://localhost:81
```

### ■Windows (64-bit version) Google Chrome (64-bit version) default installation location

```
start "" "%programfiles%\Google\Chrome\Application\chrome.exe" --allow-file-access-from-files http://localhost:81
```

### ■Windows (64-bit version) Google Chrome (32-bit version) default installation location

```
start "" "%programfiles(x86)%\Google\Chrome\Application\chrome.exe" --allow-file-access-from-files http://localhost:81
```

### ■If the Google Chrome installation location is changed from the default

```
start "" "(specify an installation folder path)\chrome.exe" --allow-file-access-from-files http://localhost:81
```

- When executing 'start\_chrome.bat,' the running task of 'nginx.exe' ends and 'nginx.exe' for MELSEC iQ-F Series Safety Extension Module Configuration Guide starts.

Therefore, while using MELSEC iQ-F Series Safety Extension Module Configuration Guide, another program that uses 'nginx.exe' cannot be used.

After ending MELSEC iQ-F Series Safety Extension Module Configuration Guide, execute another program again as necessary.

## For using Internet Explorer 11

For using MELSEC iQ-F Series Safety Extension Module Configuration Guide on Internet Explorer 11, close all the running Internet Explorer 11 and execute 'start\_IE11.bat' which is included in the configuration guide installation folder to start the browser again.

When MELSEC iQ-F Series Safety Extension Module Configuration Guide does not start normally, refer to the following:

 Page 170 Version 1.00A

### **Point**

When the message "Internet Explorer restricted this webpage from running scripts or ActiveX controls." is displayed in the lower side of the screen at the Internet Explorer 11 startup, click the [Allow blocked content] button.

## Precautions

When executing 'start\_IE11.bat,' the running task of 'nginx.exe' ends and 'nginx.exe' for MELSEC iQ-F Series Safety Extension Module Configuration Guide starts.

Therefore, while using MELSEC iQ-F Series Safety Extension Module Configuration Guide, another program that uses 'nginx.exe' cannot be used.

After ending MELSEC iQ-F Series Safety Extension Module Configuration Guide, execute another program again as necessary.

# Procedure to use

---

The following shows the procedure for using MELSEC iQ-F Series Safety Extension Module Configuration Guide.

## 1. Download

- For downloading MELSEC iQ-F Series Safety Extension Module Configuration Guide in Japan

The configuration guide can be downloaded from the Mitsubishi Electric FA website.

[www.MitsubishiElectric.co.jp/fa](http://www.MitsubishiElectric.co.jp/fa)

For downloading the configuration guide, please register for a free membership on the Mitsubishi Electric FA website in advance.

- For downloading MELSEC iQ-F Series Safety Extension Module Configuration Guide in other countries

For the information on how to obtain the configuration guide, please contact your local Mitsubishi Electric sales office or representative.

## 2. Installation

Decompress the downloaded MELSEC iQ-F Series Safety Extension Module Configuration Guide and store it in a local folder that does not include Japanese (Unicode characters) in its folder path.

(Save destination example: C:\)

## 3. Creating configurations

For the operation method, refer to the following:

☞ Page 165 Operation

## 4. Printing

Created module configurations and their wiring diagrams can be printed.

By printing the wiring diagrams, devices can be connected while checking the diagrams.

For the printing methods, refer to the following:

☞ Page 168 Printing a module configuration

☞ Page 169 Printing wiring diagrams

## 5. End

Close all the browsers opening MELSEC iQ-F Series Safety Extension Module Configuration Guide and execute 'stop.bat' which is included in the configuration guide installation folder.

A

# Screen configuration

The following explains the screen configuration when starting MELSEC iQ-F Series Safety Extension Module Configuration Guide.

## Window

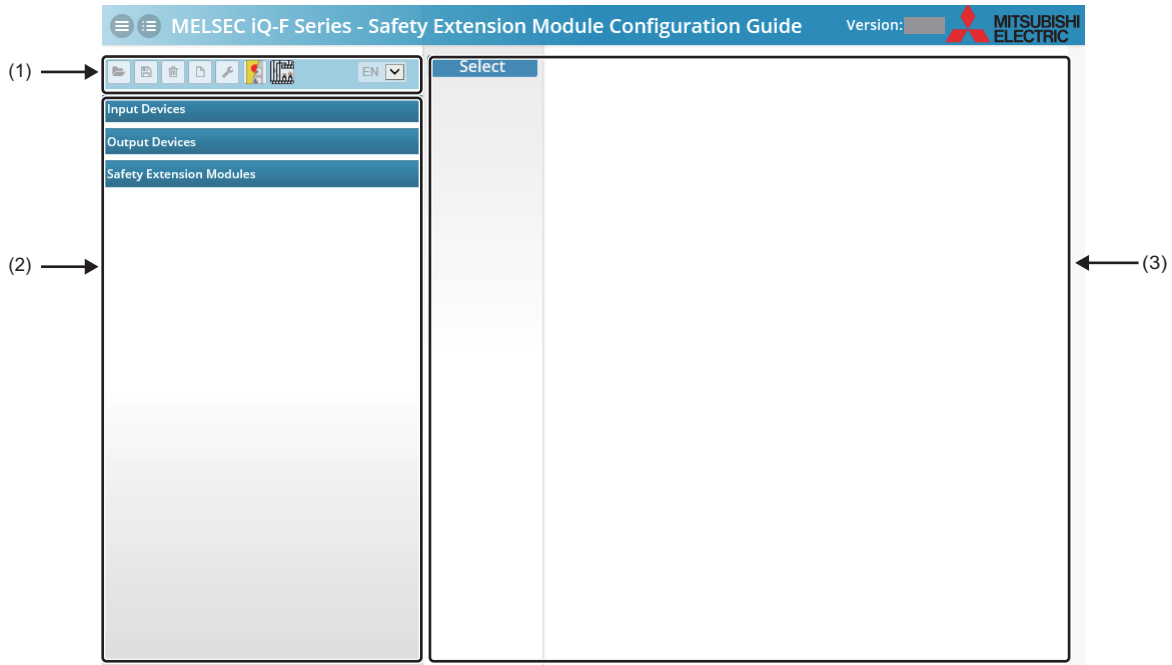

- (1) Toolbar
- (2) Menu
- (3) Module configuration area



## Toolbar

The following shows the screen configuration of the toolbar.

### Window

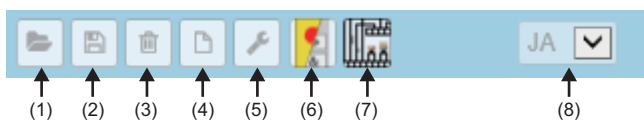

### Displayed items

No.	Item	Description
(1)		Open To open saved data.
(2)		Save To save set data.
(3)		Clear configuration To delete the open configuration.
(4)		Configuration To check and print the set configuration. For the detail screen, refer to the following: Page 160 Configuration screen
(5)		General input settings To set a restart interlock and an external device monitoring (EDM). The following shows the display example: (Example) When the program 1 is set for an FX5-SF-MU4T5  By clicking  (Setting), the setting screen of a restart interlock and an external device monitoring (EDM) are displayed.  +24 VDC
(6)		Logic To check logic of a selected program for each module.
(7)		Wiring To check the wiring of the set data. The wiring diagram can be printed. For the detail screen, refer to the following: Page 161 Wiring screen
(8)		Language selection To switch the displayed language among Japanese, English, or Simplified Chinese.

### Point

Configuration template files corresponding to each program are stored in the 'template' folder which is included in MELSEC iQ-F Series Safety Extension Module Configuration Guide.  
The template files can be opened from (Open) on the toolbar.

## Configuration screen

The following explains the configuration screen of MELSEC iQ-F Series Safety Extension Module Configuration Guide.

### Window

Click the  (Configuration) on the toolbar.

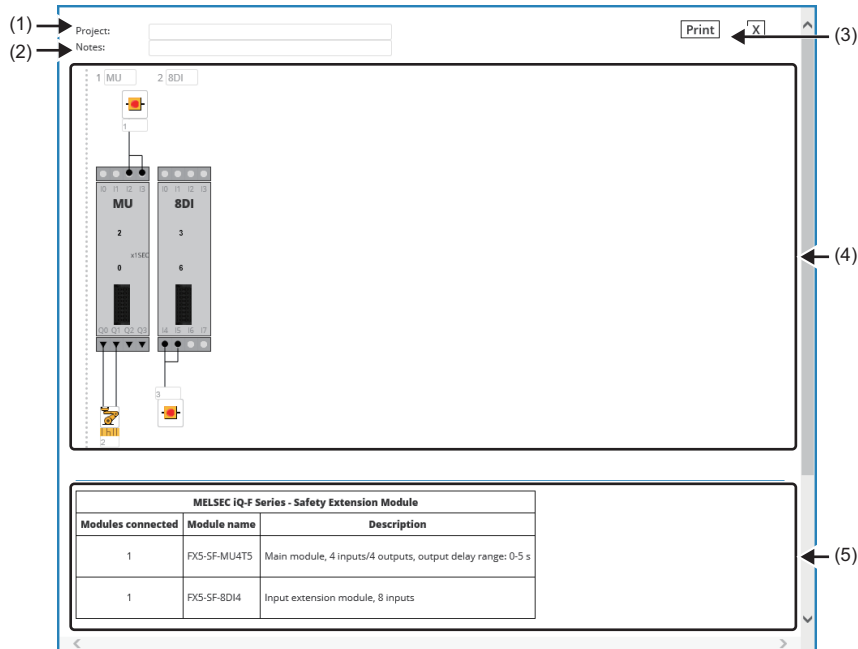

### Displayed items

No.	Item	Description
(1)	Project	To enter a project name.
(2)	Notes	To enter notes.
(3)	[Print] button	To display the print screen of a browser.
(4)	—	To display the created module configurations.
(5)	—	To display the details of a safety extension module placed in the module configuration area.

## Wiring screen

The following explains the wiring screen of MELSEC iQ-F Series Safety Extension Module Configuration Guide.

### Window

Click the  (Wiring) on the toolbar.

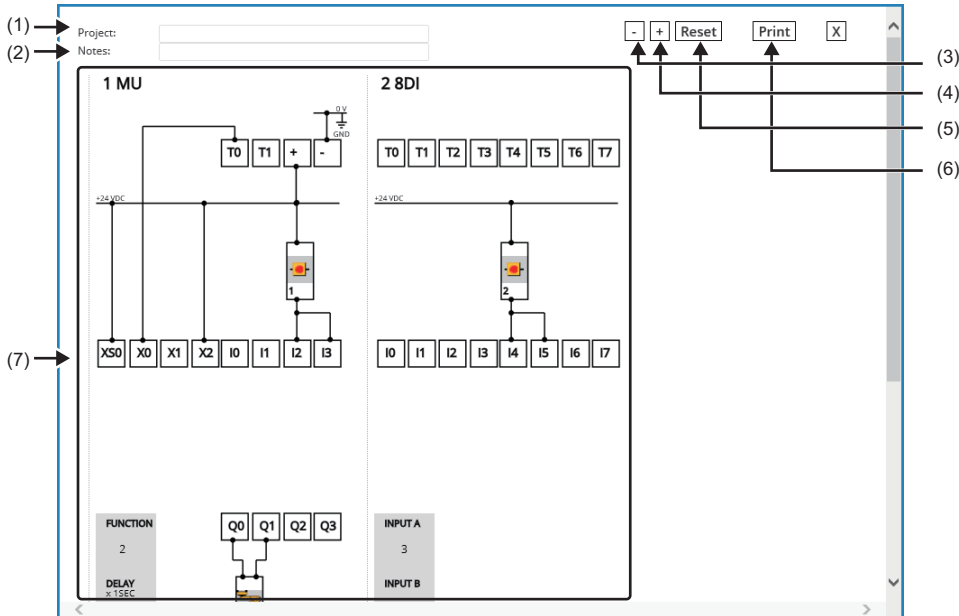

### Displayed items

No.	Item	Details
(1)	Project	To enter a project name.
(2)	Notes	To enter notes.
(3)	[ - ] button	To zoom out the display.
(4)	[ + ] button	To zoom in the display.
(5)	[Reset] button	To restore the display to its original size.
(6)	[Print] button	To display the print screen of a browser.
(7)	—	To display the wiring diagrams of created module configurations.

A

## Menu

The following explains the screen configuration of the menu.

### Window

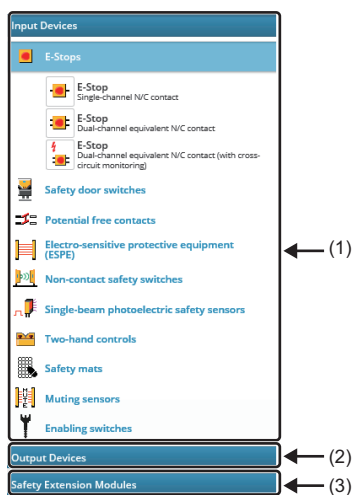

### Displayed items

No.	Item	Description
(1)	Input Devices	To display the list of input or output devices which can be connected to a safety extension module.
(2)	Output Devices	The device connection destination selection screen is displayed by clicking each device.
(3)	Safety Extension Modules	To place a selected safety extension module to the module configuration area.

## Module configuration area

The following explains the screen configuration of the module configuration area.

### Window

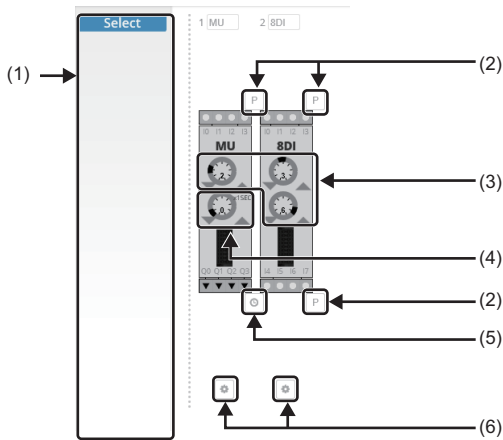

### Displayed items

No.	Item	Details
(1)	Select	To temporarily place a device may be connected to a safety extension module. The input or output devices whose "Select" is selected in the device connection destination selection screen are displayed.
(2)	<input type="checkbox"/> (FUNCTION details)	To check the program description of each rotary switch. The following shows the display example: (Example) When the program 2 is set for an FX5-SF-MU4T5. <div data-bbox="564 1099 884 1312" data-label="Image"> </div>
(3)	FUNCTION setting	To set a program number.
(4)	DELAY setting	To set a delay time.
(5)	<input type="radio"/> (DELAY details)	To set a delay time and retriggering*1. The following shows the display example: (Example) When the program 2 is set for an FX5-SF-MU4T5. <div data-bbox="564 1503 884 1715" data-label="Image"> </div>
(6)	<input type="checkbox"/> (Setting)	To change the connection order of a safety extension module by clicking the ← or → button. By clicking the  button, the safety extension module can be deleted from the module configuration area.

\*1 Retriggering is a function to disable off delay when an input is in the safe state while the off delay operates.

## Device connection destination selection screen

When clicking a device on the menu or in the module configuration area, the connection destination selection screen is displayed as shown below.

### Window

#### ■ When clicking a device on the menu

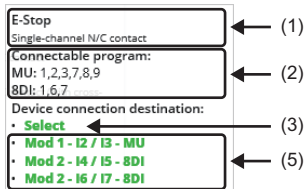

#### ■ When clicking a device in the module configuration area

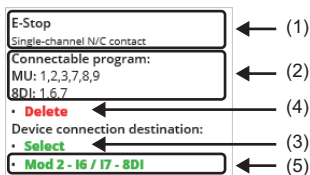

### Displayed items

No.	Item	Description
(1)	Device	To display a device type and its description.
(2)	Connectable program	To display program numbers that can be connected to a safety extension module.
(3)	Select	To register a device to the select area of the module configuration area.
(4)	Delete	To remove a device from the module configuration area.
(5)	Device connection destination	To display the terminal(s) of a safety extension module which can be connected to a device. By clicking a connection destination, the device can be connected to the terminal(s) of a safety extension module in the module configuration area. The connection destination(s) is/are displayed when a corresponding program that can connect the device is set in the safety extension module in the module configuration area.

# Operation

The following explains the basic operation of MELSEC iQ-F Series Safety Extension Module Configuration Guide.

**Ex.**

Set the following configurations.

Safety extension module	Program number (rotary switch setting)
FX5-SF-MU4T5	FUNCTION rotary switch: 2
FX5-SF-8DI4	INPUT A rotary switch: 3 INPUT B rotary switch: 6

## Adding a safety extension module to the module configuration area

The following shows the procedure for adding a safety extension module to the module configuration area.

### Operating procedure

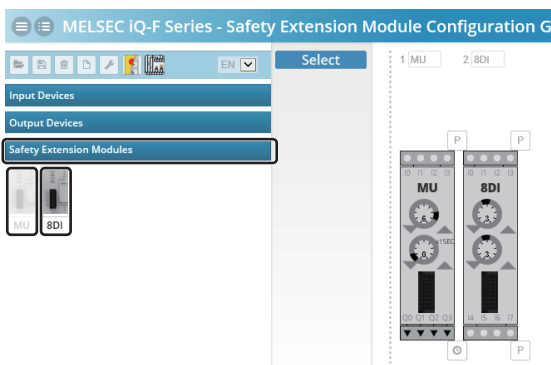

**1.** Select "Safety Extension Modules" in the menu.

**2.** Click "MU".

The FX5-SF-MU4T5 is displayed in the module configuration area.

**3.** Click "8DI".

The FX5-SF-8DI4 is displayed in the module configuration area.

## Changing a program number

The following shows the procedure for changing a program number of a safety extension module displayed in the module configuration area.

### Operating procedure

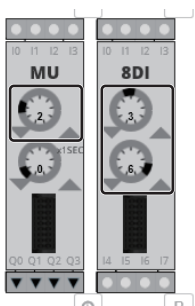

**1.** Set a program by clicking the FUNCTION setting of the safety extension module.

**A**

## Connecting an input device to input terminals of the safety extension module

The following shows the procedure for connecting an input device to a safety extension module displayed in the module configuration area.

### Operating procedure

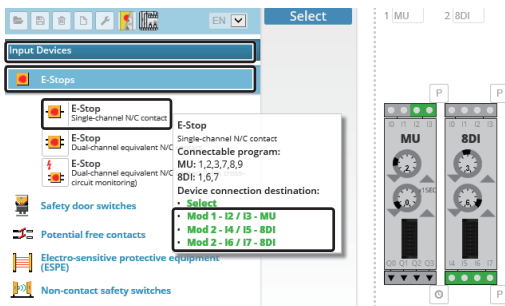

1. Click "Input Devices" on the menu and select a device from the list.

The device connection destination selection screen is displayed.

2. Select an arbitrary terminal(s) from the device connection destination.

The selected input device connected to the safety extension module is displayed.

## Connecting an output device to output terminals of the safety extension module

The following shows the procedure for connecting an output device to a safety extension module displayed in the module configuration area.

### Operating procedure

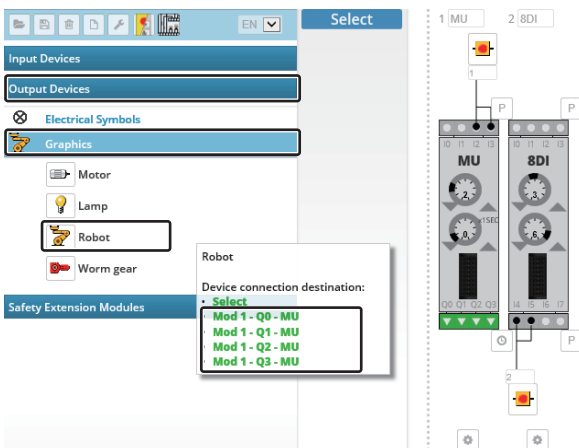

1. Click "Output Devices" on the menu and select a device from the list.

The device connection destination selection screen is displayed.

2. Select an arbitrary terminal(s) from the device connection destination.

The selected output device connected to the safety extension module is displayed.



## Editing a device connected to the safety extension module

The following shows the procedure for changing the placement of a device connected to the safety extension module and removing the device from the module.

### ■When changing a device placement

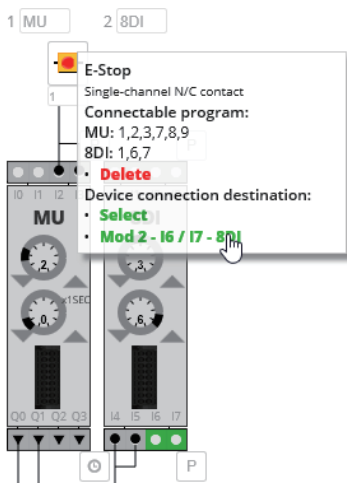

1. Click a device to change a placement in the module configuration area.
2. Select an arbitrary terminal(s) from the device connection destination in the device connection destination selection screen.

### ■When removing a device

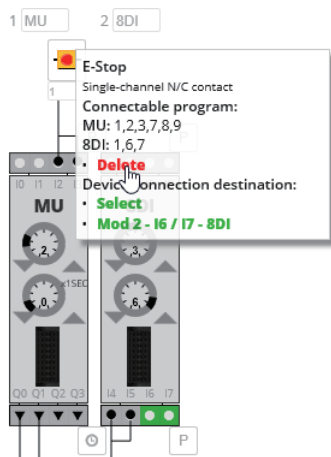

1. Click a device to be removed in the module configuration area.

The device connection destination selection screen is displayed.

2. Select "Delete".

A

## Printing a module configuration

The following shows the procedure for printing a module configuration.

### Operating procedure



1. Click the  (Configuration) on the toolbar.  
The configuration screen is displayed.

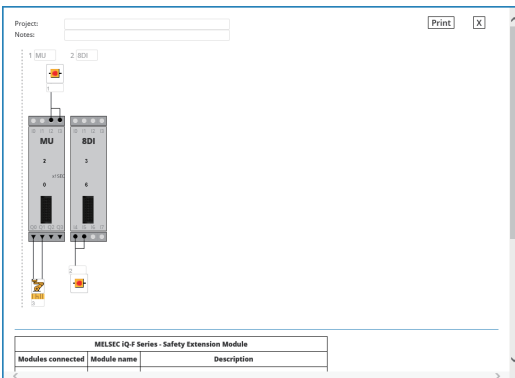

2. Click the [Print] button.  
The print screen of the browser is displayed.
3. Click the [Print] button.

## Setting a restart interlock and EDM

The following shows the procedure for setting a restart interlock and EDM.

### Operating procedure



1. Click the  (General input settings) on the toolbar.  
General input settings are displayed in the module configuration area.

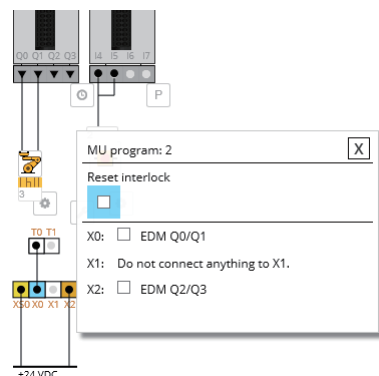

2. Click the  (Setting).  
The setting screen of a restart interlock and an external device monitoring (EDM) are displayed.
3. Set a restart interlock and EDM.

## Printing wiring diagrams

The following shows the procedure for displaying and printing the wiring diagram of the created module diagram.

### Operating procedure



1. Click the  (Wiring) on the toolbar.  
Wiring diagrams are displayed.

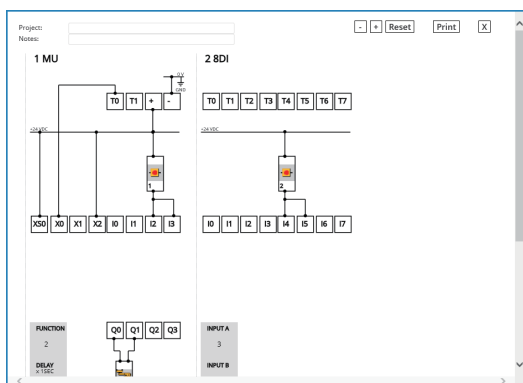

2. Click the [Print] button.  
The print screen of the browser is displayed.
3. Click the [Print] button.

# Troubleshooting

The following shows the corrective actions when MELSEC iQ-F Series Safety Extension Module Configuration Guide does not operate normally.

## Version 1.01B or later

### ■When the configuration guide does not start normally on Google Chrome (1)

Reload the browser by pressing the **[F5]** key when the activated MELSEC iQ-F Series Safety Extension Module Configuration Guide is not displayed properly on Google Chrome.

### ■When the configuration guide does not start normally on Google Chrome (2)

Make sure that the storage destination folder of MELSEC iQ-F Series Safety Extension Module Configuration Guide does not include Japanese (Unicode characters) in its folder path when MELSEC iQ-F Series Safety Extension Module Configuration Guide is not displayed on Google Chrome.

## Version 1.00A

### ■When the configuration guide does not start normally on Internet Explorer 11 (1)

Perform the following procedure when MELSEC iQ-F Series Safety Extension Module Configuration Guide does not start normally on Internet Explorer 11.

1. Start Windows Explorer and open the folder where MELSEC iQ-F Series Safety Extension Module Configuration Guide is stored.
2. Right-click 'START.html' and select [Properties] from the shortcut menu.
3. Open the [General] tab of the property screen.
4. Click the [Unblock] button in "Security".\*1
5. Click the [OK] button.
6. Execute 'START.html' again.\*2

\*1 The "Security" section may not be displayed depending on the usage environment.

\*2 When the message "Internet Explorer restricted this webpage from running scripts or ActiveX controls." is displayed in the lower side of the screen at the Internet Explorer 11 startup, click the [Allow blocked content] button.

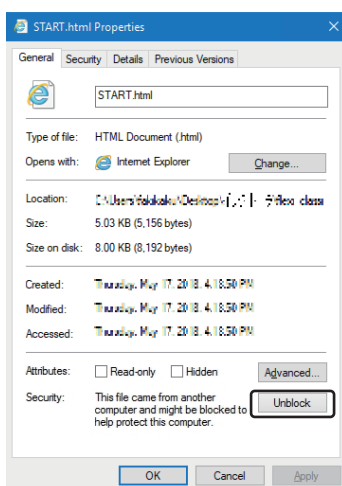

## ■When the configuration guide does not start normally on Internet Explorer 11 (2)

Perform the following operation when the activated MELSEC iQ-F Series Safety Extension Module Configuration Guide is not displayed properly on Internet Explorer 11.

1. Click the  (Tools) of Internet Explorer 11.
2. Select [Compatibility View settings] from the displayed menu.
3. Unselect the checkbox of "Display intranet sites in Compatibility View" in the "Compatibility View Settings" screen.
4. Click the [Close] button.
5. Execute 'START.html' again.\*1

\*1 When the message "Internet Explorer restricted this webpage from running scripts or ActiveX controls." is displayed in the lower side of the screen at the Internet Explorer 11 startup, click the [Allow blocked content] button.

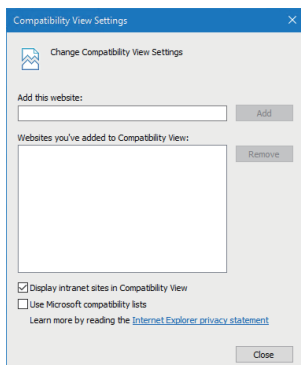

# Appendix 7 Software Licenses and Copyrights

This section describes the licenses and copyrights of software used in MELSEC iQ-F Series Safety Extension Module Configuration Guide.

## Ngix 1.21.6

Copyright © 2002-2021 Igor Sysoev

Copyright © 2011-2021 Ngix, Inc.

All rights reserved.

Redistribution and use in source and binary forms, with or without modification, are permitted provided that the following conditions are met:

1. Redistributions of source code must retain the above copyright notice, this list of conditions and the following disclaimer.
2. Redistributions in binary form must reproduce the above copyright notice, this list of conditions and the following disclaimer in the documentation and/or other materials provided with the distribution.

THIS SOFTWARE IS PROVIDED BY THE AUTHOR AND CONTRIBUTORS "AS IS" AND ANY EXPRESS OR IMPLIED WARRANTIES, INCLUDING, BUT NOT LIMITED TO, THE IMPLIED WARRANTIES OF MERCHANTABILITY AND FITNESS FOR A PARTICULAR PURPOSE ARE DISCLAIMED. IN NO EVENT SHALL THE AUTHOR OR CONTRIBUTORS BE LIABLE FOR ANY DIRECT, INDIRECT, INCIDENTAL, SPECIAL, EXEMPLARY, OR CONSEQUENTIAL DAMAGES (INCLUDING, BUT NOT LIMITED TO, PROCUREMENT OF SUBSTITUTE GOODS OR SERVICES; LOSS OF USE, DATA, OR PROFITS; OR BUSINESS INTERRUPTION) HOWEVER CAUSED AND ON ANY THEORY OF LIABILITY, WHETHER IN CONTRACT, STRICT LIABILITY, OR TORT (INCLUDING NEGLIGENCE OR OTHERWISE) ARISING IN ANY WAY OUT OF THE USE OF THIS SOFTWARE, EVEN IF ADVISED OF THE POSSIBILITY OF SUCH DAMAGE.

## OpenSSL 1.1.1

Copyright

Copyright© 1995-1998 Eric Young (eay@cryptsoft.com) All rights reserved.

This product includes cryptographic software written by Eric Young (eay@cryptsoft.com)

This Windows version of this product includes software written by Tim Hudson (tjh@cryptsoft.com)

### LICENSE ISSUES

The OpenSSL toolkit stays under a dual license, i.e. both the conditions of the OpenSSL License and the original SSLeay license apply to the toolkit. See below for the actual license texts.

### OpenSSL License

Copyright© 1998-2019 The OpenSSL Project. All rights reserved.

Redistribution and use in source and binary forms, with or without modification, are permitted provided that the following conditions are met:

1. Redistributions of source code must retain the above copyright notice, this list of conditions and the following disclaimer.
2. Redistributions in binary form must reproduce the above copyright notice, this list of conditions and the following disclaimer in the documentation and/or other materials provided with the distribution.
3. All advertising materials mentioning features or use of this software must display the following acknowledgment:  
"This product includes software developed by the OpenSSL Project for use in the OpenSSL Toolkit. (<http://www.openssl.org/>)"
4. The names "OpenSSL Toolkit" and "OpenSSL Project" must not be used to endorse or promote products derived from this software without prior written permission. For written permission, please contact [openssl-core@openssl.org](mailto:openssl-core@openssl.org).
5. Products derived from this software may not be called "OpenSSL" nor may "OpenSSL" appear in their names without prior written permission of the OpenSSL Project.
6. Redistributions of any form whatsoever must retain the following acknowledgment:  
"This product includes software developed by the OpenSSL Project for use in the OpenSSL Toolkit (<http://www.openssl.org/>)"

THIS SOFTWARE IS PROVIDED BY THE OpenSSL PROJECT "AS IS" AND ANY EXPRESSED OR IMPLIED WARRANTIES, INCLUDING, BUT NOT LIMITED TO, THE IMPLIED WARRANTIES OF MERCHANTABILITY AND FITNESS FOR A PARTICULAR PURPOSE ARE DISCLAIMED. IN NO EVENT SHALL THE OpenSSL PROJECT OR ITS CONTRIBUTORS BE LIABLE FOR ANY DIRECT, INDIRECT, INCIDENTAL, SPECIAL, EXEMPLARY, OR CONSEQUENTIAL DAMAGES (INCLUDING, BUT NOT LIMITED TO, PROCUREMENT OF SUBSTITUTE GOODS OR SERVICES; LOSS OF USE, DATA, OR PROFITS; OR BUSINESS INTERRUPTION) HOWEVER CAUSED AND ON ANY THEORY OF LIABILITY, WHETHER IN CONTRACT, STRICT LIABILITY, OR TORT (INCLUDING NEGLIGENCE OR OTHERWISE) ARISING IN ANY WAY OUT OF THE USE OF THIS SOFTWARE, EVEN IF ADVISED OF THE POSSIBILITY OF SUCH DAMAGE.

This product includes cryptographic software written by Eric Young (eay@cryptsoft.com). This product includes software written by Tim Hudson (tjh@cryptsoft.com).

### Original SSLeay License

Copyright© 1995-1998 Eric Young (eay@cryptsoft.com). All rights reserved.

This package is an SSL implementation written by Eric Young (eay@cryptsoft.com).  
The implementation was written so as to conform with Netscapes SSL.

This library is free for commercial and non-commercial use as long as the following conditions are adhered to. The following conditions apply to all code found in this distribution, be it the RC4, RSA, lhash, DES, etc., code; not just the SSL code. The SSL documentation included with this distribution is covered by the same copyright terms except that the holder is Tim Hudson (tjh@cryptsoft.com).

Copyright remains Eric Young's, and as such any Copyright notices in the code are not to be removed.

If this package is used in a product, Eric Young should be given attribution as the author of the parts of the library used. This can be in the form of a textual message at program startup or in documentation (online or textual) provided with the package.

Redistribution and use in source and binary forms, with or without modification, are permitted provided that the following conditions are met:

1. Redistributions of source code must retain the copyright notice, this list of conditions and the following disclaimer.
2. Redistributions in binary form must reproduce the above copyright notice, this list of conditions and the following disclaimer in the documentation and/or other materials provided with the distribution.
3. All advertising materials mentioning features or use of this software must display the following acknowledgement:

"This product includes cryptographic software written by Eric Young (eay@cryptsoft.com)" The word 'cryptographic' can be left out if the routines from the library being used are not cryptographic related.

4. If you include any Windows specific code (or a derivative thereof) from the apps directory (application code) you must include an acknowledgement:

"This product includes software written by Tim Hudson (tjh@cryptsoft.com)".

THIS SOFTWARE IS PROVIDED BY ERIC YOUNG "AS IS" AND ANY EXPRESS OR IMPLIED WARRANTIES, INCLUDING, BUT NOT LIMITED TO, THE IMPLIED WARRANTIES OF MERCHANTABILITY AND FITNESS FOR A PARTICULAR PURPOSE ARE DISCLAIMED. IN NO EVENT SHALL THE AUTHOR OR CONTRIBUTORS BE LIABLE FOR ANY DIRECT, INDIRECT, INCIDENTAL, SPECIAL, EXEMPLARY, OR CONSEQUENTIAL DAMAGES (INCLUDING, BUT NOT LIMITED TO, PROCUREMENT OF SUBSTITUTE GOODS OR SERVICES; LOSS OF USE, DATA, OR PROFITS; OR BUSINESS INTERRUPTION) HOWEVER CAUSED AND ON ANY THEORY OF LIABILITY, WHETHER IN CONTRACT, STRICT LIABILITY, OR TORT (INCLUDING NEGLIGENCE OR OTHERWISE) ARISING IN ANY WAY OUT OF THE USE OF THIS SOFTWARE, EVEN IF ADVISED OF THE POSSIBILITY OF SUCH DAMAGE.

The license and distribution terms for any publically available version or derivative of this code cannot be changed. i.e. this code cannot simply be copied and put under another distribution license [including the GNU Public License.]

## PCRE2 10.39

PCRE2 is a library of functions to support regular expressions whose syntax and semantics are as close as possible to those of the Perl 5 language.

Releases 10.00 and above of PCRE2 are distributed under the terms of the "BSD" licence, as specified below, with one exemption for certain binary redistributions. The documentation for PCRE2, supplied in the "doc" directory, is distributed under the same terms as the software itself. The data in the testdata directory is not copyrighted and is in the public domain.

The basic library functions are written in C and are freestanding. Also included in the distribution is a just-in-time compiler that can be used to optimize pattern matching. This is an optional feature that can be omitted when the library is built.

### THE BASIC LIBRARY FUNCTIONS

Written by: Philip Hazel  
Email local part: Philip.Hazel  
Email domain: gmail.com

Retired from University of Cambridge Computing Service,  
Cambridge, England.

Copyright © 1997-2021 University of Cambridge  
All rights reserved.

### PCRE2 JUST-IN-TIME COMPILATION SUPPORT

Written by: Zoltan Herczeg  
Email local part: hzmester  
Email domain: freemail.hu

Copyright © 2010-2021 Zoltan Herczeg  
All rights reserved.

## STACK-LESS JUST-IN-TIME COMPILER

---

Written by: Zoltan Herczeg  
Email local part: hzmester  
Email domain: freemail.hu

Copyright© 2009-2021 Zoltan Herczeg  
All rights reserved.

## THE "BSD" LICENCE

---

Redistribution and use in source and binary forms, with or without modification, are permitted provided that the following conditions are met:

- \* Redistributions of source code must retain the above copyright notices, this list of conditions and the following disclaimer.
- \* Redistributions in binary form must reproduce the above copyright notices, this list of conditions and the following disclaimer in the documentation and/or other materials provided with the distribution.
- \* Neither the name of the University of Cambridge nor the names of any contributors may be used to endorse or promote products derived from this software without specific prior written permission.

THIS SOFTWARE IS PROVIDED BY THE COPYRIGHT HOLDERS AND CONTRIBUTORS "AS IS" AND ANY EXPRESS OR IMPLIED WARRANTIES, INCLUDING, BUT NOT LIMITED TO, THE IMPLIED WARRANTIES OF MERCHANTABILITY AND FITNESS FOR A PARTICULAR PURPOSE ARE DISCLAIMED. IN NO EVENT SHALL THE COPYRIGHT OWNER OR CONTRIBUTORS BE LIABLE FOR ANY DIRECT, INDIRECT, INCIDENTAL, SPECIAL, EXEMPLARY, OR CONSEQUENTIAL DAMAGES (INCLUDING, BUT NOT LIMITED TO, PROCUREMENT OF SUBSTITUTE GOODS OR SERVICES; LOSS OF USE, DATA, OR PROFITS; OR BUSINESS INTERRUPTION) HOWEVER CAUSED AND ON ANY THEORY OF LIABILITY, WHETHER IN CONTRACT, STRICT LIABILITY, OR TORT (INCLUDING NEGLIGENCE OR OTHERWISE) ARISING IN ANY WAY OUT OF THE USE OF THIS SOFTWARE, EVEN IF ADVISED OF THE POSSIBILITY OF SUCH DAMAGE.

## EXEMPTION FOR BINARY LIBRARY-LIKE PACKAGES

---

The second condition in the BSD licence (covering binary redistributions) does not apply all the way down a chain of software. If binary package A includes PCRE2, it must respect the condition, but if package B is software that includes package A, the condition is not imposed on package B unless it uses PCRE2 independently.

## **zlib 1.2.11**

© 1995-2017 Jean-loup Gailly and Mark Adler

This software is provided 'as-is', without any express or implied warranty. In no event will the authors be held liable for any damages arising from the use of this software.

Permission is granted to anyone to use this software for any purpose, including commercial applications, and to alter it and redistribute it freely, subject to the following restrictions:

1. The origin of this software must not be misrepresented; you must not claim that you wrote the original software. If you use this software in a product, an acknowledgment in the product documentation would be appreciated but is not required.
2. Altered source versions must be plainly marked as such, and must not be misrepresented as being the original software.
3. This notice may not be removed or altered from any source distribution.

Jean-loup Gailly    Mark Adler  
jloup@gzip.org    madler@alumni.caltech.edu



## Font Awesome 3.0.2

The Font Awesome font is licensed under the SIL Open Font License - <http://scripts.sil.org/OFL>

Font Awesome CSS, LESS, and SASS files are licensed under the MIT License - <http://opensource.org/licenses/mit-license.html>

The Font Awesome pictograms are licensed under the CC BY 3.0 License -

<http://creativecommons.org/licenses/by/3.0/>

Attribution is no longer required in Font Awesome 3.0, but much appreciated:

"Font Awesome by Dave Gandy - <http://fontawesome.github.com/Font-Awesome/>"

## jQuery UI 1.9.2

Copyright 2012 jQuery Foundation and other contributors,

<http://jqueryui.com/>

This software consists of voluntary contributions made by many individuals (AUTHORS.txt, <http://jqueryui.com/about>) For exact contribution history, see the revision history and logs, available at <http://jquery-ui.googlecode.com/svn/>

Permission is hereby granted, free of charge, to any person obtaining a copy of this software and associated documentation files (the "Software"), to deal in the Software without restriction, including without limitation the rights to use, copy, modify, merge, publish, distribute, sublicense, and/or sell copies of the Software, and to permit persons to whom the Software is furnished to do so, subject to the following conditions:

The above copyright notice and this permission notice shall be included in all copies or substantial portions of the Software.

THE SOFTWARE IS PROVIDED "AS IS", WITHOUT WARRANTY OF ANY KIND, EXPRESS OR IMPLIED, INCLUDING BUT NOT LIMITED TO THE WARRANTIES OF MERCHANTABILITY, FITNESS FOR A PARTICULAR PURPOSE AND NONINFRINGEMENT. IN NO EVENT SHALL THE AUTHORS OR COPYRIGHT HOLDERS BE LIABLE FOR ANY CLAIM, DAMAGES OR OTHER LIABILITY, WHETHER IN AN ACTION OF CONTRACT, TORT OR OTHERWISE, ARISING FROM, OUT OF OR IN CONNECTION WITH THE SOFTWARE OR THE USE OR OTHER DEALINGS IN THE SOFTWARE.

## canvas-toBlob.js 1.0.0

This software is licensed under the MIT license.

MIT license

Copyright © 2016 Eli Grey and Devin Samarin.

Permission is hereby granted, free of charge, to any person obtaining a copy of this software and associated documentation files (the "Software"), to deal in the Software without restriction, including without limitation the rights to use, copy, modify, merge, publish, distribute, sublicense, and/or sell copies of the Software, and to permit persons to whom the Software is furnished to do so, subject to the following conditions:

The above copyright notice and this permission notice shall be included in all copies or substantial portions of the Software.

THE SOFTWARE IS PROVIDED "AS IS", WITHOUT WARRANTY OF ANY KIND, EXPRESS OR IMPLIED, INCLUDING BUT NOT LIMITED TO THE WARRANTIES OF MERCHANTABILITY, FITNESS FOR A PARTICULAR PURPOSE AND NONINFRINGEMENT. IN NO EVENT SHALL THE AUTHORS OR COPYRIGHT HOLDERS BE LIABLE FOR ANY CLAIM, DAMAGES OR OTHER LIABILITY, WHETHER IN AN ACTION OF CONTRACT, TORT OR OTHERWISE, ARISING FROM, OUT OF OR IN CONNECTION WITH THE SOFTWARE OR THE USE OR OTHER DEALINGS IN THE SOFTWARE.

## FileSaver.js 1.0.0

The MIT License

Copyright © 2016 Eli Grey.

Permission is hereby granted, free of charge, to any person obtaining a copy of this software and associated documentation files (the "Software"), to deal in the Software without restriction, including without limitation the rights to use, copy, modify, merge, publish, distribute, sublicense, and/or sell copies of the Software, and to permit persons to whom the Software is furnished to do so, subject to the following conditions:

The above copyright notice and this permission notice shall be included in all copies or substantial portions of the Software.

THE SOFTWARE IS PROVIDED "AS IS", WITHOUT WARRANTY OF ANY KIND, EXPRESS OR IMPLIED, INCLUDING BUT NOT LIMITED TO THE WARRANTIES OF MERCHANTABILITY, FITNESS FOR A PARTICULAR PURPOSE AND NONINFRINGEMENT. IN NO EVENT SHALL THE AUTHORS OR COPYRIGHT HOLDERS BE LIABLE FOR ANY CLAIM, DAMAGES OR OTHER LIABILITY, WHETHER IN AN ACTION OF CONTRACT, TORT OR OTHERWISE, ARISING FROM, OUT OF OR IN CONNECTION WITH THE SOFTWARE OR THE USE OR OTHER DEALINGS IN THE SOFTWARE.

## html2canvas 1.0.0

Copyright © 2012 Niklas von Herten

Permission is hereby granted, free of charge, to any person obtaining a copy of this software and associated documentation files (the "Software"), to deal in the Software without restriction, including without limitation the rights to use, copy, modify, merge, publish, distribute, sublicense, and/or sell copies of the Software, and to permit persons to whom the Software is furnished to do so, subject to the following conditions:

The above copyright notice and this permission notice shall be included in all copies or substantial portions of the Software.

THE SOFTWARE IS PROVIDED "AS IS", WITHOUT WARRANTY OF ANY KIND, EXPRESS OR IMPLIED, INCLUDING BUT NOT LIMITED TO THE WARRANTIES OF MERCHANTABILITY, FITNESS FOR A PARTICULAR PURPOSE AND NONINFRINGEMENT. IN NO EVENT SHALL THE AUTHORS OR COPYRIGHT HOLDERS BE LIABLE FOR ANY CLAIM, DAMAGES OR OTHER LIABILITY, WHETHER IN AN ACTION OF CONTRACT, TORT OR OTHERWISE, ARISING FROM, OUT OF OR IN CONNECTION WITH THE SOFTWARE OR THE USE OR OTHER DEALINGS IN THE SOFTWARE.

## Knob 1.1.2

The MIT License (MIT)

Copyright © 2013 Anthony Terrien

Permission is hereby granted, free of charge, to any person obtaining a copy of this software and associated documentation files (the "Software"), to deal in the Software without restriction, including without limitation the rights to use, copy, modify, merge, publish, distribute, sublicense, and/or sell copies of the Software, and to permit persons to whom the Software is furnished to do so, subject to the following conditions:

The above copyright notice and this permission notice shall be included in all copies or substantial portions of the Software.

THE SOFTWARE IS PROVIDED "AS IS", WITHOUT WARRANTY OF ANY KIND, EXPRESS OR IMPLIED, INCLUDING BUT NOT LIMITED TO THE WARRANTIES OF MERCHANTABILITY, FITNESS FOR A PARTICULAR PURPOSE AND NONINFRINGEMENT. IN NO EVENT SHALL THE AUTHORS OR COPYRIGHT HOLDERS BE LIABLE FOR ANY CLAIM, DAMAGES OR OTHER LIABILITY, WHETHER IN AN ACTION OF CONTRACT, TORT OR OTHERWISE, ARISING FROM, OUT OF OR IN CONNECTION WITH THE SOFTWARE OR THE USE OR OTHER DEALINGS IN THE SOFTWARE.

## jquery.finger 0.1.2

Copyright © 2013 "ngryman" Nicolas Gryman

Permission is hereby granted, free of charge, to any person obtaining a copy of this software and associated documentation files (the "Software"), to deal in the Software without restriction, including without limitation the rights to use, copy, modify, merge, publish, distribute, sublicense, and/or sell copies of the Software, and to permit persons to whom the Software is furnished to do so, subject to the following conditions:

The above copyright notice and this permission notice shall be included in all copies or substantial portions of the Software.

THE SOFTWARE IS PROVIDED "AS IS", WITHOUT WARRANTY OF ANY KIND, EXPRESS OR IMPLIED, INCLUDING BUT NOT LIMITED TO THE WARRANTIES OF MERCHANTABILITY, FITNESS FOR A PARTICULAR PURPOSE AND NONINFRINGEMENT. IN NO EVENT SHALL THE AUTHORS OR COPYRIGHT HOLDERS BE LIABLE FOR ANY CLAIM, DAMAGES OR OTHER LIABILITY, WHETHER IN AN ACTION OF CONTRACT, TORT OR OTHERWISE, ARISING FROM, OUT OF OR IN CONNECTION WITH THE SOFTWARE OR THE USE OR OTHER DEALINGS IN THE SOFTWARE.

## Tempo Template Engine 2.0.0

Copyright 2016 Twigkit

Licensed under the Apache License, Version 2.0 (the "License"); you may not use this file except in compliance with the License. You may obtain a copy of the License at

<http://www.apache.org/licenses/LICENSE-2.0>

Unless required by applicable law or agreed to in writing, software distributed under the License is distributed on an "AS IS" BASIS, WITHOUT WARRANTIES OR CONDITIONS OF ANY KIND, either express or implied.

See the License for the specific language governing permissions and limitations under the License.

# MEMO

---

A

# INDEX

---

## A

---

AND Function . . . . . 71

## B

---

Built-In Program Selection Function . . . . . 39

Bypass . . . . . 76

## E

---

ENABLE Input (XS0 Terminal) . . . . . 80

Error History . . . . . 82

External Device Monitoring (EDM) . . . . . 78

## J

---

Jog Mode . . . . . 81

## M

---

Muting Function . . . . . 69

## O

---

Off Delay Delay Setting Function . . . . . 67

OR Function . . . . . 74

## P

---

Performance level . . . . . 27

## R

---

Restart Interlock . . . . . 77

Retriggering of the Delayed OSSDs . . . . . 79

## S

---

Safety extension module . . . . . 25

Safety Information Monitoring Function . . . . . 85

## T

---

Two-Hand Operation . . . . . 81

# MEMO

---

# REVISIONS

\*The manual number is given on the bottom left of the back cover.

Revision date	*Manual number	Description
October 2019	SH(NA)-082078ENG-A	First edition
April 2021	SH(NA)-082078ENG-B	■Added or modified parts Section 2.1, Section 2.2, Section 2.4, Section 4.2, Section 4.5, Section 4.6, Chapter 5, Section 6.2, Section 6.4, Section 8.3
October 2021	SH(NA)-082078ENG-C	■Added or modified parts Chapter 3, Chapter 5, Section 10.3, Section 10.4
September 2022	SH(NA)-082078ENG-D	■Added or modified parts SAFETY PRECAUTIONS, RELEVANT MANUALS, Section 2.1, Section 2.2, Chapter 3, Section 6.4, Section 8.2, Section 9.1, Section 9.2, Appendix 2
February 2023	SH(NA)-082078ENG-E	■Added or modified parts Appendix 6, Appendix 7
September 2023	SH(NA)-082078ENG-F	■Added or modified part Manual name (old manual name 'MELSEC iQ-F FX5 User's Manual (Safety Control)') PRECAUTIONS REGARDING WARRANTY, RELEVANT MANUALS, Appendix 2, WARRANTY

Japanese manual number: SH-082077-F

This manual confers no industrial property rights or any rights of any other kind, nor does it confer any patent licenses. Mitsubishi Electric Corporation cannot be held responsible for any problems involving industrial property rights which may occur as a result of using the contents noted in this manual.

© 2019 MITSUBISHI ELECTRIC CORPORATION

# WARRANTY

Please confirm the following product warranty details before using this product.

## 1. Gratis Warranty Term and Gratis Warranty Range

If any faults or defects (hereinafter "Failure") found to be the responsibility of Mitsubishi occurs during use of the product within the gratis warranty term, the product shall be repaired at no cost via the sales representative or Mitsubishi Service Company. However, if repairs are required onsite at domestic or overseas location, expenses to send an engineer will be solely at the customer's discretion. Mitsubishi shall not be held responsible for any re-commissioning, maintenance, or testing on-site that involves replacement of the failed module.

### [Gratis Warranty Term]

The gratis warranty term of the product shall be for one year after the date of purchase or delivery to a designated place. Note that the gratis warranty term of repair parts shall not exceed the gratis warranty term before repairs.

### [Gratis Warranty Range]

- (1) The range shall be limited to normal use within the usage state, usage methods and usage environment, etc., which follow the conditions and precautions, etc., given in the instruction manual, user's manual and caution labels on the product.
- (2) Even within the gratis warranty term, repairs shall be charged for in the following cases.
  1. Failure occurring from inappropriate storage or handling, carelessness or negligence by the user. Failure caused by the user's hardware or software design.
  2. Failure caused by unapproved modifications, etc., to the product by the user.
  3. When the Mitsubishi product is assembled into a user's device, Failure that could have been avoided if functions or structures, judged as necessary in the legal safety measures the user's device is subject to or as necessary by industry standards, had been provided.
  4. Failure that could have been avoided if consumable parts (battery, backlight, fuse, etc.) designated in the instruction manual had been correctly serviced or replaced.
  5. Relay failure or output contact failure caused by usage beyond the specified life of contact (cycles).
  6. Failure caused by external irresistible forces such as fires or abnormal voltages, and failure caused by force majeure such as earthquakes, lightning, wind and water damage.
  7. Failure caused by reasons unpredictable by scientific technology standards at time of shipment from Mitsubishi.
  8. Any other failure found not to be the responsibility of Mitsubishi or that admitted not to be so by the user.

## 2. Onerous repair term after discontinuation of production

- (1) Mitsubishi shall accept onerous product repairs for seven (7) years after production of the product is discontinued.  
Discontinuation of production shall be notified with Mitsubishi Technical Bulletins, etc.
- (2) Product supply (including repair parts) is not available after production is discontinued.

## 3. Overseas service

Overseas, repairs shall be accepted by Mitsubishi's local overseas FA Center. Note that the repair conditions at each FA Center may differ.

## 4. Exclusion of loss in opportunity and secondary loss from warranty liability

Regardless of the gratis warranty term, Mitsubishi shall not be liable for compensation to:

- (1) Damages caused by any cause found not to be the responsibility of Mitsubishi.
- (2) Loss in opportunity, lost profits incurred to the user by Failures of Mitsubishi products.
- (3) Special damages and secondary damages whether foreseeable or not, compensation for accidents, and compensation for damages to products other than Mitsubishi products.
- (4) Replacement by the user, maintenance of on-site equipment, start-up test run and other tasks.

## 5. Changes in product specifications

The specifications given in the catalogs, manuals or technical documents are subject to change without prior notice.

## 6. Product application

- (1) In using the Mitsubishi MELSEC programmable controller, the usage conditions shall be that the application will not lead to a major accident even if any problem or fault should occur in the programmable controller device, and that backup and fail-safe functions are systematically provided outside of the device for any problem or fault.
- (2) The Mitsubishi programmable controller has been designed and manufactured for applications in general industries, etc. Thus, applications in which the public could be affected such as in nuclear power plants and other power plants operated by respective power companies, and applications in which a special quality assurance system is required, such as for railway companies or public service purposes shall be excluded from the programmable controller applications.  
In addition, applications in which human life or property that could be greatly affected, such as in aircraft, medical applications, incineration and fuel devices, manned transportation, equipment for recreation and amusement, and safety devices, shall also be excluded from the programmable controller range of applications.  
However, in certain cases, some applications may be possible, providing the user consults their local Mitsubishi representative outlining the special requirements of the project, and providing that all parties concerned agree to the special circumstances, solely at the user's discretion.

# TRADEMARKS

---

The company names, system names and product names mentioned in this manual are either registered trademarks or trademarks of their respective companies.

In some cases, trademark symbols such as <sup>™</sup> or <sup>®</sup> are not specified in the manual.

# COPYRIGHTS

---

For the open source software used in this product, refer to the following:

 Page 172 Software Licenses and Copyrights





**SICK** SICK AG Tel. +49 7681 202-0 [www.sick.com](http://www.sick.com)

Manual number: SH(NA)-082078ENG-F(2309)KWIX

MODEL: FX5-U-SF-E

MODEL CODE: 09R576

## **MITSUBISHI ELECTRIC CORPORATION**

HEAD OFFICE: TOKYO BLDG., 2-7-3, MARUNOUCHI, CHIYODA-KU, TOKYO 100-8310, JAPAN  
NAGOYA WORKS: 1-14, YADA-MINAMI 5-CHOME, HIGASHI-KU, NAGOYA 461-8670, JAPAN

When exported from Japan, this manual does not require application to the  
Ministry of Economy, Trade and Industry for service transaction permission.

Specifications subject to change without notice.