



Programmable Controller

MELSEC iQ-F
series

**MELSEC iQ-F FX5
Motion Module
User's Manual (CC-Link IE TSN)**

-FX5-40SSC-G
-FX5-80SSC-G

WHEN USING A SWITCHING HUB WITH CC-Link IE TSN

To connect modules on CC-Link IE TSN, a dedicated TSN switching hub may be required depending on parameter settings or the network topology used.

Read the following carefully.

☞ Page 77 Structure of CC-Link IE TSN Class B/A Devices (CC-Link IE TSN Protocol version 1.0 Only) and Ethernet Devices

📖 MELSEC iQ-F FX5 Motion Module/Simple Motion Module User's Manual (Startup)

SAFETY PRECAUTIONS

(Read the precautions before using this product.)

Before using this product, please read this manual and the relevant manuals carefully and pay full attention to safety to handle the product correctly.

This manual classifies the safety precautions into two categories: [ WARNING] and [ CAUTION].

 WARNING	Indicates that incorrect handling may cause hazardous conditions, resulting in death or severe injury.
 CAUTION	Indicates that incorrect handling may cause hazardous conditions, resulting in minor or moderate injury or property damage.

Depending on the circumstances, procedures indicated by [ CAUTION] may also cause severe injury.

Observe the precautions of both levels because they are important for personal and system safety.

Ensure that the end users read this manual and then keep the manual in a safe place for future reference.

[Design Precautions]

WARNING

- Make sure to set up the following safety circuits outside the programmable controller to ensure safe system operation even during external power supply problems or programmable controller failure. Otherwise, malfunctions may cause serious accidents.
 - Emergency stop circuits, protection circuits, and protective interlock circuits (for conflicting operations such as forward/reverse rotations or for preventing damage to the equipment such as upper/lower limit positioning) must be configured external to the programmable controller.
 - Note that when the CPU module detects an error, such as a watchdog timer error, during self-diagnosis, all outputs are turned off. - Also, when an error occurs in an input/output control block, where it cannot be detected by the CPU module, output control may be disabled. External circuits and mechanisms should be designed to ensure safe machinery operation in such a case.
 - Note that the output current of the 24 V DC service power supply varies depending on the mode and the absence/presence of extension modules. If an overload occurs, the voltage automatically drops, inputs in the programmable controller are disabled, and all outputs are turned off. External circuits and mechanisms should be designed to ensure safe machinery operation in such a case.
 - Note that when an error occurs in a relay, triac or transistor of an output circuit, the output might stay on or off. For output signals that may lead to serious accidents, external circuits and mechanisms should be designed to ensure safe machinery operation in such a case.
 - Construct an interlock circuit in the program so that the whole system always operates on the safe side before executing the control (for data change) of the programmable controller in operation. Read the manual thoroughly and ensure complete safety before executing other controls (program change, parameter change, forced output, and operation status change) to the programmable controller in operation.

Improper operation may damage machines or cause accidents.
 - In an output circuit, when a load current exceeding the rated current or an overcurrent caused by a load short-circuit flows for a long time, it may cause smoke and fire. To prevent this, configure an external safety circuit, such as a fuse.
 - For the operating status of each station after a communication failure, refer to manuals relevant to the network. Incorrect output or malfunction may result in an accident.
 - Especially, in the case of a control from an external device to a remote programmable controller, immediate action cannot be taken for a problem on the programmable controller due to a communication failure. Determine the handling method as a system when communication failure occurs along with configuration of interlock circuit on a program, by considering the external equipment and CPU module.
 - Do not write any data to the "manufacturer setting area", "system area", and "write-protect area" of the buffer memory in the module. Executing data writing to the "manufacturer setting area", "system area", or "write protect area" may cause malfunction of the programmable controller alarm. For the "manufacturer setting area", "system area", or "write-protect area", refer to  Page 169 Buffer Memory and "List of Buffer Memory Addresses" in MELSEC iQ-F FX5 Motion Module/Simple Motion Module User's Manual (Application).
 - If a communication cable is disconnected, the network may be unstable, resulting in a communication failure of multiple stations. Construct an interlock circuit in the program so that the system always operates on the safe side even if communications fail. Incorrect output or malfunction may result in an accident.
-

WARNING

[Precautions for using products in a UL/cUL Class I, Division 2 environment]

- Products*¹ with the Cl.I, DIV.2 mark on the rating plate are suitable for use in Class I, Division 2, Groups A, B, C and D hazardous locations, or nonhazardous locations only.

This mark indicates that the product is certified for use in the Class I, Division 2 environment where flammable gases, vapors, or liquids exist under abnormal conditions. When using the products in the Class I, Division 2 environment, observe the following conditions to reduce the risk of explosion.

- This device is open-type and is to be installed in an enclosed area under suitable environment which requires a tool or key to open.
- Warning - Explosion Hazard - Substitution of any component may impair suitability for Class I, Division 2.
- Warning - Explosion Hazard - Do not disconnect equipment while the circuit is live or unless the area is known to be free of ignitable concentrations.
- Do not open the cover of the CPU module and remove the battery unless the area is known to be nonhazardous.

*1 Products conforming to the UL explosion-proof standard are as follows:

Manufactured in October 2017 onwards

· FX5 CPU module

FX5UC-32MT/D, FX5UC-32MT/DSS, FX5UC-64MT/D, FX5UC-64MT/DSS, FX5UC-96MT/D, FX5UC-96MT/DSS

· FX5 extension module

FX5-C16EX/D, FX5-C16EX/DS, FX5-C16EYT/D, FX5-C16EYT/DSS, FX5-C32EX/D, FX5-C32EX/DS, FX5-C32EYT/D, FX5-C32EYT/DSS, FX5-C32ET/D, FX5-C32ET/DSS, FX5-232ADP, FX5-485ADP, FX5-C1PS-5V, FX5-CNV-BUSC, FX5-4AD-ADP, FX5-4DA-ADP

[Design Precautions]

CAUTION

- When an inductive load such as a lamp, heater, or solenoid valve is controlled, a large current (approximately ten times greater than normal) may flow when the output is turned from off to on. Take proper measures so that the flowing current does not exceed the value corresponding to the maximum load specification of the resistance load.
 - After the CPU module is powered on or is reset, the time taken to enter the RUN status varies depending on the system configuration, parameter settings, and/or program size.
Design circuits so that the entire system will always operate safely, regardless of this variation in time.
 - Simultaneously turn on and off the power supplies of the CPU module and extension modules.
 - If a long-time power failure or an abnormal voltage drop occurs, the programmable controller stops, and output is turned off. When the power supply is restored, it will automatically restart (when the RUN/STOP/RESET switch is on RUN side).
 - Do not bundle the control line and communication cables together with or lay them close to the main circuit or power line. Keep a distance of 100 mm or more between them. Failure to do so may result in malfunction due to noise.
-

[Security Precautions]

WARNING

- To maintain the security (confidentiality, integrity, and availability) of the programmable controller and the system against unauthorized access, denial-of-service (DoS) attacks, computer viruses, and other cyberattacks from external devices via the network, take appropriate measures such as firewalls, virtual private networks (VPNs), and antivirus solutions.
-

[Installation Precautions]

WARNING

- Make sure to cut off all phases of the power supply externally before attempting installation or wiring work. Failure to do so may cause electric shock or damage to the product.
 - Use the product within the generic environment specifications described in the user's manual (Hardware) of the CPU module used.
Never use the product in areas with excessive dust, oily smoke, conductive dust, corrosive gas (salt air, Cl₂, H₂S, SO₂, or NO₂), flammable gas or vibration or impacts, or expose it to high temperature, condensation, or rain and wind.
If the product is used in such conditions, electric shock, fire, malfunctions, deterioration or damage may occur.
-

[Installation Precautions]

CAUTION

- Do not touch the conductive parts of the product directly. Doing so may cause device failures or malfunctions.
 - When drilling screw holes or wiring, make sure that cutting and wiring debris do not enter the ventilation slits of the programmable controller. Failure to do so may cause fire, equipment failures or malfunctions.
 - For the products supplied together with a dust proof sheet, the sheet should be affixed to the ventilation slits before the installation and wiring work to prevent foreign objects such as chips and wiring debris.
However, when the installation work is completed, make sure to remove the sheet to provide adequate ventilation. Failure to do so may cause fire, equipment failures or malfunctions.
 - Install the product on a flat surface. If the mounting surface is rough, undue force will be applied to the PC board, thereby causing nonconformities.
 - Install the product securely using a DIN rail or mounting screws.
 - Connect the expansion board and expansion adapter securely to their designated connectors. Loose connections may cause malfunctions.
 - Make sure to affix the expansion board with tapping screws. Tightening torque should follow the specifications in the user's manual (Hardware) of the CPU module used. If the screws are tightened outside of the specified torque range, poor connections may cause malfunctions.
 - Work carefully when using a screwdriver such as installation of the product. Failure to do so may cause damage to the product or accidents.
 - Connect the extension cables, peripheral cables, input/output cables and battery connecting cable securely to their designated connectors. Loose connections may cause malfunctions.
 - When using an SD memory card, insert it into the SD memory card slot. Check that it is inserted completely. Poor contact may cause malfunction.
 - Turn off the power to the programmable controller before attaching or detaching the following devices. Failure to do so may cause device failures or malfunctions.
 - Peripheral devices, expansion board, expansion adapter, and connector conversion adapter
 - Extension modules, bus conversion module, and connector conversion module
 - Battery
 - Hold the connector part of the Ethernet cable and perform installation or removal in a straight direction. If the cable is pulled out while connected to the module, it may cause damage to the module or the cable, or may cause a malfunction due to poor connector contact.
-

[Wiring Precautions]

WARNING

- Make sure to cut off all phases of the power supply externally before attempting installation or wiring work. Failure to do so may cause electric shock or damage to the product.
 - Make sure to attach the terminal cover, provided as an accessory, before turning on the power or initiating operation after installation or wiring work. Failure to do so may cause electric shock.
 - The temperature rating of the cable should be 80°C or more.
It may differ depending on the extension devices. For details, refer to the user's manual of the extension devices used.
 - Make sure to wire the screw terminal block in accordance with the following precautions. Failure to do so may cause electric shock, equipment failures, a short-circuit, wire breakage, malfunctions, or damage to the product.
 - The disposal size of the cable end should follow the dimensions described in the user's manual (Hardware) of the CPU module used.
 - Tightening torque should follow the specifications in the user's manual (Hardware) of the CPU module used.
 - Tighten the screws using a Phillips-head screwdriver No.2 (shaft diameter 6 mm or less). Ensure that the screwdriver does not touch the partition part of the terminal block.
 - Make sure to properly wire to the terminal block (European type) in accordance with the following precautions. Failure to do so may cause electric shock, equipment failures, a short-circuit, wire breakage, malfunctions, or damage to the product.
 - The disposal size of the cable end should follow the dimensions described in the user's manual (Hardware) of the CPU module used.
 - Tightening torque should follow the specifications in the user's manual (Hardware) of the CPU module used.
 - Twist the ends of stranded wires and ensure that there are no loose wires.
 - Do not solder-plate the electric wire ends.
 - Do not connect more than the specified number of wires or electric wires of unspecified size.
 - Affix the electric wires so that neither the terminal block nor the connected parts are directly stressed.
 - Make sure to properly wire to the spring clamp terminal block in accordance with the following precautions. Failure to do so may cause electric shock, equipment failures, a short-circuit, wire breakage, malfunctions, or damage to the product.
 - The disposal size of the cable end should follow the dimensions described in the user's manual (Hardware) of the CPU module used.
 - Twist the ends of stranded wires and ensure that there are no loose wires.
 - Do not solder-plate the electric wire ends.
 - Do not connect more than the specified number of wires or electric wires of unspecified size.
 - Affix the electric wires so that neither the terminal block nor the connected parts are directly stressed.
-

[Wiring Precautions]

CAUTION

- Do not supply power externally to the [24 +] and [24 V] terminals (24 V DC service power supply) on the CPU module or extension modules. Doing so may damage the product. Note that power may be supplied even when an electronic load which equips with an internal bias power supply is connected.
 - Perform class D grounding (grounding resistance: 100Ω or less) of the grounding terminal on the CPU module and extension modules with a wire 2mm² or thicker.
Do not use common grounding with heavy electrical systems. For details, refer to the user's manual (Hardware) of the CPU module used.
 - Connect the power supply wiring to the dedicated terminals described in the user's manual (Hardware) of the CPU module used. If an AC power supply is connected to a DC input/output terminal or DC power supply terminal, the programmable controller will burn out.
 - Do not wire vacant terminals externally. Doing so may damage the product.
 - Install module so that excessive force will not be applied to terminal blocks, power connectors, I/O connectors, communication connectors, or communication cables. Failure to do so may result in wire damage/breakage or programmable controller failure.
 - Make sure to observe the following precautions to prevent any damage to the machinery or accidents due to malfunction of the programmable controller caused by abnormal data written to the programmable controller due to the effects of noise:
 - Do not bundle the power line, control line and communication cables together with or lay them close to the main circuit, high-voltage line, load line or power line. As a guideline, lay the power line, control line and connection cables at least 100 mm away from the main circuit, high-voltage line, load line or power line.
 - Ground the shield of the shielded wire or shield cable at one point on the programmable controller. However, do not use common grounding with heavy electrical systems.
 - Ground the shield of the analog I/O wire at one point on the signal receiving side. However, do not use common grounding with heavy electrical systems.
 - For Ethernet cables to be used in the system, select the ones that meet the specifications in this manual. If not, normal data transmission is not guaranteed.
-

[Startup and Maintenance Precautions]

WARNING

- Do not touch any terminal while the programmable controller's power is on. Doing so may cause electric shock or malfunctions.
- Before cleaning or retightening terminals, cut off all phases of the power supply externally. Failure to do so in the power ON status may cause electric shock.
- Before modifying the program, performing forced output, or running or stopping the programmable controller while the system is running, read through this manual carefully, and ensure complete safety. An operation error may damage the machinery or cause accidents.
- Do not change the program in the programmable controller from two or more peripherals at the same time. (such as from an engineering tool and a GOT) Doing so may cause destruction or malfunction of the programmable controller program.
- Use the battery for memory backup in conformance to the user's manual (Hardware) of the CPU module used.
 - Use the battery for the specified purpose only.
 - Connect the battery correctly.
 - Do not charge, disassemble, heat, put in fire, short-circuit, connect reversely, solder, swallow, or burn the battery, or apply excessive forces (vibration, impact, drop, etc.) to the battery.
 - Do not store or use the battery at high temperatures or expose to direct sunlight.
 - Do not expose to water, bring near fire or touch liquid leakage or other contents directly.
 - When replacing the battery, make sure to use our specified product (FX3U-32BL).
 - When a battery error occurs ("BAT" LED is lit in red), follow the description in the user's manual (Hardware) of the CPU module used.

Incorrect handling of the battery may cause heat excessive generation, bursting, ignition, liquid leakage or deformation, and lead to injury, fire or failures and malfunction of facilities and other equipment.

[Startup and Maintenance Precautions]

CAUTION

- Do not disassemble or modify the programmable controller. Doing so may cause fire, equipment failures, or malfunctions.

For repair, consult your local Mitsubishi Electric representative.
 - After the first use of the SD memory card, do not insert/remove the memory card more than 500 times. Doing so 500 times or more may cause malfunction.
 - Turn off the power to the programmable controller before connecting or disconnecting any extension cable. Failure to do so may cause device failures or malfunctions.
 - Turn off the power to the programmable controller before attaching or detaching the following devices. Failure to do so may cause device failures or malfunctions.
 - Peripheral devices, expansion board, expansion adapter, and connector conversion adapter
 - Extension modules, bus conversion module, and connector conversion module
 - Battery
 - Do not use the chemicals for cleaning.
 - If there is the possibility of touching the programmable controller inside a control panel in maintenance, make sure to discharge to avoid the influence of static electricity.
 - Since there are risks such as burn injuries, please do not touch the surface of the equipment with bare hands when it is operating in an environment which exceeds ambient temperature of 50°C.
-

[Operating Precautions]

CAUTION

- Construct an interlock circuit in the program so that the whole system always operates on the safe side before executing the control (for data change) of the programmable controller in operation. Read the manual thoroughly and ensure complete safety before executing other controls (program change, parameter change, forced output, and operation status change) to the programmable controller in operation. Improper operation may damage machines or cause accidents.
-

[Disposal Precautions]

CAUTION

- When disposing of this product, treat it as industrial waste.
 - When disposing of batteries, separate them from other waste according to local regulations. (For details on the Battery Directive in EU countries, refer to the user's manual (Hardware) of the CPU module used.)
-

[Transportation Precautions]

CAUTION

- When transporting the programmable controller with the optional battery, turn on the programmable controller before shipment, confirm that the battery mode is set using a parameter and the BAT LED is off, and check the battery life. If the programmable controller is transported with the BAT LED ON or the battery exhausted, the battery-backed data may be unstable during transportation.
 - The programmable controller is a precision instrument. During transportation, avoid impacts larger than those specified in the general specifications of the user's manual (Hardware) of the CPU module used by using dedicated packaging boxes and shock-absorbing palettes. Failure to do so may cause failures in the programmable controller. After transportation, verify operation of the programmable controller and check for damage of the mounting part, etc.
 - When transporting lithium batteries, follow required transportation regulations. (For details on the regulated products, refer to the user's manual (Hardware) of the CPU module used.)
 - The halogens (such as fluorine, chlorine, bromine, and iodine), which are contained in a fumigant used for disinfection and pest control of wood packaging materials, may cause failure of the product. Prevent the entry of fumigant residues into the product or consider other methods (such as heat treatment) instead of fumigation. The disinfection and pest control measures must be applied to unprocessed raw wood.
-

INTRODUCTION

Thank you for purchasing the Mitsubishi Electric MELSEC iQ-F series programmable controllers.

This manual contains text, diagrams and explanations which will guide the reader in the correct installation, safe use and operation of the Motion module of MELSEC iQ-F series and should be read and understood before attempting to install or use the module.

Always forward it to the end user.

Relevant products

FX5-40SSC-G, FX5-80SSC-G

Regarding use of this product

- This product has been manufactured as a general-purpose part for general industries, and has not been designed or manufactured to be incorporated in a device or system used in purposes related to human life.
- Before using the product for special purposes such as nuclear power, electric power, aerospace, medicine or passenger movement vehicles, consult Mitsubishi Electric.
- This product has been manufactured under strict quality control. However when installing the product where major accidents or losses could occur if the product fails, install appropriate backup or failsafe functions in the system.

Note

- If in doubt at any stage during the installation of the product, always consult a professional electrical engineer who is qualified and trained in the local and national standards. If in doubt about the operation or use, please consult the nearest Mitsubishi Electric representative.
- Since the examples indicated by this manual, technical bulletin, catalog, etc. are used as a reference, please use it after confirming the function and safety of the equipment and system. Mitsubishi Electric will accept no responsibility for actual use of the product based on these illustrative examples.
- This manual content, specification etc. may be changed, without a notice, for improvement.
- The information in this manual has been carefully checked and is believed to be accurate; however, if you notice a doubtful point, an error, etc., please consult your local Mitsubishi Electric representative. When doing so, please provide the manual number given at the end of this manual.
- The term "Slave station" and "Authentication Class" have been replaced with "Device station" and "CC-Link IE TSN Class" in accordance with CC-Link Partner Association's policy. However, the terms have not been replaced yet in some areas in the engineering tool, and there may be differences between some window images of the engineering tool and the corresponding description in this manual. In that case, read the terms in the engineering tool's windows as follows.

Network	Engineering tool	Replacement term
CC-Link IE TSN	Slave station	Device station
	Authentication Class	CC-Link IE TSN Class

CONTENTS

WHEN USING A SWITCHING HUB WITH CC-Link IE TSN	1
SAFETY PRECAUTIONS	1
INTRODUCTION	10
RELEVANT MANUALS	14
TERMS	15
GENERIC TERMS AND ABBREVIATIONS	17
CHAPTER 1 OVERVIEW	18
CHAPTER 2 SPECIFICATIONS	20
2.1 Performance Specifications of CC-Link IE TSN	20
2.2 Performance Specifications of Ethernet	21
CHAPTER 3 FUNCTIONS	22
3.1 Function List	22
3.2 Cyclic Transmission	25
Communications using RX, RY, RWr, and RWw	26
Link refresh	27
Cyclic data assurance	29
Communication cycle coexistence	31
I/O maintenance settings	32
Setting the Motion control station	35
CANopen communication	35
3.3 Transient Transmission	37
Communications using a dedicated instruction	37
Communications using the SLMP	37
Communications using the engineering tool	38
3.4 Ethernet Connection	39
Connection with MELSOFT products	39
Connection with SLMP-compatible devices	42
3.5 Security	43
IP filter	43
Remote password	45
3.6 RAS	48
Device station disconnection	48
Automatic return	48
Master station duplication detection	48
IP address duplication detection	49
Time synchronization	50
3.7 Others	51
Device station parameter automatic setting	51
CHAPTER 4 SYSTEM CONFIGURATION	53
4.1 Structure of CC-Link IE TSN Class B devices and Ethernet devices	55
Structure of unicast mode	56
Structure with modules on CC-Link IE TSN only	57
Structure with modules on CC-Link IE TSN and Ethernet devices	60

4.2	Structure of CC-Link IE TSN Class B/A Devices (CC-Link IE TSN Protocol version 2.0 Only) and Ethernet Devices	62
	Structure of unicast mode	64
	Structure with modules on CC-Link IE TSN only	66
	Structure of modules on CC-Link IE TSN and Ethernet devices	71
4.3	Structure of CC-Link IE TSN Class B/A Devices (Mixture of CC-Link IE TSN Protocol version 1.0 and 2.0) and Ethernet Devices	73
	Connection configuration of CC-Link IE TSN-compatible devices	76
4.4	Structure of CC-Link IE TSN Class B/A Devices (CC-Link IE TSN Protocol version 1.0 Only) and Ethernet Devices	77
	Structure of unicast mode	78
	Structure with modules on CC-Link IE TSN	80
	Structure of modules on CC-Link IE TSN and Ethernet devices	85
4.5	Connection Examples	87
	Structure of CC-Link IE TSN Class B devices only	87
	Structure of CC-Link IE TSN Class B devices and Ethernet devices	89
	Structure of CC-Link IE TSN Class B/A devices only	91
	Structure of CC-Link IE TSN Class B/A devices and Ethernet devices	95
4.6	Precautions for System Configuration	96
CHAPTER 5 PARAMETER SETTINGS		98
5.1	Setting Parameters	98
5.2	Required Settings	98
	Station Type	98
	Network No.	99
	Parameter Setting Method	99
	Station No./IP Address Setting	99
5.3	Basic Settings	100
	Refresh settings	101
	Network Topology	103
	Communication Period Setting	103
	Connection Device Information	104
	Device Station Setting	104
5.4	Application Settings	105
	Communication speed	105
	Supplementary cyclic settings	106
	Transient transmission group No. setting	106
	Parameter name	106
	Module operation mode	106
	Security	107
5.5	"CC-Link IE TSN Configuration" Window	108
	Parameter setting of a device station	108
	Connected/Disconnected module detection	111
	Parameter processing of a device station	113
	Command execution to device stations	115
	PDO mapping setting	117
CHAPTER 6 DEDICATED INSTRUCTION		119
6.1	SLMP communication instruction	119
	SLMP command for accessing to CAN application object	119

6.2	Precautions for Dedicated Instructions	121
CHAPTER 7 PROGRAMMING		122
7.1	Precautions for Programming	122
CHAPTER 8 TROUBLESHOOTING		124
8.1	Checking with LED	124
8.2	Checking the Module Status	127
	Module diagnostics	127
8.3	Checking the Network Status	129
	CC-Link IE TSN/CC-Link IE Field diagnostics	129
	Communication test	136
	Remote operation	137
8.4	Troubleshooting by Symptom	138
8.5	List of Error Codes	146
8.6	List of Parameter Numbers	164
8.7	Event List	166
8.8	Response Code (SDO Abort Code)	167
APPENDICES		169
Appendix 1 Buffer Memory		169
	List of buffer memory addresses	169
	Details of buffer memory addresses	175
Appendix 2 List of Link Special Relay (SB)		188
Appendix 3 List of Link Special Register (SW)		192
Appendix 4 Processing Time		196
	Cyclic transmission delay time	197
	Communication cycle intervals	201
	Processing time for Motion control stations	201
	Processing time for standard stations	201
Appendix 5 Port Number		207
Appendix 6 Added and Enhanced Functions		208
Appendix 7 Comparison with FX5-CCLGN-MS		209
INDEX		210
REVISIONS		212
WARRANTY		213
INFORMATION AND SERVICES		214
TRADEMARKS		214

RELEVANT MANUALS

Manual name [manual number]	Description	Available form
MELSEC iQ-F FX5 Motion Module User's Manual (CC-Link IE TSN) (This manual) [IB-0300568ENG]	Functions, parameter settings, troubleshooting, and buffer memories of the CC-Link IE TSN network	Print book e-Manual PDF
MELSEC iQ-F FX5 Motion Module/Simple Motion Module User's Manual (Startup) [IB-0300251ENG]	Specifications, procedures before operation, system configuration, wiring, and operation examples of the Motion Module/Simple Motion module	Print book e-Manual PDF
MELSEC iQ-F FX5 Motion Module/Simple Motion Module User's Manual (Application) [IB-0300253ENG]	Functions, input/output signals, buffer memories, parameter settings, programming, and troubleshooting of the Motion Module/Simple Motion module	Print book e-Manual PDF
MELSEC iQ-F FX5 Motion Module/Simple Motion Module User's Manual (Advanced Synchronous Control) [IB-0300255ENG]	Functions and programming for the synchronous control of the Motion Module/Simple Motion module	Print book e-Manual PDF
MELSEC iQ-F FX5 Motion Module/Simple Motion Module Function Block Reference [BCN-B62005-719]	Specifications, functions, and input/output labels of function blocks for the Motion Module/Simple Motion module.	e-Manual PDF

This manual does not include detailed information on the following:

- General specifications
- Available CPU modules and the number of mountable modules
- Installation

For details, refer to the following.

 MELSEC iQ-F FX5S/FX5UJ/FX5U/FX5UC User's Manual (Hardware)

Point

e-Manual refers to the Mitsubishi Electric FA electronic book manuals that can be browsed using a dedicated tool.

e-Manual has the following features:

- Required information can be cross-searched in multiple manuals.
- Other manuals can be accessed from the links in the manual.
- The hardware specifications of each part can be found from the product figures.
- Pages that users often browse can be bookmarked.
- Sample programs can be copied to an engineering tool.

TERMS

Unless otherwise specified, this manual uses the following terms.

Term	Description
Axis	A target for motion control
Buffer memory	A memory in an intelligent function module, where data (such as buffer memory setting values and monitoring values) are stored.
CC-Link IE TSN Class	A class classified by CC-Link Partner Association according to functions and performance of CC-Link IE TSN-compatible devices and switching hubs. For CC-Link IE TSN Class, refer to the CC-Link IE TSN Installation Manual (BAP-C3007ENG-001) published by the CC-Link Partner Association.
Conformance testing	Testing performed for communications of a CC-Link or CC-Link IE product to ensure their high reliability. For details, refer to the CC-Link Partner Association website. (www.cc-link.org)
Control CPU	A CPU module that controls connected I/O modules and intelligent function modules. In a multiple CPU system, there are multiple CPU modules and each connected module can be controlled by a different CPU module.
Cyclic transmission	A function by which data are periodically exchanged among stations on the network using link devices
Dedicated instruction	An instruction that simplifies programming for using functions of intelligent function modules
Device	A memory of a CPU module to store data. Devices such as X, Y, M, D, and others are provided depending on the intended use.
Disconnection	A process of stopping data link if a data link error occurs
General-purpose switching HUB	A CC-Link IE TSN Class A switching hub certified by CC-Link Partner Association
Global label	A label that is enabled for all program data when creating multiple program data in the project. There are two types of global label: a module specific label (module label), which is generated automatically by GX Works3, and an optional label, which can be created for any specified device.
Grandmaster	A source device or station to synchronize clocks in the time synchronization via PTP
GX Works3	The product name of the software package for the MELSEC programmable controllers (Version 1.072A or later)
Intelligent function module	A module in the MELSEC iQ-F series that has functions other than input and output, such as a Motion module.
Label	A variable used in a program
Link device	A device (RX, RY, RWr, or RWw) in a module on CC-Link IE TSN
Link refresh	Processing of data transfer between link device of the Motion module and CPU module devices. Link refresh is performed in "END processing" of the sequence scan of the CPU module.
Link scan (link scan time)	Time required for all the stations on the network to transmit data. The link scan time depends on data volume and the number of transient transmission requests.
Local station	A station that performs cyclic transmission and transient transmission with the master station and other local stations.
Master station	A station that controls the entire network. This station can perform cyclic transmission and transient transmission with all stations. Only one master station can be used in a network.
Module label	A label that represents one of memory areas (I/O signals and buffer memory areas) specific to each module in a given character string. For the module used, GX Works3 automatically generates this label, which can be used as a global label.
Motion control station	A station that updates a link device in the Motion module
MR-J5(W)-G	MR-J5-_G_(-RJ)/MR-J5W_-_G Servo amplifier series
MR-JET-G	MR-JET-_G_ Servo amplifier series
Multicast mode	A communication mode in which cyclic data is sent to multiple stations.
Object	Various data held by the CANopen-compatible device station.
Priority	A value that is assigned to devices or stations in a network to determine the grandmaster for time synchronization. The smaller the value, the higher the priority.
Relay station	A station that includes two or more network modules. Data are passed through this station to stations on other networks.
Remote station	A station that exchanges I/O signals (bit data) and I/O data (word data) with another station by cyclic transmission. This station can perform transient transmission.
Reserved address	An IP address reserved for special purposes, defined by RFC 6890. This IP address cannot be used when the programmable controller is connected via the global IP network.
Reserved station	A station which is not actually connected. It is included as a station in the network when its all number is counted.
Return	A process of restarting data link when a station recovers from an error
SLMP	An abbreviation for Seamless Message Protocol. This protocol is used to access an SLMP-compatible device or a programmable controller connected to an SLMP-compatible device from an external device.

Term	Description
Standard station	A station other than a Motion synchronization station
Transient transmission	<p>A function of data communication non-periodically among nodes (station) on network.</p> <p>A function used to send messages to the target station when requested by a link dedicated instruction or the engineering tool.</p> <p>Communication is available with station on another network via relay station or gateway.</p>
Transient transmission group No.	No. that is assigned for transient transmission to any given stations. By specifying a group of stations as transient transmission target, data can be sent to the stations of the same group No.
TSN switching hub	A CC-Link IE TSN Class B switching hub certified by CC-Link Partner Association
Unicast mode	A communication mode in which cyclic data is sent to one station.

GENERIC TERMS AND ABBREVIATIONS

Unless otherwise specified, this manual uses the following generic terms and abbreviations.

Generic term/abbreviation	Description
CPU module	An abbreviation for the MELSEC iQ-F series CPU module
Data link	A generic term for a cyclic transmission and a transient transmission
Device station	<ul style="list-style-type: none"> • A generic term for a local station and remote station on CC-Link IE TSN • A generic term for a local station, remote I/O station, remote device station, and intelligent device station on CC-Link IE Field Network
Drive unit	A generic term for motor drive devices such as a servo amplifier
Engineering tool	A generic term for GX Works3 and MR Configurator2
Ethernet device	A generic term for the devices supporting IP communication (such as a personal computer, a vision sensor, and a bar code reader)
Ethernet-equipped module	A generic term for the following modules when the Ethernet communication function is used: <ul style="list-style-type: none"> • CPU module • FX5-ENET • FX5-ENET/IP
Extension module	A generic term for the FX5 extension modules, extension modules (extension cable type), and extension modules (extension connector type)
I/O module	A generic term for the I/O modules (extension cable type) and I/O modules (extension connector type)
Intelligent module	The abbreviation for the intelligent function module
Motion module	An abbreviation for the MELSEC iQ-F series Motion module.
Network module	A generic term for the following modules: <ul style="list-style-type: none"> • Ethernet interface module • Module on CC-Link IE TSN (the Motion module and a module on a remote station) • CC-Link IE Controller Network module • Module on CC-Link IE Field Network (a master/local module, and a module on a remote I/O station, a remote device station, and an intelligent device station) • MELSECNET/H network module • MELSECNET/10 network module • RnENCPU (network part)
PDO	An abbreviation for Process Data Object. A collection of the application objects transmitted periodically between multiple CANopen nodes.
PTP	An abbreviation for Precision Time Protocol. A predefined protocol for time synchronization between devices on a network.
RAS	An abbreviation for Reliability, Availability, and Serviceability. This term refers to the overall usability of automated equipment.
RWr	A remote register of the link device. This refers to word data input from a device station to the master station. (For some areas in a local station, data are input in the opposite direction.)
RWw	A remote register of the link device. This refers to word data output from the master station to a device station. (For some areas in a local station, data are output in the opposite direction.)
RX	Remote input of the link device. This refers to bit data input from a device station to the master station. (For some areas in a local station, data are input in the opposite direction.)
RY	Remote output of the link device. This refers to bit data output from the master station to a device station. (For some areas in a local station, data are output in the opposite direction.)
SB	Link special relay. Bit data that indicates the operating status and data link status of a module on CC-Link IE.
SDO	A communication object of CANopen (Service Data Object). A message used to access the object entries inside the object dictionary of an optional CANopen node. Used for non-periodic transmission between stations.
SLMPSND	A generic term for the J.SLMPSND, JP.SLMPSND, G.SLMPSND, and GP.SLMPSND
SW	Link special register. Word data that indicates the operating status and data link status of a module on CC-Link IE.

1 OVERVIEW

- CC-Link IE TSN is a high-speed (1 Gbps) and large-capacity open field network that is based on Ethernet (1000BASE-T).
- The Motion module is an intelligent function module for connecting to CC-Link IE TSN as a master station.
- Wiring of CC-Link IE TSN supports a line topology, star topology, and coexistence of line and star topologies.
- Data can be communicated between the CPU module and the Motion module using the FROM/TO instructions via the buffer memory. In addition, data can be used in a program by being replaced with data in internal devices, such as X, Y, B, W, SB, and SW, using the auto refresh function.

Data communication

■Cyclic transmission

Data is periodically communicated among stations on the network using link devices.

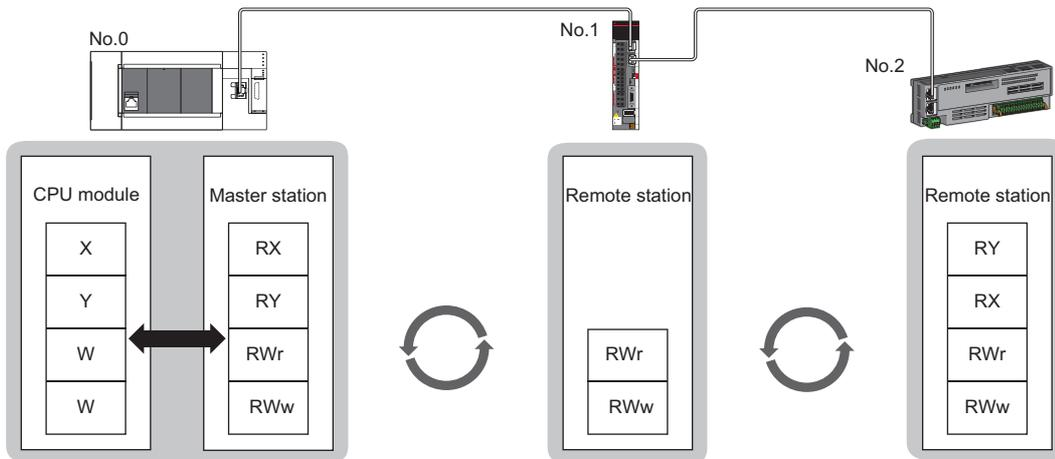

No.0: station number 0
No.1: station number 1
No.2: station number 2

■Transient transmission

This type of data communication is used to read/write data from an external device, such as a personal computer or HMI (Human Machine Interface), to devices in the CPU module of the master station and the remote station via an SLMP.

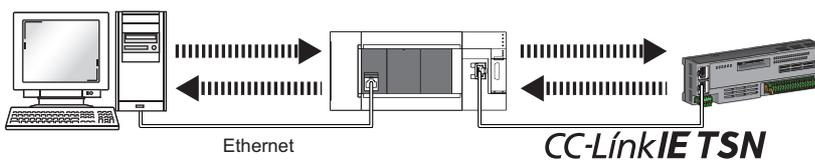

2 SPECIFICATIONS

This chapter describes the specifications of the Motion module.

2.1 Performance Specifications of CC-Link IE TSN

The following table lists the performance specifications of CC-Link IE TSN for the Motion module.

Item	Description			
		FX5-40SSC-G	FX5-80SSC-G	
Station type	Master station			
Station number	Master station: 0			
Number of connectable modules	One module can be connected to the CPU module for each station type. Master station: 4 ^{*1}			
Maximum number of link points per network	RX	16K points (8192 points, 1K bytes)		
	RY	16K points (8192 points, 1K bytes)		
	RWr	1K points (1024 points, 2K bytes)		
	RWw	1K points (1024 points, 2K bytes)		
Maximum number of link points per station ^{*2}	Master station	RX	8K points (8192 points, 1K bytes)	
		RY	8K points (8192 points, 1K bytes)	
		RWr	1K points (1024 points, 2K bytes)	
		RWw	1K points (1024 points, 2K bytes)	
Communication speed	<ul style="list-style-type: none"> • 1 Gbps • 100 Mbps^{*3} 			
Minimum synchronization cycle	500.00 μs			
CC-Link IE TSN Class	B			
CC-Link IE TSN Protocol version	<ul style="list-style-type: none"> • 2.0^{*3*4} • 1.0 			
Maximum number of connectable stations per network	When used as a master station	21 ^{*5} <ul style="list-style-type: none"> • Motion control stations: 4 • Standard stations: 16 	25 ^{*5} <ul style="list-style-type: none"> • Motion control stations: 8 • Standard stations: 16 	
Maximum number of connectable modules per network	When used as a master station	21 ^{*5*6} <ul style="list-style-type: none"> • Device stations (Motion control stations) : 4 • Device stations (Standard stations) : 16 	25 ^{*5*6} <ul style="list-style-type: none"> • Device stations (Motion control stations) : 8 • Device stations (Standard stations) : 16 	
Station-based data assurance	When used as a master station	21 ^{*5}	25 ^{*5}	
Communication cable	Ethernet cable which satisfies standard: For details, refer to "WIRING" in the following manual. □ IMELSEC iQ-F FX5 Motion Module/Simple Motion Module User's Manual (Startup)			
Overall cable distance	Line topology	2000 m (when 21 ^{*5} stations are connected)	2400 m (when 25 ^{*5} stations are connected)	
	Others	Depends on the system configuration.		
Maximum station-to-station distance	100 m			
Network number setting range	1 to 239			
Network topology	Line topology, star topology (Coexistence of line topology and star topology is also possible.)			
Communication method	Time sharing method			
Transient transmission capacity	1920 bytes			
Number of occupied I/O points	8 points			
Applicable CPU module	FX5U CPU module (Version 1.230 or later) FX5UC CPU module ^{*7} (Version 1.230 or later)			
Applicable engineering tool	GX Works3 version 1.072A or later (for FX5U CPU module) GX Works3 version 1.072A or later (for FX5UC CPU module)			

- *1 The sum of the Motion modules and a single FX5-CCLGN-MS (master station).
- *2 The maximum number of points for all link devices may not be used simultaneously depending on the number of device stations, or the number of points and assignments of the link devices that are set in the "Network Configuration Settings" of the "Basic Settings".
- *3 This setting can be used for the firmware version "1.002" or later.
- *4 Even for a firmware version "1.002" or later of the Motion module, when the CC-Link IE TSN Protocol version of the remote station is 1.0, the Motion module may operate with the CC-Link IE TSN Protocol version 1.0.
- *5 Including the master station.
- *6 When connecting multiple master stations, such as the FX5-40/80SSC-G and the FX5-CCLGN-MS, which use device station parameters for the CPU module, the total number of slave modules must be less than or equal to the number of device station parameter files that can be saved in the CPU module. For details on the number of device station parameter files that can be saved in the CPU module, refer to the following.
 MELSEC iQ-F FX5 User's Manual (Application)
- *7 To connect the Motion module to the FX5UC CPU module, the FX5-CNV-IFC and FX5-C1PS-5V are required.

2.2 Performance Specifications of Ethernet

The following table lists the performance specifications of Ethernet for the Motion module.

Item	Description	
Data transmission speed	<ul style="list-style-type: none"> • 1 Gbps • 100 Mbps^{*1} 	
Communication mode	100BASE-T	Full-duplex
	100BASE-TX ^{*1}	Full-duplex
Interface	RJ45 connector (Auto MDI/MDI-X)	
Maximum frame size	1518 bytes	
Jumbo frame	Not available	
Maximum segment length	100m (distance between a switching hub and a station) ^{*2}	
Number of cascade connections	^{*3}	
IP version	Compatible with IPv4	
Number of simultaneous open connections (maximum number of connections)	Connection with MELSOFT products	8 connections ^{*4}
	Connection to SLMP-compatible devices	8 connections ^{*4}

- *1 This setting can be used for the firmware version "1.002" or later.
- *2 For maximum segment length (length between switching hubs), consult the manufacturer of the switching hub used.
- *3 Consult the manufacturer of the switching hub used.
- *4 In the case of one connection per device, up to eight devices can be connected.

Point

The operation of commercial devices used for the following applications is not guaranteed. Check the operation before using the module.

- Internet (general public line) (Internet-access service offered by an Internet service provider or a telecommunications carrier)
- Firewall device(s)
- Broadband router(s)
- Wireless LAN

3 FUNCTIONS

3.1 Function List

The following tables list the functions of CC-Link IE TSN.

The symbols in the availability column mean as follows:

○: Available, ×: Not available

Cyclic transmission

This function communicates data periodically among stations on the network using link devices.

Function		Description	Availability		Reference
			Standard station	Motion control station	
Communications using RX, RY, RWr, and RWw		Communicates data in units of bits and words between the master station and device stations.	○	×	Page 26 Communications using RX, RY, RWr, and RWw
Link refresh		Automatically transfers data between the link devices of the Motion module and the devices of the CPU module.	○	×	Page 27 Link refresh
Cyclic data assurance		Assures the cyclic data integrity in units of 32 bits or station-based units.	○	○	Page 29 Cyclic data assurance
Communication cycle coexistence		When device stations with different communication cycles are included in the network, communicates data using multiple communication cycles according to each device station.	○	×	Page 31 Communication cycle coexistence
I/O maintenance settings	Output mode upon CPU error	When a stop error occurs in the CPU module, set whether to hold or clear output on the sending side.	○	○	Page 32 I/O maintenance settings
	Output hold/clear setting during CPU STOP	When the status of the CPU module changes from RUN to STOP, set whether to hold or clear output on the sending side.	○	○	
	Data link faulty station setting	Set whether to clear or hold input from a disconnected station. Set it on the receiving side.	○	○	
CANopen communication		Controls servo amplifiers that support CANopen profile in PDO mapping.	○	○	Page 35 CANopen communication

Transient transmission

This function is used for data communications at any timing and has the following three types.

Function		Description	Availability		Reference
			Standard station	Motion control station	
Communications using a dedicated instruction		This type of the data communication is used to read/write data from the master station to the remote station using the dedicated instructions.	○	○	Page 37 Communications using a dedicated instruction
Communications using the SLMP		This type of the data communication is used to read/write data of the master station and the remote station from the external device, such as a personal computer or HMI (Human Machine Interface), via an SLMP.	○	○	Page 37 Communications using the SLMP
Communications using the engineering tool		Sets parameters of each station or monitors each station using the engineering tool.	○	○	Page 38 Communications using the engineering tool

Ethernet connection

This function connects an Ethernet device to a module without interfering with CC-Link IE TSN.

Function	Description	Availability		Reference
		Standard station	Motion control station	
Connection with MELSOFT products	Programming and monitoring of the programmable controller are performed via Ethernet using the engineering tool.	○	○	Page 39 Connection with MELSOFT products
Connection with SLMP-compatible devices	Connects SLMP-compatible devices (such as a personal computer or a vision sensor) to the Motion module.	○	○	Page 42 Connection with SLMP-compatible devices

3

Security

This function ensures security according to the network environment by restricting access for each communication path to the CPU module.

Function	Description	Availability		Reference
		Standard station	Motion control station	
IP filter	Identifies the IP address of the access source, and prevents unauthorized access.	○	○	Page 43 IP filter
Remote password	Permits or prohibits access from the external device to the CPU module via the Motion module.	○	○	Page 45 Remote password

RAS

RAS stands for Reliability, Availability, and Serviceability. This function improves overall usability of automated equipment.

Function	Description	Availability		Reference
		Standard station	Motion control station	
Device station disconnection	Stops data link of the station where an error occurred, and continues data link only for stations that are operating normally.	○	○	Page 48 Device station disconnection
Automatic return	Restarts the data link automatically when the device station that was disconnected due to an error becomes normal again.	○	○	Page 48 Automatic return
Master station duplication detection	When one network has multiple master stations, detects duplication.	○	○	Page 48 Master station duplication detection
IP address duplication detection	When one network has stations with the same IP address, detects duplication.	○	○	Page 49 IP address duplication detection
Time synchronization	Synchronizes the time of device stations with the time synchronization source (CPU module of the master station).	○	○	Page 50 Time synchronization

Troubleshooting

This function checks the status of modules and networks by executing diagnostics and operation tests using the engineering tool.

Function	Description	Availability		Reference
		Standard station	Motion control station	
CC-Link IE TSN/CC-Link IE Field diagnostics	Monitors the status of CC-Link IE TSN. The network maps, stations where data link is not operating, selected station communication status monitor, and others are displayed on the engineering tool.	○	○	Page 129 CC-Link IE TSN/CC-Link IE Field diagnostics
Communication test	Checks if transient transmission data can be properly routed from the own station to the communication target.	○	○	Page 136 Communication test

Others

Function	Description	Availability		Reference
		Standard station	Motion control station	
"CC-Link IE TSN Configuration" window	Parameter setting of a device station	○	○	Page 108 Parameter setting of a device station
	Detection of connected/disconnected devices	○	○	Page 111 Connected/Disconnected module detection
	Parameter processing of a device station	○	○	Page 113 Parameter processing of a device station
	Command execution to device stations	○	○	Page 115 Command execution to device stations
Reserved station setting	Reserved stations are device stations to be included among the stations in the network for future extension and set in the parameters. These stations are not connected to actual networks, and are not regarded as faulty stations even if they are not connected. By setting a reserved station, link device assignment will not change even if the device station is connected (or the reservation is cleared). Therefore, modification of the program is not required.	○	×	Page 108 "CC-Link IE TSN Configuration" Window
Error invalid station setting	An error invalid station is a device station that is set to be not detected as a faulty station by the master station. It is also set when a device station is to be replaced during data link.	○	×	Page 108 "CC-Link IE TSN Configuration" Window
Device station parameter automatic setting	Saves parameters of the device station to the master station, and sets the parameters automatically when the device station is connected or returned to the network.	○	○	Page 51 Device station parameter automatic setting

3.2 Cyclic Transmission

This function communicates data periodically among stations on the network using link devices.

- The link devices can be assigned in "Network Configuration Settings" under "Basic Settings". (☞ Page 108 "CC-Link IE TSN Configuration" Window)
- The link refresh is assigned in "Refresh Settings" under "Basic Settings". (☞ Page 101 Refresh settings)

Cyclic transmission operates as follows with the communication mode set by the module parameter of the master station.

The communication mode of the Motion module is fixed to the unicast mode.

Communication mode	Description
Unicast mode	Cyclic data is sent to one station.

Communications using RX, RY, RWr, and RWw

This allows data communications in units of bits and in units of words between the master station and device station.

Master station and remote stations

At unicast mode

1:1 communications between the master station and each remote station. Remote stations do not communicate with each other.

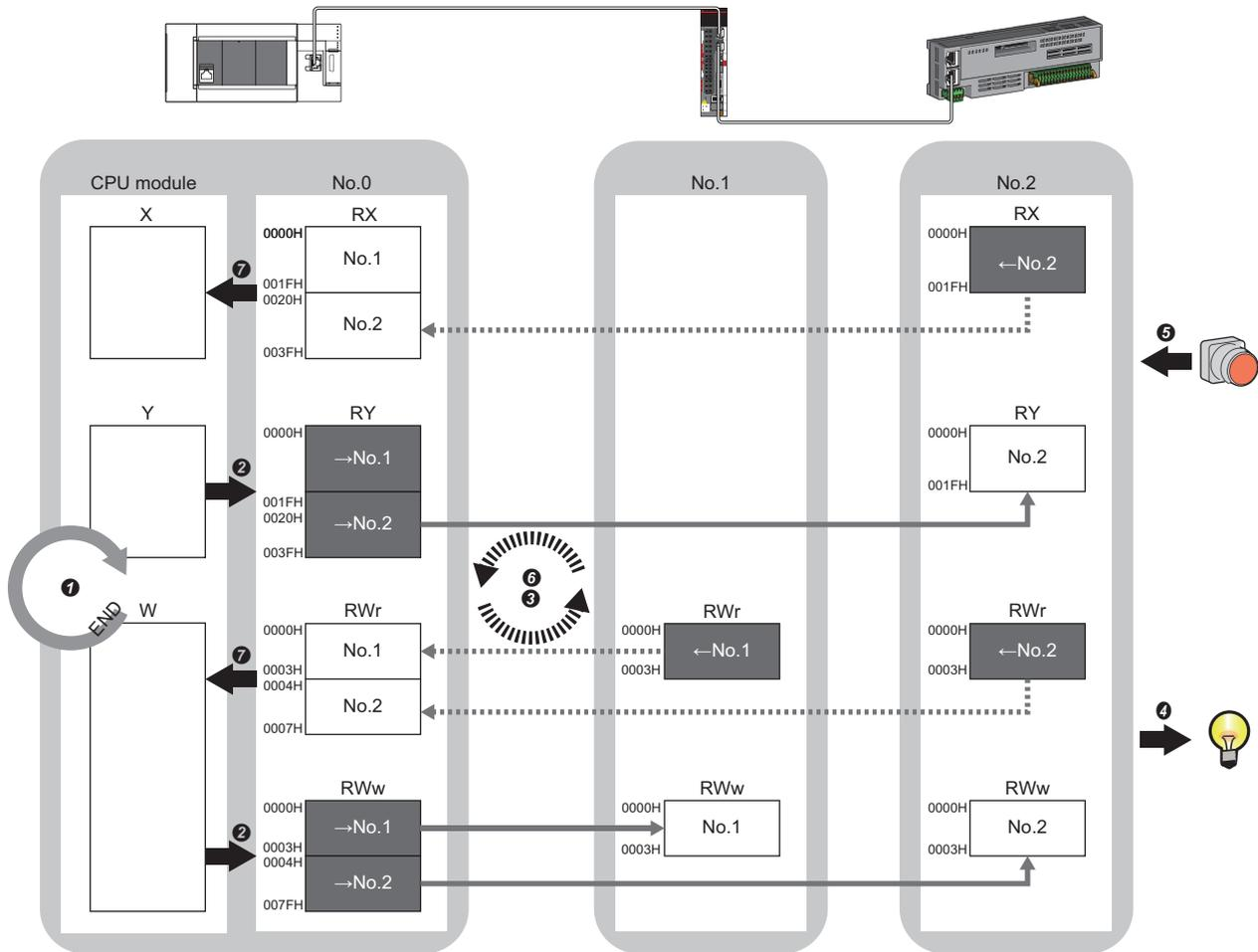

No.0, No.1, No.2: Station No.0 (master station), station No.1, station No.2

→No.1, →No.2: Send range: to station No.1, send range: to station No.2

←No.1, ←No.2: Send range: from station No.1, send range: from station No.2

Class A: CC-Link IE TSN Class A device

Class B: CC-Link IE TSN Class B device

• Output from the master station

- ① The device of the CPU module turns on.
- ② The status data of the device of the CPU module is stored in the link devices (RY, RWw) of the master station by link refresh.
- ③ The status data of the link devices (RY, RWw) of the master station is stored in the link devices (RY, RWw) of each remote station by cyclic data transfer processing.
- ④ The status data of the link devices (RY, RWw) of the remote station is output to the external device.

• Input from the remote station

- ⑤ The status data of the external device is stored in the link devices (RX, RWr) of the remote station.
- ⑥ The status data of the link devices (RX, RWr) of the remote station is stored in the link devices (RX, RWr) of the master station by cyclic data transfer processing.
- ⑦ The status data of the link devices (RX, RWr) of the master station is stored in the devices of the CPU module by link refresh.

Link refresh

This function automatically transfers data between the devices of the Motion module and the devices of the CPU module.

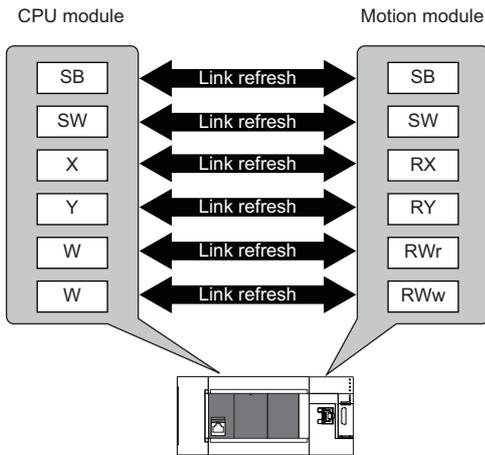

Concept of the link refresh range (number of points)

The link refresh is performed in the range set in "Refresh Settings" under "Basic Settings" and also specified in "Network Configuration Settings".

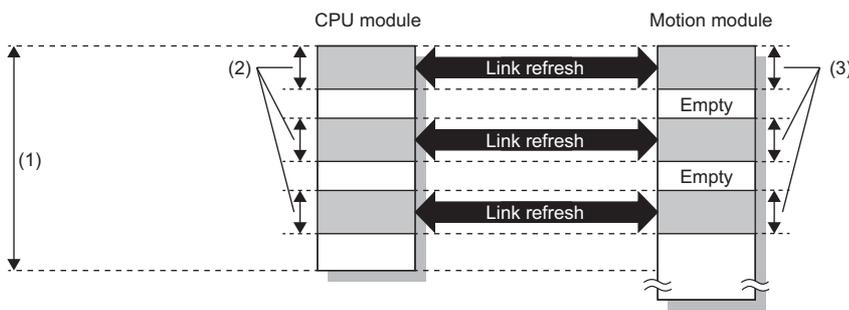

- (1) Range set in "Refresh Settings" under "Basic Settings"
- (2) Actual link refresh range
- (3) Range set in "Network Configuration Settings" under "Basic Settings"

Shortening the transmission delay time

The transmission delay time can be shortened by reducing the number of link refresh points and shortening a communication cycle interval. (☞ Page 201 Communication cycle intervals)

To reduce the number of link refresh points, in "Refresh Settings" under "Basic Settings", set only the link devices used in the CPU module as the link refresh range. (☞ Page 101 Refresh settings)

Point 🔍

Link refresh is performed in END processing of the sequence scan of the CPU module.

Setting method

The link refresh is assigned in "Refresh Settings" under "Basic Settings". (📖 Page 101 Refresh settings)

Precautions

■ Latched devices of the CPU module

If data in latched devices of the CPU module are cleared to zero on a program when the CPU module is powered off and on or reset, the data may be output without being cleared to zero, depending on the timing of the cyclic data transfer processing and link refresh. To prevent data in latched devices from being output, execute the following methods.

CPU module device	How to disable the device data
Latch relay (L), file register (R)	Use the device initial value of the CPU module to clear the device to zero.*1
CPU module device within the latch range	Delete all the latch range settings specified in "Latch Interval Operation Setting" under "Device Latch Interval Setting" in "Memory/Device Setting" of "CPU Parameter".

*1 For the initial device value setting of the CPU module, refer to the following.

📖 MELSEC iQ-F FX5 User's Manual (Application)

Cyclic data assurance

This function assures the cyclic data integrity in units of 32 bits or station-based units.

○: Assured, ×: Not assured

Method	Description	Link refresh	Access to buffer memory
32-bit data assurance	Assures data in 32-bit units. Data is automatically assured by satisfying assignment conditions of link devices.	○	○
Station-based block data assurance	Assures data in station-based units. Data is assured by enabling the station-based block data assurance in the parameter setting.	○	×

32-bit data assurance

Assures RWr and RWw data in 32-bit units.

■Data assurance at the time of access to link devices

When link refresh target devices are accessed, the integrity of 32-bit data can be assured by satisfying the following conditions:

- The start device number of RWr and RWw is a multiple of 2
- The number of points assigned to RWr and RWw is a multiple of 2.

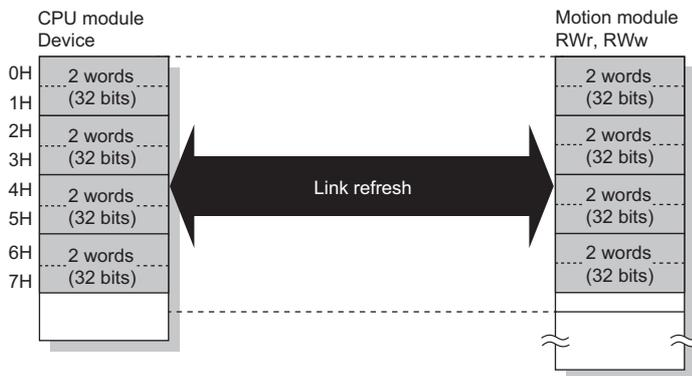

■Data assurance at the time of access to buffer memory

The integrity of 32-bit data can be assured by satisfying the following conditions:

- Access using the DMOV instruction
- The start address of the buffer memory is a multiple of 2.

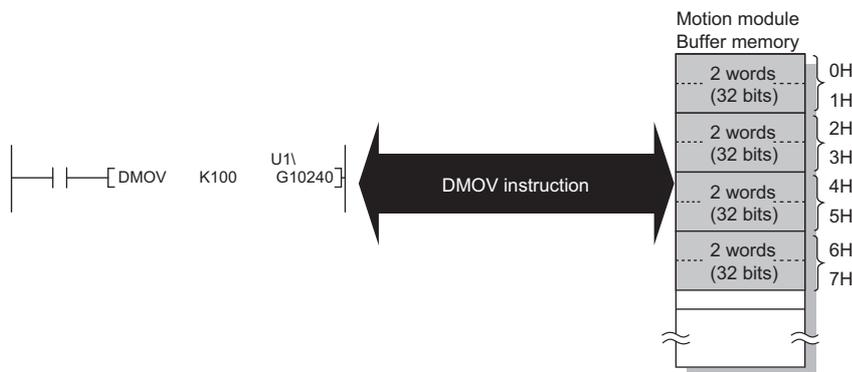

Station-based block data assurance

Integrity of the cyclic data is assured for each station by handshake between the CPU module and the Motion module for a link refresh.

■Setting

Set station-based block data assurance under "Supplementary Cyclic Settings" in "Application Settings" of the master station.

([Page 105 Application Settings](#))

Once this setting is enabled on the master station, integrity of the data for all stations is assured for each station.

■Access to link devices

During a link refresh, data is assured for each station as shown below.

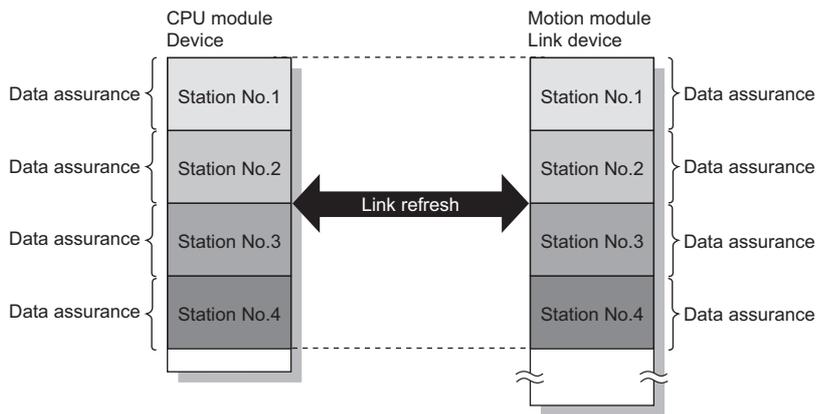

Communication cycle coexistence

When device stations with different communication cycles are included in the network, communicates data using multiple communication cycles according to each device station.

The time for each communication cycle is the total time of cyclic transmission, transient transmission, and system reservation time.

Even if device stations with different communication cycles are connected to a network, a device station with a high-speed communication cycle is not affected by a device station with a low speed.

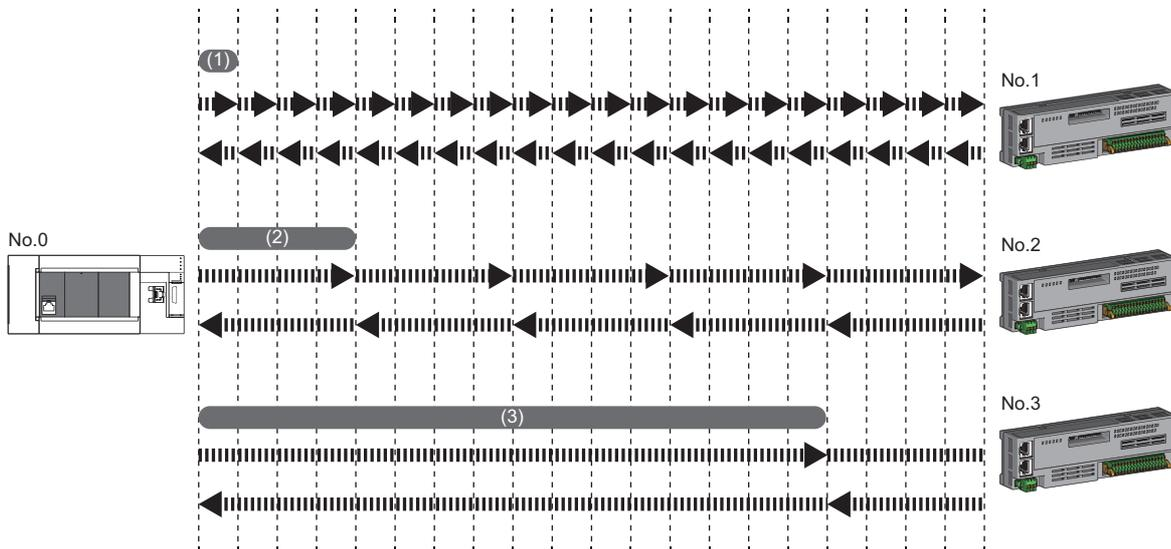

- (1) Basic cycle
- (2) Normal speed
- (3) Low speed

Setting method

The master station communicates with device stations by using three communication cycles that are the basic cycle under "Basic Period Setting", and "Normal-Speed" and "Low-Speed" under "Multiple Period Setting". (Page 103 Communication Period Setting)

The communication cycle of each device station can be selected from "Basic Period", "Normal-Speed", or "Low-Speed" in "Network Configuration Settings" under "Basic Settings".

I/O maintenance settings

When using cyclic transmission, set whether to hold or clear output on the sending side or input on the receiving side by using the following settings of (A), (B), and (C). (Page 106 Supplementary cyclic settings)

- Setting on sending side (A): "Output Mode upon CPU Error" when a stop error occurred in the CPU module on the sending side
- Setting on sending side (B): "Output Hold/Clear Setting during CPU STOP" when the status of the CPU module on the sending side changed from RUN to STOP
- Setting on receiving side (C): "Data Link Faulty Station Setting" when the sending side is disconnected

🔗 "Application Settings" ⇒ "Supplementary Cyclic Settings" ⇒ "I/O Maintenance Settings"

Input data hold/clear operation on the receiving side

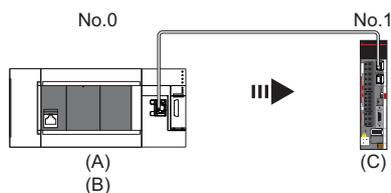

■If an CPU module stop error occurred on the sending side

- If both settings (A) and (B) on the sending side are "Hold", input data on the receiving side is held.
- If setting (A) or (B) on the sending side is "Clear", input data on the receiving side is cleared. (The sending side sends the data cleared to 0.)

■If the CPU module on the sending side changed from RUN to STOP

- If setting (B) on the sending side is "Hold", input data on the receiving side is held.
- If setting (B) on the sending side is "Clear", input data on the receiving side is cleared. (The sending side sends the data cleared to 0.)

■If the sending side disconnected

- If setting (C) on the receiving side is "Hold", input data before disconnection is held on the receiving side.
- If setting (C) on the receiving side is "Clear", input data on the receiving side is cleared.

Precautions

■When "Output Hold/Clear Setting during CPU STOP" is set to "Clear"

When the CPU module is in the STOP state, the forced output to device stations cannot be executed using the engineering tool.

Output data hold/clear operation during CPU STOP

The following figure shows the devices where the setting of "Output Hold/Clear Setting during CPU STOP" is enabled when the CPU module on the sending side changes from RUN to STOP.

■At unicast mode

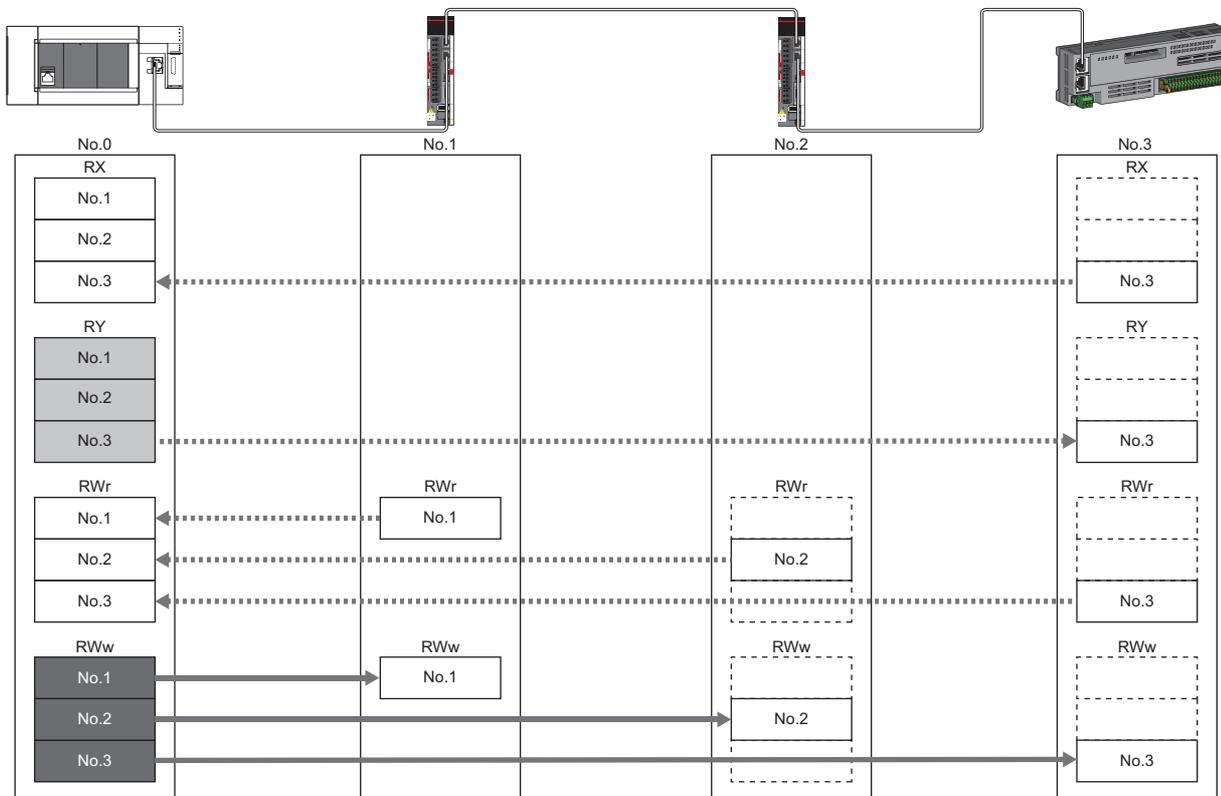

- : When the link refresh source is set to a source other than Y, data is held or cleared according to the parameter setting. When the link refresh source is set to Y, data is cleared regardless of the parameter setting.
- : Data is held regardless of the parameter setting.

Input data hold/clear operation from the data link faulty station

The following figure shows the devices where "Data Link Faulty Station Setting" is enabled when each station becomes faulty.

■At unicast mode

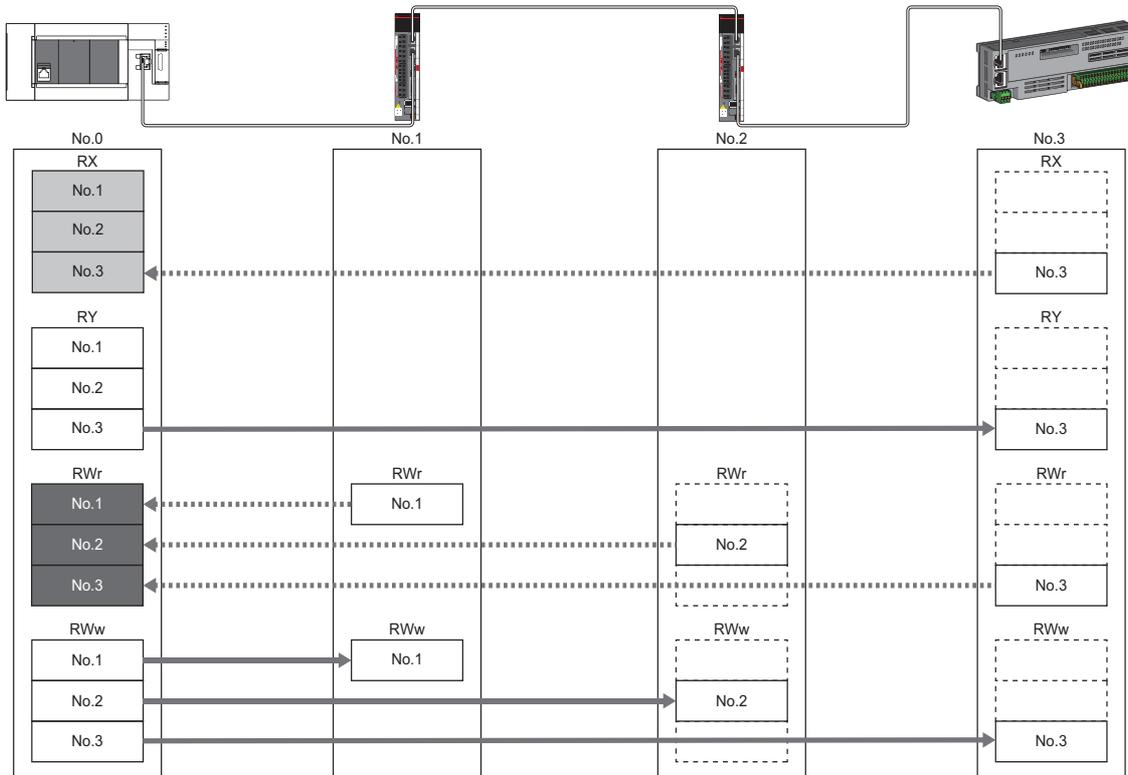

- ◻ : Devices that are held or cleared according to the parameter setting
- ◼ : Devices that are held regardless of the parameter setting

Setting the Motion control station

The transmission data from the station specified as the Motion control station in the engineering tool is assigned to the Motion control area, and control can be performed by setting the axis, etc.

Note that transmission data assigned to the Motion control area cannot be referenced from the CPU module in link refresh, etc.

CANopen communication

CANopen communication is a function used to control a device that is compatible with the CANopen profile.

The CANopen communication can control a device that supports the CANopen profile with the SDO communication by transient transmission and the PDO communication by cyclic transmission. The SDO communication reads/writes objects non-periodically by using the SLMP command to send a command for accessing the CAN application object to the target device station.

For details of a command for accessing the CAN application object, refer to the following.

📖 Page 119 SLMP command for accessing to CAN application object

For details of the SLMP command, refer to the following.

📖 MELSEC iQ-F FX5 Programming Manual (Instructions, Standard Functions/Function Blocks)

The PDO communication reads/writes objects defined with the PDO mapping by using the cyclic transmission.

The PDO mapping of the Motion control station is automatically set according to the device connected with the Motion module. For details of the PDO mapping of the Motion control station, refer to "Devices Compatible with CC-Link IE TSN" in the following manual.

📖 MELSEC iQ-F FX5 Motion Module/Simple Motion Module User's Manual (Application)

The PDO mapping of the standard station is set in "Batch Setting of PDO Mapping" or "PDO Mapping Setting".

The contents of the PDO mapping setting are sent to slave devices when the cyclic transmission with slave devices starts.

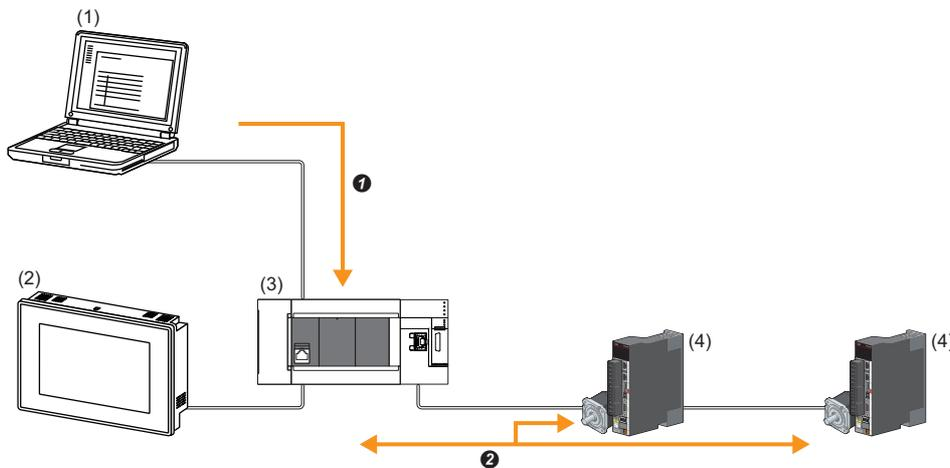

- (1) Engineering tool
- (2) HMI (Human Machine Interface)
- (3) Motion module
- (4) Drive unit
- ① Writing of PDO mapping settings
- ② PDO communication

The PDO (RPDO) output from the master station and PDO (TPDO) input from the device station are assigned as follows.

- Motion control station: Motion control area
- Standard station: RWr/RWw of the common area

The PDO of the standard station can be controlled from link refresh (label/device).

The PDO of the Motion control station is controlled by the motion part, and cannot be controlled from the CPU module.

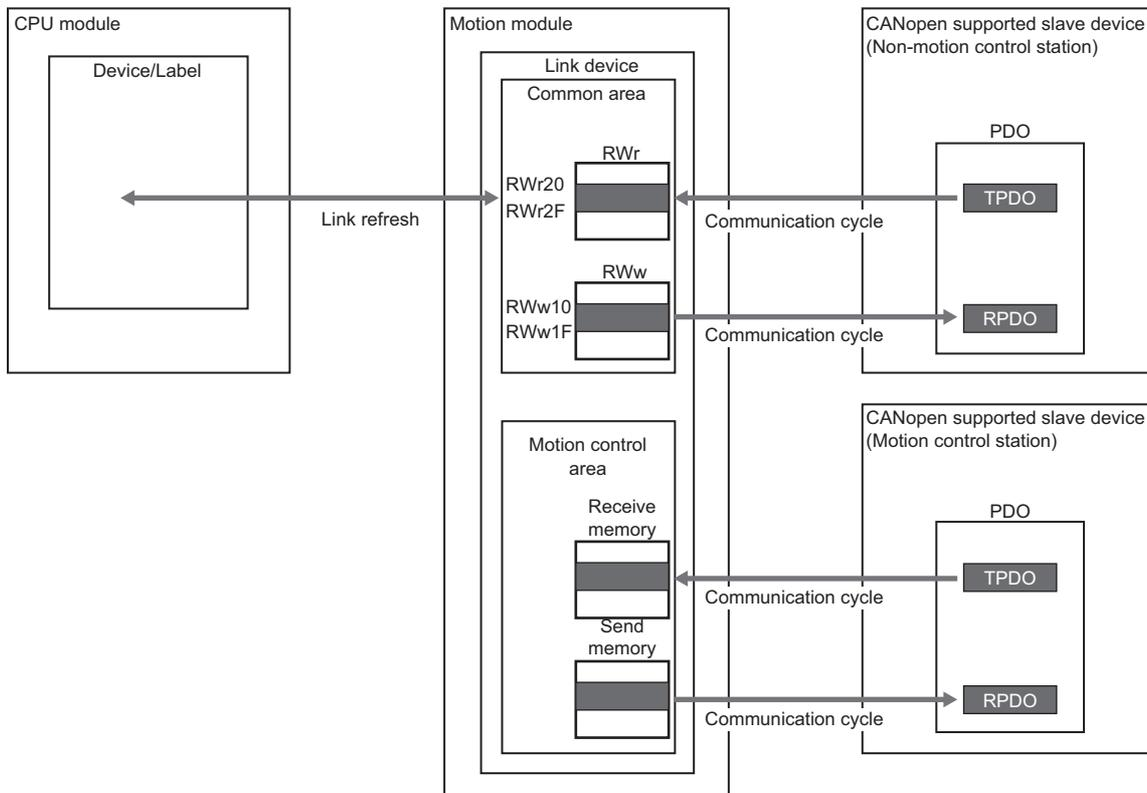

Setting method

Set "Batch Setting of PDO Mapping" and "PDO Mapping Setting" in "Network Configuration Settings" of "Basic Settings".
 (👉 Page 117 PDO mapping setting)

Precautions

■PDO mapping settings

When a device that supports the CANopen profile is added as a standard station to "Network Configuration Settings" of the Motion module, configure "PDO Mapping Setting".

If PDO mapping setting is not configured, GX Works3 will detect the following errors.

When MR-J5-G is added as the device station

- ****Error**** RPDO of module MR-J5-G PDO mapping setting is not set. Please set PDO mapping parameter in PDO mapping setting screen or batch setting of PDO mapping. MR-J5-G NV_E02731
- ****Error**** TPDO of module MR-J5-G PDO mapping setting is not set. Please set PDO mapping parameter in PDO mapping setting screen or batch setting of PDO mapping. MR-J5-G NV_E02732

■Multi-axis servo amplifier

When a multi-axis servo amplifier to the network configuration setting is added, a single device station can use up to 8 axes.

■Error code

If the PDO mapping settings are incorrect, the slave device "PDO mapping setting error" at the initial communication and the data link does not start.

For the error causes, check the response code (SDO Abort Code) (saved in the detail information of the event history) and take corrective actions.

(👉 Page 167 Response Code (SDO Abort Code))

3.3 Transient Transmission

This function is used for data communications at any timing and has the following three types.

☞ Page 37 Communications using a dedicated instruction

☞ Page 37 Communications using the SLMP

☞ Page 38 Communications using the engineering tool

The Motion module can communicate only in the same network.

Communications using a dedicated instruction

This type of the data communication is used to read/write data from the master station to the remote station using the dedicated instructions.

For dedicated instructions that can be used and details on dedicated instructions, refer to the following.

☞ Page 119 DEDICATED INSTRUCTION

Ex.

Reading objects from a remote station using the dedicated instruction (SLMPSND instruction)

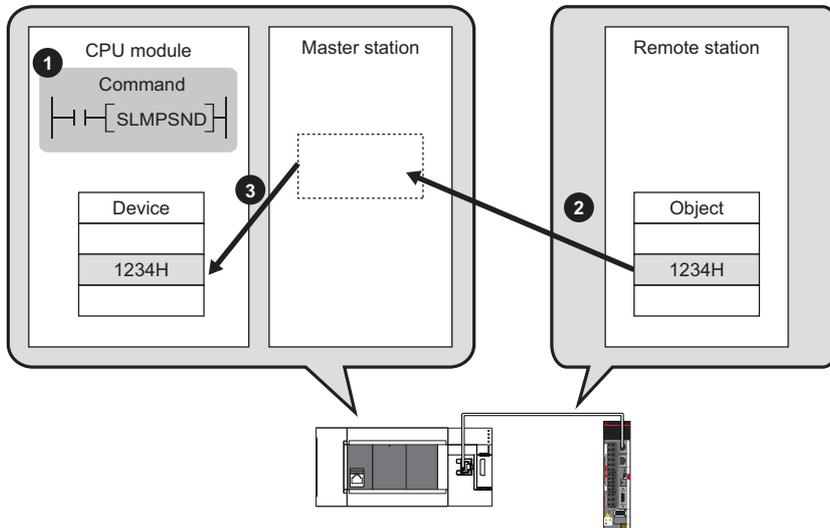

Communications using the SLMP

This type of the data communication is used to read/write data of the master station and the remote station from the external device, such as a personal computer or HMI (Human Machine Interface), via an SLMP.

The Motion module sends and receives SLMP messages. For details on SLMP, refer to the following.

☞ MELSEC iQ-F FX5 User's Manual (SLMP)

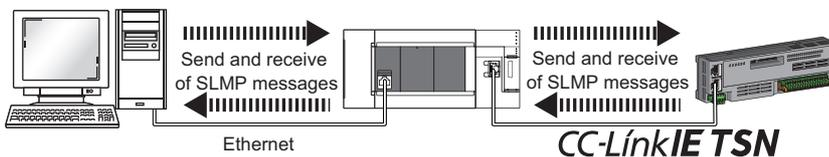

Precautions

For SLMP communications, set the same communication speed for the connected station and access destination. If the communication speed differs between the connected station and access destination, SLMP communications may not be performed.

Communications using the engineering tool

This type of the data communication is used to perform the settings of or monitor each station using the engineering tool.

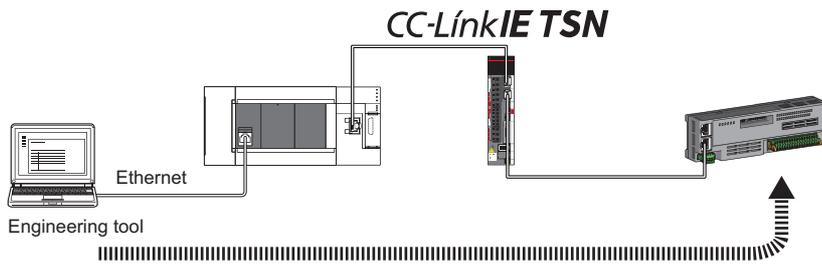

3.4 Ethernet Connection

This function connects an Ethernet device to a module without interfering with CC-Link IE TSN.

Connection with MELSOFT products

Programming and monitoring of the programmable controller are performed via Ethernet using the engineering tool. This function enables remote control using long-distance connectivity and high-speed communications via Ethernet.

The following table lists the methods of connecting the Motion module to MELSOFT products (such as engineering tool).

○: Connection available, ×: Connection not available

Connection method	Purpose	Availability	Reference
		MELSOFT product	
Connection via a HUB (Connection by specifying the IP address)	To connect multiple MELSOFT products	○	Page 39 Connection via a HUB
Connection via a HUB (Connection by specifying the network number and station number)	To connect multiple MELSOFT products	○	

Restriction

A station with a communication speed different from the communication speed of the station to which the engineering tool is connected cannot be connected by specifying another station. The online and debug function of the engineering tool may not be used.

Connection via a HUB

■Settings on the Motion module side

- For connection by specifying the IP address, set the IP address using "Required Settings". ( Page 99 Station No./IP Address Setting)
- For connection by specifying the network number and station number, set the network number and station number in "Required Settings".

Neither of connections require "Network Configuration Settings" under "Basic Settings".

■ Settings on the engineering tool side

Set in the "Specify Connection Destination Connection" window.

 [Online] ⇒ [Current Connection Destination]

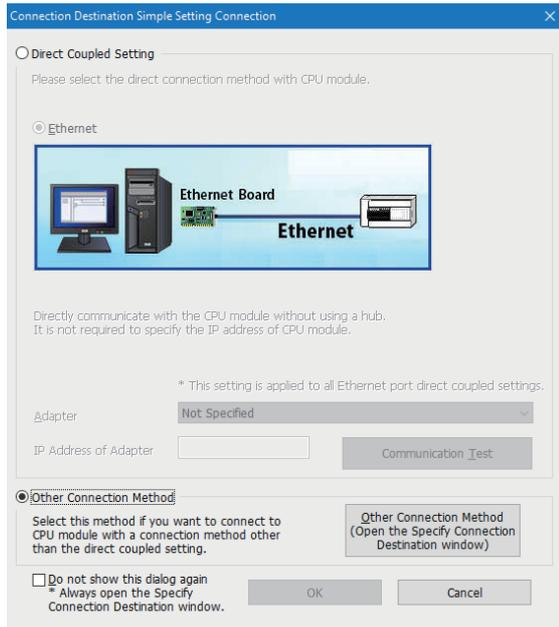

 [Other Connection Method] ⇒ [Other Connection Method (Open the Specify Connection Destination window)]

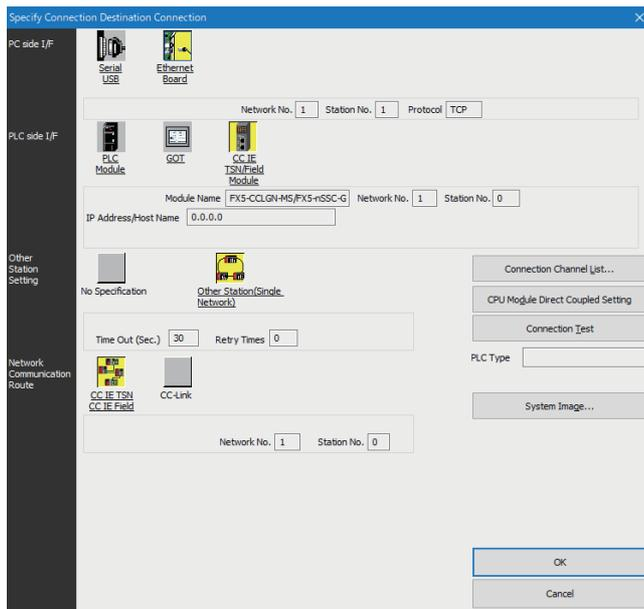

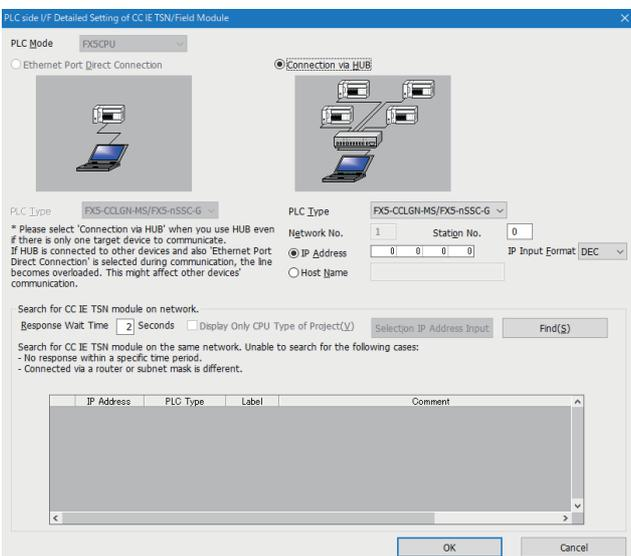
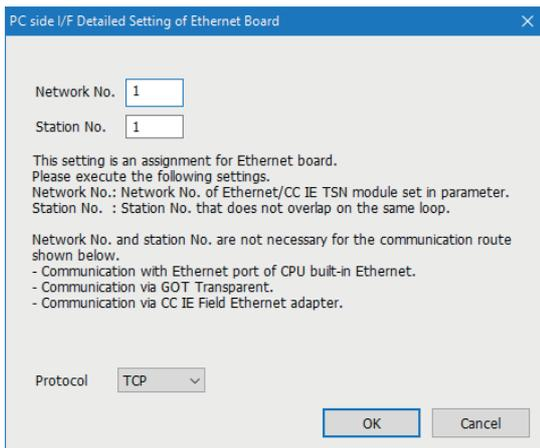

1. Set "PC side I/F" to "Ethernet Board".
2. Double-click "Ethernet Board", and open the "PC side I/F Detailed Setting of Ethernet Board" window.
3. Set the network number, station number, and protocol of the personal computer.

TCP: A connection is established during communication.

Since data is exchanged while checking that the data has correctly reached the communication destination, the data reliability can be ensured. Note that the line load is larger than UDP/IP communications.

UDP: Since a connection is not established during communication and whether the communication destination has correctly received the data is not checked, the line load is lower. Note that the data reliability is lower than TCP/IP communications.

4. Set the "PLC side I/F" to the module to be connected.
5. Double-click the icon set in step 4, and open the detailed setting window.
6. Select "Connection via a HUB" for the connection method, and enter the station number and IP address or host name of the Motion module.
7. Specify "Other Station Setting" or "Network Communication Route" if necessary.

■ Searching modules on the network

For a connection using a switching hub, a list of modules that can be searched for will appear by clicking the [Find] button on the detailed setting window.

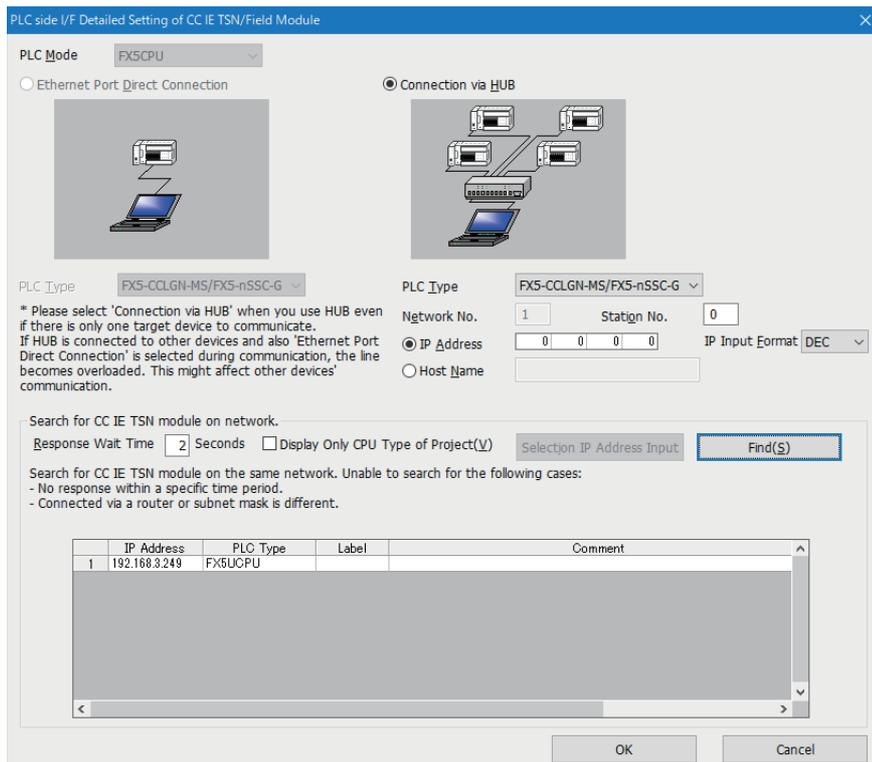

Search target modules are as follows.

- CPU module connected to the same switching hub as the engineering tool
- CPU module connected to cascade-connected switching hub

If the connected Motion module does not appear in the list after searching for the modules on the network, check the following items.

- Search cannot be performed if it is disabled with the IP filter.
- Modules connected via a router cannot be searched for.
- If modules with the same IP address are listed, correct the setting of the IP address in "Network Configuration Settings" under "Basic Settings" of the master station.
- If the service processing load of the search-target CPU module is high, a search for the corresponding module may not be performed. If the search cannot be performed, increase the response waiting time in the search dialog, and execute the search again.

Connection with SLMP-compatible devices

SLMP-compatible devices (such as a personal computer or a vision sensor) are connected to the Motion module.

For details on SLMP, refer to the following.

SLMP Reference Manual

Restriction

- To execute communications using SLMP, set the same communication speed for the connected station and access destination. If the communication speed differs between the connected station and access destination, when communications using SLMP are executed, the communications may not be performed.
- When the system configuration is mixed with an Ethernet device, there are restrictions for the network topology and connection destination of the Ethernet device. (Page 53 SYSTEM CONFIGURATION)

3.5 Security

This function ensures security according to the network environment by restricting access for each communication path to the CPU module. The following two access restriction methods can be used.

☞ Page 43 IP filter

☞ Page 45 Remote password

IP filter

This function identifies the IP address of the access source, and prevents unauthorized access.

By setting the IP address of the access source using the engineering tool, IP packets are allowed or blocked. (The IP packets received from the access source are allowed or blocked. IP packets sent from the own station are ignored.)

Use of this function is recommended when using in an environment connected to a LAN line.

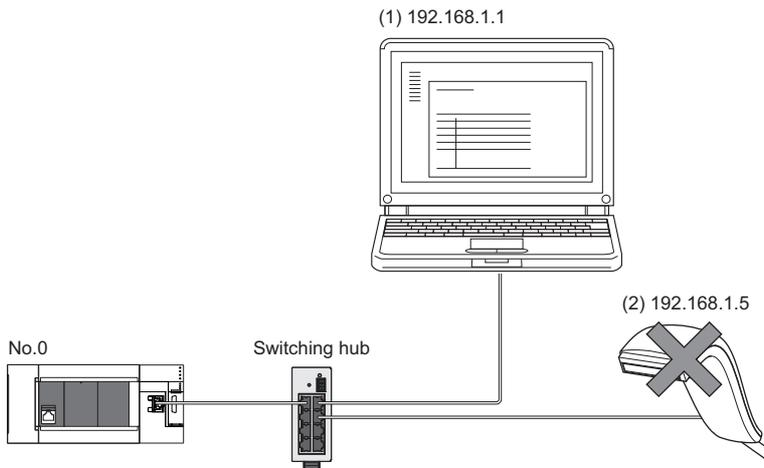

When the "Allow" IP addresses are set to 192.168.1.1 using the IP filter of the master station No.0:
Only the Ethernet device (1) can access the master station, and the Ethernet device (2) cannot access the master station.

Point

The IP filter is one method of preventing unauthorized access (such as a program or data destruction) from an external device. It does not completely prevent unauthorized access. Take appropriate measures other than this function if the safety of the programmable controller system must be maintained against unauthorized access from an external device. Mitsubishi shall not be held liable for any system problems that may occur from unauthorized access.

Examples of measures for unauthorized access are as follows.

- Install a firewall.

Setting method

1. Set the IP address to be allowed or blocked in the "IP Filter Settings" window of "Security" under "Application Settings".
(☞ Page 107 Security)

A warning is displayed in the following cases.

- When blocking the IP address of the device station set in "Network Configuration Settings" under "Basic Settings" was attempted
- When a device station is not set in "Network Configuration Settings" under "Basic Settings", and the "Allow" target IP address is not set in the "IP Filter Settings" window (because the IP filter blocks every IP address)

2. Write the module parameters to the CPU module.
3. The IP filter is enabled when the CPU module is powered off and on or reset.

Point

Even if the connection was specified in "Network Configuration Settings" under "Basic Settings" or by a program, access from the external device is either allowed or blocked according to the setting in the "IP Filter Settings" window.

Setting target

Allow or block should be set to all IP addresses that connect to the same network. Also, set allow or block to the IP address of the device station that is registered in "Network Configuration Settings" under "Basic Settings".

Register the setting details to the master station, and allow or block the IP packets received from the device station with the registered IP address.

Operation

Even for the device station registered in "Network Configuration Settings" under "Basic Settings", a station with an IP address set as blocked can become a disconnected station. As a result, cyclic transmission and transient transmission are not performed. Such a station is also displayed as a disconnected station on the "CC-Link IE TSN/CC-Link IE Field Diagnostics" window. However, Ethernet devices are not displayed on the "CC-Link IE TSN/CC-Link IE Field Diagnostics" window.

(☞ Page 129 CC-Link IE TSN/CC-Link IE Field diagnostics)

Precautions

- Do not set the IP address of the master station or of a device station as blocked. When a device station using line topology is set as blocked, cyclic and transient transmissions cannot be performed on the device stations that are connected after the device station set as blocked.

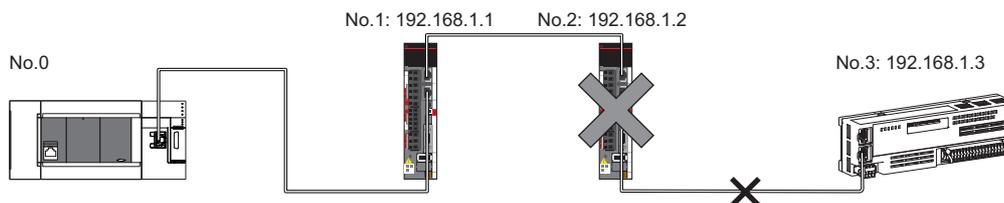

When the "Deny" IP address is set to 192.168.1.2 using the IP filter of the master station No.0:
Only the device station No.1 can access the master station, and the device stations No.2 and No.3 cannot access the master station.

- If there is a proxy server in the LAN line, block the IP address of the proxy server. If the IP address is allowed, access from personal computers that access the proxy server will not be prevented.
- To block access from an external device to another station, block access to the connected station (station connected directly to an external device) by using the IP filter.

Remote password

This function permits or prohibits access from the external device to the CPU module via the Motion module. This prevents unauthorized access to the CPU module from a remote location.

Point

The remote password is one method of preventing unauthorized access (such as program or data destruction) from an external device. It does not completely prevent unauthorized access. Take appropriate measures other than this function if the safety of the programmable controller system must be maintained against unauthorized access from an external device. Mitsubishi shall not be held liable for any system problems that may occur from unauthorized access.

Examples of measures for unauthorized access are as follows.

- Install a firewall.

Number of settable modules

Only one password for "Register Password" can be registered.

Maximum settable remote passwords are three (master station, local station, and a CPU module).

Setting method

Set a remote password on the "Remote Password Setting" window.

Navigation window ⇒ "Parameter" ⇒ [Remote Password]

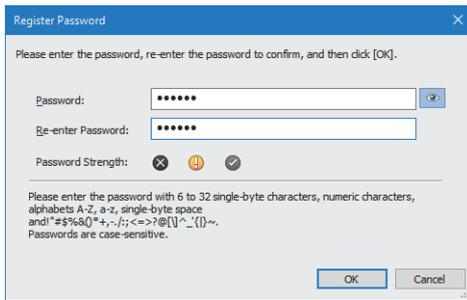

Register Password

Please enter the password, re-enter the password to confirm, and then click [OK].

Password:

Re-enter Password:

Password Strength: ✘ ! ✔

Please enter the password with 6 to 32 single-byte characters, numeric characters, alphabets A-Z, a-z, single-byte space and !#\$%&()*+,-./:;<=>@[^_`{|}~. Passwords are case-sensitive.

OK Cancel

1. Click the [Password] button, and register the remote password on the "Register Password" window.

[Password] button

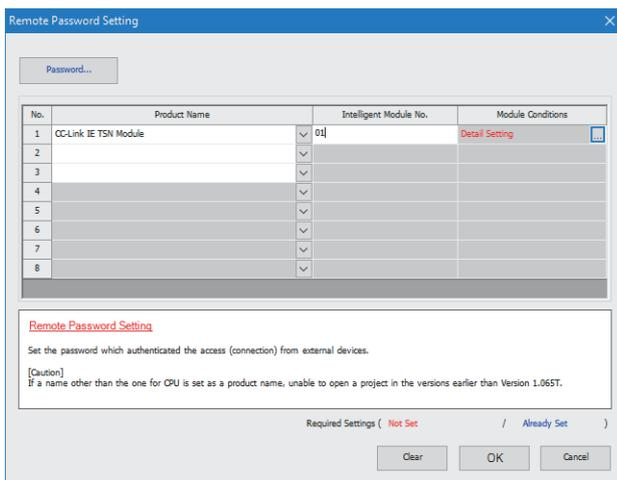

Remote Password Setting

Password...

No.	Product Name	Intelligent Module No.	Module Conditions
1	CC-Link IE TSN Module	01	Detail Setting
2			
3			
4			
5			
6			
7			
8			

Remote Password Setting

Set the password which authenticated the access (connection) from external devices.

[Caution]
If a name other than the one for CPU is set as a product name, unable to open a project in the versions earlier than Version 1.065T.

Required Settings (Not Set / Already Set)

Clear OK Cancel

2. Select the module for which the remote password is to be applied, and set the "Intelligent Module No.".

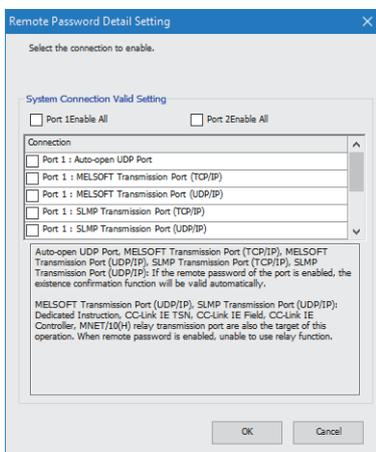

Remote Password Detail Setting

Select the connection to enable.

System Connection Valid Setting

Port 1Enable All Port 2Enable All

Connection

Port 1 : Auto-open UDP Port

Port 1 : MELSOFT Transmission Port (TCP/IP)

Port 1 : MELSOFT Transmission Port (UDP/IP)

Port 1 : SLMP Transmission Port (TCP/IP)

Port 1 : SLMP Transmission Port (UDP/IP)

Auto-open UDP Port, MELSOFT Transmission Port (TCP/IP), MELSOFT Transmission Port (UDP/IP), SLMP Transmission Port (TCP/IP), SLMP Transmission Port (UDP/IP): If the remote password of the port is enabled, the existence confirmation function will be valid automatically.

MELSOFT Transmission Port (UDP/IP), SLMP Transmission Port (UDP/IP): Dedicated Instruction, CC-Link IE TSN, CC-Link IE Field, CC-Link IE Controller, MNET/10(H) relay transmission port are also the target of this operation. When remote password is enabled, unable to use relay function.

OK Cancel

3. Set the target connection on the "Remote Password Detail Setting" window.

"Detail Setting" for the target module

4. Write the remote password to the CPU module.
5. The remote password is enabled when the CPU module is powered off and on or reset.

■PING

This function uses the PING command to perform an alive check of external devices whose access is permitted in UDP communications. When this function is used for UDP communications, check if the security setting of external devices (such as a firewall) is set to respond to PING.

Access permitted/prohibited processing operation

The following describes the processing for permitting or prohibiting access from the external device to the CPU module with a remote password.

■Access permit processing (Unlock processing)

The external device trying to communicate unlocks the remote password set for the connected Motion module.

If the password is not unlocked, the Motion module to which the external device is connected prohibits access, so an error occurs in the external device.

The unlocking methods are as follows.

- SLMP dedicated command (Remote Password Unlock)
- Password input from engineering tool

■Access processing

Access to the specified station is possible when the remote password is correctly unlocked. Execute any access.

■Access prohibit processing (Lock processing)

When access to the specified station ends, lock the remote password from the external device to disable subsequent access.

The locking methods are as follows.

- SLMP dedicated command (Remote Password Lock)
- Lock with engineering tool (executed automatically)

Precautions

The following describes the precautions when remote password is used.

■Setting of remote password for connection

Set the remote password for the connection used for data communications with an external device that can execute the unlock/lock processing.

■When remote password is set for UDP/IP connection

- Determine the external device to communicate with and perform data communications. (With UDP/IP, after the remote password is unlocked, data can be exchanged with devices other than the unlocked external device too. Determine the communication destination before starting to use.)
- Always lock the remote password after data communication is finished. (If the remote password is not locked, the unlocked state is held until timeout occurs.)

■TCP/IP close processing

If the TCP/IP is closed before the TCP/IP is locked, the CPU module will automatically start the lock processing.

■Remote password valid range

The remote password is valid only for access from the Motion module for which the parameters are set. In a system configuration in which multiple modules are used, set a remote password for each module which requires a remote password.

■Accessing the programmable controller of another station

When the external device is accessing the programmable controller of another station via the Motion module, accessing the programmable controller may not be possible if a remote password is set for the CPU module at the relay station or station to be accessed.

3.6 RAS

RAS stands for Reliability, Availability, and Serviceability. This function improves overall usability of automated equipment.

Device station disconnection

Data link of the station where an error occurred is stopped, and the data link continues only for stations that are operating normally.

Automatic return

The data link is automatically restarted when the device station that was disconnected due to an error becomes normal again.

Precautions

- When removing a device station while the system is operating, check that the device station is either performing cyclic transmission or is disconnected.
- When removing the Motion module, check that the D LINK LED is either on or off.

Master station duplication detection

When one network has multiple master stations, duplication is detected.

- When multiple master stations are simultaneously powered on, or when multiple master stations are simultaneously connected, the error "Master station duplication" (error code: 300FH) is detected in all master stations and cyclic transmission cannot be performed in any stations.

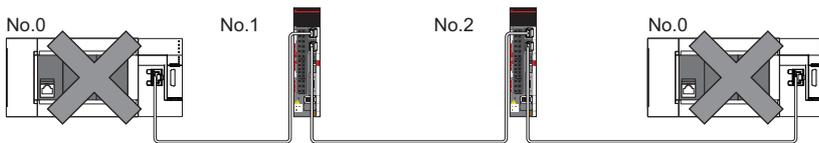

- When another master station is added to the network during data link, the error "Master station duplication" (error code: 300FH) is detected in the added master station and cyclic transmission cannot be performed. Other stations continue data link.

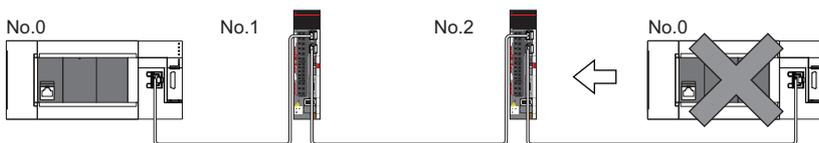

- When two networks are connected during data link, the error "Master station duplication" (error code: 300FH) is detected in master stations on both networks and cyclic transmission cannot be performed in any stations.

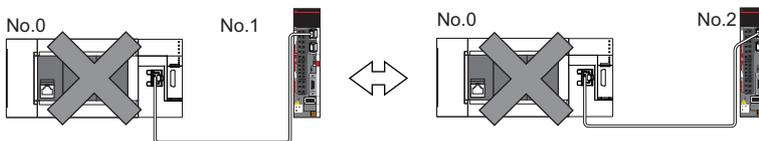

IP address duplication detection

When one network has stations with the same IP address, duplication is detected.

Precautions

When the error "IP address duplication" (error codes: 1802H, 3021H) is detected in the master station, change the IP address of the corresponding station, and power off and on the master station, or reset it.

Detection in each station

When adding a device station, if a station with the same IP address already exists, the error "IP address duplication" (error code: 2160H) is detected in a station to be added, and data link cannot be performed. (Other stations continue data link.)

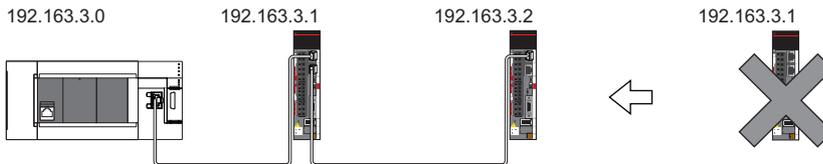

Precautions

When adding a device station that is already connected (linked up) to the TSN switching hub for each TSN switching hub, IP address duplication will not be detected in a station to be added. If the error "IP address duplication" (error code: 1802H) is detected in the master station, disconnect the relevant device station from the network. Otherwise, multiple stations with the same IP address will exist on the same network, possibly leading to transient transmission being sent to an unintended station.

Detection in the master station

■At cyclic transmission startup

If the startup processing of cyclic transmission is executed by powering off and on the master station, when a station with the same IP address is in the network, the error "IP address duplication" (error code: 3021H) is detected in the master station, and data link cannot be performed.

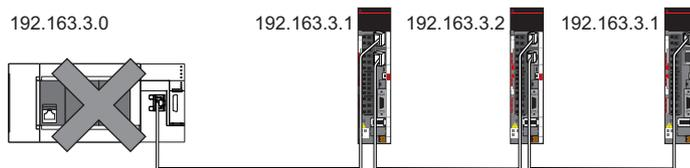

■Cyclic transmission in progress

During cyclic transmission, IP address duplication is regularly checked in the master station. When there are overlapping IP addresses, the error "IP address duplication" (error code: 1802H) is detected in the master station, and cyclic transmission cannot be performed with the relevant device station. (Other stations continue data link.)

Precautions

In any of the following combinations, IP address duplication is not detected when cyclic transmission starts up in the master station.

- Ethernet device and CC-Link IE TSN device
- Ethernet device and Ethernet device

Time synchronization

The time of device stations is synchronized with the time synchronization source (CPU module of the master station).

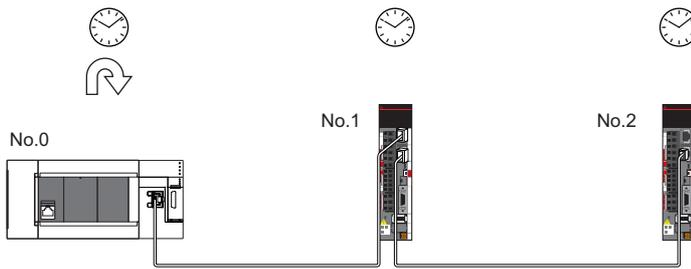

Setting method

The time synchronization is set to the buffer memory. (👉 Page 180 Time synchronization)

Point

When the Motion module is used as the master station, do not connect time synchronization devices whose time synchronization priority is 0 to 15.

For the priority verification method and setting method, refer to the manual of the time synchronization device.

Precautions

When this function is used, the time setting function (SNTP client) of the Ethernet-equipped module cannot be used. (📖 MELSEC iQ-F FX5 User's Manual (Ethernet Communication))

3.7 Others

Device station parameter automatic setting

This function saves parameters of the device station in the master station, and automatically set the parameters when the device station is connected or returned to the network.

As the parameters are changed on the device station side, the saved parameters of the master station side are automatically updated.

Restriction

Automatic update of saved parameters is available for the firmware version "1.001" or later.

3

Device station parameter automatic setting from the master station

1. Parameters of the device station set using the engineering tool are saved in the memory of the CPU module in the master station or the SD memory card by writing.
2. When the device station is connected or returned to the network by power-on, saved parameters are automatically set from the master station.

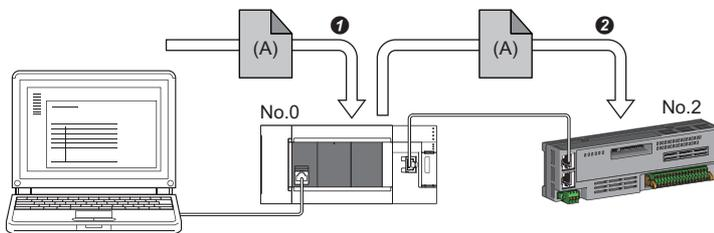

- 1 Save parameter (A) of the device station to the CPU module in the master station.
- 2 When the device station is returned/connected, saved parameter (A) is automatically set from the master station to the device station.

Point

- The master station starts data link with the device station after parameters of the device station are automatically set.
- The device station parameter automatic setting is also executed for device stations set as reserved stations.

Automatic update of saved parameter

1. If parameters on the device station side are changed by the engineering tool or SLMP, the parameters of the device station that are saved in the memory of the CPU module or the SD memory card are automatically updated.
2. When the module of the device station has been replaced, updated parameters are automatically set from the master station by resetting the master station or turning its power off and on.

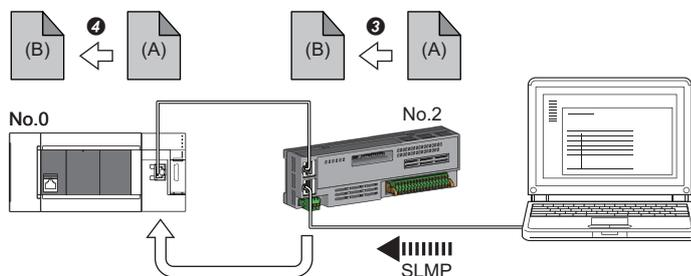

- 3 Parameter (A) of the device station is changed to (B) by SLMP.
- 4 Saved parameter (A) of the CPU module on the master station is automatically updated to parameter (B).

Device station parameter automatic setting is executed under the following conditions.

- The device station is a CC-Link IE TSN module. (For checking if a module is compatible with automatic update of saved parameter, refer to the manual of the module being used for the device station.)

Setting method

Set in the "Parameter of Device Station" window. ( Page 113 Parameter processing of a device station)

Precautions

- A device station whose device station parameter automatic setting abnormally ended does not start data link, and 'Execution result of device station parameter automatic setting function' (SW0160 to SW0167) turns on. Check 'Detailed execution result of device station parameter automatic setting' (SW0194) and the event history and perform corrective actions according to Action of the error codes list.
- Do not disconnect the device station that is currently executing an automatic update of saved parameters. Update of parameter may fail.
- Do not turn off the master station that is currently executing an automatic update of saved parameters. Incorrect parameters are automatically set in the device station at the next power-on.
- If saved parameters are not in the CPU module when executing an automatic update of saved parameters, device station parameters are newly generated.
- Check if the checkbox of "Parameter Automatic Setting" of the device station is selected in "Network Configuration Settings" under "Basic Settings".
- Check if the IP address of the device station in the "Network Configuration settings" under "Basic Settings" matches the actual IP address of the device station.
- When the communication speed differs between the master station and the station for which the device station parameter automatic setting is performed, the device station parameter automatic setting may end abnormally. When the setting ends abnormally, check that their communication speeds match.
- When the parameters of a device station are stored in the SD memory card, "Memory Card Parameter" ⇔ "Setting of File/Data Use or Not in Memory Card" ⇔ "Parameter of Device Station" for the CPU module is set to "Use" to write the memory card parameters and device station settings to the SD memory card.
- There is a limit to the number of device station parameter files that can be saved with the CPU module.

For details, refer to the following.

 MELSEC iQ-F FX5 User's Manual (Application)

Point

When using MR-J5(W)-G and executing device station parameter change (write back), the servo parameter "Parameter automatic backup update interval (PN20)" must be set. When the stored parameters are different between the CPU module and the device station for each setting time, the parameters are written back by setting this parameter. For reflecting changed parameters on the project, Take the following procedure.

- Device station parameter window ⇔ "Read" ⇔ Read parameters from servo amplifiers directly ⇔ Apply the device station parameter to the project

The number of writes to the data memory of CPU module is limited. For details, refer to the following manual.

 MR-J5-G/MR-J5W-G User's Manual (Parameters)

4 SYSTEM CONFIGURATION

CC-Link IE TSN is configured using Ethernet cables.
For details, refer to "WIRING" in the following manual.

📖 MELSEC iQ-F FX5 Motion Module/Simple Motion Module User's Manual (Startup)

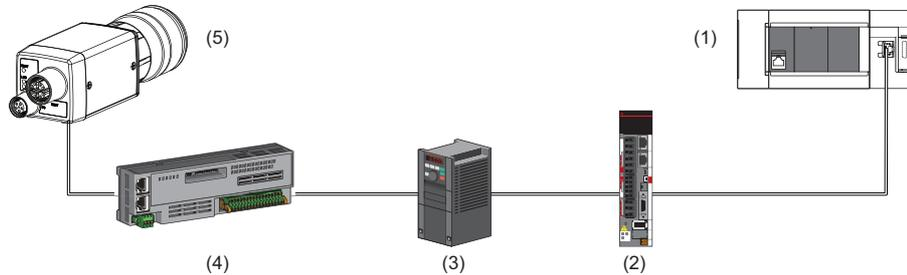

- (1) Motion module
- (2) Drive unit
- (3) Inverter device
- (4) Remote I/O module
- (5) Ethernet device (such as a vision sensor)

System configuration list

The following table shows the system configuration list.

Configuration	Firmware version of the master station	CC-Link IE TSN Protocol version of CC-Link IE TSN-compatible device	Reference
Structure of CC-Link IE TSN Class B devices and Ethernet devices	—	—	Page 55 Structure of CC-Link IE TSN Class B devices and Ethernet devices
Structure of CC-Link IE TSN Class B/A devices and Ethernet devices	"1.002" or later	2.0 only	Page 62 Structure of CC-Link IE TSN Class B/A Devices (CC-Link IE TSN Protocol version 2.0 Only) and Ethernet Devices
		Mixture of 1.0 and 2.0	Page 73 Structure of CC-Link IE TSN Class B/A Devices (Mixture of CC-Link IE TSN Protocol version 1.0 and 2.0) and Ethernet Devices
	"1.001" or later	1.0 only	Page 77 Structure of CC-Link IE TSN Class B/A Devices (CC-Link IE TSN Protocol version 1.0 Only) and Ethernet Devices

Point

The firmware version can be found in the following locations.

- The module diagnostics (CPU diagnostics) window of the engineering tool
- 'MIB information firmware version' (Un\G62933) (📖 Page 175 Firmware version (Un\G62915))

For details on MIB information, refer to the following.

📖 Page 169 Buffer Memory

Precautions

To connect modules on CC-Link IE TSN, a dedicated TSN switching hub may be required depending on parameter settings or the network topology used.

CC-Link IE TSN Class Setting

From "Connection Device Information" under "Basic Settings" of the engineering tool, select either of the following items according to devices to be connected.

Connected device information	System configuration	Switching hub	Standard
CC-Link IE TSN Class B Only	Select this if the system is to be configured without connecting the CC-Link IE TSN Class A device. <ul style="list-style-type: none"> ☞ Page 57 Connection with modules on CC-Link IE TSN only ☞ Page 60 Connection with modules on CC-Link IE TSN and Ethernet devices 	TSN switching hub (CC-Link IE TSN Class B switching hub)	IEEE802.1AS
Mixture of CC-Link IE TSN Class B/A or CC-Link IE TSN Class A Only	Select this if a CC-Link IE TSN Class A device is connected to a CC-Link IE TSN Class B device or if you want to configure a system with a CC-Link IE TSN Class A connected in the future. (Connection is also possible when the system is configured with CC-Link IE TSN Class B devices only.) <ul style="list-style-type: none"> ☞ Page 62 Structure of CC-Link IE TSN Class B/A Devices (CC-Link IE TSN Protocol version 2.0 Only) and Ethernet Devices ☞ Page 73 Structure of CC-Link IE TSN Class B/A Devices (Mixture of CC-Link IE TSN Protocol version 1.0 and 2.0) and Ethernet Devices ☞ Page 77 Structure of CC-Link IE TSN Class B/A Devices (CC-Link IE TSN Protocol version 1.0 Only) and Ethernet Devices 	General-purpose switching hub (CC-Link IE TSN Class A switching hub)	IEEE 802.1AS or IEEE 1588 ^{*1}

- *1 IEEE 1588 if the firmware version of the master station is "1.001" or earlier.
IEEE 802.1AS or IEEE 1588 depending on the CC-Link IE TSN Protocol version of the CC-Link IE TSN-compatible device when the firmware version of the master station is "1.002" or later.
For details, refer to the following.
☞ Page 76 Connection configuration of CC-Link IE TSN-compatible devices

Ethernet connection

For connection with MELSOFT products and connection with SLMP-compatible devices, refer to the following.

☞ Page 23 Ethernet connection

4.1 Structure of CC-Link IE TSN Class B devices and Ethernet devices

This section describes the system configuration when "Connection Device Information" under "Basic Settings" of the engineering tool is set to "CC-Link IE TSN Class B Only".

For the maximum number of connectable stations when "Connection Device Information" under "Basic Settings" of the master station is set to "CC-Link IE TSN Class B Only", check the following.

☞ Page 20 Performance Specifications of CC-Link IE TSN

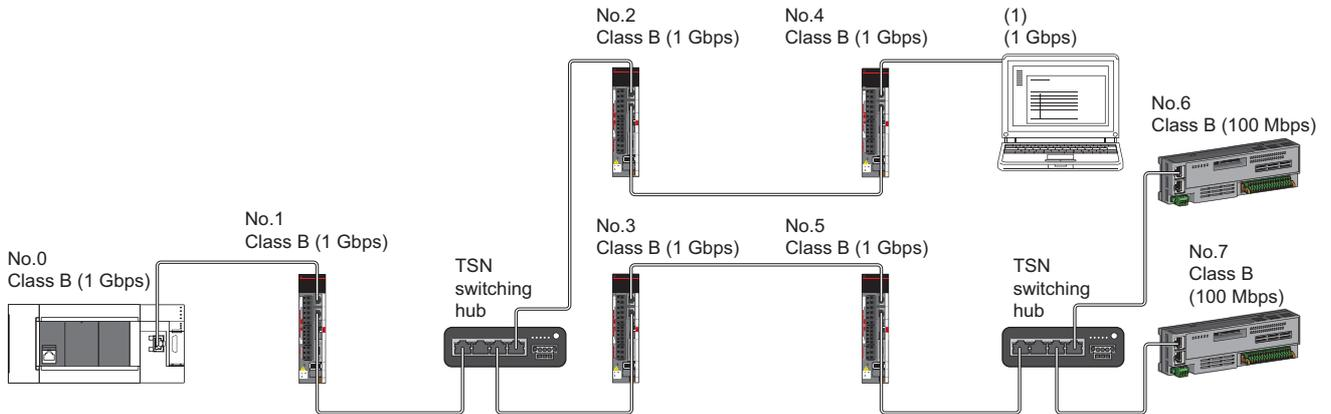

No.0: Master station
 No.1, No.2, No.3, No.4, No.5, No.6, and No.7: Remote station
 (1): Ethernet device
 Class B: CC-Link IE TSN Class B device

The availability of connection of network configuration devices varies depending on the communication mode and communication speed.

- Unicast mode

☞ Page 56 When the communication speed for the master station is set to 1 Gbps

☞ Page 56 When the communication speed for the master station is set to 100 Mbps

The following terms are used to describe the terms in the tables referenced.

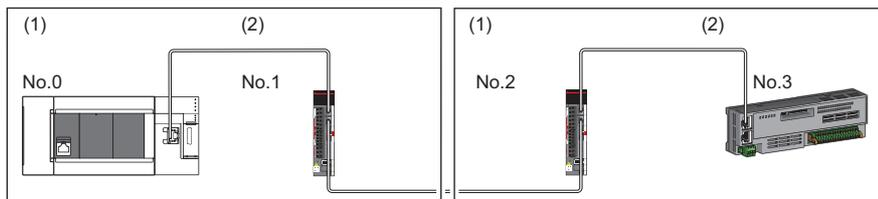

No.0: Master station
 No.1 and No.2: Remote station
 (1) Device on the master station side (The master station or a device near the master station)
 (2) Device on the end side (A device far from the master station)

Structure of unicast mode

The following indicates the availability of connection with a network configuration device.

When the communication speed for the master station is set to 1 Gbps

The following table lists the availability of connection with a network configuration device when the communication speed for the master station is set to 1 Gbps.

- : Connection available, ▲: Connection available only with a standard station, △: Connection available via a switching hub, ×: Connection not available
 S: TSN switching hub available
 H: General-purpose switching hub available

Device on the master station side (A device near the master station)		Device on the end side (A device far from the master station)			
		Remote station (CC-Link IE TSN Class B device)		Ethernet device	
		1 Gbps	100 Mbps	1 Gbps	100 Mbps
Master station (CC-Link IE TSN Class B device)	1 Gbps	○S	▲△S ^{*1}	○SH	△SH
	Remote station (CC-Link IE TSN Class B device)	1 Gbps	○S	▲△S ^{*1*2}	○SH
	100 Mbps	×	▲S ^{*1*2}	×	○SH

*1 For a device station with a communication speed of 100 Mbps, set "Communication Period Setting" to "Low-Speed".

*2 Connection cannot be made if the total cyclic data size of all device stations on the 100 Mbps device side, including the devices with a communication speed of 100 Mbps that form a boundary between the communication speed of 1 Gbps and 100 Mbps, exceeds 2K bytes. (Page 97 Calculation of the total cyclic data size)

Precautions

When a TSN switching hub is used, check the TSN switching hub specifications on the CC-Link Partner Association website (www.cc-link.org).

When the communication speed for the master station is set to 100 Mbps

This mode indicates the availability of connection with a network configuration device when "Communication Speed" of the master station is set to "100 Mbps".

- : Connection available, △: Connection available via a switching hub, ×: Connection not available
 S: TSN switching hub available
 H: General-purpose switching hub available

Device on the master station side (A device near the master station)		Device on the end side (A device far from the master station)			
		Remote station (CC-Link IE TSN Class B device)		Ethernet device	
		1 Gbps	100 Mbps	1 Gbps	100 Mbps
Master station (CC-Link IE TSN Class B device)	100 Mbps	×	○S ^{*1}	×	○SH
	Remote station (CC-Link IE TSN Class B device)	1 Gbps	×	×	×
	100 Mbps	×	○S ^{*1}	×	○SH

*1 For a device station with a communication speed of 100 Mbps, set "Communication Period Setting" to "Basic Period" or "Normal-Speed".

Precautions

When a TSN switching hub is used, check the TSN switching hub specifications on the CC-Link Partner Association website (www.cc-link.org).

Structure with modules on CC-Link IE TSN only

Connection with modules on CC-Link IE TSN only

Line topology

The network is configured in a line topology. A TSN switching hub is not required.

When an error occurs in a device station, the stations connected after the faulty station will be disconnected.

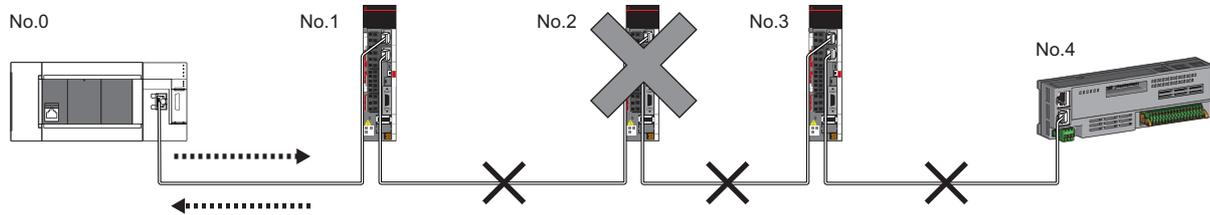

No.0: Master station
No.1, No.2, No.3, and No.4: Remote station

Star topology

The network is configured in a star topology via a TSN switching hub. This allows devices to be added easily.

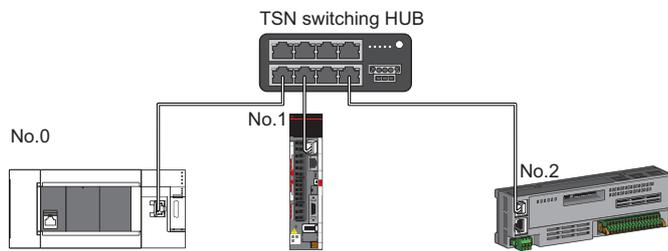

No.0: Master station
No.1 and No.2: Remote station

Even when an error occurs in a device station, a data link can be continued with the stations that are operating normally.

Coexistence of line and star topologies

Line and star topologies can be mixed in the same network configuration.

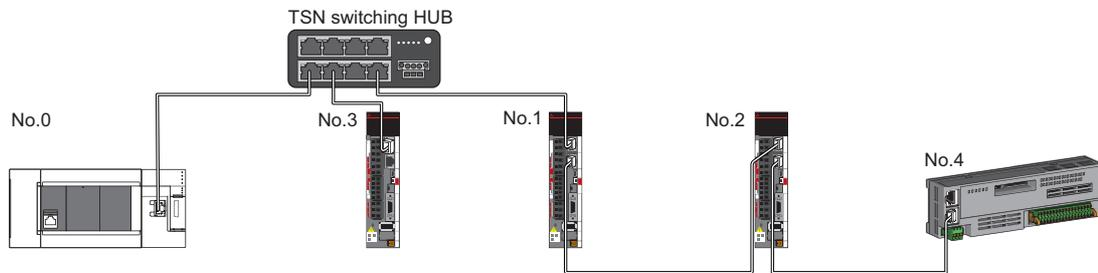

No.0: Master station
No.1, No.2, No.3, and No.4: Remote station

Connection with modules on CC-Link IE TSN with a communication speed of 100 Mbps

The following shows the network topologies when a CC-Link IE TSN module with a communication speed of 100 Mbps is connected.

Line topology

The communication speed of the module must be adjusted for connection. (When modules with different communication speeds are connected, a TSN switching hub is required.)

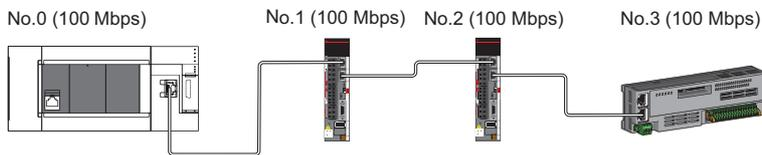

No.0: Master station
No.1, No.2, No.3: Remote station

Star topology

The network is configured in a star topology via a switching hub.

- When the master station with a communication speed of 1 Gbps and a remote station with a communication speed of 100 Mbps exist in the structure, set "Communication Period Setting" to "Low-Speed" for the remote station with a communication speed of 100 Mbps.

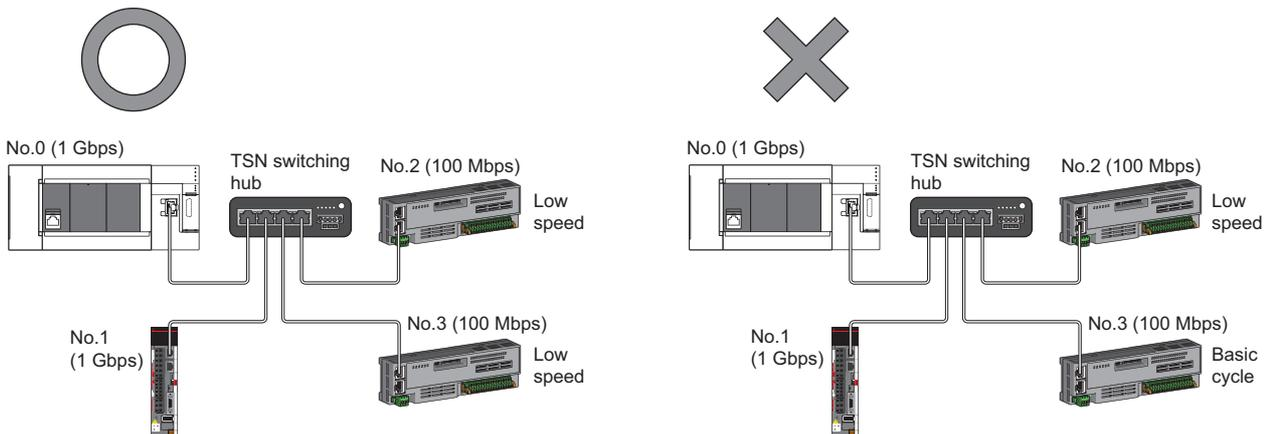

No.0: Master station
No.1, No.2, and No.3: Remote station

■ Coexistence of line and star topologies

Line and star topologies can be mixed in the same network configuration.

- When the master station with a communication speed of 1 Gbps and a remote station with a communication speed of 100 Mbps exist in the structure, set "Communication Period Setting" to "Low-Speed" for the remote station with a communication speed of 100 Mbps.

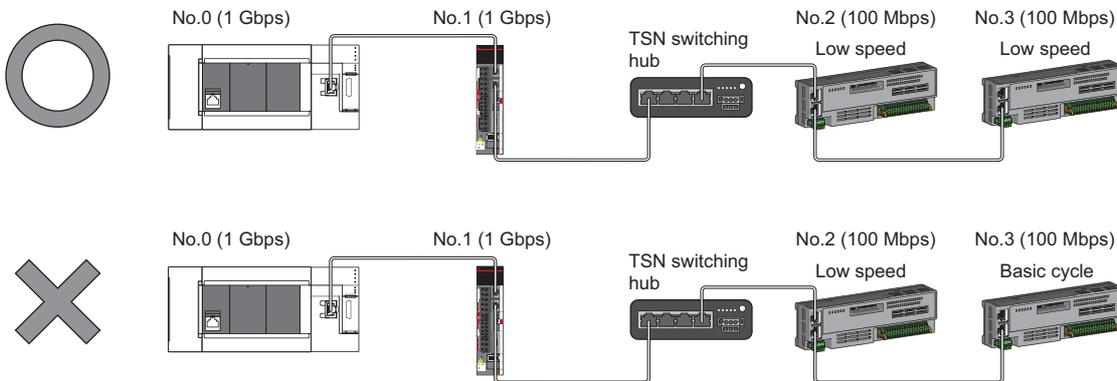

No.0: Master station
No.1, No.2, and No.3: Remote station

- When the communication speed for the master station is 1 Gbps, connection cannot be made if the total cyclic data size of all device stations on the 100 Mbps device side, including the devices with a communication speed of 100 Mbps that form a boundary between the communication speed of 1 Gbps and 100 Mbps, exceeds 2K bytes.

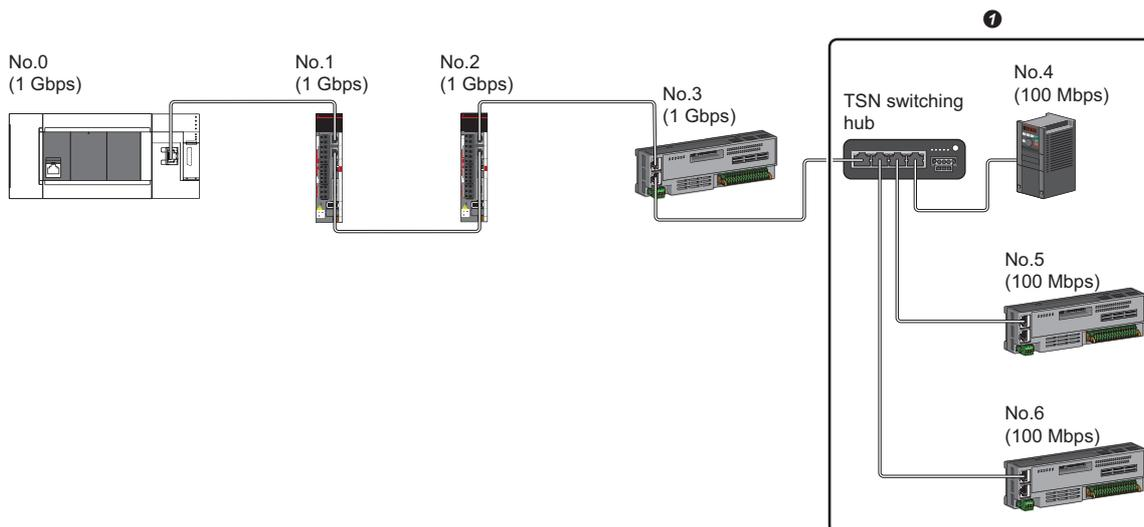

No.0: Master station
No.1, No.2, No.3, No.4, No.5, and No.6: Remote station

- ① Set the total cyclic data size within 2K bytes.

Structure with modules on CC-Link IE TSN and Ethernet devices

Connection with modules on CC-Link IE TSN and Ethernet devices

Line topology

The network with modules and devices is configured in a line topology. A TSN switching hub is not required. Connect Ethernet devices to the end of the network.

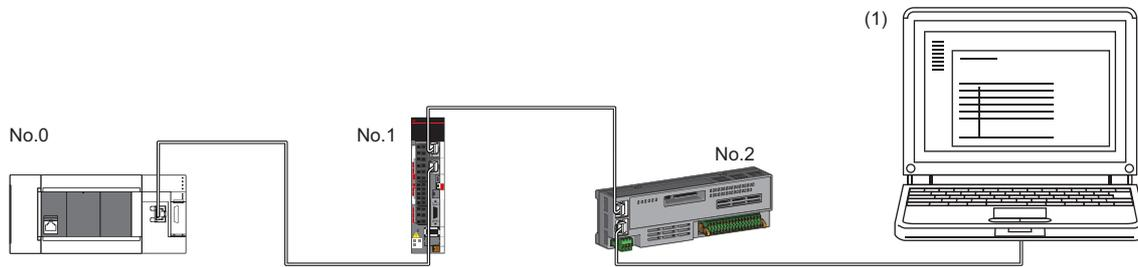

No.0: Master station
No.1 and No.2: Remote station
(1) Ethernet device (such as a personal computer)

When an error occurs in a device station, the stations connected after the faulty station will be disconnected.

Star topology

The network is configured in a star topology via a switching hub.

Device stations cannot be connected with a general-purpose switching hub. Line and star topologies should be mixed in the same network configuration.

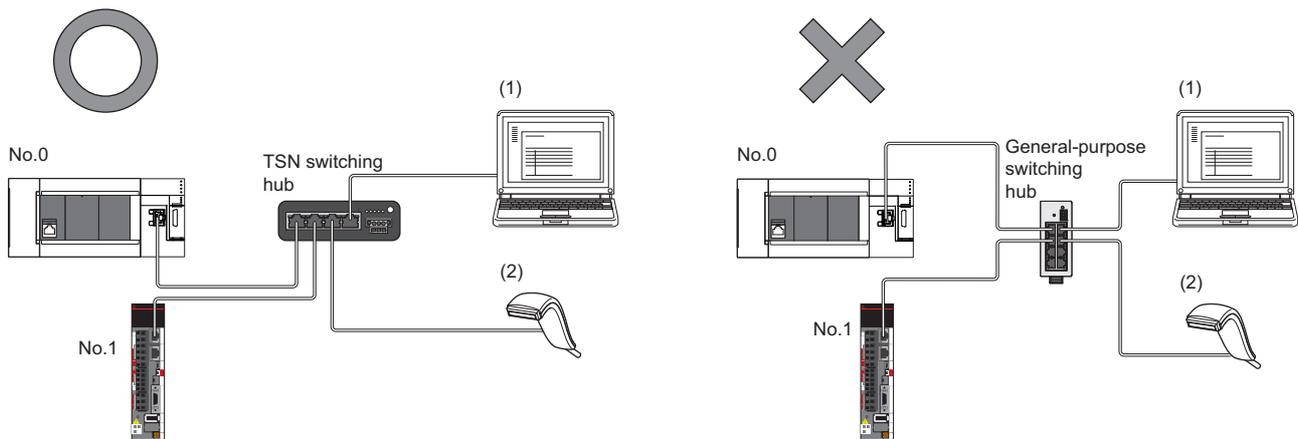

No.0: Master station
No.1: Remote station
(1), (2): Ethernet device

■ Coexistence of line and star topologies

Line and star topologies can be mixed in the same network configuration.

- Connect Ethernet devices to the end of the network.

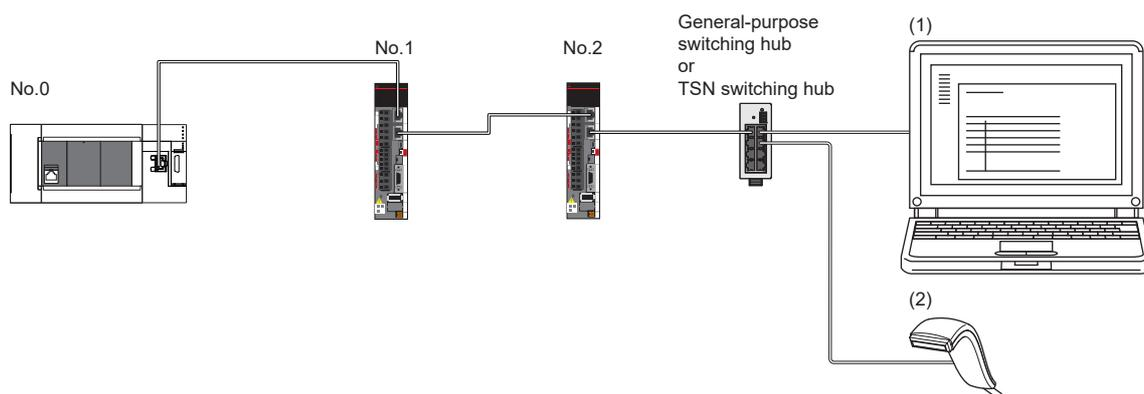

No.0: Master station
No.1, No.2: Remote station
(1), (2): Ethernet device

4.2 Structure of CC-Link IE TSN Class B/A Devices (CC-Link IE TSN Protocol version 2.0 Only) and Ethernet Devices

The following diagram shows the system configuration under the conditions below:

- "Mixture of CC-Link IE TSN Class B/A or CC-Link IE TSN Class A Only" set for "Connection Device Information" under "Basic Settings" in the engineering tool
- Master station firmware version "1.002" or later
- CC-Link IE TSN-compatible devices with the CC-Link IE TSN Protocol versions 2.0 only

For the maximum number of connectable stations when "Connection Device Information" under "Basic Settings" of the master station is set to "Mixture of CC-Link IE TSN Class B/A or CC-Link IE TSN Class A Only", check the following.

☞ Page 20 Performance Specifications of CC-Link IE TSN

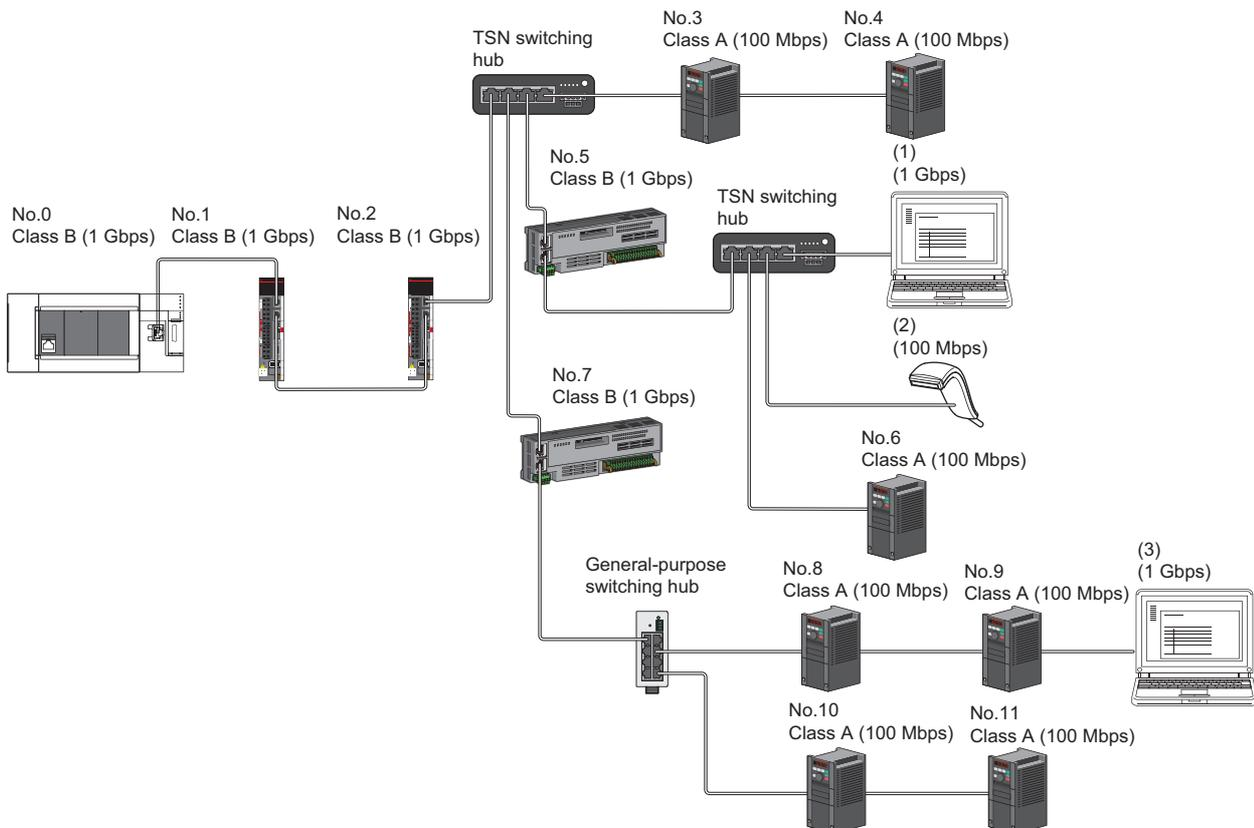

No.0: Master station
 No.1, No.2, No.3, No.4, No.5, No.6, No.7, No.8, No.9, No.10, No.11: Remote station
 (1), (2), (3) Ethernet device
 Class A: CC-Link IE TSN Class A device
 Class B: CC-Link IE TSN Class B device

The availability of connection of network configuration devices varies depending on the communication mode and communication speed.

- Unicast mode

☞ Page 64 When the communication speed for the master station is set to 1 Gbps

☞ Page 64 When the communication speed for the master station is set to 100 Mbps

The following terms are used to describe the terms in the tables referenced.

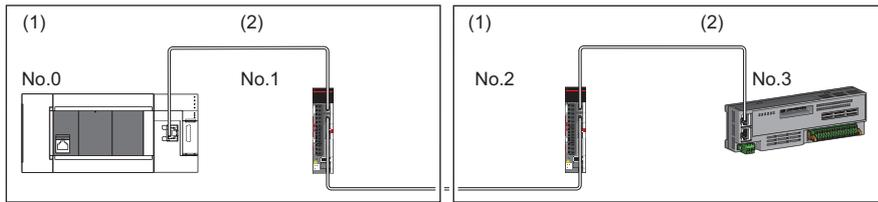

No.0: Master station

No.1, No.2, No.3: Remote station

(1) Device on the master station side (The master station or a device near the master station)

(2) Device on the end side (A device far from the master station)

Structure of unicast mode

This mode indicates the availability of connection with a network configuration device when "Communication Mode" under "Application Settings" is set to "Unicast".

When the communication speed for the master station is set to 1 Gbps

The following table lists the availability of connection with a network configuration device when the communication speed for the master station is set to 1 Gbps.

○: Connection available, ▲: Connection available only with a standard station, △: Connection available via a switching hub, ×: Connection not available

S: TSN switching hub available

H: General-purpose switching hub available

Device on the master station side (A device near the master station)		Device on the end side (A device far from the master station)					
		Remote station (CC-Link IE TSN Class B device)		Remote station (CC-Link IE TSN Class A device)		Ethernet device	
		1G bps	100 Mbps	1 Gbps	100 Mbps	1G bps	100 Mbps
Master station (CC-Link IE TSN Class B device)	1G bps	○S	▲△S ^{*1}	○SH ^{*2}	▲△SH ^{*1*2}	○SH	△SH
	100 Mbps	×	▲△S ^{*1*3}	○SH ^{*2}	▲△SH ^{*1*2}	○SH	△SH
Remote station (CC-Link IE TSN Class B device)	1G bps	×	×	○SH	▲△SH ^{*1}	○SH	△SH
	100 Mbps	×	×	×	▲SH ^{*1}	×	○SH
Remote station (CC-Link IE TSN Class A device)	1G bps	×	×	×	○SH	×	○SH
	100 Mbps	×	×	×	○SH	×	○SH

*1 For a device station with a communication speed of 100 Mbps, set "Communication Period Setting" to "Low-Speed".

*2 Use of a TSN switching hub is recommended if CC-Link IE TSN Class A devices are connected via a switching hub.

*3 A connection cannot be established if the total cyclic data size of all device stations on the 100 Mbps device side exceeds 2K bytes. This includes the devices with a communication speed of 100 Mbps that form a boundary between the communication speed of 1 Gbps and 100 Mbps. (Page 97 Calculation of the total cyclic data size)

Precautions

When a TSN switching hub is used, check the TSN switching hub specifications on the CC-Link Partner Association website (www.cc-link.org).

When the communication speed for the master station is set to 100 Mbps

This mode indicates the availability of connection with a network configuration device when "Communication Speed" of the master station is set to "100 Mbps".

○: Connection available, △: Connection available via a switching hub, ×: Connection not available

S: TSN switching hub available

H: General-purpose switching hub available

Device on the master station side (A device near the master station)		Device on the end side (A device far from the master station)					
		Remote station (CC-Link IE TSN Class B device)		Remote station (CC-Link IE TSN Class A device)		Ethernet device	
		1 Gbps	100 Mbps	1 Gbps	100 Mbps	1 Gbps	100 Mbps
Master station (CC-Link IE TSN Class B device)	100 Mbps	×	○S ^{*1}	×	○SH ^{*2}	×	○SH
	1 Gbps	×	×	×	×	×	×
Remote station (CC-Link IE TSN Class B device)	100 Mbps	×	○S ^{*1}	×	○SH ^{*2}	×	○SH
	1 Gbps	×	×	×	×	×	×
Remote station (CC-Link IE TSN Class A device)	1 Gbps	×	×	×	○SH	×	○SH
	100 Mbps	×	×	×	○SH	×	○SH

- *1 For a device station with a communication speed of 100 Mbps, set "Communication Period Setting" to "Basic Period" or "Normal-Speed".
- *2 Use of a TSN switching hub is recommended if CC-Link IE TSN Class A devices are connected via a switching hub.

Precautions

When a TSN switching hub is used, check the TSN switching hub specifications on the CC-Link Partner Association website (www.cc-link.org).

Structure with modules on CC-Link IE TSN only

Connection with modules on CC-Link IE TSN only

Line topology

Connect a CC-Link IE TSN Class A device to the end of a CC-Link IE TSN Class B device.

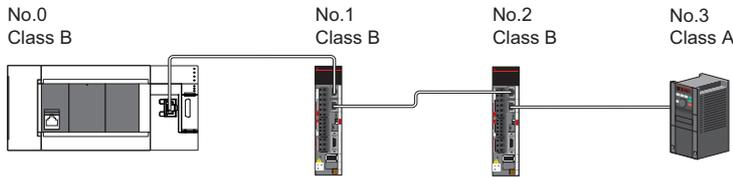

No.0: Master station
 No.1, No.2, No.3: Remote station
 Class A: CC-Link IE TSN Class A device
 Class B: CC-Link IE TSN Class B device

Star topology

The network is configured in a star topology via a switching hub.

- When connecting CC-Link IE TSN Class B devices in a star topology, connect them with a TSN switching hub.

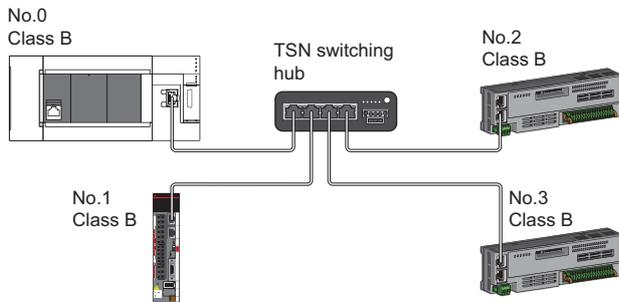

No.0: Master station
 No.1, No.2, No.3: Remote station
 Class B: CC-Link IE TSN Class B device

- When connecting CC-Link IE TSN Class A devices in a star topology, connect them via a TSN switching hub or general-purpose switching hub.

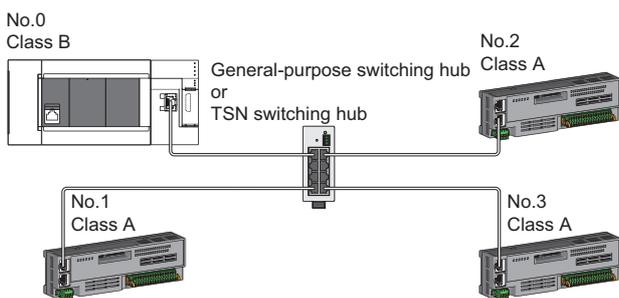

No.0: Master station
 No.1, No.2, No.3: Remote station
 Class A: CC-Link IE TSN Class A device
 Class B: CC-Link IE TSN Class B device

■ Coexistence of line and star topologies

Line and star topologies can be mixed according to the availability of connection as described below.

- When connecting CC-Link IE TSN Class A devices in a star topology, connect them with a TSN switching hub or general-purpose switching hub.

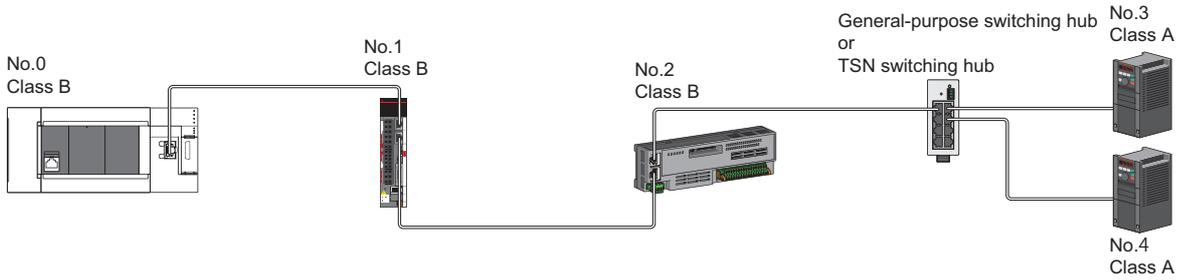

No.0: Master station
 No.1, No.2, No.3, No.4: Remote station
 Class A: CC-Link IE TSN Class A device
 Class B: CC-Link IE TSN Class B device

- When connecting CC-Link IE TSN Class B devices in a star topology, connect them with a TSN switching hub.

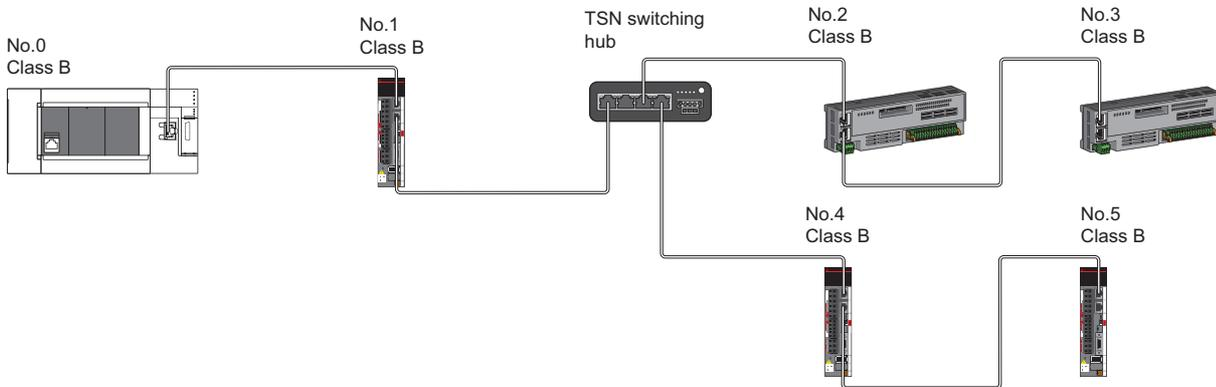

No.0: Master station
 No.1, No.2, No.3, No.4, No.5: Remote station
 Class B: CC-Link IE TSN Class B device

- When connecting CC-Link IE TSN Class A devices in a configuration where CC-Link IE TSN Class B devices are connected to a TSN switching hub, connect CC-Link IE TSN Class A devices via the TSN switching hub.

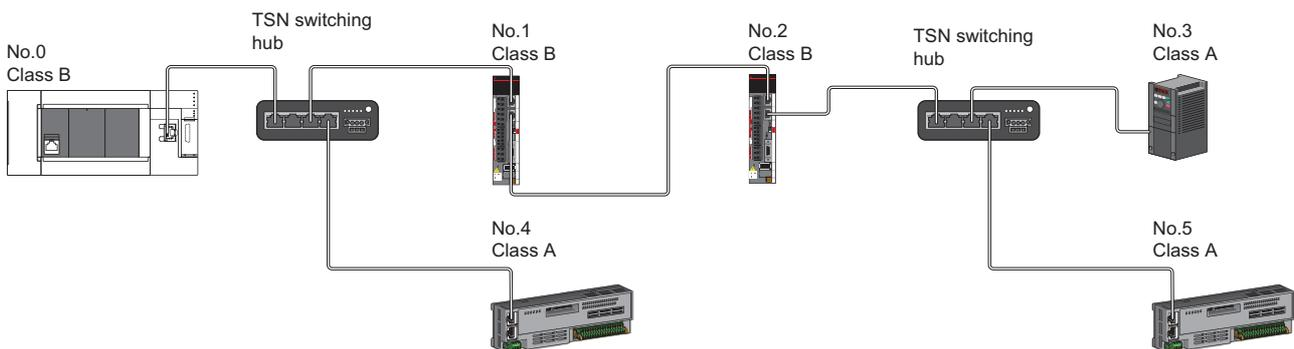

No.0: Master station
 No.1, No.2, No.3, No.4, No.5: Remote station
 Class A: CC-Link IE TSN Class A device
 Class B: CC-Link IE TSN Class B device

Precautions

TSN switching hubs cannot be connected in the following configuration.

- If "TSN HUB Setting" is set to "Not to Use TSN HUB", TSN switching hubs cannot be connected. If a TSN switching hub is connected, device stations may not perform a data link. When connecting a TSN switching hub, set "TSN HUB Setting" to "Use TSN HUB".

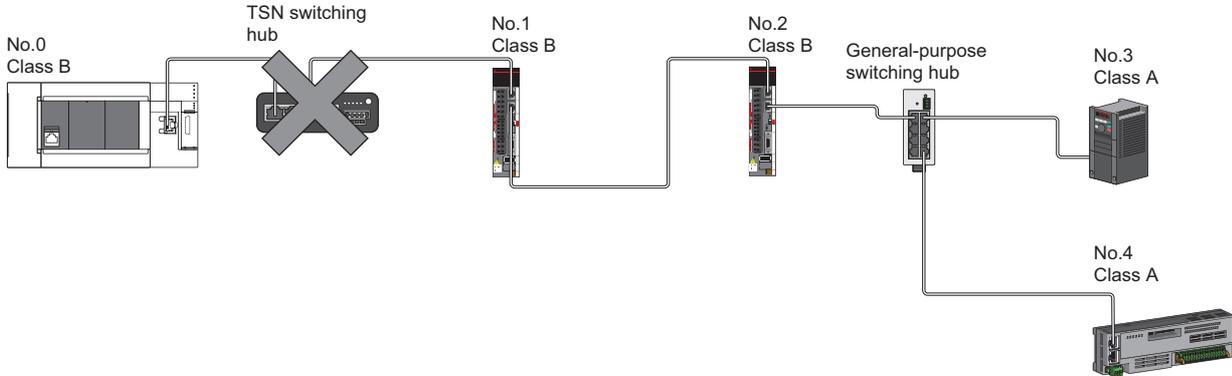

No.0: Master station
 No.1, No.2, No.3, No.4: Remote station
 Class A: CC-Link IE TSN Class A device
 Class B: CC-Link IE TSN Class B device

- If "TSN HUB Setting" is set to "Not to Use TSN HUB", connection in a star topology is not available via a TSN switching hub. If a device station is connected to a TSN switching hub, the device station may not perform a data link. In this case, the error "Connection configuration error" (error code: 1806H) occurs in the master station. When connecting a TSN switching hub, set "TSN HUB Setting" to "Use TSN HUB".

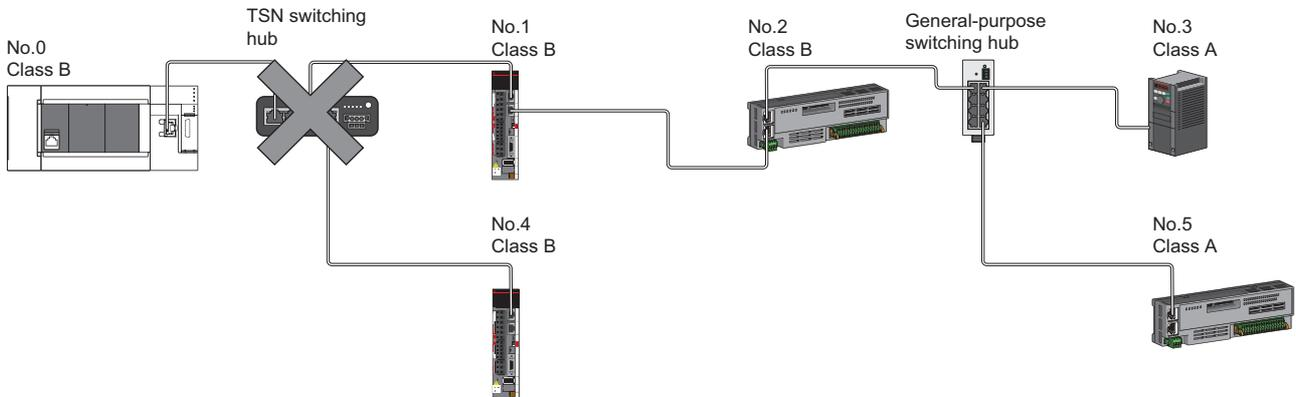

No.0: Master station
 No.1, No.2, No.3, No.4, No.5: Remote station
 Class A: CC-Link IE TSN Class A device
 Class B: CC-Link IE TSN Class B device

Connection with modules on CC-Link IE TSN with a communication speed of 100 Mbps

This section describes the network topology when "Communication Speed" under "Application Settings" is set to "100 Mbps".

Line topology

Adjust the communication speed of the module to 100 Mbps to establish connections. (When connecting modules with different communication speeds, a switching hub is required.)

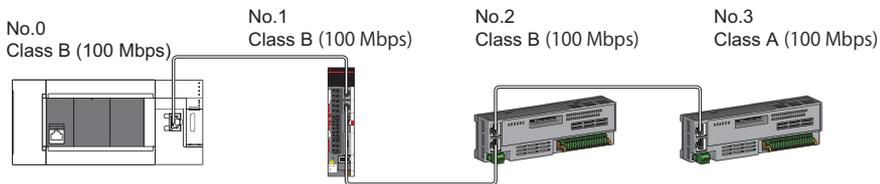

No.0: Master station
No.1, No.2, No.3: Remote station

Star topology

The network is configured in a star topology via a switching hub.

- When the master station with a communication speed of 1 Gbps and a local or remote station with a communication speed of 100 Mbps exist in the structure, set "Communication Period Setting" to "Low-Speed" for the local or remote station with a communication speed of 100 Mbps.

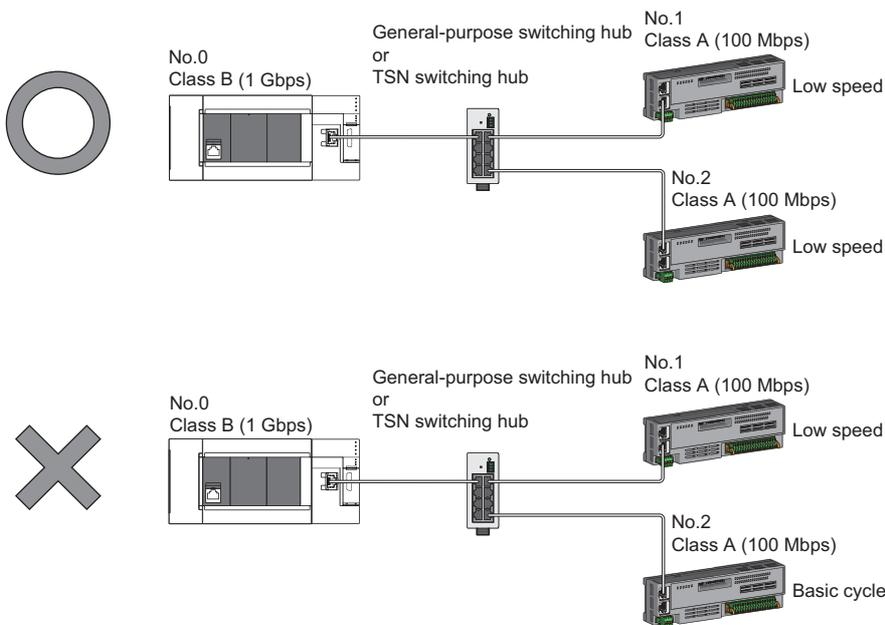

No.0: Master station
No.1, No.2: Remote station
Class A: CC-Link IE TSN Class A device
Class B: CC-Link IE TSN Class B device

■ Coexistence of line and star topologies

Line and star topologies can be mixed in the same network configuration.

- When the master station with a communication speed of 1 Gbps and a local or remote station with a communication speed of 100 Mbps exist in the structure, set "Communication Period Setting" to "Low-Speed" for the local or remote station with a communication speed of 100 Mbps.

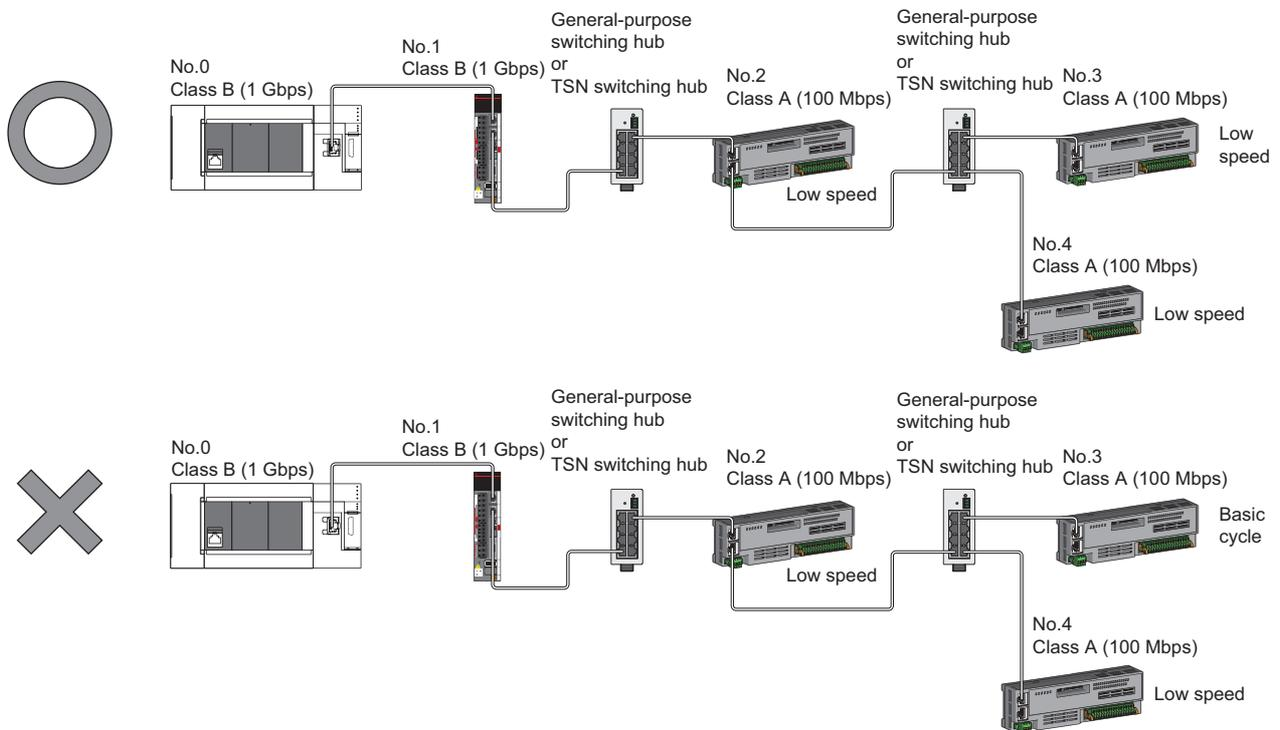

No.0: Master station
 No.1, No.2, No.3, No.4: Remote station
 Class A: CC-Link IE TSN Class A device
 Class B: CC-Link IE TSN Class B device

- If the communication speed of the master station is 1 Gbps, the total cyclic data size of all device stations on the 100 Mbps device side at the boundary between communication speeds of 1 Gbps and 100 Mbps must not exceed 2K bytes.

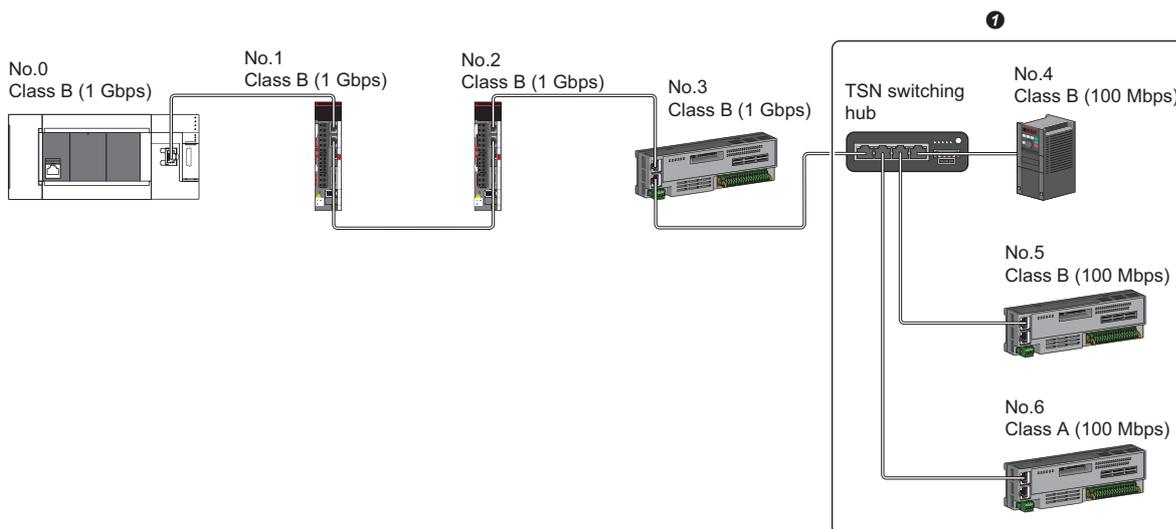

No.0: Master station
 No.1, No.2, No.3, No.4, No.5, No.6: Remote station
 Class A: CC-Link IE TSN Class A device
 Class B: CC-Link IE TSN Class B device

- ① Set the total cyclic data size within 2K bytes.

Structure of modules on CC-Link IE TSN and Ethernet devices

Connection with modules on CC-Link IE TSN and Ethernet devices

■Line topology

The network with modules and devices is configured in a line topology. A general-purpose switching hub is not required. Connect Ethernet devices to the end of the network.

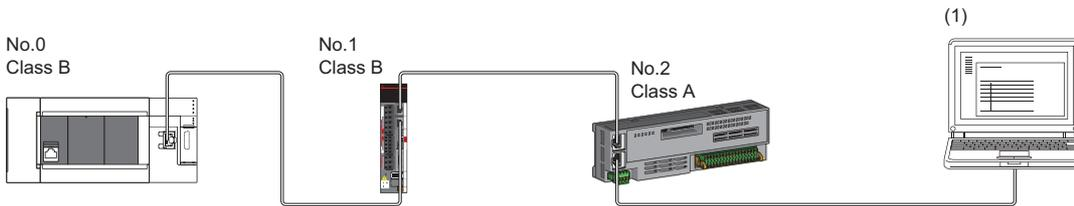

- No.0: Master station
- No.1, No.2: Remote station
- (1) Ethernet device
- Class A: CC-Link IE TSN Class A device
- Class B: CC-Link IE TSN Class B device

When an error occurs in a device station, the stations connected after the faulty station will be disconnected.

■Star topology

The network is configured in a star topology via a switching hub.

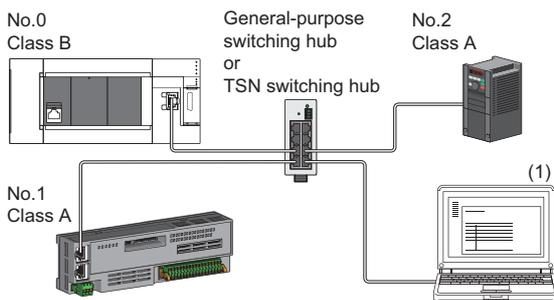

- No.0: Master station
- No.1, No.2: Remote station
- (1) Ethernet device
- Class A: CC-Link IE TSN Class A device
- Class B: CC-Link IE TSN Class B device

■ Coexistence of line and star topologies

Line and star topologies can be mixed according to the availability of each connection.

- Connect Ethernet devices at the end of line topology.
- When connecting the Ethernet device in a star topology, connect it to the TSN switching hub or general-purpose switching hub.

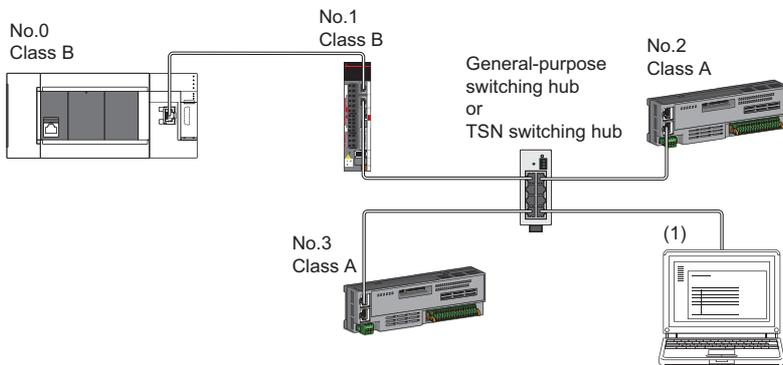

No.0: Master station

No.1, No.2, No.3: Remote station

(1) Ethernet device

Class A: CC-Link IE TSN Class A device

Class B: CC-Link IE TSN Class B device

4.3 Structure of CC-Link IE TSN Class B/A Devices (Mixture of CC-Link IE TSN Protocol version 1.0 and 2.0) and Ethernet Devices

The following diagram shows the system configuration under the conditions below:

- "Mixture of CC-Link IE TSN Class B/A or CC-Link IE TSN Class A Only" set for "Connection Device Information" under "Basic Settings" in the engineering tool
- Master station firmware version "1.002" or later
- CC-Link IE TSN-compatible devices with the CC-Link IE TSN Protocol versions 1.0 and 2.0

For the maximum number of connectable stations when "Connection Device Information" under "Basic Settings" of the master station is set to "Mixture of CC-Link IE TSN Class B/A or CC-Link IE TSN Class A Only", check the following.

☞ Page 20 Performance Specifications of CC-Link IE TSN

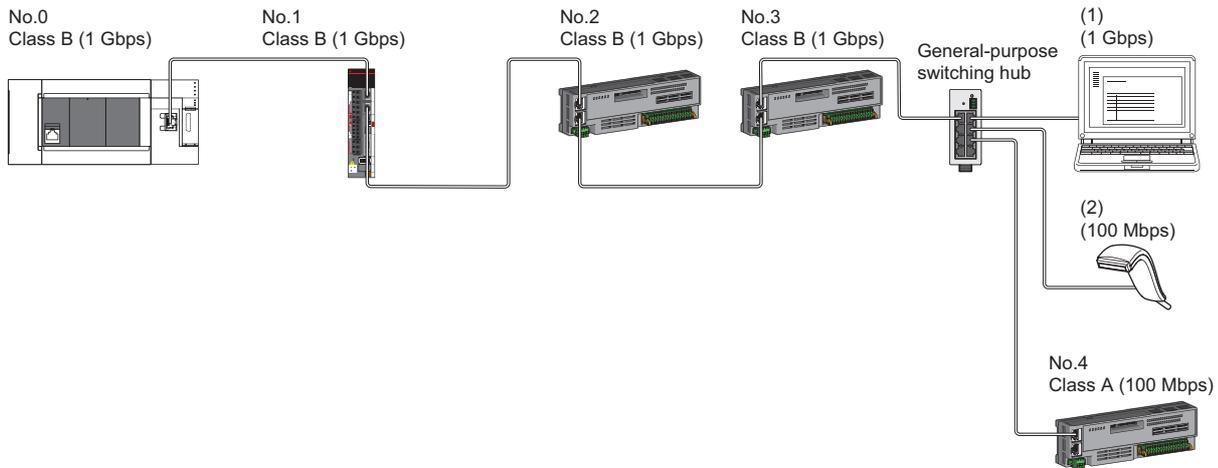

No.0: Master station
 No.1, No.2, No.3, No.4: Remote station
 (1), (2) Ethernet device
 Class A: CC-Link IE TSN Class A device
 Class B: CC-Link IE TSN Class B device

The following terms are used to describe the terms in the tables.

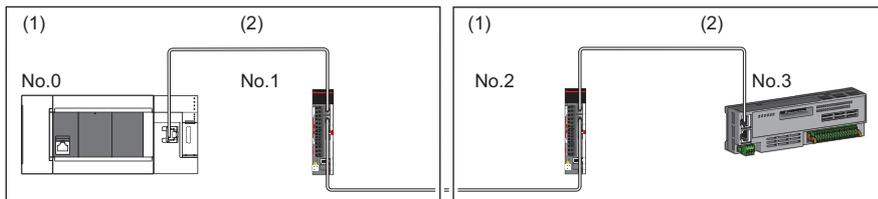

No.0: Master station
 No.1, No.2, No.3: Remote station
 (1) Device on the master station side (The master station or a device near the master station)
 (2) Device on the end side (A device far from the master station)

Precautions

- For details on troubleshooting by symptom, refer to the following.
 - ☞ Page 138 Troubleshooting by Symptom
- The protocol in operation can be found in 'Protocol operating status' (Un\G91270).
- If the device station used is "CC-Link IE TSN Class A" and "Communication Period Setting" is set to "Low-Speed", sending/receiving cyclic data within the "Low-Speed" period to/from the device station with "Communication Period Setting" set to "Low-Speed" cannot be guaranteed depending on the setting values for the maximum response time for the time managed polling method, communication period interval, and low-speed setting. In this case, the error "Communication period setting error" (error code: 31ABH) occurs and the Motion module stops.
- If "CC-Link IE TSN Class Setting" is "CC-Link IE TSN Class A" and a device station where "Communication Period Setting" is set to "Low-Speed" exists, parameter values that can guarantee the sending/receiving of cyclic data to/from the device station whose "Communication Period Setting" is set to "Low-Speed" within the "Low-Speed" period are stored in "Multiple cycle setting (low speed)" (Un\G91312) and "Communication cycle intervals (calculation value)" (Un\G91313). Set the "Multiple Period Setting" to "Low-Speed" and "Communication Period Interval Setting" to a value equal to or greater than the value stored in "Multiple cycle setting (low speed)" (Un\G91312) and "Communication cycle intervals (calculation value)" (Un\G91313).
- When "CC-Link IE TSN Class Setting" of the general CC-Link IE TSN module added to "Network Configuration Settings" is set to "CC-Link IE TSN Class A", if "Multiple Period Setting" is set to "Low-Speed" and "Communication Period Interval Setting" is set to 'Multiple period setting (low speed)' (Un\G91312) and 'Communication cycle interval (calculation value)' (Un\G91313), the cyclic data may not be sent/received. In this case, add the actual device to be used to "Network Configuration Settings", or refer to the manual for the device used to check the maximum response time for the time managed polling method and calculate and set the communication cycle interval setting value.

Operation when versions of connected devices are combined

The following tables show whether restrictions apply to possible combinations of connected devices that support the CC-Link IE TSN Protocol version 2.0 and those that do not.

- Restrictions: Up to eight CC-Link IE TSN Class B devices can be connected to the master station.

CC-Link IE TSN Protocol version 2.0 support		Restrictions
CC-Link IE TSN Class A device	CC-Link IE TSN Class B device	
Non-supporting products included	Non-supporting products included	Yes
	Supporting products only	Yes
Supporting products only	Non-supporting products included	No
	Supporting products only	No

- Restrictions: Connection cannot be made if the total cyclic data size of all device stations on the CC-Link IE TSN Class A device side that form a boundary between CC-Link IE TSN Class B and CC-Link IE TSN Class A devices exceeds 2K bytes.

CC-Link IE TSN Protocol version 2.0 support		Restrictions
CC-Link IE TSN Class A device	CC-Link IE TSN Class B device	
Non-supporting products included	Non-supporting products included	Yes
	Supporting products only	Yes
Supporting products only	Non-supporting products included	Yes
	Supporting products only	No

Operation when combined with versions of other products

The following tables show how parameters used for the Motion module operate in combination with other products that support or do not support the CC-Link IE TSN Protocol version 2.0.

- "CC-Link IE TSN Class Setting" for each device station in the "CC-Link IE TSN Configuration" window of the "Network Configuration Settings"

CC-Link IE TSN Protocol version 2.0 support		Operation
Engineering tool	Module	
Not supported	Not supported	CC-Link IE TSN Protocol version 1.0
	Supported	CC-Link IE TSN Protocol version 1.0
Supported	Not supported	CC-Link IE TSN Protocol version 1.0
	Supported	CC-Link IE TSN Protocol version 1.0/2.0

- Multiplier setting for "Low-Speed" in "Multiple Period Setting" under "Basic Settings"

CC-Link IE TSN Protocol version 2.0 support		Operation
Engineering tool	Module	
Not supported	Not supported	Only "×16" settable
	Supported	Only "×16" settable
Supported	Not supported	A value other than "×16" results in the error "Network parameter error" (error code: 2221H).
	Supported	"×16", "×32", "×64", or "×128" selectable

- "TSN HUB Setting" in "Connection Device Information" under "Basic Settings"

CC-Link IE TSN Protocol version 2.0 support		Operation
Engineering tool	Module	
Not supported	Not supported	Setting not allowed
	Supported	Setting not allowed
Supported	Not supported	CC-Link IE TSN Protocol version 1.0 regardless of the setting value
	Supported	Operate according to the setting value

Precautions

If parameters are written with an engineering tool of software version "1.085P" or later for a project created with an engineering tool of software version earlier than "1.085P" without opening "Network Configuration Settings" once, the module operates with the CC-Link IE TSN Protocol version 1.0.

Connection configuration of CC-Link IE TSN-compatible devices

The following table shows time synchronization methods based on the CC-Link IE TSN Protocol version 2.0 support status of each CC-Link IE TSN-compatible device in the network.

With CC-Link IE TSN Protocol version 1.0: Devices that do not support the CC-Link IE TSN Protocol version 2.0 are included.

CC-Link IE TSN Protocol version 2.0 only: There are only devices that support the CC-Link IE TSN Protocol version 2.0.

Mixture of device station CC-Link IE TSN Protocol version 1.0/2.0		Time synchronization method for devices				Connection specifications
CC-Link IE TSN Class A device	CC-Link IE TSN Class B device	CC-Link IE TSN Class A device		CC-Link IE TSN Class B device		
		CC-Link IE TSN Protocol version 1.0	CC-Link IE TSN Protocol version 2.0	CC-Link IE TSN Protocol version 1.0	CC-Link IE TSN Protocol version 2.0	
With CC-Link IE TSN Protocol version 1.0	With CC-Link IE TSN Protocol version 1.0	IEEE 1588	Not available	IEEE 1588	IEEE 1588	Refer to the following. ☞ Page 77 Structure of CC-Link IE TSN Class B/A Devices (CC-Link IE TSN Protocol version 1.0 Only) and Ethernet Devices
	CC-Link IE TSN Protocol version 2.0 only	IEEE 1588	Not available	—	IEEE 1588	
CC-Link IE TSN Protocol version 2.0 only	With CC-Link IE TSN Protocol version 1.0	—	Not available	IEEE 802.1AS	IEEE 802.1AS	Refer to the following. ☞ Page 62 Structure of CC-Link IE TSN Class B/A Devices (CC-Link IE TSN Protocol version 2.0 Only) and Ethernet Devices
	CC-Link IE TSN Protocol version 2.0 only	—	Not available	—	IEEE 802.1AS	

Precautions

- The protocol in operation can be found in 'Protocol operating status' (Un\G91270) in the buffer memory.
- While a device is operating with the CC-Link IE TSN Protocol version 2.0, device stations that do not support the CC-Link IE TSN Protocol version 2.0 may not perform a data link. If a device station that does not support the CC-Link IE TSN Protocol version 2.0 is detected, that station does not perform a data link, the event code 00C80 is registered on the master station, and the information about the station that does not support it is stored in 'CC-Link IE TSN Protocol version 2.0 support status for each station' (SW01A0 to SW01A7).
- In a configuration where devices with the CC-Link IE TSN Protocol versions 2.0 and 1.0 coexist, if data link starts late on CC-Link IE TSN Class A devices due to variation in power-on sequences and start times of device stations at system startup, devices with the CC-Link IE TSN Protocol version 1.0 may not perform a data link. (The event code 00C80 is registered on the master station.)

4.4 Structure of CC-Link IE TSN Class B/A Devices (CC-Link IE TSN Protocol version 1.0 Only) and Ethernet Devices

The following diagram shows the system configuration under the conditions below:

- "Mixture of CC-Link IE TSN Class B/A or CC-Link IE TSN Class A Only" set for "Connection Device Information" under "Basic Settings" in the engineering tool
- When the firmware version of the master station is "1.001" or earlier or there are only CC-Link IE TSN-compatible devices with the CC-Link IE TSN Protocol version 1.0

For the maximum number of connectable stations when "Connection Device Information" under "Basic Settings" of the master station is set to "Mixture of CC-Link IE TSN Class B/A or CC-Link IE TSN Class A Only", check the following.

☞ Page 20 Performance Specifications of CC-Link IE TSN

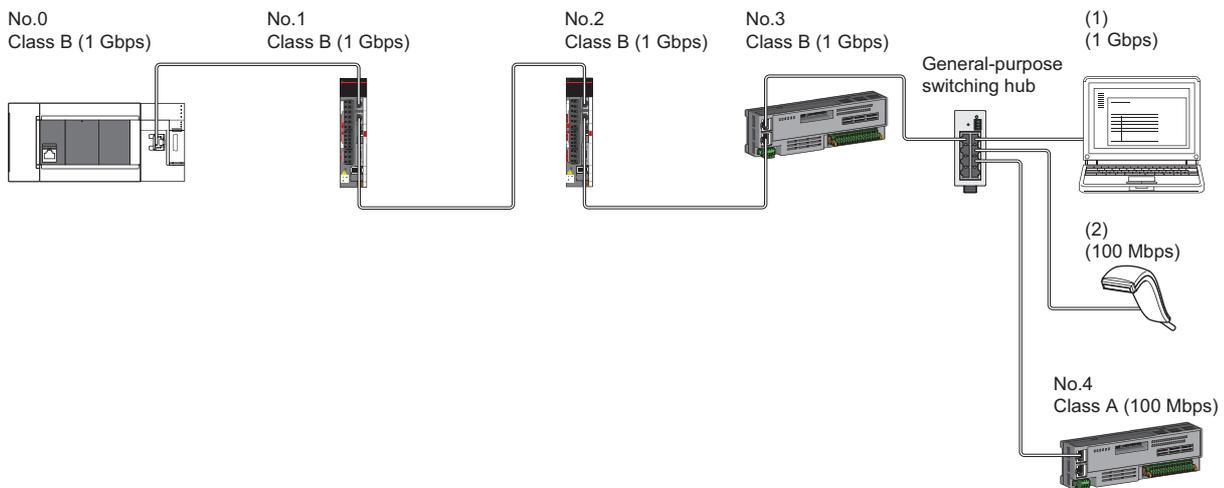

No.0: Master station
 No.1, No.2, No.3, and No.4: Remote station
 (1) and (2): Ethernet device
 Class A: CC-Link IE TSN Class A device
 Class B: CC-Link IE TSN Class B device

The availability of connection of network configuration devices varies depending on the communication mode and communication speed.

- Unicast mode

☞ Page 78 When the communication speed for the master station is set to 1 Gbps

☞ Page 78 When the communication speed for the master station is set to 100 Mbps

The following terms are used to describe the terms in the tables referenced.

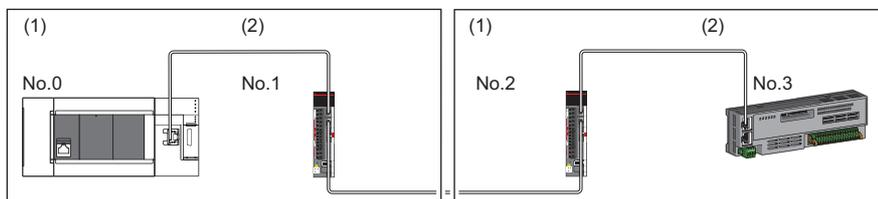

No.0: Master station
 No.1 and No.2: Remote station
 (1) Device on the master station side (The master station or a device near the master station)
 (2) Device on the end side (A device far from the master station)

Structure of unicast mode

The following indicates the availability of connection with a network configuration device.

When the communication speed for the master station is set to 1 Gbps

The following table lists the availability of connection with a network configuration device when the communication speed for the master station is set to 1 Gbps.

- : Connection available, ▲: Connection available only with a standard station, △: Connection available via a switching hub,
- ×: Connection not available
- S: TSN switching hub available
- H: General-purpose switching hub available

Device on the master station side (A device near the master station)		Device on the end side (A device far from the master station)					
		Remote station (CC-Link IE TSN Class B device)		Remote station (CC-Link IE TSN Class A device)		Ethernet device	
		1 Gbps	100 Mbps	1 Gbps	100 Mbps	1 Gbps	100 Mbps
Master station (CC-Link IE TSN Class B device)	1 Gbps	○S	▲△S ^{*1}	○SH	▲△SH ^{*1}	○SH	△SH
	100 Mbps	×	▲△S ^{*1*3}	×	▲SH ^{*1*2*3}	×	○SH
Remote station (CC-Link IE TSN Class A device)	1 Gbps	×	×	○SH ^{*2}	▲△SH ^{*1*2}	○SH	△SH
	100 Mbps	×	×	×	▲SH ^{*1*2}	×	○SH

- *1 For a device station with a communication speed of 100 Mbps, set "Communication Period Setting" to "Low-Speed".
- *2 Connection cannot be made if the total cyclic data size of all device stations on the CC-Link IE TSN Class A device side that form a boundary between CC-Link IE TSN Class B and CC-Link IE TSN Class A devices exceeds 2K bytes.
- *3 A connection cannot be established if the total cyclic data size of all device stations on the 100 Mbps device side exceeds 2K bytes. This includes the devices with a communication speed of 100 Mbps that form a boundary between the communication speed of 1 Gbps and 100 Mbps.

Precautions

When a TSN switching hub is used, check the TSN switching hub specifications on the CC-Link Partner Association website (www.cc-link.org).

When the communication speed for the master station is set to 100 Mbps

This mode indicates the availability of connection with a network configuration device when "Communication Speed" of the master station is set to "100 Mbps".

- : Connection available, △: Connection available via a switching hub, ×: Connection not available
- S: TSN switching hub available
- H: General-purpose switching hub available

Device on the master station side (A device near the master station)		Device on the end side (A device far from the master station)					
		Remote station (CC-Link IE TSN Class B device)		Remote station (CC-Link IE TSN Class A device)		Ethernet device	
		1 Gbps	100 Mbps	1 Gbps	100 Mbps	1 Gbps	100 Mbps
Master station (CC-Link IE TSN Class B device)	100 Mbps	×	○S ^{*2}	×	○SH	×	○SH
	1 Gbps	×	×	×	×	×	×
Remote station (CC-Link IE TSN Class A device)	1 Gbps	×	×	×	×	×	×
	100 Mbps	×	○S ^{*2}	×	○SH ^{*1}	×	○SH

- *1 Connection cannot be made if the total cyclic data size of all device stations on the CC-Link IE TSN Class A device side that form a boundary between CC-Link IE TSN Class B and CC-Link IE TSN Class A devices exceeds 2K bytes. ( Page 97 Calculation of the total cyclic data size)
- *2 For a device station with a communication speed of 100 Mbps, set "Communication Period Setting" to "Basic Period" or "Normal-Speed".

Precautions

When a TSN switching hub is used, check the TSN switching hub specifications on the CC-Link Partner Association website (www.cc-link.org).

Structure with modules on CC-Link IE TSN

Connection with modules on CC-Link IE TSN only

Line topology

The network is configured in a line topology.

- Up to eight CC-Link IE TSN Class B devices can be connected to the master station.

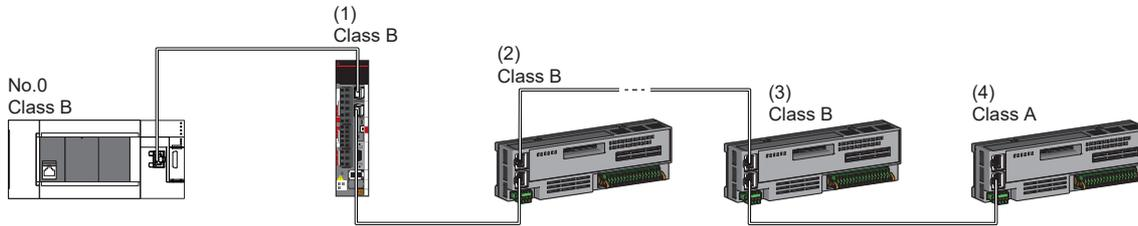

No.0: Master station
 (1) Remote station (1st station)
 (2) Remote station (2nd station)
 (3) Remote station (8th station)
 (4) Remote station (9th station)
 Class A: CC-Link IE TSN Class A device
 Class B: CC-Link IE TSN Class B device

- A CC-Link IE TSN Class B device cannot be connected to a CC-Link IE TSN Class A device.

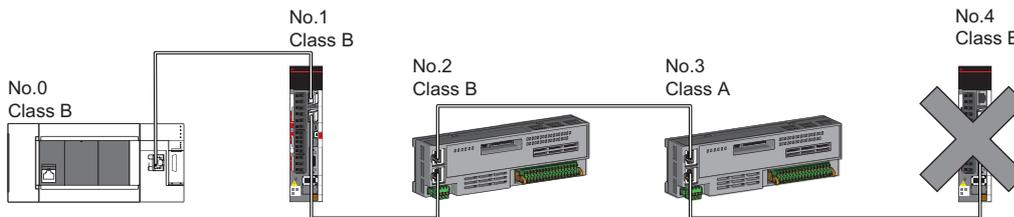

No.0: Master station
 No.1, No.2, No.3, and No.4: Remote station
 Class A: CC-Link IE TSN Class A device
 Class B: CC-Link IE TSN Class B device

- Connection cannot be made if the total cyclic data size of all device stations on the CC-Link IE TSN Class A device side that form a boundary between CC-Link IE TSN Class B and CC-Link IE TSN Class A devices exceeds 2K bytes.

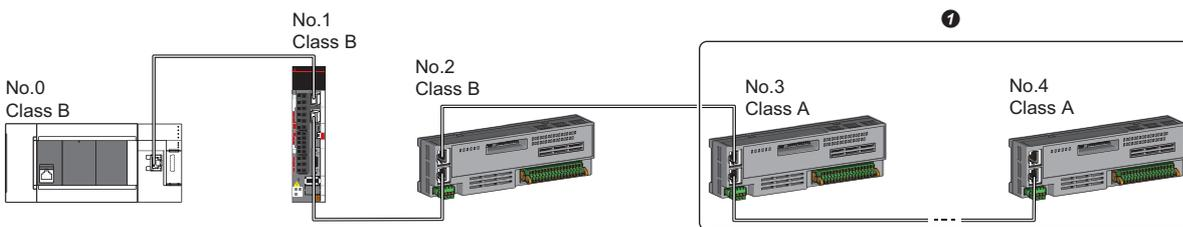

No.0: Master station
 No.1, No.2, No.3, and No.4: Remote station
 Class A: CC-Link IE TSN Class A device
 Class B: CC-Link IE TSN Class B device
 ① Set the total cyclic data size within 2K bytes.

- When the device stations are CC-Link IE TSN Class A devices only, up to 16 device stations can be connected.

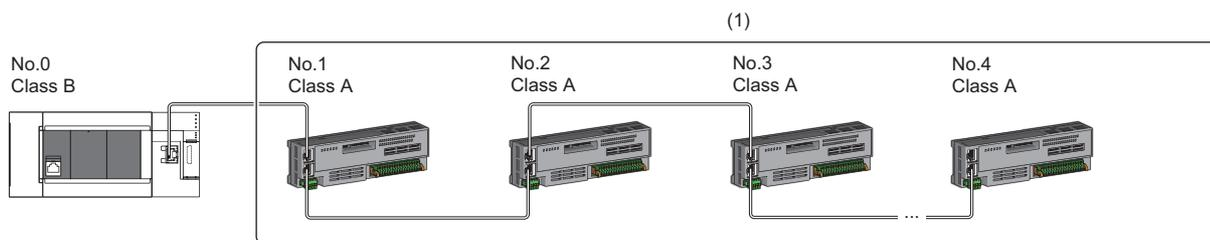

No.0: Master station
 No.1, No.2, No.3, No.4: Remote station
 Class A: CC-Link IE TSN Class A device
 Class B: CC-Link IE TSN Class B device
 (1): Total number of device stations: Up to 16

■ Star topology

The network is configured in a star topology via a switching hub.

- When connecting CC-Link IE TSN Class B devices in a star topology, a TSN switching hub must be used.

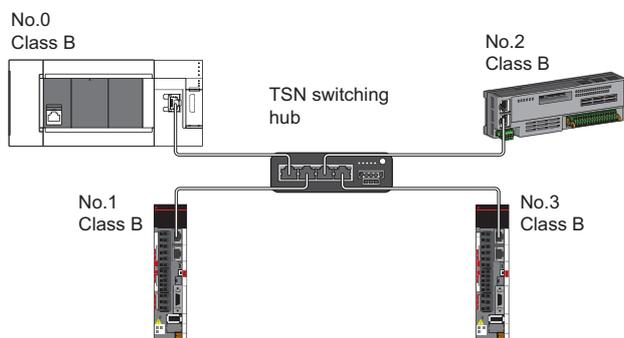

No.0: Master station
 No.1, No.2, No.3, No.4: Remote station
 Class B: CC-Link IE TSN Class B device

- To connect a CC-Link IE TSN Class A device to a CC-Link IE TSN Class B device in a star topology or to connect a CC-Link IE TSN Class A device to a CC-Link IE TSN Class A device in a star topology, connect them via a TSN switching hub or general-purpose switching hub.

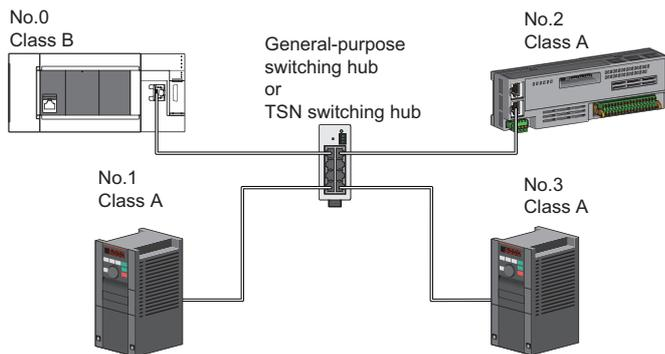

No.0: Master station
 No.1, No.2, and No.3: Remote station
 Class A: CC-Link IE TSN Class A device
 Class B: CC-Link IE TSN Class B device

■ Coexistence of line and star topologies

Line and star topologies can be mixed according to the availability of connection as described below.

- Configure the number of the CC-Link IE TSN Class B device stations and TSN switching hubs to eight or less in total on the transmission path from the master station to the CC-Link IE TSN Class B device of the end.
- When connecting CC-Link IE TSN Class A devices, they must be connected to the end side of a CC-Link IE TSN Class B device or to a TSN switching hub. In this case, a star topology is also possible by using a TSN switching hub or general-purpose switching hub.

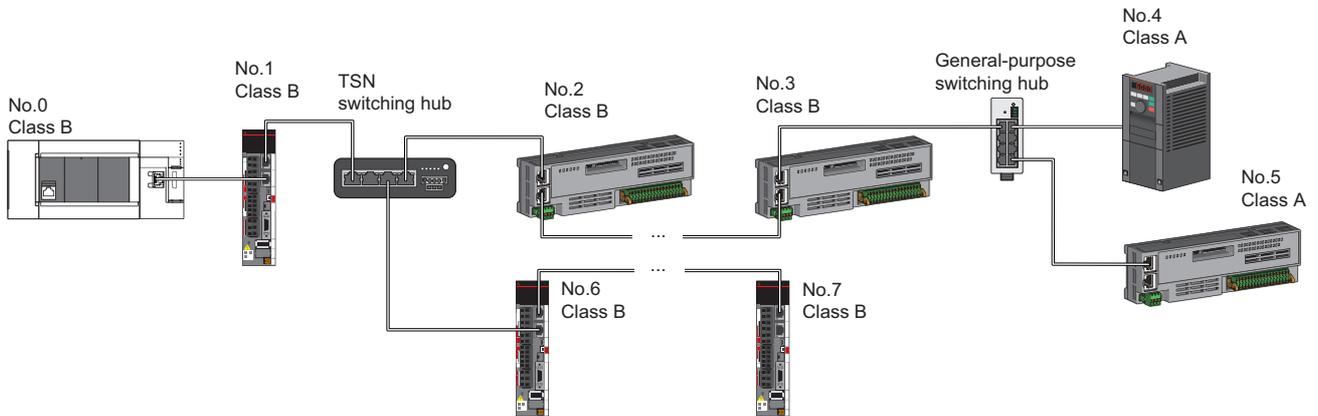

No.0: Master station
 No.1: Remote station (1st station)
 No.3, No.7: Remote station (8th station)
 No.2, No.4, No.5, No.6: Remote station
 Class A: CC-Link IE TSN Class A device
 Class B: CC-Link IE TSN Class B device

- Connection cannot be made if the total cyclic data size of all device stations on the CC-Link IE TSN Class A device side that form a boundary between CC-Link IE TSN Class B and CC-Link IE TSN Class A devices exceeds 2K bytes.

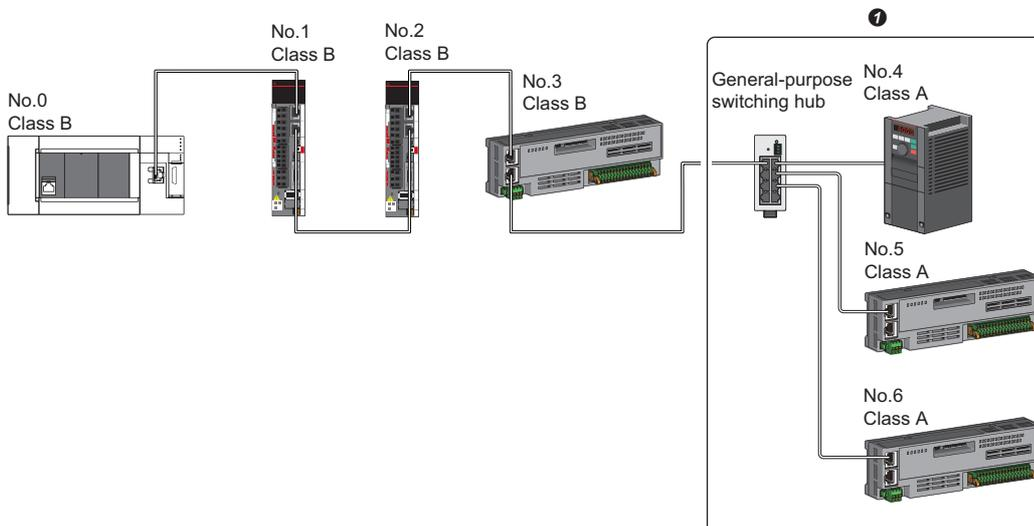

No.0: Master station
 No.1, No.2, No.3, No.4, No.5, and No.6: Remote station
 Class A: CC-Link IE TSN Class A device
 Class B: CC-Link IE TSN Class B device

- ❶ Set the total cyclic data size within 2K bytes.

Connection with modules on CC-Link IE TSN with a communication speed of 100 Mbps

This section describes the network topology when "Communication Speed" under "Application Settings" is set to "100 Mbps".

Line topology

In a configuration where modules with a communication speed of 100 Mbps exist, the communication speed must be the same for all connected modules. When connecting modules with different communication speeds, a general-purpose switching hub is required. Therefore, the line topology is not available for the Motion module.

Star topology

The network is configured in a star topology via a switching hub.

- When the master station with a communication speed of 1 Gbps and a remote station with a communication speed of 100 Mbps exist in the structure, set "Communication Period Setting" to "Low-Speed" for the remote station with a communication speed of 100 Mbps.

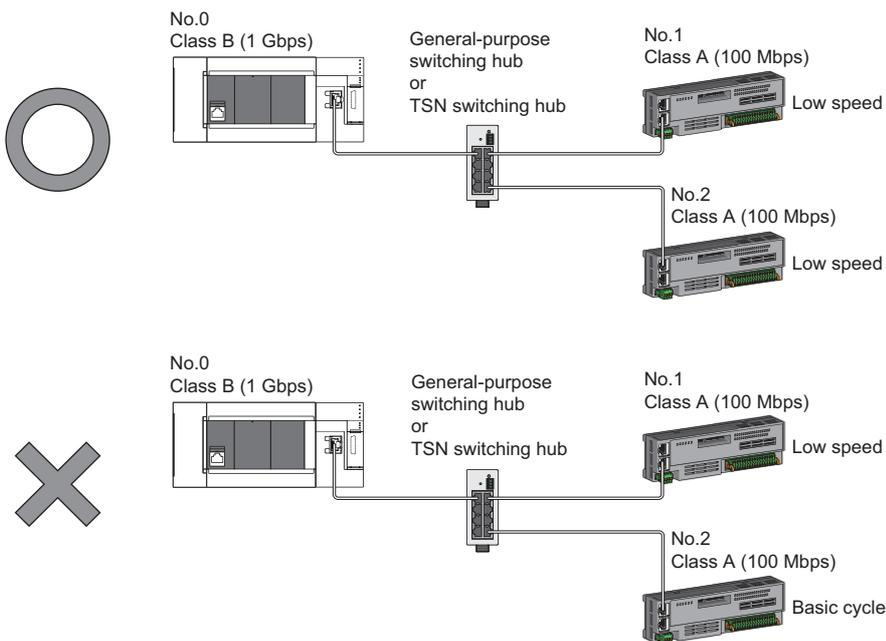

No.0: Master station
No.1, No.2: Remote station
Class A: CC-Link IE TSN Class A device
Class B: CC-Link IE TSN Class B device

■ Coexistence of line and star topologies

Line and star topologies can be mixed in the same network configuration.

- Configure the number of the CC-Link IE TSN Class B device stations and TSN switching hubs to eight or less in total on the transmission path from the master station to the CC-Link IE TSN Class B device of the end.
- When the master station with a communication speed of 1 Gbps and a remote station with a communication speed of 100 Mbps exist in the structure, set "Communication Period Setting" to "Low-Speed" for the remote station with a communication speed of 100 Mbps.

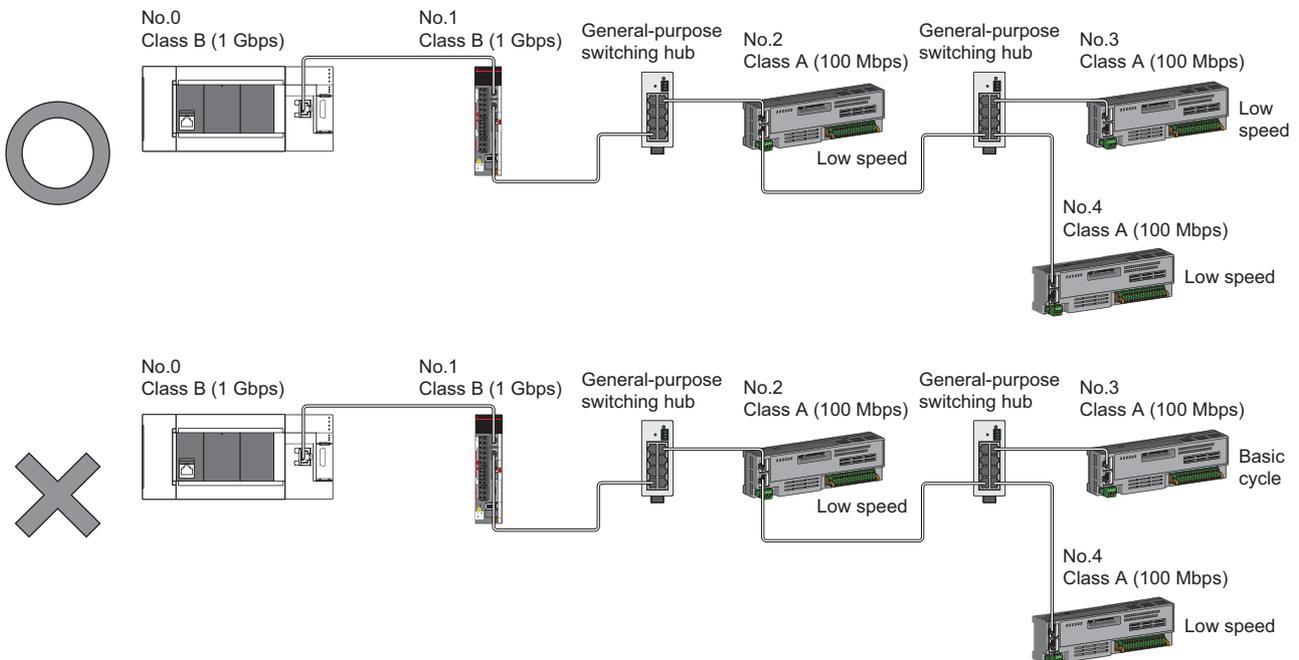

No.0: Master station
 No.1, No.2, No.3, and No.4: Remote station
 Class A: CC-Link IE TSN Class A device
 Class B: CC-Link IE TSN Class B device

- When the communication speed of the master station is 1 Gbps, a connection cannot be established if the total cyclic data size of all device stations on the 100 Mbps device side exceeds 2K bytes. This includes the devices with a communication speed of 100 Mbps that form a boundary between the communication speed of 1 Gbps and 100 Mbps.

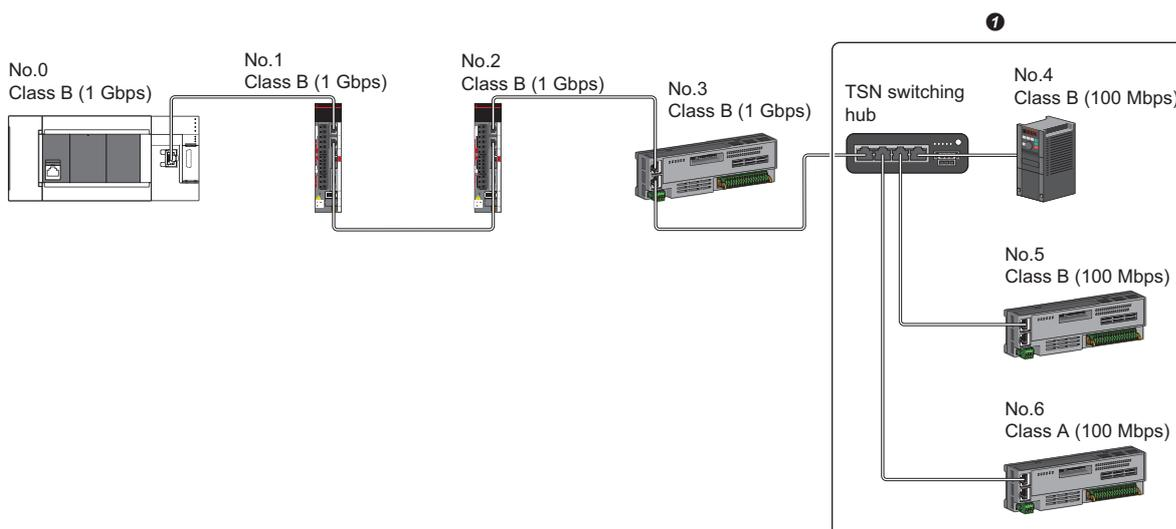

No.0: Master station
 No.1, No.2, No.3, No.4, No.5, No.6: Remote station
 ❶ Set the total cyclic data size within 2K bytes.

Structure of modules on CC-Link IE TSN and Ethernet devices

Connection with modules on CC-Link IE TSN and Ethernet devices

Line topology

The network with modules and devices is configured in a line topology. A general-purpose switching hub is not required. Up to eight CC-Link IE TSN Class B devices can be connected to the master station at the position indicated with (1). Connect Ethernet devices to the end of the network.

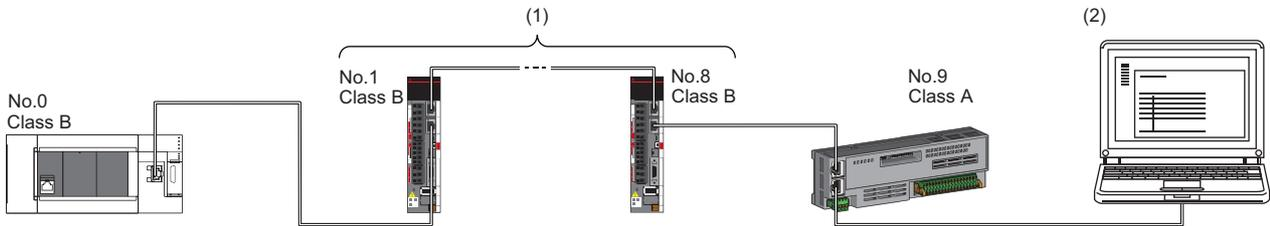

- No.0: Master station
- No.1: Remote station (1st station)
- No.8: Remote station (8th station)
- No.9: Remote station (9th station)
- (2) Ethernet device
- Class A: CC-Link IE TSN Class A device
- Class B: CC-Link IE TSN Class B device

When an error occurs in a device station, the stations connected after the faulty station will be disconnected.

Star topology

Modules or devices are connected in a star topology via a general-purpose switching hub.

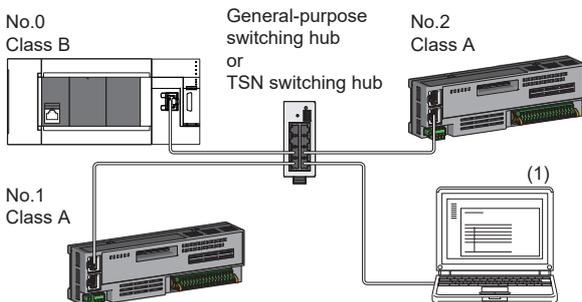

- No.0: Master station
- No.1, No.2: Remote station
- (1) Ethernet device (such as a personal computer)
- Class A: CC-Link IE TSN Class A device
- Class B: CC-Link IE TSN Class B device

■ Coexistence of line and star topologies

Line and star topologies can be mixed according to the availability of each connection.

- Configure the number of the CC-Link IE TSN Class B device stations and TSN switching hubs to eight or less in total on the transmission path from the master station to the CC-Link IE TSN Class B device of the end.
- Connect Ethernet devices at the end of line topology.
- When connecting the Ethernet device in a star topology, connect it to the general-purpose switching hub or TSN switching hub.

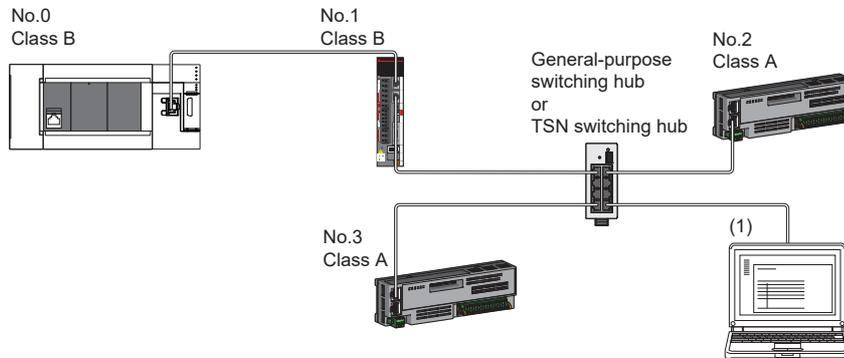

No.0: Master station

No.1, No.2, and No.3: Remote station

(1): Ethernet device

Class A: CC-Link IE TSN Class A device

Class B: CC-Link IE TSN Class B device

4.5 Connection Examples

Category	Connection	Description	Reference
Structure of CC-Link IE TSN Class B devices only	Connection of servo amplifiers, remote I/O modules and inverters (for line topology)	<ul style="list-style-type: none"> The master station and all of the device stations are CC-Link IE TSN Class B. Line topology 	Page 87 Connection of servo amplifiers, remote I/O modules, and inverters (for line topology)
	Connection of servo amplifiers, remote I/O modules and inverters (for star topology)	<ul style="list-style-type: none"> The master station and all of the device stations are CC-Link IE TSN Class B. Star topology 	Page 88 Connection of servo amplifiers, remote I/O modules, and inverters (for star topology)
Structure of CC-Link IE TSN Class B devices and Ethernet devices	Direct connection of Ethernet devices	<ul style="list-style-type: none"> Connection of Ethernet devices to the structure of CC-Link IE TSN Class B devices only Direct connection of Ethernet devices to CC-Link IE TSN-compatible devices 	Page 89 Direct connection of Ethernet devices
	Connection of Ethernet devices to a switching hub	<ul style="list-style-type: none"> Connection of Ethernet devices to the structure of CC-Link IE TSN Class B devices only Connection of Ethernet devices via a switching hub 	Page 90 Connection of Ethernet devices to a switching hub
Structure of CC-Link IE TSN Class B/A devices only	Connection of inverters (Only the master station is CC-Link IE TSN Class B.)	Structure of all of the device stations being CC-Link IE TSN Class A	Page 91 Connection of inverters (Only the master station is CC-Link IE TSN Class B.)
	Connection of servo amplifiers, remote I/O modules, and inverters	Structure of CC-Link IE TSN Class B/A devices coexisting as device stations	Page 93 Connection of servo amplifiers, remote I/O modules, and inverters
Structure of CC-Link IE TSN Class B/A devices and Ethernet devices	Direct connection of Ethernet devices	Connection of Ethernet devices to the structure of CC-Link IE TSN Class B/A devices coexisting	Page 95 Connection of Ethernet devices

Structure of CC-Link IE TSN Class B devices only

Connection of servo amplifiers, remote I/O modules, and inverters (for line topology)

The following figure shows connection of the Motion module + servo amplifiers + remote I/O modules + inverters (for line topology).

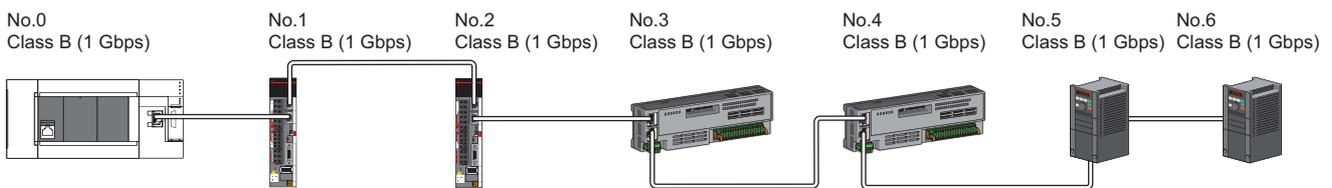

- No.0: Motion module (master station)
- No.1, No.2: Servo amplifiers (remote station)
- No.3, No.4: Remote I/O module (remote station)
- No.5, No.6: Inverter (remote station)

Point

- Device stations can be connected up to the maximum number of connectable stations specified in the CC-Link IE TSN performance specifications.
- There is no fixed orientation, such as IN and OUT, of a connection port of each station. Any ports, such as P1 and P1, P2 and P2, and P1 and P2, can be connected each other.

Connection of servo amplifiers, remote I/O modules, and inverters (for star topology)

The following figure shows connection of Motion module + servo amplifiers + remote I/O modules + inverters (for star topology).

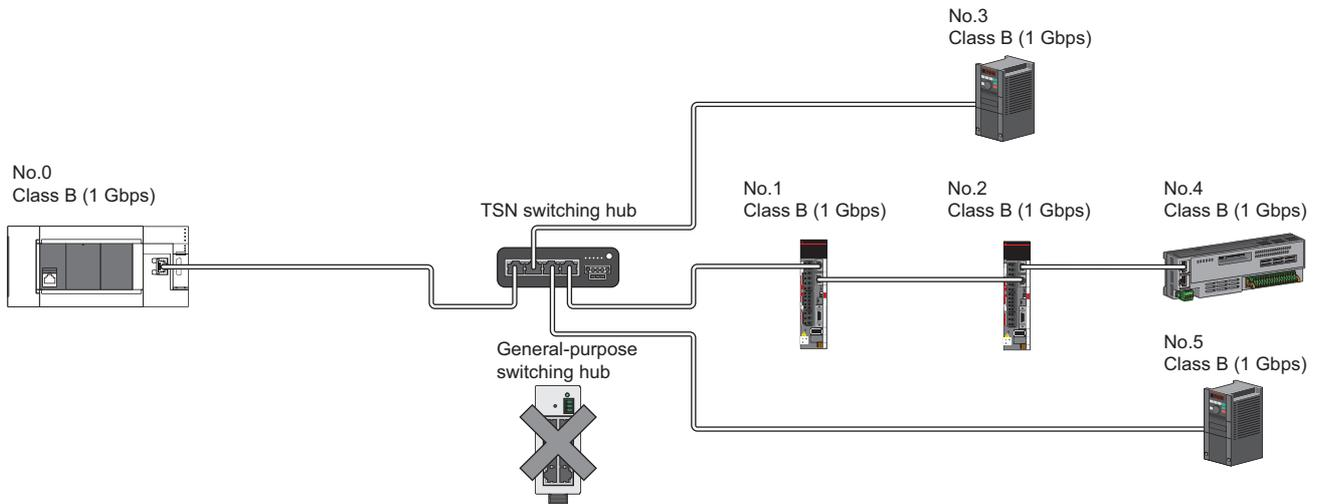

No.0: Motion module (master station)
No.1, No.2: Servo amplifiers (remote station)
No.3, No.5: Inverter (remote station)
No.4: Remote I/O module (remote station)

Point

- Device stations can be connected up to the maximum number of connectable stations specified in the CC-Link IE TSN performance specifications.
- A system in which line topology and star topology coexist using a TSN switching hub can be configured. (For the available TSN switching hubs, refer to the CC-Link Partner Association website (www.cc-link.org.)
- To use a TSN switching hub, settings of IP address and communication cycle for communicating on CC-Link IE TSN are required.
- General-purpose switching hubs cannot be used. (By using a general-purpose switching hub, an error related to device station disconnection or time synchronization may occur.)

Structure of CC-Link IE TSN Class B devices and Ethernet devices

Direct connection of Ethernet devices

The following figure shows direct connection of Ethernet devices to CC-Link IE TSN-compatible devices.

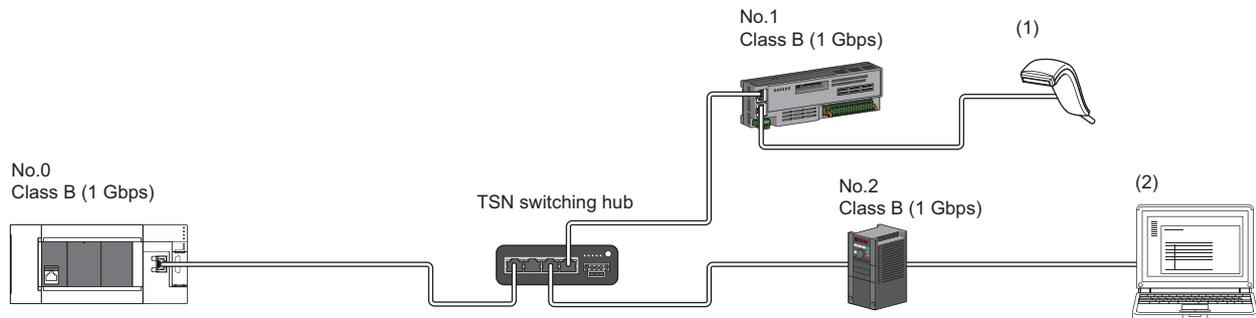

No.0: Motion module (master station)
No.1: Remote I/O module (remote station)
No.2: Inverter (remote station)
(1), (2): Ethernet device

Point

- The Ethernet devices (1 Gbps) can be directly connected to unused ports of the CC-Link IE TSN-compatible devices without the switching hub.
- The Ethernet devices can perform MELSOFT connection and SLMP communications with the master station. They also can communicate with each other using a protocol that supports each other. For the maximum number of MELSOFT connection and SLMP communications, refer to the following.
☞ Page 21 Performance Specifications of Ethernet
- Since the CC-Link IE TSN-compatible devices have a smaller memory capacity for packet reception compared to the switching hub, packets may not reach external devices if the Ethernet devices are directly connected and high-frequent communications are performed. This can be solved by using a TSN switching hub and expanding the memory capacity for packet reception.

Connection of Ethernet devices to a switching hub

The following figure shows connection of Ethernet devices to a TSN switching hub and general-purpose switching hubs.

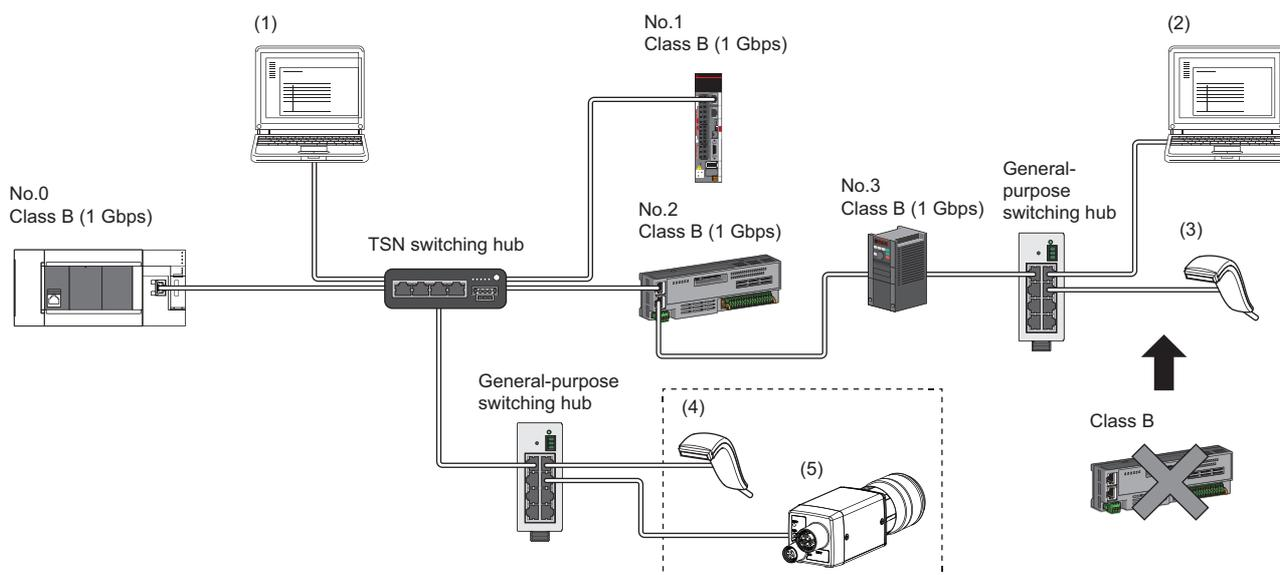

- No.0: Motion module (master station)
- No.1: Servo amplifiers (remote station)
- No.2: Remote I/O module (remote station)
- No.3: Inverter (remote station)
- (1), (2), (3), (4), (5): Ethernet device

Point

- The Ethernet devices can be connected to the general-purpose switching hub connected to the end of the line topology.
- The Ethernet devices can perform MELSOFT connection and SLMP communications with the master station. They also can communicate with each other using a protocol that supports each other. For the maximum number of MELSOFT connection and SLMP communications, refer to the following.

☞ Page 21 Performance Specifications of Ethernet

- When connecting the Ethernet device (100 Mbps), use switching hubs that support the communication speed of 1 Gbps/100 Mbps.
- The CC-Link IE TSN Class B devices cannot be used by connecting them to the general-purpose switching hubs installed for Ethernet device connection. CC-Link IE TSN Class A devices can be used by connecting to them.
- Since Ethernet communications use the transient transmission band on CC-Link IE TSN, the throughput of the Ethernet communications may decrease when the basic communication cycle is extremely short or when a large number of packets are communicated. This can be solved by correcting the communication frequency and the number of connected Ethernet devices.

Structure of CC-Link IE TSN Class B/A devices only

Connection of inverters (Only the master station is CC-Link IE TSN Class B.)

■If a switching hub is used to configure a system (master station: 1 Gbps)

The following figure shows connection of the Motion module (1 Gbps) + inverters. (Only the master station is CC-Link IE TSN Class B.)

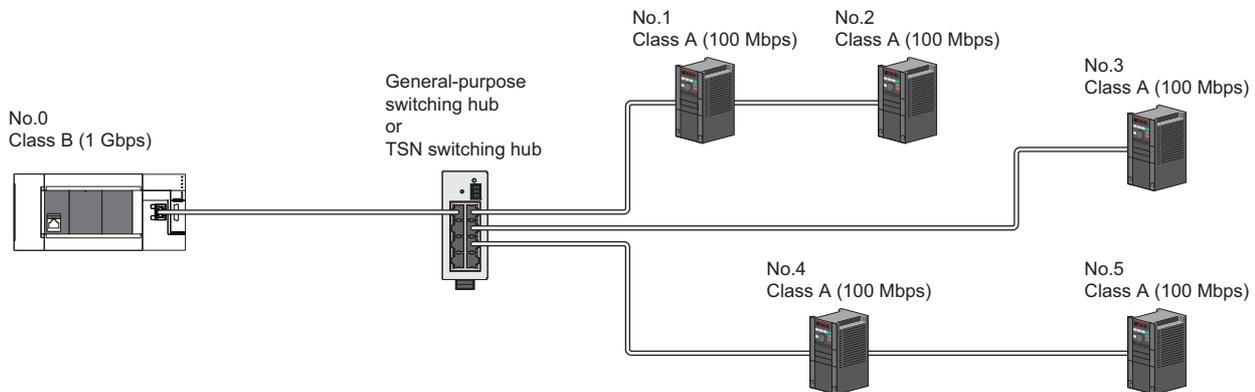

No.0: Motion module (master station)
No.1, No.2, No.3, No.4, No.5: Inverter (remote station)

Point

- When all the device stations are CC-Link IE TSN Class A, they can be connected up to the maximum number of connectable stations specified in the CC-Link IE TSN performance specifications.
- If the firmware version is "1.001" or earlier, use a general-purpose switching hub that supports the communication speed of 1 Gbps/100 Mbps to convert the communication speed.
- If the firmware version is "1.002" or later, use a TSN switching hub or general-purpose switching hub that supports the communication speed of 1 Gbps/100 Mbps to convert the communication speed to 100 Mbps. When using a TSN switching hub, set "TSN HUB Setting" to "Use TSN HUB".
- Connection after the TSN switching hub or general-purpose switching hub can be a line topology, star topology, and coexistence of line and star topologies.
- Set "Connection Device Information" of the master station parameters to "Mixture of CC-Link IE TSN Class B/A or CC-Link IE TSN Class A Only". In "Network Configuration Settings" under "Basic Settings", set "Communication Period Setting" of the inverters to "Low-Speed".

■If a switching hub is not used to configure a system (master station: 100 Mbps)

The following figure shows connection of the Motion module (100 Mbps) + inverters. (Only the master station is CC-Link IE TSN Class B.)

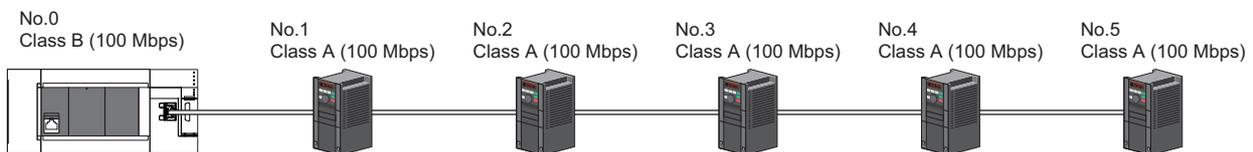

No.0: Motion module (master station)
No.1, No.2, No.3, No.4, No.5: Inverter (remote station)

- When all the device stations are CC-Link IE TSN Class A, they can be connected up to the maximum number of connectable stations specified in the CC-Link IE TSN performance specifications.
 - To branch the network with a firmware version of "1.001" or earlier, a general-purpose switching hub can be used.
 - To branch the network with a firmware version of "1.002" or later, a TSN switching hub or general-purpose switching hub can be used. When using a TSN switching hub, set "TSN HUB Setting" to "Use TSN HUB".
 - Set "Connection Device Information" of the master station parameters to "Mixture of CC-Link IE TSN Class B/A or CC-Link IE TSN Class A Only". In addition, because the Motion module with a firmware version of "1.001" or earlier does not support 100 Mbps communication, refer to the following.
- ☞ Page 91 If a switching hub is used to configure a system (master station: 1 Gbps)

■If a switching hub is used to configure a system (master station: 100 Mbps)

The following figure shows connection of the Motion module (100 Mbps) + inverters. (Only the master station is CC-Link IE TSN Class B.)

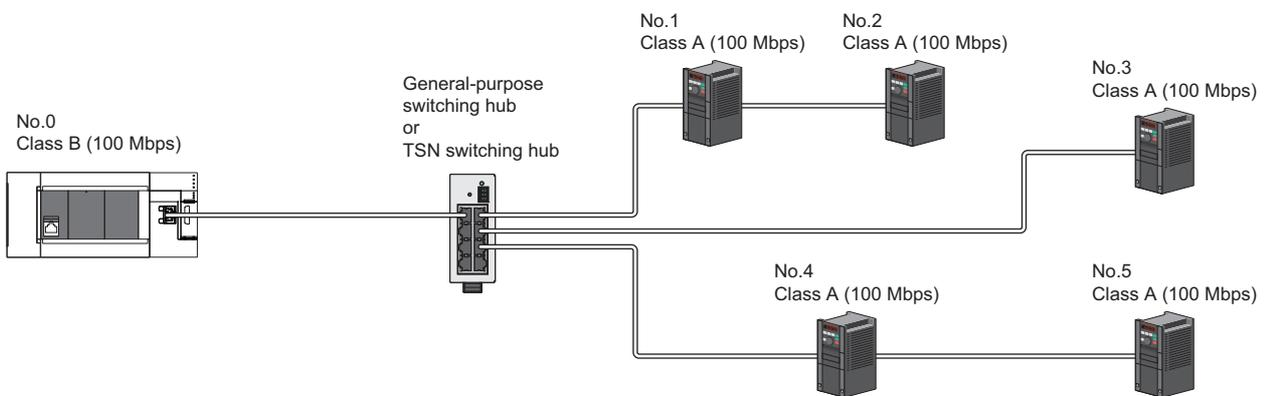

No.0: Motion module (master station)
 No.1, No.2, No.3, No.4, No.5: Inverter (remote station)

- When all the device stations are CC-Link IE TSN Class A, they can be connected up to the maximum number of connectable stations specified in the CC-Link IE TSN performance specifications.
 - To branch the network with a firmware version of "1.001" or earlier, a general-purpose switching hub can be used.
 - To branch the network with a firmware version of "1.002" or later, a TSN switching hub or general-purpose switching hub can be used. When using a TSN switching hub, set "TSN HUB Setting" to "Use TSN HUB".
 - Connection after the TSN switching hub or general-purpose switching hub can be a line topology, star topology, and coexistence of line and star topologies.
 - Set "Connection Device Information" of the master station parameters to "Mixture of CC-Link IE TSN Class B/A or CC-Link IE TSN Class A Only". In addition, because the Motion module with a firmware version of "1.001" or earlier does not support 100 Mbps communication, refer to the following.
- ☞ Page 91 If a switching hub is used to configure a system (master station: 1 Gbps)

Connection of servo amplifiers, remote I/O modules, and inverters

The following figure shows connection of Motion module + servo amplifiers + remote I/O modules + inverters.

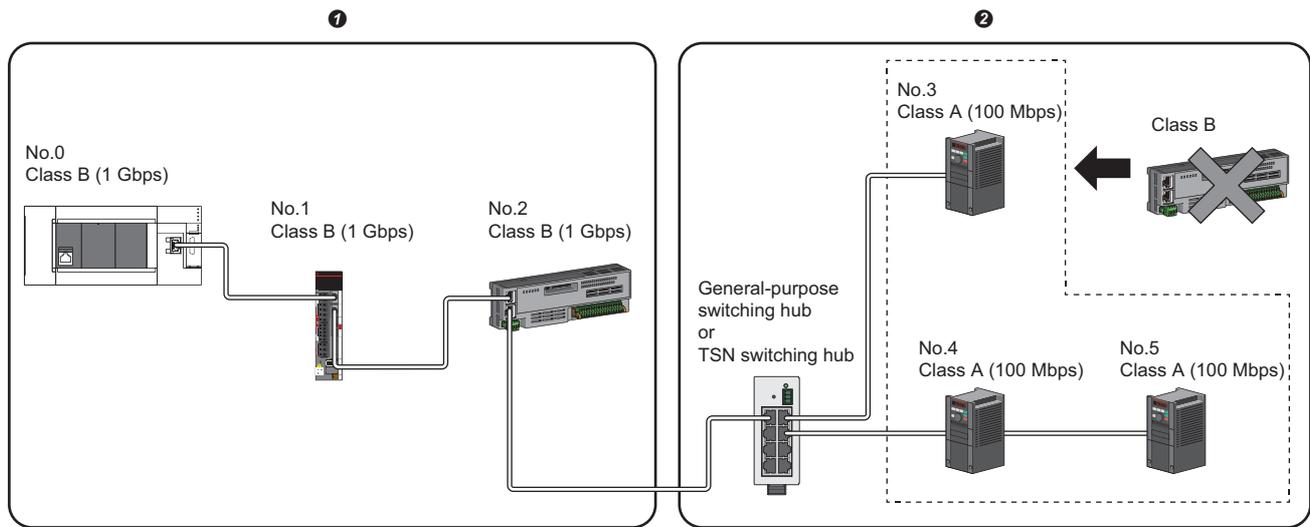

- No.0: Motion module (master station)
 No.1: Servo amplifier (remote station)
 No.2: Remote I/O module (remote station)
 No.3, No.4, No.5: Inverter (remote station)
 ❶ CC-Link IE TSN Class B device area
 ❷ CC-Link IE TSN Class A device area

Point

- If the firmware version is "1.001" or earlier, connect in the order of the master station → the CC-Link IE TSN Class B device area → the CC-Link IE TSN Class A device area. Use a general-purpose switching hub on the boundary between the CC-Link IE TSN Class B and CC-Link IE TSN Class A areas.
- If the firmware version is "1.002" or later, connect in the order of the master station → the CC-Link IE TSN Class B device area → the CC-Link IE TSN Class A device area. Use a TSN switching hub or general-purpose switching hub on the boundary between the CC-Link IE TSN Class B and CC-Link IE TSN Class A areas. When using a TSN switching hub, set "TSN HUB Setting" to "Use TSN HUB".
- If the firmware version is "1.001" or earlier, a TSN switching hub or general-purpose switching hub cannot be used in the CC-Link IE TSN Class B area.
- If the firmware version is "1.002" or later, a general-purpose switching hub cannot be used in the CC-Link IE TSN Class B area.
- If the firmware version is "1.001" or earlier, up to eight CC-Link IE TSN Class B devices can be connected per port.
- If the firmware version is "1.002" or later and any CC-Link IE TSN Class A device that does not support the CC-Link IE TSN Protocol version 2.0 is included, up to eight CC-Link IE TSN Class B devices can be connected per port. If all CC-Link IE TSN Class A devices support the CC-Link IE TSN Protocol version 2.0, nine and more CC-Link IE TSN Class B devices can be connected.
- A CC-Link IE TSN Class B device cannot be connected after a CC-Link IE TSN Class A device.
- Set "Connection Device Information" of the master station parameters to "Mixture of CC-Link IE TSN Class B/A or CC-Link IE TSN Class A Only". In "Network Configuration Settings" under "Basic Settings", set "Communication Period Setting" of the inverters to "Low-Speed".

Precautions

If the firmware version is "1.001" or earlier, connection cannot be made if the total cyclic data size of the CC-Link IE TSN Class A devices exceeds 2K bytes. (The total cyclic data size of the CC-Link IE TSN Class A devices in the entire system configuration, regardless of the connection path) For example, when the cyclic data size of one device is 0.2K bytes, the upper limit is 10 devices.

If the firmware version is "1.002" or later and there is any CC-Link IE TSN Class B or A device that does not support the CC-Link IE TSN Protocol version 2.0, connection cannot be made if the total cyclic data size of the CC-Link IE TSN Class A devices (the total cyclic data size of the CC-Link IE TSN Class A devices in the entire system configuration, regardless of the connection path) exceeds 2K bytes.

For cyclic data size of each device, refer to the manual for the device used.

Structure of CC-Link IE TSN Class B/A devices and Ethernet devices

Connection of Ethernet devices

The following figure shows connection of Ethernet devices to CC-Link IE TSN-compatible devices and a general-purpose switching hub

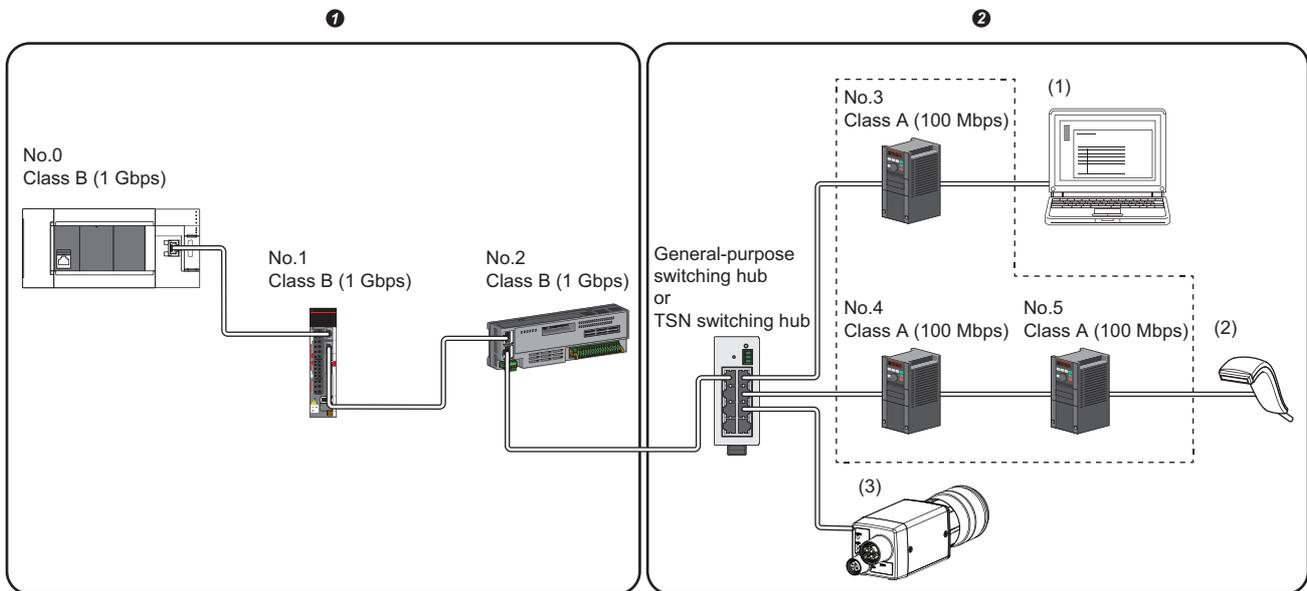

- No.0: Motion module (master station)
- No.1: Servo amplifier (remote station)
- No.2: Remote I/O module (remote station)
- No.3, No.4, No.5: Inverter (remote station)
- (1), (2), (3): Ethernet device
- ① CC-Link IE TSN Class B device area
- ② CC-Link IE TSN Class A device area

Point

- The Ethernet devices (1 Gbps) can be directly connected to unused ports of the CC-Link IE TSN-compatible devices without the switching hub.
- The Ethernet devices (100 Mbps) can be connected to the general-purpose switching hub on the boundary between the CC-Link IE TSN Class B and CC-Link IE TSN Class A areas.
- The Ethernet devices can perform MELSOFT connection and SLMP communications with the master station. They also can communicate with each other using a protocol that supports each other. For the maximum number of MELSOFT connection and SLMP communications, refer to the following.
 ➔ Page 21 Performance Specifications of Ethernet
- Since the CC-Link IE TSN-compatible devices have a smaller memory capacity for packet reception compared to the switching hub, packets may not reach external devices if the Ethernet devices are directly connected and high-frequent communications are performed.
- Since Ethernet communications use the transient transmission band on CC-Link IE TSN, the throughput of the Ethernet communications may decrease when the basic communication cycle is extremely short or when a large number of packets are communicated. This can be solved by correcting the communication frequency and the number of connected Ethernet devices.

4.6 Precautions for System Configuration

Restriction of firmware version

■Combination of the engineering tool and Motion module

The following table shows operations according to the combination of the engineering tool and the firmware version of the Motion module.

Engineering tool	Motion module	
	Firmware version "1.001" or earlier	Firmware version "1.002" or later
Earlier than software version "1.085P"	Operates normally.	<ul style="list-style-type: none"> • The restrictions of the connection configuration are the same as those of the firmware version "1.001" or earlier. • If a parameter is written, the communication speed cannot be set, resulting in a speed of 1 Gbps. • The system reserved time cannot be set, resulting in operation at 20 μs. • "TSN HUB Setting" cannot be set, resulting in operation with "Not to Use TSN HUB". • "CC-Link IE TSN Class Setting" cannot be set for device stations so that the Motion module operates without CC-Link IE TSN Class. • "Multiple Period Setting" cannot be set to "Low-Speed", resulting in ×16 operation.
Software version "1.085P" or later	<ul style="list-style-type: none"> ■If "Communication Speed" is set to 100 Mbps <ul style="list-style-type: none"> • For the master station, the error code 2440H occurs on the CPU side. ■If "Low-Speed" in "Multiple Period Setting" is set to a value other than "×16" <ul style="list-style-type: none"> • The error "Network parameter error" (error code: 2221H) occurs. <p>The newly added parameters below are not recognized on the module side and no error judgment or notification process is implemented, resulting in the same operation as with the firmware version "1.001" or earlier.</p> <ul style="list-style-type: none"> • System Reservation Time • TSN HUB Setting • CC-Link IE TSN Class Setting 	Operates normally.

Devices connected to the same network

Do not connect the devices as described below. Doing so may cause the disconnection of all stations.

- A module on CC-Link IE TSN and a device having network types other than an Ethernet device (such as CC-Link IE Controller Network and CC-Link IE Field Network) are connected to the same network.
- A module on CC-Link IE TSN and an Ethernet device (such as a personal computer), both of which are on different networks, are connected to one switching hub.

Adding a device station with no IP address setting

In a line topology, do not connect the device station with no IP address setting at a place other than the end of the network. A data link may not be performed in the device stations after the device station with no IP address setting.

CC-Link IE TSN/CC-Link IE Field diagnostics

If operations such as the following are performed, the actual network configuration and the network map of the CC-Link IE TSN/CC-Link IE Field diagnostics may be a mismatch.

Network configuration	Operation
Star topology	<ul style="list-style-type: none">• Powering off and on a device station or switching hub• Connecting/disconnecting an Ethernet cable connected to the switching hub• Disconnecting an Ethernet cable from a device station and connecting it to another device station or a switching hub• Disconnecting more than nine stations, or half the number of device stations or more in the system• Changing the network topology when adding a device station
Line topology	<ul style="list-style-type: none">• Simultaneously powering off/on multiple stations• Simultaneously connecting/disconnecting Ethernet cables to/from multiple stations (When a data link faulty station returns, a data link error will occur in all the stations.)• Disconnecting more than nine stations, or half the number of device stations or more in the system• Changing the network topology when adding a device station

Point

The actual network configuration and network map can be matched by executing the network map update of the CC-Link IE TSN/CC-Link IE Field diagnostics. ( Page 129 CC-Link IE TSN/CC-Link IE Field diagnostics)

Calculation of the total cyclic data size

The following shows the calculation formula of the total cyclic data size. The part of the variable surrounded by double quotes (" ") is the setting value of "Network Configuration Settings" under "Basic Settings".

Total cyclic data size = 204 + (106 × Number of remote stations) + (Number of "RX setting" points ÷ 8) + (Number of "RWr setting" points × 2) [byte]

5 PARAMETER SETTINGS

This chapter describes the parameter settings required for communications between the Motion module and other stations.

5.1 Setting Parameters

1. Add the Motion module in the engineering tool.
 - Navigation window ⇒ "Parameter" ⇒ "Module Information" ⇒ Right-click ⇒ [Add New Module]
2. The required settings, basic settings, and application settings are included in the parameter settings. Select one of the settings from the tree on the following window.
 - Navigation window ⇒ "Parameter" ⇒ "Module Information" ⇒ Target Module ⇒ "Module Parameter (Network)"
3. After setting parameters, click the [Apply] button.
4. Write parameters to the CPU module using the engineering tool.
 - [Online] ⇒ [Write to PLC]
5. The parameters are reflected by resetting the CPU module or powering off and on the system.

5.2 Required Settings

Set such items as the station type and network number of the Motion module.

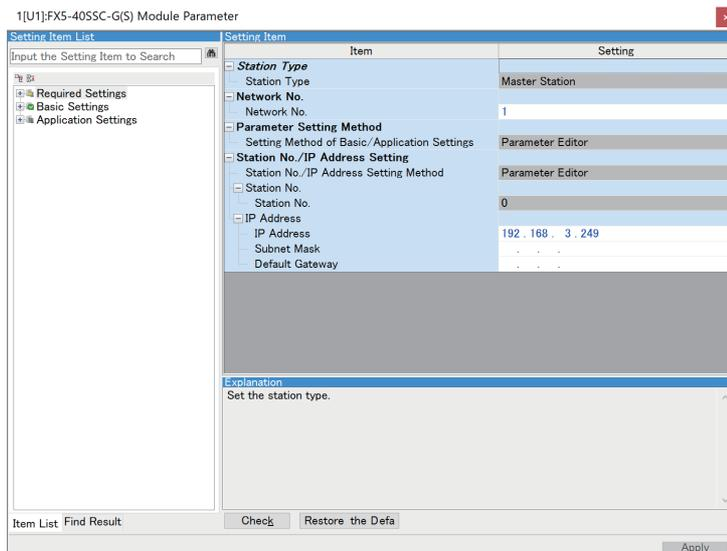

Item	Description	Reference
Station Type	Set the station type of the Motion module.	Page 98 Station Type
Network No.	Set the network number of the Motion module.	Page 99 Network No.
Parameter Setting Method	Set "Basic Settings" and "Application Settings" items using the engineering tool or in program.	Page 99 Parameter Setting Method
Station No./IP Address Setting	Set the station number or IP address of the Motion module.	Page 99 Station No./IP Address Setting

Station Type

Set the station type of the Motion module.

Item	Description	Setting range
Station Type	Uses the Motion module as the master station. Only one master station can be set in a network.	—

Network No.

Set the network number of the Motion module.

Item	Description	Setting range
Network No.	Set the network number of the Motion module.	1 to 239 (Default: 1)

Precautions

Set a network number that does not duplicate any other network numbers.

When a network number is duplicated in the same system, an error will occur in the CPU module.

In particular, when using an Ethernet-equipped module (CPU module) at default, the IP address is 192.168.3.250 and the network number is the third octet of the IP address, thus 3. Because setting the network number of the Motion module to 3 causes duplication, set another network number.

Parameter Setting Method

Set "Basic Settings" and "Application Settings" items using the engineering tool or in program.

Item	Description	Setting range
Setting Method of Basic/ Application Settings	Select this item to set the parameter using the engineering tool. The following are advantages. <ul style="list-style-type: none"> • All parameters can be easily set in the window without creating a program for setting. • Data can be automatically transferred from the link special relay (SB), link special register (SW), and link devices of the Motion module to the devices of the CPU module. 	Parameter Editor (fixed)

Station No./IP Address Setting

Set the station number and IP address of the own station of the Motion module.

Item	Description	Setting range
Station No.	The master station is fixed to "0".	—
IP Address	Set the IP address of the own station. Set an IP address different from those used in other stations. (☞ Page 49 IP address duplication detection) Do not set the following values. <ul style="list-style-type: none"> • The third and fourth octets are all 0 or all 1. • The host address bits are all 0 or all 1. • Reserved address 	0.0.0.1 to 223.255.255.254 (00.00.00.01 to DF.FF.FF.FE) (Default: 192.168.3.249)
Subnet Mask	Set the subnet mask. Set the same value for the master station and device station. If the subnet mask is empty, the address class (class A, class B, class C) is determined from the setting of "IP Address", and operation is done with the subnet mask according to the address class. The subnet mask for each class is as follows. <ul style="list-style-type: none"> • Class A: 255.0.0.0 • Class B: 255.255.0.0 • Class C: 255.255.255.0 The IP address for each class is as follows. <ul style="list-style-type: none"> • Class A: 0.x.x.x to 127.x.x.x • Class B: 128.x.x.x to 191.x.x.x • Class C: 192.x.x.x to 223.x.x.x The host address for each class is the 0 section shown below. <ul style="list-style-type: none"> • Class A: 255.0.0.0 • Class B: 255.255.0.0 • Class C: 255.255.255.0 	• Empty • 0.0.0.1 to 255.255.255.255 (00.00.00.01 to FF.FF.FF.FF) (Default: empty)
Default Gateway	Set the default gateway.	• Empty • 0.0.0.1 to 223.255.255.254 (00.00.00.01 to DF.FF.FF.FE) (Default: empty)

5.3 Basic Settings

Set the network configurations, refresh settings, or other parameters for the Motion module.

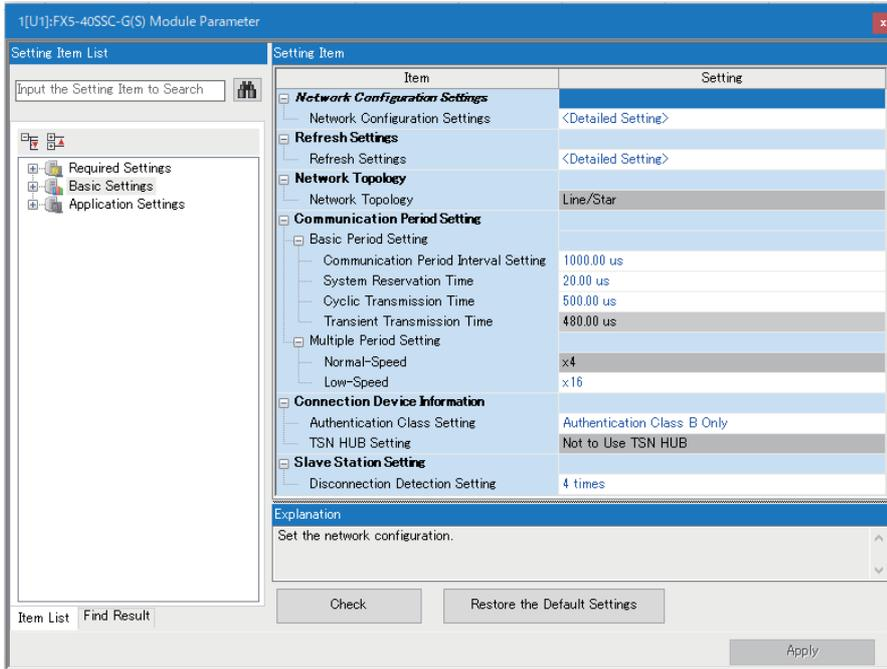

In this manual, "Authentication Class" is described as "CC-Link IE TSN Class" and "slave station" is described as "device station".

Item	Description	Reference
Network Configuration Settings	Set parameters of device stations (the number of points and assignment of link devices) in the master station.	Page 108 "CC-Link IE TSN Configuration" Window
Refresh Settings	Assign link refresh ranges between the following devices. • SB, SW, link devices (RX, RY, RWr, RWw) of the Motion module ↔ Devices of the CPU module	Page 101 Refresh settings
Network Topology	Select the network topology type according to the actual network configuration.	Page 103 Network Topology
Communication Period Setting	Perform basic cycle setting and multiple cycle setting.	Page 103 Communication Period Setting
Connection Device Information	Sets the CC-Link IE TSN Class of connected devices.	Page 104 Connection Device Information
Device Station Setting	Set the number of consecutive communication failures until a device station is considered disconnected.	Page 104 Device Station Setting

Refresh settings

Assign link refresh ranges between the following devices.

- SB, SW, link devices (RX, RY, RWr, RWw) of the Motion module ↔ Devices of the CPU module

Setting method

The procedure for the refresh settings is as follows.

1. Set the required items.
2. Click the [Apply] button to finish "Refresh Settings".

Setting items

The setting items for the refresh settings are as follows.

No.	Link Side					CPU Side				
	Device Name	Points	Start	End		Target	Device Name	Points	Start	End
-	SB				↔					
-	SW				↔					
1					↔					
2					↔					

Item	Description	Setting range
Device Assignment Method	Right-click in the setting window and select a link device assignment method from the "Device Assignment Method" menu. <ul style="list-style-type: none"> • Start/End: Enter the start and end numbers of link devices. • Points/Start: Enter the numbers of points and start numbers of link devices. 	<ul style="list-style-type: none"> • Start/End • Points/Start (Default: Start/End)
—	<p>Link Side</p> <p>Set the link refresh ranges of SB and SW. One link refresh range can be set for each of SB and SW. (☞ Page 27 Link refresh)</p> <p>Ex.</p> <p>CPU Side</p>	<ul style="list-style-type: none"> ■ Device Name <ul style="list-style-type: none"> • SB (fixed) • SW (fixed) ■ Points <ul style="list-style-type: none"> • SB: 16 to 4096 (set in increments of 16 points) • SW: 1 to 4096 (Default: empty) ■ Start <ul style="list-style-type: none"> • SB: 0H to FF0H (set in increments of 16 points) • SW: 0H to FFFH (set in increments of 1 point) (Default: empty) ■ End <ul style="list-style-type: none"> • SB: FH to FFFH (set in increments of 16 points) • SW: 0H to FFFH (set in increments of 1 point) (Default: empty) ■ Target <ul style="list-style-type: none"> • Specify Device (Default: empty) ■ Device name <ul style="list-style-type: none"> • Specify Device (link side is SB): SB, M, L, B, D, R • Specify Device (link side is SW): SW, M, L, B, D, R (Default: empty) ■ Points, End <ul style="list-style-type: none"> Displayed according to setting of "Start". (Default: empty) ■ Start <ul style="list-style-type: none"> Device range of CPU modules (Set bit devices in increments of 16 points and word devices in increments of 4 points.) (Default: empty)

Item	Description	Setting range																																																										
1 to 256	<p>Link Side</p> <p>Set the link refresh ranges of RX, RY, RWr, and RWw. A maximum of 256 points can be set for the link refresh range of each. (Page 27 Link refresh)</p> <p>Ex.</p> <table border="1"> <thead> <tr> <th rowspan="2">No.</th> <th colspan="4">Link Side</th> <th rowspan="2">Target</th> <th colspan="4">CPU Side</th> </tr> <tr> <th>Device Name</th> <th>Points</th> <th>Start</th> <th>End</th> <th>Device Name</th> <th>Points</th> <th>Start</th> <th>End</th> </tr> </thead> <tbody> <tr> <td>1</td> <td>RX</td> <td>256</td> <td>00000</td> <td>000FF</td> <td>Specify Device</td> <td>X</td> <td>256</td> <td>1000</td> <td>1377</td> </tr> <tr> <td>2</td> <td>RY</td> <td>256</td> <td>00000</td> <td>000FF</td> <td>Specify Device</td> <td>Y</td> <td>256</td> <td>1000</td> <td>1377</td> </tr> <tr> <td>3</td> <td>RWr</td> <td>256</td> <td>00000</td> <td>000FF</td> <td>Specify Device</td> <td>W</td> <td>256</td> <td>00000</td> <td>000FF</td> </tr> <tr> <td>4</td> <td>RWw</td> <td>256</td> <td>00000</td> <td>000FF</td> <td>Specify Device</td> <td>W</td> <td>256</td> <td>00100</td> <td>001FF</td> </tr> </tbody> </table> <p>Motion module</p> <p>CPU module</p>	No.	Link Side				Target	CPU Side				Device Name	Points	Start	End	Device Name	Points	Start	End	1	RX	256	00000	000FF	Specify Device	X	256	1000	1377	2	RY	256	00000	000FF	Specify Device	Y	256	1000	1377	3	RWr	256	00000	000FF	Specify Device	W	256	00000	000FF	4	RWw	256	00000	000FF	Specify Device	W	256	00100	001FF	<p>■Device name</p> <ul style="list-style-type: none"> • RX, RY, RWr, RWw (Default: empty) <p>■Points</p> <ul style="list-style-type: none"> • RX, RY: 16 to 8192 (set in increments of 16 points) • RWr, RWw: 4 to 1024 (set in increments of 4 points) (Default: empty) <p>■Start</p> <ul style="list-style-type: none"> • RX, RY: 0H to 1FF0H (set in increments of 16 points) • RWr, RWw: 0 to 3FCH (set in increments of 4 points) (Default: empty) <p>■End</p> <ul style="list-style-type: none"> • RX, RY: FH to 1FFFH (set in increments of 16 points) • RWr, RWw: 3H to 3FFH (set in increments of 4 points) (Default: empty) <p>■Target</p> <ul style="list-style-type: none"> • Specify Device (Default: empty) <p>■Device name</p> <ul style="list-style-type: none"> • Specify Device (link side is RX): X, M, L, B, D, W, R • Specify Device (link side is RY): Y, M, L, B, D, W, R • Specify Device (link side is RWr, RWw): M, L, B, D, W, R (Default: empty) <p>■Points, End Displayed according to setting of "Start". (Default: empty)</p> <p>■Start Device range of CPU modules (Set bit devices in increments of 16 points and word devices in increments of 4 points.) (Default: empty)</p>
No.	Link Side				Target	CPU Side																																																						
	Device Name	Points	Start	End		Device Name	Points	Start	End																																																			
1	RX	256	00000	000FF	Specify Device	X	256	1000	1377																																																			
2	RY	256	00000	000FF	Specify Device	Y	256	1000	1377																																																			
3	RWr	256	00000	000FF	Specify Device	W	256	00000	000FF																																																			
4	RWw	256	00000	000FF	Specify Device	W	256	00100	001FF																																																			

Precautions

■Device set to "CPU Side"

Set a device range not to overlap the one used for the following:

- "Refresh settings" of intelligent function modules

■Link refresh range

Set only link devices used in the CPU module for link refresh range. Doing so will reduce the number of excess points, resulting in a shorter link refresh time.

Network Topology

Select the network topology type according to the actual network configuration.
Setting is not required and can be left as "Line/Star" (default).

Communication Period Setting

Perform basic cycle setting and multiple cycle setting.

- Basic cycle setting requires calculation of the communication cycle interval and cyclic transmission time. ( Page 201 Communication cycle intervals)
- Multiple cycle setting is used when communication cycles coexist. ( Page 31 Communication cycle coexistence)

Item	Description	Setting range
Basic Period Setting	Communication Period Interval Setting	Input a communication cycle interval. • 500.00 μ s • 1000.00 μ s • 2000.00 μ s • 4000.00 μ s (Default: 1000.00 μ s)
	System Reservation Time	Necessary time for the system to guarantee the communication cycle interval. • 20.00 μ s • 200.00 μ s (Default: 20.00 μ s)
	Cyclic Transmission Time	Of communication cycle intervals, set the time to be allocated to cyclic transmission. 5.00 μ s to 3966.00 μ s (in increments 1 μ s) (Default: 500.00 μ s)
	Transient Transmission Time	The value of "Communication Period Interval Setting" minus "Cyclic Transmission Time" and "System Reservation Time" is displayed. 14.00 μ s to 3975.00 μ s (in increments of 1 μ s) (Default: 480.00 μ s)
Multiple Cycle Setting	Normal-Speed	Select the "Normal-Speed" cycle for a basic cycle. Setting is not required and can be left as "x4". (Default: x4)
	Low-Speed	Select the "Low-Speed" cycle for a basic cycle. • x16 • x32 ^{*1} • x64 ^{*1} • x128 ^{*1} (Default: x16)

*1 An error occurs if it is set in the Motion module with the firmware version "1.001" or earlier.

Point

When the TSN switching hub is used, set the timeslot information from the setting values in "Basic Period Setting".

The timeslot information can be checked with the buffer memory. ( Page 177 Timeslot information)

Connection Device Information

Set the information of the connected device.

Item	Description	Setting range
CC-Link IE TSN Class Setting	Sets the CC-Link IE TSN Class of connected devices.	<ul style="list-style-type: none">• CC-Link IE TSN Class B Only• Mixture of CC-Link IE TSN Class B/A or CC-Link IE TSN Class A Only (Default: CC-Link IE TSN Class B Only)
TSN HUB Setting	Sets whether to use the TSN switching hub or not.	<ul style="list-style-type: none">• Not to Use TSN HUB• Use TSN HUB (Default: Not to Use TSN HUB)

Precautions

- To connect a TSN switching hub to the structure of a mixture of CC-Link IE TSN Class B and CC-Link IE TSN Class A devices, set "TSN HUB Setting" to "Use TSN HUB".
- If a TSN switching hub is connected with "TSN HUB Setting" set to "Not to Use TSN HUB", device stations may not perform data link.
- If a TSN switching hub is used for connection in a star topology with "TSN HUB Setting" set to "Not to Use TSN HUB", device stations connected to the TSN switching hub do not perform data link. Also, the error "Connection configuration error" (error code: 1806H) occurs in the master station.

Device Station Setting

Set items related to the device station.

Item	Description	Setting range
Disconnection Detection Setting	Set the number of consecutive communication failures until a device station is considered disconnected.	<ul style="list-style-type: none">• 2 times• 4 times• 8 times (Default: 4 times)

Precautions

The disconnection detection setting does not necessarily guarantee that the disconnection is performed according to the number of times set. When disconnection is detected, a bit of the disconnected station in 'Data link status of each station' (SW00B0 to SW00B7) turns on. However, the time required this may be at least four times the time required for the number of consecutive communication failures set in the disconnection detection setting.

5.4 Application Settings

Set the supplementary cyclic settings, transient transmission group number, and other settings for the Motion module.

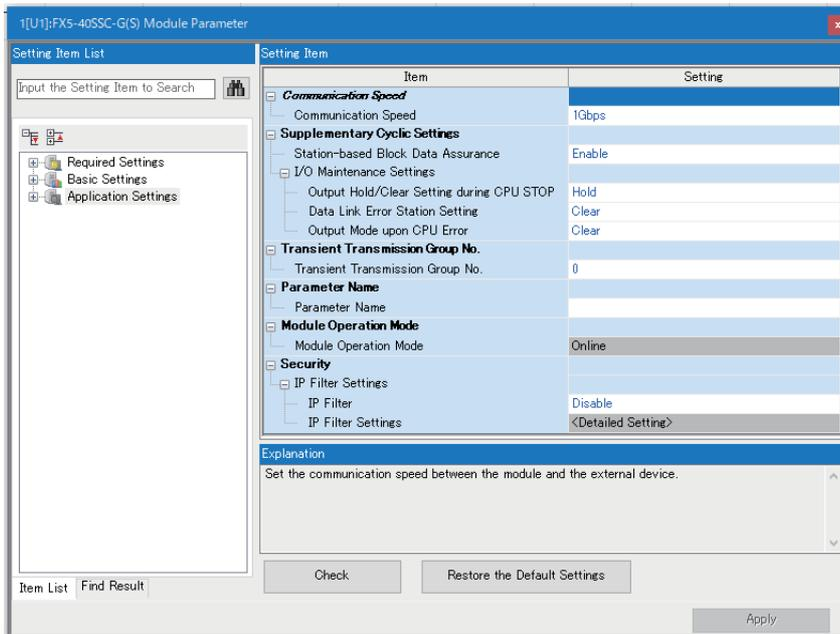

Item	Description	Reference
Communication Speed	Set the communication speed.	Page 105 Communication speed
Supplementary Cyclic Settings	Set the station-based block data assurance and I/O maintenance settings.	Page 106 Supplementary cyclic settings
Transient Transmission Group No. Setting	Set the transient function.	Page 106 Transient transmission group No. setting
Parameter Name	Set a name for the module parameter if desired.	Page 106 Parameter name
Module Operation Mode	Set the mode for the Motion module.	Page 106 Module operation mode
Security	Set the security measures for access to the Ethernet device.	Page 107 Security

Communication speed

Set the communication speed.

Item	Description	Setting range
Communication Speed	Select the communication speed.	<ul style="list-style-type: none"> • 1 Gbps • 100 Mbps (Default: 1 Gbps)

For details on the connection of modules or devices based on the communication speed setting, refer to the following.

☞ Page 53 SYSTEM CONFIGURATION

Supplementary cyclic settings

Set the station-based block data assurance and I/O maintenance settings.

Item	Description	Setting range
Station-based Block Data Assurance	Select whether to ensure data integrity of the data blocks being refreshed between the CPU module and the Motion module. (☞ Page 29 Cyclic data assurance)	<ul style="list-style-type: none"> • Enable • Disable (Default: Enable)
I/O Maintenance Settings	Output Hold/Clear Setting during CPU STOP	Select whether cyclic data output is held or cleared when the CPU module mounted with the Motion module is set to the STOP state. (☞ Page 32 I/O maintenance settings) <ul style="list-style-type: none"> • Hold • Clear (Default: Hold)
	Data Link Error Station Setting	Select whether input data from the master station is held or cleared when a data link error occurs. (☞ Page 32 I/O maintenance settings) <ul style="list-style-type: none"> • Clear • Hold (Default: Clear)
	Output Mode upon CPU Error	Select whether cyclic transmission output data is held or cleared when a stop error occurs in the CPU module mounted with the Motion module. (☞ Page 32 I/O maintenance settings) <ul style="list-style-type: none"> • Clear • Hold (Default: Clear)

Transient transmission group No. setting

Set the transient transmission group number.

Item	Description	Setting range
Transient Transmission Group No. Setting	Set the group number to perform transient transmission using group specification.	0 to 32 (0: No group specification) (Default: 0)

Parameter name

Set a name for the module parameter if desired.

Item	Description	Setting range
Parameter Name	Set a name for the module parameter if desired.	Up to 8 one-byte or two-byte characters (Default: empty)

Module operation mode

Set the mode for the Motion module.

Item	Description	Setting range
Module Operation Mode	Online Select this mode to connect the Motion module to the network for performing data link with other stations.	—

Security

Set the security measures for access to the Ethernet device.

Item		Description	Setting range
IP Filter Settings	IP Filter	Set whether to use the IP filter.	<ul style="list-style-type: none"> • Do Not Use • Use (Default: Do Not Use)
	IP Filter Settings	Set the IP addresses to be allowed or denied.	—

IP Filter Settings

Up to 32 IP addresses can be set as an IP address to be allowed or denied by the IP filter.

Range specification as a single setting and specification of the IP addresses to be excluded from the set range are also possible.

Item	Description	Setting range
Access from IP address below	Select whether to allow or deny the access from the specified IP addresses.	<ul style="list-style-type: none"> • Allow • Deny (Default: Allow)
Range Setting	Select this item when specifying the IP addresses by range.	(Default: Clear)
IP Address	Set the IP addresses to be allowed or denied. When selecting "Range Setting", enter the start IP address (left field) and end IP address (right field) of the range.	0.0.0.1 to 223.255.255.254 (Default: empty)
IP Address Excluded from Range	When selecting "Range Setting", set the IP address to be excluded from the set range. Up to 32 IP addresses can be set.	0.0.0.1 to 223.255.255.254 (Default: empty)

5.5 "CC-Link IE TSN Configuration" Window

Perform the parameter setting of device stations, the detection of connected/disconnected devices, or others.

Navigation window ⇒ "Parameter" ⇒ "Module Information" ⇒ Target module ⇒ "Module Parameter (Network)" ⇒ "Basic Settings" ⇒ "Network Configuration Settings"

Parameter setting of a device station

Set parameters of device stations (the number of points and assignment of link devices) in the master station.

1. Select the module in "Module List" and drag it to the list of stations or the network map.

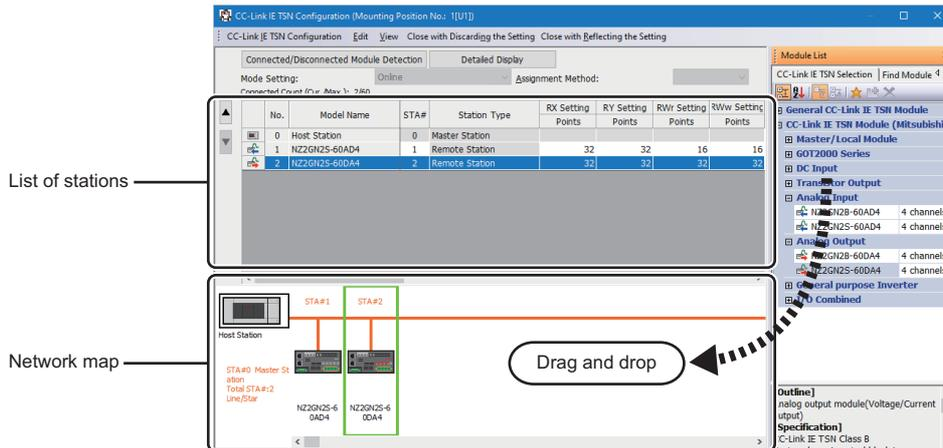

2. Set the required items.
3. Select [Close with Reflecting the Setting] and close the "CC-Link IE TSN Configuration" window.

Setting items

- Simple Display: Click the [Simple Display] button to display a narrow portion of items. Use for operation with default settings or the minimum required settings. (Default)
- Detailed Display: Click the [Detailed display] button to display all items.

Simple display	Detailed display	Description	Setting range
—	Assignment Method	Select a link device assignment method. • Points/Start: Enter the numbers of points and start numbers of link devices. • Start/End: Enter the start and end numbers of link devices.	• Points/Start • Start/End (Default: Points/Start)
No.		The total number of device stations set in the "CC-Link IE TSN Configuration" window is displayed.	—
Model Name		The module model name is displayed. To set a module where the profile is not registered, select it from the "General CC-Link IE TSN Module" list or register the profile before setting the model name. For how to register a profile, refer to the following. GX Works3 Operating Manual	—
STA#		Enter the station number of each device station connected to the network. Station numbers do not need to be set consecutively, but must be unique.	FX5-40SSC-G • Master station: Fixed to "0" • Device station: 1 to 20 FX5-80SSC-G • Master station: Fixed to "0" • Device station: 1 to 24 (Default: Serial number of added stations)
Station Type		Set the station types. Select the station types same as those of the modules connected to the network.	• Master Station • Remote Station (Default: Varies depending on the set module)
Motion control station		Use the profile to enable selection of the station to be used as the target for Motion control. Page 35 Setting the Motion control station	• Target for Motion control • Not a target for Motion control (Default: Do Not check)
RX Setting ^{*1}		Assign RX/Ry points in increments of 16. (Page 26 Communications using RX, RY, RWr, and RWw) Modules with settings provided by profile are automatically set from selected models. (Excluding modules with a number of points that is not fixed) This setting is not available for Motion control stations.	• Number of points: 16 to 8192 • Start: 0H to 1FF0H • End: FH to 1FFFH (Default: Varies depending on the set module)
RY Setting ^{*1}			
RWw Setting		Assign RWw/RWr points in increments of 4. (Page 26 Communications using RX, RY, RWr, and RWw) Modules with settings provided by profile are automatically set from selected models. (Excluding modules with a number of points that is not fixed) Motion control stations are fixed to 40 points.	• Number of points: 4 to 1024 • Start: 0H to 3FCH • End: 3H to 3FFH (Default: Varies depending on the set module)
RWr Setting			
Parameter Automatic Setting		Set whether to set the parameters of each device station automatically. This cannot be set for extension modules. However, the parameter automatic setting of extension modules is interlocked with the settings of the connected main module.	• Check: Automatically set parameters • Do Not check: Do not automatically set parameters (Default: Do Not check)
PDO Mapping Setting		Sets the PDO mapping for standard stations that support CANopen communication. This setting is not available for Motion control stations. (Page 117 PDO mapping setting)	—
IP Address		Set the IP address of a station that performs cyclic transmission.	0.0.0.1 to 223.255.255.254 (Default: The first to third octets have the same values as the master station, the fourth octet has a serial number from 1 to 254)
Subnet Mask		Set a subnet mask to identify a network address. Set the same value for the master station and device station. Even if a device station has a different subnet mask from the master station, it does not result in an input error. If 255.255.255.255 is set, leave it empty.	• 0.0.0.1 to 255.255.255.255 • Empty (Default: The same value as the subnet mask set in module parameters for the master station)
Default Gateway		Set the default gateway address to connect to the external network.	• 0.0.0.1 to 223.255.255.254 • Empty (Default: empty)

Simple display	Detailed display	Description	Setting range
Reserved/Error Invalid Station		Set the device station as a reserved station or error invalid station. <ul style="list-style-type: none"> • No Setting: The device station is connected to the network. • Reserved Station: The device station is reserved for future expansion. By using a reserved station, link device assignment will not change even if the device station is added (reservation is canceled). Therefore, modification of the program is not required. Physical connection of the device station on the network is not required. • Error Invalid Station: Even if a device station is disconnected during data link, the master station will not detect the device station as a faulty station. This setting is not available for Motion control stations. 	<ul style="list-style-type: none"> • No Setting • Reserved Station • Error Invalid Station (Default: No setting, master station is fixed as empty)
Communication Period Setting		When multiple communication cycles are set, set the cycle of each device station. (☞ Page 31 Communication cycle coexistence) Set master control stations to "Basic Period".	<ul style="list-style-type: none"> • Basic Period • Normal-Speed*² • Low-Speed*² (Default: Basic cycle, master station is fixed as empty)
CC-Link IE TSN Class Setting		Set the CC-Link IE TSN Class of the device for each device station.	<ul style="list-style-type: none"> • CC-Link IE TSN Class B • CC-Link IE TSN Class A (Default: Varies depending on the device)
Station Information	■Alias Enter the name of a device if required. The name entered is displayed in "Network Status" of the "CC-Link IE TSN/CC-Link IE Field Diagnostics" window. For the extension module of the remote station, the name is not displayed in the "CC-Link IE TSN/CC-Link IE Field Diagnostics" window, even if entered.	Up to 32 one-byte characters (one-byte or two-byte) (Default: empty)	
	■Comment Information entered in "Comment1" on the "Properties" window displayed by right-clicking the module in the list of stations or the network map is displayed.	Up to 32 one-byte characters (one-byte or two-byte) (Default: empty)	
	■Station-specific mode setting Set the station-specific mode of the device station. (Only when the device station supports the station-specific mode)	The setting varies depending on the set device station.	

*1 When the RX/Ry start address, end address, or points are equal to 20h, the RX/Ry data is guaranteed to be 32bit data.

*2 If it is set for the device station that supports CANopen communication in the Motion module with the firmware version "1.001" or earlier, the error "Network parameter error" (error code: 2221H) occurs.

Point

Because a portion of the setting items are not displayed in simple display, when there are deficiencies in setting items that are not displayed, the "Output" window may display a warning or error by selecting [Close with Reflecting the Setting].

If a warning is displayed, switch to detailed display and correct the items.

Connected/Disconnected module detection

Connected device stations are detected and displayed on the "CC-Link IE TSN Configuration" window.

1. Click the [Connected/Disconnected Module Detection] button.
2. When the [Execute] button is clicked according to the instruction on the window, connected device stations are detected and displayed on the "CC-Link IE TSN Configuration" window.

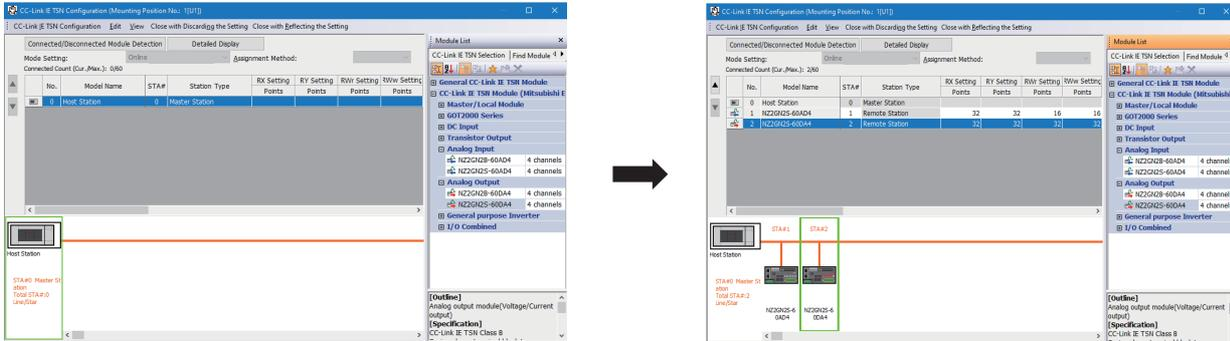

3. Check items in the list of stations and change them as necessary. (☞ Page 109 Setting items)
4. Select [Close with Reflecting the Setting] and close the "CC-Link IE TSN Configuration" window.

Point

Detection of connected/disconnected devices cannot be executed in the following cases.

- The Motion module is not in online mode. (☞ Page 106 Module operation mode)
- The actual system configuration is incorrect. (Such as IP address duplication)
- The master station does not perform data link.

Connection/Disconnection/Replacement

When the [Connected/Disconnected Module Detection] button is clicked while the saved CC-Link IE TSN configuration is displayed, IP addresses of detected device stations are compared with the saved IP addresses of device stations and displayed as follows by connection/disconnection/replacement.

IP address verification result	Operation	Display	When station numbers of detected device stations are not set
Detected device stations are in the saved CC-Link IE TSN structure.	Replace	When parameters between a detected device station and a saved CC-Link IE TSN structure mismatch, the parameters are replaced with the parameters of the detected device station. When the model name, model version, and station type are mismatched, the following settings are inherited. • "RX Setting", "RY Setting", "RWr Setting", "RWw Setting" • "IP Address" of the master station • "Subnet Mask" • "Default Gateway" • "Reserved/Error Invalid Station" (however, if "Reserved Station" is set, the setting will change to the default.) • "Network Synchronous Communication" • "Communication Period Setting" If only the station number is mismatched, only the station number is reflected, and all the settings are inherited. (However, if the station number of the detected device has not been set, the station number of the device before replacement is inherited.)	The station number takes over the station number of the saved CC-Link IE TSN structure.
Device stations in the saved CC-Link IE TSN structure are not detected.	Disconnect	• Modules other than extension modules: Setting of "Reserved/Error Invalid Station" is changed to "Reserved Station". • Extension modules: Are deleted.	—

IP address verification result	Operation	Display	When station numbers of detected device stations are not set
Detected device stations are not in the saved CC-Link IE TSN structure.	Connect	Detected device stations are added. (Settings other than "IP Address", "STA#", and "Station Type" are default) When adding a device, the defaults other than IP address, station number, and station type are set. (However, if the station number of the detected device has not been set, the station number is also set to the default.) Added device stations are displayed in the list of stations in the following order. <ul style="list-style-type: none"> • Modules other than extension modules: In the order of IP addresses, following disconnected device stations. • Extension modules: In the order of sub-IDs, following connected main modules and extension modules. 	A station number is automatically numbered as the lowest unused station number in the setting range. FX5-40SSC-G: 1 to 20 FX5-80SSC-G: 1 to 24 The order of automatic numbering is the same as the displayed order in the list of stations (see left).

Precautions

In the CC-Link IE TSN structure, when a station number is set to a device station and parameters are written to the CPU module, the station number of the device station is held in the master station. When parameters are not to be written in CPU modules, they are saved in the CC-Link IE TSN structure as device stations with the station number not set.

Point

Register the profile of the target device to detect in advance.

If the profile is not registered, the following may be displayed.

- "Model Name" is "General Remote Station", or "General Extension Module".
- "Station Type" is "Remote Station", or "Extension Module".

For how to register a profile, refer to the following.

 GX Works3 Operating Manual

Restriction

- Even when the profile is registered, if modules that are not available for detection of connected/disconnected devices are used, "Model Name" and "Station Type" are not displayed correctly.
- Reserved stations or data link faulty stations cannot be detected by this function.
- If this function is executed when the device station has been disconnected after the master station was powered on, the setting of "Reserved Station/Error Invalid Station" does not change to "Reserved Station", but it becomes "No Setting".
- A module that cannot be used with Motion module, for example, a module with a safety communication function or a module that requires a CANopen profile, may be detected.
- Some of the devices cannot be detected at extension device stations.

Parameter processing of a device station

The processing is to read and save the parameters from the device station, and to write the saved parameters to the device station.

Also, it automatically sets parameters of the device station from the master station. (☞ Page 51 Device station parameter automatic setting)

☞ Navigation window ⇒ "Parameter" ⇒ "Module Information" ⇒ Target module ⇒ "Module Parameter (Network)" ⇒ "Basic Settings" ⇒ "Network Configuration Settings"

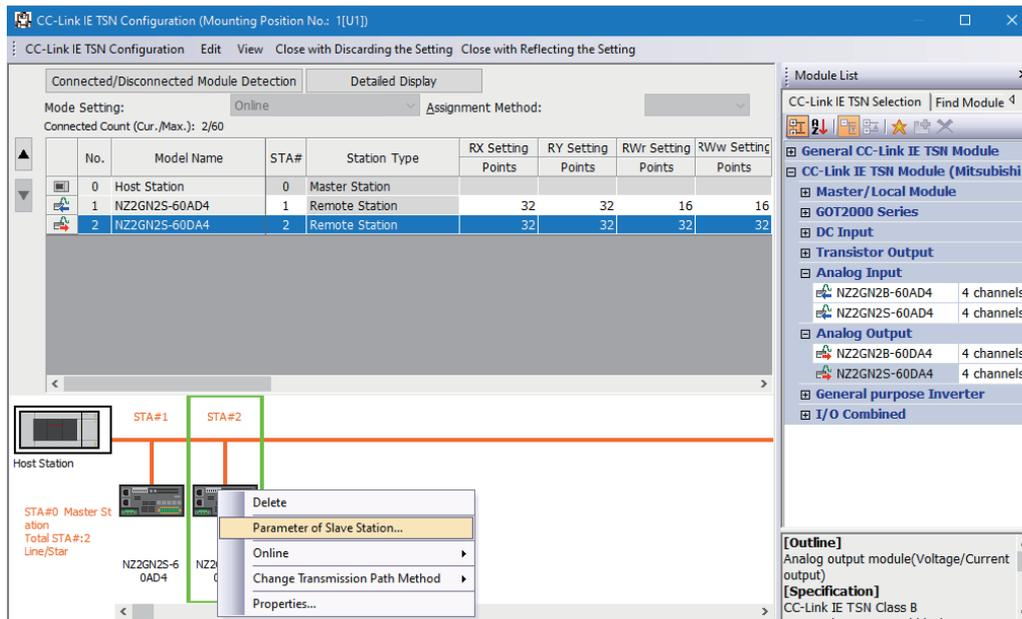

Select and right-click the device station, and select "Parameter of Device Station" to display the "Parameter of Device Station" window.

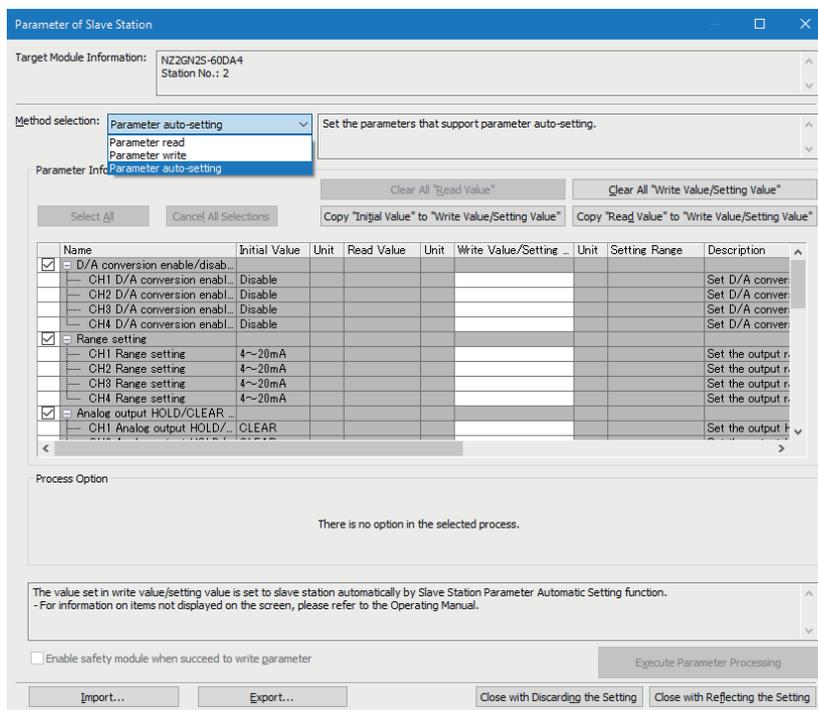

In this manual, "slave station" is described as "device station".

Item	Description	
Target Module Information	Information for the selected device stations is displayed.	
Method selection	Select processing to be executed for selected device stations. <ul style="list-style-type: none"> Parameter auto-setting: Automatically set contents of "Write Value/Setting Value" to the device station. (Page 51 Device station parameter automatic setting) Parameter read: Read parameters from the selected device station. Parameter write: Write parameters to the selected device station. 	
Parameter Information	[Clear All "Read Value"] button	Click to clear all setting details that were read using "Parameter read".
	[Clear All "Write Value/Setting Value"] button	Click to clear all setting details that are written using "Parameter write".
Processing option	When there are options for processing selected by "Method Selection", setting items are displayed.	
[Import] button	Read contents of parameter processing created in a CSV file.	
[Export] button	Output contents of parameter processing set in this window to a CSV file.	

Procedure for clearing a saved parameter

When returning the saved parameters of a not-required device station to the not-set status, perform the following procedure.

1. If the saved parameters are to be saved, output them in a CSV file using the [Export] button.
2. Delete not-required device stations from the list of stations.
3. Select the same module as the deleted device station in "Module List", and drag it to the list of stations or the network map.

Conditions for clearing a saved parameter

Saved parameters of a device station can be cleared under the following conditions.

When saved parameters are cleared, execute "Parameter auto-setting" or "Parameter read" in the "Parameter of Device Station" window and read the parameters of the device station.

Item	Operation	Description
"CC-Link IE TSN Configuration" window	Open the "CC-Link IE TSN Configuration" window.	When there is not a device station with the station number that matches saved parameters in the "CC-Link IE TSN Configuration" window, saved parameters of the relevant device station are skipped. Skipped parameters of the device station are cleared.
	Reflect setting and close the window.	Saved parameters of a device station that is not in the actual system configuration are cleared.
	Execute detection of connected/disconnected devices.	All saved parameters are cleared.
	Change the function version in the "Properties" window.	When the "Properties" window is closed, saved parameters are cleared.
"Parameter of Device Station" window	Open the "Parameter of Device Station" window.	Saved parameters that mismatch the relevant device station are skipped. Clicking the [Close with Reflecting the Setting] button in the above state clears the skipped saved parameters.
Module Parameter	Manually delete "Network Configuration Settings" to apply.	Parameters of "Network Configuration Settings" return to default.
	Change "Station Type" or set parameters that do not exist.	
System Parameter	Divert system parameters from another project.	Parameters of the device station are not diverted.
Module Configuration	Delete a module and check.	Parameters are deleted together with the module.
Navigation window	Delete a module.	
Read from PLC	Read module parameters that have a different network configuration and the same Intelligent module No.	Parameters are overwritten.
Navigation window	Import the data of a Simple Motion module to take network settings.	
MELSOFT Navigator	Reflect the parameter.	Saved parameters are cleared.

Command execution to device stations

Commands to a device station (Error clear request, Error history clear request) are executed.

Navigation window ⇒ "Parameter" ⇒ "Module Information" ⇒ Target module ⇒ "Module Parameter (Network)" ⇒ "Basic Settings" ⇒ "Network Configuration Settings"

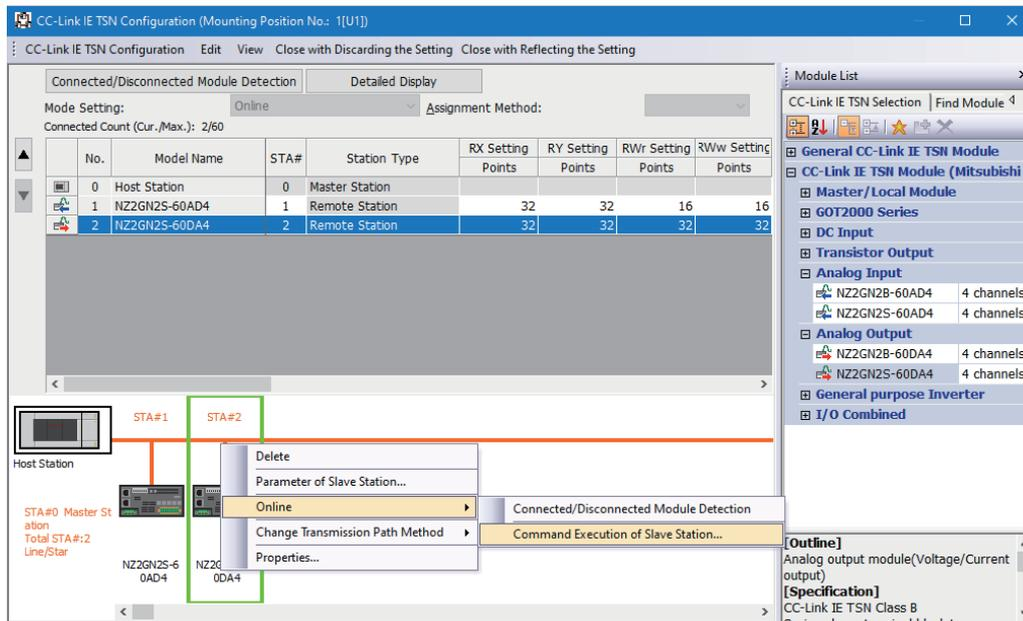

In this manual, "slave station" is described as "device station".

Select and right-click the device station, select "Command Execution of Device Station" from "Online" to display the "Command Execution of Device Station" window.

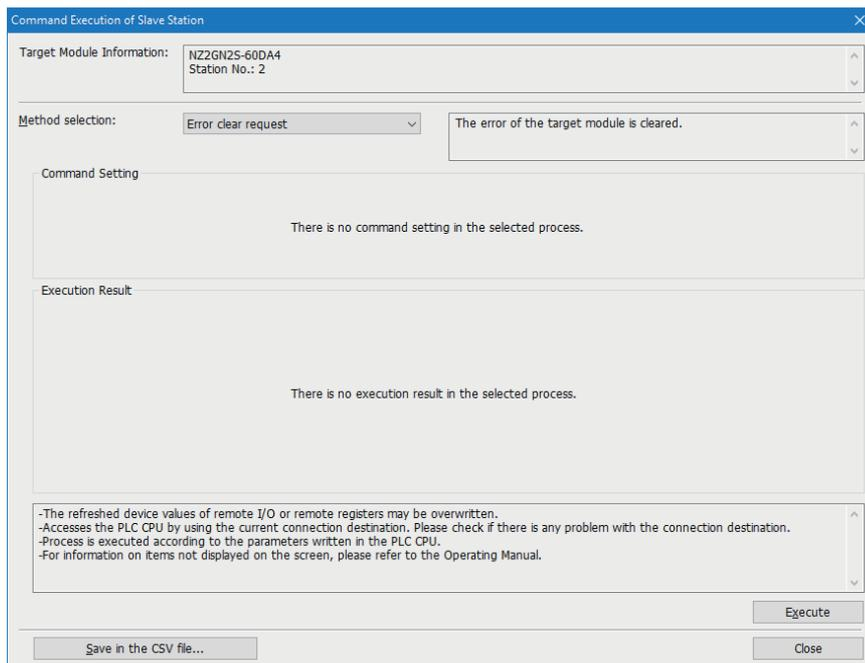

In this manual, "slave station" is described as "device station".

Item	Description
Target Module Information	Information for the selected device stations is displayed.
Method selection	Select processing to be executed for selected device stations. <ul style="list-style-type: none"> • Error clear request • Error history clear request
Command setting	When there are command settings for processing selected by "Method selection", setting items are displayed.
Execution Result	Execution results of the processing selected in "Method selection" are displayed.
[Save in the CSV file] button	Outputs the contents of this window to a CSV file.

PDO mapping setting

Sets the PDO mapping for standard stations that support CANopen communication.

When connecting an extension module such as a multi-axis servo amplifier that contains PDO mapping information, the maximum number of connectable stations changes depending on the number of axes.

Ex.

When connecting a 3-axis multi-axis servo amplifier with 16 maximum number of connectable stations and 3 axes, station 1 to station 5 can be connected.

"Batch Setting of PDO Mapping"

Set the appropriate device station to the default PDO mapping in a batch.

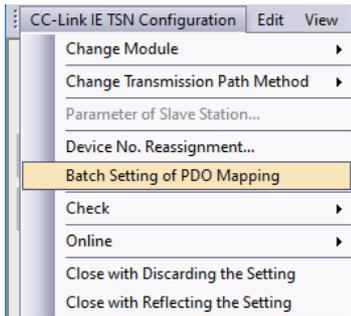

1. Click "Batch Setting of PDO Mapping".

"Basic Settings" ⇒ "Network Configuration Settings" ⇒ [CC-Link IE TSN Configuration] ⇒ [Batch Setting of PDO Mapping]

2. Check the contents of the displayed confirmation message, then click the [Yes] button.

3. When the completion screen for "Batch Setting of PDO Mapping" is displayed, click the [OK] button.

5

■Cases where the PDO mapping will not be set

In the following cases, the PDO mapping will not be set for the appropriate device station.

- When a station for which PDO mapping can be set does not exist.
- When the points for "RW_r Setting" and "RW_w Setting" are less than the points used in the default pattern.
- When the setting for "RW_r Setting" and "RW_w Setting" is left blank, and PDO mapping is performed while "Batch set default pattern only for device station for which PDO mapping is not set" is unchecked.

"PDO Mapping Setting"

Set the PDO mapping for each appropriate device station separately.

"Basic Settings" ⇒ "Network Configuration Settings" ⇒ "PDO Mapping Setting" ⇒ Double-click <Detailed Setting> of the device station

1. Select the Transmit PDO mapping pattern to assign to the link device (RW_r). Click the [Next] button.

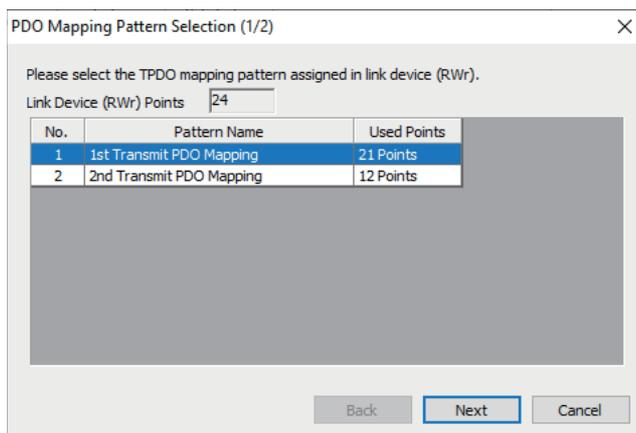

2. Select the Receive PDO mapping pattern to assign to the link device (RW_w). Click the [OK] button.

3. Confirm the selected PDO mapping patterns.

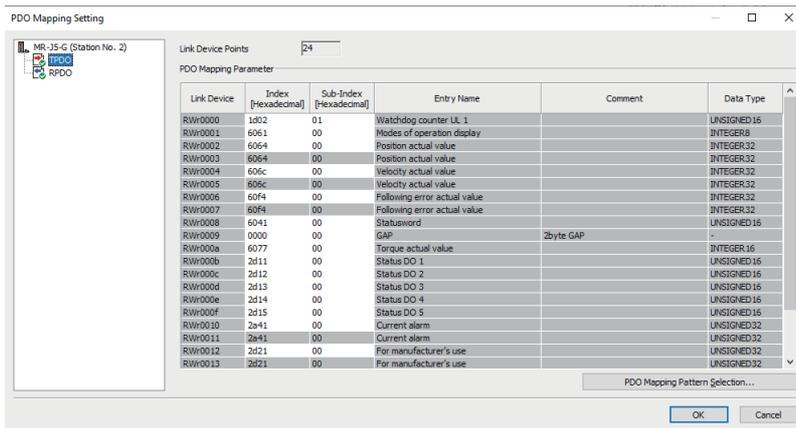

4. Click the [OK] button to close "PDO Mapping Setting".

■Cases where the PDO mapping will not be set

In the following cases, the PDO mapping will not be set for the appropriate device station.

- When more than one point is set in "RWr Setting" and the TPDO entry is not assigned.
- When more than one point is set in "RWw Setting" and the RPDO entry is not assigned.
- When there is a value entered in "Index" while there is a blank row in "Sub-Index".
- When an entry exceeding the link device range is assigned.
- When a single entry is assigned to multiple link devices.

6 DEDICATED INSTRUCTION

This section describes dedicated instructions that can be used in the Motion module.

Point

For details on dedicated instructions, refer to the following.

MELSEC iQ-F FX5 Programming Manual (Instructions, Standard Functions/Function Blocks)

6.1 SLMP communication instruction

The following table lists the dedicated instruction used to send an SLMP frame to an SLMP-compatible device in the same network.

Instruction	Description
SLMPSND	Send an SLMP message to the SLMP-compatible device in the same network. For details, refer to the following manual. MELSEC iQ-F FX5 Programming Manual (Instructions, Standard Functions/Function Blocks)

Restriction

The SLMPSND instruction is available for the firmware version "1.001" or later.

6

SLMP command for accessing to CAN application object

The list of SLMP commands for accessing to CAN application objects is shown below.

Control	Command	Subcommand	Description
ReadObject	4020h	0001h	Read the value of objects specified by Index and Sub Index.
WriteObject	4020h	0002h	Write the value of objects specified by Index and Sub Index.
ObjectSubIDReadBlock	4020h	0005h	Read the object value of specified Index from specified Sub Index continuously.
ObjectSubIDWriteBlock	4020h	0006h	Write the object value of specified Index from specified Sub Index continuously.

For response data at abnormal response, refer to the following manual.

MELSEC iQ-F FX5 Programming Manual (Instructions, Standard Functions/Function Blocks)

ReadObject

Request data

Command		Subcommand		Index	Sub Index	00H	Data read size (*1)
20H	40H	01H	00H				

*1 Read with the default size of objects by specifying 0 for the data read size.

Response data (normal response)

Index	Sub Index	00H	Read data size (1 byte unit)	Read data

WriteObject

Request data

Command		Subcommand		Index	Sub Index		Write data size (1 byte unit)	Write data
20H	40H	01H	00H			00H		

Response data (normal response)

Index	Sub Index			
		00H	00H	00H

ObjectSubIDReadBlock

Request data

Command		Subcommand		Index	Sub Index (*1)		Data read size
20H	40H	01H	00H			00H	

*1 Only 0 or 1 can be specified for Sub Index.

Response data (normal response)

Index	Sub Index		Read data size (1 byte unit)	Read data
		00H		

ObjectSubIDWriteBlock

Request data

Command		Subcommand		Index	Sub Index (*1)		Write data size (1 byte unit)	Write data
20H	40H	01H	00H			00H		

*1 Only 0 or 1 can be specified for Sub Index.

Response data (normal response)

Index	Sub Index			
		00H	00H	00H

6.2 Precautions for Dedicated Instructions

This section describes precautions when using dedicated instructions.

Precautions

■When changing data specified by dedicated instructions

Do not change any data (such as control data) until execution of the dedicated instruction is completed.

7 PROGRAMMING

This chapter describes about programming for CC-Link IE TSN.

7.1 Precautions for Programming

This section describes precautions to create CC-Link IE TSN programs.

Cyclic transmission program

For a cyclic transmission program, configure an interlock with the following module labels (link special relay (SB), link special register (SW)).

- 'Data link error status of own station' (SB0049)
- 'Data link status of each station' (SW00B0 to SW00B7)

8 TROUBLESHOOTING

This chapter describes troubleshooting of CC-Link IE TSN.

8.1 Checking with LED

This section describes troubleshooting with LEDs.

When the RUN LED turns off

When the RUN LED turns off after powering on the Motion module, check the following.

Check item	Action
Is the Motion module mounted correctly?	Securely mount the Motion module on the FX5 CPU module.

When the ERROR LED turns on or is flashing

When the ERROR LED turns on or is flashing, check the following.

Check item	Action
Does any error occur in the module diagnostics?	Take the actions displayed on the window.
Is a disconnected station displayed by the CC-Link IE TSN/CC-Link IE Field diagnostics?	<ul style="list-style-type: none"> Perform the network configuration setting and communication period setting in accordance with the station actually connected. Execute the following for the disconnected station.  Page 124 When the D LINK LED turns off or is flashing
Are RX, RY, RWr, and RWW assigned for the CC-Link IE TSN configuration of the master station?	Check that all the assignment of RX, RY, RWr, and RWW of a station where an error occurs is not blank.
Is the event code 00C81 registered in the event history of the master station?	Take the following action for the device station with the IP address displayed in the detailed information of the event history. <ul style="list-style-type: none"> Match "CC-Link IE TSN Class Setting" in "Network Configuration Setting" under "Basic Settings" of the master station to the CC-Link IE TSN Class of the device station.
Is the event code 00C72 registered in the event history of the master station?	<ul style="list-style-type: none"> Update the engineering tool to the latest version. Take the following action for the device station with the IP address displayed in the detailed information of the event history. Update the firmware of the device stations to the latest version.

When the D LINK LED turns off or is flashing

When the D LINK LED turns off or is flashing, check the following.

Check item	Action
Is the master station operating normally?	<ul style="list-style-type: none"> If an error occurs in the CPU module on the master station, eliminate the cause of the CPU module error. If an error occurs in the Motion module on the master station, take action according to the module diagnosis procedure.
Is the master station connected to the network?	Connect the master station to the network.
Does the IP address of each station match the "Network Configuration Settings" of the master station?	Correct the setting of the IP address in "Network Configuration Settings" of the master station.
In the "Network Configuration Settings" of the master station, are the third and fourth octets of the IP address duplicated with those of any other stations?	<ul style="list-style-type: none"> Set IP addresses in a way that does not duplicate the third to fourth octets of the IP address in all stations. Set the IP address and subnet mask to match the network addresses of all stations. Set the third and fourth octets of the IP address to values other than all 0 or all 1. Set the host section to a value other than all 0 or all 1. Set an address other than some reserved addresses fixed for special purposes as the IP address.
In the "Network Configuration Settings" of the master station, does the network address (the subnet mask part of the IP address) match the master station?	
Are the third and fourth octets of the IP address set to values other than all 0 or all 1?	
Is the host section set to a value other than all 0 or all 1?	
Is there a reserved address fixed for a special purpose set as the IP address?	
Do the used Ethernet cables conform to the Ethernet standard?	Replace the cables with Ethernet cables which conform to the standard. ( Page 20 Performance Specifications of CC-Link IE TSN)

Check item	Action
Is the switching hub used operating normally?	<ul style="list-style-type: none"> Use a switching hub that conforms to the standard. (☞ Page 20 Performance Specifications of CC-Link IE TSN) Power off and on the switching hub.
Does the station-to-station distance meet the specifications?	Set the station-to-station distance within range. (☞ Page 20 Performance Specifications of CC-Link IE TSN)
Does the cabling condition (bending radius) meet the specifications?	Refer to the manual for the Ethernet cable, and correct the bending radius.
Is any Ethernet cable disconnected?	Replace the Ethernet cable.
Is the network configured in the ring topology?	Configure the network to avoid the ring topology.
Has the time synchronization source station been reset?	<ul style="list-style-type: none"> Since a station is temporarily disconnected after switching the time synchronization source, wait for it to return. Avoid unnecessary disconnections or returns in a station that is the time synchronization source.
Is the time synchronization source station turned off?	
Is the time synchronization source station operating normally?	Take action by referring to the manual for the time synchronization device.
Has any other station been reset?	<ul style="list-style-type: none"> Avoid unnecessary reset since a station is disconnected while resetting. Start other stations.
Are other stations turned off?	Power on other stations.
Are other stations connected to the Motion module operating normally?	Execute the CC-Link IE TSN/CC-Link IE Field diagnostics from the master station to identify the faulty module of another station. After identification, take action by referring to the manual for the relevant module.
Is the IP address of another station set?	Set an IP address to a device station with no IP address setting.
Are other stations set in the network configuration of the master station?	Set connected device stations in the network configuration of the master station.
Is a type of wiring described in the restrictions in the wiring specifications mistakenly performed?	Correct the wiring. For details, refer to "WIRING" in the following manual.  MELSEC iQ-F FX5 Motion Module/Simple Motion Module User's Manual (Startup)
Are station numbers unique?	Change the duplicated station number.
Is the IP address duplicated with another station?	Change the IP address of the duplicated station.
Is the number of device stations connected exceeded the maximum number of connectable stations?	Make sure that the number of device stations connected is within the maximum number of connectable stations specified in the CC-Link IE TSN performance specifications. ☞ Page 20 Performance Specifications of CC-Link IE TSN
Do CC-Link IE TSN devices and Ethernet devices coexist?	Correct the wiring. For details, refer to "WIRING" in the following manual.  MELSEC iQ-F FX5 Motion Module/Simple Motion Module User's Manual (Startup)
Does the IP filter setting mistakenly block communications from the IP address of another station?	Change the IP filter setting parameter to allow communication for the IP address of another station.
Are time synchronization devices with time synchronization priority of 0 to 15 connected?	Remove time synchronization devices with time synchronization priority of 0 to 15, or change the priority to between 16 and 255.  Manual for the time synchronization devices used
Is the connected TSN switching hub operating normally?	Power off and on the TSN switching hub. Check the TSN switching hub parameters and correct the settings. For the setting method, refer to the manual for the TSN switching hub. The main check items are as follows: <ul style="list-style-type: none"> Enable each port of the TSN switching hub. Set the communication speed and port type to Auto. Match the settings for the time synchronization and communication period of the TSN switching hub to those of the master station. Match the VLAN setting of the master station to that of the device stations.

When the L ER LED turns on

When the L ER LED turns on, check the following.

Check item	Action
Are the Ethernet cables used normally?	<ul style="list-style-type: none"> • Use an Ethernet cable that conforms to the standard. ( Page 20 Performance Specifications of CC-Link IE TSN) • Set the station-to-station distance within range. ( Page 20 Performance Specifications of CC-Link IE TSN) • If the Ethernet cable is disconnected, reconnect it.
Is the switching hub used operating normally?	<ul style="list-style-type: none"> • Use a switching hub that conforms to the standard. ( Page 20 Performance Specifications of CC-Link IE TSN) • Power off and on the switching hub.
Is "Module Operation Mode" under "Application Settings" of the master station set to "Online"?	Set "Module Operation Mode" under "Application Settings" of the master station to "Online".
Is there any source of noise near the module or cables?	Change the location of the module or cables.

When the LINK LED turns off

When the LINK LED turns off, check the following.

Check item	Action
Do the used Ethernet cables conform to the Ethernet standard?	Replace the cables with Ethernet cables which conform to the standard. For details, refer to "WIRING" in the following manual.  MELSEC iQ-F FX5 Motion Module/Simple Motion Module User's Manual (Startup)
Does the station-to-station distance meet the specifications?	Set the station-to-station distance within range. ( Page 20 Performance Specifications of CC-Link IE TSN)
Does the cabling condition (bending radius) meet the specifications?	Refer to the manual for the Ethernet cable, and correct the bending radius.
Is any Ethernet cable disconnected?	Replace the Ethernet cable.
Is the switching hub used operating normally?	<ul style="list-style-type: none"> • Use a switching hub that conforms to the standard. For details, refer to "WIRING" in the following manual. •  MELSEC iQ-F FX5 Motion Module/Simple Motion Module User's Manual (Startup) • Power off and on the switching hub.
Are other stations connected to the Motion module operating normally?	Take action by referring to the manual for the modules of other stations.
Does the communication speed of the connected device match the communication speed set in "Communication Speed"?	Connect the device with the communication speed set in "Communication Speed".
Is the communication speed of connected devices 1 Gbps?	Connect devices that support a communication speed of 1 Gbps.
If the communication speed is set to 100 Mbps for the master station to connect a device with a communication speed of 100 Mbps, is the auto-negotiation of the connected device valid?	Enable the auto-negotiation of the connected device. Or, connect a device with auto-negotiation enabled.

8.2 Checking the Module Status

Module diagnostics

The following items can be checked in the "Module Diagnostics" window for the Motion module.

Item	Description
[Error Information] tab	Displays the details of the errors currently occurring and the corrective actions for these errors. "-" may be displayed in "Occurrence Data" of an error that occurred immediately after the power was turned on. To check the occurrence date, click the [Event History] button and refer to the event history.
[Module Information List] tab	Displays the LED information and individual information of the Motion module.
Supplementary Function	CCIET/CCIEF diagnostics
	Enables checking the cause to resolve the problem when an error occurs in the CC-Link IE TSN. (Page 129 Checking the Network Status)

Error Information

The details of the errors currently occurring and the corrective actions for these errors are displayed in the [Error Information] tab.

Item	Description
Status	Major: An error such as hardware failure or memory failure. The module stops operating. Moderate: An error, such as parameter error, which affects module operation. The module stops operating. Minor: An error such as communication failure. The module continues operating.
Error code	Page 146 List of Error Codes
[Event History] button	Click this button to check the history of errors that have occurred on the network, errors detected for each module, and operations that have been executed. (Page 166 Event List)
Detailed Information	Displays up to three information items for each error, such as parameter information, operation source information, and system configuration information. (Page 164 List of Parameter Numbers)
Cause	Displays the detailed error causes.
Action	Displays the actions to eliminate the error causes.

Module Information List

The LED information and individual information of the Motion module are displayed in the [Module Information List] tab.

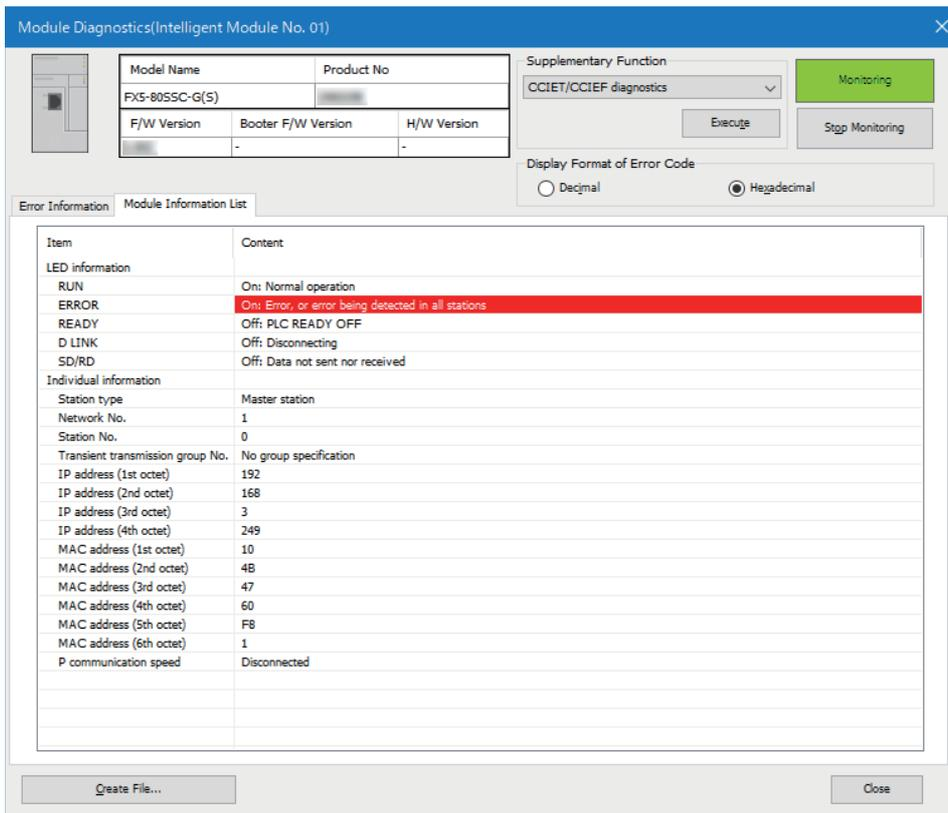

Item	Description	
LED information	Displays the LED status of the Motion module.	
Individual information	Station Type	Displays the station type set for the selected module.
	Network No.	Displays the network number set for the selected module.
	Station Number	Displays the station number set for the selected module.
	Transient transmission group No.	Displays the transient transmission group number set for the selected module.
	IP address	Displays the IP address set for the selected module.
	MAC address	Displays the MAC address of the selected module.
	P Communication Speed	Displays the communication speed set using the auto-negotiation function.

8.3 Checking the Network Status

The network status is checked and troubleshooting is performed by using the CC-Link IE TSN/CC-Link IE Field diagnostics to check the network status and error definition and by performing an operation test to check communications.

CC-Link IE TSN/CC-Link IE Field diagnostics

For CC-Link IE TSN, perform status monitoring, operation tests, or others.

Precautions

In the following cases, the CC-Link IE TSN/CC-Link IE Field diagnostics cannot start.

- The Motion module is not connected to CPU modules specified on the "Specify Connection Destination Connection" window.
- "Module Operation Mode" under "Application Settings" of the Motion module is not set to online mode.
- The error "The module error" (error code: 20E0H) occurs.
- The engineering tool is not connected to a station with the same communication speed as the master station.
- The network topology of the diagnostics destination does not support the version of the engineering tool or module.

Function list

The following table lists the functions of the CC-Link IE TSN/CC-Link IE Field diagnostics.

○: Diagnosed △: Diagnosed with restrictions ×: Not diagnosed

Function type	Function	Description	Connection destination of engineering tool	Reference
			Master station	
Network status monitor function	Network map	<ul style="list-style-type: none"> • Displays the network configuration of CC-Link IE TSN. This function displays the current status of the same network as a network map, and displays the Ethernet cable connection status, IP address duplication, and station disconnection status. A network map to be displayed is automatically generated from the current configuration on the network. • Whether an error occurred in any of the devices and Ethernet cables that configure the network can be checked. In addition, the operating status of a station set in the network parameters can be checked. 	○	Page 132 "CC-Link IE TSN/CC-Link IE Field Diagnostics" window
	Selected Station Communication Status Monitor	<ul style="list-style-type: none"> • Displays the module status and communication status of the selected station. If an error occurred in the module, this function displays diagnostic information such as the cause of the error and corrective action. • Detailed error definition of the selected station and corrective action for the error can be checked. 	○	
	Data Unlinked	<ul style="list-style-type: none"> • Displays a station with its setting existing in the network parameters but not displayed in the network map (a station that has never joined the network). • This function can check the non-existence of a station set in the network parameter. 	○	
Operation test/ execution function	Communication Test	<ul style="list-style-type: none"> • This test specifies the network number and station number or the IP address to check whether transient transmission can be performed from the connected station (own station) to the communication destination. • Transient transmission to the specified communication destination (on the same network only) can be checked. 	○	Page 136 Communication test
Remote Operation		This function can remotely operate (RUN, STOP, and RESET) the CPU module and slave module.	△ ^{*1}	Page 137 Remote operation

*1 If the setting on the "Specify Connection Destination Connection" window of the engineering tool is as follows, remote operation cannot be executed with "All Stations Specified".
Connection via Ethernet with the selections "Ethernet Board" for the personal computer-side I/F and "CC IE TSN/Field Module" for the programmable controller-side I/F

Restriction

When starting the CC-Link IE TSN/CC-Link IE Field diagnostics by specifying "Other Station (Single Network)" or "Other Station (Co-existence Network)" in "Other Station Setting" on the "Specify Connection Destination Connection" window, the following restrictions apply.

- A communication test cannot be used.
- If MELSECNET/H, multidrop connection of serial communication modules, an interface board for a personal computer, or network modules of the MELSEC-Q/L series are included in the communication path, diagnostics cannot start.

Usage methods

The following describes how to use the CC-Link IE TSN/CC-Link IE Field diagnostics.

1. Connect the engineering tool to the CPU module.

If a device station cannot be monitored due to an error such as Ethernet cable disconnection, directly connect the engineering tool to the device station.

2. Start the CC-Link IE TSN/CC-Link IE Field diagnostics.

[Diagnostics] ⇒ [CC-Link IE TSN/CC-Link IE Field Diagnostics]

3. When the following window opens, select the Motion module to be diagnosed and click the [OK] button to start the CC-Link IE TSN/CC-Link IE Field diagnostics.

Modules are listed in the order configured in module information.

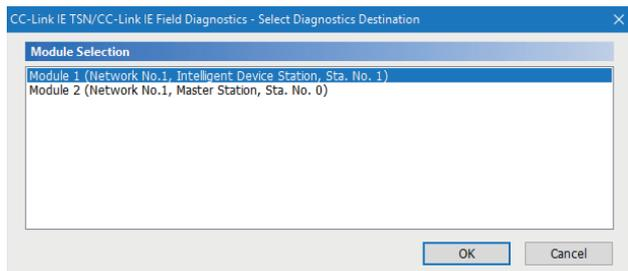

4. Select the station to be diagnosed from "Select Station" or in the network map.

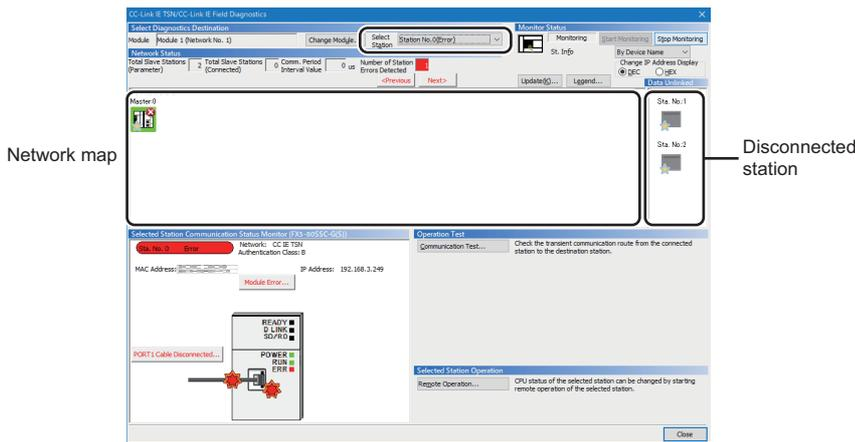

In this manual, "Authentication Class" is described as "CC-Link IE TSN Class".

- An icon indicating an error is displayed on the module icon of the station where an error occurs.
- A disconnected station that has performed data link is indicated with the disconnected station icon in the network map. However, a disconnected station in the following cases are displayed on the right end of the area.

Stations displayed on the right end of the area.

- A station that was reconnected to a network after disconnecting/inserting the Ethernet cable or powering off and on the system, and remains disconnected
 - A disconnected station with the station icon deleted in the network map by clicking the [Update] button
- The "Error" icon is displayed on the icon of a cable where a communication error occurs. To check the details of the communication error, click the neighboring stations of the "Error" icon.

Point

When the station to be diagnosed cannot be selected, the status of network number mismatch or duplication of master stations cannot be checked using the CC-Link TSN/CC-Link IE Field diagnostics. Connect the engineering tool directly to the station where the error has occurred, and check the error details on the "System Monitor" window.

5. The status of a station selected in "Network Status" is displayed in "Selected Station Communication Status Monitor". (☞ Page 132 "CC-Link IE TSN/CC-Link IE Field Diagnostics" window)

The station status is displayed on the top of "Selected Station Communication Status Monitor".

If an error occurs, a button indicating the error such as [PORT1 Communication Error] is displayed in "Selected Station Communication Status Monitor". Click the button to check the error details and actions.

6. Various tests and operations can be performed by clicking the "Operation Test" or "Selected Station Operation" on the bottom left of the window. (☞ Page 136 Communication test, Page 137 Remote operation)

"CC-Link IE TSN/CC-Link IE Field Diagnostics" window

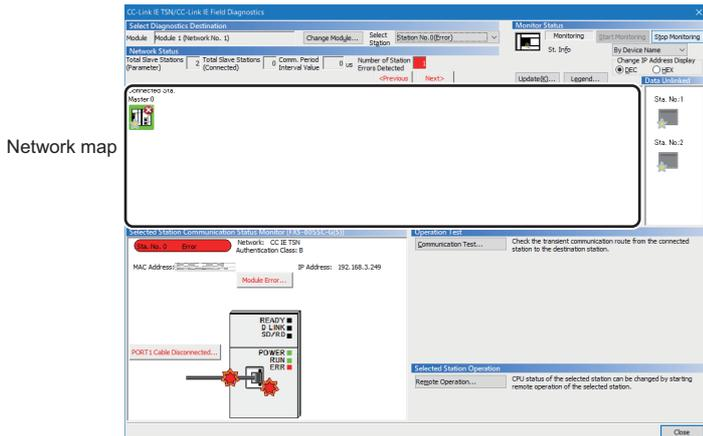

In this manual, "Authentication Class" is described as "CC-Link IE TSN Class".

Item		Description
Select Diagnostics Destination	Module	The Motion module under diagnostics is displayed.
	[Change Module] button	Allows to change the target Motion module when multiple Motion modules are mounted.
	Select Station	Selects the station number of the station to be diagnosed. A station to be diagnosed can also be selected by clicking the module icon displayed in the network map.
Monitor Status	[Start Monitoring] button	Starts monitoring the CC-Link IE TSN/CC-Link IE Field diagnostics.
	[Stop Monitoring] button	Stops monitoring the CC-Link IE TSN/CC-Link IE Field diagnostics.
[Update] button		If the actual network configuration and network map of the "CC-Link IE TSN/CC-Link IE Field Diagnostics" window are inconsistent, the network map update is executed so they are matched. A data link error may momentarily occur in all the stations and outputs of the connected device stations may turn off since all stations on the network will be reconnected when executing the network map update. Set output data if needed.
[Legend] button		Displays the meaning of icons displayed in the "CC-Link IE TSN/CC-Link IE Field Diagnostics" window.
St. Info		The display name of the device station can be selected from "By Device Name", "By Station Type", "By Model Name", or "By IP Address". (Default: "By Device Name") "By Device Name" displays the information entered in "Alias" of "Network Configuration Settings" under "Basic Settings". The station type is displayed when the "Alias" is not entered.
Network Status	Total Device Stations (Parameter)	Displays the total number of device stations set in "Network Configuration Settings" under "Basic Settings".
	Total Device Stations (Connected)	Stores the total number of device stations (number of device stations) that are actually connected by data link in the CC-Link IE TSN.
	Communication Cycle Interval Setting value	The communication cycle interval set in "Communication Period Setting" under "Basic Settings" of the master station is displayed. (μ s unit)
	Number of Station Errors Detected	Indicates the number of error stations in the displayed network.
	Change IP Address Display	Allows to select from "DEC" or "HEX" for IP address display on the selected communication status monitor and network map. (Default: Decimal)
	Network map	Indicates the CC-Link IE TSN structure and the status of each station. (Page 133 Network map)
	Data Unlinked	Displays a disconnected station that has been set in "Network Configuration Settings" under "Basic Settings" but has not yet performed data link. Reserved stations or error invalid stations are also included.
Selected Station Communication Status Monitor		Displays status of the station selected in "Network Status". (Page 135 Selected Station Communication Status Monitor)
Operation Test	[Communication Test] button	Performs a communication test. (Page 136 Communication test)
Selected Station Operation	[Remote Operation] button	Performs remote operations (such as RUN, STOP, and RESET operations) on the CPU module. (Page 137 Remote operation)

Network map

Icon

The module type and station number are displayed with an icon.

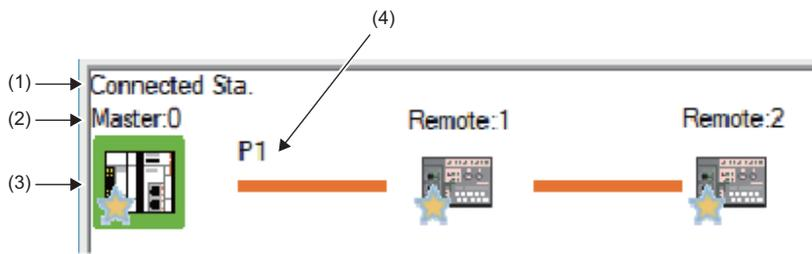

- Click: Selection
- Right-click: Executes tests or debugging.
- [F4] [F5] [F6] [F7] keys on the keyboard: Move the focus to the module to be diagnosed, and determine it with the [Space] key.

No.	Description
(1)	Displays the station (own station) where the engineering tool is connected.
(2)	Displays the station type and station number. "?" is displayed when a station number has not been set. When the background of the text is colored, the relevant station may have been set as a reserved station or an error invalid station. Click the [Legend] button to check the meaning of the background colors.
(3)	Module status is displayed. Click the [Legend] button to check the meaning of the icon.
(4)	Ethernet port to which an Ethernet cable is connected is displayed.

Network map

A network map is displayed according to the connection status.

Connection status	Display of the network map
<p>Line topology</p>	
<p>Star topology</p>	
<p>Coexistence of line and star topologies</p>	

In the following cases, the network map is displayed differently from the actual connection status.

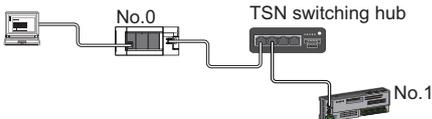
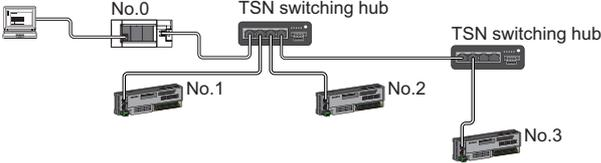
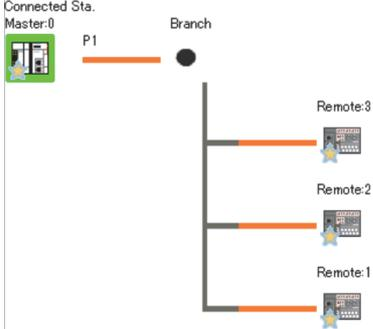
Connection status	Display of the network map
<p>Two stations are connected through a switching hub.</p> 	<p>Branches are not displayed in the network map.</p> 
<p>Switching hubs are in cascade connection.</p> 	<p>Only one branch is displayed.</p> 

Precautions

Stations in offline mode are not displayed in the network map. In line topology, stations connected after a station in offline mode are not displayed because they are disconnected.

Selected Station Communication Status Monitor

Status of the station selected in "Network Status" is displayed.

■When a station where an error has occurred is selected

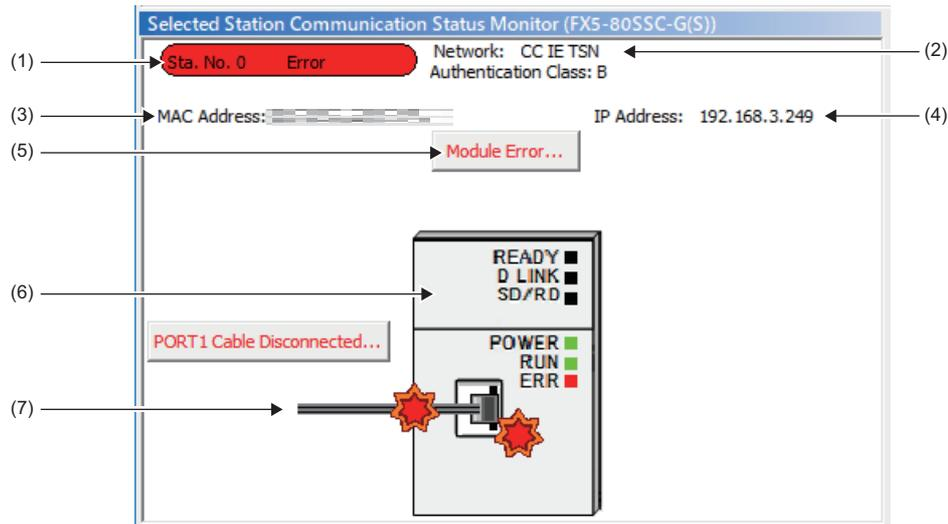

In this manual, "Authentication Class" is described as "CC-Link IE TSN Class".

No.	Description
(1)	Indicates the station number and operating status. <ul style="list-style-type: none"> • Station number No error (light blue): Normal operation • Station number Error (yellow): Error (Data link is continued) • Station number Error (red): Error (Data link is stopped)
(2)	Displays the network type.
(3)	Displays a MAC address.*1
(4)	Displays an IP address.
(5)	Click this button to check error details. Take actions according to the description displayed in "Error Factor" and "Troubleshooting".
(6)	The LED status of a module and communication status is displayed. For details, refer to "LED Display Specifications" in the following manual. MELSEC iQ-F FX5 Motion Module/Simple Motion Module User's Manual (Startup)
(7)	Status of the Ethernet cables connected is displayed.

*1 When 00-00-00-00-00-00 is displayed as a MAC address, the status of the selected station cannot be checked with the selected station communication status monitor. Connect the engineering tool directly to the station where the error has occurred, and check the error details on the "System Monitor" window.

■When a selected station is not available for communication status monitor

The information of devices are not displayed. The "Error details" window (detailed information, error factor, troubleshooting) is displayed.

Communication test

This function checks if transient transmission data can be properly routed from the own station to the communication target. Depending on selection for "Communication Method" ("Network No./Station No." or "IP Address"), the range that can be checked may vary.

Selection of "Communication Method"	Communication target of transient transmission	
	Stations on the same network	Stations on the other network
Network No./Station No.	<input type="radio"/> Available for check	<input checked="" type="radio"/> Not available for check
IP Address	<input type="radio"/> Available for check	<input checked="" type="radio"/> Not available for check

The following explains the procedure for a communication test.

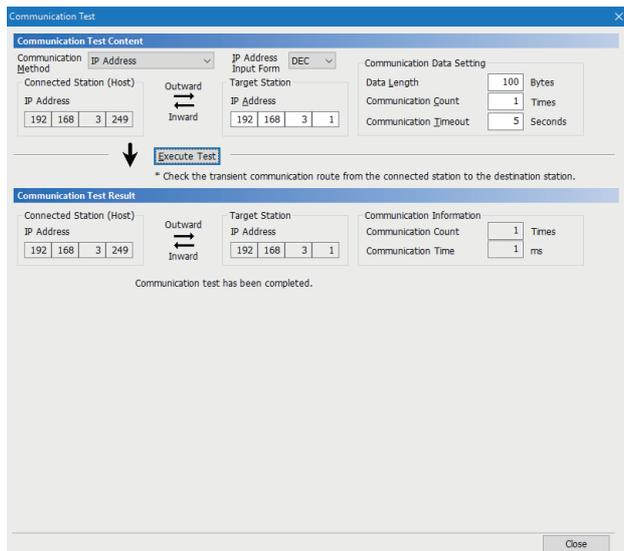

1. Display the "Communication Test" window and select "Network No./Station No." or "IP Address" from "Communication Method".
 [Diagnostics] ⇒ [CC-Link IE TSN/CC-Link IE Field Diagnostics] ⇒ [Communication Test] button
2. Enter values for "Target Station" and "Communication Data Setting".
3. Click the [Execute Test] button to execute the communication test. If an error occurs, take corrective actions according to the error message.

Precautions

- When a relay sending station is set to "Target Station", the communication test ends with an error. Set a relay receiving station to "Target Station".

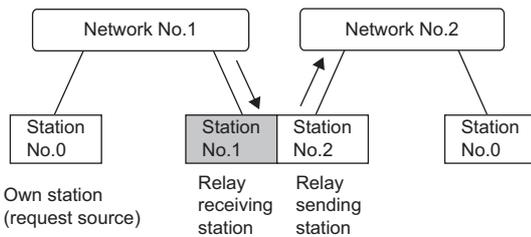

- When "Network No./Station No." is selected for "Communication Method" and a station mounted on the same system (module connected with a connector or cable) is set for "Target Station", the communication test ends with an error.
- This test cannot check whether transient transmission can be performed from the connected station (own station) to a station on another network by specifying an IP address.
- Since this function uses PING, the error "a communication test target station communication error" (error code D919H) occurs if the communication target does not respond to PING. When executing this function, check if the security setting (such as firewall) of the communication target is set to respond to PING. Moreover, if the target is set not to respond to PING in the security settings (such as a firewall), it may take some time until a timeout error occurs on the engineering tool. For details on when communication of the engineering tool is not allowed in the firewall settings of Windows, refer to the following.

GX Works3 Operating Manual

Remote operation

This function executes remote operations (such as RUN, STOP, and RESET operations) to the station selected on the "CC-Link IE TSN/CC-Link IE Field Diagnostics" window, from the engineering tool. (Remote operation for device stations is available only for RESET.)

The displayed window varies depending on the station selected. For the operations with a module other than the Motion module selected, refer to the manual for the module used.

Procedure

To perform remote operations, follow the steps below.

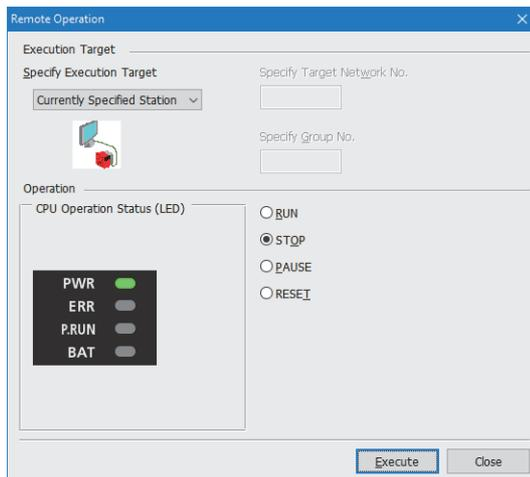

1. Select the module where the remote operations are performed in the "CC-Link IE TSN/CC-Link IE Field Diagnostics" window.
2. Click the [Remote Operation] button in the "CC-Link IE TSN/CC-Link IE Field Diagnostics" window, or right-click a module icon in the "Network Status" and click [Remote Operation].

The "Remote Operation" window is displayed.

3. Specify "Current Specified Station" in "Specify Execution Target".

The remote operations are performed only to the CPU module on the station selected in the CC-Link IE TSN/CC-Link IE Field diagnostics.

4. Select a remote operation (RUN, STOP, PAUSE, or RESET) to be performed in "Operation" to the CPU module.*1
5. Click the [Execute] button to perform the remote operation.

*1 To perform remote RESET, set "Remote Reset Setting" under "Operation Related Setting" of "CPU Parameter" to "Enable" in advance.



For details on the remote operations, refer to the user's manual for the CPU module used.

8.4 Troubleshooting by Symptom

This section describes troubleshooting by symptom. Perform the troubleshooting by symptom when a data link cannot be performed with the target station even though no error occurs in the Motion module. If an error has occurred in the Motion module, identify the error cause using the engineering tool. (☞ Page 129 Checking the Network Status)

When cyclic transmission cannot be performed

The following table lists the actions to be taken if cyclic transmission cannot be performed to the master station.

Check item	Action	
Is the D LINK LED of the Motion module turned on?	Perform troubleshooting for when the D LINK LED turns off or is flashing. (☞ Page 124 When the D LINK LED turns off or is flashing)	
Do the station types set in "Network Configuration Settings" of the master station match those set for the connected device stations?	<ul style="list-style-type: none"> • Check 'Station type match status' (SB00E8) and 'Station type match status' (SW00E8 to SW00EF) to correct the station type of stations in which the station type does not match. • Correct that "Network Configuration Settings" of the master station and the actual system configuration match. 	
When "Connection Device Information" is set to "CC-Link IE TSN Class B Only", is a TSN switching hub used?	<p>Correct the switching hub and the switching hub settings. For the setting method, refer to the manual for the switching hub used.</p> <ul style="list-style-type: none"> • When using a TSN switching hub, check the precautions and restrictions for system configuration on the CC-Link Partner Association website. (www.cc-link.org) • Correct the switching hub delay time according to the switching hub used. (☞ Page 201 Communication cycle intervals) For the switching hub delay time of the switching hub used, contact the manufacturer. 	
When "Communication Speed" of the master station is set to "100 Mbps", is "Basic Settings" ⇒ "Communication Period Setting" ⇒ "Basic Period Setting" ⇒ "System Reservation Time" of the master station set to 20 μs?	Set "System Reservation Time" to 200 μs.	
Does the IP filter setting mistakenly block communications from the IP address of another station?	Change the IP filter setting parameter to allow communication for the IP address of another station.	
The connection device information of the master station is set to "CC-Link IE TSN Class B Only".	Are CC-Link IE TSN Class A devices connected?	Disconnect the CC-Link IE TSN Class A devices.
	Is a general-purpose switching hub connected between CC-Link IE TSN Class B devices?	Check the connected device and disconnect the general-purpose switching hub or replace it with a TSN switching hub.
The connection device information of the master station is set to "Mixture of CC-Link IE TSN Class B/A or CC-Link IE TSN Class A Only".	<p>■For firmware version "1.001" or earlier</p> Are nine or more CC-Link IE TSN Class B devices and switching hubs connected in total in the transmission path from the master station to the CC-Link IE TSN Class B device of the end?	Check the connected devices and reduce the number of CC-Link IE TSN Class B devices and TSN switching hubs to eight or less in total in the transmission path from the master station to the CC-Link IE TSN Class B device of the end.
	Is a CC-Link IE TSN Class B device connected to a station other than the master station in a star topology via a general-purpose switching hub?	Other than the master station, do not connect CC-Link IE TSN Class B devices to a general-purpose switching hub in star topology. Alternatively, connect CC-Link IE TSN Class B devices to the TSN switching hub in star topology.
	Is a general-purpose switching hub connected between the master station and CC-Link IE TSN Class B devices?	<p>Check the connected device and connect the master station to CC-Link IE TSN Class B devices in line topology instead of using a general-purpose switching hub.</p> <p>Check the connected device and connect the master station with CC-Link IE TSN Class B devices via a TSN switching hub.</p>
	Is an Ethernet device connected to a place other than the end of the network?	Check the connected device and connect the Ethernet device at the end of the network.
	Is a general-purpose switching hub other than the NZ2EHG-T8(N) and DT135TX used?	Use the NZ2EHG-T8(N) or DT135TX.
	<p>■For firmware version "1.002" or later</p> Is the event code 00C81 registered in the event history?	Change "CC-Link IE TSN Class Setting" under "Network Configuration Setting" or "CC-Link IE TSN Class Setting" on the device station side so that the "CC-Link IE TSN Class Setting" for each station match.
	When the device stations to be used operate with the CC-Link IE TSN Protocol version 2.0, is a master station that does not support the CC-Link IE TSN Protocol version 2.0 used?	<ul style="list-style-type: none"> • Update the firmware of the master station to a version supporting the CC-Link IE TSN Protocol version 2.0. • Replace the master station with a master station supporting the CC-Link IE TSN Protocol version 2.0.

Check item	Action
The connection device information of the master station is set to "Mixture of CC-Link IE TSN Class B/A or CC-Link IE TSN Class A Only".	<ul style="list-style-type: none"> Check 'CC-Link IE TSN Protocol version 2.0 support status for each station' (SW01A0 to SW01A7), and update the firmware of the device station that does not support the CC-Link IE TSN Protocol version 2.0 to a version supporting the CC-Link IE TSN Protocol version 2.0. Replace the device station with a device station supporting the CC-Link IE TSN Protocol version 2.0.
<ul style="list-style-type: none"> For firmware version "1.002" or later Is the event code 00C80 registered in the event history?	<ul style="list-style-type: none"> Update the firmware of the device station that does not support the CC-Link IE TSN Protocol version 2.0 to a version supporting the CC-Link IE TSN Protocol version 2.0. Replace the device station with a device station supporting the CC-Link IE TSN Protocol version 2.0. Power on the device stations and devices in the communication path, and then power on the master station.
<ul style="list-style-type: none"> For firmware version "1.002" or later Is 'Protocol operating status' (Un\91270) set to "2" (A device is operating with the CC-Link IE TSN Protocol version 2.0)?	<ul style="list-style-type: none"> Update the firmware of the device station that does not support the CC-Link IE TSN Protocol version 2.0 to a version supporting the CC-Link IE TSN Protocol version 2.0. Replace the device station with a device station supporting the CC-Link IE TSN Protocol version 2.0.
<ul style="list-style-type: none"> For firmware version "1.002" or later Is 'Protocol operating status' (Un\91270) set to "1" (A device is operating with the CC-Link IE TSN Protocol version 1.0)?	<ul style="list-style-type: none"> Update the firmware of the device station that does not support the CC-Link IE TSN Protocol version 2.0 to a version supporting the CC-Link IE TSN Protocol version 2.0. Replace the device station with a device station supporting the CC-Link IE TSN Protocol version 2.0.
Are nine or more CC-Link IE TSN Class B devices and switching hubs connected in total in the transmission path from the master station to the CC-Link IE TSN Class B device of the end?	Check the connected devices and reduce the number of CC-Link IE TSN Class B devices and TSN switching hubs to eight or less in total in the transmission path from the master station to the CC-Link IE TSN Class B device of the end.
Does the cyclic data size exceed 2K bytes in total for CC-Link IE TSN Class A devices connected to a CC-Link IE TSN Class B device except for the master station? (Including when a switching HUB is used to connect to a CC-Link IE TSN Class B device)	<ul style="list-style-type: none"> Use a TSN switching hub to connect to CC-Link IE TSN Class B devices. (When a switching hub is used to establish a connection, change the general-purpose switching hub to a TSN switching hub.) Restrict the number of connected stations so that the cyclic data size of the CC-Link IE TSN Class A devices does not exceed 2K bytes in total. Connect the CC-Link IE TSN Class A devices to the master station.
<ul style="list-style-type: none"> For firmware version "1.002" or later Do the system configuration of mixture of CC-Link IE TSN Class B/A and "TSN HUB Setting" in "Connection Device Information" under "Basic Settings" differ?	For details, refer to the following. <ul style="list-style-type: none"> Page 145 A CC-Link IE TSN Class A device does not perform data link.
Is the event code 00C72 registered in the event history of the master station?	<ul style="list-style-type: none"> Update the engineering tool to the latest version. Take the following action for the device station with the IP address displayed in the detailed information of the event history. Update the firmware of the device stations to the latest version.
When the station is connected in line topology, is the communication speed setting matched among stations?	Correct "Communication Speed" under "Application Settings" so that the communication speed is matched for each station.
Is there any reason on the device station side why cyclic communication is not performed?	<ul style="list-style-type: none"> Check if an error has occurred on the device station. Check if the device station settings and parameters are correct. Refer to the manual of the device station for troubleshooting.
Is the event code 00C44 registered in the event history?	Set the same communication speed for the master station and the device station parameter automatic setting target station.
Is a device number outside the setting range set for a link side device in "Refresh Setting"?	Check that the device numbers of RX and RWr set in "Refresh Setting" are within the applicable range.
When "Communication Speed" of the master station is 1 Gbps, does the cyclic data size exceed 2K bytes in total for all device stations on the 100 Mbps device side at the boundary between a 1 Gbps CC-Link IE TSN Class B device except for the master station and 100 Mbps CC-Link IE TSN Class B device?	<ul style="list-style-type: none"> Restrict the number of connected stations so that the cyclic data size of 100 Mbps devices does not exceed 2K bytes in total. Connect 100 Mbps device to the master station.
<ul style="list-style-type: none"> For firmware version "1.001" or earlier When the communication speed of the master station and CC-Link IE TSN Class A device station each are 1 Gbps, is "Communication Period Setting" of the CC-Link IE TSN Class A device station set to "Basic Period" or "Normal Speed"?	<ul style="list-style-type: none"> Update the firmware version of the master station to "1.002" or later. For the values set for "Communication Period Interval Setting" and "Cyclic Transmission Time" each in "Communication Period Setting" under "Basic Settings", set a value not smaller than the minimum value for the communication cycle interval (cyclic data transfer processing time). Page 201 Communication cycle intervals

When transient transmission cannot be performed

The following lists the actions to be taken if transient transmission cannot be performed with the target station, and the engineering tool cannot perform monitoring.

Check item		Action
Is the D LINK LED of the Motion module flashing or turned on?		Perform troubleshooting to be performed when the D LINK LED turns off. (☞ Page 124 When the D LINK LED turns off or is flashing)
Is the data link status of the target station normal?		In the CC-Link IE TSN/CC-Link IE Field diagnostics, identify the cause of the error and take action. (☞ Page 129 Checking the Network Status)
Are the following data set correctly when a module FB or dedicated instruction is executed? • Target station CPU type • Target network number • Target station number		Correct the section where the module FB or dedicated instruction is executed in the program.
Is the network number duplicated on the network?		Correct the parameter so that duplication does not occur among network numbers.
Are multiple link dedicated instructions with the same channel setting executed simultaneously?		• Set a different channel to each instruction. • Shift the execution timing of the link dedicated instructions.
Does the IP filter setting mistakenly block communications from the IP address of another station?		Change the IP filter setting parameter to allow communication for the IP address of another station.
The connection device information of the master station is set to "CC-Link IE TSN Class B Only".	Are CC-Link IE TSN Class A devices connected?	Disconnect the CC-Link IE TSN Class A devices.
	Is a general-purpose switching hub connected?	Disconnect the general-purpose switching hub or replace it with a TSN switching hub.
The connection device information of the master station is set to "Mixture of CC-Link IE TSN Class B/A or CC-Link IE TSN Class A Only".	■For firmware version "1.001" or earlier Are nine or more CC-Link IE TSN Class B devices and switching hubs connected in total in the transmission path from the master station to the CC-Link IE TSN Class B device of the end?	Check the connected devices and reduce the number of CC-Link IE TSN Class B devices and TSN switching hubs to eight or less in total in the transmission path from the master station to the CC-Link IE TSN Class B device of the end.
	Is a CC-Link IE TSN Class B device connected to a station other than the master station in a star topology via a general-purpose switching hub?	Other than the master station, do not connect CC-Link IE TSN Class B devices to a general-purpose switching hub in star topology. Alternatively, connect CC-Link IE TSN Class B devices to the TSN switching hub in star topology.
	Is a general-purpose switching hub connected between the master station and CC-Link IE TSN Class B devices?	Check the connected device and connect the master station to CC-Link IE TSN Class B devices in line topology instead of using a general-purpose switching hub. Check the connected device and connect the master station with CC-Link IE TSN Class B devices via a TSN switching hub.
	Is an Ethernet device connected to a place other than the end of the network?	Check the connected device and connect the Ethernet device at the end of the network.
	Is a general-purpose switching hub other than the NZZEHG-T8(N) and DT135TX used?	Use the NZZEHG-T8(N) or DT135TX.
	■For firmware version "1.002" or later Is the event code 00C81 registered in the event history?	Change "CC-Link IE TSN Class Setting" under "Network Configuration Setting" or "CC-Link IE TSN Class Setting" on the device station side so that the "CC-Link IE TSN Class Setting" for each station match.
	When the device stations to be used operate with the CC-Link IE TSN Protocol version 2.0, is a master station that does not support the CC-Link IE TSN Protocol version 2.0 used?	• Update the firmware of the master station to a version supporting the CC-Link IE TSN Protocol version 2.0. • Replace the master station with a master station supporting the CC-Link IE TSN Protocol version 2.0.
	■For firmware version "1.002" or later Is the event code 00C80 registered in the event history?	• Check 'CC-Link IE TSN Protocol version 2.0 support status for each station' (SW01A0 to SW01A7), and update the firmware of the device station that does not support the CC-Link IE TSN Protocol version 2.0 to a version supporting the CC-Link IE TSN Protocol version 2.0. • Replace the device station with a device station supporting the CC-Link IE TSN Protocol version 2.0.
■For firmware version "1.002" or later Is 'Protocol operating status' (Un91270) set to "2" (A device is operating with the CC-Link IE TSN Protocol version 2.0)?	Is 'CC-Link IE TSN Protocol version 2.0 support status for each station' (SW01A0 to SW01A7) set to "0: Not supported"?	• Update the firmware of the device station that does not support the CC-Link IE TSN Protocol version 2.0 to a version supporting the CC-Link IE TSN Protocol version 2.0. • Replace the device station with a device station supporting the CC-Link IE TSN Protocol version 2.0. • Power on the device stations and devices in the communication path, and then power on the master station.

Check item	Action
The connection device information of the master station is set to "Mixture of CC-Link IE TSN Class B/A or CC-Link IE TSN Class A Only".	<ul style="list-style-type: none"> Update the firmware of the device station that does not support the CC-Link IE TSN Protocol version 2.0 to a version supporting the CC-Link IE TSN Protocol version 2.0. Replace the device station with a device station supporting the CC-Link IE TSN Protocol version 2.0.
<p>■For firmware version "1.002" or later</p> <p>Is 'Protocol operating status' (Un\91270) set to "1" (A device is operating with the CC-Link IE TSN Protocol version 1.0)?</p>	Is 'CC-Link IE TSN Protocol version 2.0 support status for each station' (SW01A0 to SW01A7) set to "0: Not supported"?
	Are nine or more CC-Link IE TSN Class B devices and switching hubs connected in total in the transmission path from the master station to the CC-Link IE TSN Class B device of the end?
	Does the cyclic data size exceed 2K bytes in total for CC-Link IE TSN Class A devices connected to a CC-Link IE TSN Class B device except for the master station? (Including when a switching HUB is used to connect to a CC-Link IE TSN Class B device)
<p>■For firmware version "1.002" or later</p> <p>Do the system configuration of mixture of CC-Link IE TSN Class B/A and "TSN HUB Setting" in "Connection Device Information" under "Basic Settings" differ?</p>	<p>For details, refer to the following.</p> <p>☞ Page 145 A CC-Link IE TSN Class A device does not perform data link.</p>
Is the event code 00C72 registered in the event history of the master station?	<ul style="list-style-type: none"> Update the engineering tool to the latest version. <p>Take the following action for the device station with the IP address displayed in the detailed information of the event history.</p> <ul style="list-style-type: none"> Update the firmware of the device stations to the latest version.
When the station is connected in line topology, is the communication speed setting matched among stations?	Correct "Communication Speed" under "Application Settings" so that the communication speed is matched for each station.
Is there any reason on the device station side why cyclic communication is not performed?	<ul style="list-style-type: none"> Check if an error has occurred on the device station. Check if the device station settings and parameters are correct. Refer to the manual of the device station for troubleshooting.
Is the event code 00C44 registered in the event history?	Set the same communication speed for the master station and the device station parameter automatic setting target station.
Is a device number outside the setting range set for a link side device in "Refresh Setting"?	Check that the device numbers of RX and RWr set in "Refresh Setting" are within the applicable range.
When "Communication Speed" of the master station is 1 Gbps, does the cyclic data size exceed 2K bytes in total for all device stations on the 100 Mbps device side at the boundary between a 1 Gbps CC-Link IE TSN Class B device except for the master station and 100 Mbps CC-Link IE TSN Class B device?	<ul style="list-style-type: none"> Restrict the number of connected stations so that the cyclic data size of 100 Mbps devices does not exceed 2K bytes in total. Connect 100 Mbps device to the master station.
<p>■For firmware version "1.001" or earlier</p> <p>When the communication speed of the master station and CC-Link IE TSN Class A device station each are 1 Gbps, is "Communication Period Setting" of the CC-Link IE TSN Class A device station set to "Basic Period" or "Normal Speed"?</p>	<ul style="list-style-type: none"> Update the firmware version of the master station to "1.002" or later. For the values set for "Communication Period Interval Setting" and "Cyclic Transmission Time" each in "Communication Period Setting" under "Basic Settings", set a value not smaller than the minimum value for the communication cycle interval (cyclic data transfer processing time). ☞ Page 201 Communication cycle intervals

If the above actions do not solve the problem, perform the following tests to check for an error.

Communication test (☞ Page 136 Communication test)

When a station is disconnected from the network

The following is the action to be taken when a station in data link is disconnected.

Check item	Action
Is the ambient temperature for the module outside the specified range?	Keep the ambient temperature within the specified range by taking action such as removing heat source.

When a station is repeatedly disconnected and reconnected

The following lists the actions to be taken when a station in data link is repeatedly disconnected and reconnected.

Check item	Action		
Do the used Ethernet cables conform to the Ethernet standard?	If not, replace them with Ethernet cables that satisfy the Ethernet standard. For details, refer to "WIRING" in the following manual.  MELSEC iQ-F FX5 Motion Module/Simple Motion Module User's Manual (Startup)		
Is the station-to-station distance 100 m or less?	Change the station-to-station distance to 100 m or less.		
Does the cabling condition (bending radius) meet the specifications?	Refer to the manual for the Ethernet cable, and if the bending radius exceeds the specified range, correct the bending radius.		
Is any Ethernet cable disconnected?	If an Ethernet cable is disconnected, replace the Ethernet cable.		
Is the switching hub used in the system operating normally?	<ul style="list-style-type: none"> Check that a switching hub that conforms to the standard is used. For details, refer to "WIRING" in the following manual.  MELSEC iQ-F FX5 Motion Module/Simple Motion Module User's Manual (Startup) Power off and on the switching hub. 		
Is the time synchronization source station operating normally?	Take action by referring to the manual for the module of the time synchronization source station.		
Are resets of other stations repeated?	Avoid unnecessary reset since a station is disconnected while resetting.		
Are other stations repeatedly powering on/off?	Avoid unnecessary power-off, since a station is disconnected while turned off.		
When "Communication Speed" of the master station is set to "100 Mbps", is "Basic Settings" ⇒ "Communication Period Setting" ⇒ "Basic Period Setting" ⇒ "System Reservation Time" of the master station set to 20 μs?	Set "System Reservation Time" to 200 μs.		
When the communication speed of the master station is set to 1 Gbps and a CC-Link IE TSN Class B/A device with a communication speed of 100 Mbps is used, is "Communication Period Setting" set to "Basic Period" or "Normal-Speed"?	For a CC-Link IE TSN Class B/A device with a communication speed of 100 Mbps, set "Communication Period Setting" to "Low-Speed".		
Is 'Protocol operating status' (Un\91270) set to "1" (A device is operating with the CC-Link IE TSN Protocol version 1.0)? <table border="1" style="margin-left: 20px;"> <tr> <td style="width: 30%;"></td> <td>Does the cyclic data size exceed 2K bytes in total for CC-Link IE TSN Class A devices connected to a CC-Link IE TSN Class B device except for the master station? (Including when a general-purpose switching hub is used to connect to a CC-Link IE TSN Class B device)</td> </tr> </table>		Does the cyclic data size exceed 2K bytes in total for CC-Link IE TSN Class A devices connected to a CC-Link IE TSN Class B device except for the master station? (Including when a general-purpose switching hub is used to connect to a CC-Link IE TSN Class B device)	<ul style="list-style-type: none"> Use a TSN switching hub to connect to CC-Link IE TSN Class B devices. (When a general-purpose switching hub is used to establish a connection, change the general-purpose switching hub to a TSN switching hub.) Restrict the number of connected stations so that the cyclic data size of the CC-Link IE TSN Class A devices connected to a CC-Link IE TSN Class B device except for the master station does not exceed 2K bytes in total. (Including when a general-purpose switching hub is used to connect to a CC-Link IE TSN Class B device)
	Does the cyclic data size exceed 2K bytes in total for CC-Link IE TSN Class A devices connected to a CC-Link IE TSN Class B device except for the master station? (Including when a general-purpose switching hub is used to connect to a CC-Link IE TSN Class B device)		
■For firmware version "1.002" or later Do the system configuration of mixture of CC-Link IE TSN Class B/A and "TSN HUB Setting" in "Connection Device Information" under "Basic Settings" differ?	For details, refer to the following.  Page 145 A CC-Link IE TSN Class A device does not perform data link.		
Does any of the stations break the restrictions of the TSN switching hub?	Follow the restrictions for the TSN switching hub. For the restrictions, refer to the manual for the TSN switching hub used.		
When "Communication Speed" of the master station is 1 Gbps, does the cyclic data size exceed 2K bytes in total for all device stations on the 100 Mbps device side at the boundary between a 1 Gbps CC-Link IE TSN Class B device except for the master station and 100 Mbps CC-Link IE TSN Class B device?	<ul style="list-style-type: none"> Restrict the number of connected stations so that the cyclic data size of 100 Mbps devices does not exceed 2K bytes in total. Connect 100 Mbps device to the master station. 		

When communication is unstable

When cyclic transmission delay time is long or when a transient transmission timeout occurs, check the following items.

Check item	Action
Is the L ER LED of the Motion module turned on?	Perform troubleshooting to be performed when the L ER LED turns on. (☞ Page 126 When the L ER LED turns on)
Is the ambient temperature for the module outside the specified range?	Keep the ambient temperature within the specified range by taking action such as removing heat source.
Is any error shown in "Selected Station Communications Status Monitor" of CC-Link IE TSN/CC-Link IE Field diagnostics?	If an error occurs, perform a cable test.
Is there any noise affecting the system?	Change the installation of the modules and wiring so that the system is not affected by noise.

When communication with an SLMP-compatible device cannot be performed

When communication with an SLMP-compatible device cannot be performed, check the following items.

Check item	Action
Has the connection with the external device been opened normally?	<ul style="list-style-type: none"> • If the connection with the external device is not opened, perform the open processing.*1 • If an error occurs, check and eliminate the error cause.
Is the correct command format used for the command type, device specification, address specification, and others?	Correct the command to be sent.
Did the external device send a command?	If the external device did not send a command, send a command to this module.
Was a response returned to the device that had sent the command?	<ul style="list-style-type: none"> • If no response was returned, check if the correct IP address was specified in the command. If not, correct the IP address and send the command again. • If a response was returned, check the end and error codes to correct the faulty area.
Is the same communication speed set for the connected device and access destination?	Change the connection destination so that the connected station and the access destination have the same communication speed, and execute communication.

*1 If the connection of only the external device is closed due to cable disconnection, personal computer restart, or other reasons, reopen the connection using the same port used before the error occurred. A connection is not closed if another Active open request is received from the external device with a different IP address or a port number.

When communications with Ethernet devices cannot be performed

When communications (CC-Link IE TSN/CC-Link IE Field diagnostics, transient transmission, remote password, or communication test) with Ethernet devices cannot be performed, check the following items.

Check item	Action
Is the firewall or proxy server setting enabled on the Ethernet device?	Check and correct the firewall and proxy server settings on the Ethernet device such as checking if a response to the PING command (ICMP echo request) is disabled.
Is the antivirus software on the Ethernet device blocking the communication?	Check and correct the antivirus software settings on the Ethernet device. <ul style="list-style-type: none"> • Is the security setting level of the antivirus software low? • Is a response to the PING command (ICMP echo request) disabled in the firewall settings?

Point

For details when communications of GX Works3 are not allowed in the firewall settings of Windows, refer to the following.

 GX Works3 Operating Manual

When the link device cannot communicate although the data link is normal

When the link device cannot communicate although the data link is normal (D LINK LED is on), check the following items.

Check item	Action
Is "Reserved/Error Invalid Station" of the device station set to "Reserved Station" in "Network Configuration Settings" of the master station?	Set "Reserved/Error Invalid Station" of the device station to "No Setting".
Is the input/output bit setting or input/output word setting of the device station set in "Network Configuration Settings" of the master station? (Simple display)	Set a link device used in the device station correctly.
Are "RX Setting", "RY Setting", "RWw Setting", "RWr Setting", "LB Setting", and "LW Setting" of the device station set in "Network Configuration Settings" of the master station? (Detailed display)	Set a link device used in the device station correctly.
Does the device station support the link devices set in "Network Configuration Settings" of the master station?	Correct the link devices to be assigned to the device station in "Network Configuration Settings" of the master station.
Is the link refresh setting range correct?	Correct the setting in "Refresh Settings" of "Basic Settings".
Is the refresh range of "CPU Side" in "Refresh Settings" duplicated with that of "CPU Side" of another network module?	Correct the setting in "Refresh Settings" of "Basic Settings".

When a communication time-out occurs on the engineering tool

Check items and corrective actions for when a communication time-out occurs on the engineering tool are described below.

Check item	Action
Is the operation cycle set for the operation cycle time sufficiently long?	Check the positioning details, or change the setting of the network parameter "Communication cycle interval setting" to a longer value. ( Page 201 Communication cycle intervals) In addition, when a communication time-out occurs when performing flash ROM writing or parameter initialization from the engineering tool, perform communication load reduction by turning OFF the power supply of the connected servo amplifier, etc., to shorten the operation processing time.

A CC-Link IE TSN Class A device does not perform data link.

■When "Not to Use TSN HUB" is set

When "TSN HUB Setting" in "Connection Device Information" under "Basic Settings" is set to "Not to Use TSN HUB", check the following.

Check item	Action
Are a CC-Link IE TSN Class B device and CC-Link IE TSN Class A device connected via a TSN switching hub?	<ul style="list-style-type: none">• Set "TSN HUB Setting" in "Connection Device Information" under "Basic Settings" to "Use TSN HUB".• Connect the CC-Link IE TSN Class B device and CC-Link IE TSN Class A device directly. Alternatively, connect them via a general-purpose switching hub.
Is a TSN switching hub used for connection between CC-Link IE TSN Class B devices?	<ul style="list-style-type: none">• Set "TSN HUB Setting" in "Connection Device Information" under "Basic Settings" to "Use TSN HUB".• Do not use a TSN switching hub for connection between CC-Link IE TSN Class B devices.

■When "Use TSN HUB" is set

When "TSN HUB Setting" in "Connection Device Information" under "Basic Settings" is set to "Use TSN HUB", check the following.

Check item	Action
Are a CC-Link IE TSN Class B device and CC-Link IE TSN Class A device connected directly or via a general-purpose switching hub?	<ul style="list-style-type: none">• Set "TSN HUB Setting" in "Connection Device Information" under "Basic Settings" to "Not to Use TSN HUB".• Connect the CC-Link IE TSN Class B device and CC-Link IE TSN Class A device via the TSN switching hub.• Connect the master station and the CC-Link IE TSN Class A device directly or via a general-purpose switching hub.• Ensure that the total cyclic data size of all device stations on the CC-Link IE TSN Class A device side that form a boundary between CC-Link IE TSN Class B and CC-Link IE TSN Class A devices does not exceed 2K bytes.

8.5 List of Error Codes

The following table lists the error codes, error definitions and causes, and actions for the errors that occur in the processing for data communication between the Motion module and external devices or occur by processing requests from the CPU module on the own station.

Error codes are displayed in the [Error Information] tab in the "Module Diagnostics" window of the Motion module. (Page 127 Error Information)

Error code	Error definition and causes	Action	Detailed information 1
			Detailed information 2
1124H	<ul style="list-style-type: none"> The default gateway is not set correctly. The gateway IP address is not set correctly. The default gateway/gateway IP address (network address after the subnet mask) is different from that of the IP address of the own node. 	<ul style="list-style-type: none"> Correct the default gateway IP address. Set the same network address as that of the IP address. 	■Parameter information <ul style="list-style-type: none"> Parameter type Intelligent module No. Parameter No. Network No. Station No. ■—
1128H	The port number is incorrect.	Correct the port number.	—
1129H	System error	Please consult your local Mitsubishi representative.	—
112DH to 112EH	System error	Please consult your local Mitsubishi representative.	—
1134H	System error	Please consult your local Mitsubishi representative.	—
1152H	The IP address is not set correctly.	Correct the IP addresses.	■Parameter information <ul style="list-style-type: none"> Parameter type Intelligent module No. Parameter No. Network No. Station No. ■—
1155H	<ul style="list-style-type: none"> The specified connection was already closed in TCP/IP communications. Open processing is not performed. 	<ul style="list-style-type: none"> Perform the open processing for the specified connection. Check if the open processing has been performed in the external device. 	—
1157H	<ul style="list-style-type: none"> The specified connection was already closed in UDP/IP communications. Open processing is not performed. 	<ul style="list-style-type: none"> Perform the open processing for the specified connection. Check if the open processing has been performed in the external device. 	—
1158H	System error	Please consult your local Mitsubishi representative.	—
1166H	System error	Please consult your local Mitsubishi representative.	—
1167H	Unsent data found, but could not be sent.	<ul style="list-style-type: none"> Check the settings for connection with the external device. Check the operation of the external device or switching hub. Since there may be congestion of packets on the line, send data after a certain period of time. Check if the device cable is disconnected. Check that there is no connection failure with the switching hub. Execute the communication test, and if the test was completed with an error, take corrective action. 	—
1800H	<ul style="list-style-type: none"> An error occurred in the SDO communication. Issued a large quantity of SLMP requests at a time. Issued an SLMP request for a slave emulation enabled axis. 	<ul style="list-style-type: none"> Remove error factors according to the SDO error code. Reduce the number of SLMP requests issued, or correct the program to not to issue a new request until a response has been returned. Correct the program to not to issue an SLMP request when slave emulation is enabled. 	—

Error code	Error definition and causes	Action	Detailed information 1
			Detailed information 2
1802H	During data link, overlapping IP addresses have been detected.	Change the IP address of devices with a duplicated IP address.	<ul style="list-style-type: none"> ■ Operation source information <ul style="list-style-type: none"> • IP address ■ IP address duplication information <ul style="list-style-type: none"> • Duplication station 1 MAC address (1st octet, 2nd octet) • Duplication station 1 MAC address (3rd octet, 4th octet) • Duplication station 1 MAC address (5th octet, 6th octet) • Duplication station 2 MAC address (1st octet, 2nd octet) • Duplication station 2 MAC address (3rd octet, 4th octet) • Duplication station 2 MAC address (5th octet, 6th octet)
1803H	Over the number of stations that can be connected.	Reduce the number of CC-Link IE TSN Class B devices and TSN switching hubs to eight or less in total in the transmission path from the master station to the CC-Link IE TSN Class B device of the end.	—
1804H	<p>During data link, invalid connection structure has been detected.</p> <ul style="list-style-type: none"> • A CC-Link IE TSN Class B station is connected further on the end side than a CC-Link IE TSN Class A station. • With the master station with a communication speed of 1 Gbps, further on the end side than a station with a communication speed of 100 Mbps, a station with a communication speed of 1 Gbps is connected. • With the master station with a communication speed of 1 Gbps, there is a 100 Mbps station whose communication cycle setting is set to Basic Period or Normal-Speed (4 times). • With the master station with a communication speed of 1 Gbps, a 1 Gbps station is connected. • For a master station with a communication speed of 100 Mbps, "Communication Period Setting" of the CC-Link IE TSN Class B station with a communication speed of 100 Mbps is set to "Low-Speed". • The communication speed of the master station and local station are not matched. <p>■ Multicast mode</p> <ul style="list-style-type: none"> • A CC-Link IE TSN Class A local station is connected further on the end side than a CC-Link IE TSN Class A remote station. • With the master station with a communication speed of 1 Gbps, stations with a communication speed of 1 Gbps and 100 Mbps are connected on the end side via the switching hub. 	<p>Check the connection and setting on the end side of the station shown in detailed information 2 and take the following actions.</p> <ul style="list-style-type: none"> • Connect the CC-Link IE TSN Class A station further on the end than the CC-Link IE TSN Class B station. • If the master station has a communication speed of 1 Gbps, connect the station with a communication speed of 1 Gbps on the master station side rather than on the side where a station with a communication speed of 100 Mbps is connected. • If the master station has a communication speed of 1 Gbps, set "Communication Period Setting" to "Low-Speed" for the station with a communication speed of 100 Mbps. • If the master station has a communication speed of 1 Gbps, set the station with a communication speed of 100 Mbps as a standard station. • If the master station has a communication speed of 100 Mbps, set the communication speed of the device station to 100 Mbps. • If the master station has a communication speed of 100 Mbps, set "Communication Period Setting" of the CC-Link IE TSN Class B station with a communication speed of 100 Mbps to "Basic Period" or "Normal-Speed" (×4). • Set the same communication speed for the master station and local station. <p>■ Multicast mode</p> <ul style="list-style-type: none"> • Connect the CC-Link IE TSN Class A remote station further on the end than the CC-Link IE TSN Class A local station. • If the master station has a communication speed of 1 Gbps, do not connect a station with a communication speed of 1 Gbps and 100 Mbps on the end side via the switching hub. 	<ul style="list-style-type: none"> ■ Own station information <ul style="list-style-type: none"> • Intelligent module No. • Network No. • Station No. • IP address ■ Target station information <ul style="list-style-type: none"> • Station No. • IP address

Error code	Error definition and causes	Action	Detailed information 1
			Detailed information 2
1805H	<ul style="list-style-type: none"> The total cyclic data size of all device stations on the CC-Link IE TSN Class A device side that form a boundary between CC-Link IE TSN Class B and CC-Link IE TSN Class A devices exceeds 2K bytes. The total cyclic data size of all device stations on the CC-Link IE TSN Class A device side at the boundary between CC-Link IE TSN Class B and CC-Link IE TSN Class A exceeds 2K bytes. 	<p>Check the connection and setting on the end side of the station shown in detailed information 2 based on the error definition and cause and take the following actions.</p> <ul style="list-style-type: none"> Ensure that the total cyclic data size of all device stations on the CC-Link IE TSN Class A device side that form a boundary between CC-Link IE TSN Class B and CC-Link IE TSN Class A devices does not exceed 2K bytes. Do not set the total cyclic data size of all device stations on the side of the station with a communication speed of 100 Mbps at the boundary between the station with a communication speed of 1 Gbps and the station with a communication speed of 100 Mbps to exceed 2K bytes. 	<ul style="list-style-type: none"> Own station information <ul style="list-style-type: none"> Intelligent module No. Network No. Station No. IP address Target station information <ul style="list-style-type: none"> Network No. Station No. IP address
1806H	<ul style="list-style-type: none"> When "TSN HUB Setting" is set to "Not to Use TSN HUB", connection of the CC-Link IE TSN Class B devices in a star topology has been detected. A CC-Link IE TSN Class B device is connected further on the end side than a CC-Link IE TSN Class A device. 	<ul style="list-style-type: none"> Disconnect the switching hub connected with the CC-Link IE TSN Class B device. Set "TSN HUB Setting" to "Use TSN HUB". Connect the CC-Link IE TSN Class A device further on the end than the CC-Link IE TSN Class B device. 	<ul style="list-style-type: none"> Own station information <ul style="list-style-type: none"> Intelligent module No. Network No. Station No. IP address —
1810H	A connection failure was detected in the network.	Correct the wiring status.	—
1811H	A stop error has been detected in the CPU module.	Check the error of the CPU module in "Module Diagnostics" of the engineering tool and take action.	—
1830H	Number of reception requests of transient transmission (link dedicated instruction) exceeded the upper limit of simultaneously processable requests.	Lower the transient transmission usage frequency, and retry the operation.	—
1845H	Too much processing of transient transmission (link dedicated instruction) and cannot perform transient transmission.	Correct the transient transmission (link dedicated instruction) execution count.	—
18D0H	System error	Please consult your local Mitsubishi representative.	—
18D1H	System error	Please consult your local Mitsubishi representative.	—
18D2H	System error	Please consult your local Mitsubishi representative.	—
1C40H	The station number of the device station to connect to network in "Network Configuration Settings" exceeds the total number of device stations configured.	Set the station number of the device station to connect to network smaller than the total number of device stations.	—
1C41H	A WDT error of the driver was detected.	<ul style="list-style-type: none"> When a stop error of the CPU module is detected, check the error of the CPU module and take corrective action. Review the communication period. Check for errors in surrounding environment, e.g. noise, and remove the error factor. After the above procedure, switch the power off and then on, or reset the CPU module." 	—
1C42H	An unsupported driver was connected.	Please connect a supported driver.	—
1C43H	An error occurred in SLMP communication.	<ul style="list-style-type: none"> Review slave object settings. Check the manual of the driver. 	—
1C44H	System error	Please consult your local Mitsubishi representative.	—
1C445	Response timeout was detected in SLMP communication.	<ul style="list-style-type: none"> Review the transient transmission time. It is derived by the following formula. (Transient Transmission Time = Communication Period Interval Setting - Cyclic Transmission Time - System Reserved Time)" 	—
1C46H	System error	Please consult your local Mitsubishi representative.	—
1C47H	System error	Please consult your local Mitsubishi representative.	—
1C48H	Abnormal response for PDO mapping setting was received from a device station.	<ul style="list-style-type: none"> Check the error according to the error code (SDO Abort Code) and review the PDO mapping setting. Check that CiA402 objects that are set for "(Pr.91) Optional data monitor : Data type setting 1" to "(Pr.94) Optional data monitor : Data type setting 4" and "(Pr.591) Optional data monitor : Data type expansion setting 1" to "(Pr.594) Optional data monitor : Data type expansion setting 4" can be monitored." 	—
1C49H	A model name mismatch was detected on reconnection of device station.	Connect the device station with the same model name as the disconnected device station.	—

Error code	Error definition and causes	Action	Detailed information 1
			Detailed information 2
1C4AH	Connection with a slave device that does not support Motion control station was detected.	Connect a slave device that supports Motion control station. For connectable slave devices, refer to "Devices Compatible with CC-Link IE TSN [FX5-SSC-G]" the following manual.  MELSEC iQ-F FX5 Motion Module/Simple Motion Module User's Manual (Application)	—
1C4BH	A Motion control station setting error was detected.	<ul style="list-style-type: none"> • Check that a Motion control station is set for "(Pr.141) IP address". • Check if "(Pr.141) IP address" is set for an axis that exceeds "(Pr.152) Control axis number upper limit". 	—
1D10H to 1D11H	System error	Please consult your local Mitsubishi representative.	—
1D20H	System error	Please consult your local Mitsubishi representative.	—
1D21H	System error	Please consult your local Mitsubishi representative.	—
20E0H	The module cannot communicate with the CPU module.	The hardware failure of the CPU module may have been occurred. Please consult your local Mitsubishi representative.	—
2160H	IP address duplication was detected.	Check the IP addresses.	—
2220H	The parameter setting is corrupted.	Check the detailed information of the error in "Module Diagnostics" of the engineering tool, and write the displayed parameter. If the same error occurs again, the possible cause is a hardware failure of the module. Please consult your local Mitsubishi representative.	<ul style="list-style-type: none"> ■Parameter information • Parameter type ■—
2221H	<ul style="list-style-type: none"> • The set value is out of the range. Or the setting values of the master station and local stations are not consistent. • Parameters that are not supported by the firmware version of the Motion module have been set. 	<ul style="list-style-type: none"> • Check the detailed information of the error in "Module Diagnostics" of the engineering tool, and correct the parameter setting corresponding to the parameter number. • Check the firmware version of the Motion module. If parameters that are not supported are set, update the firmware version or correct the parameters. 	<ul style="list-style-type: none"> ■Parameter information • Parameter type • Intelligent module No. • Parameter No. • Network No. • Station No. ■—
24C0H to 24C3H	System error	Please consult your local Mitsubishi representative.	—
24C6H	System error	Please consult your local Mitsubishi representative.	—
2600H	System error	Please consult your local Mitsubishi representative.	—
2610H	System error	Please consult your local Mitsubishi representative.	—
2611H	System error	Please consult your local Mitsubishi representative.	—
3000H	System error	Please consult your local Mitsubishi representative.	—
3004H	System error	Please consult your local Mitsubishi representative.	—
3009H	The result when the value set in "Communication Period Interval Setting" in "Communication Period Setting" under "Basic Settings" of the master station is multiplied by "Communication Period Setting" of the device station set in "Network Configuration Settings" under "Basic Settings" is out of the range.	<p>Check the detailed information in "Module Diagnostics" of the engineering tool. Correct the parameter settings described below so that the result when the value set in "Communication Period Interval Setting" in "Communication Period Setting" under "Basic Settings" of the master station is multiplied by "Communication Period Setting" of the device station set in "Network Configuration Settings" under "Basic Settings" becomes within 16ms.</p> <ul style="list-style-type: none"> • "Communication Period Interval Setting" in "Basic Settings" • "Communication Period Setting" of the relevant device station in "Network Configuration Settings" <p>Set a value to "Communication Period Setting" of device stations by selecting a multiple value on "Multiple Period Setting" of "Communication Period Setting" under "Basic Settings".</p>	<ul style="list-style-type: none"> ■— ■Target station information • Station Number • IP address
300AH	<ul style="list-style-type: none"> • The combination of the local station firmware version and the master station firmware version is incorrect. • The set value is out of the range. Or the setting values of the master station and local stations are not consistent. 	<ul style="list-style-type: none"> • Check the firmware versions of the master station and local station. If the combination is incorrect, update the firmware version of the older local station or that of the master station. • Check the detailed information of the error in "Module Diagnostics" of the engineering tool, and correct the parameter setting of the master station corresponding to the parameter number. If the same error occurs again, the possible cause is a hardware failure of the module. Please consult your local Mitsubishi representative. 	<ul style="list-style-type: none"> ■Parameter information • Parameter type • Intelligent module No. • Parameter No. • Network No. • Station No. ■—

Error code	Error definition and causes	Action	Detailed information 1
			Detailed information 2
300BH	The Announce frame send cycle parameter error was detected.	Check the Announce frame send cycle parameter setting value of the device operating as the grandmaster. When the Motion module is operating as the grandmaster, reset the CPU module, and run it again. If the same error occurs again even after taking the above measure, the possible cause is a hardware failure of the module. Please consult your local Mitsubishi representative.	—
300CH	A propagation delay send cycle parameter error was detected.	Check the propagation delay send cycle parameter setting value of the device operating as the grandmaster. When the Motion module is operating as the grandmaster, reset the CPU module, and run it again. If the same error occurs again even after taking the above measure, the possible cause is a hardware failure of the module. Please consult your local Mitsubishi representative.	—
300DH	The Sync frame send cycle parameter error was detected.	Check the Sync frame send cycle parameter setting value of the device operating as the grandmaster. When the Motion module is operating as the grandmaster, reset the CPU module, and run it again. If the same error occurs again even after taking the above measure, the possible cause is a hardware failure of the module. Please consult your local Mitsubishi representative.	—
300EH	The set values of the master station and local station do not match.	Set the same parameter setting values for "Network No." and "Station No." of the local station to the setting values of the master station.	<ul style="list-style-type: none"> ■Parameter information • Parameter type • Intelligent module No. • Parameter No. • Network No. • Station No. ■—
300FH	Multiple master stations were detected in the network.	<ul style="list-style-type: none"> • Connect only one master station on the same network. • After taking the above action, power off and on or reset all stations where the error was detected. 	<ul style="list-style-type: none"> ■Parameter information • Parameter type • Intelligent module No. • Parameter No. • Network No. • Station No. ■Overlapped type information • 5: Master station duplication
3010H	The value set in "Communication Period Interval Setting" in "Communication Period Setting" under "Basic Settings" of the master station is smaller than the communication cycle interval calculated by the number of stations and points of device stations that was set in "Network Configuration Settings" under "Basic Settings".	Set the value of "Communication Period Interval Setting" as a value equal to or larger than the value in the detailed information displayed in "Module Diagnostics" using "Communication Period Setting" under "Basic Settings" of the master station.	<ul style="list-style-type: none"> ■— ■Communication Period Interval Information • Communication Period Interval (Calculation value: μs)
3011H	The value set in "Cyclic transmission time" in "Communication Period Setting" under "Basic Settings" of the master station is smaller than the cyclic transmission time calculated by the number of stations and points of device stations set in "Network Configuration Settings" under "Basic Settings".	Set the value of "Cyclic Transmission Time" as a value equal to or larger than the value in the detailed information displayed in "Module Diagnostics" using "Communication Period Setting" under "Basic Settings" of the master station.	<ul style="list-style-type: none"> ■— ■Communication Period Interval Information • Cyclic Transmission Time (Calculation value: μs)
3012H	System error	Please consult your local Mitsubishi representative.	—
3013H	The value set in "Transient Transmission Time" in "Communication Period Setting" under "Basic Settings" of the master station is smaller than the transient transmission time calculated using the number of device stations and the points of device stations set in "Network Configuration Settings" under "Basic Settings".	Set "Communication Period Interval Setting" and "Cyclic Transmission Time" so that the value of "Transient Transmission Time" in "Communication Period Setting" under "Basic Settings" of the master station is equal to or larger than the value shown in the detailed information displayed in "Module Diagnostics".	<ul style="list-style-type: none"> ■— ■Communication Period Interval Information • Transient Transmission Time (Calculation value: μs)
3014H	System error	Please consult your local Mitsubishi representative.	—
3015H	System error	Please consult your local Mitsubishi representative.	—
3016H	System error	Please consult your local Mitsubishi representative.	—
3017H	System error	Please consult your local Mitsubishi representative.	—
3018H	System error	Please consult your local Mitsubishi representative.	—

Error code	Error definition and causes	Action	Detailed information 1
			Detailed information 2
3019H	An entry that is not supported by the master station is set in the PDO mapping setting.	Change the PDO mapping setting so that the entry "Watchdog counter UL 1" is not assigned.	—
3021H	At startup of data link, IP address duplication among device stations has been detected.	Correct the IP addresses of the device stations.	<ul style="list-style-type: none"> ■ Operation source information • IP address ■ IP address duplication information • Duplication station 1 MAC address (1st octet, 2nd octet) • Duplication station 1 MAC address (3rd octet, 4th octet) • Duplication station 1 MAC address (5th octet, 6th octet) • Duplication station 2 MAC address (1st octet, 2nd octet) • Duplication station 2 MAC address (3rd octet, 4th octet) • Duplication station 2 MAC address (5th octet, 6th octet)
3031H	System error	Please consult your local Mitsubishi representative.	—
3040H	System error	Please consult your local Mitsubishi representative.	—
3060H	The send/receive data size exceeds the allowable range.	<ul style="list-style-type: none"> • Check and change the send data size of the Ethernet-equipped module or the external device. • If the same error occurs again even after taking the above, the possible cause is a hardware failure of the error module or CPU module. Please consult your local Mitsubishi representative. 	—
3061H	System error	Please consult your local Mitsubishi representative.	—
3062H	System error	Please consult your local Mitsubishi representative.	—
3110H to 3111H	System error	Please consult your local Mitsubishi representative.	—
3121H	The cyclic transmission setting information received from the master station exceeds the setting range.	Write the module parameter to the CPU module again. If the same error occurs again even after taking the above, please consult your local Mitsubishi representative.	—
3130H	Devices with time synchronization priority of 0 to 15 have been connected.	Remove devices with time synchronization priority of 0 to 15, or change the priority to between 16 and 255.	—
3135H	Over the number of stations that can be connected.	<ul style="list-style-type: none"> • Reduce the number of connected Motion control stations to the number of module axes or less, and the number of connected standard stations to 16 or less. • Reduce the number of CC-Link IE TSN Class B devices to eight or less for each port of the master station. 	—
3136H	System error	Please consult your local Mitsubishi representative.	—
31ABH	Sending/receiving cyclic data within the "Low-Speed" period to/from a device station with "Communication Period Setting" set to "Low-Speed" cannot be guaranteed.	<ul style="list-style-type: none"> • Set "Low-Speed" in "Multiple Period Setting" to a value that is equal to or higher than the one displayed for 'Multiple period setting (low speed)' (Un\G91312). • Set "Communication Period Interval Setting" in "Basic Period Setting" to a value that is equal to or higher than the one displayed for 'Communication cycle interval (calculation value)' (Un\G91313). 	<ul style="list-style-type: none"> ■ Parameter information • Parameter type ■ —
31ACH	The settings do not match between "CC-Link IE TSN Class Setting" of the device stations set in "Network Configuration Setting" and "CC-Link IE TSN Class Setting" under "Connection Device Information" of "Basic Settings".	Set "CC-Link IE TSN Class Setting" in "Network Configuration Setting" of the device stations to "CC-Link IE TSN Class B". Alternatively, set "CC-Link IE TSN Class Setting" under "Connection Device Information" of "Basic Settings" to "Mixture of CC-Link IE TSN Class B/A or CC-Link IE TSN Class A Only".	<ul style="list-style-type: none"> ■ Parameter information • Parameter type ■ —
3600H	Response data of the dedicated instruction cannot be created.	<ul style="list-style-type: none"> • Increase the request interval. • Decrease the number of request nodes. • Wait for a response to the previous request before sending the next request. • Correct the timeout value. 	—

Error code	Error definition and causes	Action	Detailed information 1
			Detailed information 2
3601H to 3603H	System error	Please consult your local Mitsubishi representative.	—
3607H to 360DH	System error	Please consult your local Mitsubishi representative.	—
3C00H	A hardware failure has been detected.	<ul style="list-style-type: none"> Take measures to reduce noise. Reset the CPU module, and run it again. If the same error occurs again even after taking the above, the possible cause is a hardware failure of the module or extension cable. Please consult your local Mitsubishi representative. 	—
3C01H	A hardware failure has been detected.	<ul style="list-style-type: none"> Take measures to reduce noise. Reset the CPU module, and run it again. If the same error occurs again even after taking the above, the possible cause is a hardware failure of the module or extension cable. Please consult your local Mitsubishi representative. 	—
3C02H	A hardware failure has been detected.	<ul style="list-style-type: none"> Take measures to reduce noise. Reset the CPU module, and run it again. If the same error occurs again even after taking the above, the possible cause is a hardware failure of the module or extension cable. Please consult your local Mitsubishi representative. 	—
3C03H	System error	Please consult your local Mitsubishi representative.	—
3C0FH	A hardware failure has been detected.	<ul style="list-style-type: none"> Take measures to reduce noise. Reset the CPU module, and run it again. If the same error occurs again even after taking the above, the possible cause is a hardware failure of the module or extension cable. Please consult your local Mitsubishi representative. 	—
3C10H	A hardware failure has been detected. A function which is not supported was used.*1	<ul style="list-style-type: none"> Take measures to reduce noise. Reset the CPU module, and run it again. If the same error occurs again even after taking the above, the possible cause is a hardware failure of the module or extension cable. Please consult your local Mitsubishi representative. Check that firmware version of the module supports the function to be used.*1 	—
3C11H	System error	Please consult your local Mitsubishi representative.	—
3C13H	A hardware failure has been detected.	Reset the CPU module, and run it again. If the same error occurs again even after doing so, the possible cause is a hardware failure of the error module or CPU module. Please consult your local Mitsubishi representative.	—
3C14H	A hardware failure has been detected.	Reset the CPU module, and run it again. If the same error occurs again even after doing so, the possible cause is a hardware failure of the error module or CPU module. Please consult your local Mitsubishi representative.	—
3C2FH	An error was detected in the memory.	Reset the CPU module, and run it again. If the same error occurs again even after taking the above, the possible cause is a hardware failure of the error module. Please consult your local Mitsubishi representative.	—
3E00H	System error	Please consult your local Mitsubishi representative.	—
3E01H	Network type of the own station is unexpected setting.	Rewrite the module parameter using the engineering tool. If the same error occurs again even after taking the above, the possible cause is a hardware failure of the error module. Please consult your local Mitsubishi representative.	—
3E02H	A time synchronization error was detected.	Reset the CPU module, and run it again. If the same error occurs again even after doing so, the possible cause is a hardware failure of the error module or CPU module. Please consult your local Mitsubishi representative.	—
3E03H	An error was detected in the memory.	Reset the CPU module, and run it again. If the same error occurs again even after doing so, the possible cause is a hardware failure of the error module or CPU module. Please consult your local Mitsubishi representative.	—
3E04H	A hardware failure has been detected.	Reset the CPU module, and run it again. If the same error occurs again even after doing so, the possible cause is a hardware failure of the error module or CPU module. Please consult your local Mitsubishi representative.	—
3F00H	The firmware version of the CPU module is not supported.	Use a CPU module that is supported by the Motion module.	—

Error code	Error definition and causes	Action	Detailed information 1
			Detailed information 2
4000H to 4FFFH	Errors detected by the CPU module (📖 User's Manual for the module used)		
C011H	The port number of the external device is not set correctly.	Correct the port number of the external device.	—
C012H	The port number used in a connection already opened is set. (For TCP/IP)	Correct the port numbers of the Ethernet-equipped module and the external device.	—
C013H	The port number used in a connection already opened is set. (For UDP/IP)	Correct the port numbers of the Ethernet-equipped module and the external device.	—
C015H	The data was sent to the connected device while the IP address setting of the device set in the network configuration setting was incorrect.	<ul style="list-style-type: none"> • Correct the IP address of the connected device in the network configuration setting. • Check that the IP address class of the connected device is set to A, B, or C in the network configuration setting. 	—
C017H	A connection could not be established in the open processing.	<ul style="list-style-type: none"> • Check the operation of the external device. • Check if the open processing has been performed in the external device. • When a firewall is set in the external device, check if access is permitted. • Check if the Ethernet cable is disconnected. 	—
C018H	The specified IP address of the external device is incorrect.	Correct the specified IP address of the external device.	—
C032H	The external device does not send an ACK response in the TCP/IP communications.	<ul style="list-style-type: none"> • Since there may be congestion of packets on the line, send data after a certain period of time. • Check if the cable is disconnected. 	—
C035H	The alive status of an external device could not be checked.	<ul style="list-style-type: none"> • Check the operation of the external device. • Check if the cable is disconnected. 	—
C037H	<ul style="list-style-type: none"> • The receive buffer or send buffer is not sufficient. • The window size of the external device is not sufficient. 	<ul style="list-style-type: none"> • Check the operation of the external device or switching hub. • When the value of the 'Receive Buffer Status Storage Area' (UnIG94948) is 0001H, reduce the reception frequency of data from the external device. 	—
C038H	Data was not sent correctly with UDP/IP.	<ul style="list-style-type: none"> • Check the settings for connection with the external device (including a switching hub) and the operation of the external device (error or during resetting). Check that there is no connection failure (if the Ethernet cable is disconnected). • Since there may be congestion of packets on the line, send data after a certain period of time. • Execute the PING test and communication status test, and if the test was completed with an error, take the corrective action. • Correct the network number and station number/IP address of the target station of the dedicated instruction. 	—
C039H	Data was not sent correctly with TCP/IP.	<ul style="list-style-type: none"> • Check the settings for connection with the external device (including a switching hub) and the operation of the external device (error or during resetting). Check that there is no connection failure (if the Ethernet cable is disconnected). • Since there may be congestion of packets on the line, send data after a certain period of time. • Execute the PING test and communication status test, and if the test was completed with an error, take the corrective action. 	—
C040H	<ul style="list-style-type: none"> • Sufficient data for the data length could not be received. • The remaining part of the message divided at the TCP/IP level could not be received. 	<ul style="list-style-type: none"> • Correct the data length of the communication data. • Since there may be congestion of packets on the line, send the data again from the external device after a random amount of time has passed. 	—
C050H	ASCII code data that cannot be converted to binary code was received.	Check if the ASCII code data that cannot be converted into binary code data was sent from the external device.	—
C051H	<ul style="list-style-type: none"> • The number of read/write points from/to the device of SLMP message is out of the allowable range in the CPU module (in units of words). • The number of write points for the long counter of SLMP message is not in two-word units. 	Correct the number of read/write points and send the SLMP message to the Ethernet-equipped module again.	—

Error code	Error definition and causes	Action	Detailed information 1
			Detailed information 2
C052H	The number of read/write points from/to the device of SLMP message is out of the allowable range in the CPU module (in units of bits).	Correct the number of read/write points and send the SLMP message to the Ethernet-equipped module again.	—
C053H	The number of read/write points from/to the random device of SLMP message is out of the allowable range in the CPU module (in units of bits).	Correct the number of read/write points and send the SLMP message to the Ethernet-equipped module again.	—
C054H	The number of read/write points from/to the random device of SLMP message is out of the allowable range in the CPU module (in units of words, double words).	Correct the number of read/write points and send the SLMP message to the Ethernet-equipped module again.	—
C055H	The read/write size from/to the file data of SLMP message is out of the allowable range.	Correct the read/write size and send the SLMP message to the Ethernet-equipped module again.	—
C056H	The read/write request exceeds the largest address.	<ul style="list-style-type: none"> • Correct the start address or the number of read/write points so that the request does not exceed the largest address and send the data to the Ethernet-equipped module again. • If the access target and connection stations are modules of the MELSEC iQ-R series, send the SLMP message again to the Ethernet-equipped module using 00□3 and 00□2 of subcommands. 	—
C057H	The request data length of the SLMP message does not match the number of data in the character (a part of text).	Check and correct the text or request data length, and send the SLMP message to the Ethernet-equipped module again.	—
C058H	The request data length of the SLMP message after the ASCII/binary conversion does not match with the number of data in the character (a part of text).	Check and correct the text or request data length, and send the SLMP message to the Ethernet-equipped module again.	—
C059H	<ul style="list-style-type: none"> • The specified command and subcommand of the SLMP message are incorrect • A function that is not supported by the target device was executed. 	<ul style="list-style-type: none"> • Check that there are no errors in the specification of the command and subcommand of the SLMP message. • Check whether the function executed is supported by the target device. • Check the version of the target device. 	—
C05AH	The Ethernet-equipped module cannot read/write data from/to the device specified by the SLMP message.	Correct the specification of the device to be read/written and send the SLMP message to the Ethernet-equipped module again.	—
C05BH	The Ethernet-equipped module cannot read/write data from/to the device specified by the SLMP message.	Correct the specification of the device to be read/written and send the SLMP message to the Ethernet-equipped module again.	—
C05CH	<ul style="list-style-type: none"> • The received request data of the SLMP message is incorrect. • The setting value of the communication setting when the iQSS function is executed is out of range. • When the iQSS function is executed, the items of communication setting which cannot be set on the target device are set. • When the iQSS function is executed, the required setting items have not been set to the target device. 	<ul style="list-style-type: none"> • Correct the request data and send the SLMP message to the Ethernet-equipped module again. • Correct the setting details of when the iQSS function is executed, and retry the operation. 	—
C05DH	The "Monitor Request" command is received before the monitor registration is performed by the "Monitor Registration/Clear" command of the SLMP message.	Register the monitoring data using "Monitor Registration/Clear" command and perform monitoring.	—

Error code	Error definition and causes	Action	Detailed information 1
			Detailed information 2
C05EH	<ul style="list-style-type: none"> The time between reception of the SLMP request message by the Ethernet-equipped module and the returned response from the access destination exceeded the monitoring timer value set in the SLMP command. An unresponsive command was sent to another network station as the access destination. (If this error does not cause any problems, it can be ignored.) 	<ul style="list-style-type: none"> Increase the monitoring timer value. Check if the access destination is operating normally. Correct the network number or request destination station number. If the access destination is a module with a different network number, check if the network number is not in use. 	—
C05FH	This request cannot be executed to the access destination specified by the SLMP message.	Correct the access destination.	—
C060H	The request details for bit devices of the SLMP message is incorrect.	Correct the request details and send the SLMP message to the Ethernet-equipped module again.	—
C061H	<ul style="list-style-type: none"> The request data length of the SLMP message does not match the number of data in the character (a part of text). The write data length specified by the label write command is not even byte. When the iQSS function is executed, incorrect frame is received. 	<ul style="list-style-type: none"> Check and correct the text or request data length, and send the SLMP message to the Ethernet-equipped module again. Add one byte of dummy data, and specify the length as an even number of bytes. Check the operating status and connection status of the target device at the time the iQSS function is executed. Check the connection of the cable and switching hub at the time the iQSS function is executed. Check the line status of Ethernet at the time the iQSS function is executed. Reset the CPU module and device to be targets of the iQSS function, and retry the operation. <p>For errors that occur when the iQSS function is executed, contact the manufacturer of the target device if the above actions do not solve the problem.</p>	—
C06FH	The station number of the request destination specified by the SLMP request message is out of range.	<ul style="list-style-type: none"> If the 3E or 4E frame is used at SLMP, check that there is no error for the network number of the request destination and station number. If the station number extension frame is used at SLMP, check that there is no error for the network number of the request destination and station number. 	—
C070H	The device memory cannot be extended for the access destination specified by the SLMP message.	<ul style="list-style-type: none"> Correct the SLMP message to read/write data without the device memory set for extension. Specify the extension of the device memory only for an Ethernet-equipped module mounted station and a MELSEC iQ-R/Q/QnACPU via CC-Link IE Controller Network, MELSECNET/H, or MELSECNET/10. 	—
C071H	The number of device points for data read/write set for modules other than a MELSEC iQ-R/Q/QnACPU with the SLMP message is out of the range.	Correct the number of read/write points and send the SLMP message to the Ethernet-equipped module again.	—
C072H	The request details of the SLMP message are incorrect. (For example, a request for data read/write in bit units has been issued to a word device.)	<ul style="list-style-type: none"> Check if the data can be requested to the access destination. Correct the request details and send the SLMP message to the Ethernet-equipped module again. 	—
C073H	The access destination of the SLMP message cannot issue this request. (For example, the number of double word access points cannot be specified for modules other than a MELSEC iQ-R/Q/QnACPU.)	Correct the request details of the SLMP message.	—
C075H	The request data length for the label access is out of range.	<ul style="list-style-type: none"> Correct the number of read/write points and send the SLMP message to the Ethernet-equipped module again. Correct the label to shorten the label name and send the SLMP message to the Ethernet-equipped module again. 	—
C081H	The termination processing for the Ethernet-equipped module that is involved with the reinitialization processing is being performed, and arrival of link dedicated instructions cannot be checked.	Finish all the communications to perform the reinitialization processing of the Ethernet-equipped module.	—

Error code	Error definition and causes	Action	Detailed information 1
			Detailed information 2
C087H	IP address of the destination external device could not be acquired.	<ul style="list-style-type: none"> • Correct the IP address in the network station number ↔ IP information setting. • Check if the network or station number of the external device is correctly specified by using control data of the dedicated instruction. • Check if the cable is disconnected. 	—
C0B2H	There is insufficient space in the receive buffer or the send buffer of the relay station or external station for the MELSOFT connection, link dedicated instructions, or SLMP. (Send · receive buffer full error)	<p>Increase the request interval (execution interval) and execute the operation.</p> <ul style="list-style-type: none"> • Do not access through one station using the MELSOFT connection, link dedicated instruction, or SLMP. • Wait for a response to the previous request before sending the next request. • Correct the timer setting value for data communication of the Ethernet-equipped module. 	—
C0B3H	A request that cannot be processed was issued from the CPU module.	<ul style="list-style-type: none"> • Correct the request details. • Correct the network number or request destination station number. 	—
C0D4H	The number of relay stations to communicate with other networks exceeds the allowable range.	<ul style="list-style-type: none"> • Check if the specification (network number/station number) for the communication destination is correct. • Check that the number of relay stations accessing the communication destination is 7 or less. • Correct the settings in the network station number ↔ IP information setting for the stations from the own station to the communication destination. 	—
C0D8H	The number of specified blocks exceeded the range.	Correct the number of blocks.	—
C0D9H	The specified subcommand of the SLMP message is incorrect.	Correct the subcommand.	—
C1A4H	<ul style="list-style-type: none"> • There is an error with the command, subcommand, or request destination module I/O number specified by the SLMP message. • A function that is not supported by the target device was executed. 	<ul style="list-style-type: none"> • Correct the command, subcommand, or request destination module I/O number specified by SLMP message. • Check the version of the target device. 	—
C1A7H	The specified network number is incorrect.	Correct the specified network number.	—
C1A9H	The specified device number is incorrect.	Correct the specified device number.	—
C1ADH	The specified data length is incorrect.	Correct the specified data length.	—
C1CCH	A response with a data length that exceeds the allowable range was received by the SLMPSND.	<ul style="list-style-type: none"> • Execute again after correcting the request data to be within the range. • If the error occurs again even after taking the above, please consult your local Mitsubishi representative. 	—
C200H	The remote password is incorrect.	Correct the remote password, and unlock/lock the remote password again.	—
C201H	The remote password status of the port used for communications is in the lock status.	After unlocking the remote password, perform communications.	—
C202H	When another station was accessed, the remote password could not be unlocked.	When accessing another station, do not set the remote password on the relay station or access station, or do not execute the remote password check on them.	—
C203H	An error has occurred when checking the remote password.	Correct the remote password, and unlock/lock the remote password again.	—
C204H	The device is different from the one requesting the remote password unlock processing.	Request the lock processing of the remote password from the external device that requested the unlock processing of the remote password.	—
C207H	The file name has too many characters.	Name the file with 255 characters or less.	—
C208H	The password length is out of range.	Set the password within 6 to 32 characters.	—
C612H	The module processing was completed with an error.	Execute the communication status test, and if the test was completed with an error, take the corrective action.	—
C613H	The module processing was completed with an error.	Execute the communication status test, and if the test was completed with an error, take the corrective action.	—
C615H	The module processing was completed with an error.	Execute the communication status test, and if the test was completed with an error, take the corrective action.	—

Error code	Error definition and causes	Action	Detailed information 1
			Detailed information 2
C810H	Remote password authentication has failed when required.	Set a correct password and perform password authentication again.	—
C811H	Remote password authentication has failed when required.	Set a correct password and perform password authentication again one minute later.	—
C812H	Remote password authentication has failed when required.	Set a correct password and perform password authentication again 5 minutes later.	—
C813H	Remote password authentication has failed when required.	Set a correct password and perform password authentication again 15 minutes later.	—
C814H	Remote password authentication has failed when required.	Set a correct password and perform password authentication again 60 minutes later.	—
C815H	Remote password authentication has failed when required.	Set a correct password and perform password authentication again 60 minutes later.	—
C816H	The security function was activated and remote password authentication cannot be performed.	Set a correct password and perform password authentication again after a certain period of time.	—
C844H	Incorrect frame was received. • Unsupported command	<ul style="list-style-type: none"> • Replace the network module with a module of the version supporting the function that has been executed. • If the error occurs again even after taking the above, please consult your local Mitsubishi representative. 	—
C900H	Communication failed.	Do not execute communication from multiple engineering tools to the same master station simultaneously.	—
C901H	The size of the request data to the external device or response data from the external device exceeds the range supported for communications.	Correct the size of the request data or response data to within 1500 bytes.	—
C902H	Communication was interrupted because no response was returned from the external device.	Execute the communication test, and if the test was completed with an error, take corrective action.	—
C903H	Failed to send request to the external device.	<ul style="list-style-type: none"> • Correct the IP address of the external device. • Check if the subnet mask of the external device matches the master station. • Check if the external device matches the communication speed. • Check if the cable is connected properly and there is no failure. 	—
CA00H to CA0AH	System error	Please consult your local Mitsubishi representative.	—
CCC7H	An object was accessed under a condition in which access to the object is not allowed.	<ul style="list-style-type: none"> • Check if the specified Index and subIndex are correct. • Check the condition that the object corresponding to the specified Index and subIndex can be accessed. 	—
CCC8H	A write-only object was accessed for reading.	<ul style="list-style-type: none"> • Check if the specified Index and subIndex are correct. • Check the condition that the object corresponding to the specified Index and subIndex can be accessed. 	—
CCC9H	A read-only object was accessed for writing.	<ul style="list-style-type: none"> • Check if the specified Index and subIndex are correct. • Check the condition that the object corresponding to the specified Index and subIndex can be accessed. 	—
CCCAH	An object that is not defined in the object dictionary was accessed.	<ul style="list-style-type: none"> • Check if the specified Index and subIndex are correct. • Check the condition that the object corresponding to the specified Index and subIndex can be accessed. 	—
CCCBH	An object not permitted for PDO mapping was mapped.	<ul style="list-style-type: none"> • Check if the specified Index and subIndex are correct. • Check if the object corresponding to the specified Index and subIndex is allowable object. 	—
CCCCH	The number of data or data length total for PDO mapping exceeds the value defined in the application, etc.	Check the number and the size of objects corresponding to the specified Index and subIndex and the maximum value of the number and the size of objects of RPDO/TPDO of the external device.	—
CCD3H	A SubIndex that does not exist was specified.	<ul style="list-style-type: none"> • Check if the specified Index and subIndex are correct. • Check if the external device supports the object corresponding to the specified Index and subIndex. 	—
CCD4H	An invalid parameter value was set.	<ul style="list-style-type: none"> • Check if the specified Index and subIndex are correct. • Check if the data value of the object corresponding to the specified Index and subIndex is correct. • Set the PDO mapping again and try again. 	—

Error code	Error definition and causes	Action	Detailed information 1
			Detailed information 2
CCD5H	A value greater than the parameter range is set.	<ul style="list-style-type: none"> • Check if the specified Index and subIndex are correct. • Check if the data value of the object corresponding to the specified Index and subIndex is correct. • Set the PDO mapping again and try again. 	—
CCD6H	A value smaller than the parameter range is set.	<ul style="list-style-type: none"> • Check if the specified Index and subIndex are correct. • Check if the data value of the object corresponding to the specified Index and subIndex is correct. • Set the PDO mapping again and try again. 	—
CCDAH	The application cannot transmit or store the data.	The same error is displayed even if the data transmission or storage is performed again, please consult your local Mitsubishi representative.	—
CCFFH	Others Failed to access to CAN application objects	The same error is displayed even if the access to the object is performed again, please consult your local Mitsubishi representative.	—
CF40H	Incorrect frame was received.	<ul style="list-style-type: none"> • Check the operating status and connection status of the target device. • Check the connection of the cable and switching hub. • Check the line status of Ethernet. • Reset the CPU module and target device, and retry the operation. <p>If the above actions do not solve the problem, contact the manufacturer of the target device.</p>	—
CF41H	Incorrect frame was received.	<ul style="list-style-type: none"> • Check the operating status and connection status of the target device. • Check the connection of the cable and switching hub. • Check the line status of Ethernet. • Reset the CPU module and target device, and retry the operation. <p>If the above actions do not solve the problem, contact the manufacturer of the target device.</p>	—
CF42H	Incorrect frame was received.	<ul style="list-style-type: none"> • Check the operating status and connection status of the target device. • Check the connection of the cable and switching hub. • Check the line status of Ethernet. • Reset the CPU module and target device, and retry the operation. <p>If the above actions do not solve the problem, contact the manufacturer of the target device.</p>	—
CF43H	An error has occurred.	<ul style="list-style-type: none"> • Check the operating status of the external device. • Check if there is any error in the line status. <p>If the above actions do not solve the problem, contact the manufacturer of the target device.</p>	—
CF44H	Incorrect frame was received.	<ul style="list-style-type: none"> • Check the operating status and connection status of the target device. • Check the connection of the cable and switching hub. • Check the line status of Ethernet. • Reset the CPU module and target device, and retry the operation. <p>If the above actions do not solve the problem, contact the manufacturer of the target device.</p>	—
D03BH to D03CH	System error	Please consult your local Mitsubishi representative.	—
D0A3H	Send processing of the transient transmission has failed.	<ul style="list-style-type: none"> • Check the network status using the CC-Link IE TSN/CC-Link IE Field diagnostics of the engineering tool, and take action. • When the own station, target station, or relay station detected an error, identify the cause of the error and take action. • Correct the target station number of transient data, and retry the operation. 	—
D203H	The read data or write address of the transient transmission is incorrect.	Correct the read data or write address at the transient request source, and retry the operation.	—
D205H	The target station number of transient transmission is incorrect.	Correct the target station number at the transient request source, and retry the operation.	—
D20AH	The target network number of transient transmission is incorrect.	Correct the target network number at the transient request source, and retry the operation.	—

Error code	Error definition and causes	Action	Detailed information 1
			Detailed information 2
D20BH	There was no master station when the specified master station was specified for transient transmission.	Correct the target station number at the transient request source, and retry the operation.	—
D20CH	There was no master station when the current master station was specified for transient transmission.	Correct the target station number at the transient request source, and retry the operation.	—
D20DH	Transmission completion wait timeout has occurred in transient data transmission.	<ul style="list-style-type: none"> • Check the network status using the CC-Link IE TSN/CC-Link IE Field diagnostics of the engineering tool, and take action. • When the own station, target station, or relay station detected an error, identify the cause of the error and take action. • Lower the transient transmission usage frequency, and retry the operation. • Check if the switching hub and the cables connected at the request source are connected properly. 	—
D20EH	The header information of transient transmission is incorrect.	Correct the header information at the transient request source, and retry the operation.	—
D20FH	In transient transmission, the command which cannot be requested to all or a group of stations was executed with all stations specification or group specification.	Check that the command can be requested to all or a group of stations at the transient request source, and retry the operation.	—
D213H	<ul style="list-style-type: none"> • The command of transient transmission is incorrect. • The CC-Link IE TSN/CC-Link IE Field diagnostics was used for the network to which the relay receiving station belongs. • This function is not available for the module of the connection destination. 	<ul style="list-style-type: none"> • Correct the request command at the transient request source, and retry the operation. • Review the connection destination so that the CC-Link IE TSN/CC-Link IE Field diagnostics is used for the network to which the relay sending station belongs. • Refer to the manual for the module of the connection destination, and check whether the module supports this function. If the module does not support the function, update firmware version so that the module supports the function. 	—
D214H	The data length of transient transmission is incorrect.	Correct the data length at the transient request source, and retry the operation.	—
D239H	SLMP transmission failed.	<ul style="list-style-type: none"> • Retry the operation after a while. • If the error occurs again even after taking the above, please consult your local Mitsubishi representative. 	—
D240H	The network number specification of the dedicated instruction is incorrect.	Correct the network number at the request source of the dedicated instruction, and retry the operation.	—
D241H	The target station number of the dedicated instruction is incorrect.	Correct the target station number at the request source of the dedicated instruction, and retry the operation.	—
D242H	The command code of the dedicated instruction is incorrect.	Correct the command code at the request source of the dedicated instruction, and retry the operation.	—
D243H	The channel specified in the dedicated instruction is incorrect.	Correct the used channel within the allowable range at the request source of the dedicated instruction, and retry the operation.	—
D244H	The transient data is incorrect.	<ul style="list-style-type: none"> • Correct the transient data at the transient request source, and retry the operation. • If the error occurs again even after taking the above, please consult your local Mitsubishi representative. 	—
D245H	The target station number of the dedicated instruction is incorrect.	Correct the target station number at the request source of the dedicated instruction, and retry the operation.	—
D247H	When the dedicated instruction was executed, response from the target station was received twice.	<ul style="list-style-type: none"> • Check the network status using the CC-Link IE TSN/CC-Link IE Field diagnostics of the engineering tool, and take action. • Check if the switching hub and the cables connected at the request source are connected properly. 	—
D249H	The target station CPU type of the dedicated instruction is incorrect.	Correct the CPU type of the target station at the request source of the dedicated instruction, and retry the operation.	—
D24AH	The arrival monitoring time specification of the dedicated instruction is incorrect.	<ul style="list-style-type: none"> • Correct the arrival monitoring time at the request source of the dedicated instruction, and retry the operation. • When the own station, target station, or relay station detected an error, identify the cause of the error and take action. • Lower the transient transmission usage frequency, and retry the operation. • Check if the switching hub and the cables connected at the request source are connected properly. 	—

Error code	Error definition and causes	Action	Detailed information 1
			Detailed information 2
D24BH	The number of resends specified in the dedicated instruction is incorrect.	<ul style="list-style-type: none"> • Correct the number of resends at the request source of the dedicated instruction, and retry the operation. • When the own station, target station, or relay station detected an error, identify the cause of the error and take action. • Lower the transient transmission usage frequency, and retry the operation. • Check if the switching hub and the cables connected at the request source are connected properly. 	—
D24CH	The network number specification of the dedicated instruction is incorrect.	Correct the network number at the request source of the dedicated instruction, and retry the operation.	—
D24DH	The channel specified in the dedicated instruction is incorrect.	<ul style="list-style-type: none"> • Set 1 to 2 for the target channel number in the control data when executing the SEND instruction. • Correct the number of the channel used by own station in the control data, and retry the operation. 	—
D24EH	The target station setting in the dedicated instruction is incorrect.	<ul style="list-style-type: none"> • The value set for the control block of the dedicated instruction is out of range. Correct the value and retry the operation. • If the error occurs again even after taking the above, please consult your local Mitsubishi representative. 	—
D24FH	The dedicated instruction was executed when the station number/IP address of the own station had not been set yet.	<ul style="list-style-type: none"> • Specify the station number/IP address using the UINI instruction, and execute the instruction again. • If the error occurs again even after taking the above, please consult your local Mitsubishi representative. 	—
D251H	At execution of a dedicated instruction, or group specification or all stations specification of the target station, the execution type is set with arrival check.	<ul style="list-style-type: none"> • Execute again after changing the execution type in the control data to no arrival check. • If the error occurs again even after taking the above, please consult your local Mitsubishi representative. 	—
D253H	A response timeout has occurred when the dedicated instruction was executed.	<ul style="list-style-type: none"> • Check the network status using the CC-Link IE TSN/CC-Link IE Field diagnostics of the engineering tool, and take action. • For IP address specification, it is not possible to target stations beyond a relay station. Execute the dedicated instruction by specifying the network number/station number. • Increase the number of resends at the request source of the dedicated instruction, and retry the operation. • Lower the transient transmission usage frequency, and retry the operation. • Execute the dedicated instruction for a target station that supports the executed dedicated instruction. • For the RECV instruction, correct the channels used by own station in the control data, and retry the operation. • For the RECV instruction, check that 'RECV execution request flag CH1' (SB0030) to 'RECV execution request flag CH8' (SB0037) are on. • For the SLMPSND instruction, check if the external device port number set by the control data is an available port number in the manual of the external device, and then execute the instruction again. • Correct the network number and station number/IP address of the target station of the dedicated instruction. • Check if the cable is disconnected. • If the error occurs again even after taking the above, please consult your local Mitsubishi representative. 	—
D254H	A dedicated instruction which the target station does not support was executed.	<ul style="list-style-type: none"> • Change the target station at the station that executed the SEND instruction. • If the error occurs again even after taking the above, please consult your local Mitsubishi representative. 	—
D255H	The target station number of the dedicated instruction is incorrect.	<ul style="list-style-type: none"> • Correct the target station number in the control data, and retry the operation. • If the error occurs again even after taking the above, please consult your local Mitsubishi representative. 	—
D256H	The execution or error completion type of the dedicated instruction is incorrect.	<ul style="list-style-type: none"> • Correct the execution or error completion type in the control data, and retry the operation. • If the error occurs again even after taking the above, please consult your local Mitsubishi representative. 	—

Error code	Error definition and causes	Action	Detailed information 1
			Detailed information 2
D257H	The request type of the REQ instruction is incorrect.	<ul style="list-style-type: none"> Correct the request type in the request data, and retry the operation. If the error occurs again even after taking the above, please consult your local Mitsubishi representative. 	—
D258H	The control station does not exist when the dedicated instruction was executed to the specified control station or current control station.	<ul style="list-style-type: none"> Correct the target station number in the control data, and retry the operation. If the error occurs again even after taking the above, please consult your local Mitsubishi representative. 	—
D25AH	The dedicated instruction was executed specifying the channel in use.	<ul style="list-style-type: none"> Retry the operation after a while. Change the channels used by own station or the target station's channel in the control data. Execute the RECV instruction at the external device, and then execute the SEND instruction. 	—
D25BH	The dedicated instruction was executed specifying the channel in use.	Change the channels used by own station or the target station's channel in the control data.	—
D25DH	The transient data is incorrect.	<ul style="list-style-type: none"> Correct the transient data at the transient request source, and retry the operation. If the error occurs again even after taking the above, please consult your local Mitsubishi representative. 	—
D25FH	System error	Please consult your local Mitsubishi representative.	—
D260H	System error	Please consult your local Mitsubishi representative.	—
D262H to D26CH	System error	Please consult your local Mitsubishi representative.	—
D26FH to D272H	System error	Please consult your local Mitsubishi representative.	—
D273H	The request data size of transient transmission is incorrect.	<ul style="list-style-type: none"> Correct the request command at the transient request source, and retry the operation. If the error occurs again even after taking the above, please consult your local Mitsubishi representative. 	—
D275H	Other dedicated instructions are in execution, and the executed instruction cannot be processed.	<ul style="list-style-type: none"> Other dedicated instructions are in execution. Execute again after a while. If the error occurs again even after taking the above, please consult your local Mitsubishi representative. 	—
D27AH to D27CH	System error	Please consult your local Mitsubishi representative.	—
D27FH	System error	Please consult your local Mitsubishi representative.	—
D2C0H to D2D1H	System error	Please consult your local Mitsubishi representative.	—
D2D2H	The IP address/port number of the target station is incorrect.	<ul style="list-style-type: none"> Execute again after correcting the port number of the target station in the setting data. If the error occurs again even after taking the above, please consult your local Mitsubishi representative. 	—
D2D3H	Send processing of the transient transmission has failed.	<ul style="list-style-type: none"> Check the network status using the CC-Link IE TSN/CC-Link IE Field diagnostics of the engineering tool, and take action. When the own station, target station, or relay station detected an error, identify the cause of the error and take action. Correct the target IP address of transient data, and retry the operation. 	—
D602H	Parameter error	<ul style="list-style-type: none"> Write the network parameter to the CPU module again. If the error occurs again even after taking the above, please consult your local Mitsubishi representative. 	—
D605H	Parameter error	<ul style="list-style-type: none"> Write the network parameter to the CPU module again. If the error occurs again even after taking the above, please consult your local Mitsubishi representative. 	—
D60BH to D622H	System error	Please consult your local Mitsubishi representative.	—
D625H	System error	Please consult your local Mitsubishi representative.	—

Error code	Error definition and causes	Action	Detailed information 1
			Detailed information 2
D628H to D62BH	System error	Please consult your local Mitsubishi representative.	—
D630H	System error	Please consult your local Mitsubishi representative.	—
D641H to D658H	System error	Please consult your local Mitsubishi representative.	—
D65BH to D65DH	System error	Please consult your local Mitsubishi representative.	—
D720H to D725H	System error	Please consult your local Mitsubishi representative.	—
D727H to D729H	System error	Please consult your local Mitsubishi representative.	—
D731H	System error	Please consult your local Mitsubishi representative.	—
D742H	System error	Please consult your local Mitsubishi representative.	—
D840H	Number of transient requests exceeded the upper limit of simultaneously processable requests.	<ul style="list-style-type: none"> • Pause the transient transmission temporarily, and retry the operation. • Lower the transient transmission usage frequency, and retry the operation. 	—
D841H	The request data size of memory read/write command is out of range.	Correct the read or write size specification at the transient request source, and retry the operation.	—
D842H	<ul style="list-style-type: none"> • Routing information to the destination network No. is not registered. • In transient transmission, the number of relays to other networks exceeded seven. • The communication path is being updated. • The communication path is not supported. 	<ul style="list-style-type: none"> • Execute the instruction again after correcting the target network No. at the transient request source. • Execute the instruction again after correcting the communication path from the transient request source to the destination. • Change the system configuration so that the number of relay stations is seven or less. • Transient transmission cannot be performed while the communication path is being updated. Retry the operation. • Correct the communication path. 	—
D843H	System error	Please consult your local Mitsubishi representative.	—
D844H	Incorrect frame was received. <ul style="list-style-type: none"> • Unsupported pre-conversion protocol • Unsupported frame type • Application header variable part • Application header HDS • Application header RTP • Read command not requiring response 	Correct the request data at the transient request source, and retry the operation.	—
D902H	The online test data is incorrect.	<ul style="list-style-type: none"> • Correct the data at the station that started the online test, and retry the operation. • If the error occurs again even after taking the above, please consult your local Mitsubishi representative. 	—
D903H	During execution of the communication test, the test was retried.	After completion of the communication test, retry the operation.	—
D905H	A communication monitoring timeout has occurred in communication test.	<ul style="list-style-type: none"> • Check the network status using the CC-Link IE TSN/CC-Link IE Field diagnostics of the engineering tool, and take action. Then, retry the operation. 	—
D906H	Transmission completion wait timeout has occurred in communication test.	<ul style="list-style-type: none"> • Check the network status using the CC-Link IE TSN/CC-Link IE Field diagnostics of the engineering tool, and take action. Then, retry the operation. • Lower the transient transmission usage frequency, and retry the operation. 	—
D909H	The header information of transient transmission is incorrect.	Correct the header information at the transient request source, and retry the operation.	—
D90AH	During execution of the communication test, the test was retried.	Check the network status using the CC-Link IE TSN/CC-Link IE Field diagnostics of the engineering tool, and take action. Then, retry the operation.	—

Error code	Error definition and causes	Action	Detailed information 1
			Detailed information 2
D90BH	The number of stations that communicate in the network is out of the specification range.	<ul style="list-style-type: none"> Check the network status using the CC-Link IE TSN/CC-Link IE Field diagnostics of the engineering tool, and take action. Reduce the number of device stations on the network to be within the range. 	—
D90CH	The communication destination specified for the communication test is incorrect.	<ul style="list-style-type: none"> Correct "Target Station" of communication test, and retry the operation. Do not execute the communication test for own station and relay sending station. Set "Target Station" to other than own station and relay transmission station. The target station is mounted on the same CPU module as the connected station (own station). Do not execute the communication test for a station on the same CPU module as the connected station (own station). 	—
D90DH	An error was detected in the network module.	Please consult your local Mitsubishi representative.	—
D912H	Transient transmission sending failed.	<ul style="list-style-type: none"> Lower the transient transmission usage frequency, and retry the operation. Check if the switching hub and the cables are connected properly. 	—
D913H to D917H	An error was detected in the network module.	Please consult your local Mitsubishi representative.	—
D919H	No response from the target station of the communication test.	<ul style="list-style-type: none"> Correct the network number, station number, or IP address for the target station of the communication test. Check if the network configuration setting is correctly set in the master station within the same network as the target station of the communication test. When "IP Address" is selected for "Communication Method", "Communication Test" cannot be executed for stations on networks different from that of the connected station (own station). Change "Communication Method" to "Network No./ Station No.". 	—
DA00H	An error was detected in the network module.	Please consult your local Mitsubishi representative.	—
DA10H to DA17H	An error was detected in the network module.	Please consult your local Mitsubishi representative.	—
DA19H	An error was detected in the network module.	Please consult your local Mitsubishi representative.	—
DA1AH	System error	Please consult your local Mitsubishi representative.	—
DA1BH	A dedicated instruction which the target station does not support was executed.	<ul style="list-style-type: none"> Change the target station at the station that executed the READ/SREAD/WRITE/SWRITE/SEND/ instruction. Correct the network number and station number/IP address of the target station of the dedicated instruction. 	—
DA1CH	The target station of the READ/SREAD/WRITE/SWRITE/SEND instruction does not exist.	If the target station of the READ/SREAD/WRITE/SWRITE/SEND instruction is disconnected, execute the dedicated instruction again after return of the target station.	—
DB00H	A station outside the range is specified.	Check station numbers.	—
DC00H	System error	Please consult your local Mitsubishi representative.	—
DC01H	System error	Please consult your local Mitsubishi representative.	—

*1 IEC (twisted pair) only.

8.6 List of Parameter Numbers

The following table lists the parameter numbers displayed in "Module Diagnostics".

If there is an error in the parameter settings and the parameter number is displayed, the corresponding parameter can be identified.

It is displayed in "Detailed information" in the [Error Information] tab in the "Module Diagnostics" window of the Motion module.

( Page 127 Error Information)

Item			Parameter No.	
Required Settings	Station Type	Station Type	7100H	
	Network No.	Network No.	7100H	
	Parameter Setting Method	Setting Method of Basic/Application Settings	7100H	
	Station No./IP Address Setting	Setting Method of Station No./IP Address Setting Method		7100H
		Station No.	Station No.	7100H
		IP Address	IP Address	A012H
			Subnet Mask	A012H
	Default Gateway	A013H		
Basic Settings	Network Configuration Settings	Total No. of Stations	A100H	
		Simple Display, Detailed Display	STA#	A104H
			Station Type	A104H
			RX Setting	A101H, A10BH
			RY Setting	A101H, A10BH
			RWr Setting	A101H, A10BH
			RWw Setting	A101H, A10BH
			Parameter Automatic Setting	A104H
			PDO Mapping Setting	A109H
			IP Address	A105H
			Subnet Mask	A105H
			Default Gateway	A105H
			Reserved/Error Invalid Station	A001H: Reserved Station A002H: Error Invalid Station
		Communication Period Setting	A108H	
	Station Information	Alias	A011H	
		Comment	A011H	
		Station-specific mode setting	A106H	
		Detailed Display	Motion Control Station	A104H
	Refresh Settings	Refresh Settings	7401H	
	Network Topology	Network Topology	A100H	
	Communication Period Setting	Basic Period Setting	Communication Period Interval Setting	A100H
			Cyclic Transmission Time	A100H
			Transient Transmission Time	A100H
Multiple Period Setting		Normal-Speed	A108H	
		Low-Speed	A108H	
Connection Device Information	CC-Link IE TSN Class Setting	A100H		
	TSN HUB Setting	A100H		
Device Station Setting	Disconnection Detection Setting	A100H		

Item			Parameter No.		
Application Settings	Supplementary Cyclic Settings	Station-based Block Data Assurance		A100H	
		I/O Maintenance Settings	Output Hold/Clear Setting during CPU STOP	A110H	
			Data Link Error Station Setting	A110H	
			Output Mode upon CPU Error	7101H	
	Transient Transmission Group No.		Transient Transmission Group No.	A010H	
	Parameter Name		Parameter Name	7310H	
	Module Operation Mode		Module Operation Mode	7100H	
	Security	IP Filter Settings	IP Filter		A03AH
			IP Filter Settings	Deny/Allow	A03AH
				IP Address	A03AH
				Range Setting	A03AH
IP Address Excluded from Range				A03AH	

8.7 Event List

This section lists the events which occur in CC-Link IE TSN.

The event history is displayed when the [Event History] button in the [Error Information] tab in the "Module Diagnostics" window of the Motion module is clicked. ( Page 127 Error Information)

System		
Event code	Description	Cause
00800	Link-down	The system was linked down by removing a device (such as an external device).
00801	Link-down	Link-down occurred when a network cable connected to an external device was disconnected.
00907	Divided messages receive timeout error	<ul style="list-style-type: none"> • Sufficient data for the data length could not be received. • The remaining part of the divided message could not be received.
00C27	Transient reception error	Frequency of transient transmission to the own station is too high and transient reception failed.
00C28	<<Own station>> Receive frame error Line status warning level	A receive frame error (line status: warning level) has occurred.
00C29	<<Other station>> Receive frame error Line status warning level	A receive frame error (line status: warning level) has occurred.
00C30	<<Other station>> Parameter error occurrence	A parameter error has occurred in other station
00C31	<<Other station>> Moderate/major error occurrence	A moderate/major error has occurred in other station.
00C32	<<Other station>> Minor error occurrence	A minor error has occurred in other station.
00C33	Master station/sub-master station duplication error	Master station/sub-master station duplication has occurred on the network.
00C34	Station duplication occurrence	Station number duplication has occurred on the network.
00C35	Receive parameter error occurrence (station number out of range)	An error of parameter (station number out of range) received from the master station/control station has been detected.
00C36	Receive parameter error occurrence (station type mismatch)	An error of parameter (station type mismatch) received from the master station/control station has been detected.
00C37	<<Own station>> Receive frame error Line status warning level	A receive frame error (line status: warning level) has occurred.
00C39	<<Other station>> Receive frame error Line status warning level	A receive frame error (line status: warning level) has occurred.
00C3B	Control master station duplication occurrence	2 or more control master stations have been detected on the same line when the multimaster function is used.
00C40	Device station parameter automatic setting: Interruption	An abnormal response was received from the device station, and device station parameter automatic setting processing was interrupted. (For details on device station response codes, refer to the manual for the device station.)
00C41	Device station parameter automatic setting: Parameter update interruption	An abnormal response was received from the device station, and parameter update processing for the device station parameter automatic setting was interrupted. (For details on device station response codes, refer to the manual for the device station.)
00C42	Device station parameter automatic setting: System error	An error occurred while the device station parameter automatic setting was executing.
00C43	Device station parameter automatic setting: Transmission timeout	Transmission timed out while communicating with the device station parameter automatic setting.
00C44	Device station parameter automatic setting: Receive timeout	The specified period of time expired without receiving while communicating with the device station parameter automatic setting.
00C46	Device station parameter automatic setting: SLMP transmission error	An error occurred while transmitting SLMP for the device station parameter automatic setting.
00C47	Device station parameter automatic setting: CPU module access failure	Access to the CPU module failed during device station parameter automatic setting.
00C48	Device station parameter automatic setting: No target station parameter	When executing device stations parameter automatic setting, the target device station parameter file was not stored in the CPU module.
00C70	CANopen initialization failure	A communication error occurred in the initialization processing of CANopen.
00C72	Maximum response time mismatch for the time managed polling method	A maximum response time mismatch was detected for the time managed polling method. Update the engineering tool and the device stations to the latest version.
00C80	Detection of device station that does not support the CC-Link IE TSN Protocol version 2.0	A device station that does not support the CC-Link IE TSN Protocol version 2.0 was detected.

Event code	Description	Cause
00C81	CC-Link IE TSN Class setting mismatch	A mismatch was detected between the parameter of the master station and "CC-Link IE TSN Class Setting" of the device stations.

8.8 Response Code (SDO Abort Code)

The following shows the response code when the send/receive error occurred in the object data using the PDO mapping and transient transmission function.

SDO Abort Code	Description	Remedy
0601 0000h	An unsupported object was accessed.	Revise the Index and subIndex.
0601 0001h	A write-only object was accessed for reading.	
0601 0002h	A read-only object was accessed for writing.	
0602 0000h	An object that is not defined in the object dictionary was accessed.	
0604 0041h	An object not permitted for PDO mapping was mapped.	Revise the data for PDO mapping.
0604 0042h	The number of data or data length total for PDO mapping exceeds the value defined in the application, etc.	
0607 0010h	The accessed object data size does not match the specified data size at request.	Revise the specified value for object size.
0607 0012h		
0607 0013h		
0609 0011h	A SubIndex that does not exist was specified.	Revise the Index and subIndex.
0609 0030h	An invalid parameter value was set.	Revise the data value.
0609 0031h	A value larger than the parameter range was set.	
0609 0032h	A value smaller than the parameter range was set.	
0800 0020h	The application cannot transmit or store the data.	Check the status of the target device.

APPENDICES

Appendix 1 Buffer Memory

The buffer memory is used to exchange data between the Motion module and the CPU module. Buffer memory values are reset to default when the CPU module is reset or the system is powered off.

List of buffer memory addresses

P1		Name	Read, write		
Address (decimal)	Address (hexadecimal)				
62884 to 62912	F5A4H to F5C0H	Module information area	System area		
62913	F5C1		Latest error code	Read	
62914	F5C2		Unique code	Read	
62915	F5C3		Firmware version	Read	
62916 to 62917	F5C4H to F5C5H		System area		
62918 to 62919	F5C6H to F5C7H		Input signals	Read	
62920 to 62921	F5C8H to F5C9H		Output signals	Read, write	
62922 to 62931	F5CAH to F5D3H		System area		
62932	F5D4H		MIB information device version	Read	
62933	F5D5H		MIB information firmware version	Read	
62934	F5D6H		MIB information hardware version	Read	
62935 to 63019	F5D7H to F62BH		System area		
63020 to 63139	F62CH to F6A3H		System area		
63140 to 64163	F6A4H to FAA3H		Device area	RX area	Read
64164 to 65187	FAA4H to FEA3H	RY area		Read, write	
65188 to 66211	FEA4H to 102A3H	RWw area		Read, write	
66212 to 67235	102A4H to 106A3H	RWr area		Read	
67236 to 67491	106A4H to 107A3H	SB area		Read, write	
67492 to 68771	107A4H to 10CA3H	SW area		Read, write	
68772 to 68773	10CA4H to 10CA5H	Timeslot 0 information		Timeslot 0 cycle start offset (ns unit)	Read
68774	10CA6H		Timeslot 0 cycle start offset (s unit)	Read	
68775	10CA7H		System area		
68776 to 68777	10CA8H to 10CA9H		Timeslot 0 cycle end offset (ns unit)	Read	
68778	10CAAH		Timeslot 0 cycle end offset (s unit)	Read	
68779 to 68783	10CABH to 10CAF		System area		
68784	10CB0H		VID (VLAN Identifier)	Read	
68785	10CB1H		PCP (Priority Code Point)	Read	
68786	10CB2H		Ether Type	Read	
68787	10CB3H		System area		
68788 to 68899	10CB4H to 10D23H		Timeslot 1 to 7 information	Same as Timeslot 0 information	Read
68900 to 68901	10D24H to 10D25H		RX offset/size information	Station No.0 RX offset	Read
68902 to 68903	10D26H to 10D27H			Station No.0 RX size	Read
:				:	
68996 to 68997	10D84H to 10D85H	Station No.24 RX offset		Read	
68998 to 68999	10D86H to 10D87H	Station No.24 RX size		Read	
69000 to 69423	10D88H to 10F2FH	System area			

P1		Name		Read, write	
Address (decimal)	Address (hexadecimal)				
69424 to 69425	10F30H to 10F31H	RY offset/size information	Station No.0 RY offset	Read	
69426 to 69427	10F32H to 10F33H		Station No.0 RY size	Read	
⋮			⋮		
69520 to 69521	10F90H to 10F91H		Station No.24 RY offset	Read	
69522 to 69523	10F92H to 10F93H		Station No.24 RY size	Read	
69524 to 69947	10F94H to 1113BH		System area		
69948 to 69949	1113CH to 1113DH	RWw offset/size information	Station No.0 RWw offset	Read	
69950 to 69951	1113EH to 1113FH		Station No.0 RWw size	Read	
⋮			⋮		
70044 to 70045	1119CH to 1119DH		Station No.24 RWw offset	Read	
70046 to 70047	1119EH to 1119FH		Station No.24 RWw size	Read	
70048 to 70471	111A0H to 11347H		System area		
70472 to 70473	11348H to 11349H	RWr offset/size information	Station No.0 RWr offset	Read	
70474 to 70475	1134AH to 1134BH		Station No.0 RWr size	Read	
⋮			⋮		
70568 to 70569	113A8H to 113A9H		Station No.24 RWr offset	Read	
70570 to 70571	113AAH to 113ABH		Station No.24 RWr size	Read	
70572 to 70995	113ACH to 11553H		System area		
70996 to 70999	11554H to 11557H	System area			
71000 to 87649	11558H to 15661H	Motion area*1			
87650 to 87905	15662H to 15761H	System area			
87906	15762H	Own station (network card) information	Manufacturer code	Read	
87907	15763H		Model type	Read	
87908	15764H		Model code (lower 2 bytes)	Read	
87909	15765H		Model code (upper 2 bytes)		
87910	15766H		Version	Read	
87911 to 87913	15767H to 15769H		MAC address	Read	
87914	1576AH	Own station (controller) information	Controller information valid/invalid flag	Read	
87915	1576BH		Manufacturer code	Read	
87916	1576CH		Model type	Read	
87917	1576DH		Model code (lower 2 bytes)	Read	
87918	1576EH		Model code (upper 2 bytes)		
87919	1576FH		Version	Read	
87920 to 87929	15770H to 15779H		Model name string	Read	
87930 to 87931	1577AH to 1577BH		Vendor-specific device information	Read	
87932 to 87937	1577CH to 15781H		System area		
87938 to 88897	15782H to 15B41H		System area		
88898	15B42H		Communication path determination status	Communication path determination status (network No.1 to 16)	Read
88899 to 88913	15B43H to 15B51H			Communication path determination status (network No.17 to 239)	Read
88914 to 89491	15B52H to 15D93H	System area			
89492	15D94H	Time synchronization	Time distribution interval setting of the CPU module	Read, write	
89493	15D95H		System area	Read, write	
89494 to 89507	15D96H to 15DA3H	System area			
89508	15DA4H	Grandmaster information	Grandmaster	Read	
89509 to 89510	15DA5H to 15DA6H		System area		
89511 to 89513	15DA7H to 15DA9H		Grandmaster MAC address	Read	
89514 to 89536	15DAAH to 15DC0H	System area			

P1		Name		Read, write
Address (decimal)	Address (hexadecimal)			
89537	15DC1H	Time synchronization setting	PTP frame send source check enable/disable	Read, write
89538	15DC2H		PTP frame send source check result (P1)	Read
89539	15DC3H		System area	Read
89540 to 89733	15DC4H to 15E85	System area		
89734 to 89735	15E86H to 15E87H	PDO information	Multidrop No.0 of station No.1 RPDO use link device start offset	Read
89736 to 89737	15E88H to 15E89H		Multidrop No.0 of station No.1 RPDO size	Read
89738 to 89739	15E8AH to 15E8BH		Multidrop No.0 of station No.1 TPDO use link device start offset	Read
89740 to 89741	15E8CH to 15E8DH		Multidrop No.0 of station No.1 TPDO size	Read
89742 to 89789	15E8EH to 15EBDH	:		
89790 to 89791	15EBEH to 15EBFH	PDO information	Multidrop No.7 of station No.1 RPDO use link device start offset	Read
89792 to 89793	15EC0H to 15EC1H		Multidrop No.7 of station No.1 RPDO size	Read
89794 to 89795	15EC2H to 15EC3H		Multidrop No.7 of station No.1 TPDO use link device start offset	Read
89796 to 89797	15EC4H to 15EC5H		Multidrop No.7 of station No.1 TPDO size	Read
89798 to 91205	15EC6H to 16445H	:		
91206 to 91207	16446H to 16447H	PDO information	Multidrop No.0 of station No.24 RPDO use link device start offset	Read
91208 to 91209	16448H to 16449H		Multidrop No.0 of station No.24 RPDO size	Read
91210 to 91211	1644AH to 1644BH		Multidrop No.0 of station No.24 TPDO use link device start offset	Read
91212 to 91213	1644CH to 1644DH		Multidrop No.0 of station No.24 TPDO size	Read
91214 to 91261	1644EH to 1647DH	:		
91262 to 91263	1647EH to 1647FH	PDO information	Multidrop No.7 of station No.24 RPDO use link device start offset	Read
91264 to 91265	16480H to 16481H		Multidrop No.7 of station No.24 RPDO size	Read
91266 to 91267	16482H to 16483H		Multidrop No.7 of station No.24 TPDO use link device start offset	Read
91268 to 91269	16484H to 16485H		Multidrop No.7 of station No.24 TPDO size	Read
91270	16486H	Protocol information	Protocol operation status	Read
91271 to 91285	16487H to 16495		System area	
91286	16496	Timeslot information for device station cyclic transmission	Timeslot for cyclic transmission (station No.1)	Read
:	:		:	
91309	164AD		Timeslot for cyclic transmission (station No.24)	Read
91310 to 91311	164AEH to 164AFH	System area		
91312	164B0	Information for ensuring cyclic data are sent/received	Multiple period setting (low speed)	Read
91313	164B1		Communication cycle interval (calculation value)	Read



P1		Name		Read, write	
Address (decimal)	Address (hexadecimal)				
91314	164B2H	Communication cycle setting value (CC-Link IE TSN Protocol version 2.0)	Communication cycle interval (calculation value)	Read	
91315	164B3H		Cyclic transmission time (calculation value)	Read	
91316	164B4H		Transient transmission time (calculation value)	Read	
91317 to 91325	164B5H to 164BDH	System area			
91326	164BE	Information for device station cyclic transmission	Multiplier for transmission delay information of CC-Link IE TSN Class A (low-speed)	Read	
91327	164BFH	System area			
93574 to 93575	16D86H to 16D87H	P1: Own node setting status storage area	Own node IP address	Read	
93576 to 93583	16D88H to 16D8FH		System area		
93584 to 93585	16D90H to 16D91H		Subnet mask	Read	
93586 to 93587	16D92H to 16D93H		System area		
93588 to 93589	16D94H to 16D95H		Default gateway IP address	Read	
93590 to 93597	16D96H to 16D97H		System area		
93598 to 93600	16D9EH to 16DA0H		Own node MAC address	Read	
93601	16DA1H		Own node network number	Read	
93602	16DA2H		Station No.	Read	
93603	16DA3H		Transient transmission group No.	Read	
93604 to 93606	16DA4H to 16DA6H		System area		
93607	16DA7H		Auto-open UDP port port number	Read	
93608	16DA8H		MELSOFT transmission port (TCP/IP) port number	Read	
93609	16DA9H		MELSOFT transmission port (UDP/IP) port number	Read	
93610	CC28H16DAAH		System area		
93611	16DABH		SLMP transmission port (TCP/IP) port number	Read	
93612	16DACH		SLMP transmission port (UDP/IP) port number	Read	
93613	16DADH		System area		
93614 to 93741	16DAEH to 16E2DH		P1: Connection status storage area	System area	
93742 to 93748	16E2EH to 16E34H			Latest error code after the 2nd connection of MELSOFT transmission port (TCP/IP)	Read
93749 to 93869	16E35H to 16EADH	System area			
93870 to 93876	16EAEH to 16EB4H	Latest error code after the 2nd connection of SLMP transmission port (TCP/IP)		Read	
93877 to 94025	16EB5H to 16F49H	System area			
94026 to 94027	16F4AH to 16F4BH	P1: System port latest error code storage area	System area		
94028	16F4CH		Auto-open UDP port latest error code	Read	
94029	16F4DH		MELSOFT transmission port (UDP/IP) latest error code	Read	
94030	16F4EH		MELSOFT transmission port (TCP/IP) latest error code	Read	
94031	16F4FH		SLMP transmission port (UDP/IP) latest error code	Read	
94032	16F50H		SLMP transmission port (TCP/IP) latest error code	Read	
94033	16F51H		SLMPSND instruction latest error code	Read	
94034 to 94281	16F52H to 17049H	System area			

P1		Name		Read, write
Address (decimal)	Address (hexadecimal)			
94282 to 94283	1704AH to 1704BH	Status for each protocol (IP packet)	Received packet total count	Read
94284 to 94285	1704CH to 1704DH		Received packet checksum error discard count	Read
94286 to 94287	1704EH to 1704FH		Sent packet total count	Read
94288 to 94303	17050H to 1705FH		System area	
94304 to 94305	17060H to 17061H		Simultaneous transmission error detection count (receive buffer full count)	Read
94306 to 94310	17062H to 17066H		System area	
94311	17067H		Receive abort count	Read
94312 to 94313	17068H to 17069H		System area	
94314 to 94321	1706AH to 17071H	System area		
94322 to 94323	17072H to 17073H	Status for each protocol (ICMP packet)	Received packet total count	Read
94324 to 94325	17074H to 17075H		Received packet checksum error discard count	Read
94326 to 94327	17076H to 17077H		Sent packet total count	Read
94328 to 94329	17078H to 17079H		Received echo request total count	Read
94330 to 94331	1707AH to 1707BH		Sent echo reply total count	Read
94332 to 94333	1707CH to 1707DH		Sent echo request total count	Read
94334 to 94335	1707EH to 1707FH		Received echo reply total count	Read
94336 to 94361	17080H to 17099H		System area	
94362 to 94363	1709AH to 1709BH	Status for each protocol (TCP packet)	Received packet total count	Read
94364 to 94365	1709CH to 1709DH		Received packet checksum error discard count	Read
94366 to 94367	1709EH to 1709FH		Sent packet total count	Read
94368 to 94369	170A0H to 170A1H		System area	
94370 to 94401	170A2H to 170C1H	System area		
94402 to 94403	170C2H to 170C3H	Status for each protocol (UDP packet)	Received packet total count	Read
94404 to 94405	170C4H to 170C5H		Received packet checksum error discard count	Read
94406 to 94407	170C6H to 170C7H		Sent packet total count	Read
94408 to 94411	170C8H to 170CBH		System area	
94412 to 94470	170CCH to 17106H	System area		
94471	17107H	P1: Own node operating status storage area	LED on/off status	Read
94472	17108H	System area		
94473	17109H	Own node operation status storage area (switching hub connection information area)	Communication mode	Read
94474	1710AH		Connection status	Read
94475	1710BH		Communication speed	Read
94476	1710CH		Disconnection count	Read
94477 to 94481	1710DH to 17111H	System area		
94482	17112H	P1: Own node operation status storage area (IP address duplication status storage area)	IP address duplication flag	Read
94483 to 94485	17113H to 17115H		MAC address of the station already connected to the network	Read
94486 to 94488	17116H to 17118H		MAC address of the station with the IP address already used	Read
94489 to 94492	17119H to 1711CH	System area		
94493 to 94773	1711DH to 17235H	System area		
94774 to 94777	17236H to 17239H	Remote password lock status storage area	System area	
94778	1723AH		Remote password lock status system port	Read
94779 to 94789	1723BH to 17245H	System area		



P1		Name		Read, write
Address (decimal)	Address (hexadecimal)			
94790 to 94853	17246H to 17285H	Remote password function monitoring area	System area	
94854	17286H		Auto-open UDP port continuous unlock failure count	Read
94855	17287H		MELSOFT transmission port (UDP/IP) continuous unlock failure count	Read
94856	17288H		MELSOFT transmission port (TCP/IP) continuous unlock failure count	Read
94857 to 94858	17289H to 1728AH		System area	
94859	1728BH		SLMP transmission port (UDP/IP) continuous unlock failure count	Read
94860	1728CH		SLMP transmission port (TCP/IP) continuous unlock failure count	Read
94861 to 94875	1728DH to 1729BH		System area	
94876 to 94906	1729CH to 172BAH	System area		
94907	172BBH	P1: Network type information area (Network type information)		Read
94908 to 94917	172BCH to 172C5H	System area		
94918 to 94941	172C6H to 172DDH	System area		
94942	172DEH	Ethernet information	Initial status	Read
94943	172DFH		Initial error code	Read
94944 to 94947	172E0H to 172E3H	System area		
94948	172E4H	Receive buffer status storage area (Receive buffer status)		Read
94949 to 100350	172E5H to 187FEH	System area		

*1 For details, refer to "List of Buffer Memory Addresses" in the following manual.

 MELSEC iQ-F FX5 Motion Module/Simple Motion Module User's Manual (Application)

Point

- Do not write data to "system areas". Doing so may cause malfunction of the programmable controller system.
- If the value in an area of one word becomes equal to or higher than 65536, the count stops at 65535 (FFFFH).

Details of buffer memory addresses

Module information area

■Latest error code (Un\G62913)

The error code for the latest error that occurred in the Motion module is stored. (0 is stored in normal condition.)

For details on error codes, refer to the following.

 Page 146 List of Error Codes

■Unique code (Un\G62914)

The unique code (6988H) of the Motion module is stored.

(The same value is also stored in "[Md.59] Module information".)

For details, refer to "Monitor Data" in the following manual.

 MELSEC iQ-F FX5 Motion Module/Simple Motion Module User's Manual (Application)

- Unique code of the FX5-40SSC-G: 6959H
- Unique code of the FX5-80SSC-G: 695AH

■Firmware version (Un\G62915)

The firmware version of the Motion module is stored.

(The same value is also stored in "[Md.130] F/W version".)

For details, refer to "Monitor Data" in the following manual.

 MELSEC iQ-F FX5 Motion Module/Simple Motion Module User's Manual (Application)

Ex.

When the firmware version of the Motion module is "1.000": K1000

■Input signal (Un\G62918 to Un\G62919)

This signal is used to check the status of the Motion module.

Address	Bit	Signal name	Description
Un\G62918	b0	Module failure	<ul style="list-style-type: none"> • Off: Module normal • On: Module failure
	b1	Own station data link status	<ul style="list-style-type: none"> • Off: Data link stop • On: Data link in progress Shows the data link status of the own station in the same way as 'Data link error status of own station' (SB0049). However, the ON/OFF status is reversed between this bit and 'Data link error status of own station' (SB0049).
	b3	Data link status of another station	<ul style="list-style-type: none"> • Off: All stations normal • On: Faulty station exists The specifications are the same as the specifications for 'Data link error status of each station' (SB00B0).
	b15	Module READY	<ul style="list-style-type: none"> • Off: Module not in operation • On: Available for module operation When b0 of Un\G62918 turns on, this bit turns off.

■MIB information device version (Un\G62932)

The MIB information device version of the Motion module is stored.

- 1: Ver.1.001 or earlier
- 2: Ver.1.002

■MIB information firmware version (Un\G62933)

The MIB information firmware version of the Motion module is stored.

- 1: Ver.1.001 or earlier
- 2: Ver.1.002

■MIB information hardware version (Un\G62934)

The MIB information hardware version of the Motion module is stored.

- 1: Ver.1.001 or later



Device area

The RX, RY, RWw, RWr, SB, and SW values are stored.

Remote input (RX) (Un\G63140 to Un\G64163)

The RX value is stored. The RX start number and number of points for each station number can be checked by the RX offset/size information (Un\G68900 to Un\G69423). (Page 177 RX offset/size information)

Address	b15	b14	b13	b12	b11	b10	b9	b8	b7	b6	b5	b4	b3	b2	b1	b0
Un\G63140	RX F	RX E	RX D	RX C	RX B	RX A	RX 9	RX 8	RX 7	RX 6	RX 5	RX 4	RX 3	RX 2	RX 1	RX 0
⋮																
Un\G64163	RX 3FFF	RX 3FFE	RX 3FFD	RX 3FFC	RX 3FFB	RX 3FFA	RX 3FF9	RX 3FF8	RX 3FF7	RX 3FF6	RX 3FF5	RX 3FF4	RX 3FF3	RX 3FF2	RX 3FF1	RX 3FF0

Each bit corresponds to 1 bit of RX.

Remote output (RY) (Un\G64164 to Un\G65187)

The RY value is stored. The RY start number and number of points for each station number can be checked by the RY offset/size information (Un\G69424 to Un\G69947). (Page 178 RY offset/size information)

Address	b15	b14	b13	b12	b11	b10	b9	b8	b7	b6	b5	b4	b3	b2	b1	b0
Un\G64164	RY F	RY E	RY D	RY C	RY B	RY A	RY 9	RY 8	RY 7	RY 6	RY 5	RY 4	RY 3	RY 2	RY 1	RY 0
⋮																
Un\G65187	RY 3FFF	RY 3FFE	RY 3FFD	RY 3FFC	RY 3FFB	RY 3FFA	RY 3FF9	RY 3FF8	RY 3FF7	RY 3FF6	RY 3FF5	RY 3FF4	RY 3FF3	RY 3FF2	RY 3FF1	RY 3FF0

Each bit corresponds to 1 bit of RY.

Remote register (RWw) (Un\G65188 to Un\G66211)

The RWw value is stored. The RWw start number and number of points for each station number can be checked by the RWw offset/size information (Un\G69948 to Un\G70471). (Page 178 RWw offset/size information)

Address	b15	b14	b13	b12	b11	b10	b9	b8	b7	b6	b5	b4	b3	b2	b1	b0
Un\G65188	RWw0															
Un\G65189	RWw1															
⋮																
Un\G66211	RWw3FF															

Remote register (RWr) (Un\G66212 to Un\G67235)

The RWr value is stored. The RWr start number and number of points for each station number can be checked by the RWr offset/size information (Un\G70472 to Un\G70995). (Page 178 RWr offset/size information)

Address	b15	b14	b13	b12	b11	b10	b9	b8	b7	b6	b5	b4	b3	b2	b1	b0
Un\G66212	RWr0															
Un\G66213	RWr1															
⋮																
Un\G67235	RWr3FF															

Link special relay (SB) (Un\G67236 to Un\G67491)

The SB value is stored.

Address	b15	b14	b13	b12	b11	b10	b9	b8	b7	b6	b5	b4	b3	b2	b1	b0
Un\G67236	SBF	SBE	SBD	SBC	SBB	SBA	SB9	SB8	SB7	SB6	SB5	SB4	SB3	SB2	SB1	SB0
⋮																
Un\G67491	SBFF F	SBFF E	SBFF D	SBFF C	SBFF B	SBFF A	SBFF 9	SBFF 8	SBFF 7	SBFF 6	SBFF 5	SBFF 4	SBFF 3	SBFF 2	SBFF 1	SBFF 0

Each bit corresponds to 1 bit of SB.

■Link special register (SW) (Un\G67492 to Un\G68771)

The SW value is stored.

Address	b15	b14	b13	b12	b11	b10	b9	b8	b7	b6	b5	b4	b3	b2	b1	b0
Un\G67492	SW0															
Un\G67493	SW1															
⋮																
Un\G68771	SW4FF															

Timeslot information

■Timeslot 0 information (Un\G68772 to Un\G68787)

Cycle start offset (ns, s unit) of Timeslot 0 and cycle end offset (ns, s unit) are stored.

Address	Name	Description
Un\G68772 to Un\G68773	Cycle start offset (ns unit)	The ns digits of cycle start offset are stored. Stored range: 0 to 999999999ns
Un\G68774	Cycle start offset (s unit)	The s digits of cycle start offset are stored. Stored range: 0 to 65535s
Un\G68775	System area	
Un\G68776 to Un\G68777	Cycle end offset (ns unit)	The ns digits of cycle end offset are stored. Stored range: 0 to 999999999ns
Un\G68778	Cycle end offset (s unit)	The s digits of cycle end offset are stored. Stored range: 0 to 65535s
Un\G68779 to Un\G68783	System area	
Un\G68784	VID (VLAN Identifier)	The VID is stored. Stored range: 1 to 4094, 65535 (the VID is not used or the relayed frame is not determined based on the VID)
Un\G68785	PCP (Priority Code Point)	The PCP is stored. Stored range: 0 to 7, 65535 (the PCP is not used or the relayed frame is not determined based on the PCP)
Un\G68786	Ether Type	The Ether Type of the relayed frame is stored. Stored range: Ether Type value of the relayed frame, 65535 (The relayed frame is not determined based on the Ether Type.) If the timeslot is 0, 65535 is stored.
Un\G68787	System area	

■Timeslot 1 to 7 information (Un\G68788 to Un\G68899)

Timeslot 1 to 7 information is stored in the same order as Timeslot 0 information.

RX offset/size information

■RX offset/size information (Un\G68900 to Un\G69423)

The start number and the number of points of RX for each station are stored.

Address	Description
Un\G68900 to Un\G68901	Station No.0 offset
Un\G68902 to Un\G68903	Station No.0 size (in units of words)
Un\G68904 to Un\G68905	Station No.1 offset
Un\G68906 to Un\G68907	Station No.1 size (in units of words)
⋮	
Un\G68996 to Un\G68997	Station No.24 offset
Un\G68998 to Un\G68999	Station No.24 size (in units of words)
Un\G69000 to Un\G69423	System area

The buffer memory address for the offset and size of each station number can be calculated using the following formulas:

- Offset buffer memory address = 68900 + (station No.) × 4
- Size buffer memory address = 68902 + (station No.) × 4

R_Y offset/size information

■R_Y offset/size information (Un\G69424 to Un\G69947)

The start number and the number of points of R_Y for each station are stored.

Address	Description
Un\G69424 to Un\G69425	Station No.0 offset
Un\G69426 to Un\G69427	Station No.0 size (in units of words)
Un\G69428 to Un\G69429	Station No.1 offset
Un\G69430 to Un\G69431	Station No.1 size (in units of words)
⋮	
Un\G69520 to Un\G69521	Station No.24 offset
Un\G69522 to Un\G69523	Station No.24 size (in units of words)
Un\G69524 to Un\G69947	System area

The buffer memory address for the offset and size of each station number can be calculated using the following formulas:

- Offset buffer memory address = $69424 + (\text{station No.}) \times 4$
- Size buffer memory address = $69426 + (\text{station No.}) \times 4$

R_{Ww} offset/size information

■R_{Ww} offset/size information (Un\G69948 to Un\G70471)

The start number and the number of points of R_{Ww} for each station are stored.

Address	Description
Un\G69948 to Un\G69949	Station No.0 offset
Un\G69950 to Un\G69951	Station No.0 size (in units of words)
Un\G69952 to Un\G69953	Station No.1 offset
Un\G69954 to Un\G69955	Station No.1 size (in units of words)
⋮	
Un\G70044 to Un\G70045	Station No.24 offset
Un\G70046 to Un\G70047	Station No.24 size (in units of words)
Un\G70048 to Un\G70471	System area

The buffer memory address for the offset and size of each station number can be calculated using the following formulas:

- Offset buffer memory address = $69948 + (\text{station No.}) \times 4$
- Size buffer memory address = $69950 + (\text{station No.}) \times 4$

R_{Wr} offset/size information

■R_{Wr} offset/size information (Un\G70472 to Un\G70995)

The start number and the number of points of R_{Wr} for each station are stored.

Address	Description
Un\G70472 to Un\G70473	Station No.0 offset
Un\G70474 to Un\G70475	Station No.0 size (in units of words)
Un\G70476 to Un\G70477	Station No.1 offset
Un\G70478 to Un\G70479	Station No.1 size (in units of words)
⋮	
Un\G70568 to Un\G70569	Station No.24 offset
Un\G70570 to Un\G70571	Station No.24 size (in units of words)
Un\G70572 to Un\G70995	System area

The buffer memory address for the offset and size of each station number can be calculated using the following formulas:

- Offset buffer memory address = $70472 + (\text{station No.}) \times 4$
- Size buffer memory address = $70474 + (\text{station No.}) \times 4$

Own station information

The information of the own station on the network is stored.

■Own station (network card) information (Un\G87906 to Un\G87913)

Address	Name	Description
Un\G87906	Manufacturer code	The Motion module information of the own station is stored. (Also used in the CLPA conformance test.) (Updated even if set as an error invalid station.) (Updated even if set as a reserved station.)
Un\G87907	Model type	
Un\G87908	Model code (lower 2 bytes)	
Un\G87909	Model code (upper 2 bytes)	
Un\G87910	Version	
Un\G87911 to Un\G87913	MAC address	The own station MAC address is stored. Un\G87911: 5th byte, 6th byte of the MAC address Un\G87912: 3rd byte, 4th byte of the MAC address Un\G87913: 1st byte, 2nd byte of the MAC address

■Own station (controller) information (Un\G87914 to Un\G87937)

Address	Name	Description
Un\G87914	Controller information valid/invalid flag	Whether the value stored in the own station (controller) information is valid or invalid is stored. • 0: Invalid • 1: Valid
Un\G87915	Manufacturer code	The Motion module information of the own station is stored.
Un\G87916	Model type	
Un\G87917	Model code (lower 2 bytes)	
Un\G87918	Model code (upper 2 bytes)	
Un\G87919	Version	
Un\G87920 to Un\G87929	Model name string	
Un\G87930 to Un\G87931	Vendor-specific device information	
Un\G87932 to Un\G87937	System area	

A

Communication path determination status

■Communication path determination status (Un\G88898 to Un\G88913)

The determination information on the communication path for each network number of the destination station is stored.

- 0: Path undetermined
- 1: Path determined

Address	b15	b14	b13	b12	b11	b10	b9	b8	b7	b6	b5	b4	b3	b2	b1	b0
Un\G88898	16	15	14	13	12	11	10	9	8	7	6	5	4	3	2	1
⋮																
Un\G88912	Empty	239	238	237	236	235	234	233	232	231	230	229	228	227	226	225
Un\G88913	Empty															

The numbers in the table indicate network numbers.

Time synchronization

■Time distribution interval setting of the CPU module (Un\G89492)

This setting specifies the interval for distributing the clock time of the CPU module on the same system as the master module from the master station to device stations.

When the setting is changed, the new setting value is enabled after the interval of the distribution operating with the old setting value has elapsed. The setting value is distributed once after the distribution interval elapses. If the new setting value needs to be enabled immediately, stop the distribution and set the value.

- 0000H: 10 s (default)
- 0001H to FFEH: Send using the set time interval (second).
- FFFFH: Distribution stop

Grandmaster information

The grandmaster status of the own station and MAC address are stored.

■Grandmaster (Un\G89508)

When the own station is the grandmaster, "1" is stored.

- 0: Another station is the grandmaster.
- 1: Own station is the grandmaster.

■Grandmaster MAC address (Un\G89511 to Un\G89513)

The grandmaster MAC address is stored.

- Un\G89511: 5th byte, 6th byte of the MAC address
- Un\G89512: 3rd byte, 4th byte of the MAC address
- Un\G89513: 1st byte, 2nd byte of the MAC address

Time synchronization setting

■PTP frame send source check enable/disable (Un\G89537)

- 0: Do not check
- 1: Check

■PTP frame send source check result (P1) (Un\G89538)

- 0: One send source
- 1: Two or more send sources

PDO information

■PDO information (Un\G89734 to Un\G91269)

Address	Name	Description
Un\G89734 to Un\G89735	Multidrop No.0 of station No.1	RPDO use link device start offset The RPDO use link device start offset is stored. (Master station: RWw)
Un\G89736 to Un\G89737		RPDO size The RPDO size is stored in words.
Un\G89738 to Un\G89739		TPDO use link device start offset The TPDO use link device start offset is stored. (Master station: RWr)
Un\G89740 to Un\G89741		TPDO size The TPDO size is stored in words.
⋮		
Un\G89790 to Un\G89797	Multidrop No.7 of station No.1	The same as multidrop No.0 of station No.1
⋮		
Un\G91206 to Un\G91213	Multidrop No.0 of station No.24	The same as multidrop No.0 of station No.1
⋮		
Un\G91262 to Un\G91269	Multidrop No.7 of station No.24	The same as multidrop No.0 of station No.1

Protocol information

■ Protocol operation status (Un\G91270)

The operation status of the protocol is stored.

- 0: Operation protocol is undetermined, or "CC-Link IE TSN Class Setting" is set to "CC-Link IE TSN Class B Only".
- 1: A device is operating with the CC-Link IE TSN Protocol version 1.0.
- 2: A device is operating with the CC-Link IE TSN Protocol version 2.0.

Timeslot information for device station cyclic transmission

■ Timeslot information for device station cyclic transmission (Un\G91286 to Un\G91309)

The timeslot for cyclic transmission is stored for each station number.

Address	Description
Un\G91286	The timeslot for cyclic transmission (Station No.1) is stored. <ul style="list-style-type: none">• 0: Undetermined• 1: Timeslot 1• 3: Timeslot 3• 4: Timeslot 4• 5: Timeslot 5• 6: Timeslot 6
⋮	
Un\G91309	The timeslot for cyclic transmission (Station No.24) is stored. <ul style="list-style-type: none">• 0: Undetermined• 1: Timeslot 1• 3: Timeslot 3• 4: Timeslot 4• 5: Timeslot 5• 6: Timeslot 6

Information for ensuring cyclic data are sent/received

■ Multiple period setting (low speed) (Un\G91312)

The setting value of the multiple period setting (low speed) for ensuring that cyclic data are sent/received is stored.

- 0: Not calculated
- 16, 32, 64, 128: The "low speed" period for the basic period

(Conditions where a value is stored)

A value is stored in the buffer memory if the following conditions are met.

"CC-Link IE TSN Class Setting" of "Network Configuration Settings" is set to "CC-Link IE TSN Class A" and "Communication Period Setting" is set to "Low-Speed" for any of the device stations.

However, no value is stored in the buffer memory if the following condition is met.

In "Network Configuration Settings", "General CC-Link IE TSN Module" is set for all

■ Communication cycle interval (calculation value) (Un\G91313)

The setting value of the communication period interval for ensuring that cyclic data are sent/received is stored.

- 0: Not calculated
- 125 to 4294967295: Communication cycle interval (unit: μ s)

(Conditions where a value is stored)

A value is stored in the buffer memory if the following conditions are met.

"CC-Link IE TSN Class Setting" of "Network Configuration Settings" is set to "CC-Link IE TSN Class A" and "Communication Period Setting" is set to "Low-Speed" for any of the device stations.

However, no value is stored in the buffer memory if the following condition is met.

In "Network Configuration Settings", "General CC-Link IE TSN Module" is set for all

Communication cycle setting value (CC-Link IE TSN Protocol version 2.0)

■Communication cycle interval (calculation value) (Un\G91314)

The communication cycle interval of "CC-Link IE TSN Protocol version 2.0" calculated by the number of device stations and the number of points that are set in "Network Configuration Settings" under "Basic Settings" are stored. (Unit: μs)

■Cyclic transmission time (calculation value) (Un\G91315)

The cyclic transmission time of "CC-Link IE TSN Protocol version 2.0" calculated by the number of device stations and the number of points that are set in "Network Configuration Settings" under "Basic Settings" is stored. (Unit: μs)

■Transient transmission time (Calculation value) (Un\G91316)

The transient transmission time of "CC-Link IE TSN Protocol version 2.0" calculated by the number of device stations and the number of points that are set in "Network Configuration Settings" under "Basic Settings" is stored. (Unit: μs)

Information for device station cyclic transmission

■Multiplier for transmission delay information of CC-Link IE TSN Class A (low-speed) (Un\G91326)

The multiplier n is stored for calculating the transmission delay time for device stations for which "CC-Link IE TSN Class A" is set and "Communication Period Setting" is set to "Low-Speed".

- 0: There are no device stations for which "CC-Link IE TSN Class A" is set and "Communication Period Setting" is set to "Low-Speed" in the network configuration.
- 1 or higher: Value of n

If 'Protocol operating status' (Un\G91270) is "1" (A device is operating with the CC-Link IE TSN Protocol version 1.0), this is fixed to 1.

Own node setting status storage area

■Own node IP address (Un\G93574 to Un\G93575)

The setting values of the IP address are stored.

Range: 1H to DFFFFFFEH

■Subnet mask (Un\G93584 to Un\G93585)

The setting values of the subnet mask are stored.

Range: 1H to FFFFFFFFH

0: No setting

■Default gateway IP address (Un\G93588 to Un\G93589)

The setting values of the default gateway are stored.

Range: 1H to DFFFFFFEH

0: No setting

■Own node MAC address (Un\G93598 to Un\G93600)

The own node MAC addresses are stored.

- Un\G52252: 5th byte, 6th byte of the MAC address
- Un\G52253: 3rd byte, 4th byte of the MAC address
- Un\G52254: 1st byte, 2nd byte of the MAC address

■Own node network number (Un\G93601)

The setting value of the network number is stored.

Range: 1 to 239

0: Network number not set

■Station number (Un\G93602)

The setting value of the station number is stored.

Range: 1 to 24

0: Station number not set

125: Master station

■Transient transmission group No. (Un\G93603)

The setting value of the transient transmission group number is stored.

Range: 1 to 32

0: No group specification

■Auto-open UDP port port number (Un\G93607)

The port number used for the auto-open UDP port is stored.

■MELSOFT transmission port (TCP/IP) port number (Un\G93608)

The port number used for the MELSOFT transmission port (TCP/IP) is stored.

■MELSOFT transmission port (UDP/IP) port number (Un\G93609)

The port number for the MELSOFT transmission port (UDP/IP) is stored.

■SLMP transmission port (TCP/IP) port number (Un\G93611)

The port number used for the SLMP transmission port (TCP/IP) is stored.

■SLMP transmission port (UDP/IP) port number (Un\G93612)

The port number used for the SLMP transmission port (UDP/IP) is stored.

Connection status storage area

■Latest error code after the 2nd connection of MELSOFT transmission port (TCP/IP) (Un\G93742 to Un\G93748)

The latest error code of the 2nd to 8th connection of the MELSOFT transmission port (TCP/IP) is stored.

■Latest error code after the 2nd connection of SLMP transmission port (TCP/IP) (Un\G93870 to Un\G93876)

The latest error code of the 2nd to 8th connection of the SLMP transmission port (TCP/IP) is stored.

System port latest error code storage area

■Auto-open UDP port latest error code (Un\G94028)

The latest error code of the auto-open UDP port is stored.

■MELSOFT transmission port (UDP/IP) latest error code (Un\G94029)

The latest error code of the MELSOFT transmission port (UDP/IP) is stored.

■MELSOFT transmission port (TCP/IP) latest error code (Un\G94030)

The latest error code of the MELSOFT transmission port (TCP/IP) is stored.

■SLMP transmission port (UDP/IP) latest error code (Un\G94031)

The latest error code of the SLMP transmission port (UDP/IP) is stored.

■SLMP transmission port (TCP/IP) latest error code (Un\G94032)

The latest error code of the SLMP transmission port (TCP/IP) is stored.

■SLMPSND instruction latest error code (Un\G94033)

The latest error code of the SLMPSND instruction is stored.

Status for each protocol (IP packet)

■Received packet total count (Un\G94282 to Un\G94283)

The status is counted from 0 to 4294967295 (FFFFFFFFH).

■Received packet checksum error discard count (Un\G94284 to Un\G94285)

The status is counted from 0 to 4294967295 (FFFFFFFFH).

■Sent packet total count (Un\G94286 to Un\G94287)

The status is counted from 0 to 4294967295 (FFFFFFFFH).

■Simultaneous transmission error detection count (receive buffer full count) (Un\G94304 to Un\G94305)

The status is counted from 0 to 4294967295 (FFFFFFFFH).

■Receive abort count (Un\G94311)

The status is counted from 0 to 65535 (FFFFH).

Status for each protocol (ICMP packet)

■Received packet total count (Un\G94322 to Un\G94323)

The status is counted from 0 to 4294967295 (FFFFFFFFH).

■Received packet checksum error discard count (Un\G94324 to Un\G94325)

The status is counted from 0 to 4294967295 (FFFFFFFFH).

■Sent packet total count (Un\G94326 to Un\G94327)

The status is counted from 0 to 4294967295 (FFFFFFFFH).

■Received echo request total count (Un\G94328 to Un\G94329)

The status is counted from 0 to 4294967295 (FFFFFFFFH).

■Sent echo reply total count (Un\G94330 to Un\G94331)

The status is counted from 0 to 4294967295 (FFFFFFFFH).

■Sent echo request total count (Un\G94332 to Un\G94333)

The status is counted from 0 to 4294967295 (FFFFFFFFH).

■Received echo reply total count (Un\G94334 to Un\G94335)

The status is counted from 0 to 4294967295 (FFFFFFFFH).

Status for each protocol (TCP packet)

■Received packet total count (Un\G94362 to Un\G94363)

The status is counted from 0 to 4294967295 (FFFFFFFFH).

■Received packet checksum error discard count (Un\G94364 to Un\G94365)

The status is counted from 0 to 4294967295 (FFFFFFFFH).

■Sent packet total count (Un\G94366 to Un\G94367)

The status is counted from 0 to 4294967295 (FFFFFFFFH).

Status for each protocol (UDP packet)

■Received packet total count (Un\G94402 to Un\G94403)

The status is counted from 0 to 4294967295 (FFFFFFFFH).

■Received packet checksum error discard count (Un\G94404 to Un\G94405)

The status is counted from 0 to 4294967295 (FFFFFFFFH).

■Sent packet total count (Un\G94406 to Un\G94407)

The status is counted from 0 to 4294967295 (FFFFFFFFH).

Own node operation status storage area (LED on/off status)

■Own node operation status storage area (LED on/off status) (Un\G94471)

ERROR LED (b0)

- 0: Off
- 1: On/flashing

Own node operation status storage area (switching hub connection information area)

■Communication mode (Un\G94473)

- 0: Half-duplex
- 1: Full-duplex

■Connection status (Un\G94474)

- 0: Switching hub not connected/disconnected
- 1: Switching hub connected

■Communication speed (Un\G94475)

- 1: Operating at 100BASE-TX
- 2: Operating at 1000BASE-T

■Disconnection count (Un\G94476)

The number of times the cable was disconnected is stored.

Own node operation status storage area (IP address duplication status storage area)

■IP address duplication flag (Un\G94482)

- 0: IP address not duplicated
- 1: IP address duplicated

■MAC address of the station already connected to the network (Un\G94483 to Un\G62913)

It is stored in the station with duplicated IP address.

■MAC address of the station with the IP address already used (Un\G94486 to Un\G94488)

It is stored in the station that has been already connected to the network.

Remote password lock status storage area

■Remote password lock status system port (Un\G94778)

[b0]: Auto-open UDP port

[b1]: MELSOFT transmission port (UDP/IP)

[b2]: MELSOFT transmission port (TCP/IP)

[b5]: SLMP transmission port (UDP/IP)

[b6]: SLMP transmission port (TCP/IP)

- 0: Unlocked/remote password not set
- 1: Lock status

Remote password function monitoring area

■Auto-open UDP port continuous unlock failure count (Un\G94854)

The mismatch count of remote password at unlock of the auto-open UDP port is stored. The count is cleared when the password matches.

Range: 0 to 65535 (Values of 65535 or more are not changed)

■MELSOFT transmission port (UDP/IP) continuous unlock failure count (Un\G94855)

The mismatch count of remote password at unlock of the MELSOFT transmission port (UDP/IP) is stored. The count is cleared when the password matches.

Range: 0 to 65535 (Values of 65535 or more are not changed)

■MELSOFT transmission port (TCP/IP) continuous unlock failure count (Un\G94856)

The mismatch count of remote password at unlock of the MELSOFT transmission port (TCP/IP) is stored. The count is cleared when the password matches.

Range: 0 to 65535 (Values of 65535 or more are not changed)

■SLMP transmission port (UDP/IP) continuous unlock failure count (Un\G94859)

The mismatch count of remote password at unlock of the SLMP transmission port (UDP/IP) is stored. The count is cleared when the password matches.

Range: 0 to 65535 (Values of 65535 or more are not changed)

■SLMP transmission port (TCP/IP) continuous unlock failure count (Un\G94860)

The mismatch count of remote password at unlock of the SLMP transmission port (TCP/IP) is stored. The count is cleared when the password matches.

Range: 0 to 65535 (Values of 65535 or more are not changed)

Network type information area

■Network type information (Un\G94907)

- 5: CC-Link IE TSN

Ethernet information

■Initial status (Un\G94942)

The initial processing status of the Motion module Ethernet connection is stored.

[b0]: Initial normal completion status

- 0: —
- 1: Initialization normal completion

[b1]: Initial abnormal completion status

- 0: —
- 1: Initialization abnormal completion

[b2 to b15]: Not used (Use prohibited)

■Initial error code (Un\G94943)

The information when the initial processing is completed with an error is stored.

- 0: In initial processing or initial normal completion
- 1 or more: Initialization abnormal code

Receive buffer status storage area

■Receive buffer status (Un\G94948)

The receive buffer status is stored.

- 0: Receive buffer not full
- 1: Receive buffer full

Appendix 2 List of Link Special Relay (SB)

The link special relay (SB) is turned on/off depending on various factors during data link. Any error status of the data link can be checked by using or monitoring it in the program.

Application of link special relay (SB)

By using link special relay (SB), the status of CC-Link IE TSN can be checked from HMI (Human Machine Interfaces) as well as the engineering tool.

Refresh of link special relay (SB)

To use link special relay (SB), set them in "Refresh Settings" under "Basic Settings" so that they are refreshed to the devices of the CPU module. (☞ Page 101 Refresh settings)

Ranges turned on/off by users and by the system

The following ranges correspond to when the link special relay areas (SB) are assigned from SB0000 to SB0FFF.

- Turned on/off by users: SB0000 to SB001F
- Turned on/off by the system: SB0020 to SB0FFF

List of link special relay (SB)

The following table lists the link special relay areas (SB) when they are assigned from SB0000 to SB0FFF.



Do not turn on or off areas whose numbers are not in the following list. Doing so may cause malfunction of the programmable controller system.

No.	Name	Description
SB0006	Clear communication error count	Clears the link special register areas related to communication errors (SW0074 to SW0077) to 0. Off: Clear not requested On: Clear requested (valid while on)
SB0014	Cyclic data receive status clear	Clears 'Cyclic data receive status' (SB0064). While 'Cyclic data receive status clear' (SB0014) is on, the cyclic data receive status does not turn on. Off: Clear not requested On: Clear requested (enabled while on)
SB0040	Network type of own station	Stores the network type of the own station. ON: CC-Link IE TSN network
SB0043	Module operation mode of own station	Stores the module operation mode of the own station. Off: Online mode On: Other than online mode
SB0044	Station setting 1 of own station	Stores the station type of the own station. Off: Device station (other than the master station) On: Master station
SB0045	Station setting 2 of own station	Stores the communication mode of the own station. Off: Unicast mode On: Multicast mode
SB0046	Station number setting status of own station	Stores the station number setting status. Off: Station number set On: Station number not set (local station only) If parameters are set, this relay is always off.
SB0049	Data link error status of own station	Stores the data link error status of the own station. Off: Normal On: Error When this relay is turned on, the cause of the error can be checked with 'Cause of data link stop' (SW0049). Depending on the link refresh timing, the update of 'Cause of data link stop' (SW0049) may be offset by one sequence scan. (Also used in the CLPA conformance test.) (Updated even if set as an error invalid station.)
SB004A	CPU minor error status of own station	Stores the minor error status of the CPU module on the own station. Off: No minor error On: Minor error
SB004B	CPU moderate/major error status of own station	Stores the moderate/major error status of the CPU module on the own station. Off: No moderate/major error On: Moderate/major error
SB004C	CPU operating status of own station	Stores the operating status of the CPU module on the own station. OFF: RUN or PAUSE On: STOP, or moderate/major error
SB004D	Received parameter error	Stores the status of received parameter. (For the master station, this relay stores the parameter status of the own station) Off: Normal On: Error
SB0064	Cyclic data receive status	Shows the receive status in the communication cycle in which the cyclic data from the device station is set using "Disconnection Detection Setting" in the master station. Off: Cyclic data received On: Cyclic data not received consecutively (Conditions) • This relay turns on when an error is detected for one or more stations by an alive check. • Reserved stations and stations that surpass the maximum station number are ignored. (Also used in the CLPA conformance test.) (Updated even if set as an error invalid station.) (Updated even if set as a reserved station.)

No.	Name	Description
SB006A	PORT1 link-down status of own station	Stores the link-down status of the own station P1 side. Off: Link-up On: Link-down The time until link-up starts after power-on or Ethernet cable connection may vary. Normally link-up takes several seconds. Depending on device status on the line, link-up processing is repeated and may increase the time. (Also used in the CLPA conformance test.) (Updated even if set as an error invalid station.) (Updated even if set as a reserved station.)
SB0074	Reserved station specification status	Stores the status of reserved station specification by parameter. The station number of the station set as a reserved station can be checked with 'Reserved station setting status' (SW00C0 to SW00C7). Off: Not specified On: Specified
SB0075	Error invalid station setting status	Stores the status of error invalid station setting by parameter. The station number of the station set as an error invalid station can be checked with 'Error invalid station setting status' (SW00D0 to SW00D7). Off: Not specified On: Specified
SB0077	Parameter reception status	Stores the status of parameter reception from the master station. Off: Reception complete On: Reception not completed
SB007B	Input data status of data link faulty station	Stores the setting status of "Data link faulty station setting" of the own station. Off: Clear On: Hold
SB007D	Hold/clear status setting for CPU STOP	Stores the setting status of "Output Hold/Clear Setting during CPU STOP" of the own station. Off: Hold On: Clear
SB007E	Type of IP Address	Stores the type of IP address. OFF: IPv4 ON: IPv6
SB007F	IP address setting status	Stores the status of the IP address setting by parameter. Off: No setting On: Set For local stations, this relay stores the acceptance status of the IP address from the master station.
SB00B0	Data link error status of each station	Stores the data link status of each station. Off: All stations normal On: Faulty station exists When this relay is turned on, the status of each station can be checked with 'Data link status of each station' (SW00B0 to SW00B7). Depending on the link refresh timing, the update of 'Data link status of each station' (SW00B0 to SW00B7) may be offset by one sequence scan. Since a local station cannot obtain the station information of the CC-Link IE TSN Class A remote station when communicating in multicast mode, "0: Data link normally operating station" is reflected to the CC-Link IE TSN Class A remote station. (Conditions) Reserved stations and stations that surpass the maximum station number are ignored.
SB00B1	Data link error status of master station	Stores the data link status of the master station. Off: Normal On: Error
SB00C0	Reserved station setting status	Stores whether a reserved station is set. Off: No setting On: Set When this relay is turned on, the status of each station can be checked with 'Reserved station setting status' (SW00C0 to SW00C7). Depending on the refresh timing, the update of 'Reserved station setting status' (SW00C0 to SW00C7) may be offset by one sequence scan.
SB00D0	Error invalid station setting current status	Set whether an error invalid station is set. Off: No setting On: Set When this relay is turned on, the status of each station can be checked with 'Error invalid station setting status' (SW00D0 to SW00D7). Depending on the refresh timing, the update of 'Error invalid station setting status' (SW00D0 to SW00D7) may be offset by one sequence scan.

No.	Name	Description
SB00E8	Station type match status of each station	Shows the station type match status of each station. 0: Station types of all stations match 1: Station type mismatch exists. This relay is turned to "0: Station types of all stations match" when all areas of 'Station type match status' (SW00E8 to SW00EF) are "0: Station type match". Depending on the refresh timing, the update of 'Station type match status' (SW00E8 to SW00EF) may be offset by one sequence scan.
SB00F0	CPU operating status of each station	Stores the operating status of the CPU module on each station. Off: All stations at RUN or PAUSE state On: Station at STOP state, or station with a moderate/major error exists. When this relay is turned on, the status of each station can be checked with 'CPU operating status of each station' (SW00F0 to SW00F7). Depending on the refresh timing, the update of 'CPU operating status of each station' (SW00F0 to SW00F7) may be offset by one sequence scan. Since a local station cannot obtain the station information of the CC-Link IE TSN Class A remote station when communicating in multicast mode, "0: RUN, PAUSE" is reflected to the CC-Link IE TSN Class A remote station.
SB00F1	CPU operating status of master station	Stores the operating status of the CPU module on the master station (master operating station). Off: RUN or PAUSE On: STOP, or moderate/major error
SB0100	CPU moderate/major error status of each station	For local stations, stores the moderate/major error occurrence status of the CPU module on each station. For remote stations, stores the moderate/major error occurrence status of each station. Off: No station with a moderate/major error On: Station with a moderate/major error exists When this relay is turned on, the status of each station can be checked with 'CPU moderate/major error status of each station' (SW0100 to SW0107). Depending on the refresh timing, the update of 'CPU moderate/major error status of each station' (SW0100 to SW0107) may be offset by one sequence scan. Since a local station cannot obtain the station information of the CC-Link IE TSN Class A remote station when communicating in multicast mode, "0: No moderate/major error" is reflected to the CC-Link IE TSN Class A remote station.
SB0101	CPU moderate/major error status of master station	Stores the moderate/major error occurrence status of the CPU module on the master station (master operating station). Off: No moderate/major error On: Moderate/major error
SB0110	CPU minor error status of each station	For local stations, stores the minor error occurrence status of the CPU module on each station. For remote stations, stores the minor error occurrence status of each station. Off: All stations normal or station with a moderate/major error exists. On: Station with a minor error exists. When this relay is turned on, the status of each station can be checked with 'CPU minor error status of each station' (SW0110 to SW0117). Depending on the refresh timing, the update of 'CPU minor error status of each station' (SW0110 to SW0117) may be offset by one sequence scan. Since a local station cannot obtain the station information of the CC-Link IE TSN Class A remote station when communicating in multicast mode, "0: Normal, or a moderate or serious error occurring" is reflected to the CC-Link IE TSN Class A remote station.
SB0111	CPU minor error status of master station	Stores the minor error occurrence status of the CPU module on the master station (master operating station). Off: No minor error or a moderate/major error On: Minor error

*1 This register is enabled when 'Data link status of own station' (SB0049) is off.



Appendix 3 List of Link Special Register (SW)

The link special register (SW) stores the information during data link as a numerical value. Faulty areas and causes can be checked by using or monitoring the link special register (SW) in programs.

Application of link special register (SW)

By using link special register (SW), the status of CC-Link IE TSN can be checked from HMI (Human Machine Interfaces) as well as the engineering tool.

Refresh of link special register (SW)

To use link special register (SW), set them in "Refresh Settings" under "Basic Settings" so that they are refreshed to the devices of the CPU module. ( Page 101 Refresh settings)

Range where data is stored by users and range where data is stored by the system

The following ranges correspond to when the link special register areas (SW) are assigned from SW0000 to SW0FFF.

- Stored by users: SW0000 to SW001F
- Stored by the system: SW0020 to SW0FFF

List of link special register (SW)

The following table lists the link special register areas (SW) when they are assigned from SW0000 to SW0FFF.



Do not write any data to an area whose number is not on the following list. Doing so may cause malfunction of the programmable controller system.

No.	Name	Description												
SW0040	Network number	Stores the network number of the own station. Range: 1 to 239												
SW0042	Station number	Stores the station number of the own station. Master station range: 125												
SW0043	Mode status of own station	Stores the module operation mode setting or communication mode setting of the own station. 0: Online mode/Unicast mode 1: Online mode/Multicast mode 2: Offline mode B: Module communication test mode												
SW0045	Module type	Stores the hardware status of the own station. <div style="text-align: center;"> <table border="1" style="margin-left: auto; margin-right: auto;"> <tr> <td style="border: none;">SW0045</td> <td style="border: none; text-align: center;">b15</td> <td style="border: none; text-align: center;">...</td> <td style="border: none; text-align: center;">b2</td> <td style="border: none; text-align: center;">b1</td> <td style="border: none; text-align: center;">b0</td> </tr> <tr> <td style="border: none;"></td> <td style="border: 1px solid black; text-align: center;">0</td> <td style="border: none; text-align: center;">...</td> <td style="border: 1px solid black; text-align: center;">0</td> <td style="border: 1px solid black; text-align: center;"></td> <td style="border: 1px solid black; text-align: center;"></td> </tr> </table> </div> Model type (b1, b0) 00: Module 01: Board 10: HMI (Human Machine Interface)	SW0045	b15	...	b2	b1	b0		0	...	0		
SW0045	b15	...	b2	b1	b0									
	0	...	0											
SW0046 to SW0047	IPv4 address	Shows the IP address (IPv4) set in the own station. <div style="text-align: center;"> <table border="1" style="margin-left: auto; margin-right: auto;"> <tr> <td style="border: none;">SW0046</td> <td style="border: 1px solid black; text-align: center;">(1)</td> <td style="border: 1px solid black; text-align: center;">(2)</td> </tr> <tr> <td style="border: none;">SW0047</td> <td style="border: 1px solid black; text-align: center;">(3)</td> <td style="border: 1px solid black; text-align: center;">(4)</td> </tr> </table> </div> (1): Third octet (2): Fourth octet (3): First octet (4): Second octet	SW0046	(1)	(2)	SW0047	(3)	(4)						
SW0046	(1)	(2)												
SW0047	(3)	(4)												
SW0049	Cause of data link stop	Stores the cause that stopped the data link of the own station. 00H: At normal communication or power-on 02H: Monitoring time timeout 05H: No device station (master station only) 10H: Parameter not received (local station only) 11H: Outside the range of own station numbers 12H: Reserved station setting of own station (local station only) 14H: Master station duplication (master station only) 16H: Station number not set (local station only) 18H: Parameter error 19H: Parameter communication in progress 20H: CPU module moderate error, major error 60H: Illegal ring topology (master station only) (Also used in the CLPA conformance test.) (Updated even if set as an error invalid station.) (Updated even if set as a reserved station.)												
SW004B	CPU status of own station	Stores the status of the CPU module on the own station. 00H: No CPU module mounted 01H: STOP (normal) 02H: STOP (moderate/major error) 03H: STOP (minor error) 04H: RUN (normal) 05H: RUN (minor error) 07H: PAUSE 0EH: Reset in progress 0FH: Initial processing in progress												
SW004C	Parameter setting status	Stores the status of parameter settings. 0: Normal 1 or greater: Error definition (Error code is stored.) (Conditions) <ul style="list-style-type: none"> • This register is enabled when 'Received parameter error' (SB004D) is on. 												

No.	Name	Description
SW0058	Total number of device stations setting value	Stores the total number of device stations that are set by the parameters. Range: 1 to 24
SW0059	Total number of device stations present value	Stores the total number of device stations that are actually connected by data link. Range: 1 to 24 (0 when own station is disconnected)
SW005B	Maximum data link station number	Stores the maximum station number of the station where the data link is normally performed. Range: 1 to 24 (0 when own station is disconnected) (Conditions) • This register is enabled when 'Data link error status of own station' (SB0049) is off.
SW0060	Communication cycle intervals	Stores the setting value of "Communication Period Interval Setting" set with the module parameter of the master station. (Unit: μ s)
SW0061	System reserved time	Stores the setting value of "System Reservation Time" set with the module parameter of the master station. (Unit: μ s)
SW0062	Cyclic transmission time	Stores the setting value of "Cyclic Transmission Time" set with the module parameter of the master station. (Unit: μ s)
SW0063	Transient transmission time	Stores the setting value of "Transient Transmission Time" set with the module parameter of the master station. (Unit: μ s)
SW0064	Multiple cycle setting (medium speed)	Stores the setting value of "Multiple Period Setting (Normal-Speed)" set with the module parameter of the master station.
SW0065	Multiple cycle setting (low speed)	Stores the setting value of "Multiple Period Setting (Low-Speed)" set with the module parameter of the master station.
SW0066	Connection status of own station	Stores the connection status of the own station. 00H, 01H: Normal (communication in progress on P1) 10H: Normal (cable disconnected on P1) 11H, 12H: Disconnected (cable disconnected on P1) 21H, 22H: Disconnected (establishing line on P1)
SW0072	Communication cycle intervals (calculation value)	Stores the communication cycle intervals calculated by the number of device stations and the number of points that are set in "Network Configuration Settings" under "Basic Settings". (Unit: μ s)
SW0073	Cyclic transmission time (calculation value)	Stores the cyclic transmission time calculated by the number of device stations and the number of points that are set in "Network Configuration Settings" under "Basic Settings". (Unit: μ s)
SW0074	PORT1 cable disconnection detection count	Stores the cumulative count that was detected for cable disconnections at the P1 side. When 'Clear communication error count' (SB0006) is turned on, the stored count is cleared. When FFFFH (maximum value 65535) is counted, the value returns to 0 and the module continues to count.
SW0075	PORT1 receive error detection count	Stores the cumulative count that error data was received at the P1 side. The count stores only error data that is not transmitted to all stations. When 'Clear communication error count' (SB0006) is turned on, the stored count is cleared. When FFFFH (maximum value 65535) is counted, counting stops.
SW0076	PORT1 total number of received data (lower 1 word)	Stores the cumulative count that data was received at the P1 side. When 'Clear communication error count' (SB0006) is turned on, the stored count is cleared.
SW0077	PORT1 total number of received data (upper 1 word)	When FFFFFFFFH (maximum value 4294967295) is counted, counting stops.
SW0078	Transient transmission time (calculation value)	Stores the transient transmission time calculated by the number of device stations and the number of points that are set in "Network Configuration Settings" under "Basic Settings". (Unit: μ s)
SW00B0 to SW00B7	Data link status of each station	Stores the data link status of each station. 0: Data link normally operating station 1: Data link faulty station • If multiple stations change from faulty to normal, because they are reconnected to the network one by one per cycle, the time until the status changes to "0: Data link normally operating station" may vary by several seconds. • If no response is received for several cycles, the station is determined to be a data link faulty station. Since a local station cannot obtain the station information of the CC-Link IE TSN Class A remote station when communicating in multicast mode, "0: Data link normally operating station" is reflected to the CC-Link IE TSN Class A remote station. (Conditions) • Stations that surpass the maximum station number are ignored. (Also used in the CLPA conformance test.)
SW00C0 to SW00C7	Reserved station setting status	Stores the reserved station setting status of each station. 0: Station other than a reserved station 1: Reserved station (Conditions) • Stations that surpass the maximum station number are ignored. (Also used in the CLPA conformance test.)

No.	Name	Description
SW00C8 to SW00CF	Parameter setting status	Stores the status of parameter settings. 0: No parameter setting 1: Parameter set (Conditions) • Stations that surpass the maximum station number are ignored.
SW00D0 to SW00D7	Error invalid station setting status	Stores the error invalid station setting status of each station. 0: Station other than an error invalid station 1: Error invalid station (Conditions) • Stations that surpass the maximum station number are ignored.
SW00E8 to SW00EF	Station type match status	Shows the match status of the parameters with the station types. (This is available only for the number of connected stations.) 0: Station type matched 1: Station type mismatch
SW00F0 to SW00F7	CPU operating status of each station	Stores the CPU operating status of each station. 0: RUN or PAUSE 1: STOP or moderate/major error (Conditions) • Reserved stations and stations that surpass the maximum station number are ignored. • Since a local station cannot obtain the station information of the CC-Link IE TSN Class A remote station when communicating in multicast mode, "0: RUN, PAUSE" is reflected to the CC-Link IE TSN Class A remote station.
SW0100 to SW0107	CPU moderate/major error status of each station	Stores the CPU moderate/major error occurrence status of each station in the local station. Stores the moderate/major error occurrence status of each station in the remote station. 0: No moderate/major error 1: Moderate/major error occurring (Conditions) • If an error occurs, data prior to error is held. • Reserved stations and stations that surpass the maximum station number are ignored. • Since a local station cannot obtain the station information of the CC-Link IE TSN Class A remote station when communicating in multicast mode, "0: No moderate/major error" is reflected to the CC-Link IE TSN Class A remote station.
SW0110 to SW0117	CPU minor error status of each station	Stores the CPU minor error occurrence status of each station in the local station. Stores the minor error occurrence status of each station in the remote station. 0: Normal, or a moderate or serious error occurring 1: Minor error occurring (Conditions) • Reserved stations and stations that surpass the maximum station number are ignored. • Since a local station cannot obtain the station information of the CC-Link IE TSN Class A remote station when communicating in multicast mode, "0: Normal, or a moderate or serious error occurring" is reflected to the CC-Link IE TSN Class A remote station.
SW0160 to SW0167	Execution result of device station parameter automatic setting function	When the device station parameter automatic setting is completed with an error, the bit of the target station is turned on. On: Completed with an error Off: Completed successfully When the setting is completed with an error, the error code is stored in 'Detailed execution result of device station parameter automatic setting' (SW0194). When completed with an error caused by the master station, the bit is not turned on.
SW0194	Detailed execution result of device station parameter automatic setting	When the device station parameter automatic setting is completed with an error, the error code is stored. When completed with an error caused by the device station, the bit of the target station of 'Execution result of device station parameter automatic setting function' (SW0160 to SW0167) is turned on.
SW01A0 to SW01A7	CC-Link IE TSN Protocol version 2.0 support status for each station	The CC-Link IE TSN Protocol version 2.0 support status for each station is stored. 0: Not supported 1: Supported (Condition) • Stations that surpass the maximum station number are ignored.
SW04A0	Time synchronization method	Stores the time synchronization method. 0: IEEE1588 1: IEEE802.1AS
SW04B0 to SW04B7	Station time synchronization status	Stores the time synchronization status for each station. 0: Time asynchronous station 1: Time synchronized station For time synchronized stations, the time synchronization method can be found in 'Time synchronization method' (SW04A0). (Condition) Stations that surpass the maximum station number are ignored.



Appendix 4 Processing Time

The transmission delay time of CC-Link IE TSN consists of the time components below. (☞ Page 197 Cyclic transmission delay time)

(1) Master station sequence scan time + (2) Communication cycle interval (cyclic data transfer processing time) + (3) Device station processing time

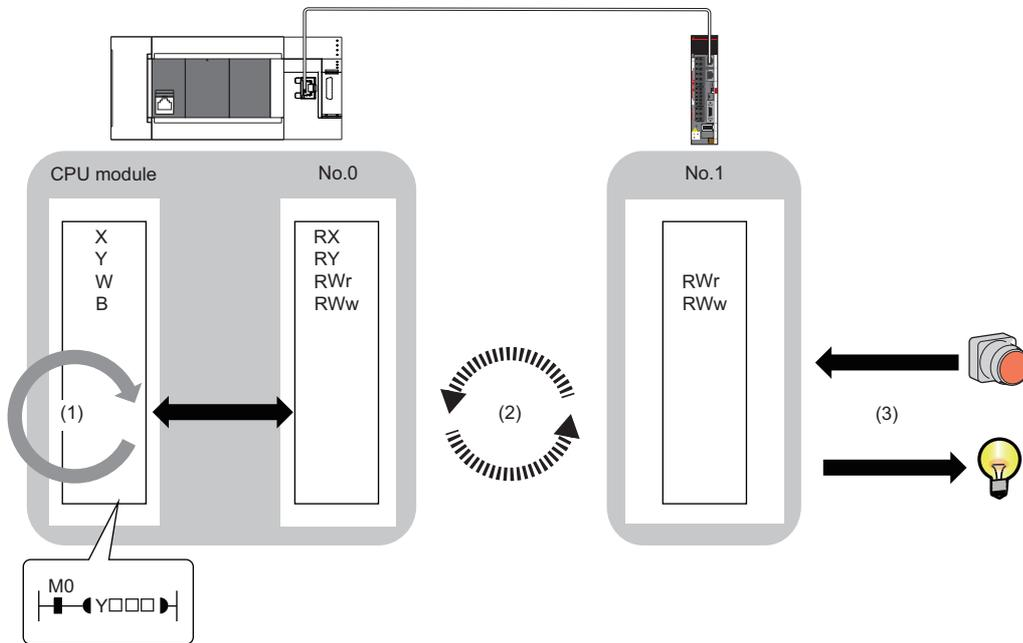

- Sequence scan time: ☞ MELSEC iQ-R CPU Module User's Manual (Application)
- Communication cycle interval (cyclic data transfer processing time): ☞ Page 201 Communication cycle intervals
- Device station processing time: ☞ Manual for the device station used

Cyclic transmission delay time

Standard station

This section shows how to calculate the following cyclic transmission delay time.

- The time between the transmission source CPU module device turning on or off and the transmission destination CPU module device turning on or off
- The time between data setting in the transmission source CPU module device and the data being stored in the transmission destination CPU module device

In "Basic Settings" of the master station, when "Communication Period Setting" of the communication destination in "Network Configuration Settings" is set to an option other than "Basic Period", multiply the LS (communication period interval) by the multiplier corresponding to the set option, which is specified in "Multiple Period Setting" under "Communication Period Setting". In this case, the multiplier is determined according to "CC-Link IE TSN Class Setting" in "Network Configuration Settings" as follows:

- For "CC-Link IE TSN Class B": The multiplier specified for "Multiple Period Setting" in "Basic Settings"
- For "CC-Link IE TSN Class A" and "Normal-Speed": The multiplier specified for "Multiple Period Setting" in "Basic Settings"
- For "CC-Link IE TSN Class A" and "Low-Speed": (The multiplier specified for "Multiple Period Setting" in "Basic Settings") × n

The number n can be found in 'Information for device station cyclic transmission' (Un\G91326).

Stations with "CC-Link IE TSN Class A" and "Low-Speed" set are grouped by the data size of the Ms and Ss frames. The number n is determined by the number of these groups.

The following table shows the algorithm for determining the number n.

No.	Processing	Detail	Loop 1	Loop 2	Branch	
					Yes	No
1	Start	Check stations in "Network Configuration Settings" for the master station in the order of the No. column to assign stations with "CC-Link IE TSN Class A" and "Low-Speed" set to groups.	—	—	—	—
2	Loop as many times as the number of stations (j=1; i≤ the number of stations to set; i++)	Check device stations with values 1 to 60 set in the No. column of "Network Configuration Settings" for the master station one by one.	No.2 to No.11	—	—	—
3	Are both "CC-Link IE TSN Class A" and "Low-Speed" set?	Check "CC-Link IE TSN Class" and "Communication Period Setting" for the No. i station in "Network Configuration Settings" for the master station. If both "CC-Link IE TSN Class A" and "Low-Speed" are set, perform processes.		—	→No.4	→No.11
4	Determine the data sizes (DMsi and DSsi) of the Ms and Ss frames.	The following formulas are used to determine the data sizes (DMsi and DSsi) of the Ms and Ss frames. DMsi = (HBL × n1i) + (16 × n2i) + ndmi DSsi = (HBL × n3i) + (20 × n4i) + ndsi		—	—	—
5	Loop to the maximum number of groups (j = 1; j ≤ 60; j++)	Up to 2K bytes can be allocated to a group. Determine which group number (1 to 60) the ith station can be allocated to by checking from the group number 1 to 60.		No.5 to No.10	—	—
6	Is GMsj + DMsi ≤ 2048 true?	Define GMsj as the total value of the data sizes of the Ms frames assigned to the jth group and determine whether the following condition is met. GMsj + DMsi ≤ 2048			→No.7	→No.10
7	Is GSsj + DSsi ≤ 2048 true?	Define GSsj as the total value of the data sizes of the Ss frames assigned to the jth group and determine whether the following condition is met. GSsj + DSsi ≤ 2048			→No.8	→No.10
8	Update the data sizes (GMsj and GSsj) of assigned groups.	If the conditions No.6 and No.7 are both met, update the values of GMsj and GSsj.			—	—
9	Assign the group number j to the ith station.	If the conditions No.6 and No.7 are both met, assign the group number j to the ith station.			—	—
10	End of the No.5 loop	—			—	—
11	End of the No.2 loop	—			—	—



No.	Processing	Detail	Loop 1	Loop 2	Branch	
					Yes	No
12	Determine the maximum value J of the group numbers.	After assigning group numbers to all stations with "CC-Link IE TSN Class A" and "Low-Speed" set, determine the maximum value J of the group numbers.	—	—	—	—
13	Value of $n = J \div 4$ rounded up to the nearest integer	The following formula is used to determine the number n. Value of $n = J \div 4$ rounded up to the nearest integer	—	—	—	—
14	End	—	—	—	—	—

The following table shows the variables used in the algorithm.

Name of variable	Description
HBL	42
n1i	Value of $(ndmi + (16 \times n2i)) \div 1488$ rounded up to the nearest integer
n2i	$(RYbi + RWwbi)$ RYbi: Value of (Points of "RY setting" for the ith station with "CC-Link IE TSN Class A" and "Low-Speed" set) $\div 11776$ rounded up to the nearest integer RWwbi: Value of (Points of "RWw setting" for the ith station with "CC-Link IE TSN Class A" and "Low-Speed" set) $\div 736$ rounded up to the nearest integer
ndmi	$(\text{Points of "RY setting" for the } i\text{th station with "CC-Link IE TSN Class A" and "Low-Speed" set}) \div 8 + (\text{Points of "RWw setting" for the } i\text{th station with "CC-Link IE TSN Class A" and "Low-Speed" set}) \times 2$
n3i	Value of $(ndsi + (20 \times n4i)) \div 1488$ rounded up to the nearest integer
n4i	$(RXbi + RWrbi) + 1$ RXbi: Value of (Points of "RX setting" for the ith station with "CC-Link IE TSN Class A" and "Low-Speed" set) $\div 11744$ rounded up to the nearest integer RWrbi: Value of (Points of "RWr setting" for the ith station with "CC-Link IE TSN Class A" and "Low-Speed" set) $\div 734$ rounded up to the nearest integer
ndsi	$(\text{Points of "RX setting" for the } i\text{th station with "CC-Link IE TSN Class A" and "Low-Speed" set}) \div 8 + (\text{Points of "RWr setting" for the } i\text{th station with "CC-Link IE TSN Class A" and "Low-Speed" set}) \times 2 + 8$

Ex.

For the inverter FR-E800 (RX: 32 points and RWr: 32 points)

If $1 \leq SnA \leq 44$, $n=1$

If $45 \leq SnA \leq 88$, $n=2$

If $89 \leq SnA \leq 120$, $n=3$

■ Master station ← remote station

When data is transmitted from a remote station (input) to the master station (RX/RWr).

Calculation value	Station-based block data assurance	No station-based block data assurance
Normal value	$(SM \times 1) + (LS \times n1) + Rio$	$(SM \times 1) + (LS \times 1) + Rio$
Maximum value	$(SM \times 1) + (LS \times (n1 + 1)) + Rio$	$(SM \times 1) + (LS \times 2) + Rio$

• Variable

Name of variable	Description	Unit
SM	Master station sequence scan time	μs
LS	Communication cycle interval	μs
Rio	Processing time of the remote station	μs
n1	Round up the calculated value to the nearest integer of $(SM \div LS)$	—

■ Master station → remote station

When data is transmitted from the master station (RY/RWw) to a remote station (output).

Calculation value	Station-based block data assurance	No station-based block data assurance
Normal value	$(SM \times n2) + (LS \times 1) + Rio$	$(SM \times 1) + (LS \times 1) + Rio$
Maximum value	$(SM \times n2) + (LS \times 2) + Rio$	$(SM \times 2) + (LS \times 2) + Rio$

- Variable

Name of variable	Description	Unit
SM	Master station sequence scan time	μs
LS	Communication cycle interval	μs
Rio	Processing time of the remote station	μs
n2	Round up the calculated value to the nearest integer of (LS ÷ SM)	—

Motion control station

This section shows how to calculate the following cyclic transmission delay time.

- The time between the Motion module device turning on or off and the transmission destination device turning on or off
- The time between data setting in the Motion module device and the data being stored in the transmission destination device

■ Master station ← remote station

When data is transmitted from a remote station (input) to the master station (RX/RWr).

Calculation value	Transmission delay time
Normal value	$(LS \times 1) + Rio$
Maximum value	$(LS \times 2) + Rio$

- Variable

Name of variable	Description	Unit
LS	Communication cycle interval (It can be found in SW0060.)	μs
Rio	Processing time of the remote station	μs

■ Master station → remote station

When data is transmitted from the master station (RY/RWw) to a remote station (output).

Calculation value	Transmission delay time
Normal value	$(LS \times 2) + Rio$
Maximum value	$(LS \times 3) + Rio$

- Variable

Name of variable	Description	Unit
LS	Communication cycle interval (It can be found in SW0060.)	μs
Rio	Processing time of the remote station	μs

A

Feedback on the cyclic data sent by the Motion control module takes a minimum of three cycles.

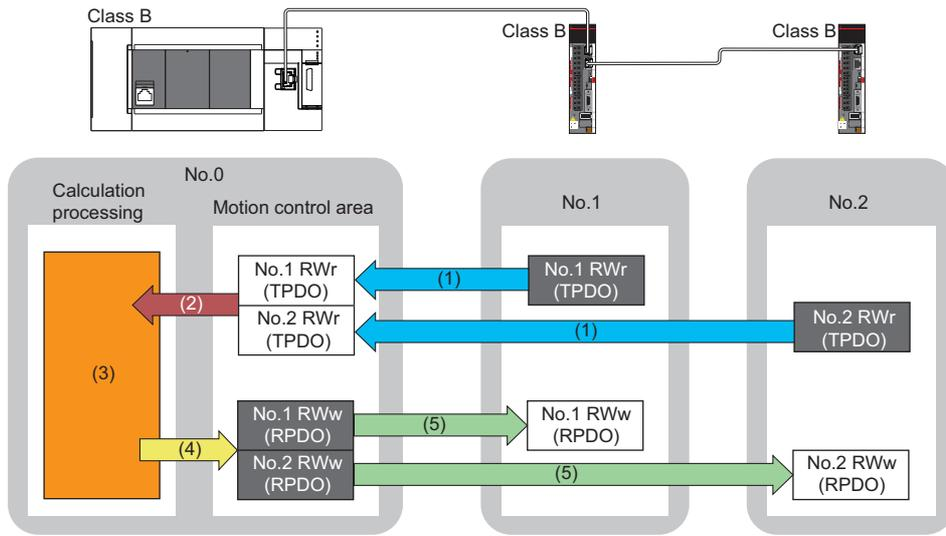

No.0, No.1, No.2: Station No.0 (master station), station No.1, station No.2

- (1) Sent from remote station
- (2) Read received data
- (3) Motion calculation
- (4) Write send data
- (5) Send to remote station

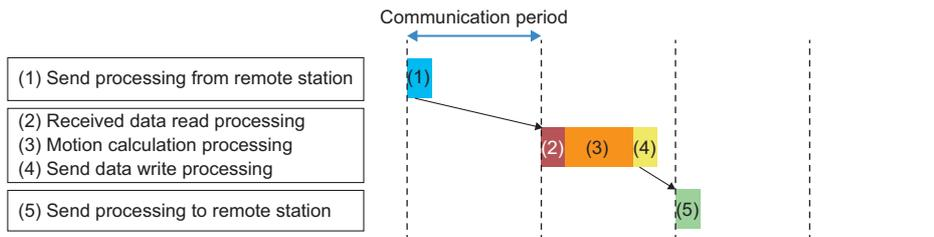

Communication cycle intervals

Set the communication cycle interval (cyclic data transfer processing time) using the following calculation formula as a reference.

■ Calculation formula

Communication cycle interval = Processing time for Motion control station + Processing time for standard station

Setting example

When performing interpolation control or synchronous control with a configuration where the number of set axes for the Motion control station is 16 axes (8 real servo amplifier axes and 8 command generation axes) and the number of standard stations is 16 stations (link device points: 3072 points)

Communication cycle interval = Processing time for Motion control station: 897 μ s + Processing time for standard station: 2100 μ s = 2997 μ s

As such, set the communication interval cycle to 4000 μ s or higher.

Processing time for Motion control stations

The calculation formula differs by the number of set axes. The number of set axes is the total number of real servo amplifier axes and command generation axes.

Number of set axes	Processing time for Motion control station[μ s] ^{*1}
1 axis to 8 axes	$59 \times \text{number of set axes} + 212$
9 axes to 16 axes	$25 \times \text{number of set axes} + 497$

*1 The basis for the measured value is as follows. Real servo amplifier axis: 2-axes circular interpolation, Command generation axis: 1-axis incremental control.

As such, the calculated processing time may be exceeded depending on the control details. Use only as a reference when setting.

Processing time for standard stations

The minimum value of the processing time for standard stations is calculated by the following calculation formula. The parts enclosed in double quotation marks (" ") in the table of Variable are the values set for "Network Configuration Settings" under "Basic Settings".

Precautions

■ When cyclic transmission is not performed with a calculation value

The minimum values for communication cycle interval and cyclic transmission time calculated by the formulas serve as a guide. If cyclic transmission is not performed with a calculation value as a setting value, add the largest value below to the minimum value of the cyclic transmission time and set the value again.

- 10% of minimum value of the calculated cyclic transmission time
- Communication speed of the master station is 1 Gbps: Number of device stations \times 2 μ s
- Communication speed of the master station is 100 Mbps: Number of device stations \times 20 μ s

Each calculation value obtained from the calculation formulas mentioned above are stored in the following SW.

- SW0072: Communication cycle interval (calculation value) [μ s]
- SW0073: Cyclic transmission time (calculation value) [μ s]
- SW0078: Transient transmission time (Calculation value) [μ s]



■When the calculation value is larger than the set value

If each calculation result is larger than the set value of "Basic Period Setting" under "Basic Settings" as follows, an error occurs.

When an error occurs, each calculation value is displayed in "Detailed information" in the [Error Information] tab of module diagnostics. Correct each set value of "Basic Period Setting" referring to the calculation value displayed so that the set value is equal to or larger than the calculation value.

- 3010H: When the communication cycle interval (calculation value) [μs] is larger than the set value of "Communication Period Interval Setting"
- 3011H: When the cyclic transmission time (calculation value) [μs] is larger than the set value of "Cyclic Transmission Time"
- 3013H: When the transient transmission time (calculation value) [μs] is larger than the displayed value of "Transient Transmission Time"

■When a general CC-Link IE TSN module is CC-Link IE TSN Class A

When "CC-Link IE TSN Class Setting" of the general CC-Link IE TSN module added to the list of stations in "Network Configuration Settings" is set to CC-Link IE TSN Class A and 'Communication period interval (calculation value)' (SW0072) and 'Cyclic transmission time (calculation value)' (SW0073) are set to "Communication Period Interval Setting" and "Cyclic Transmission Time", the cyclic transmission may not be performed. In such a case, perform either of the following operation.

- Select the device to be actually used from "Module List" and add the device to the list of station.
- Check the maximum response time for the time-managed polling by referring to the manual of device to be used, and calculate and set the values of the communication cycle interval and cyclic transmission time.

Unicast mode (1 Gbps)

■Calculation formula

The processing time for standard stations [ns]= $\alpha_c + \alpha_p$ or 250000, whichever is larger. Round up values of α_c and α_p that are less than 1 μs .

Cyclic transmission time [ns] = α_c

- α_c : This value varies depending on whether a CC-Link IE TSN Class A device station with the basic period or normal speed period exists or not.

Item	Calculation formula
When a CC-Link IE TSN Class A device station with the basic period or normal speed period does not exist	(The largest value in items No.1 to No.5) + No.6
When a CC-Link IE TSN Class A device station with the basic period or normal speed period exists	((The value in No.1 or No.2, whichever is larger) + (the value in No.3 or No.4, whichever is larger), or the value in No.5, whichever is larger) + No.6 + No.7

No.	Calculation formula
1	$\{(50 \times n1) + (16 \times n2) + \text{ndm}\} \times 8 + (\text{Sn} - 1) \times 830 + 14000 + \text{nh}$
2	$\{(30 \times n1) + (16 \times n2) + \text{ndm}\} \times 4 + (1661 \times n1) + (\text{Sn} - 1) \times 830 + 14300 + \text{nh}$
3	$\{(50 \times n3) + (20 \times n4) + \text{nds}\} \times 8 + 14000 + \text{nh}$
4	$\{(50 \times n5) + (20 \times n6) + \text{ndl}\} \times 8 + (\text{Sn} - 1) \times 830 + 14000 + \text{nh}$
5	50000
6	$E \times n7$
7	Largest value of the maximum response times for the time managed polling method for CC-Link IE TSN Class A device stations with "Basic Period" and "Normal-Speed" set

Point

For details on the maximum response time for the time managed polling method of a device station, refer to the user's manual for the device station used.

- α_p : Cyclic processing time [ns] is calculated by $p1 + p4$. Round up values that are less than 1 μs .

■Variable

Name of variable	Description
n1	Value of $(\text{ndm} + (16 \times n2))/1488$ rounded up to the nearest integer or Sn, whichever is larger
n2	$\text{Sn} \times (\text{RYb} + \text{RWwb})$ RYb: Value of (Total number of points of "RY setting")/(11776 \times Sn) rounded up to the nearest integer RWwb: Value of (Total number of points of "RWw setting") / (736 \times Sn) rounded up to the nearest integer

Name of variable	Description
ndm	$((\text{Total number of points of "RY setting"}) / 8) + ((\text{Total number of points of "RWw setting"}) \times 2)$
Sn	Number of device stations
nh	Switching hub delay time \times Number of switching hubs connected to the network Switching hub delay time: 50000*1
n3	$Sn \times nhs$ nhs: Value of $(nds + (20 \times n4)) / (1488 \times Sn)$ rounded up to the nearest integer
n4	$Sn \times (RXb + RWrb) + Sn$ RXb: Value of $(\text{Total number of points of "RX setting"}) / (11744 \times Sn)$ rounded up to the nearest integer RWrb: Value of $(\text{Total number of points of "RWr setting"}) / (734 \times Sn)$ rounded up to the nearest integer
nds	$((\text{Total number of points of "RX setting"}) / 8) + ((\text{Total number of points of "RWr setting"}) \times 2) + 8 \times Sn$
n5	Value of $(ndl + 20 \times n6) / 1488$ rounded up to the nearest integer
n6	$(ndl - 8) / 1468 + 1$
ndl	$(RXl / 8) + (RWrl \times 2) + 8$ RXl: Number of points of "RX setting" of the device station*2 to be used as the maximum number of link points RWrl: Number of points of "RWr setting" of the device station*2 to be used as the maximum number of link points
E	$E: (Sn - 1) \times 830 + 39102$ Round up values of E that are less than 1 μs .
n7	When "CC-Link IE TSN Class Setting" is set to "Mixture of CC-Link IE TSN Class B/A or CC-Link IE TSN Class A Only", and "TSN HUB Setting" is set to "Not to Use TSN HUB": 4 Other than the above: 0
p1: RX/Ry/RWr/RWw processing time	$\{((\text{Total number of points of "RX setting"}) + (\text{Total number of points of "RY setting"})) / 8 + ((\text{Total number of points of "RWr setting"}) + (\text{Total number of points of "RWw setting"})) \times 2\} \times 5 + (Sn \times 3300)$ However, if Total number of points of "RY setting" = Total number of points of "RX setting" = Total number of points of "RWr setting" = Total number of points of "RWw setting" = 0, then p1 = 0.
p4: RX/Ry/RWr/RWw data transfer time*3	$((dw \times kX) + kY) \times Mg) + kM$ However, if dW is 0, p4 = 0.
dw: Total number of words	$((sRX + sRY) / 16) + sRWr + sRWw$ [Word]
sRX	Total number of points of "RY setting"*4
sRY	Total number of points of "RY setting"*4
sRWr	Total number of points of "RWr setting"*4
sRWw	Total number of points of "RWw setting"*4
kX	dW is less than 1000 [words]: 580 dW is 1000 [words] or more: 254
kY	dW is less than 1000 [words]: 160000 dW is 1000 [words] or more: 477200
Mg	Station-based block data assurance setting Assured: 1 Not assured: 1.55
kM	$Sn \times 10000$

*1 The switching hub delay time changes depending on the switching hub model and settings.

*2 This is the device station with the largest calculation value when, for each device station, $(\text{"RX setting"} / 8) + (\text{"RWr setting"} \times 2)$ is calculated.

*3 The relation of dw (Total number of words) and p4 (RX/Ry/RWr/RWw data transfer time) is as follows. (Station-based block data assurance: When "not assured")

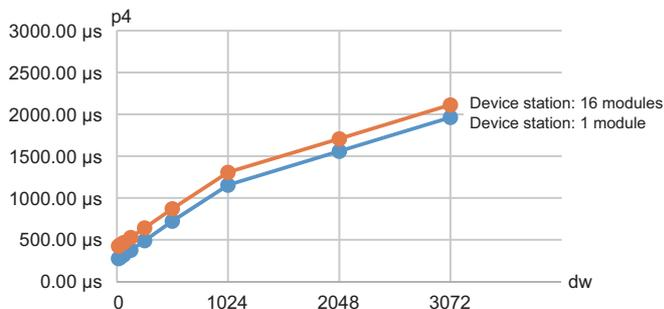

*4 Total number of points to be set for device stations

Unicast mode (100 Mbps)

■ Calculation formula

The processing time [ns] of the standard station is $\alpha_c + \alpha_p$. Round up values of α_c and α_p that are less than 1 μ s.

Cyclic transmission time [ns] = α_c

- α_c : This value varies depending on whether a CC-Link IE TSN Class A device station with the basic period or normal speed period exists or not.

Item	Calculation formula
When a CC-Link IE TSN Class A device station with the basic period or normal speed period does not exist	(The largest value in items No.1 to No.4) + No.5
When a CC-Link IE TSN Class A device station with the basic period or normal speed period exists	(No.1 + (the value in No.2 or No.3, whichever is larger), or the value in No.4, whichever is larger) + No.5 + No.6

No.	Calculation formula
1	$\{(42 \times n1) + (16 \times n2) + ndm\} \times 80 + (Sn - 1) \times 5150 + 14000 + nh$
2	$\{(42 \times n3) + (20 \times n4) + nds\} \times 80 + 14000 + nh$
3	$\{(42 \times n5) + (20 \times n6) + ndl\} \times 80 + (Sn - 1) \times 5150 + 14000 + nh$
4	50000
5	$D \times n7$
6	Largest value of the maximum response times for the time managed polling method for CC-Link IE TSN Class A device stations with "Basic Period" and "Normal-Speed" set

Point

For details on the maximum response time for the time managed polling method of a device station, refer to the user's manual for the device station used.

Cyclic processing time [ns] = α_p or 340000, whichever is larger. Round up values that are less than 1 μ s.

- α_p : Cyclic processing time [ns] is calculated by $p1 + p4$. Round up values that are less than 1 μ s.

■ Variable

Name of variable	Description
n1	Value of $(ndm + (16 \times n2))/1488$ rounded up to the nearest integer or Sn, whichever is larger
n2	$Sn \times (RYb + RWwb)$ RYb: Value of (Total number of points of "RY setting")/(11776 \times Sn) rounded up to the nearest integer RWwb: Value of (Total number of points of "RWw setting")/(736 \times Sn) rounded up to the nearest integer
ndm	$((\text{Total number of points of "RY setting"})/8) + ((\text{Total number of points of "RWw setting"}) \times 2)$
Sn	Number of device stations
nh	Switching hub delay time \times Number of switching hubs connected to the network Switching hub delay time: 160000 ^{*1}
n3	$Sn \times nhs$ nhs: Value of $(nds + (20 \times n4))/1488 \times Sn$ rounded up to the nearest integer
n4	$Sn \times (RXb + RWrb) + Sn$ RXb: Value of (Total number of points of "RX setting")/(11744 \times Sn) rounded up to the nearest integer RWrb: Value of (Total number of points of "RWr setting")/(734 \times Sn) rounded up to the nearest integer
nds	$((\text{Total number of points of "RX setting"})/8) + ((\text{Total number of points of "RWr setting"}) \times 2) + 8 \times Sn$
n5	Value of $(ndl + 20 \times n6)/1488$ rounded up to the nearest integer
n6	$(ndl - 8) / 1468 + 1$
ndl	$(RXl / 8) + (RWrl \times 2) + 8$ RXl: Number of points of "RX setting" of the device station ^{*2} to be used as the maximum number of link points RWrl: Number of points of "RWr setting" of the device station ^{*2} to be used as the maximum number of link points
D	$D: (Sn - 1) \times 5150 + 187440$ Round up values of D that are less than 1 μ s.
n7	When "CC-Link IE TSN Class Setting" is set to "Mixture of CC-Link IE TSN Class B/A or CC-Link IE TSN Class A Only", and "TSN HUB Setting" is set to "Not to Use TSN HUB": 4 Other than the above: 0
p1: RX/RY/RWr/RWw processing time	$\{((\text{Total number of points of "RX setting"}) + (\text{Total number of points of "RY setting"}))/8 + ((\text{Total number of points of "RWr setting"}) + (\text{Total number of points of "RWw setting"})) \times 2\} \times 5 + (Sn \times 3300)$ However, if Total number of points of "RY setting" = Total number of points of "RX setting" = Total number of points of "RWr setting" = Total number of points of "RWw setting" = 0, then p1 = 0.

Name of variable	Description
p4: RX/RY/RWr/RWw data transfer time ^{*3}	$((dw \times kX) + kY) \times Mg) + kM$ However, if dw is 0, p4 = 0.
dw: Total number of words	$((sRX+sRY)/16) + sRW_r + sRW_w$ [Word]
sRX	Total number of points of "RX setting" ^{*4}
sRY	Total number of points of "RY setting" ^{*4}
sRW_r	Total number of points of "RW_r setting" ^{*4}
sRW_w	Total number of points of "RW_w setting" ^{*4}
kX	dW is less than 1000 [words]: 580 dW is 1000 [words] or more: 254
kY	dW is less than 1000 [words]: 160000 dW is 1000 [words] or more: 477200
Mg	Station-based block data assurance setting Assured: 1 Not assured: 1.55
kM	$S_n \times 10000$

*1 The switching hub delay time changes depending on the switching hub model and settings.

*2 This is the device station with the largest calculation value when, for each device station, ("RX setting"/8) + ("RW_r setting" × 2) is calculated.

*3 The relation of dw (Total number of words) and p4 (RX/RY/RWr/RWw data transfer time) is as follows. (Station-based block data assurance: When "not assured")

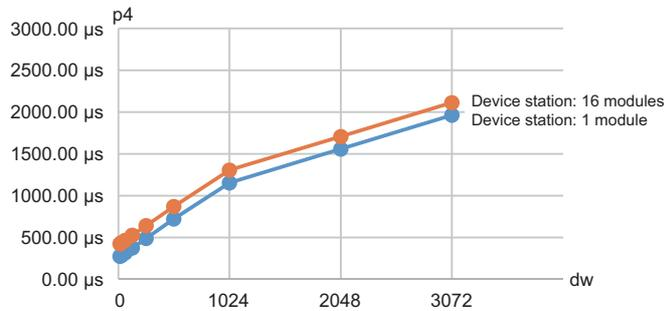

*4 Total number of points to be set for device stations



The calculated result (μs) is stored in 'Communication period interval (calculation value)' (SW0072), 'Cyclic transmission time (calculation value)' (SW0073), and 'Transient transmission time (calculation value)' (SW0078).

The calculated result (μs) is compared with "Communication Period Interval Setting", "Cyclic Transmission Time", and "Transient Transmission Time" set in "Communication Period Setting" under "Basic Settings". If any of them are lower than the calculated result (μs), an error occurs. In this case, change the setting values that have caused the error to a value that is higher than the value shown in the detailed information of module diagnostics. The following error codes may occur.

- 3010H: The calculated communication period interval is higher than the communication period interval set in the engineering tool.
- 3011H: The calculated cyclic transmission time is higher than the cyclic transmission time set in the engineering tool.
- 3013H: The calculated transient transmission time is higher than the transient transmission time set in the engineering tool.

When "CC-Link IE TSN Class Setting" of the general CC-Link IE TSN module added to the list of stations in "Network Configuration Settings" is set to CC-Link IE TSN Class A and 'Communication cycle interval (calculation value)' (SW0072) and 'Cyclic transmission time (calculation value)' (SW0073) are set to "Communication Period Interval Setting" and "Cyclic Transmission Time", the cyclic transmission may not be able to be performed. In such a case, select the actual device to be used from "Module List" to add to the list of stations, or refer to the manual for the device used to check the maximum response time for the time managed polling method and calculate and set the communication period interval and cyclic transmission time.

Appendix 5 Port Number

A port number for the system cannot be specified.

Port number		Applications
Decimal	Hexadecimal	
20 to 21	14H to 15H	For system
161 to 162	A1H to A2H	For system
5000	1388H	For system
5001	1389H	MELSOFT transmission port (UDP/IP)
5002 to 5009	138AH to 1391H	For system
5010	1392H	SLMP transmission port (UDP/IP)
5011	1393H	SLMP transmission port (TCP/IP)
5552 to 5553	15B0H to 15B1H	For system
5554	15B2H	MELSOFT transmission port (TCP/IP)
5555	15B3H	Auto-open UDP port
5560 to 5562	15B8H to 15BAH	For system
5565	15BDH	For system
45237 to 45239	B0B5H to B0B7H	For system
61440 to 61442	F000H to F002H	For system
61448	F008H	For system
61450 to 61451	F00AH to F00BH	For system
61460 to 61464	F014H to F018H	For system
61500 to 61501	F03CH to F03DH	For system
62000 to 65534	F230H to FFFE H	For system

Appendix 6 Added and Enhanced Functions

The following table lists the added and enhanced functions in the Motion module.

Added and enhanced functions	Firmware version
Updated the firmware using the engineering tool* ¹	"1.001" or later
Communication speed of 100 Mbps supported	"1.002" or later
Time managed polling method (CC-Link IE TSN Protocol version 2.0) supported	"1.002" or later

*1 For details on firmware update, refer to the following.
 MELSEC iQ-F FX5 User's Manual (Application)

Appendix 7 Comparison with FX5-CCLGN-MS

The following tables list the functions as compared with those for FX5-CCLGN-MS.

The symbols in the availability column mean as follows:

○: Available, ×: Not available

Function		Availability for Motion module (FX5-SSC-G)	Availability for master/local module (FX5-CCLGN-MS)		
		Master station	Master station	Local station	
Cyclic transmission	Communications using RX, RY, RWr, and RWw	○ (standard station only)	○	○	
	Link refresh	○ (standard station only)	○	○	
	Cyclic data assurance	○	○	×	
	Communication cycle coexistence	○ (standard station only)	○	×	
	I/O maintenance settings	Output mode upon CPU error	○	○	○
		Output hold/clear setting during CPU STOP	○	○	○
		Data link faulty station setting	○	○	○
CANopen communication	○	×	×		
Transient transmission	Communications using a dedicated instruction	×	○	○	
	Communications using the SLMP	○	○	○	
	Communications using the engineering tool	○	○	○	
Ethernet connection	Connection with MELSOFT products	○	○	○	
	Connection with SLMP-compatible devices	○	○	○	
Security	IP filter	○	○	○	
	Remote password	○	○	○	
RAS	Device station disconnection	○	○	×	
	Automatic return	○	○	○	
	Master station duplication detection	○	○	×	
	IP address duplication detection	○	○	○	
	Time synchronization	○	○	○	
Troubleshooting	Module communication test	×	○	○	
	CC-Link IE TSN/CC-Link IE Field diagnostics	○	○	○	
	Communication test	○	○	○	
"CC-Link IE TSN Configuration" screen	Parameter setting of a device station	○	○	×	
	Detection of connected/disconnected devices	○	○	×	
	Parameter processing of a device station	○	○	×	
	Command execution to device stations	○	○	○	
Reserved station setting		○ (standard station only)	○	×	
Error invalid station setting		○ (standard station only)	○	×	
Device station parameter automatic setting		○	○	×	
Station number/IP address setting using a program		×	×	○	

INDEX

0 to 9

32-bit data assurance 29

A

Automatic return 23

C

CC-Link IE TSN/CC-Link IE Field diagnostics. . . . 24
Coexistence of line and star topologies
. 57,59,61,67,70,72,82,84,86
Communication cycle coexistence 22,209
Communication mode 21
Communication Speed 105
Communication test 136
Communications using a dedicated instruction. . . 22
Communications using the engineering tool. . . . 22
Communications using the SLMP 22
Cyclic data assurance 22,209

D

Data Link Error Station Setting 106
Data transmission speed 21
Device Assignment Method 101
Device station parameter automatic setting 24

E

Error information 127
Error invalid station setting. 24

I

I/O maintenance settings 22,106,209
IP filter 43
IP filter settings 107

L

Line topology 57,58,60,66,69,71,80,83,85
Link refresh 22,209
Lock processing 47

M

Maximum frame size 21
Maximum segment length 21
Module information list. 127
Module Operation Mode 105,106

N

Network No. 98
Network status 132

O

Output Hold/Clear Setting during CPU STOP. . . 106
Output Mode upon CPU Error 106

P

Parameter Name 105,106
Parameter Setting Method 98

R

Remote operation 137
Reserved station setting 24

S

Security 105
Select diagnostics destination 132
Selected station communication status monitor
. 132
Star topology 57,58,60,66,69,71,81,83,85
Station No./IP Address Setting 98
Station Type. 98
Station-based block data assurance 30,106
Supplementary Cyclic Settings 105
Supplementary function. 127

T

Transient Transmission Group No. Setting 105

U

Unlock processing 47

MEMO

REVISIONS

*The manual number is given on the bottom left of the back cover.

Date	*Manual number	Description
March 2021	IB(NA)-0300568ENG-A	First edition
December 2021	IB(NA)-0300568ENG-B	■Added or modified parts SAFETY PRECAUTIONS, RELEVANT MANUALS, TERMS, Chapter 1, Section 2.1, 3.1, 3.2, 3.3, 3.4, 3.5, 3.6, 3.7, Chapter 4, Section 4.1, 4.2, 4.3, 5.1, 5.2, 5.3, 5.5, Chapter 6, Section 6.1, 6.2, 8.1, 8.3, 8.5, 8.8, Appendix 1, Appendix 3, INDEX
July 2022	IB(NA)-0300568ENG-C	■Added or modified parts WHEN USING A SWITCHING HUB WITH CC-Link IE TSN, SAFETY PRECAUTIONS, INTRODUCTION, RELEVANT MANUALS, TERMS, GENERIC TERMS AND ABBREVIATIONS, Chapter 1, Section 2.1, 2.2, 3.1, 3.2, 3.4, 3.5, 3.6, 3.7, Chapter 4, Section 4.1, 4.2, 4.3, 4.4, 4.5, 4.6, 5.1, 5.2, 5.3, 5.4, 5.5, 6.1, 8.1, 8.2, 8.3, 8.4, 8.5, 8.6, 8.7, 8.8, Appendix 1, 2, 3, 4, 6, 7, INDEX
November 2023	IB(NA)-0300568ENG-D	■Added or modified parts INFORMATION AND SERVICES, TRADEMARKS

Japanese manual number: IB-0300567-D

This manual confers no industrial property rights or any rights of any other kind, nor does it confer any patent licenses. Mitsubishi Electric Corporation cannot be held responsible for any problems involving industrial property rights which may occur as a result of using the contents noted in this manual.

© 2021 MITSUBISHI ELECTRIC CORPORATION

WARRANTY

Please confirm the following product warranty details before using this product.

1. Gratis Warranty Term and Gratis Warranty Range

If any faults or defects (hereinafter "Failure") found to be the responsibility of Mitsubishi occurs during use of the product within the gratis warranty term, the product shall be repaired at no cost via the sales representative or Mitsubishi Service Company. However, if repairs are required onsite at domestic or overseas location, expenses to send an engineer will be solely at the customer's discretion. Mitsubishi shall not be held responsible for any re-commissioning, maintenance, or testing on-site that involves replacement of the failed module.

[Gratis Warranty Term]

For terms of warranty, please contact your original place of purchase.

[Gratis Warranty Range]

- (1) The range shall be limited to normal use within the usage state, usage methods and usage environment, etc., which follow the conditions and precautions, etc., given in the instruction manual, user's manual and caution labels on the product.
- (2) Even within the gratis warranty term, repairs shall be charged for in the following cases.
 1. Failure occurring from inappropriate storage or handling, carelessness or negligence by the user. Failure caused by the user's hardware or software design.
 2. Failure caused by unapproved modifications, etc., to the product by the user.
 3. When the Mitsubishi product is assembled into a user's device, Failure that could have been avoided if functions or structures, judged as necessary in the legal safety measures the user's device is subject to or as necessary by industry standards, had been provided.
 4. Failure that could have been avoided if consumable parts (battery, backlight, fuse, etc.) designated in the instruction manual had been correctly serviced or replaced.
 5. Relay failure or output contact failure caused by usage beyond the specified life of contact (cycles).
 6. Failure caused by external irresistible forces such as fires or abnormal voltages, and failure caused by force majeure such as earthquakes, lightning, wind and water damage.
 7. Failure caused by reasons unpredictable by scientific technology standards at time of shipment from Mitsubishi.
 8. Any other failure found not to be the responsibility of Mitsubishi or that admitted not to be so by the user.

2. Onerous repair term after discontinuation of production

- (1) Mitsubishi shall accept onerous product repairs for seven (7) years after production of the product is discontinued.
Discontinuation of production shall be notified with Mitsubishi Technical Bulletins, etc.
- (2) Product supply (including repair parts) is not available after production is discontinued.

3. Overseas service

Overseas, repairs shall be accepted by Mitsubishi's local overseas FA Center. Note that the repair conditions at each FA Center may differ.

4. Exclusion of loss in opportunity and secondary loss from warranty liability

Regardless of the gratis warranty term, Mitsubishi shall not be liable for compensation to:

- (1) Damages caused by any cause found not to be the responsibility of Mitsubishi.
- (2) Loss in opportunity, lost profits incurred to the user by Failures of Mitsubishi products.
- (3) Special damages and secondary damages whether foreseeable or not, compensation for accidents, and compensation for damages to products other than Mitsubishi products.
- (4) Replacement by the user, maintenance of on-site equipment, start-up test run and other tasks.

5. Changes in product specifications

The specifications given in the catalogs, manuals or technical documents are subject to change without prior notice.

6. Product application

- (1) In using the Mitsubishi MELSEC programmable controller, the usage conditions shall be that the application will not lead to a major accident even if any problem or fault should occur in the programmable controller device, and that backup and fail-safe functions are systematically provided outside of the device for any problem or fault.
- (2) The Mitsubishi programmable controller has been designed and manufactured for applications in general industries, etc. Thus, applications in which the public could be affected such as in nuclear power plants and other power plants operated by respective power companies, and applications in which a special quality assurance system is required, such as for railway companies or public service purposes shall be excluded from the programmable controller applications.
In addition, applications in which human life or property that could be greatly affected, such as in aircraft, medical applications, incineration and fuel devices, manned transportation, equipment for recreation and amusement, and safety devices, shall also be excluded from the programmable controller range of applications. However, in certain cases, some applications may be possible, providing the user consults their local Mitsubishi representative outlining the special requirements of the project, and providing that all parties concerned agree to the special circumstances, solely at the user's discretion.
- (3) Mitsubishi shall have no responsibility or liability for any problems involving programmable controller trouble and system trouble caused by DoS attacks, unauthorized access, computer viruses, and other cyberattacks.

INFORMATION AND SERVICES

For further information and services, please contact your local Mitsubishi Electric sales office or representative.
Visit our website to find our locations worldwide.

MITSUBISHI ELECTRIC Factory Automation Global Website

Locations Worldwide

www.MitsubishiElectric.com/fa/about-us/overseas/

TRADEMARKS

Microsoft and Windows are trademarks of the Microsoft group of companies.

The company names, system names and product names mentioned in this manual are either registered trademarks or trademarks of their respective companies.

In some cases, trademark symbols such as [™] or [®] are not specified in this manual.

Manual number: IB(NA)-0300568ENG-D(2311)MEE

MODEL: FX5SSC-U-TSN-E

MODEL CODE: 1XB044

MITSUBISHI ELECTRIC CORPORATION

HEAD OFFICE: TOKYO BLDG., 2-7-3, MARUNOUCHI, CHIYODA-KU, TOKYO 100-8310, JAPAN
NAGOYA WORKS: 1-14, YADA-MINAMI 5-CHOME, HIGASHI-KU, NAGOYA 461-8670, JAPAN

When exported from Japan, this manual does not require application to the
Ministry of Economy, Trade and Industry for service transaction permission.

Specifications subject to change without notice.